

THE No.1 MAGAZINE FOR ELECTRONICS TECHNOLOGY & COMPUTER PROJECTS

EVERYDAY

OCTOBER 2000

PRACTICAL

ELECTRONICS

INCORPORATING **ELECTRONICS TODAY INTERNATIONAL**

£2.75

PIC V-SCOPE

Inexpensive Dual Channel
PC Virtual 'Scope

WIND-UP TORCH

No batteries,
I.e.d. illumination

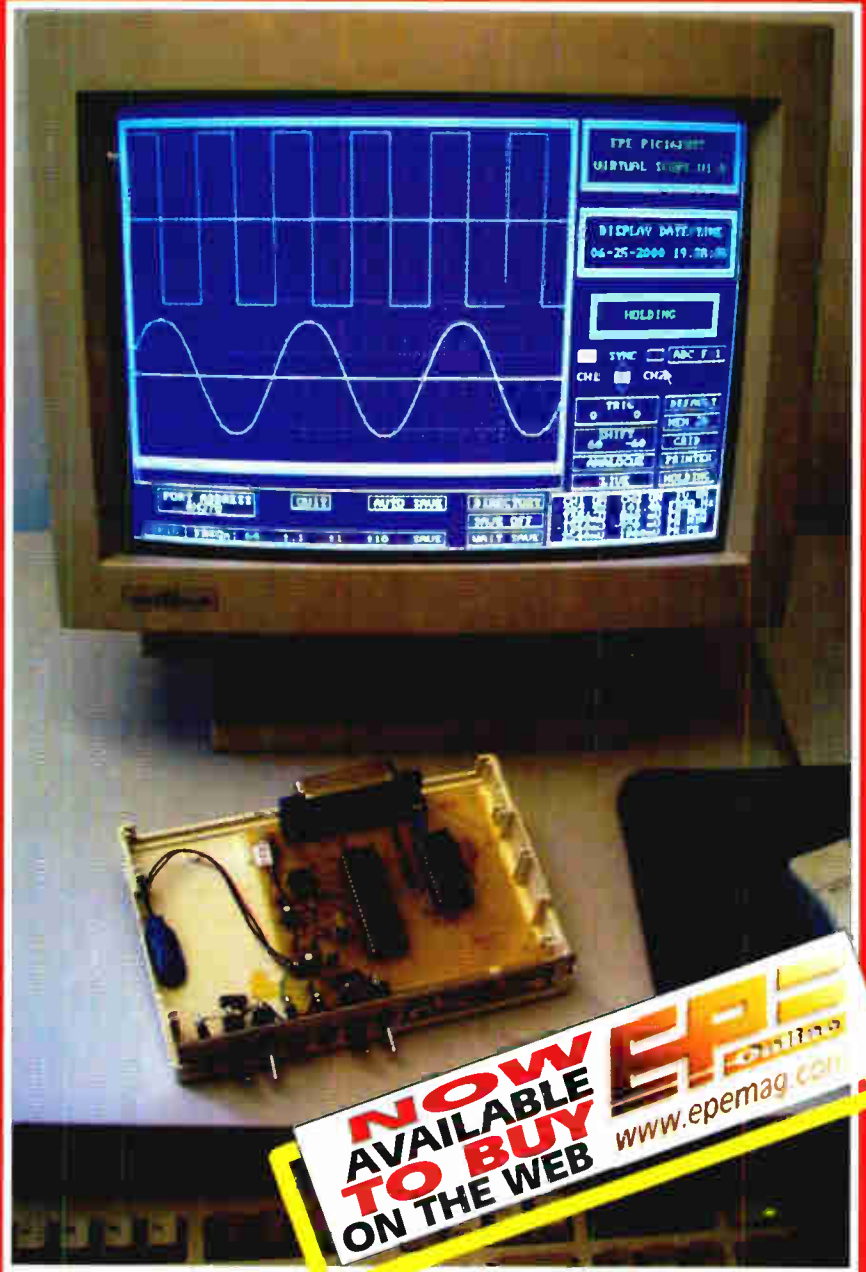

Top Tenner
**FRIDGE/FREEZER
ALARM** Safeguard
your frozen food

PLUS
Circuit Surgery · Interface ·
Ingenuity Unlimited · **News**

**NOW
AVAILABLE
TO BUY
ON THE WEB** **EPi** ON THE
www.epemag.com



<http://www.epemag.wimborne.co.uk>

12v 18Ah SEALED LEAD ACID BATTERIES, new and boxed, unused pack of 4 £39.95 ref CYC7 or £15 each ref CYC6

AUTOMATIC CHARGER For the above batteries charges 2 at once charge level indicator circuitry, 6 hour charge £10 ref CYC8

A new range of 12v to 240v INVERTERS
IV400S (400 watt) £89
IV800S (800 watt) £159
IV1200S (1200 watt) £219

ECG MACHINES 7.6v 10AH BATT/24V 8A TX Ex government ECG machines! Measures 390X320X120mm, on the front are controls for scan speed, scan delay, scan mode, loads of connections on the rear including video out etc. On the front panel are two DIN sockets for connecting the body sensors to. Sensors not included, inside 2 x 6v 10AH lead acid batts (not in good condition), pcb's and a BA724v transformer (mains in) sold as seen, may have one or two broken knobs etc due to poor storage. £15.99 ref VP2

SODIUM LAMP SYSTEMS £75.70 Complete system with 250w or 400watt SON-T Agro bulb, reflector with bulb holder and remote ballast and starter (uncased) all you need is wire. 250W system ref SLS1, 400W system SLS2.

PC SUPPORT HANDBOOK The ultimate technical guide to building and maintaining PC's. Over 460 A4 pages packed with technical data and diagrams just £10 ref PCBK. If you want 4 copies for £33 ref PCBK2. Also available is a CD pack with diagnostic programmes to use with the book £6 ref PCBK1

D SIZE NICADS Tagged, 1200mA, 1.2v pack of 4 for £6 ref CYC9 or as a pack of 24 for £22 ref CYC10

D SIZE SEALED LEAD ACID BATTERIES

2v 2.5ah rechargeable sealed lead acid battery made by Cyclon 60x45mm (standard D size) supplied as a pack of 12 or 20 giving you options for battery configurations eg 12v at 5ah, 24v at 2.5ah, 6v at 10ah. These batteries are particularly useful in that you can arrange them in your project to optimise space etc (eg boat ballast etc) Pack of 12 £10 ref CYC4, pack of 20 £16 ref CYC5

HYDROPONICS DO YOU GROW YOUR OWN? We have a full colour hydroponics catalogue available containing nutrients, pumps, fittings, environmental control, light fittings, plants, test equipment etc Ring for your free copy.

PC COMBINED UPS AND PSU The unit has a total power of 292 watts, standard mother board connectors and 12 peripheral power leads for drives etc. Inside is 3 12v 7.2Ah sealed lead acid batteries. Backup time is 8 mins at full load or 30 mins at half load. Made in the UK by Magnum, 110 or 240vac input, +5v at 35A, -5v at 5A, +12v at 9A, -12v at 5A outputs. 170x260x220mm, new and boxed £29.95 Ref PCUPS2

ALTERNATIVE ENERGY CD, PACKED WITH HUNDREDS OF ALTERNATIVE ENERGY RELATED ARTICLES, PLANS AND INFORMATION ETC £14.50 REF CD56

AERIAL PHOTOGRAPHY KIT This rocket comes with a built in camera! It flies up to 500 feet (150 m) turns over, and takes an aerial photograph of the ground below. The rocket then returns with its film via its parachute. Takes 110 film. Supplied complete with everything including a launch pad and 3 motors (no film) £29.98 ref astro

PROJECT BOXES Another bargain for you are these smart ABS project boxes, smart two piece screw together case measuring approx 6"x5"x2" complete with panel mounted LED. Inside you will find loads of free bits, tape heads, motors, chips resistors, transistors etc. Pack of 20 £19.95 ref MD2

TELEPHONES Just in this week is a huge delivery of telephones, all brand new and boxed. Two piece construction - illuminated keypad, tone or pulse (switchable), recall, redial and pause, high/low and off ringer switch and quality construction. Off white colour and is supplied with a standard international lead (same as US or modems) if you wish to have a BT lead supplied to convert the phones these are £1.55 each ref BTLX. Phones £4.99 each ref PH210 off £30 ref SS2

3HP MAINS MOTORS Single phase 240v, brand new, 2 pole, 340x180mm, 2850 rpm, builtin automatic reset overload protector, keyed shaft (40x16mm) Made by Leeson £99 each ref LEE1

BUILD YOUR OWN WINDFARM FROM SCRAP New publication gives step by step guide to building wind generators and propellers. Armed with this publication and a good local scrap yard could make you self sufficient in electricity! £12 ref LOT81

CHIEFTAN TANK DOUBLE LASERS 9WATT+3 WATT+LASER OPTICS Could be adapted for laser listener, long range comms etc. Double beam units designed to fit in the barrel of a tank, each unit has 2 semiconductor lasers and motor drive units for alignment? 7 mile range, no circuit diagrams due to MOD, new price £50,000? us? £199. Each unit has two gallium Arsenide injection lasers, 1 x 9 watt, 1 x 3 watt, 900nm wavelength, 28vdc, 600hz pulse freq. The units also contain a receiver to detect reflected signals from targets. £99 Ref LOT4

MAGNETIC CREDIT CARD READERS AND ENCODING MANUAL £9.95 Cased with flyleads, designed to read standard credit cards! complete with control electronics PCB and manual covering everything you could want to know about what's hidden in that magnetic strip on your card! just £9.95 ref BAR31

SOLAR POWER LAB SPECIAL 2x6"x6" 6v 130mA cells, 4LED's, wire, buzzer, switch + relay or motor £7.99 REF SA27

SOLAR NICAD CHARGERS 4x AA size £9.99 ref 6P476, 2x C size £9.99 ref 6P477

BRAND NEW MILITARY ISSUE DOSE METERS

Current NATO issue Standard emergency services unit. Used by most of the worlds Military personnel New and boxed Normal retail price £400, BULLS bargain price just £99! The PDRM 82 M is a portable, lightweight, water resistant gamma radiation survey meter to measure radiological dose rate in the range 0 to 300 centigrays per hour in air. The Geiger Muller (G.M.) tube detecting unit is energy and polar in response corrected. The radiation level is displayed on a Liquid Crystal Display. The microcomputer corrects for the non-linearity of the G.M. tube response. The instrument is powered by three international C size batteries giving typically 400 hours operation in normal conditions. The dose rate meter PDRM 82M designed and selected for the United Kingdom Government, has been fully evaluated to satisfy a wide range of environmental conditions and is nuclear hard. The construction enables the instrument to be easily decontaminated. The instrument is designed for radiation surveys for post incident monitoring. Used in a mobile role either carried by troops or in military vehicles for rapid deployment enabling radiation hot spots to be quickly located. Range 0 - 300 cGy/h in 0.1 cGy/h increments. Over range to 1500 cGy/h - indicates flashing 300 Accuracy (20% of true dose rate) +0.1 cGy/h, 0 - 100 cGy/h. (30% of true dose rate, 100 - 300 cGy/h. Energy Response 0.3 MeV to 3 MeV - within (20% (Ra 226) 80 KeV to 300 KeV - within 40% (Ra 226) Detector Energy compensated Halogen quenched Geiger Muller Tube. Controls Combined battery access and ON/OFF switch. Batteries 3 International standard C cells. Weight 560gms. Operating Temperature Range -30deg C to +60deg C. Indications High contrast 4 digit LCD. Battery low indication. Dose rate Rising/Falling £99 ref PDRM

Hydrogen fuel cells Our new Hydrogen fuel cells are 1v at up to 1A output, Hydrogen input, easily driven from a small electrolosis assembly or from a hydrogen source, our demo model uses a solar panel with the output leads in a glass of salt water to produce the hydrogen! Each cell is designed to be completely taken apart, put back together and expanded to what ever capacity you like, (up to 10 watts and 12v per assembly. Cells cost £49 ref HFC11

PHILIPS VP406 LASER DISC PLAYERS, SCART OUTPUT, JUST PUT YOUR VIDEO DISK IN AND PRESS PLAY. STANDARD AUDIO AND VIDEO OUTPUTS. £14.95 REF VP406

SMOKE ALARMS Mains powered, made by the famous Gent company, easy fit next to light fittings, power point. Pack of 5 £15 ref SS23, pack of 12 £24 ref SS24

4AH D SIZE NICADS pack of 4 £10 ref 4AHPK

SENDER KIT Contains all components to build a A/V transmitter complete with case £35 ref VSX2

10 WATT SOLAR PANEL Amorphous silicon panel fitted in a anodized aluminium frame. Panel measures 3' by 1' with screw terminals for easy connection. 3' x 1' solar panel £56 ref MAG46

12V SOLAR POWERED WATER PUMP Perfect for many 12v DC uses, from solar fountains to hydroponics! Small and compact yet powerful works direct from our 10 watt solar panel in bright sun. Max hd 17 ft Max flow = 8 Lpm. 1 5A Ref AC8 £18.99

SOLAR ENERGY BANK KIT 60x6"x12" 6v solar panels (amorphous)+50 diodes £99 ref EF112

PINHOLE CAMERA MODULE WITH AUDIO! Superb board camera with on board sound! extra small just 28mm square (including microphone) ideal for covert surveillance. Can be hidden inside anything - even a matchbox! Complete with 15 metre cable, psu and tv/rv connectors. £49.95 ref CC6J

SOLAR MOTORS Tiny motors which run quite happily on voltages from 3-12vdc. Works on our 6v amorphous 6" panels and you can run them from the sun! 32mm dia 20mm thick. £1.50 each WALKIE TALKIES 1 MILE RANGE £37/PAIR REF MAG30

LIQUID CRYSTAL DISPLAY Bargain prices, 40 character 1 line 154x16mm £6.00 ref SMC4011A

YOUR HOME COULD BE SELF SUFFICIENT IN ELECTRICITY Comprehensive plans with loads of info on designing systems, panels, control electronics etc £7 ref PV1

AUTO SUNCHARGER 155x300mm solar panel with diode and 3 metre lead and cigar plug 12v 2w £12.99 REF AUG10P3

SOLAR POWER LAB SPECIAL 2x6"x6" 6v 130mA cells, 4LED's, wire, buzzer switch + relay or motor £7.99 REF SA27

SOLAR NICAD CHARGERS 4 x AA size £9.99 ref 6P476, 2 x C size £9.99 ref 6P477

MINATURE TOGGLE SWITCHES These top quality Japanese panel mount toggle switches measure 35x13x12mm, are 2 pole changeover and will switch 1A at 250vac, or 3 A at 125vac. Complete with mounting washers and nuts. Supplied as a box of 100 switches for £29.95 ref SWT35 or a bag of 15 for £4.99 ref SWT34

VOICE CHANGERS Hold one of these units over your phone mouth piece and you can adjust your voice using the controls on the unit! Battery operated £15 ref CC3

BULL ELECTRICAL

250 PORTLAND ROAD, HOVE, SUSSEX.
BN3 5QT. (ESTABLISHED 50 YEARS).

MAIL ORDER TERMS: CASH, PO OR CHEQUE
WITH ORDER PLUS £4.00 P&P PLUS VAT.

24 HOUR SERVICE £6.50 PLUS VAT.
OVERSEAS ORDERS AT COST PLUS £3.50
(ACCESS, VISA, SWITCH, AMERICAN EXPRESS)

'phone orders : 01273 203500

FAX 01273 323077

Sales@bull-electrical.com

30 WATTS OF SOLAR POWER for just £69, 4 panels each one 3'x1' and producing 8w, 13v. PACK OF FOUR £69 ref SOLX

200 WATT INVERTERS plugs straight into your car cigarette lighter socket and is fitted with a 13A socket so you can run your mains operated devices from your car battery. £49.95 ref S566

THE TRUTH MACHINE Tells if someone is lying by micro tremors in their voice, battery operated, works in general conversation and on the phone and TV as well! £42.49 ref TD3

INFRA RED FILM 6" square piece of flexible infra red film that will only allow IR light through. Perfect for converting ordinary torches, lights, headlights etc to infra red output only using standard light bulbs. Easily cut to shape 6" square £15 ref IRF2

33 KILO LIFT MAGNET Neodymium, 32mm diameter with a fixing bolt on the back for easy mounting. Each magnet will lift 33 kilos, 4 magnets bolted to a plate will lift an incredible 132 kilos! £15 ref MAG33 Pack of 4 just £39 reg MAG33AA

HYDROGEN FUEL CELL PLANS Loads of information on hydrogen storage and production. Practical plans to build a hydrogen fuel cell (good workshop facilities required) £8 set ref FCP1

STIRLING ENGINE PLANS Interesting information pack covering all aspects of Stirling engines, pictures of home made engines made from an aerosol can running on a candle! £12 ref STIR2

ENERGY SAVER PLUGS Saves up to 15% electricity when used with fridges, motors up to 2A, light bulbs, soldering irons etc. £9 ea ref LOT171, 10 pack £69 ref LOT172

12V OPERATED SMOKE BOMBS Type 3 is a 12v trigger and 3 smoke cannisters, each cannister will fill a room in a very short space of time! £14.99 ref SB3. Type 2 is 20 smaller cannisters (suitable for mock equipment fires etc) and 1 trigger module for £29 ref SB2. Type 1 is a 12v trigger and 20 large cannisters. £49 ref SB1

HI POWER ZENON VARIABLE STROBES Useful 12v PCB fitted with hi power strobe tube and control electronics and speed control potentiometer. Perfect for interesting projects etc. 70x55mm 12vdc operation. £6 ea ref FLS1, pack of 10 £49 ref FLS2

NEW LASER POINTERS 4 5mw, 75 metre range, hand held unit runs on two AA batteries (supplied) 670nm. £29 ref DEC49J

HOW TO PRODUCE 35 BOTTLES OF WHISKY FROM A SACK OF POTATOES Comprehensive 270 page book covers all aspects of spirit production from everyday materials. Includes construction details of simple stills. £12 ref MS3

NEW HIGH POWER MINI BUG With a range of up to 800 metres and a 3 days use from a PP3, this is our top selling bug! less than 1" square and a 10m voice pickup range. £28 ref LOT102

IR LAMP KIT Suitable for CCTV cameras, enables the camera to be used in total darkness! £6 ref EF138

INFRA RED POWERBEAM Hand held battery powered lamp, 4 inch reflector, gives out powerful pure infrared light! perfect for CCTV use, night sights etc. £29 ref PB1

SUPER WIDEBAND RADAR DETECTOR Detects both radar and laser. X, K and KA bands, speed cameras, and all known speed detection systems. 360 degree coverage, front & rear waveguides. 1" x 2" 7" x 4" 6" fits on visor or dash. £149

LOPTX Made by Samsung for colour TV. £3 each ref SS52

LAPTOP LCD SCREENS 240x175mm, £12 ref SS51

WANT TO MAKE SOME MONEY? STUCK FOR AN IDEA? We have collated 140 business manuals that give you information on setting up different businesses, you peruse these at your leisure using the text editor on your PC. Also included is the certificate enabling you to reproduce (and sell) the manuals as much as you like! £14 ref EP74

ELECTRONIC SPEED CONTROLLER KIT For the above motor is £19 ref MAG17. Save £5 if you buy them both together, 1 motor plus speed controller rrp is £41, offer price £36 ref MOT5A

INFRA RED REMOTE CONTROLS made for TV's but may have other uses pack of 100 £39 ref IREM

RCB UNITS In line IEC lead with fitted RC breaker, installed in seconds. Pack of 3 £9.98 ref LOT5A

On our web sites you can

1. Order online.
2. Check your premium bonds.
3. Enter our auction or build your own.
4. Add E-commerce to your own site.

5. Discover our software site, optical site, hydroponics site, holiday home exchange site, inkjet site, hotels site.
6. View our web camera.
7. Invest in our future.

<http://www.bullnet.co.uk>

YOUR HOME COULD BE SELF SUFFICIENT IN ELECTRICITY Comprehensive plans with loads of info on designing systems, panels, control electronics etc £7 ref PV1

AUTO SUNCHARGER 155x300mm solar panel with diode and 3 metre lead and cigar plug 12v 2w £12.99 REF AUG10P3

STEPPER MOTORS Brand new stepper motors, 4mm fixing holes with 47 14mm fixing centres, 20mm shaft, 6 35mm diameter, 5v phase, 0.7A/phase, 1.8 deg step (200 step) Body 56x36mm £14.99 ea ref STEP6, pack of 4 for £49.95. PIC based variable speed controller kit £15 ref STEP7

ISSN 0262 3617
 PROJECTS ... THEORY ... NEWS ...
 COMMENTS ... POPULAR FEATURES ...

EVERYDAY
PRACTICAL
ELECTRONICS

INCORPORATING **ELECTRONICS TODAY INTERNATIONAL**

VOL. 29. No. 10 OCTOBER 2000

<http://www.epemag.wimborne.co.uk>



Projects and Circuits

- WIND-UP TORCH** by Thomas Scarborough **724**
 An occasional twist of a knob provides light without battery power
- PIC DUAL-CHAN VIRTUAL SCOPE** by John Becker **752**
 A virtual oscilloscope interface for monitoring audio frequency signals via your computer
- FRIDGE/FREEZER ALARM** by Owen Bishop **764**
 Another Top-Tenner – audibly warns of imminent money loss!
- INGENUITY UNLIMITED** hosted by Alan Winstanley **766**
 Anti-Tamper Loop Alarm; Doorbell Extension and Entry/Exit Indicator; Mini Photo Slave Flash; Colour TV Tester Add-On
- EPE MOODLOOP FIELD STRENGTH INDICATOR** by Andy Flind **781**
 Check that your Moodloop's loop is working, and find the sources of 50Hz mains fields

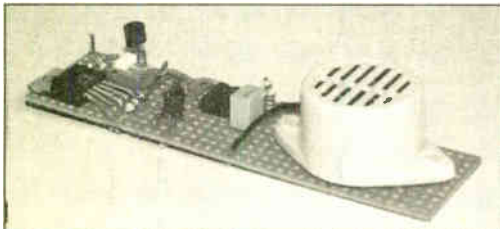

Series and Features

- INTERFACE** by Robert Penfold **734**
 Digital and Analogue Temperature PC Interface
- TEACH-IN 2000 – 12. 7-Segment Displays, L.C.D.s, Digital-to-Analogue, Miscellany** by John Becker **736**
 Concluding the 12-part series providing essential info for the electronics novice, with breadboard experiments and interactive computer simulations
- NEW TECHNOLOGY UPDATE** by Ian Poole **744**
 IBM proposes a microprocessor that performs one quadrillion operations per second
- CIRCUIT SURGERY** by Alan Winstanley and Ian Bell **747**
 Testing transistors the quick and easy way; Keep Soldering On; Earthy Feelings
- PEAK ATLAS COMPONENT ANALYSER REVIEW** by Andy Flind **770**
 Testing a surprisingly powerful semiconductor analyser
- NET WORK – THE INTERNET PAGE** surfed by Alan Winstanley **774**
 Multiple Choice Mail; Problems Addressed

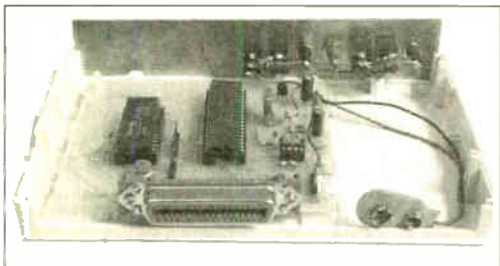

Regulars and Services

- EDITORIAL** **723**
- SHOPTALK** with David Barrington **728**
 The *essential* guide to component buying for *EPE* projects
- NEWS** – Barry Fox highlights technology's leading edge **730**
 Plus everyday news from the world of electronics
- ELECTRONICS VIDEOS** Our range of educational videos **746**
- READOUT** John Becker addresses general points arising **761**
- CD-ROMS FOR ELECTRONICS** **772**
 Electronic Projects; Filters; Digital Works 3.0; Parts Gallery + Electronic Circuits and Components; Digital Electronics; Analogue Electronics; PICtutor; Modular Circuit Design; Electronic Components Photos
- BACK ISSUES** Did you miss these? Some now on CD-ROM! **776**
- ELECTRONICS MANUALS** **778**
 Essential reference works for hobbyists, students and service engineers
- DIRECT BOOK SERVICE** **785**
 A wide range of technical books available by mail order
- PRINTED CIRCUIT BOARD AND SOFTWARE SERVICE** **788**
 PCBs for *EPE* projects. Plus *EPE* software
- ADVERTISERS INDEX** **792**

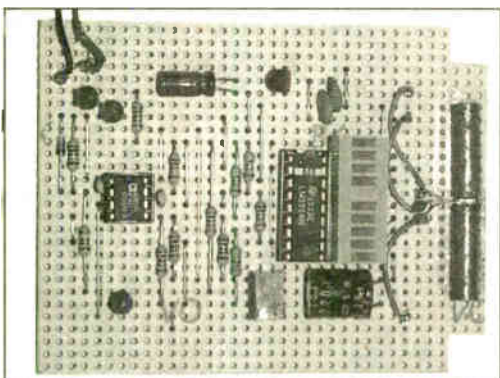

NOTE NEW PUBLISHING DATE
 November issue on sale
 Thursday October 12

© Wimborne Publishing Ltd 2000. Copyright in all drawings, photographs and articles published in **EVERYDAY PRACTICAL ELECTRONICS** is fully protected, and reproduction or imitations in whole or in part are expressly forbidden.

Our November 2000 issue will be published on Thursday, 12 October 2000. See page 715 for details

Readers Services • Editorial and Advertisement Departments 723

Visit our website
www.distel.co.uk

THE ORIGINAL SURPLUS WONDERLAND!

THIS MONTH'S SELECTION FROM OUR VAST EVER CHANGING STOCKS

Surplus always
wanted for cash!

THE AMAZING TELEBOX

Converts your colour monitor into a QUALITY COLOUR TV!!



TV SOUND & VIDEO TUNER
CABLE COMPATIBLE*

The TELEBOX is an attractive fully cased mains powered unit, containing all electronics ready to plug into a host of video monitors or AV equipment which are fitted with a composite video or SCART input. The composite video output will also plug directly into most video recorders, allowing reception of TV channels not normally receivable on most television receivers* (TELEBOX MB) Push button controls on the front panel allow reception of 8 fully tuneable 'off air' UHF colour television channels. TELEBOX MB covers virtually all television frequencies VHF and UHF including the HYPERBAND as used by most cable TV operators. Ideal for desktop computer video systems & PIP (picture in picture) setups. For complete compatibility - even for monitors without sound - an integral 4 watt audio amplifier and low level Hi Fi audio output are provided as standard. Brand new - fully guaranteed.

TELEBOX ST for composite video input type monitors £36.95
TELEBOX STL as ST but fitted with integral speaker £39.50
TELEBOX MB Multiband VHF/UHF/Cable/Hyperband tuner £69.95
For overseas PAL versions state 5.5 or 6 MHz sound specification.
*For cable / hyperband signal reception Telebox MB should be connected to a cable type service. Shipping on all Telebox's code (B)

NEW State of the art PAL (UK spec) UHF TV tuner module with composite 1V pp video & NICAM hi fi stereo sound outputs. Micro electronics all on one small PCB only 73 x 160 x 52 mm enable full tuning control via a simple 3 wire link to an IBM pc type computer. Supplied complete with simple working program and documentation. Requires +12V & +5V DC to operate. **BRAND NEW - Order as MY00. Only £49.95 code (B)**
See www.distel.co.uk/data_my00.htm for picture + full details

FLOPPY DISK DRIVES 2 1/2" - 8"

All units (unless stated) are **BRAND NEW** or removed from often brand new equipment and are fully tested, aligned and shipped to you with a full 90 day guarantee. Call or see our web site www.distel.co.uk for over 2000 unlisted drives for spares or repair

3 1/2" Mitsubishi MF355C-L 1.4 Meg Laptops only £25.95(B)
3 1/2" Mitsubishi MF355C-D 1.4 Meg Non laptop £18.95(B)
5 1/4" Teac FD-55FH 1.2 Meg (for IBM PCs) RFE £18.95(B)
5 1/4" Teac FD-55F-03U 720K 40/80 (for BBC's etc) RFE £29.95(B)
5 1/4" BRAND NEW Mitsubishi MF501B 360K £29.95(B)
Table top case with integral PSU for HH 5 1/4" Floppy / HD £210.00(E)
8" Shugart 800/801 8" SS refurbished & tested £195.00(E)
8" Shugart 810 8" SS HH Brand New £260.00(E)
8" Shugart 851 8" double sided refurbished & tested £295.00(E)
8" Mitsubishi M2894-63 double sided NEW £295.00(E)
8" Mitsubishi M2896-63-02U DS slimline NEW £499.00(E)
Dual 8" casad drives with integral power supply 2 Mb

HARD DISK DRIVES 2 1/2" - 14"

2 1/2" TOSHIBA MK1002MAV 1.1Gb laptop(12.5 mm H) New £79.95
2 1/2" TOSHIBA MK2101MAN 2.16 Gb laptop (19 mm H) New £89.50
2 1/2" TOSHIBA MK4309MAT 4.3Gb laptop (8 2 mm H) New £105.00
2 1/2" TOSHIBA MK6409MAV 6.1Gb laptop (12.7 mm H) New £190.00
2 1/2" to 3 1/2" conversion kit for PCs, complete with connectors £14.95
3 1/2" FUJII FK-309-26 20mb MFM I/F RFE £59.95
3 1/2" CONNER CP3024 20 mb IDE I/F (or equiv.) RFE £59.95
3 1/2" CONNER CP3044 40 mb IDE I/F (or equiv.) RFE £69.00
3 1/2" QUANTUM 40S Prodriv 4e 42mb SCSI I/F, NEW RFE £49.00
5 1/4" MINISCRIBE 3425 20mb MFM I/F (or equiv.) RFE £49.95
5 1/4" SEAGATE ST-238R 30 mb RLL I/F Refurbished £69.95
5 1/4" CDC 94205-51 40mb HH MFM I/F RFE tested £69.95
5 1/4" HP 97548 850 Mb SCSI RFE tested £99.00
5 1/4" HP C3010 2 Gbyte SCSI differential RFE tested £195.00
8" NEC D2246 85 Mb SMD interface New £199.00
8" FUJITSU M2322T 160Mb SMD I/F RFE tested £195.00
8" FUJITSU M2392K 2 Gb SMD I/F RFE tested £345.00
Many other drives in stock - Shipping on all drives is code (C1)

TEST EQUIPMENT & SPECIAL INTEREST ITEMS

MITs, FA3445ETKL 14" Industrial spec SVGA monitors £245
FARNELL 0-60V DC @ 50 Amps, bench Power Supplies £995
FARNELL AP3080 0-30V DC @ 80 Amps, bench Supply £1850
1kW to 400 kW - 400 Hz 3 phase power sources - ex stock £POA
IBM 8230 Type 1, Token ring base unit driver £760
Wayne Kerr RA200 Audio frequency response analyser £2500
IBM 53F5501 Token Ring ICS 20 port lobe module £750
IBM MAU Token ring distribution panel 8228-23-5050N £95
AIM 501 Low distortion Oscillator 9Hz to 330KHz, IEEE £250
ALLGON 8360, 11805-1880 MHz hybrid power combiners £250
Trend DSA 274 Data Analyser with G703(2M) 64 v/o £POA
Marconi 6310 Programmable 2 to 22 GHz sweep generator £6500
Marconi 2022C 10KHz-1GHz RF signal generator £1550
Marconi 2030 opt 03 10KHz-1.3 GHz signal generator, New £4995
HP1650B Logic Analyser £3750
HP3781A Pattern generator & HP3782A Error Detector £POA
HP6621A Dual Programmable GPIB PSU 0.7 V 160 watts £1800
HP6264 Rack mount variable 0-20V @ 20A metered PSU £675
HP54121A DC to 22 GHz four channel test set £7900
HP1830A opt 020 300 MHz pulse generator, GPIB etc £550
HP A1, A0 8 pen HPGL high speed drum plotters from HP DRAFTMASTER 1 8 pen high speed plotter £750
EG+G Brookdeal 95035C Precision lock in amp £1800
View Eng. Mod 1200 computerised inspection system £POA
Sony DXC-3000A High quality CCD colour TV camera £995
Keithley 590 CV capacitor / voltage analyser £POA
Racal ICR40 dual 40 channel video recorder system £3750
Fiskers 45KVA 3 ph On Line UPS - Now batteries £9500
Emerson AP150 2.5KVA industrial spec UPS £2100
Mann Tally MT645 High speed line printer £2200
Intel SBC 486/133SE Multibus 486 system 8Mb Ram £945
Siemens K4400 64Kb to 140Mb demux analyser £2950

IC's - TRANSISTORS - DIODES

OBSELETE - SHORT SUPPLY - BULK
10,000,000 items EX STOCK
For MAJOR SAVINGS

CALL OR SEE OUR WEB SITE www.distel.co.uk
VIDEO MONITOR SPECIALS

One of the highest specification monitors you will ever see -
At this price - Don't miss it!!

Mitsubishi FA3415ETKL 14" SVGA Multisync colour monitor with fine 0.28 dot pitch tube and resolution of 1024 x 768. A variety of inputs allows connection to a host of computers including IBM PCs in CGA, EGA, VGA & SVGA modes, BBC, COMMODORE (including Amiga 1200), ARCHIMEDES and APPLE. Many features. Etched faceplate, test switching and LOW RADIATION MPR specification. Fully guaranteed, in EXCELLENT little

used condition.
Tilt & Swivel Base £475
VGA cable for IBM PC included.
Only £119 (E) Order as MITS-SVGA

External cables for other types of computers available - CALL

Ex demo 17" 0.28 SVGA Mitsubishi Diamond Pro monitors, Full multisync etc.
Full 90 day guarantee. Only £199.00 (E)

Just In - Microvitec 20" VGA (800 x 600 res.) colour monitors.
Good SH condition - from £299 - CALL for info

PHILIPS HCS35 (same style as CM8833) attractively styled 14" colour monitor with both RGB and standard composite 15.625 KHz video inputs via SCART socket and separate phono jacks. Integral audio power amp and speaker for all audio visual uses. Will connect direct to Amiga and Atari BBC computers. Ideal for all video monitoring / security applications with direct connection to most colour cameras. High quality with many features such as front concealed flap controls, VCR correction button etc. Good used condition - fully tested - guaranteed
Dimensions: W14" x H12 1/4" x 15 1/2" D.
Only £99.00 (E)

PHILIPS HCS31 Ultra compact 9" colour video monitor with standard composite 15.625 KHz video input via SCART socket. Ideal for all monitoring / security applications. High quality, ex-equipment fully tested & guaranteed (possible minor screen burns). In attractive square black plastic case measuring W10" x H10" x 1 1/4" D. 240 V AC mains powered.
Only £79.00 (D)

KME 10" 15M10009 high definition colour monitors with 0.28" dot pitch. Superb clarity and modern styling. Operates from any 15.625 KHz sync RGB video source, with RGB analog and composite sync such as Atari, Commodore Amiga, Acorn Archimedes & BBC. Measures only 13 1/2" x 12" x 11". Good used condition.
Only £125 (E)

20" 22" and 26" AV SPECIALS

Superbly made UK manufacture PIL all solid state colour monitors, complete with composite video & optional sound input. Attractive teak style case. Perfect for Schools, Shops, Disco, Clubs, etc. In EXCELLENT little used condition with full 90 day guarantee.

20"....£135 22"....£155 26"....£185 (F)

We probably have the largest range of video monitors in Europe. All sizes and types from 4" to 42" call for info.

DC POWER SUPPLIES

Virtually every type of power supply you can imagine. Over 10,000 Power Supplies Ex Stock
Call or see our web site.

HP6030A 0-200V DC @ 17 Amps bench power supply £1950
Intel SBC 486/125C08 Enhanced Multibus (MSA) New £1150
Nikon HFX-11 (Ephopt) exposure control unit £1450
PHILIPS PM5518 pro. TV signal generator £1250
Motorola VME Bus Boards & Components List. SAE / CALL £POA
Trio 0-18 vdc linear, metered 30 amp bench PSU. New £550
Fujitsu M3041R 600 LPM high speed band printer £1950
Fujitsu M3041D 600 LPM printer with network interface £1250
Perkin Elmer 299B Infrared spectrophotometer £500
Perkin Elmer 597 Infrared spectrophotometer £3250
VG Electronics 1035 TELETEST Decoding Margin Meter £3500
LightBand 60 output high spec 2u rack mount Video VDA's £495
Sekonic SD 1500 18 channel digital Hybrid card recorder £1995
B&K 2633 Microphone pre amp £300
Taylor Hobson Tallysurv amplifier / recorder £750
ADC SS200 Carbon dioxide gas detector / monitor £1450
BBC AM203 PPM Meter (Ernest Turner) + drive electronics £75
ANRITSU 9654A Optical DC-2.5Gb/waveform monitor £5650
ANRITSU MS9001B1 0-6.1 uC optical spectrum analyser £POA
ANRITSU ML93A optical power meter £990
ANRITSU Fibre optic characteristic test set £POA
R&S FTDB Dual sound unit £650
R&S SBUF-E1 Vision modulator £775
WILTRON 6630B 12.4 / 20GHz RF sweep generator £5750
TEK 2445 150 MHz 4 trace oscilloscope £1250
TEK 2465 300 MHz 300 MHz oscilloscope rack mount £1955
TEK TDS380 400MHz digital realtime + disk drive, FFT etc £2900
TEK TDS524A 500MHz digital realtime + colour display etc £5100
HP3585A Opti 907 20Hz to 40 MHz spectrum analyser £3950
PHILIPS PW1730 10 60KV XRAY generator & accessories £POA
CLAUDE LYONS 12A 240v single phase auto volt. regs £325
CLAUDE LYONS 100A 240/415V 3 phase auto volt. regs £2900

19" RACK CABINETS

Superb quality 6 foot 40U
Virtually New, Ultra Smart
Less than Half Price!

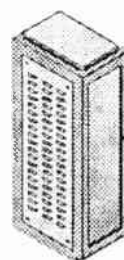

Top quality 19" rack cabinets made in UK by Optima Enclosures Ltd Units feature designer, smoked acrylic lockable front door, full height lockable half louvered back door and louvered removable side panels. Fully adjustable internal fixing struts, ready punched for any configuration of equipment mounting, plus ready mounted integral 12 way 13 amp socket switched mains distribution strip make these racks some of the most versatile we have ever sold. Racks may be stacked side by side and therefore require only two side panels to stand singly or in multiple bays. Overall dimensions are 77 1/4" H x 32 1/4" D x 22" W. Order as:

OPT Rack 1 Complete with removable side panels. £345.00 (G)
OPT Rack 2 Rack less side panels. £245.00 (G)

Over 1000 racks, shelves, accessories
19" 22" & 24" wide 3 to 46 U high.
Available from stock !!

32U - High Quality - All steel RakCab

Made by Eurocraft Enclosures Ltd to the highest possible spec, rack features all steel construction with removable side, front and back doors. Front and back doors are hinged for easy access and all are lockable with five secure 5 lever barrel locks. The front door is constructed of double walled steel with a 'designer style' smoked acrylic front panel to enable status indicators to be seen through the panel, yet remain unobtrusive. Internally the rack features fully slotted reinforced vertical fixing members to take the heaviest of 19" rack equipment. The two movable vertical fixing struts (extras available) are pre punched for standard 'cage nuts'. A mains distribution panel internally mounted to the bottom rear, provides 8 x IEC 3 pin Euro sockets and 1 x 13 amp 3 pin switched utility socket. Overall ventilation is provided by fully louvered back door and double skinned top section with top and side louvers. The top panel may be removed for fitting of integral fans to the sub plate etc. Other features include: fitted castors and floor levelers, pre-punched utility panel at lower rear for cable / connector access etc. Supplied in excellent, slightly used condition with keys Colour Royal blue. External dimensions mm=1625H x 635D x 603 W (64" H x 25" D x 23 1/4" W)

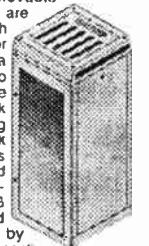

Sold at LESS than a third of makers price !!

A superb buy at only £245.00 (G)
42U version of the above only £345 - CALL

12V BATTERY SCOOP - 60% off !!

A special bulk purchase from a cancelled export order brings you the most amazing savings on these ultra high spec 12V DC 14 Ah rechargeable batteries. Made by Hawker Energy Ltd, type SBS15 featuring pure lead plates which offer a far superior shelf & guaranteed 15 year service life. Fully BT & BS6290 approved. Supplied BRAND NEW and boxed. Dimensions 200 wide, 137 high, 77 deep. M8 bolt terminals. Fully guaranteed. Current makers price over £70 each. **Our Price £35 each (C) or 4 for £99 (E)**

RELAYS - 200,000 FROM STOCK

Save ££££'s by choosing your next relay from our Massive Stocks covering types such as Military, Octal, Cradle, Hermetically Sealed, Continental, Contactors, Time Delay, Reed, Mercury Wetted, Solid State, Printed Circuit Mounting etc. CALL or see our web site www.distel.co.uk for more information. Many obsolete types from stock. Save ££££'s

COLOUR CCD CAMERAS

Undoubtedly a miracle of modern technology & our special buying power! A quality product featuring a fully cased COLOUR CCD camera at a giving away price! Unit features full autolight sensing for

use in low light & high light applications. A 10 mm fixed focus wide angle lens gives excellent focus and resolution from close up to long range. The composite video output will connect to any composite monitor or TV (via SCART socket) and most video recorders. Unit runs from 12V DC so ideal for security & portable applications where mains power not available.

Overall dimensions 66 mm wide x 117 deep x 43 high. Supplied BRAND NEW & fully guaranteed with user data, 100's of applications including Security, Home Video, Web TV, Web Cams etc. etc.

Web ref = LK33 ONLY £99.00 or 2 for £180.00 (B)

SOFTWARE SPECIALS

NT4 WorkStation, complete with service pack 3 and licence - OEM packaged. ONLY £89.00 (B)
ENCARTA 95 - CDROM. Not the latest - but at this price! £7.95
DOS 5.0 on 3 1/2" disks with concise books c/w QBasic £14.95
Windows for Workgroups 3.11 + Dos 6.22 on 3.5" disks £55.00
Wordperfect 6 for DOS supplied on 3 1/2" disks with manual £24.95
shipping charges for software is code B.

DISTEL on the web !! - Over 16,000,000 items from stock - www.distel.co.uk



ALL MAIL TO
Dept PE, 29/35 Osborne Rd
Thornton Heath
Surrey CR7 8PD
Open Mon - Fri 9.00 - 5.30

LONDON SHOP
Open Mon - Sat 9.00 - 5.30
215 Whitehorse Lane
South Norwood
On 68A Bus Route
N. Thornton Heath &
Selhurst Park SR Rail Stations

NEW DISTEL ©
Visit our web site
www.distel.co.uk
email = admin@distel.co.uk

ALL ENQUIRIES
0208 653 3333
FAX 0208 653 8888

All prices for UK Mainland UK customers add 17.5% VAT to TOTAL order amount. Minimum order £10. Bona Fide account orders accepted from Government, Schools, Universities and Local Authorities - minimum account order £50. Cheques over £100 are subject to 10 working days clearance. Carriage charges (A)-£3.00, (A1)-£4.00, (B)-£5.00, (C)-£8.50, (C1) £12.50, (D)-£15.00, (E)-£18.00, (F)-£20.00, (G)-CALL. Allow approx 6 days for shipping - faster CALL. All goods supplied to our Standard Conditions of Sale and unless stated guaranteed for 90 days. All guarantees on a return to base basis. All n/g's reserved to change prices / specifications without prior notice. Orders subject to stock. Discounts for volume. Top CASH prices paid for surplus goods. All trademarks, tradenames etc acknowledged © Display Electronics 1999 L & O L. 07/99

NEXT MONTH

FREE! GIANT DATA CHART – BIPOLAR TRANSISTORS –

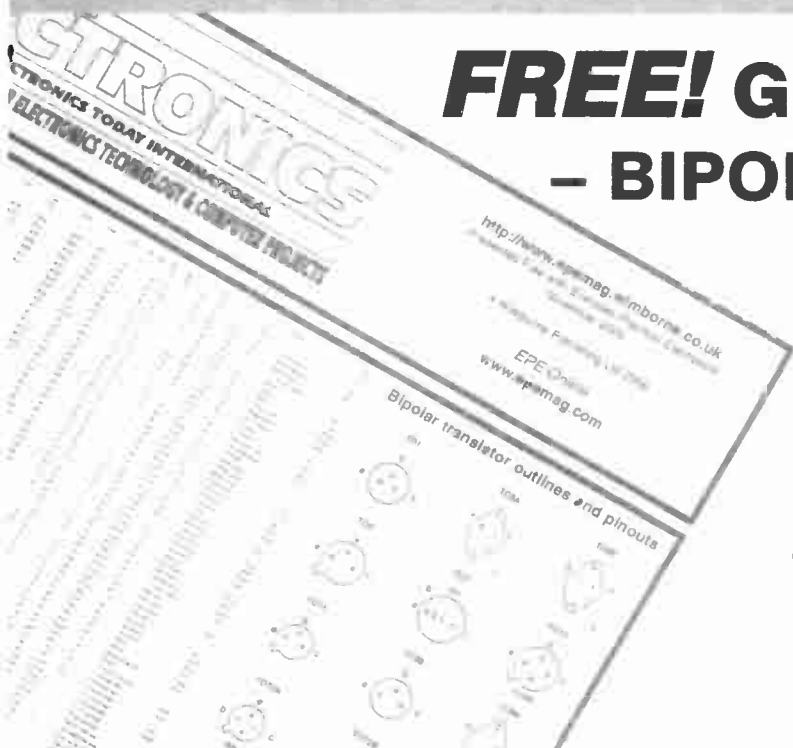

**PAST, PRESENT AND PINOUTS!
AROUND 500 TRANSISTORS AND
THEIR CHARACTERISTICS**

**COVERS NPN, PNP, SILICON,
GERMANIUM, EQUIVALENTS,
COMPLEMENTS, FUNCTIONS
AND OUTLINES. TABLING VOLTAGE,
CURRENT, FREQUENCY AND POWER
FACTORS**

**GIANT SIZE – 57cm x 77cm.
THE IDEAL PINOUT PIN-UP FOR
ANY WORKSHOP OR CLASSROOM!**

**Top
Tanner**

SAMPLE AND HOLD MODULE

An add-on unit for your multimeter which works equally well with analogue or digital types. As the name suggests, its function is to sample a changing voltage and hold it to give you time to read its value. Reading a changing voltage is difficult with a digital meter because the final two or three figures of the reading may be changing too fast to be seen.

Typically, the meter takes several samples per second so it is not possible to read each sample individually. We can only read a value when it is reasonably steady, perhaps varying only in the least significant digit. An analogue meter is easier to read with a rapidly changing voltage, because the eye can average out the changes over a small interval of time. There is also the inertia of the needle and coil unit to help steady the readings.

Whether you have a digital or analogue meter, there are occasions when you might want to sample and read the voltage at a precise instant, or to sample it and read it at regular intervals of time. This project helps you do this.

OPTO-ALARM

An optically balanced light alarm for general purpose security applications. The alarm is triggered by increasing light level. Alarm activation occurs when the light level increases rapidly. Varying light levels from cloud movement, 50Hz mains flicker from fluorescent lamps, dusk to dawn light changes and total darkness situations, will not cause false alarms.

The Opto-Alarm incorporates an exit delay indicated by a green l.e.d. to allow departure from the protected area, and to allow time to set the system for required operation, a red l.e.d. indicates any triggering whilst setting up. When time-out occurs, the exit l.e.d. extinguishes and further triggering will activate a warning tone, followed by full siren activation for a pre-set period, after which the alarm will fully reset until activated further.

NOTE NEW PUBLISHING DATE

NO ONE DOES IT BETTER

EVERYDAY
PRACTICAL
ELECTRONICS
INCORPORATING **ELECTRONICS TODAY INTERNATIONAL**

**DON'T MISS AN
ISSUE – PLACE YOUR
ORDER NOW!**
Demand is bound to be high

NOVEMBER ISSUE ON SALE THURSDAY, OCTOBER 12



ADD £2.00 P&P to all orders (or 1st Class Recorded £4 Next day) (Invoiced £2.00) £7 Europe £4.00, Rest of World £8. We accept all major credit cards. Make cheques/PO's payable to Quasar Electronics. Prices include 17.5% VAT. MAIL ORDER ONLY. FREE CATALOGUE with order or send 2 x 1st class stamps (refundable) for details of over 110 kits & publications.

PROJECT KITS

Our electronic kits are supplied complete with all components, high quality PCBs (NOT cheap Tripad strip board!) and detailed assembly/operating instructions

- **2 x 25W CAR BOOSTER AMPLIFIER** Connects to the output of an existing car stereo cassette player. CD player or radio. Heatsinks provided. PCB 76x75mm 1046KT £24.95
- **3-CHANNEL WIRELESS LIGHT MODULATOR** No electrical connection with amplifier. Light modulation achieved via a sensitive electret microphone. Separate sensitivity control per channel. Power handling 400W/channel PCB 54x112mm. Mains powered Box provided 6014KT £24.90
- **12 RUNNING LIGHT EFFECT** Exciting 12 LED light effects ideal for parties, discos, shop-windows & eye-catching signs. PCB design allows replacement of LEDs with 220V bulbs by inserting 3 TRIACS. Adjustable rotation speed & direction. PCB 54x112mm. 1026KT £16.95; BOX (for mains operation) 2026KT £8.50
- **DISCO STROBE LIGHT** Probably the most exciting of all light effects. Very bright strobe tube. Adjustable strobe frequency 1-60Hz. Mains powered PCB: 60x68mm Box provided. 6037KT £44.95
- **ANIMAL SOUNDS** Cat, dog, chicken & cow. Ideal for kids farmyard toys & schools. SG10M £5.50
- **3 1/2 DIGIT LED PANEL METER** Use for basic voltage/current displays or customise to measure temperature, light, weight, movement, sound levels, etc with appropriate sensors (not supplied). Various input circuit designs provided 3061KT £12.95
- **IR REMOTE TOGGLE SWITCH** Use any TV/VR remote control unit to switch onboard 12V/1A relay on/off! 3058KT £9.95
- **SPEED CONTROLLER** for any common DC motor up to 100V/5A. Pulse width modulation gives maximum torque at all speeds. 5-15VDC Box provided 3067KT £14.95
- **3 x 8 CHANNEL IR RELAY BOARD** Control eight 12V/1A relays by Infra Red (IR) remote control over a 20m range in sunlight! 6 relays turn on only the other 2 toggle on/off! 3 operation ranges determined by jumpers. Transmitter case & all components provided Receiver PCB 76x89mm 3072KT £44.95

NEW PRODUCT FEATURE

Introduction to L.C.D.s and More!

Kit teaches you to understand and use L.C.D.s. First, you learn how to connect the 2 x 16 L.C.D.s to a PC and how to make the L.C.D. display messages typed on the PC keyboard. It will show you how to process this data. Second, there is an on-board DS1620 to measure temperature (°F or °C). Control is provided for you to set breakpoints to turn a thermostat on/off. Once the DS1620 is programmed it may be removed and placed in another device for temperature control. Many web references are provided. All software code & DS1620 data sheets provided on disk. 3134KT £26.95



- **SOUND EFFECTS GENERATOR** Easy to build. Create an almost infinite variety of interesting/unique sound effects from birds chirping to sirens. 9VDC PCB 54x85mm 1045KT £8.95
- **ROBOT VOICE EFFECT** Make your voice sound similar to a robot or Darlek. Great fun for discos, school plays, theatre productions, radio stations & playing jokes on your friends when answering the phone! PCB 42x71mm 1131KT £8.95
- **AUDIO TO LIGHT MODULATOR** Controls intensity of one or more lights in response to an audio input. Safe, modern opto-coupled design. Mains voltage experience required. 3012KT £7.95
- **MUSIC BOX** Activated by light. Plays 8 Christmas songs and 5 other tunes. 3104KT £6.95
- **20 SECOND VOICE RECORDER** Uses non-volatile memory - no battery backup needed. Record/replay messages over & over. Playback as built-in rec. 6VDC. PCB 50x73mm. 3131KT £11.95
- **TRAIN SOUNDS** 4 selectable sounds - whistle blowing, levers clacking bell, 'clackety-clack' & 4 in sequence. SG01M £5.95
- **PC CONTROLLED RELAY BOARD** Convert any 286 upward PC into a dedicated automatic controller to independently turn on/off up to eight lights, motors & other devices around the home, office, laboratory or factory using 8 240VAC/12A onboard relays. DOS utilities, sample test program, full-featured Windows utility & all components (except cable) provided. 12VDC. PCB 70x200mm. 3074KT £29.95
- **2 CHANNEL UHF RELAY SWITCH** Contains the same transmitter/receiver pair as 30A15 below plus the components and PCB to control two 24VAC/10A relays (also supplied). Ultra bright LEDs used to indicate relay status. 3082KT £27.95
- **TRANSMITTER RECEIVER PAIR** 2-button keyfob style 300-375MHz Tx with 30m range Receiver encoder module with matched decoder IC. Components must be built into a circuit like kit 3082 above 30A15 £13.95
- **PC DATA ACQUISITION/CONTROL UNIT** Use your PC to monitor physical variables (e.g. pressure, temperature, light, weight, switch state, movement, relays, etc.) process the information & use results to control physical devices like motors, sirens, relays, servo & stepper motors. Inputs 16 digital & 11 analogue. Outputs, 8 digital & 1 analogue. Plastic case with printed front/rear panels, software utilities, programming examples & all components (except sensors & cable) provided 12VDC. 3093KT £89.95
- **PIC 16C71 FOUR SERVO MOTOR DRIVER** Simultaneously control up to 4 servo motors. Software & all components (except servo/control pots) supplied 5VDC PCB 50x70mm 3102KT £14.95
- **PC SERIAL PORT ISOLATED I/O BOARD** Provides eight 240VAC/10A relay outputs & 4 optically isolated inputs. Designed for use in various control & sensing applications e.g. load switching, external switch input sensing, contact closure & external voltage sensing. Controlled via serial port & a terminal emulator program (built into Windows). Can be used with ANY computer/operating system. Plastic case with printed front/rear panels & all components (except cable) provided 3108KT £49.95
- **UNIPOLAR STEPPER MOTOR DRIVER** for any 5/6/8 lead motor. Fast/stop & single step rates. Direction control & on/off switch. Wave, 2-phase & half-wave step modes. 4 LED indicators PCB 50x65mm 3109KT £14.95
- **PC CONTROLLED STEPPER MOTOR DRIVER** Control two unipolar stepper motors (3A max each) via PC printer port. Wave, 2-phase & half-wave step modes. Software accepts 4 digital inputs from external switches & will single step motors. PCB fits in D-shell case provided 3113KT £19.95
- **12-BIT PC DATA ACQUISITION/CONTROL UNIT** Similar to kit 3093 above but uses a 12 bit Analogue-to-Digital Converter (ADC) with internal analogue multiplexer. Reads 8 single ended channels or 4 differential inputs or a mixture of both. Analogue inputs read 0-4V. Four TTL/CMOS compatible digital input/outputs. ADC conversion time <10µs. Software (C, OB & Win), extended D shell case & all components (except sensors & cable) provided 3118KT £49.95

X-FACTOR PUBLICATIONS

THE EXPERTS IN RARE & UNUSUAL INFORMATION!

Full details of all X-FACTOR PUBLICATIONS can be found in our catalogue. N.B. Minimum order charge for reports and plans is £5.00 PLUS normal P&P.

- **SUPER-EAR LISTENING DEVICE** Complete plans to build your own parabolic dish microphone. Listen to distant voices and sounds through open windows and even walls! Made from readily available parts. R002 £3.50
- **TELEPHONE BUG PLANS** Build your own micro-beetle telephone bug. Suitable for any phone. Transmits over 250 metres - more with good receiver. Made from easy to obtain cheap components. R006 £2.50
- **LOCKS** - How they work and how to pick them. This fact filled report will teach you more about locks and the art of lock picking than many books we have seen at 4 times the price. Packed with information and illustrations. R008 £3.50
- **RADIO & TV JOKER PLANS** We show you how to build three different circuits for disrupting TV picture and sound plus FM radio! May upset your neighbours & the authorities! DISCRETION REQUIRED! R017 £3.50
- **INFINITY TRANSMITTER PLANS** Complete plans for building the famous Infinity Transmitter. Once installed on the target phone device acts like a room bug. Just call the target phone & activate the unit to hear all room sounds. Great for home/office security! R019 £3.50
- **THE ETHER BOX CALL INTERCEPTOR PLANS** Grabs telephone calls out of the air! No need to wire-in a phone bug. Simply place this device near the phone lines to hear the conversations taking place! R025 £3.00
- **CASH CREATOR BUSINESS REPORTS** Need ideas for making some cash? Well this could be just what you need! You get 40 reports (approx. 800 pages) on floppy disk that give you information on setting up different businesses. You also get valuable reproduction and duplication rights so that you can sell the manuals as you like. R030 £7.50

SURVEILLANCE

High performance surveillance bugs. Room transmitters supplied with sensitive electret microphone & battery holdover. All transmitters can be received on an ordinary VHF/FM radio between 88-108MHz. Available in Kit Form (KT) or Assembled & Tested (AS)

ROOM SURVEILLANCE

- **MTX - MINIATURE 3V TRANSMITTER**
 Easy to build & guaranteed to transmit 300m @ 3V Long battery life. 3.5V operation. Only 45x18mm ● 3007KT £5.95
 AS3007 £10.95
- **MRTX - MINIATURE 9V TRANSMITTER**
 Our best selling bug. Super sensitive, high power - 500m range ● 9V (over 1km with 18V supply and better aerial) 45x19mm 3018KT £6.95 AS3018 £11.95
- **HPTX - HIGH POWER TRANSMITTER**
 High performance 2 stage transmitter gives greater stability & higher quality reception 1000m range ● 12V DC operation. Size 74x55mm 3032KT £8.95 AS3032 £17.95
- **MMTX - MICRO-MINIATURE 9V TRANSMITTER**
 The ultimate bug for its size performance and price. Just 15x25mm 500m range ● 9V Good stability 6.18V operation 3051KT £7.95 AS3051 £13.95
- **VTX - VOICE ACTIVATED TRANSMITTER**
 Operates only when sounds detected. Low standby current. Variable trigger sensitivity 500m range. Peaking circuit supplied for maximum RF output. On/off switch 6V operation. Only 63x38mm 3028KT £9.95 AS3028 £22.95
- **HARD-WIRED BUG/TWO STATION INTERCOM**
 Each station has its own amplifier, speaker and mic. Can be set up as either a hard-wired bug or two station intercom. 10m x 2-core cable supplied 9V operation 3021KT £13.95 (Kit form only)
- **TRM - AREA RECORDER VOX SWITCH**
 Used to automatically operate a tape recorder (not supplied) via its REMOTE socket when sounds are detected. All conversations recorded. Adjustable sensitivity & turn-off delay. 115x19mm 3013KT £7.95 AS3013 £19.95

TELEPHONE SURVEILLANCE

- **M7TX - MINIATURE TELEPHONE TRANSMITTER**
 Attaches anywhere to phone line. Transmits only when phone is used. Tune-in your radio or hear both parties. 300m range. Uses line as aerial. Power source: 20x45mm 3016KT £7.95 AS3016 £13.95
- **T7I - TELEPHONE RECORDING INTERFACE**
 Automatically record all conversations. Connects between phone line & tape recorder (not supplied). Operates recorders with 1.5-12V battery systems. Powered from line. 50x33mm 3033KT £7.95 AS3033 £16.95
- **TPA - TELEPHONE PICK-UP AMPLIFIER/WIRELESS PHONE BUG**
 Place pick-up coil on the phone line or near phone earpiece and hear both sides of the conversation. 3055KT £10.95 AS3055 £19.95
- **1 WATT FM TRANSMITTER** Easy to construct. Delivers a crisp, clear signal. Two-stage circuit. Kit includes microphone and requires a simple open dipole aerial. 12-18VDC PCB 42x45mm 1009KT £14.95
- **4 WATT FM TRANSMITTER** Comprises three RF stages and an audio preamplifier stage. Piezo-electric microphone supplied or you can use a separate preamplifier circuit. Antenna can be an open dipole or Ground Plane. Ideal project for those who wish to get started in the fascinating world of FM broadcasting and want a good basic circuit to experiment with. 12-18VDC PCB 44x146mm 1028KT £23.95
- **15 WATT FM TRANSMITTER (PRE-ASSEMBLED & TESTED)** Four transistor based stages with Philips BLY 88 in final stage. 15 Watts RF power on the air. 88-108MHz. Accepts open dipole, Ground Plane, 5/8, J, or YAGI configuration antennas. 12-18VDC PCB 70x220mm SWS meter needed for alignment. 1021KT £69.95
- **SIMILAR TO ABOVE BUT 25W Output.** 1031KT £79.95

- **LIQUID LEVEL SENSOR/RAIN ALARM** Will indicate fluid levels or simply the presence of fluid. Relay output to control a pump to add/remove water when it reaches a certain level. 1080KT £6.95
- **STEREO VU METER** Shows peak music power using 2 rows of 10 LED's (mixed green & red) moving bar display 0-30db 3089KT £10.95
- **AM RADIO KIT 1** Tuned Radio Frequency front-end, single chip AM radio IC & 2 stages of audio amplification. All components inc speaker provided. PCB 32x102mm 3063KT £9.95
- **DRILL SPEED CONTROLLER** Adjust the speed of your electric drill according to the job at hand. Suitable for 240V AC mains powered drills up to 700W power. PCB 48mm x 65mm. Box provided 6074KT £16.90
- **3 INPUT MONO MIXER** Independent level control for each input and separate bass/treble controls. Input sensitivity 240mV. 18V DC. PCB: 60mm x 185mm 1052KT £16.95
- **NEGATIVE/POSITIVE ION GENERATOR** Standard Cockcroft-Walton multiplier circuit. Mains voltage experience required. 3057KT £9.95
- **LED DICE** Classic intro to electronics & circuit analysis. 7 LED's simulate dice roll, slow down & land on a number at random. 555 IC circuit. 3003KT £8.95
- **STAIRWAY TO HEAVEN** Tests hand-eye co-ordination. Press switch when green segment of LED lights to climb the stairway - miss & start again! Good intro to several basic circuits. 3005KT £8.95
- **ROULETTE LED** 'Ball' spins round the wheel, slows down & drops into a slot. 10 LED's. Good intro to CMOS decade counters & Op-Amps. 3006KT £10.95
- **9V XENON TUBE FLASHER** Transformer circuit steps up 9V battery to flash a 25mm Xenon tube. Adjustable flash rate (0.25-2 Sec's). 3022KT £10.95
- **LED FLASHER 1.5** ultra bright red LED's flash in 7 selectable patterns. 3037MKT £4.95
- **LED FLASHER 2** Similar to above but flash in sequence or randomly. Ideal for model railways. 3052MKT £4.95
- **INTRODUCTION TO PIC PROGRAMMING.** Learn programming from scratch. Programming hardware a P16F84 chip and a two-part, practical hands-on tutorial series are provided. 3081KT £21.95
- **SERIAL PIC PROGRAMMER** for all 8/18/28/40 pin DIP serial programmed PICs. Shareware software supplied limited to programming 256 bytes (registration costs £14.95) 3096KT £14.95
- **PICALL SERIAL & PARALLEL PIC PROGRAMMER** for all 8/18/28/40 pin DIP parallel AND serial PICs. Includes fully functional & registered software (DOS, W3.1, W95/98). 3117KT £59.95
- **ATMEL 89C051 PROGRAMMER** Simple-to-use yet powerful programmer for the Atmel 89C1051, 89C2051 & 89C4051 uC's. Programmer does NOT require special software other than a terminal emulator program (built into Windows). Can be used with ANY computer/operating system. 3121KT £34.95
- **3V/1.5V TO 9V BATTERY CONVERTER** Replace expensive 9V batteries with economic 1.5V batteries. IC based circuit steps up 1 or 2 'AA' batteries to give 9V/18mA 3035KT £4.95
- **STABILISED POWER SUPPLY 3-30V/2.5A** Ideal for hobbyist & professional laboratory. Very reliable & versatile design at an extremely reasonable price. Short circuit protection. Variable DC voltages (3-30V). Rated output 2.5 Amps. Large heatsink supplied. You just supply a 24VAC/3A transformer. PCB 55x112mm. Mains operation. 1007KT £17.50. Custom Designed Box 2007 £34.95
- **STABILISED POWER SUPPLY 2-30V/5A** As kit 1007 above but rated at 5Amp. Requires a 24VAC/5A transformer. 1096KT £29.95. Custom Designed Box 2096 £34.95
- **MOTORBIKE ALARM** Uses a reliable vibration sensor (adjustable sensitivity) to detect movement of the bike to trigger the alarm & switch the output relay to which a siren, bikes horn, indicators or other warning device can be attached. Auto-reset. 6-12VDC PCB 57x64mm 1011KT £11.95 Box £5.95
- **CAR ALARM SYSTEM** Protect your car from theft. Features vibration sensor, courtesy/boot light voltage drop sensor and bonnet/boot earth switch delay. Entry delay, auto-reset and adjustable alarm duration. 6-12V DC. PCB: 47mm x 55mm 1019KT £11.95 Box £6.50
- **PIEZO SCREAMER** 110dB of ear piercing noise. Fits in box with 2 x 35mm piezo elements built into their own resonant cavity. Use as an alarm siren or just for fun! 6-9VDC 3015KT £9.95
- **COMBINATION LOCK** Versatile electronic lock comprising main circuit & separate keypad for remote opening of lock. Relay supplied. 3029KT £9.95
- **ULTRASONIC MOVEMENT DETECTOR** Crystal locked detector frequency for stability & reliability. PCB 75x40mm houses all components. 4-7m range. Adjustable sensitivity. Output will drive external relay/circuits 9VDC. 3049KT £12.95
- **PIR DETECTOR MODULE** 3-lead assembled unit just 25x35mm as used in commercial burglar alarm systems. 3076KT £8.95
- **INFRARED SECURITY BEAM** When the invisible IR beam is broken a relay is tripped that can be used to sound a bell or alarm. 25 metre range. Mains rated relays provided. 12VDC operation. 3130KT £11.95
- **SQUARE WAVE OSCILLATOR** Generates square waves at 6 preset frequencies in factors of 10 from 1Hz-100KHz. Visual output indicator. 5-18VDC. Box provided 3111KT £8.95
- **PC DRIVEN POCKET SAMPLER/DATA LOGGER** Analogue voltage sampler records voltages up to 2V or 20V over periods from milli-seconds to months. Can also be used as a simple digital scope to examine audio & other signals up to about 5KHz. Software & D-shell case provided. 3122KT £19.95
- **20 MHz FUNCTION GENERATOR** Square, triangular and sine waveforms up to 20MHz over 3 ranges using 'coarse' and 'fine' frequency adjustment controls. Adjustable output from 0.2V p-p. A TTL output is also provided for connection to a frequency meter. Uses MAX038 IC. Plastic case with printed front/rear panels & all components provided 7-12VAC. 3101KT £54.95

BARGAIN BUY!

Great introduction to electronics. Ideal for the budding electronics expert! Build a radio, burglar alarm, water detector, Morse code practice circuit, simple computer circuits, and much more! NO soldering, tools or previous electronics knowledge required. Circuits can be built and unassembled repeatedly. Comprehensive 68-page manual with explanations, schematics and assembly diagrams. Suitable for age 10+. Excellent for schools. Requires 2 x AA batteries ONLY £17.95 (phone for bulk discounts)

30-in-ONE Electronic Projects Lab



**WEB: <http://www.QuasarElectronics.com>
 email: epesales@QuasarElectronics.com**

**Secure Online Ordering Facilities
 Full Kit Listing, Descriptions & Photos
 Kit Documentation & Software Downloads**

The science lab in a PC

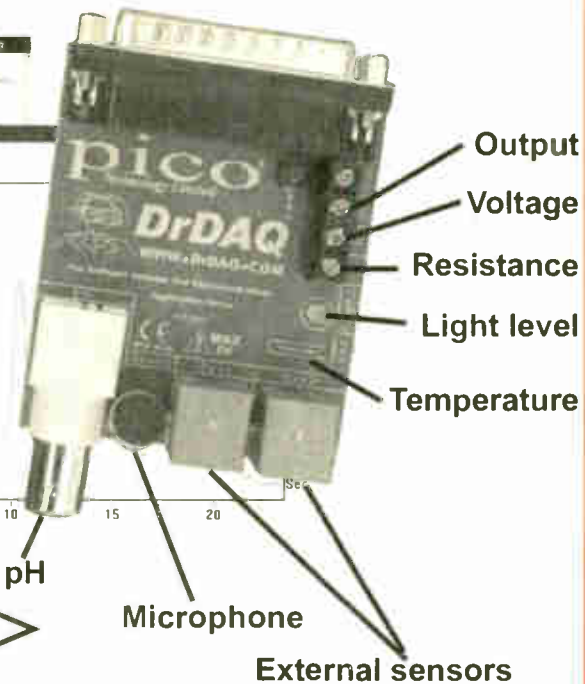
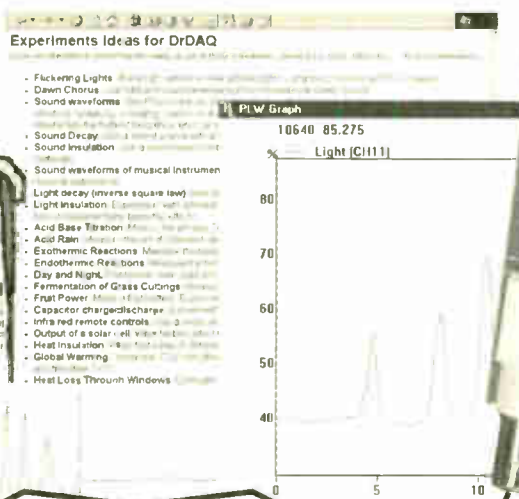

Only £59!

+VAT

The DrDAQ is a low cost data logger from Pico Technology. It is supplied ready to use with all cables, software and example science experiments.

DrDAQ represents a breakthrough in data logging. Simply plug DrDAQ into any Windows PC, run the supplied software and you are ready to collect and display data. DrDAQ draws its power from the parallel port, so no batteries or power supplies are required.

- ✓ Very low cost
- ✓ Built in sensors for light, sound (level and waveforms) and temperature
- ✓ Use DrDAQ to capture fast signals (eg sound waveforms)
- ✓ Outputs for control experiments
- ✓ Supplied with both PicoScope (oscilloscope) and PicoLog (data logging) software

Transform your PC.... Into an oscilloscope, spectrum analyser and multimeter...

The Pico Technology range of PC based oscilloscopes offer performance only previously available on the most expensive 'benchtop' scopes. By intergrating several instruments into one unit, they are both flexible and cost effective.

Connection to a PC gives these virtual instruments the edge over traditional oscilloscopes: the ability to print and save waveforms is just one example. Units are supplied with PicoScope for Windows which is powerful, yet simple to use, with comprehensive on line help.

Features

- ▼ A fraction of the cost of comparable benchtop scopes
- ▼ Oscilloscope and data logging software supplied
- ▼ Prices from £69 (excl VAT)
- ▼ Up to 100 MS/s sampling, 50 MHz spectrum analyser

Applications

- ▼ Video
- ▼ Automotive
- ▼ Audio
- ▼ Electronics design
- ▼ Fault finding
- ▼ Education

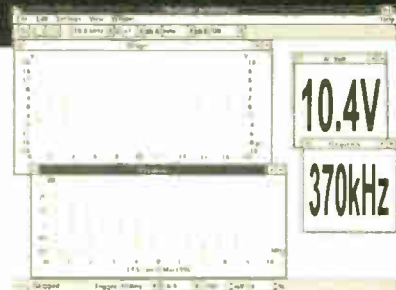

PICO
Technology Limited

Tel: 01480 396395, Fax: 01480 396296, E:mail: post@picotech.com, Web: www.drdaq.com

SQUIRES

MODEL & CRAFT TOOLS

A COMPREHENSIVE RANGE OF MINIATURE HAND AND POWER TOOLS AND AN EXTENSIVE RANGE OF ELECTRONIC COMPONENTS
FEATURED IN A FULLY ILLUSTRATED 400-PAGE MAIL ORDER CATALOGUE

2001 ISSUE

**SAME DAY DESPATCH
FREE POST AND PACKAGING**

CATALOGUES: FREE OF CHARGE TO ADDRESSES IN THE UK. OVERSEAS: CATALOGUE FREE, POSTAGE AT COST CHARGED TO CREDIT CARD

SQUIRES

100 LONDON ROAD,
BOGNOR REGIS,
WEST SUSSEX, PO21 1DD

TEL: 01243 842424
FAX: 01243 842525



SHOP NOW OPEN

FRUSTRATED!

Looking for ICs TRANSISTORS?

A phone call to us could get a result. We offer an extensive range and with a worldwide database at our fingertips, we are able to source even more. We specialise in devices with the following prefix (to name but a few).



2N 2SA 2SB 2SC 2SD 2P 2SJ 2SK 3N 3SK 4N 6N 17 40 AD
ADC AN AM AY BA BC BD BDT BDV BDW BDX BF
BFR BFS BFT BFX BFY BLY BLX BS BR BRX BRY BS
BSS BSV BSW BSX BT BTA BTB BRW BU BUK BUT BUV
BUW BUX BUY BUZ CA CD CX CXA DAC DG DM DS
DTA DTC GL GM HA HCF HD HEF ICL ICM IRF J KA
KIA L LA LB LC LD LF LM M M5M MA MAB MAX MB
MC MDAJ MJE MJF MM MN MPS MP5A MP5H MP5U
MRF NJM NE OM OP PA PAL PIC PN RC S SAA SAB
SAD SAJ SAS SDA SG SI SL SN SO STA STK STR STRD
STRM STRS SV1 T TA TAA TAG TBA TC TCA TDA TDB
TEA TIC TIP TIPL TEA TL TLC TMP TMS TPU U UA
UAA UC UDN ULN UM UPA UPC UPD VN X XR Z ZN
ZTS + many others

We can also offer equivalents (at customers' risk)
We also stock a full range of other electronic components
Mail, phone, Fax Credit Card orders and callers welcome



Connect

Cricklewood Electronics Ltd

40-42 Cricklewood Broadway London NW2 3ET
Tel: 0181 452 0161 Fax: 0181 208 1441

PIC LOGICATOR™

The fully graphical environment for designing control systems for PICmicros

Draw the system as an on-screen flowchart, test it in the software, and download it directly to the PICmicro.

- Fast and easy
- Ideal for new PICmicro users
- Great for robotics and animatronics projects

Primarily designed for use with FLASH reprogrammable microcontrollers (e.g. PIC16F84 and PIC16F873). Also supports OTP devices. A separate software application is provided to allow the Programmer to download hex files generated from assembler code or C.

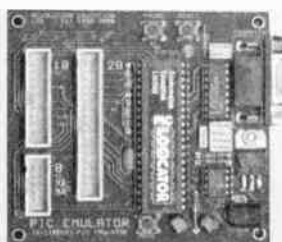

PIC-Logicator Emulator
Allows in-circuit emulation of the PICmicro, either in real time or responding directly to an on-screen simulation.
PIC-EM £119.95

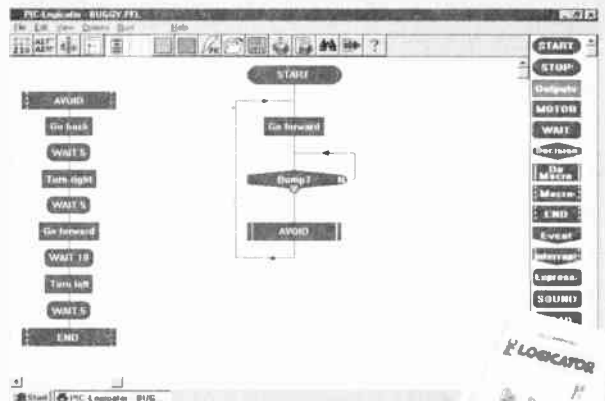

PIC-Logicator Pack
PIC-Logicator Software for PCs running Windows 95/98, and Programmer complete with serial lead, power supply and user manual.

PIC-L £149.95

www.pic-logicator.com

- Interactive software demo
- Direct purchase

Prices include UK carriage and VAT.

PIC-Logicator, Economatronics(Education)Ltd, Epic House, Darnall Rd, Sheffield S95AA UK.
Tel 0114 281 3311 Email education@economatronics.co.uk



**8 CAVANS WAY,
BINLEY INDUSTRIAL
ESTATE,
COVENTRY CV3 2SF
Tel: 01203 650702
Fax: 01203 650773
Mobile: 0860 400683**

(Premises situated close to Eastern-by-pass in Coventry with easy access to M1, M6, M40, M45 and M69)

OSCILLOSCOPES

Beckman 8020 - 20MHz - Dual Channel.....	£150
Gould 06 245A/250/255/300/3000/3351/4000.....	from £125
Hewlett Packard 180A/180C/181A/182C.....	from £150
Hewlett Packard 1740A, 1741A, 1744A 100MHz Dual Channel.....	from £300
Hewlett Packard 84100D - 1 GHz Digitizing.....	£1250
Hewlett Packard 84201A - 300MHz Digitizing.....	£1450
Hewlett Packard 84512B - 300MHz - 1GS/s 4-Channel.....	£2250
Hewlett Packard 84501A - 100MHz - 100Ms/s 4-Channel.....	£1250
Hitachi V182F/V302B/V302F/V303F/V600B/V800F.....	from £105
Hitachi V850F - 50MHz Dual Channel.....	£250
Hitachi V1100A - 100MHz 4-Channel.....	£300
Intron 2020 - 20MHz Digital Storage (NEW).....	£450
Iwatsu S857/10/S85702 - 20MHz.....	from £125
Meguro - MSO 1270A - 20 MHz Digital Storage (NEW).....	£450
Lecroy 5304 AM - 200MHz - 100 Ms/s 4-Channel.....	£3000
Lecroy 4900A - 300MHz/400 Ms/s D.S.O. 2-Channel.....	£2250
Philips PM 3065 - 50MHz Dual Trace.....	£450
Philips PM 3211/PM 3212/PM 3214/PM 3217/PM 3234/PM3240/PM 3243/PM 3244/PM 3261/PM 3262/PM 3263/PM 3540.....	from £125
Philips PM 3295A - 400MHz Dual Channel.....	£1500
Philips PM 3335 - 50MHz/20 Ms/s D.S.O. 2-Channel.....	£950
Tektronix 465 - 50MHz Dual Channel.....	£2200
Tektronix 464/465 - 100MHz Analogue Storage.....	from £300
Tektronix 466/468 - 100MHz Dual Channel.....	from £300
Tektronix 468 - 100MHz D.S.O.....	£500
Tektronix TAB 475 - 100MHz - 4-Channel.....	from £950
Tektronix 475/475A - 200MHz/250MHz Dual Channel.....	from £400
Tektronix 485 - 350MHz - 2.....	£750
Tektronix 2211 - Digital Storage - 50MHz.....	£900
Tektronix 2213 - 60MHz Dual Channel.....	£350
Tektronix 2215 - 60MHz Dual Trace.....	£375
Tektronix 2220 - 80MHz Dual Channel D.S.O.....	£950
Tektronix 2221 - 60MHz Digital Storage 2-Channel.....	£950
Tektronix 2225 - 50MHz Dual Channel.....	£350
Tektronix 2235 - 100MHz Dual trace.....	£900
Tektronix 2235 - Dual Trace 100MHz (portable).....	£900
Tektronix 2440 - 300MHz/500 Ms/s D.S.O. 2-Channel.....	£2500
Tektronix 2445 - 150MHz - 4-Channel+DMM.....	£300
Tektronix 2445A - 100MHz - 4-Channel.....	£300
Tektronix 2475B - 400MHz - 4-Channel.....	£850
Tektronix 5403 - 60MHz - 2 or 4-Channel.....	from £150
Tektronix 7313, 7803, 7823, 7833 - 100MHz 4-Channel.....	from £225
Tektronix 7704 - 250MHz 4-Channel.....	from £350
Tektronix 7904 - 500MHz.....	from £400
Trio C6-1022 - 20MHz - Dual Channel.....	£125

Other scopes available too

SPECIAL OFFER

HITACHI V212 - 20MHz DUAL TRACE.....	£160
HITACHI V222 - 20MHz DUAL TRACE+ALTERNATE MAGNIFY.....	£180

SPECTRUM ANALYSERS

Ando AC9211 - Spectrum Analyser 1.7GHz.....	£1995
Anritsu MS62B - 10kHz-1700MHz.....	£1995
Anritsu MS3401A-MS3401B - (10Hz-30MHz).....	£3500-£3895
Anritsu MS610B - 10kHz-2GHz - (Mini).....	£4500
Anritsu MS710F - 100kHz-23GHz Spectrum Analyser.....	£5500
Avcom PSA555 - 1000MHz - portable.....	£580
Hamog 8028/8038 - Spectrum Analyser/Tracking Gen+100MHz Oscilloscope.....	£1000
Hewlett Packard 1821 with 8658A (10MHz-21GHz).....	£2750
Hewlett Packard 1821 + 8658B - 0-1 to 1500MHz.....	£1250
Hewlett Packard 883A + 8658B - 0-1 to 1500MHz.....	£2250
Hewlett Packard 3682A - Dual Channel Dynamic Sig. Analyser.....	£5750
Hewlett Packard 3680A - 5Hz-50kHz.....	£900
Hewlett Packard 3682A - 0-2Hz-25.6kHz (Dual Channel).....	£2000
Hewlett Packard 3685A - 20Hz-40MHz.....	£4000
Hewlett Packard 8690B - (0-01 to 22GHz).....	£4250
Hewlett Packard 86046A - 'S' Parameter Test Set.....	£2500
Hewlett Packard 8783A - Network Analyser.....	from £3000
Hewlett Packard 8783B - Network Analyser.....	from £4500
IFR 7750 - 10kHz-1GHz.....	£2000
Meguro MSA 4901 - 1-300GHz (AS NEW).....	£750
Meguro MSA 4912 - 1-1GHz (AS NEW).....	£1000
Rohde & Schwarz - SWOB 5 Polyskop 0-1-1300MHz.....	£1500
Takeda Riken 4132 - 1-0GHz Spectrum Analyser.....	£2100
Tektronix 7L19 with mainframe (1.5-60GHz with external mixers).....	£2000
Tektronix 485B - 100Hz-1.8GHz programmable.....	£4500
Tektronix 486P - 1kHz-1.8GHz Spectrum Analyser.....	£4250

MISCELLANEOUS

Adret 740A - 100kHz-1120MHz Synthesised Signal Generator.....	£900
Anritsu MG 3801A Signal Generator 0.1-1040MHz.....	£1250
Anritsu MG 4801A Synthesised Signal Generator.....	£2500
Anritsu MG 645B Signal Generator 0.05-1050MHz.....	£750
Boonton 82C R/F Millivoltmeter.....	£195
Boonton 83A True RMS Voltmeter.....	£195
Dransetz 826 - AC/DC - Multifunction Analyser.....	£900
EIP 331 - Frequency Counter 18GHz.....	£450
EIP 845 - Frequency Counter 18GHz.....	£1250
EIP 875 - Frequency Counter 18GHz.....	£1450
Etkac 8MP8 - Power Supply 60V-30V.....	£350
Farnell T8V-70 MKII Power Supply (70V - 5A or 35V - 10A).....	£200
Farnell D90-1 Synthesised Signal Generator.....	£125
Farnell AP 3006A Power Supply 250V.....	£1750
Feedback PFG 605 Power Function Generator.....	£180
Fluke 5100A - Calibrator.....	£1950
GN ELM EPR31 PCM Signalling Recorder.....	£2000
Guideline 8182 - T12 Battery Standard Cell.....	£550
Hewlett Packard 1639D - Logic Analyser (43 Channels).....	£900
Hewlett Packard 16800A/B and C - Fitted with 16510A/1651A/161530A/16531A - Logic Analyser.....	from £2000
Hewlett Packard 331A - Distortion Analyser.....	£300
Hewlett Packard 333A - Distortion Analyser.....	£300
Hewlett Packard 334A - Distortion Analyser.....	£300
Hewlett Packard 335A - 21MHz Synthesiser/Function Generator.....	£900
Hewlett Packard 332A - Synthesised Signal Generator (20Hz-81MHz).....	£250
Hewlett Packard 333C - Synthesised Signal Generator (10Hz-21MHz).....	£900
Hewlett Packard 3458A - 6 1/2 Digit Multimeter (Autocal).....	£500
Hewlett Packard 3458A - Digital Voltmeter.....	£900
Hewlett Packard 3458A - HP - 1B Switch Control Unit (various Plug-Ins available).....	£3750
Hewlett Packard 35900A - Dual Channel Dynamic Signal Analyser.....	£900
Hewlett Packard 3711A/3712A/3713B/3793B - Microwave Link Analyser.....	£1500
Hewlett Packard 3746A - Selective Measuring Set.....	£500
Hewlett Packard 3778A - PCM Terminal Test Set.....	£1000
Hewlett Packard 3779A/3779C - Primary Mux Analyser.....	from £400

Hewlett Packard 3784A - Digital Transmission Analyser.....	£5000
Hewlett Packard 3786A - Jitter Generator+Receiver.....	£1250
Hewlett Packard 37900D - Signalling Test Set (No. 7 and ISDN).....	£4250
Hewlett Packard P382A - Variable Attenuator.....	£250
Hewlett Packard 4192A - LF Impedance Analyser.....	£9500
Hewlett Packard 4192A - Digital LCR Meter.....	£350
Hewlett Packard 4342A - 'Q' Meter.....	£900
Hewlett Packard 435A or B Power Meter (with 8461A/8484A).....	from £400
Hewlett Packard 436A and 437B - Power Meter and Sensor.....	from £900
Hewlett Packard 4648A - (TIMS) Transmission Impairment M/Set.....	£1000
Hewlett Packard 4872A - Lan Protocol Analyser.....	£1250
Hewlett Packard 5183A - Waveform Recorder.....	£750
Hewlett Packard 5238A - Frequency Counter 100MHz.....	£250
Hewlett Packard 5314A - (NEW) 100MHz Universal Counter.....	£250
Hewlett Packard 5316A - Universal Counter (IEEE).....	£400
Hewlett Packard 5335A - 200MHz High Performance Systems Counter.....	£900
Hewlett Packard 5332A - Microwave Frequency Counter (500MHz-16GHz) Opts 1+3.....	£300
Hewlett Packard 5358A - High Resolution Time Synthesiser.....	£2950
Hewlett Packard 5370B - Universal Timer/Counter.....	£2000
Hewlett Packard 5384A - 225MHz Frequency Counter.....	£900
Hewlett Packard 5385A - Frequency Counter - 1GHz - (HP1B) with OPTS 001/003/004/005.....	£750
Hewlett Packard 6033A - Power Supply Autoranging (20V - 30A).....	£200
Hewlett Packard 6253A - Power Supply 20V - 3A Twin.....	£200
Hewlett Packard 6256A - Power Supply 40V - 1.5A Twin.....	£200

**HEWLETT PACKARD 6261B
Power Supply 20V - 50A E350 Discount for Quantities**

Hewlett Packard 6264B - Power Supply (0-20V, 0-25A).....	£300
Hewlett Packard 6266B - Power Supply 40V - 5A.....	£225
Hewlett Packard 6271B - Power Supply 60V - 3A.....	£220
Hewlett Packard 6824A - Quad Power Supply.....	£2000
Hewlett Packard 6832A - Power Supply (20V - 5A).....	£300
Hewlett Packard 6901B - Data Generator System P.S.U.....	£200
Hewlett Packard 7475A - 6 Pen Plotter.....	£250
Hewlett Packard 7650A - 6 Pen Plotter.....	£350
Hewlett Packard 778D - Coax Dual Directional Coupler.....	£900
Hewlett Packard 9015A - 50MHz Pulse Generator.....	£500
Hewlett Packard 8185A - 50MHz Programmable Signal Source.....	£1250
Hewlett Packard 8182A - Data Generator.....	£1500
Hewlett Packard 8182A - Data Analyser.....	£1500
Hewlett Packard 8350B - Sweep Oscillator Mainframe (various plug-in options available).....	£2800
Hewlett Packard 83554A - Wave Source Module 26.5 to 40GHz.....	£3600
Hewlett Packard 83555A - Millimeter - Wave Source Module 33-50GHz.....	£4250
Hewlett Packard 8405A - Vector Voltmeter.....	£350
Hewlett Packard 8657A - Signal Generator (100kHz-1040MHz).....	from £250
Hewlett Packard 8640B - Signal Generator (512MHz+1024MHz).....	from £350
Hewlett Packard 9642A - Signal Generator (0-01 to 1050MHz) High Performance Synthesiser.....	£6600
Hewlett Packard 9656A - Synthesised Signal Generator (990MHz).....	£450
Hewlett Packard 9659B - Synthesised Signal Generator.....	£1450
Hewlett Packard 9659A - Cellular Radio Interface.....	£1900
Hewlett Packard 9660D - Synthesised Signal Generator (10kHz-2800MHz).....	£350
Hewlett Packard 8750A - Storage Normaliser.....	£295
Hewlett Packard 8758A - Scalar Network Analyser.....	£1500
Hewlett Packard 8757A - Scalar Network Analyser.....	£2250
Hewlett Packard 8901A - Modulation Analyser.....	£1050
Hewlett Packard 8903E - Modulation Analyser.....	£2000
Hewlett Packard 8903B - Distortion Analyser.....	£1900
Hewlett Packard 8903B - Distortion Analyser (Mini).....	£1500
Hewlett Packard 8920A - R/F Comms Test Set.....	£2500
Hewlett Packard 8922B/G/H - Radio Comms Test Sets (G.S.M.).....	from £9000
Hewlett Packard 9695A - Cellular Radio Interface.....	£1800
Keytek MZ-18/EC - Minizap 15kV Hand-Held ESD Simulator.....	£1750
Krohn-Hite 2200 - Lin/Log Sweep Generator.....	£995
Krohn-Hite 4024A - Oscillator.....	£250
Krohn-Hite 5200 - Sweep, Function Generator.....	£350
Krohn-Hite 6500 - Phase Meter.....	£250
Krohn-Hite 7000 - Distortion Meter.....	£350
Leader 3218 - Signal Generator (100kHz-140kHz) AM/FM/CW with built-in FM stereo modulator (mint).....	£995
Marconi 1068B - Demultiplexer and Frame Alignment Monitor (new).....	£90A
Marconi 2018 - 80kHz-1040MHz Synthesised Signal Generator.....	£750
Marconi 2019A - 80kHz-1040MHz Synthesised Signal Generator.....	£1000
Marconi 2111 - UHF Synthesiser (new).....	£90A
Marconi 2185 - 1.5GHz Programmable Attenuator (new).....	£90A
Marconi 2305 - Modulation Meter.....	£1750
Marconi 2337A - Automatic Distortion Meter.....	£180
Marconi 2610 - True RMS Voltmeter.....	£700
Marconi 2871 - Data Comms Analyser.....	£500
Marconi 2965 - Radio Comms Test Set.....	£2000
Marconi 6310 - Sweep Generator - Programmable - new (2-20GHz).....	£3500
Marconi 8950/8960 - Power Meter & Sensor.....	from £500
Marconi 8960 - Power Meter & Sensor.....	from £950
Marconi 893 - A/F Power Meter.....	£250
Marconi 9187 - Multi-Function Generator.....	£400
Philips 5190 - L.F. Synthesiser (G.P.I.B.).....	£300
Philips 5518 - Synthesised Function Generator.....	£1800
Philips PM5519 - TV Pattern Generator.....	£350
Philips PM5718 - 50MHz Pulse Generator.....	£525
Prema 4006 - 8 Digit Multimeter (NEW).....	£350
Quinton Dale 2A - R/F Frequency Standard.....	£200
Racal 1992 - 1.3GHz Frequency Counter.....	£700
Racal 6111/6151 - GSM Radio Comms Test Set.....	£90A
Racal Dana 9061/9062 - Synthesised Signal Generator 520MHz.....	from £400
Racal Dana 9084 - Synthesised Signal Generator 104MHz.....	£450
Racal 9301A - True RMS R/F Multivoltmeter.....	£260
Racal Dana 9302 - R/F Multivoltmeter (new version).....	£275
Racal Dana 9303 - R/F Level Meter & Head.....	£350
Racal Dana 9917 - UHF Frequency Meter 560MHz.....	£175
Rohde & Schwarz LFM2 - 60MHz Group Delay Sweep Generator.....	£950
Rohde & Schwarz CMTA 94 - GSM Radio Comms Analyser.....	£995
Schaffner NSG 205A - Line Voltage Variation Simulator.....	£750
Schaffner NSG 222A - Interference Simulator.....	£700
Schaffner NSG 223 - Interference Generator.....	£700
Schlumberger 2720 - 1250MHz Frequency Counter.....	£400
Schlumberger 4031 - 1GHz Radio Comms Test Set.....	£495
Schlumberger Stablock 4040 - Radio Comms Test Set.....	£195
Schlumberger 7067/7068/7078 - Multimeters.....	from £350
Stanford Research DS 340 - 15MHz Synthesised Function (NEW) and Arbitrary Waveform Generator.....	£1200
Syston Donner 8030 - Microwave Frequency Counter (26-5GHz).....	£1995
Tektronix AM503+TG501+PG302 - Current Probe Amplifier.....	£995
Tektronix PG506+TG501+PG302 - Oscilloscope Calibrator.....	£1995
Tektronix 1210 - Logic Analyser.....	£1100
Tektronix 14A - PAL Test Signal Generator.....	£250
Tektronix AA5001 + TM5006 M/F - Programmable Distortion Analyser.....	£1995
Tektronix TM5003+AFG 5101 - Arbitrary Function Generator.....	£1800
Tektronix - Plug-Ins - many available such as SC504, SW503, SG502, PG506, TG504, FG503, TG501, TR503+ many more.....	£900
Time 9811 - Programmable Resistance.....	£400
Time 9814 - Voltage Calibrator.....	£550
Vahlhal Scientific - 2724 Programmable Resistance Standard.....	£90A
Wandel & Göttermann PF-8 - Error/Jitter Test Set.....	£11800
Wandel & Göttermann PCM4 (+options).....	£995
Wandel & Göttermann MU30 - Test Point Scanner.....	£1600
Wayne Kerr 4225 - LCR Bridge.....	£300
Wavetek 171 - Synthesised Function Generator.....	£250
Wavetek 172B - Programmable Signal Source (0-0001Hz-13MHz).....	£90A
Wavetek 184 - Sweep Generator - 5MHz.....	£250
Wavetek 3010 - 1-1GHz Signal Generator.....	£1250
Wiltron 8408 - RF Analyser (1MHz-2GHz).....	£90A
Wiltron 8620S - Programmable Sweep Generator (3.8GHz-6.5GHz).....	£950
Wiltron 8747-20 - Sweep Frequency Synthesiser (10MHz-20GHz).....	£3950
Yokogawa 3655 - Analysing Recorder.....	£90A

**MANY MORE ITEMS AVAILABLE -
SEND LARGE SAE FOR LIST OF EQUIPMENT
ALL EQUIPMENT IS USED -
WITH 30 DAYS GUARANTEE.
PLEASE CHECK FOR AVAILABILITY BEFORE ORDERING
CARRIAGE & VAT TO BE ADDED TO ALL GOODS**

MAIL ORDER ONLY • CALLERS BY APPOINTMENT

EPE MICROCONTROLLER P.I. TREASURE HUNTER

The latest MAGENTA DESIGN – highly stable & sensitive – with I.C. control of all timing functions and advanced pulse separation techniques.

- High stability drift cancelling
- Easy to build & use
- No ground effect, works in seawater



- Detects gold, silver, ferrous & non-ferrous metals

- Efficient quartz controlled microcontroller pulse generation.
- Full kit with headphones & all hardware

KIT 847 £63.95

PORTABLE ULTRASONIC PEST SCARER

A powerful 23kHz ultrasound generator in a compact hand-held case. MOSFET output drives a special sealed transducer with intense pulses via a special tuned transformer. Sweeping frequency output is designed to give maximum output without any special setting up.

KIT 842.....£22.56

ICEBREAKER

PIC REAL TIME IN-CIRCUIT EMULATOR – SEE PAGE 749

DC Motor/Gearboxes

Our Popular and Versatile DC motor/Gearbox sets. Ideal for Models, Robots, Buggies etc. 1-5V to 4-5V Multi ratio gearbox gives wide range of speeds.

LARGE TYPE – MGL £6.95
SMALL – MGS – £4.77



Stepping Motors

MD38...Mini 48 step...£8.65

MD35...Std 48 step...£9.99

MD200...200 step...£12.99

MD24...Large 200 step...£22.95



PIC PIPE DESCALER

- SIMPLE TO BUILD
- HIGH POWER OUTPUT
- AUDIO & VISUAL MONITORING
- SWEPT FREQUENCY

An affordable circuit which sweeps the incoming water supply with variable frequency electromagnetic signals. May reduce scale formation, dissolve existing scale and improve lathering ability by altering the way salts in the water behave. Kit includes case, P.C.B., coupling coil and all components. High coil current ensures maximum effect. L.E.D. monitor.

KIT 868 £22.95 POWER UNIT.....£3.99



MICRO PEST SCARER

Our latest design – The ultimate scarer for the garden. Uses special microchip to give random delay and pulse time. Easy to build reliable circuit. Keeps pets/pests away from newly sown areas, play areas, etc. uses power source from 9 to 24 volts.

- RANDOM PULSES
- HIGH POWER
- DUAL OPTION



Plug-in power supply £4.99

KIT 867.....£19.99

KIT + SLAVE UNIT.....£32.50

WINDICATOR

A novel wind speed indicator with LED readout. Kit comes complete with sensor cups, and weatherproof sensing head. Mains power unit £5.99 extra.

KIT 856.....£28.00

★ TENS UNIT ★

DUAL OUTPUT TENS UNIT

As featured in March '97 issue.

Magenta have prepared a FULL KIT for this excellent new project. All components, PCB, hardware and electrodes are included. Designed for simple assembly and testing and providing high level dual output drive.

KIT 866. . Full kit including four electrodes £32.90

Set of 4 spare electrodes £6.50

1000V & 500V INSULATION TESTER



Superb new design. Regulated output, efficient circuit. Dual-scale meter, compact case. Reads up to 200 Megohms.

Kit includes wound coil, cut-out case, meter scale, PCB & ALL components.

KIT 848. £32.95

EPE TEACH-IN 2000

Full set of top quality NEW components for this educational series. All parts as specified by EPE. Kit includes breadboard, wire, croc clips, pins and all components for experiments, as listed in introduction to Part 1.

*Batteries and tools not included.

TEACH-IN 2000 -

KIT 879 £44.95

MULTIMETER £14.45

SPACEWRITER

An innovative and exciting project. Wave the wand through the air and your message appears. Programmable to hold any message up to 16 digits long. Comes pre-loaded with "MERRY XMAS". Kit includes PCB, all components & tube plus instructions for message loading.

KIT 849£16.99

12V EPROM ERASER

A safe low cost eraser for up to 4 EPROMS at a time in less than 20 minutes. Operates from a 12V supply (400mA). Used extensively for mobile work - updating equipment in the field etc. Also in educational situations where mains supplies are not allowed. Safety interlock prevents contact with UV.

KIT 790£29.90

SUPER BAT DETECTOR

1 WATT O/P, BUILT IN SPEAKER, COMPACT CASE 20kHz-140kHz

NEW DESIGN WITH 40kHz MIC.

A new circuit using a 'full-bridge' audio amplifier i.e., internal speaker, and headphone/tape socket. The latest sensitive transducer, and 'double balanced mixer' give a stable, high performance superheterodyne design.

KIT 861£24.99

ALSO AVAILABLE Built & Tested... £39.99



MOSFET MKII VARIABLE BENCH POWER SUPPLY 0-25V 2-5A

Based on our Mk1 design and preserving all the features, but now with switching pre-regulator for much higher efficiency. Panel meters indicate Volts and Amps. Fully variable down to zero. Toroidal mains transformer. Kit includes punched and printed case and all parts. As featured in April 1994 EPE. An essential piece of equipment.



Kit No. 845 £64.95

EPE PROJECT PICS

Programmed PICs for all* EPE Projects 16C84/18F84/16C71

All **£5.90 each**
PIC16F877 now in stock £10 inc. VAT & postage

(*some projects are copyright)

ULTRASONIC PEST SCARER

Keep pets/pests away from newly sown areas, fruit, vegetable and flower beds, children's play areas, patios etc. This project produces intense pulses of ultrasound which deter visiting animals.

- KIT INCLUDES ALL COMPONENTS, PCB & CASE
- EFFICIENT 100V TRANSDUCER OUTPUT
- COMPLETELY INAUDIBLE TO HUMANS



- UP TO 4 METRES RANGE
- LOW CURRENT DRAIN

KIT 812..... £15.00

SIMPLE PIC PROGRAMMER

INCREDIBLE LOW PRICE! Kit 857 **£12.99**

INCLUDES 1-PIC16F84 CHIP
SOFTWARE DISK, LEAD
CONNECTOR, PROFESSIONAL
PC BOARD & INSTRUCTIONS

Power Supply £3.99

EXTRA CHIPS:

PIC 16F84 £4.84

Based on February '96 EPE. Magenta designed PCB and kit. PCB with 'Reset' switch, Program switch, 5V regulator and test L.E.D.s, and connection points for access to all A and B port pins.

PIC 16C84 DISPLAY DRIVER

INCLUDES 1 PIC16F84 WITH
DEMO PROGRAM SOFTWARE
DISK, PCB, INSTRUCTIONS
AND 16-CHARACTER 2-LINE
LCD DISPLAY

Kit 860 **£19.99**

Power Supply £3.99

FULL PROGRAM SOURCE
CODE SUPPLIED - DEVELOP
YOUR OWN APPLICATION!

Another super PIC project from Magenta. Supplied with PCB, industry standard 2-LINE x 16-character display, data, all components, and software to include in your own programs. Ideal development base for meters, terminals, calculators, counters, timers - Just waiting for your application!

PIC 16F84 MAINS POWER 4-CHANNEL CONTROLLER & LIGHT CHASER

- WITH PROGRAMMED 16F84 AND DISK WITH SOURCE CODE IN MPASM
- ZERO VOLT SWITCHING MULTIPLE CHASE PATTERNS
- OPTO ISOLATED 5 AMP OUTPUTS
- 12 KEYPAD CONTROL
- SPEED/DIMMING POT.
- HARD-FIRED TRIACS

Kit 855 **£39.95**

LOTS OF OTHER APPLICATIONS

Now features full 4-channel chaser software on DISK and pre-programmed PIC16F84 chip. Easily re-programmed for your own applications. Software source code is fully 'commented' so that it can be followed easily.

PIC TOOLKIT V1

- PROGRAMS PIC16C84 and 16F84 • ACCEPTS TASM AND MPASM CODE
- Full kit includes PIC16F84 chip, top quality p.c.b. printed with component layout, turned-pin PIC socket, all components and software*
*Needs QBASIC or QUICKBASIC

Kit 871 . . . **£13.99** Built and tested **£21.99**

PhizzyB

ALL PARTS FOR SERIES INCLUDING PCBs, PROGRAMMED CHIP, CD-ROM AND DISPLAYS

MAIN BOARD - FULL KIT	£131.95	BUILT.....	£149.95
I/O PORT KIT.....	£16.99	BUILT.....	£24.99
L.C.D.....	£12.49	POWER SUPPLY	£3.99
8-BIT SWITCH/LATCH.....	£7.95	INT. MODULE.	£10.45

68000 DEVELOPMENT AND TRAINING KIT

- NEW PCB DESIGN
- 8MHz 68000 16-BIT BUS
- MANUAL AND SOFTWARE
- 2 SERIAL PORTS
- PIT AND I/O PORT OPTIONS
- 12C PORT OPTIONS



KIT 621

£99.95

- ON BOARD 5V REGULATOR
- PSU **£6.99**
- SERIAL LEAD **£3.99**

Mini-Lab & Micro Lab Electronics Teach-In 7

As featured in EPE and now published as Teach-In 7. All parts are supplied by Magenta.

Teach-In 7 is £3.95 from us or EPE
Full Mini Lab Kit - £119.95 -
Power supply extra - £22.55
Full Micro Lab Kit - £155.95
Built Micro Lab - £189.95



EPE PIC Tutorial

At last! A Real, Practical, Hands-On Series

- Learn Programming from scratch using PIC16F84
- Start by lighting I.e.d.s and do 30 tutorials to Sound Generation, Data Display, and a Security System.
- PIC TUTOR Board with Switches, I.e.d.s, and on board programmer

PIC TUTOR BOARD KIT

Includes: PIC16F84 Chip, TOP Quality PCB printed with Component Layout and all components* (*not ZIF Socket or Displays). Included with the Magenta Kit is a disk with Test and Demonstration routines.

KIT 870 **£27.95, Built & Tested £42.95**

Optional: Power Supply - **£3.99**, ZIF Socket - **£9.99**

LCD Display **£7.99** LED Display **£6.99**

Reprints Mar/Apr/May 98 - **£3.00 set 3**

PIC TOOLKIT V2

- SUPER UPGRADE FROM V1 • 18, 28 AND 40-PIN CHIPS
- READ, WRITE, ASSEMBLE & DISASSEMBLE PICS
- SIMPLE POWER SUPPLY OPTIONS 5V-20V
- ALL SWITCHING UNDER SOFTWARE CONTROL
- MAGENTA DESIGNED PCB HAS TERMINAL PINS AND OSCILLATOR CONNECTIONS FOR ALL CHIPS
- INCLUDES SOFTWARE AND PIC CHIP

KIT 878 . . . **£22.99** with 16F84 . . . **£29.99** with 16F877

SUPER PIC PROGRAMMER

- READS PROGRAMS, AND VERIFIES
- WINDOWS™ SOFTWARE
- PIC16C6X, 7X, AND 8X
- USES ANY PC PARALLEL PORT
- USES STANDARD MICROCHIP • HEX FILES
- OPTIONAL DISASSEMBLER SOFTWARE (EXTRA)
- PCB, LEAD, ALL COMPONENTS, TURNED-PIN SOCKETS FOR 18, 28, AND 40 PIN ICs

- SEND FOR DETAILED INFORMATION - A SUPERB PRODUCT AT AN UNBEATABLE LOW PRICE

Kit 862 **£29.99**

Power Supply £3.99

DISASSEMBLER SOFTWARE **£11.75**

PIC STEPPING MOTOR DRIVER

INCLUDES PCB, PIC16F84 WITH DEMO PROGRAM, SOFTWARE DISC, INSTRUCTIONS AND MOTOR.

Kit 863 **£18.99**

FULL SOURCE CODE SUPPLIED ALSO USE FOR DRIVING OTHER POWER DEVICES e.g. SOLENOIDS

Another NEW Magenta PIC project. Drives any 4-phase unipolar motor - up to 24V and 1A. Kit includes all components and 48 step motor. Chip is pre-programmed with demo software, then write your own, and re-program the same chip! Circuit accepts inputs from switches etc and drives motor in response. Also runs standard demo sequence from memory.

8-CHANNEL DATA LOGGER

As featured in Aug./Sept. '99 EPE. Full kit with Magenta redesigned PCB - LCD fits directly on board. Use as Data Logger or as a test bed for many other 16F877 projects. Kit includes programmed chip, 8 EEPROMs, PCB, case and all components.

KIT 877 **£49.95** inc. 8 x 256K EEPROMS

MAGENTA

All prices include VAT. Add £3.00 p&p. Next day **£6.99**

Tel: 01283 565435 Fax: 01283 546932 E-mail: sales@magenta2000.co.uk

102000



Station Road, Cullercoats, Tyne & Wear, NE30 4PQ

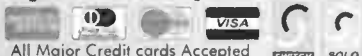

All Major Credit cards Accepted... Prices Exclude Vat @17.5%. Add £1.25 (UK) carriage & Vat to all orders. Cheques / Postal orders payable to ESR Electronic Components.

See Next / Last Months Ad. for COMPONENT ACCESSORIES

Table listing electronic components such as 4000 Series, 74HC Series, and 74 Series. Includes part numbers, descriptions, and prices.

Table listing electronic components including EPROM's, RAM, Bridge Rectifiers, A/D Converters, Voltage Regulators, Diodes, and Linear ICs. Includes part numbers, descriptions, and prices.

Table listing electronic components including Electrolytic Radial, Electrolytic Axial, Resistors, Potentiometers, and PCB Mount components. Includes part numbers, descriptions, and prices.

Quality Components Quantity Discounts Available

Tel: 0191 2514363 Fax: 0191 252296 Email: sales@esr.co.uk http://www.esr.co.uk

EVERYDAY PRACTICAL ELECTRONICS

INCORPORATING ELECTRONICS TODAY INTERNATIONAL

THE No.1 MAGAZINE FOR ELECTRONICS TECHNOLOGY & COMPUTER PROJECTS

VOL. 29 No. 10 OCTOBER 2000

Editorial Offices:
EVERYDAY PRACTICAL ELECTRONICS EDITORIAL
ALLEN HOUSE, EAST BOROUGH, WIMBORNE
DORSET BH21 1PF
Phone: Wimborne (01202) 881749
Fax: (01202) 841692.

E-mail: editorial@epemag.wimborne.co.uk
Web Site: <http://www.epemag.wimborne.co.uk>
EPE Online www.epemag.com

See notes on Readers' Enquiries below – we regret lengthy technical enquiries cannot be answered over the telephone.

Advertisement Offices:
EVERYDAY PRACTICAL ELECTRONICS ADVERTISEMENTS
MILL LODGE, MILL LANE
THORPE-LE-SOKEN, ESSEX CO16 0ED
Phone/Fax: (01255) 861161

SUPPLY PROBLEMS

I have often referred to supply problems associated with components but now we are facing one associated with the magazine. To put it briefly the major retail chains in the UK simply cannot carry all the available magazines in their shops, so they are restricting the range of titles they carry. You may find it increasingly difficult to obtain your copy of *EPE* (and many other specialist magazines) off the shelf, particularly if you do not live in a large town or city.

There is little we can do to overcome this problem but there are ways in which you can overcome it. If you normally buy your magazine off the shelf it may be worthwhile placing an order with your supplier so that he will "shop save" an issue for you. Since all issues supplied to retailers are on Sale Or Return you do not have to buy the magazine when you get to see it, your newsagent can always return it to his wholesaler. Elsewhere in this issue you will find a Newsagent Order Form (page 768) which will allow you to request that your newsagent reserves or delivers your copy of *EPE* each month.

CHEAPER AND CHEAPER

There is the cheaper alternative of taking out a subscription. This of course means that you have to pay in advance, but we have tried to take the sting out of that by offering a new six month subscription and by giving a discount of over 12% (that's £2 off the cover price for six issues). If you are truly committed to the magazine there is also now an extra discount if you buy a one year subscription – 16% off, or the equivalent of two issues free – or a two year subscription – 24% off, or the equivalent of nearly six issues free.

So, although you pay in advance for a subscription, you will get a discount on the cover price each year and your magazine will be posted in time to arrive before it appears on the bookstalls (UK addresses). You also avoid any cover price rises that may occur during the subscription period. A subscription order form appears on page 732.

A two year subscription on standard air service to overseas addresses now also represents a saving on the normal UK cover price and that includes the postage, so it's also a bargain.

Of course, there is an even cheaper alternative and that is to download the magazine from our Online web site. *EPE Online* is available a few days after the printed issue but only costs \$9.99(US) for 12 issues – that's about 55p an issue. It's certainly a bargain and it's the way to go if you live outside of the UK, where printed issues are hard to find, and have good web access and a decent printer. Log on to www.epemag.com and take a look, you can pay on-line on a secure server using a credit card and download the magazine almost immediately – it takes about 20 seconds to verify and charge your credit card.

NOT PUBLISHED

Please don't believe the "not yet published", "never heard of it mate", "it's late coming out this month" stories we get reported to us. We have not published an issue late, or missed an issue, in the last 20 years, so we don't intend to start now. You should, however, note our new publishing date which, from next month onwards, will be the second Thursday in the month – the November issue will be out on October



AVAILABILITY

Copies of *EPE* are available on subscription anywhere in the world (see below), from all UK newsagents (distributed by COMAG) and from the following electronic component retailers: Omni Electronics and Maplin in S. Africa. *EPE* can also be purchased from retail magazine outlets around the world. An Internet on-line version can be purchased for just \$9.99(US) per year available from www.epemag.com

SUBSCRIPTIONS

Subscriptions for delivery direct to any address in the

UK: 6 months £14.50, 12 months £27.50, two years £50; Overseas: 6 months £17.50 standard air service or £27 express airmail, 12 months £33.50 standard air service or £51 express airmail, 24 months £62 standard air service or £97 express airmail.

Online subscriptions, for downloading the magazine via the Internet, \$9.99(US) for one year available from www.epemag.com.

Cheques or bank drafts (in £ sterling only) payable to *Everyday Practical Electronics* and sent to EPE Sub. Dept., Allen House, East Borough, Wimborne, Dorset BH21 1PF. Tel: 01202 881749. Fax: 01202 841692. E-mail: subs@epemag.wimborne.co.uk. Also via the Web at: <http://www.epemag.wimborne.co.uk>. Subscriptions start with the next available issue. We accept MasterCard or Visa. (For past issues see the Back Issues page.)

BINDERS

Binders to hold one volume (12 issues) are available from the above address. These are finished in blue p.v.c., printed with the magazine logo in gold on the spine. Price £5.95 plus £3.50 p&p (for overseas readers the postage is £6.00 to everywhere except Australia and Papua New Guinea which cost £10.50). Normally sent within seven days but please allow 28 days for delivery – more for overseas.

Payment in £ sterling only please. Visa and MasterCard accepted, minimum credit card order £5. Send, fax or phone your card number and card expiry date with your name, address etc. Or order on our secure server via our UK web site. Overseas customers – your credit card will be charged by the card provider in your local currency at the existing exchange rate.

Editor: MIKE KENWARD

Deputy Editor: DAVID BARRINGTON

Technical Editor: JOHN BECKER

Business Manager: DAVID J. LEAVER

Subscriptions: MARILYN GOLDBERG

Administration: FAY KENWARD

Editorial/Admin: Wimborne (01202) 881749

Advertisement Manager:
PETER J. MEW, Frinton (01255) 861161

Advertisement Copy Controller:
PETER SHERIDAN, Wimborne (01202) 882299

On-Line Editor: ALAN WINSTANLEY

EPE Online (Internet version) Editors:
CLIVE (MAX) MAXFIELD and ALVIN BROWN

READERS' ENQUIRIES

E-mail: techdept@epemag.wimborne.co.uk
We are unable to offer any advice on the use, purchase, repair or modification of commercial equipment or the incorporation or modification of designs published in the magazine. We regret that we cannot provide data or answer queries on articles or projects that are more than five years old. Letters requiring a personal reply must be accompanied by a stamped self-addressed envelope or a self-addressed envelope and international reply coupons. All reasonable precautions are taken to ensure that the advice and data given to readers is reliable. We cannot, however, guarantee it and we cannot accept legal responsibility for it.

COMPONENT SUPPLIES

We do not supply electronic components or kits for building the projects featured, these can be supplied by advertisers (see *Shoptalk*). We advise readers to check that all parts are still available before commencing any project in a back-dated issue.

ADVERTISEMENTS

E-mail: adverts@epemag.wimborne.co.uk
Although the proprietors and staff of EVERYDAY PRACTICAL ELECTRONICS take reasonable precautions to protect the interests of readers by ensuring as far as practicable that advertisements are bona fide, the magazine and its Publishers cannot give any undertakings in respect of statements or claims made by advertisers, whether these advertisements are printed as part of the magazine, or in inserts.

The Publishers regret that under no circumstances will the magazine accept liability for non-receipt of goods ordered, or for late delivery, or for faults in manufacture.

TRANSMITTERS/BUGS/TELEPHONE EQUIPMENT

We advise readers that certain items of radio transmitting and telephone equipment which may be advertised in our pages cannot be legally used in the UK. Readers should check the law before buying any transmitting or telephone equipment as a fine, confiscation of equipment and/or imprisonment can result from illegal use or ownership. The laws vary from country to country; readers should check local laws.



Constructional Project

WIND-UP

TORCH

THOMAS SCARBOROUGH

An occasional twist of a knob provides light without battery power.

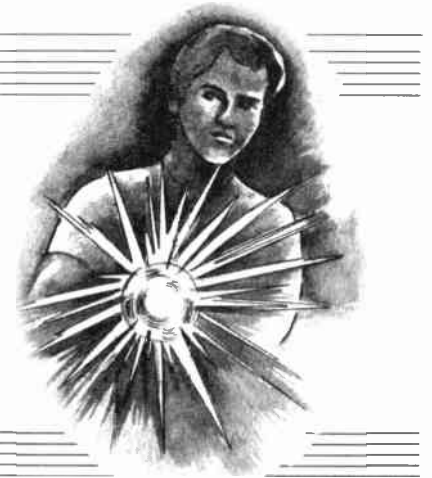

A COMMON problem with small torches is the short life-span both of the batteries and the bulb. The batteries of a small "penlite" torch will commonly last only two to three hours, and many bulb filaments burn no more than a few weeks before fusing. Besides this, torch batteries can sometimes be hard to come by, especially when camping or visiting remote areas.

The idea for a better torch was born a few years ago when the author was caught in a violent tropical storm on a remote dirt track, and his penlite torch rapidly faded and died.

LIGHTING THE WAY

With new light emitting diode (l.e.d.) technology, it is now possible to build a torch that quite adequately lights the way five to ten metres in front. In fact, since power consumption is so small, it is possible to power the light for a considerable length of time from a few turns of a small generator with a capacitor "reservoir" – the sole source of power for this torch (no batteries).

In addition to this, the white l.e.d. used in the circuit has a life expectancy of years, not weeks as in the case of a standard filament bulb.

While the light output of the Wind-up Torch is modest in comparison with some modern torches, it matches several

candlepower at medium power, and is thus quite serviceable. It will provide ample light around a camp table, for walking on a foot-path, or for reading.

The light output of the torch is continuously variable, and its expected service from each full wind is as follows:

- Book-light 90 minutes
- Medium-power beam 40 minutes
- Beam for walking 15 minutes

readily and cheaply obtainable second-hand or as surplus goods.

The a.c. voltage from the stepper motor is full-wave rectified, regulated, and fed into a two Farad (2F) reservoir capacitor. Since a capacitor's characteristics are very different to those of an ordinary power supply, a special regulator is required between the reservoir and the l.e.d.

Unlike a battery, which gradually discharges, a capacitor releases a surge of power, which becomes a weaker and more steady flow with time. This may be likened to a breach in a dam wall: an initial surge of water becomes, after a while, a weaker and more steady stream.

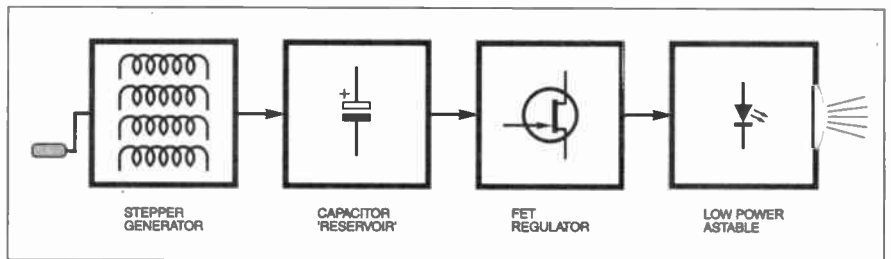

Fig.1. Schematic block diagram for the Wind-up Torch.

TORCH OPERATION

The block diagram of the Wind-up Torch is given in Fig.1.

Power is provided by a generator based on a stepper motor. A stepper motor was chosen for two reasons: such motors produce a good a.c. voltage at fairly low revs, thus obviating the need for complicated gearing. Also, since the demise of floppy disk drives, these motors are

The regulator is based on a field effect transistor (f.e.t.), which draws just a few microamps, and provides a very steady voltage from the falling voltage of the reservoir capacitor.

The final stage incorporates a very low power astable circuit, which pulses the white l.e.d. so as to conserve power. A compromise was sought that reduces power consumption to a minimum, while not reducing light level too noticeably, or causing any visual disturbance through the pulsed light. By pulsing the light, power consumption is greatly reduced, and torch-light extended more than ten times.

GENERATOR

A wide range of 12V stepper motors may be used for the generator and they come in various shapes and sizes. If they are purchased new, they can be costly. However, if an old floppy disk drive (working or non-working) is purchased and the stepper motor removed, the cost may be reduced considerably.

It is unlikely that a floppy disk drive has failed due to stepper motor failure, so even if a motor has been removed from a non-working drive, it is still likely to be sound. The stepper motor in the circuit was removed from an old 5-25-inch floppy disk drive.

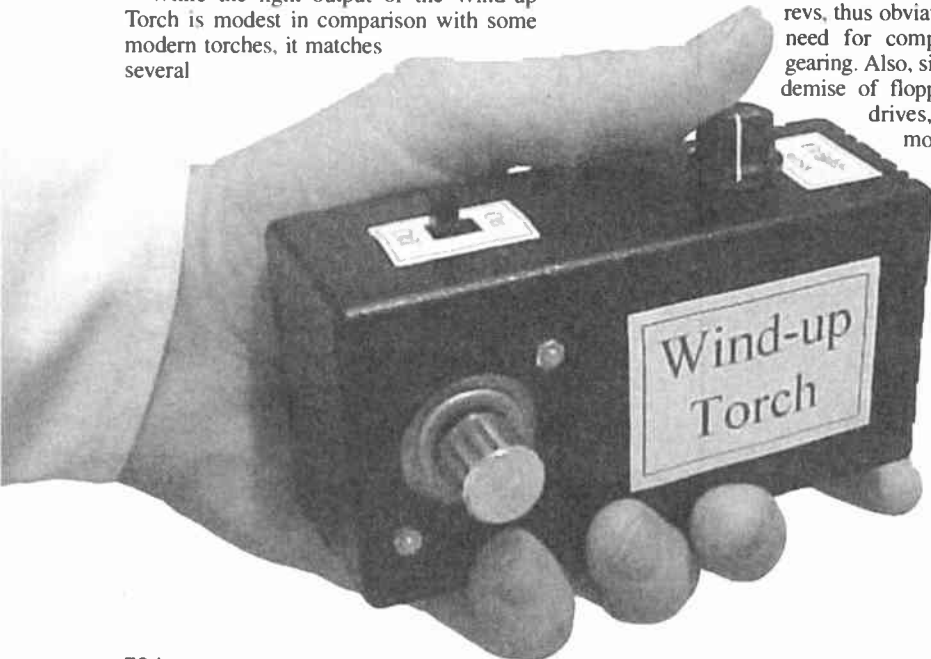

More often than not, the four windings of a stepper motor are commoned, with the common (+VE) lead coloured red. It is easy to test with a multimeter which is the common lead. Measure the resistances across every combination of leads – if the resistances from one lead to all the rest are less than every other resistance measured, this is the common lead. If, on the other hand, some combinations of leads indicate open circuit, the motor's windings are likely to be separate.

The voltage produced by both types of motor is a.c., which needs to be converted to d.c., using full-wave rectification, as shown in Fig.2.

The circuit in Fig.2a illustrates how the four windings of a stepper motor are wired if it has commoned leads. Fig.2b shows the circuit if the motor has separate windings.

Since commoned windings are by far the most usual arrangement with stepper motors, the component layout of the Wind-up Torch (Fig.4 later) is designed specifically for such motors.

MAIN CIRCUIT DIAGRAM

The main circuit diagram for the Wind-up Torch is shown in Fig.3.

The rectified d.c. output from the stepper motor circuit is fed into capacitor C1, which serves to smooth the fluctuating output of the generator.

From C1, the voltage is fed via rectifier diode D1, which prevents reverse leakage of current, into two 1F (one Farad) reservoir capacitors, C2 and C3. These are "memory retention" (back-up) types and need to be treated with care, since they are both pricy and easily damaged.

The rectified d.c. voltage from the stepper motor will vary considerably, depending on its type and the speed at which it is turned. Since the maximum voltage rating of C2 and C3 is 5.5V, a 5.1V Zener diode regulator (D2) is incorporated into the supply line following diode D1. The Zener used has a 5W rating, although a 1.3W type was tested thoroughly without failure. Charge current is around 15mA on a moderate wind.

CIRCUIT OPERATION

The main regulator section of the circuit is based on f.e.t. TR2. This holds a very steady voltage as the reservoir voltage falls, and will likely show a marginal rise in voltage for some time.

When the Wind-up Torch is adjusted for use as a book-light (3V), it maintains over 95 per cent of voltage for about 90 minutes. At the highest brightness setting (3.6V), it maintains over 95 per cent of voltage for 15 minutes. The regulator was tested up to 5V without failure of the l.e.d. – however, this is not advised, and the circuit disallows it.

Originally, a simple resistor was tried as a regulator between the reservoir capacitor and astable IC1. This limited current consumption and was found to double the life of the reservoir voltage. Assume, however, that the resistance could be automatically reduced as capacitor voltage falls – this would further extend the reservoir's life.

In fact, by substituting a f.e.t. (TR2) for the resistor, and controlling its conductance, the circuit used here outperforms the simple "resistor regulator" by a factor of 10. Total power consumption of the regulator is just 15µA.

A f.e.t. was chosen for the task since, unlike a bipolar transistor which is current controlled, it is voltage (or field effect) controlled, and draws a minute current – a very necessary feature of this application. A negative voltage applied to the gate of the f.e.t. creates a field effect, and "pinches off" current travelling from drain to source – while a positive voltage at the gate increases conductance.

Bipolar transistor TR1, potentiometer VR1 and resistor R4 form a voltage divider which determines the conductance of the f.e.t. As the voltage (and therefore current) declines across capacitors C2 and C3, so TR1 becomes less conductive, the potential at its collector rises, and TR2's conductance increases. Therefore TR2

provides a very steady supply to IC1 and l.e.d. D3.

Note that transistor TR1 has an "A" suffix. This is important, and refers to the low gain of the transistor. Equivalents should be chosen carefully. The considerably larger BD241C may be used as a replacement, if transistors R1 and R2 are paralleled in the R1 position, and a link wire is substituted in the R2 position on the circuit board.

The purpose of capacitor C4 is to maintain a steady power supply for astable IC1, reducing peak current passing through TR2, which has a maximum rating of about 20mA.

The astable circuit is very straightforward, being based on an ICM7555IPA timer, IC1. The importance of using this particular device is that it has a supply

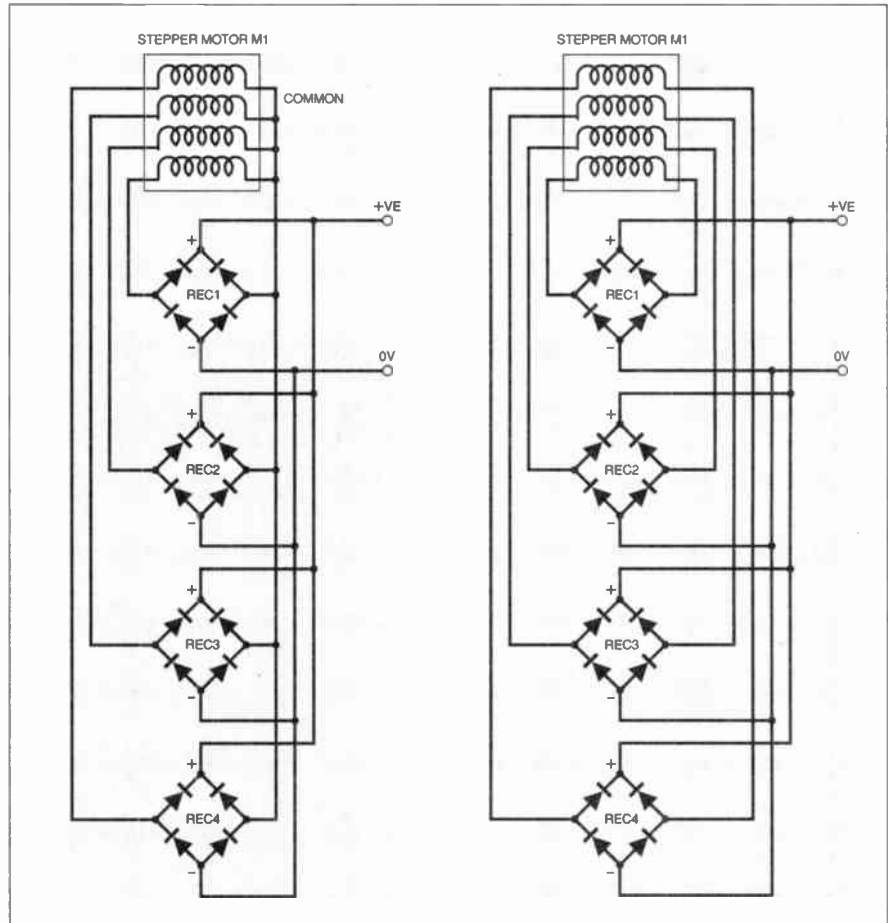

Fig.2. Bridge rectifying the stepper motor windings, (a) if the stepper motor has four common windings, and (b) if the motor has separate windings.

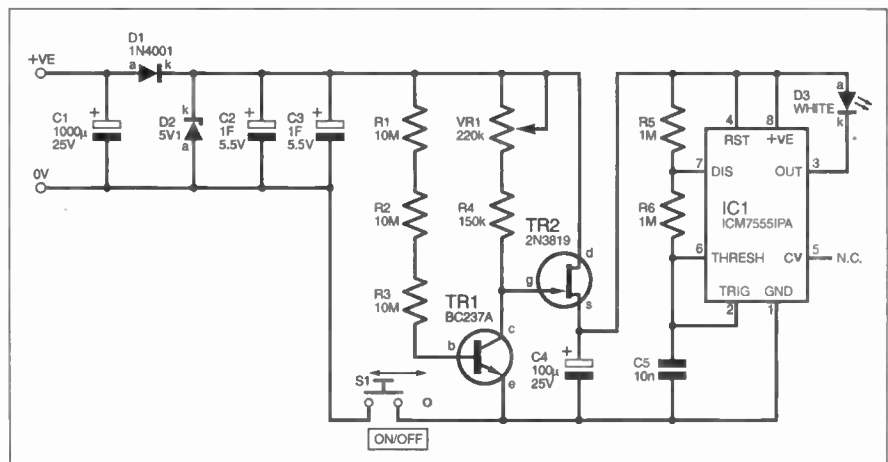

Fig.3. Main regulator circuit diagram for the Wind-up Torch. Power input terminals marked +VE and 0V are joined to one of the identical output points on the stepper motor diagrams in Fig.2.

current of just 60 μ A, and will operate effectively down to 2V. It also has an output sink current of 100mA, which is more than adequate for the present application. A standard 555 timer should not be used, due to its vastly greater current consumption.

High values have been chosen for resistors R5 and R6, so as to keep power consumption to a minimum.

The timer (IC1) is used in oscillator mode and outputs a square wave at pin 3, the peak amplitude being the same as the voltage powering the i.c. This output drives l.e.d. D3, pulsing it on for the duration that the output is low. A ballast resistor is not required for the l.e.d. since the effective current flow is limited by the control circuit.

The high brightness white l.e.d. used is the product of recent advances in semiconductor technology, having been commercially available for about two years. It has a 400mcd output, which, when focussed, gives a beam of several candlepower. If focussed into a tight beam with a quality lens, it will light up objects at a distance of about 30 metres.

If a white l.e.d. is unobtainable, a high brightness coloured l.e.d. may be used in its place, although their light is not as effective, or as pleasing to the eye.

CONSTRUCTION

The Wind-up Torch circuit is built on a piece of stripboard having 15 holes by 24 copper strips. Details of the topside component layout, together with the underside details, are shown in Fig.4.

Commence construction by cutting a standard piece of stripboard down to size using a hacksaw. A small indentation may be cut in the stripboard at positions O15-P16 to pass wires if desired. Create the breaks in the underside of the stripboard with a drill or other appropriate tool.

Space is at a premium, but all the components should fit into place without difficulty, provided you use a miniature plate ceramic capacitor for C5, miniature radial capacitors for C1 and C4, and the specified bridge rectifiers.

Solder the wire links and solder pins (double-ended pins serve best), then the 8-pin dual-in-line socket. Continue with the resistors, diodes D1 and D2, and the four rectifiers (one for each motor winding), followed by the capacitors and transistors. Be careful to observe the correct polarity of the bridge rectifiers, transistors, diodes and electrolytic capacitors.

Solder in l.e.d. D3, leaving it with long legs for later adjustment, and be sure to orientate it parallel with the board for the best optical results.

Capacitor C3 is piggy-backed on top of C2 to conserve space. Additional memory retention capacitors could be used to extend torch life, but this would make winding more time-consuming.

Prepare four sheathed wires 10cm long, and solder them to potentiometer VR1 and switch S1, and then back to the stripboard. Finally, attach the stepper motor leads to the solder pins, and insert IC1, observing its correct orientation.

CASING

The Wind-Up Torch is built into a plastic case with slotted walls, but more

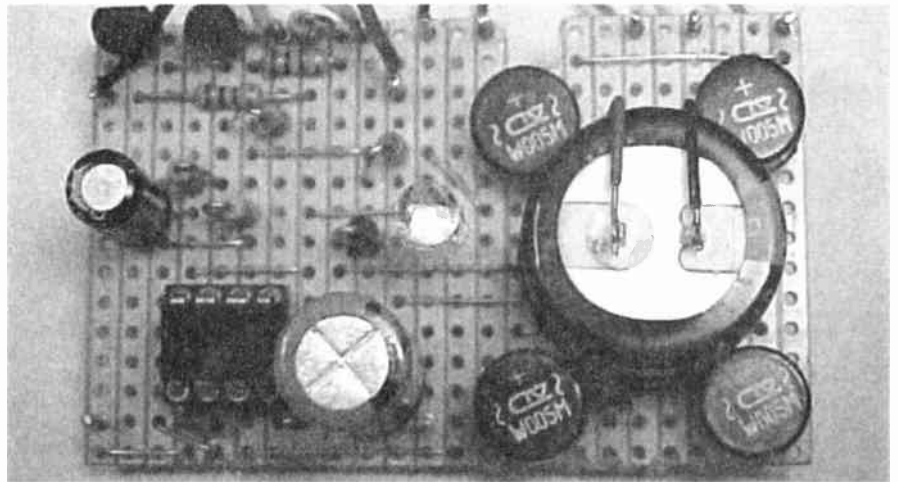

Complete prototype circuit board. Reservoir capacitors C2 and C3 are mounted one on top of the other. This construction differs slightly from the final version.

adventurous constructors might wish to choose a case of their own preferred shape and size.

In order to keep construction as simple as possible, the generator is operated simply by turning a small knob, attached to the motor spindle, between index finger and thumb (a larger knob necessitates movement of the wrist, and is not as convenient).

COMPONENTS

Resistors		See SHOP TALK page
R1 to R3	10M (3 off)	
R4	150k	
R5, R6	1M (2 off)	
All 0.25W 5% carbon film		
Potentiometer		
VR1	220k rotary carbon, lin	
Capacitors		
C1	1000 μ radial elect, 25V	
C2, C3	1F, memory retention, 5.5V (2 off)	
C4	100 μ radial elect, 16V	
C5	10n resin dipped plate ceramic	
Semiconductors		
D1	1N4001 rectifier diode	
D2	5V1 Zener diode, 5W	
D3	white l.e.d., 400mcd	
REC1 to REC4	W005 50V 1.5A bridge rectifier (4 off)	
TR1	BC237A npn transistor (see text)	
TR2	2N3819 n-channel f.e.t.	
IC1	ICM7555IPA low power timer	
Miscellaneous		
M1	12V four-phase stepper motor (see text)	
S1	s.p.s.t. (or d.p.d.t.) sub-min. slide switch	

Lens (see text); plastic case, 104mm x 54mm x 42mm (see text), small knobs with fixing nuts (2 off); stripboard, 0.1in, 15 holes by 24 strips; 8-pin d.i.l. socket; solder pins, double-sided; solder, etc.

Approx. Cost
Guidance Only

£18

excluding motor and lens

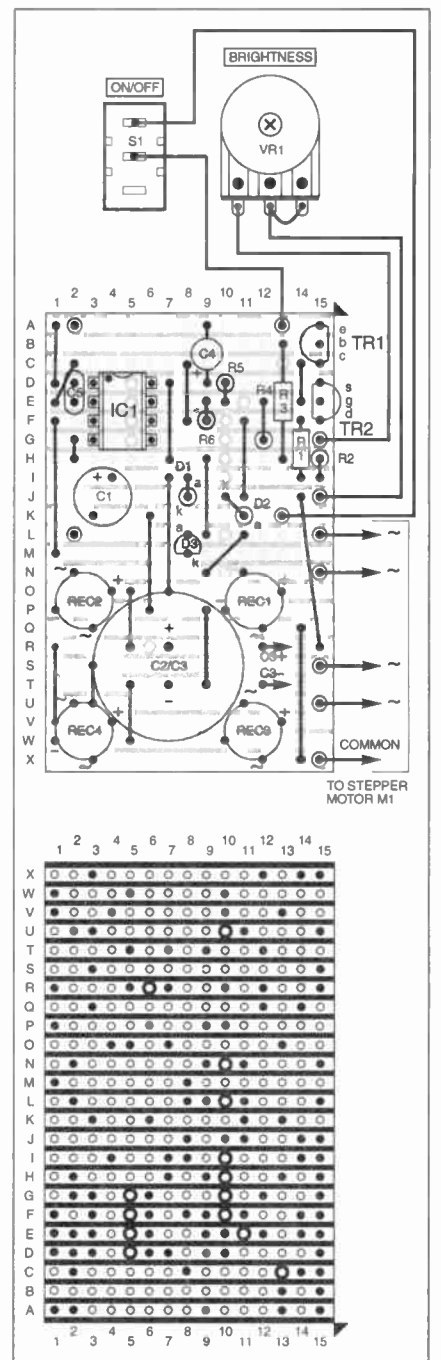

Fig.4. Wind-up Torch stripboard component layout, interwiring and details of breaks required in the underside copper tracks.

The knob should have a fixing nut to prevent any slippage. A regular stepper motor will easily produce sufficient charge in this way – more ambitious constructors could construct a crank handle with the help of a brazing iron or Meccano parts.

The motor is housed at one far end of the case, with its shaft pointing face downwards, and protruding through a hole in the case. If the motor has a mounting bracket, this may be used to brace it. Or, particularly if it is square in shape, it may be wedged into place with wooden wedges on each side, and glued into position.

If a stepper motor has been salvaged from a floppy disk drive, it is likely to have a large, bulbous head. In such an instance, the head may be removed fairly easily with a hacksaw, or a knob may be mounted over the head.

Holes are prepared in one of the narrow sides of the case to receive slider switch S1 and potentiometer VR1 (mounting on the flat side of the case may interfere with the light beam). A large hole is prepared for the lens at the opposite end to the motor. S1 is a slide switch, so as to prevent accidental switching when packed into a suitcase or rucksack. Prepare the holes for S1 and VR1 after having established the position of the lens or lenses.

LENS

The light of the white l.e.d. is fairly diffuse, and needs to be focussed into a beam. In order to focus it, a convex lens with short focal length (a short focussing distance) is required. A focal length of 30mm to 60mm is ideal. At any rate, the focal length should not exceed the available space in the case.

The lens diameter should also be large enough to catch sufficient light from the l.e.d., otherwise the torch's brightness will be compromised. Lenses may also be twinned in order to shorten the focal length. It may be necessary to crop the sides of a larger lens to fit it into the case. Lenses may be glued to a "slide" and slotted into the case, or may be glued at their edges to the inside of the case.

If ordered from a specialist supplier, lenses can be pricy. However, the author found adequate plastic lenses in a nearby toy shop. Those employed in this design were taken from two cheap "bug viewers" and twinned. Suitable lenses may also be found at fetes or in junk shops.

Once the motor and the lens have been installed, and holes for S1 and VR1 prepared, the circuit board is inserted into a slot inside the case. It may be secured with dabs of general purpose glue.

IN FOCUS

You will need to establish the correct distance from the circuit board to the lens, so as to obtain a beam of ideal width. It was found that if the torch's beam was too narrow, it was of little use in illuminating a page, or the full width of a path. A good compromise may be found as follows:

Aim the torch at a white wall, from a distance of about two metres. Adjust the distance between the circuit board and lens so as to find the most compact spot of light on the wall. Then shift the lens closer to the circuit board, until the diameter of the beam is about 50cm on the wall. It may

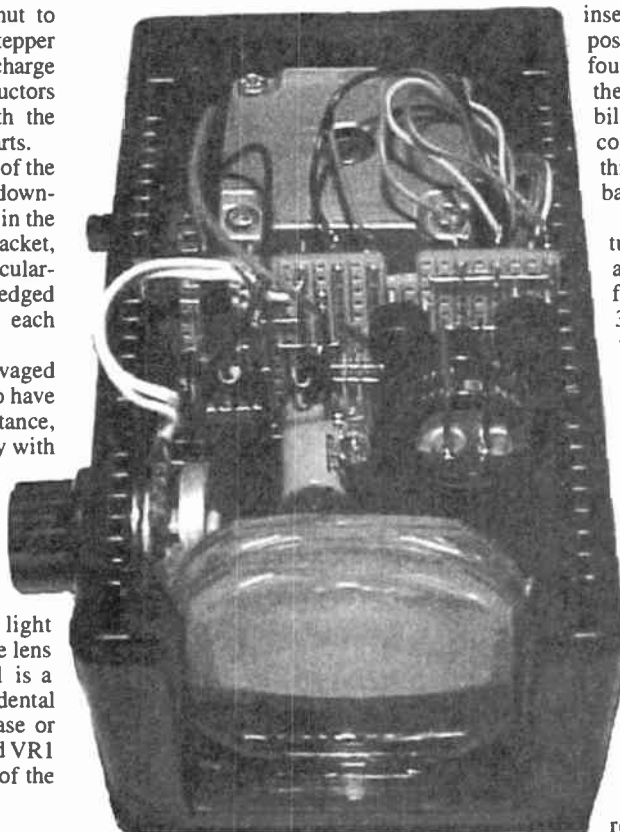

Close-up view of the "beam window" showing the lenses slotted into p.c.b. retaining guide slots. The circuit board is positioned further back in the slots, see photograph below.

even be necessary to adjust the position of the l.e.d. slightly on the circuit board.

The optical characteristics of the l.e.d. are such that banding (a bright circle of light) may occur at the perimeter of the beam. This may be cured by adding a strong, small convex lens (having a very short focal distance) directly in front of the l.e.d. to give an even distribution of light.

CALIBRATION

To check that the regulator is working correctly, measure the voltage across capacitor C4 (two solder pins have been

inserted on the circuit board for this purpose at positions A2 and L2). Wire up four AA batteries (6V) across C1 until the voltage at C4 seems to have stabilised. Do not leave the AA batteries connected for any length of time, since this places heavy demands both on the batteries and on Zener diode D2.

As Brightness control VR1 is turned through its full range, the voltage across capacitor C4 should vary from less than 3V to higher than 3-6V, but not higher than 4V. If the voltage rises above 4V, resistor R4 needs its value to be increased; if it does not rise above 3-6V, then R4 needs to be decreased. Differences in the tolerances of transistors TR1 and TR2 may in exceptional circumstances necessitate such modification.

Mark off the 3V, 3-3V, and 3-6V settings on the outside of the case for reference.

IN USE

Set the Brightness control VR1 to 3V (book-light brightness). Turn the generator knob briskly between index finger and thumb (it may be turned in either direction).

Generally speaking, once a residual charge exists in the reservoir capacitors, a good wind of half a minute will fully charge the torch, and small "in between" charges will keep it going almost effortlessly. Note, however, that the very first time the Wind-up Torch is used, it may need up to

five minutes to reach full charge, and one or two minutes of winding before the l.e.d. even illuminates. Do not despair – once a residual charge exists in the reservoir, subsequent charges will require only a fraction of the effort.

Assuming you begin with no charge at all in the reservoir capacitors, at first no light will be seen; then the light will pulsate in sync with your turning. Finally a steady light will shine. The Wind-up Torch will be fully charged a little while after a steady shine is observed.

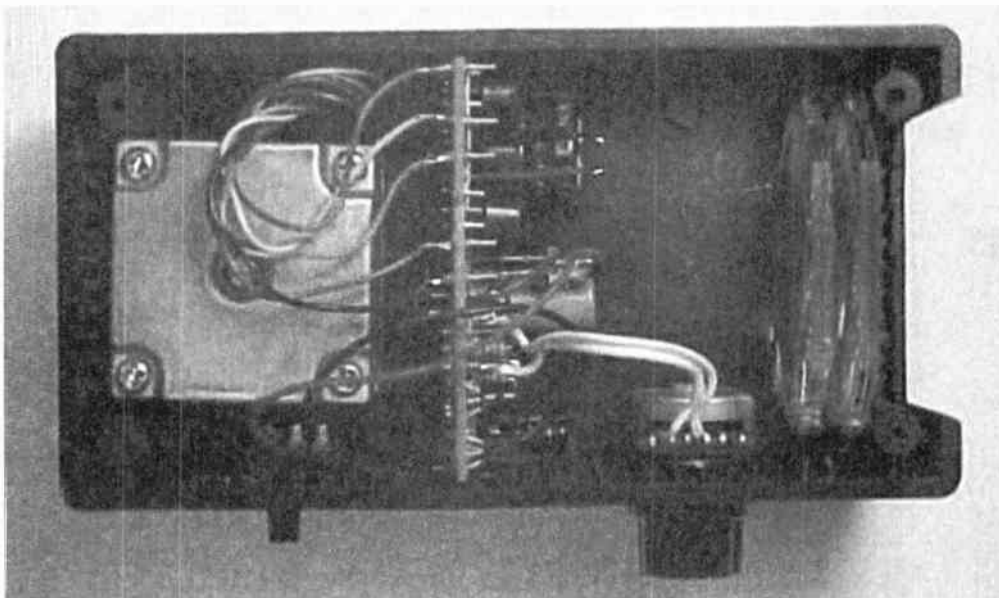

General positioning of components inside the case. The Brightness control and On/Off switch are mounted on one of the narrow side panels.

JUMP START

Instead of such initial effort, the torch may also be "jump-started" by connecting four AA batteries (6V) across C1 until the l.e.d. begins to illuminate (as suggested for the calibration test). Then disconnect the batteries and continue winding. Be careful to observe the correct polarity. You may even wish to incorporate small batteries and a pushbutton switch into the design, attached to C1, to jump-start the torch after long periods of disuse.

The torch may also be wound up whilst it is switched off, then switched on at a later time. When switched off, it will hold its charge for a day before requiring recharging. If the torch's light has faded, and it is not likely to be used again immediately, switch it off so as not to lose what residual charge is in the capacitors.

Small adjustments of VR1 can mean large extensions of life, and vice versa. The torch's life shortens rapidly at higher light intensities, yet lengthens exponentially at dimmer settings. □

The author may be contacted at:
scarboro@iafrica.com.



Completed Wind-up Torch showing the small wind-up knob and l.e.d. lens beam window.

SHOP TALK

with David Barrington

PIC Dual-Chan Virtual Scope

Although using a PIC microcontroller does cut down on the component count, you would think that it is almost inevitable that with a project like this month's *PIC Dual-Chan Virtual Scope* that some of the components would appear to be a bit special and will cause local sourcing problems.

Not so! Nearly all the components used in the prototype model are RS types and readers should be able to order these through any *bona-fide* RS stockist in their area. Alternatively, they can be ordered through **Electromail** (☎ 01536 304555 or <http://rswww.com>), their mail order outlet.

Starting with the Maxim MAX492 dual, rail-to-rail, op.amp, this carries the RS order code of 182-2738. (Maxim can be found on the web at: www.maxim-ic.com).

Regarding the Toshiba TC55257-85L 32Kbyte SRAM, of the several versions listed, either of the following will be OK for this circuit. The TC55257DPL-85L is listed as code 298-190 and the TC55257DPI-85L is code 317-007.

The 20MHz version of the PIC16F877 is now quite plentiful and should be easy to obtain. However, for those readers unable to program their own PICs, a ready-programmed PIC16F877-20P can be purchased from **Magenta Electronics** (☎ 01283 565435 or www.magenta2000.co.uk) for the inclusive price of £10 (overseas readers add £1 for p&p). For those who wish to program their own PICs, the software is available from the Editorial offices on a 3.5in. PC-compatible disk, see *PCB Service* page. It is also available *free* via the *EPE* website: <ftp://ftp.epemag.wimborne.co.uk/pub/PICS/PICvscope>. The software is written in TASM.

The rest of the components are standard shelf items. If you wish to use the same RS case, this is listed as 267-2720. The printed circuit board is available from the *EPE PCB Service*, code 275 (see page 788).

Wind-up Torch

The first item we would like to cover concerning parts for the *Wind-up Torch* project is the 12V stepper motor. Some good news here, one which closely resembles the one used in the prototype is currently being advertised by **Magenta Electronics** (☎ 01283 565435 or www.magenta2000.co.uk), order code MD38. Also, we understand that a Philips 12V mini stepper motor advertised recently by **J&N Factors** (☎ 01444 881965) is still available and is a "bargain" at just £2 each; quote order ref. 2P457. These two motors have not been tried in the model.

Note that the BC237 transistor must be the one with an "A" suffix. This is important as it refers to the required low gain version. The only listing for the BC237A appears to be from **Cricklewood** (☎ 020 8452 0161, Fax 020 8208 1441). The author advises that the BD241C may be used as a replacement, but you will have to parallel resistors R1 and R2 in R1's position on the p.c.b. and add a link wire in R2's position.

The 1 Farad 5.5VW d.c. "memory back-up" capacitors are fairly expensive items and it might pay to shop around before buying, try **Greenweld**, **Bull Electrical**, **Cricklewood** and **J&N Factors** to name a few. The ones in the model came from **Maplin**, code JR01B and will set you back nearly £6 each plus p&p. They can also supply the following: plastic case (code YU52G) and the 5W Zener diode (code AY65V).

The high brightness "white light" l.e.d. used in the model also came from the last mentioned company and is the 5mm 400mcd version, code NR73Q. Although not tried, the author informs us a much brighter one has just been introduced in Germany (Conrad Elec., code 153745-11). This same company keeps focussing lenses for l.e.d.s, code 183621-11. Conrad's web site is at: www.conrad.de. However, you may still find that copying the author and extracting plastic lenses from toys is your cheapest approach here.

Fridge/Freezer Alarm

Only the temperature sensor chip is likely to be a problem when sourcing parts for the *Fridge/Freezer Alarm*, this month's "Top Tenner" project.

The Te Com TC622 single trip-point temperature sensor comes in two versions: the TC622VAT has a temperature range of -40°C to +125°C, with a claimed precision of ±1°C; and the slightly cheaper TC622EAT which has a range of -40°C to +85°C, with the same precision. Both types are suitable for this project and can be purchased from **Maplin** (☎ 0870 264 6000 or www.maplin.co.uk), code NU41U (TC622EAT) and NU42V (TC622VAT).

The latest news we have concerning the sensors is that stocks are running at around 150 pieces of the TC622EAT and about 300 of the TC622VAT. We understand that once stocks are exhausted they will not be replaced.

The *n*-channel power MOSFET device should be readily available, but if any readers do have trouble finding the VN10KM MOSFET it is currently listed by **Electromail** (☎ 01536 304555 or <http://rswww.com>) code 655-537 and **Maplin**, code QQ27E.

Most of our component advertisers will be able to suggest a suitable 6V or 12V solid-state buzzer for this project. The prototype used the **Maplin** 6V round buzzer, code FK81C. If you opt for a higher supply voltage, try the 12V version, code FK82D.

EPE Moodloop Field Strength Indicator

Some readers may experience difficulty in purchasing the AD8532 dual op.amp called for in the *EPE Moodloop Field Strength Indicator* project. This is intended for low voltage operation and has rail-to-rail outputs, ideal for this application. The one in the model came from **Maplin** (☎ 0870 264 6000 or www.maplin.co.uk), code OA16S.

Although the author states that the linear Hall Effect device is inexpensive and widely available, we have not found it so. The only listing for the type UGN3503U we came across was from the above company, code GX09K.

The LP2950 micropower 5V regulator was chosen as it is claimed to be better suited to battery operation than the standard 78L05 voltage regulator, has a smaller quiescent current and can operate with an input to output voltage difference of just 100mV. The LP2950 regulator also came from the above source, code AV35Q, but most of our components advertisers should be able to help regarding the 10-l.e.d. bargraph and the small hand-held case, with battery compartment. Remember, it is the bargraph with individual l.e.d.s that is required. **Maplin** supplied the bargraph (code BY65V) and case (type HH2-code ZB16S) used in the prototype.

PLEASE TAKE NOTE

Remote Control IR Decoder

Source code (.ASM) files were added to the ftp site and *EPE* Disk 3 on 12 Aug '00.

Sept '00

P L A N E T



M I C R O C H I P

2.0 VOLTS

SELF-PROGRAMMING

PICmicro FLASH

IN-CIRCUIT DEBUGGER

TWO-SPEED OSC

10-BIT A/D

Get More in a Flash

Discover the power and flexibility of an 8-bit PICmicro® RISC MCU with FLASH. The possibilities are endless! When you incorporate self-programming and two-wire In-Circuit Serial Programming™ over the entire voltage range, *without* external components. PICmicros feature an operating voltage from 2V, 10-bit A/D converter with up to 8 channels, RS-485 type USART, up to 256 bytes high-endurance EEPROM data

memory and up to 5 MIPS performance. For added flexibility, the PICmicro MCU Migratable Memory™ path gives you socket compatible OTP, ROM and FLASH MCUs... and a design without limits. Add world-class development tools and technical support and you've got the most complete 8-bit RISC MCU solution with FLASH.

Italy: + 39 039 689 9939 France: + 33 (0) 1 69 53 63 20
Germany: + 49 (0) 89 627 1440 UK: + 44 (0) 118 921 5818



MICROCHIP

The Embedded Control Solutions Company®

Explore the Universe of Embedded Control at www.microchip.com

SUPER CCD SHARPENS PHOTOS

Octagonal sensor pixels pack more closely and collect more light.
Barry Fox reports.

ENGINEERS working for Fuji Photo Film in Japan have taken time off from making digital cameras to look at nature, and decided that the electronics industry has been doing things the wrong way. Whereas natural views contain mainly vertical and horizontal lines, the sensor chips used in digital cameras are best suited to capturing diagonal lines. Fuji is now changing the shape and angle of its sensors to let a digital camera take sharper pictures in lower light.

Matrixed Pixels

Digital cameras have a conventional lens which focuses the scene to be photographed on a charge coupled device (CCD) instead of photo film. The CCD is a matrix of tiny photo-diodes and electrical connectors, arranged in horizontal lines like the scanning lines of a TV picture. The diodes convert light into electricity which digitally codes the image, and the code is stored in a memory chip.

Each diode represents one picture point or pixel and modern CCDs cram two million onto a rectangular chip, a few centimetres wide. If the diodes are made smaller, to make room for more and increase resolution, they collect less light. So the camera can only be used in bright

sunlight or with electronic flash. The practical limit for conventional CCDs is around three million pixels.

Fuji spent three years analysing a wide range of photographs and saw that, largely because of gravity, most natural and man-made objects have vertical and horizontal edge details. The horizontal alignment pattern of the CCD pixels creates linear gaps in which horizontal and vertical detail is lost.

Honeycomb Mosaic

Because still picture cameras are not tied to TV line structures, Fuji's new Super CCD can use diodes which are octagonal, instead of rectangular, and arranged in a honeycomb mosaic, along 45 degree diagonals. This allows larger diodes to be packed closer together, with no linear gaps to lose natural detail.

The larger diodes gather more light energy so need less ambient light to take a picture. The first Super CCD chips have a sensitivity equivalent to photographic film with an ISO rating of 800. The honeycomb arrangement gives 2.5 million octagonal pixels the resolution of four million rectangles.

Super CCD recently made its debut in Fuji's new FinePix 4700 camera, costing around £700/\$1000.

SURFACE SOUND

YOU are probably aware that British company NXT invented SurfaceSound flat panel loudspeaker technology. This technology has revolutionised the way in which loudspeaker units can be manufactured, moving totally away from the time-honoured concept that such items must have large internal dimensions in order to allow the enclosure to satisfactorily reproduce the audio spectrum.

Flat panel speakers are in use in many venues, frequently unrecognisable as such, being "disguised" as pictures hanging on the wall, the sound generated across their surface, and without internal depth. Restaurants and hotels are typical users.

The domestic market is now being appealed to by NXT's latest involvement. LG Electronics of Korea has launched its first TV which features motorised NXT panels on each side. The TV can be used with the panels folded in or out.

For more information contact New Transducers Ltd, 37 Ixworth Place, London SW3 3QH. Tel: 020 7343 5050. Fax: 020 7343 5055. E-mail: marketing@nxtsound.com. Web: www.nxtsound.com.

MORE PICS DUE

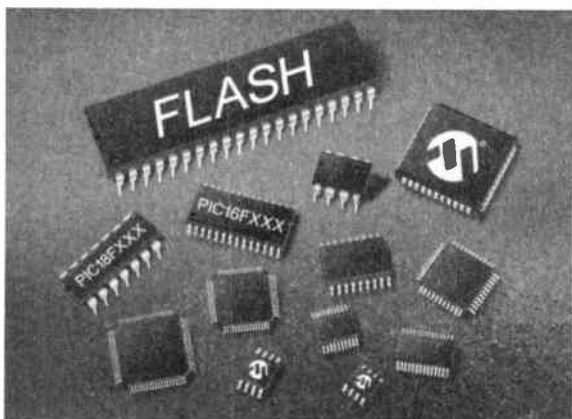

Microchip tell us that they will be adding 37 devices to their PIC16Fxxx and PIC18Fxxx Flash microcontroller families over the next several months.

The new microcontrollers feature 1K to 64K words of Flash program memory, up to 4K bytes of data SRAM, and up to 256 bytes of data EEPROM. Available in 8-pin to 84-pin configurations, these devices provide features such as 10-bit 12-channel A/D converters, comparators, capture/compare/pulse-width modulation, phase locked loop, 8 x 8 hardware multiply, and USB and CAN communications capability.

Microchip have also released their Analogue Design Pack CD-ROM, a complete compilation of technical documentation on their analogue microcontrollers and development tools etc.

For more information contact Arizona Microchip Technology Ltd., Dept. EPE, Microchip House, 505 Eskdale Road, Winnersh Triangle, Wokingham, Berks RG41 5TU. Tel: 0118 921 5858. Fax: 0118 921 5835. Web: www.microchip.com.

SKY'S 2001 CATALOGUE

The Sky Tronic brand of electronic products is now successfully established in nine European countries and is regarded as a major brand in consumer electronics. The products are well itemised and displayed in the 240 pages of the new 2000/2001 catalogue received from Sky Electronics.

The catalogue is superbly produced with full-colour photographs of the enormous range of products, which are so numerous we can only summarise the general categories: audio and video, disco, car hi-fi, communication, time and temperature, CCTV and security, electrical, hobby electronic kits, computer accessories, test equipment, power supplies, tools, connectors, cables, speakers, PA systems.

The catalogue is free to callers, or send stamps to the value of £1.85 to cover postage.

Sky Electronics are at 40-42 Cricklewood Broadway, London NW2 3ET. Tel: 020 8450 0995. Fax: 020 8208 1441. Web: www.skyelectronics.co.uk.

JACKSON VARIABLE CAPACITORS

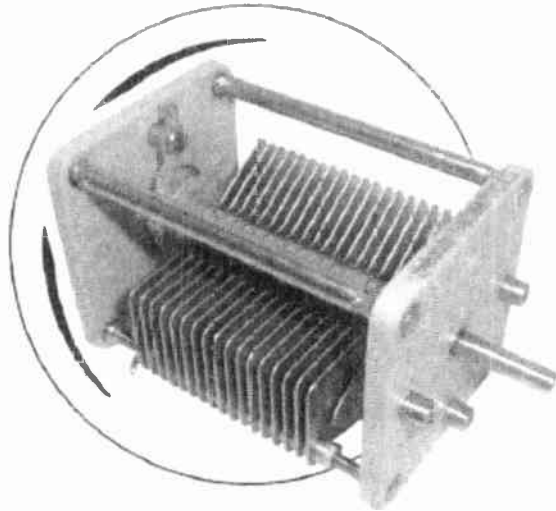

VARIABLE capacitors of the type used in applications such as radio transmission and reception, and other frequency-tuning circuits, are covered in depth within the latest Jackson Brothers catalogue.

Specifications for all types are detailed and well-presented, and include colour photographs which are superbly clear, being printed on a glossy art paper. Ball drives, dials, universal couplings and other accessories are covered too. You may recall that the original Jackson Brothers company suffered severe problems a while back, but were rescued from disaster by Mainline Electronics. The quality of the products shown in the new catalogue confirms how well the business has recovered. Interestingly, a brief history of Jacksons is given in the catalogue.

For more information contact Mainline Electronics, Dept. EPE, PO Box 235, Leicester LE2 9SH. Tel: 0116 277 7648. Fax: 0116 247 7551. E-mail: sales@mainlinegroup.co.uk.

WAP WAY OUT?

By Barry Fox.

THE much hyped WAP (Wireless Application Protocol) cellphone system is on its way out. The phones are so hard to set up, the stripped-down online content so unexciting and the 9.6Kbps data speed so slow that the manufacturers have sold less than half the million they hoped. The networks are giving WAP phones away in the hope that users will generate revenue by playing with them.

BT Cellnet gives away the Motorola Talkabout WAP phone pre-loaded with a strategic selection of accessible sites (like BT's Genie) and no instructions on how to go through the very tricky process of altering the selection. Those who try to change the settings must go online and spend on calltime while struggling.

Motorola says it is ready to sell new phones which use the General Packet Radio Service, and since 1994 has been building GPRS capability into network control equipment. Cisco Systems is providing software. T-Mobile in Germany and BT Cellnet in the UK are supposedly up and running, although how to get a phone and service remains unclear.

GPRS works ten times faster with full-featured Internet Protocol. Users are charged for data transferred, not time connected.

New GPRS phones, such as Motorola's Accompli, should handle WAP if anyone still wants it, but WAP phones cannot use GPRS.

PIC Programming CD-ROM

IN June's *News* we reported favourably on Eric Edward's CD-ROM *Let's Do It - The Practical Electronics Book*. Well, Eric's been enjoying himself again, this time writing a CD-ROM called *Let's Do It - PIC Programming*.

Eric is really devoted to sharing with you, in his own inimitable and enthusiastic style, his knowledge and experience of electronics and "all that sails with her". Once again Eric has written the CD-ROM in the style of a "book", with chapters and indexes. It can be read through Adobe Acrobat which, if you do not already possess it, can be installed from the CD-ROM itself (Adobe V4.05).

The "book" is dedicated to PIC BASIC, although there is an introduction to machine code and mnemonics. You will need a PIC BASIC compiler because, as Eric says, one cannot be included on the CD-ROM for copyright reasons. He gives a short list of recommendations on obtaining one inexpensively (or free!).

Included on the CD-ROM is an enormous selection of text files of the examples and projects which Eric discusses, and which you can compile to suitable HEX files with your PIC BASIC compiler. We reckon you'll thoroughly enjoy Eric's offerings if you prefer to take the PIC BASIC route to PIC software development.

This CD-ROM costs £10, plus £1 p&p (£1.95 Europe, £2.95 rest of world). Send for your copy to Eric Edwards GFW8LJJ, 11 Old Vicarage Road, Barry, Vale of Glamorgan, CF62 6RA. Tel: 01446 740498. E-mail: gw8ljj@tesco.net.

SMART FOOD

By Barry Fox

SUPERMARKET chain Sainsbury's will soon trial a new smart radio labelling system that lets a warehouse or store identify goods, by date or batch.

Philips has developed disposable sticky labels which sandwich a memory and 13.56MHz transceiver chip between layers of paper. Product identification data is loaded into the labels before they are stuck to crates, pallets or individual items. The labels then use the power from interrogation signals to transmit identifying code.

Sainsbury's will first use the system on frozen foods to identify use-by dates. If there is a health scare, with infected beef or poisoned food, the labels allow rapid recall. The labels will later allow shoppers hands-free checkout.

RAPID'S CATALOGUE

RAPID Electronics' latest components catalogue has landed (heavily!) on the Editorial desk. It is Rapid's largest issue to date and features over 19,000 product lines across nearly 700 pages.

We periodically say that some catalogues are an absolute *must* for all electronics hobbyists, Rapid's is certainly one of them. There are all the regular components included that we all need from time to time, passives, semiconductors, switches, sensors, transducers and the like. There are also the larger equipment-type products, plus tools, technical publications and service aids.

Being a leading BSI Registered Supplier, Rapid say they are committed to total customer service and their friendly staff will be delighted to help you with any enquiry, and ensuring that orders are despatched on the day of receipt. There is no minimum order value and orders over £30 are carriage free, with £2.50 carriage charged for orders below that value. Since May this year Rapid have been operating out of a purpose built distribution centre.

For more information contact Rapid Electronics, Dept. EPE, Heckworth Close, Colchester CO4 4BF. Tel: 01206 751166. Fax: 01206 751188. E-mail: rapidelec.co.uk. Web: www.rapidelectronics.co.uk.

HANDS-FREE DEBATE

IN the July issue Barry Fox advised that *Which?* magazine's research report brought into question the safety of mobile phone earpieces in respect of possible increased radiation hazard.

A press release from the Department of Trade and Industry (DTI) has added to the debate. E-Minister Patricia Hewitt has published a report which "confirms that using Personal Hands-Free (PHF) kits with mobile phones reduces exposure to electromagnetic fields... compared to the normal use of mobile phones".

However, the DTI communication goes on to state that "the Independent Expert Group on Mobile Phones and Health (IEGMP)... recommended further work".

For more details, access:
www.iegmp.org.uk,
www.dti.gov.uk/cii/mobile_resp.htm,
www.dti.gov.uk/cii/sartest.pdf,
www.sartest.com.

KWIK-I-E PROBE



HERE'S a handy tool for the DIY-er, a non-contact probe that can measure both voltage and current without the need to strip or break wires. Manufacturers Amprobe have introduced their KWIK-I-E probe (also known as K-1) that has a two-range bargraph display to indicate voltage from 6V to 600V and current from 0.6A to 60A.

It is small, compact, easy to use and can be carried in the pocket. It is also CE and UL approved. Priced at £69 plus VAT, the probe is available from Professional Instrument Distributors, Dept EPE, 3 Brackenley Court, Embsay, N. Yorks BD23 6PX. Tel: 01756 799737.

EASY-PC V3

FOR many years one of the leading popular printed circuit design software packages has been Easy-PC. Version 3 for Windows has recently been released as an upgrade for Easy-PC ProXM users. A demo disk is available which allows you to try all of the options, including the autorouter.

For more information contact Number One Systems, Dept. EPE, Oak Lane, Bredon, Tewkesbury, Glos GL20 7LR. Tel: 01684 773662. Fax: 01684 773664. E-mail info@numberone.com. Web: www.numberone.com

POWER-LESS L.C.D.S

ZBD Displays Ltd are a subsidiary of DERA, the Defence Evaluation and Research Agency, and are to commercialise a new type of liquid crystal display, known as ZBD and invented by DERA.

Whereas conventional l.c.d.s require the image to be rewritten more than 30 times a second, even if the image remains unchanged, ZBD displays retain their image even after power is turned off.

In principle, ZBD displays with thousands of lines are feasible at resolutions equivalent to desk top printing. DERA's press release suggests a range of potential applications, including mobile phones, credit and smart cards, supermarket labels, electronic books. Currently the displays are monochrome but colour versions are likely to be developed.

For more information browse: www.dera.gov.uk and www.zbdisplays.com.

★ **DON'T WAIT - TAKE OUT A SUBSCRIPTION NOW AND SAVE MONEY!** ★

ALSO: NEXT MONTH WE ARE GIVING AWAY A GIANT TRANSISTOR DATA CHART - WITH DATA ON AROUND 500 TRANSISTORS - IT'S THE IDEAL PIN-UP FOR ANY WORKSHOP OR CLASSROOM!

EVERYDAY
PRACTICAL
ELECTRONICS

INCORPORATING **ELECTRONICS TODAY INTERNATIONAL**
THE No. 1 MAGAZINE FOR ELECTRONICS TECHNOLOGY & COMPUTER PROJECTS

Annual subscription rates (2000/2001):
6 Months: UK £14.50, Overseas £17.50 (standard air service),
£27 (express airmail)
1 Year: UK £27.50, Overseas £33.50 (standard air service)
£51 (express airmail)
2 Years: UK £50.00, Overseas £62.00 (standard air service)
£97 (express airmail)

To: Everyday Practical Electronics,
Allen House, East Borough, Wimborne, Dorset BH21 1PF
Tel: 01202 881749 Fax: 01202 841692
E-mail: subs@epemag.wimborne.co.uk

SUBSCRIPTION ORDER FORM



I enclose payment of £..... (cheque/PO in £
sterling only),
payable to Everyday Practical Electronics



Access or Visa No.

--	--	--	--	--	--	--	--	--	--	--	--	--	--	--	--	--	--	--	--	--

Signature.....

Card Ex. Date.....

Please supply name and address of cardholder if different from the subscription address shown below. Subscriptions can only start with the next available issue. For back numbers see the Editorial page.

Name

Address

.....

..... Post code

10/00

CONTROL & ROBOTICS

Milford Instruments

BASIC Stamp Microcontrollers

Still the simplest and easiest way to get your project or development work done. BASIC Stamps are small computers that run BASIC programs. With either 8 or 16 Input-Output pins they may be connected directly to push-buttons, LEDs, speakers, potentiometers and integrated circuits such as digital thermometers, real-time clocks and analog-digital converters.

BASIC Stamps are programmed using an ordinary PC running DOS or Windows. The language has familiar, easy-to-read instructions such as FOR...NEXT, IF...THEN and GOTO. Built-in syntax make it easy to measure and generate pulses, read push-buttons, send/receive serial data etc. Stamps from £25 (single quantities). Full development kits from £79.



Full information on using BASIC Stamps plus lots of worked projects and practical electronics help. CD-ROM also includes 30+ post magazine articles and Stamp software. £29.95



New to PICs or just wanting to learn more tricks? We stock the excellent PIC primer books from David Benson - suitable for the complete beginner to the advanced user.



SERIAL I/Os

Banish the hassle of interfacing to LCD displays. We stock a comprehensive range of alphanumeric and Graphic I/Os all with an easy-to-use standard RS232 serial interface. Sizes from 2x16 to 4x40 plus 128x64 graphic panels. Prices start at £25 (single quantity)



Stamp2 based 3-axis machine
Stepper drive to X, Y and Z axes with 0.1mm (difficult) resolution.
IG contains pre-coded laser components.
Complete with Windows software for drilling PCBs.
Full kit at £269, Part kit at £189



Robotics-4
New range of robotic arms for educational and hobbyist use with super powerful servos. Controlled from PC (Windows software provided) or from optional keypad. Stands about 450mm high when fully extended. IG includes of pre-cut body parts, servo controller board, servos and software. Requires 9v Dc. Kits start at £189



On Screen Display
Superpower led onto standard CCTV from simple RS232 serial line.
Body built/tested at £59



IR Decoder Board
Control your project using a standard domestic IR remote.
7 Output lines (5- @ 20mA) may be set to momentary or toggle action.
Simple teaching machine. Requires 9-12VDC.
Supplied built and tested.
£29 single quantity

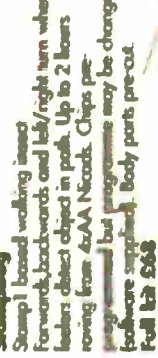

Stamping
Stamp1 based walking insect. Forward, backward and left/right turn when leaders detect object in path. Up to 2 hours running from 4xAA Nicads. Chips programmed but programs may be changed (software supplied). Body parts pre-cut.
Full kit £68



BigFoot
Stamp1 based walking humanoid.
Walks forwards/backwards with left and right turn when detects obstacles. Electronics pcb pre-built and tested.
Programs pre-loaded but may be changed with supplied software.
Full kit £68



Alex - Animated Head
Stamp2 based controller with voice record/playback capability. IR input and/or random playback. 4-servo actions are recorded/edited one track at a time. May also be controlled from PC.
Head kits start at £299. Controllers from £29



Servo Driver Board
Control up to 8 standard hobby servos from an RS232 serial data line using this controller board. Simple command structure holds servos in position until update is received. Fully built and tested. Requires 9VDC and servos. Supplied with Windows software.
£29 single quantity. Optional keypad available.

Milford Instruments
120 High Street, South Milford, LEEDS LS25 5AQ
Tel: 01977 683665 Fax: 01977 681465

All prices exclude VAT and shipping. BASIC Stamp is the registered trademark of Parallax Inc. For further details on the above and other interesting products, please see our web site: www.milford-instruments.co.uk

500 takes care of the offset. Deducting this value from 5000 provides the required inversion so that the value goes from 4500 at 0 degrees to 500 at 100 degrees.

In Use

If the interface is used with liquids it is essential to ensure that the liquids are kept away from the leads of IC2. The usual solution is to fit the temperature sensor in something like a small glass test-tube. A plastic tube is not a good choice if the unit will be used with hot liquids, since it might melt.

Some heatsink compound can be used to provide a good thermal contact between the temperature sensor and the test-tube. Due care and adequate safety precautions must be taken if the unit is used with hot liquids.

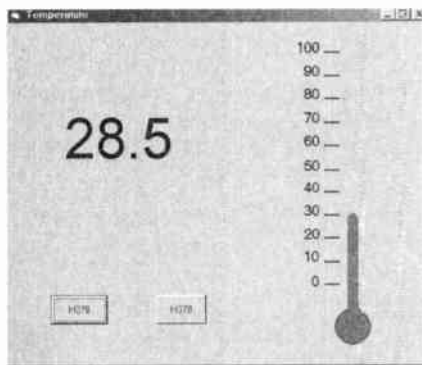

Fig.3. The program has digital and analogue readouts.

Listing 1: Temperature interface program

```
Dim Port1 As Integer
Dim Port2 As Integer
Dim Port3 As Integer
```

```
Private Sub Command1_Click()
Port1 = 632
Port2 = 633
Port3 = 634
Timer1.Enabled = True
End Sub
```

```
Private Sub Command2_Click()
Port1 = 888
Port2 = 889
Port3 = 890
Timer1.Enabled = True
End Sub
```

```
Private Sub Timer1_Timer()
Out Port3, 1
Out Port3, 3
Out Port3, 2
For D = 1 To 2000
Next D
Dta = Inp(Port2) And 8
If Dta = 8 Then Reading = 128
Else Reading = 0
Out Port3, 3
Out Port3, 2
Dta = Inp(Port2) And 8
If Dta = 8 Then Reading =
Reading + 4
Out Port3, 3
Out Port3, 2
Dta = Inp(Port2) And 8
```

```
If Dta = 8 Then Reading =
Reading + 32
Out Port3, 3
Out Port3, 2
Dta = Inp(Port2) And 8
If Dta = 8 Then Reading =
Reading + 16
Out Port3, 3
Out Port3, 2
Dta = Inp(Port2) And 8
If Dta = 8 Then Reading =
Reading + 8
Out Port3, 3
Out Port3, 2
Dta = Inp(Port2) And 8
If Dta = 8 Then Reading =
Reading + 4
Out Port3, 3
Out Port3, 2
Dta = Inp(Port2) And 8
If Dta = 8 Then Reading =
Reading + 2
Out Port3, 3
Out Port3, 2
Dta = Inp(Port2) And 8
If Dta = 8 Then Reading =
Reading + 1
Out Port3, 3
Out Port3, 1
Label1.Caption = Reading / 2
Reading = Reading * 20
Reading = Reading + 500
Reading = 5000 - Reading
Line1.Y2 = Reading
End Sub
```

SPECIAL OFFERS

TEKTRONIX 2445A

4-channel, 150MHz, delay sweep, cursors/readout

£750

TEKTRONIX 475

Dual trace, 200MHz, delay sweep

£400

AVO 8 MK. 6 MULTI-METER

In Ever-Ready Case with Leads and Batteries

£80

Other AVOs from

£50

RACAL TRUE RMS VOLTMETERS

9300 5Hz-20MHz usable to 60MHz, 10V-316V £95
9300B Version £150
9301/9302 RF Version to 1.5GHz from £200-£300

RACAL/AIM 9343M LCR Databridge, Digital Auto measurements of R, C, L, Q, D £200
HUNTRON TRACKER Model 1000 £125
H.P. 5315A Universal Counter 1GHz, 2-ch £80
FLUKE 805DA DMM 4½ digit 2A True RMS £75
FLUKE 801DA DMM 3½ digit 10A £50

GOODWILL GFC 8010G FREQUENCY COUNTER, Range 1Hz-120MHz, 8-Digit Display, 15mV RMS Sensitivity Unused £75

GOODWILL GVT472 DUAL CHANNEL A.C. MILLIVOLTMETER 10mV 300V in 12 ranges Frequency 10Hz-1MHz

SINAD MEASUREMENTS

for only £60

MARCONI 893C AF POWER METER

300W Watts-30 Watts, 20Hz-35kHz 2.5 ohm-20 kilohms

MARCONI 893C unused, boxed £100
MARCONI 893B - to 10 Watts max. NO SINAD £90

GOULD J3B SINE/SQ. OSCILLATOR

10Hz-100kHz

Low distortion Balanced metered output. Attenuator

£75-£125

SOLARTRON 7150

DMM 6½-digit, TRUE R.M.S. High Accuracy IEEE

HIGH QUALITY RACAL COUNTERS

9904 Universal Timer Counter, 50MHz £50
9916 Counter, 10Hz-520MHz £75
9918 Counter, 10Hz-560MHz, 9-digit £50

MARCONI 2610 TRUE RMS VOLTMETER

Digital LCD + Analogue Meter

5Hz to 25MHz + D.C. Autoranging

£195

MARCONI TF2015 AM/FM sig. gen.

10-520MHz £175
RACAL 9008 Auto Mod Meter, 1.5MHz-2GHz £200
LEVELL TG200DMP RC Oscillator, 1Hz-1MHz £50
Sine/Sq. Meter, battery operated (batts. not supplied)
FARNELL LFT Sine/Sq. Oscillator, 10Hz-1MHz £75

FARNELL L30/2 Bench Power Supply

0-30 Volts; 0-2 Amps. Constant D.C. outputs/ Constant current ONLY £80

MANY OTHER POWER SUPPLIES AVAILABLE



MARCONI 2022E Syn AM/FM SIG GEN. 10kHz-1.01GHz Up to +10dBm output, phase mod. I.C.D. display, keyboard entry, etc., small, lightweight.

£525-£600-£750

RADIO COMMUNICATIONS TEST SETS

MARCONI 2955/2956 £2000
MARCONI 2955A/2956A £2900

MARCONI 2019 Synth AM/FM sig gen. 80kHz-1040MHz £475
H.P. 8657A Synth sig gen. 100kHz-1040MHz £2500
H.P. 8656B Synth sig gen. 100kHz-990MHz £1350
H.P. 8656A Synth sig gen. 100kHz-990MHz £995
GIGATRONIC 7100 Synth sig gen. 10MHz-20GHz £5000
MARCONI 2017 AM/FM phase-locked sig gen. 10kHz-1024kHz, good signal purity £1200
H.P. 8640A AM/FM sig gen. 500kHz-1024MHz £400
H.P. 8640A AM/FM sig gen. 500kHz-512MHz £250
PHILIPS PMS328 sig gen. 100kHz-180MHz with 200MHz, freq. counter IEEE £650
RACAL 9081 Synth AM/FM sig g. en. 5-520MHz £350
H.P. 3325A Synth function gen. 21MHz £900
MARCONI 6500 Amplitude Analyser £1500
H.P. 4273A LCR Meter, 10kHz-10MHz £2750
H.P. 8903C Distortion Analyser £750
WAYNE KERR 3245 Inductance Analyser £2000
H.P. 8112A Pulse Generator, 50MHz £1250
DATRON AutoCa Multimeter, 5½-7½-digit, 1065/1061A-1071 from £300-£500

MARCONI 2400 Frequency Counter, 20GHz £1000
H.P. 5350B Frequency Counter, 20GHz £2000
H.P. 5342A 10Hz-18GHz Frequency Counter £800
FARNELL AP10030 Power Supply £1000
FARNELL AP7030 Power Supply £900
PHILIPS PMS4187M Colour TV Pattern Generator £1750
PHILIPS PMS4187X1 Colour TV Pattern Generator £2000
B&K Accelerometer, type 4366 £300
H.P. 11692D Dual Directional Coupler, 2MHz-18GHz £1600
H.P. 11691D Dual Directional Coupler, 2MHz-18GHz £1250
TEKTRONIX P6109B Probe, 100MHz readout, unused £90
TEKTRONIX P6106A Probe, 250MHz readout, unused £85

WELLER EC3100A Temperature controlled Soldering Station 200°C-450°C. Unused £125

FARNELL AMM255 Automatic Mod Meter, AM/FM, 1.5MHz-2GHz, 3.5-digit I.C.D. display Unused £400

Also available:
FARNELL AMM2600 Auto Mod Meter, 10Hz-2.4GHz. Unused £950
MARCONI 2305 Mod Meter, 500kHz-2GHz. from £750

SPECTRUM ANALYSERS

H.P. 8562A 1kHz-22GHz £9000
TEKTRONIX 492 50kHz-19GHz £3500
EATON/AILTECH 757 0.001-22GHz £2500
ADVANTECH R3261A 9kHz-2.6GHz, synthesised £4000
H.P. 853A (Dig Frame) with 8559A 100kHz-21GHz £2750
H.P. 8558B with main frame, 100kHz-1500MHz £1250
MARCONI 2382 130Hz-400MHz, high resolution £2000
B&K 2033A Signal Analyser £1500
ADVANTECH TR4131 10kHz-3.5GHz £2750
MARCONI 2370 33Hz-110MHz from £500
H.P. 141 SYSTEMS 8553 1kHz-110MHz from £500
8554 50kHz-1250MHz from £750
8555 10MHz-19GHz from £1000

UNUSED OSCILLOSCOPES

TEKTRONIX TDS350 dual trace, 200MHz, 1GS/s £1500
TEKTRONIX TAS485 4-channel, 200MHz etc. £1100
H.P. 54600B dual trace, 100MHz, 20MS/s £1000

OSCILLOSCOPES

PHILIPS PM3082 2+2-ch., 200MHz, delay, TB etc. £950
PHILIPS PM3082 2+2-ch., 100MHz, delay etc. £900
TEKTRONIX TAS465 dual trace, 100MHz, delay etc. £900
TEKTRONIX 2845 4-ch., 300MHz, delay sweep cursors £1250
TEKTRONIX 2430 dual trace, 150MHz, 100MS/s, cursors etc. £900
TEKTRONIX 2232 dual trace, 100MHz, 100MS/s, cursors etc. £900
TEKTRONIX 2212 dual trace, 60MHz, 20MS/s, cursors etc. £950
TEKTRONIX 2210 dual trace, 50MHz, 20MS/s £450
H.P. 54200A Degr. signt., 50MHz, 20MS/s £800



PHILIPS FM3217 - Dual Trace 50MHz Delay OSCILLOSCOPE VERY GOOD. Incld. 2 probes, pouch & Front cover FROM £250-£300

THIS IS THE BEST CHEAP SCOPE YOU WILL EVER BUY!!! GOULD OS1100 - Dual Trace, 30MHz Delay Very bright! Supplied with manual and two probes £200



TEKTRONIX 400 SERIES 468 Digital Storage Dual Trace 100MHz Delay £550
466 Analogue Storage Dual Trace 100MHz Delay £250
485 Dual Trace 350MHz Delay Sweep £750
475 Dual Trace 200MHz Delay Sweep £400
465 Dual Trace 100MHz Delay Sweep £400

STEWART of READING

110 WYKEHAM ROAD, READING, BERKS. RG6 1PL Telephone: (0118) 9268041. Fax: (0118) 9351696

Callers welcome 9am-5.30pm Monday to Friday (other times by arrangement)

Used Equipment - GUARANTEED. Manuals supplied

This is a VERY SMALL SAMPLE OF STOCK. SAE or Telephone for lists. Please check availability before ordering. CARRIAGE all units £16. VAT to be added to Total of Goods and Carriage

TEACH-IN 2000

Part Twelve – 7-segment Displays, L.C.D.s, Digital-to-Analogue, Miscellany

JOHN BECKER



Doesn't time fly when you're having fun? Incredibly, here we are at the final part of *Teach-In 2000*. At the beginning of the series, back in the last Millennium, we promised that we would lead you through the fascinating maze of what electronics is all about. We assumed that you knew nothing about the subject and proceeded to examine the basic building blocks, encouraging you to experiment with them to reinforce your understanding.

There are still two subjects that we wish to tell you about (actually, many more, but the space-time continuum doesn't allow it!). The first is displays, 7-segment and liquid crystal, telling you about the theory but without experiments. The other is digital-to-analogue conversion, for which we do have some hands-on practice. We conclude by telling you how to continue exploring your electronics interest.

WITH your breadboard experiments throughout much of the *Teach-In 2000* series, you have frequently been illustrating the response of digital gate outputs by using light emitting diodes (l.e.d.s) as the display devices.

As you are probably well aware, there are many types of more sophisticated display devices manufactured, allowing numerals, alphabet and other characters to be displayed.

We are not going to ask you to experiment with any of these other display types. They are too numerous and you might never find a future application for any particular type which we might recommend. Consequently we do not feel justified in putting you to the expense of buying one.

However, we can illustrate the basic principles through five computer demos. First we shall describe the principle behind the type known as a 7-segment display. We shall discuss it initially from the point of view of a device constructed using l.e.d.s as the illumination source.

7-SEGMENT DISPLAYS

From your main menu select Displays – Menu, then from the sub-menu offered select 7-Segment Display – Basics. Note that you can only return to the menu from this demo by using the <ENTER> key.

As the name implies, a 7-segment display has seven internal structures which are arranged as seven bars (segments). The segments are visible through the top surface of the display. In the case of an l.e.d. type, each segment has an l.e.d. behind it, seven l.e.d.s in all.

You already know that an l.e.d. can be turned on by supplying it with a current-limited voltage. If the voltage is absent, the l.e.d. is turned off. To use digital logic terminology, logic 1 (voltage high) turns the l.e.d. on, logic 0 (zero voltage) turns it off.

On your screen display when you first enter it (see also Photo 12.1) you will see the seven segments arranged as a figure-of-eight. Each segment is allocated an identity letter (A to G) and the order of this lettering is an "industry standard", i.e. these letters always refer to the same segment irrespective of the display's manufacturer (although they might be in either capital or lower case letters).

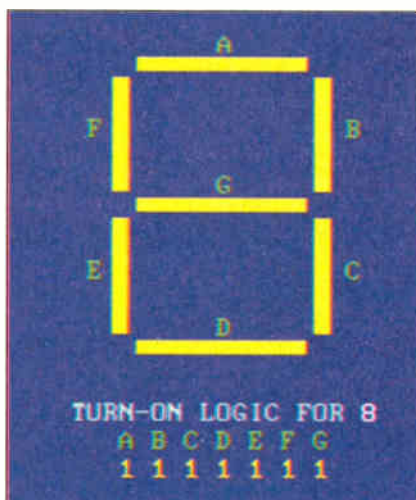

Photo 12.1. Screen dump section from the interactive 7-segment display demo.

In the screen display, your eyes tell you that numeral 8 is displayed when all seven segments are turned on (it's an optical illusion, of course, but we are accustomed to interpreting incomplete patterns as though they were complete).

Below the display, the turn-on logic is shown, a 1 appearing beneath each of the seven letters, 1111111 representing the logic for numeral 8.

From your keyboard, press <0>. Segment G has now disappeared (the l.e.d. has been turned off) and numeral zero is displayed. The logic line has changed to read 1111110.

Press any of the other numeral keys and observe the display results and their logic.

Your own mental logic will tell you that while numerals can be constructed using seven segments, to display alphabet and other characters presents a problem. There are *some* alphabet letters, though, which can be displayed if you use a bit of visual imagination, but by no means all letters, and some of them only work if lower-case rather than capitals are acceptable.

The program allows you to press any keyboard key to see what letters can be generated using seven segments. Try with the full set of capital and lower case letters. When a letter cannot be constructed, the screen tells you so.

COMMON LOGIC

There are two basic types of 7-segment l.e.d. display manufactured, known as *common cathode* and *common anode*. Select sub-menu option 7-Segment LED Display – Detail. Again note that you can only return to the menu by pressing <ENTER>.

On the screen revealed (see also Photo 12.2) are two blocks of l.e.d.s, shown with ballast (current limiting) resistors for each l.e.d. The left-hand block shows that all the l.e.d. cathodes (*k*) are *commoned* and connected to the 0V line. The logic which controls each l.e.d. is brought into each anode (*a*) separately via its own resistor.

This construction is known as a *common cathode* display, because all the cathodes have been commoned together. The logic which controls this arrangement is that which we illustrated via the previous display screen.

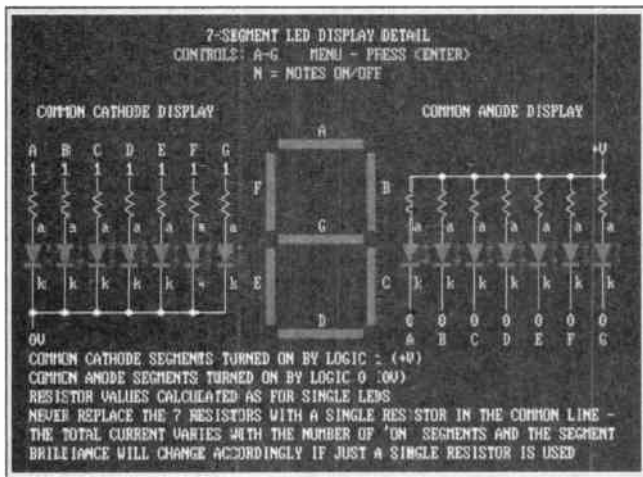

Photo 12.2. Screen dump of the interactive 7-segment l.e.d. display demo.

The right-hand block of seven l.e.d.s shows that all the anodes (a) have been connected to the positive (+V) line via the ballast resistors, while the control logic is connected to each l.e.d. cathode separately. This type of display arrangement is known as a *common anode* display.

Note, however, that in a real common anode display, the anodes would literally be commoned together within the device, and the resistors would be connected between the cathodes and the 0V line.

Because the controlling voltage is applied to the cathodes, you will spot that logic 1 on any of them will turn that segment *off*, because logic 1 is the same voltage as applied to the resistors (i.e. no current can flow through the resistor-diode path). It is now *logic 0* which turns on a segment.

Experiment by pressing any of the keys <A> to <G> (representing the segment letters) to turn the l.e.d.s on and off. Observe how the common anode logic is the opposite of that for the common cathode.

It is important to note that common anode and common cathode displays cannot be interchanged in a circuit because of the opposite controlling logic.

ALWAYS RESIST IT

With 7-segment l.e.d. displays, the same rules apply for calculating ballast resistor values in respect of the supply voltage as for single l.e.d.s (see Part 4).

NEVER use a single resistor to provide current to all seven segments simultaneously via the common line. Each segment **MUST ALWAYS** have its own ballast resistor.

You will occasionally see designs produced by inexperienced constructors in which a single resistor is used. *Do not follow their example.*

The problem is that each l.e.d. requires a certain amount of current to produce a given amount of brightness when turned on. The total current drawn from the power supply therefore varies depending on how many segments are turned on simultaneously.

If a single resistor provides the current to all seven segments, the current passed through each l.e.d. will vary with the number of other l.e.d.s turned on. Consequently, overall segment brightness will change accordingly. For example, numeral 1 (two segments) will thus appear brighter than numeral 8 (seven segments).

MULTIPLEXED DISPLAYS

You have probably seen that displays are available which have several 7-segment digits embodied in the same device, probably two or four (Photo 12.3).

With these devices it is common for just one set of seven segment-controlling lines to be used, these feeding to *all* of the digits simultaneously. Each digit, though has a separate power line feeding to its common anode or common cathode pin.

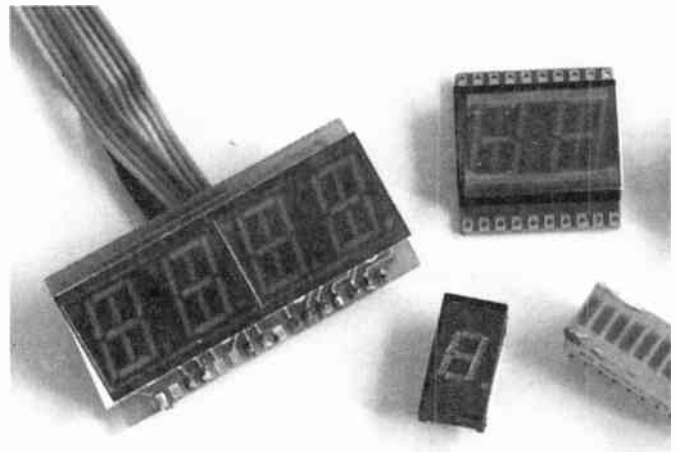

Photo 12.3. Typical l.e.d. 7-segment display, 4-digit, 2-digit and single digit (with part of a bargraph display just visible). This is an enlarged section of Photo 4.3 in Part 4.

These devices work by only turning on a digit's power line when the other digits' power lines are turned off. The 7-bit data logic code is output to all digits simultaneously, but only the digit which has power applied shows that data.

With the data and digit power lines controlled at a sufficiently fast rate, the eye is deceived into thinking that all digits are turned on at the same time, but with each showing its own data. This system is known as *multiplexing*.

The principle is illustrated through sub-menu option 7-Segment LED Display - Multiplex.

On entry to the display (see also Photo 12.4), four digits are shown, displaying four numerals, 3456. Above them are the logic codes which represent each digit's power line being turned on and off. They may appear just as a blur with faster computers. A common anode display is assumed.

This part of the program has been written so that you are deceived into thinking that all four digits are on simultaneously. However, press <F>.

The display is now shown at a much slower rate and you can see each digit being turned on while the others are turned off (see Photo 12.5). The power control logic above the digits is seen to be alternating between 0 and 1. A digit is only turned on if the power control is set at logic 1.



Photo 12.4. Screen dump of the interactive 4-digit l.e.d. display being multiplexed at a fast rate, all digits appear visible.

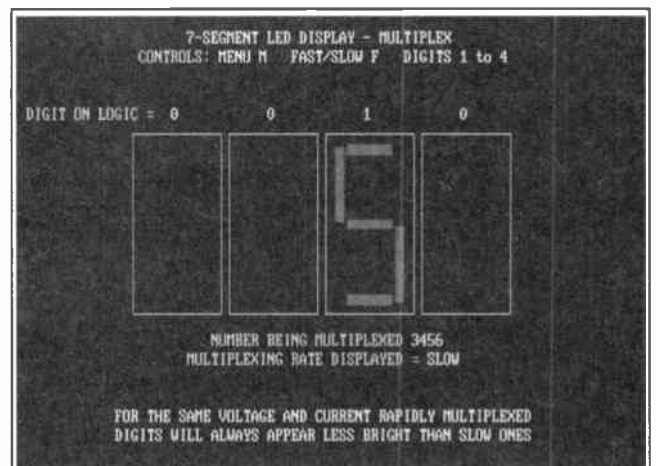

Photo 12.5. Screen dump of the interactive 4-digit l.e.d. display being multiplexed at a slow rate, only one digit is seen at a time.

You will also see that each digit now appears much brighter than it did when all four were displayed simultaneously. This illustrates a problem with multiplexed displays.

Because (in this case of four digits) the time for which each digit is turned on is only a quarter of the total time between each occasion that this digit is turned on, when the multiplexing rate is fast the eye responds as though the digit is much less bright than if it were on continuously or multiplexed slowly. Press <F> a few times to alternate between fast and slow multiplexing.

If a 2-digit multiplexed display is used, the brilliance would appear to be half that of a continuous display. Likewise, the brilliance would appear to fall to one-eighth for an 8-digit multiplexed display.

To increase the apparent brilliance, lower values of ballast resistor can be used, provided that the specified current limit of each digit is not exceeded. There are also high-brightness displays available which are better suited to providing adequate brilliance without large current flow.

Be aware that a real-life multiplexed l.e.d. display may show a much reduced brilliance at faster rates than the demo screen would imply. We have cheated with the demo and just used two different colours for the fast/slow displays.

Use numeral keys <1> to <4> to increase the value displayed in each digit. The display behaves like a counter when digit rollover to zero occurs.

MATRIXED DISPLAYS

Another type of display technique is commonly encountered, known as a *matrixed* display. The principle is similar to that used for 7-segment displays, but it uses more segments. In fact, the segments are typically formed as small squares rather than bars and are usually known as *pixels* (picture screen elements).

Such devices as alphanumeric displays and your computer screen use this technique (so does a dot-matrix printer). Select sub-menu option Matrixed Displays – Basics, and also refer to Photo 12.6.

Matrixed displays use a block of pixels, varying in quantity depending on the application. The alphanumeric l.c.d.s used in some recent *EPE* projects have 35 pixels per character, arranged as five across by seven down (a 5 × 7 matrix). The computer

screen mode being used by the *Teach-In 2000* software (QBasic/QuickBASIC screen mode 9) uses an 8 × 14 matrix for each standard text character.

The demo screen shows exaggerated examples of both matrix formats. As with 7-segment displays, information is generated by turning the pixels on or off.

On first entry, the screen displays the pixels used to generate numeral 8, but the great advantage of matrixed displays is that they can be used to generate an enormous variety of characters, right across the full alphanumeric range and beyond, including various patterns. The 8 × 14 matrix, though, allows a greater variety than the 5 × 7.

Press any of the keys on the keyboard and see the equivalent data displayed in the two large matrixed formats. At the right of the final screen text line (e.g. Turn-on Matrix for 8), the same character selected (in this case 8) is also shown as a normal screen character. Cursor control keys do not generate a display.

In fact, the large 8 × 14 matrix is generated by the program actually scanning the screen area at the end of the final text line and "reading" the pixels which are used to display the selected character. It then reinterprets those same pixels and creates the larger pixel-representing squares that illustrate how the character is made up. If you examine the screen with a magnifying glass, you will see the truth of this.

ANOTHER CHALLENGE

The information displayed in the 5 × 7 matrix zone, however, has been created by using a look-up table. Being of an occasionally devious nature, the author felt that he would get you to create some of the data for that table!

Consequently, you will find as you press various keys, that although the equivalent 8 × 14 matrix is shown, the 5 × 7 is not. Your challenge is to add the necessary format data to the look-up table in order to create the missing characters. We'll give more information in the Experimental section.

LIQUID CRYSTAL DISPLAYS

Unlike light emitting diodes (l.e.d.s), liquid crystal displays (l.c.d.s) do not emit light and operate on a very different principle. When switched on, the internal crystal structure polarises incident light (light shining on them) preventing it from passing through. When switched off, they allow the light to pass unhindered.



Photo 12.7. Typical alphanumeric l.c.d. screen. This one has two lines, each of 16 character cells.

In the former case, the crystals appear dark compared to their background. In the latter, they appear almost invisible. By varying their darkness, the crystals can be made to form visible images, such as those demonstrated in the previous Matrixed Display section, or even pictures with some (expensive) graphic types.

Most l.c.d.s provide monochrome displays (effectively black and white). As you will probably know, though, l.c.d. colour displays are also manufactured (for laptop computer screens, for example).

Practically no current is required to flow through l.c.d.s, consequently they can be controlled without significant power consumption and are ideal for connecting to modern digital integrated circuits, such as those you have been using for this *Teach-In* series (but see important proviso later).

The advantages of low power consumption, though, are offset by certain disadvantages:

- Controlling signals need to be square waves
- An external lighting source is needed, either daylight or artificial
- The operating temperature range is limited (they can turn dark on a hot day, for example)
- The response time is slow – they typically operate at between 30Hz and 50Hz.

However, as the main advantage of low power consumption outweighs the disadvantages, l.c.d.s find use in numerous applications, from electronic meters and calculators to computer and TV screens.

They are available in many forms in which the quantity and shape of the segments or pixels can be manufactured so that letters, numbers and graphics can be displayed.

L.C.D. CONTROL PRINCIPLES

An l.c.d. is constructed with a *backplane* (BP) that is common to all segments and to which a square wave is applied. The segments or pixels are then indirectly controlled by the same square wave source but via their own pins. This aspect of the square wave can be set to be either *in phase* or *out of phase* (inverted) with respect to the backplane square wave.

When both signals have the same phase, i.e. both are at a positive level at the same time and then both are low at the same time, the l.c.d. crystals do not polarise the light and appear to be absent (turned off).

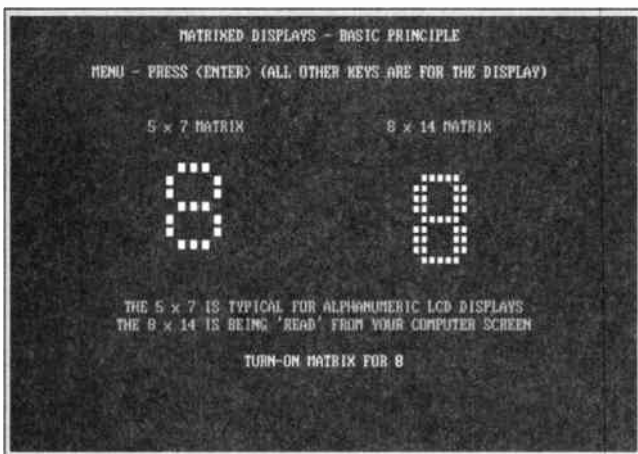

Photo 12.6. Screen dump of the interactive matrixed displays demo.

When both signals are out of phase, however, i.e. when one is high and the other is low, the individual segment to which the control line is connected then changes its crystalline orientation so that the light becomes polarised, in other words the segment is turned on (appears dark).

As you may have guessed, each segment has to be connected to its own control line, which can result in very large numbers of control lines being connected. With a simple 7-segment display with can show numbers from 0 to 9, seven control lines are needed for *each* digit, plus one for the backplane. Additional lines are needed if colons and decimal points are also required.

Very complex l.c.d.s have their controlling lines and circuits connected to them during manufacture, although simpler numeric displays need to be connected by the user, generally speaking in conjunction with a specially designed printed circuit board.

The sophistication of some l.c.d.s is such that "intelligent" integrated circuits are soldered directly to them to comprise a module which not only allocates the correct phase to various segments or pixels, but also contains a memory storage area for data sent by a computer or microcontroller. See Photos 12.7 and 12.8.

Many examples of the use of "intelligent" alphanumeric l.c.d.s have been published in recent *EPE* constructional projects. A forthcoming article discusses graphics l.c.d.s.

In circuit diagrams and constructional charts there are no specific symbols which are internationally recognised for l.c.d.s. Their representation depends on the whim of the circuit designer or the illustrator, although consistency of style is frequently observed by both.

The nature of the l.c.d. is usually obvious from the illustration and from written descriptions associated with it. An example circuit diagram symbol for a typical 4½-digit 7-segment l.c.d. is shown in Fig.12.1. There are countless variations. The control lines (40 of them) for the one shown each have to be connected by the user, usually in conjunction with special control devices (i.c.s).

L.C.D. DEMO SCREEN

Select LCD Displays – Principle from your sub-menu and we'll illustrate the principle of l.c.d. control. See also Photo 12.9.

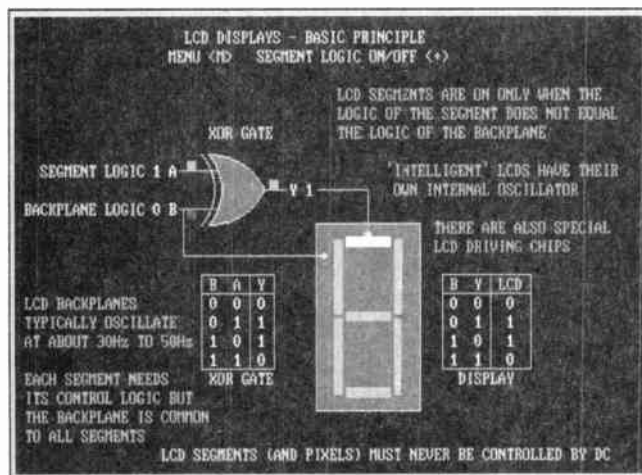

Photo 12.9. Screen dump of the interactive l.c.d.s control demo. Just one segment's control is illustrated, the other segments are identically controlled.

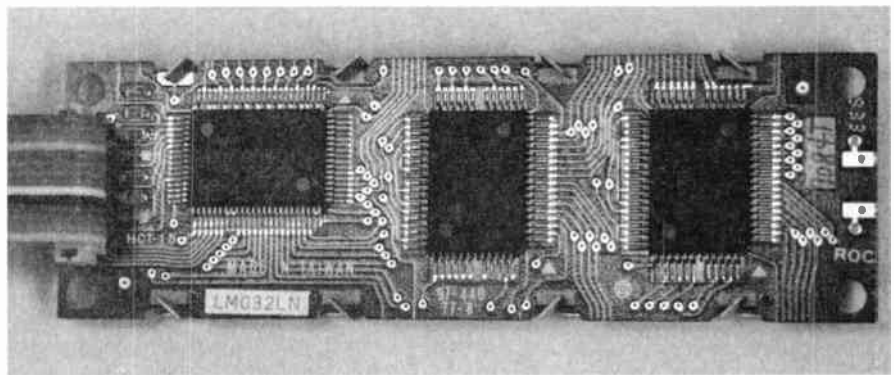

Photo 12.8. Control electronics on the rear of a 2-line by 20 (per line) character alphanumeric l.c.d., with 1400 pixels. It can be externally controlled by just six connections (plus power lines).

The screen demo shows the representation of a single l.c.d. 7-segment digit, but we only demonstrate the control of one segment, the top one. Although not shown, the same segment letters apply as for the l.e.d. version.

Note the two connections made to the digit, one to the top segment and one to the surrounding backplane. An XOR gate (discussed in Part 6) is shown controlling the segment. To the XOR gate at one input is connected the same backplane signal line, and a controlling signal line is connected to the other input.

The logic level at the XOR gate's inputs and output is indicated numerically and by coloured "flags" (for fun!). The backplane

To turn on the top segment, the backplane and segment control logic levels need to oppose each other, as said earlier. You can cause this to happen by pressing the <+> key. You will see that this changes the segment logic level as applied to the input of the XOR gate.

When this input is high, the XOR gate causes the output to be inverted compared to the alternating square wave backplane logic. In this condition, of course, the segment and backplane have different signal polarities, and the segment is turned on, illustrated on screen by it turning white.

Logical truth tables (discussed in Part 6) for the XOR gate and the l.c.d. segment response are shown on screen.

Repeatedly press the <+> key to control the selected segment.

Remember that *each* segment or pixel of an l.c.d. requires control in the fashion similar to that illustrated. Consequently, such displays are complex to control unless special chips are used.

It is MOST IMPORTANT to stress that l.c.d.s must NEVER be operated directly using d.c. control signals. The signals must ALWAYS be square waves.

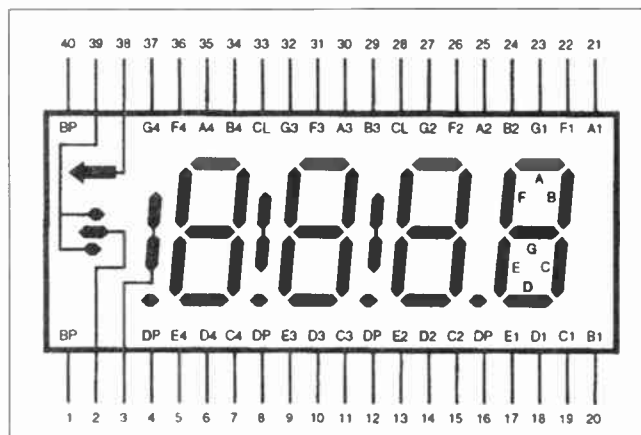

Fig.12.1. Example of a symbol for an l.c.d. module; there are many variations. This one shows a 4½-digit module.

logic is seen to be alternating between high and low, representing the controlling square wave.

Notice how all seven segments are the same light grey colour and that the logic level of the backplane and top segment are the same. In this condition, the controlled segment is turned off. In a real l.c.d. the background, shown here as dark grey, would appear to be a much lighter shade and the turned off segments would probably not be apparent.

MISCELLANY

During this *Teach-In* series we have occasionally had to omit small items of information for space reasons, saying that we would discuss them at a later date. Now's the time for it!

TEMP-CO

In Part 1 reference was made in passing to a resistor's power and temperature coefficients.

You've no doubt deduced it by now, but a component's power rating is expressed in watts (W) or fractions of a watt, e.g. milliwatts (mW). It refers to the amount of power (volts x amps) which that component can safely handle without becoming overheated. Since heat can affect the characteristics of components, wattage ratings should be chosen to be higher than that calculated for normal operation.

Where a manufacturer quotes the temperature coefficient of a component, this parameter states the typical amount by which a component's nominal value will change in response to a change in its temperature. It may be quoted as a value in parts per million (ppm) or as a percentage of its value related to a given temperature change unit, i.e. one per cent per degree Celsius (1%/°C).

Such components as resistors and capacitors always have this coefficient quoted by the manufacturer. Temperature ratings can also be of significance regarding some aspects of more sophisticated components, such as transistors and integrated circuits, for example.

The term *temperature coefficient* is sometimes abbreviated to *tempco* or *temp-co*.

FAN-OUT

In Part 2 we suggested that you should note the actual output voltage of a logic gate when different load values were placed on it. All integrated circuits have a limit on the amount of power that can be drawn from the (*sourced*) or drawn by (*sunk*) their outputs.

In extreme circumstances of excess current flow, the i.c. could die, but it is more usual in many modern components for the output to limit the amount of current flow being required of it. The result is that often the output voltage will either fall below the usual maximum when sourcing, or rise above the usual minimum when sinking.

In such cases when digital logic is concerned, the logic voltage swing may be insufficient to be recognised as a logic change by the ensuing circuit(s). In many cases, data sheets will state the amount of current which a logic output can handle before the trigger thresholds are not reached.

Data sheets may sometimes quote a *fan-out* value. Fan-out states the number of similar logic devices which a particular device can control. The limitation is caused by the fact that the inputs of the controlled

PANEL 12.1. SPEED AND FREQUENCY

To expand a bit on Frequency which we covered in Part 5, here are just a few additional comments:

Data sheets for integrated circuits (i.c.s) may quote several speed factors, each of them referring to different aspects of an i.c.'s operation. Values relating to speed and frequency may seem to be similar factors, but there is a significant difference between them.

Speed may be quoted with regard to how quickly an i.c. responds to a single event, i.e. how quickly it can respond to a change in voltage at one of its inputs, say from 0V to 5V. Other inputs on the same i.c. may be quoted as having different rates of response.

Frequency response, though, in this context of an i.c., is the rate at which the component can handle and process repeated changes on all inputs and

through subsequent internal operations. Although a frequency value can be calculated for a given speed at which an input responds, this should not be taken as the frequency at which the whole device can operate.

Frequency is also quoted in other contexts, with regard to capacitors, transistors, coils etc. Here the frequency value is usually the maximum that the component will respond to or allow to pass through without degradation of the signal amplitude and/or waveform shape.

Components can often *seem* to be theoretically capable of handling higher frequencies, but examination of the resulting waveforms on an oscilloscope may show, for example, that square waves have become more like sine waves and that the peak-to-peak voltage is far less than the original input value.

devices may require a small but significant amount of current flow. With that factor specified, the manufacture calculates the fan-out value accordingly.

Modern CMOS digital logic devices have inputs which usually require hardly any current, being formed from *field effect transistors* (f.e.t.s), see Part 7.

OSCILLOSCOPES

We had hoped to describe the features which you might expect on an oscilloscope. Sadly, there is no space to include this subject.

Instead, we refer you to the *EPE* two-part feature article on oscilloscopes, *More Scope for Good Measurements* of June/July '96. Whilst technology has moved on somewhat since then, you should find that the basic discussion is informative.

We strongly recommend that you purchase an inexpensive standard oscilloscope or computer controlled *virtual* oscilloscope as soon as funds permit. We would also

recommend that you read *How To Use Oscilloscopes and Other Test Equipment* – available from the *EPE Direct Book Service*, see page 785.

Since you have proved by following this *Teach-In* series that you are interested in electronics, obtaining a 'scope of some sort is the next vital step you should take. Whereas our simple real-time computer 'scope displays will have shown you a fair bit about waveforms, the detail has been too coarse and slow to be of use when you progress to more sophisticated circuit designing or construction and testing.

If you study adverts carefully, you could even purchase a reasonable second-hand 'scope inexpensively. But do generally find out about what 'scopes can do before you buy.

ONWARDS

That's all for this final Tutorial, but do move on to the Experimental section. We shall then generally wind-up the *Teach-In 2000* series in a brief concluding section.

TEACH-IN 2000 – Experimental 12

THE first part of this concluding Experimental section illustrates the function of a *digital-to-analogue converter* (DAC). You will recall that *analogue-to-digital* conversion (ADC) was discussed and demonstrated in Part 5. As part of the screen demo you were also shown an example of a DAC in operation.

In Part 1 we recommended that you obtained a DAC device type DAC0800. Some of you may have been supplied with a DAC08, which is just as acceptable and has the same pin order.

We shall now demonstrate a DAC in real life by connecting it to the outputs of your computer's printer port, via breadboard connections OUT0 to OUT7.

Set up your breadboard according to

Fig.12.2, the equivalent circuit diagram for which is given in Fig.12.3. (The power supply needs will be discussed presently.)

Ensure that the eight connections from the DAC to the printer port interface are insulated from each other. They need to be about 8cm long. The order of the interface pins was originally shown in Part 4. The existing connections to the ADC (IC2) can remain in place.

DAC NATURE

The basic nature of a DAC is quite simple. Typically they have eight digital inputs, and thus can accept 256 different binary input values, between 0 and 255 (as discussed when examining 8-bit binary logic in Part 6).

Internally, the DAC connects those inputs to a ladder-type arrangement of resistors such that a binary code of 11111111 (decimal 255) causes a maximum output voltage to be produced, whereas a binary code of 00000000 (zero) causes a minimum output voltage. DAC devices often allow those minimum and maximum voltages to be preset via reference pins.

The voltage difference between each input step change from 0 to 255 is the difference between the maximum and minimum voltages divided by 255. For example, suppose that the reference voltages have been set so that the output is 0V for an input code of zero and 2.55V for an input of decimal 255. The voltage step difference

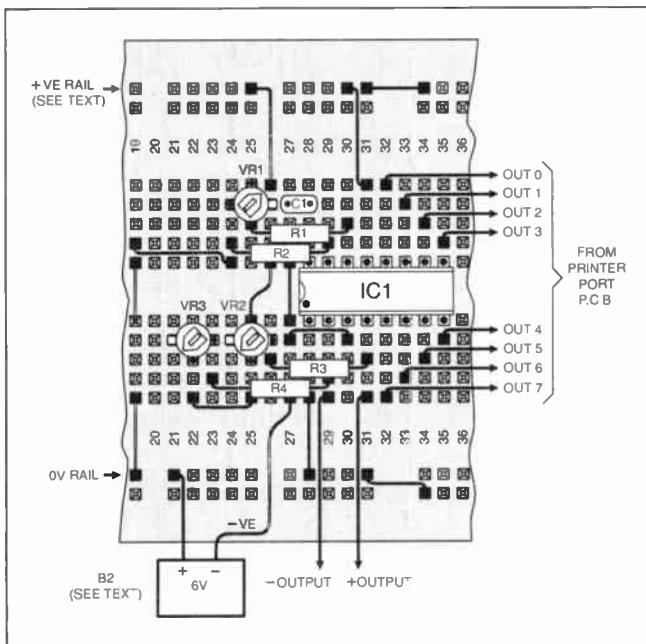

Fig.12.2. Breadboard layout for the digital-to-analogue experiment.

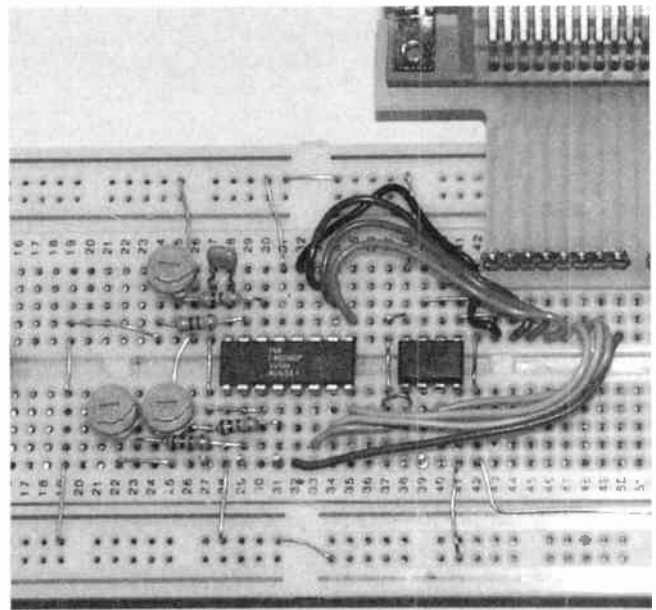

Photo 12.10. Detail of the DAC circuit, showing connections to port interface board.

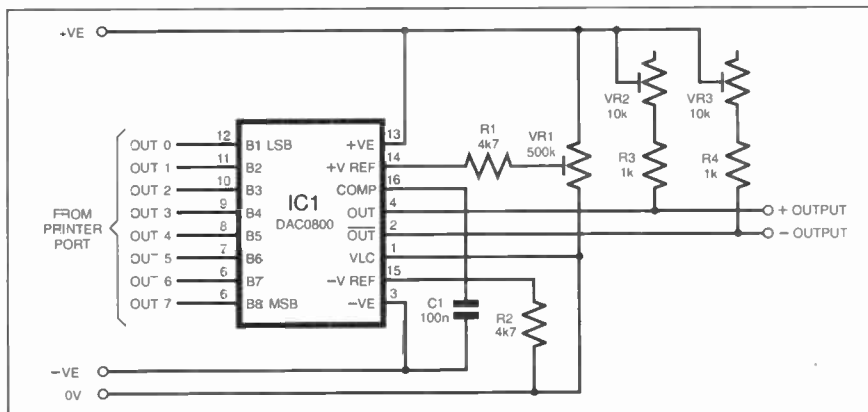

Fig.12.3. Circuit diagram for the digital-to-analogue experiment.

between consecutive input values is thus $2.55V / 255 = 0.01V$.

The DAC used now has a slightly more complicated structure, however. The upper and lower references against which the D-to-A conversion is compared are actually set by currents flowing at pins 14 and 15.

The negative reference current is fixed by resistor R2. The positive reference is set by R1 and preset VR1, in order to simulate the voltage control that would be used in other types of DAC.

There are two outputs at which it is also changes in current flow (sink) into them that are produced in respect of the binary input values, rather than changes in voltage.

Current increases occur on the positive output (pin 4) with increases in input code, while decreases in current simultaneously occur on the negative output (pin 2). You already know that increases in current through a resistor cause a change in voltage across it (discussed particularly in Part 9 – transistors).

Consequently, as you did with transistor collectors, all you need to do to convert the current to a voltage level is to insert a resistor between each of the DAC's outputs and the positive line. To allow you the opportunity to experiment, presets VR2 and VR3 are used in series with resistors R3 and R4.

There are DACs which directly produce an output voltage rather than a current, but the DAC0800 was chosen because it is probably the least expensive.

DAC POWER SUPPLY

The DAC0800 is normally used with a positive voltage on pin 13, 0V on pin 1 and a negative voltage on pin 3. Ideally the positive and negative supplies should be symmetrical with reference to 0V, i.e. +5V/0V/-5V. The device can in fact operate at between +4.5V/0V/-4.5V and +18V/0V/-18V.

For our demo, however, we want you to use either +6V/0V/-6V or +5V/0V/-6V. For the former ($\pm 6V$) you will need a second 6V battery. Those of you who built the regulated supply described in Part 11, can use that supply for +5V, and use your existing 6V battery to provide -6V.

Note that although we described in Part 11 how a negative supply could be generated from a positive supply, the current available by that method is insufficient to power the DAC0800's negative pin.

RELATIVITY MATTERS

Make sure that the battery supplying -6V is connected as shown in Fig.12.2, i.e. its positive terminal (+) connected to the 0V rail of the breadboard, and its negative terminal (-) to the point indicated. Connect the positive supply in the same way you have been doing in previous parts of *Teach-In*.

The equivalent power supply circuit is shown in Fig.12.4a. It is worth noting how two batteries can be connected in series to provide either a +VE/0V/-VE supply, or a supply that is the total of the two battery voltages (Fig.12.4b), depending on which terminal is regarded as the 0V (common) connection. Other power sources (e.g. mains operated power supplies) can sometimes be treated similarly, depending on how they are constructed. It's *relativity* again.

Set VR1 fully clockwise to provide the maximum reference current from the positive rail. Set VR2 and VR3 fully anticlockwise to provide the minimum resistance between the positive rail and the respective output pins.

Connect your meter to read the voltage at the positive output terminal pin, and connect the breadboard to the computer via the printer cable.

COMPUTER-TO-DAC

From the main program menu now run Parallel Port Data Display/Set. Since the original software was released with Part 1, a minor change has been made to this option and is included with the V1.1 software released with Part 7.

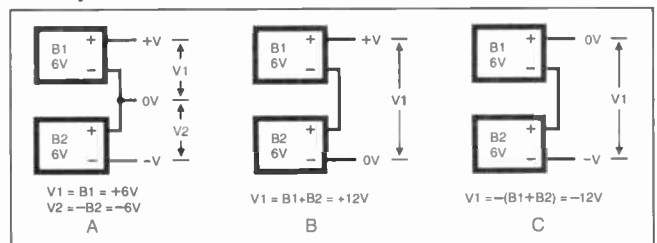

Fig.12.4. Effective battery output voltages are relative to which terminal is nominated as the 0V (ground) connection.

the UK which have the largest general catalogues which are a MUST to possess for any user of electronic components, are those from RS Components (trade only) or Electromail (the retail division of RS), Farnell Electronic Components, Maplin Electronics and Rapid Electronics.

However, do not overlook other suppliers whose catalogues may be smaller but who may have ranges and prices which compete favourably with larger companies. Indeed some of them stock components which the larger suppliers do not.

KEEPING INFORMED

Also keep reading *EPE* – remember that we are the leading hobbyist electronics publication and place a heavy emphasis on electronics education.

Other sources of information are available on CD-ROM and Video as listed each month in *EPE*. Also, if you have Internet access, take a browse through the *EPE* On-line Web Site (www.epemag.com), from where a number of informative feature articles can be downloaded covering a variety of electronics subjects.

Make use, too, of our web site at www.epemag.wimborne.co.uk, through which you can access many other sources of information, and exchange views with other electronics enthusiasts through our Chat Zone. You will also find Alan Winstanley's excellent illustrated *Basic Soldering Guide* and the *History of EPE* here.

HERE'S WISHING YOU . . .

We hope that your increasing study and knowledge of electronics will not only provide you with designing and constructional pleasure, but that it might also lead to career opportunities for some of you. This has happened for many *EPE* readers over the years.

Whilst it's goodbye for this series, we'll meet again through our other pages!

Table 12.1. Teach-In Subjects

Part	Issue	Subject
1	Nov 99	Colour codes Resistors
2	Dec 99	Capacitors – general Capacitors – RC timing Inverter gate Inverter gate oscillator Schmitt trigger
3	Jan 00	Potentiometers Sensor resistors Ohm's Law
4	Feb 00	Diodes and l.e.d.s Schmitt trigger oscillator Computer interface construction
5	Mar 00	Waveforms Sine wave relationships Frequency and time Analogue-to-Digital converter
6	Apr 00	Logic gates Binary and hexadecimal Binary and decimal counters
7	May 00	Op.amps – general
8	Jun 00	Op.amps – Comparators, Mixers, Audio and Sensor Amplifiers
9	Jul 00	Transistors
10	Aug 00	Power supplies – Transformers, Rectifiers
11	Sep 00	Power supplies – Voltage regulation Variable Power supply, +5V regulator assembly Capacitors – Integration, Differentiation
12	Oct 00	7-segment displays Liquid crystal displays Digital-to-Analogue converter Miscellany

Mail Order Suppliers Of
ELECTRONIC COMPONENTS & SURPLUS STOCK
Educational Kits - Ideal Technology Projects
For Schools & Colleges

GREENWELD

Power Supplies
BATTERIES VALVE
COMPONENTS RADIO KITS
Disco Equipment
Hobby Books Tools
SURPLUS ITEMS
Solid State Kits
Low, Low Prices!

Visit our website: www.greenweld.co.uk

Greenweld Limited
Unit 24 Horndon Industrial Park · West Horndon
Brantwood · Essex · CM13 3XD
Tel: 01277 811042 · Fax: 01277 812419
Email: service@greenweld.co.uk
Office Hours: Monday · Friday 08.00 to 17.00

FREE 240-page colour catalogue

Great value for Speakers, Microphones, Headphones, Aerials, Transmitters, TV Amps, Plugs, Sockets, Leads, CD Storage Cases, CCTV, Security, Connectors, Adaptors, Switch Boxes, Gadgets, Disco Lighting & Effects, Mixers, Amplifiers, Turntables, Musicians' Leads, Car Audio, Test Equipment, Hobby Kits, Computer Leads & Accessories, Power Supplies, Inverters, Transformers, Battery Chargers, Tools, Soldering, Switches, Fuses, Indicators, Cable & Wire, Crossovers, PA Amps, and a great deal more . . . all for the price of a stamp.

2000
2001

SKY ELECTRONICS
Tel: 020 8450 0995
Fax: 020 8208 1441

Sky Electronics
40-42 Cricklewood Broadway London NW2 3ET
Tel: 020 8450 0995 Fax: 020 8208 1441
www.skyelectronics.co.uk

The Catalogue is FREE to callers or send stamps to the value of £1.85 to cover postage.

ELECTRONICS 2001

New Technology Update

IBM's proposed multiple processor architecture has self-healing properties and could perform one quadrillion operations per second. Ian Poole reports.

COMPUTING has come a long way in the last few years, but new developments that are under way at IBM may mean that computing technology will take a quantum leap in the next few years. Recently they have announced a new development that will ultimately lead to a computer that is capable of performing one quadrillion operations per second (one petaflop).

This project is being funded by IBM themselves and is not a government development programme, and this is quite unusual for a programme of this size. Taking about five years in total, the development adopts a radical new approach to computer design. Both the technology to be used and the approach are revolutionary, and this will enable the programme to be undertaken so quickly. The time estimated is about a third that would normally be expected under normal project conditions.

Called Blue Gene, the programme has resulted from a requirement to study the immensely complicated human proteins. It is expected that when the project is complete, the computer will be able to provide significant help in increasing our knowledge of the way in which proteins are structured and in particular the way in which they fold. This will be an important step in the future of healthcare and medicine.

Smash

The new computer is based around a new architecture called SMASH. This stands for Simple, MAny and Self-Healing. This gives an insight into the way in which it works. In fact the new technology appears to be one of the largest revolutions in computer science since the mid-1980s.

To give an idea of the extent of the performance of the new computer it is estimated to be 500 times more powerful than the most powerful computer in existence, and typically two million times more powerful than the high performance PCs in use today.

To achieve these levels of performance the new architecture has three particular features. It greatly simplifies the number of instructions that each processor has to carry out. Not only does this allow them to operate faster, but in doing so it reduces the power requirements that would otherwise be needed. Secondly it enables a far greater degree of parallel processing to be undertaken.

Typically the system will be capable of handling more than eight million different computational threads. This is a major advance when compared to a maximum of around 5000 using current technology.

The third new feature is possibly one of the most interesting because the computer will be self-stabilising and healing. This feature will enable the computer to recognise and overcome failures by avoiding faulty areas like processors and computing threads. With a computer of this complexity, this type of feature is of particular importance, and it is one that should become more important as technology becomes more complex in the years to come.

Thread Unit

The core item in the Blue Gene computer is an item called the thread unit. This is basically a RISC processor that has been reduced to the bare minimum. Having an instruction set of 57 instructions it has been designed to produce the maximum throughput for the minimum amount of silicon.

Further analysis of the actual architecture needed for the new units revealed that floating point functions were only required on a small proportion of the operations. To maximise the efficiency of the whole processor eight thread units are grouped together with two 500MHz floating point processors. One of these units is used for add and subtract and the other for multiply and divide functions.

Additionally, half a megabyte of memory is provided in each processor group and this has been made possible by the use of IBM's recently developed memory-in-logic process. The whole combination of the eight thread units, two floating-point units, memory and some additional logic combines to produce a one Gflop processor.

However, this is only part of a single chip that will be used in Blue Gene. Around thirty of these processors will be incorporated into a chip. The exact number still needs to be finalised and will depend on a number of factors relating to the performance and the removal of heat.

One of the other major areas to be addressed is that of inter-processor communication. To achieve the best performance from each of the processors communication will need to be very efficient. It will use two bi-directional 128-bit data rings. There will be one between each row and column of processors on the chip.

Using these, data is tagged and can be transferred internally between the processors, or it can be transferred off the chip via six external busses. The speed of this will be kept down to 500MHz to enable the chips to operate within their required power rating. Although it is anticipated

they could operate at speeds up to 1GHz, this would increase the overall power consumption to a point that would be unacceptable.

Manufacturing

Each chip will measure 21mm x 21 mm. This is a significant advance over anything currently in production today. The main problem will be yield. Using current technology the yield on chips of this complexity would be very low. However, the self-healing aspects of the architecture can be used to advantage, and chips with up to two defective processors will be used. This will enable costs to be kept within reasonable bounds.

There are six external busses and these will operate at speeds of one or two Gbytes per second. These provide interconnectivity with external chips and they are organised in a three dimensional matrix with 30 processors at each node.

Physically, the chips will be mounted on boards containing a total of around 36 chips. The actual design of this board is quite challenging because the chip to chip busses will need to be kept below 150mm to ensure that delays do not rise to levels that cannot be tolerated. These boards will then be able to provide a throughput equivalent to 900 Gflops.

In turn these boards will be arranged in a matrix 16 boards by 16 boards in the horizontal plane and five boards high to give a total of 1280 boards and the final performance of over one Pflop.

Failures

With the phenomenal number of processors in the computer it is estimated that random failures will occur about every four days. In addition to this random soft errors caused by cosmic rays will also be a problem. To resolve these problems the processors will operate in a master-slave configuration so that the results can be checked. If incorrect they will be recalculated.

This mode of operation means that the whole system is very resilient, and significant amounts of the system could fail or be removed and the system would still work, albeit rather more slowly.

This new computer is a particularly exciting development. Although not complete yet, it paves the way for the future. Not only does it promise to provide a way of analysing proteins for research into better healthcare, but it also maps out the way for the future of computers as well.

Further information can be found at www.ibm.com and search on Blue Gene.

tech supplies

www.tech-supplies.co.uk is a new online store that caters for all your electronic, robotic and educational technology projects. We already supply a wide range of unique materials and components to the educational sector, and are now pleased to offer the public the same range, with the added benefit of secure online ordering and prompt delivery. Visit the site now to find out more! As a special introductory offer all orders over £30 received before the end of November 2000 will automatically be entered into a draw to win an amazing Aibo robotic dog worth over £1800.

Win an Aibo robotic dog worth over £1800!



MODELLING MATERIALS

We supply a wide range of unique modelling materials such as 'polymorph' plastic, low cost wheels/cams & gearboxes, and electronic components.



ROBOTS, BUGGYS, ETC..

Bugs, rockets, self-assembly radio control robots and parts for school and public competitions. These make ideal gifts!

www.tech-supplies.co.uk

MICROCONTROLLERS

Our award winning range of PIC microcontroller products is already widely used in education. These unique programming and emulator systems are now available direct to the public.

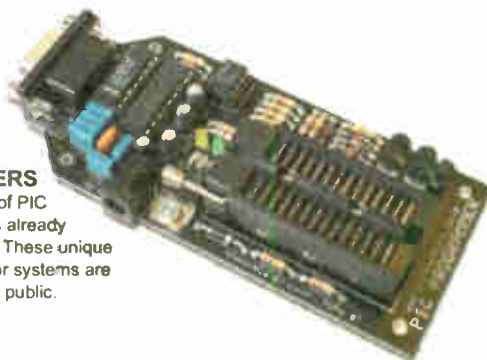

Customise your

Hot Rod

At Antex we not only make a wide range of thermally balanced soldering irons, we also offer you a big choice of accessories so you can get the most from your hobby.

Take our bits for example, because they're made from highgrade copper then plated with iron and chrome you can push them to the limit.

We apply the same high standards to our bench stands, soldering stations and of course our irons – the toughest and safest money can buy.

Not that you'll need a lot of money, because the only thing not hot about our hot rods is the price.

So visit our web site or your electronics retailer and take one for a test drive

ANTEX

NOT JUST ANY OLD IRON



YOU CAN NOW BUY ANTEX EQUIPMENT ON-LINE

ALL ON-LINE ORDERS OVER £20 TAKEN IN AUGUST & SEPTEMBER WILL RECEIVE A 25% DISCOUNT

www.antex.co.uk

VIDEOS ON ELECTRONICS

A range of videos selected by *EPE* and designed to provide instruction on electronics theory. Each video gives a sound introduction and grounding in a specialised area of the subject. The tapes make learning both easier and more enjoyable than pure textbook or magazine study. They have proved particularly useful in schools, colleges, training departments and electronics clubs as well as to general hobbyists and those following distance learning courses etc



BASICS

VT201 to VT206 is a basic electronics course and is designed to be used as a complete series, if required.

VT201 54 minutes. Part One; D.C. Circuits. This video is an absolute must for the beginner. Series circuits, parallel circuits, Ohms law, how to use the digital multimeter and much more. **Order Code VT201**

VT202 62 minutes. Part Two; A.C. Circuits. This is your next step in understanding the basics of electronics. You will learn about how coils, transformers, capacitors, etc are used in common circuits. **Order Code VT202**

VT203 57 minutes. Part Three; Semiconductors. Gives you an exciting look into the world of semiconductors. With basic semiconductor theory. Plus 15 different semiconductor devices explained. **Order Code VT203**

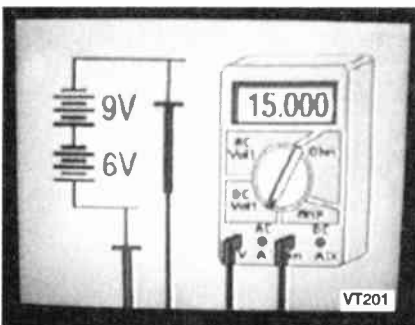

VT204 56 minutes. Part Four; Power Supplies. Guides you step-by-step through different sections of a power supply. **Order Code VT204**

VT205 57 minutes. Part Five; Amplifiers. Shows you how amplifiers work as you have never seen them before. Class A, class B, class C, op.amps. etc. **Order Code VT205**

VT206 54 minutes. Part Six; Oscillators. Oscillators are found in both linear and digital circuits. Gives a good basic background in oscillator circuits. **Order Code VT206**

£34.95 each
inc. VAT & postage

Order 8 or more get one extra FREE
Order 16 get two extra FREE

VCR MAINTENANCE

VT102 84 minutes: Introduction to VCR Repair. Warning, not for the beginner. Through the use of block diagrams this video will take you through the various circuits found in the NTSC VHS system. You will follow the signal from the input to the audio/video heads then from the heads back to the output. **Order Code VT102**

VT103 35 minutes: A step-by-step easy to follow procedure for professionally cleaning the tape path and replacing many of the belts in most VHS VCR's. The viewer will also become familiar with the various parts found in the tape path. **Order Code VT103**

DIGITAL

Now for the digital series of six videos. This series is designed to provide a good grounding in digital and computer technology.

VT301 54 minutes. Digital One; Gates begins with the basics as you learn about seven of the most common gates which are used in almost every digital circuit, plus Binary notation. **Order Code VT301**

VT302 55 minutes. Digital Two; Flip Flops will further enhance your knowledge of digital basics. You will learn about Octal and Hexadecimal notation groups, flip-flops, counters, etc. **Order Code VT302**

VT303 54 minutes. Digital Three; Registers and Displays is your next step in obtaining a solid understanding of the basic circuits found in today's digital designs. Gets into multiplexers, registers, display devices, etc. **Order Code VT303**

VT304 59 minutes. Digital Four; DAC and ADC shows you how the computer is able to communicate with the real world. You will learn about digital-to-analogue and analogue-to-digital converter circuits. **Order Code VT304**

VT305 56 minutes. Digital Five; Memory Devices introduces you to the technology used in many of today's memory devices. You will learn all about ROM devices and then proceed into PROM, EPROM, EEPROM, SRAM, DRAM, and MBM devices. **Order Code VT305**

VT306 56 minutes. Digital Six; The CPU gives you a thorough understanding in the basics of the central processing unit and the input/output circuits used to make the system work. **Order Code VT306**

RADIO

VT401 61 minutes. A.M. Radio Theory. The most complete video ever produced on a.m. radio. Begins with the basics of a.m. transmission and proceeds to the five major stages of a.m. reception. Learn how the signal is detected, converted and reproduced. Also covers the Motorola C-QUAM a.m. stereo system. **Order Code VT401**

VT402 58 minutes. F.M. Radio Part 1. F.M. basics including the functional blocks of a receiver. Plus r.f. amplifier, mixer oscillator, i.f. amplifier, limiter and f.m. decoder stages of a typical f.m. receiver. **Order Code VT402**

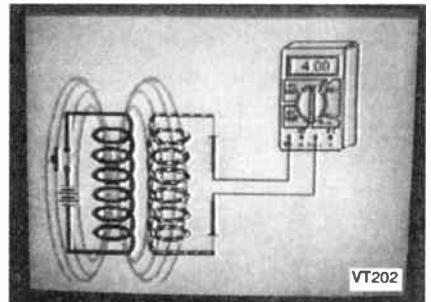

VT403 58 minutes. F.M. Radio Part 2. A continuation of f.m. technology from Part 1. Begins with the detector stage output, proceeds to the 19kHz amplifier, frequency doubler, stereo demultiplexer and audio amplifier stages. Also covers RDS digital data encoding and decoding. **Order Code VT403**

MISCELLANEOUS

VT501 58 minutes. Fibre Optics. From the fundamentals of fibre optic technology through cable manufacture to connectors, transmitters and receivers. **Order Code VT501**

VT502 57 minutes. Laser Technology A basic introduction covering some of the common uses of laser devices, plus the operation of the Ruby Rod laser, HeNe laser, CO₂ gas laser and semiconductor laser devices. Also covers the basics of CD and bar code scanning. **Order Code VT502**

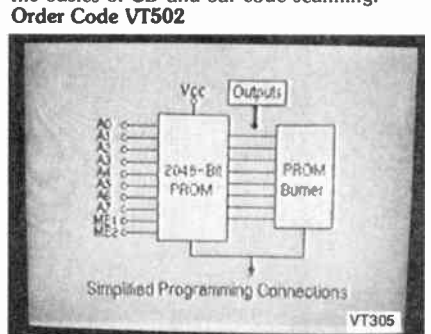

Each video uses a mixture of animated current flow in circuits plus text, plus cartoon instruction etc., and a very full commentary to get the points across. The tapes are imported by us and originate from VCR Educational Products Co, an American supplier. We are the worldwide distributors of the PAL and SECAM versions of these tapes. (All videos are to the UK PAL standard on VHS tapes unless you specifically request SECAM versions.)

ORDERING: Price Includes postage to anywhere in the world.

OVERSEAS ORDERS: We use the VAT portion of the price to pay for *airmail* postage and packing, wherever you live in the world. Just send £34.95 per tape. All payments in £ sterling only (send cheque or money order drawn on a UK bank). Make cheques payable to Direct Book Service.

Visa and Mastercard orders accepted – please give card number, card expiry date and cardholder's address if different from the delivery address.

Orders are normally sent within seven days but please allow a maximum of 28 days, longer for overseas orders.

Send your order to: Direct Book Service, Allen House, East Borough, Wimborne, Dorset BH21 1PF

Direct Book Service is a division of Wimborne Publishing Ltd., Publishers of *EPE*

Tel: 01202 881749. Fax: 01202 841692

Due to the cost we cannot reply to overseas orders or queries by Fax.

E-mail: dbs@epemag.wimborne.co.uk

CIRCUIT SURGERY

ALAN WINSTANLEY
and IAN BELL

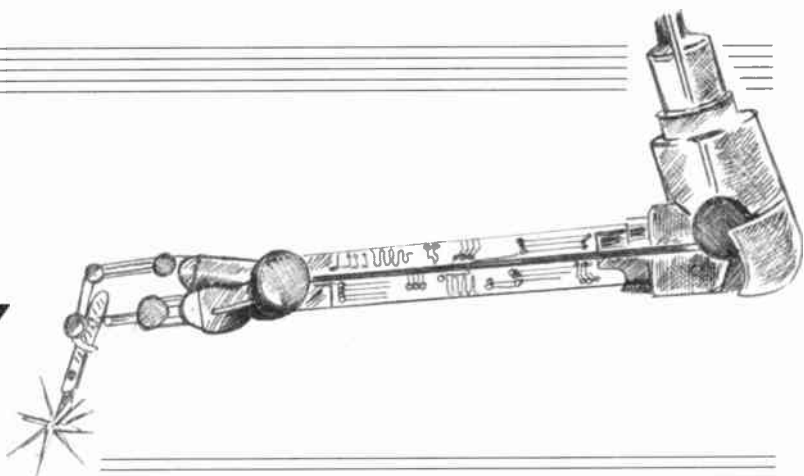

A few practical reminders about testing transistors the quick and easy way are discussed in this month's column of reader's queries.

Keep Soldering On

I am building a tube amplifier kit that uses "eyelet" fibre circuit boards. The instructions say to heat the eyelet and then put the solder to the tip.

My concern is that there is a brown residue (from the rosin?) left on the solder afterwards. I understood that the rosin burns away, but on my boards it is still visible. The joints seem solid. Am I doing something wrong? A. Harris via E-mail.

The purpose of flux in a solder is to help the molten solder to flow better, by removing oxides and deposits. What you are seeing is the remainder of the rosin flux contained within the solder.

It does mostly burn away (which is where the smoke comes from) but there will be some left on the board afterwards. You can clean it off using a proprietary aerosol cleaner if you like, but on a "turret board" or eyelet board it won't make any difference whatsoever on performance.

Reminds me of the managing director of an electronics company I worked for many years ago, who gave me a rocket for "using far too much solder" claiming that I had probably shorted out the entire board. He was actually referring to the flux residue which he thought conducted electricity! ARW.

Check Those Transistors

I have a bit of trouble with a metal-cased 2N3055 power transistor - I can't seem to find which of the two pins is the collector/emitter! The only thing I found was that when doing a continuity test across the pins, I get a reading one way but not the other. I'm not sure what conclusion to draw from that. Mark, via the Net.

A quick and easy transistor test is one of those things worth reminding readers about. With experience you'll learn that the metal case of most power transistors is wired to the collector (c). The two pins are for the base (b) and emitter (e) connections.

You can hook up to the collector in a number of ways, e.g. if screwing the transistor to a heatsink, use a solder tag under one of the mounting bolts. It is sometimes

important to ensure that nothing else comes in contact with the collector, so an insulated mounting kit should be used.

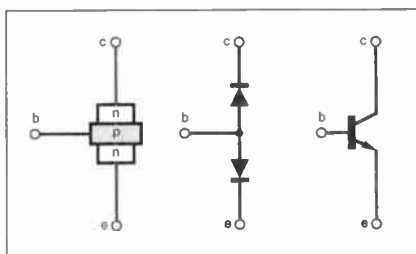

Fig.1. How an npn transistor is formed internally of two back-to-back diodes. These can be checked with a Multi-meter on an Ohm's or diode range.

A bipolar transistor, including the metal-cased 2N3055, can be considered as equivalent to two back-to-back diodes. How bipolar transistors are formed this way using an n-p-n sandwich structure is shown in Fig.1. An npn transistor appears to contain two cathodes (emitter and collector) and one anode (base), and you can see how the base is common to both diodes. The opposite conditions pertain to pnp transistors.

By using an ordinary moving coil multimeter you can perform some quick tests to help identify the pinouts, and also to help test the integrity of the device. A digital multimeter may have a diode check range which can also be used to test bipolar transistors, see later.

Take Note

The first thing to note is that a moving-coil multimeter has an internal battery needed for measuring resistance, and the meter's positive terminal actually sinks

current, i.e. current comes out of its negative terminal. (The opposite seems to be true of digital types.)

An ordinary silicon diode can soon be given a "go-no-go" check using the resistance range. Diodes have a high resistance in one direction only. Obviously a high resistance in both directions indicates open circuit whilst a low resistance indicates a short.

A random 1N4148 diode measured 5kΩ (5 kilohms) when forward biased: the negative lead therefore being connected to the anode. This can be used as the basis for testing transistors and it's handy to know how to run a quick check on a suspect or unmarked device.

A sample 2N3055 power transistor was tested (see photos) and the following results were obtained, remembering that when a terminal is positively biased, this means it is connected to the negative test lead of a moving-coil meter. The pinout details are shown in Fig. 2.

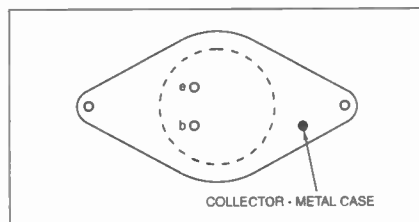

Fig.2. Pinout configuration of a metal-cased 2N3055 power transistor.

A low resistance of about 4k was read, a high resistance about 800k. If the emitter-collector test shows a low or high resistance in both directions, this indicates a short or open circuit respectively, and you can consign it to the bin.

		Positive Bias:		
		Base	Emitter	Collector
Negative Bias	Base	X	High resistance	High resistance
	Emitter	Low resistance	X	High resistance
	Collector	Low resistance	High resistance	X

Source of Leaks

The leakage current of an *npn* bipolar transistor can also be quickly checked. Simply hook the resistance meter negative lead (+supply) to the collector and the emitter to the positive terminal (-supply), leaving the base unconnected. This should indicate a high resistance. Any noticeable deflection in the reading hints at a leaky transistor.

Leakage current actually rises with temperature, so you can try heating it with a hot air gun (a hot air blower on my gas-powered iron was ideal) to see what happens. After about a minute or so the leakage current will rise substantially. Experiment with some old surplus devices as well.

When using an auto-ranging digital multimeter, the preceding go-no-go testing method won't work on the resistance range as the DMM has a very high impedance, but you can still use a diode check function to measure and identify the internal diodes of bipolar transistors (see photos). Just

remember that this time, the DMM's positive lead is a *source* of current. A "good" diode will have a forward voltage of roughly 0.45V upwards as shown on my AVO meter, and its anode will be connected to the positive lead. ARW.

Earthy feelings

I was a test engineer for an electrical contractor for many years, and reading Circuit Surgery in EPE September 2000 issue 1 noted that Fernando Bentes de Jesus is receiving electric shocks from his dishwasher which does not appear to be earthed - any voltage appearing on the metal case would otherwise flow to earth and not through him. All electrical installation must be earthed for the RCD [GFCI in the USA] to protect life and property.

The RCD works by sensing the imbalance between the phase "live" and neutral, with current flowing phase to earth, or neutral to earth. It will not protect against phase to neutral. As you rightly say, the RCD should trip out in 40

CIRCUIT THERAPY

Circuit Surgery is your column. If you have any queries or comments, please write to: Alan Winstanley, *Circuit Surgery*, Wimborne Publishing Ltd., Allen House, East Borough, Wimborne, Dorset, BH21 1PF, United Kingdom. E-mail (no attachments) alan@epemag.demon.co.uk. Please indicate if your query is not for publication. A personal reply cannot always be guaranteed but we will try to publish representative answers in this column.

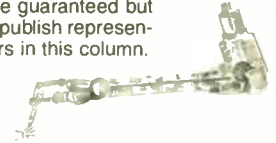

milliseconds. Ideally, it should be tested with a RCD tester that will pass the rated current and measure the trip time; the test button on the RCD only tests the mechanical side of the trip. Tony Hitchings, Hereford via E-mail.

Thanks for the valuable advice. ARW.

Quick and Easy Go-No-Go Testing Using Your Multimeter

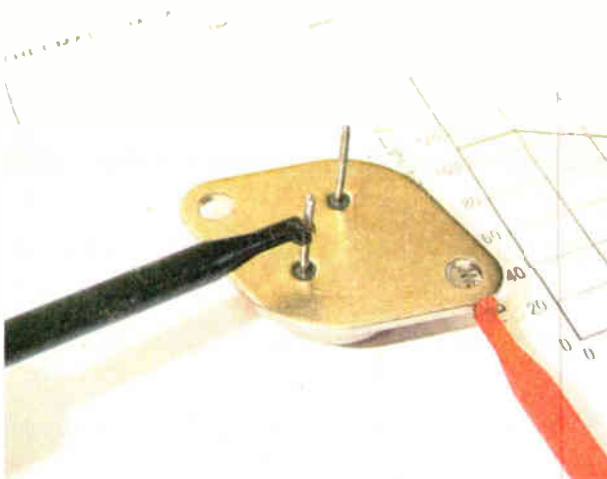

The collector of a 2N3055 is connected to the metal case of the device. Use multimeter test probes to check the internal diodes.

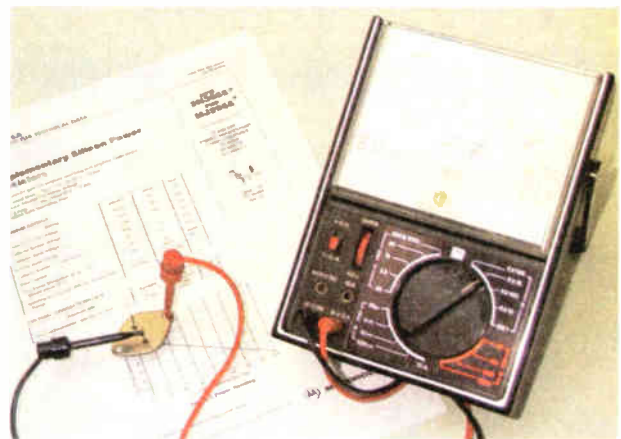

Using a moving coil meter set to its resistance range to test the transistor. Note that current flows out of the negative lead. The device will have a low resistance (4k to 5k) when forward biased.

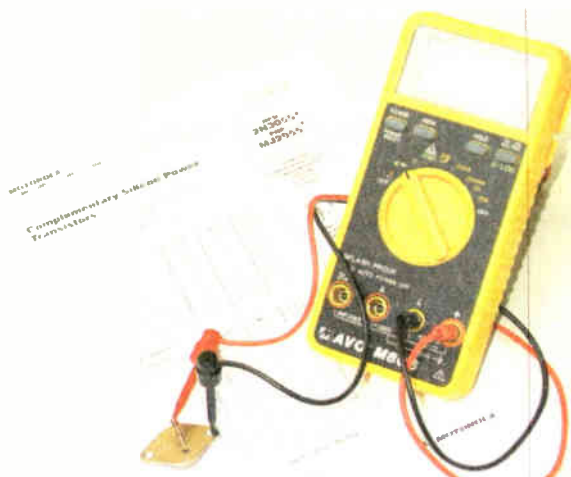

The diode test range of a digital multimeter can be used to measure the forward voltage of a transistor diode. A good reading is in the region of 0.45V to 0.9V.



ICEBREAKER

□□□□□□□□□□

PIC Real Time In-Circuit Emulator

- 20MHz full speed operation
- PC Serial port connection
- Use With Microchip MPLAB
- Standard MPASM Language
- PCB with solder mask & component ID
- Kit with all components, PIC16F877
- Solderless Breadboard, lcd, Serial Lead, and Software
- Kit 900 £34.99

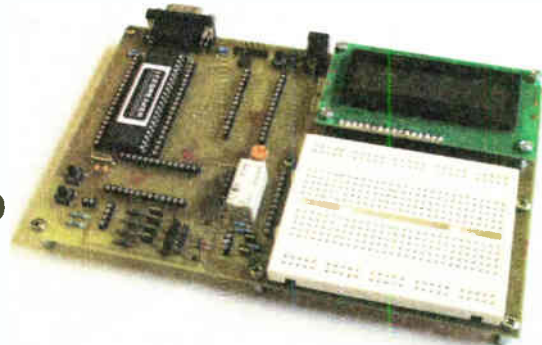

Stepping Motor & Power Supply Extra

MAGENTA
ELECTRONICS LTD

135 Hunter Street, Burton-on-Trent, Staffs. DE14 2ST
Tel: 01283 565435 Fax: 546932
<http://www.magenta2000.co.uk>
E-mail: sales@magenta2000.co.uk
All Prices include VAT. Add £3.00 p&p. £6.99 next day



A COMPLETE RANGE OF INVERTERS

150W TO 1000W - 12V & 24V

A Complete range of regulated inverters to power 220V and 240V AC equipment via a car, lorry or boat battery. Due to their high performance (>90%) the inverters generate very little heat. The high stability of the output frequency (+/-1%) makes them equally suitable to power sensitive devices.

These inverters generate a modified sine wave, which are considerably superior to the square waves which are produced by most other inverters. Due to this superior feature they are capable of powering electrical equipment such as TV,s, videos, microwave ovens, electrical lamps, pumps, battery chargers, etc.

Low Battery Alarm

The inverters give an audible warning signal when the battery voltage is lower than 10.5V (21V for the 24V version). The inverter automatically shuts off when the battery voltage drops below 10V (20V for the 24V version). Fuse protected input circuitry.

Order Code	Power	Voltage	Price
651.581	150W Continuous	12V	£38.49
651.578	150W Continuous	24V	£38.49
651.582	300W Continuous	12V	£54.36
651.585	300W Continuous	24V	£54.36
651.583	600W Continuous	12V	£118.42
651.593	600W Continuous	24V	£118.42
651.587	1000W Continuous	12V	£174.60
651.597	1000W Continuous	24V	£174.60

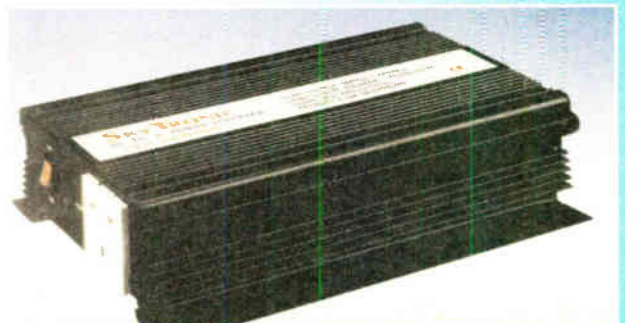

ILLUSTRATION SHOWN IS 651.583 600W VEF3ION

All prices are inclusive

Many uses include:- * Fetes * Fairgrounds * Airshows * Picnics * Camping * Caravans * Boats * Carnivals * Field Research and * Amateur Radio field days.

DELIVERY CHARGES ARE £6-00 PER ORDER. OFFICIAL ORDERS FROM SCHOOLS, COLLEGES, GOVT. BODIES, PLC.S ETC. PRICES ARE INCLUSIVE OF V.A.T. SALES COUNTER. VISA AND ACCESS ACCEPTED BY POST, PHONE OR FAX, OR EMAIL US AT SALES@BKELEC.COM ALTERNATIVELY SEND CHEQUE OR POSTAL ORDERS MADE PAYABLE TO BK ELECTRONICS.



B.K. ELECTRONICS



UNIT 1, COMET WAY, SOUTHEND-ON-SEA, ESSEX. SS2 6TR
TEL.: +44(0)1702-527572 FAX.:+44(0)1702-420243

For Full Specifications View our web site at:-
WWW.BKELEC.COM/INVERTERS.HTM

Radio Bygones

The leading magazine
for vintage radio
enthusiasts



WHETHER your interest is in domestic radio and TV or in amateur radio, in military, aeronautical or marine communications, in radar and radio navigation, in instruments, in broadcasting, in audio and recording, or in professional radio systems fixed or mobile. RADIO BYGONES is the magazine for you.

ARTICLES on restoration and repair, history, circuit techniques, personalities, reminiscences and just plain nostalgia – you'll find them all. Plus features on museums and private collections and a full-colour photo-feature in every issue.

IT'S MOSTLY about valves, of course, but 'solid-state' – whether of the coherer and spark-gap variety or early transistors – also has a place.

FROM THE DAYS of Maxwell, Hertz, Lodge and Marconi to what was the state-of-the-art just a few short years ago . . .

There is also a selection of free readers' For Sale and Wanted advertisements in every issue.

Radio Bygones covers it all!

THE MAGAZINE is published six times a year, and is available by postal subscription. It is **not available at newsagents**.

TO TAKE OUT a subscription, or to request a sample copy, please complete the form below and return it to:
RADIO BYGONES, Allen House, East Borough, Wimborne, Dorset BH21 1PF.

Tel: 01202 881749. Fax 01202 841692. Web sites: www.radiobygones.co.uk www.radiobygones.com

RADIO BYGONES ORDER FORM

A SAMPLE COPY of Radio Bygones £3.25
(Add 70p for overseas Airmail postage)

SUBSCRIPTIONS (post paid):	1 YEAR	2 YEAR
UNITED KINGDOM	£18.50	£35.00
REST OF EUROPE (AIRMAIL)	£20.50	£39.00
REST OF THE WORLD (AIRMAIL)	£24.50	£47.00

- Yes, I would like a sample copy of RADIO BYGONES
- Yes, I would like to take out a subscription for:
- One year (6 issues) Two years (12 issues)
- I enclose a cheque/Eurocheque/PO for £ payable to Wimborne Publishing Ltd
- Please debit my Visa/Mastercard
- NOTE** Minimum credit card payment is £5

My credit card number is:

--	--	--	--	--	--	--	--	--	--	--	--	--	--	--	--	--	--	--	--	--

Please print clearly, and check that you have the number correct

The card is valid from: to:

My name is

My address

Post Code/Zip

Signed

Prices fully inclusive

New – The PIC 18Cxxx series

FED PIC C Compiler – Version 3.0 now available

- Designed to ANSI C Standards
- Complete development environment includes Editor, assembler, simulator, waveform analyser and terminal emulator (see screenshot below)
- Libraries include serial interfaces, I2C, LCD, keypads, delays, string handling, hardware etc.
- Simulator runs up to 10 times faster than MPLAB, allows inputs to be defined, multiple breakpoint types, single stepping, step over etc.
- Supports all 14-bit core PICs – 12C67x, 16C55x, 16C6x, 16C7x, 16C8x, 16C87x, etc.
- Will produce code for MPLAB

LEARN to Program PIC's in C with FED! Download FREE from our web site

With the FED introductory manual:
"Learn to program PIC's with FED PIC C"

- Suitable for complete beginners to PICs or to the C programming language
- Leads through example
- Introduces simple C programs, then covers variables and casting, pointers, structures and unions, functions, etc.
- All examples will run fully within the simulator, or on the FED 16F84 and 16F877 development boards
- Covers use of interrupts and programming for real time applications
- Hints and tips on good programming practice with the PIC
- Full examples of debugging using FED PIC C are included
- Included FREE on our PIC C Compiler CD ROM, or available in paper copy

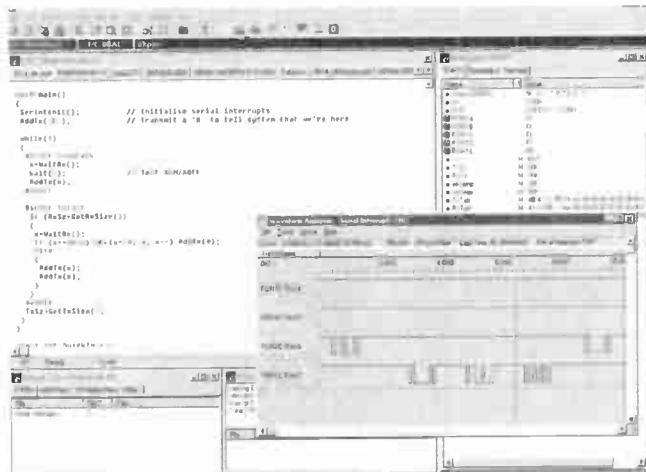

Prices (reductions for PICDESIM/WIZPIC & our programmer users)

C Compiler with all manuals on CD ROM £60. CD ROM with printed manuals £75.

Buy with PICDESIM/WIZPIC or our Programmer – £45.00 CD-ROM.

"Learn to program PICs with FED PIC C" paper copy – £7.50.

PIC Programmers including 18Cxxx

PIC Serial Programmer (Left)

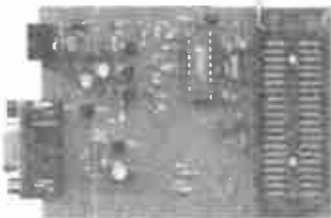

Handles serially programmed PIC devices in a 40-pin multi-width ZIF socket. 16C55X, 16C6X, 16C7X, 16C8x, 16F8X, 12C508, 12C509, 16C72XPIC 14000, 16F87X, 18Cxxx etc. Also In-Circuit programming. Operates on PC serial port

Price : £45/kit
£50/built & tested

PIC Introductory – Programs 8 & 18 pin devices : 16C505, 16C55X, 16C61, 16C62X, 16C71, 16C71X, 16C8X, 16F8X, 12C508/9, 12C671/2 etc. £25/kit.

AVR – AVR1200, 2313, 4144, 8515, 8535, 4434 etc. in ZIF. 4.5V battery powered. Price : £40 for the kit or £45 built & tested.

All our Programmers operate on PC serial interface. No hard to handle parallel cable swapping ! Programmers supplied with instructions, + Windows 3.1/95/98/NT software. Upgrade programmers from our web site !

WIZPIC

PIC Visual Development



- Rapid Application Development for the PIC microcontroller
- Drag and drop your software component selections on to your design

- Included components support timers, serial interfaces, I2C, LCD, 7-Seg displays, keypads, switches, port controls, and many more.
- Connect software components to PIC pins by point & click using the mouse
- Set parameters for each component from drop down list boxes, check boxes, or text entry
- Links your code automatically into library events (e.g. Button Pressed, Byte Received etc)
- Up to 10 times faster than MPLAB
- Supports all 14-bit core PIC's -12C67x, 16C55x, 16C6x, 16C7x, 16C8x, 16C87x etc.

Cost – CD-ROM with Data sheets and application notes – £35.00, Floppy version £30.00.

Forest Electronic Developments

60 Walkford Road, Christchurch, Dorset, BH23 5QG.
E-mail – info@fored.co.uk, or sales@fored.co.uk
Web Site – <http://www.fored.co.uk>

01425-274068 (Voice/Fax)

Prices are fully inclusive. Add £3.00 for P&P and handling to each order. Cheques/POs payable to Forest Electronic Developments, or phone with credit card details.



18C452

New architecture (more instructions + Hardware multiply), 40MHz clock, 16K program words, 1536 bytes RAM. Easy to upgrade from 16F877

18C452/JW £20.00
18C452/OTP £8.00

<http://www.fored.co.uk>

Constructional Project

PIC DUAL-CHAN VIRTUAL SCOPE

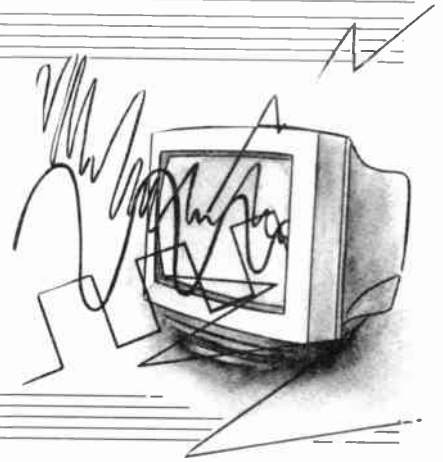

JOHN BECKER

A virtual oscilloscope for monitoring audio frequency waveforms via your computer.

MID-RANGE is perhaps a reasonable opening description of this design. At one end of the scale of *EPE* virtual oscilloscope designs is the simple Analogue Input Waveform Display computer interface used with the *Teach-In 2000* series. At the other end is the sophisticated and versatile *EPE Virtual Scope* of Jan/Feb '98.

With the *TI* interface, analogue waveforms from a single source are digitised under elementary computer control and displayed on screen. The sampling rate depends heavily on the rate at which the computer operates. A maximum signal frequency of perhaps 1kHz can just be displayed using a 120MHz computer.

The *TI* unit's simplicity of construction and use make it an ideal "eye-opener" for electronic novices, enabling them to gain an insight into what happens with electronic circuits and waveforms.

The *V-Scope*, on the other hand, uses a very complex set of electronic circuits to convert two analogue channels simultaneously for computer display at frequency rates up to several megahertz. It uses a mixture of QuickBASIC routines which access high-speed machine code assemblies. Operation is principally under mouse control. Its circuit complexity, however, makes it unsuitable for building by inexperienced constructors.

PIC V-SCOPE

Sitting between these two designs is the *PIC V-Scope* described here. It provides waveform display of two signals simultaneously at rates much higher than the *TI* design offers, although lower than *V-Scope* can handle. It is considerably easier to construct than *V-Scope*. With care, even less-experienced hobbyists should stand an excellent chance of constructing it successfully.

In order to use the design, however, you need a PC-compatible computer capable of running QBasic or QuickBASIC and for it to "read" mouse controls via those programming dialects. As discussed later, the controlling program allows you to check on both points before purchasing any components. The author has run the prototype under Windows 3.1, 95 and 98.

Many of the functions offered by this design are closely similar to those offered by *V-Scope*. Indeed, the controlling software is a cut-down version of that design.

CIRCUIT DIAGRAM

The complete circuit diagram for the *PIC V-Scope* is shown in Fig.1. Both input channels are identical and are formed around op.amps IC1a and IC1b.

Taking just Channel 1, the signal is brought into socket SK1 and to switch S1, at which a choice of gain is offered, $\times 1$

(unity) or $\times 10$, as set by resistors R1 and R2 in relation to the value of R3. Other gains may be preset by changing the values of the resistors during assembly.

From R1/R2, the signal is routed to a.c. coupling capacitor C1, which can be bypassed via switch S2 for d.c. operation. The signal is then fed to the inverting input of IC1a, from where it is output to the PIC microcontroller, IC2, a PIC16F877 device.

Mid-rail bias (2.5V) for both op.amps is set by the potential divider formed across R9 and R10, with smoothing provided by capacitor C3. This bias must be taken into account when monitoring d.c. signals.

The PIC16F877 microcontroller, as discussed in several previous *EPE* issues, has eight inputs which can be used for analogue-to-digital conversion. In this design, only inputs RA0 and RA1 are used. All other active PIC port pins are used in conventional digital input or output mode.

The basic role of the PIC is to perform the A-to-D conversion and output the result to the computer via socket SK4, either immediately on conversion, or after storing it temporarily in memory chip IC3.

PORTD is used for the memory data routing, while PORTC outputs the data to the computer. As is frequently the case with *EPE* designs, the computer's parallel printer port handshake lines are used for the data output. Read/write control of IC3 is via the RA4/OE and RA5/WE connection pairs.

Communication from the computer to the PIC is via computer data lines DA0 to DA3, also connected through socket SK4.

SPECIFICATIONS . . .

- PIC microcontroller performs analogue-to-digital conversion, buffer memory storage/recall and output to PC-compatible computer for display
- Computer control of all PIC program modes
- Selectable dual channel or either channel individually
- Two signal display modes, analogue and digital
- Waveform gain switchable for $\times 1$ or $\times 10$
- Input impedance 10k Ω and 100k Ω
- Maximum input signal level before display clipping 5V pk-pk, or 50V if $\times 10$ scope probe used
- Input switchable for a.c. or d.c.
- Waveform synchronisation (sync) selectable on/off by channel, with controllable trigger levels
- Waveform shift vertically for each channel
- Frequency range: nominally audio, but extending well below 1Hz and above 10kHz
- Frequency counting and waveform amplitude monitoring for each channel, selectable on/off
- Frequency count accuracy presettable from screen for fine tuning, with automatic recall of settings on start-up
- Three sampling modes: via 2Kbyte or 32Kbyte buffer memory, or immediate
- Screen grid on/off
- Waveform display hold on/off
- Waveform data output to disk, on demand or automatic, date and time stamped
- Waveform data input from disk files
- Disk files selectable by mouse from on-screen directory
- Operation via parallel printer port
- Port address selectable on-screen, with automatic recall on start-up
- Screen dump to printer, date and time stamped
- All functions mouse-selectable
- Additional keyboard control for some options
- Power supply, d.c., nominally 9V, but 7V to 15V acceptable, approx 6mA average, on-board 5V regulator

Resistors R12 to R15 bias the PIC's respective input pins to 0V when the computer is not connected.

The PIC is operated at 5MHz, as set by crystal X1, and use of the 20MHz version (PIC16F877-20) is recommended. Whilst the author has successfully "over-run" a standard PIC16F877-4 (nominally 4MHz max.) in this circuit, satisfactory results cannot be guaranteed for other assemblies.

The PIC may be programmed on-board by those who have suitable programmers (e.g. *PIC Toolkit Mk2* of May/June '99). Terminal strip TB1 provides the access connections.

The prototype is powered at 9V d.c., with connection via a PP3 battery clip. A power supply socket could be used instead. The circuit may be powered at between 7V and 15V d.c., with an average current consumption of about 6mA.

Full software, including source code, is available on 3.5-inch disk (for which a nominal handling charge applies) or free via the *EPE* web site. Pre-programmed PICs are also available from an external supplier. For more details see this month's *Shoptalk* page.

PROGRAM OPERATION

Whether the PIC is instructed by the computer to sample with or without using the buffer memory, the basic process is the same. It samples the analogue input signals as fast as it can, converts them to digital format which it sooner or later outputs to the computer.

A series of handshake commands are exchanged between the PIC and computer in order to maintain the correct sequence of events. The 8-bit data is output as two 4-bit nibbles, which are re-assembled by the computer software to a single byte and plotted on screen according to the value of the signal voltage. The entire sequence of data input and plotting is performed by a set of machine code routines.

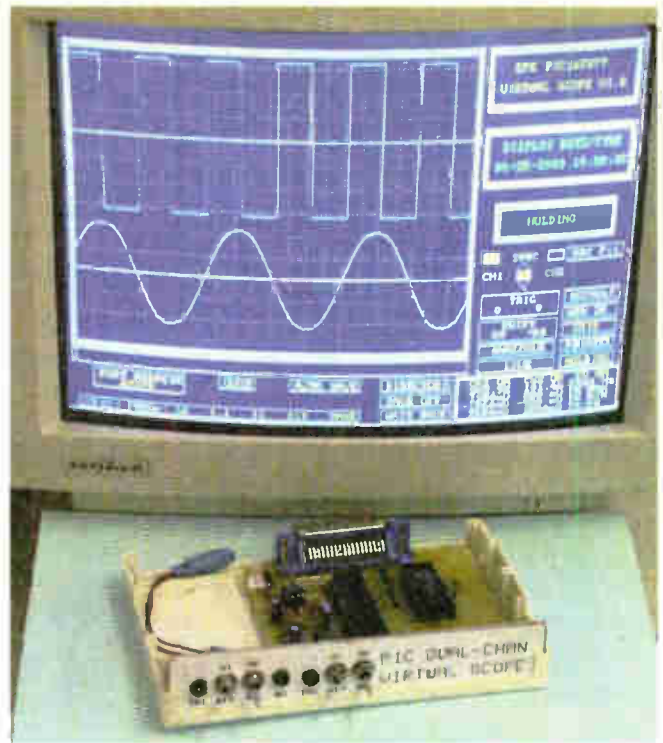

This simple but powerful tool allows two signal waveforms to be viewed on a PIC-compatible computer screen.

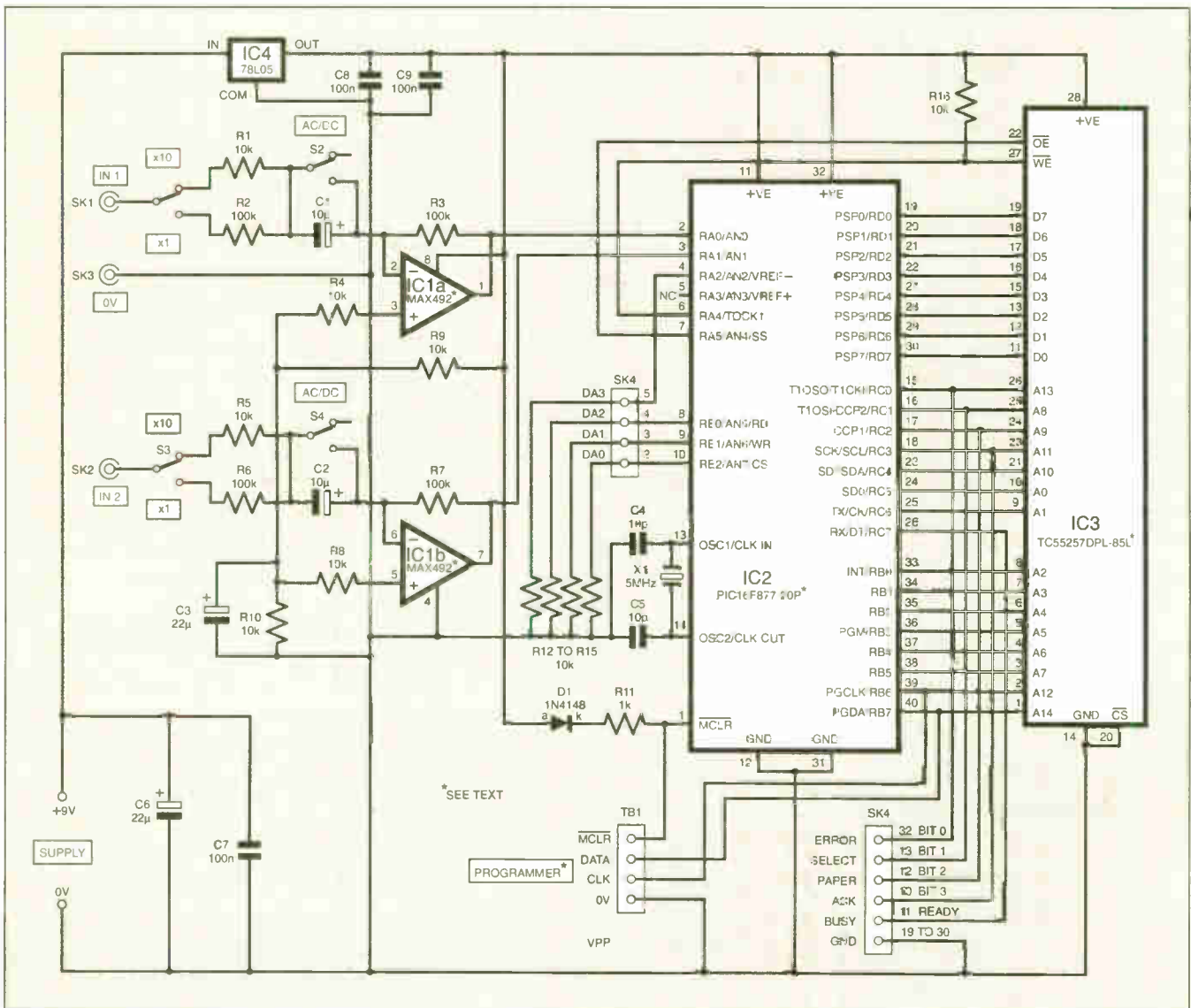

Fig.1. Complete circuit diagram for the PIC Dual-Chan Virtual Scope.

During this process, the computer software assesses the data for display synchronisation, in which repeating signal traces commence on screen at the same relative waveform amplitudes. The sync trigger thresholds can be set under mouse control, both for amplitude levels, and whether positive or negative-going triggering is required. Sync control may be turned on or off via the mouse.

Data is also analysed for signal frequency and amplitude, with the results output to the screen at the end of each waveform traversing the display area. Frequency is quoted in Hertz (Hz). Amplitude is quoted in three values, maximum and minimum peaks, and the absolute difference between the two (peak-to-peak), in volts. This analysis sequence may also be turned on and off via the mouse.

The PIC microcontroller can be instructed to sample either two channels in parallel (the second channel sampled a few microseconds after the first), or either channel individually.

MEMORY

There are two basic sampling modes, immediate or buffered. In the immediate mode the PIC samples and converts the analogue data to digital and immediately outputs it to the computer. The process, however, is slowed by the fact that handshaking and sample taking are interlinked, the PIC and the computer waiting for each other's response before the next sample is taken.

This method is more suited to sampling lower frequency waveforms, of a few tens of hertz or less.

The fastest method is achieved by using the memory buffer, IC3. Samples are taken as in the immediate mode but immediately stored in IC3. Handshaking is not required and the process is entirely under PIC control.

Each sample is output to IC3 via PORTD and with IC3's \overline{OE} (output enable) pin held high, the \overline{WE} (write enable) pin is toggled low then high again, an action which causes the data to be stored.

The memory's data address is controlled by PORTB and PORTC, providing a 15-bit (32768 bytes) address range. After each sample is written to IC3, the address count is updated, ready for the next sample.

TWIN BUFFERS

There are two memory buffer modes, 32Kbyte and 2Kbyte, respectively allowing 32768 and 2048 samples to be stored. In dual-channel mode, alternate addresses are used for each channel, with a maximum sample quantity of 16K and 1K per channel. In single channel mode the full allocated block is used by that channel.

When the memory count reaches 2K or 32K, as appropriate, the PIC signals to the computer that the data is now ready to be transferred.

A slightly cut-down version of the sampling routine for one channel is shown in Listing 1. In the actual program, another routine is also called, to determine whether or not the mode needs to be changed.

To read data back from the memory in the same order, the counters are reset, IC3 \overline{WE} is set high and \overline{OE} set low with the commands:

```
MOVLW %00100000
MOVWF PORTA
```

Data is then recalled from each address via PORTD, with the command **MOVFPOR TD,W**. The data is output to the computer, after which the counter is updated and the next sample recalled. The data transfer uses the same handshake protocol as for the immediate mode. The routines are too complex to be listed here.

This buffered technique allows samples to be taken far more rapidly than the immediate mode. There is, though, a brief delay between each sample batch being displayed on screen, but this is usually almost unnoticeable.

The choice of sampling mode is mouse-controlled, the computer sending the mode commands to the PIC via data lines DA0 to DA3.

A summary of the sampling modes is as follows:

LISTING 1. Single channel data sampling and storage

DX0:	BSF ADCON0,GO	; start conversion for 1st sample
	PAGE1	
	CLRF TRISD	; PORTD as outputs
	PAGE0	
	MOVLW %00110000	; set WE hi (bit 4), OE hi (bit 5)
	MOVWF PORTA	
	CLRF PORTB	; reset PORTB counter
	MOVWF LIMIT,W	; set limit value into PORTC
WAITAD0:	MOVWF PORTC	
	BTFSZ ADCON0,GO	; wait until conversion flag is set
	GOTO WAITAD0	
	MOVWF ADRESH,W	; get ADC val
	BSF ADCON0,GO	; start conversion for next sample
	MOVWF PORTD	; put it out to mem
	BCF PORTA,4	; toggle mem WE down
	BSF PORTA,4	; toggle mem WE up
	INCFSZ PORTB,F	; inc PORTB counter, is it 0?
	GOTO WAITAD0	; no, get next sample
	DECFSZ PORTC,F	; yes, dec PORTC counter, is it 0?
	GOTO WAITAD0	; no, get next sample
	(end of routine)	; yes, so end of batch storage

- Single channel (A or B): Immediate, continuous, no batch limit
- Single channel (A or B): Buffered, 2048 or 32768 samples per batch
- Dual channel (A + B): Immediate, continuous, no batch limit
- Dual channel (A + B): Buffered, 1024 or 16384 samples per channel per batch

MODE RATES

To simplify programming and, more particularly, to speed data acquisition, separate routines are used in the PIC program for each mode.

There is also a choice of the rate at which the PIC actually does the analogue-to-digital conversion. As detailed in Table 11.1 of the PIC16F87x data book, the maximum rate (T_{osc}) at which the PIC can perform its A/D conversion is dependent upon the frequency at which the PIC is operated.

COMPONENTS

Resistors

R1, R4, R5,
R8 to R10,
R12 to R16 10k
(11 off)
R2, R3,
R6, R7 100k (4 off)
R11 1k

All 0.25W 5% carbon film or better.

See
SHOP
TALK
page

Capacitors

C1, C2 10 μ radial elect, 16V
(2 off)
C3, C6 22 μ radial elect, 16V
(2 off)
C4, C5 10p ceramic disc, 5mm
(2 off)
C7 to C9 100n ceramic disc, 5mm
(3 off)

Semiconductors

D1 1N4148 signal diode
IC1 MAX492 dual op.amp,
rail-to-rail (see text)
IC2 PIC16F877-20P
microcontroller,
pre-programmed
(see text)
IC3 TC55257DPL-85L
32Kbyte SRAM
(see text)
IC4 78L05 +5V 100mA
voltage regulator

Miscellaneous

S1 to S4 min.s.p.d.t. toggle
switch (4 off)
SK1 to SK3 2mm single socket
(3 off) (see text)
SK4 36-way Centronics
socket, right-angle,
p.c.b. mounting
TB1 4-way 1mm pin-header
strip (see text)
X1 5MHz crystal

Printed circuit board, available from the *EPE PCB Service*, code 275; plastic case, 180mm x 120mm x 40mm; 8-pin d.i.l. socket; 28-pin d.i.l. socket; 40-pin d.i.l. socket; PP3 battery clip (see text); p.c.b. supports, self-adhesive, low profile (4 off); connecting wire; solder, etc.

Approx. Cost
Guidance Only

£33
excluding case

For a 5MHz clock, as used in this design, register **ADCON0** has a maximum recommended **ADCS1:ADCS0** (bits 7 and 6) value of binary 01 (**8Tosc**). However, on experimentation, it was found that the **2Tosc** rate (binary 00) worked perfectly satisfactorily, providing a four-times increase in A/D conversion speed.

Because this higher operating rate cannot be guaranteed for all devices, the PIC software has been given the option for either rate to be selected from the computer (see later). **ADCON0** bit 7 is held low and bit 6 is toggled between high and low to alternate between **8Tosc** and **2Tosc** (respectively).

DELAY CALLS

In the author's *PIC16F87x Mini Tutorial* (Oct '99), an example of A/D conversion was illustrated in which a delay was imposed during multiple sampling routines, in order to allow time for the PIC to fully acquire each analogue value before the conversion is performed.

The PIC16F87x data book discusses this timing subject, but presents a complicated formula for establishing the optimum value. In the *Tutorial* example, delays of 256 clock cycles were given.

Further experience with the PIC16F87x in several other applications, however, shows that this length of delay can be considerably reduced. In the *PIC V-Scope* routine for single channel sampling, the delay caused simply by the number of commands in the routine is all that is required.

For dual channel sampling, though, an additional delay routine is called (**DELAYB**) which, with the **CALL** command itself, introduces a delay of nine clock cycles in addition to that caused by the sampling routine itself.

Without this additional delay, it was found that small amounts of each channel's sampling were superimposed on the other channel's sampling. The reason being that the channels are sampled alternately throughout the full cycle and the PIC uses the same internal conversion circuit for all sampling. The effect was most noticeable when one channel was sampling a 5V logic waveform while the other sampled a lower amplitude analogue waveform.

The sample source inputs are alternated between **RA0** and **RA1** by toggling **ADCON0** bit 3. The **DELAYB** routine is called immediately following the change of this bit, and eliminates the effect. In fact a delay of only six clock cycles also cured it, but another three were included to allow for tolerance variations between devices.

BEFORE YOU BUILD

Through feedback from readers it is apparent that not all PC-compatible computer systems and their software are capable of running a QuickBASIC or QBasic program with the type of machine code routines that are an integral part of this design.

It is strongly recommended that *before* you purchase any components for this circuit, you obtain and run its program as a test of your computer's suitability.

First though, check that your computer has either QuickBASIC or QBasic already

installed. If it has not, the chances are that you have QBasic available on your Windows 95/98 CD ROM. Recent correspondence in *Readout* says that it is to be found in one of the following directories:

Win95: \other\oldmsdos
Win98: \tools\oldmsdos

There are two files, **QBASIC.EXE** and **QBASIC.HLP**, being the program and its Help file. Make a directory (folder) called **QBasic** on your hard drive and copy both files into it. To run the program, just type **QBASIC**.

Your *PIC V-Scope* files must all be copied into the same directory that holds QBasic or QuickBASIC. From either version of Basic, then load and run program **PVSCOPE.BAS** (which may also be called via the **PVSCOPE.BAT** file).

It is important to note that *QuickBASIC* must be loaded and run with the command **QB/L**, which additionally loads a QuickBASIC library routine that allows machine code to be run with a Basic program. The *PIC V-Scope* program will crash if the **QB** library routine is not loaded. *QBasic* has this routine automatically included and does not require (or accept) the **QB/L** command.

On entry, the *PIC V-Scope* screen should appear similar to that in the photographs, except that it will say that it is waiting for a response from the circuit, and will be without signal trace lines. Ignore this statement and check that the mouse cursor arrow is visible and that you can move it around the screen. Additionally check that when you left-click it on the values in the **TRIG** and **SYNC** boxes they increment, and decrement if you right-click.

Note that throughout this text the terms *left-click* and *right-click* mean pressing the left-hand and right-hand mouse buttons, respectively. If *click* is used on its own, either button will perform the required action.

Also check that when either mouse button is held down and any keyboard key (except **Q**) is pressed, the **TRIG** or **SYNC** values continue to change.

If the mouse performs these actions, your computer should be capable of running the rest of the program and controlling the *PIC V-Scope* circuit. Sadly, if it does not do these things, your computer is incapable of controlling the circuit.

QUITTING THE PROGRAM

Pressing **Q** causes a **Quit** (exit) from running the program. Left-clicking on the box labelled **QUIT** causes the computer to "bleep" and a screen statement appears asking if you are sure you want to quit.

Left-click if you wish to quit, or right-click if you wish to continue running the program.

If the program has initially been run from the **PVSCOPE.BAT** command, quitting will return you to the screen from which the command was originally given. If the program has been loaded and run from the Basic menu, the program will stop, telling you to "press any key", and then show the program listing within the Basic editing environment. To exit from Basic in this instance, press in turn **ALT, F, X** (the usual exit command keys).

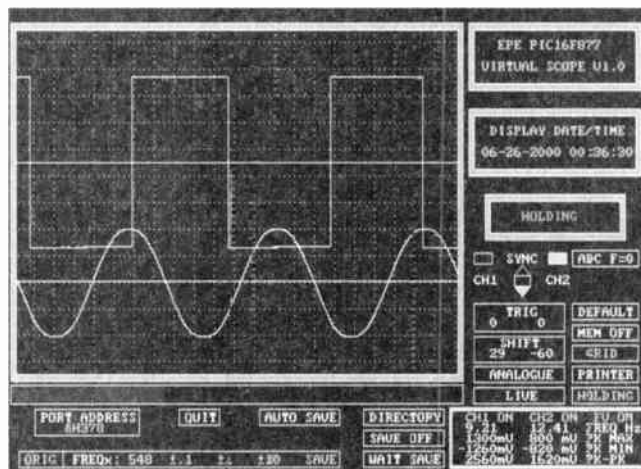

Two low-frequency waveforms sampled in immediate mode, with negative-going sync applied to Channel 2.

CONSTRUCTION

First a note on the op.amp (IC1) and memory (IC3). A MAX492 dual op.amp having rail-to-rail outputs was used in the prototype. It is likely that other dual rail-to-rail op.amps could be used if this Maxim device is hard to locate (see *Shoptalk* page). Alternatively, a more universal op.amp such as the LM358 or TL072 could be used, although their outputs do not swing fully between the power line voltages.

Whilst the TC55257DPL-85L 32Kbyte SRAM (static random access memory) device used for IC3 is readily available, the 85ns access time (as indicated by the 85L suffix) is faster than actually needed and the 100ns version would be acceptable.

Printed circuit board component layout and tracking details are shown in Fig.2. This board is available from the *EPE PCB Service*, code 275.

Assemble the board in order of component size, starting with the link wires, and noting that two go under the IC3 position. Sockets must be used for IC1, IC2 and IC3. Do not insert these dual-in-line (d.i.l.) devices until the correctness of the power supply regulator circuit around IC4 has been proved. The d.i.l. devices are CMOS and require the usual anti-static handling precautions, e.g. touching an earthed (grounded) item before handling them.

Note that some components are mounted directly on the switches. Sockets SK1 to SK3 are 2mm single types in the test model but other types may be substituted if preferred (e.g. BNC sockets for use with proper scope probes).

Use 1mm terminal pins for the off-board connections to the battery clip and front panel components. A 4-pin 1mm pitch pin-header was used for TB1

allowing the author to plug in *PIC Toolkit Mk2* via an existing connector (for on-board PIC programming – see later).

In the photograph of the p.c.b., two additional pin-header strips plus a preset pot are visible. These were purely for the author's use during program development (an l.c.d. was used to monitor various aspects) and are not required for the published version. Ignore the unused holes seen in the p.c.b. component layout.

The plastic case used has detachable front and rear panels and measures 180mm x 120mm x 40mm. A source part number is quoted on this month's *Shoptalk* page. In the prototype, the front panel components are positioned 12.5mm (0.5in) apart. The rear panel was omitted, allowing easy access to the computer connection socket, although a suitable slot could be cut if preferred.

If the unit is to be used with an external power supply rather than a 9V battery, a socket could be added to the front or rear panel.

FIRST CHECKS

Having thoroughly checked the complete assembly for satisfactory solder joints and component positioning, apply power and check that +5V is available at the output of regulator IC4, and at other principal points shown in the circuit diagram.

If all is well, the PIC can be programmed on-board, via the TB1 connector. The *PIC Toolkit Mk2* programmer is ideal for this. The configuration settings required by the PIC before loading it with the program itself are those shown in Table 1. Insert IC1 and IC3 after the PIC has been programmed.

Table 1. PIC16F877 configuration settings

CP1	CP0	DBG	NIL	WRT	CPD	LVP
1	1	1	1	1	1	0
BOR	CP1	CP0	POR	WDT	OS1	OS0
0	1	1	0	0	1	0

PORT REGISTER

Any PC might have any one of three possible parallel printer port register pairs set as the active input/output address. In hex, the addresses are 378/379, 278/279, 3BC/3BD. The *PIC V-Scope* program must be set to use the same address pairs as set within the computer's own system configuration.

When the *PIC V-Scope* Basic program is run, the "waiting response from circuit" message will initially be shown, but should disappear when the unit is plugged in and switched on, providing the correct port address applies. The initial port address default value is for 378/379.

If the message does not disappear, click on the PORT ADDRESS box at the bottom left of the screen. The value will change from showing &H378 to &H278 (&H being the prefix recognised by QB as meaning hex). If the message still does not disappear, click again to show &H3BC. A third click returns to &H378. The program automatically deduces the secondary address (e.g. &H379) from the primary.

If none of these addresses cause the computer to recognise that *PIC V-Scope* is

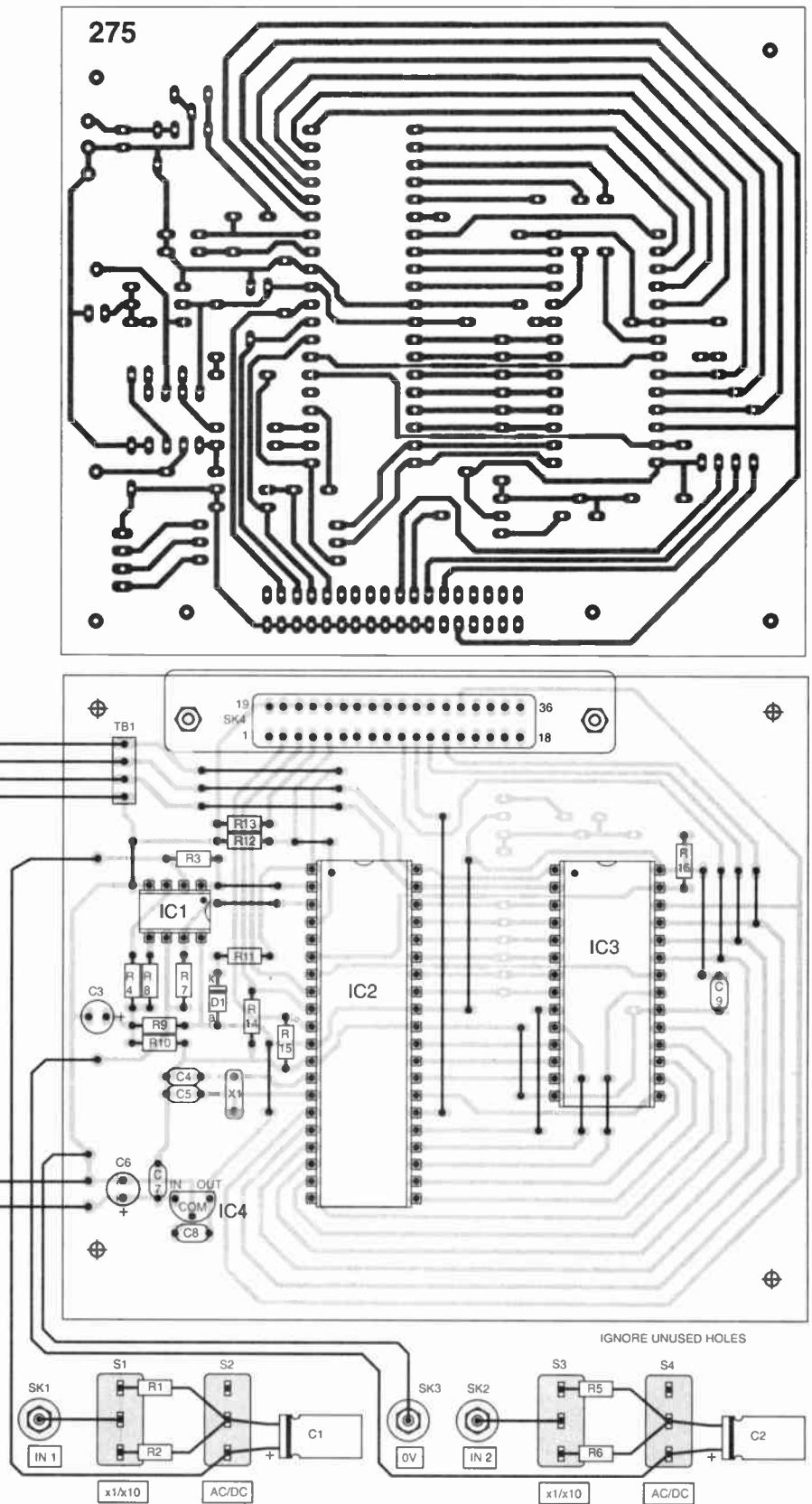

Fig.2. Printed circuit board full size copper foil master pattern and component layout. Ignore unused holes (see text).

connected and powered, recheck your assembly and its connections.

When the message disappears, the display area fills with a grid and two horizontal lines. The program and unit are now successfully operational.

The selected port register address value is automatically stored on disk (file *PSCOPATH.TXT*) and is recalled when the program is next loaded and run.

USING THE SCOPE

With the *PIC V-Scope* connected and powered, on entry to the program screen the dual-channel mode is operational. Without signals being input to the circuit, two continuous horizontal lines will be seen across the display area. They are the signal trace lines for Channel 1 (upper) and Channel 2 (lower).

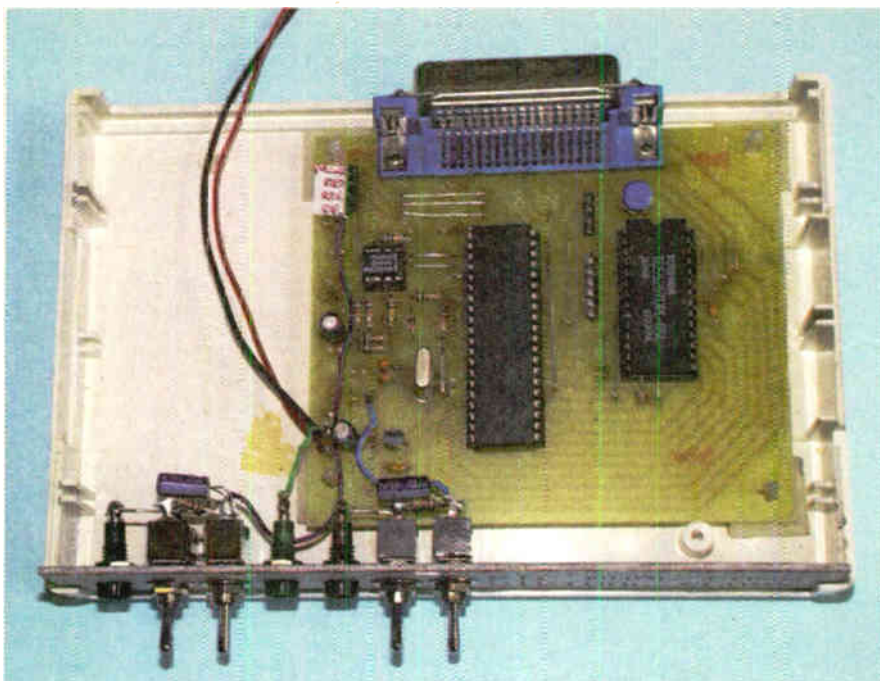

Details of the assembled prototype. Ignore the preset pot and extra pin-header strip seen on the p.c.b. (see text).

There are in fact two continuous lines in each position, the second indicating the 2.5V midway reference for that channel. Due to component tolerances in the circuit, there may be a slight displacement between the trace and reference lines. The latter is generated by the computer as the reference level, the other depends on the actual midway voltage as seen by the PIC's ADC.

You may also just be able to make out a third line, which is dotted. This is the synchronisation trigger line, showing the level at which sync and frequency values are referenced.

Move the mouse pointer above the left-hand TRIG value (0 at present) and repeatedly left-click on this value. The dotted trigger line will be redrawn slightly higher up the screen on each click, immediately recommencing from the left even if the trace has not reached the right of the display. Right-clicking will lower the line position. The TRIG value in the box will increment or decrement accordingly on each click.

Clicking on the right-hand TRIG value similarly alters Channel 2.

As said earlier, pressing any keyboard key (except Q) while a mouse button is held pressed, progressively changes the TRIG value. The redrawing of the screen data, however, waits until the key has been released.

Clicking on the SHIFT values changes the relative positions of all three lines for the selected channel.

Connect a signal generator to input 1, with an output frequency of about 1kHz, and with any reasonably uniform waveform shape. Set the input switches for $\times 1$ and AC.

Note that if PIC V-Scope is battery powered, there must be a connection between its common (0V) socket SK3 and the common (ground) line of the signal generator or its power supply.

Increasing the amplitude of the input waveform from zero, observe the waveform similarly increasing on the screen display. Experiment with shifting the display up and down, and with changing the input frequency.

Clicking in the column headed CH2 ON at the bottom right of the display turns off Channel 2, with the

heading changing to CH2 OFF. Channel 1 is now displayed on its own, more centrally on the screen. As the PIC is now only sampling one channel, the process is quicker and the waveform on screen is seen to be expanded horizontally – fewer cycles across its width.

Clicking on CH2 OFF restores Channel 2, with Channel 1 returning to its previous position and cycles per width.

Column CH1 ON behaves in the reverse fashion in respect of Channel 1. The program prevents both channels being switched off at once.

MEMORY BOX

The PIC is currently sampling with the buffer memory set for 2K bytes. A right-hand screen box confirms this, stating MEM 2K. Left-clicking on this box sets the buffer memory for 32K bytes, confirmed in the box as MEM 32K.

The waveform is now plotted at the end of this much longer sample batch, each screen-full consisting of consecutive sections of the memory. There is a brief pause when the memory has been down-loaded and the next batch is sampled.

A blue bargraph below the display area shows the progress of the sampling and display.

Left-clicking on the MEM 32K box puts the program into immediate mode, in which the buffer memory is not used, confirmed as MEM OFF. Waveforms are now much more closely spaced since the sampling and output process is slower, as stated earlier.

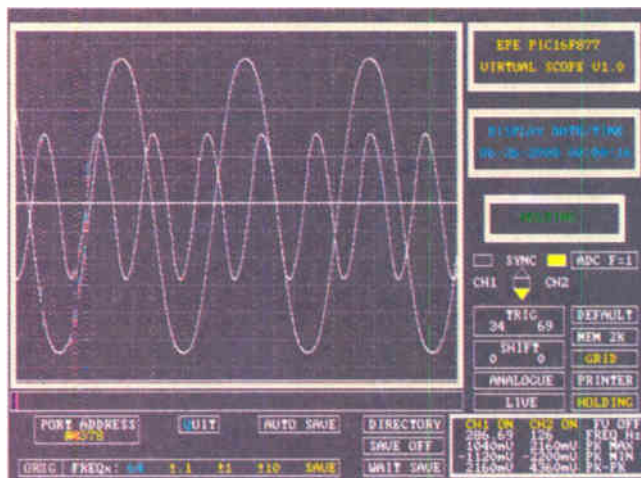

Twin waveforms sampled in MEM 2K mode. Note the dotted sync trigger lines, with the larger waveform negatively triggering just after its peak.

Left-clicking on MEM OFF returns the mode to MEM 2K. The MEM box can be right-clicked to select the options in the reverse order. The process is fully cyclic.

SYNC

So far you will have found that each waveform screen-full has started at different points in the waveform. Using SYNC stabilises the display so that repeating waveforms start at similar amplitude points.

Centre-right of the screen are the sync control boxes. The box to the left of the word SYNC is shown as yellow, indicating that sync is switched for Channel 1. However, the 3-box "lozenge" has its centre section in yellow, indicating that sync is turned off.



Clicking in the upper or lower triangles turns them yellow instead, indicating that sync is now active, triggering on the upwards or downwards edges, respectively. Clicking on the central box again turns sync off. Clicking in the box to the right of SYNC allocates sync to Channel 2.

The position in the waveform at which sync is triggered is changeable via the TRIG box, as described earlier. Note that if the value is set outside the amplitude range of the signal, the display will freeze because the trigger amplitude is not being found. There is a narrow "window" of values through which the waveform has to pass for the sync level to be recognised.

Sync may be turned off while the display is frozen. There might be a brief pause before the mouse button is responded to due to a time-out routine while a sync level is being sought from the input signal.

DISPLAY HOLD

Clicking on the RUNNING box (lower right) causes the display to hold once it has reached the right-most point, upon which the word HOLDING is shown. Pressing any key (except Q) steps the display onto the next batch of samples. Clicking on HOLDING restores the program to RUNNING mode.

SCREEN GRID

Clicking on GRID (lower right) toggles the display grid on and off. Each vertical grid square represents approximately 400mV. The full screen height represents about 5V. The program does not allow signal amplitudes to be "tuned" precisely. This would have required extra processing commands (and thus time) both for the PIC and the data acquisition program, slowing down the display.

For a similar reason, the horizontal grid squares are not time/frequency related. Both vertically and horizontally, the grid should be used only as a guide to the relative positions of waveform points.

WAVEFORM SAVING

Waveforms can be saved to disk (in the same current QB directory/folder on the hard drive), under automatic or manual control. For the manual saving option, click on SAVE OFF (lower centre) to reveal SAVE (lower centre) to reveal SAVE OFF (lower centre) to reveal SAVE ON. When a full batch of samples has been received, the WAIT SAVE box changes to SAVE NOW.

Left-clicking on the SAVE NOW box causes the raw waveform data (numerical values) to be saved with a unique coded time and date file name, which is displayed at the top of the screen until the next batch is waiting to be saved.

Right-clicking on WAIT SAVE aborts the save option for the current batch.

Clicking on SAVE ON turns off the saving mode.

Clicking on AUTO SAVE causes each batch of data to be saved upon completion, again with timed and dated file names. This mode automatically sets the buffer memory

for 32K if it is currently in 2K mode. In MEM OFF mode, 32K samples are always saved. All saved files hold 32K samples.

SAMPLE RECALL

Saved sample files can be recalled via the DIRECTORY or LIVE boxes. Left-clicking on either clears the display screen to show a directory of the sample files on disk. If there are no files yet saved, the screen tells you so, reverting to the display screen once the mouse button is released.

Files are listed with their coded names and can be selected via the mouse. Moving the mouse causes a highlight bar to shift over the file names. Left-clicking on a name reveals a lower screen line which asks if you wish to load that file, showing its code name and the time and date it was saved. To accept the file either left-click or press "Y". Doing so loads it and returns to the display screen, showing the loaded waveforms.

Right-clicking or pressing "N" at this time allows you to choose another file.

Before a file name is selected, the directory can be exited by right-clicking. The highlight can move across most of the screen, but only a proper file name can be accepted, except any shown in the first line.

The first line shows the file name of the current replay waveform (if loaded). It also shows, at top left, the most recent file name selected by the mouse. This name cannot be selected from this position, the location is used by the program when reading the screen data. (Reading from the screen for directory purposes is quite complex, as a study of the program's source code will reveal.)

During replay mode, the LIVE box changes to show REPLAY. The SYNC, TRIG and SHIFT values become those at

File name = 07913713.Y00

Imagine it split as 07 9 1 37 13 .Y00

Digits 1 and 2 = day of month (7)
Digit 3 = month number in hex from 1 to C (9 = September)

Digit 4 = hour in hex-fashion - 0 to 9 followed by A to N (0 to 23), in this case 1 = 1 a.m. (post-midnight oil and toil in the workshop yet again!)

Digits 5 and 6 = minutes in decimal (37)

Digits 7 and 8 = seconds in decimal (13)

.Y00 = year 2000 (who cares about Millennium Compliancy in this instance!)

The example file name thus decodes as 7 September 2000 at 1:37.13 a.m. and would be shown as 07SEP00 1:37.13 if selected.

Saved files can only be deleted from DOS or Windows.

FREQUENCY COUNTING

While waveform batches are being input, they are analysed for signal frequency. There must be at least three waveform cycles displayed for frequency to be calculated. The total number of amplitude changes above and below the trigger threshold is counted and at the end of the batch input this value is related to the number of sample bytes and then to a conversion value depending on the channel and buffer memory modes in use.

As explained earlier, the data acquisition rate changes depending on these modes and in relation to the speed at which the PIC and the computer process data.

Since these factors will be different for individual users, an on-screen correction facility has been provided.

The long oblong box at the bottom left of the screen is the area from which the

values can be changed. The word **FREQ:** is followed by the value (in blue) by which the basic frequency count result is to be multiplied. Initially, this is the default value used by the author with the prototype. To the right of this value are three increment/decrement options. Clicking on these will change the multiplying value by the same amount, left-click upwards, right-click downwards.

Frequency factor correction needs to be done for each channel mode and using different settings of the frequency generator (which should be calibrated or have a frequency count display). Table 2 shows the modes and their suggested alignment frequencies for ADC F = 0 and ADC F = 1 (see later).

For each mode, change the screen's frequency multiplying value until the frequency box at the bottom right shows close to the same frequency value(s) being input. Exact matching of the values should not be expected due to the nature of the sampling and analysis process.

During frequency alignment, a "Save when done" message is shown above the box. When you have finished alignment, click on SAVE in the box. The new factors will be stored in file **PSCOPATH.TXT** and will automatically be recalled when the program is next loaded and run.

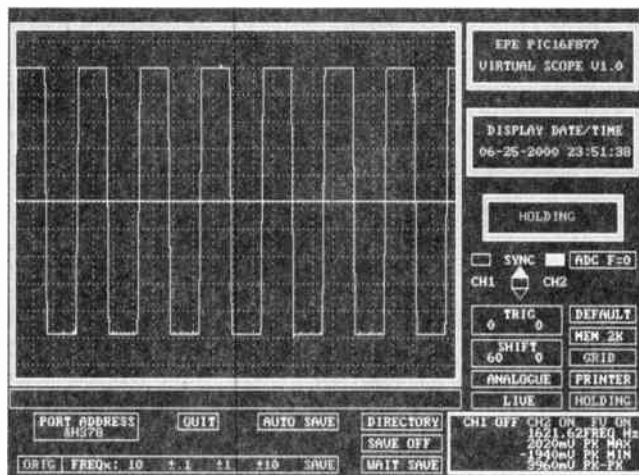

Displaying a single square waveform via Channel 2, with Channel 1 turned off.

the time of recording. These and some other boxes become coloured red. The memory mode and save options are inoperative during replay.

To revert from replay mode to live sampling, right-click on DIRECTORY or REPLAY.

FILE NAME CODING

Saved waveform file names are coded in exactly the same fashion as used with the original *V-Scope*. The following is an example:

Table 2. Suggested channel alignment modes and frequencies.

CHAN 1	CHAN 2	MEM	FREQ (F=0)	FREQ (F=1)
On	Off	Off	200Hz	200Hz
Off	On	Off	200Hz	200Hz
On	On	Off	200Hz	200Hz
On	Off	2K	10kHz	4kHz
Off	On	2K	10kHz	4kHz
On	On	2K	2kHz	1kHz
On	Off	32K	10kHz	4kHz
Off	On	32K	10kHz	4kHz
On	On	32K	2kHz	1kHz

The word ORIG is at the left of the box. Clicking on this recalls the author's default values, which you then have the option of saving in place of your own if you wish.

Correction of the frequency values can be done on any occasion you want.

DIGITAL DISPLAY

So far the sampled data has been displayed as analogue waveforms. There are two other modes available, Digital and Lissajous.

Left-click on the ANALOGUE box (lower right). It changes to DIGITAL and a whole mass of waveforms appear on screen, up to 16. They are in two groups of eight, representing the eight bits of each channel's samples. The bits are in ascending order on the screen, bit 0 (LSB) lowest in each block, bit 7 (MSB) highest.

The digital display option was principally used in the original *V-Scope* to display 8-bit digital signals via separate input lines, but it seemed worthwhile leaving the mode in *PIC V-Scope* even though the input channels are analogue.

Frequency and voltage analysis are turned off in this mode, as is their display box at bottom right. Channels may still be turned on or off in this mode.

LISSAJOUS

Left-clicking on DIGITAL moves the display on to LISSAJOUS mode. Lissajous is that mode in which one channel provides vertical deflection while the other controls the horizontal. In a real scope it can be useful in visual comparison of frequency and phase between two signals.

It was written for the original *V-Scope* in which the sampling repetition rates are fast. Frankly, though, it has no realistic use in *PIC V-Scope*, other than as a visual curiosity. However, it seemed a pity to delete it and it has been retained purely for that reason.

Left-clicking on the display mode box (now showing as LISSAJOUS), returns the display to analogue mode. Right-clicking reverses the mode display order of selection.

PRINTER OUTPUT

The use of the PRINTER box (lower right) is the same as with the original *V-Scope*, and requires the printer port cable to be temporarily removed from the unit.

When the screen is HOLDING, its display can be output to some types of

printer by clicking on PRINTER. The machine-code routine was originally written for an Epson ESC/P2 compatible 24-pin dot-matrix printer but has been found to also work with an Epson stylus Photo 750 ink-jet printer.

It seems probable that other similar Epson printers can also be used. Nothing is known about laser printers in this context – reader feedback to the Editorial office will be appreciated, for possible inclusion in *Readout*.

The entire screen display is printed (in monochrome), including the boxes as well as the waveforms.

Once the print is complete, reconnect the cable to the unit and click on DEFAULT, as discussed in a moment.

Do not click on PRINTER if the printer is not ready to receive data. Doing so could cause a **Device Fault** error from the computer and a program crash.

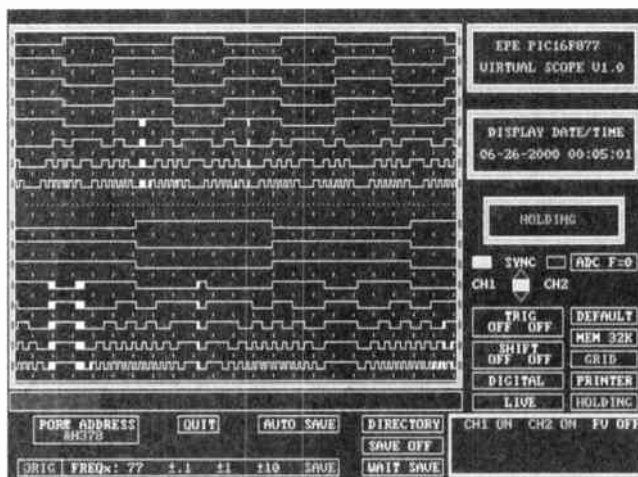

Digital display screen showing the 8-bit logic levels for two analogue input waveforms.

You may be able to recover from the crash by ensuring the printer is ready and then pressing the <ENTER> key on the screen error display word OK. This will reveal the program listing at the point at which the error occurred. Now press function key <F5>.

If the computer finds that all is well, it will resume the program at the point where it crashed and send the screen data to the printer. Failing that, you will need to fully restart the program by using <shift-F5>.

If you are running the *PIC V-Scope* program through Windows, you can produce screen dumps which can be printed in colour (if you have a colour printer!). When ready, with the program Holding, press the keyboard's <Print Screen> key. The screen will momentarily flicker as data is copied into the Windows clipboard. Now exit the program.

From the Windows desktop screen left-click the Windows Start icon to reveal the Start menu. Select Programs, select Accessories and then select Paint. Within Paint click on Edit and then on Paste. The image stored in the clipboard will be

placed on screen. It can be saved under whatever name you choose, as well printed out to paper.

If the program is being run under MS-DOS, the <Print Screen> key works differently. The screen's text data is output directly to the printer, but not the graphics data (unless you have a DOS Graphics routine installed and active – consult your MS-DOS handbook).

OTHER OPTIONS

FREQ OFF

The frequency and amplitude analysis routine may be turned off or on by clicking in the FV ON column at bottom right. This does not affect the rate at which the PIC samples data, but does increase the rate at which each sample batch is displayed.

DEFAULT

If *PIC V-Scope*'s power is interrupted while the display program is running, the PIC's mode setting data will be lost and it will revert to 2K 2-channel mode when reconnected. The same thing could happen if the printer port lead is disconnected (as is necessary when screen-dumping to a printer).

In this situation, once power or the printer lead are reinstated, it is necessary to click on the DEFAULT box to restore the PIC's mode values to those being used by the display program.

ADC BOX

The ADC box, middle right, can be clicked to alternate between F = 1 and F = 0. This toggles the Tosc sampling rate value discussed earlier.

DATE/TIME BOX

Towards screen top right is the Display Date/Time box. This is updated on each completion of a waveform plotted across the screen. It should not be regarded as a true real-time clock since it is not updated while sampling is taking place, nor when the display is being Held, nor when the printer routine is in use.

INFO BOXES

The top-right box shows the program identity and version number. The current version is V1.0. This number will be updated should any program modifications be introduced (which will be reported in *EPE* if they are).

The third box down on the right was originally introduced for the author's development information. Regard it as you wish – it has no significant user value!

OTHER READING

Discussing how to get the best out of any type of scope is beyond the reach of this article. However, the *EPE* feature article *More Scope for Good Measurements* (June/July '96) is a useful text to read. See the *Back Issues* pages.

May you too find *more scope* for improving your understanding and successful construction of electronic circuits through using *PIC V-Scope* (and continuing to read *EPE*)! □

PIC BASIC

£49.95

- The new PicBasic Pro Compiler makes it even easier for you to program the fast and powerful Microchip Technology PICmicro microcontrollers. PicBasic Pro converts your BASIC programs into files that can be programmed directly into a PICmicro.
- The PicBasic Pro Compiler features: BASIC Stamp II commands, direct and library routine access to pins on PORTA, C, D, E, as well as PORTB, arrays, real IF...THEN...ELSE and interrupt processing in BASIC.
- The PicBasic Pro Compiler gives you direct access to all of the PICmicro registers - I/O ports, A/D converters, hardware serial ports, etc. - easily and in BASIC. It automatically takes care of the page boundaries and RAM banks. It even includes built-in commands to control intelligent LCD modules.
- The PicBasic Pro Compiler instruction set is forward compatible with the BASIC Stamp II and Pro uses BS2 syntax. Programs can be compiled and programmed directly into a PICmicro, even if the PICmicro is not a BASIC Stamp module. These programs execute much faster and may be longer than their Stamp equivalents. They may also be protected so no one can copy your code.
- The PicBasic Pro Compiler is the DOS command line application (it also works in Windows) and runs on PC compatibles. It can create programs for the PIC12C67x, PIC12C67x, PIC14C00x, PIC16C55x, 6xx, 7xx, 84, 92x, PIC16C62x, PIC16F62x, 8x, 87x, PIC17C00x and PIC18Cxx microcontrollers and works with most PICmicro programmers, including our EPIC Plus Pocket PICmicro Programmer. A printed manual and sample programs are included to get you started.
- The PicBasic Pro Compiler can also be used inside Microchip's MPLAB IDE. This allows programs to be edited and simulated within Windows. Programs can also be used with our professional 16F877 in-circuit emulator/programmer. See our web page for more info.
- Version 2.3 of the PicBasic Pro Compiler adds support for the 15-bit code PIC18Cxx microcontrollers. If you are a current PicBasic Pro owner and would like the latest version, please contact us for an upgrade.

The low-cost PicBasic Compiler (PBC) makes it easy to write programs for the Microchip PICmicros. PBC converts your basic language ideas into programs into hex or binary files that can be programmed directly into a PICmicro microcontroller. The easy-to-use BASIC language makes PICmicro programming available to everyone with its English-like instruction set. No more scary assembly language!

The PicBasic Compiler instruction set is compatible with the Parallax BASIC Stamp - Stamp I programs can be compiled into PICmicro code and programmed directly into a PICmicro, eliminating the need for a BASIC Stamp module. These programs execute much faster and may be longer than their Stamp equivalents. They may also be protected so no one can copy your code. Other benefits include substantial cost savings over a BASIC Stamp.

The PicBasic Compiler has many features beyond the BS1 Peek and Poke instructions. It lets you use additional PICmicro features not available on the BASIC Stamp I. These include access to PORTA, B, C, D and E (if the particular PICmicro has them), A/D converters, hardware serial ports and other on-chip features in BASIC, foregoing the need to use assembly language.

But if you really want to use assembly language instructions, they may be mixed with BASIC instructions through the use of the PicBasic Compilers in-line assembler and I/O instruction. Our PICmicro macro assembler is included and automatically invoked by the PicBasic Compiler.

The I2C commands let the PICmicro talk to external I2C devices, such as serial EEPROMs, using only a 2-wire interface. Two PORTA pins have been dedicated to the task (the particular pins assigned may be easily changed if desired) so there is no need to tie up any of the special purpose PORTB pins.

PBC has more user variables. The BS1 only provides variables from 30 - B13 and W0 - W6. The PicBasic Compiler allows variables from 30 - B79 and W0 - W39 when used with PICmicros having 96 RAM registers in one 0 like the PIC16C622 and 16C74.

The PicBasic Compiler is a DOS command line application (it also works in Windows) and runs on PC compatibles. It can create programs for the PIC12C67x, PIC14Cxx, PIC16C55x, 6xx, 7xx, 84, 92x and PIC16F8xx microcontrollers and works with most PICmicro programmers, including our EPIC PICmicro Programmer. A printed manual and sample programs are included to get you started.

The new PicBasic Pro Compiler makes it even easier for you to program the fast and powerful Microchip Technology PICmicro microcontrollers. PicBasic Pro converts your BASIC programs into files that can be programmed directly into a PICmicro.

The PicBasic Pro Compiler features: BASIC Stamp II commands, direct and library routine access to pins on PORTA, C, D, E, as well as PORTB, arrays, real IF...THEN...ELSE and interrupt processing in BASIC.

The PicBasic Pro Compiler gives you direct access to all of the PICmicro registers - I/O ports, A/D converters, hardware serial ports, etc. - easily and in BASIC. It automatically takes care of the page boundaries and RAM banks. It even includes built-in commands to control intelligent LCD modules.

The PicBasic Pro Compiler instruction set is forward compatible with the BASIC Stamp II and Pro uses BS2 syntax. Programs can be compiled and programmed directly into a PICmicro, even if the PICmicro is not a BASIC Stamp module. These programs execute much faster and may be longer than their Stamp equivalents. They may also be protected so no one can copy your code.

The PicBasic Pro Compiler is the DOS command line application (it also works in Windows) and runs on PC compatibles. It can create programs for the PIC12C67x, PIC12C67x, PIC14C00x, PIC16C55x, 6xx, 7xx, 84, 92x, PIC16C62x, PIC16F62x, 8x, 87x, PIC17C00x and PIC18Cxx microcontrollers and works with most PICmicro programmers, including our EPIC Plus Pocket PICmicro Programmer. A printed manual and sample programs are included to get you started.

The PicBasic Pro Compiler can also be used inside Microchip's MPLAB IDE. This allows programs to be edited and simulated within Windows. Programs can also be used with our professional 16F877 in-circuit emulator/programmer. See our web page for more info.

Version 2.3 of the PicBasic Pro Compiler adds support for the 15-bit code PIC18Cxx microcontrollers. If you are a current PicBasic Pro owner and would like the latest version, please contact us for an upgrade.

- The new PicBasic Pro Compiler makes it even easier for you to program the fast and powerful Microchip Technology PICmicro microcontrollers. PicBasic Pro converts your basic language ideas into programs into hex or binary files that can be programmed directly into a PICmicro microcontroller. The easy-to-use BASIC language makes PICmicro programming available to everyone with its English-like instruction set. No more scary assembly language!
- The PicBasic Compiler instruction set is compatible with the Parallax BASIC Stamp - Stamp I programs can be compiled into PICmicro code and programmed directly into a PICmicro, eliminating the need for a BASIC Stamp module. These programs execute much faster and may be longer than their Stamp equivalents. They may also be protected so no one can copy your code. Other benefits include substantial cost savings over a BASIC Stamp.
- The PicBasic Compiler has many features beyond the BS1 Peek and Poke instructions. It lets you use additional PICmicro features not available on the BASIC Stamp I. These include access to PORTA, B, C, D and E (if the particular PICmicro has them), A/D converters, hardware serial ports and other on-chip features in BASIC, foregoing the need to use assembly language.
- But if you really want to use assembly language instructions, they may be mixed with BASIC instructions through the use of the PicBasic Compilers in-line assembler and I/O instruction. Our PICmicro macro assembler is included and automatically invoked by the PicBasic Compiler.
- The I2C commands let the PICmicro talk to external I2C devices, such as serial EEPROMs, using only a 2-wire interface. Two PORTA pins have been dedicated to the task (the particular pins assigned may be easily changed if desired) so there is no need to tie up any of the special purpose PORTB pins.
- PBC has more user variables. The BS1 only provides variables from 30 - B13 and W0 - W6. The PicBasic Compiler allows variables from 30 - B79 and W0 - W39 when used with PICmicros having 96 RAM registers in one 0 like the PIC16C622 and 16C74.
- The PicBasic Compiler is a DOS command line application (it also works in Windows) and runs on PC compatibles. It can create programs for the PIC12C67x, PIC14Cxx, PIC16C55x, 6xx, 7xx, 84, 92x and PIC16F8xx microcontrollers and works with most PICmicro programmers, including our EPIC PICmicro Programmer. A printed manual and sample programs are included to get you started.

The Professionals' choice!

Get your PICmicro projects running quicker and easier!

High-quality blank prototyping boards for PICmicro microcontrollers. Holds PICmicro, 5-volt regulator, oscillator, capacitors, DB9-25 connector. Large prototyping area. Double-sided board with plated-through holes. Solder mask on both sides makes soldering easy. Silkscreen legend on the top side to ease parts placement and wiring. Includes documentation sheet with diagram. PICProto prototyping boards are designed to help you get your PICmicro projects up and running faster and easier. The PICmicro I/O pins are brought to the edge of the prototyping area and labeled for quick identification. Proto boards are pre-wired to hold your PICmicro, 5-volt regulator, capacitors and the oscillator crystal, RC or ceramic resonator. At the bottom edge of each board is a place for a DB9-25 RS232 style connector. From £4.95 to £8.95



PIC16x84 programmer Kit

WINDOWS Driver - £15.00 Inc P&P and VAT
Programs the popular PIC1684 and 24 series serial memory devices. Connects to the serial port of PC upto pentium (not P2 or P3) and requires NO External power supply. The KIT includes Diagram, layout, High Quality PCB and all components. Software on 3.5" FD

2 x PIC Micro CD-ROMs

over 1.2Gb of info £10 Inc P&P and VAT

Xtals and Resonators

4MHz and 20MHz from 45p

LCD DISPLAYS

£7.50 each!

NEW 16x2 line super twist displays
SERIAL 16x2 & 20x4 displays IN STOCK NOW!
16x2 serial 1200, 2400 or 9600baud & I2C £15.00
20x4 serial 1200, 2400 or 9600baud & I2C £35.00
data sheets, circuit diagrams and free example code is supplied - we won't leave you in the dark!

* Unless otherwise stated, all prices are exclusive of VAT postage and packing *

Visit the NEW web page www.picbasic.co.uk

EPIC 2000 In Circuit Programmer

- IN CIRCUIT PROGRAMMING of 16F84 and 16F877 - connects directly to your circuit board, no more plugging / unplugging while testing code. WORKS with ANY Circuit. Full 20Mhz operation, no loss of code-space. Program, download and test in circuit in one keystroke. Ideal for use with our Project Boards.
- Low cost programmer for PIC12Cxx, PIC12Cxx, PIC14Cxx, PIC16C505, 55x, 6xx, 7xx, 84, 92x, PIC16C62x, PIC16F62x, 8x, 87x and PIC17Cxx microcontrollers
- ZIF adapters available for 8/18/20- and 40/28-pin DIP, 8-, 18- and 28-pin SOIC, 44-pin MQFP and 44-, 68- and 84-pin PLCC PICmicro microcontrollers (not ICP)
- Connects to PC parallel printer port
- Software upgradeable for future PICmicro microcontrollers
- Includes "8051" style PICmicro macro assembler

Forms a Low Cost Professional Development System when used with our project boards

Epic £49.95 or £35 when purchased with PIC BASIC or PRO
Epic ICP £79.95



PIC BASIC Programming Books and Tutorials

now in stock, call or visit our web page
WWW.CROWNHILL.CO.UK
WWW.PICBASIC.CO.UK

MICROCHIP
The Fast and Convenient Way to Program PICmicros

PIC12C508A - £0.63	PIC12C509A - £0.63
PIC16F84 / 04p - £1.90	PIC16F84 / 50 - £2.80
PIC16F84 / 10p - £3.95	
PIC16C622 / 04p - £2.50	PIC16C671 - £1.60
PIC16C674 - £1.90	
PIC16F877 / 04p - £5.50	PIC16F877 / 20p - £6.00
PIC16F876 / 04p - £4.50	PIC16F874 / 04p - £4.50
16F873 - £4.50	
24LC16 - £0.75	24LC16 / 50 - £0.95
24LC32 - £0.95	
24LC64 - £0.95	24LC65 - £1.95

Crownhill Associates Limited

32 Broad Street Ely Cambridge Cb7 4PW
Tel: 01353 666709 Fax: 01353 666710

ORDER ON-LINE www.crownhill.co.uk



READOUT

John Becker addresses some of the general points readers have raised. Have you anything interesting to say? Drop us a line!

WIN A DIGITAL MULTIMETER

A 3½ digit pocket-sized I.c.d. multimeter which measures a.c. and d.c. voltage, d.c. current and resistance. It can also test diodes and bipolar transistors.

Every month we will give a Digital Multimeter to the author of the best Readout letter.



★ LETTER OF THE MONTH ★

TRIALS AND TRIBULATIONS

Dear EPE

Greetings from Zimbabwe. I have been a keen follower of *EPE* for the past four years and have built some of your projects. One of them has helped me earn a National Certificate in Electronics Servicing from the Ministry of Higher Education and Technology.

I have been a student at a government college, studying Radio and Television Servicing for the last three years. One component of our syllabus required us to construct a project and write explanatory notes on it. All this had to be done in 10 supervised two-hour lessons a month before we sat for our final exams.

Due to the easy availability of *EPE* I chose the *Variable Dual Power Supply* by Tony Sercombe (Sept '99). I found it to be a very useful piece of equipment for a future technician like myself. Simple as the project seemed it had its trials and tribulations during its construction.

First of all, the town I was residing in didn't have a reputable electronics shop, so I had to source a lot of components from old circuit boards and scrap radios. I got all the resistors and capacitors, but had difficulties in getting the LM301 and TIP142/7 devices and had to travel to the capital city (Harare), 300km away.

After all the components had been sourced it was now time to etch the p.c.b. and assemble the project. There was to be one etch resist pen and 100ml of ferric chloride (provided by the college) which was to be used to etch all the 13 p.c.b.s of my class. By the time it was my turn to etch my board, the etching pen had been used up, for my classmates had been making mistakes on their boards and re-doing them again. The etching solution was now saturated with copper and it was taking up to a day to etch a 10cm² board. So I now had to use gloss enamel paint as etch resist and had to boil the etching acid to speed up the etching. It came out just fine.

After the project had been assembled and cased it was submitted and ready for assessment by the responsible authorities and it was now time for me to revise all my work, for it's rather unfortunate (or is it?) that our courses run for three years and are examinable in only three hours. So I had to read all I had learnt in the past three years in three weeks

and had to be prepared to write four three-hour exams.

It was here that I fully appreciated your magazine and would like to extend my sincere gratitude and appreciation to Ian Bell, Rob Miles, Alan Winstanley and John Becker and everyone else at *EPE* for the *Teach-In 1998* and *Teach-In 2000* series. These two proved to be easy reference notes as they covered almost my entire electronics syllabus and were easy to understand with the short time I had to prepare for my exams.

I sat for my final exams in a happy mood thanks to *EPE*. I do believe that yours is quite an understandable magazine, although as of late I have been noticing that you are moving towards PICing everything. This, however, might disadvantage a lot of readers from Africa for these PICs are not available in many government institutions like ours.

I would also like to extend my sincere thanks to Mr A.G. Edwards who provided me with an electronics design assistant disk which I used fully during my studies. It was great that I got hold of *EPE* through my course and from that day on I have treasured this magazine more than any other electronics magazine. I have graduated from college with a certificate and am ready to face any challenges and jobs that come my way and part of the credit goes to you at *EPE*.

**Innocent Mutasa,
Mkoba, Gweru, Zimbabwe**

We are delighted to hear of your success and that you pay tribute to us for helping you achieve it. Your letter also brings home how fortunate we are in the UK to have components so readily available, usually by return of post mail order, but also by nipping round to a local electronics store in some cases. Having to travel 300km to buy components must really sort out the committed electronics enthusiasts from the dabblers.

In theory, of course, mail ordering from the UK should work for wherever people live worldwide. What, though, is the general experience of overseas readers who are not necessarily living in cities? Is the postal service in your country speedy and reliable? Share your experiences with us.

Nice to hear from you Oliver. We do not recall being asked to publish pen-friend requests before and hope that you have success making many new contacts.

PIANO TUNING

Dear EPE,

As a pianist as well as subscribing to *EPE*, do you know of, or could suggest where to approach for a tried and trusted digital system, if it exists, for tuning one's own piano?

F.J. Misson, via the Net

You might consider PIC-a-Tuner of EPE May 1997.

SINCLAIR ZX

Dear EPE,

The many letters on using Basic are very interesting, as is Peter Gardner's letter about the Sinclair ZX computer (July '00). Unfortunately, the Sinclair ZX was the best and last computer to use a good Basic, and many owners learnt Z80 machine code on it. I have always been surprised that nobody ever brought out a program to enable the PC to handle a proper Basic and let it deal with machine code in the excellent way the ZX did, which means among other things, the reclaiming of empty memory space each time and not just bunging programs into next available memory area.

I currently use Turbo Basic, which compiles into machine code before running. Again this is no longer available and I am looking for an alternative, as this is still very slow and seriously well past its sell by date. I have used it to make platform shoot-em-up games and simple programs to check the lottery, but I need something better.

In the days of Sinclair ZX computing, users took a genuine interest in how their computer worked and a huge number of people learnt ZX assembler language for speed. Sadly the majority of users switched to being just games players. This in the short term increased computer sales. In the long term it meant less and less people capable of writing computer programs (in Basic or code) and the eventual demise of genuine computing. The PC, although basically a business computer, was in great danger of heading into oblivion as far as the home user was concerned, but was rescued just in time by the build-up of the Internet.

The only way now is to use QBasic, as it is available. You cannot hope to use it properly without a book on it, or print out the very lengthy Help pages held in your computer. Learning 8086 code would help as you could use it for any parts of your program you need to do at speed. This is not the easiest of languages to learn, but if you learnt another computer language in the past, learning a new one is surprising easy.

**G. A. Bobker,
Unsworth, Bury, Lancs**

Curiously, I never got on with Sinclair machines but did take to the Commodore PET 32K and C64. It was with the PET I learned 6502, which was to hold me in good stead when upgrading to PCs and 8086 machine code. The latter still forms part of any of my QBasic/QuickBASIC programs that require machine code for high speed sub-routines, using the excellent shareware A86/D86 assembler/disassembler. However, I must admit that I have not yet cracked how to fully integrate the machine code with Basic, although I have evolved a workable "good-hodge" solution (as a study of such programs will reveal, e.g. the PIC V-Scope PC interface in this issue).

But, yes, you are right, learning a new programming language is easier if you have had experience with others. This is a fact I point out to readers who want to get into PIC programming - if they have already proved they have the logical thinking capabilities required for programming, migrating to PICs is a doddle!

FREUND PULLING

Dear EPE,

I have been reading your interesting magazine for a few months now. I started computing, with the Acorn Electron, in 1986 when I was 14. I subscribed to the *Electron User* and the contacts I won through it helped to improve my English a lot. Unfortunately, most contacts have been lost and I would like to make new contacts again.

Could you please print this letter in *Readout*? My interests are microcontroller programming, electronics, music listening and general interest in almost anything. I look forward to hearing from anybody who wants to write!

**Oliver Debus, St. Ulrich Str. 12,
85354 Pulling, Germany**

CANUTE TIDE DISPLAY

Dear EPE,

Following your instructions in *EPE* June '00, I embarked on putting together one of the *Canute Tide Predictors*. I took the easy route and got almost all the components from Magenta, including a pre-programmed chip.

It has been many years since I carried out such a project but the idea of a tide predictor had me enthralled. Happily, I got everything together last weekend and bingo everything seemed to work as described. Unfortunately, only five days passed and the display started to lose its contrast. A quick adjustment to the variable resistor restored clarity, but a day later it faded again. Please advise what is the life expectancy of a PP3 battery operating such a tide predictor 24 hours a day, and what current should the unit be drawing? I would like to leave the unit on all the time but a PP3 per week seems a little steep.

Richard Berney, via the Net

Canute's current consumption was quoted at just under 6mA. I believe a typical alkaline PP3 is rated at about 550mA/hours, so in a worst-case situation you might get close to 100 hours per battery. However, you are likely to get a bit more life since Canute's regulator can accept down to 7V and still provide a 5V output.

But, having quoted 6mA current, it was assumed that readers would recognise that for long term use Canute should be run from a mains adaptor (9V battery eliminator). Only if a circuit draws a few microamps should long term battery use be ever considered.

Incidentally, it is aggravating that not all battery suppliers quote the charge capacity of their products. It is appreciated that the amount of charge a battery can deliver is subject to conditions of use and storage etc, but a guide to life expectancy under broad typical conditions would seem to be an essential requirement.

Surely this is something that the EU should investigate. As a consumer, this matter is of far more significance to me than whether or not measurements are quoted in Imperial or metric.

The figure of 550mA/hours was quoted unconditionally in Farnell's and Rapid's catalogues in respect of Duracell alkaline PP3. Maplin's had the decency to quote a condition of "0.55Ah at 470Ω for 36 hours to 4.8V" for seemingly the same battery. No mention of capacity could be found in the RS catalogue or CD-ROM.

Lithium PP3 batteries appear to have twice the capacity, but at twice the price. Rechargeable NiCad PP3 types are a bit cheaper but have a capacity quoted at only 110mA.

MOODLOOP

Dear EPE,

I read with some concern the description of the *MoodLoop* (Aug '00). I have recently been doing some casual research into the effects of low frequency electric and magnetic fields on biological systems, and I have come across a wealth of published research papers which all clearly indicate that extremely weak, ultra-low frequency (ULF) magnetic fields have profound effects on cell growth and metabolism in most organisms, from the viral level upward.

In general, the effects are difficult to quantify but many indicate that pulsed or alternating magnetic fields of only a few nano-Tesla, particularly in the range of 1Hz to 100Hz can, depending on frequency, either profoundly inhibit or stimulate cell processes like DNA replication, mitogenic division, RNA transcription and protein and enzyme synthesis. Some reports indicate that nT intensity fields in the range of 16Hz to 18Hz have various effects (both stimulatory and inhibitory) on human T-lymphocytes which are one of the body's primary defences against cancer.

Many studies also indicate that the effects are most pronounced and unpredictable on growing organisms and many researchers believe there is a definite link between childhood leukaemia, miscarriages, foetal deformities, cot death and weak ambient ULF magnetic fields.

I am sure that you and Andy Flind, the designer of the unit, were not aware of this and I am sure very few people are. However, under the circumstances I believe you owe a duty to your readers to publish a health warning that clearly explains that the fields produced by this device (and possibly earlier variants as well) may potentially cause serious health risks and may be particularly dangerous to pregnant women and children.

For the record, I applaud Andy Flind for his work and your magazine for publishing innovative designs.

Aubrey Scoon,
Bracknell, Berks, via the Net

Our understanding of the information periodically sent to us by the National Radiological Protection Board (NRPB) is that there is no proven evidence of human health risk from electrical and magnetic fields, although they continue to actively research the situation.

Nonetheless, we bring your comments to the attention of readers and have sent a copy to Andy Flind. Also relevant, perhaps, is Andy's Magnetic Field Detector in this issue.

QB-DRIVEN

Dear EPE,

After reading the letters from Bob Allan and Peter Gardner, prompting your reply in *Readout* July '00, I thought it too much of a coincidence not to send you a reply via E-mail.

I'll explain myself. Back in the mid-eighties when computing was new to the great unwashed, I did a fair amount of programing in Basic with a Commodore 64. Over a period of time I became proficient enough to do some programing that could be put to useful practical work, at my daytime job (I was, and still am, an LGV Driver). Anyway to get to my point quickly, after many years of doing other things in my spare time (getting a life and a wife and in 1999 a PC for her work), I gradually started messing around with computers again. My, how the world had moved on.

Confused by so much choice I messed my brain up with a little bit of this language and a little bit of that, getting nowhere fast. To re-orientate myself, I invested in a book I picked up in desperation, called *Writing your First Computer Program. Your Shortcut to Success*, published by IDG Books Worldwide (ISBN 0764585231): In chapter four, it confirms Alan S. Raistrick's E-mail referred to in your reply, namely that QBASIC is included on every CD-ROM with Windows 95 and 98.

Michael Moxon, via the Net

Thanks Michael for this useful further confirmation. We are much relieved to find that all PC users can have the benefit of using QBASIC; so much of our software is written for QB (as well as PICs), such as the PC interface for the PIC V-Scope in this issue, for example.

PIC TUTORIAL

Dear EPE,

I have been following with interest the recent correspondence in your magazine regarding difficulty with parallel ports. Some while back I purchased the *PICtutor* CD to go alongside the *EPE PIC Tutorial* and a PIC board. After many fruitless hours I could not get programs to download to the board, and moved on to pastures new.

However, after reading July's *Readout* I tracked down a copy of Basic on my Windows 95 CD, and tried the troubleshooting method as suggested in the *EPE Tutorial*, with my oscilloscope connected to D0 and D1 of the PIC. This worked fine, and when I reconnected the board, magically I could download programs.

Chuffed to bits, I merrily started working on the *Tutorials*, this lasted for three happy evenings, but next time when I came to use the board, yet again no joy. I tried reconfiguring the PIC, still with no joy. The PIC accepted the TUTCLR program but wouldn't accept anything else.

However, I believe I've sussed it out. I borrowed a laptop off my neighbour to use the board, and hey-presto the PIC downloaded and ran the program with no problems. Checking the differences between the PCs. I found that my PC maintains lines D0 and D1 at 5V, unlike the laptop (0V). Changing the printer drivers made no difference, still both lines were at 5V. The PIC seemingly will not accept a program when these lines are at a background 5V.

To overcome this, I now send a file (e.g. a Word document) to print. This document is automatically held in the pause mode. If I take it out of the mode (by unticking the "pause printing" selection in the printer menu), I get a dialogue box warning of a print error and asking to re-try etc, but, in doing so, it takes the two lines D0 and D1 to 0V. If I now ignore this dialogue box (don't close it, as it deletes the print-job, thus taking the lines back to 5V), I can then happily download programs to the PIC.

My info may be of help to your readers. I use a Time 200MHz Pentium MW machine.

Phill Davies, via the Net

Thanks Phill. It's curious how "PC-compatibility" can be so diversely interpreted! It seems also that interfaces via some parallel printer ports really need buffering I/O devices included, as I provided with the Toolkit Mk2 programmer.

ISOLATING TRANSFORMERS

Dear EPE,

I am writing as a result of glancing through *Teach-In 2000* Part 10 (Aug '00), covering transformers and rectifiers.

Years ago, whilst attending a TOPs course at a small London training college, my teacher mentioned in passing that a particular piece of electronic equipment should incorporate a 1:1 isolating transformer, in order that the equipment should not be connected directly to the electrical mains. Although you describe an 1:1 isolating transformer, you do not say how it provides safety through isolating equipment from the mains supply.

Even more years ago, whilst working for a company which was involved in the manufacture of infra-red emitting diodes and integrated circuits, I first learned of the rectifying (diode) bridge and imagined that all power supplies used this device. Much later, whilst attending the previously-mentioned training college, I learned about other types of diode and transformer rectifiers, such as the ones which you discuss. Why, if the diode bridge is such a good device, do other circuits exist, at all?

M.P. Hopkins,
Barnes, London

The basic safety provided by an isolating transformer is that its output windings are not connected to the mains earth. They are said to be "floating" with respect to it. In other words, if you touch a terminal of "floating" winding, you are not completing a circuit between it and the mains supply. You will recall that in order for current to flow, there must be a path between the positive and negative terminals of the current generator. You will only complete an electrical path across the secondary winding of an isolating transformer if you touch both its terminals simultaneously.

*Expediency dictates what form of power supply rectification is used. The considerations include whether voltage or current is the most important (see the *Demo* software formulae), relative expense of diodes and bridges (especially on a commercial scale), and also space available on a p.c.b., to name but a few.*

*For more information on mains a.c. generation and supply, read Alan Winstanley's interesting two-part article *Power Generation* from *Pipelines to Pylons* (Aug/Sep '99).*

SURVEILLANCE

Electronic Surveillance Equipment Kits from the UK's No.1 Supplier

SUMA DESIGNS has been supplying professional quality electronic surveillance equipment kits for over 20 years. Whether your requirement is hobbyist, amateur or professional you can be sure that you are buying from a company that knows the business. We ONLY sell surveillance products, no alarms, disco lights or computer bits. All of our kits are designed for self assembly and are well tried, tested and proven. All kits are supplied complete with top grade components, fibreglass PCB, full instructions, circuit diagrams and assembly details. Unless otherwise stated all transmitter kits are tuneable and can be received using an ordinary VHF FM radio.

UTX Ultra-miniature Room Transmitter

At less than 1/2 the size of a postage stamp the UTX is the smallest room transmitter kit in the world! Incredible 10mm x 20mm including microphone, 3-12V operation. Range up to 500m **£13.95**

MTX Micro-miniature Room Transmitter

Our best selling room transmitter kit. Just 17mm x 17mm including mic. Extremely sensitive. 3-12V operation. Range up to 1000m. . . **£14.95**

STX High-performance Room Transmitter

High performance transmitter with buffered output for greater stability and range. Measures just 22mm x 22mm including mic. 6-12V operation. Range up to 1500m. **£16.95**

VT500 High-power Room Transmitter

Our most powerful room transmitter with around 250mW of output power. Excellent range and penetration. Size 20mm x 40mm, 6-12V operation. Range up to 3000m. **£17.95**

VXT Voice-activated Room Transmitter

Triggers only when sounds are detected by on-board mic. Variable trigger sensitivity and on-time with LED trigger indicator. Very low standby current. Size 20mm x 67mm, 9V operation, range up to 1000m. **£21.95**

HVX400 Mains Powered Room Transmitter

Connects directly to 240V AC supply. Ideal for long-term monitoring. Size 30mm x 35mm, range up to 500m. **£21.95**

SCRX Subcarrier Scrambled Room Transmitter

To increase the security of the transmission the audio is subcarrier modulated. Receiver now requires the decoder module (SCDM) connected to allow monitoring. Size 20mm x 67mm. 9V operation, up to 1000m range. **£24.95**

SCDM Subcarrier Decoder for SCRX

Connects to earphone socket on receiver and provides decoded audio output to headphones. Size 32mm x 70mm, 9-12V operation. . . **£27.95**

UTLX Ultra-miniature Telephone Transmitter

Smallest kit available. Connects onto telephone line, switches on and off automatically as phone is used. All conversations transmitted. Size 10mm x 20mm, powered from line, up to 500m range. **£13.95**

TLX700 Micro-miniature Telephone Transmitter

Best selling kit. Performance as UTLX but easier to assemble as PCB is 20mm x 20mm. **£14.95**

STLX High-performance Telephone Transmitter

High-performance transmitter with buffered output for greater stability and range. Connects onto telephone line and switches on and off automatically as phone is used. Both sides of conversation transmitted up to 1000m. Powered from line. Size 22mm x 22mm. **£16.95**

PTS7 Automatic Telephone Recording Interface

Connects between telephone line (anywhere) and normal cassette recorder. Automatically switches recorder on and off as phone is used. Both sides of any conversation recorded. 9V operation, size 20mm x 67mm. **£21.95**

CD400 Pocket Size Bug Detector/Locator

LED and piezo bleeper pulse slowly. Pulse rate and tone pitch increase as signal source is approached. Variable sensitivity allows pinpointing of signal source. 9V operation, size 45mm x 54mm. **£34.95**

CD600 Professional Bug Detector/Locator

Multicolour bargraph LED readout of signal strength with variable rate bleeper and variable sensitivity allows pinpointing of any signal source. When found, unit is switched into AUDIO CONFIRM mode to distinguish between bugging devices and legitimate signals such as pagers, cellphones etc. Size 70mm x 100mm. 9V operation. **£59.95**

QTX180 Crystal Controlled Room Transmitter

Narrow band FM crystal transmitter for ultimate in privacy. Output frequency 173.225 MHz. Designed for use with QRX180 receiver unit. Size 20mm x 67mm, 9V operation, range up to 1000m **£44.95**

QLX180 Crystal Controlled Telephone Transmitter

Specifications as per QTX180 but connects onto telephone line to allow monitoring of both sides of conversations. **£44.95**

QSX180 Line Powered Crystal Telephone Transmitter

Connects onto telephone line, switches on and off as phone is used. Power is drawn from line. Output frequency 173.225 MHz. Designed for use with QRX180 receiver. Size 32mm x 37mm. Range up to 500m. **£39.95**

QRX180 Crystal Controlled FM Receiver

Specifically designed for use with any of the SUMA 'O' range kits. High sensitivity design. Complex RF front end section supplied as pre-built and aligned sub-assembly so no difficult setting up. Headphone output. PCB size 60mm x 75mm. 9V operation. **£69.95**

TKX900 Signalling/Tracking Transmitter

Transmits a continuous stream of audio beeps. Variable pitch and bleep rate. Ideal for signalling, alarm or basic tracking uses. High power output. Size 25mm x 63mm, 9-12V operation, up to 2000m range. **£23.95**

MBX-1 Hi-Fi Micro Broadcaster

Connects to headphone socket of CD player, Walkman or Hi-Fi and broadcasts your favourite music around house and garden up to 250m. Size 27mm x 60mm, 9V operation. **£22.95**

DLTX/RX Radio Remote Switch System

Two kits, transmitter sends a coded signal (256 selectable codes) when button pressed. Receiver detects signal, checks code and activates relay. Can be set to be momentary or toggle (on/off) operation. Range up to 100m. 9V operation on both units. TX 45mm x 45mm, RX 35mm x 90mm. **£44.95**

TO ORDER:

Post, fax or telephone your order direct to our sales office. Payment can be Credit card (Visa or Mastercard), Postal Order, cash (please send registered) or cheques. Kits despatched same day (cheques need clearing). All orders sent by recorded or registered post. Please add postage as follows:

ORDER UP TO £30.00: To UK £2.50 To EUROPE £5.50 All other £7.50

ORDERS OVER £30.00: To UK £3.65 To EUROPE £7.50 All others call

Overseas customers please use credit cards or send sterling cheque or bank draft.



SEND 2 x 1st CLASS STAMPS FOR OUR 2000 KIT CATALOGUE CONTAINING FULL DETAILS OF THESE AND OTHER KITS.

A BUILD-UP SERVICE IS AVAILABLE ON ALL OF OUR KITS, DETAILS IN CATALOGUE. VISIT OUR WEBSITE: www.suma-designs.co.uk

Please note: Some of our part numbers are being unscrupulously used by other companies selling kits eg. MTX, VXT. DO NOT BE MISLEAD! These are NOT GENUINE SUMA KITS which are only available direct from us or our appointed distributors.

If you wish to collect kits direct from our office
PLEASE TELEPHONE

SUMA DESIGNS

Dept. EE, The Workshops, 95 Main Road,
Baxterley, Warwickshire, CV9 2LE, U.K.

Website: www.suma-designs.co.uk

TEL/FAX: 01827 714476
(24 HOUR ORDERLINE)

email: sales@suma-designs.co.uk

FRIDGE/FREEZER ALARM

OWEN BISHOP Project 3

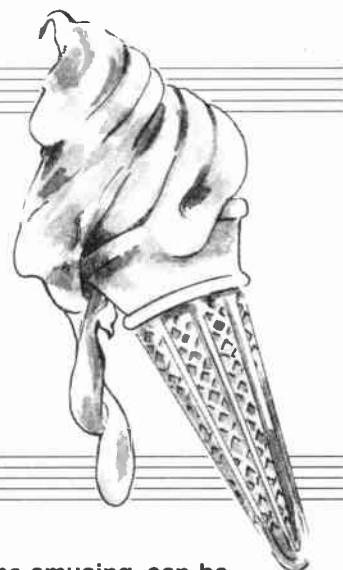

This short collection of projects, some useful, some instructive and some amusing, can be made for around the ten pounds mark. The estimated cost does not include an enclosure, for many of them work just as well as an open board.

All of the projects are built on stripboard, and have been designed to fit on to boards of standard dimensions. All of the projects are battery-powered, so are safe to build. In a few cases in which, by its nature, the project is to be run for long periods, power may be provided by an inexpensive mains adaptor. Again, the cost of such a unit is not included because most spares boxes contain a few of these, possibly pensioned off from obsolete electronic gadgets.

MANY people have a sizeable amount of capital tied up in their deep-freeze. A long power cut or a failure of the freezer itself can lead to significant financial loss, not to mention the prospect of losing the delicious smoked trout from last summer's fishing holiday.

There are also accidents. If the lead on the freezer is a little too short, someone catching their foot in it by chance may drag the plug from the socket without noticing.

Usually, the disaster is not discovered until later, when it's too late to do anything about it. Similar remarks apply to the contents of a refrigerator, though it may be more a matter of disappointment than loss when somebody (who was it?) leaves the door ajar and the chilled lemonade warms up on a summer's day.

This simple alarm project circuit sits in the freezer and simply waits for the temperature to rise above a preset limit. Then it turns on a loud buzzer, one that is loud enough to be heard with the freezer door shut.

It runs from a 9V battery pack and, since the circuit takes only 200µA when not sounding, the battery should last about 100 days. However, there is no "flat battery" warning on this project, so test the battery once a month and replace it when the voltage starts to drop.

CIRCUIT DETAILS

The full circuit diagram for the Fridge/Freezer Alarm is shown in Fig.1. The circuit is based on a useful semiconductor device known as a single trip point temperature sensor, IC1.

This is the TC622 integrated circuit, which comes in two versions. The TC622VAT has a

temperature range of -40°C to +125°C, with a precision of ±1°C. The slightly cheaper TC622EAT has a more limited range of -40°C to +85°C with the same precision. Either type is suitable for this project.

TRIP POINT

The principle of the TC622 is that its output at pin 1 is high when the temperature is below the trip point and falls sharply as the temperature rises above this. The i.c. has a built-in hysteresis of 2°C. This means that, if it is set for a trip point at say -18°C, its output does not rise again until the temperature has fallen below -20°C. This hysteresis is very important because, if the temperatures at which it falls and rises were both close to -18°C, the alarm would chatter like a magpie for as long as the temperature stayed near that level.

The trip point is set by connecting a resistor between the positive supply rail and pin 5 (T_{SET}). The equation for calculating the value of the resistor is:

$$R_{SET} = 0.6 \times t^{2.1312}$$

In this equation, *t* is the absolute temperature in Kelvin. For example, to set the trip point to 6°C, add 273 to the temperature in degrees Celsius to obtain the equivalent in Kelvin:

$$t = 6 + 273 = 279K$$

$$R_{SET} = 0.6 \times 279^{2.1312} = 97774\Omega$$

A 97k6 0.1% resistor from the E96 series would be ideal. The nearest "standard" resistor from the E24 series is 100k, which would give a temperature trip point of around 9°C. Connecting a 4M7 resistor in parallel with 100k would produce 97k9 and a trip temperature just above 6°C.

TWO LEVELS

In this project, we have made the temperature switchable to two levels, 9°C for the refrigerator and -16°C for the freezer.

These are practicable levels that should not cause a false alarm every time some fresh unchilled food is put in the fridge or freezer. Incidentally, if you want to make a device that sounds the alarm when the temperature falls, use the output at pin 2. This works in the opposite sense to pin 1.

The next point to consider is the alarm. This is to be switched on when the output from pin 1 of IC1 falls to almost zero. A *pnp* transistor, TR1, can be switched by a low-going input so we have used a BC558 and powered the sounder circuit with the current flowing from its collector (c).

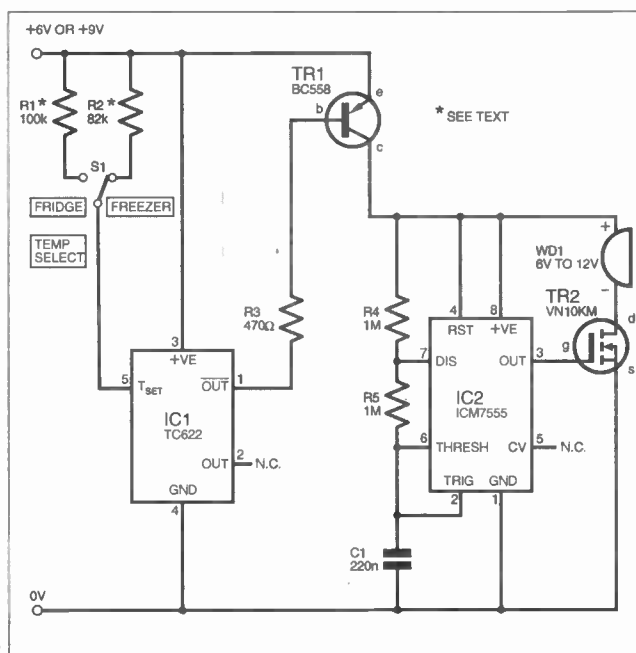

Fig.1. Complete circuit diagram for the Fridge/Freezer Alarm.

An intermittent tone is always much more noticeable than a continuous tone so the next stage in the circuit is an astable based on a 7555 timer (IC2). The values of the resistors R4 and R5 and the capacitor C1 are chosen to give a frequency of just over 2Hz. This produces an "urgent" rate of beeping that is easily heard from outside the freezer.

The output at pin 3 of the timer IC2 goes to a MOSFET, TR2. This type of transistor was used for switching instead of a bipolar transistor in order to maximise the voltage drop across the warning device WD1. There is already a voltage drop of 0.6V across TR1, and a further drop of 0.6V across a bipolar TR2 would mean that there was only 7.8V across WD1. It

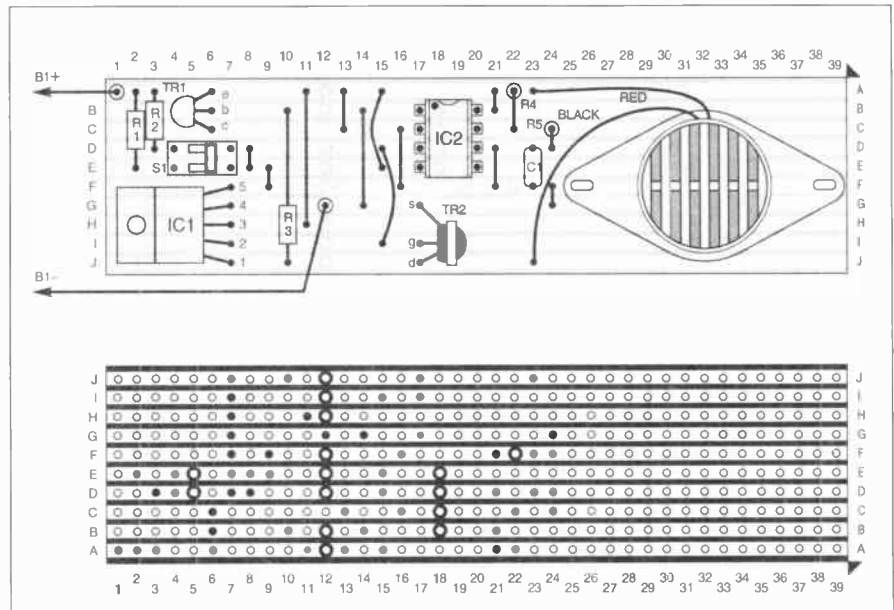

Fig.2. Fridge/Freezer Alarm stripboard component layout and details of breaks required in the underside copper tracks.

COMPONENTS

Resistors		See SHOP TALK page
R1	100k (see text)	
R2	82k (see text)	
R3	470Ω	
R4, R5	1M (2 off)	
All 0.25W, 1% metal film		
Capacitor		
C1	220n polyester film, p.c.b mounting	
Semiconductors		
TR1	BC558 pnp transistor	
TR2	VN10KM n-channel power MOSFET	
IC1	TC622 single trip-point temperature sensor	
IC2	7555 CMOS timer	
Miscellaneous		
S1	2-way s.p.d.t. d.i.l. switch	
WD1	6V to 12V solid-state round buzzer	

Stripboard 0.1 inch matrix, size 10 copper strips by 39 holes; 8-pin d.i.l. socket; AA size cells with holder – see text; battery clips, double-sided adhesive pad; multistrand connecting wire; 1mm solder pins (2 off); solder, etc.

Approx. Cost
Guidance Only **£9.50**
excluding batts.

would be only 4.8V if we used a 6V supply. Under-running WD1 reduces its loudness, an important consideration when it is inside a thick-walled enclosure.

CONSTRUCTION

The Fridge/Freezer Alarm can conveniently be run on a 9V supply, but you can run it on 6V or 12V if you prefer. Using a battery holder with four AA type cells or larger will mean that the battery needs renewing less often.

Once completed, the circuit board should be enclosed in a container but, if you are trying to keep costs down, this need not be a regular "enclosure". A used plastic food container with a snap-on lid will do almost as well. It is just a matter of keeping the integrated circuits away from the frozen chops!

The circuit is built up on a small piece of stripboard, size 10 strips × 39 holes. The component layout and details of breaks required in the underside copper tracks are shown in Fig.2. Construction should commence by making the track cuts (15 off) and inserting the wire links (11 off) and the two solder pins.

Next, assemble the alarm circuit section, which is everything to the right of column 13 in Fig.2. The warning buzzer WD1 has two lugs for bolting it to the board, but it is easier to fix it in place using a double-sided adhesive pad. Temporarily connect its power-input point (A13) to the positive power supply. The buzzer should produce its note as a series of bleeps, about two per second.

Now assemble the remainder of the circuit. If you prefer at first to test it outside the fridge, temporarily wire a 10 kilohms (10k) resistor in series with R1 and switch to the Fridge setting. The total resistance of 110 kilohms gives a trip point of about 22°C, a more comfortable temperature for trials.

Finally, place the completed unit in the fridge or freezer with switch S1 switched to the appropriate resistor and no battery connected. Leave it for 15 minutes or more to cool. When you connect the battery, the warning buzzer should stay silent. Remove it from the fridge or freezer and very soon the beeping should begin. □

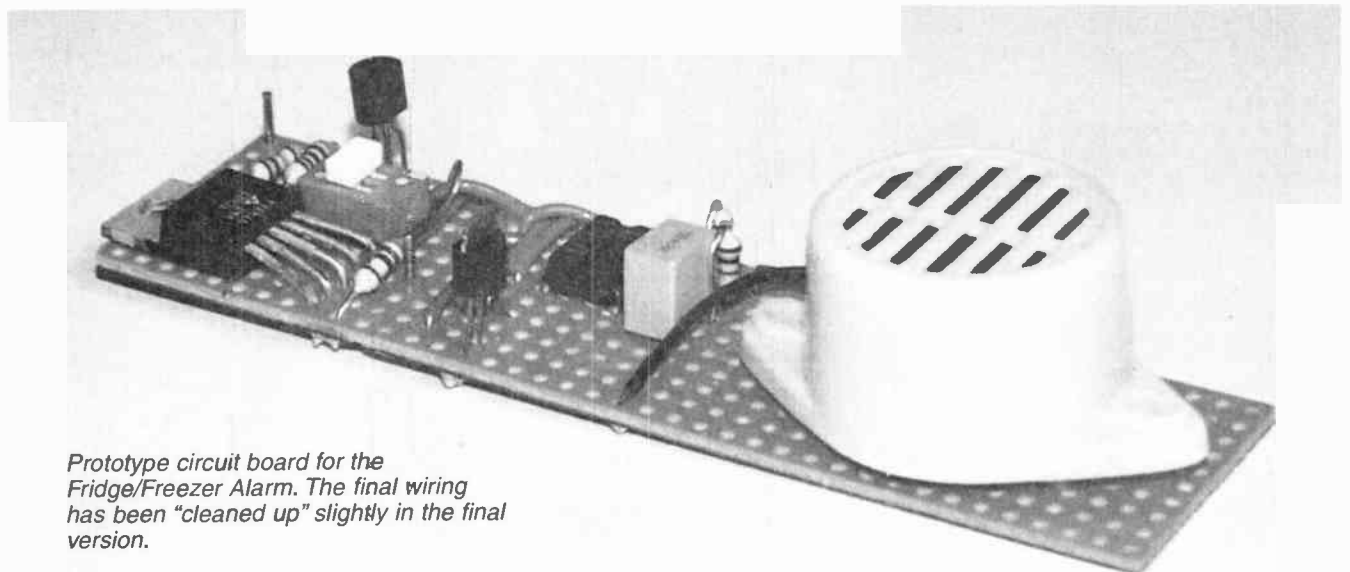

Prototype circuit board for the Fridge/Freezer Alarm. The final wiring has been "cleaned up" slightly in the final version.

INGENUITY UNLIMITED

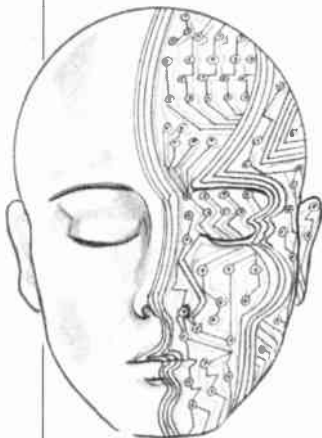

Our regular round-up of readers' own circuits. We pay between £10 and £50 for all material published, depending on length and technical merit. We're looking for novel applications and circuit tips, not simply mechanical or electrical ideas. Ideas *must be the reader's own work* and **not have been submitted for publication elsewhere.**

The circuits shown have NOT been proven by us. *Ingenuity Unlimited* is open to ALL abilities, but items for consideration in this column should preferably be typed or word-processed, with a brief circuit description (between 100 and 500 words maximum) and full circuit diagram showing all relevant component values. **Please draw all circuit schematics as clearly as possible.**

Send your circuit ideas to: Alan Winstanley, *Ingenuity Unlimited*, Wimborne Publishing Ltd., Allen House, East Borough, Wimborne, Dorset BS21 1PF.

They could earn you some real cash and a prize!

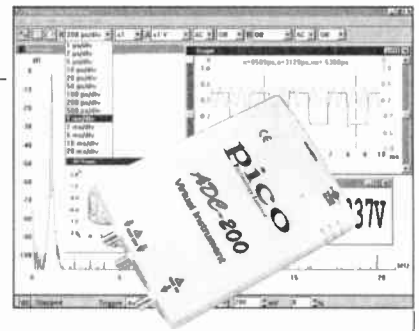

WIN A PICO PC BASED OSCILLOSCOPE

- 50MSPS Dual Channel Storage Oscilloscope
- 25MHz Spectrum Analyser
- Multimeter • Frequency Meter
- Signal Generator

If you have a novel circuit idea which would be of use to other readers then a Pico Technology PC based oscilloscope could be yours.

Every six months, Pico Technology will be awarding an ADC200-50 digital storage oscilloscope for the best IU submission. In addition, two single channel ADC-40s will be presented to the runners-up.

Anti-Tamper Loop Alarm – On Your Bike

THE circuit diagram of Fig.1 was designed as an anti-tamper bike alarm using a screened phono to phono (RCA plug) audio lead as the loop wire. The heart of the circuit is the SR latch based around two NOR gates IC1a and IC1b. This latches high at pin 4 when Set goes high and latches low when Reset goes high.

The anti-tamper feature is implemented by using both the inner signal wire and the screen of the cable. The outer screen carries almost 5V via two 510 ohm resistors R1 and R2. The SR latch Set (S) terminal is pulled high by resistor R5. The inner wire is a loop between resistor R4 (in series with the Set terminal) and R3 to ground (0V). Under normal conditions the Set pin is grounded via the loop.

If the loop cable is completely cut (severing the screen and inner core) then the Set terminal is no longer pulled low via resistor R3 and is pulled high by R5 instead. This "sets" the latch and the alarm buzzer WD1 sounds until the alarm is turned off and on again.

No Short-cuts

If the would-be thief attempts to "hot wire" the loop by bridging it with his own cable before cutting the loop through the bike, he is probably only likely to bridge the outer screen by mistake and the alarm will still sound when the inner core is cut.

However, if he cuts through to the inner loop wire in order to try and bridge it then he is likely to short the outer screen to the inner loop in which case resistors R1 and R2 are connected to R3 and R4. This forms a potential divider as shown in circuit Fig.2. The resistor values were chosen so that under these circumstances Set (V_T) is pulled high to $0.887V_{cc}$, equivalent to a logic high so the latch is set and the alarm sounds. The value of 0.887 is derived from standard potential divider theory:

$$V_T = R_3 / R_3 + [(R_4 + R_5) // (R_1 // R_2)]$$

The circuit is powered from a 9V battery and armed through keyswitch S1. By placing a normally-closed microswitch (not shown) in series with resistor R4, the alarm can be made to sound when the lid of the circuit housing is removed. Consider gold-plated phono connectors for higher reliability.

(Footnote: in industry I once came across a

simple commercial cycle alarm (a thyristor and sounder) which Nottingham Police later informed me was easily hotwired by the local cycle-stealing population. So well done for addressing these aspects comprehensively. ARW)

Alan Bradley,
Belfast, Northern Ireland.

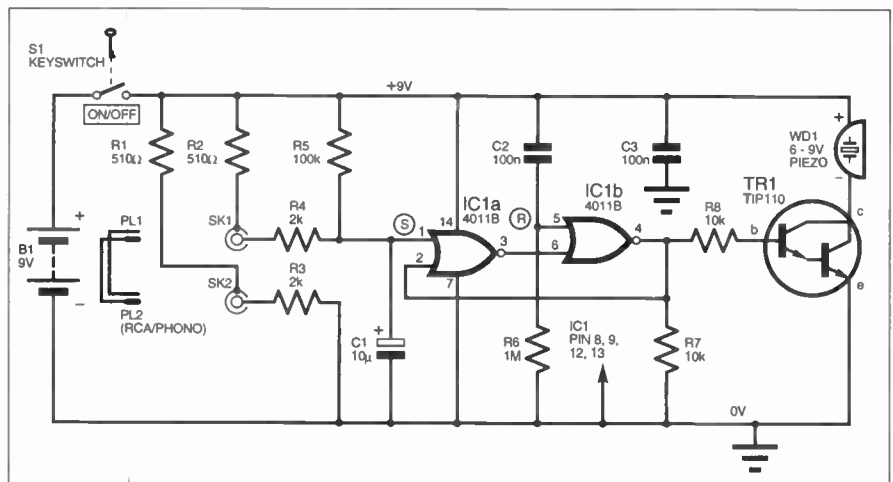

Fig.1. Circuit diagram for the Anti-Tamper Loop Alarm.

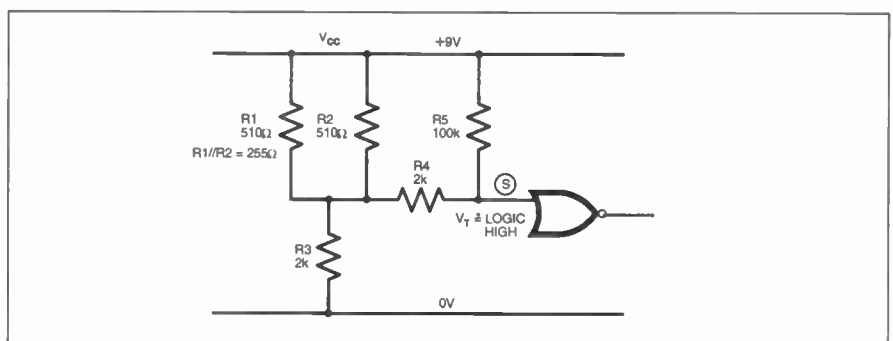

Fig.2. Equivalent circuit when inner core and outer screen are shorted together.

Doorbell Extension and Entry/Exit Indicator – On Call

Using piezo sounders together with an existing doorbell, the circuit of Fig.3 provides a doorbell extension to the garden or patio (for example) and in the author's system the kitchen, porch and other locations too. Also, and using the same extension units, the circuit can provide an indication of whenever the front door is opened or closed, while other circuitry (optional) mutes the extension/s as darkness falls, thereby reducing the disturbance to neighbours whenever their windows are left open during the summer.

Operation

In Fig.3a, closing the doorbell pushbutton S1 operates the gong solenoid as normal together with relay RLA in the main unit, both devices being powered by the four 1.5V cells in the gong. Relay contacts RLA1 (Fig.3b) close which turns on transistor switches TR1 and TR2 and relay RLB. Capacitor C1 also charges up.

The relay contact RLB2 applies 9V to the remote piezo sounder unit WD1 (Fig.3c), announcing the presence of a caller. When the doorbell button is released relay contact RLA1 reverts to its open state, disconnecting the base of transistor TR1 from the 9V supply.

However, TR1 still conducts and relay RLB remains latched because TR1 base current is now drawn from capacitor C1. When C1 discharges (at a rate determined by potentiometer VR1, wired as a variable resistor) the entire circuit returns to its dormant state until next time. This means the piezo sounder operates for a preset period.

Refinements

Whenever the front door is opened or closed a permanent magnet attached to the door passes a reed relay (S2) and triggers it. The reed contacts briefly apply 9V to the collector (c) of transistor TR3 and the RC network C2/R6, so TR3 switches on momentarily as capacitor C2 quickly discharges via resistor R5. As a result the piezo sounders emit a short tone signifying the opening or closing of the door. The value of resistors R5 and R6 may be adjusted to alter the duration of the tone.

As an optional refinement, the light dependent resistor (l.d.r.) R7, together with R8 and TR4, allow a piezo sounder to emit its tone at full volume during daylight only. In the author's system an l.d.r. associated with the corresponding sounder (e.g. in the kitchen) is arranged so that daylight from the kitchen window falls upon it and light from the kitchen lamp falls upon it as well; the sounder is enabled at night-time if someone is using the kitchen.

An l.d.r. in the porch is positioned to do the same thing with its associated sounder while the l.d.r. in the garden/ patio area allows the sounder there to operate during daylight only. Many of the component values are flexible, and some experimentation may be necessary to achieve the desired result.

C. Embleton,
Northallerton,
N. Yorks.

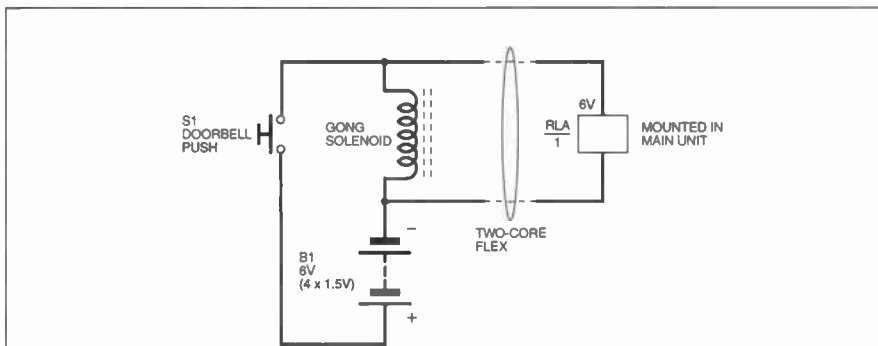

Fig.3a. Modification to the bell circuit.

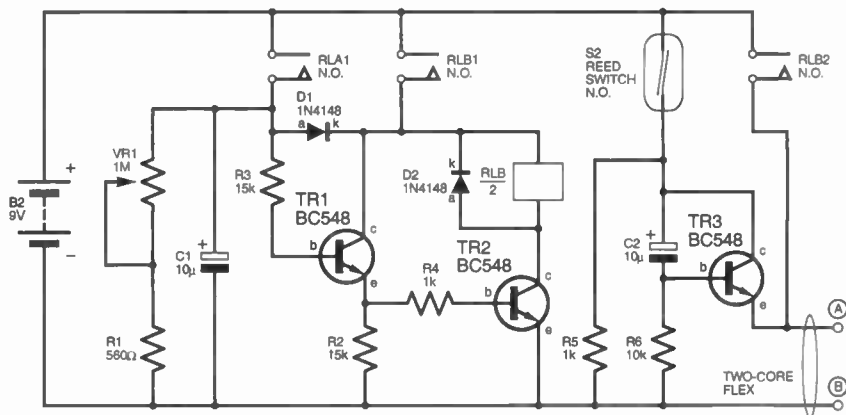

Fig.3b. Main circuit diagram for the Doorbell Extension and Entry/Exit Indicator.

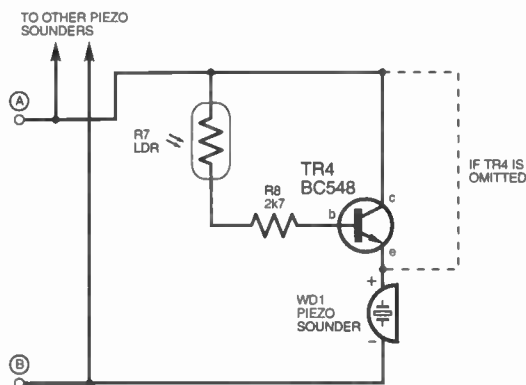
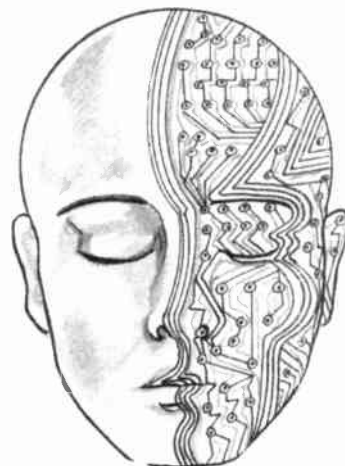

Fig.3c. Adding an l.d.r. to the remote sounder unit to give daylight operation only.

MORE I/Us ON NEXT PAGE

**WHY NOT
SEND US YOUR
CIRCUIT IDEA**
Earn some extra
cash and possibly
a prize!



Mini Photo Slave Flash – Flashback

A CIRCUIT diagram for a simple Mini Photo Slave Flash trigger is shown in Fig. 4. It has evolved over more than thirty years from a design originally published in October 1967 *Practical Electronics* (thanks for sending the fascinating reprint – ARW) to the miniature version presented today.

The circuit uses a TIL78 phototransistor (the original used a Mullard OCP71) which conducts when light from the main flash gun falls on it. A pulse is sent through the capacitor C1 which causes the thyristor CSR1 to conduct, thereby triggering the slave flash either through the sync lead or through the hot shoe. The thyristor should be rated 300V or more. (If the thyristor does not trigger the flash, try reversing the connections – ARW)

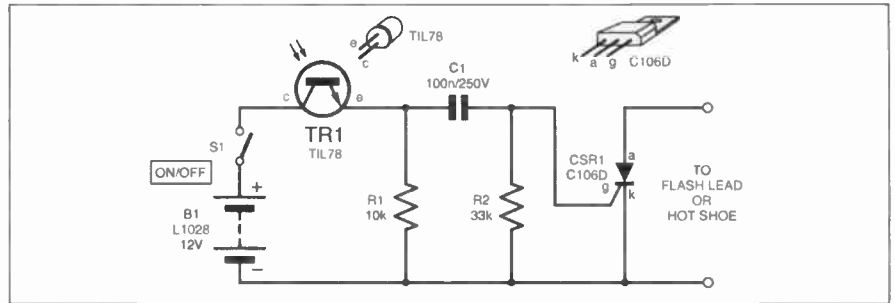

Fig.4. Mini Photo Slave Flash circuit diagram.

A miniature 12V “remote key fob” battery type L1028 powers the circuit, which is built on a tiny piece of stripboard 5 strips x 11 holes. A translucent 35mm film canister has

proved ideal as a diffuser/housing for the circuit.

Syd Mercer,
Retford, Notts.

Colour TV Tester Add-On – Right Stripes

THE circuit diagram shown in Fig. 5 is an add on for my TV Test Pattern Generator (*Ingenuity Unlimited* Sept '99) to display vertical alternate black & white lines which help in setting up a TV's width and horizontal linearity. Also, if this pattern is recorded on a well aligned VCR it can be used to check back tension during servicing.

The circuit consists of a quad Schmitt NAND gate. Its function is to remove/blank the 1MHz square wave clock, which produces the vertical lines, during the sync pulse and colour burst so they aren't corrupted. A delay formed via the resistor R1, preset VR1 and capacitor C1 allows the length of clock blanking to be adjusted.

With an oscilloscope triggered from the line sync pulses, adjust the preset VR1 so that the 1MHz clock signal is removed at the output during both the sync pulse and colour burst. Alternatively, adjust for satisfactory sync/colour on a TV/monitor.

Preset VR2 is used to adjust the output level for 1V peak-to-peak or alternatively for correct contrast on a TV, and should be routed

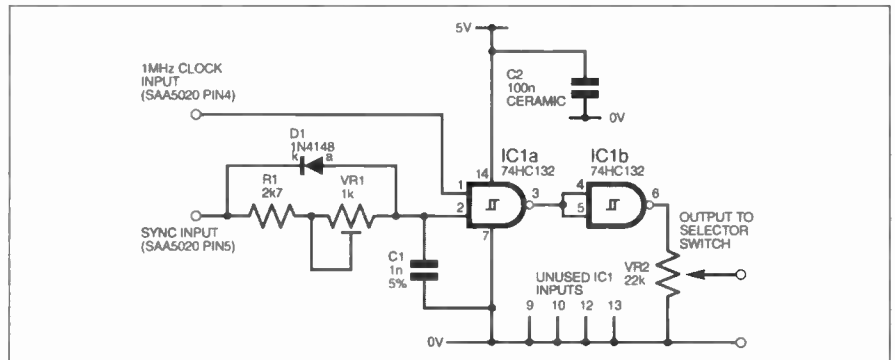

Fig.5. Circuit diagram for the Colour TV Tester Add-On.

to the Red, Green and Blue inputs of the CXA1145P i.e. simultaneously by linking the bases of transistors TR2, TR3 and TR4 or the three sections on the Pattern selector switch S2.

Only two of the gates in the 74HC132 package are used and the remaining two gates

should be disabled by grounding their inputs as shown at the bottom of the circuit diagram. Also, a decoupling capacitor of about 100nF should be located as close to the i.c. as possible to reduce interference on the output signal.

Lee Archer, Wigan, Lancs.

**DON'T WAIT – NEXT MONTH WE ARE GIVING AWAY
A GIANT TRANSISTOR DATA CHART**

**ORDER YOUR
COPY NOW**



NO. 1 FOR ELECTRONICS AND COMPUTER PROJECTS

NEWSAGENT ORDER FORM

Please reserve/deliver a copy of *Everyday Practical Electronics* for me each month

Signed

Name and Address

.....Post Code

Everyday Practical Electronics is published on the second Thursday of each month and distributed S.O.R. by COMAG. Make sure of your copy of *EPE* each month – cut out or photostat this form, fill it in and hand it to your newsagent.

Our philosophy is simple

Don't just test it...



...Analyse it!

The new Peak Atlas Component Analyser, UK price £60 fully inclusive.
(Shown approx actual size)

To find out just what the Atlas is capable of, give us a call and we'll send you our data pack.
Alternatively, see comprehensive data on our web site.

PEAK

Peak Electronic Design Limited - West Road House - West Road - Buxton - Derbyshire - SK17 6HF - UK
www.peakelec.co.uk - sales@peakelec.co.uk - Tel. +44 (0)1298 70012 - Fax. +44 (0)1298 22044

Special Review

PEAK ATLAS COMPONENT ANALYSER

ANDY FLIND

It may be small, but Atlas is an incredibly useful and versatile little tester, reports Andy Flind.

THE "Atlas" Component Analyser from Peak Electronics is a pocket-sized semiconductor tester. On opening the box, first impressions were of a very neat and simple-to-operate piece of equipment. Pleasant in appearance, the contoured case fits comfortably into the hand and could easily be carried in a shirt pocket. It has just two control buttons marked "On-Test" and "Scroll-Off" plus a two-line sixteen-character l.c.d. and it sports three leads coloured red, blue and green with matching test clips for connection to the component to be tested.

The small manual supplied is clear and easy to follow, and in addition to explaining what the unit can do is honest about its limitations, which is refreshing. Despite its simplicity the Atlas is surprisingly powerful, able to test a wide range of semiconductor devices from simple diodes right up to power MOSFETs and triacs.

INSIDE STORY

Before trying out the Atlas, a quick inspection was made of its construction. Removal of three self-tapping screws allows the back of the case to be removed, officially for battery replacement, but the p.c.b. can also be simply lifted out for examination. To enable it to fit into the slim case the board has two cut-outs to accommodate a small 12V battery and the l.c.d. display, an intelligent type with COB (Chip-On-Board) controlling i.c.s.

The main circuit is implemented mainly with surface-mount components, some easily recognisable ones being a 78L05 voltage regulator, two 74HC4051 "one-of-eight" electronic switches and an LM324 quad op.amp. The main processing unit is a PIC16C73, one of the more powerful members of the PIC microcontroller family with 4K of program memory and up to five analogue-to-digital converters.



Of interest to users is the fact that if the three connection leads became damaged replacement would be a fairly simple matter since they are soldered to relatively large pads on the board. Changing the battery might be a bit fiddly but would be well within the capabilities of most EPE readers. The overall impression was of neat and tidy construction.

ON TRIAL

Following the physical inspection the unit was tried out on a wide variety of semiconductors. To use it, either two or all three test leads are connected to the device to be tested. They may be applied in any order, which makes connection rapid and simple. The "On-Test" button is then pressed and the unit displays "The Peak Atlas is analysing . . ." for a second or two, following which the first data screen appears.

In the case of a bipolar transistor, for example, it may tell you that the device is an "NPN transistor", following which successive presses of the "Scroll-Off" button will bring up further screens, showing firstly which colour leads are connected to the emitter (e), the base (b) and the collector (c), then the current gain (H_{fe}), the collector test current used, the base-emitter voltage (V_{be}) and the test current used to determine this. Further scrolling returns to the first screen so if the user wishes to see a particular screen again repeated pressing of the scroll button soon brings it back into view.

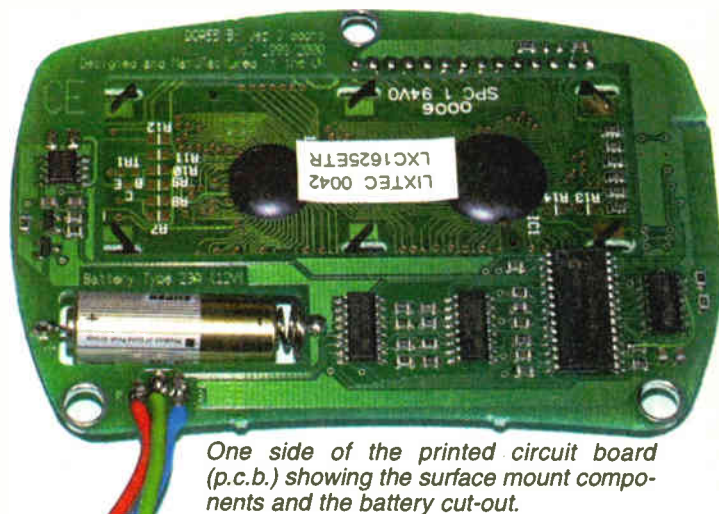

One side of the printed circuit board (p.c.b.) showing the surface mount components and the battery cut-out.

Everyday Practical Electronics, October 2000

The Peak Atlas
is analysing....

NPN bipolar
transistor

The actual testing is completed in one go at the start, so the tested semiconductor may be disconnected whilst the various screens are read. It can be turned off ready for the next test by holding the "Scroll-Off" button for a couple of seconds, or it will shut down automatically thirty seconds after the last button press, allowing ample time to make notes of the data if required.

The unit was tried with a large range of components, old and exotic types as well as standard modern components, and by and large gave an excellent account of itself. Amongst the diodes tested were germanium and Schottky types as well as various silicon ones, plus diode combinations such as bridge rectifiers, and i.e.d.s including two and three lead bi-colour types.

Germanium diodes have a recognisable low forward voltage, Schottkys lower still. It recognises i.e.d.s from their higher forward voltage drops (try three silicon diodes in series and it will tell you that it has found an i.e.d.!) and bi-colours are determined from their differing forward voltage drops.

Though it doesn't actually tell you which diode is which colour, it gives their forward voltages and the manual gives the likely corresponding colours. L.E.D.s, by the way, flicker briefly as the test current is applied, which shows they are working and gives the colour for clear-bodied types.

UP THE JUNCTION

Transistors of most varieties can be checked. Bipolar *npns* and *pnps* of all kinds, including power types, will have their polarity shown, leads identified, and gain figure displayed. Some old germanium transistors, such as OC44 and AC127, were tested satisfactorily.

Darlington types will be clearly identified as such and their high gain can also be measured and displayed. Special features such as internal protection diodes and shunt resistors may also be indicated on the i.c.d. screen. Enhancement mode MOSFETs of both polarities and high and low power can be checked as easily as bipolar transistors. At the time of testing a *p*-type MOSFET was not available, so the internal ones in a CMOS 4007B i.c. were substituted for this and were checked out by the unit with no problems.

A couple of types the unit cannot test are junction f.e.t.s and uni-junction transistors, but these will at least be identified as two diodes with a common anode or cathode, which of course they are from a practical point of view. At least it gives a clue as to which lead is which.

BEING SENSITIVE

With thyristors and triacs the practical tests were slightly less successful. To be fair the manual does state that only "sensitive or

low power" types can be tested, but in practice it was found that most of the ones tried, including some normally classed as "sensitive" produced an uninspiring "Faulty/Unknown Component" message.

Rather sad this, because when it does recognise one the information is just as clear as for transistors, with the gate, the cathode and anode or the MT1 and MT2 connections clearly identified. It seems likely that the problem is due to the high threshold voltages of some of these devices, perhaps combined with the minimum "holding" current required by some of them.

IN CONCLUSION

The verdict on the Atlas is that despite the limitation described above, it is an incredibly useful and versatile little tester, well worth the current asking price of £60 including postage and VAT. Many readers will have large collections of old or unidentified semiconductors which could be easily put to use if analysed with this unit.

For those with poor memories (like the author!) it can save much time searching through data sheets for device connection and polarity data. A classic example came when a medium power *npn* transistor was required for a switching application during a design session.

RED GREEN BLUE
Base Coll Emit

Some ZTX653 and ZTX 753s were available, but the author was quite unable to remember which was the *npn*, let alone which lead was which. This would previously have required a trip to the office to fetch a catalogue, followed by five minutes locating the device in the data sheets, but the Atlas resolved the problem in seconds.

It's the kind of instrument which should be on every engineer and enthusiast's bench, along with other universal items such as the multimeter. All in all, it can be thoroughly recommended.

The Atlas Component Analyser cost £60 all inclusive and for more

information contact: **Peak Electronic Design Ltd., Dept EPE, West Road House, West Road, Buxton, Derbyshire, SK17 6HF.** Tel. 01298 70012, Fax 01298 22044, E-mail sales@peakelec.co.uk. More information and data is also available at the Peak Web site at www.peakelec.co.uk. □

Forward voltage
V_f=0.67V

Enhancement mode
N-Ch MOSFET

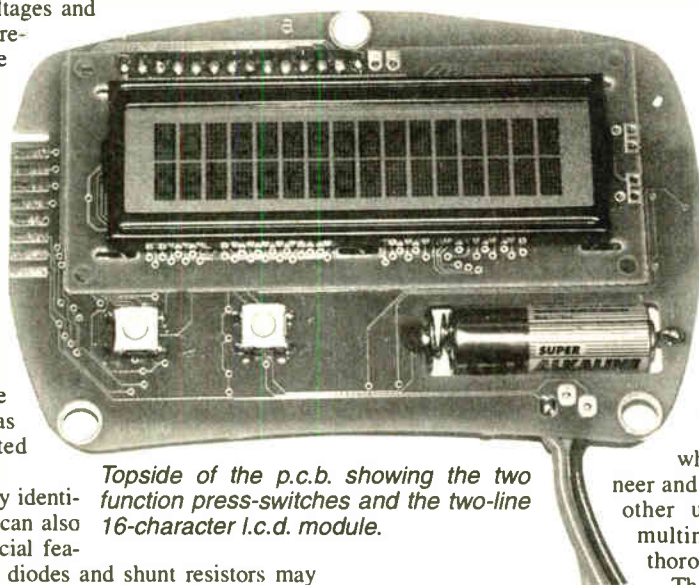

Topside of the p.c.b. showing the two function press-switches and the two-line 16-character i.c.d. module.

The reviewer would like to thank the Handy Shop of Taunton, Somerset, for their help and the loan of components used to test the Atlas Component Analyser.

EPE BINDERS

KEEP YOUR ISSUES SAFE – RING US NOW!

This ring binder uses a special system to allow the issues to be easily removed and re-inserted without any damage. A nylon strip slips over each issue and this passes over the four rings in the binder, thus holding the magazine in place.

The binders are finished in hard-wearing royal blue p.v.c. with the magazine logo in gold on the spine. They will keep your issues neat and tidy but allow you to remove them for use easily.

The price is £5.95 plus £3.50 post and packing. If you order more than one binder add £1 postage for each binder after the initial £3.50 postage charge (overseas readers the postage is £6.00 each to everywhere except Australia and Papua New Guinea which costs £10.50 each).

Send your payment in £'s sterling cheque or PO (Overseas readers send £ sterling bank draft, or cheque drawn on a UK bank or pay by credit card), to **Everyday Practical Electronics, Allen House, East Borough, Wimborne, Dorset BH21 1PF.** Tel: 01202 881749. Fax: 01202 841692. E-mail: editorial@epemag.wimborne.co.uk.

Web site: <http://www.epemag.wimborne.co.uk>



We also accept credit card payments. Mastercard (Access) or Visa (minimum credit card order £5). Send your card number and card expiry date plus cardholder's address (if different to the delivery address).



Everyday Practical Electronics are pleased to be able to offer all readers these **ELECTRONICS CD-ROMS**

NEW ELECTRONICS PROJECTS



Logic Probe testing

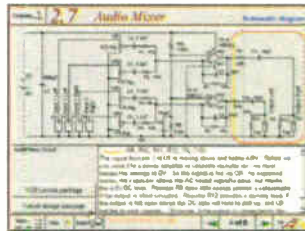

Audio Mixer circuit description

Electronic Projects is split into two main sections: **Building Electronic Projects** contains comprehensive information about the components, tools and techniques used in developing projects from initial concept through to final circuit board production. Extensive use is made of video presentations showing soldering and construction techniques. The second section contains a set of ten projects for students to build, ranging from simple sensor circuits through to power amplifiers. A shareware version of Matrix's CADPACK **schematic capture, circuit simulation and p.c.b. design** software is included.

The projects on the CD-ROM are: Logic Probe; Light, Heat and Moisture Sensor; NE555 Timer; Egg Timer; Dice Machine; Bike Alarm; Stereo Mixer; Power Amplifier; Sound Activated Switch; Reaction Tester. Full parts lists, schematics and p.c.b. layouts are included on the CD-ROM.

ANALOGUE ELECTRONICS

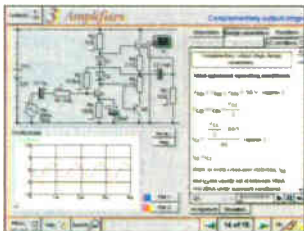

Complimentary output stage

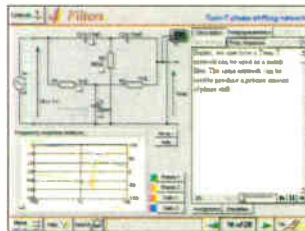

Twin-T phase shifting network

Analogue Electronics is a complete learning resource for this most difficult branch of electronics. The CD-ROM includes a host of virtual laboratories, animations, diagrams, photographs and text as well as a SPICE electronic circuit simulator with over 50 pre-designed circuits.

Sections on the CD-ROM include: **Fundamentals** – Analogue Signals (5 sections), Transistors (4 sections), Waveshaping Circuits (6 sections). **Op.Amps** – 17 sections covering everything from Symbols and Signal Connections to Differentiators. **Amplifiers** – Single Stage Amplifiers (8 sections), Multi-stage Amplifiers (3 sections). **Filters** – Passive Filters (10 sections), Phase Shifting Networks (4 sections), Active Filters (6 sections). **Oscillators** – 6 sections from Positive Feedback to Crystal Oscillators. **Systems** – 12 sections from Audio Pre-Amplifiers to 8-Bit ADC plus a gallery showing representative p.c.b. photos.

DIGITAL ELECTRONICS

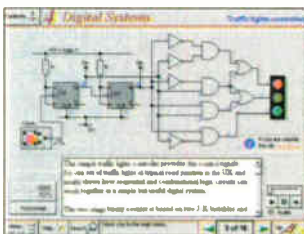

Virtual laboratory – Traffic Lights

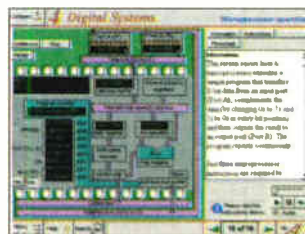

Microprocessor

Digital Electronics builds on the knowledge of logic gates covered in *Electronic Circuits & Components* (opposite), and takes users through the subject of digital electronics up to the operation and architecture of microprocessors. The virtual laboratories allow users to operate many circuits on screen.

Covers binary and hexadecimal numbering systems, ASCII, basic logic gates and their operation, monostable action and circuits, and bistables – including JK and D-type flip-flops. Multiple gate circuits, equivalent logic functions and specialised logic functions. Introduces sequential logic including clocks and clock circuitry, counters, binary coded decimal and shift registers. A/D and D/A converters and their parameters, traffic light controllers, memories and microprocessors – architecture, bus systems and their arithmetic logic units.

FILTERS

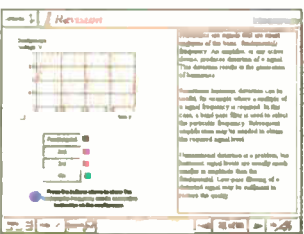

Filter Theory

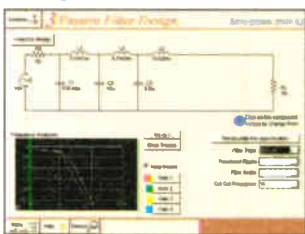

Active filter synthesis

Filters is a complete course in designing active and passive filters that makes use of highly interactive virtual laboratories and simulations to explain how filters are designed. It is split into five chapters: **Revision** which provides underpinning knowledge required for those who need to design filters. **Filter Basics** which is a course in terminology and filter characterization, important classes of filter, filter order, filter impedance and impedance matching, and effects of different filter types. **Advanced Theory** which covers the use of filter tables, mathematics behind filter design, and an explanation of the design of active filters. **Passive Filter Design** which includes an expert system and filter synthesis tool for the design of low-pass, high-pass, band-pass, and band-stop Bessel, Butterworth and Chebyshev ladder filters. **Active Filter Design** which includes an expert system and filter synthesis tool for the design of low-pass, high-pass, band-pass, and band-stop Bessel, Butterworth and Chebyshev op.amp filters.

DIGITAL WORKS 3.0

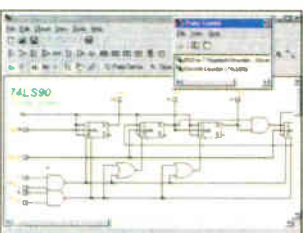

Macro screen

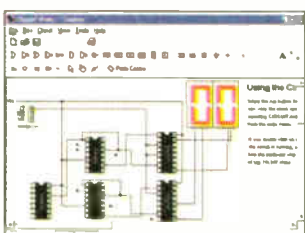

Counter project

Digital Works Version 3.0 is a graphical design tool that enables you to construct digital logic circuits and analyze their behaviour. It is so simple to use that it will take you less than 10 minutes to make your first digital design. It is so powerful that you will never outgrow its capability.

- Software for simulating digital logic circuits
- Create your own macros – highly scalable
- Create your own circuits, components, and i.c.s
- Easy-to-use digital interface
- Animation brings circuits to life
- Vast library of logic macros and 74 series i.c.s with data sheets
- Powerful tool for designing and learning

PRICES

Prices for each of the CD-ROMs above are:

Hobbyist/Student£45 inc VAT
 Institutional (Schools/HE/FE/Industry).....£99 plus VAT
 Institutional 10 user (Network Licence)£199 plus VAT

(UK and EU customers add VAT at 17.5% to "plus VAT" prices)

Interested in programming PIC microcontrollers? Learn with **PICtutor** by John Becker



The Virtual PIC

This highly acclaimed CD-ROM, together with the PICtutor experimental and development board, will teach you how to use PIC microcontrollers with special emphasis on the PIC16x84 devices. The board will also act as a development test bed and programmer for future projects as your programming skills develop. This interactive presentation uses the specially developed **Virtual PIC Simulator** to show exactly what is happening as you run, or step through, a program. In this way the CD provides the easiest and best ever introduction to the subject.

Nearly 40 Tutorials cover virtually every aspect of PIC programming in an easy to follow logical sequence.

HARDWARE

Whilst the CD-ROM can be used on its own, the physical demonstration provided by the **PICtutor Development Kit**, plus the ability to program and test your own PIC16x84s, really reinforces the lessons learned. The hardware will also be an invaluable development and programming tool for future work. Two levels of PICtutor hardware are available – Standard and Deluxe. The **Standard** unit comes with a battery holder, a reduced number of switches and no displays. This version will allow users to complete 25 of the 39 Tutorials. The **Deluxe** Development Kit is supplied with a plug-top power supply (the **Export** Version has a battery holder), all switches for both PIC ports plus l.c.d. and 4-digit 7-segment l.e.d. displays. It allows users to program and control all functions and both ports of the PIC. All hardware is supplied **fully built and tested** and includes a PIC16F84.

PICtutor CD-ROM

Hobbyist/Student£45 inc. VAT
 Institutional (Schools/HE/FE Industry) ..£99 plus VAT
 Institutional 10 user (Network Licence) ..£199 plus VAT

HARDWARE

Standard PICtutor Development Kit£47 inc. VAT
 Deluxe PICtutor Development Kit£99 plus VAT
 Deluxe Export Version£96 plus VAT

(UK and EU customers add VAT at 17.5% to "plus VAT" prices)

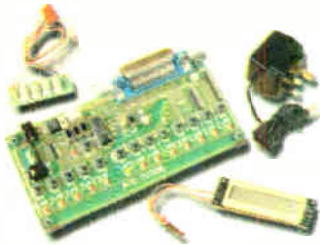

Deluxe PICtutor Hardware



ELECTRONIC COMPONENTS PHOTOS

A high quality selection of over 200 JPG images of electronic components. This selection of high resolution photos can be used to enhance projects and presentations or to help with training and educational material. They are royalty free for use in commercial or personal printed projects, and can also be used royalty free in books, catalogues, magazine articles as well as worldwide web pages (subject to restrictions – see licence for full details). Also contains a **FREE** 30-day evaluation of Paint Shop Pro 6 – Paint Shop Pro image editing tips and on-line help included!

Price **£19.95** inc. VAT

ELECTRONIC CIRCUITS & COMPONENTS + THE PARTS GALLERY

Provides an introduction to the principles and application of the most common types of electronic components and shows how they are used to form complete circuits. The virtual laboratories, worked examples and pre-designed circuits allow students to learn, experiment and check their understanding. Sections include: **Fundamentals:** units & multiples, electricity, electric circuits, alternating circuits. **Passive Components:** resistors, capacitors, inductors, transformers. **Semiconductors:** diodes, transistors, op.amps, logic gates. **Passive Circuits . Active Circuits**

The Parts Gallery will help students to recognise common electronic components and their corresponding symbols in circuit diagrams. Selections include: **Components, Components Quiz, Symbols, Symbols Quiz, Circuit Technology**

Hobbyist/Student.....£34 inc VAT
 Institutional (Schools/HE/FE/Industry).....£89 plus VAT
 Institutional 10 user (Network Licence).....£169 plus VAT

(UK and EU customers add VAT at 17.5% to "plus VAT" prices)

MODULAR CIRCUIT DESIGN

This CD-ROM contains a range of tried and tested analogue and digital circuit modules, together with the knowledge to use and interface them. Thus allowing anyone with a basic understanding of circuit symbols to design and build their own projects.

Essential information for anyone undertaking GCSE or "A" level electronics or technology and for hobbyists who want to get to grips with project design. Over seventy different Input, Processor and Output modules are illustrated and fully described, together with detailed information on construction, fault finding and components, including circuit symbols, pinouts, power supplies, decoupling etc.

Single User Version **£19.95** inc. VAT

Multiple User Version **£34** plus VAT

(UK and EU customers add VAT at 17.5% to "plus VAT" prices)

Minimum system requirements for these CD-ROMs: PC with 486/166MHz, VGA+256 colours, CD-ROM drive, 32MB RAM, 10MB hard disk space. Windows 95/98, mouse, sound card, web browser.

Please send me:

CD-ROM ORDER FORM

- Electronic Projects
- Analogue Electronics
- Digital Electronics
- Filters
- Digital Works 3.0
- PICtutor
- Electronic Circuits & Components +The Parts Gallery

Version required:

- Hobbyist/Student
- Institutional
- Institutional 10 user

Note: The software on each version is the same, only the licence for use varies.

- PICtutor Development Kit – Standard
- PICtutor Development Kit – Deluxe

Deluxe Export

Note: The PICtutor CD-ROM is not included in the Kit prices.

- Electronic Components Photos
- Modular Circuit Design – Single User
- Modular Circuit Design – Multiple User

Note: The software on each version is the same, only the licence for use varies.

Full name:

Address:

.....Post code:Tel. No:

Signature:

I enclose cheque/PO in £ sterling payable to WIMBORNE PUBLISHING LTD for £

Please charge my Visa/Mastercard: £Card expiry date:

Card No:

Please supply name and address of cardholder if different to the delivery address.

ORDERING

ALL PRICES INCLUDE UK POSTAGE

Student/Single User/Standard Version price includes postage to most countries in the world
 EU residents outside the UK add £5 for airmail postage per order

Institutional, Multiple User and Deluxe Versions – overseas readers add £5 to the basic price of each order for airmail postage (do not add VAT unless you live in an EU country, then add 17½% VAT or provide your official VAT registration number).

Send your order to:

Direct Book Service

Allen House, East Borough, Wimborne Dorset BH21 1PF

Direct Book Service is a division of Wimborne Publishing Ltd. To order by phone ring

01202 881749. Fax: 01202 841692

Goods are normally sent within seven days
 E-mail: orders@epemag.wimborne.co.uk

SURFING THE INTERNET

NET WORK

ALAN WINSTANLEY

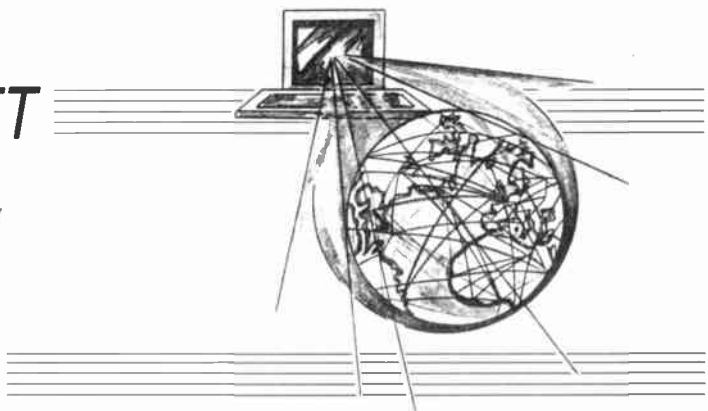

With no sign of the breakthrough we all hoped for concerning unmetered access – more ISPs seem to be back-peddling or pulling out at the present time than offering an unmetered service – this month's column discusses some practical aspects of using multiple Internet Service Providers.

Multiple Choice Mail

These days it's quite common to use more than one Internet Service Provider, especially if you have to manage several domain names or web sites at the same time. Users often utilise more than one Internet account – whether a paid-for professional dial-up account or a free one – and also it is common to fetch mail from several different mailboxes. You might want to use multiple ISPs for various reasons, perhaps running one as a back-up for the other.

You can usually FTP your files (e.g. a web site) to any server regardless of which dial-in service you choose, although there may be exceptions to this rule: some ISPs may demand that you use their own access number when FTPing to their server, other ISPs may insist that you route a minimum number of hours' worth of calls per month through their own access number instead.

When running several ISPs, trying to manage E-mail can be quite a headache. With a little thought, however, you can streamline and refine your set-up to make the most of multiple ISP management. This month's *Net Work* focuses on collecting and sending mail from multiple mailboxes using several ISPs.

As far as incoming E-mail is concerned, this is usually handled in one of two ways:

- through a "multiple address" mailbox in the form of <any-one>@yourname.co.uk. All your incoming mail is routed into this mailbox by your ISP.
- use separate POP3 mailboxes such as tom@yourname.co.uk, fred@yourname.co.uk, sales@anothername.com etc.

In the first method, your E-mail software (e.g. Microsoft Outlook Express 5, Eudora or Turnpike) can be used to fetch all the E-mail in one batch, and place it into an "incoming" folder or Inbox. Depending on how elaborate a system you want, you could then use sort rules and filters to re-route those incoming mails into more folders on your computer system. In Outlook Express 5.0, for example, you can right-click the Inbox icon and then create and name a New Folder. Then go Tools/Message Rules/Mail . . . and create new routing rules which will sort the mail from the inbox into the new folder. This takes a little bit of thinking about but is actually quite a reasonable "plain English" approach to creating sort rules once you get used to it. You could also sort mail by sender, for example, so that mail from a particular person (e.g. the Boss) is routed to its own folder. The added benefit of this system (unlike the second method) is that you don't need the intervention of the ISP to set up any more usernames, because your software handles the sorting. In the second system, mail can only be addressed to that individual user (tom, fred or sales) and is routed to that folder.

Incoming E-mail is usually handled by a POP3 mailserver, and the ISP will advise you of the appropriate POP3 address. Often it's something like "pop3mail.your-isp.co.uk". In Outlook Express 5, the mail server addresses are configured using the Tools/Accounts . . . menu. You can check your set-up by clicking the Mail tab for the ISP (or "Account") being configured. Under the Mail tab, look for Properties then Servers: in the two dialogue boxes you can enter the mail server details.

Problems Addressed

Your outgoing mail is usually sent through an SMTP (Simple Mail Transfer Protocol) server. Your ISP will tell you its address, and obviously you must configure your E-mail software so that it sends mail to the correct server. At this point, however, things

become messy if you are using multiple Internet Service Providers. I mentioned earlier that you can often use virtually any Internet connection in order to, say, connect to an FTP server or to collect E-mail from all your mailboxes. Your software will contact the mailserver address followed by the specific mailbox login and password to fetch any mail back onto your system. Outlook Express displays a bargraph showing what it's doing: each server will be addressed in turn and incoming E-mail will be fetched from the POP server configured for that Account.

At the same time, outgoing mail will be sent to the corresponding SMTP server. The question is, what if you have another ISP as well? For example you might run a Freeserve account in tandem with your main dial-up account.

The important point here is that unlike incoming mail which can usually be checked using any connection, the outgoing mail server you configured must correspond with the ISP through which you connect to the Internet. So if you've connected through Demon Internet for example, you can usually fetch all your incoming E-mails from all your mailboxes (no matter which ISP provides them) without a problem. However, you can only use Demon's SMTP mail server to send out your outgoing mail. You couldn't use Demon's dial-up service to send outgoing mail out through, say, Freeserve's mail server. Your configuration should reflect this.

Imagine what would happen if you could use anyone's outgoing mail server: the entire system would soon choke, because bulk unsolicited E-mails (spam and so forth) could be broadcast using any ISP's mail server. By rights, if you connect through a specific ISP you shouldn't have the privilege of using another ISP's outgoing mail server. Sometimes, badly-configured mail servers do allow open access accidentally (called open relaying), a problem I discussed in previous articles.

Outlook Choice

When it comes to sending E-mail and accessing multiple ISP accounts, Outlook Express will offer you a choice: after finishing with the first ISP's mail servers Outlook will prompt you to hang up and dial another ISP (which is a nuisance), or it will try to "use the existing connection" to search for the second ISP's mail servers. If you allow it to use the existing connection, you will probably get an error message caused by Outlook's failure to send outgoing mail.

This happens because the first ISP's dial-up account is now being used to talk to another ISP's outgoing mail server. A workaround is to ensure that the same SMTP server address is configured on all Accounts, then dial in using that corresponding account. In this example, I would dial in using ISP1, so the server addresses would be set as follows:

- ISP 1 – smtp.mailISP1.co.uk and pop3.mailISP1.co.uk
- ISP 2 – smtp.mailISP1.co.uk and pop3.mailISP2.co.uk

Then go to Tools/Options/Connections, and tick the box which says "Ask before switching dial-up connections". If you set up Outlook Express in this way, when you dial through your regular ISP, the software will send all your E-mail through that SMTP server, then it will switch connections without complaint. You can therefore operate two ISPs in tandem without having to hang up and redial.

Of course, if you decide to dial in through your second ISP instead, then you're back to square one, only worse: you wouldn't be able to send any E-mail at all! You would have to point to the second ISP's SMTP server. At least this system allows you to configure multiple ISPs and use Outlook Express to work with them without getting error messages or needing to redial. The last thing to check is under Options/Connection: Hang up after sending and receiving. You might want to disable this option if you intend to use your web browser.

Learn The Easy Way!

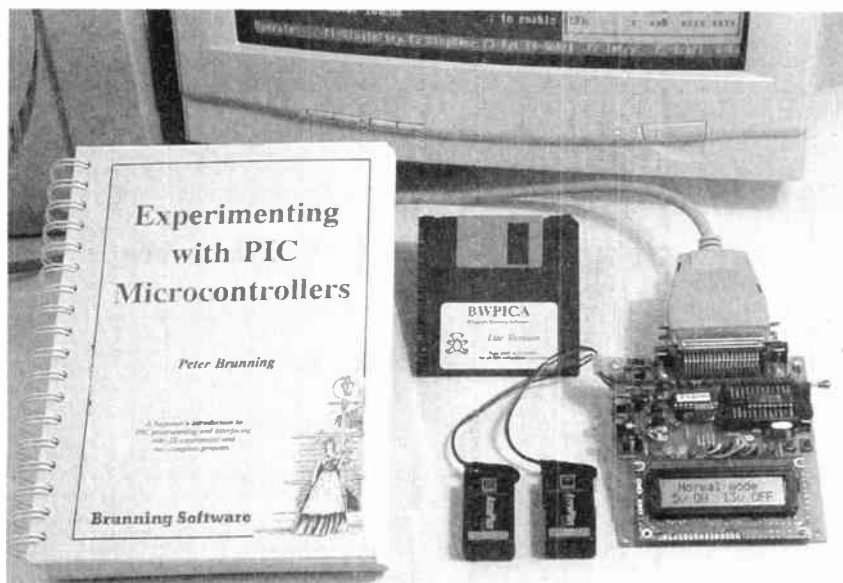

Experimenting with PIC Microcontrollers

This third release in our series teaches how to programme and interface to the PIC16F84 and PIC16C711 microcontrollers, and consists of the book, an integrated suite of programmes to run on a PC, and a programmer/experimental module.

The book with its abundance of flow diagrams and circuit diagrams is the heart of the system, and the software is the brains. A text editor with word processing power is the key stone supporting the assembler, disassembler, simulator, and programming software. As the text is typed in the assembler works in the background testing each line so that errors are immediately highlighted. When the typing is done the simulator can be used to single step or run the programme. Boxes pop up showing the contents of registers and the result of any text written to a standard 2 line by 16 character display. If it works correctly plug the programmer/experimental module onto the end of your printer lead and test it using a real live PIC. All operations work directly from the assembler text in the editor.

The experiments are all performed using the programmer/experimental module which is already wired with LEDs, push buttons, and an alphanumeric liquid crystal display. Flashing LEDs, text display, real time clock, period timer, beeps and music, including a rendition of Beethoven's *Für Elise*. Then there are two projects to work through; building a sinewave generator covering 0.2Hz to 20kHz in five ranges, and investigating measurement of the power taken by domestic appliances. In the space of 24 experiments, two projects and 56 exercises the system works through from absolute beginner to experienced engineer level.

Kit or Ready Built

The programming/experimental module can be purchased built, tested and ready to use, or in kit form. The ready built module verifies first at normal 5 volts then with $\pm 10\%$ volts applied, and uses the built in display to show programming messages. The kit version uses a simplified design which verifies only at normal 5 volts and where the display is dedicated to the test PIC (the status is indicated using 2 LEDs).

The kit consists of two parts. PIC3u-a contains the PCB, control PIC, 2 slide switches, software suite, and a booklet containing a full parts list and construction details. PIC3u-b contains all the other items to build the programmer/experimental module and includes a test PIC.

The system will also programme similar PICs (83, 710, 71, 620, 621 etc). The made up module is supplied with a test PIC fitted. Two PP3 batteries are also required, these are not supplied.

Assembler

The first book *Experimenting with PC Computers* with its kit is the easiest way ever to learn assembly language programming, simple circuit design and interfacing to a PC. If you have enough intelligence to understand the English language and you can operate a PC computer then you have all the necessary background knowledge. Flashing LEDs, digital to analogue converters, simple oscilloscope, charging curves, temperature graphs and audio digitising.

C & C++

The second book *Experimenting with C & C++ Programmes* uses a similar approach. It teaches the user to programme by using C to drive the simple hardware circuits built using the materials supplied in the kit of parts. The experimental circuits build up to a storage oscilloscope using relatively simple C techniques to construct a programme that is by no means simple. When approached in this way C is only marginally more difficult than BASIC and infinitely more powerful. C programmers are always in demand. Ideal for absolute beginners and experienced programmers.

The Kits

The kits contain the prototyping board, lead assemblies, components and programming software to do all the experiments. The 'made up' kits are supplied ready to start the first experiment. The 'unmade' Kits require the prototyping board and leads to be assembled and soldered before you can start. The 'top up' kit CP2t is for readers who have purchased a kit to go with the first book, and contains all the components and programming software but not the prototyping board or leads.

Hardware required

All three systems assume you have a PC (386 or better) and a printer lead.

Mail Order Form

Please make your cheque/PO payable to *Brunning Software* and send with this form to Brunning Software, 138 The Street, Little Clacton, Clacton-on-sea, Essex, CO16 9LS. Your order will be processed as soon as your cheque arrives. Despatch is usually the same day. Software supplied on 3.5" HD discs. *The kits do not include the book.*

- Book *Experimenting with PCs* (Maplin code NV68) £23.99.....
- Kit 1a 'made up' and ready to start (Not from Maplin) . . . £46.00.....
- Kit 1u 'unmade' needs assembling (Maplin code NV67) . . . £39.99.....
- Book *Experimenting with C & C++* (Maplin code NW47) . . £24.99.....
- Kit CP2a 'made up' and ready to start (Not from Maplin) . . £46.00.....
- Kit CP2u 'unmade' needs assembling (Maplin code NW48) . . £39.99.....
- Kit CP2t 'top up' to add to kit 1 (Maplin code NW49) . . . £22.99.....
- Book *Experimenting with PIC Microcontrollers* £23.99.....
- PIC Programmer/experimental module & software £74.00.....
- Kit PIC3u-a: PCB, control PIC, switches & software . . £30.00.....
- Kit PIC3w-b: all other items required to build module . . £25.00.....

JK postage: free for orders above £30 otherwise add £3 per order.
Prices include VAT where applicable.

Name.....

Address.....

.....

.....

.....

Postcode..... Date.....



Telephone for full details.

Mail order address:-

Brunning Software

138 The Street, Little Clacton, Clacton-on-sea,
Essex, CO16 9LS. Tel 01255 862308.

STORE YOUR BACK ISSUES IN YOUR WALLET!



A new way to buy *EPE* Back Issues – our wallet-sized CD-ROMs contain back issues from our *EPE Online* website plus bonus articles, all the relevant PIC software and web links. All this for just £12.45 including postage and packing.

**VOL 2
NOW AVAILABLE**

**ONLY
£12.45**

including VAT
and p&p



VOL 1 CONTENTS

BACK ISSUES – November 1998 to June 1999 (all the projects, features, news, IUs etc. from all eight issues).
Note: No advertisements or Free Gifts are included.

PIC PROJECT CODES – All the available codes for the PIC based projects published in issues from November 1998 to June 1999.

EPE ONLINE STORE – Books, PCBs, Subscriptions, etc.

VOL 2 CONTENTS

BACK ISSUES – July 1999 to December 1999 (all the projects, features, news, IUs, etc. from all six issues).
Note: No advertisements or Free Gifts are included.

PIC PROJECT CODES – All the available codes for the PIC-based projects published in issues from July to December 1999.

EPE ONLINE STORE – Books, PCBs, Subscriptions, etc.

EXTRA ARTICLES – ON ALL VOLUMES

THE LIFE & WORKS OF KONRAD ZUSE – a brilliant pioneer in the evolution of computers. A bonus article on his life and work written by his eldest son, including many previously unpublished photographs.

BASIC SOLDERING GUIDE – Alan Winstanley's internationally acclaimed fully illustrated guide.

UNDERSTANDING PASSIVE COMPONENTS – Introduction to the basic principles of passive components.

HOW TO USE INTELLIGENT L.C.D.s. By Julyan Ilett – An utterly practical guide to interfacing and programming intelligent liquid crystal display modules.

PhyzyB COMPUTERS BONUS ARTICLE 1 – Signed and Unsigned Binary Numbers. By Clive "Max" Maxfield and Alvin Brown.

PhyzyB COMPUTERS BONUS ARTICLE 2 – Creating an Event Counter. By Clive "Max" Maxfield and Alvin Brown.

INTERGRAPH COMPUTER SYSTEMS 3D GRAPHICS – A chapter from Intergraph's book that explains computer graphics technology in an interesting and understandable way with full colour graphics.

NOTE: This mini CD-ROM is suitable for use on any PC with a CD-ROM drive. It requires Adobe Acrobat Reader (available free from the Internet – www.adobe.com/acrobat)

Order on-line from www.epemag.com or by Phone, Fax, E-mail or Post

BACK ISSUES CD-ROM ORDER FORM

Please send me (quantity) BACK ISSUES CD-ROM VOL 1

Please send me (quantity) BACK ISSUES CD-ROM VOL 2
Price £12.45 (approx \$20) each – includes postage to anywhere in the world.

Name

Address

..... Post Code

I enclose cheque/P.O./bank draft to the value of £

Please charge my Visa/Mastercard £

Card No. Expiry Date

Note: Minimum order for credit cards £5. Please supply name and address of cardholder if different from that shown above.

SEND TO: Everyday Practical Electronics, Allen House, East Borough, Wimborne, Dorset BH21 1PF.

Tel: 01202 881749. Fax: 01202 841692.

E-mail: orders@epemag.wimborne.co.uk

Payments must be by credit card or in £ Sterling – cheque or bank draft drawn on a UK bank.

Normally supplied within seven days of receipt of order.

Send a copy of this form, or order by letter if you do not wish to cut your issue.

We can supply back issues of *EPE* by post, most issues from the past five years are available. An *EPE* index for the last five years is also available – see order form. Alternatively, indexes are published in the December issue for that year. Where we are unable to provide a back issue a photostat of any *one article* (or *one part* of a series) can be purchased for the same price. Issues from Nov. 98 onwards are also available to download from www.epemag.com.

DID YOU MISS THESE?

MAY '99

PROJECTS • MIDI Handbells • A.M./F.M. Radio Remote Control • PhizzyB Computers-7 • PIC Toolkit Mk2-1.
FEATURES • PC Engines – From 4004 to Pentium III • Ingenuity Unlimited • Practically Speaking • PhizzyB Computers-7 • Circuit Surgery • New Technology Update • Net Work • **FREE** pull-out 7400 series Pinout Data Chart.

JUNE '99

PROJECTS • Clipping Video Fader (Starter Project) • PC Audio Frequency Meter • Musical Sundial • PIC Toolkit Mk2-2.
FEATURES • Alan Dower Blumlein • Circuit Surgery • Interface • PhizzyB Computers-8 • Ingenuity Unlimited • Edison 3 Review • Net Work – The Internet.

JULY '99

PROJECTS • 12V Lead-acid Battery Tester • L.E.D. Stroboscope • EPE Mood Picker • Intruder Deterrent.
FEATURES • Practical Oscillator Designs-1 • Practically Speaking • Circuit Surgery • Ingenuity Unlimited • New Technology Update • Net Work – The Internet.

AUG '99

PROJECTS • Ultrasonic Puncture Finder • Magnetic Field Detective • Freezer Alarm • 8-Channel Analogue Data Logger-1 • Sound Activated Switch.
FEATURES • Practical Oscillator Designs-2 • Power Generation from Pipelines to Pylons-1 • Ingenuity Unlimited • Circuit Surgery • Interface • Net Work – The Internet.



SEPT '99

PROJECTS • Loop Aerial SW Receiver • Child Guard • 8-Channel Analogue Data Logger-2 • Variable Dual Power Supply.
FEATURES • Practical Oscillator Designs-3 • Power Generation from Pipelines to Pylons-2 • Practically Speaking • Circuit Surgery • Ingenuity Unlimited • New Technology Update • Net Work.

OCT '99

PROJECTS • Interior Lamp Delay • Mains Cable Detector • QWL Loudspeaker System • Micro Power Supply.
FEATURES • PIC16F87x Mini Tutorial • Practical Oscillator Designs-4 • Circuit Surgery • Interface • Ingenuity Unlimited • Net Work – The Internet.

NOV '99

PROJECTS • Acoustic Probe • Vibralarm • Ginormous Stopwatch-1 • Demister One-Shot.
FEATURES • Teach-In 2000-Part 1 • Ingenuity Unlimited • Practically Speaking • Practical Oscillator Designs-5 • Circuit Surgery • New Technology Update • Net Work – The Internet **FREE** Identifying Electronic Components booklet.

DEC '99

PROJECTS • PIC Micro-Probe • Magnetic Field Detector • Loft Guard • Ginormous Stopwatch – Giant Display-2.
FEATURES • Teach-In 2000-Part 2 • Practical Oscillator Designs-6 • Interface • Ingenuity Unlimited (Special) • Circuit Surgery • Network-The Internet • 1999 Annual Index.



JAN '00

PROJECTS • Scratch Blanker • Versatile Burglar Alarm • Flashing Snowman • Vehicle Frost Box.
FEATURES • Ingenuity Unlimited • Teach-In 2000-Part 3 • Circuit Surgery • Practically Speaking • Tina Pro Review • Net Work – The Internet.

FEB '00 Photostats Only

PROJECTS • PIC Video Cleaner • Voltage Monitor • Easy-Typist Tape Controller • Find It – Don't Lose It!
FEATURES • Technology Timelines-1 • Circuit Surgery • Teach-In 2000-Part 4 • Ingenuity Unlimited • Interface • Net Work – The Internet.

MAR '00

PROJECTS • EPE ICEbreaker • High Performance Regenerative Receiver-1 • Parking Warning System • Automatic Train Signal.
FEATURES • Teach-In 2000 – Part 5 • Practically Speaking • Technology Timelines-2 • Ingenuity Unlimited • Circuit Surgery • New Technology Update • Net Work – The Internet.

APRIL '00

PROJECTS • Flash Slave • Garage Link • Micro-PICscope • High Performance Regenerative Receiver-2.
FEATURES • Teach-In 2000-Part 6 • Ingenuity Unlimited • Technology Timelines-3 • Circuit Surgery • Interface • Telcan Home Video • Net Work – The Internet.

MAY '00

PROJECTS • Versatile Mic/Audio Preamplifier • PIR Light Checker • Low-Cost Capacitance Meter • Multi-Channel Transmission System-1.
FEATURES • Teach-In 2000-Part 7 • Technology Timelines-4 • Circuit Surgery • Practically Speaking • Ingenuity Unlimited • Net Work – The Internet • **FREE** Giant Technology Timelines Chart.

JUNE '00

PROJECTS • Atmospheric Electricity Detector-1 • Canute Tide Predictor • Multi-Channel Transmission System-2 • Automatic Nightlight.
FEATURES • Teach-In 2000 – Part 8 • Technology Timelines-5 • Circuit Surgery • Interface • New Technology Update • Ingenuity Unlimited • Net Work – The Internet.

JULY '00

PROJECTS • G-Meter • Camera Shutter Timer PIC-Gen Frequency Generator/Counter • Atmospheric Electricity Detector-2.
FEATURES • Teach-In 2000-Part 9 • Practically Speaking • Ingenuity Unlimited • Circuit Surgery • PICO DrDAQ Reviewed • Net Work – The Internet.



AUG '00

PROJECTS • Handy-Amp • EPE Moodloop • Quiz Game Indicator • Door Protector
FEATURES • Teach-In 2000-Part 10 • Cave Electronics • Ingenuity Unlimited • Circuit Surgery • Interface • New Technology Update • Net Work – The Internet.

SEPT 00

PROJECTS • Active Ferrite Loop Aerial • Steeplechase Game • Remote Control IR Decoder • EPE Moodloop Power Supply.
FEATURES • Teach-In 2000-Part 11 • New Technology Update • Circuit Surgery • Ingenuity Unlimited • Practically Speaking • Net Work – The Internet Page.

BACK ISSUES ONLY £3.00 each inc. UK p&p.

Overseas prices £3.50 each surface mail, £4.95 each airmail.

We can also supply issues from earlier years: 1992 (except March, April, June to Sept. and Dec.), 1993 (except Jan. to March, May, Aug., Dec.), 1994 (except April to June, Aug., Oct. to Dec.), 1995 (No Issues), 1996 (except Jan. to May, July, Aug., Nov.), 1997 (except Feb. and March), 1998 (except Jan., March to May, July, Nov., Dec.), 1999.

We can also supply back issues of *ETI* (prior to the merger of the two magazines) for 1998/9 – Vol. 27 Nos 1 to 13 and Vol. 28 No. 1. We are not able to supply any material from *ETI* prior to 1998. Please put *ETI* clearly on your order form if you require *ETI* issues.

Where we do not have an issue a photostat of any *one article* or *one part* of a series can be provided at the same price.

ORDER FORM – BACK ISSUES – PHOTOSTATS– INDEXES

- Send back issues dates
 Send photostats of (article title and issue date)
 Send copies of last five years indexes (£3.00 for five inc. p&p – Overseas £3.50 surface, £4.95 airmail)

Name

Address

I enclose cheque/P.O./bank draft to the value of £

Please charge my Visa/Mastercard £

Card No. Card Expiry Date

Note: Minimum order for credit cards £5. Please supply name and address of cardholder if different from that shown above.

SEND TO: Everyday Practical Electronics, Allen House, East Borough, Wimborne, Dorset BH21 1PF.

Tel: 01202 881749. Fax: 01202 841692.

E-mail: orders@epemag.wimborne.co.uk

Payments must be in £ sterling – cheque or bank draft drawn on a UK bank. Normally supplied within seven days of receipt of order.

Send a copy of this form, or order by letter if you do not wish to cut your issue.

M10/00

**WHETHER ELECTRONICS IS YOUR HOBBY
OR YOUR LIVELIHOOD . . .
YOU NEED THE MODERN ELECTRONICS MANUAL
and the ELECTRONICS SERVICE MANUAL**

THE MODERN ELECTRONICS MANUAL

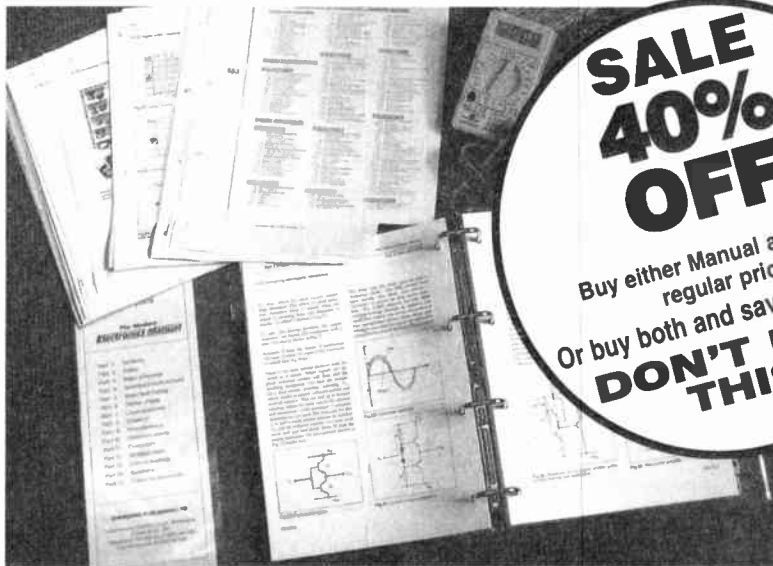

*The essential reference
work for everyone
studying electronics*

- Over 900 pages
- In-depth theory
- Projects to build
- Detailed assembly instructions
- Full components checklists
- Extensive data tables
- Detailed supply information
- Easy-to-use format
- Clear and simple layout
- Comprehensive subject range
- Professionally written
- Regular Supplements
- Sturdy gold blocked ring-binder

EVERYTHING YOU NEED TO GET STARTED AND GO FURTHER IN ELECTRONICS!

The revised edition of the Modern Electronics Base Manual contains practical, easy-to-follow information on the following subjects:

BASIC PRINCIPLES: Electronic Components and their Characteristics (16 sections from Resistors and Potentiometers to Crystals, Crystal Modules and Resonators), Circuits Using Passive Components (9 sections), Power Supplies, The Amateur Electronics Workshop, The Uses of Semiconductors, Digital Electronics (6 sections), Operational Amplifiers, Introduction to Physics, Semiconductors (6 sections) and Digital Instruments (5 sections).

CIRCUITS TO BUILD: There's nothing to beat the satisfaction of creating your own project. From basic principles, like soldering and making printed circuit boards, to circuit-building, the Modern Electronics Manual and its Supplements describe clearly, with appropriate diagrams, how to assemble radios, loudspeakers,

amplifiers, car projects, computer interfaces, measuring instruments, workshop equipment, security systems, etc. The Base Manual describes 13 projects including a Theremin and a Simple TENS Unit.

ESSENTIAL DATA: Extensive tables on diodes, transistors, thyristors and triacs, digital and linear i.c.s.

EXTENSIVE GLOSSARY: Should you come across a technical word, phrase or abbreviation you're not familiar with, simply turn to the glossary included in the Manual and you'll find a comprehensive definition in plain English.

The Manual also covers **Safety and Suppliers**. The most comprehensive reference work ever produced at a price you can afford, the revised edition of **THE MODERN ELECTRONICS MANUAL** provides you with all the *essential* information you need.

THE MODERN ELECTRONICS MANUAL

Revised Edition of Basic Work: Contains over 900 pages of information. Edited by John Becker.

Regular Supplements: Approximately 160-page Supplements of additional information which, if requested, are forwarded to you immediately on publication (four times a year). These are billed separately and can be discontinued at any time.

Presentation: Durable looseleaf system in large A4 format

Price of the Basic Work: ~~£30.95~~ **SALE PRICE £23.97** (to include a recent Supplement **FREE**)

Guarantee

Our 30 day money back guarantee gives you **complete peace of mind**. If you are not entirely happy with either Manual, for whatever reason, simply return it to us in good condition within 30 days and we will make a **full refund of your payment** – no small print and no questions asked.
(Overseas buyers do have to pay the overseas postage charge)

ELECTRONICS SERVICE MANUAL

EVERYTHING YOU NEED TO KNOW TO GET STARTED IN REPAIRING AND SERVICING ELECTRONIC EQUIPMENT

SAFETY: Be knowledgeable about Safety Regulations, Electrical Safety and First Aid.

UNDERPINNING KNOWLEDGE: Specific sections enable you to Understand Electrical and Electronic Principles, Active and Passive Components, Circuit Diagrams, Circuit Measurements, Radio, Computers, Valves and manufacturers' Data, etc.

PRACTICAL SKILLS: Learn how to identify Electronic Components, Avoid Static Hazards, Carry Out Soldering and Wiring, Remove and Replace Components.

TEST EQUIPMENT: How to Choose and Use Test Equipment, Assemble a Toolkit, Set Up a Workshop, and Get the Most from Your Multimeter and Oscilloscope, etc.

SERVICING TECHNIQUES: The regular Supplements include vital guidelines on how to Service Audio Amplifiers, Radio Receivers, TV Receivers, Cassette Recorders, Video Recorders, Personal Computers, etc.

TECHNICAL NOTES: Commencing with the IBM PC, this section and the regular Supplements deal with a very wide range of specific types of equipment – radios, TVs, cassette recorders, amplifiers, video recorders etc..

REFERENCE DATA: Detailing vital parameters for Diodes, Small-Signal Transistors, Power Transistors, Thyristors, Triacs and Field Effect Transistors. Supplements include Operational Amplifiers, Logic Circuits, Optoelectronic Devices, etc.

The essential work for servicing and repairing electronic equipment

- Around 900 pages
- Fundamental principles
- Troubleshooting techniques
- Servicing techniques
- Choosing and using test equipment
- Reference data
- Easy-to-use format
- Clear and simple layout
- Vital safety precautions
- Professionally written
- Regular Supplements
- Sturdy gold blocked ring-binder

ELECTRONICS SERVICE MANUAL

Basic Work: Contains around 900 pages of information. Edited by Mike Tooley BA

Regular Supplements: Approximately 160-page Supplements of additional information which, if requested, are forwarded to you immediately on publication (four times a year). These are billed separately and can be discontinued at any time.

Presentation: Durable looseleaf system in large A4 format

Price of the Basic Work: ~~£39.95~~ **SALE PRICE £23.97** (to include a recent Supplement FREE)

ORDER BOTH MANUALS TOGETHER AND SAVE ANOTHER £8

A mass of well-organised and clearly explained information is brought to you by expert editorial teams whose combined experience ensures the widest coverage
Regular Supplements to these unique publications, each around 160 pages, keep you abreast of the latest technology and techniques if required

REGULAR SUPPLEMENTS

Unlike a book or encyclopedia, these Manuals are living works – continuously extended with new material. If requested, Supplements are sent to you approximately every three months. Each Supplement contains around 160 pages – all for only £23.50+£2.50 p&p. You can, of course, return any Supplement (within ten days) which

you feel is superfluous to your needs. You can also purchase a range of past Supplements to extend your Base Manual on subjects of particular interest to you.

RESPONDING TO YOUR NEEDS

We are able to provide you with the most important and popular, up to date, features in our

Supplements. Our unique system is augmented by readers' requests for new information. Through this service you are able to let us know exactly what information you require in your Manuals.

You can also contact the editors directly in writing if you have a specific technical request or query relating to the Manuals.

PLEASE send me

THE MODERN ELECTRONICS MANUAL plus a FREE SUPPLEMENT

ELECTRONICS SERVICE MANUAL plus a FREE SUPPLEMENT

I enclose payment of £23.97 (for one Manual) or £39.94 for both Manuals (saving another £8 by ordering both together) plus postage if applicable.

I also require the appropriate Supplements four times a year. These are billed separately and can be discontinued at any time. (Please delete if not required.)

Should I decide not to keep the Manual/s I will return it/them to you within 30 days for a full refund.

FULL NAME
(PLEASE PRINT)

ADDRESS

.....POSTCODE

SIGNATURE

I enclose cheque/PO payable to Wimborne Publishing Ltd.

Please charge my Visa/Mastercard

Card No. Card Exp. Date

ORDER FORM

Simply complete and return the order form with your payment to the following address:

Wimborne Publishing Ltd, Dept. Y10, Allen House, East Borough, Wimborne, Dorset BH21 1PF

We offer a 30 day MONEY BACK GUARANTEE

– if you are not happy with either Manual simply return it to us in good condition within 30 days for a full refund.

Overseas buyers do have to pay the overseas postage – see below

POSTAGE CHARGES

Postal Region	Price PER MANUAL	
	Surface	Air
Mainland UK	FREE	–
Scottish Highlands, UK Islands & Eire	£5.50 each	–
Europe (EU)	–	£20 each
Europe (Non-EU)	£20 each	£26 each
USA & Canada	£25 each	£33 each
Far East & Australasia	£31 each	£35 each
Rest of World	£25 each	£45 each

Please allow four working days for UK delivery.

NOTE: Surface mail can take over 10 weeks to some parts of the world. Each Manual weighs about 4kg when packed.

esm2

£1 BARGAIN PACKS Selected Items

CROCODILE CLIPS. Small size, 10 each red and black. Order Ref: 116.

30A PANEL MOUNTING TOGGLE SWITCH. Double pole. Order Ref: 166.

SUB MIN TOGGLE SWITCHES. Pack of 3. Order Ref: 214.

HIGH POWER 3in. SPEAKER (11W 8ohm). Order Ref: 246.

MEDIUM WAVE PERMEABILITY TUNER. It's almost a complete radio with circuit. Order Ref: 247.

HEATING ELEMENT. Mains voltage 100W, brass encased. Order Ref: 8.

MAINS MOTOR with gearbox giving 1 rev per 24 hours. Order Ref: 89.

ROUND POINTER KNOBS for flatted 1/4in. spindles. Pack of 10. Order Ref: 295.

CERAMIC WAVE CHANGE SWITCH. 12-pole, 3-way with 1/4in. spindle. Order Ref: 303.

REVERSING SWITCH. 20A double pole or 40A single pole. Order Ref: 343.

LUMINOUS PUSH-ON PUSH-OFF SWITCHES. Pack of 3. Order Ref: 373.

SLIDE SWITCHES. Single pole changeover. Pack of 10. Order Ref: 1053.

PAXOLIN PANEL. Approximately 12in. x 12in. Order Ref: 1033.

CLOCKWORK MOTOR. Suitable for up to 6 hours. Order Ref: 1038.

TRANSISTOR DRIVER TRANSFORMER. Maker's ref. no. LT44, impedance ratio 20k ohm to 1k ohm, centre tapped, 50p. Order Ref: 1/23R4.

HIGH CURRENT RELAY. 12V D.C. or 24V A.C., operates changeover contacts. Order Ref: 1026.

2-CORE CURLY LEAD. 5A, 2m. Order Ref: 846.

3 CHANGEOVER RELAY. 6V A.C., 3V D.C. Order Ref: 859.

3 CONTACT MICRO SWITCHES, operated with slightest touch. Pack of 2. Order Ref: 861.

HIVAC NUMICATOR TUBE. Hivac ref XN3. Order Ref: 865.

2IN. ROUND LOUDSPEAKERS. 50Ω coil. Pack of 2. Order Ref: 908.

5K POT, standard size with DP switch, good length 1/4in. spindle, pack of 2. Order Ref: 11R24.

13A PLUG, fully legal with insulated legs, pack of 3. Order Ref: GR19.

OPTO SWITCH on p.c.b., size 2in. x 1in., pack of 2. Order Ref: GR21.

COMPONENT MOUNTING PANEL, heavy Paxolin 10in. x 2in., 32 pairs of brass pillars for soldering binding components. Order Ref: 7RC26.

PEA LAMPS, only 4mm but 14V at 0.04A, wire ended, pack of 4. Order Ref: 7RC28.

HIGH AMP THYRISTOR, normal 2 contacts from top, heavy threaded fixing underneath, think amperage to be at least 25A, pack of 2. Order Ref: 7FC43.

BRIDGE RECTIFIER, ideal for 12V to 24V charger at 5A, pack of 2. Order Ref: 1070.

TEST PRODS FOR MULTIMETER with 4mm sockets. Good length very flexible lead. Order Ref: D86.

LUMINOUS ROCKER SWITCH, approximately 30mm square, pack of 2. Order Ref: D64.

MES LAMP HOLDERS, slide onto 1/4in. tag, pack of 10. Order Ref: 1054.

HALL EFFECT DEVICES, mounted on small heatsink, pack of 2. Order Ref: 1022.

12V POLARISED RELAY, 2 changeover contacts. Order Ref: 1032.

PROJECT CASE, 95mm x 66mm x 23mm with removable lid held by 4 screws, pack of 2. Order Ref: 876.

LARGE MICRO SWITCHES, 20mm x 6mm x 10mm, changeover contacts, pack of 2. Order Ref: 826.

PIEZO ELECTRIC SOUNDER, also operates efficiently as a microphone. Approximately 30mm diameter, easily mountable, 2 for £1. Order Ref: 1084.

LIQUID CRYSTAL DISPLAY on p.c.b. with ICs etc. to drive it to give 2 rows of 8 characters, price £1. Order Ref: 1085.

FERRITE RODS, 7in. with coils for long and medium waves, pack of 2. Order Ref: D52.

THIS MONTH'S SPECIAL

IT IS A DIGITAL MULTITESTER AT A BARGAIN PRICE OF JUST £5.99

It measures DC volts up to 1000 and AC volts up to 750, DC current up to 10A and resistance up to 2 megohms, also tests transistors and diodes and has internal buzzer for continuity tests. Comes complete with test prods, battery and instructions, is yours for only £5.99. Order Ref: 6P65.

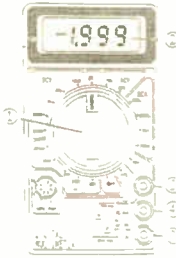

YOUR CHANCE TO BUY SOME POPULAR LINES AT BARGAIN PRICES

250W WOOFER. Made by Challenger, this is 10in. 4 ohm, very high quality make. Our normal price £29, we are reducing to £20, which is almost a third off. Order Ref: 29P7L.

200W WOOFER. Again by Challenger, this is 8in. 4 ohm, our normal price £18 but it is reduced to £14 making it a terrific bargain. Order Ref: 18P81.

9in. PHILIPS MONITOR. In a Metal frame, made for the OPD computer, our normal price £15, now reduced to £12. Order Ref: 15P1L.

100A TIME SWITCH. Ex-electricity board, this is extra useful because it has a mechanism to keep it going should there be a power failure, and although 100A it will operate quite happily on 5A. Regular price £10, now reduced to £8. Order Ref: 10P14L.

POWERFUL WATER PUMP. Made originally for commercial washing machines. The motor is probably around 1/4hp so it is very powerful. Our regular price £10, reduced to £8. Order Ref: 10P76L.

MOTORISED DISPLAY. This could control up to 120A of lighting or other equipment. The mains operated motor drives 12 x 10A microswitches, each of which can be set to come on at a different time, so giving running lights or other interesting displays. Regular price £10, reduced to £8. Order Ref: 1P191L.

BRUSH TYPE MAINS MOTOR. Probably 1/4hp but being brush type it is easily speed controllable. Normal price £5, special offer price £4. Order Ref: 5P275L.

SOLAR KITS. To make an old fashioned gramophone which will operate in sunlight or under a light bulb. Normal price £7.50, reduced to £6. Order Ref: 7P16L.

A SIMILAR SOLAR KIT. This one makes a monoplane, again £6. Order Ref: 7P18L.

THIS OFFER IS OF SPECIAL INTEREST TO ANY OF YOU WHO WANT HIGH QUALITY AMPLIFICATION. It is the famous Mullard Unilex, supplied in 4 modules with handbook. Normal price £8 for the 4 modules, reduced to £6. Order Ref: 8P48L.

MOST USEFUL MAINS TRANSFORMER. This is a 12V-0-12V 35W rated, has mounting legs so can stand directly on base panel, price £2.50. Order Ref: 2.5P15.

PROJECT BOX BARGAIN. Conventional plastic construction, colour is beige and size approximately 250mm x 130mm wide and 50mm deep. Divides into 2 halves, held together by screws and the two sections have internal pillars for mounting components or boards by self-lapping screws. The box itself is not drilled at all. It has ventilators in the top and bottom corners, but these are quite a decoration and give the box a pleasing look. Price £1. Order Ref: D201.

OVEN THERMOSTAT with knob calibrated so you can set it to cut out at any temperature up to 600 degrees F. Price £3. Order Ref: 3P229.

EMERGENCY LIGHTING. Has internal NiCad batteries and a fluorescent tube. The mains keeps the batteries charged and switches on the tube immediately there is a break. Price £15 each. Order Ref: 15P32B.

MAINS INPUT SOCKET. Takes normal flat pin mains plug, 2 for £1. Order Ref: 1082.

5A BRIDGE RECTIFIER FOR 12V or 24V CHARGER. With heatsink coupler if used on full current, 2 for £1. Order Ref: 1070.

ENGINEERS BENCH PANEL. This has 2 x 13A mains sockets which are switched and illuminated, thus saving you having to keep pulling out the plugs. Nicely cased, only £2. Order Ref: 2P461.



RELAYS

We have thousands of relays of various sorts in stock, so if you need anything special give us a ring. A few new ones that have just arrived are special in that they are plug-in and come complete with a special base which enables you to check voltages of connections of it without having to go underneath. We have 6 different types with varying coil voltages and contact arrangements. All contacts are rated at 10A 250V AC.



Coil Voltage	Contacts	Price	Order Ref:
12V DC	4-pole changeover	£2.00	FR10
12V DC	2-pole changeover	£1.50	FR11
24V DC	2-pole changeover	£1.50	FR12
24V DC	4-pole changeover	£2.00	FR13
240V AC	1-pole changeover	£1.50	FR14
240V AC	4-pole changeover	£2.00	FR15

Prices include base
NOT MUCH BIGGER THAN AN OXO CUBE. Another relay just arrived is extra small with a 12V coil and 6A changeover contacts. It is sealed so it can be mounted in any position or on a p.c.b. Price 75p each, 10 for £6 or 100 for £50. Order Ref: FR16.

RECHARGEABLE 12V JELLY GEL BATTERIES. Yuasa 12V 2.3AH. These are 7in. long, 3in. high and 1 1/2in. wide with robust terminals protruding through the top. Price £3.50. Order Ref: 3.5P11.

DITTO, but 12V 18AH. This is 7in. long, 7in. high and 3in. wide. Brand new with 12 months guarantee, price £12.50 or pack of 4 for £48, including VAT and carriage. Order Ref: 12.5P3.

Note - This battery will start a car and is ideal for golf trolleys, etc.

CHARGER for these batteries and other sealed lead acid batteries, £5. Order Ref: 5P269.

RECHARGEABLE NICAD BATTERIES. AA size, 25p each, which is a real bargain considering many firms charge as much as £2 each. These are in packs of 10, coupled together with an output lead so are a 12V unit but easily divisible into 2 x 6V or 10 x 1.2V. £2.50 per pack, 10 packs for £25 including carriage. Order Ref: 2.5P34.

FOR QUICK HOOK-UPS. You can't beat leads with a croc clip each end. You can have a set of 10 leads, 2 each of 5 assorted colours with insulated crocodile clips on each end. Lead length 36cm, £2 per set. Order Ref: 2P459.



1MA PANEL METER. Approximately 80mm x 55mm, front engraved 0-100. Price £1.50 each. Order Ref: 1/16R2.

VERY THIN DRILLS. 12 assorted sizes vary between 0.6mm and 1.6mm. Price £1. Order Ref: 128.

EVEN THINNER DRILLS. 12 that vary between 0.1 and 0.5mm. Price £1. Order Ref: 129.

TWIN TELEPHONE PLUG. Enables you to plug 2 telephones into the one socket for all normal BT plugs. price £1.50. Order Ref: 1.5P67.

D.C. MOTOR WITH GEARBOX. Size 60mm long, 30mm diameter. Very powerful, operates off any voltage between 6 and 24 D.C. Speed at 6V is 200 rpm, speed controller available. Special price £3 each. Order Ref: 3P108.

MOST USEFUL POWER SUPPLY. Rated at 9V 1A, this plugs into a 13A socket, is really nicely boxed. £2. Order Ref: 2P733.

BT TELEPHONE EXTENSION WIRE. This is proper heavy duty cable for running around the skirting board when you want to make a permanent extension. 4 cores properly colour coded, 25m length. Only £1. Order Ref: 1067.

12V 8A DC POWER SUPPLY. Totally enclosed with its own cooling fan. Normal mains operation. Price £11. Order Ref: 11P6.

TWIN 13A SWITCHED SOCKET. Standard in all respects and complete with fixing screws. White, standard size and suitable for flush mounting or in a surface box. Price £1.50. Order Ref: 1.5P61.

BIG 12V TRANSFORMER. It is 55VA so that is over 4A which is normal working, intermittently it would be a much higher amperage. Beautiful transformer, well made and very well insulated, terminals are in a plastic frame so can't be accidentally touched. Price £3.50. Order Ref: 3.5P20.

TERMS

Send cash, PO, cheque or quote credit card number - orders under £25 add £3.50 service charge.

J & N FACTORS
Pilgrim Works (Dept. E.E.)
Stalbridge Lane, Bolney
Sussex RH17 5PA
Telephone: 01444 881965

Constructional Project

EPE MOODLOOP FIELD STRENGTH INDICATOR



ANDY FLIND

Check your "loop" is working. Will also sniff out unwanted sources of high levels of 50Hz field from mains-powered equipment.

A PART from the beneficial effects that may be experienced, there is no quick way to ascertain whether the *EPE Moodloop* (Aug. '00) project is actually working correctly. Various output arrangements can be used with it; the prototype used two loops constructed with a single length of 15-way ribbon cable which were connected in parallel to produce the required impedance of about 10 ohms.

If one of these loops were to fail the field strength would obviously drop, but there would be no immediate indication of this to the user. Since plug and socket connections are used and the cable is fairly long and easy to damage this is quite a likely occurrence so a means of checking the field strength is clearly needed.

This difficulty was spotted during the original "loop" design and consideration was given to the possibility of fitting some form of l.e.d. indication of the output current, but the various disadvantages of adding this to the circuit led to the idea being dropped at the time. However, indication is definitely required and this little project should fill that need.

COMPASS READING

To begin with, it is not strictly necessary to build an electronic indicator at all, since the field can be checked with nothing more technical than a compass! The method is to measure and note the field strength of the *EPE Moodloop* during correct operation so that any subsequent changes, indicating possible fault conditions, can be seen.

To do this it should be ensured that the *Moodloop's* output voltage and the impedance of the output inductive loop connected to it are both correct so that it is reasonably certain that the output current and hence field strength are as they should be. A section of the output loop should then be positioned in a North-South direction

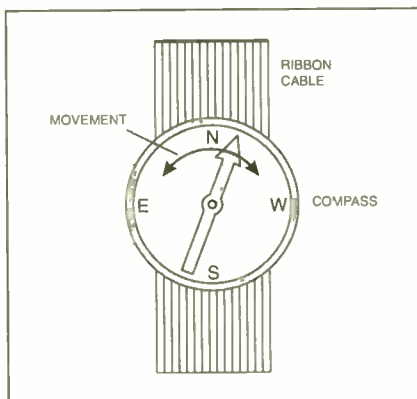

Fig.1. Checking the *EPE Moodloop* with a compass.

with a compass positioned above it as shown in Fig.1.

If the lowest output frequency is selected, the compass needle will deflect East and West in time with the generated magnetic field. In all probability it will swing much too far and may even start to rotate, a good example of a simple brushless electric motor!

The trick is to place something of suitable thickness between the cable and the compass, such as a paperback book, so that the compass deflects to about fifteen or twenty degrees in either direction. This setup may then be repeated at any time in the future when any change in the field

strength should show up as a change in deflection. A fluid-damped compass is preferable for this exercise as a non-damped one will probably be too "lively" to be read easily.

FIELD STRENGTH INDICATOR

However, that's a cheapskate's solution! Readers of *EPE* can apply their knowledge to construct a much better indicator, which will operate at higher frequencies and in any position. It may also be used to locate and indicate other sources of magnetic field, particularly those at 50Hz which are considered by some to be a health hazard.

A block diagram for the Field Strength Indicator is shown in Fig.2. It uses an inexpensive linear Hall Effect sensor to detect the field, an a.c. coupled amplifier to give a voltage gain of about 270 over a bandwidth from 0.5Hz to 100Hz, and an l.e.d. bargraph display to indicate the intensity and frequency of the sensed field. A.C. coupling is used to eliminate the effects of standing fields such as those of the earth and any permanent magnets in the vicinity of the unit, and also the effects of temperature which causes appreciable output voltage drift with most Hall devices.

The bargraph display output is configured as "dot mode" where only one segment is illuminated at any time and is arranged so that this is around the centre and deflects to the left for one polarity of field and to the right for the other. This means that the overall width of deflection indicates field strength and the rate at which it moves from side to side indicates frequency, for low frequencies at least. At higher frequencies it becomes more of a

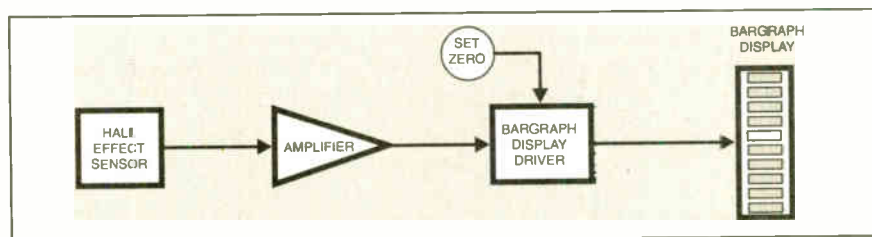
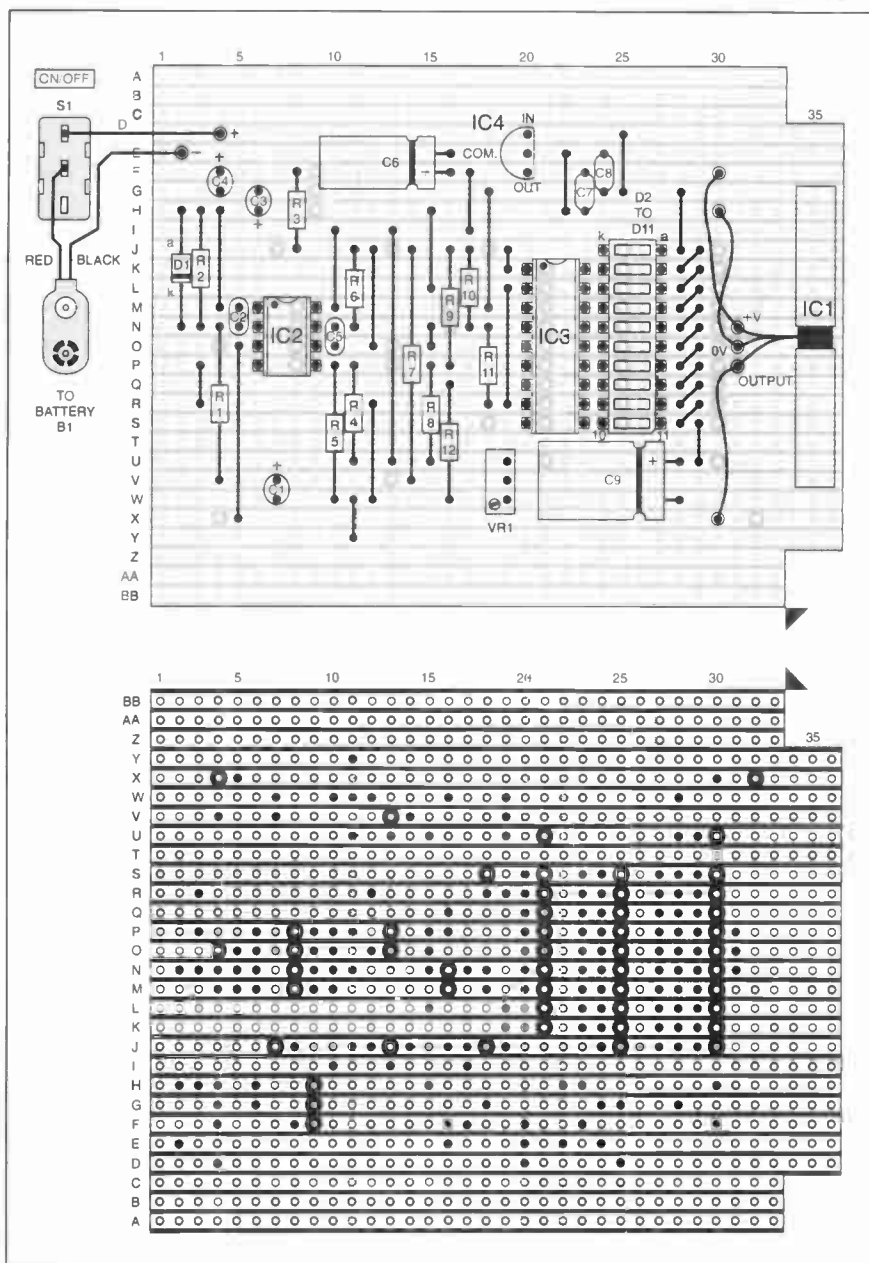
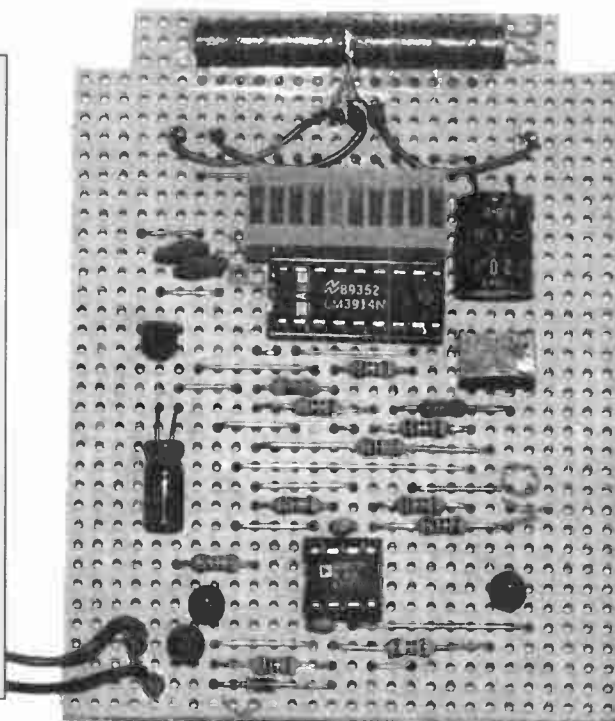
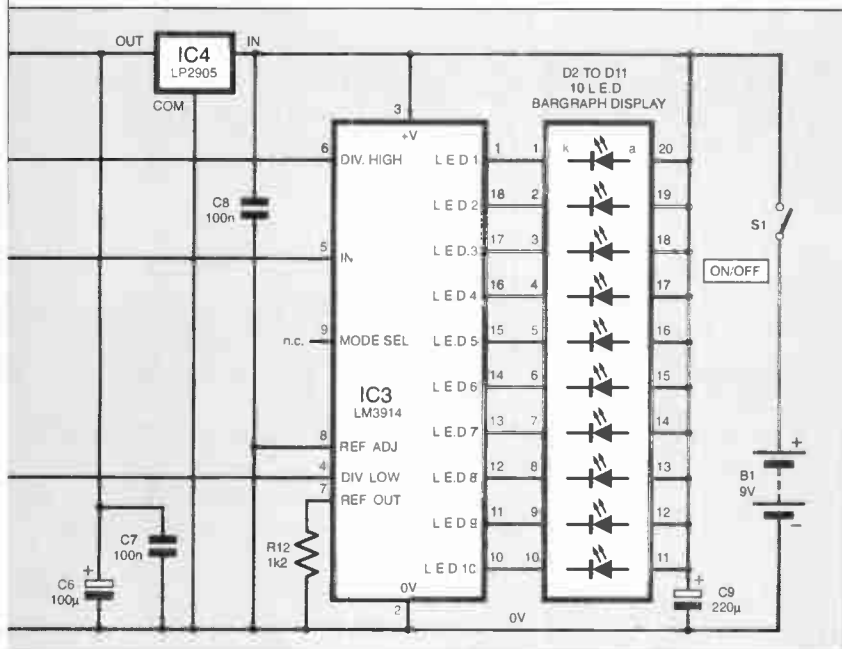

Fig.2. Block diagram for the *EPE Moodloop* Field Strength Indicator.



COMPONENTS

Resistors

R1	39k
R2, R6	1M (2 off)
R3	100k
R4, R5,	
R8, R11	10k (4 off)
R7	22k
R9, R10	4k7 (2 off)
R12	1k2

All 0.6W 1% metal film.

Potentiometer

VR1	10k 22-turn cermet preset (see text)
-----	--------------------------------------

Capacitors

C1, C3, C4	22µ tantalum bead, 16V (3 off)
C2, C5	470p ceramic (2 off)
C6	100µ radial elect. 10V
C7, C8	100n ceramic (2 off)
C9	220µ radial elect. 16V

Semiconductors

D1	1N4148 silicon diode.
D2 to D11	10-segment l.e.d. bargraph array, red
IC1	UGN3503U linear Hall Effect sensor
IC2	AD8532 dual op.amp
IC3	LM3914 linear bargraph display driver
IC4	LP2905 micropower 5V positive regulator

Miscellaneous

S1	sub-min. changeover slide switch
----	----------------------------------

Stripboard, 0.1 inch matrix, size 28 strips x 36 holes; handheld case, (145mm x 80mm x 34mm), with battery compartment; 8-pin d.i.l. socket; 18-pin d.i.l. socket; 20-pin d.i.l. socket; PP3 type battery connector; multistrand connecting wire; solder pins; solder etc.; iron nail, approx 5mm dia. (see text).

Approx. Cost
Guidance Only

£19
excl. batt. & case

Fig.4. Stripboard component layout, details of breaks required in the underside copper tracks and wiring to the on/off switch and battery connector.

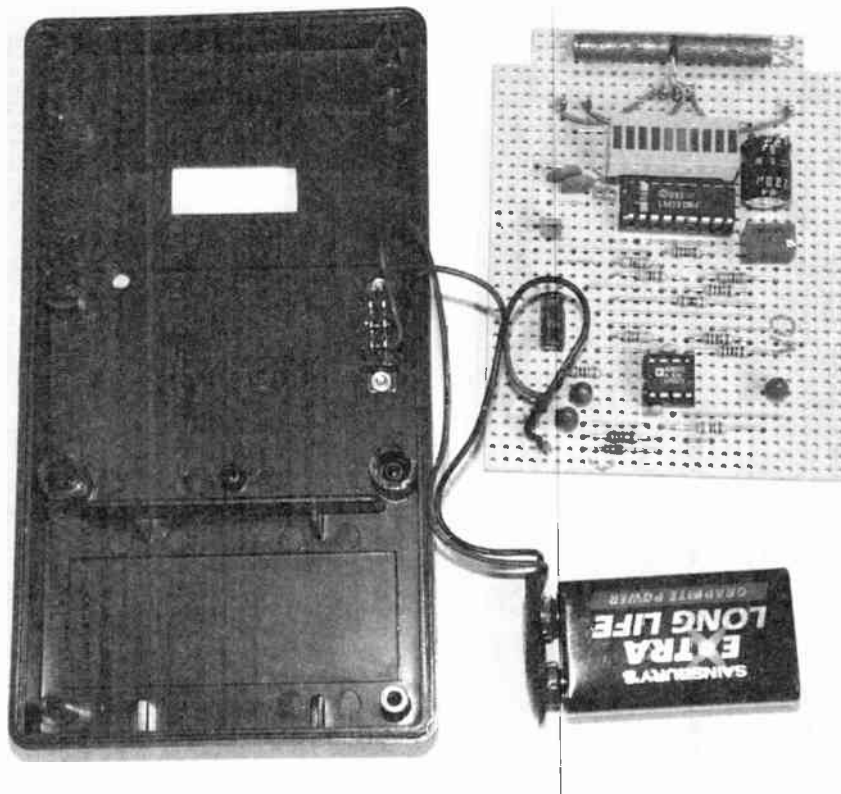

Once the wiring is completed, the circuit board is flipped-over to rest on the plastic tubular supports glued inside the case lid. These supports should allow the bargraph to fit flush in the display window cutout.

The Hall Effect sensor IC1 should be temporarily connected next. Provided there are no strong magnets close by, its output should be about 2.5V. This can be conveniently measured at pin 3 of the socket for IC2. The current drain will now have risen to about 10mA.

Next, IC2 can be inserted and the circuit powered again. It will raise the drain to about 11mA. About 15 seconds should be allowed for the circuit to settle, after which the voltages at pin 1 and pin 7 should both be about 2.5V. The voltage at pin 7 should also appear at pin 5 of the socket for IC3, and moving a magnet close to the sensor should result in visible fluctuations.

Finally, IC3 and the bargraph should be inserted. The bargraph in the prototype has a small bevel on one corner which denotes bottom right, but if there are any doubts it may be advisable to check polarity of this component.

The circuit board should now be powered again and allowed time to settle thoroughly, after which preset VR1 should be adjusted so that the two centre segments of the bargraph are flickering, due to circuit noise, with about equal intensity. The total operating drain of the complete circuit will be about 30mA.

SENSOR

The method of fitting the Hall Effect sensor (IC1) to the board can be seen in Fig.4, whilst details of its connections are shown in Fig.5. The prototype uses solder pins for external connections and three more of these were added for securing the sensor and connected to their points on the board with short lengths of wire.

Originally it was thought that the inexpensive UGN3503 sensor would not be

sensitive enough for this application, but the inclusion of a short length of soft iron to either side of it concentrates the magnetic field passing through it which produces a huge increase in sensitivity. These pieces of soft iron, about 20mm in length and 5mm diameter, were cut from a large nail, about 120mm long. The ends were hand filed as flat and square as possible, and they were then pressed tightly against the sensor and glued in place. This simple notion made this project possible and may well find many other applications using this type of sensor.

CASING UP

The prototype was constructed as a self-contained handheld unit in a small plastic box, 145mm x 80mm x 34mm which has a separate compartment for a PP3 battery. This allows it to be used for checking other sources of alternating magnetic field, in particular sniffing out high levels of 50Hz field from mains-powered equipment using transformers.

The circuit board is shaped to fit neatly into the circuit compartment in the case and rests on five pillars cut from some old plastic tubing and glued into place. These are just high enough to bring the top of the bargraph flush with the top of the case when the board is in position. Some polyurethane foam (of the stiffer type) presses it firmly into place when the case is screwed together. A small hole was drilled to allow external access to the multiturn preset VR1, but in practice this has not required any further adjustment.

IN USE

When switched on the unit takes about twelve seconds to settle. Initially the

display remains "off" for a couple of seconds, then the light travels across from left to right, then slowly settles back to the centre two segments. It looks deceptively like a sophisticated self-test routine! It is sensitive enough to respond to the earth's field if rotated rapidly relative to this.

Using it to check the *EPE Moodloop* is similar to the method described for a compass, except that it doesn't have to be aligned North to South. It can be simply placed over a section of the loop with a spacer such as a paperback book such that the moving light just about reaches the ends of the display.

Subsequent placement in the same position will reveal any changes in field strength. The speed at which the light travels from end to end will clearly indicate the frequency being used, right up to the highest rate.

The unit can be operated from any supply between 6V and 15V. An alternative to the handheld construction described would be to fit it into the *Moodloop* project's case and power it directly from the 13V supply.

If a longer wire is used to connect one of the *Moodloop*'s p.c.b. outputs to its socket, this could be given a turn or two close to the sensor, which could easily be physically placed to obtain full bargraph deflection for normal output. This would then indicate output current for any load connected to the *Moodloop*.

There is a slight chance that the 5V regulator IC4 might run slightly hot if this is done, since with a 13V supply and a 30mA output current it would be dissipating around 240mW. This could easily be cured with the inclusion of a suitable resistor however, about 100 ohms to 150 ohms should be suitable. This would give the unit an attractive built in monitoring display. □

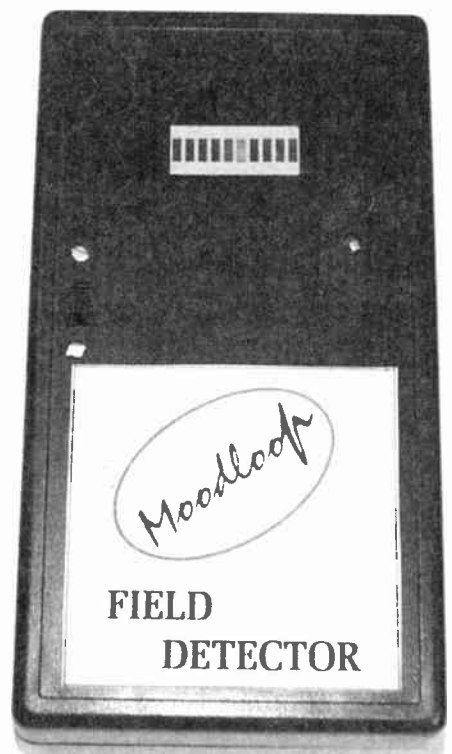

Everyday Practical Electronics Books

TEACH-IN No. 7. plus FREE SOFTWARE
ANALOGUE AND DIGITAL ELECTRONICS COURSE
 (published by *Everyday Practical Electronics*)
Alan Winstanley and Keith Dye B.Eng(Tech)AMIEE
 This highly acclaimed *EPE Teach-In* series, which included the construction and use of the Mini Lab and Micro Lab test and development units, has been put together in book form. Additionally, EPT Educational Software have developed a GCSE Electronics software program to compliment the course and a **FREE DISK** covering the first two parts of the course is included with the book.

An interesting and thorough tutorial series aimed specifically at the novice or complete beginner in electronics. The series is designed to support those undertaking either GCSE Electronics or GCE Advanced Levels, and starts with fundamental principles.

If you are taking electronics or technology at school or college, this book is for you. If you just want to learn the basics of electronics or technology you must make sure you see it. *Teach-In No. 7* will be invaluable if you are considering a career in electronics or even if you are already training in one. The Mini Lab and software enable the construction and testing of both demonstration and development circuits. These learning aids bring electronics to life in an enjoyable and interesting way: you will both see and hear the electron in action! The Micro Lab microprocessor add-on system will appeal to higher level students and those developing microprocessor projects.

152 pages **Order code T17** £3.95



DIRECT BOOK SERVICE

The books listed have been selected by *Everyday Practical Electronics* editorial staff as being of special interest to everyone involved in electronics and computing. They are supplied by mail order to your door. Full ordering details are given on the last book page.

For a further selection of books see the next two issues of *EPE*.

Robotics

INTRODUCING ROBOTICS WITH LEGO MINDSTORMS

Robert Penfold
 Shows the reader how to build a variety of increasingly sophisticated computer controlled robots using the brilliant Lego Mindstorms Robotic Invention System (RIS). Initially covers fundamental building techniques and mechanics needed to construct strong and efficient robots using the various "click-together" components supplied in the basic RIS kit. Explains in simple terms how the "brain" of the robot may be programmed on screen using a PC and "zapped" to the robot over an infrared link. Also, shows how a more sophisticated Windows programming language such as Visual BASIC may be used to control the robots.

Detailed building and programming instructions provided, including numerous step-by-step photographs.

288 pages - large format **Order code BP901** £12.99

ANDROIDS, ROBOTS AND ANIMATRONS

John Lovine
 Build your own working robot or android using both off-the-shelf and workshop constructed materials and devices. Computer control gives these robots and androids two types of artificial intelligence (an expert system and a neural network). A lifelike android hand can be built and programmed to function doing repetitive tasks. A fully animated robot or android can also be built and programmed to perform a wide variety of functions.

The contents include an Overview of State-of-the-Art Robots; Robotic Locomotion; Motors and Power Controllers; All Types of Sensors; Tilt; Bump; Road and Wall Detection; Light; Speech and Sound Recognition; Robotic Intelligence (Expert Type) Using a Single-Board Computer Programmed in BASIC; Robotic Intelligence (Neural Type) Using Simple Neural Networks (Insec: Intelligence); Making a Lifelike Android Hand; A Computer-Controlled Robotic Insect Programmed in BASIC; Teletpresence Robots With Actual Arcade and Virtual Reality Applications; A Computer-Controlled Robotic Arm; Animated Robots and Androids; Real-World Robotic Applications.

224 pages **Order code MGH1** £20.99

Radio

BASIC RADIO PRINCIPLES AND TECHNOLOGY

Ian Poole
 Radio technology is becoming increasingly important in today's high technology society. There are the traditional uses of radio which include broadcasting and point to point radio as well as the new technologies of satellites and cellular phones. All of these developments mean there is a growing need for radio engineers at all levels.

Assuming a basic knowledge of electronics, this book provides an easy to understand grounding in the topic.

Chapters in the book: Radio Today, Yesterday, and Tomorrow; Radio Waves and Propagation; Capacitors, Inductors, and Filters; Modulation; Receivers; Transmitters; Antenna Systems; Broadcasting; Satellites; Personal Communications; Appendix - Basic Calculations.

263 pages **Order code NE30** £14.99

PROJECTS FOR RADIO AMATEURS AND S.W.L.S.

R. A. Penfold
 This book describes a number of electronic circuits, most of which are quite simple, which can be used to enhance the performance of most short wave radio systems.

The circuits covered include: An aerial tuning unit; A simple active aerial; An add-on b.f.o. for portable sets; A wavetrap to combat signals on spurious responses; An audio notch filter; A parametric equaliser; C.W. and S.S.B. audio filters; Simple noise limiters; A speech processor; A volume expander.

Other useful circuits include a crystal oscillator, and RTTY/C.W. tone decoder and a RTTY serial to parallel converter. A full range of interesting and useful circuits for short wave enthusiasts.

92 pages **Order code BP304** £3.95

AN INTRODUCTION TO AMATEUR RADIO

I. D. Poole
 Amateur radio is a unique and fascinating hobby which has attracted thousands of people since it began at the turn of the century. This book gives the newcomer a comprehensive and easy to understand guide through the subject so that the reader can gain the most from the hobby. It then remains an essential reference volume to be used time and again. Topics covered include the basic aspects of the hobby, such as operating procedures, jargon and setting up a station. Technical topics covered include propagation, receivers, transmitters and aerials etc.

150 pages **Order code BP257** £4.99

SIMPLE SHORT WAVE RECEIVER CONSTRUCTION

R. A. Penfold
 Short wave radio is a fascinating hobby, but one that seems to be regarded by many as an expensive pastime these days. In fact it is possible to pursue this hobby for a minimal monetary outlay if you are prepared to undertake a bit of d.i.y., and the receivers described in this book can all be built at low cost. All the sets are easy to construct, full wiring diagrams etc. are provided, and they are suitable for complete beginners. The receivers only require simple aerials, and do not need any complex alignment or other difficult setting up procedures.

The topics covered in this book include: The broadcast bands and their characteristics; The propagation of radio signals; Simple aerials; Making an earth connection; Short wave crystal set; Simple r.f. receivers; Single sideband reception; Direct conversion receiver. Contains everything you need to know in order to get started in this absorbing hobby.

88 pages **Order code BP275** £3.95

Computers and Computing

MULTIMEDIA ON THE PC

Ian R. Sinclair
 In this book, you'll find out what a CD ROM is, how it works, and why it is such a perfect add-on for a PC, allowing you to buy programmes, text, graphics and sound on a CD. It also describes the installation of a CD ROM drive and a sound card, pointing out the common problems that arise, and then shows how to use them to create a complete multimedia presentation that contains text, photos, a soundtrack with your own voice recorded as a commentary, even animation and edited video footage.

184 pages **Order code PC112** £11.95

HOW TO BUILD YOUR OWN PC

Morris Rosenthal
 More and more people are building the own PCs. They get more value for their money, they create exactly the machine they want, and the work is highly satisfying and actually fun. That is, if they have a unique beginner's guide like this one, which visually demonstrates how to construct a state-of-the-art computer from start to finish.

Through 150 crisp photographs and clear but minimal text, readers will confidently absorb the concepts of computer building. The extra-big format makes it easy to see what's going on in the pictures. For non-specialists, there's even a graphical glossary that clearly illustrates technical terms. The author goes "under the hood" and shows step-by-step how to create a socket 7 (Pentium and non-intel chips) and a Slot 1 (Pentium II) computer, covering: What first-time builders need to know: How to select and purchase parts; How to assemble the PC; How to install Windows 98. The few existing books on this subject, although badly outdated, are in steady demand. This one delivers the expertise and new technology that fledgling computer builders are eagerly looking for.

224 pages - large format **Order code MGH2** £19.99

UNDERSTANDING PC SPECIFICATIONS

R. A. Penfold (Revised Edition)
 If you require a microcomputer for business applications or a high quality home computer, an IBM PC or compatible is often the obvious choice. They are competitively priced, and are backed up by an enormous

range of applications programs, hardware add-ons, etc. The main difficulty for the uninitiated is deciding on the specification that will best suit his or her needs. PCs range from simple systems of limited capabilities up to complex systems that can happily run applications that would have been considered beyond the abilities of a microcomputer not so long ago. It would be very easy to choose a PC system that is inadequate to run your applications efficiently, or one which goes beyond your needs and consequently represents poor value for money.

This book explains PC specifications in detail, and the subjects covered include the following: Differences between types of PC (XT, AT, 80386, etc); Maths co-processors; Input devices (keyboards, mice, and digitisers); Memory, including both expanded (EMS) and extended RAM; RAM disks and disk caches; Floppy disk drive formats and compatibility; Hard disk drives (including interleaved factors and access times); Display adaptors, including all standard PC types (CGA, Hercules, Super VGA, etc); Contains everything you need to know if you can't tell your EMS from your EGA!

128 pages **Order code BP282** £4.95

Theory and Reference

Bebop To The Boolean Boogie

By Clive (call me Max)
Maxfield

Specially imported by EPE –
Excellent value

An Unconventional Guide to
Electronics Fundamentals,
Components and Processes

This book gives the "big picture" of digital electronics. This indepth, highly readable, up-to-the-minute guide shows you how electronic devices work and how they're made. You'll discover how transistors operate, how printed circuit boards are fabricated, and what the innards of memory ICs look like. You'll also gain a working knowledge of Boolean Algebra and Karnaugh Maps, and understand what Reed-Muller logic is and how it's used. And there's much, MUCH more (including a recipe for a truly great seafood gumbo!). Hundreds of carefully drawn illustrations clearly show the important points of each topic. The author's tongue-in-cheek British humor makes it a delight to read, but this is a REAL technical book, extremely detailed and accurate. A great reference for your own shelf, and also an ideal gift for a friend or family member who wants to understand what it is you do all day. . . .

470 pages – large format

Order code BEB1

£24.95

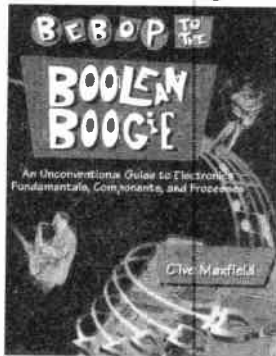

Bebop Bytes Back

FREE
CD-ROM

By Clive "Max" Maxfield
and Alvin Brown

Specially imported by EPE
– Excellent value

An Unconventional Guide
To Computers

Plus FREE CD-ROM which includes:
Fully Functional Internet-Ready
Virtual Computer with Interactive Labs

This follow-on to *Bebop to the Boolean Boogie* is a multimedia extravaganza of information about how computers work. It picks up where "Bebop I" left off, guiding you through the fascinating world of computer design. . . and you'll have a few chuckles, if not belly laughs, along the way. In addition to over 200 megabytes of mega-cool multimedia, the accompanying CD-ROM (for Windows 95 machines only) contains a virtual microcomputer, simulating the motherboard and standard computer peripherals in an extremely realistic manner. In addition to a wealth of technical information, myriad nuggets of trivia, and hundreds of carefully drawn illustrations, the book contains a set of lab experiments for the virtual microcomputer that let you recreate the experiences of early computer pioneers.

If you're the slightest bit interested in the inner workings of computers, then don't dare to miss this one!

Over 500 pages – large format

Order code BEB2

£29.95

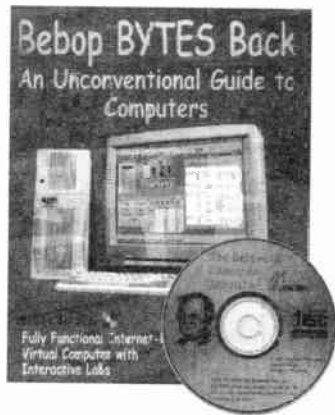

DIGITAL ELECTRONICS – A PRACTICAL APPROACH
With FREE Software: Number One Systems – EASY-PC
Professional XM and Pulsar (Limited Functionality)

FREE
SOFTWARE

Richard Monk
Covers binary arithmetic, Boolean algebra and logic gates, combination logic, sequential logic including the design and construction of asynchronous and synchronous circuits and register circuits. Together with a considerable practical content plus the additional attraction of its close association with computer aided design including the FREE software.

There is a 'blow-by-blow' guide to the use of EASY-PC Professional XM (a schematic drawing and printed circuit board design computer package). The guide also conducts the reader through logic circuit simulation using Pulsar software. Chapters on p.c.b. physics and p.c.b. production techniques make the book unique, and with its host of project ideas make it an ideal companion for the integrative assignment and common skills components required by BTEC and the key skills demanded by GNVQ. The principal aim of the book is to provide a straightforward approach to the understanding of digital electronics.

Those who prefer the 'Teach-In' approach or would rather experiment with some simple circuits should find the book's final chapters on printed circuit board production and project ideas especially useful.

250 pages

Order code NE28

£16.99

DIGITAL GATES AND FLIP-FLOPS
Ian R. Sinclair

This book, intended for enthusiasts, students and technicians, seeks to establish a firm foundation in digital electronics by treating the topics of gates and flip-flops thoroughly and from the beginning.

Topics such as Boolean algebra and Karnaugh mapping are explained, demonstrated and used extensively, and more attention is paid to the subject of synchronous counters than to the simple but less important ripple counters.

No background other than a basic knowledge of electronics is assumed, and the more theoretical topics are explained from the beginning, as also are many working practices. The book concludes with an explanation of microprocessor techniques as applied to digital logic.

200 pages

Order code PC106

£8.95

Music, Audio and Video

**AN INTRODUCTION TO LOUDSPEAKERS
AND ENCLOSURE DESIGN**

V. Capel

This book explores the various features, good points and snags of speaker designs. It examines the whys and wherefores so that the reader can understand the principles involved and so make an informed choice of design, or even design loudspeaker enclosures for him – or herself. Crossover units are also explained, the various types, how they work, the distortions they produce and how to avoid them. Finally there is a step-by-step description of the construction of the *Kapellmeister* loudspeaker enclosure.

148 pages

Order code BP256

£3.99

ELECTRONIC MUSIC AND MIDI PROJECTS

R. A. Penfold

Whether you wish to save money, boldly go where no musician has gone before, rekindle the pioneering spirit, or simply have fun building some electronic music gadgets, the designs featured in this book should suit your needs. The projects are all easy to build, and some are so simple that even complete beginners at electronic project construction can tackle them with ease. Stripboard layouts are provided for every project, together with a wiring diagram. The mechanical side of construction has largely been left to individual constructors to sort out, simply because the vast majority of project builders prefer to do their own thing in this respect.

None of the designs requires the use of any test equipment in order to get them set up properly. Where any setting up is required, the procedures are very straightforward, and they are described in detail.

Projects covered: Simple MIDI tester, Message grabber, Byte grabber, THRU box, MIDI auto switcher, Auto/manual switcher, Manual switcher, MIDI patchbay, MIDI controlled switcher, MIDI lead tester, Program change pedal, Improved program change pedal, Basic mixer, Stereo mixer, Electronic swell pedal, Metronome, Analogue echo unit.

138 pages

Order code PC116

£9.95

**VIDEO PROJECTS FOR THE ELECTRONICS
CONSTRUCTOR**

R. A. Penfold

Written by highly respected author R. A. Penfold, this book contains a collection of electronic projects specially designed for video enthusiasts. All the projects can be simply constructed, and most are suitable for the newcomer to project construction, as they are assembled on stripboard.

There are faders, wipers and effects units which will add sparkle and originality to your video recordings, an audio mixer and noise reducer to enhance your soundtracks and a basic computer-control interface. Also, there's a useful selection on basic video production techniques to get you started.

Complete with explanations of how the circuit works, shopping lists of components, advice on construction, and guidance on setting up and using the projects, this invaluable book will save you a small fortune.

Circuits include: video enhancer, improved video enhancer, video fader, horizontal wiper, improved video wiper, negative video unit, fade to grey unit, black and white keyer, vertical wiper, audio mixer, stereo headphone amplifier, dynamic noise reducer, automatic fader, pushbutton fader, computer control interface, 12 volt mains power supply.

124 pages

Order code PC115

£9.95

COMPUTERS AND MUSIC – AN INTRODUCTION

R. A. Penfold

Computers are playing an increasingly important part in the world of music, and the days when computerised music was strictly for the fahational few are long gone.

If you are more used to the black and white keys of a synth keyboard than the QWERTY keyboard of a computer, you may be understandably confused by the jargon and terminology bandied about by computer buffs. But fear not, setting up and using a computer-based music making system is not as difficult as you might think.

This book will help you learn the basics of computing, running applications programs, wiring up a MIDI system and using the system to good effect, in fact just about everything you need to know about hardware and the programs, with no previous knowledge of computing needed or assumed. This

book will help you to choose the right components for a system to suit your personal needs, and equip you to exploit that system fully.

174 pages

Temporarily out of print

**THE INVENTOR OF STEREO – THE LIFE AND WORKS
OF ALAN DOWER BLUMLEIN**

Robert Charles Alexander

This book is the definitive study of the life and works of one of Britain's most important inventors who, due to a cruel set of circumstances, has all but been overlooked by history.

Alan Dower Blumlein led an extraordinary life in which his inventive output rate easily surpassed that of Edison, but whose early death during the darkest days of World War Two led to a shroud of secrecy which has covered his life and achievements ever since.

His 1931 Patent for a Binaural Recording System was so revolutionary that most of his contemporaries regarded it as more than 20 years ahead of its time. Ever years after his death, the full magnitude of its detail had not been fully utilized. Among his 128 patents are the principal electronic circuits critical to the development of the world's first electronic television system. During his short working life, Blumlein produced patent after patent breaking entirely new ground in electronic and audio engineering.

During the Second World War, Alan Blumlein was deeply engaged in the very secret work of radar development and contributed enormously to the system eventually to become 'H2S' – blind-bombing radar. Tragically during an experimental H2S flight in June 1942, the Halifax bomber in which Blumlein and several colleagues were flying, crashed and all aboard were killed. He was just days short of his thirtieth birthday.

420 pages

Order code NE32

£14.99

HIGH POWER AUDIO AMPLIFIER CONSTRUCTION

R. A. Penfold

Practical construction details of how to build a number of audio power amplifiers ranging from about 50 to 300/400 watts r.m.s. includes MOSFET and bipolar transistor designs.

96 pages

Order code BP277

£3.99

Circuits, Data and Design

PRACTICAL ELECTRONIC FILTERS

Owen Bishop

This book deals with the subject in a non-mathematical way. It reviews the main types of filter, explaining in simple terms how each type works and how it is used.

The book also presents a dozen filter-based projects with applications in and around the home or in the constructor's workshop. These include a number of audio projects such as a rhythm sequencer and a multi-voiced electronic organ.

Concluding the book is a practical step-by-step guide to designing simple filters for a wide range of purposes, with circuit diagrams and worked examples.

88 pages

Order code BP299

£4.99

ELECTRONIC HOBBYISTS DATA BOOK

R. A. Penfold

This book should tell you everything you are ever likely to want to know about hobby electronics, but did not know where to ask or refer. Comprehensive contents pages makes it easy to quickly locate the data you require.

The subjects covered include: Common circuits, and related data (including helpful graphs and tables of values); Colour codes for resistors, capacitors and inductors; Pinout details for a wide range of CMOS and TTL devices, plus basic data on the various logic families; Pinout details and basic data for a wide range of operational amplifiers; Data and leadout information for a wide range of transistors, FETs, power FETs, triacs, thyristors, diodes, etc; General data including MIDI message coding, radio data, ASCII/Baudot coding, decibel ratios, etc.

242 pages

Order code BP396

£5.95



50 SIMPLE LED CIRCUITS

R. N. Soar

Contains 50 interesting and useful circuits and applications, covering many different branches of electronics, using one of the most inexpensive and freely available components - the light-emitting diode (LED). Also includes circuits for the 707 common anode display.

64 pages

Temporarily out of print

BOOK 2 50 more l.e.d. circuits.

50 pages

Order code BP87

£2.99

A BEGINNER'S GUIDE TO TTL DIGITAL ICs

R. A. Penfold

This book first covers the basics of simple logic circuits in general, and then progresses to specific TTL logic integrated circuits. The devices covered include gates, oscillators, timers, flip/flops, d dividers, and decoder circuits. Some practical circuits are used to illustrate the use of TTL devices in the "real world".

142 pages

Order code BP332

£4.95

HOW TO USE OP. AMPS

E. A. Parr

This book has been written as a designer's guide covering many operational amplifiers, serving both as a source book of circuits and a reference book for design calculations. The approach has been made as non-mathematical as possible.

160 pages

Order code BP88

£3.99

CIRCUIT SOURCE BOOK 1

A. Penfold

Written to help you create and experiment with your own electronic designs by combining and using the various standard "building block" circuits provided. Where applicable, advice on how to alter the circuit parameters is given.

The circuits covered in this book are mainly concerned with analogue signal processing and include: Audio amplifiers (op.amp and bipolar transistors); audio power amplifiers; d.c. amplifiers; highpass, lowpass, bandpass and notch filters; tone controls; voltage controlled amplifiers and filters; triggers and voltage comparators. gates and electronic switching; bargraphs; mixers; phase shifters, current mirrors, hold circuits, etc.

Over 150 circuits are provided, which it is hoped will be useful to all those involved in circuit design and application, be they professionals, students or hobbyists.

182 pages

Order code BP321

£4.99

CIRCUIT SOURCE BOOK 2

R. A. Penfold

This book will help you to create and experiment with your own electronic designs by combining and using the various standard "building blocks" circuits provided. Where

applicable, advice on how to alter the circuit parameters is provided.

The circuits covered are mainly concerned with signal generation, power supplies, and digital electronics.

The topics covered in this book include: 555 oscillators; sinewave oscillators; function generators; CMOS oscillators; voltage controlled oscillators; radio frequency oscillators; 555 monostables; CMOS monostables; TTL monostables; precision long timers; power supply and

regulator circuits; negative supply generators and voltage boosters; digital dividers; decoders, etc; counters and display drivers; D/A and A/D converters; opto-isolators, flip/flops, noise generators, tone decoders, etc.

Over 170 circuits are provided, which it is hoped will be useful to all those involved in circuit design and application, be they professionals, students or hobbyists

192 pages

Order code BP322

£4.99

Project Building & Testing

ELECTRONIC PROJECTS FOR EXPERIMENTERS

R. A. Penfold

Many electronic hobbyists who have been pursuing their hobby for a number of years seem to suffer from the dreaded "seen it all before" syndrome. This book is fairly and squarely aimed at sufferers of this complaint, plus any other electronics enthusiasts who yearn to try something a bit different. No doubt many of the projects featured here have practical applications, but they are all worth a try for their interest value alone.

The subjects covered include:- Magnetic field detector, Basic Hall effect compass, Hall effect audio isolator, Voice scrambler/descrambler, Bat detector, Bat style echo location, Noise cancelling, LED stroboscope, Infra-red "torch", Electronic breeze detector, Class D power amplifier, Strain gauge amplifier, Super hearing aid.

138 pages

Order code BP371

£4.95

PRACTICAL FIBRE-OPTIC PROJECTS

R. A. Penfold

While fibre-optic cables may have potential advantages over ordinary electric cables, for the electronics enthusiast it is probably their novelty value that makes them worthy of exploration. Fibre-optic cables provide an innovative interesting alternative to electric cables, but in most cases they also represent a practical approach to the problem. This book provides a number of tried and tested circuits for projects that utilize fibre-optic cables.

The projects include:- Simple audio links, F.M. audio link, P.W.M. audio links, Simple d.c. links, P.W.M. d.c. link, P.W.M. motor speed control, RS232C data links, MIDI link, Loop alarms, R.P.M. meter.

All the components used in these designs are readily available, none of them require the constructor to take out a second mortgage.

132 pages

Order code BP374

£4.95

ELECTRONIC PROJECT BUILDING FOR BEGINNERS

R. A. Penfold

This book is for complete beginners to electronic project building. It provides a complete introduction to the practical side of this fascinating hobby, including the following topics:

Component identification, and buying the right parts; resistor colour codes, capacitor value markings, etc;

advice on buying the right tools for the job; soldering; making easy work of the hard wiring; construction methods, including stripboard, custom printed circuit boards, plain matrix boards, surface mount boards and wire-wrapping; finishing off, and adding panel labels; getting "problem" projects to work, including simple methods of fault-finding.

In fact everything you need to know in order to get started in this absorbing and creative hobby.

135 pages

Order code BP392

£4.95

A BEGINNER'S GUIDE TO MODERN ELECTRONIC COMPONENTS

R. A. Penfold

The purpose of this book is to provide practical information to help the reader sort out the bewildering array of components currently on offer. An advanced knowledge of the theory of electronics is not needed, and this book is not intended to be a course in electronic theory. The main aim is to explain the differences between components of the same basic type (e.g. carbon, carbon film, metal film, and wire-wound resistors) so that the right component for a given application can be selected. A wide range of components are included, with the emphasis firmly on those components that are used a great deal in projects for the home constructor.

166 pages

Order code BP285

£4.99

HOW TO USE OSCILLOSCOPES AND OTHER TEST EQUIPMENT

R. A. Penfold

This book explains the basic function of an oscilloscope, gives a detailed explanation of all the standard controls, and provides advice on buying. A separate chapter deals with using an oscilloscope for fault finding on linear and logic circuits, plenty of example waveforms help to illustrate the control functions and the effects of various fault conditions. The function and use of various other pieces of test equipment are also covered, including signal generators, logic probes, logic pulsers, and crystal calibrators.

104 pages

Order code BP267

£3.50

BOOK ORDERING DETAILS

Our postage price is the same no matter how many books you order, just add £1.50 to your total order for postage and packing (overseas readers add £3 for countries in the EEC, or add £6 for all countries outside the EEC, surface mail postage) and send a PO, cheque, international money order (£ sterling only) made payable to Direct Book Service or credit card details, Visa or Mastercard - minimum credit card order is £5 - to:

DIRECT BOOK SERVICE, ALLEN HOUSE, EAST BOROUGH, WIMBORNE, DORSET BH21 1PF

Books are normally sent within seven days of receipt of order, but please allow 28 days for delivery (more for overseas orders). Please check price and availability (see latest issue of *Everyday Practical Electronics*) before ordering from old lists.

For a further selection of books see the next two issues of *EPE*.

DIRECT BOOK SERVICE IS A DIVISION OF WIMBORNE PUBLISHING LTD. Tel 01202 881749

Fax 01202 841692. E-mail: dbs@epemag.wimborne.co.uk

BOOK ORDER FORM

Full name:

Address:

..... Post code: Telephone No:

Signature:

I enclose cheque/PO payable to DIRECT BOOK SERVICE for £

Please charge my Visa/Mastercard £ Card expiry date

Card Number

Please send book order codes:

Please continue on separate sheet of paper if necessary

PCB SERVICE

Printed circuit boards for most recent EPE constructional projects are available from the PCB Service, see list. These are fabricated in glass fibre, and are fully drilled and roller tinned. All prices include VAT and postage and packing. Add £1 per board for airmail outside of Europe. Remittances should be sent to The PCB Service, Everyday Practical Electronics, Allen House, East Borough, Wimborne, Dorset BH21 1PF. Tel: 01202 881749; Fax 01202 841692; E-mail: orders@epemag.wimborne.co.uk. Cheques should be crossed and made payable to Everyday Practical Electronics (Payment in £ sterling only).

NOTE: While 95% of our boards are held in stock and are dispatched within seven days of receipt of order, please allow a maximum of 28 days for delivery – overseas readers allow extra if ordered by surface mail.

Back numbers or photostats of articles are available if required – see the Back Issues page for details.

Please check price and availability in the latest issue.

Boards can only be supplied on a payment with order basis.

PROJECT TITLE	Order Code	Cost
★ EPE Time Machine	NOV'97	171 £8.34
Auto-Dim Bedlight		172 £6.63
Portable 12V PSU/Charger		173 £6.61
Safe and Sound (Security Bleep)	DEC'97	179 £7.32
Surface Thermometer		174 £7.64
Disco Lights Flasher		178 £8.30
Waa-Waa Pedal (Multi-project PCB)	FEB'98	932 £3.00
★ Virtual Scope – Digital Board		176 £14.49
Analogue Board (per board)		177 £7.34
★ Water Wizard		180 £7.69
Kissometer		181 £7.67
★ EPE PIC Tutorial	MAR'98	182 £7.99
The Handy Thing (Double-Sided)		183 £6.58
Lighting-Up Reminder		184 £5.90
★ Audio System Remote Controller – PSU		185 £7.05
Main Board		186 £8.29
Simple Metal Detector (Multi-project PCB)	APR'98	932 £3.00
★ RC-Meter		188 £7.66
Security Auto-Light	MAY'98	189 £8.10
Stereo Tone Control plus 20W Stereo Amplifier		190 £7.78
Tone Control		191 £8.58
20W Amplifier		192 £8.05
★ Dice Lott		193 £7.75
EPE Mood Changer	JUNE'98	194 £8.50
★ AT89C2051/1051 Programmer		195 £8.69
Main Board		196 £6.96
Test Board		197 £9.08
★ Reaction Timer Software only		198 £8.10
★ PIC16x84 Toolkit	JULY'98	199 £6.59
★ Greenhouse Computer		202 £3.00
Control Board		200 £8.32
PSU Board		201 £8.15
Float Charger	AUG'98	203 £7.18
Lightbulb Saver		204 £7.69
Personal Stereo Amplifier (Multi-project PCB)	SEPT'98	205 £3.00
★ Greenhouse Radio Link		206 £3.50
★ PIC Altimeter		207 £6.82
Voice Processor	OCT'98	208 £4.00
★ Digiserv R/C Expander		209 £4.50
IR Remote Control – Transmitter		210 £7.55
– Receiver		211 £3.00
★ PIC Tape Measure	NOV'98	212 £4.00
Electronic Thermostat – T-Stat		213 £4.00
PhizzyB		214 £6.30
A – PCB B – CD-ROM C – Prog. Microcontroller		215 £3.95
15-Way IR Remote Control		216 £3.95
Switch Matrix		217 £6.72
15-Way Rec/Decoder		218 £6.78
Damp Stat	DEC'98	219-a £9.92
Handheld Function Generator		220-a £8.56
★ Fading Christmas Lights		221 See Feb'99
PhizzyB I/O Board (4-section)		222 £7.37
★ EPE Mind PICKler	JAN'99	223 £6.36
★ EPE Mind PICKler		224 £5.94
PhizzyB I/O Board (4-section)		225 £5.15
Alternative Courtesy Light Controller		226A&B £5.12
Light Alarm	FEB'99	207 £6.82
★ Wireless Monitoring System Transmitter		227 £8.95
Receiver		228 £3.00
★ PIC MIDI Sustain Pedal Software only		229 £3.20
★ Wireless Monitoring System-2	MAR'99	231 £9.51
F.M. Trans/Rec Adaptors		232 £8.79
★ Time and Date Generator		233 £6.78
Auto Cupboard Light		234 £6.72
Smoke Absorber		235 £7.10
★ Ironing Board Saver	APR'99	932 £3.00
Voice Record/Playback Module		224 £5.15
Mechanical Radio (pair)		225 £5.12
★ Versatile Event Counter		226A&B £7.40
PIC Toolkit Mk2	MAY'99	207 £6.82
A.M./F.M. Radio Remote Control		227 £8.95
Transmitter		228 £3.00
Receiver		229 £3.20
★ Musical Sundial	JUNE'99	231 £9.51
PC Audio Frequency Meter		232 £8.79
★ EPE Mood PICKler	JULY'99	233 £6.78
12V Battery Tester		234 £6.72
Intruder Deterrent		235 £7.10
L.E.D. Stroboscope (Multi-project PCB)		932 £3.00

PROJECT TITLE	Order Code	Cost
Ultrasonic Puncture Finder	AUG'99	236 £5.00
★ 8-Channel Analogue Data Logger		237 £8.88
Buffer Amplifier (Oscillators Pt 2)		238 £6.96
Magnetic Field Detective		239 £6.77
Sound Activated Switch		240 £6.53
Freezer Alarm (Multi-project PCB)		932 £3.00
Child Guard	SEPT'99	241 £7.51
Variable Dual Power Supply		242 £7.64
Micro Power Supply	OCT'99	243 £3.50
★ Interior Lamp Delay		244 £7.88
Mains Cable Locator (Multi-project PCB)		932 £3.00
Vibralarm	NOV'99	230 £6.93
Demister One-Shot		245 £6.78
★ Ginormous Stopwatch – Part 1		246 £7.82
★ Ginormous Stopwatch – Part 2	DEC'99	247 £7.85
Giant Display		248 £3.96
Serial Port Converter		249 £4.44
Loft Guard		250 £4.83
Scratch Blanker	JAN'00	932 £3.00
Flashing Snowman (Multi-project PCB)		251 £5.63
★ Video Cleaner	FEB'00	252 £4.20
Find It		253 £4.52
★ Teach-In 2000 – Part 4		254, 255 } £5.49
High Performance Regenerative Receiver	MAR'00	256 Set
★ EPE Icebreaker – PCB257, programmed PIC16F877 and floppy disc		Set Only £22.99
Parking Warning System		258 £5.08
★ Micro-PICscope	APR'00	259 £4.99
Garage Link Transmitter		261 } Set £5.87
Receiver		262
Versatile Mic/Audio Preamplifier	MAY'00	260 £3.33
PIR Light Checker		263 £3.17
★ Multi-Channel Transmission System		264 } Set £6.34
Transmitter		265
Receiver		266
Interface		267 £3.05
★ Canute Tide Predictor	JUNE'00	268 £5.07
★ PIC-Gen Frequency Generator/Counter	JULY'00	269 £4.46
Q-Meter		271 £5.47
★ EPE Moodloop	AUG'00	272 £4.52
Quiz Game Indicator		273 £4.52
Handy-Amp		274 £4.67
Active Ferrite Loop Aerial	SEPT'00	275 £5.15
★ Remote Control IR Decoder Software only		–
★ PIC Dual-Channel Virtual Scope	OCT'00	–

EPE SOFTWARE

Software programs for EPE projects marked with an asterisk * are available on 3.5 inch PC-compatible disks or free from our Internet site. Six disks are available: PIC Tutorial (Mar-May '98 issues); PIC Toolkit Mk2 (May-Jun '99 issues); EPE Disk 1 (Apr '95-Dec '98 issues); EPE Disk 2 (Jan-Dec '99); EPE Disk 3 (Jan '00 issue to current cover date); EPE Teach-In 2000. The disks are obtainable from the EPE PCB Service at £3.00 each (UK) to cover our admin costs (the software itself is free). Overseas (each): £3.50 surface mail, £4.95 each airmail. All files can be downloaded free from our Internet FTP site: <ftp://ftp.epemag.wimborne.co.uk>.

EPE PRINTED CIRCUIT BOARD SERVICE

Order Code	Project	Quantity	Price												
.....															
Name															
Address															
.....															
I enclose payment of £..... (cheque/PO in £ sterling only) to:															
<p>Everyday Practical Electronics</p> <p>MasterCard or Visa No. Minimum order for credit cards £5</p>															
<table border="1" style="width: 100%; height: 20px;"> <tr> <td style="width: 12.5%;"></td> <td style="width: 12.5%;"></td> <td style="width: 12.5%;"></td> <td style="width: 12.5%;"></td> <td style="width: 12.5%;"></td> <td style="width: 12.5%;"></td> <td style="width: 12.5%;"></td> <td style="width: 12.5%;"></td> <td style="width: 12.5%;"></td> <td style="width: 12.5%;"></td> <td style="width: 12.5%;"></td> <td style="width: 12.5%;"></td> </tr> </table>															
Signature..... Card Exp. Date.....															
Please supply name and address of cardholder if different from the address shown															
<p>NOTE: You can also order p.c.b.s by phone, Fax, E-mail or via our Internet site on a secure server:</p> <p>http://www.epemag.wimborne.co.uk</p>															

KITMASTER EDUCATIONAL KITS RADIO CLUBS - NOVICES - COLLEGES - SCHOOLS

TELEPHONE (07941) 252679

ALL KITS BUILT ON TRIPAD PCB
BUILD AS YOU SEE SYSTEM

FULL KIT &
INSTRUCTIONS

PERFECT FOR NOVICE FIRST TIME
BUILDERS IN ELECTRONICS

X1	2-IC MK484 M.W. RADIO	£10.00	B41	TRANSMITTER R.F. INDICATOR	£4.80
X3	1-IC + TRAN M.W. RADIO	£10.00	B43	AUDIO NOISE GENERATOR	£10.00
X5	MK484 - 2030 M.W. RADIO	18.00	B45	GENERAL 3-TRANSISTOR AMP	£5.50
X7	MK484 TUNER M.W. NO AMP	£6.00	B46	LM386 AMPLIFIER GENERAL	£5.50
B2	BASIC CRYSTAL SET AMPLIFIED	0.00	B48	COMMON PRE-AMP RADIO	£5.50
B4	WORKSHOP AMPLIFIER	10.00	B49	PEST SCARER HIGH PITCH	£12.00
X11	S. METER	10.50	B50	VARIABLE FREQ. OSCILLATOR	£5.50
B44	SIMPLE H.F. M.W. ATU	£7.50	B51	AUTOMATIC NIGHT LIGHT	£5.50
B8	S.W. TUNER GENERAL	10.00	B52	FROST ALARM	£5.80
C1	BASIC CRYSTAL SET M.W.	£6.50	B53	PRESSURE MAT & ALARM	£13.50
B61	MW SIGNAL BOOSTER	12.50	B54	GUITAR TUNER	£9.50
B9	FAKE CAR ALARM FLASHER	£5.00	B55	TOUCH ALARM	£5.80
B10	2 L.E.D. FLASHER	£4.80	B56	SIMPLE LIGHT METER	£13.50
B11	LOW VOLTS L.E.D. ALARM 9V-12V	£5.00	B57	L.E.D. CONTINUITY METER	£4.50
B12	LIE DETECTOR WITH METER	£10.00	B58	SOUND-OPERATED SWITCH	£6.50
B13	TOY ORGAN	£6.50	B58A	8 FLASHING L.E.D.s	£6.80
B14	METRONOME I.C. CONTROL	£5.00	B59	TBA 820M AUDIO AMP	£10.50
B15	TOUCH SWITCH	£5.00	B60	TDA 2030 AUDIO AMP	£9.50
B16	HEADS OR TAILS GAME	£5.00	B62	ELECTRONIC DICE GAME	£8.50
B17	SIREN	£4.80	B63	ADVANCED THERMIN-MUSIC	£10.50
B18	RAIN DETECTOR	£4.80	B64	TOUCH DELAY LAMP	£5.50
B19	CONTINUITY TESTER	£4.50	B65	FISHERMAN'S ROD BITE ALARM	£5.00
B20	MORSE CODE OSCILLATOR	£4.80	B66	BEAM BREAK DETECTOR ALARM	£8.00
B21	BURGLAR ALARM L.E.D. & SPEAKER	£5.00	B67	LATCHING BURGLAR ALARM	£7.50
B22	LOOP SECURITY ALARM	£5.00	B68	LIGHT-OPERATED RELAY	£7.50
B23	VIBRATION ALARM	£4.80	B69	MICROPHONE PRE-AMP	£7.50
B24	METAL DETECTOR + METER	£14.00	B70	MAGNETIC ALARM - MODELS	£7.50
B25	HAND TREMOR GAME	£4.80	B72	BATH OR WATER BUTT ALARM	£6.80
B26	RAIN SYNTHESISER - NOISE	£10.50	B73	0-18 VOLT POWER SUPPLY UNIT	£6.80
B27	AUTO LIGHT DARK INDICATOR	£4.80	B74	F.M. BUG POWER SUPPLY 0V-9V	£6.50
B28	ADJ. LOW LIGHT INDICATOR	£4.80	B75	1 TRANSISTOR F.M. BUG	£6.50
B29	DARK ACTIVATED L.E.D. FLASHER	£4.80	B76	2 TRANSISTOR F.M. BUG	£7.50
B30	LIGHT ACTIVATED TONE ALARM	£4.80	B77	CHIRP GENERATOR	£6.80
B31	CAR ELECTRIC PROBE	£4.50	B78	TONE BURST GENERATOR	£1.80
B32	SIGNAL INJECTOR	£4.50	B79	SOUND EFFECTS GENERATOR	£10.50
B33	MOISTURE METER - L.E.D.	£4.80	B80	LIGHT METER - PHOTOGRAPHY	£10.50
B34	L.E.D. TRANSISTOR TESTER NPN	£4.50	B81	LIGHT OSCILLATOR - PHOTOGRAPHY	£9.50
B35	DIODE TESTER - L.E.D.	£4.50	B82	LIGHT-ACTIVATED RELAY	£9.50
B36	L.E.D. TRANSISTOR TESTER PNP	£4.50	B83	DARK-ACTIVATED RELAY	£9.50
B37	IC 555 TESTER - L.E.D.	£5.50	B84	SOUND SIREN + LOUD AMPLIFIER	£11.50
B38	0-18 MIN. TIMER L.E.D. & SPEAKER	£5.50	X12	AUDIO PROBE	£10.50
B39	TOY THERMIN MUSIC	£6.80	X14	CHILD SPEAK LAMP	£6.50
B40	AMPLIFIED R.F. PROBE + METER	£10.50	Z1	SW GEN RECEIVER	£13.50

SOLID STATE KITS P&P £3 UK
WORDWIDE P&P £10.
PAYMENT CHEQUES STERLING

★ SEND FOR FREE CATALOGUE ★
READY BUILT KITS £5 EXTRA

KITMASTER RADIO VALVE KITS

K1 - VALVE RADIO POWER SUPPLY UNIT	IDEAL PSU FOR MOST OF OUR VALVE KITS	£20.00
K2 - VALVE RADIO POWER SUPPLY UNIT	SIMILAR TO K1 BUT OFFERS HIGHER VOLTAGE OUTPUT ON H.T. SIDE	£22.00
K3 - TWO VALVER REGEN RADIO	WORKS ON MW OR SW INTERCHANGEABLE COILS. KIT COMES WITH SPEAKER. GOOD VOLUME	£25.00
K4 - ONE VALVE AMPLIFIER.	USES THE EL84 VALVE STILL MADE TODAY. IDEAL SHACK AMPLIFIER. GOOD STARTER KIT	£12.00
K5 - BATTERY ONE VALVER NOVICE KIT	RUNS ON 36 VOLTS. IDEAL EXPERIMENTAL VALVE PROJECT. ALSO SOLID STATE UNIT INCORPORATED TO GIVE SPEAKER VOLUME	£15.00
K6 - ONE VALVE REGEN RADIO.	COMES WITH CRYSTAL EARPIECE. MW/SW	£15.00
K7 - TWO VALVE AMPLIFIER.	GOOD VOLUME	£17.50
K8 - CRYSTAL SET ONE VALVER	EXPERIMENTAL VALVE + SOLID STATE WITH SPEAKER	£18.00
K9 - ONE VALVE MW RADIO. NOT REGEN	SOLID STATE INCORPORATED. GOOD VOLUME WITH SPEAKER SUPPLIED. WORKS VERY WELL	£22.50
K10 - MODERN TWO VALVE RADIO WITH SOLID STATE	THIS RADIO USES TWO VALVES STILL PRODUCED TODAY AND THERE ARE NO COILS TO WIND. IT OPERATES ON MEDIUM WAVE AND HAS NO REGENERATION PROBLEMS	£28.50
K11 - TWO VALVE SW GENERAL RECEIVER 6MHz TO 14MHz	USING MODERN SOLID STATE COMBINED WITH VALVE TECHNOLOGY THIS RADIO HAS VERY GOOD VOLUME, BY USING THE ECC83 AND EL54 VALVES	£27.50
K12 - TWO VALVE AMPLIFIED CRYSTAL SET RADIO	SIMILAR TO THE K8 PROJECT BUT WITH MORE AMPLIFICATION THIS IS IDEAL IF YOU ARE INTO EXPERIMENTING WITH CRYSTAL SETS AND YOU REQUIRE LOTS OF VOLUME	£26.50
K13 - TWO VALVER REGEN RADIO, MW & SW	USES THE EF91 VALVE AS A DETECTOR AND THE ECL80 FOR AUDIO AMPLIFICATION CIRCUITRY SIMILAR TO ITS SISTER, THE K3 REGEN RADIO KIT, AS THESE VALVES ARE VERY COMMON THIS KIT IS SLIGHTLY CHEAPER	£24.00
K14 - 3-VALVE RADIO MW & SW AND WITH RF STAGE ADDED WHICH GIVES MORE SELECTIVITY.	ALSO COMES WITH INTERCHANGEABLE COIL FORMER. ALSO RADIO GIVES GOOD VOLUME. EASY TO ASSEMBLE - THIS SET USES TWO EF91 VALVES AND THE ECL80 FOR AUDIO	£30.00
K15 - 3-VALVE RADIO MW & SW. ANOTHER DIFFERENT TYPE OF REGENERATION RADIO.	ALSO WITH ADDED R.F. STAGE THIS CIRCUIT USES THE MODEL EL84 FOR AUDIO WITH THE POPULAR EF80 VALVE FOR THE DETECTOR AND THE EF91 FOR THE R.F. STAGE. THIS MAKES FOR A SUPERIOR REGEN RADIO	£32.00

★ ALL RADIO CHASSIS PRE-DRILLED AND VALVE BASES FITTED READY FOR QUICK ASSEMBLY ★

Visit our new Website Address:

<http://www.kit-master.co.uk>

For your Catalogue E-mail: david@kit-master.co.uk

VALVE KITS P&P £6 UK
WORDWIDE P&P £12
PAYMENT - CHEQUES
STERLING

MAIL ORDER ONLY
PLEASE ALLOW UP TO
28 DAYS FOR DELIVERY

MAKE POSTAL ORDERS/CHEQUES PAYABLE TO DAVID JOHNS AND SEND TO:
37 GOSBECKS ROAD, COLCHESTER, ESSEX CO2 9JR
TEL. 07941 252679 FAX 01206 369226.

Bell College
Almada Street
Hamilton
Scotland ML3 0JB
Tel: 01698 283100
Fax: 01698 282131



Make your Expertise pay!

In today's world you need qualifications to obtain and keep employment. Our open learning courses make obtaining these qualifications as convenient as possible.

Choose from our dozens of SQA accredited units, either singly to **update your skills** or as a group to obtain a **Higher National Certificate**.

- Learn at your own pace in your own home
- Support from professional engineers via phone, FAX and the Internet
- Courses from Introductory Bridging Modules to HNC Electronics
- Units from Programmable Logic Controllers to Engineering Computing

DON'T DELAY - we are waiting to hear from you.

Contact Laura Murdoch, Open Learning Co-ordinator
Tel 01698 283100 Ext. 214.
E-mail l.murdoch@bell.ac.uk
Web: <http://floti.bell.ac.uk/openlearning>

Member of the British Association for Open Learning
Preview Centre for FT Knowledge



Bell College of Technology
a registered charity No. SC 021179
providing quality Higher Education and
Training opportunities for all.



DISTANCE LEARNING COURSES in:

Analogue and Digital Electronics, Fibre Optics, Fault Diagnosis, Mechanics, Mathematics and Programmable Logic Controllers leading to a

BTEC PROFESSIONAL DEVELOPMENT CERTIFICATE

- Suitable for beginners and those wishing to update their knowledge and practical skills
- Courses are very practical and delivered as self contained kits
- No travelling or college attendance
- Learning is at your own pace
- Each course can stand alone or be part of a modular study programme
- Tutor supported and BTEC certified

For information contact:
NCT Ltd., P.O. Box 11
Wendover, Bucks HP22 6XA
Telephone 01296 624270; Fax 01296 625299
Web: <http://www.nct.ltd.uk>

Everyday Practical Electronics reaches twice as many UK readers as any other UK monthly hobby electronics magazine, our audited sales figures prove it. We have been the leading independent monthly magazine in this market for the last fifteen years.

If you want your advertisements to be seen by the largest readership at the most economical price our classified and semi-display pages offer the best value. The prepaid rate for semi-display space is £8 (+VAT) per single column centimetre (minimum 2.5cm). The prepaid rate for classified adverts is 30p (+VAT) per word (minimum 12 words).

All cheques, postal orders, etc., to be made payable to Everyday Practical Electronics. VAT must be added. Advertisements, together with remittance, should be sent to Everyday Practical Electronics Advertisements, Mill Lodge, Mill Lane, Thorpe-le-Soken, Essex CO16 0ED. Phone/Fax (01255) 861161.

For rates and information on display and classified advertising please contact our Advertisement Manager, Peter Mew as above.

Valve Output Transformers: Single ended 50mA, £4.50; push/pull 15W, £27; 30W, £32; 50W, £38; 100W, £53. Mains Transformers: Sec 220V 30mA 6V 1A, £3; 250V 60mA 6V 2A, £5; 250V 80mA 6V 2A, £6. High Voltage Caps: 50µF 350V, 68µF 500V, 150µF 385V, 330µF 400V, 470µF 385V, all £3 ea., 32+32µF 450V £5. Postage extra.
Record Decks and Spares: BSR, Garrard, Goldring, motors, arms, wheels, headshells, spindles, etc. Send or phone your want list for quote.

RADIO COMPONENT SPECIALISTS

337 WHITEHORSE ROAD, CROYDON SURREY, CR0 2HS. Tel: (020) 8684 1665
Lots of transformers, high volt caps, valves, output transformers, speakers, in stock. Phone or send your wants list for quote.

Z88 NOW AVAILABLE WITH 128K AND 512K - OZ4

ALSO SPECTRUM AND QL PARTS
W. N. RICHARDSON & CO.
PHONE/FAX 01494 8713196
RAVENSMEAD, CHALFONT ST PETER, BUCKS, SL9 0NB

TIS - Midlinbank Farm
Ryeland, Strathaven ML10 6RD
Manuals on anything electronic
Circuits - VCR £8, CTV £6
Service Manuals from £10
Repair Manuals from £5
P&P any order £2.50
Write, or ring 01357 440280 for full details of our lending service and FREE quote for any data

BTEC ELECTRONICS TECHNICIAN TRAINING

GNVQ ADVANCED ENGINEERING (ELECTRONIC) - PART-TIME
HND ELECTRONICS - FULL-TIME
B.Eng FOUNDATION - FULL-TIME
Next course commences
Monday 18th September 2000
FULL PROSPECTUS FROM

LONDON ELECTRONICS COLLEGE
(Dept EPE) 20 PENYWERN ROAD
EARLS COURT, LONDON SW5 9SU
TEL: (020) 7373 8721

THE BRITISH AMATEUR ELECTRONICS CLUB

exists to help electronics enthusiasts by personal contact and through a quarterly Newsletter.
For membership details, write to the Secretary:
Mr. M. P. Moses,
5 Park View, Cwmaman,
Aberdare CF44 6PP
Space donated by
Everyday Practical Electronics

Miscellaneous

LOUDSPEAKER CABINETS FOR SALE

These are brand new ex-Rogers HI-FI models, sold at a fraction of cost. Save money by building your own. Bookshelf, stand-mounted or floor-standing. Real veneer and vinyl finishes in black, walnut, rosewood and other colours.

Prices from **£19 pair** to **£149 pair**

Drive units, ports, gold-plated terminal pods, etc., all available. Carriage extra or collect

For further details, Please call:

AVANTI AUDIO
TEL: 01344 638830

X-10® Home Automation
We put you in control™

Why tolerate when you can automate?

An extensive range of 230V X-10 products and starter kits available. Uses proven Power Line Carrier technology, no wires required. Products Catalogue available Online. Worldwide delivery.
Philips Pronto Intelligent Remote now available!

Laser Business Systems Ltd.

E-Mail: info@laser.com
http://www.laser.com
Tel: (020) 8441 9788
Fax: (020) 8449 0430

PRINTED CIRCUIT BOARDS - QUICK SERVICE. Prototype and production artwork raised from magazines or draft designs at low cost. PCBs designed from schematics. Production assembly, wiring and software programming. For details contact Patrick at Agar Circuits, Unit 5, East Belfast Enterprise Park, 308 Albertbridge Road, Belfast, BT5 4GX. Phone 028 9073 8897, Fax 028 9073 1802, E-mail agar@argonet.co.uk.

G.C.S.E. ELECTRONIC KITS, at pocket money prices. S.A.E. for FREE catalogue. SIR-KIT Electronics, 52 Severn Road, Clacton, CO15 3RB.

PROTOTYPE PRINTED CIRCUIT BOARDS one offs and quantities, for details send s.a.e. to B. M. Ansbro, 38 Poynings Drive, Hove, Sussex BN3 8GR, or phone Brighton 883871, Mobile 07949 598309.

VALVE ENTHUSIASTS: Capacitors and other parts in stock. For free advice/lists please ring, Geoff Davies (Radio), Tel. 01788 574774.

FREE PROTOTYPE PRINTED CIRCUIT BOARDS! Free prototype p.c.b. with quantity orders. Call Patrick on 028 9073 8897 for details. Agar Circuits, Unit 5, East Belfast Enterprise Park, 308 Albertbridge Road, Belfast BT5 4GX.

DETECT ATMOSPHERIC ACTIVITY. Unique Designs. Self-addressed envelope: PO Box 694, Saint Helier, JE4 9PZ, Jersey, CI.

ELECTRONIC ENGINEER/CONSULTANT available for EMC, circuit design and problem solving, reasonable rates. 07940 705496, 01525 220722. quantek@pobox.com.

EPE NET ADDRESSES

EPE FTP site: <ftp://ftp.epemag.wimborne.co.uk>
Access the FTP site by typing the above into your web browser, or by setting up an FTP session using appropriate FTP software, then go into quoted sub-directories:
PIC-project source code files: /pub/PICS
PIC projects each have their own folder; navigate to the correct folder and open it, then fetch all the files contained within. *Do not try to download the folder itself!*
EPE text files: /pub/docs
Basic Soldering Guide: solder.txt
EPE TENS Unit user advice: tens.doc and tens.txt
Ingenuity Unlimited submission guidance: Ing_unlft.txt
New readers and subscribers info: epe_info.txt
Newsgroups or Usenet users advice: usenet.txt
Ni-Cad discussion: nicadfaq.zip and nicad2.zip
Writing for EPE advice: write4us.txt

On-line readers! Try the EPE Chat Zone - a virtually real-time Internet "discussion board" in a simple to use web-based forum!
<http://www.epemag.wimborne.co.uk/wwwboard>
Or buy EPE Online: www.epemag.com

Ensure you set your FTP software to ASCII transfer when fetching text files, or they may be unreadable.
Note that any file which ends in .zip needs unzipping before use. Unzip utilities can be downloaded from:
<http://www.winzip.com> or
<http://www.pkware.com>

TRAIN TODAY FOR A BETTER FUTURE

Now you can get the skills and qualifications you need for career success with an ICS Home Study Course. Learn in the comfort of your own home at the pace and times that suit you. ICS is the world's largest, most experienced home study school. Over the past 100 years ICS have helped nearly 10 million people to improve their job prospects. Find out how we can help YOU. Post or phone today for FREE INFORMATION on the course of your choice.

Electrical Contracting & Installation
Electrical Engineering
C&G/ICS Basic Electronic Engineering
C&G/ICS Basic Mechanical Engineering
TV and Video Servicing
Radio and Hi-Fi Servicing
Refrigeration Heating & Air Conditioning
Motorcycle Maintenance

FREEPHONE 0500 581 557

Or write to: International Correspondence Schools, FREEPOST 882, 8 Elliot Place, Clydeway Skypark, Glasgow, G3 8BR. Tel: 0500 581 557 or Tel/Fax: Dublin 285 2533

Please send me my Free Information on your Electronics Courses.

Mr/Mrs/Ms/Miss (BLOCK CAPITALS PLEASE) _____ Date of Birth / / _____
Address _____
Postcode _____
Occupation _____ Tel No. _____
From time to time we permit other carefully screened organisations to write to you about products and services if you would prefer not to hear from such organisations please tick box Dept. ZEEE 080900

Professional 88-108MHz FM Broadcasting Kits

All Our Kits Include

Detailed Instructions with Schematics
High Quality Screen Printed PCBs
High Quality Components

Our Product Range Includes

Transmitters from 0.05W to 35W
FM Stereo Coders
Audio Compressor Limiters
Antennas
RF Power Amps

Our Kits Are Also Available Fully Assembled And Tested



WE DELIVER WORLD-WIDE AND ACCEPT MAJOR CREDIT CARDS

Contact Us Now For A Free Brochure

Tel 01274 883434 Fax 01274 428665

email info@veronica.co.uk

Unit 5/6 1A Sandbeds/Albert Rd Queensbury BRADFORD BD13 1AA

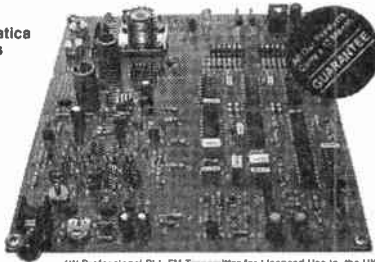

1W Professional PLL FM Transmitter for Licensed Use in the UK

Visit our Website at <http://www.veronica.co.uk>



VARIABLE VOLTAGE TRANSFORMERS

INPUT 220V/240V AC 50/60Hz OUTPUT 0V-260V

PANEL MOUNTING

	Price	P&P
0.5KVA 2.5 amp max	£33.00	£6.00
		(£45.84 inc VAT)
1KVA 5 amp max	£45.25	£7.00
		(£61.39 inc VAT)

SHROUDED

	Price	P&P
0.5KVA 2.5 amp max	£34.00	£6.00
		(£47.00 inc VAT)
1KVA 5 amp max	£46.25	£7.00
		(£62.57 inc VAT)
2KVA 10 amp max	£65.00	£8.50
		(£86.36 inc VAT)
3KVA 15 amp max	£86.50	£8.50
		(£111.63 inc VAT)

5KVA 25 amp max £150.00 (+ Carriage & VAT)
Buy direct from the Importers. Keenest prices in the country.

500VA ISOLATION TRANSFORMER

Input lead 240V AC. Output via 3-pin 13A socket 240V AC continuously rated mounted in fibreglass case with handle. Internally fused Price £35.00 carriage paid + VAT (£41.13)

TOROIDAL L.T. TRANSFORMER

Primary 0-240V AC Secondary 0-30V + 0-30V 600VA Fixing bolt supplied Price £25.00 carriage paid + VAT (£29.38)

COMPREHENSIVE RANGE OF TRANSFORMERS - LT - ISOLATION & AUTO

110V-240V Auto transfer either cased with American socket and mains lead or open frame type Available for immediate delivery

ULTRA VIOLET BLACK LIGHT BLUE FLUORESCENT TUBES

4ft. 40 watt	£14.00 (callers only)	(£16.45 inc VAT)
2ft. 20 watt	£9.00 (callers only)	(£10.58 inc VAT)
12in 6 watt	£4.80 + 75p p&p	(£6.52 inc VAT)
9in 6 watt	£3.96 + 50p p&p	(£5.24 inc VAT)
6in 4 watt	£3.96 + 50p p&p	(£5.24 inc VAT)

230V AC BALLAST KIT

For either 6in 9in or 12in tubes £6.05-£1.40 p&p (£8.75 inc VAT)
The above Tubes are 3500/4000 angstrom (350-400nm) ideal for detecting security markings, effects lighting & Chemical applications.
Other Wavelengths of UV TUBE available for Germodal & Photo Sensitive applications. Please telephone your enquiries

400 WATT BLACK LIGHT BLUE UV LAMP

GES Mercury Vapour lamp suitable for use with a 400W PF Ballast Only £39.95 incl p&p & VAT



5 KVA ISOLATION TRANSFORMER

As New. Ex-Equipment, fully shrouded, Line Noise Suppression, Ultra Isolation Transformer with terminal covers and knock-out cable entries. Primary 120V/240V, Secondary 120V/240V, 50/60Hz, 0.005PF Capacitance. Size L 37cm x W 19cm x H 16cm, Weight 42 kilos Price £120 + VAT Ex-warehouse. Carriage on request.

24V DC SIEMENS CONTACTOR

Type 3TH8022-0B 2 x NO and 2 x NC 230V AC 10A. Contacts. Screw or On Rail fixing. Size L- 120mm x W 45mm x D 75mm. Brand New Price £7.63 incl. p&p and VAT.

240V AC WESTCOOL SOLENOIDS

Model TT2 Max stroke 16mm, 5lb pull Base mounting Rating 1 Model TT6 Max stroke 25mm, 15lb. pull. Base mounting, Rating 1. Series 400 Max. stroke 28mm, 15lb. pull. Front mounting, Rating 2. Prices inc. p&p & VAT: TT2 £5.88, TT6 £8.81, Series 400 £8.64.

AXIAL COOLING FAN

230V AC 120mm square x 38mm 3 blade 10 watt Low Noise fan. Price £7.29 incl. p&p and VAT
Other voltages and sizes available from stock. Please telephone your enquiries.

INSTRUMENT CASE

Brand new. Manufactured by Imhof. L 31cm x H 18cm x 19cm Deep. Removable front and rear panel for easy assembly of your components. Grey textured finish, complete with case. Price £16.45 incl. p&p and VAT. £18.20 inclusive.

DIECAST ALUMINIUM BOX

with internal PCB guides. Internal size 265mm x 165mm x 50mm deep. Price £9.93 incl. p&p & VAT. 2 off £17.80 incl.

230V AC SYNCHRONOUS GEARED MOTORS

Brand new. Ovoid Gearbox. Crouzet type motors. H 65mm x W 55mm x D 35mm, 4mm dia. shaft x 10mm long. 6 RPM anti cw. £9.99 incl. p&p & VAT.
20 RPM anti cw. Depth 40mm. £11.16 incl. p&p & VAT

16 RPM REVERSIBLE Crouzet 220V/230V 50Hz geared motor with ovoid gear box.

4mm dia. shaft. New manuf. surplus. Sold complete with reversing capacitor, connecting block and circ. Overall size. H 68mm x W 52mm x 43mm deep
PRICE incl. P&P & VAT £9.99

EPROM ERASURE KIT

Build your own EPROM ERASURE for a fraction of the price of a made-up unit. Kit of parts less case includes 12m. 8 watt 2537, Argon Tube Ballast unit, pair of bi-pin leads, neon indicator, on/off switch, safety microswitch and circuit £15.00+£2.00 p&p. (£19.98 inc VAT)

WASHING MACHINE WATER PUMP

Brand new 240V AC fan cooled. Can be used for a variety of purposes. Inlet 1 1/2", outlet 1/2" dia. Price includes p&p & VAT. £17.20 each or 2 for £20.50 inclusive.



SERVICE TRADING CO

57 BRIDGMAN ROAD, CHISWICK, LONDON W4 5BB

Tel: 0181-995 1560

FAX: 0181-995 0549



Ample Parking Space

COVERT VIDEO CAMERAS

Black and White Pin Hole Board Cameras with Audio. Cameras in P.I.R., Radios, Clocks, Briefcases etc. Transmitting Cameras with Receiver (Wireless).

Cameras as above with colour.

Audio Surveillance Kits and Ready Built Units, Bug Detector etc.

A.L. ELECTRONICS

Please phone 0181 203 6008 for free catalogue.
Fax 0181 201 5359

E-mail: surveillance@btclick.com www.uspy.com

New DTI approved Video Transmitters and Receivers (Wireless)

Major credit cards now taken

ELECTRONICS SURPLUS CLEARANCE SALE

SCOOP PURCHASE:

FLUKE HAND HELD DIGITAL MULTIMETER, MODEL 8024B

Cancelled export order 750V AC/DC 2 amp AC/DC Resistance 20Megohm plus Siemens range. Also measures temperature -20°C to +1265°C. Temp. probe not included. Calibrated for K-type thermocouple. Peak hold facility. Supplied brand new and boxed but with original purchasing organisation's small identifying mark on case. Test leads and handbook included.
Offered at a fraction of original price: £47.50, p&p £6.50

THE ELECTRONICS SURPLUS TRADER - This is a listing of new first class components and electronic items at below trade prices. Includes manufacturers' surplus and overstocks. Also obsolete semiconductors, valves and high voltage caps and components. Send two first class stamps for large catalogue.

(Dept E) CHEVET SUPPLIES LTD

157 Dickson Road, BLACKPOOL FY1 2EU

Tel: (01253) 751858. Fax: (01253) 302979

E-mail: chevet@globalnet.co.uk Telephone Orders Accepted

Callers welcome Tues, Thurs, Fri and Sat.



N. R. BARDWELL LTD (EPE)

100	Signal Diodes 1N4148	£1.00	200	Asst. disc ceramic capacitors	£1.00
75	Rectifier Diodes 1N4001	£1.00	50	Asst. Skel Presets (sm, stand, cermet)	£1.00
50	Rectifier Diodes 1N4007	£1.00	50	Asst. RF Chokes (inductors)	£1.00
10	W01 Bridge Rectifiers	£1.00	50	Asst. grommets	£1.00
10	555 Timer I.C.s	£1.00	80	Asst. solder tags, p/conn, terminals	£1.00
4	741 Op Amps	£1.00	10	Asst. crystals - plug in	£1.00
10	Assorted Zener Diodes 400mW	£1.00	24	Asst. coil formers	£1.00
12	Assorted 7-segment Displays	£1.00	8	Asst. di switches	£1.00
25	5mm I.e.d.s. red, green or yellow	£1.00	20	Mixture slide switches sp/co	£1.00
25	3mm I.e.d.s. red, green or yellow	£1.00	10	Stand ard slide switches dp/dt	£1.00
50	Axial I.e.d.s. 2mod red Diode Package	£1.00	100	Asst. beads (ceramic, teflon, fish spine)	£1.00
25	Asst. High Brightness I.e.d.s. var cols	£1.00	80	Asst. small stand offs, U/throughs etc	£1.00
20	BC182L Transistors	£1.00	30	Asst. di sockets up to 40 way	£1.00
25	BC212L Transistors	£1.00	10	TV coax plugs, plastic	£1.00
30	BC237 Transistors	£1.00	40	metres very thin connecting wire, red	£1.00
20	BC327 Transistors	£1.00	20	1in glass reed switches	£1.00
30	BC328 Transistors	£1.00	20	Magnetic ear pips with lead and plug	£1.00
30	BC547 Transistors	£1.00	100	Any one value 1/4W 5% cf resistors range	£0.45
30	BC548 Transistors	£1.00	1R to 10M		
30	BC549 Transistors	£1.00	10	7812 Voltage Regulators	£1.00
25	BC557 Transistors	£1.00			
30	BC558 Transistors	£1.00			
30	BC559 Transistors	£1.00			
20	2N3904 Transistors	£1.00			
100	1nf 50V wkg Axial Capacitors	£1.00			
100	4N7 50V wkg Axial Capacitors	£1.00			
12	1uf 250V encapsulated radial plastic				
	cased capacitors	£1.00			
80	Asst. capacitors electrolytic	£1.00			
80	Asst. capacitors 1nF to 1uF	£1.00			

Prices include VAT, Postage £1.65. 44p stamp for Lists

288 Abbeydale Road, Sheffield S7 1FL

Phone (0114) 2552886 Fax (0114) 2500689

E-mail sales@Bardwells.co.uk

Web site: <http://www.bardwells.co.uk>



DIGITAL TEST METER

Built-in transistor test socket and diode test position.
DC volts 200mV to 1000V.
AC volts 200V to 750V.
DC current 200mA to 10A.
Resistance 200 ohms to 2000K ohms.

£6.99 incl. VAT

Watch Slides on TV.

Make videos of your slides. Digitise your slides (using a video capture card)
 "Liesgang diatv" automatic slide viewer with built in high quality colour TV camera. It has a composite video output to a phono plug (SCART & BNC adaptors are available). They are in very good condition with few signs of use.
 £91.91 + VAT = £108.00



Board cameras all with 512 x 582 pixels 8.5mm 1/3 inch sensor and composite video out. All need to be housed in your own enclosure and have fragile exposed surface mount parts. They all require a power supply of between 10V and 12V DC 150mA.
 47MIR size 60 x 36 x 27mm with 6 infra red LEDs (gives the same illumination as a small torch but is not visible to the human eye) £37.00 + VAT = £43.48
 30MP size 32 x 32 x 14mm spy camera with a fixed focus pin hole lens for hiding behind a very small hole £35.00 + VAT = £41.13
 40MC size 39 x 38 x 27mm camera for 'C' mount lens these give a much sharper image than with the smaller lenses £32.00 + VAT = £37.60
 Economy C mount lenses all fixed focus & fixed iris
 VSL1220F 12mm F1.6 12 x 15 degrees viewing angle £15.97 + VAT £18.76
 VSL4022F 4mm F1.22 63 x 47 degrees viewing angle £17.65 + VAT £20.74
 VSL6022F 6mm F1.22 42 x 32 degrees viewing angle £19.05 + VAT £22.38
 VSL8020F 8mm F1.22 32 x 24 degrees viewing angle £19.90 + VAT £23.38

Better quality C Mount lenses

VSL1614F 16mm F1.6 30 x 24 degrees viewing angle £26.43 + VAT £31.06
 VWL813M 8mm F1.3 with iris 56 x 42 degrees viewing angle £77.45 + VAT = £91.00
 1206 surface mount resistors E12 values 10 ohm to 1M ohm
 100 of 1 value £1.00 + VAT 1000 of 1 value £5.00 + VAT

866 battery pack originally intended to be used with an orbital mobile telephone it contains 10 1.6Ah sub C batteries (42 x 22 dia. the size usually used in cordless screwdrivers etc.) the pack is new and unused and can be broken open quite easily
 £7.46 + VAT = £8.77



Please add £1.66 + vat = £1.95 postage & packing per order

JPG Electronics

276-278 Chatsworth Road, Chesterfield, S40 2BH.
 Tel 01246 211202 Fax 01246 550959

Mastercard/Visa/Switch

Callers welcome 9.30 a.m. to 5.30 p.m. Monday to Saturday

SHERWOOD ELECTRONICS

FREE COMPONENTS

Buy 10 x £1 Special Packs and choose another one FREE

SP1	15 x 5mm Red LEDs	SP131	2 x TL071 Op.Amps
SP2	12 x 5mm Green LEDs	SP133	20 x 1N4004 diodes
SP3	12 x 5mm Yellow LEDs	SP134	15 x 1N4007 diodes
SP6	15 x 3mm Red LEDs	SP135	6 x Min. slide switches
SP7	12 x 3mm Green LEDs	SP136	3 x BFY50 transistors
SP10	100 x 1N4148 diodes	SP137	4 x W005 1.5A bridge rectifiers
SP11	30 x 1N4001 diodes	SP138	20 x 2.2/63V radial elect. caps.
SP12	30 x 1N4002 diodes	SP140	3 x W04 1.5A bridge rectifiers
SP18	20 x BC182 transistors	SP142	2 x CMOS 4017
SP20	20 x BC184 transistors	SP143	5 Pairs min. crocodile clips (Red & Black)
SP21	20 x BC212 transistors	SP145	6 x ZTX300 transistors
SP23	20 x BC549 transistors	SP146	10 x 2N3704 transistors
SP24	4 x CMOS 4001	SP147	5 x Stripboard 9 strips x 25 holes
SP25	4 x 555 timers	SP151	4 x 8mm Red LEDs
SP26	4 x 741 Op.Amps	SP152	4 x 8mm Green LEDs
SP28	4 x CMOS 4011	SP153	4 x 8mm Yellow LEDs
SP29	3 x CMOS 4013	SP154	15 x BC548 transistors
SP31	4 x CMOS 4071	SP156	3 x Stripboard, 14 strips x 27 holes
SP34	20 x 1N914 diodes	SP160	10 x 2N3904 transistors
SP36	25 x 10/25V radial elect. caps.	SP161	10 x 2N3906 transistors
SP37	15 x 100/35V radial elect. caps.	SP165	2 x LF351 Op.Amps
SP39	10 x 470/16V radial elect. caps.	SP167	6 x BC107 transistors
SP40	15 x BC237 transistors	SP168	6 x BC108 transistors
SP41	20 x Mixed transistors	SP175	20 x 1/63V radial elect. caps.
SP42	200 x Mixed 0.25W C.F. resistors	SP177	10 x 1A 20mm quick blow fuses
SP47	5 x Min. PB switches	SP182	20 x 4.7/63V radial elect. caps.
SP102	20 x 8-pin DIL sockets	SP183	20 x BC547 transistors
SP103	15 x 14-pin DIL sockets	SP187	15 x BC239 transistors
SP104	15 x 16-pin DIL sockets	SP191	3 x CMOS 4023
SP105	4 x 74LS00	SP192	3 x CMOS 4066
SP109	15 x BC557 transistors	SP193	20 x BC213 transistors
SP112	4 x CMOS 4093	SP194	8 x OA90 diodes
SP114	5 x ZTX500 transistors	SP195	3 x 10mm Yellow LEDs
SP115	3 x 10mm Red LEDs	SP197	6 x 20 pin DIL sockets
SP116	3 x 10mm Green LEDs	SP198	5 x 24 pin DIL sockets
SP118	2 x CMOS 4047		
SP120	3 x 74LS93		
SP124	20 x Assorted ceramic disc caps		
SP130	100 x Mixed 0.5W C.F. resistors		

RESISTOR PACKS - C.Film

RP3	5 each value - total 365 0.25W	£2.85
RP7	10 each value - total 730 0.25W	£4.10
RP10	1000 popular values 0.25W	£5.85
RP4	5 each value-total 365 0.5W	£3.80
RP8	10 each value-total 730 0.5W	£6.45
RP11	1000 popular values 0.5W	£8.15

2000 Catalogue now available £1 inc. P&P or FREE with first order.

P&P £1.25 per order. NO VAT

Orders to:

Sherwood Electronics,
 7 Williamson St., Mansfield,
 Notts. NG19 6TD.

Millions of quality components at lowest ever prices!

Plus anything from bankruptcy - theft recovery - frustrated orders - over productions etc.
 Send 54p stamped self-addressed label or envelope for clearance lists.

Brian J Reed

6 Queensmead Avenue, East Ewell, Epsom, Surrey KT17 3EQ

Tel: 07775 945386 or 0208 393 9055

Mall Order UK only.

Lists are updated and only 40 are sent out every 2 weeks. This normally ensures that orders can be fulfilled where only a few thousands of an item is available. (Payment is returned if sold out. I do not deal in credit notes).

ADVERTISERS INDEX

A.L. ELECTRONICS	791
ANTEX	745
N. R. BARDWELL	791
BELL COLLEGE	789
B.K. ELECTRONICS	Cover (iii)/749
BRIAN J. REED	792
BRUNNING SOFTWARE	775
BULL ELECTRICAL	Cover (ii)
CHEVET SUPPLIES	791
CRICKLEWOOD ELECTRONICS	718
CROWNHILL ASSOCIATES	760
DAVID JOHNS	789
DISPLAY ELECTRONICS	714
ECONOMATICS (EDUCATION)	718
EPT EDUCATIONAL SOFTWARE	Cover (iv)
ESR ELECTRONIC COMPONENTS	722
FOREST ELECTRONIC DEVELOPMENTS	751
GREENWELD	743
ICS	791
J&N FACTORS	780
JPG ELECTRONICS	792
MAGENTA ELECTRONICS	720/721/749
MICROCHIP	729
MILFORD INSTRUMENTS	733
NATIONAL COLLEGE OF TECHNOLOGY	789
PEAK ELECTRONIC DESIGN	769
PICO TECHNOLOGY	717
QUASAR ELECTRONICS	716
REVOLUTION EDUCATION	745
SERVICE TRADING CO	791
SHERWOOD ELECTRONICS	792
SKY ELECTRONICS	743
SQUIRES	718
STEWART OF READING	735
SUMA DESIGNS	763
TELNET	719
VERONICA KITS	791

ADVERTISEMENT MANAGER: PETER J. MEW

ADVERTISEMENT OFFICES:

EVERYDAY PRACTICAL ELECTRONICS, ADVERTISEMENTS,

MILL LODGE, MILL LANE, THORPE-LE-SOKEN,

ESSEX CO16 0ED.

Phone/Fax: (01255) 861161

For Editorial address and phone numbers see page 723

OMP MOS-FET POWER AMPLIFIERS
HIGH POWER, TWO CHANNEL 19 INCH RACK

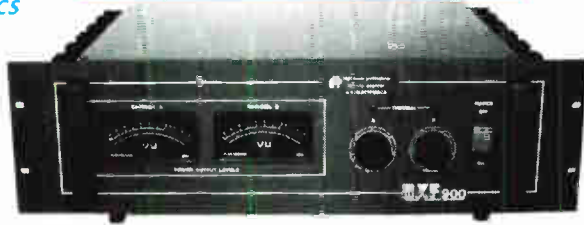

1000's
 SOLD
 TO PRO
 USERS

THE RENOWNED MXF SERIES OF POWER AMPLIFIERS

FOUR MODELS:- MXF200 (100W + 100W) MXF400 (200W + 200W)
 MXF600 (300W + 300W) MXF900 (450W + 450W)

ALL POWER RATINGS ARE R.M.S. INTO 4 OHMS, WITH BOTH CHANNELS DRIVEN
 FEATURES: ★ Independent power supplies with two toroidal transformers ★ Twin L.E.D. VU Meters
 ★ Level controls ★ Illuminated on/off switch ★ Jack/XLR inputs ★ Speaker outputs ★ Standard 775mV
 inputs ★ Open and short circuit proof ★ Latest Mos-Fets for stress free power delivery into virtually any load
 ★ High slew rate ★ Very low distortion ★ Aluminium cases ★ MXF600 & MXF900 fan cooled with D.C.
 loudspeaker and thermal protection.

USED THE WORLD OVER IN CLUBS, PUBS, CINEMAS, DISCOS ETC

SIZES:-
 MXF200 W19" D11" H3 1/2" (2U)
 MXF400 W19" D12" H5 1/2" (3U)
 MXF600 W19" D13" H5 1/2" (3U)
 MXF900 W19" D14 1/2" H5 1/2" (3U)

PRICES:- MXF200 £175.00 MXF400 £233.85
 MXF600 £329.00 MXF900 £449.15

SPECIALIST CARRIER DEL. £12.50 EACH



**FLIGHTCASED
 LOUDSPEAKERS**

A new range of quality loudspeakers, designed to take
 advantage of the latest loudspeaker technology and
 enclosure designs. All models utilize high quality studio

cast aluminium loudspeakers with factory fitted grilles, wide dispersion constant
 directivity horns, extruded aluminium corner protection and steel ball corners,
 complimented with heavy duty black covering. The enclosures are fitted as standard
 with top hats for optional loudspeaker stands. The FC15-300 incorporates a large
 16 X 6 inch horn. All cabinets are fitted with the latest Speakon® connectors
 for your convenience and safety. Five models to choose from.

W
E
D
G
E
M
O
N
I
T



PLEASE NOTE:- POWER RATINGS
 QUOTED ARE IN WATTS R.M.S. FOR
 EACH INDIVIDUAL CABINET.
 ALL ENCLOSURES ARE 8 OHM.

15-15 inch speaker
 12-12 inch speaker

ibl FC15-300 WATTS Freq Range 35Hz-20KHz, Sens 101dB, Size H695 W502 D415mm
 PRICE:- £299.00 per pair

ibl FC12-300 WATTS Freq Range 45Hz-20KHz, Sens 96dB, Size H600 W405 D300mm
 PRICE:- £249.00 per pair

ibl FC12-200 WATTS Freq Range 40Hz-20KHz, Sens 97dB, Size H600 W405 D300mm
 PRICE:- £199.00 per pair

ibl FC12-100 WATTS Freq Range 45Hz-20KHz, Sens 100dB, Size H546 W380 D300mm
 PRICE:- £179.00 per pair

ibl WM12-200 WATTS Freq Range 40Hz-20KHz, Sens 97dB, Size H418 W600 D385mm
 PRICE:- £125.00 EACH

SPECIALIST CARRIER DEL:- £12.50 per pair, Wedge Monitor £7.00 each

Optional Metal Stands PRICE:- £49.00 per pair Delivery:- £6.00

OMP XO3-S STEREO 3-WAY ACTIVE CROSS OVER SWI CHA LE 2 WA



BASS MID TOP 2 WAY BASS/MID COMBINED BASS MID/TOP COMBINED
 CONFIGURED 3 WAY

FEATURES:

Advanced 3-Way Stereo Active Cross Over (switchable two way), housed in a 19" x 1U case. Each channel
 has three level controls: Bass, Mid & Top. The removable front fascia allows access to the programmable DIL
 switches to adjust the cross-over frequency: Bass-Mid 125/250/500Hz, Mid-Top 1.8/3.5/7Hz, all at 24dB per
 octave. The 2/3 way selector switches are also accessed by removing the front fascia. Each stereo channel
 can be configured separately. Bass Invert Switches are incorporated on each channel. Nominal 775mV
 input/output. Fully compatible with OMP Rack Amplifier and Modules.

PRICE:- £117.44 + £5.00 P&P

SoundLAB SPM 12 AND 16 CH.MIXERS

The 12 and 16 Channel SPM Series Of Studio Quality Mixers
 Are Ideal For Fixed Installation Stage And Mobile Use

- ★ 48v PHANTOM POWER
- ★ BUILT IN POWER SUPPLY
- ★ 230V AC/50Hz
- ★ PEAK INPUT LEVEL LEDS
- ★ PRE FADE LISTEN (PFL)
- ★ SUB MASTER OUTPUT
- ★ COMBINED XLR/ 1/2" JACK
- ★ 80mm FADERS ★ CH.MUTE
- ★ 2 STEREO AUX SEND/RETURNS
- ★ CONSTANT PAN CONTROL
- ★ 3 BAND EQ WITH MID SWEEP
- ★ HEADPHONE/CONTROL ROOM O/P
- ★ CD/TAPE INPUTS & OUTPUTS
- ★ BALANCED INPUTS & OUTPUTS
- ★ BUS ASSIGN SWITCH
- ★ MONITOR SEND

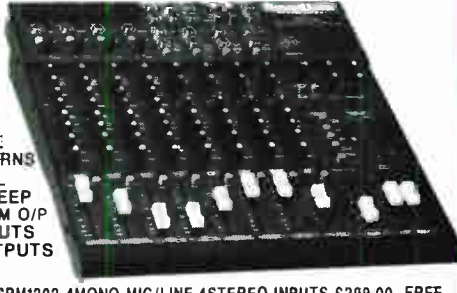

PRICES SPM1202 4MONO MIC/LINE,4STEREO INPUTS £299.00 FREE
 SPM1602 8MONO MIC/LINE,4STEREO INPUTS £399.00 UK P&P

STEREO DISCO MIXER MPX-7700

ECHO & SOUND EFFECTS



- ★ 4 STEREO INPUT CHANNELS
- ★ 2 DJ MIC INPUT CHANNELS
- ★ 2X7 BAND GRAPHIC EQUALISERS
- ★ HEADPHONE MONITOR WITH PFL
- ★ ASSIGNABLE CROSSFADE
- ★ DIGITAL ECHO

STEREO DISCO MIXER WITH:- ★2X7 GRAPHIC EQUALISERS ★2 MONO MIC INPUTS ★DJ MIC WITH FADER, TALKOVER AND VOICE CHANGER ★4 STEREO CHANNELS WITH INDIVIDUAL FADERS AND ASSIGNABLE CROSSFADE ★CHANNELS SWITCHABLE, TURNTABLE (MAG CARTRIDGE), CD, LINE, TAPE, ETC. ★ECHO WITH BALANCE, REPEAT AND DELAY ★HEADPHONE MONITOR WITH PREFADE LISTEN ★CHOICE OF 6 SOUND EFFECTS ★STEREO MONO SWITCH ★2 X LED VU METERS ★MASTER FADER ★OUTPUT 775mV
 ★SIZE:- 482X240X115mm ★POWER:- 230V AC 50/60Hz. PRICE:- £169.00 + £5.00 P&P

RADIO MICROPHONE CYBERWAVE FMM 1000



- ★ IDEAL FOR: LIVE BANDS, PUBLIC ADDRESS & KARAOKE ETC.
- ★ ON/STANDBY/OFF SWITCH MOUNTED ON MIC BARREL FOR EASE OF USE
- ★ 100 HOURS BATTERY RUNNING TIME. 1 PP3 (NOT SUPPLIED)
- ★ SINGLE CHANNEL RF MICROPHONE 174.23 OR 174.56MHz
- ★ MAINS ADAPTOR FOR RECEIVER SUPPLIED ★ FM LOCK INDICATOR & VOL CONTROL ON RECEIVER. PRICE:- £119.99 FREE UK P&P

FANE COLOSSUS POWER
 VERY HIGH POWER LOUDSPEAKERS

THE COLOSSUS RANGE OF LOUDSPEAKERS
 ARE DESIGNED FOR USE IN SUPERIOR HIGH
 POWER OUTPUT SYSTEMS. ALL MODELS ARE 8 OHM
 COLOSSUS 12MB:- ★ 12 INCH ★ 450WATT R.M.S.
 ★ 900 WATTS PEAK ★ Sens 98 dB ★ Res Freq.55 Hz.
 ★ Frequency Range 40 Hz-3.5KHz PRICE £129.00
 COLOSSUS 15XB:- ★ 15 INCH ★ 600WATTS R.M.S.
 ★ 1200 WATTS PEAK ★ Sens 99 dB ★ Res Freq.35 Hz.
 ★ Frequency Range 30 Hz-1.0KHz PRICE £159.00
 COLOSSUS 18XB:- ★ 18 INCH ★ 600WATTS R.M.S.
 ★ 1200 WATTS PEAK ★ Sens 100dB ★ Res Freq.30 Hz.
 ★ Frequency Range 27 Hz-1.0KHz PRICE £183.00
 ALL MODELS ARE DELIVERED CARRIAGE FREE(UK ONLY)



OMP MOS-FET PÖWE AMPLIFIER MODULES

SUPPLIED READY BUILT AND TESTED

These modules now enjoy a world-wide reputation for quality, reliability and performance at a realistic price. Four
 models are available to suit the needs of the professional and hobby market i.e. Industry, Leisure, Instrumental and
 Hi-Fi etc. When comparing prices, NOTE that all models include toroidal power supply, integral heat sink, glass fibre
 P.C.B. and drive circuits to power a compatible VU meter. All models are open and short circuit proof.

THOUSANDS OF MODULES PURCHASED BY PROFESSIONAL USERS



OMP/MF 100 Mos-Fet Output power 100 watts
 R.M.S. into 4 ohms, frequency response 1Hz - 100KHz -
 3dB, Damping Factor >300, Slew Rate 45V/uS, T.H.D.
 typical 0.002%, Input Sensitivity 500mV, S.N.R. -
 110dB. Size 300 x 123 x 60mm
 PRICE:- £42.85 + £4.00 P&P



OMP/MF 200 Mos-Fet Output power 200 watts
 R.M.S. into 4 ohms, frequency response 1Hz - 100KHz
 -3dB, Damping Factor >300, Slew Rate 50V/uS, T.H.D.
 typical 0.001%, Input Sensitivity 500mV, S.N.R. -110dB.
 Size 300 x 155 x 100mm.
 PRICE:- £66.35 + £4.00 P&P



OMP/MF 300 Mos-Fet Output power 300 watts
 R.M.S. into 4 ohms, frequency response 1Hz - 100KHz
 -3dB, Damping Factor >300, Slew Rate 60V/uS, T.H.D.
 typical 0.001%, Input Sensitivity 500mV, S.N.R. -110dB.
 Size 330 x 175 x 100mm.
 PRICE:- £83.75 + £5.00 P&P



OMP/MF 450 Mos-Fet Output power 450 watts
 R.M.S. into 4 ohms, frequency response 1Hz - 100KHz
 -3dB, Damping Factor >300, Slew Rate 75V/uS,
 T.H.D. typical 0.001%, Input Sensitivity 500mV, S.N.R.
 -110dB, Fan Cooled, D.C. Loudspeaker Protection, 2
 Second Anti-Thump Delay. Size 385 x 210 x 105mm.
 PRICE:- £135.85 + £6.00 P&P



OMP/MF 1000 Mos-Fet Output power 1000 watts
 R.M.S. into 2 ohms, 725 watts R.M.S. into 4 ohms,
 frequency response 1Hz - 100KHz -3dB, Damping
 Factor >300, Slew Rate 75V/uS, T.H.D. typical
 0.002%, Input Sensitivity 500mV, S.N.R. -110dB, Fan
 Cooled, D.C. Loudspeaker Protection, 2 Second
 Anti-Thump Delay. Size 422 x 300 x 125mm.
 PRICE:- £261.00 + £12.00 P&P

NOTE: MOS-FET MODULES ARE AVAILABLE IN TWO VERSIONS
 STANDARD INPUT SENS 500mV, BAND WIDTH 100KHz. OR
 PEC (PROFESSIONAL EQUIPMENT COMPATIBLE) INPUT SENS
 775mV, BAND WIDTH 50KHz. ORDER STANDARD OR PEC

B.K. ELECTRONICS

UNIT 1 COMET WAY, SOUTHEM ON-SEA,
 ESSEX, SS2 6TR.

TEL.: 01702 527572 FAX.: 01702-420243

Web:- <http://www.bkelec.com> E-mail:- Sales@bkelec.com



DELIVERY CHARGES PLEASE INCLUDE AS ABOVE TO A MAXIMUM
 AMOUNT £30.00 OFFICIAL ORDERS FROM SCHOOL, COLLEGE'S
 GOVT. BODIES, PLC, ETC. PRICES INCLUSIVE OF V.A.T. SALES
 COUNTER CREDIT CARD ORDERS ACCEPTED BY POST PHONE OR FAX



'Electronics and Computing Principles V7'

New version for 2000

Principles V7'

Studying electronics or computing or just want to keep up-to-date in a easy and enjoyable way, then this is the software for you.

eptsoft.com

Personal user £99.95 +VAT.
 Education/Industry £299.95 +VAT.
 Includes unlimited multi-user site licence.

Including all the previous version six topics, many of which are revised and updated, from DC and AC theory, transistors, OpAmps, electrical, filters, digital techniques, microprocessors, programming the PIC micro controller, where the architecture and full instruction set can be explored. More than a thousand interactive electronics, electrical, mathematics topics (just five shown above), now including computer science. V7 (developed in the UK) is a huge source of electronic and computing information.

Our software is used in colleges and universities at home and overseas to support electronics and computing courses from GCSE, A' Level, City & Guilds, BTEC to Degree level. It's extremely easy to use, making it ideally suited to the novice just starting out, up to the qualified engineer who is looking to access hundreds of formulae covering practically every aspect of electronics. Telephone for a full list.

ADDITIONAL TOPICS: Computer Science from how a CD-ROM works to calculating the placement of data on a hard disk drive, to file handling and data management systems, Component Testing, Physical Science, More Electronics, Self Assessment Questions, Electronics Lab software and a completely new Component and Equipment Dictionary. A 700 slide PowerPoint presentation is included on the CD-ROM.

PLUS: Changes to graphical presentation, function selection toolbar, number formatting and printing.

eptsoft limited. Pump House, Lockram Lane, Witham, Essex. UK. CM8 2BJ.
Tel: +44 (0)1376 514008. Fax: +44 (0)870 0509660 Email: info@eptsoft.com
Switch, Delta, Visa and MasterCard payments accepted.

Cheques and P.O. made payable to eptsoft limited. UK and OVERSEAS POSTAGE ARE FREE