

To be Complete in about 32 weekly parts.

NEWNES. PRACTICAL ELECTRICAL ENGINEERING

IN THIS PART

ELECTRIC LIFTS

MAINTENANCE OF
AN ELECTRICALLY-
EQUIPPED FACTORY

CHURCH LIGHTING

THE RECORDING OF
SOUND AS APPLIED
TO TALKING
PICTURES

TIN, LEAD AND
ZINC

REPAIRS TO
ELECTRIC COOKERS

1/-

PART
20

A PRACTICAL WORK WRITTEN BY EXPERTS

STUDY
AT
HOME

YOU CAN HAVE A COLLEGE
TRAINING IN ALMOST ANY
CAREER FOR A FEW
SHILLINGS MONTHLY

IN
YOUR
SPARE
TIME

FOUNDED 1900.

32 YEARS OF SUCCESS.

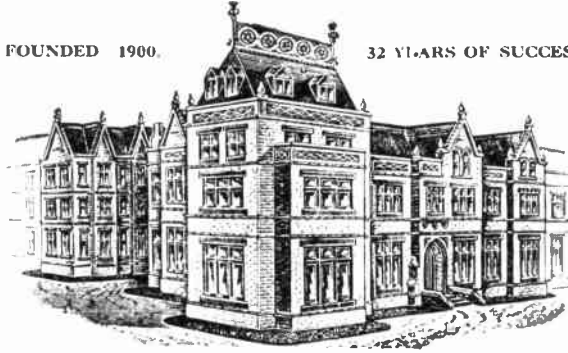

THIS IS THE BENNETT COLLEGE - - ALL OF IT

The Bennett College is not a Rented Room in a well-known street—it is a College. Over 31 years ago the Founder took as his motto what has now become a household slogan:

LET ME BE YOUR FATHER

In many trades and professions there are more vacancies than trained men to fill them. We do not profess to act as an employment agency, but our gigantic organisation certainly does tell us where the demand exists, thus enabling us to give FATHERLY ADVICE ON ALL CAREERS AND THE POSSIBILITY OF EMPLOYMENT, FREE.



J. Bennett

WE TEACH ALL
BRANCHES OF
THE FOLLOW-
ING VOCATIONS
AND SPECIALISE
IN ALL EXAM-
INATIONS CON-
NECTED THERE-
WITH.

**THE MOST SUCCESSFUL AND MOST PROGRESSIVE
CORRESPONDENCE COLLEGE IN THE WORLD**

Aviation Engineering.
Boiler Engineering.
Boiler Making.
B.Sc. (Engineering).
Civil Engineering:
A.M.I.C.E.
Quantities—Specifications.
Commercial Art

Concrete and Steel.
Draughtsmanship:
Electrical or
Mechanical.
Electrical Engineering:
A.M.I.E.E.
City and Guilds.
Engineering Mathematic.
Foundry Work.
Heat Engines.

Heating, Ventilating and
Lighting.
Internal Combustion Engines.
Machine Designs:
Theory of Machines.
Marine Engineering:
Motor.
Steam.
Mechanical Engineering:
A.M.Inst.B.E.
A.M.I.Mech.E.
City and Guilds.
Pattern Making.

Mechanics.
Metallurgy of Steel.
Mine Electrician:
A.M.E.E.
Mining (all examinations).
Motor Engineering:
A.M.I.A.E.
Municipal and County
Engineers:
M. and C.E.
Naval Architecture.
Pumps and Pumping
Machinery.
Radio Reception.
Ship Building.
Structural Engineering.
Telegraphy and Telephony.

IF YOU DO NOT SEE YOUR OWN REQUIREMENTS ABOVE, WRITE TO US ON ANY SUBJECT.

IT COSTS NOTHING TO ENQUIRE.

Also ask for Our New Book
(FREE OF CHARGE)

THE HUMAN MACHINE

SECRETS OF
SUCCESS

WE TEACH BY POST IN ALL PARTS OF THE WORLD

Note Address Carefully:

The BENNETT COLLEGE, Ltd., Dept. 119, Sheffield



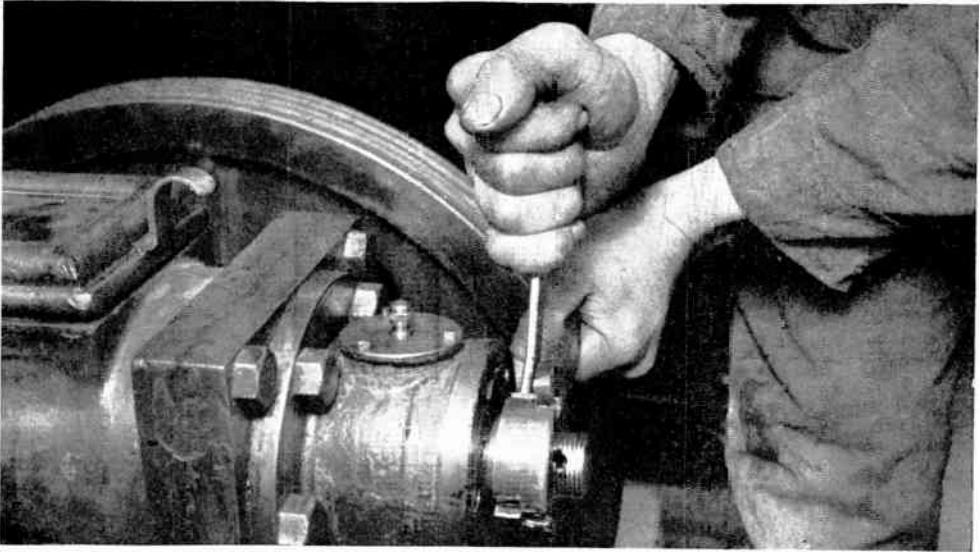

Fig. 19.—TAKING UP END PLAY IN THE WORM BY ADJUSTING THE THRUST BEARING.

The small end cap of the gear is removed, to disclose two locking collars on the end of the shaft. These collars act as a nut, and lock nut, and in the event of their slackening, are prevented from coming right off by means of a split pin. Special "C" spanners are required to adjust the thrust. To take up end play, first unlock the two collars. Then screw up the collar nearest to the gear until the correct adjustment is obtained. Then lock up the collar remote from the gear against the adjusted collar. Remember that owing to slight play which is bound to occur between the thread on the shaft and the thread on these collars, the action of locking has a slight tightening effect on the adjusting collar, so that the adjustment before locking up should permit slight end play, something less than $\frac{1}{64}$ inch.

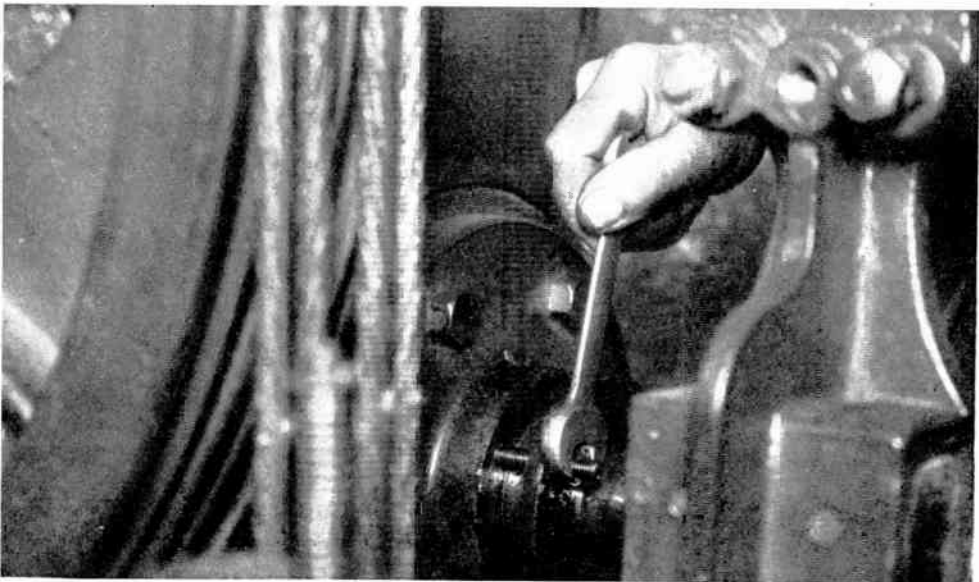

Fig. 20.—ADJUSTING THE GLAND.

A gland is fitted to most gears having the worm below the worm wheel to prevent leakage of oil round the worm shaft. Only one adjusting nut can be seen in the illustration. Actually in this, and in most other cases, there are three nuts evenly spaced round the flange of the gland. The method of adjusting is described in the text.

A

times both electrically and mechanically. On the mechanical interlock there is usually an adjustment to allow for wear, etc.

Testing the Interlock.

To test this interlock, open the main

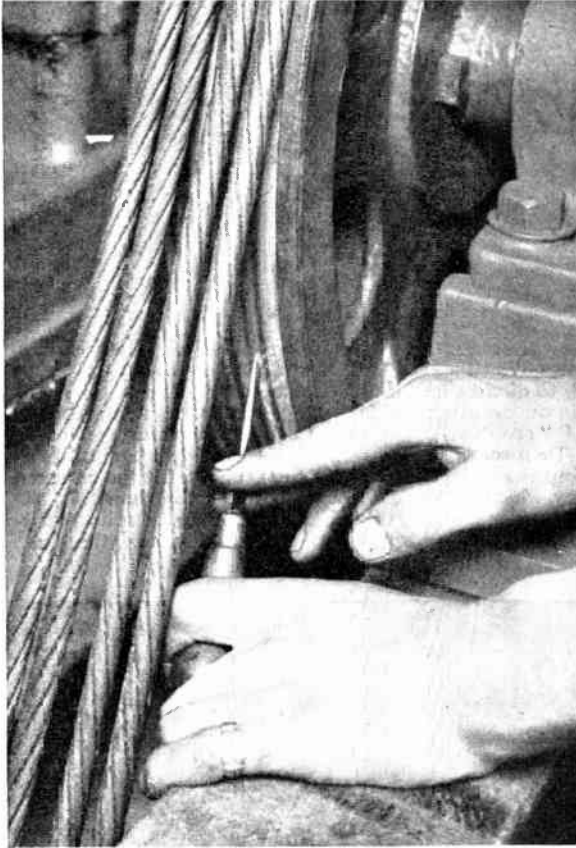

Fig. 21.—TESTING THE GROOVE IN THE VEE DRIVING SHEAVE FOR WEAR.

The current *must* be switched off. By moving the small screwdriver radially up and down the side of the groove, a ridge can be felt if undue wear has occurred.

switch, then hold in, say the "Up" direction contactor by hand. Now try and operate the "Down" direction contactor by hand. It should be impossible to make contact. If it is possible, the interlock requires adjustment. Then repeat the experiment holding in the "Down" contactor, and trying to put in the "Up" contactor. Here again, the

adjustment of the interlock will be obvious by inspection.

Electrical interlocks take the form of small auxiliary contacts, operated by the movement of the main contactor. When the "Up" direction contactor makes contact, this smaller interlocking contact is broken, and being in the circuit of the "Down" contactor, prevents this being operated. Similarly, with the "Down" direction contactor.

Purpose of Small Interlocking Contacts.

A close examination of the controller will also disclose other small interlocking contacts, which are in the control circuit, and which decide the sequence of operation of the various contactors, or prevent operation of the lift should a dangerous condition arise. For instance, an interlocking contact will be found to work in conjunction with the starting resistance. As soon as the rheostat commences to cut out the starting resistance, this interlocking contact opens its circuit. On the main contactor will be found another interlock, which when the contactor has closed circuit, will also have closed. These two interlocking contacts are in parallel in the control circuit, and their function is to prevent the possibility of the lift being started unless the whole of the starting resistance has been reinserted in the circuit. Thus, when the lift stops, the interlock on the main contactor opens circuit. If the starting rheostat returns to the "off" position, this closes the circuit so that the main contactor

may again be operated. If, however it should stick, and not return, the circuit will remain open and it will be impossible to start the lift.

Main Series Rheostat Interlock.

On some high speed direct current machines, field regulation is employed, that is to say, when all the series resistance

has been cut out of the armature circuit, an auxiliary rheostat operates, and reduces the field excitation by inserting resistance in the field circuit. An interlock will be found on the main series rheostat, which makes the circuit for the field rheostat only when the whole of the series resistance in the armature circuit of the motor has been cut out. There is also an interlock on the field rheostat to prevent operation of the lift if the field regulator has not returned to the starting position. The operation of these interlocks is obvious from an inspection. Be careful to adjust them so that they carry out the function for which they were designed. That is to say, by inspection, it is easy to see whether the interlock is intended to make circuit or break circuit when the contactor operates. Test with the current switched off by operating the contactor armature by hand.

Operation of Relays.

The relays on automatic lifts will be found to make a circuit when in the "off" position. All these contacts on the relays which are made in the "off" position are in series with the "push-button feed." When any relay is operated, this feed is broken, so that all the push-buttons are dead, and interference is prevented. It is necessary, however, so to adjust the relay that the contacts which it makes when it operates are made before the push feed is open-circuited, otherwise, chattering and irregular operation of the relay will occur. Be certain that when any relay has operated, the push-feed is definitely broken.

Time Lag Devices.

In examining the controller, you will probably find that some of the contactors

are fitted with time lag devices, for the purpose of controlling their speed of operation, either on making or breaking. These time lags are of three main types, (1) dashpots; (2) fans operating through a train of gears; (3) eddy current brakes in the form of aluminium or copper discs rotated between the poles of a permanent magnet by a train of gears.

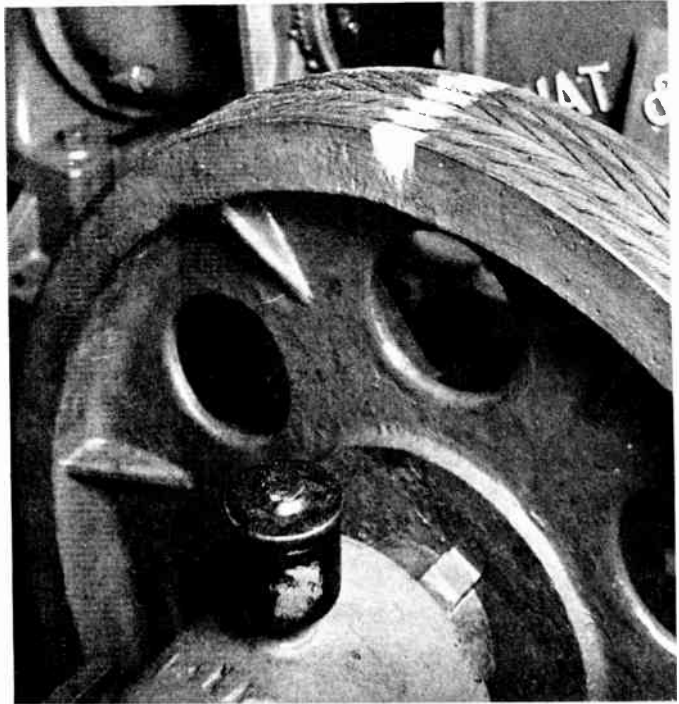

Fig. 22.—METHOD OF MARKING THE ROPES AND VEE DRIVING SHEAVE TO DETECT ROPE SLIP, SHOULD THIS BE SUSPECTED.

If no rope slip is present, the marks on the ropes will always coincide with the marks on the sheave, no matter how much the lift is run up and down the lift shaft. If the marks correspond after a trip in first one direction and then the other, the sheave may be considered to be satisfactory.

(1) Dashpots—may be of the air or oil type. In the former, motion is resisted by the suction on a piston working in a cylinder. The partial vacuum set up is relieved through an adjustable orifice, the variation of which determines the speed of operation.

Only the lightest oil should be used on the leather washer on the piston.

Oil to Use.

Oil dashpots have a cylinder filled with

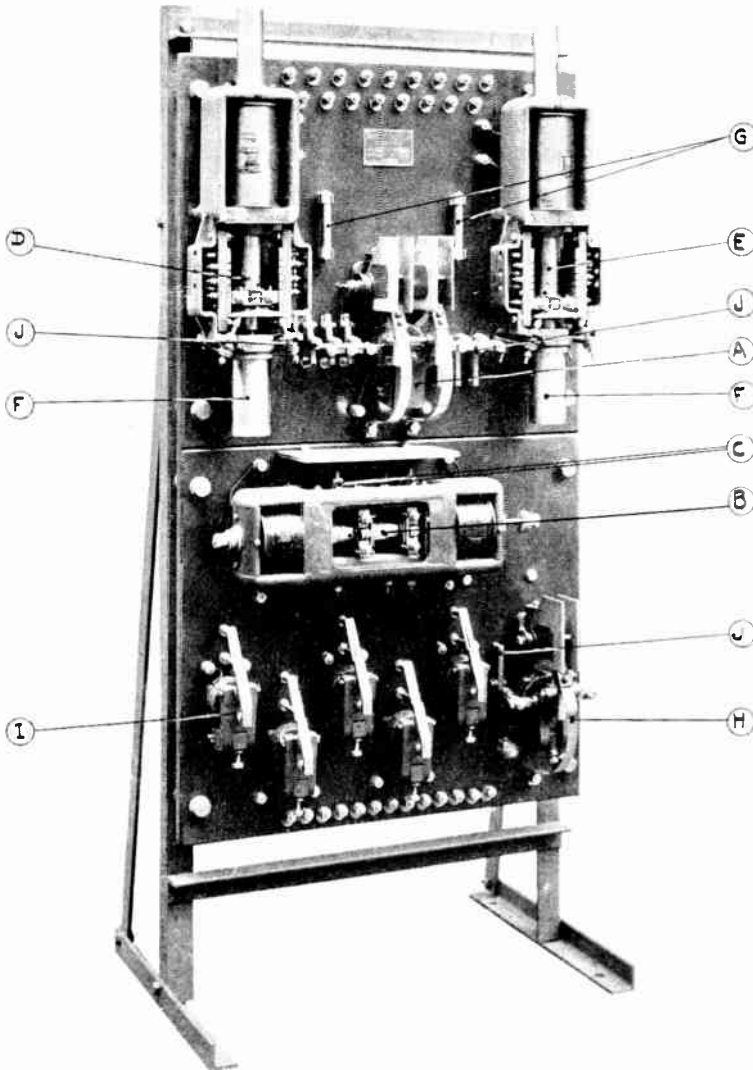

Fig. 23. - TYPICAL MODERN D.C. LIFT CONTROLLER FOR HIGH-SPEED PUSH-BUTTON LIFTS.

(a) Double pole main contactor. (b) Reversing switch. (c) Interlocking contacts to ensure that reversing switch has changed over before (a) operates. (d) Starting rheostat in series with motor armature. (e) Decelerator rheostat placing graded resistance across armature for slowing prior to stopping at floor. (f) Dashpots. (g) Control circuit buses. (h) Decelerator contactor operating in conjunction with (e). (i) Floor relays. (j) Interlocking contacts.

oil with a piston whose action is retarded by regulating the speed at which oil flows from one side of the piston to the other as it moves in the cylinder. The valve through which the oil flows is adjustable for aperture and is usually situated in the

piston. The size of the aperture determines the retardation, provided suitable oil is used. It is of the utmost importance that only the oil recommended by the makers should be employed in the dashpot. It is generally a thin oil whose viscosity is practically unaffected by normal temperature variations. Ordinary machine oil is useless except in an emergency and if used should be replaced at the earliest opportunity by oil of the correct grade.

(2) Fans.—The amount of retardation which these effect is usually determined by the angle of the blades of the fan which is adjustable.

(3) The retarding effect of eddy current brakes is usually varied by varying the number of lines of force passing through the disc either by altering

the air gap or the amount by which the magnet poles embrace the disc.

Ultimate Main Limit Switch.

Finally, in the motor-room there is the ultimate main limit. This is, as it were,

the last line of electrical defence on the lift. That is to say, should the lift travel to one of the extremes of the lift-shaft, and all the rest of the electrical machinery fail, this switch would disconnect the machine from the mains and also should disconnect the brake circuit from the rest of the machine, so that the brake will not be held off by regenerated current from the motor. This main limit should be tested every time you attend to the machine by turning the operating wheel by hand when the lift is running. It requires practically no attention, except an occasional drop of oil on the various spindles.

If you make this the last test that you carry out in the motor-room, don't forget to reset the main limit before you leave. In resetting, also be careful to turn the wheel in the

opposite direction to that in which you turned it to operate the limit. Otherwise, this limit will be entirely out of adjustment, and will cut off the lift before it reaches one extreme of travel, and will fail to

cut it off, should it be necessary, at the other extreme of travel. A later article deals with the care of those portions of the lift not situated in the motor-room, the tracing of faults, and some of the more usual repairs.

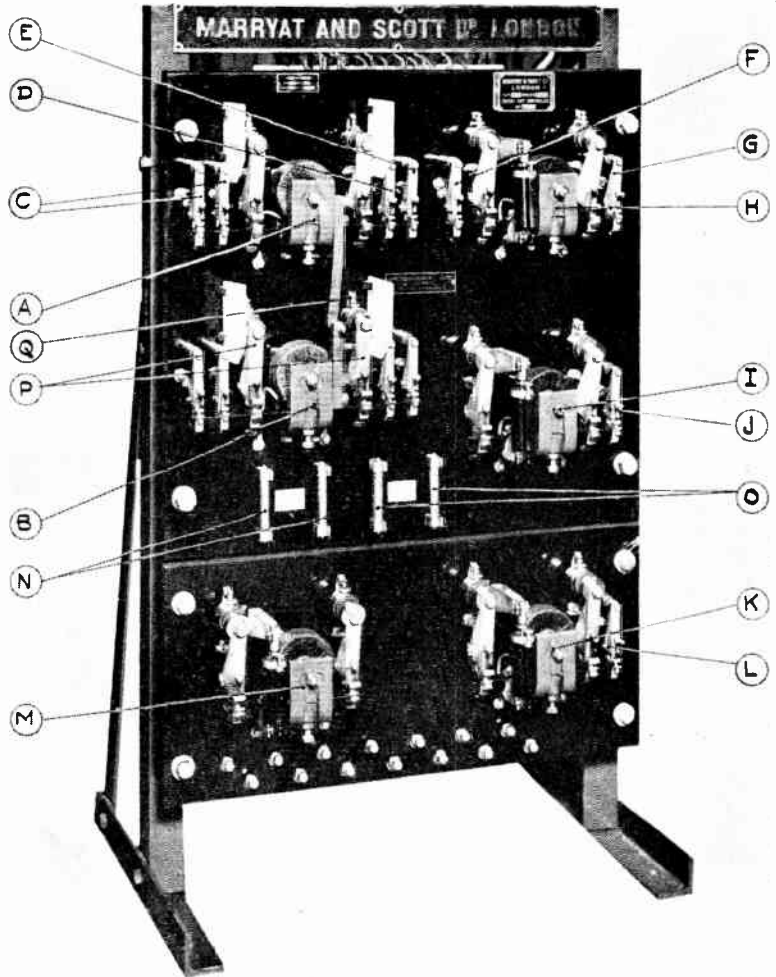

Fig. 24.—A TYPICAL MODERN A.C. LIFT CONTROLLER.

Having control and brake circuits operating on D.C. through a Westinghouse metal rectifier. (a) "Up" direction contactor. (b) "Down" direction contactor. (c) Brake coil contacts. (d) Electrical interlock on "down" direction contactor circuit. (e) and (f) Interlocks to ensure controller has returned to starting position before the motor is again started. (g) Sequence switch, making circuit for (i). (h) Rotor contactor, first step. (i) Rotor contactor, second step. (j) Sequence switch, making circuit for (k). (k) Rotor contactor, third step. (l) Sequence switch, making circuit for (m). (m) Rotor contactor, final step. (n) Rectifier circuit fuses. (o) Control circuit fuses. (p) Main "down" direction contacts. (q) Mechanical interlock between "up" and "down" direction.

MAINTENANCE OF AN ELECTRICALLY EQUIPPED FACTORY

By H. W. JOHNSON

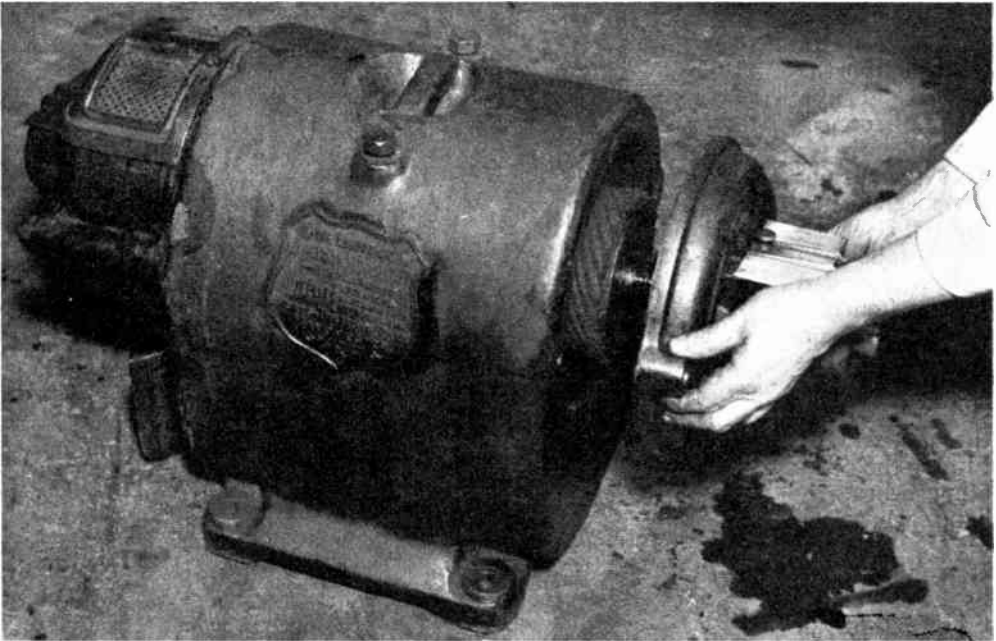

Fig. 1.—REMOVING THE END PLATE OF A MOTOR.

The set-screws which hold the end plate to the motor case are taken out and the end of the motor shaft given a jerk in an outward direction. This will move the plate from its "housing" in the case. The end plate is then drawn off the shaft. If the end of the shaft is scored or rusty, it must be cleaned up before attempting to draw off the end plate.

THE electrical equipment of a factory may be maintained in good working order most economically by a regular, careful inspection of all wiring and apparatus. By this means extensive and serious breakdowns may be avoided. Faults and defects are discovered and made good soon after they have developed.

Cleanliness.

A regular system of cleaning the equipment should be adopted. Each day should be detailed for cleaning certain parts of the

equipment, having due regard to the necessity of shutting down any of the plant, and the inconvenience which may be caused by the temporary stoppage of the manufacturing processes carried out in the factory.

The Electricity Supply Source.

The supply of electricity will generally be obtained from a public supply company, unless the factory is situated in an isolated district where there are no electrical distributing mains. In this case a

suitable generating plant would be installed in the factory and would considerably add to the work of maintenance. Occasionally it is possible to generate electricity for consumption in a factory much more cheaply than it can be supplied by the supply company, in which case the public supply could be used as a standby for use when the factory plant is shut down for overhaul.

Nature of the Supply.

The supply given may be low tension

the switchboard. There will be a gangway between the wall and the back of the switchboard to allow of safe inspection of the cable connections to the switchboard.

Access to the gangway should only be allowed to trained persons who are competent to deal with electrical apparatus.

The Equipment of the Panels.

Each generator will have its own panel. The generator panels will be fitted with a reverse current overload circuit breaker, a voltage regulating resistance, an ammeter, a voltmeter switch which is used to connect the machine to the paralleling voltmeter, and a synchronising device if the plant generates alternating current.

Power circuits and heavy current circuits will have panels which will be equipped with overload circuit breakers and ammeters. Each circuit will be controlled with a circuit breaker and the current supplied to the circuit registered with an ammeter. Lighting circuits and small current circuits will be connected to panels equipped with

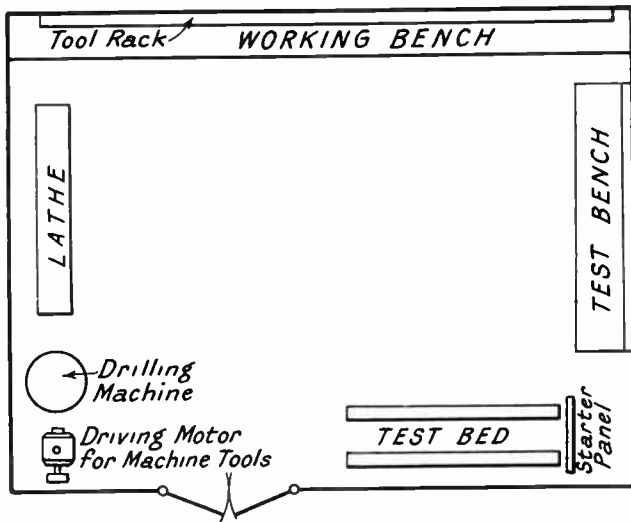

Fig. 2.—LAYOUT OF A REPAIR WORKSHOP.

3-phase 4-wire A.C., or 3-wire D.C., and in certain cases E.H.T. 3-phase A.C. In the latter cases the high voltage current could be given direct to certain of the equipment and also transformed to supply low voltage appliances and lighting circuits.

The Main Switchboard.

The main switchboard will control all the main circuits which supply current to the electrical equipment, and will distribute the current from the generating plant if this is installed.

The switchboard will consist of a number of enamelled slate or marble panels fitted on a suitable steel frame which is bolted to the floor and made secure with stays which are bolted to a wall at the back of

main switches of the knife type, and will be protected by a fuse on each pole of the circuit.

Schedule of the Wiring and Equipment of the Factory.

A schedule should be prepared for each of the main circuits supplied from the main switchboard.

The schedules will give details under appropriate headings of 1, the wiring; 2, the distribution boxes; 3, the electrical appliances; and 4, the fuses.

The layout, type of wiring and size of all the cables used for each sub-circuit.

The location of each distributing box, identifying each sub-circuit fed from the distribution boxes.

The whole of the electrical appliances

SPECIMEN INSPECTION SHEET.

APPLIANCE
DRIVE
CIRCUIT
WIRING
FUSES
SWITCHGEAR

10 *B.H.P* 400-volt *D.C.* shunt motor. *Maker's Motor No.* 1947. *Continuous rating, speed* 1,000 *r.p.m.*
Belt drive to line shafting. Pulley diameter 12 inches. *Shaft* 2 inches diameter.
No. 4 on 3 *A.* *Distributing box fixed on ground floor.*
 25 yards run of 7/.036 *V. I. R.* cable run on porcelain cleats.
 1 strand *No.* 22 *S.W.G.* tinned copper wire.
 30-ampere *D.P.* switch and fuses. *Heavy duty starter. Overload release setting* 30 amperes.

Date of Inspection.	Date of Repairs.	The Motor.		The Switchgear.		The Wiring.		Insulation Resistance of Circuit.	Running Speed of Motor.	Load Current.	Material for Repairs.	Time Taken for Repairs.
		Condition.	Repairs.	Condition.	Repairs.	Condition.	Repairs.					
—	—	Brushes sparking. Commutator dirty. Pulley end bearing worn.	New brush fitted, bushgear and commutator cleaned, bearing washed out with paraffin and oil renewed.	Starter contact studs burned. Main <i>D.P.</i> switch contacts hot.	Studs filed up. Starter arm contact adjusted and cleaned. Main switch contacts adjusted and cleaned.	In good order.	—	5 megohms.	1,040 <i>r.p.m.</i>	15 amps.	1 new bush. 1 gill of paraffin. ½ gill of oil (lubricating). 1 sheet of glass paper.	1 hour
—	—	Armature core fouling the pole shoes, brushes sparking, pulley end bearing worn.	New bearing bush fitted, bearing cleaned out, brushes bedded, commutator cleaned.	In good order.	—	Cables sagging between cleats.	Slack cable taken up.	3 megohms.	960 <i>r.p.m.</i>	25 amps.	1 bearing bush. ½ gill of paraffin. 1 sheet of glass paper.	1½ hours

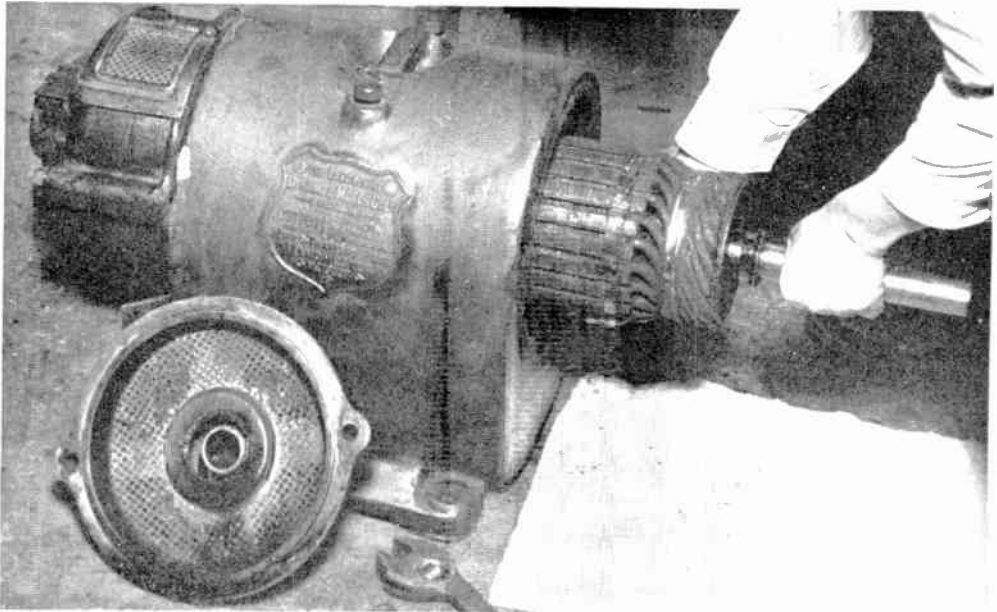

Fig. 3. — TAKING THE ARMATURE FROM THE MOTOR CASE.

The brushes are lifted in the holders. Care must be exercised to prevent the commutator falling on the pole shoes. The weight is taken by placing the hand underneath the centre of the armature core. When the armature is too heavy to be held in this manner, a sling is placed round the armature core. When the armature is completely drawn out, it should be placed on a cradle, or on a clean sheet.

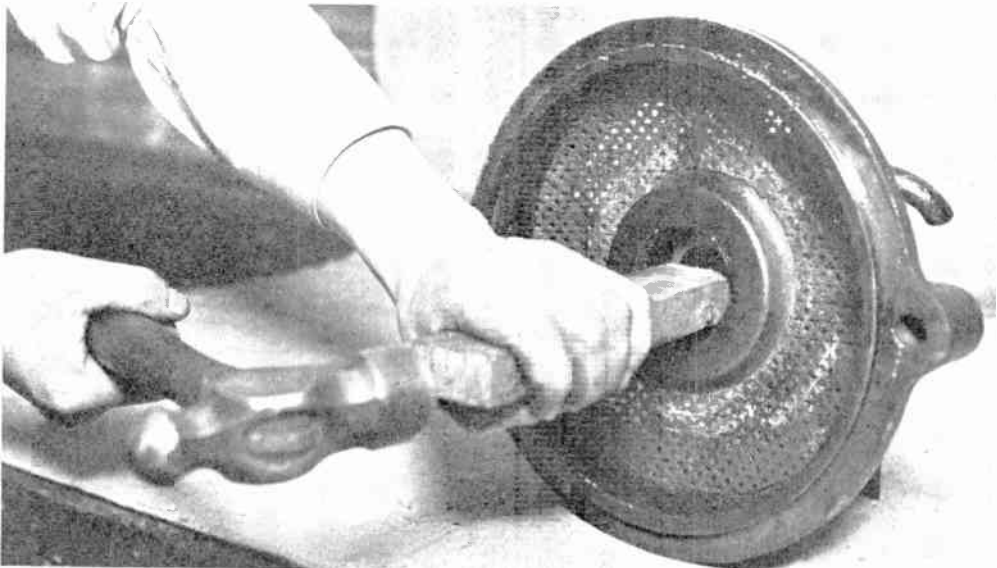

Fig. 4.—REMOVING THE BEARING BUSH FROM THE MOTOR END PLATE.

The bush screw is taken out, and the end plate of the motor reversed so that the oil rings will not foul the bush as it is knocked out. A piece of wood should be used when knocking the bush out, and on no account should the end of the bush be hit with the hammer head.

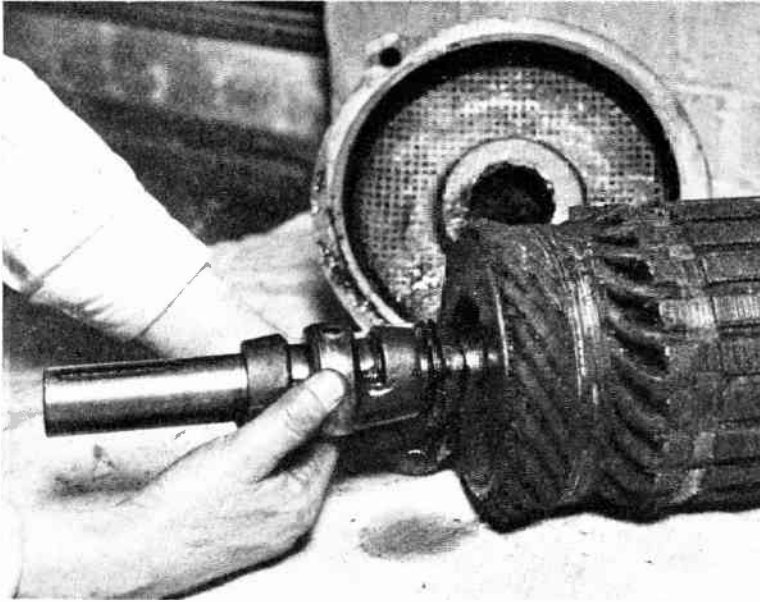

Fig. 5.—INSPECTION OF A BEARING BUSH FOR WEAR.

The shaft is cleaned, any "scores" are carefully removed with oo carborundum cloth.

The bush is placed on the shaft in the position which it occupies when the motor is in commission. If the bush will rock about on the shaft a new bush should be fitted to the bearing.

supplied from the sub-circuits, stating the current taken by each appliance and the switchgear which controls it.

The nature and size of each fuse for all the sub-circuits.

Inspection Sheets.

An inspection sheet should be drawn out for each sub-circuit.

After each inspection of a circuit and repair made to the wiring and appliances on that circuit, the following details may be recorded.

- (1) The date of the inspection.
- (2) The condition of the wiring.
- (3) The condition of the appliances and switchgear and fuses.
- (4) The performance of each appliance.
- (5) The repairs effected to the appliances, switchgear wiring, and the date on which the repairs were made.
- (6) The materials used to effect the repairs and the time taken.
- (7) A special note of any recurring "fault."

The Advantage of Using Inspection Sheets.

The output and performance of any appliance can be observed from week to week.

The maintenance work to be done is determined with accuracy. Gradual deterioration, indicating a more serious trouble, can be noticed and complete overhaul undertaken before actual breakdown occurs.

The Stores.

It is important that at all times

spare parts required to make repairs and renewals to any faulty parts of the equipment should be available. A judicious selection of materials and spare parts should be kept in stock. Details of the materials to be ordered for stock may be obtained by consulting the schedule of the equipment. A list of materials suitable would include:—

- (1) A number of each type of electric lamp in general use in the factory.
- (2) Lampholders and lamp fittings.
- (3) A selection of switches and switch contacts.
- (4) Motor brushes of various sizes.
- (5) Motor bearing bushes.
- (6) Spare armatures for motors which are vital to the continued running of the factory.
- (7) Motor starter and controller parts, especially finger contacts for controllers.
- (8) Fuse bridges for distribution boxes.
- (9) Fuse wire of various sizes.

Fig. 6 (Right).—MAKING AN INSULATION RESISTANCE TEST ON A MAIN CIRCUIT AT THE SWITCHBOARD.

The main switch is opened and the live wire from the megger testing set is connected to the "dead" contact of the switch. The earth wire is connected to the frame of the board, which is "earthed."

The handle of the testing set is turned at a steady rate so that the magneto will develop its normal voltage. When the needle of the instrument has settled down to a steady position on the scale, the value of the insulation resistance in megohms is noted.

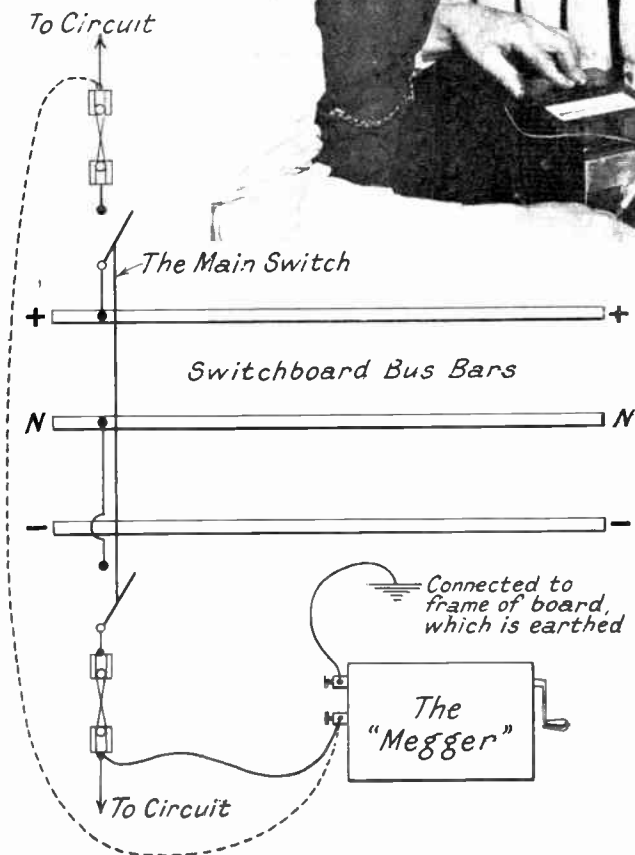
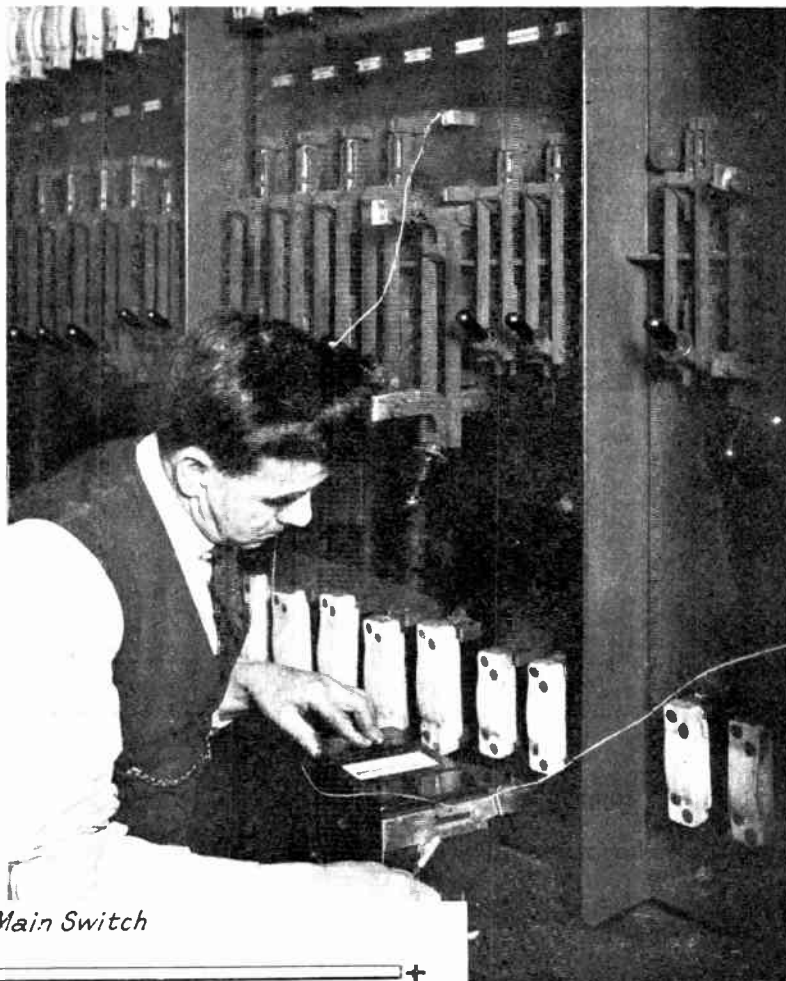

Fig. 7 (Left).—CONNECTIONS FOR THE INSULATION RESISTANCE TEST OF A MAIN CIRCUIT.

This is taken at the switchboard. The insulation resistance between each pole and earth is tested.

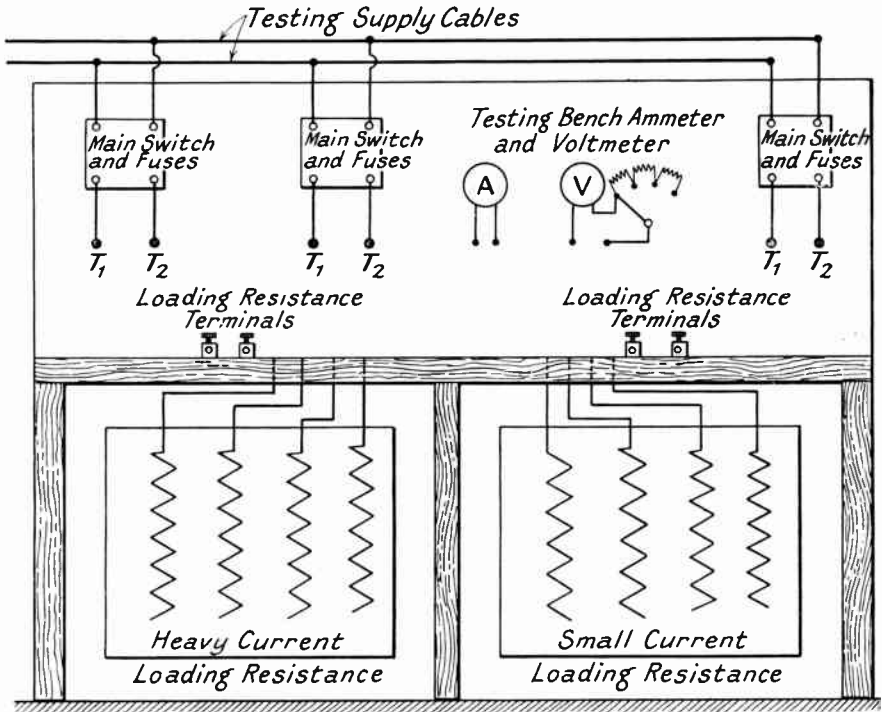

Fig. 8.—ARRANGEMENT OF A TESTING BENCH.

- (10) D.C.C. copper wire for magnet coil re-winds.
- (11) Cable for renewal and repairs of wiring.

- (12) Insulating tapes, empire cloth, press-palm and cotton tapes.
- (13) Shellac varnish.
- (14) Lubricating and paraffin oils.
- (15) Cleaning materials, glass paper.
- (16) Flexible wire for rewiring light pendants.
- (17) Materials required for the renewals and repairs to special appliances.

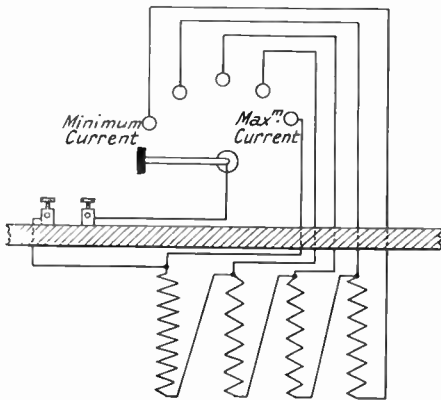

Fig. 9.—THE CONNECTIONS OF THE SMALL CURRENT LOADING RESISTANCE.

The current in the circuit is increased by moving the switch arm over towards the maximum position.

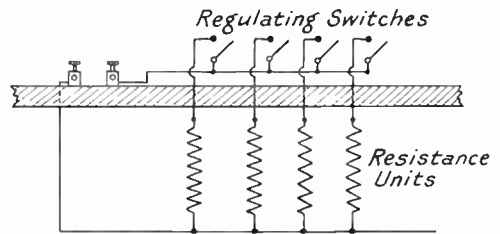

Fig. 10.—THE CONNECTIONS OF THE HEAVY CURRENT LOADING RESISTANCE.

To increase the current the switches are closed one after another. The maximum current is obtained by closing all the switches.

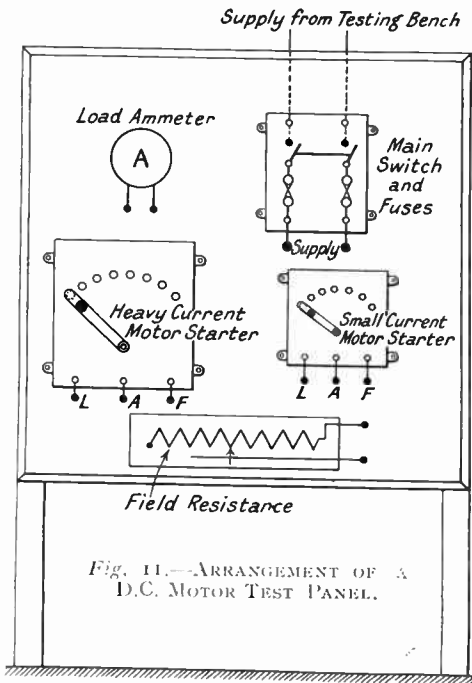

Fig. 11.—ARRANGEMENT OF A D.C. MOTOR TEST PANEL.

- (18) Sulphuric acid, if accumulators are used in the factory.
- (19) Supply of belting, belt straps and fasteners.

The Repair Workshop.

A workshop should be provided, where appliances which are down for overhaul, may be taken. The workshop should be convenient and easy of access. The layout and equipment would include working benches, a testing bench, a lathe large enough to accommodate armatures of motors which require their commutators truing up and a drilling machine. A testing bed to which motors which have been repaired may be bolted down and given a trial run before placing them in commission, would be found to be very useful.

Hooks bolted to good fixings in the ceiling over the working benches, test bench, lathe and test bed should be provided, also a set of pulley blocks for lifting heavy appliances. The hooks would be used to support lifting tackle when moving heavy motor parts and appliances. The working benches would be fitted with a

suitable number of engineers' vices and tool racks.

A convenient testing bench may be made and fitted with a stout wooden back.

Switches, circuit breakers and appliances which require mounting before they can be tested, can be fixed to this back.

Supply terminals to give a supply of testing current may be fixed at convenient points along the bench. Each set of terminals should be controlled with a switch and protected with fuses. High voltage terminals should be shielded and labelled with a danger label.

Loading resistances for use when testing the current carrying capacity of resistance starters, controller units, etc., may be placed under the test bench and their regulating switches mounted on the bench immediately above.

Ammeters and Voltmeters.

A reliable multi-range ammeter and a voltmeter fitted with multiplying resistances for various voltage ranges could be fixed to the back of the testing bench in a central position. Portable leads,

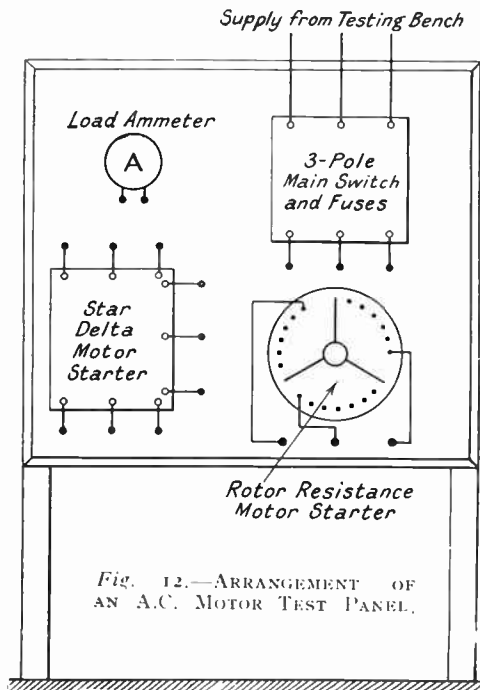

Fig. 12.—ARRANGEMENT OF AN A.C. MOTOR TEST PANEL.

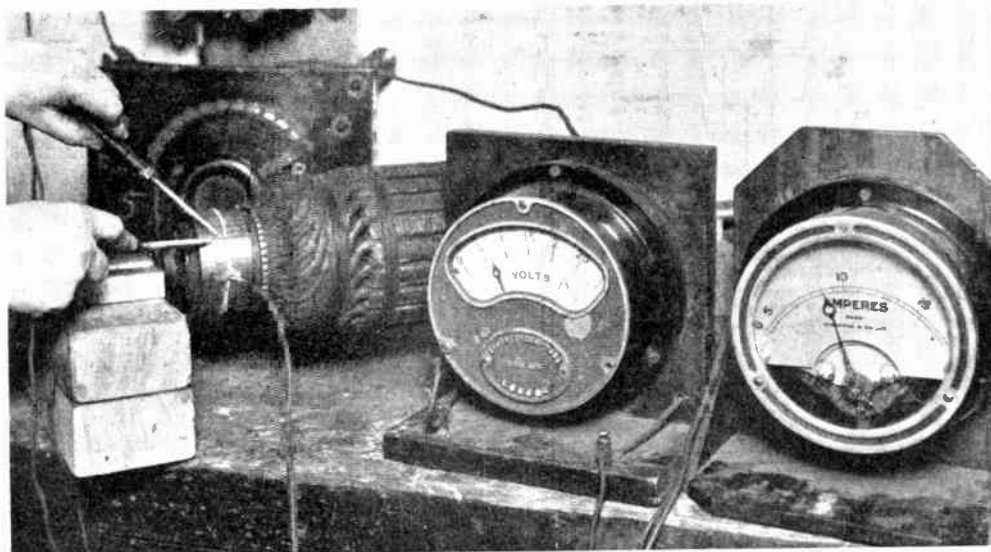

Fig. 13.—LOCATING A "SHORT CIRCUITED" COIL ON AN ARMATURE.

A "short circuited" coil will cause a certain part of the armature to get hot and the insulation of the faulty coil will begin to smoke. The motor should be immediately shut down and the armature removed from the case.

A "bar to bar" test is made to locate the ends of the faulty coil. (See also Fig. 15.)

The armature is connected in series with a suitable ammeter and loading resistance and the full load current for the motor is passed through the armature.

The "pressure drop" across each pair of adjacent commutator segments, all round the commutator, is tested. Owing to the low resistance of an armature a low-reading voltmeter will be required to read the pressure drop.

The ends of a shorted coil or section will be indicated when there is no appreciable reading on the voltmeter across any pair of segments. The ends of the faulty coil or section will be connected to this pair of segments.

long enough to reach any part of the bench, should be connected to each instrument. If the equipment of the factory is supplied with A.C. a wattmeter will be useful in order to take input tests to appliances and also to determine their power factor when required.

Insulation Testing Set.

A reliable insulation testing set will be required, and a portable milli-voltmeter. The milli-voltmeter is used when making "bar to bar" tests on D.C. armatures and when making low resistance tests.

Testing Bed for Motors.

A portion of the workshop floor should be fitted up as a test bed. For this purpose two pieces of 9 inch by 3 inch wood, 12 feet long, are bolted to the selected portion of the floor. The pieces of wood should be

parallel to each other and be about 2 feet apart. Motors which are to be given a

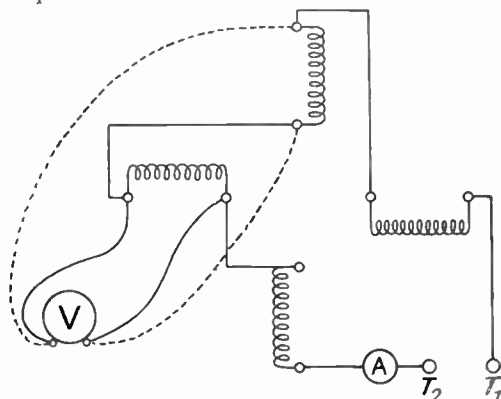

Fig. 14.—TESTING THE FIELD MAGNET COILS OF A MOTOR FOR "SHORT CIRCUITS."

A "short circuited" coil is located when the voltmeter reading across it is low compared with the voltmeter readings across the other magnet coils.

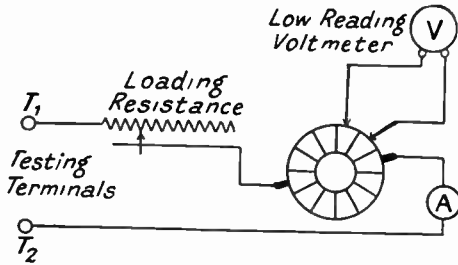

Fig. 15.—CIRCUIT CONNECTIONS FOR AN ARMATURE "BAR TO BAR" TEST TO LOCATE A "SHORT CIRCUITED" COIL.

test run are bolted to these parallel pieces of wood with coach screws. A motor-starting panel, fitted with a main switch and fuses, and two motor starters, one for small motors and one for large motors, is fixed near the test bed. Cables to give a supply of testing current are run from the supply to the panel and these connected to the main switch.

The working benches, the lathe and the drilling machine should be equipped with a good selection of tools. Drawing irons for removing pulleys and two or three "tommy" bars of different lengths will be required.

Emergency Tools.

Always have at hand an emergency set of tools in readiness for use on breakdown jobs. The list of tools would include a hammer, a cold chisel, a tommy bar, a crosscut wood saw, a Clyburn adjustable spanner, large and small screwdrivers, one pair of cutting pliers with insulated handles, a file, a piece of glass cloth and a few cleaning cloths; also a lamp-holder wired to about 5 yards of flexible for rough testing and a pair of rubber gloves.

MAINTENANCE WORK ON THE LIGHTING EQUIPMENT.

The Distribution Boxes.

The panels, fuse bridges and contacts must be cleaned regularly with a soft dry cloth.

Inspect the cable connections and tighten up any which are loose.

Examine fuses for signs of corrosion and loose binding nuts. Renew any faulty fuses with the correct size of wire.

A list of the circuits and their fusing

currents should be fixed in each of the boxes.

Adjust any of the fuse contacts which are not making good connection with the fuse bridges. A warm contact will indicate a bad connection.

Examine the joint between the door and case of the box; this should be dust-proof. A rubber joint should be provided if the distribution boxes are ironclad.

The Wiring.

Examine the wiring system in use for signs of deterioration. Tighten any loose fittings and renew any wiring the insulation of which is perished or defective. Examine earth wires for good connection. Make insulation resistance tests at regular intervals and keep records of the results obtained.

The Lamps.

Remove them from the lampholders and clean the bulbs with a soft dry cloth. A deposit of sooty grease may be removed by moistening the deposit with a weak solution of nitric acid and water, 1 part of acid to 100 parts of water.

Examine the lamp cap terminals and the brass cap of lamp. Renew any lamps having loose terminals or cap. Lamps with bulbs blackened by disintegration of the filament should be renewed. Such lamps are very inefficient.

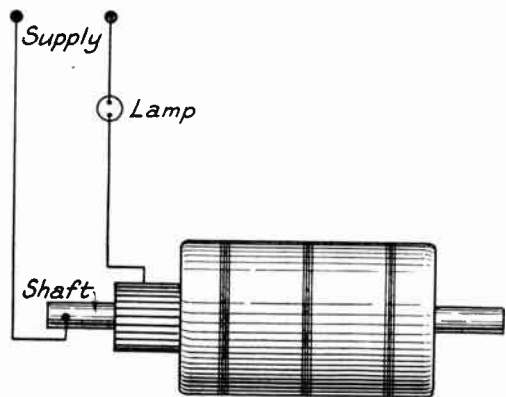

Fig. 16.—EARTH TEST OF ARMATURE.

A test lamp which will take the voltage of the supply may be used to test an armature for a "dead earth."

A "dead earth" is indicated when the lamp glows.

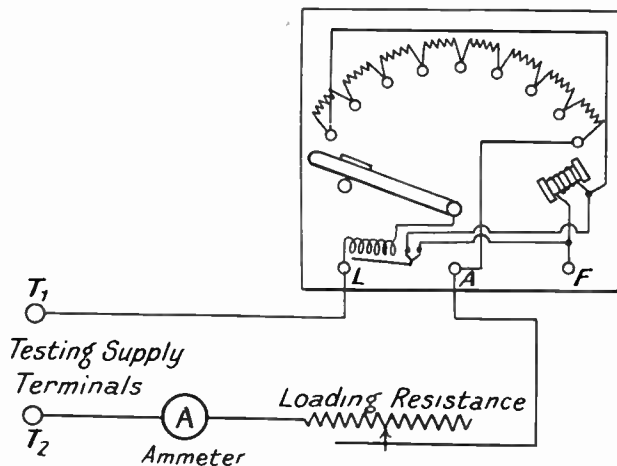

Fig. 17.—TESTING THE RESISTANCE UNITS OF A MOTOR STARTER FOR CONDUCTIVITY AND CURRENT CARRYING CAPACITY.

The loading resistance is adjusted whilst the starter arm is brought over the studs, so that the ammeter reads the correct loading capacity of the starter.

The Lampholders.

Examine the connections and the ends of the flexible wires. Any stray ends should be removed and loose binding screws tightened up.

Tighten up loose locking rings and note that the plunger contacts are at right angles to the bayonet slots in the brass ferrule or cover. Examine the cord grips and the flexible wires where they enter the cord grips.

Renew any lampholders showing signs of corrosion or serious blackening of the porcelain interior.

The Reflectors.

Clean the reflecting surfaces with warm water and a little soap and dry with a clean soft cloth. A deposit of sooty grease may be removed by using the same method as applied to cleaning lamp bulbs. Threads of fixing screws and nuts should be rubbed with a rag moistened with paraffin oil.

Glass reflectors or shades which are cracked should be immediately renewed.

Suspension Chains and Cords.

Examine chains, cords and hooks for signs of corrosion and renew any which are not safe.

Chains, cords and hooks which are subject to the action of corrosive fumes should be given a coating of acid-resisting paint.

Ceiling Roses.

The terminals and connections to them should be examined for signs of corrosion. Loose connections should be screwed up tight.

Any stray ends of flexible wire from the terminal plates should be removed.

Renew any ceiling roses whose bases are cracked. Examine the fixing screws and renew any screws which are corroded.

Screw the covers up to prevent dust entering the interior of the ceiling roses.

The Switches.

Examine the fixings and make secure any loose plugs. If the base of the switch is cracked renew the switch.

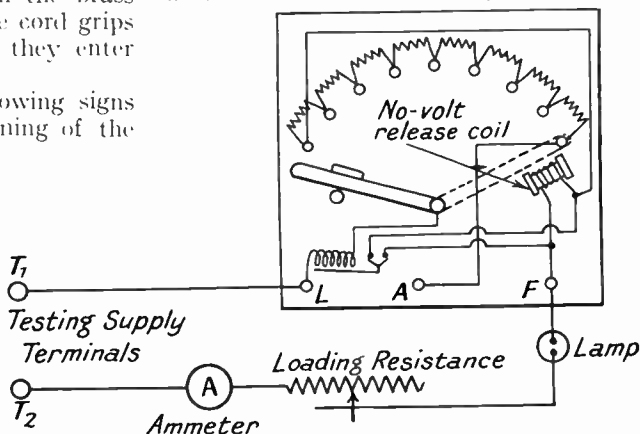

Fig. 18.—TESTING THE NO-VOLT RELEASE COIL OF A MOTOR STARTER FOR THE LEAST HOLDING-ON CURRENT.

A lamp whose resistance is high enough to prevent too large a current passing through the circuit is used. The starter arm is brought over to the running position and the loading resistance is adjusted until the starter arm is released by the no-volt release coil. The reading of the ammeter is taken.

The quick break and make action should be in good working order. Examine the spring which controls the action and renew the switch if the spring is corroded or the temper gone.

A good connection must be made between the switch blade and the contacts. The contacts can be adjusted to ensure this. Heating up of the contacts when the switch is closed indicates a bad connection. Examine the cable connections to the terminals of the switch, and screw up the binding screws which are loose.

Portable Hand Lamps.

The thorough examination at regular intervals of portable hand lamps, the plug connector and the flexible wire is most important.

Especially examine the point of entry of the flex into the plug connector for damaged insulation, and make good any defect immediately.

The whole length of the flexible wire should be examined for damaged or perished insulation. If the flexible is soaked with oil, renew it at the first opportunity.

The handle of the hand lamp should be firm and the lamp guard, if made of metal, should be perfectly insulated from the lamp and lampholder.

Lavatory, Telephone Call Box and Store Cupboard Switches.

These are generally of the automatic type. A plunger which is pressed home by the tip of the door bolt closes the switch, or a trigger which closes the

switch engages with the top of the door when the latter is opened or closed.

Examine the plunger springs and test them to see they are in working order. A little light mineral oil rubbed on the coils of the springs will prevent them from rusting. The insulation of the switch parts should be in good condition, and there should be no possibility of the bolt which operates the plunger of the switch to become "alive."

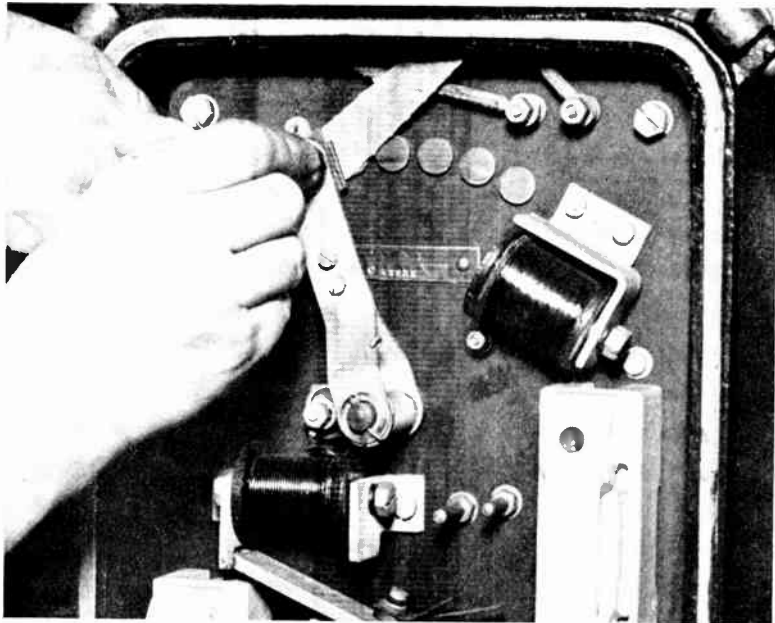

Fig. 19.—OVERHAUL OF A MOTOR STARTER PANEL.

The contact on the starter arm is cleaned by placing a strip of fine glass paper, the prepared side uppermost, on the contact studs and pulling over the starter arm.

General Repairs to Lighting Fittings and Accessories.

Defective fittings and accessories can be repaired and renovated in the repairs workshop at convenient times.

The spare parts required for these repairs may partly be obtained by dismantling fittings and accessories which have been scrapped.

MAINTENANCE WORK ON MOTORS AND MOTOR STARTER EQUIPMENT.

(1) **D.C. MOTORS.**

The Brush Holders.

Take the brushes out and thoroughly

B

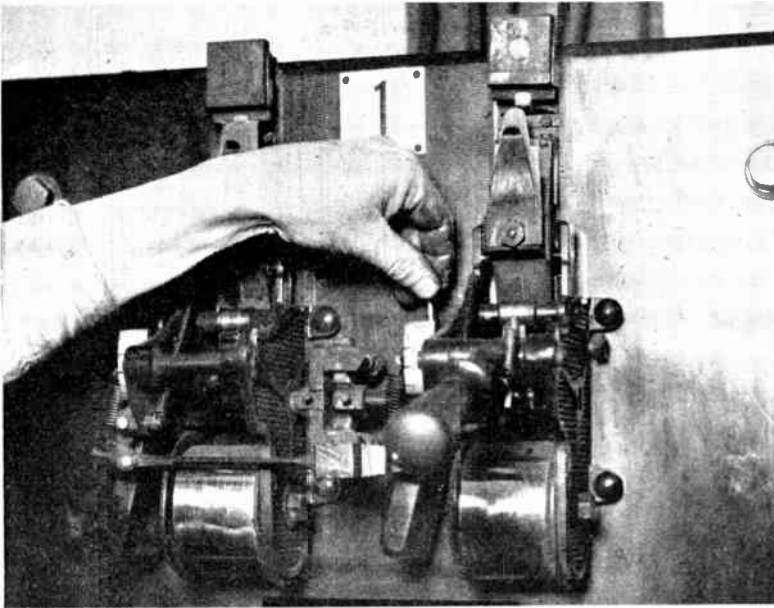

Fig. 20.—ADJUSTING THE OVERLOAD CURRENT SETTING ON A D.P. CIRCUIT BREAKER.

The tension of the springs which hold the magnet armature from the coil is increased by turning the adjusting screw.

clean the inside of the holders. The brushes should slide easily through the holders when replaced.

Adjust the tension of the brush springs. A good contact between the brushes and the commutator is essential.

The "rake" of a set of brush-holders should be all the same so that the toes of the brushes on the commutator shall be in the same straight line.

The position of the brush holders on one rocker bar should be adjusted so that they are nearer the armature end of the commutator than the brush holders on another rocker bar of the same machine. In other words, the brushes are "staggered" so that the whole surface of the commutator will be subject to the pressure of one or other brushes. This adjustment will prevent ridges being formed on the commutator.

The Brushes.

Examine the surface of the brushes which make contact with the commutator. They should be perfectly smooth, have a shiny appearance, and be shaped to

the rounded surface of the commutator. If the surfaces are rough and show signs of burning they should be "bedded" to the surface of the commutator with a piece of fine glass paper.

Examine the pig tails for good connection with the carbon of the brushes. Renew any brushes whose pig tails are loose.

Worn brushes should be replaced to prevent serious sparking.

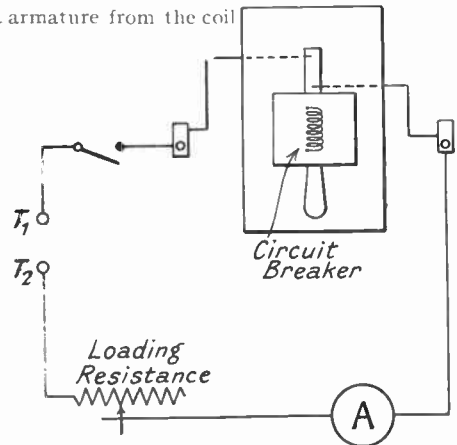

Fig. 21.—TESTING A CIRCUIT BREAKER.

A circuit breaker is tested for its tripping current, and the time taken for the switch to open, when the tripping current flows through the circuit. The scale on the circuit breaker is set for the tripping current desired, and the loading resistance adjusted until the current through the circuit trips the switch. The switch is opened, and the circuit breaker reset. The switch is now closed again, and the time noted for the circuit breaker to trip.

The difference between the tripping current marked on the scale and the current which is read on the ammeter, to open the switch, is noted.

The Brush Rocker.

Examine the brush rocker and note that it is in the best position for obtaining sparkless commutation. If the brushes are sparking, and yet are well bedded and making a good contact with the commutator, a readjustment of the brush rocker position may stop the sparking.

The best position will be found by trial, giving the brushes first a small "backward lead" and then a small forward lead from their existing position. When the best position is found screw up tightly the brush rocker binding screw.

The Commutator.

Remove all traces of dirt and grease from the surface of the commutator with a cloth soaked with paraffin oil.

Pick out all the copper dust and greasy deposit from between the commutator segments with the sharp tang of a file.

Mica insulation which is standing up above the surface of the segments should be cut down with a sharp knife.

A blackened commutator may be cleaned with a small carborundum block which is pressed on the surface of the commutator when the motor is running. Make sure to remove all traces of copper dust, after cleaning with a dry cloth.

Removing a "Flat" from Commutator Surface.

To remove a "flat" from the surface of a commutator in a satisfactory manner, the armature must be taken out of the motor frame and mounted between the centres of a lathe. The surface is turned

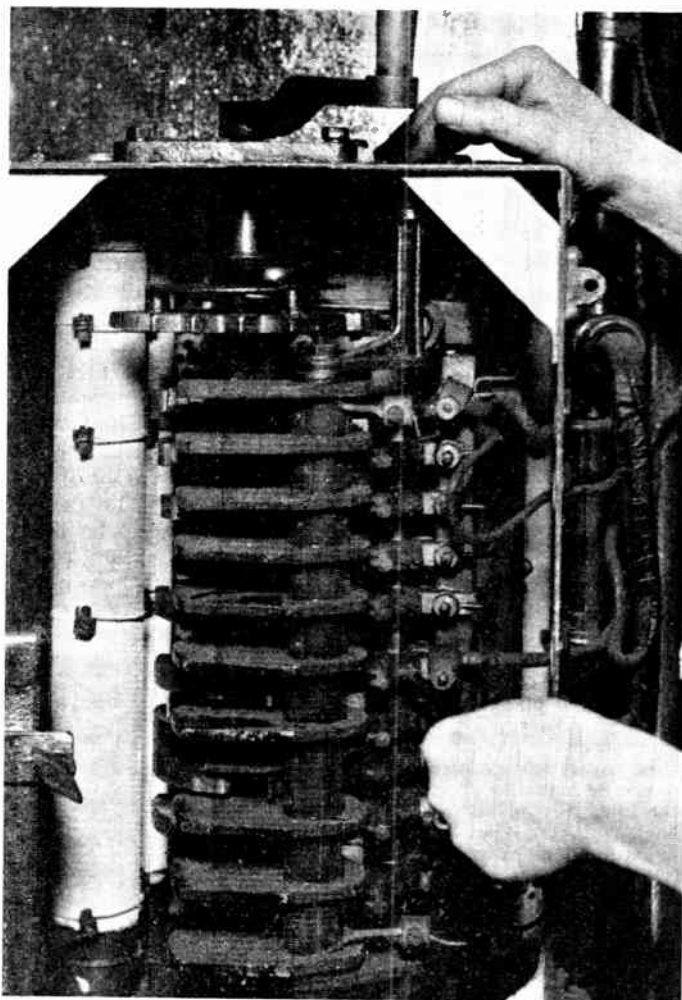

Fig. 22.—OVERHAUL OF A CONTROLLER.

The connections of the cables to the terminals are tightened up and the contact fingers adjusted and cleaned up.

up with a keen tool which is firmly fixed in the slide rest. Do not take heavy cuts, as the tool may dig in and cause the bars to be displaced, and also produce heavy burrs on the edges of the bars. These burrs will be difficult to remove. The mica insulation will not be cut away if a heavy cut is taken, but it will bend over between the surface of the commutator and the edge of the cutting tool. When all traces of the "flat" have been removed the surface must be made perfectly smooth with a fine grained carborundum

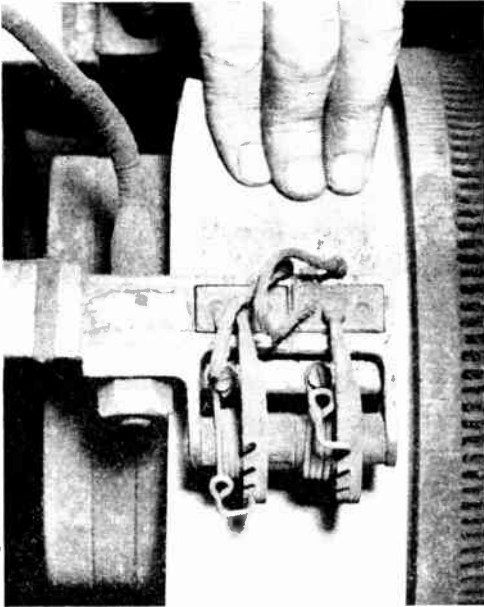

Fig. 23.—BEDDING THE BRUSHES OF A MOTOR.

A strip of fine glass paper is placed between the commutator and the ends of the brushes. The prepared side of the glass paper is uppermost.

Tension is placed on the brush to be bedded and the glass paper pulled in the direction of rotation of the motor. The glass paper is kept close to the surface of the commutator as it is pulled under the brushes. The tension of the brush is released and the glass paper pulled back again into its original position. The whole operation is repeated until the face of the brush is perfectly smooth and is the shape of the curvature of the commutator.

block or a piece of fine glass paper fixed to the end of a block of wood shaped to the curved surface of the commutator.

Remove all burrs from the edges of the bars with a smooth file and then scrape out all the copper dust which may be embedded in the surface of the mica insulation.

The Bearings.

Test the bearings for wear. This is best done by lifting each of the ends of the motor shaft in turn, first in an upward direction and secondly in a horizontal direction, noticing if there is any movement in either direction of the shaft in the bearings. A worn bearing should be immediately attended to. A solid bearing will have to be replaced with a new

bush, and the wear taken up if the bearing is in two halves.

The Lubrication.

A light mineral oil with a good body should be used. Examine the oil rings and note that they move round over the shaft, carrying oil from the well with them. Oil should not leak out from the ends of the bearings. A worn bearing is generally the cause of this happening.

Sight feed lubricators must be adjusted to give enough oil drip into the bearings. Examine the oil holes and clear them of any dirt which may have collected in them.

The bearings should be washed out with paraffin oil about once a month and a supply of new oil given to the bearing.

The dirty oil which has been run out may be filtered and used again with discretion.

Grease cups should be examined regu-

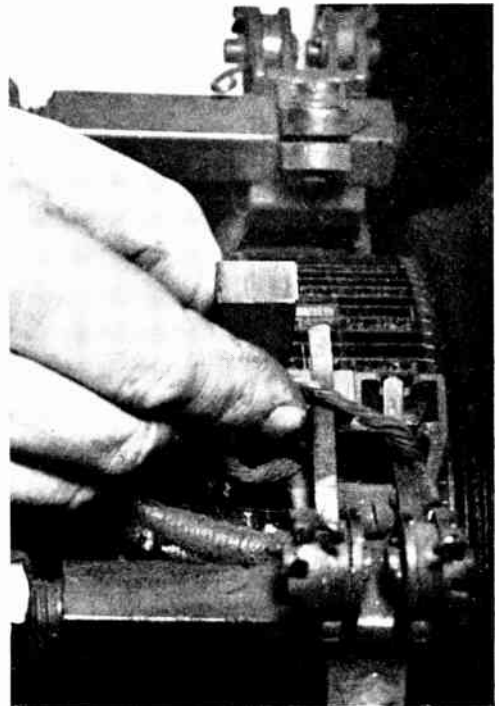

Fig. 24.—THE BRUSH HAS BEEN TAKEN OUT OF THE HOLDER FOR CLEANING AND EXAMINATION OF THE FACE WHICH BEDS ON THE COMMUTATOR SURFACE.

larly. The spring cap which forces the grease into the bearing should be in working order.

The Armature Windings and End Connections to the Commutator.

The end connections of the armature coils to the commutator segments are subjected to vibration, which makes them brittle. Examine the connections carefully and make good immediately any which have become loose or broken.

The insulation of the armature windings should be examined for signs of deterioration; the insulation may have become hard. In such cases take the armature out of the case and revarnish the windings with special armature varnish.

Examine the steel binding wires round the core which hold the armature windings in the slots. Renew any which have broken or become adrift.

The Field Magnet Windings.

A careful examination of the condition of the insulating tape covering the magnet coils and the electrical connections of the windings. If the insulating tape is hard and brittle the coils should be re-insulated with a new winding of cotton and Blackley tapes. The work entailed in doing this is extensive, and a convenient time should be chosen to shut the motor down to carry out the work.

Re-insulating the Magnet Coils.

Disconnect the motor drive and take the pulley or pinion off the motor shaft. Remove the motor end plate and draw the armature out of the case. Place armature in a safe place and cover it over with a sheet so as to exclude dust and grease. The laminated shoes on the ends of the magnet poles are unscrewed and removed. The pole shoes should be marked to ensure them being replaced in the correct positions. Now disconnect the magnet coils from each other and from the terminals. Identify each connection which is broken with a suitably marked label. Take out the wedges between the magnet coils and the magnet poles. The coils may now be taken off the poles. The defective insulation is then stripped. Examine the windings and note that the cotton covering of the wires is not charred



Fig. 25.—OVERHAULING THE CONNECTIONS TO THE MAGNET WINDINGS OF A SOLENOID "BRAKE" WHICH ACTS ON THE SHAFT OF A MOTOR.

It is essential that the motor must stop immediately the current is switched off. See Fig. 20 for details of a brake fitted to the drawing frame in a cotton mill.

or damaged. Retape the windings with white cotton tape and give them a coat of shellac varnish. Finish off with a winding of Blackley tape. Now replace the magnet coils on their respective poles and fix them in position with the wedges. The pole shoes are then screwed tightly in their correct positions. Reconnect the magnet coils and carefully replace the armature. Replace the motor end plate and check the air gap distances between the pole shoes and the armature. If these distances are correct the pulley or pinion is fixed in its original position on the armature shaft. Give the motor

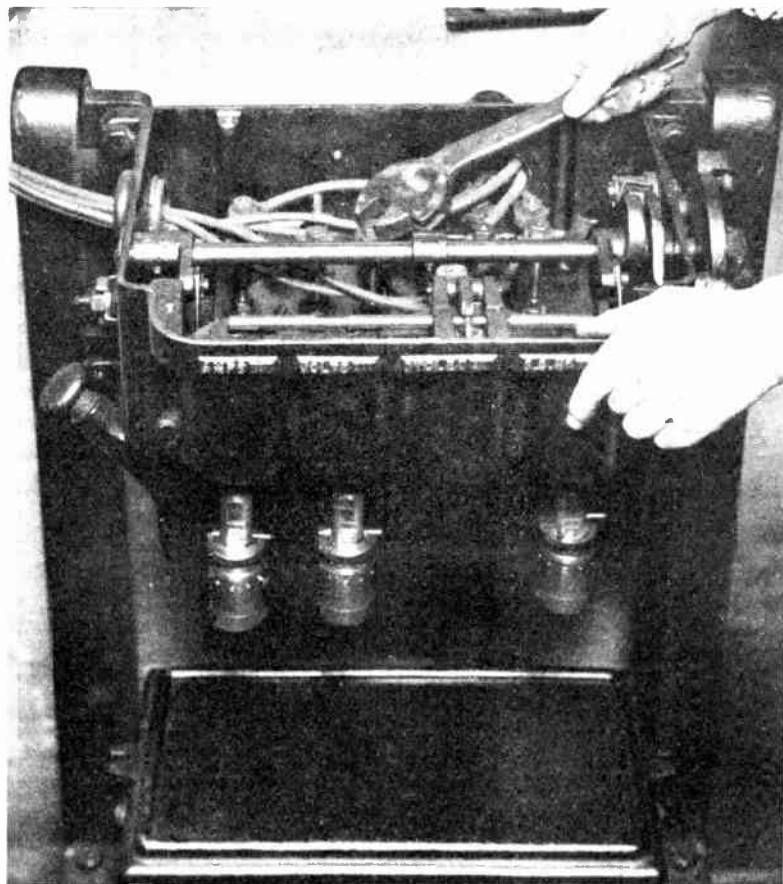

Fig. 26.—OVERHAULING AND SCREWING UP THE CONNECTIONS TO AN AUTO TRANSFORMER STARTING SWITCH PANEL WHICH CONTROLS A THREE-PHASE A.C. MOTOR.

Note the time lag devices fitted to the switch. These delay the overload action of release coils which open the switch.

a trial run before reconnecting the motor drive.

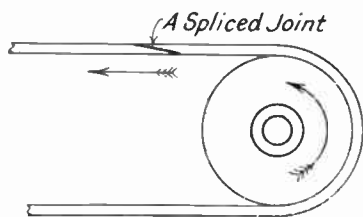

Fig. 27.—THE BELT IS RUNNING IN THE RIGHT DIRECTION SO AS TO PROTECT THE JOINT FROM BREAKING.

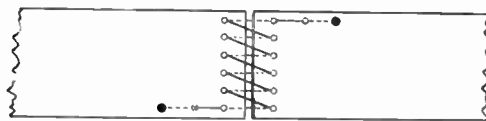

Fig. 28.—A LACED BUTT JOINT FOR A BELT.

The Terminals and Terminal Box.

Examine all the connections to the terminals and tighten any which have worked loose. The insulation between the terminals and the terminal box must be carefully inspected. Remove any traces of dirt or dust which may have collected on the insulation.

The Earth Wire.

Inspect the condition of the earth wire and make sure a good connection is made with it to the case of the motor, and to the general earth of the factory installation.

(2) A.C. MOTORS

If the factory is equipped with A.C. motors the majority of them

will be of the induction type.

The maintenance of this type of A.C. motor is much less than that of the D.C. motor because they are more robust mechanically, there is no commutator, and only low-voltage currents circulate through the motor.

The Squirrel-cage Motor. The Stator.

Examine the condition of the insulation of the stator coils, occasionally giving them a coat of insulating varnish. The stator core plates should always be tightly clamped. Sometimes these work loose due to periodic vibrations which may be set up in them by the A.C. current passing through the stator windings.

Any oil which may have been thrown out from the bearings on to the windings must be removed.

The Rotor.

Carefully examine the joints between the rotor conductors and the metal end rings. Large currents circulate through these joints, and a loose or weak joint will not pass its due share, which will cause the current through the remaining joints to be increased, and probably cause the complete breakdown of the rotor.

The Bearings.

Inspect the bearings for signs of wear. This is most important, as the air gap between the stator core and rotor is very small, and an appreciable amount of wear in the bearings will cause the rotor to foul the stator core. Always renew the

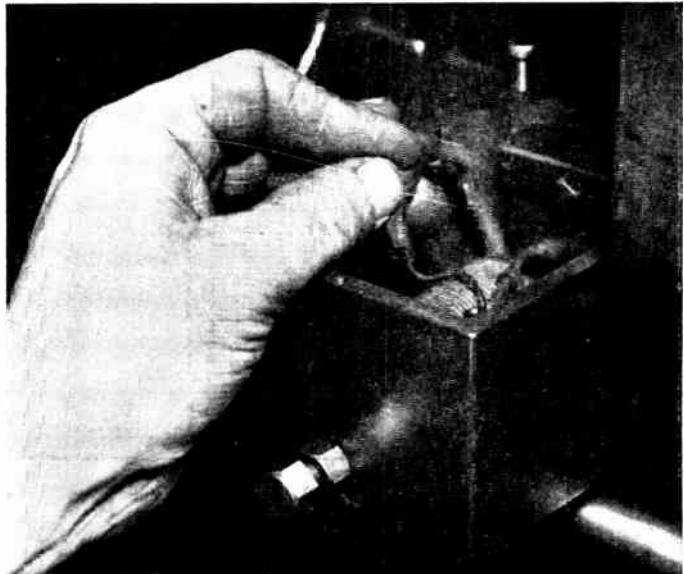

Fig. 29.—EXAMINATION OF THE CONNECTIONS TO THE MAGNET WINDINGS OF AN ELECTRIC STOP MOTION FITTED TO THE DRAWING FRAME IN A COTTON MILL.

When the cotton sliver which is passing through the roller breaks, the rollers come into contact with each other. This contact closes an electrical circuit and the magnet windings are supplied with a current. The magnet armature is attracted to the core, and the "stop motion" put into operation, which stops the machine.

bearing bushes when the wear in them becomes appreciable.

WOUND ROTOR MOTORS.

The Sliprings.

The connections to the rings from the rotor windings should be tight. A loose connection will materially affect the running of the motor. Keep the rings perfectly clean and free from oil.

The Brushes.

The tension of the brush springs must be enough to allow of the brushes making a good rubbing contact on the sliprings. The brushes should slide freely through the brush holders and should be perfectly bedded to the curvature of the sliprings. Tighten any loose connections of the pig tails to the brush holders and loose cable connections from the brush holders to the rotor starting resistance.

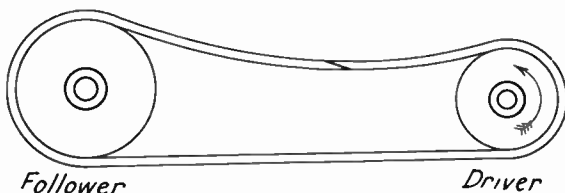

Fig. 30.—THE CORRECT DIRECTION FOR A BELT DRIVE. THE SLACK SIDE OF THE BELT IS UPPERMOST.

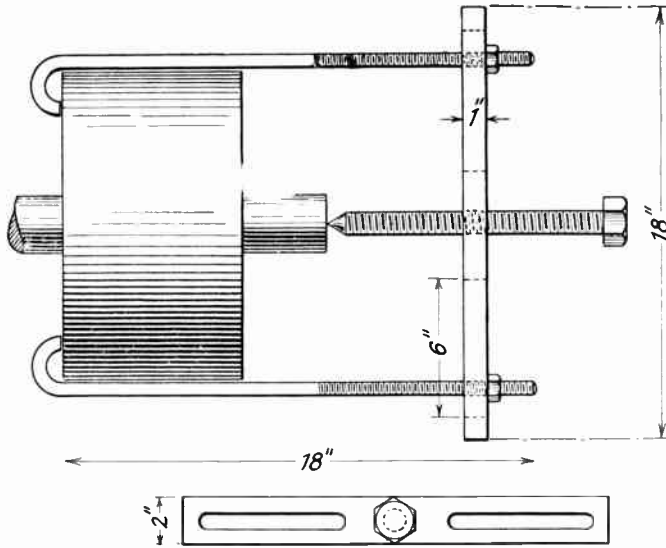

Fig. 31.—USING PULLEY DRAWING IRONS.

A pulley which is fast on a shaft may be drawn off by fixing drawing irons to it. Screw up the set screw in the centre of the draw bar until the end of it bears up against the centre of the motor shaft. In turn, screw up the nuts on the hook spindles, tapping the pulley with a hammer at the same time.

The Brush Lifting and Slipping Short-circuiting Gear.

Examine the operation of the slide bar which lifts the brushes and short circuits the sliprings; adjust and clean the short-circuiting contacts of the switch if necessary.

General Maintenance of Wound Rotor Motors.

In addition to the attention to the sliprings and brush gear, always examine the bearings for signs of wear, the condition of the insulation of the stator windings and all stator connections to the terminals of the stator.

THE SWITCHGEAR.

Cleanliness is the most important factor in the maintenance of switchgear. A dirty switch contact will introduce a resistance in the circuit and will reduce the current in the circuit to a low value, thus preventing the appliance from operating correctly. The dirty switch contact will also heat up and produce arcing at that point. This will cause the switch contacts and blade to be burned, and make the switches useless.

Motor - starting Resistances.

The contact studs should be regularly cleaned with fine glass paper, and a trace of light mineral oil rubbed over them.

The starter arm contact tension spring should be examined and the tension adjusted if insufficient. This contact is cleaned by inserting a piece of fine glass paper between the studs and the contact, the prepared surface of the glass paper being uppermost. The arm is then moved backwards and forwards over the contact studs.

The spindle and the spring which forces the starter arm into the "off" position must be quite clean and a touch

of light mineral oil given to them. Test the starter arm to make sure it will return to the "off" position when the current is switched off to the motor.

The "settings" of overload release coils should be checked and adjusted to the correct overload current.

Test the working of the overload release. The short circuiting contacts and contact blade should be perfectly

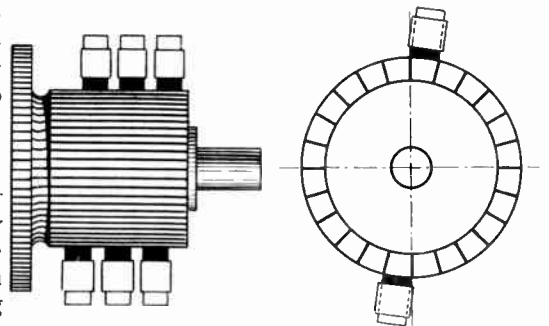

Fig. 32.—HOW THE BRUSHES ARE "STAGGERED" ON THE COMMUTATOR TO OBTAIN UNIFORM WEAR OF ITS SURFACE.

Fig. 33.—THE BRUSH HOLDERS ARE FIXED DIAMETRICALLY OPPOSITE TO EACH OTHER.

clean. Examine the connections to the terminals and tighten up any which may be loose. The earth wire should be properly connected to the starter case.

The operating handle should be in good condition and firm. Examine the insulating sleeve between the starter arm and the handle. This must be in good order.

Main Switches and Circuit Breakers.

The make and break action of main switches should be carefully examined, and the operating springs made good if they are faulty. Clean the contacts and contact blades and rub them over with a trace of light mineral oil.

Examine the trip levers of circuit breakers. The spindles on which they turn should be lubricated, and the springs which pull them into their positions should be in good condition. Check the current "settings" of the scale and adjust the setting spring if required. Keep the contacts and contact blades clean, and note that the carbon break is in good order.

Controllers.

The contact fingers should be examined and any of them renewed which are burned. Adjust the springs and test the fingers for making good contact with the segments. Clean the segments with fine glass paper and remove any traces of metal dust which may have lodged between them on the barrel.

The bearings of the barrel should be lubricated with a little light mineral oil. Tighten up any cable connections which have worked loose.

Auto Transformer Starting Switches.

Examine the working of the dash pot which delays the action of switching over from the starting to the running position of the switch. Inspect the cable connections to the terminals and tighten up any which are loose. Take the cover off the transformer tank and examine the condition of the oil in which the windings are immersed. The insulation on the wires to the transformer windings should be in good condition.

MOTOR DRIVES.

The motor drives should be regularly inspected and kept in good order. An inefficient motor drive will produce bad work and considerable power transmission losses.

Belts should be kept clean and dry. No grease or oil should be allowed to collect on their driving faces.

A leather belt is more durable if the flesh side is in contact with the pulley, and the driving power will be as good as the smooth side if it receives a coating of dubbin and a coating of linseed oil once a year.

Belt joints should be regularly inspected and kept in good condition.

A belt having a spliced joint should always run over the pulleys in such a direction that the lower edge of the joint which is in contact with the pulley faces will not be turned back.

Laced joints should be kept tight, and the laces renewed from time to time.

Leather belts should not be used in damp situations; a cotton belt is much more durable and efficient.

Adjustment of Wheel and Pinion Drives.

Wheel and pinion drives should not be too deep in mesh or they will be noisy, will produce excessive wearing in the bearings and cause considerable loss of power.

Where a raw hide or compressed paper pinion is used in a drive no oil or moisture should be allowed to collect on the pinion. Lubricate with black lead or French chalk.

Chain drives should be lubricated frequently with a heavy oil. Arrange the drive so that the tight side of the chain is uppermost.

Make sure that the alignment of the driver and driven wheels is correct. If it is not correct there will be a twisting action in the chain which will ruin it in a short time.

Worm and wheel and helical gear drives often run in an oil bath. Examine the condition of the oil frequently and clean out the bath from time to time.

INSULATION RESISTANCE TESTING.

An insulation resistance test should

be made once a week on each of the main circuits fed from the switchboard.

The test should be made between each pole of the main circuits and earth. Make sure to open the main switch of each circuit before making the test. A permanent record should be made of the results obtained. This will help to decide the cause of a low test which may be obtained on any particular circuit, by consulting previous values of the test obtained on that circuit.

If a low test is obtained on a main

circuit, make separate tests of each of the circuits fed from the distributing box, which is supplied by the main circuit. In this manner the faulty final circuit may be located and the wiring or faulty appliance made good.

In conclusion, to maintain any special electrical appliances with which the factory is equipped consult the maker's specification and general instructions relating to the appliance, in addition to applying the general methods of maintenance described in this article.

QUESTIONS AND ANSWERS

What tools should be kept in readiness for use in an emergency ?

- A hammer.
- A cold chisel.
- A tommy bar.
- A crosscut wood saw.
- A Clyburn adjustable spanner.
- Large and small screwdrivers.
- Cutting pliers with insulated handles.
- A file.
- A piece of glass cloth and a few cleaning cloths.
- A lampholder wired to about 5 yards of flexible for rough testing.
- A pair of rubber gloves.

How should a circuit breaker be tested for its tripping current ?

- (1) Set the scale on the circuit breaker for the tripping current required.
- (2) Adjust the loading resistance until the circuit breaker is tripped.
- (3) Note the ammeter reading when the circuit breaker trips. It should agree with the setting on the scale.
- (4) With the switch open reset the circuit breaker.
- (5) Close the switch.
- (6) Note the time taken for the circuit breaker to trip. It should not exceed the scheduled time limit for the circuit breaker under test.

How would you remove a "flat" from a commutator ?

- (1) Take the armature out of the motor frame.
- (2) Mount it between the centres of a lathe.

(3) Turn up the surface with a keen tool, taking care not to take heavy cuts. This will remove all traces of the "flat."

(6) Smooth the surface with a fine-grained carborundum block or a piece of fine glass paper fixed to the end of a block of wood shaped to the curved surface of the commutator.

(7) Remove all burrs from the edges of the bars with a smooth file.

(8) Scrape out any copper dust or turnings from between the segments.

How should bearings be tested for wear ?

Lift each of the ends of the motor shaft in turn first in an upward direction, and secondly in a horizontal direction, noticing if there is any movement in either direction of the shaft in the bearings.

How often should plain bearings be washed out ?

About once a month and a supply of new oil given to the bearing.

What are the points to watch in the maintenance of a wound rotor motor ?

- (1) The sliprings and brush gear.
- (2) Bearings.
- (3) Condition of the insulation of the stator windings.
- (4) All stator connections to the terminals of the stator.

In what direction should a belt with a spliced joint run ?

It should always run over the pulleys in such a direction that the lower edge of the joint which is in contact with the pulley faces will not be turned back.

LIGHTING IN CHURCHES

By E. H. FREEMAN, M.I.E.E.

THE principles involved in church lighting are the same as those for any other building, but their application involves special problems, and, as in the case of domestic lighting, the personal preferences of the authorities concerned must usually be a deciding factor in selecting one or other of the various alternative schemes, any one of which might provide adequate illumination.

The plan and sections show an imaginary church, which can be used to illustrate the problem. As in other cases, the first step is to work out the total volume of light required, and it is best to consider

the nave and aisles separately in case the system adopted requires independent lighting units.

Calculating the Number of Lumens Required.

For the nave we have an area of 20 feet by 70 feet, or 1,400 square feet, and 4 to 5 candle feet will be sufficient. The nett lumens will thus be about 6,000 to 7,000. The allowance for losses is difficult to estimate as church interiors vary very widely. Whilst some may have clean walls of light stone others may have brick walls darkened with age and old oak roofs with little or no reflective value.

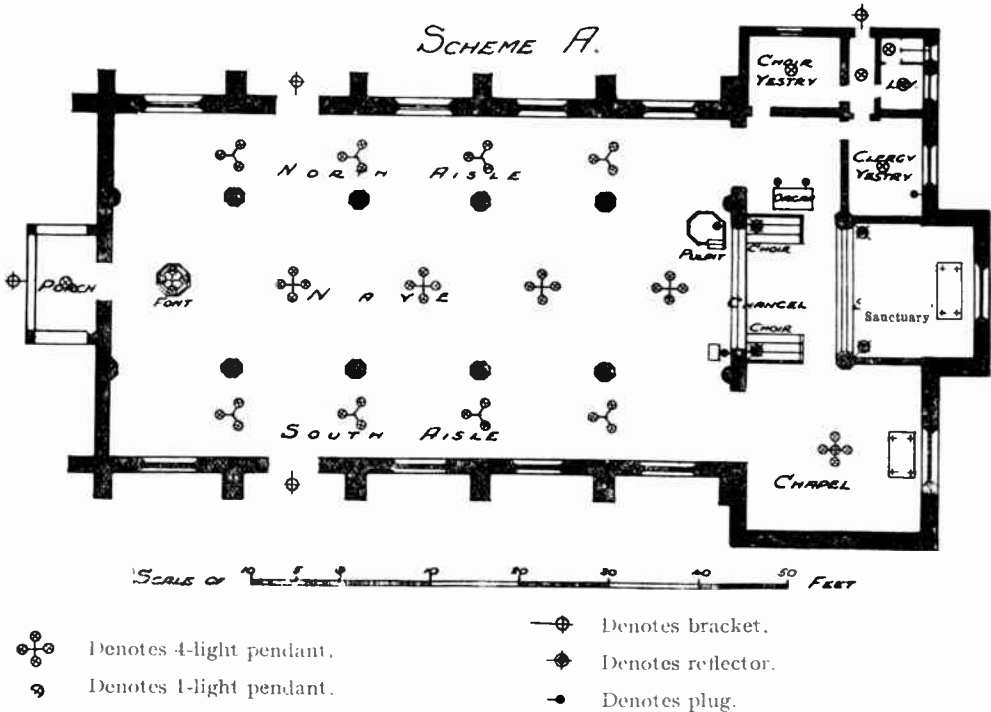

Fig. 1.—THE CENTRAL PENDANT SYSTEM FOR LIGHTING A CHURCH.

This illustration shows the plan of an imaginary church with central pendants hanging in the nave and aisles.

THE FOUR LIGHTING SYSTEMS DESCRIBED.

Scheme A.—Central Pendants.

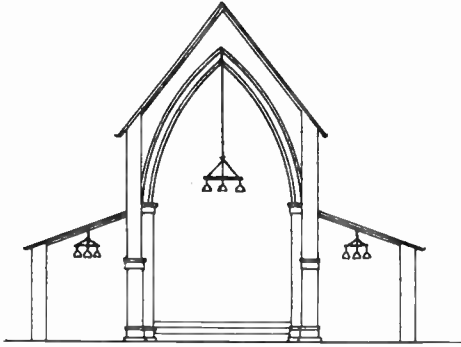

Fig. 2.—SHOWING ELEVATION TO SANCTUARY.

With central pendant fittings as in Scheme A.

Such details must be taken into account in each case, but for purposes of illustration we will assume the walls to be stone and fairly light in colour. The gross lumens should then be about 50 per cent. over the nett lumens, and a total allowance of, say, 10,000 should be sufficient. With very adverse conditions this might need to be increased to 15,000, or even more.

Similarly, in the aisles we have to deal with an area on each side of 10 feet by 70 feet, or 700 square feet, and for each aisle the gross lumens required will be about 5,000.

Choosing the System of Lighting.

The next step is to decide the system of lighting, and the opinion of the architect or the church authorities must be given full consideration as to this point. One or other of four normal schemes will probably be found to meet their views:—

- (a) With central pendants in the nave and aisles.
- (b) With pendants hanging from the arches between the nave and aisles.
- (c) Using reflectors to provide concealed lighting fixed in some convenient position in the caps of the supporting columns.
- (d) Bracket fittings of some kind attached to the piers.

These four systems are indicated in the three key plans below. The numbers of the fittings to be used on any of these systems is decided quite definitely by the plan of the church.

With this design the pendants in the nave must be suspended as shown in Fig. 1, opposite the arches, and there must therefore be five of these. As the height of the church is great in proportion to its width, the fittings can be suspended at such a height as will ensure even illumination. They must be fixed 20 feet apart, as will be evident from the plan and the "working" height for even lighting should therefore be about 14 feet. Taking the height at which light is required as 3 feet, the lamps should thus be about 17 feet from the ground.

Each of the five fittings must be wired for lamps with a total of 2,000 lumens, and it is unlikely that any single-lamp unit would be considered suitable. They will almost certainly be five or six-light electroliers of some kind, and lamp sizes must be selected on this basis. Reference to lamp tables shows that 40-watt 230-volt lamps give 316 lumens, and 60-watt lamps 570 lumens. The total volume of light required could thus be obtained from fittings with six or seven 40-watt lamps or four 60-watt lamps, and the selection of one type or the other is mainly a matter of the personal taste of the authorities. Obviously, the four 60-watt lamps will give better results as far as illumination goes.

For the aisles it will be desirable to "stagger" the fittings and fix them half way between the nave fittings, i.e., opposite the columns. These fittings cannot be fixed at the correct height for even lighting as the ceiling of the aisles is only 12 feet from the floor in the centre. The fittings must be placed as high as possible and each arranged for 1,000 lumens, i.e., three or four 40-watt lamps;

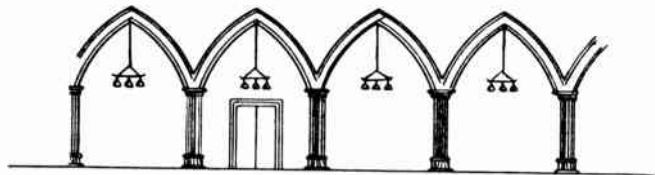

Fig. 3.—SHOWING ELEVATION TO AISLES.
With pendants hanging from aisles as in Scheme B.

two 60-watt lamps would not allow for a suitable fitting. The uneven lighting will probably not be of importance as a considerable volume of light will pass through the arches from the nave fittings and compensate for the excessive spacing of the aisle fittings.

Scheme B.—Pendants Hanging from Arches.

If pendants hanging from the arches are used, 10 such fittings will be required, and they must provide the total illumina-

be more or less concealed in the mouldings of the column caps, in window recesses or in some such position.

Schemes of this description are likely to be most successful in very large churches such as Peterborough Cathedral or Southwark Cathedral, in each of which such a scheme has been adopted. In these large churches there are special opportunities for concealing the reflectors in the clerestory or triforium galleries, which run round the church. Where such features exist there is not only the opportunity of

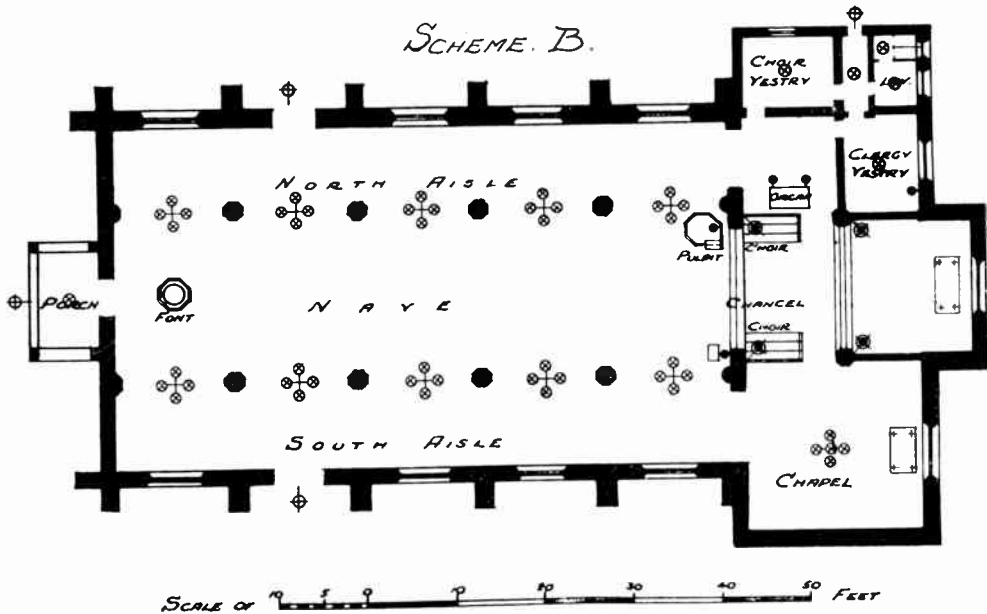

Fig. 4.—ARRANGEMENT FOR USE OF PENDANTS HANGING FROM ARCHES.

tion for the entire church—aisles and nave—i.e., a total of 20,000 lumens. Each fitting must thus give 2,000 lumens. The fittings can thus be similar to those proposed for the nave in Scheme A, i.e., six or seven 40-watt lamps or four 60-watt lamps.

Scheme C.—Reflectors.

If some system of concealed reflectors is to be used, the architectural features of the church need careful attention, as such a scheme is sure to meet with much adverse criticism unless the reflectors, which are at best unsightly objects 10 inches to 12 inches in diameter, can

concealing the reflectors, but also the possibility of cleaning the fittings, changing lamps, etc., from these galleries. This is a serious problem in the ordinary church, and one that makes it frequently impossible to adopt the best theoretical scheme of concealed lighting.

Assuming there are convenient positions for the reflectors, the lighting problem is not difficult. As before, we have to provide some 20,000 lumens, and there are ten positions at which reflectors can be fixed, and at each of these either one or two reflectors might be used. This may be decided by the architectural details, but otherwise it would give better

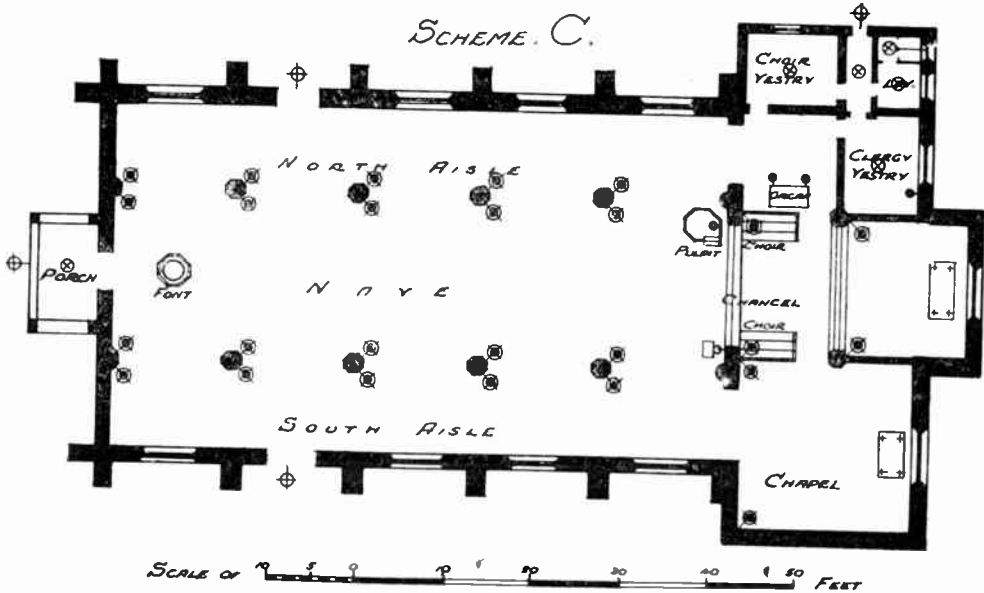

Fig. 5.—ARRANGEMENT FOR USE OF REFLECTORS.

The reflectors, which are 10 or 12 inches in diameter, should be more or less concealed in the mouldings of the column caps, in window recesses, or in some such position.

results to use two reflectors at each position as indicated in Fig. 5. The number of reflectors will then be 20 in all, and each must give 1,000 lumens. Lamps of 100-watt size give 1,130 lumens each, and these will therefore be quite suitable.

A scheme of lighting on these lines would give very satisfactory illumination for the congregation, who will always have the lights behind them, but it may be very trying for the preacher, who will be looking directly into the glare of the fittings. For this reason it will often be desirable to omit the reflectors nearest to the pulpit even at the risk of low illumination immediately below the pulpit. Some system of dimming all the lights will also be found preferable to switching off entirely some of the fittings.

Scheme D.—Bracket Fittings Attached to the Piers.

The calculations for this scheme are similar to those above. There are eight lamp caps in the main area, but some extra lighting will also be required on the west wall of the church so that the lighting points can be taken as 10 in number. Once again each must give

2,000 lumens, and probably four 60-watt lamps at each position will be most suitable.

It is unlikely that this scheme will be found satisfactory. The lamps cannot be fixed as high as those in the pendants in either Scheme A and B, and it is probable that in most churches the lamps would only be 10 feet or so from the ground and that at such a height the glare from the lamps would be considered a definite bar to the adoption of such an arrangement of the lamps. It may be possible to conceal the lamps in the mouldings of the columns, and in that case the scheme becomes an adaptation of Scheme C, but with several small lighting units in place of one large one at each lighting point.

The Chancel and Sanctuary.

The remaining areas of the building do not involve special problems. The chancel and sanctuary will usually have a lighting scheme corresponding to the nave, though frequently concealed reflector lighting can be adopted in these sections, even if it is not found suitable for the nave. The screen between nave and chancel provides an opportunity for concealing the reflectors.

SCHEDULE OF LIGHTING POINTS. (SCHEME B.)

Room or Area.	No. of Points.	Type of Fitting.	No. of Switches.	Position of Switch.	Watts per Fitting.	Total Watts.
Outside west porch	1	Bracket	1	Inside porch ..	60	60
West porch ..	1	Pendant	1	Inside porch ..	60	60
Nave and aisles ..	10	4-light Pendants	6	Near west porch	240	2,400
North entrance ..	1	Bracket (outside)	1	Near entrance ..	60	60
South entrance ..	1	Bracket (outside)	1	Near entrance ..	60	60
Choir vestry ..	1	Pendant	1	Door	100	100
Clergy entrance ..	1	Bracket	1	Door	60	60
Passage	1	Pendant	1	Door	40	40
Lavatory	2	Pendants	2	Doors	40	80
Clergy vestry ..	1	Pendant	1	Door	100	100
Organ	2	Plug	1	Near plug ..	40	40
Chancel	4	Plugs	2	Near plugs ..	40	80
		Concealed reflectors	2	Near organ ..	150	600
Sanctuary	4	Concealed reflectors	2	Near organ ..	150	600
Side chapel ..	1	6-light centre Pendants	1	Near chapel ..	360	360
Pulpit	1	Plug for reading lamp	1	On pulpit ..	60	60
Lectern	1	Plug for reading lamp	1	Near lectern ..	60	60

Vestries and Lobbies.

Side chapels, if any, can also be lit on similar lines to the nave, whilst the choir and clergy vestries, entrance lobbies and similar sections need only normal lighting. Accurate calculations of illumination are not necessary or even possible, and rough estimates of candle power are sufficient for practical purposes. An allowance of about 1 to 1½ watts per square foot of floor space is sufficiently accurate for these areas, which are not used in such a way as to need careful illumination.

SCHEDULE OF LIGHTING POINTS.

Having completed these detailed calculations for the main body of the church, and the more approximate estimates for the other parts, a schedule of the lighting points can be prepared as shown above.

Number of Fuse Boards Required.

It will be seen that the lighting divides itself naturally into two groups—one west of the chancel, covering the main church lighting; and the other east of the chancel for the remainder of the building, and this is commonly the case with church installations. The switch

controls also follow the same arrangement, and it is generally convenient to control the lights for the nave from the west end and the remaining lights from near the choir. This naturally suggests two fuse boards—near the west porch and near the vestry respectively. By adding the loads in each area as detailed in the schedule it will be found that these total up to:—

West end (nave, aisles and porches), 14 lighting points, totalling 2,640 watts.

East end (chancel, sanctuary, vestries and side chapel), 20 lighting points, totalling 2,180 watts.

Cable Distribution Scheme.

Details of the cable distribution scheme can now be easily calculated. The position of the supply company's service must be settled, and this would no doubt be arranged either in the west porch or in one of the vestries. Assuming the former is found suitable, and that the supply is two-wire, 230-volt, one main switch of 30 amps. capacity (the nearest standard size) will control the whole load, and as the total load is 21½ amps., the cables required must be not less than 7/0.30,

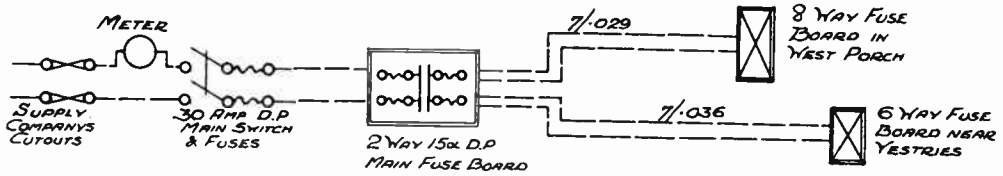

Fig. 6.—LAYOUT OF THE DISTRIBUTION SCHEME FOR THE COMPLETE INSTALLATION.

which will carry 24 amps. under I.E.E. rules. A two-way main fuse board, 15 amps. per way, would be required near the main switch and sub-mains run from this to sub-fuse boards—one near the west porch and the other near the vestries. These sub-mains will carry 12 and 9½ amps. respectively, and cables of 3/.036 section would actually carry these currents without overheating.

Type of Cable to be Used.

It would be undesirable to cut the sizes quite so fine as this, and it would be better to use cables with a small margin—say, using 7/.029 conductors. Apart from this, the size must be checked for voltage drop, and if the length of the main cable to the vestry board is measured and the runs of the circuit wires thence to the lighting points it will be found that mains as small as 3/.036 and with the circuit wiring run with 3/.029 conductors, will give too high a voltage drop to comply with I.E.E. rules. On such mains alone the voltage drop would be about 7½ volts, whereas the total drop must not exceed 3 per cent. plus 1 volt, or 7.9 volts, under I.E.E. rules. The circuit wiring, fittings, fuse board contacts, etc., will give a drop

of 2 or 3 volts so that the mains must give a drop not exceeding, say, 5 volts to be safe, and the cable section should therefore be increased to 7/.036 section.

Fuse Board Circuits.

The fuse board circuits can then be arranged and a convenient distribution of the lights would be:—

- Porch fuse board :
- Nave and aisle lights 6 circuits (3 per side)
 - Entrances 1 circuit
 - Spare way 1 circuit
 -
 - Total 8 circuits
 -
- Vestry fuse board :
- Chancel 1 circuit
 - Sanctuary 1 circuit
 - Side chapel 1 circuit
 - Vestries, etc. . . . 2 circuits
 - Spare way 1 circuit
 -
 - Total 6 circuits
 -

The layout of the distribution scheme for the complete installation would then be as shown in Fig. 6.

QUESTIONS AND ANSWERS

What would be a suitable intensity of illumination for the nave of a church ?
4 to 5 candle-feet.

What special problems are met with in churches ?

The allowance for losses is very difficult to estimate. Whilst some church interiors may have clean walls of light stone, others may have brick walls darkened with age, and old oak roofs with little or no reflective value.

What Four Schemes are Generally Used ?

(1) Central pendants in the nave and aisles.

(2) Pendants hanging from arches between nave and aisles.

(3) Reflectors to provide concealed lighting.

(4) Bracket fittings attached to the piers.

What is considered the most up-to-date scheme for large churches or cathedrals ?

The reflector scheme, where there are special opportunities for concealing the reflectors in the clerestory or triforium galleries. Another advantage is the possibility of cleaning the fittings, changing the lamps, etc., from these galleries.

THE RECORDING OF SOUND

AS APPLIED TO TALKING PICTURES

By J. I. MARTIN, A.M.I.C.E.

THE methods employed in the reproduction of sound for talking pictures is dealt with in an earlier article. The following brief survey is intended to show the theory underlying

largely the outcome of the great advance made in telephone engineering in the past decade or so. The application of the thermionic valve in conjunction with electrical amplifiers for the purposes of

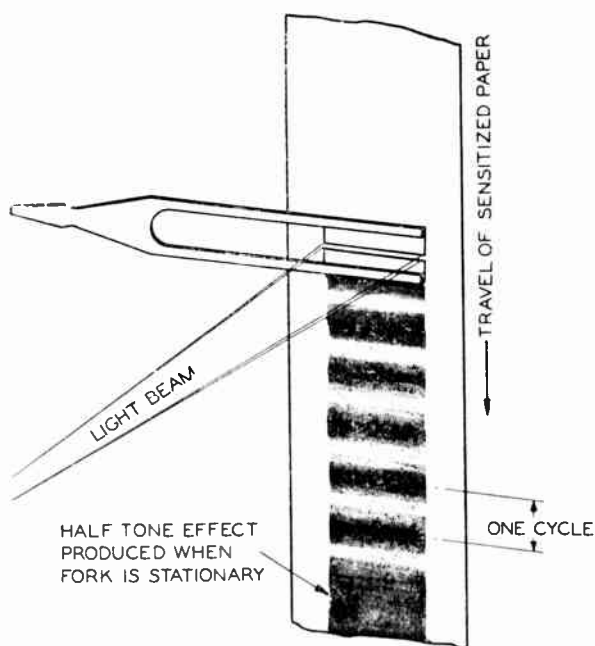

Fig. 1.—How Sound is Recorded Photographically on to Film. (1) The Variable Density Method.

The alternate bands of light and dark are shown well apart for clearness, but if the paper were travelling at the same speed as that which is used in film recording, these would be very close together.

the recording of sound on film, and will enable the practical electrical engineer to obtain a clear understanding of this interesting subject.

The recording and reproduction of sound as an accompaniment to motion pictures is one of the most phenomenal developments of recent years. It is

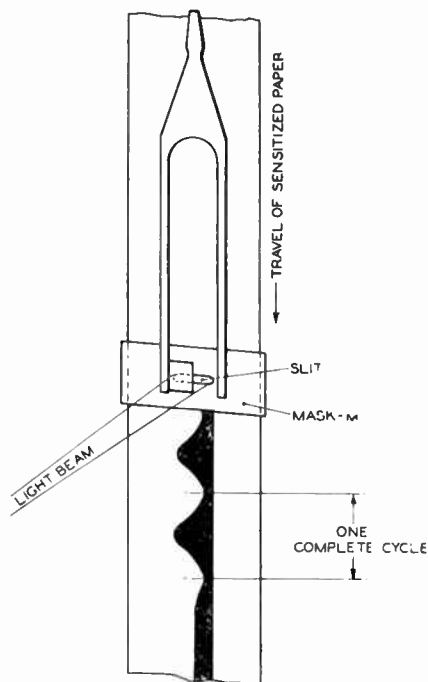

Fig. 2.—How Sound is Recorded Photographically on to Film. (2) The Variable Area Method.

In this method the dark band is not of constant width, but has one side bounded by an undulating line.

relaying telephone and telegraph signals over long distance lines paved the way for radical changes and methods in the recording of sound as used by the gramophone industry.

Advent of the Thermionic Valve.

Hitherto, the making of records was

greatly restricted by the necessity of the performer having to be close to the recording mechanism. Up to this time, the only energy available for converting into mechanical energy for the purpose of cutting the impression in the original wax record was limited to that produced by the performer's voice or instrument he was playing and picked up by the mouthpiece or horn of the recorder. The advent of the thermionic valve amplifier and corresponding improvements in microphone design increased the energy available and opened

The success attained encouraged the rapid development of other methods of recording, and very shortly the application of the photo-electric process of recording sound photographically on to film became a commercial proposition.

Whilst the earlier talking pictures were almost entirely disc recorded, there has been a gradual change, and at the present moment film recording undoubtedly predominates.

In order to get a better appreciation of the methods used in the recording and

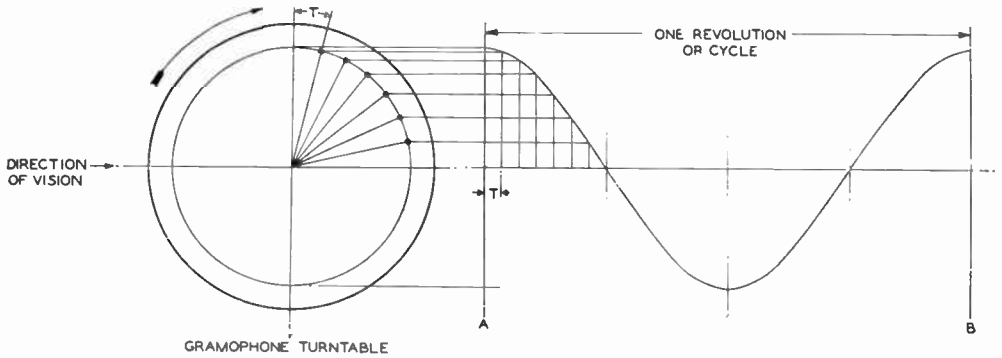

Fig. 3.— DIAGRAM SHOWING EXPLANATION OF HARMONIC MOTION.

If the distance between the vertical lines A and B represents the time taken for an object, revolving at a uniform circular speed, to make one complete revolution, and this distance is divided into small equal intervals of time, and the distance of the object away from the centre line is plotted by vertical lines at each of these smaller intervals, a sine curve similar to the above will result from joining the ends of these vertical lines. All pure musical sounds are capable of being represented thus.

great possibilities, in that it permitted the recorder itself to be more robust in design, and removed the necessity or restriction of the performer having to be close to the recorder. The performance of large orchestras could be recorded with great fidelity and equal facility to those of soloists, and the actual recording could be done at a point at a considerable distance away from the players.

First Method of Recording Sound and Scene.

The simultaneous recording of both the sound and the scene was but a short development. At first this was done by using the same electro-mechanical methods of recording sound as used in the gramophone industry, and driving both the camera and the sound recorder together.

reproduction of sound, it may be well to elucidate some of the fundamental principles involved.

NATURE OF SOUND.

Sound is a form of physical energy and is produced by the rapid vibration of various material substances. It cannot be transmitted through a medium that does not possess mass or body, and for this reason it cannot pass through a vacuum.

How Pitch or Frequency is determined.

The number of vibrations made in a given time determines the pitch or frequency. The pitch of middle C of the musical scale represents a frequency of 258 cycles per second. The average human being is sensible to sounds having frequencies from 20 up to 10,000 cycles per

second, but the sensitivity is not equal for the whole range. It is greatest for sounds whose frequencies are between 500 and 4,000 cycles; that is to say, for a given intensity, sounds which may be just audible over this range would not be heard if the frequency were to drop below 500, or to increase above 4,000 cycles.

How Sensitivity Varies.

The sensitivity of individuals varies considerably, especially in the higher frequency range. If the intensity of a sound becomes very great, its effect is felt rather than heard, and if the intensity is great enough it will cause pain. Again, in this instance, sounds in the middle range of frequencies produce the greatest effect. In Fig. 7 is given a curve representing the range of frequencies and intensities in which sound is heard.

Harmonic Motion—What It Is.

Pure notes are produced when the vibrations take the form known as the sine wave, which is very common in applied science. This is called harmonic motion. The motion of the ends of a tuning fork, when struck, is an example of approximate harmonic motion, and this follows the same law as the motion of a swing or of a pendulum of a clock. In pure harmonic motion the number of vibrations or swings in a given time will remain the same whatever the magnitude or extent of the vibration or swing. Another example of this kind of motion would be given if an object such as a piece of sugar (or thimble) were placed near the edge of a turntable of a gramophone and the latter made to rotate at a uniform speed, and the motion of the lump of sugar be observed at a distance with the eyes of the observer on a level with the top of the turntable. The lump of sugar or thimble would appear to be moving from side to side; when at the extreme left or right it would appear to be stationary for an instant and then to increase in speed as it moves toward the centre, and it will seem to slow down as it again moves outwards.

If we were to plot out on a piece of paper the position of the piece of sugar

at equal intervals of time as in Fig. 3, and we divide the line A B, passing through the centre of the turntable, into equal intervals of time, and indicate at each successive interval, by vertical heights above or below this line, the distance of the lump of sugar away from

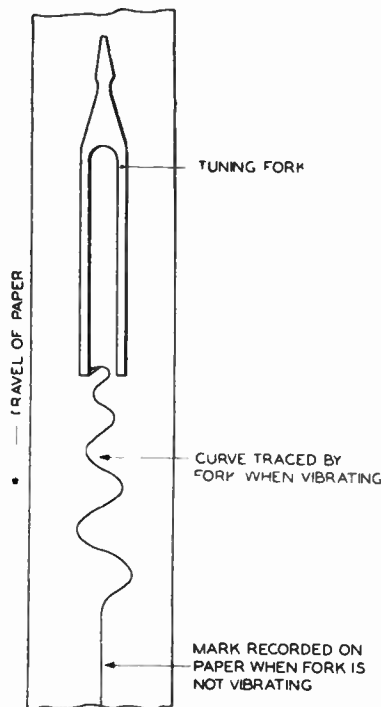

Fig. 4.—HOW TO MEASURE FREQUENCY WITH A TUNING FORK.

If a leg of a tuning fork is fitted with a pen and held so that the point is just lightly making contact with a strip of paper which is drawn at uniform speed in the same direction as the length of the fork, and the fork is made to vibrate, a curve similar to that shown above will result.

the centre and we join the ends of these vertical lines together, we would get a curve as shown in the diagram. This would be a sine curve.

When viewed along the plane of rotation, the lump of sugar appears to have only one path. We might, therefore, define harmonic motion as the motion of an object rotating at a uniform circular speed when viewed in the same plane as that of rotation.

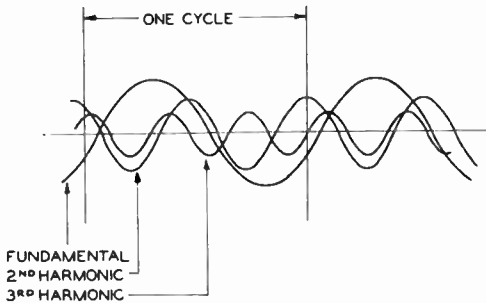

Fig. 5.—CURVES PRODUCED BY THE SIMULTANEOUS PRODUCTION OF THE SECOND AND THIRD HARMONICS TOGETHER WITH THE FUNDAMENTAL.

How to Measure Frequency with a Tuning Fork.

If a leg of a tuning fork is fitted with a stylus or pen, and held so that the point of the pen is just lightly making contact with a strip of paper which is drawn at a uniform speed in the same direction as the length of the fork, and the fork is struck and caused to vibrate, a curve similar in shape to that shown in Fig. 4 will result. At first the crests or waves will be well defined, and then will gradually diminish in height as the vibrations of the fork die down. The distance from the crest of one wave to the crest of the next will remain constant and will represent a complete vibration or cycle, and the number of such cycles made in a given time will be a measure of the pitch or frequency. In the example, the crests are shown far apart for the sake of clearness, but actually in practice it would be necessary to use a tuning fork having an extremely low pitch and to cause the paper to travel at a very high speed or rapid rate to give such a record.

Musical Sounds.

Musical sounds are, however, not usually represented by simple sine waves, but most of them can be analysed and proved to be combinations of a number of simple sine waves. The characteristic quality or tone given to a particular note when played by various instruments is due to the production of harmonics simultaneously with the fundamental note. Harmonics

are vibrations whose frequencies are definite multiples of the fundamental or principal note. The tones produced by a violin for example, are particularly rich in harmonics. In Fig. 5 are given the curves produced by the simultaneous production of the second and third harmonics together with the fundamental, and in Fig. 6 we see the resultant curve produced by the combination of the three separate sets of vibrations.

Speech Sounds.

Speech sounds are usually very complex in their composition and it is only the vowels which have any semblance to being musical in character.

TRANSMISSION OF SOUND.

When sound is produced in a medium of uniform density it tends to radiate equally in all directions, in the form of waves of compression and depression. Everyone is familiar with the effect produced by dropping a stone in the middle of a still pond. Waves are produced which move in increasing circles towards the edges of the pond. The height of the waves gradually diminishes as the distance they have travelled becomes greater. The body of the water itself has not moved outwards, as we know by watching the motion of a cork or other object which may be floating on the surface; the cork tends to remain in the same place. We can conceive the surface of the water as an elastic medium, and the crests of the waves as zones where the material has become stretched, and the troughs as zones of compression. The stretching at

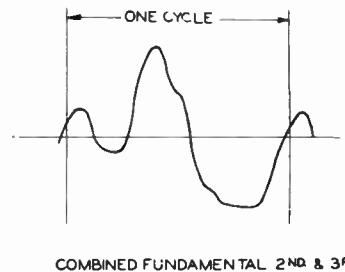

Fig. 6.—RESULTANT CURVE PRODUCED BY THE COMBINATION OF THE THREE SEPARATE SETS OF VIBRATIONS SHOWN IN FIG. 5.

the crests being equal to the amount of the compression in the troughs, the surface as a whole has not moved forward; it is only the zones which have travelled towards the edges of the pond. In this example, the motion has been limited to the plane of the surface of the water, whereas we must conceive the transmission of sound as spheres of a densely compressed medium interspersed with spheres of a stretched medium continually increasing in size and radiating from a central point.

How to Find Out the Length of a Sound Wave.

Sound normally travels at a speed of about 1,130 feet per second in air of normal temperature, and the speed is independent of the frequency. The length of a sound wave varies inversely with the frequency, and can easily be determined thus:—

L (Length of one complete cycle or wave) $\times N$ (number of waves or cycles per second) = 1,130 (the distance travelled by sound per second).

$$\text{Therefore } L = \frac{1,130 \text{ feet}}{N}$$

$$\text{If } N = 50 \text{ cycles } \quad L = 22.6 \text{ feet.}$$

$$\text{If } N = 1,000 \quad \quad L = 1.13 \text{ feet.}$$

$$\text{If } N = 5,000 \quad \quad L = 2.7 \text{ inches.}$$

Reflection of Sound.

Sound can be reflected in much the same way as light, and when sound waves impinge on to large flat surfaces such as the side walls of a theatre, they are reflected off at an angle approximately equal to the angle of the impinging beam and the wall. The continual reflection back and forth between the walls and ceiling tends to sustain the sounds, and results in what is known as reverberation. A certain amount of reverberation is necessary for good hearing. A building possessing a large number of hard reflecting surfaces usually has very poor acoustic qualities, as the reverberation is excessive.

Effect of Sound on Uneven Surfaces.

When sound impinges on uneven surfaces it becomes dispersed. Small surface irregularities will break up sound of short wave length or high frequencies and

large cavities will break up the longer wave lengths or sounds of lower frequencies.

Absorption of Sound.

Sound can be absorbed in much the same way as light can when it falls on objects of dark hue. If a room is filled with dark drapings, it will require a greater amount of illumination.

The physical form and the nature of the material of which the walls of a room are made, will play a very important part in the absorption of sound. Here again, the effect will not be the same for all frequencies.

Conversion of Sound Energy.

If a tuning fork is struck in the vicinity of a microphone, vibrations of the fork will be transmitted by sound waves through the air, and on reaching the microphone will be translated into electrical impulses. Provided the microphone is one of good quality and is connected to a well-designed amplifier, the resultant impulses will vary in exactly the same way as the vibrations of the fork. If now the output of the amplifier be connected to a pair of headphones or loud speaker, the same note of the tuning fork will be heard, but the sound will be louder, that is, its amplitude will be increased, but there will be no change in its characteristic quality. If instead of connecting the output of the amplifier to a pair of headphones we couple this to a gramophone or disc recorder, it will be found that the spiral grooves cut in the surface of the wax record will be wavy in shape, and will follow out a similar path to that shown in the previous example of the tuning fork and travelling strip of paper, except that the normal line of travel, which, in the first example was straight, will in this case be circular. If the recorder be replaced by a sound box or reproducer, and the wax record made to revolve at the same speed as during the recording process, the note of the tuning fork will be reproduced. Records for use on ordinary gramophones are usually 10 inches or 12 inches in diameter, and are recorded at a speed of 78 r.p.m. The record starts from the outside and finishes near the centre.

Motion Picture Sound Records.

Records for reproducing sound for accompanying motion pictures are usually 16" in diameter, and the record starts near the centre and finishes at the outer edge, and is recorded at a speed of $33\frac{1}{3}$ r.p.m. The track is started from the centre of the record so that the needle may be better able, while it is new, to follow the undulations of the track, which being shorter near the centre of the record, have the undulations closer together. When the needle is nearing the end of the record and has become worn, the undulations are longer and the needle can more easily follow them.

How the Recording is Done.

In both cases the recording is actually done on flat circular cakes about $1\frac{1}{2}$ " to 2" thick, made of a specially fine grade metallic soap. This cake is very accurately machined on both sides, using a ruby or sapphire tool. The end of the working arm of the recorder, which is fitted with a sapphire or ruby cutter, moves from side to side in a plane at right angles to the direction of motion of the wax, in accordance with the direction and amplitude of the electrical impulses.

FILM RECORDING.

There are two outstanding methods used for recording sound photographically on to film. One is known as the variable density and the other the variable area system. There are other methods which are variations or combinations of both these two. Over 80 per cent. of recording to-day is done by the variable density method. It has already been explained how a visual record of the motions of the end of a tuning fork can be recorded on to a moving strip of paper and an explanation will now be given of how a photographic record can be obtained by both the variable density and variable area systems.

Variable Density.

When a tuning fork is struck, the ends of the fork alternately move towards and away from one another. Suppose two light strips of pasteboard are attached to the ends of a tuning fork so that their

edges come very close to one another leaving a narrow slit or gap between them, as in Fig. 1. If the fork is now struck the ends will vibrate in such a way that the gap between the pieces of pasteboard alternately opens or closes.

If now a beam of light is concentrated on to one side of the pieces of pasteboard and a strip of photographically sensitive paper is placed on the other side and this is drawn or moved at a uniform speed in a direction at right angles to the length of the fork, it will be found that the paper will have become darkened by being exposed to the light which had been transmitted through the gap between the edges of the pasteboard strips. If the fork is now struck and caused to vibrate, the paper will have horizontal strips of dense black gradually shading off into strips of very light density, and this will be repeated, at regular intervals. In Fig. 1 the alternate bands of light and dark are shown well apart for clearness, but if the paper were travelling at the same speed as that which is used in film recording, these would be very close together. With a paper speed of 90' per minute, and the tuning fork pitch representing middle C, which is 258 cycles per second, the distance between adjacent bands of light and dark, representing one complete cycle of vibration, would be calculated as follows:—

$$90' / \text{min.} = \frac{90'}{60} \text{ or } 1\frac{1}{2}' \text{ or } 18'' \text{ per second.}$$

During this length there will be 258 complete cycles or strips of dark and light. Therefore, one cycle will be represented by a distance of

$$\frac{18''}{258} \text{ or approximately } .07 \text{ of an inch.}$$

Variable Area.

Suppose a piece of pasteboard is attached to one leg of a tuning fork as in Fig. 2, and the ends of the fork are placed close to a mask M having a small narrow slit S, so that the pasteboard covers about half the width of the slit. If a beam of light is concentrated on to the mask M so that it covers the whole width of the slit, and a piece of sensitised paper is drawn close behind the mask and in the same direction as the length of the fork,

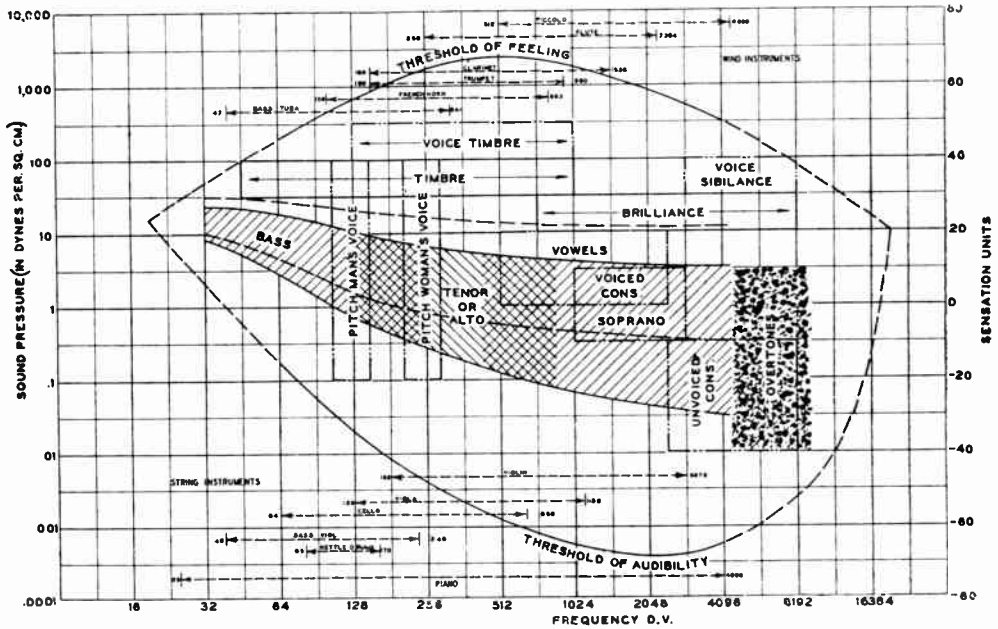

Fig. 7.—CURVE REPRESENTING THE RANGE OF FREQUENCIES AND INTENSITIES IN WHICH SOUND IS HEARD.

Sounds, which for intensity and frequency come within the area enclosed by the two lines representing the threshold of audibility and feeling, are sounds which are audible to the average human ear, and sounds outside this area are either inaudible or produce the sensation of pain rather than hearing.

that portion of the paper which had been exposed to the light (which has passed through the uncovered portion of the slit S) would be indicated by a dark band, whose width would be equal to half the width of the slit.

If the fork is now struck, the ends will vibrate in the same direction as the plane of the mask M. This would cause the piece of pasteboard to cover more or less of the slit, according to the position of the end of the fork at any particular instant, with the result that the dark band would now no longer be of constant width, but would have one side bounded by an undulating line as in Fig. 2.

The shape or contour of one side of the line of demarcation between the light and dark portions of the paper will be the same as in the example previously given of the tuning fork with the pen or stylus attached to one end. This would be an example of recording the motion of a tuning fork by the variable area system.

As in the previous examples, if the

speed of the paper is constant, the distance from the crest of one wave to the crest of the one adjacent would be constant for a given tuning fork, although the height from the trough of a wave to its crest will gradually grow smaller as the vibrations of the fork die down.

Practical Variable Density Recording.

In the system that is most commonly employed, the place of the tuning fork is taken by what is known as the light valve. This controls the light received from an incandescent filament lamp, after passing through a condenser and lens, in accordance with the electrical impulses picked up by the microphone. It consists of a metal ribbon 4 mils wide by 1/2 mil thick, stretched over an insulated bridge, and placed between the pole faces of an electro-magnet in such a way that the two sides of the loop are normally 1 mil apart. The ribbon loop is adjusted to have a natural frequency of vibration in the neighbourhood of 10,000 cycles. The

smaller dimensions of the ribbons are in the same plane. The operation of the valve is such that when a current passes through the loop in one direction, the two ribbons move away from one another, thus allowing more light through; when the current is reversed they tend to come closer together, thus shutting off the light.

After passing through the valve the light beam passes through a lens and is concentrated on to the film as a narrow slit of light 100 mils wide and varying in thickness from nearly zero to a maximum of 1 mil according to the modulation, but having a value of $\frac{1}{2}$ mil when there is

that portion of the film upon which the sound record is made, there is a gap extending over the entire periphery and mounted inside the drum between the flanges opposite this gap is a photo electric cell, which will be referred to later. After passing over the recording drum B the film again passes under the main driving drum A and thence on to the lower magazine. Between the two drums A and B are pivoted idler rollers which maintain a constant tension on the film during its passage through the machine.

The photo electric cell is subjected to the modulated light after it has actually

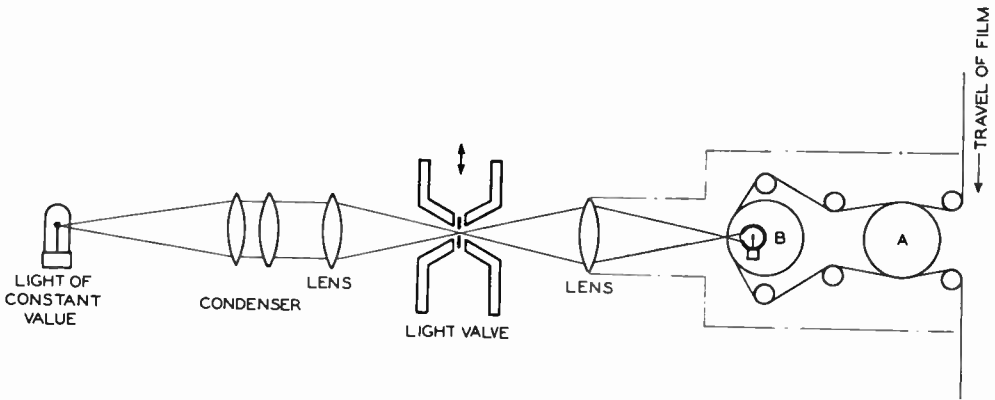

Fig. 8.—HOW VARIABLE DENSITY RECORDING IS DONE IN PRACTICE.

After passing through the valve the light beam passes through a lens and is concentrated on to the film as a narrow slit of light.

no current passing through. The arrangement is shown in Fig. 8.

The Film Recorder.

The film recorder consists of a light-tight metal box. The film is drawn from the top magazine over an idler roller on to the main driving drum A, in Fig. 8, which is provided with sprocket teeth, and is driven by a synchronous motor. From there it passes on to the recording drum B, where it receives the modulated light beam. This drum is coupled to the first drum A through a special mechanical filter device, in order to damp out any small mechanical vibration or any unevenness in the driving torque. This drum is provided with sprocket teeth which engage with the holes in the sides of the film. Between the sprockets and opposite

passed through the film. Although the intensity of the light transmitted through the film is greatly reduced, amounting to only about 5 per cent. of the original value, the character of its modulation is not fundamentally changed. The changes in the amount of light falling on to the cell are converted into electrical impulses which are amplified by means of a special amplifier provided at the back of the recorder. The output is taken to a loud speaker or headphone in the monitor or control room. By this means the engineer obtains an exact replica of the sound as it has actually been recorded on the film.

Another Method Using Variable Density.

Instead of using a source of light of constant intensity and interposing between this and the film an electro-mechanical

device for modulating the beam, the light valve is entirely dispensed with, and a special gaseous type of lamp is used in place of the incandescent type used in the previous example.

In this case a light of varying intensity is used in conjunction with a slit of constant width.

There are no moving parts. The aeolight as it is called, obtains its current from a source of constant voltage. Inserted in its circuit is a transformer through which the amplified speech currents from the microphone are passed. These speech currents produce changes in the normal voltage applied to the aeolight,

Variable Area Recording.

In one particular application of this system of recording (see Fig. 9) a very small mirror about 80 mils long and 16 mils wide is attached to a vertical loop of metal ribbon 5 mils wide and $\frac{1}{2}$ a mil thick, which is stretched between the poles of a powerful magnet. A beam of light is directed on to the mirror and this is reflected on to one side of the film. By a system of masks and lenses the beam is concentrated into a narrow slit of light. The free ends of the loop are connected to the output of the recording amplifier. In the normal position when no current is flowing through the loop, the

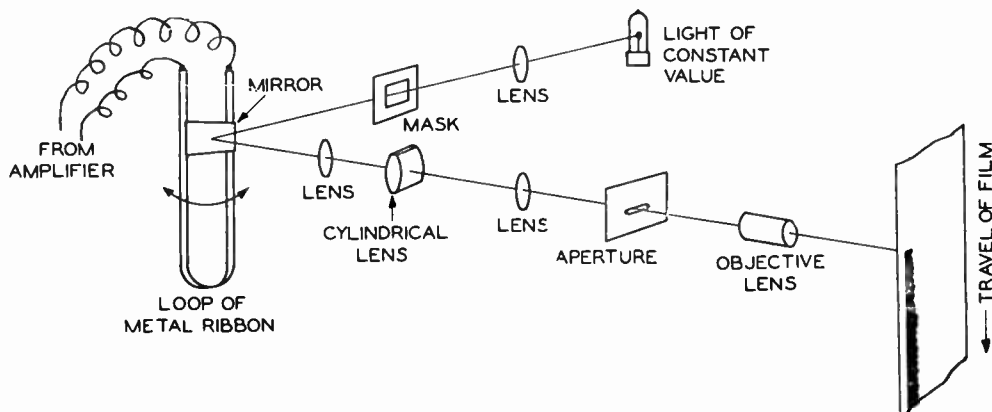

Fig. 9.—A TYPICAL ARRANGEMENT FOR VARIABLE AREA RECORDING.

Note especially the very small mirror, about 80 mils long and 16 mils wide, which is attached to a vertical loop of metal ribbon which is stretched between the poles of a powerful magnet.

producing, in turn, corresponding changes in the intensity of the light emitted.

The light passes through a slit .8 mil in width engraved on a piece of silvered quartz. In front of the slit is placed another piece of quartz against which the film passes. This second piece of quartz is to protect the slit and is about 1 mil in thickness opposite the slit. The two pieces of quartz are secured in a metal assembly which is rigidly attached to the aeolight.

The apparatus required for this system of recording is very compact and does not require such rigid support as that usually required. For this reason it lends itself for portable use in conjunction with news reel work, but it does not find much application in the studio.

beam of light is masked to about half its normal width, i.e. 35 mils. When sound is being recorded, the width of the beam directed on to the film becomes greater or smaller than the normal, till at one instant it may be occupying the whole width of the sound track, and at the next may have no width at all.

How Sound is Synchronised on the Film.

When sound is recorded on film the actual sound record is $14\frac{1}{2}$ inches in advance of the scene to which it relates. The reason for this is that during its passage through the camera, or the reproducing projector, the film is moving intermittently, i.e. it remains stationary for a fraction of a second and then moves forward to expose the next picture, and it is essential for

sound recording and reproducing purposes that the film be moving at a uniform speed. Having the two records this distance apart does not interfere with the synchronism, provided that the distance is kept the same during recording and reproduction, and it has the advantage that it permits the sound unit being placed in a position where it does not offer any obstruction to the picture projection.

In order to get a combined record of both the sound and the scene, a portion of the space previously occupied by the scene has to be sacrificed to accommodate the sound record. This consists of a narrow band on one side extending the whole length of the film, having a width of about 70-80 mils.

It is usual practice for the actual recording of the sound to be done on an entirely separate film. Positive stock is used for this purpose in preference to negative material, as the grain of the emulsion of the former has a finer texture.

Simultaneous Process.

The processes of recording the sound and photographing the scene take place simultaneously, and in order that there shall be absolute synchronism between them all, the motors for driving the cameras and the recorders are of the synchronous type. Special provision is made to ensure that they keep in step from the moment they are switched on. Furthermore, special devices are provided to ensure that the speed does not vary more than a fraction of 1 per cent. at any time.

While a shot is being taken, an engineer is in charge of the sound apparatus. He is located in a sound-proofed position where he can command a view of the action taking place. He controls the sound input from the various microphones (if there are more than one). A monitor horn and headphones are provided which are connected in to the recorder or recording amplifier.

When the separate records of the sound and scene are developed, they are printed separately on to a third positive. The sound part is printed first.

SILENT RECORDING.

Engineers directly concerned with the actual recording processes, and research workers engaged in associated industries, are continually introducing improvements in the technique of recording, but the outstanding recent development is the introduction of what is called noiseless film recording.

One of the greatest defects which has existed in the presentation of talking pictures is due to the presence of what is called surface noises. The presence of these extraneous noises which are due to defects in the quality of the film, amplifier, lamp and valve noises, etc., becomes particularly noticeable in silent passages or when the recorded sounds are low in level, and tends to destroy the illusion. In the older methods the intensity of most of these extraneous noises remained at a constant level and was independent of the intensity of the sounds which were being deliberately recorded. The new process aims at allowing the extraneous noises to attain their maximum value only when the intensity of the sounds being deliberately recorded is also at its greatest value, and to suppress the extraneous noises as the intensity of the desired sounds diminishes.

In both systems of variable area and variable density recording already mentioned, provision is made that during silent passages there shall be practically no light allowed to pass through on to the film and when sound is being recorded the amount of light allowed to pass through is only sufficient to allow for the modulation required at any particular instant.

This result is achieved by giving the light beam a bias and varying the amount of this bias in accordance with the modulation at any particular instant, by rectifying a portion of the speech current and either passing the resultant D.C. through the ribbon of the light valve or galvanometer, or by utilising this rectified current to control a mechanical shutter.

HOW SOUND IS MEASURED.

As the processes of recording and reproduction of sound involve changes from one form of energy to another and

vice versa and the ultimate result of all our efforts has eventually to be experienced by the human ear, it is important that we have some understanding of the relationship between the sensation of loudness and the intensity of the sound expressed as mechanical or electrical energy.

If we cause eight similar tuning forks to vibrate and after listening for a short time four of them are suppressed, the average human ear will just appreciate the change in loudness, and if two of the remaining four are suppressed, the change will again only just be noticeable, and if one of the remaining two is stopped from vibrating, the change in loudness will be regarded as the same as in the previous instances.

Loudness and Intensity.

From this we can gather that the relationship between the sensation of loudness and the actual intensity of the sound is not a simple one, but we can deduce from the above example that equal changes in loudness are produced when the intensity is changed by a fixed ratio or proportion. This can be proved to be equivalent to saying that the change in the sensation of loudness is proportional to the logarithm of the ratio of the intensities involved in the changes.

This relationship, however, does not hold strictly true for extremes of frequency or intensity.

Changes in Pitch.

While not strictly relevant to the subject in question, there is another capacity in which the ear recognises this same relationship, and that is in its response to changes in pitch. The ear regards as equal changes in pitch those which are proportional to the logarithm of the frequency. Thus the frequencies represented by the same note played in different octaves bear a logarithmic ratio to one another. It is for this reason that it is now universal practice to use a logarithmic scale for frequency characteristics. In this connection we would refer the reader to the curve in Fig. 7.

Now reverting back, changes in the

intensities of sound are produced by corresponding changes in the inputs and outputs of associated electrical apparatus, such as amplifiers and volume controls, etc., and it will readily be understood that it will be of advantage if we represent these changes as logarithmic ratios, for in this form their value will be directly appreciated by the human ear.

There is a further advantage in adopting such a scale to represent power ratios, for when we want to determine the effect of the combinations of a number of amplifiers and resistance networks, such as volume controls, etc., in series, we have only to deal in simple additions and subtractions, instead of having to multiply the individual gains and losses together, which would often result in figures of such magnitude that they become meaningless.

An arbitrary standard has been fixed by international agreement which is called the bel, and this is equal to the logarithm of the ratio of two powers one of which is ten times that of the other.

$$\text{A bel} = \log_{10} \left(\frac{P_1}{P_2} \right) \text{ where } P_1 = 10 P_2.$$

The practical unit of gain or loss is one-tenth of this and is called the decibel and therefore:—

$$N \text{ (in decibels)} = 10 \log_{10} \frac{P_1}{P_2}$$

when P_1 and P_2 represent the power outputs and inputs respectively.

Example: If an amplifier has an output of 20 watts and an input of 1 watt, its gain in db. =

$$\begin{aligned} 10 \log_{10} \frac{(20)}{1} &= 10 \times 1.301 \\ &= 13.01 \text{ db.} \end{aligned}$$

and again a power ratio of 2 : 1 represents a change of 3 db. approx.

When we express the ratio of input to output in current or voltage, the above

becomes $N \text{ (in db.)} = 20 \log_{10} \frac{I_1}{I_2}$ or

$$N \text{ (db.)} = 20 \log \frac{V_1}{V_2}$$

as power is proportional to the square of the current or voltage for a constant impedance.

TIN, LEAD, ZINC AND THEIR ALLOYS IN ELECTRICAL WORK

By A. W. JUDGE, A. R. C. Sc., D. I. C., WHITWORTH SCHOLAR

TIN.

TIN is an important metal in electrical engineering work, although it is hardly ever used in its pure metallic state, but as an alloy with other metals such as copper, zinc and lead.

Tin in the pure form is a silvery-white soft metal, capable of taking a high polish and resisting corrosion to a marked degree. It is rather lighter in weight than copper, the specific gravity being about 7.35. It is one of the weak metals, for it has a breaking strength in tension of only 1.25 tons per square inch; i.e., it is about one-sixth the strength of aluminium.

Further, tin has a low melting point, namely, 232° C.; it is readily melted in an ordinary blue, or Bunsen, gas flame.

Having briefly reviewed the metal itself, let us now consider some of its electrical applications.

In the first place, tin can be rolled or beaten out into very thin foil, one use of which is for plates of fixed condensers, with mica, glass or bakelite as the insulating member.

The Leyden Jar.

The well-known Leyden jars used for storing charges of static electricity have tinfoil plates for the positive and negative surfaces. One of the plates is given a positive and the other a negative charge from a static friction machine, such as the Wimshurst type. By connecting the two tinfoil surfaces with a wire, held in a glass-insulated handle, it is possible to get a powerful spark due to the discharge (see Fig. 1).

Fuse Wires.

Tin also forms one of the metals of fuse wire, lead being the other metal. In this connection a well-known electrical fuse-wire alloy consists of 75 parts lead and 25 parts tin. A wire of 16 S.W.G. will fuse with a current of 16 amps., whilst one of 20 S.W.G. will break down with 7 amps. It may be of interest to mention here that fuse wires of this alloy for fusing currents of 4, 5 and 6 amps. require to be of 23, 22 and 21 S.W.G. respectively.

Bronze and Gunmetal.

Tin also forms an important constituent of bronze and gunmetal, castings of which are used for various electrical purposes where great strength and good electrical conductivity are required.

Hardening Effect of Tin.

Copper by itself is a relatively weak metal that cannot be cast satisfactorily. By hammering it, however, it can be hardened to some extent, but this effect is not, of course, applicable to castings. The ancients, in their quest for a

harder metal than copper, discovered that tin ores when melted with copper gave a much harder and whiter metal, suitable for weapons and tools—this was the beginning of the bronze era of history. It is interesting to note that a number of Roman bronze swords and tools that have been analysed in recent times showed an average composition of 90 parts copper and 10 parts tin. This corresponds to our modern gunmetal with 8 to 14 per cent. tin and the rest copper.

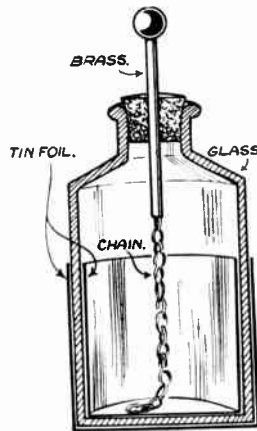

Fig. 1.—A LEYDEN JAR.
This is used for storing electric charges.

Tincoated Steelplate.

Another application of tin is as a protecting coat for iron or steel, the coated sheets being known as tinplate.

Electrical Bearings.

Many of the bearings of electrical plant consist of brass or bronze shells lined with white metal. The latter is an alloy consisting usually of copper, tin and antimony; the latter constituent has a hardening effect on the alloy. A typical bearing metal of this class consists of tin 78 parts, copper 10 parts and antimony 12 parts. These bearing metals when used for lubricated steel shafts have a very low coefficient of friction, due partly to the very high surface polish they give and partly to the slightly yielding nature of the metal; the latter property enables the bearing metal to accommodate itself to the shape of the shaft.

Tin Solders.

Before concluding this brief account of tin as an electrical engineering metal, mention should be made of the fact that tin forms an important constituent of solders for various purposes. Thus the ordinary tinman's solder, so widely used in electrical work, contains about 2 parts of tin to 1 part of lead. *Plumbers' solder*, such as that used for lead-pipe work, consists of 1 part tin and 2 parts lead. There is another solder, known as *Medium Solder*, which consists of equal parts of tin and lead.

The *die castings* frequently used in electrical work for complicated parts of instruments and electric meters, electric fans, and certain domestic electrical apparatus, usually contain tin as a constituent; a typical alloy consists of zinc, tin, copper and aluminium.

LEAD.

Lead is another metal that has many electrical applications principally as an alloying member with other metals. We

have already seen that it is used in fuse wire and solders. Lead is a soft heavy metal of specific gravity 11.34, and melting point 327° C. It has little strength in tension, but can be beaten out, or extended, readily into various shapes. Thus it can be squeezed out through dies into pipes and tubes, which can be bent with little effort.

Lead-sheathed Cables.

Lead sheathings are used to protect electric cables since the lead itself when exposed to the atmosphere forms a protective oxide and no further corrosion occurs. Lead-sheathed single, twin and multiple-strand insulated electric cables are much used in electric wiring work, both for buildings and underground work.

The advantage of lead-sheathed wires for domestic wiring purposes lies in the protective action of the lead casing, and the great flexibility of the latter; it is thus possible to make fairly sharp bends or turns without injuring the casing or insulated wires inside. Moreover, the lead can readily be cut with a knife, when it is required to bare the insulation; it can also be soldered readily in the case of water-tight joints.

Lead is a poor conductor of electricity and also of heat; compared with copper it has about 13 times this metal's electrical resistance. Lead is an important metal in connection with the plates, grids and electrodes of lead-acid cells.

ZINC.

Zinc is another metal used to a certain extent in electrical work, although chiefly in the alloyed state with other metals, e.g., copper, lead and tin.

Zinc is a white metal with a slightly bluish tinge, but it is soft in nature. It is neither ductile nor malleable, being of a somewhat brittle nature. For example, a commercial slab of zinc can easily be broken with a hammer and it gives a

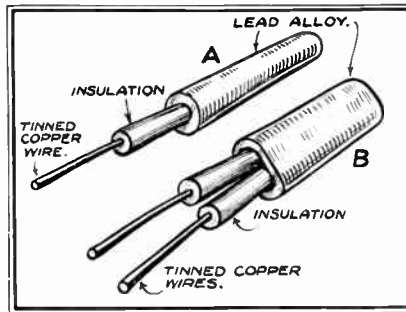

Fig. 2.—EXAMPLES OF LEAD SHEATHED CABLES USED FOR HOUSE WIRING.

coarse crystalline fracture. Zinc wire can, however, be drawn to give a tensile strength of 8 tons per square inch. It melts at 419°C . and boils at 906°C . It is a poor conductor of electricity and heat.

Zinc Electrodes in Cells.

Zinc is of special importance, electrically, in connection with the plates of primary cells, e.g., Leclanché and the dry batteries used for electric bells, torches and wireless work. Only the pure grades of zinc are used for this purpose. Zinc also forms an important constituent of brasses as is described in a later article on Copper.

Zinc Coatings.

Another important application of zinc is that of coating iron sheet, wire, castings, etc., as a protective measure against atmospheric corrosion.

Many electrical fittings which have to be made of iron or steel for reasons of strength and to be exposed for long periods to the corroding influence of town or sea air are now protected by coating with zinc; this is known as the *galvanising* process. The thoroughly cleaned iron or steel articles are usually dipped into baths of molten zinc and then allowed to drain the surplus metal off. In another process, known as the *Schoofe*, the molten zinc is sprayed on to the iron by compressed air, using a spray pistol for the purpose.

Die-castings.

Zinc is also used as a constituent of alloys used for the die-castings employed in electrical instruments and meters.

Mazak Castings.

Very strong die-castings of this class can now be obtained by a process known as the Mazak. This contains about 93 per cent. zinc, 4 per cent. aluminium and 3 per cent. copper. It has good electrical

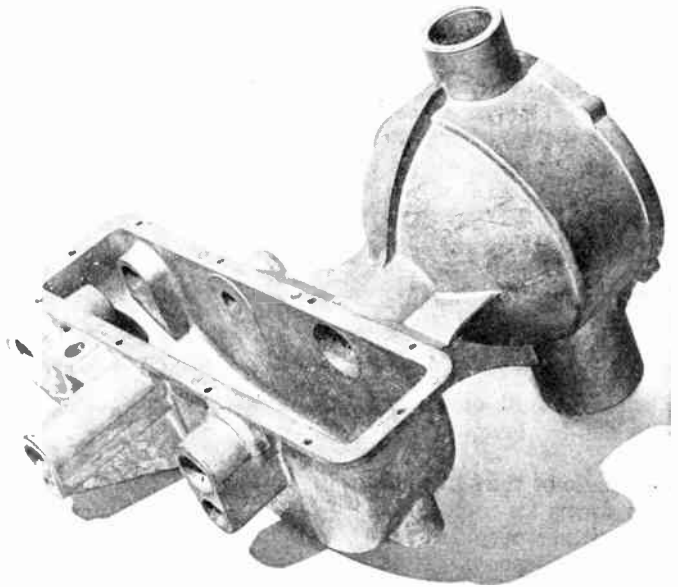

Fig. 3.—A COMPLICATED DIE CASTING IN MAZAK ALLOY.

and mechanical properties. The die-castings in Mazak give very sharp impressions of the dies. Laminated pole pieces can be made an integral part of the casting and such parts are now being used in electrical work. Mazak die-castings are also employed for electrical instruments, meters, small electric motors, magnetos and similar parts.

REPAIRS TO ELECTRIC COOKERS

By F. H. HOWELL

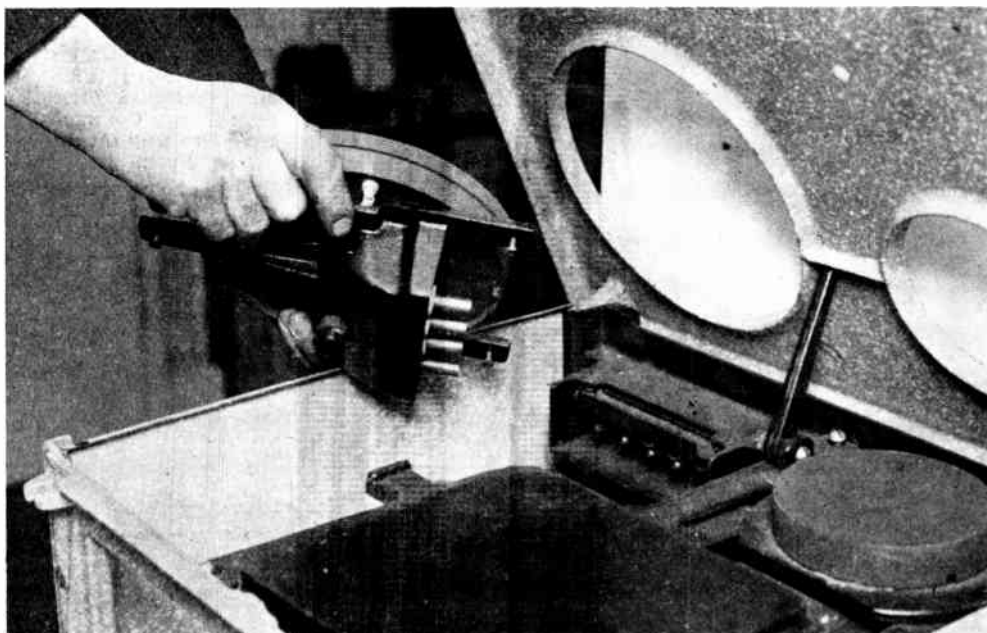

Fig. 1.—METHOD OF REMOVING THE FOUR-PIN BOILING PLATE FOR REPAIRS.

If it is to be returned to the manufacturers, it should be sent back complete with undercover.

This illustration also shows the adjusting screws, one on the extreme left, just under the little finger of the electrician, and the other two on the extreme right. These screws enable the height of the boiling plate, when fitted, to be adjusted, so that it is dead level with the hob, ensuring perfect contact for the utensils.

IT is quite a fixed idea in the minds of many people, even electricians, that electric cookers are constantly going wrong. This is quite a fallacy; the author has had an electric cooker in use for nearly 20 years and only on one occasion, and that pre-war, has the dinner stopped cooking, and then the fault was due to an interception of the supply. Even if one hotplate fails completely there is in most modern cookers a second hotplate or grill boiler, while it is almost unprecedented for the oven to fail entirely.

In a previous article beginning on page 845, mention was made of one type

of cooker with fixed terminals in the elements and a removable oven; there is another type, i.e., with fixed oven interior but plug-in elements. Fig. 5 shows a "Dolphin" cooker, which is a good example of this type.

How the Oven is Fitted in.

In this cooker the oven interior or inner lining is fitted to the outer lining and the intervening space is packed tightly with a species of asbestos wool and then cemented round the front edges. As the interior is in one piece it is impossible for any fumes or moisture to get at the lagging. The door is finely machined,

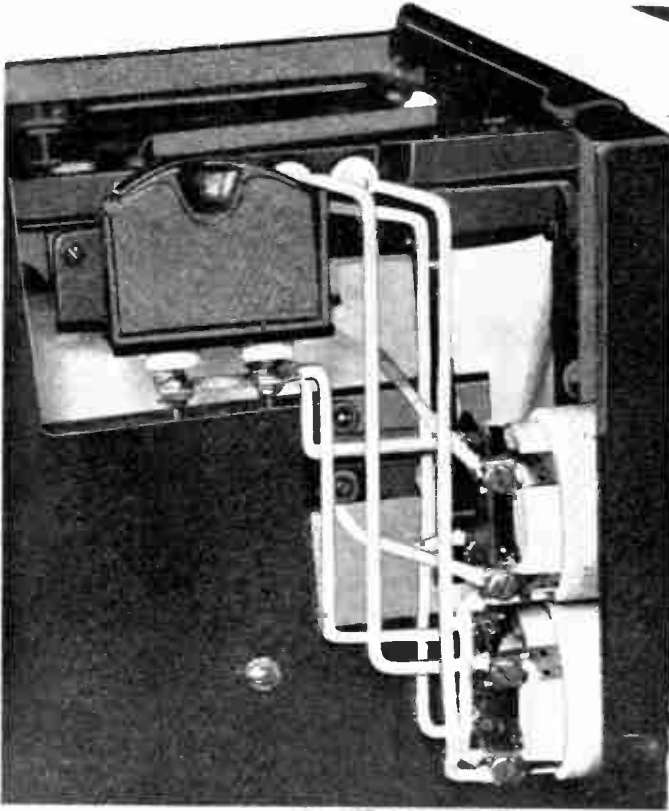
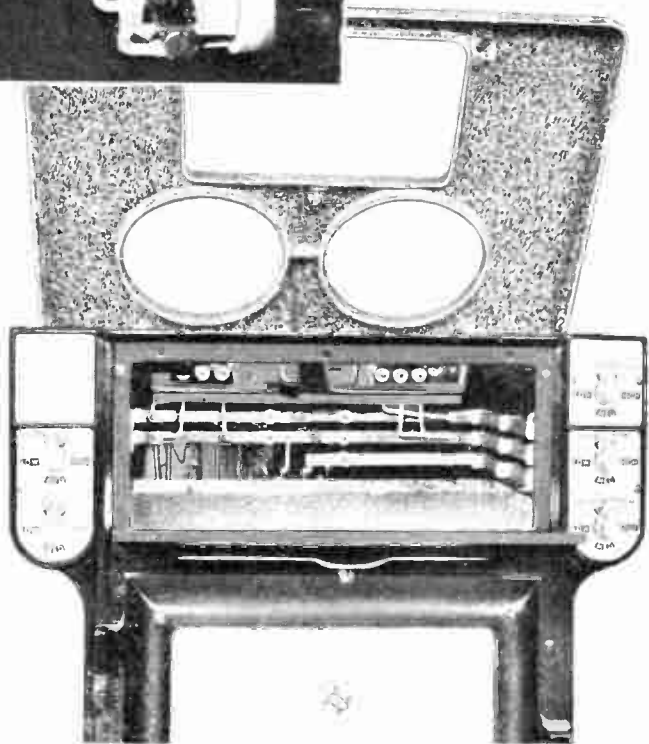

Fig. 2 (Left).—THE WIRING FROM THE HART SWITCHES WITH SIDE ENTRY CONNECTIONS TO THE ARTIC FUSE.

This photograph is taken with the side off and the hob lifted.

Fig. 3 (Right).—THE BUSBAR WIRING TO THE BOILING PLATE SOCKETS.

Showing the cooker with the hot-cupboard sides and back removed. The view shown in Fig. 2 is behind the switchplate on the left-hand side of this illustration.



RALPH STRANGER'S WIRELESS BOOKS

*The Wireless Library for the
Man in the Street:*

MATTER AND ENERGY
ELECTRONIC CURRENTS
ELECTRIFIED MATTER
MAGNETISM AND ELECTRO-
MAGNETISM
THE MATHEMATICS OF WIRELESS
BATTERIES AND ACCUMULATORS
SEEING BY WIRELESS (TELEVISION)
MODERN VALVES
WIRELESS COMMUNICATION AND
BROADCASTING
WIRELESS WAVES
HOW TO UNDERSTAND WIRELESS
DIAGRAMS
SELECTION OF WIRELESS SIGNALS
DETECTION OF WIRELESS SIGNALS
AMPLIFICATION OF WIRELESS SIGNALS
REPRODUCTION OF WIRELESS SIGNALS
WIRELESS RECEIVING CIRCUITS
WIRELESS MEASURING INSTRUMENTS
THE BY-PRODUCTS OF WIRELESS

SOME PRESS OPINIONS:—

"The new shilling library aims at giving the wireless enthusiast a sound theoretical and practical grip of his subject. The author employs clear and simple language, and starts practically from zero."—*The Broadcaster*.

"These books deal with a highly technical subject in the simplest language which enables those who have no scientific training to grasp the wonders of wireless, and assist the listener to get the best possible results from a receiving set."—*Railway Review*.

ONE SHILLING EACH

By Post 1/2 each.

WIRELESS: THE MODERN MAGIC CARPET

Fourth and Revised Edition

If you know nothing about wireless and do not even possess a receiving set, this book will show you how to provide yourself with an interesting and absorbing hobby. If you are a listener, but rather weak on the technical side, it will save you much unnecessary worry and expense. If you wish to experiment, this volume will provide you with valuable experimental data. If you are an expert and have to lecture, it will give you some useful lecture material.

SOME PRESS OPINIONS:—

"Mr. Stranger . . . gives a simple, yet authentic introduction to all the 'mysteries,' and explains them away in an exceedingly interesting and readable way. . . . A book which should go on every listener's bookshelf."—*The Star*.

"A good book simply written."—*The Daily Mirror*.

" . . . It will be surprising if such an ably written book as this does not find a wide sale."—*Daily News*.

" . . . Mr. Stranger has succeeded in doing one thing that will endear him to all students interested in electricity. He has succeeded in making static electricity fascinating. . . . The book should prove of great value to all those who have a set or contemplate the construction of one."—*World-Radio*.

" . . . The subject, in both theoretical and practical aspects, is dealt with in a lucid manner guaranteed to inculcate knowledge without pains."—*Amateur Wireless*.

3/6 nett.

By Post 3/9.

On sale at all Newsagents, Bookstalls and Bookshops, or by post from **GEORGE NEWNES, Ltd.**, 8-11, Southampton Street, Strand, London, W.C. 2

Geo. Newnes, Ltd.

**This article on Electric Cookers is continued in Part 21.
Ready March 4th. Order your copy to-day.**

GROW FOR YOURSELF and SELL TO OTHERS.

Now's the Time to Make Money out of

**STRAWBERRIES
CUCUMBERS
GREEN PEAS
MUSHROOMS**

**NEW POTATOES
CARNATIONS
CUT FLOWERS
CARROTS**

**LETTUCE
TURNIPS
GREEN BEANS
CAULIFLOWERS**

because £15,000,000 worth is wanted this year. Supplies to this value formerly came from abroad. Owing to the new import duties it will be almost impossible for foreign produce to sell in our markets and home-grown garden produce *must* take its place.

You can join in the great vegetable and flower-growing boom. You can learn the right way—and how to sell what you grow at top prices—by reading

THE SMALLHOLDER GARDENER & POULTRY KEEPER

Every Thursday ————— *Twopence*

THE SMALLHOLDER is the food-growing paper. Every week it is full of suggestions for all who would make money or save money with home-grown produce. It not only tells you what to do, but how to do it.

SPECIAL HOW-TO-DO-IT ARTICLES.

THE SMALLHOLDER has persuaded famous market growers to write special articles on how they are going to grow the vegetables and flowers the country now needs. Here are some of them.

- In issue of Feb. 6th. (now on sale) Strawberries
- In issue of Feb. 13th. New Potatoes and New Carrots
- In issue of Feb. 20th. Lettuce and Cucumbers
- In issue of Feb. 27th. Carnations
- In issue of Mar. 5th. Green Peas and Beans
- In issue of Mar. 12th. Cut Flowers
- In issue of Mar. 19th. Mushrooms and Cauliflowers

These articles will tell you everything you need to know to make money.