

To be Completed in about 32 weekly parts.

NEWNES PRACTICAL ELECTRICAL ENGINEERING



DEALING WITH
 ALL PRACTICAL APPLICATIONS OF ELECTRICITY IN EVERYDAY LIFE.

INTENDED FOR
 ELECTRIC LIGHTING and POWER ENGINEERS. ELECTRICIANS AND WIREMEN. WIRELESS DEALERS. STUDENTS, APPRENTICES AND IMPROVERS IN ALL BRANCHES OF THE ELECTRICAL AND WIRELESS INDUSTRIES.

1 1/2

PART 14

A PRACTICAL WORK WRITTEN BY EXPERTS

STUDY
AT
HOME

YOU CAN HAVE A COLLEGE
TRAINING IN ALMOST ANY
CAREER FOR A FEW
SHILLINGS MONTHLY

IN
YOUR
SPARE
TIME

FOUNDED 1900.

31 YEARS OF SUCCESS.

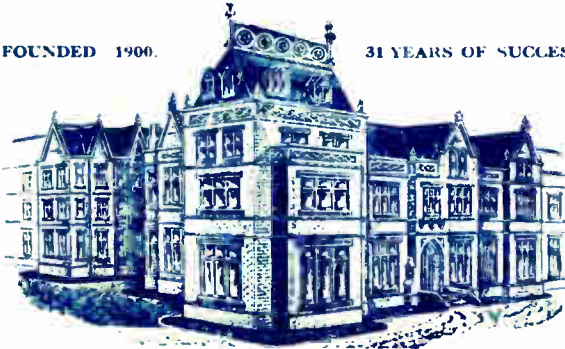

THIS IS THE BENNETT COLLEGE - - ALL OF IT
The Bennett College is not a Rented Room in a well-known street—it is a College. Over 30 years ago the Founder took as his motto what has now become a household slogan:

LET ME BE YOUR FATHER

In many trades and professions there are more vacancies than trained men to fill them. We do not profess to act as an employment agency, but our gigantic organisation certainly does tell us where the demand exists, thus enabling us to give FATHERLY ADVICE ON ALL CAREERS AND THE POSSIBILITY OF EMPLOYMENT, FREE.



J.W. Bennett

WE TEACH ALL
BRANCHES OF
THE FOLLOW-
ING VOCATIONS
AND SPECIALISE
IN ALL EXAM-
INATIONS CON-
NECTED THERE-
WITH.

**THE MOST SUCCESSFUL AND MOST PROGRESSIVE
CORRESPONDENCE COLLEGE IN THE WORLD**

Aviation Engineering.
Boiler Engineering.
Boiler Making.
B.Sc. (Engineering).
Civil Engineering.
A.M.I.C.E.
Quantities—Specifications.
Commercial Art

Concrete and Steel.
Draughtsmanship :
Electrical or
Mechanical.
Electrical Engineering :
A.M.I.E.E.
City and Guilds.
Engineering Mathematics.
Foundry Work.
Heat Engines.

Heating, Ventilating and
Lighting.
Internal Combustion Engines.
Machine Designs :
Theory of Machines.
Marine Engineering :
Motor.
Steam.
Mechanical Engineering :
A.M.Inst.B.E.
A.M.I.Mech.E.
City and Guilds.
Pattern Making.

Mechanics.
Metallurgy of Steel.
Mine Electrician :
A.M.E.E.
Mining (all examinations).
Motor Engineering :
A.M.I.A.E.
Municipal and County
Engineers :
M. and C.E.
Naval Architecture.
Pumps and Pumping
Machinery.
Ship Building.
Structural Engineering.
Telegraphy and
Telephony.

IF YOU DO NOT SEE YOUR OWN REQUIREMENTS ABOVE, WRITE TO US ON ANY SUBJECT.

IT COSTS NOTHING TO ENQUIRE.

Also ask for Our New Book
(FREE OF CHARGE)

THE HUMAN MACHINE

SECRETS OF
SUCCESS

WE TEACH BY POST IN ALL PARTS OF THE WORLD

Note Address Carefully :

The BENNETT COLLEGE, Ltd., Dept. 119, Sheffield



ELECTRIC RADIATORS AND FIRES.

A current of electricity is passed round a series of spiral coils of Nichrome resistance wire. The coils are mounted on fireclay formers which are fitted in the radiator case. The coils of resistance wire become red hot, due to the passage of the current through them, and the heat generated is distributed in the room by radiation. A polished metal reflector placed behind the spirals considerably assists in radiating the heat into the room.

Imitating a Coal Fire.

A thick orange-coloured plate of glass is fixed in the radiator case. Pieces of coal are embedded in the glass. The glass is illuminated with a red coloured pilot lamp which is fixed inside the radiator case immediately below the glass plate. The resistance elements of the fire are fitted behind a metal plate which is fixed on the back edge of the glass plate. A polished metal reflector is arranged behind the heating element to radiate the heat into the room.

The Flickering Flame Effect.

This effect is produced by a "spinner" which is rotated by the air convection currents produced by the heat of the pilot lamp. The spinner is suspended, so as to rotate about a vertical axis, between the pilot lamp and the illuminated plate of glass. The shadow of the rotating spinner on the illuminated glass plate is reflected

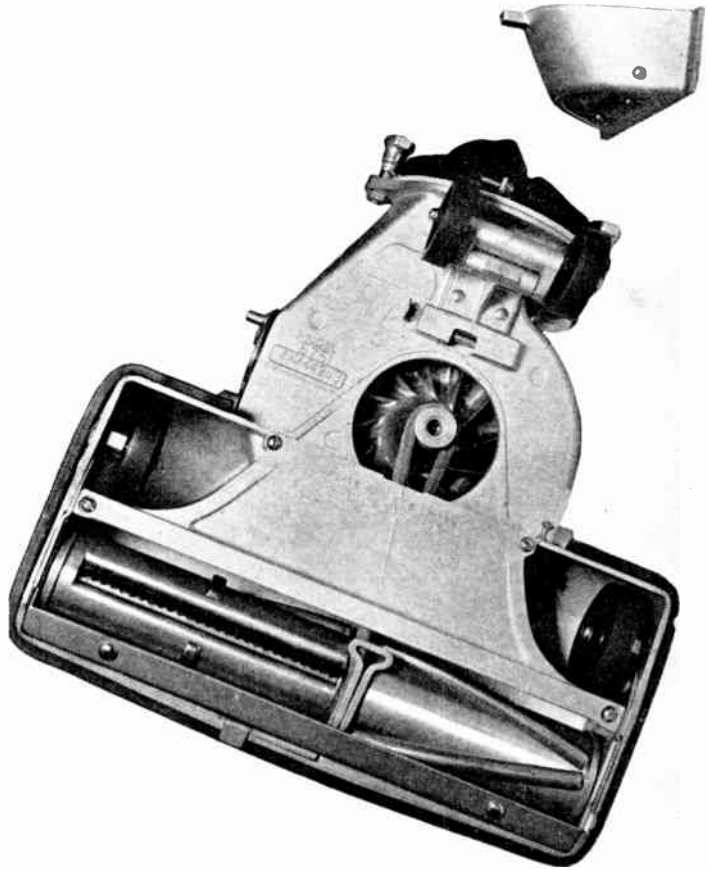

Fig. 7.—AN ELECTRICALLY DRIVEN VACUUM CLEANER.

Showing the rotary brush which is driven from the fan shaft. The brush loosens the dust from the surface to be cleaned and the induced draught created by the rotary fan removes the dust into the dust container. The cover from the fan chamber has been removed to show the method of driving the revolving brush.

by the polished reflector which gives a flame effect to the observer.

Switch Control of the Heating Spirals.

A radiator or imitation coal fire may be fitted with a number of heating elements each of which is controlled with a switch fixed on the side or front of the radiator case. This control will give full, medium, and low heat when desired. In a radiator it is generally arranged that one of the heating elements is switched on when the plug is connected to the socket which supplies the current to the radiator. With

▲

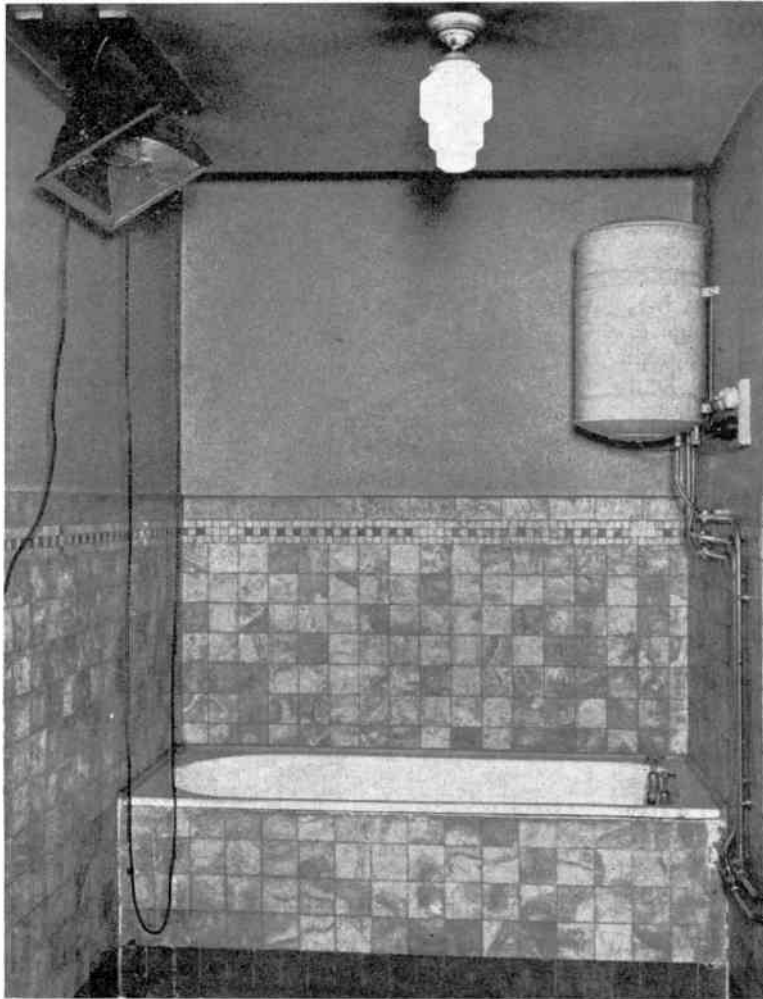

Fig. 8.—AN ELECTRIC RADIATOR FITTED TO THE CEILING OF A BATHROOM. The reflector directs the heat rays in a downward direction. The radiator is fitted on a movable spindle which can be turned by the cord in order to direct the radiated heat in any desired direction. The ceiling radiator cannot be easily touched and any possibility of being burned when stepping out of the bath is avoided. This illustration also shows an electrically heated hot-water cistern.

an imitation coal fire only the pilot lamp is switched on when the plug is connected, each of the heating elements having a separate switch control.

Loading of Radiators to Heat a Given Floor Space.

The loading of a radiator to heat efficiently a room 9 feet high is approximately 1 kilowatt per 100 square feet of floor space.

A room 10 feet by 10 feet by 9 feet high will require a 1 kilowatt radiator which consumes 1 unit an hour.

A room 14 feet by 14 feet of the same height will require a 2 kilowatt radiator which consumes 2 units an hour.

ELECTRICALLY DRIVEN WASHING MACHINES.

The machine consists of a set of rollers

Fig. 9 (Right).—AN ELECTRICALLY HEATED TOWEL RAIL.

The towel rail is fitted with a low-temperature heating element which produces convection currents of warm air. The supply is given through a two-core flexible to a plug connector fixed to the side of the rail. A permanent earth connection is made to the base of the rail. The consumption of the heating element is 660 watts, or .66 unit per hour.



Fig. 10 (Left).—AN ELECTRICALLY DRIVEN WASHING MACHINE.

The motor is fixed to a bracket on the side of the washing tub and drives through gearing an oscillating "dolly" and the rollers. The "dolly" and the rollers are independently controlled by hand-operated clutches.

The "dolly" is raised clear of the tub by raising the hinged lid.

Always wipe off any moisture from the carcass of the motor after finishing with the machine.

The clutches for the "dolly" shaft and the roller drive should be opened before stopping the motor.



Fig. 11 (Left).—AN AIRING FRAME FOR CLOTHES.

A low-temperature electric heating element is fitted inside the triangular base of the frame, convection currents of warm air rise from the frame and air off the clothes hanging on the pegs of the frame. The loading of the heating element for the airing frame is 660 watts and it consumes 0.66 unit per hour. The element is a low-temperature heater.

Fig. 12 (Right).—AN ELECTRICALLY HEATED WASH BOILER.

The heating element is controlled with a three-heat rotary switch. The power taken by the wash boiler is 2 kilowatts when the regulating switch is in the full position. The supply is given through a 4-core cab-type cable, three of the cores being connected to the heating element terminals, and the fourth core connected to the metal work of the boiler to make the earth connection.



fitted in a frame, and a washing tub fitted with a hinged cover.

The Drive for the "Oscillating Dolly."

A wooden "dolly" inside the tub is given an oscillatory motion through gears from a shaft fitted above the hinged cover of the tub. This shaft is driven from a side shaft fixed to the side of the machine. The electric motor is geared to the side shaft with suitable pinion wheels. A hand-operated clutch puts the "dolly" driving shaft in or out of gear with the side shaft driven by the motor. The "dolly" may be raised clear of the tub by lifting up the hinged cover of the washing tub.

The Drive for the Rollers.

The rollers are driven through reversible gears from the side shaft which is geared to the motor.

The rollers are put in or out of gear, or their direction of rotation reversed, with a hand-operated clutch. The roller frame may be swung clear of the washing tub when so desired.

The Electric Motor.

The driving motor develops $\frac{1}{4}$ h.p. and is fitted on a bracket which is fixed to the frame of the machine. The supply of electricity to the motor is given with a cab tyre cable connected to a plug. The frame of the machine is permanently earthed. The motor will consume about 0.2 unit per hour.

ELECTRICALLY OPERATED REFRIGERATORS.

There are several types in general use. One type which has been found to be satisfactory for domestic use has



Fig. 13A.—AN ELECTRICALLY OPERATED REFRIGERATOR. The electrical circuit is controlled by an automatic switch which cuts off the electricity supply if the water supply fails. A switch on the left of the control panel gives two adjustments for regulating the temperature.

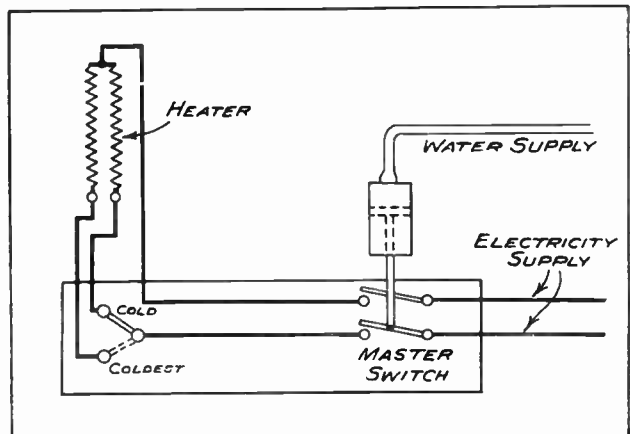

Fig. 13B.—CIRCUIT OF REFRIGERATOR. The heater circuit has two loadings which may be selected by the two-way switch.



Fig. 14.—AN ELECTRICALLY HEATED WATER CISTERN FOR LOCAL SUPPLY TO A SINK.

The hot water is drawn off by turning on the cold water supply to the cistern. When first installing the electrically heated cistern the switch should not be closed until water flows from the hot water closet. The heating element and the thermostat may be removed from the copper sheath without emptying the cistern. The loading of the element is 500 watts and it consumes 0.5 unit per hour.



Fig. 15.—FITTING AN IMMERSION HEATER TO A HOT-WATER CYLINDER.

The cylinder of a hot-water system is drilled and a screwed flange fitted in the drilled hole. The immersion heater which is placed inside the cylinder is fastened to a screwed nut which makes a watertight pressure joint with the screwed flange.



Fig. 16.—AN IMMERSION HEATER FITTED IN THE CYLINDER OF A HOT-WATER SYSTEM.

The thermostat can be adjusted to operate at different temperatures with the graduated dial fixed to the mechanism of the tilting glass tube.

no moving parts and requires no attention beyond turning on or off the water supply and regulating the heating circuit.

The electrical circuit consists of a heating element which is fitted inside the lower part of the generator. The heating element has two parts which are controlled by a two-way regulating switch fixed on the left side of the control panel. The two-way switch gives the low or high loading of the heating element, and is marked on the control panel as the cold and coldest positions of the switch.

The Master Switch.

A master switch, which is operated by a plunger whose motion is controlled by the pressure of the water supply to the condenser of the refrigerator, will open the electrical circuit when the water supply is cut off or the water pressure fails.

Operation of the Refrigerator.

When the water supply is turned on, and the electrical circuit closed, the heating

element boils the liquid contained in the generator and ammonia gas is driven off from the liquid. The gas passes into the condenser coil which is cooled by the water circulating through the condenser chamber. The ammonia gas is now condensed to a liquid which runs into the evaporator. The liquid ammonia which has run into the evaporator vaporises and cools down the walls of the evaporator chamber to a low temperature. The coldness of the walls of this chamber is communicated to the interior of the refrigerator where the food-stuffs are placed. The evaporated ammonia goes from the evaporator to the absorber where it mixes with water and the liquid now passes on to the generator. This cycle of operations continues whilst the refrigerator is in use.

The Loadings of the Heating Element.

The loading of the heating element when the regulating switch is in the "cold" position is 150 watts and the circuit consumes 0.15 unit per hour, and

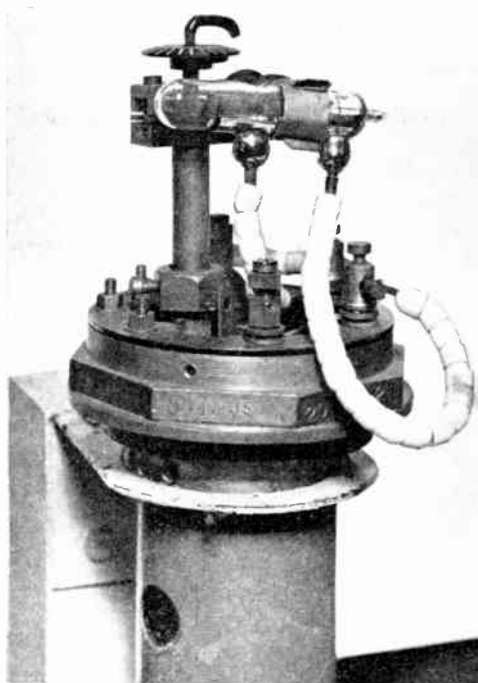

Fig. 17A.—AN IMMERSION HEATER WITH THERMOSTATIC CONTROL, FOR HEATING THE DOMESTIC WATER SYSTEM.

The heater is fitted inside the water circulator tube. The heating element circuit is controlled by a thermostat, which tilts a glass tube containing mercury, when the temperature exceeds the limit, and the circuit is opened. The hole in the top of the circulator tube is the outlet for the heated water.

when the regulating switch is in the "coldest" position the loading is 375 watts and the circuit consumes 0.375 unit per hour.

ELECTRICALLY DRIVEN VACUUM CLEANERS.

Great care should be exercised to select a vacuum cleaner which will do its work efficiently. A good vacuum cleaner will have a motor large enough to do the work required of it without overloading, its mechanical construction should be sound, and a good suction should be obtained by the induced draught created by the rotating fan.

The cleaner should be fitted with a device which will loosen the particles of dust, etc., on the surface which is to be cleaned, in

order that the whole of the dust may be completely removed into the dust container by the induced draught of air.

A revolving brush driven from the fan shaft, and in contact with the surface to be cleaned, will be found to be completely efficient in this respect.

The motor circuit may be controlled with a switch fixed to the handle of the sweeper, or a switch fixed on the side of the motor case, which is switched on or off by the movement of the sweeper handle.

The loading of a vacuum cleaner motor is about 200 watts, and it consumes 0.2 unit per hour.

MOTOR-CAR RADIATOR HEATER.

This appliance is used to prevent the water in the radiator of a motor-car from freezing during frosty weather when the car is in the garage.

The Heater.

This consists of a resistance spiral wound on a fireclay former and the complete element fixed in a ventilated metal case. The case is provided with a hook to enable

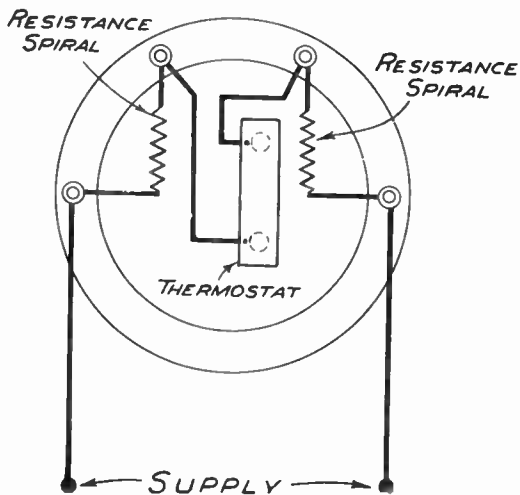

Fig. 17B.—CONNECTIONS FOR THERMOSTATICALLY CONTROLLED ELECTRICAL IMMERSION HEATER.

The terminals of the heating element and the thermostat are mounted on an ebonite ring which is fixed on the flanged nut of the immersion heater. The heater element consists of two resistance spirals which are connected in series.

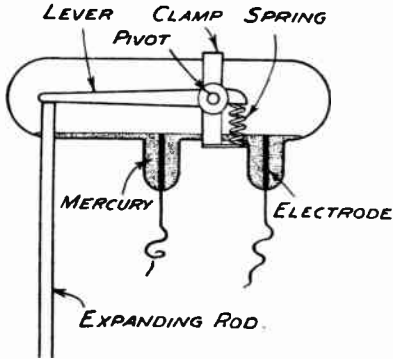

Fig. 17C.—THERMOSTATIC CONTROL FOR IMMERSION HEATER.

The tilting device for the glass tube containing mercury. When the rod expands, due to the excessive temperature of the cylinder water, it raises the end of the pivoted lever which causes the glass tube to be tilted. The element circuit is opened by the mercury flowing to the right-hand end of the tube and disconnecting the electrodes from each other.

the heater to be hung on the radiator frame.

When the current is switched on, the element gets warm, but does not attain a temperature sufficiently high to be a source of danger. Convection currents of warm air are circulated round the frame of the radiator. The loading of the heater is 660 watts, and it consumes 0.66 unit per hour. An earth wire should be connected from the case of the heater to a water-pipe. The connection to the water-pipe should be made with a suitable earthing clip.

A CLOTHES AIRING FRAME.

A low-temperature resistance element is fitted at the foot of the frame and protected with a triangular ventilated cover. When the current to the element is switched on, the warm air produced by the hot element rises through the ventilated cover and dries off any clothing which is hung on the adjustable pegs. The pegs are fitted into slots in the upper part of the frame. The element has a loading of 660 watts and consumes 0.66 unit per hour. The supply to the element is given from a 5-ampere plug and socket with earthing pin through a three-wire flexible.

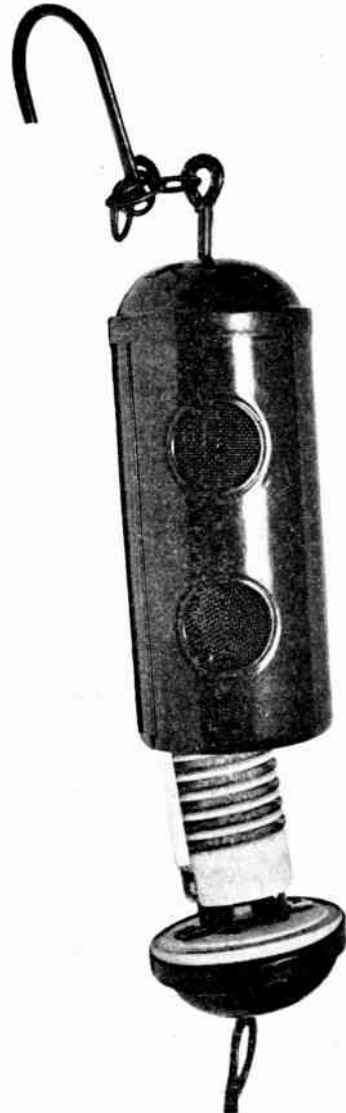

Fig. 18.—PREVENTING THE RADIATOR OF A MOTOR CAR FROM FREEZING UP.

A low-temperature electric heater is fitted in a ventilated metal case, and hung on the radiator inside the bonnet of the car.

The loading of the radiator heater is 660 watts and it consumes 0.66 unit per hour. The gauze-covered holes in the case should be in contact with the radiator, warm air will then circulate freely round the radiator.

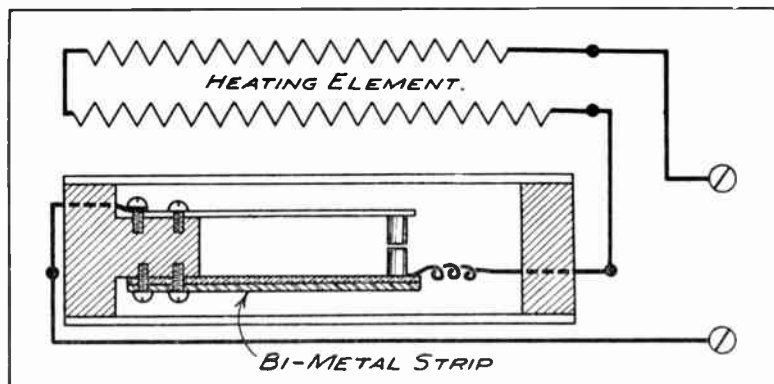

Fig. 19.—THERMOSTATIC CONTROL OF AN ELECTRIC IRON CIRCUIT.

The element circuit of an electric iron controlled by a bi-metal strip, which bends in an outward direction when the temperature of the ironing surface becomes excessive.

ELECTRICALLY HEATED WASH BOILER.

The boiler is fitted in a cylindrical iron case provided with metal feet. An air space between the boiler and the case increases the heat efficiency of the boiler and reduces heat losses caused by radiation and conduction.

The Heating Element Control.

The heating element is controlled with a three-heat rotary switch which will give full, medium and low loading of the heater.

The switch is fixed on a pateras which is fitted in a convenient position near the boiler.

A four-core cable supplies current to the heating element, three of the cores being connected to the terminals of the

element to enable the three-heat control to be obtained. The fourth core connects the metal case of the boiler to earth.

Care in Earthing the Boiler Case.

Particular attention should be paid to the earthing, as probably a fatal electric shock would be received by anyone touching the metal case of the boiler, should a leakage occur from the heating element. This is owing to the fact that a very good connection, due to the water about a wash-house floor, will be made by a person touching the boiler.

The element is fitted directly underneath the bottom of the boiler.

The full loading of the element is 2 kilowatts and it consumes 2 units per hour.

ELECTRICAL INSULATING MATERIALS

By M. G. SAY, Ph.D., M.Sc.

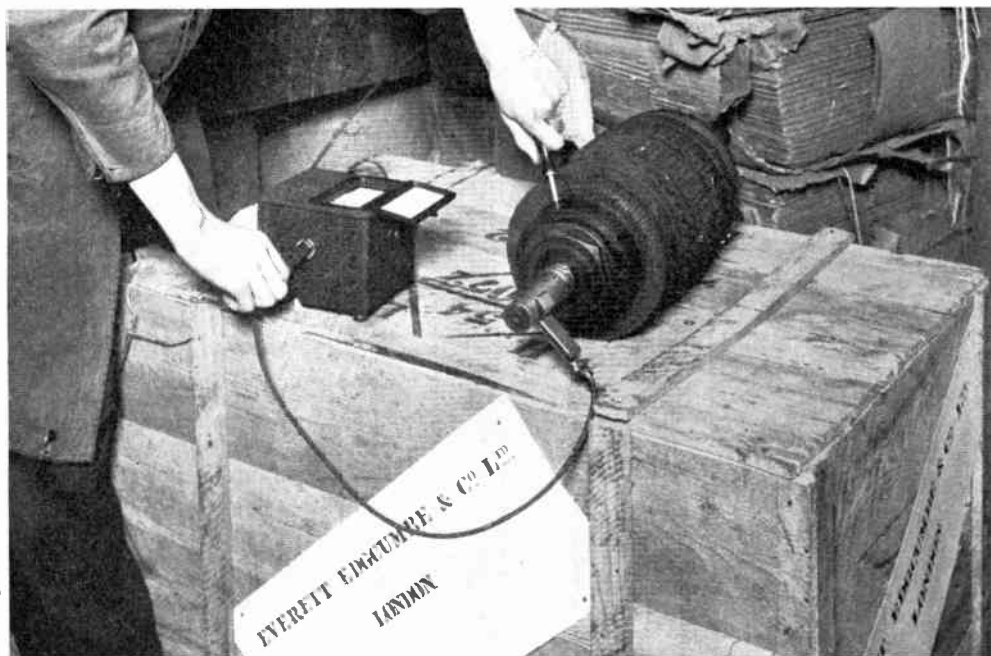

Fig. 1.—TESTING THE INSULATION OF A DIRECT CURRENT MOTOR ARMATURE WITH A METROHM. The armature spindle is connected to the “earth” terminal of the instrument by means of the bull-dog clip and an insulated hand spike, connected to the other terminal, is pressed on to a conducting part. A few turns of the handle and the insulation in megohms is shown on the dial. When repairing an armature, each coil should be tested in this way, before soldering on to the commutator lugs, otherwise a fault is difficult to locate.

Insulation.

IT may be a surprising statement to many readers that it is the *insulation*, not the *conductor*, that provides the mechanism whereby electrical energy is conveyed. The matter is intimately concerned with the electrostatic and electromagnetic fields surrounding a live circuit; with the nature of electrons; indeed, with the very basis of electricity, as yet but dimly understood. Physicists all over the world are working strenuously to give us more light on this dark subject, and until much more has been discovered

and proved, our knowledge of the reason why insulation does actually insulate must remain vague.

In view of our great ignorance, it is perhaps better for the practical study, which is our present concern, to revert to the easy conception that an insulator is like a conductor, but with an extremely high resistance. It is common knowledge to most readers that conductors of electricity—all the metals, that is, and a few other materials like carbon—have *resistance*. It requires the application of a greater or lesser voltage to cause a given

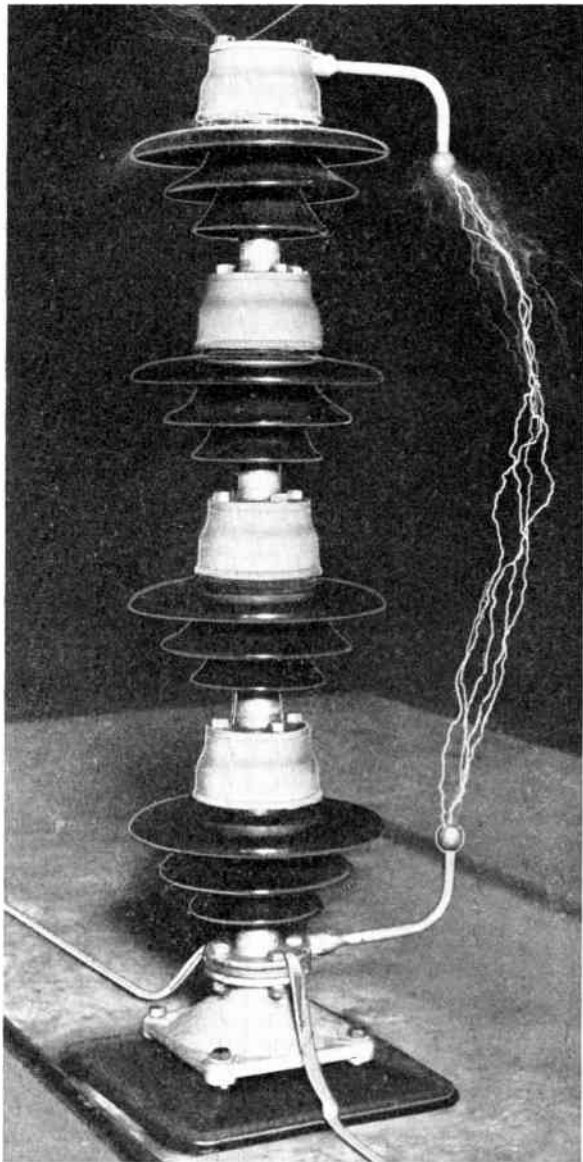

Fig. 2.—AN EXAMPLE OF HIGH FREQUENCY FLASHOVER.

This shows the flashover on 132 kV. post insulator at 1,000 kV., 125,000 cycles. This huge current is produced by a high frequency generator consisting of an air core Tesla transformer. High frequency tests are made by allowing the high frequency to discharge across the insulator under test for a certain period of time.—(G.E.C.)

current to flow through a circuit the conductors of which are made of a given metal. Precisely the same conditions hold, however, for the materials termed

“insulators,” the only difference being one of degree. These materials have, by comparison with metals, an enormous resistance. If, therefore, we cover or support a material of low resistance (e.g., copper) with another material of high resistance (e.g., rubber) and apply an electric current to the system, this current will flow substantially along the low-resistance “conductor” and a very small quantity only will traverse the high-resistance “insulator.”

This, in brief, is the underlying principle of electrical insulation.

As an example, the resistance of a length of wire may be, say, half an ohm, and that of the insulating material round it may be of the order of 5,000,000 ohms.

Insulating Materials.

Nature has so arranged matters that all the substances usable as insulating materials are essentially non-metallic. All the metals are more or less efficient conductors, silver being the best, copper second, and aluminium third. On account of its cost of course, silver is used to a small extent only for delicate scientific apparatus: copper is the almost universal conductor.

Now man has gone far towards developing the technique of metal treatment. Metals may be refined, purified, cast, drawn, bent, rolled, extruded, welded, forged, soldered, so that it is usually possible to find some simple way of making the metal conform to the end desired. Insulating materials, unfortunately, might almost be classified as including “everything not a metal.” This definition is, of course, far too wide, but it serves to indicate the tremendous range and diversity of form that insulating materials can show.

What the Engineer Wants.

The engineer requires his working

materials to be cheap, easily made up into the required form, strong, durable, resistant to moisture, heat and shock, and possessing good electrical properties. The latter include high ohmic resistance, and high breakdown or dielectric strength (a term explained later). No one material possesses all these desirable qualities. Most materials are extremely good in one particular, and extremely bad in another almost equally essential. Thus out of all the known diversity of Nature, a few substances only have been used for insulation purposes. The range becomes larger as the process of elimination and selection goes on, and as improved methods and intensive research reveal new qualities: it is nevertheless limited. Some success has been had with "synthetic" materials, such as the "bakelite" class of synthetic resin, produced by a composition of certain chemicals in a controlled process. In many cases these man-made materials have ousted the natural product which they originally imitated.

Qualities of Insulating Materials.

Some of the electrical qualities of insulating materials have already been



Fig. 3.—TESTING SHEET INSULATING MATERIALS, ETC., FOR DEFECTS.

The sheet is laid flat upon a metal-covered slab and 2,500-3,000 volts are applied by means of the insulated hand spike. In this way, any defects such as pin holes or conducting particles or veins can be at once detected. The voltmeter measures the applied voltage, which can be regulated by the resistance shown on the right. The double-pole switch is normally open and is closed by a foot pedal, whilst the red lamp on the left lights up as a warning that the hand spike is alive. For testing objects that cannot be conveniently laid down on a flat surface, the second hand spike is used to form the other pole.

mentioned by name. They are so important, however, as a measure of the value of the materials to the engineer, that some further description is necessary. The mechanical properties are so varied that it is not possible to enter into them here. They will be mentioned when the various insulators are individually considered. It is assumed that the reader understands the terms "compressive stress," "tensile stress," "torsion," "shearing," and others applied to the mechanical properties of materials.

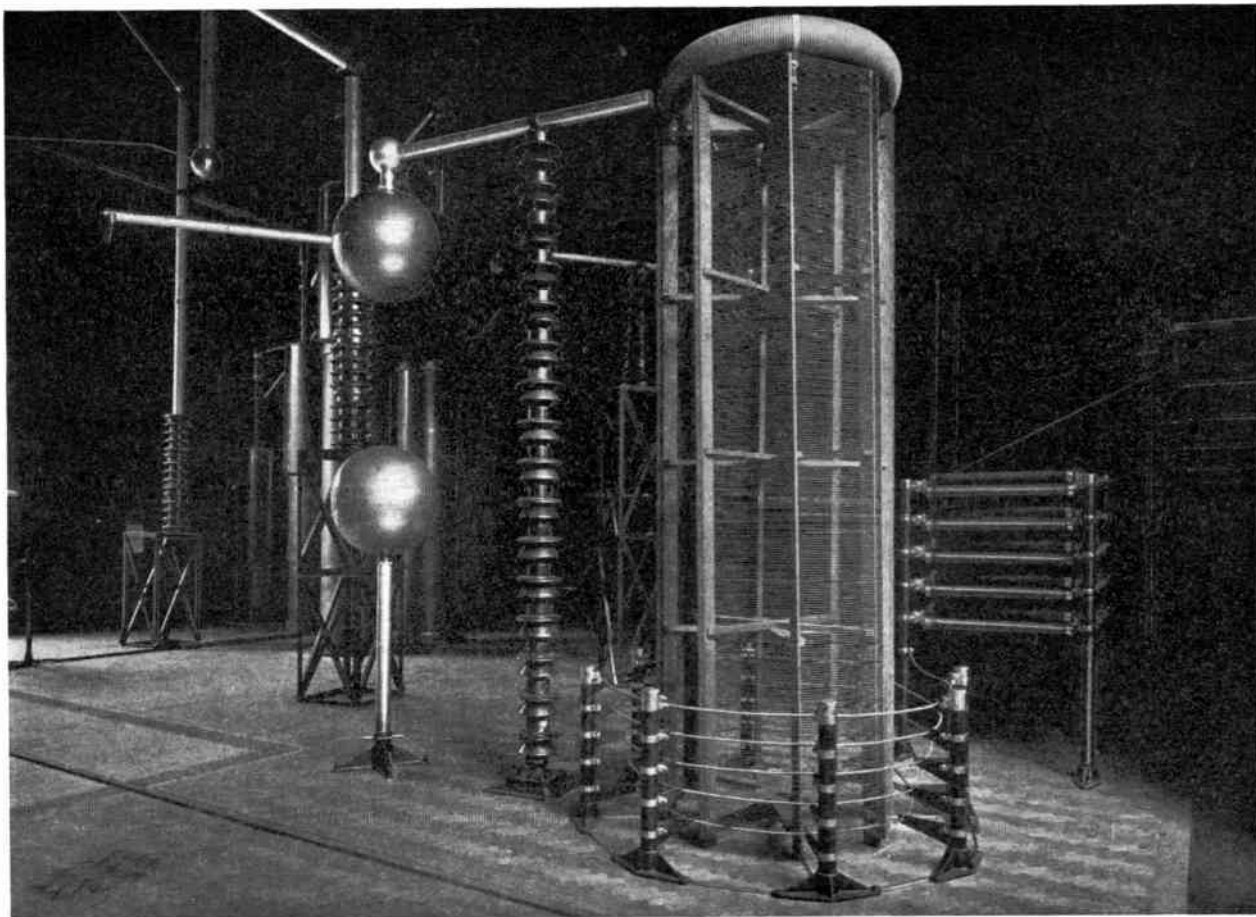

Fig. 4.—INSIDE THE HIGH TENSION LABORATORY AT THE WITTON WORKS OF THE G. E. C.
This shows a high frequency generator (Tesla coil) capable of giving one million volts.

Breakdown Strength, or Dielectric Strength.

This term refers to the electric stress and strain set up in an insulating material when subjected to a voltage difference. A simple case to consider is that of the testing of a sample of sheet insulation for this quality. The sheet is placed between flat-faced metal electrodes, joined to the opposite poles of a high-voltage testing transformer. The voltage is gradually raised until the material is so highly strained that it breaks down.

Why Insulation Breaks Down.

The reason why breakdown occurs is not very well understood. It seems to depend on the kind of insulating material tested.

Heating Effect.

For example, fibrous materials like paper or "Empire" cloth break down because the very small current passing between the electrodes heats them, causing their resistance to fall: the reduced resistance allows more current to flow, which in turn produces more heat. This

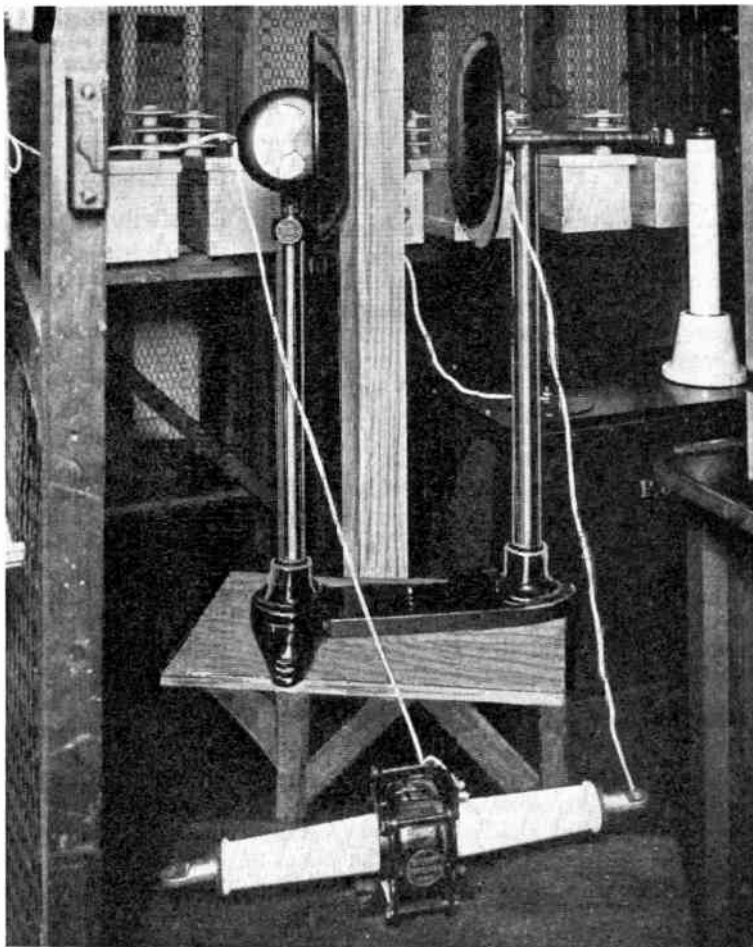

Fig. 5.—TESTING THE INSULATION OF A HIGH VOLTAGE CURRENT TRANSFORMER BEFORE INSTALLATION.

This 40,000-volt current transformer has to withstand a 100,000-volt test for one minute. The voltage is generated by the transformer seen on the right, measured by the Abraham Electrostatic Voltmeter seen in the centre and applied between the primary and the secondary and carcass, connected together, of the current transformer seen in the foreground. It will be noticed that the high tension test cubicle is surrounded by a wire cage. This cage is earthed and, on grounds of safety, the transformer switch is so interlocked with the door of the cubicle that nothing can be made alive until the door has been closed, with the operator outside.

process continues until the material "carbonises" or chars. Carbon being a good conductor, the current now becomes very large indeed, and a hole is burnt through the material. The circuit-breakers or other switchgear now cut off

the transformer, which would otherwise be damaged were it allowed to pass such a large current through the insulating material—now worthless.

Mechanical Forces.

Materials such as mica and porcelain and glass break down in quite a different way. Although in their case heat is also produced, it does not seem to contribute directly to breakdown. It appears that the electric stress wrenches the molecules apart, setting up internal mechanical forces which tend to split or fracture the material. In this case breakdown occurs very suddenly.

Explosive Action of Discharge.

Certain materials exhibit evidence that a small explosion has occurred in their interior under the violent action of the electric stress. All these forms of breakdown depend on the structure of the tested material, and are important evidence of its suitability for various applications.

Breakdown Voltage.

Reverting to the case of the sheet material between the metal electrodes, it is usual to express the breakdown stress as the voltage at which breakdown occurs divided by the thickness of the sheet; e.g., in volts per mil (1 mil = $\frac{1}{1000}$ inch) or kilovolts per centimetre. Much depends upon the conditions of the test, such as the temperature and moisture. Moreover, a test taken on a thick specimen will give a lower breakdown strength than one taken on a thinner specimen. The time of application of the test voltage is another factor, more particularly for those materials which break down by heating. Thus the determination of breakdown strength is a process requiring care and experience, and the results need expert interpretation if they are to be of any value.

The breakdown voltage is of little significance for low voltage insulation. As an example, if it were desired to insulate a wire for, say, 50 volts, with rubber covering, then the thickness of the rubber as calculated on its breakdown strength would be far too thin to be

durable or to give the necessary mechanical protection. In high-voltage work, on the contrary, the dielectric strength becomes the limiting factor, for insulators have of necessity to be so large that their mechanical strength does not come in question.

Resistivity or Specific Resistance.

Sufficient has already been said to explain the significance of the resistance of a material. Unless the resistance is high, the material is useless for insulating purposes. A low dielectric strength can be overcome by using adequate thickness, but high resistance is an essential characteristic which, if absent, necessitates the rejection of the material.

For the purposes of comparison, the resistance of a material is quoted as for a definite length and cross section: e.g., the resistance between opposite faces of an inch cube, or between the ends of a rod one metre long and one square millimetre in cross section. The resistance of such a standard size is termed the specific resistance or *resistivity*.

The resistivities of insulating materials are very variable quantities. They are affected by temperature and moisture in particular. A rise in temperature is invariably accompanied by a fall in resistance, and one of the results of this has already been referred to. Some insulators, particularly the cellular varieties such as cotton and paper, readily absorb water, and in so doing, undergo a drastic reduction in their resistivity. Materials that absorb moisture are termed "hygroscopic," and in most cases have to be treated by *impregnation* to close up or fill up the small cells or pores with some material filler, which will prevent the absorption of moisture. The reader will appreciate that cotton-covered wires, for example, are rarely left without a coat of varnish or immersion in oil.

Resistance to Heat.

The insulating materials capable of withstanding high temperatures are few. Mica and asbestos are usable at about 500°C., but have mechanical disadvantages: asbestos, for example, is extremely weak

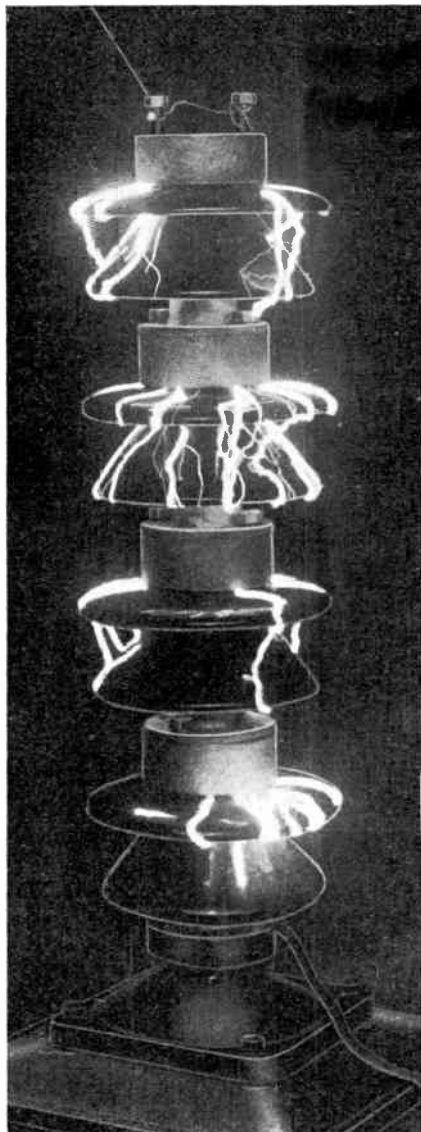

Fig. 6.—AN EXAMPLE OF SURGE FLASH-OVER.

This shows a small unit post type insulator under test at 700 kV. (max.). It is necessary to test insulators as to their capacity to withstand the application of electrical surges, in addition to the high voltage tests.—(G. E. C.)

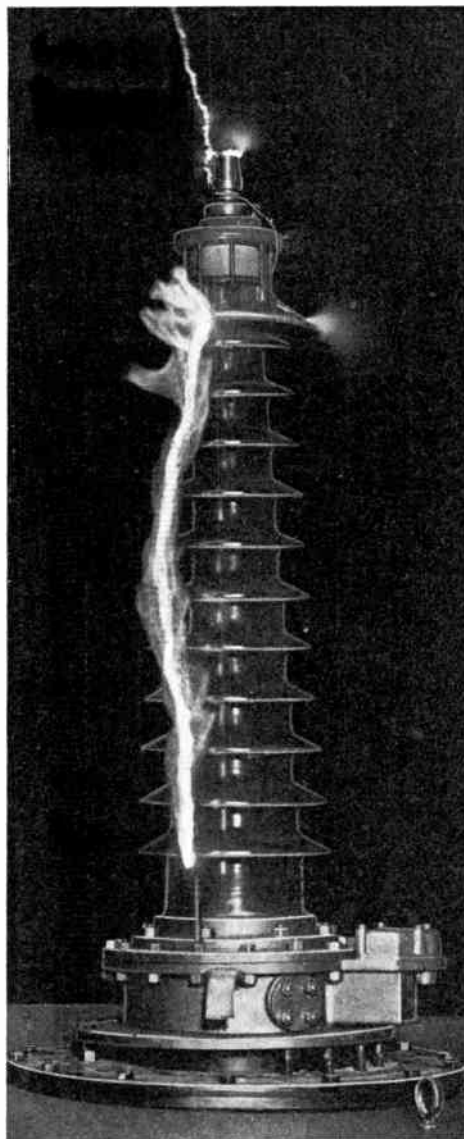

Fig. 7.—A HIGH VOLTAGE TEST AT NORMAL FREQUENCY.

Showing dry flashover at 385 kV., 50 cycles, on 66kV. bushing, lower end immersed in hot oil.—(G. E. C.)

and fibrous, and cannot be used alone. Fireclay and steatite withstand fairly high temperatures and can be used in electric fires. Quartz, although not a

particularly useful insulator, has to be employed in electric furnaces. The commoner materials such as tape, paper boards, etc., have to be used under con-

B

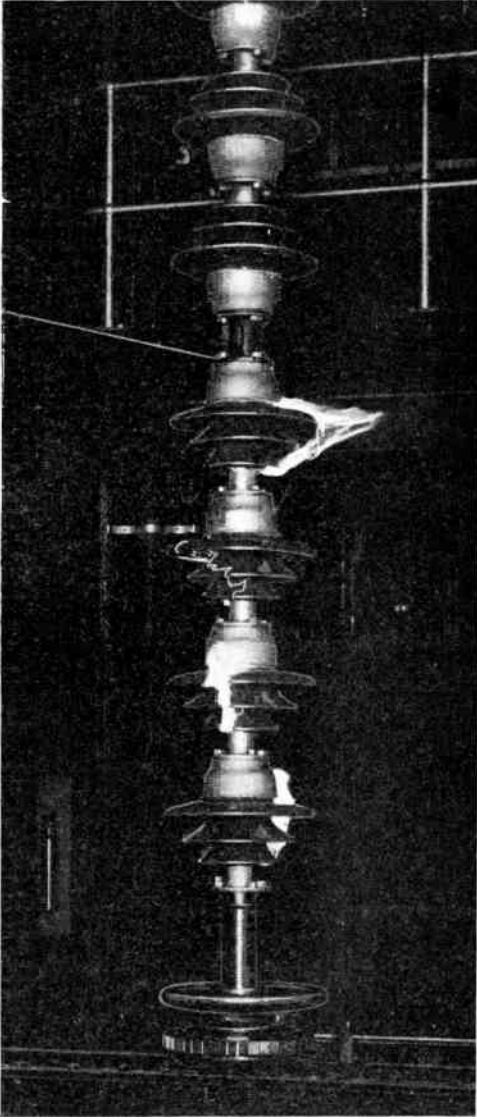

Fig. 8.—SIMULTANEOUS MECHANICAL TEST AND DRY FLASHOVER AT 500 kV., 50 CYCLES, ON FOUR UNITS OF A POST TYPE INSULATOR.

This type of insulator is used in the grid open-air substations.—(G.E.C.)

ditions for which the temperature is strictly limited.

Durability.

This quality is possessed by but few materials, principally the ceramics—porce-

lain, steatite, glass, etc. Many of the organic materials such as rubber, varnish and cotton tape, deteriorate with time, especially when hot. Tapes and papers, moreover, only adhere and retain their flexibility by reason of a small amount of moisture, and if maintained at high temperatures will either burn, or dry out and crumble. This example, incidentally, illustrates why engineers have so much more trouble with insulating than with conducting parts: paper, if wet, is a bad insulator; if dry, it falls to pieces!

CLASSIFICATION OF INSULATING MATERIALS.

An important and serviceable classification is that given by the British (Engineering) Standards Association, upon which the manufacture and use of machinery and apparatus in this country is based. The various classes are:—

Class O.—Cotton, silk, paper and similar organic materials when neither impregnated nor oil-immersed.

Class A.—Cotton, silk, paper and similar organic materials when impregnated or oil-immersed; also enamelled wire.

Class B.—Mica, asbestos and similar materials in built-up form with binding cement.

Class C.—Mica without binding cement; porcelain, glass, quartz, etc.

In Table I a summary is made of the chief characteristics and qualities of a number of important insulating materials. Breakdown strengths are quoted as these are of importance in high voltage work. Figures for resistivity, however, are not given, as they are unreliable and in any case would not convey much information to the general reader. The resistivities of the materials quoted are, at normal temperatures, almost all very high, ranging between a million and a million-million ohms between opposite faces of a centimetre cube.

Table II gives an idea of the origin, production and chief uses of a few of the more important insulating materials in the order in which they will be considered in subsequent articles.

TABLE I.
ELECTRICAL INSULATION.

	Breakdown Strength, Volts/mil.	Allowable Temperature, °C.	Specific Gravity.	Hygroscopic (h) or non-hygroscopic (n)	Remarks.
Mica	2,500	800	2.8	n	Heat resisting, good insulator.
Micanite	800	100	2	n	Hard or flexible for machinery.
Micafolium	700	100	1.9	n	Wrapping coils.
Micalex	340	350	3.4	n	High frequency insulators.
Porcelain	240	—	2.4	n	Transmission line insulators.
Steatite	200	700	2.5	n	Heat resisting.
Basalt	100	600	2.9	n	Cast insulators.
Stoneware	95	—	2.5	n	Very large terminal insulators.
Quartz	600	1,000	2.1	n	Highly heat-resisting.
Glass	350	400	2.2	n	Internal structure visible.
Slate	6	200	2.9	h	Switchboards.
Ebonite	900	60	1.3	n	Panels, etc., easily machined.
Oil (transformer)	8,000	120	0.86	h	For cooling and insulating.
Varnish (baking oil)	1,000	—	0.9	h	Impregnating coils.
Cotton (varnished tape)	600	—	—	h	Taping conductors.
(black)	800	—	—	h	Flexible.
(bakelised cloth)	60	140	1.3	n	Silent gears.
Paper	250	70	0.5-1	h	Backing for mica, etc.
Pressboard	250	—	1.2	h	Slot linings.
Vulcanized fibre	370	—	1.0	h	Easily machined.
Paper board (bakelised)	400	150	—	n	Extra high-voltage construction.
Asbestos (cement, plain)	7	500	3	h	Arc resisting, poor insulation.
(cement, impreg.)	60	200	—	n	Better than above for insulation.
(bakelite)	40	200	—	n	High-temperature mouldings.
Mouldings (shellac)	500	50	1.4	n	Good surface, expensive.
(bitumen)	90	200	2	n	Poor surface, heat-resisting.
(rubber)	600	90	1.6	n	High polish, good insulator.
(bakelite)	400	150	1.4	n	Excellent finish, mass production.

TABLE II.
ORIGIN AND USE OF SOME IMPORTANT INSULATING MATERIALS.

Origin.	Process.	Use.
Mica rock	Split and stuck with shellac	Commutators, h.v. machine windings.
China clay, quartz, etc.	Ground, kneaded and baked	Porcelain insulators.
Marble and slate quarries	Split, sawn, ground	Switch panels.
Juice from rubber trees	Mixed with fillers and sulphur, and vulcanised.	Cables, mouldings.
Bitumen, lac, flax plants,	Gums in linseed oil	Varnish.
Oil wells	Refined	Transformers.
Cotton, flax, trees	Spun and woven	Cotton tape.
	Pulped	Paper.
Silkworm	Cocoon fibres woven	Silk.
Asbestos rock	Pulped and dried	Asbestos tape, etc.
Trees	Seasoned and impregnated	Switch parts.
Coal tar and trees	Carbolic acid and formaldehyde	Synthetic resin.

All the materials mentioned above are dealt with fully in later articles in this work.

SHOP LIGHTING AND WIRING

By C. W. HARVEY.



Fig. 1.—How the ENCLOSED DUST-PROOF TYPE OF UNIT IS FITTED IN A LARGE DEPARTMENTAL STORE. It will be seen that the illumination over all is very even and of adequate intensity.

THE design of a shop lighting and wiring system is governed by the type of shop and its position. For instance, a shop in a comparatively poor locality would need a much less pretentious installation than one situated in the West End area of London. This point should be borne in mind when beginning a scheme for a shop installation.

Interior Shop Lighting.

Lighting of a shop interior is substantially the same as that required for any other commercial purpose. The main objects in view being adequate illumination with absence of glare and inconvenient shadows.

It is common practice in shops, whether they be of departmental store class or of the small specialist class, for the interior furnishings to be more or less frequently rearranged. Therefore the

ideal arrangement would be well diffused lighting at an advantageous intensity for the shop's requirements, and of uniform strength over the whole of the working area. It is then immaterial in what position the various articles of shop furniture are placed.

Type of Fitting to Use.

The units should be of diffusive glass, such as opal or sandblasted or acid frosted, and constructed in such a manner that the filament of the lamp cannot be seen. Various examples of these shop fittings are shown in Fig. 2. They should be dust-proof and constructed of glass with a low light absorption.

It must be borne in mind, however, that it is not always possible to use a commercial design fitting of this type. For instance, an antique dealer would probably insist upon some form of fitting which

might take the form of a lantern, candelabra or an ornamental bowl, in which case it probably would be necessary to augment the main lighting system with a number of local lighting units, such as showcase lights, wall brackets or floor standards.

The use of the enclosed dust-proof type of unit is, however, becoming more and more popular in large departmental stores.

An example of this fitting in use is

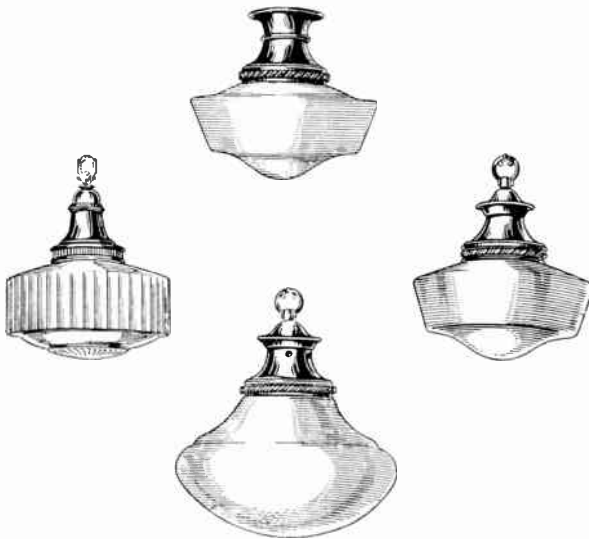

Fig. 2.—EXAMPLES OF DUST-PROOF SHOP FITTINGS. These should be constructed of glass with a low light absorption.

shown in Fig. 1, which is a photograph of a ladies' outfitting shop, and it will be noticed the illumination over all is very even and of adequate intensity.

Flush Fitting in Ceiling.

An alternative method of treating the lighting of a shop where the owner does not approve of the commercial type of fitting, is by means of a flush fitting in the ceiling.

Colour and its Effect on Reflection.

A glareless light which is very pleasing and restful to the eye can be obtained in this manner. In fact, in some shops it is the usual practice to have a Lay light which is used during the day for daylight

illumination where possible, and is constructed in such a manner that at night the same Lay light can be illuminated electrically. One must bear in mind when designing a lighting installation that the colour of the walls and ceiling affects the illumination intensity to a very large degree. In most shops there are cases and show-cupboards, the goods in which should be illuminated in a vertical plane. If the wall surfaces are of a good reflecting medium sufficient light is reflected to light the surfaces of the goods at whatever angle they are placed.

When to Use Brackets or Standards.

If the size of the lighting units is correct and based on the requisite foot-candle intensity required for the adequate display of goods, it should not be necessary to augment the main lighting system with brackets or standards except for artistic effect. In exceptional instances, such as a jeweller's shop, or a shop dealing in very small intricate goods, it may be necessary to use some form of local lighting on the counter.

A Concentrating Unit.

When it is absolutely necessary that this form of additional lighting should be used, a concentrating unit (such as that shown in Fig. 3) should be installed, in order that the goods offered for sale should be seen to better advantage.

The foot-candle intensities recommended for small shops and departmental store interiors is as follows :—

	Foot-candles
General interior lighting	6 to 12
Shelves (minimum)	5
Counters	6 ,, 12
Windows	25 ,, 100
Stores, packing rooms, etc.	5

This has been compiled from data that has been found in practice to give the best results, and has been obtained from the study of numerous shops under varying conditions. The table on page 654 gives

the average intensity required for efficient working in each particular instance.

The *Lumen* is the unit of luminous flux or quantity of light and is equal to the quantity of light incident upon a surface one square foot in area illuminated uniformly with an intensity of 1 foot-candle.

The *Footcandle* represents the intensity of illumination equal to that produced at a point or plane one foot distance from a source of one candle power.

The *Depreciation Factor* is employed to compensate for loss of light due to lamp deterioration and normal depreciation of surroundings and varies between 1.20 and 1.40 according to conditions. Obviously the depreciation factor for a foundry would be more than for an office or clean workshop.

In foundries use the higher value. In offices, shops, etc., the lower value.

A proportion of light emitted is absorbed by reflector equipment, walls and ceilings. To compensate for this loss we employ utilisation factors as follows:—
 Direct light equipment5
 Semi-indirect lighting and enclosed units35

1. Decide first the footcandle intensity desired on the bench, desk or working plane (see table below).

2. Multiply area in square feet by foot-candles required, and again by the depreciation factor, and divide by the utilisation factor.

Thus:—

$$\text{Total lumens} = \frac{\text{Area} \times \text{F.C.} \times \text{Dep. Factor}}{\text{Utilisation Factor}}$$

3. Plan area into squares and arrange points.

METHOD OF OBTAINING REQUIRED LAMP WATTAGE FOR A GIVEN FOOTCANDLE INTENSITY.

These calculations do not apply to window lighting or floodlighting where high efficiency reflectors are used. In those cases the manufacturers' charts should be consulted. An example of one of these is Fig. 9.

Average Lumen Value of Lamps.—Gasfilled Type.

Volts.	Watts.	Lumens.	Volts.	Watts.	Lumens.
100-150	60	732	200-260	60	582
"	100	1,330	"	100	1,160
"	150	2,130	"	150	1,920
"	200	2,960	"	200	2,660
"	300	4,770	"	300	4,260
"	500	8,700	"	500	7,700
"	1,000	19,300	"	1,000	17,400



Fig. 3.—A CONCENTRATING UNIT.

This type of lamp is only used when it is absolutely necessary for some form of additional lighting.

4. Divide the total lumens by number of points to find lumens per lamp. Consult table below for lumens value of lamps, which will decide the size and wattage of lamps per point.

5. The mounting height above the working plane is in many cases governed by local conditions, but the ratio of mounting height to distance apart should not exceed 2 : 1 wherever possible.

Using the spacing ratios given will provide for an even illumination on the horizontal working plane, for average variation of which will not exceed approximately 20 per cent.

Every installation will obviously have a different value for the utilisation factor, according to the area to be illuminated,



Fig. 4.—EXAMPLES OF REFLECTORS FOR WINDOW LIGHTING.

These are of the silvered glass variety.

mounting height of reflectors and colour of surroundings. For the average installation the utilisation factor given being based on practical experience will be found very satisfactory.

When to Use Strip Lighting.

In some shops it is necessary to have glass cases for the display of certain goods. Usually the space in these is very restricted, and consequently there is not room for the ordinary reflector type of lighting, in which case strip lighting is fitted (a form of which is shown in Fig. 5). It is now possible to buy these strip lamps in 100-watt size, and as the length is approximately 12 inches, it can be seen that one

could get 100 watts per foot run of lighting, which should be ample intensity for most showcase purposes.

Departmental Signs.

In shops with a number of departments it is necessary to make use of signs for directing the customer. The same type of sign could also be used to call attention to any particular form of goods. The most pleasing and useful sign of this type is that embodying the Iternalite principle.

There are, of course, various other forms of box signs, which take the form of metal frames housing sheets of glass on which is etched or sandblasted the necessary lettering. Lamps are fitted in these signs, and the light from them causes the lettering to stand out more boldly.

Colour or Corrected Light.

Certain goods may have to be displayed in a light which closely approximates to daylight. For this purpose the ordinary daylight lamps may be used, or, better still, the enclosed dust-proof unit in Fig. 2, but with corrected glass; that is, glass which in its construction embodies a bluish element which causes the light to approximate to daylight.

The Sheringham unit has been produced for the reproduction of north sky daylight. An illustration of this unit is shown in Fig. 6. The Sheringham pigments are sprayed on the undersurface of the reflector. The porcelain enamel being previously sandblasted, this unit gives perhaps the best form of reproduced daylight.

When using colour or corrected lighting, it should be borne in mind that to obtain



Fig. 5.—STRIPLIGHTING FOR USE IN GLASS CASES.

the same intensity as with ordinary white lighting units, it is necessary to increase the size of the lamps. It is generally taken that daylight units require a lamp of 50 per cent. higher wattage than an ordinary white glass unit.

Window Lighting.

In designing a scheme for window lighting, it should be borne in mind that this is the shopkeeper's most profitable form of advertising.

There is a distinct tendency for shop window lighting to become stereotyped, that is to say, one would probably see the window of a jeweller's shop lit in the same manner as a tailor's, and in many cases it would probably be of the same intensity. This is wrong, because as has already been



Fig. 7.—EXAMPLE OF A FLOODLIGHT.

mentioned, the tailor's window would need much more light because of the high absorption factor of the goods displayed.

The light source for the ideal installation should be entirely concealed. This point is most important, because one is usually working with very high candlepower lamps and the glare from the filament from these is most distressing to the eye, apart from being detrimental to trade from the shop owner's point of view.

Generally speaking, the lighting is obtained from the top of the window, the source being towards the front. It is not only necessary that the lamps should be screened from the customer looking in the shop window, but also they should be screened from sight from inside. This is most important in shops where there is a low back to the shop front. It is not advisable to attempt any form of lighting



Fig. 6.—THE SHERINGHAM UNIT.
This is specially designed for the reproduction of north sky daylight.

other than from the top, because of the difficulty of screening the lamp filament from the eye.

Reflectors for Window Lighting.

There are many types of reflectors for window lighting, the most efficient being those of the silvered glass variety, some types of which are seen in Fig. 4. The most effective way of electric lighting for the shop window is on the reflector principle, either in the manner illustrated, or by fixing the reflectors directly overhead, and screening them by means of a glass pelmet. This latter form of lighting lends itself to many variations.

Silver Glass Type of Reflector.

Crystal glass, having a minimum absorption factor, is used in the construction of the silver glass type of reflector. It is heavily silvered direct on to the polished glass surface, which in turn is heavily copper-plated. The whole is then finished

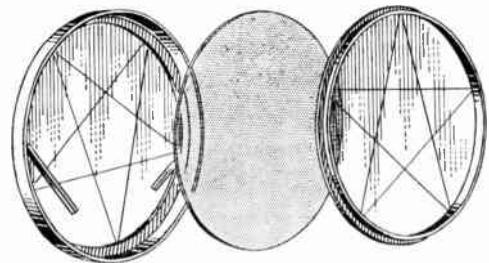

Fig. 8.—A STANDARD FORM OF COLOUR SCREEN EQUIPMENT.

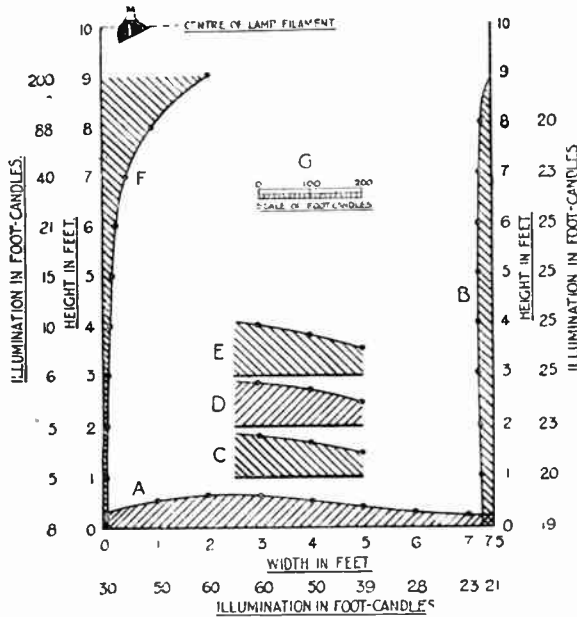

Fig. 9.—DIAGRAM SHOWING THE INTENSITY OF ILLUMINATION AT ALL POINTS IN A WINDOW EQUIPPED WITH A REFLECTOR SIMILAR TO (a) IN FIG. 4.

The reflectors are equipped with 100-watt lamps spaced about 12 inches apart.

with either silver or gold coloured paint, which is neutral in tone, and will harmonise easily with its surroundings.

Adding Colour Screens.

By simply adding colour screens which most manufacturers market, many interesting effects can be obtained to bring out the salient points of a window display. These screens are made to clip on to the reflector quickly and easily without alteration of the fixing. Fig. 8 shows a standard form of colour screen equipment, which is neat in design. The colour film is held in place between two rings with a retaining wire stretching across the opening of each. The two spiral springs serve to attach the film to the gallery. Colour schemes obtained in this way can be adapted to

suit any required purpose or type of window display, and by the use of a motor-flasher colour changes can be effected at pre-determined intervals with very striking results. It may be required to direct the attention to some particular feature, in which case a floodlight or spotlight would be used, to illuminate it with greater intensity than that of the rest of the window. An example of a floodlight is shown in Fig. 7.

Intensity of Illumination with Reflector.

Fig. 9 is a diagram showing the intensity of illumination at all points in a window equipped with a reflector like that shown in (a), Fig. 4, and is typical of any window of which the height is approximately two-thirds the depth. In this instance the reflectors are equipped with

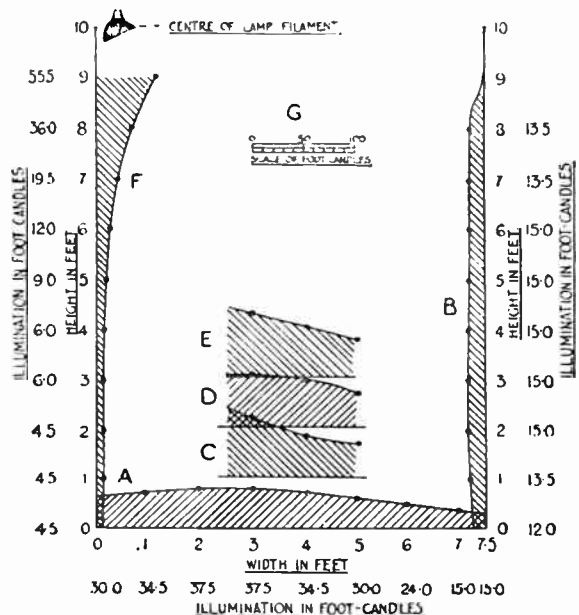

Fig. 10.—DIAGRAM SHOWING THE INTENSITY OF ILLUMINATION AT ALL POINTS OF WINDOW, USING DIFFERENT SPACING FROM THAT SHOWN IN FIG. 9.

The reflectors are spaced at 24-inch centres instead of 12-inch.



Fig. 11.—A SHOP ILLUMINATED BY SILVER GLASS REFLECTORS.



Fig. 12.—ANOTHER EXAMPLE OF THE USE OF A SILVER GLASS REFLECTOR FOR LIGHTING SHOP WINDOWS.

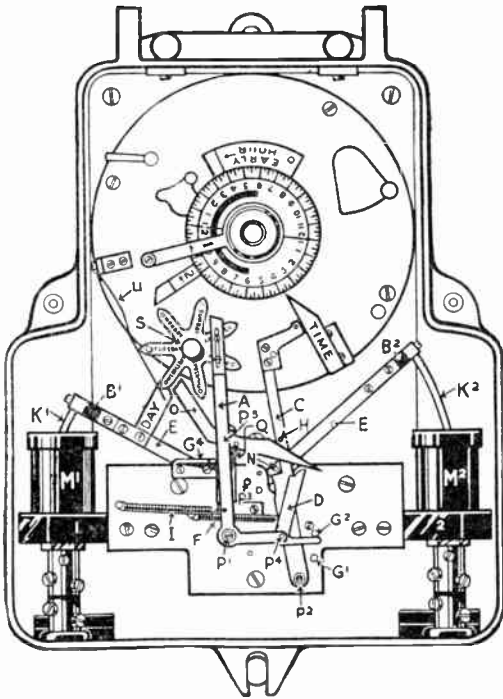

Fig. 13.—SECTIONAL VIEW OF A STANDARD TYPE OF TIME SWITCH, USED FOR THE CONTROL OF WINDOW LIGHTING.

A, bell-crank lever; B¹, B², ebonite blocks; C, lever; D, right-angled pawl; E, double arm; G¹, G², banking pins; H, peg; K¹, K², copper plungers; M¹, M², mercury cups; N, peg; P¹-P², pivots; Q, spring; S, star wheel.

100 watts Pearl gasfilled lamps and spaced about 12 inches apart.

Calculating the Intensity of Illumination.

The illumination upon the floor of the window at distances of from 1 foot to 7 feet 6 inches from the glass is given at the bottom of the diagram. Intermediate values can be obtained by measuring the height of the shaded portion of the diagram marked A to the footcandle scale G. Similarly the illumination at the back of the window at various heights is given on the right-hand side of the diagram, and intermediate values can be obtained by measuring the width of the shaded

portion B. The three smaller shaded sections marked C, D and E enable the intensity of illumination on goods placed in the centre of the window at heights of 1, 2 and 3 feet, or upon shelves similarly placed, to be ascertained. In each case the height of the shaded curve must be measured against the footcandle scale G. The actual illumination upon the glass of the window itself is ascertained by the thickness of the shaded portion F on the left-hand side of the curve. A well-designed reflector properly placed should have a curve for this portion of the window similar to that in the illustration, since all light directed on the glass and consequently outside the window is wasted; this curve should have a minimum value.

Using Different Spacing.

Fig. 10 is an example of the same type of window lit with the same design of reflector spaced at 24-inch centres instead of 12-inch. A window lit in this way probably be used for light-coloured goods with good reflecting values.

How Outside Lighting Affects the Shop.

When deciding on the necessary intensity for a shop window, it must be borne in mind that this is not determined only by the light necessary to show the goods. A higher value should be provided in order to produce a striking contrast with external conditions and with adjacent windows.

It is clear from this that consideration must be given to the standard of lighting in the street where the shop is situated or any other external lighting conditions, because the window which is not so brightly lighted as those on either side of it, is almost bound to suffer from the unfavourable contrast, although the neces-

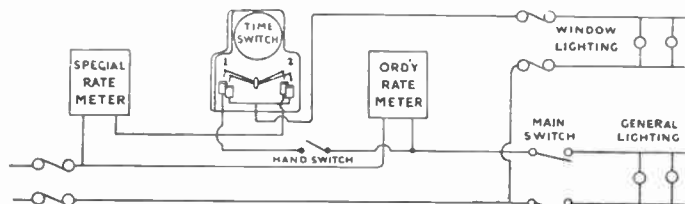

Fig. 14.—A CONVENIENT SYSTEM OF METERING.

sary calculated intensity may be ample to see the goods clearly. Generally speaking, in main thoroughfares, the window lighting intensity should be higher than a shop situated in a side street.

Fig. 11 is a photograph of a shop window illuminated by silver glass reflectors in a main thoroughfare which has quite bright street lighting. It can be seen that the intensity of this window is such that it stands out boldly from its surroundings. Fig. 12 is an example of a shop window lit with a silver glass reflector; the pelmet screens can be just seen at the top of the photograph.

It will be noticed that there are no heavy shadows, and the illumination of the whole of the shop window area is very diffused, and yet is of ample intensity.

Neon Lighting.

Various lighting devices are used for attracting attention to a window. For instance, some form of sign which could possibly be made to switch on and off at various intervals, or, better still, where expense is not such a limiting factor, Neon tubing can be used.

(Owing to the highly specialised nature of this form of lighting, the manufacturer should be consulted regarding the best method of installation. It is only possible in the scope of this article to mention a few facts regarding its general use.)

Coloured Tubes.

These tubes can be had in red, green and blue colours, and they represent a most efficient form of electric sign, because of their low power consumption. Another big factor in their use for internal decorative lighting of a shop window is the fact that they burn very "cold," the working temperature being only a few degrees above the surrounding temperature of the

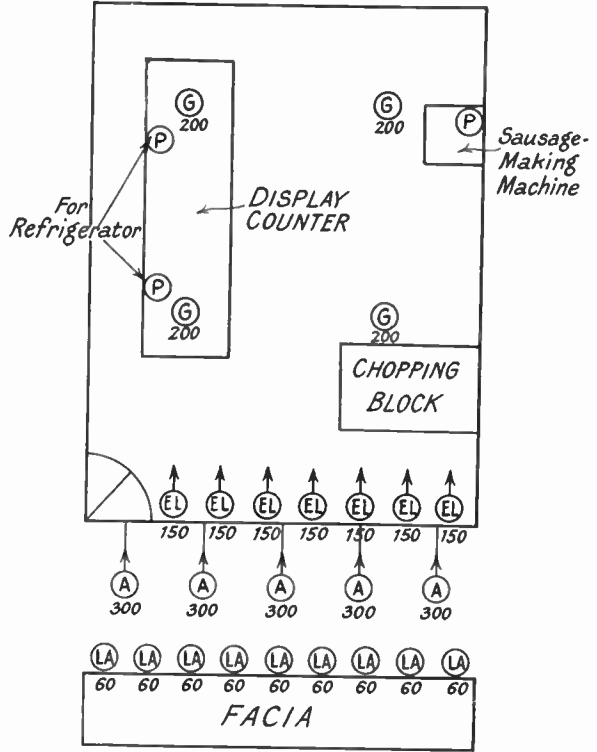

Diagram Key

- ⓐ₂₀₀ Diffusers, 200-watt Lamps
- ⓔ₁₅₀ Elliptical Angle Reflectors, 150-watt Lamps
- ⓐ₃₀₀ Parabolic Angle Reflectors, 300-watt Lamps
- Ⓛⓐ₆₀ Local Angle Reflectors, 60-watt Lamps
- Ⓟ Power or Heating Point

Fig. 15.—A TYPICAL BUTCHER'S SHOP IN MAIN ROAD. The same form of lighting, but with smaller lamps, would be suitable for side streets.

air. The life of the tube is in the nature of some 2,000 to 3,000 hours, after which period it is necessary to refill the tube with gas. The red Neon tube has a very high intrinsic brilliancy, and can be seen even in foggy weather, whereas the ordinary brilliant white light in a shop window would appear quite dull. If the general lighting effect is assisted by Neon lighting,

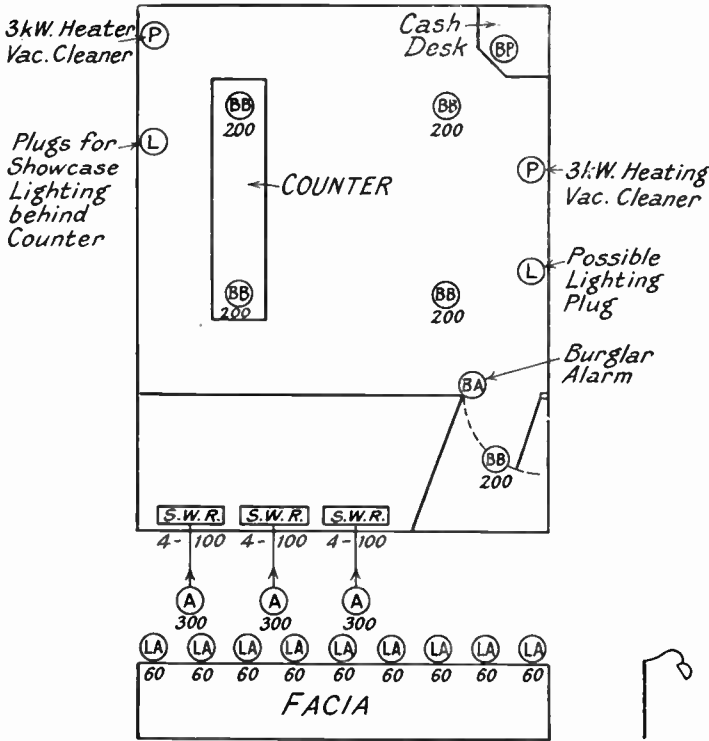

Diagram Key

- (BB)
200 Enclosed Unit (type B) 200-watt Lamps
- (A) Parabolic Angle Reflectors, 300-watt Lamps
- (LA)
60 Local Angle Reflectors 60-watt Lamps
- (P) Power or Heating Point
- (L) Lighting Plug
- (BA) Burglar Alarm

S.W.R.
4-100 Shop Window Reflectors 4-100-watt Lamps

Fig. 16.—A TYPICAL DRAPER'S SHOP IN MAIN ROAD.

The same form of lighting, but with smaller lamps, would be suitable for side streets.

the window can become a great centre of attraction.

Drawback of Neon Tubes.

Neon tubes have one drawback, their

operating pressure being in the nature of 3,000 volts A.C., therefore considerable care must be exercised in their installation and the selection of the controlling position. Where direct current forms the source of supply it is necessary to install a small rotary convertor or motor alternator and step-up transformers to obtain the necessary high tension voltage. The current consumption of Neon tubing is approximately about 90 watts per 10-foot length, when one colour is used. For a combination of colours the consumption is approximately about 600 watts per 10-foot length.

Lights made up of Neon tubing can be used on the shop facia board, or the window may be framed with Neon tubes of a combination of colours. In this way many striking effects can be obtained.

Floodlighting for Use in Shops.

Floodlighting of shop interiors is becoming more important now that most shop owners realise the advertising value of light. Floodlighting is the illumination of large surfaces by projectors. These floodlights are, in fact, very large models of the silver reflector previously mentioned for window lighting. A flood-

lit building has a very great appeal, and cannot fail to attract the attention of the passer-by. It calls attention to the building where it is installed for a large number of hours.

How to Avoid Shadows.

Care must be exercised when designing a flood-lighting scheme, because it should be realised that owing to the intensity of the light used, very strong shadows are produced. By careful selection of the floodlight positions, and by directing beams from several angles, any hard shadows can usually be avoided.

Lights Must be Hidden.

It must be borne in mind that in the best form of floodlighting, like shop window lighting, it should be impossible for the observer to see where the light is coming from. In fact, it is well known that the most effective way of securing public interest is to present an effect without an apparent cause. On existing buildings it would probably be impossible to conceal the source of light, but by careful arrangement and planning, this difficulty can be reduced, and many interesting effects can be obtained.

Types of Building Suitable for Floodlighting.

Of course, it must be borne in mind that floodlighting is not always possible on every type of building surface, and Table 2 shows the foot-candle intensity required on various building surfaces. From this it can be seen that to endeavour to floodlight a very dirty stone or concrete building would not be an economic proposition.

By the use of colour screens many very

interesting combinations of light on the building surfaces can be obtained. Colour floodlighting, however, should only be attempted on a white building. The combination of floodlighting and Neon

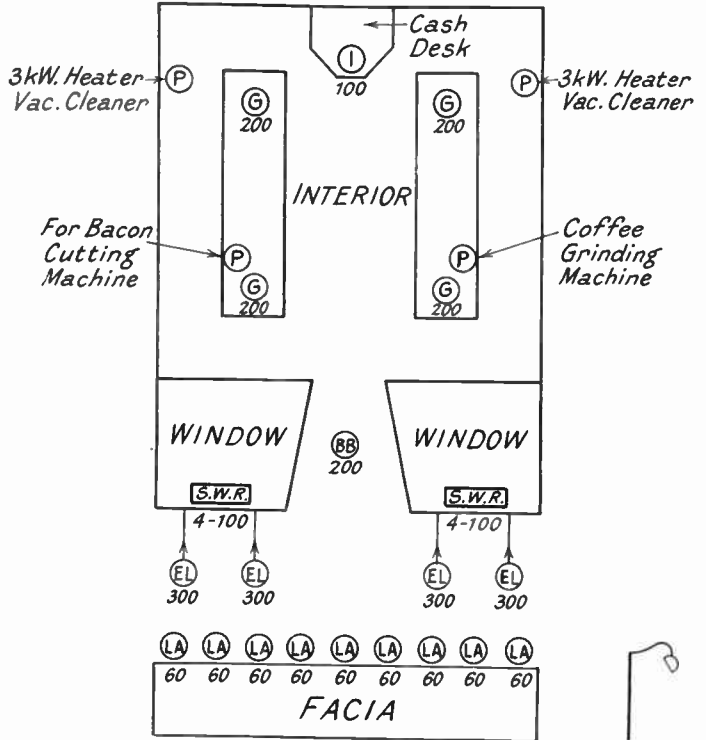

Diagram Key

- Ⓛ 100 Local Intensive Reflector, 100-watt Lamps
- ⓐ 200 Diffusers, 200-watt Lamps
- ⓑ 200 Enclosed Unit (type B) 200-watt Lamps
- ⓔ 300 Elliptical Angle Reflectors, 300-watt Lamps
- Ⓛ 60 Local Angle Reflectors, 60-watt Lamps
- ⓐ Power or Heating Point

S.W.R. 4-100 Shop Window Reflectors, 4-100-watt Lamps

Fig. 17.—A TYPICAL GROCER'S SHOP IN MAIN ROAD. ALSO SUITABLE FOR A CONFECTIONER, TOBACCONIST, ETC.

The same form of lighting, but with smaller lamps, would be suitable for side streets.

lighting on a shop fascia furnishes a most striking example of interest.

INSTALLATIONS.

Having designed the lighting of the interior and exterior of a shop, it is now necessary to consider the wiring installation to supply current for it. The circuits would be arranged in much the same way as for any other type of installation. One point that should be borne in mind, however, is that usually in shops, switches should be fixed in one central position, and also arrangement should be made for time switching, for "after-hours" display to take place on the various circuits, since supply authorities have different rates for shop window lighting, exterior lighting and interior lighting, and a shop which is lit at night will always have a number of people interested in its display.

How a Time Switch Works.

Fig. 13 is a sectional view of a standard type of time switch, used for the control of window lighting.

The double arm E is pivoted at P₃ and carries copper plungers (K₁, K₂) at each end, these being insulated from E by ebonite blocks B₁, B₂. E also carries a peg N, the latter resting on detent of lever C when No. 1. circuit is closed. The hand 2, at the desired hour, trips C (which is pivoted at P₂) and allows K₂

to be pulled into mercury cups M₂ by a spring at back of plate. When the time for changing circuits arrives, the hand 1 engages with bell-crank lever A, which is pivoted at P₁ and has pivoted on it (at P₄) a right-angle pawl D. As A is pushed to the right D is carried down vertically until its bottom end meets the banking pin G₁. The further movement of A then causes D to be rotated until its top end is below N. At this moment the clock hand releases A, which is pulled sharply back to its original position by spring 1, and brings D up at the same time. D, in ascending, engages with N and thus carries the right-hand arm of E up until N is caught and held by detent C, which is controlled by spring F. One circuit is thus broken in cups M₂ and another made in cups M₁. The banking pin G₂ causes D to take up a final position clear of N, so as to allow E to drop over to the right at the next operation.

The star wheel S has a pin at the back of "Sunday" which on that day comes into notch at top end of "Day" pointer (this pointer being rigidly fixed to E) and so prevents E changing over from M₁ to M₂ on that day.

Another peg on the front of spoke corresponding to "Early Closing Day" on that day presses against left-hand end of O (which is pivoted at P₅ and controlled by spring Q) when star wheel is turned by

TABLE 2.—FOOTCANDLE INTENSITY REQUIRED ON DIFFERENT BUILDING SURFACES, TAKING INTO CONSIDERATION THE BRIGHTNESS OF SURROUNDINGS.

Material.	Condition.	Reflection Factor.	Footcandles.		
			Poorly Lighted District.	Medium Lighted District.	Brightly Lighted District.
		Per cent.			
White marble	Fairly clean	60-65	2	3½	6
Light concrete or stone	Fairly clean	40-50	3	5	8
Dark concrete or stone	Fairly clean	25	6	9	15
Granite	Fairly clean	10-15	13	21	33
Concrete or stone	Very dirty	5	Usually require too much light to be practicable.		
Concrete painted buff	New	50	3	5	8
White glazed brick	Clean	85	1½	2½	4
Yellow brick	New	35	4	6	10
Red brick	New	25	6	9	15
Brick	Dirty	1-5	Usually require too much light to be practicable.		

"Early Hour" hand, causing the other end to engage with peg H, on lever C, thus actuating C, as described above, by "Early Hour" hand and star wheel instead of by hand 2 as on other days.

System of Metering.

Fig. 14 is a diagram showing the most widely adopted system of metering. It will be seen that it adds an additional meter and change-over time switch to the existing installation. The time switch does the double job of controlling the meters and the window lights.

The cheap rate on the window lighting automatically comes on at the proper time, independent of outside control.

There are various other ways of arranging shop lighting for time switch control, varying with local electric supply companies' regulations, but this example is the most usual.

Time switching lends the finished touch to the correctly designed and installed shop lighting system. Without it the installation would not be complete.

Use Screwed Steel Conduit for Wiring.

There are no especial public regulations governing the wiring of shops other than those imposed by the supply authorities concerned, and the insurance company or any other interested body, but whenever possible it is always advisable to install the wiring in screwed steel conduit, which allows for the complete and safe concealment of the wiring.

Size of Wire.

A point that should always be borne in mind is that the lamp sizes employed are larger than is customary in most installations. The wiring therefore should be large enough to prevent any excessive voltage drop at full load, or overheating. Another point in favour of installing screwed steel conduit is ease of renewal of the wiring without damaging the decorations of the shop.

In small shops there are often many high powered and consequently very hot lamps installed in a confined space, and the insulation of the cables often suffers

in consequence. This sometimes necessitates their early renewal. Not a big job with a "pull in" type of installation.

Wiring Should be Watertight.

With regard to any wiring to be done on the outside of the shop, this would definitely be of the watertight variety, and suitably protected against mechanical damage if in lead-covered sheathing.

Fuses.

The fuseboard, main switches and fuses should be in an easily accessible position. It is a very damaging event to a shop-keeper to be more or less temporarily plunged into darkness. For this reason, wherever possible the number of lights controlled by a single local fuse should be the lowest minimum, no more than three points per fuse if possible. This is, of course, controlled by the question of expense, but the electrician should always make this point clear to his customer.

Use of Electricity in Shops.

It is impossible to give a detailed list of the various uses to which electricity can be put in every type of shop. But a grocer would no doubt need a power point for his coffee-grinding and his bacon-cutting machine, and possibly a refrigerator point, and most certainly the question of electric heating should be raised.

Since it is almost impossible to have a coal fire in the average shop, what more attractive proposition than the electric imitation coal fire, with its decided heating efficiency. Then the tailor, draper, milliner, etc., would need provision for the use of the vacuum cleaner, and of course electric heating.

In the case of places such as fish shops, restaurants, etc., the question of electric cooking should be raised.

It should be borne in mind that it is much better to suggest the uses of electricity, other than for lighting, to the client before the wiring is begun rather than during its installation. Also the best positions for the outlet positions should be discussed with him rather than they should be installed where the electrician thinks best.

Bells and Burglar Alarms.

The question of bells and burglar alarms should also be raised. Sometimes it is necessary to call a messenger from a store to the shop, or the manager from his office. This work should be done at the time of the original installation. The positions for burglar alarms, of course, suggest themselves, on doors and windows. It only remains a question of type.

TYPICAL SMALL SHOP INSTALLATIONS.

The following are one or two examples of typical small shop installations which should be found of use when designing the lay-out for a shop installation.

A Draper's Shop.

It will be noted (see Fig. 16) that even lighting is obtained over the whole shop area by means of four 200-watt enclosed units. Also provision has been made for cleaning and heating purposes, and lighting plugs have been installed for possible extensions for showcase lighting. Shop window reflectors of standard variety are installed in the window, and angle type reflectors are used for illuminating the fascia board. The average intensity in this particular installation is on the high side, but this could be reduced by cutting down the lamp sizes. A burglar alarm has been provided for on the door since valuable goods are displayed at night.

The Parabolic and Elliptical angle reflectors used for the exterior are not strictly necessary for the window lighting, but are suggested as being useful for compelling interest in the shop. If they are dispensed with it would be advisable to increase the lamp sizes in the window and the number of reflectors.

A Grocer's Shop.

The interior general lighting explains itself (see Fig. 17). It will be noted that points have been taken to allow the use of a coffee-grinding machine, and also a bacon-cutting machine. Heating points have also been arranged. The window and fascia are lit by the standard type of equipment. A burglar alarm is fitted on the door, and on a laylight over the shop, and also over two windows in the basement.

The Elliptical and Parabolic angle reflectors used for the exterior are not essential in this instance, and the same remarks apply as for the draper's shop.

A Butcher's Shop.

Here again the general lighting is self-explanatory (see Fig. 15). It will be noted that powerpoints are taken for a sausage machine, and also a refrigerator display counter. The latter is an innovation likely to become the rule in the near future. In this particular installation considerable power was needed for a large cold room, which is not shown on the plan. With regard to the window lighting display, it was found by experiment that considerable interest was added by the provision of orange sprayed lamps at certain intervals. Say one orange lamp in every five. By this means the meat on show was given the best appearance.

In the case of this shop, the question of a burglar alarm did not arise, since easily removable articles of value were not left in the shop overnight. Should an alarm be considered necessary, the door and show window, and also the window at the back of the shop, would probably be the selected positions.

Exterior lighting in this type of installation would probably be necessary, since it is customary for an outside display on certain occasions.

MAGNETS AND MAGNETISM

By H. GREENLY.

IT will no doubt have been observed in the reader's more elementary experiments with electricity that magnetic effects can be obtained without using what is usually called a magnet, and when the various phenomena which arise are reviewed in a detailed manner the close linkage between electricity and magnetism should be more fully understood. Further, the interconnection between electricity and mechanical motion will also be revealed.

What is Magnetism ?

Magnetism is a force. It is present in concentric circles around any wire which is conducting an electric current. Its effects remain constant while the current is flowing in proportion to the strength of the current. The farther away the detecting instrument is placed from the electric wire creating the magnetic effects the more feeble does it appear to become. The magnetism also shows a sense of direction, and it is capable of being led into paths other than those it would naturally traverse in passing from pole to pole. This direction of the lines of force depends on the material through which the magnetism is made to flow. Finally, when the energising current in the conducting wire is shut off the rings of magnetic force—the magnetic field, as it is called—collapse. The return to the

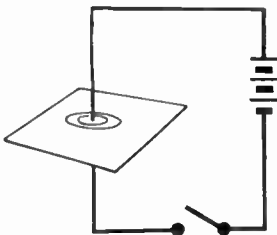

Fig. 1.—Magnetism is present in concentric circles around any wire which is conducting an electric current. This illustration shows the field round a wire and this can be proved by the experiment shown in Fig. 4.

normal state of the conductor before it was energised can be made to do useful work just the same as a rubber diaphragm would act if a hand which has been pressing on it and stretching it is suddenly released. The collapse of field has much the same effect as a moving field.

Faraday's Discovery of Electro-magnetism.

Another feature of electro-magnetism—the discovery of which is due to the immortal Michael Faraday—is that when a magnetic field is made to pass across an electrical conductor, if the circuit in this wire is closed—by a measuring or detecting instrument, for instance—a current will flow momentarily in the conductor so long as the field is maintained and kept moving. The converse is also true, a current will flow if the conductor is kept moving in the maintained field of force. Further, there will be a mechanical resistance to the movement of a conductor wire if it is passed across a magnetic field, which effect is again only present so long as the circuit is complete. It is also as well to note at this juncture that this retarding effect to mechanical motion is directly comparable with the amount of electrical energy, viz., electric current in volts and amperes, that is obtained.

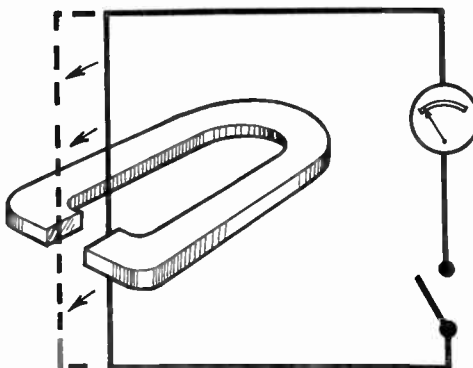

Fig. 2.—THIS INDICATES THAT A WIRE IN A MAGNETIC FIELD SHOWS AN ELECTRIC CURRENT.

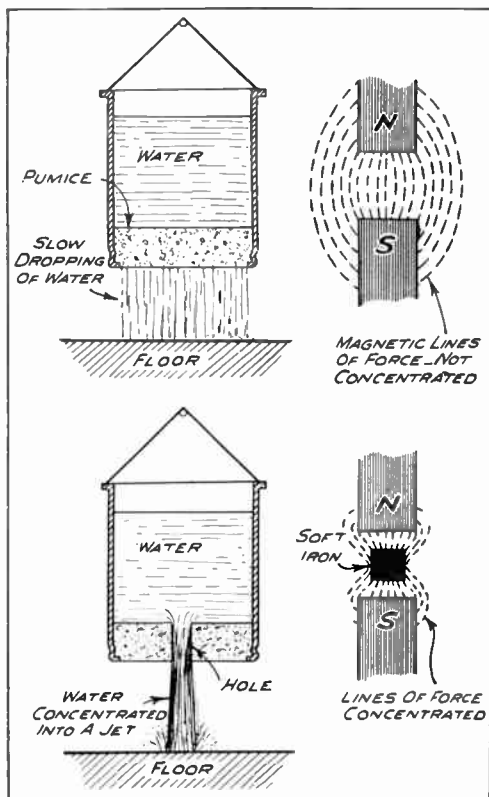

Fig. 3.—A SIMPLE ANALOGY BETWEEN THE MECHANICAL EFFECT OF A HOLE IN A WATER VESSEL AND THE MAGNETIC EFFECT OF A PIECE OF IRON IN THE LINES OF FORCE.

Imagine a pot of water with a pumice-stone bottom hanging up full of water. The water will ooze out all over the surface of the bottom, as the material is permeable to it in a certain degree. But if a hole is drilled in the centre all the water will concentrate to this hole and flow out quite rapidly. The hole becomes a spot of greatest permeability, just as a piece of soft iron in a magnetic field.

Mechanical Power from an Electro Motor.

In an electro motor mechanical power is obtained by passing a current through the coils of wire forming the revolving armature while they are moving in a "field" between the poles of a magnet made up either of magnetic bars or a wound field magnet, as the case may be. In such a machine the rotative power obtained is directly comparable with the

amount of electricity, measured as before in volts and amperes, that is passed through the coils of the motor when the circuit is closed by the switch.

Reluctance—What it Means to Electrical Engineers.

All these are bald statements of fact which while they cannot be gainsaid or even put into simpler language will perhaps need some experimental justification. Before these tangible proofs are considered in detail, one other attribute of magnetism may be referred to. While magnetic forces can pass through air or a vacuum they may be made to alter their direction and density in a more or less degree when their paths encounter other substances. Pure soft wrought iron is a material which for some reason or other offers the least resistance to passage of a magnetic force. Therefore it is known as a substance of the greatest magnetic permeability. In addition, it has been found that as the hardness and impurities of the iron are increased so is its permeability impaired. Steels, which are alloys of iron, have different magnetic characteristics according to their exact composition and state of hardness, the value as a conductor of magnetic lines of force of some manganese steels, for example, being very comparatively low indeed. Cobalt and nickel also reduce the permeability of the steels of which they may form a part, but the former material is now used as an alloy of steel to produce a better permanence and strength in the finished permanent magnet, such as are used in all kinds of magneto machines. This question of permanence has, therefore, a different bearing on the subject to that of permeability.

Magnetic Permeability.

The magnetic permeability of some metals, among which may be mentioned bismuth and copper, is actually slightly less than that of air, and taking air as 1, the figure for bismuth is 0.999 and for soft iron 2,500. This means 2,500 more lines of magnetic force can be accommodated (i.e., concentrated) in a given cross-sectional area of soft iron than in the same area of air.

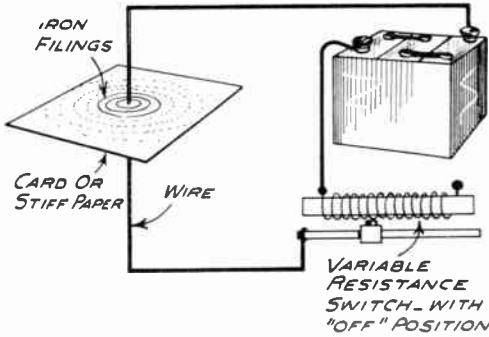

Fig. 4.—A SIMPLE EXPERIMENT TO PROVE THAT THE LINES OF MAGNETIC FORCE RANGE THEMSELVES ROUND THE CONDUCTOR IN CIRCLES.

A wire is pushed through a sheet of stiff paper having iron filings spread lightly over it. A large accumulator or other source of power capable of standing a discharge of at least 10 amperes is necessary to show this experiment successfully.

It is, of course, understood by the merest novice in electrical engineering that

$$\text{Current strength} = \frac{\text{Electro motive force,}}{\text{Resistance}}$$

or, in other words,

$$\text{Amperes} = \frac{\text{Volts}}{\text{Ohms}}$$

In the same way there is a ratio between number of lines of force, the force itself and the resistance to the magnetic flow, which may be stated as follows :—

$$\frac{\text{Total No. of force lines}}{\text{Magnetic resistance}} = \frac{\text{Magnetic motive force}}{\text{force lines}}$$

This analogy must, however, not be pushed too far, otherwise difficulties may arise. The density of the lines of magnetic force is often termed the magnetic "flux" and the resistance to the flow of these lines called the magnetic "reluctance." It is very important, therefore, in practical design and construction to know something about the magnetic qualities of the materials employed.

Referring back to the various points that have been raised in dealing with the phenomena of electro-magnetism, the illustrations of experimental proofs reproduced in Figs. 1 and 2 should

make the verbal explanations clear.

Make these Experiments.

A wire pushed through a sheet of stiff paper having iron filings spread lightly over it readily indicates that the lines of magnetic force range themselves round the conductor in circles, as soon as the current is switched on. That the movement of a wire connected to the two terminals of a detecting instrument, such as a galvanometer, between poles of an electro-magnet will definitely cause a current to flow in it while there is movement and also while the field is maintained, can be demonstrated by a "rig up" arranged as shown in Fig. 7. The same apparatus may be made to show that the strength of the induced current in the circuit will increase with both the speed of movement and with the power of the magnetic field. For this experiment a wound electro-magnet separately excited by a battery with a means of altering the strength of the energising current is necessary.

Proving Resistance to Mechanical Movement Between Poles of an Electro-magnet.

The next experiment, Fig. 7, shows that there is resistance to the mechanical movement of a closed coil between the

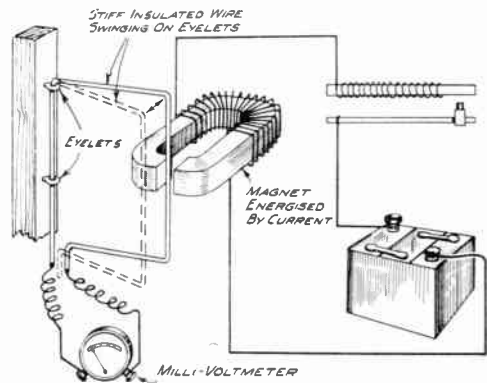

Fig. 5.— AN EXPERIMENT TO SHOW THAT THE STRENGTH OF THE INDUCED CURRENT IN THE CIRCUIT WILL INCREASE WITH BOTH THE SPEED OF MOVEMENT AND THE POWER OF THE MAGNETIC FIELD.

For this experiment a wound electro-magnet, separately excited by a battery with a means of altering the strength of the energising current, is necessary.

poles of an electro-magnet. This only occurs if two other things are happening at the same moment: (1) when the magnet is being energised so that there is a field concentrated between its poles and the lines of this force are being cut at more or less right angles by the conductors of the moving coil or coils, and (2) when the circuit in the coils is completed so that an induced current will flow. There will be no braking effect on the pendulum

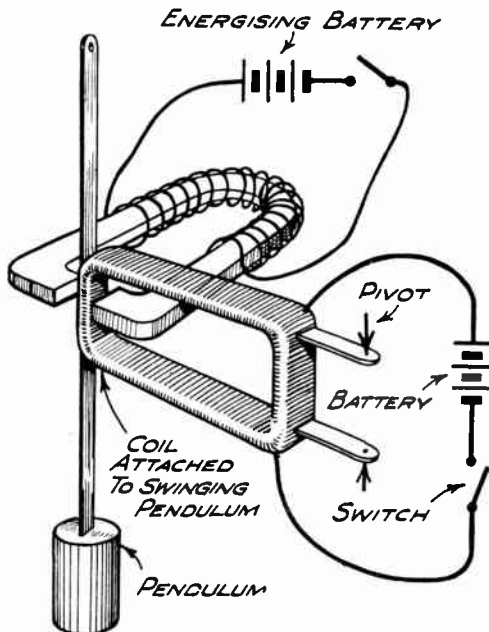

Fig. 6.—SHOWING THE RESISTANCE TO MECHANICAL WORK OF AN ENERGISED COIL IN A MAGNETIC FIELD.

which carries the swinging coil, when it is moved, if the magnet is not energised and is not, therefore, exerting lines of force between its poles. Even if the latter are made magnetic there will be no retardation other than that due to its natural slowing down observed in the swing of the pendulum if the current is broken in the coil by the switch shown in the diagram.

An Experiment with Induced Currents.

Another experiment may be devised as illustrated in Fig. 8 to show what happens on the collapse of the lines of

force which surround a conductor when a current that has been passing through it is shut off; and also what happens when the current is started. For this simple experiment a delicate galvanometer may be necessary if the currents used are small in strength. The secondary circuit is arranged parallel but not touching (i.e., not electrically touching) the main or primary circuit. This secondary has the aforesaid sensitive detector in circuit to show the passage of any current induced in it. When the switch of the primary circuit is closed a current flows in the conductor (P) and, as has been shown by the experiment Fig. 1, the lines of force spread out and surround the primary wire. In doing so they have crossed the path, or "cut"—to use the term so much used in this connection—the secondary wire and the galvo will deflect, showing that a current has been induced in it. This deflection is only observed at start, showing that a movement of the magnetic field is essential to the propagation of an induced current in the secondary wire. The same momentary flow occurs in the secondary conductor when the primary current ceases. In both cases the more violent the action the greater is the observed deflection on the detecting instrument.

Using Soft Iron Wires as a Core.

The same effects may be shown if the primary and secondary circuits are arranged to be made in many convolutions round a bundle of soft iron wires as a core. The windings must of course be made in insulated wire so that the turns as well as the two separate circuits are insulated from each other. The lines of magnetic force are concentrated by the presence of the iron and the results obtained from a given expenditure of electric current because of the smaller losses. The magnetic lines cannot stray away from the job in hand—so to speak.

What the Experiments Show.

These experiments are useful in leading the way to an understanding of the action of the transformer. In the apparatus illustrated in Figs. 8 and 9 the starting and stopping of the primary current

—or, in effect, the changing state of no current to full current and full current to no current—is obtained by the medium of a plain switch. The same results could be obtained, only more rapidly, by supplying the primary with an ordinary alternating current supply. The secondary would exhibit a similar state of alternations in current flow, both in incidence and magnitude. This leads, of course, directly to the consideration of the action of a modern transformer. The apparatus can also be made to demonstrate that the rate of movement of the lines of force has some influence on the effects produced in the secondary by the currents in the primary. If the primary currents are started and stopped with a very slow rise and fall in strength then the secondary will not respond so readily. This can be illustrated by using an infinitely variable resistance as the switching-in device in the primary in place of a quick-acting tumbler switch.

Why the Poles of an Electro-magnet Attract Iron.

That the poles of an electro-magnet of any type will attract a piece of iron is common knowledge, but the causes underlying this phenomenon are perhaps not so apparent. The high magnetic permeability of soft wrought iron and the small degree of reluctance to the passage of lines of magnetic force through such material compared with that through other substances, say, air, for example, have been remarked on.

The poles of an electro-magnet show, as is well known, a field of force traversing the space between them in ever-spreading curves of magnitude and direction, but by placing a piece of iron in the air gap the effect is immediately to concentrate them.

This action of crowding up the lines of force may be explained by a simple analogy. Imagine a pot of water with a pumice-stone bottom hanging up full of the fluid. The water will ooze out

all over the surface of the bottom as the material is permeable to it in a certain degree. But if a hole is drilled in the centre of the pumice-stone all the water will concentrate to this hole and flow out quite rapidly, in proportion to its size. The hole becomes a spot of greatest permeability, just as a piece of soft iron acts in a magnetic field. (See Fig. 3.)

Horseshoe Magnets.

In the case of a magnet of horseshoe form the magnetism is concentrated in

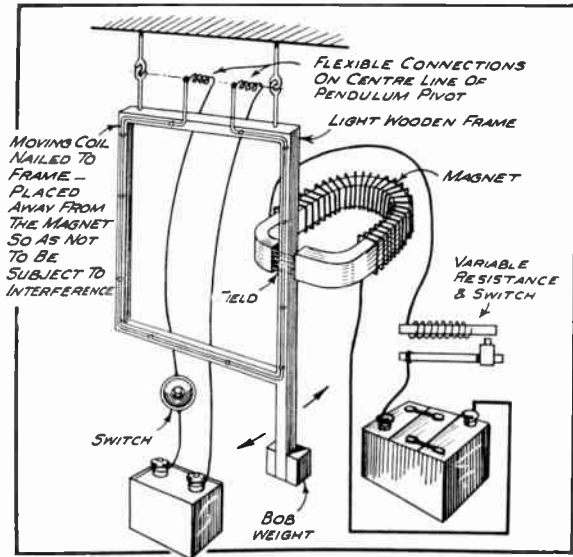

Fig. 7.—EXPERIMENT TO SHOW THE RETARDATION TO MECHANICAL MOTION OF A WIRE CARRYING A CURRENT IN A MAGNETIC FIELD.

the steel and it is only at the tips or poles that the exterior effects are most pronounced. At this air gap between the poles the substance (air) not being so permeable to the lines of force, in trying to get from one pole to the other, spread out because the air will not take them so closely packed together. A piece of iron if brought within the magnetic influence of the poles forms a splendid path for the lines of force and the magnet therefore attracts it into the gap to provide a shorter and easier course for the magnetism. The piece of iron becomes to all intents and purposes a part of the magnetic circuit. (See Fig. 10.)

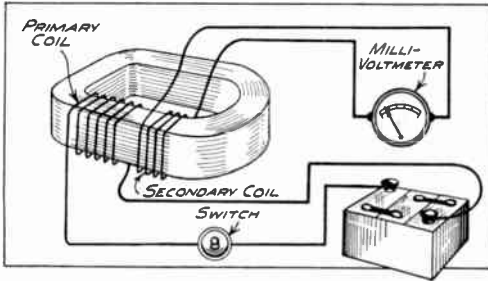

Fig. 8.—AN EXPERIMENT TO SHOW THAT A CURRENT CAN BE INDUCED IN A WIRE BY ANOTHER SEPARATE CIRCUIT.

Why Poles Repel and Attract.

Should the gap between the poles be filled by another magnet and the polarity and field strength of this magnet is arranged to be the same as that of the main one, i.e., north seeking pole to north seeking pole and south pole to south pole, they mutually resent the action. Virtually, the main magnet cannot make a magnet of the second one, and therefore it resists its intrusion. Hence the rule "like poles repel and unlike poles attract."

If the second magnet is turned the other way round it will rush into the gap, with double power, just like the piece of soft iron. The soft iron is not a magnet

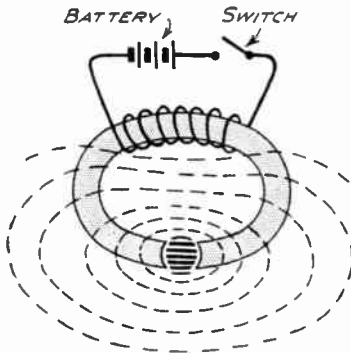

Fig. 10.—A PIECE OF IRON IF BROUGHT WITHIN THE MAGNETIC INFLUENCE OF THE POLES OF A HORSESHOE MAGNET FORMS A SPLENDID PATH FOR THE LINES OF FORCE, AND THE MAGNET THEREFORE ATTRACTS IT INTO THE GAP TO PROVIDE A SHORTER AND EASIER COURSE FOR THE MAGNETISM.

until it is brought into the influence of the field, but as this material is so susceptible and permeable to magnetism it fits in the space with almost equal alacrity.

Questions of Polarity.

This question of polarity is bound up with the direction of electrical currents in a conductor. In a permanent horse-

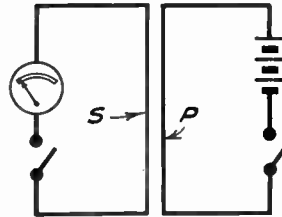

Fig. 9.—SHOWING INDUCED CURRENT DUE TO MAGNETIC LINES.

shoe or bar magnet the poles are marked "N" and "S" respectively, i.e., north seeking and south seeking, and this polarity is immutable. To alter it the only course is to destroy the magnetism in the bar and remagnetise it with a new force of the opposite polarity.

With a wound magnet the polarity depends on the direction of the current in the electric circuit which produces it. There are many rules for remembering which way round the current should flow

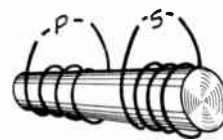

Fig. 11.—A RUDIMENTARY TRANSFORMER.

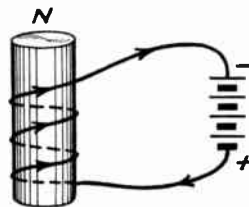

Fig. 12.—THE RIGHT-HAND SCREW RULE FOR POLARITY.

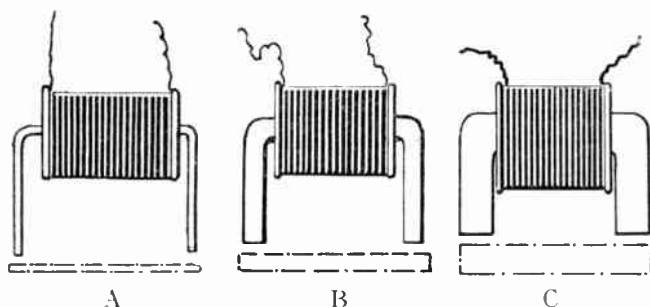

Fig. 13.—THREE MAGNETS AND ARMATURES OF DIFFERENT MATERIALS WHICH CARRY THE SAME NUMBER OF LINES OF FORCE WITH A GIVEN ENERGISING CURRENT. THE LESS PERMEABLE THE MATERIAL, THE GREATER IS THE AMOUNT REQUIRED.

A, soft pure wrought iron; B, hard drawn iron wire or grey cast iron; C, average quality carbon steel in unhardened state.

to produce a north pole at any one end of the iron core which the coil of wire usually encircles. The presence of the iron does not, of course, affect this polarity: the end of the coil will be N and S respectively, whether there is an iron core or not.

A Point to Bear in Mind.

It is useful to bear in mind in making analogies between the flow of an electric current and the state of magnetism that with the electric current there is a true flow. With a magnetic flux there is no true flow. The lines of force just take a certain path as if they were flowing in that direction and exhibit polarities. Under given temperature conditions the specific conductivity is independent of the strength of an electric current, but in the case of magnetic permeability the value of material as expressed in the text books by the symbol μ (a Greek letter pronounced "mu") is not independent of the total flux.

Further, in electricity the energy is expended so long as the current flows, but in a magnetic circuit the energy is only required in producing the flux and not in maintaining it.

Magnetic Effect in Solenoid or Other Magnet.

The magnetic effect produced in a solenoid or other magnet depends directly on the number of turns multiplied by the amperes of the current, viz., "ampere turns," in the energising coil. But to

arrive at a useful result we must know something about the resistance to the magnetic circuit. The useful part of the flux is, of course, the gap—the place where we can put something that will be worked by the magnetism. The subject of electro magnetism usually contains a number of difficult symbols and formulæ which although excellent for the scientist are not so useful for the practical man. A later article will deal in a simple manner with all calculations relating to electricity and the reader is advised to refer to this for further information.

The Importance of a Small Air Gap.

As in a magnetic circuit the carrying value (the flux) is limited by the air gap, it is important that this shall be reduced to the minimum. The presence of iron of even a low grade of permeability will concentrate a large number of lines of force, but the reluctance offered by quite a small air gap is proportionately very considerable. Hence designers put a large value on a small air gap.

In air magnetic attraction and repulsion of iron armatures varies as the square of the distance from the pole to the armature affected.

Magnetic Leakage.

Considerable attention is necessary in the design of magnets to prevent unnecessary leakage of magnetic lines. To test the relative value of different designs the iron filings spread on a card method may be adopted if there is any doubt as to these values when judged in the drawing office stages. The test magnets may be quite thin sheets of iron plate with a single layer coiled round it in the proper place arranged to carry a fairly heavy current. The cardboard will then lay up quite close to the magnet.

In the sketch of the magnet, Fig. 10, the straight dark lines represent the useful magnetic flux and the dotted lines the leakage paths—lines of force which are lost.

HOW TO INSTALL A POWER TRANSFORMER

By T. J. BARFIELD

THIS article deals with the installation, care and operation of transformers in works and factories.

Principle of Static Transformers.

A very brief outline of the principle and construction of static transformers may be of use. If a coil is wound round an iron bar and the bar is magnetised, the magnetism varying in strength, a current will be induced in this coil. Conversely, if a current is passed through the coil, it will magnetise the iron. If now two coils are wound round the iron, a current flowing in the first and regularly varying in strength or reversing its direction, a corresponding current will be induced in the second coil. This is the principle of the transformer; the primary current is passed through one coil and induces current in the second. If there are twice as many turns on the first coil as on the second, the voltage across the second coil will be half that of the first, but the current

may be twice as much; thus, ignoring losses, the power taken out is the same as that put in.

How the Transformer is Constructed.

The modern transformer consists of a closed magnetic circuit formed of a large number of laminations of sheet iron. Round the limbs of this circuit are placed, first insulating material, next the low

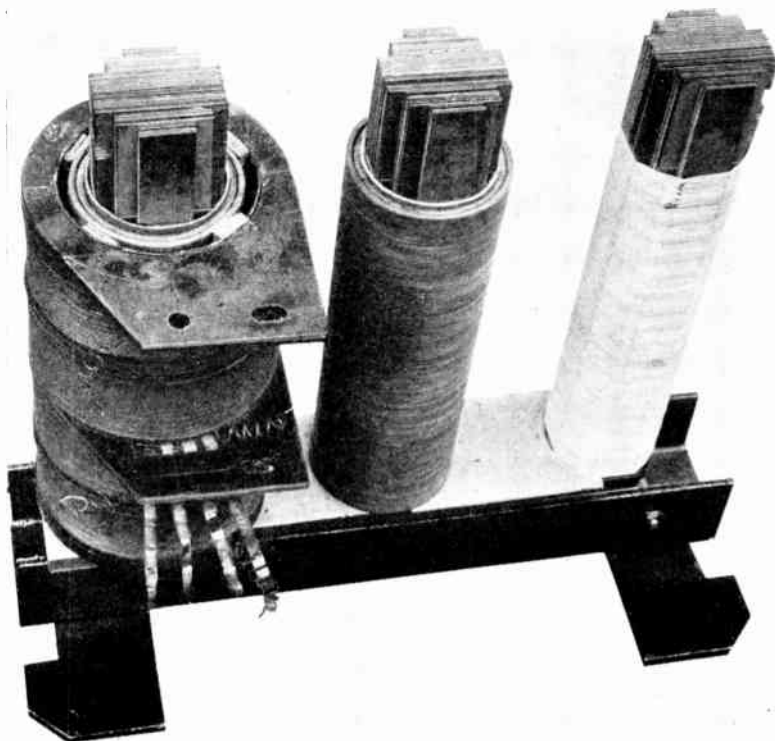

Fig. 1.—THREE-PHASE TRANSFORMER IN COURSE OF CONSTRUCTION.

The right-hand limb has been taped, ready to receive an insulating cylinder. The middle limb has this cylinder in position, over which the L.T. coils have been slipped. Over the left-hand limb, in addition, first, spacing pieces (to give a gap or duct for oil circulation) have been placed; next, an insulating cylinder, and finally, the H.T. winding. The top yoke has to be interleaved with the laminations of the limb and the connections taken from the windings to suitable terminals.

tension winding, another layer of insulating material, and finally the high tension winding. The windings and insulating cylinders are spaced apart, leaving ducts through which oil can circulate. The whole core, as the magnetic circuit is termed, with windings, is placed in a suitably designed tank and immersed in a special oil, which has the double function of adding to the strength of the insulating materials used and carrying away heat generated in the core and windings by magnetic and resistance losses. On small transformers, up to about 30 K.V.A. capacity, a plain tank is used, the surface being sufficient to radiate the heat evolved. Larger transformers have cooling tubes to increase the radiating surface, the oil circulating through these tubes in the same way as hot water circulates in a radiator.

Fig. 1 shows a transformer in course of construction, before the top of the magnetic circuit, or yoke, has been fitted. Fig. 2 shows a similar transformer completed, and Fig. 3A the appearance of the transformer in its tank. This construction is typical of all transformers for ordinary indoor use except the smallest. The latter may be in plain tanks, as already mentioned, and if for comparatively low voltage on both sides, say transforming from 440 volts down to a lower voltage, they may not be immersed in oil.

INSPECTION ON DELIVERY.

The great enemy of the insulating materials used in transformers is damp. To prevent the windings absorbing moisture, therefore, transformers are dispatched in the tanks in oil wherever possible. Sometimes, to reduce the weight and facilitate handling, only enough oil is put into the tanks just to cover the windings, the extra required being sent in steel drums.

What to Do When the Transformer Arrives.

On arrival unload the transformer by means of a crane or suitable lifting tackle (the weight of the transformer, if not marked on the rating plate on the tank, will be stated on the delivery note), lifting by means of the shackles provided on the

sides of the tank. The transformer should then be got under cover, in its final position if that affords head-room for lifting the core. If rollers have not been ordered, it will be necessary to move the transformer on temporary rollers. In handling the transformer do not use levers on the tank itself, but on the base of angle or channel iron.

The protecting battens, if provided, may be removed from the tank and a thorough external inspection made. Note especially any exposed insulators, projecting fittings, such as oil level indicators, etc., and examine for oil leakage.

Inspecting the Core and Windings.

The core and windings should now be lifted for inspection. The tank cover will probably be a plain sheet with no fittings requiring removal before it can be lifted. Remove the fixing bolts, lift the cover and carefully raise the gasket of cork sheet or similar material. If left in position while the cover is off this gasket may be damaged.

Note now any obstructions, which must be removed before the core and windings can be lifted. These include any connections from the transformer to insulators or terminals on the tank, including earthing leads and long insulators projecting through the tank. Common terminal arrangements are shown in Fig. 4, from which it will be seen that the connections from the H.T. windings and the H.T. insulators must be removed. This is done by removing the nuts on the screwed stems passing through the insulators, unbolting the clamping collar which secures the insulators to the tank, and drawing the insulators out complete with their stems. If a terminal box is fitted for paper insulated cable (see Fig. 3A), this also may need to be removed.

Make a Systematic Examination.

When all is clear lift the core straight upwards by means of a crane or suitable tackle high enough for the whole of the windings to be inspected, and go over everything systematically, examining for loose nuts or bolts in the mechanical structure or connections, and making sure that nothing loose has lodged anywhere.

(It is not unknown for careless workmen at the factory to leave spanners inside!)

Voltage Adjusting Tappings.

The connections may now be traced out by reference to the diagram plate, and if voltage adjusting tappings are provided they may be set to the required position either now or after the core has been partly lowered. These tappings are connected so that a few turns in the primary winding can be cut in or out of circuit to give a slightly lower or higher voltage on the secondary side. Usually these tappings are brought up to a terminal board at oil level, and are (see Fig. 2) connected by means of a bolted link. This link must never be touched while the transformer is alive, and after reconnection the bolts must be securely tightened. Sometimes a tapping switch is provided so that an alteration in the tapping can be made without removing the tank cover (Fig. 7). Less frequently an "on-load" tapping switch is provided, by means of which the voltage can be adjusted while the transformer is supplying current.

INSTALLATION.

The core should now be lowered

into the tank, the insulators replaced and any connections which have been disturbed should be replaced and the nuts made tight. The cover should not yet be replaced.

Oil may require to be added to bring the level up to the mark or the height indicated by the oil gauge. Only special transformer oil may be used, and the drums should be clean and dry externally before the oil is poured into the tank.

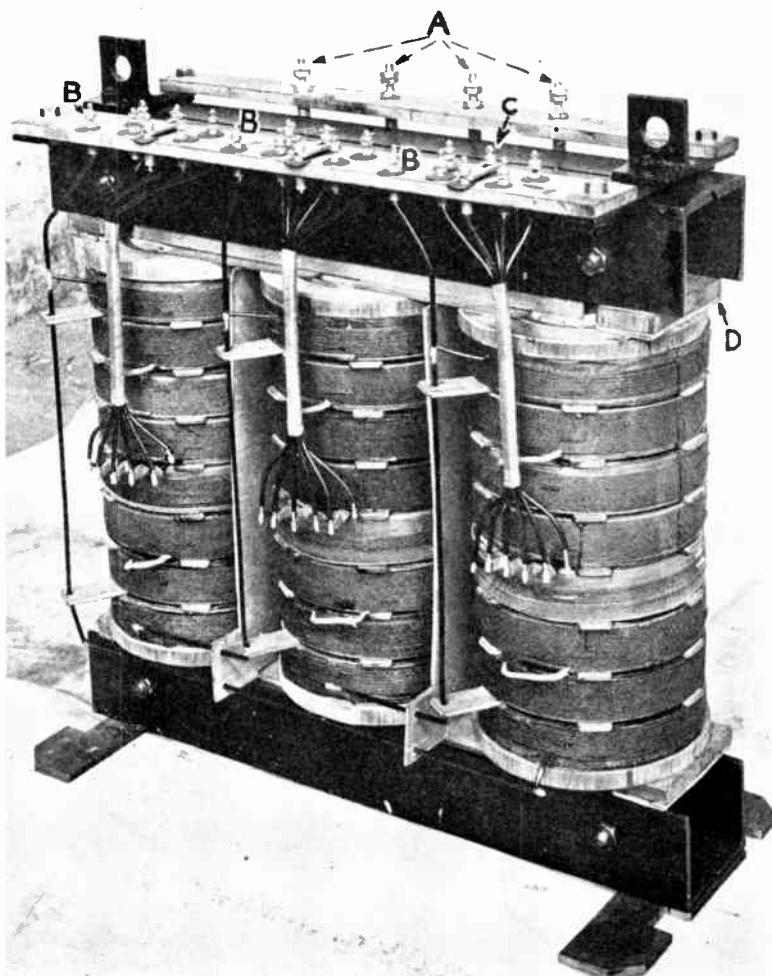

Fig. 2.—COMPLETED CORE AND WINDINGS OF A THREE-PHASE TRANSFORMER. A shows the three-phase terminals and the neutral on the L.T. side; B, the H.T. terminals; C, one of the three link-type voltage-adjusting terminals. On the tops of the windings may be seen packing pieces, D.

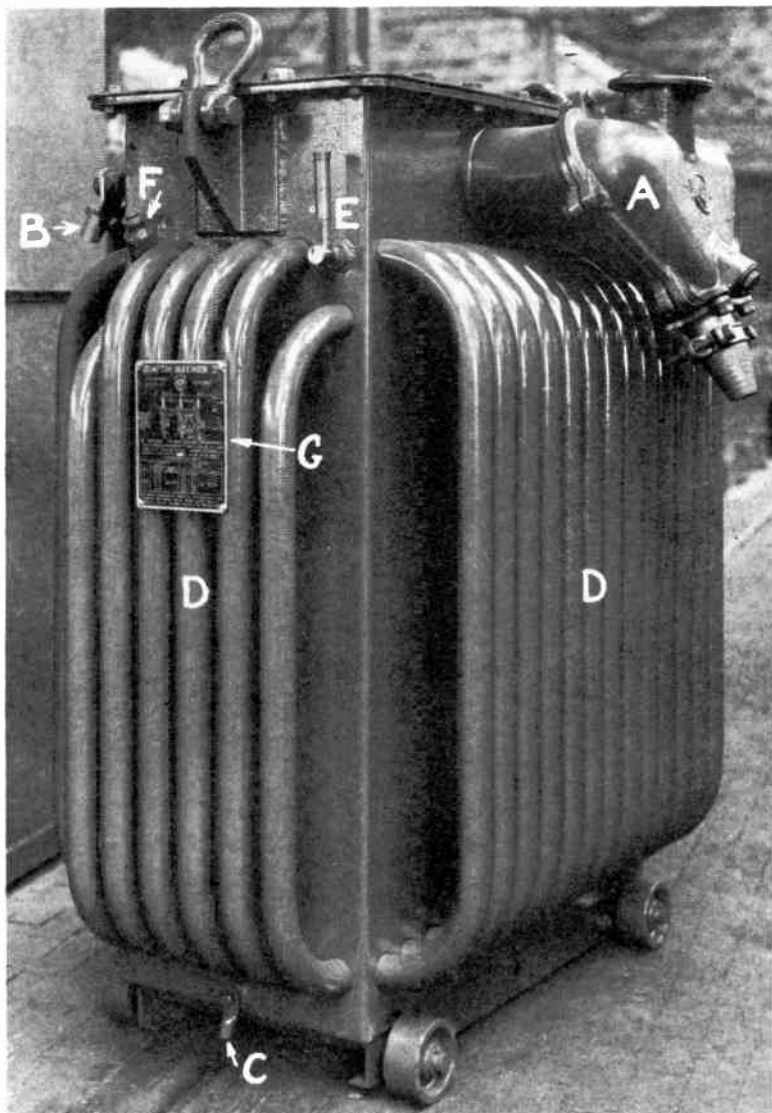

Fig. 3A.—EXTERNAL VIEW OF TYPICAL THREE-PHASE OIL IMMERSSED SELF-COOLED TRANSFORMER FOR INDOOR USE.

The parts marked are: (A) Cable box for E.H.T. cable; (B) One of the L.T. cable sockets; (C) Earthing terminal; (D) Cooling tubes; (E) Oil level gauge; (F) Thermometer pocket; (G) Diagram plate. (Crompton Parkinson Ltd.)

Drying-Out.

After a short journey in oil, especially in the case of transformers wound for a H.T. voltage of 6,600 or lower, it should not be necessary to dry-out the windings and oil. If it is suspected that moisture has been absorbed, draw off a sample of

oil from the bottom of the tank, after the oil has stood for some time, and forward this for examination, in a scrupulously clean and well-sealed bottle, to the manufacturers or the oil suppliers. If they report the presence of moisture drying-out must be undertaken.

Moisture in oil cannot be detected by ordinary insulation testing apparatus. An insulation test of the windings, if it shows resistances in the neighbourhood of 1 megohm, may point to the presence of moisture; on the other hand, quite high readings may be obtained when the resistance is tested on arrival of the transformer, although considerable moisture may be present.

The process of drying-out simply involves raising the temperature

of the core, windings and oil to as high a temperature as is convenient and safe, and maintaining it until all moisture is driven off. The heat required may be produced in a variety of ways, of which two only need be considered. The first and best of these involves the use of special resistance heaters which can be

immersed in the bottom of the tank. It is unlikely that these will be available, and therefore only the second method will be described in detail. This, the "short-circuit" method, consists of passing current from an external source through one of the windings, the other being short-circuited. This current will heat the windings due to the resistance losses, a current being induced in the short-circuited windings so that both are heated uniformly, and will also energise the magnetic circuit, the magnetic losses assisting in warming the core.

The First Steps of Drying-Out.

First lag the sides of the tank so as to conserve the heat as much as possible, wrapping round sacking or any similar material available. The tank cover should be removed or raised at least a foot, so that any moisture driven off may evaporate. The voltage of the heating current required is about that of the impedance voltage of the transformer, which should be marked on the rating plate. If this is anything less than the voltage of the supply available, connections may be made so that it can be fed into the H.T. windings. If 3-phase supply is available connect to the three H.T. terminals; if single phase only is available connect as in Fig. 5. In either case resistances must be provided to adjust the current, with an ammeter in each phase. Probably suitable D.C. motor starters or similar resistances can be found for this purpose; or a number of electric fires might be employed.

Short-Circuit the L.T. Winding Terminals.

The terminals of the L.T. winding should be short-circuited by means of cable, or by drilling a piece of copper strip and bolting it to the terminals. Make secure connections, for approximately the full load current will flow in the short-circuited winding.

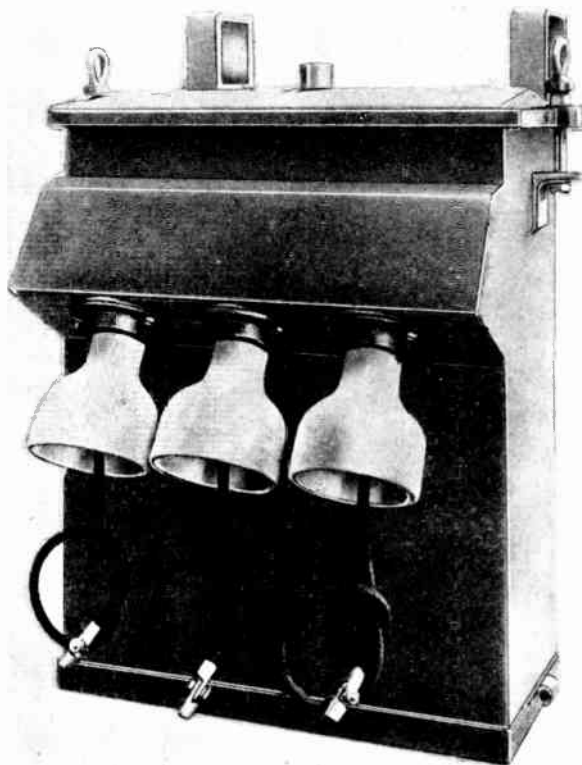

Fig. 3B.—SMALL POLE-MOUNTING TRANSFORMER WITH LEADS BROUGHT OUT.

Obtaining Sufficient Voltage.

If the available voltage is insufficient to pass enough current through the H.T. windings, it may be applied to the L.T. windings with the H.T. side short-circuited. In this case be very careful not to break the H.T. connections while current is flowing, or a dangerous voltage will be induced.

Failing suitable A.C. supply, direct current equal to full load current may be passed through either winding, or through both if this can be arranged. This method is not recommended if A.C. is available, since it directly heats the windings only, and the drying of the core, which is not heated from within itself by magnetic losses, may not be so thorough.

Use Spirit Type Thermometers.

Having determined by test that the

voltage of supply and the resistances are suitable, connect up, using V.I.R. leads securely bolted to the transformer terminals. Before switching on arrange thermometers in the upper layer of oil; and also if possible in the oil ducts between the windings, where the highest temperatures may be recorded. These thermometers should be of the spirit type; mercury thermometers may give incorrect high readings, due to eddy currents being induced in the mercury and generating heat, and also there is some danger of mercury causing short-circuits if the bulb should be broken.

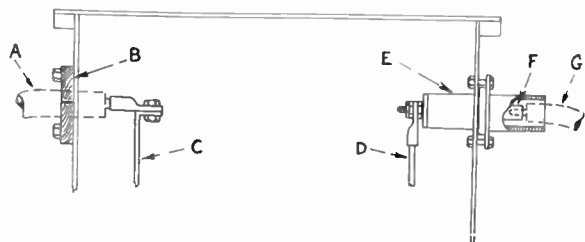

Fig. 4.—TYPICAL TERMINAL ARRANGEMENTS.

On the left is a split wood cleat for single-core V.I.R. L.T. cables. On the right, porcelain insulators with recessed sockets for single-core H.T. cables. The parts marked are: A, L.T. cable; B, wood cleat; C, L.T. connections to transformer windings; D, H.T. connections to transformer windings; E, porcelain insulator; F, recessed socket; G, H.T. cable.

Switching On the Current.

The current may now be switched on and adjusted by means of the resistance to not more than normal full load current. A slightly higher current at first will do no harm, but will probably have to be reduced as the transformer heats up. The maximum oil temperature should not exceed 90° C. A somewhat lower temperature will not matter, but will increase the time required for drying-out. If the supply available does not permit of a high enough current to raise the oil temperature to the required figure, try more effective lagging to reduce the heat loss.

Keep the Temperature Steady.

When the temperature has been raised to 90° C. lower the current and keep the temperature as steady as possible. If a

variable resistance is not available the current must be switched off for, say, 15 minutes, switching on again as soon as the temperature drops perceptibly. Constant attendance during drying-out is necessary.

Use a "Megger" to Measure Insulation Resistance.

Before starting, and at regular intervals, measure the insulation resistance of the windings to earth by connecting one lead from a "Megger" to a terminal and the earth lead to the yoke. This should be done for both H.T. and L.T. windings; and then test the resistance between windings by connecting one lead to an H.T. terminal and the other to an L.T. terminal. Current must be interrupted while these measurements are made. These readings should then be plotted in the form of a curve connecting temperature, resistance and time. This is shown in Fig. 6. (resistance of one winding to earth only shown for simplicity), from which it will be seen that at first, as the transformer warms up, the resistance drops. Next during the actual drying-out period the resistance remains fairly steady; during this time small bubbles may be observed rising to the surface of the oil, indicating that moisture is being driven off. When the resistance begins to rise the drying-out may be considered complete and the current switched off.

Before drying out the insulation readings obtained will probably be high—20 megohms or more. They may then drop to a low figure if moisture is present, say 1 or 2 megohms. When drying-out is complete they should again rise to 20 megohms or more. Exact figures cannot be given, since they depend on the size of transformer, voltage for which it is wound, etc.

Phasing-in.

If the transformer has to operate in parallel with another it must be properly phased-in. Not all transformers will operate in parallel, but it is assumed that

the manufacturers have been provided with the information required to enable them to design a transformer to parallel with the existing one. If the existing and new transformers are of the same make a study of the diagram plates on the side of each tank will show the correct connections, but as an added precaution the simple operation of phasing-in should be carried out.

Connections Required for Three-Phase Transformer.

In the usual case of a three-phase transformer the connections required are shown in Fig. 8. No. 1 is the existing transformer, connected to H.T. and L.T. busbars. No. 2 is the new transformer, connected to the H.T. busbars only, with temporary connections between one L.T. terminal only (the neutral, if available) and what is believed to be the correct L.T. busbar. Switch on the primary supply and with a voltmeter take readings between D and D¹, E and E¹, F and F¹. If these readings are all zero the transformer is correctly phased-in and the secondary connections may be made, D¹ to the busbar to which D is connected, and so on. If zero readings are not obtained try readings between D and E¹, etc., until the three correct connections are obtained.

Connections for Single-Phase Transformer.

For a single-phase transformer connect both the H.T. terminals of the new transformer to the busbars and one of the L.T. terminals to what is thought to

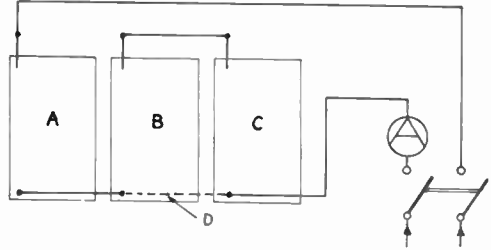

Fig. 5.—CONNECTIONS FOR DRYING-OUT A TRANSFORMER BY THE SHORT-CIRCUIT METHOD, USING SINGLE-PHASE SUPPLY.

A, B and C are the three-phase windings, the common connection D being temporarily broken. The other winding of the transformer, not shown, has the three terminals short-circuited. For a single-phase transformer, connect single-phase supply to two terminals (the two H.T. or the two L.T.) and short-circuit the other two.

be the correct busbar. Then measure the voltage between the other L.T. terminal and the corresponding terminal on the existing transformer. If the reading is zero the connections are correct.

The comparatively simple case of a transformer of correct polarity, i.e. wound so as to parallel with the existing transformer, has been considered. If it is found that no arrangement of connections gives zero readings, the internal connections of the transformer may need alteration and the assistance of an expert should be sought.

This operation is not necessary for transformers isolated from all others on their secondary side. This includes furnace transformers, transformers supplying one large machine, small transformers supplying one independent section of a factory, etc.

CONNECTING-UP.

After drying-out and phasing-in, if these operations have been necessary, permanent connections may be made. The actual work of making the cable connections usually calls for the services of a skilled joiner. In general, the L.T. connections will be made by single-core V.I.R. cables, and these will be taken into the transformer through a split wood cleat indicated in Fig. 4, the ends being bared

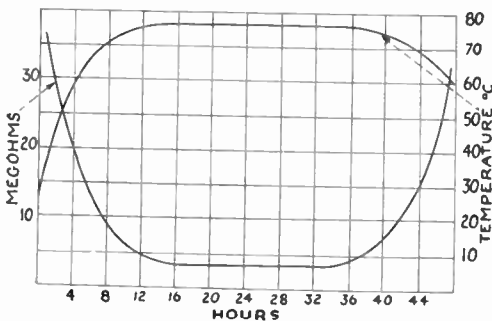

Fig. 6.—GENERAL SHAPE OF RESISTANCE, TEMPERATURE AND TIME CURVE FOR THE DRYING-OUT OF A TRANSFORMER.

and sweated into the sockets provided. When the core has to be removed for inspection the sockets may be unbolted from the transformer terminals, the wood cleat removed and the cables drawn out without unsweating the sockets.

Cables for the H.T. Side.

On the H.T. side single-core cables may be used when the voltage is not above, say, 6,600, and for short connections. Here porcelain insulators are provided, usually with screwed stems with the sockets shrouded so that all live metal is shielded. Here again the stems may be unbolted and drawn out without disturbing sweated connections where the core is to be lifted. When three-core paper insulated and lead covered cable is used on the H.T. side a special terminal box may be ordered, mounted directly on the transformer tank, as shown in Fig. 3A.

Small transformers are often ordered with insulated leads brought out of the tank, as in Fig. 3B.

Secure the Cables Firmly.

All cables should be secured so that their weight is taken off the insulators (Fig. 12), and in the case of heavy current cables it must be remembered that under short-circuit conditions very heavy electromagnetic forces are produced between the cables; rigid fixing by means of cleats or racks is therefore necessary. In the case of single-core cables, particularly for heavy current, several inches distance should be allowed between the cable and any ironwork, or heating of the iron by induced currents may take place. These remarks apply particularly to furnace transformers, the heavy current connections of such transformers requiring careful planning.

When to Use Bare Copper Rod or Strip.

When the L.T. current exceeds, say, 300 amps. it is often convenient to arrange for connections of bare copper rod or strip. These should be rated at a current density of not more than 1,000 amps. per square inch. They must be screened from accidental contact by means of expanded metal screens, and where the lay-out of the substation permits may be

run up to the ceiling, across and down to the L.T. switchboard. They should be supported by means of porcelain racks or busbar insulators. For current of about 600 amps. and over strip should be used, or a number of copper rods in parallel, to avoid the "skin" effect which reduces the effective current carrying capacity of round conductors carrying heavy A.C. currents; for such high currents, also, the current density should not exceed 800 amps. per sq. in.

Earthing the Tank.

When connecting up, the tank must be earthed by means of a cable or copper strip (of about 0.125 sq. in. section) sweated to the socket provided or bolted to the tank and connected at the other end to the general earthing system, or, if none exists, to a water main or earth plate. Power earths of this kind must be substantial and of low resistance, for very heavy currents can flow in the event of a fault in the transformer, and an uncertain earth is perhaps as dangerous as none.

When the connections have all been made replace the tank cover, not forgetting its gasket, and the transformer is ready for service.

The Transformer Room.

Before the transformer is delivered its location must be considered. Usually this will be the factory substation; and may be assumed to be reasonably clean, dry and well ventilated. The latter consideration is important, for lack of adequate air circulation may cause an abnormal temperature rise, for which the only cure, other than artificial ventilation, is reduction of the load.

Transformers should not be installed too close to each other or to a wall, or a "blanketing" effect may be set up, hindering heat dissipation. The required spacing varies somewhat with the size of the transformer, but a minimum of two feet all round should be allowed.

Leave Enough Head-room.

Where possible enough head-room should be allowed above the transformer to permit the lifting of the core and windings for inspection without disturbing the

Of extraordinary value to every handyman

NEWNES' Home Mechanic BOOKS

Clearly written and fully illustrated
each book contains 96 pages

TOY MAKING FOR AMATEURS

Tells you how to make toys of every description and lays bare the principles by means of abundant illustrations and simple text. Every mechanical movement known in toy manufacture is included.

TWENTY-FIVE TESTED WIRELESS CIRCUITS

A book for the modern wireless enthusiast. All the sets described have been designed to meet modern needs. They range from simple crystal receivers to a seven-valve super-heterodyne, and all the sets have been made and tested before inclusion.

SIMPLE ELECTRICAL APPARATUS

An excellent little book for those who wish to make simple and useful electrical appliances, such as galvanometers, electric motors, dynamos, and Leyden jars. All these may be made by anyone with the aid of a few tools and some inexpensive materials. Clear instructions are given in every case.

MODEL BOAT BUILDING

There are few more fascinating hobbies than Boat Building. In this book there are designs for a battleship, a speed boat, a paddle-steamer and yachts, from which excellent models may be built with the help of the simple directions and diagrams that are given. No elaborate tools are needed, and each model can be made at small cost.

Other Titles

THE HANDYMAN'S ENQUIRE WITHIN
THE HOME WOODWORKER
25 SIMPLE WORKING MODELS
MODEL AEROPLANES AND AIRSHIPS

One Shilling each

On sale at all Newsagents and Bookstalls, or by post 1/2 each from George Newnes, Ltd., 8-11, Southampton Street, Strand, London, W.C.2

Geo. Newnes, Ltd.

This article on How to Install a Power Transformer will be continued in Part 15. Ready January 22nd.

RALPH STRANGER'S WIRELESS BOOKS

The Wireless Library for the
Man in the Street :

MATTER AND ENERGY
ELECTRONIC CURRENTS
ELECTRIFIED MATTER
MAGNETISM AND ELECTRO-
MAGNETISM
THE MATHEMATICS OF WIRELESS
BATTERIES AND ACCUMULATORS
SEEING BY WIRELESS (TELEVISION)
MODERN VALVES
WIRELESS COMMUNICATION AND
BROADCASTING
WIRELESS WAVES
HOW TO UNDERSTAND WIRELESS
DIAGRAMS
SELECTION OF WIRELESS SIGNALS
DETECTION OF WIRELESS SIGNALS
AMPLIFICATION OF WIRELESS SIGNALS
REPRODUCTION OF WIRELESS SIGNALS
WIRELESS RECEIVING CIRCUITS
WIRELESS MEASURING INSTRUMENTS
THE BY-PRODUCTS OF WIRELESS

SOME PRESS OPINIONS:—

"The new shilling library aims at giving the wireless enthusiast a sound theoretical and practical grip of his subject. The author employs clear and simple language, and starts practically from zero."—*The Broadcaster*.

"These books deal with a highly technical subject in the simplest language which enables those who have no scientific training to grasp the wonders of wireless, and assist the listener to get the best possible results from a receiving set."—*Railway Review*.

ONE SHILLING EACH

By Post 1/2 each.

**WIRELESS:
THE MODERN
MAGIC CARPET**

Fourth and Revised Edition

If you know nothing about wireless and do not even possess a receiving set, this book will show you how to provide yourself with an interesting and absorbing hobby. If you are a listener, but rather weak on the technical side, it will save you much unnecessary worry and expense. If you wish to experiment, this volume will provide you with valuable experimental data. If you are an expert and have to lecture, it will give you some useful lecture material.

SOME PRESS OPINIONS:—

"Mr. Stranger . . . gives a simple, yet authentic introduction to all the 'mysteries,' and explains them away in an exceedingly interesting and readable way. . . . A book which should go on every listener's bookshelf."—*The Star*.

"A good book simply written."—*The Daily Mirror*.

" . . . It will be surprising if such an ably written book as this does not find a wide sale."—*Daily News*.

" . . . Mr. Stranger has succeeded in doing one thing that will endear him to all students interested in electricity. He has succeeded in making static electricity fascinating. . . . The book should prove of great value to all those who have a set or contemplate the construction of one."—*World-Radio*.

" . . . The subject, in both theoretical and practical aspects, is dealt with in a lucid manner guaranteed to inculcate knowledge without pains."—*Amateur Wireless*.

3/6 nett.

By Post 3/9.

On sale at all Newsagents, Bookstalls and Bookshops, or by post from **GEORGE NEWNES, Ltd., 8-11, Southampton Street, Strand, London, W.C. 2.**

Geo. Newnes, Ltd.

Printed in Great Britain for the Proprietors, **GEORGE NEWNES, LTD., 8-11, Southampton Street, Strand, W.C. 2.** by **W. LLIAMS, LEA & Co., LTD., Clifton House, Worship Street, E.C. 2.** Sole Agents: Australasia: **GORDON & GORCH (Australasia), LTD.** South Africa: **CENTRAL NEWS AGENCY, LTD.**