

Electrical Train Control and Braking

The PRACTICAL ELECTRICAL ENGINEER

A MONTHLY MAGAZINE OF ELECTRICAL PROGRESS



VOL. 1.—No. 9

MAY, 1933



PHOTO-ELECTRIC CONTROL

*The Door
Opens!*



BTH

A Complete Description in this Issue.

RUGBY

THE BRITISH THOMSON-HOUSTON COMPANY LIMITED, RUGBY, ENGLAND

GEORGE NEWNES LTD.



World Radio History



EDISWAN



The name that means 'EXCELLENCE'

THE CENTRAL ELECTRICITY BOARD

ARE USING

30 EDISWAN STATIONARY TYPE BATTERIES FOR SERVICE IN THE GRID SCHEME



Installed at:—

- | | | |
|---------------|------------|------------|
| Lancaster | Bolton | Rotherham |
| Clarence Dock | Warrington | Sheffield |
| Agecroft | Thornhill | St. Helens |
| Chadderton | Bradford | Carlisle |
| Wakefield | Keighley | Harthead |
| Ferrybridge | Southport | Kirkstall |
| York | Crewe | Lincoln |
| Poplar | Stockport | Hull |
| Wigan | Ribble | Saltcoats |
| Runcorn | Grimsby | West Ham |

Here is a further indication of the reliability of Ediswan Batteries. Twenty-five years of experience of battery building is behind them. Only the finest materials are used in their manufacture at the Ediswan Works, Ponders End, Middlesex.

EDISWAN STATIONARY TYPE BATTERIES

THE EDISON SWAN ELECTRIC CO., LTD.



PONDERS END, MIDDLESEX

Bring your lighting problems to **EDISWAN**

B. 222.

PRACTICAL ELECTRICAL ENGINEER

The PRACTICAL ELECTRICAL ENGINEER

A MONTHLY SURVEY OF MODERN PRACTICE IN ELECTRICAL ENGINEERING

VOL. I

MAY, 1933

No. 9

Published by GEORGE NEWNES, Ltd.,
8-11, Southampton Street, Strand, London W.C. 2.

Telephone—Temple Bar 7760

Telegrams—"Newnes, Rand, London"

Price - 1/- Monthly

Yearly Subscription, 14/- Post Free

6 months' Subscription, 7/- Post Free

Registered for Transmission by Canadian Magazines Post
Canadian Rate: Yearly Subscription, 13/6 Post Free
6 months' Subscription 6/9 " "

Lamp Prices.

In response to our recent Editorial on this subject we have received many interesting letters. Some of these are from wiring contractors who sell lamps to the public, others from professional men who realise the importance of this question to the industry as a whole, others from works engineers. A selection from these is given in our correspondence pages.

We have decided to award the guinea prize to Mr. M. E. Shoenberg, whose letter sums up the position from the viewpoint of the Electrical Contractor in a well-reasoned statement.

The Eddy Current Brake.

Whilst the application of the Eddy Current Brake is of particular interest to Railway Electrical Engineers, we believe that most readers of the Magazine will be keenly interested in the description of this new application of a well-known principle. It appears that in railway shunting operations the problem of braking the shunt wagons as they run into the sidings presents several difficulties from a mechanical point of view. The Eddy Current Brake which applies a strong magnetic field across the rims of the wheels of the wagons as they pass over a certain section of the track provides a simple and effective solution of the difficulty.

The first installation in this country has just been completed at the Whitmore sidings (L.N.E.R.), March, and owing to its success will solve the problem of controlling flyshunting operations.

Electrical Methods of Train Control.

Electricity provides an ideal medium for signalling purposes. In fact the application of electricity for purposes of telegraphy and

telephony was at one time by far the most important application. The present Institution, as most readers are well aware, developed from the original Society of Telegraph Engineers. In view of this, is it not surprising that signalling on railways has so long remained largely in the domain of what one would describe as the Heath Robinson type of mechanical engineering? Enormous levers in signal boxes have to be pulled over by hand to operate the signals through a system of wires, rods, chains and bell crank levers. No doubt, the reason for the slow development of electrical signalling on main lines has been the difficulty of obtaining a uniform electrical supply at different points on a given railway system. The rapid growth of the Grid is putting an end to this condition of affairs, and we see a corresponding growth of electrical signalling. Automatic train control is of course an integral part of the electrical signalling system used on electrified lines. Present-day practice tends towards the use of electrical control apparatus on all main line steam operated railways. An article on this subject which is one likely to become of increasing importance in the near future will therefore be read with interest.

Electric Door Opening.

Opening doors by electricity is not new. In the Electrical Exhibition held in Manchester in 1910 we recollect that an electrically operated self-opening door was exhibited. The opening device was, we believe, actuated by the closing of a contact placed immediately under a loose section of flooring in front of the door. The idea provided excellent copy for the newspapers,

II

The Thrustor Mechanism.

The very latest type of electrical door-opening mechanism which has been developed by the British Thomson-Houston Company comprises the following main components. First, a photo-electric relay operated by the interruption of a beam of light; next a valve amplifier for strengthening the photo-electric impulses; third, a sensitive relay for closing the contact of the electric motor, the rotation of which operates the thrustor mechanism. This new device is fully described in our article "*A New Electric Door Opener.*"

Transmitting a Movement Electrically.

For the transmission of signals such as the movement of a telegraph needle or a telephone diaphragm, and for the transmission of power, electricity is an ideal medium. If, however, it is desired to transmit movement, e.g., a movement of a float in a measuring tank to some distant point, it is found not so simple a problem to do this by electrical methods. One successful method which for many years has been applied to engine room telegraphs is the Selsyn system. Recent developments in the way of using valve apparatus in connection with the Selsyn unit has led to greatly extended possibilities of this system which can now be applied successfully to a very wide range of industrial activities, including Printing, Textile Manufacturing, Chemical Manufacturing, Paper-making, the control of Theatre Lighting, etc. Readers who are interested are referred to the article "*Modern Developments in Selsyn Units,*" on page 424.

Another Opportunity for Electrical Manufacturers.

We take the liberty of quoting from a recent issue of *The Light Car and Cyclecar* :—

STARTING OFF THE MAINS.

Medical men and many others who use their cars a lot for short journeys and after-dark work will be glad to learn that a gadget has been introduced which, in conjunction with a specially converted starter motor, enables one to start the engine from a mains power plug. The gadget, of course, takes the form of a suitable transformer, and all that is necessary when starting up in the home garage is to plug in the mains current and close the special starter circuit switch. You then sit back with a broad grin and wait for the engine to fire, rejoicing the while in the thought that the precious amps. in the battery are being hoarded against subsequent start-ups and long periods of parking with the lights on.

Fifteen years ago such an innovation would have been a doubtful proposition for the simple reason that comparatively few garages were equipped with electric light. To-day it appears not only a reasonable proposition, but one which is likely to receive very wide acceptance. It is not beyond the bounds of possibility that the fitting of "universal" starting motors might become standard practice, providing these motors can be made to give the necessary torque at low speeds. Every garage attached to a house having an electricity supply, should undoubtedly be wired both for lighting and power.

Immersion Heaters for Car Radiators.

The possible uses of electricity in connection with the car have hardly begun to be explored. Electrical vacuum cleaners, car battery charging plant, and radiator warmers for winter are just the beginning. Another item that suggests itself is the use of some form of immersion heater attached to the radiator cap for warming up the water to assist easy starting on cold mornings. Has this been done? If not, why not? It may be found on trial that it would require half an hour to warm up the water sufficiently to give a good start, but many people would not mind this, as they usually know well beforehand when the car will be required. We suggest it might repay some enterprising electrical manufacturer to look into the question.

The I.E.E. Wiring Rules.

Although these are now known under the more imposing title of "*Regulations Relating to the Electrical Equipment of Buildings,*" we think that most engineers still think of them as the *Wiring Rules*. Mr. D. Winton Thorpe, A.M.I.E.E., has struck a new note in his contribution to this issue in which he comments on the application of these rules to actual practice. Mr. Thorpe's guiding motive has been to attempt to make the rules "come to life," and we believe that in his article dealing with the Conduit System has succeeded admirably.

A further supplement (9th March, 1933) has been issued to the Ninth Edition of the I.E.E. Regulations for the Electrical Equipment of Buildings. It relates to electric signs and luminous-discharge-tube installations, and is issued, for convenience, in advance of the Tenth Edition. Copies of this supplement can be obtained free of charge, on application to the Secretary of the Institution of Electrical Engineers, Savoy Place, Victoria Embankment, London, W.C.2.

A NEW ELECTRIC DOOR OPENER



ONE OF THE MANY USEFUL APPLICATIONS OF THE B.T.-H. THRUSTOR MECHANISM. It will be seen that the waitress has interrupted the light beam of the photo-electric thrustor control system and that the door has partly opened. By the time she reaches the door it will be fully opened.

W E have already described in our issue of February an automatic door opener, operated by a solenoid. The latest development is the B.T.-H. Thrustor mechanism used with a photo electric relay.

The Complete Equipment.

By means of this new automatic door-opening device, a swing or sliding door or gate can be opened and will remain open for a definite period of time, by the momentary interruption of a beam of light falling on a photo-electric cell. The complete equipment comprises a B.T.-H. thrustor; suitable link mechanism coupling the thrustor with the door or gate; a control pillar; a projector lamp; and a photo-electric cell mounted in a holder.

Equipments can be supplied for operation on either A.C. or D.C. supply.

The Thrustor and Link Mechanism.

The thrustor and its link mechanism are set up at the side of the door, on the same side as the hinge, and the door is arranged to open only in the same direction as the oncoming traffic. In this way, all the mechanical control gear is unseen by anyone approaching, being hidden by the door when the latter opens. The photo-electric cell and projector lamp are set up a suitable distance away from the door, so that the approaching traffic will interrupt the beam of light on approaching the door; the electrical control pillar is erected in close proximity to the photo-electric cell.

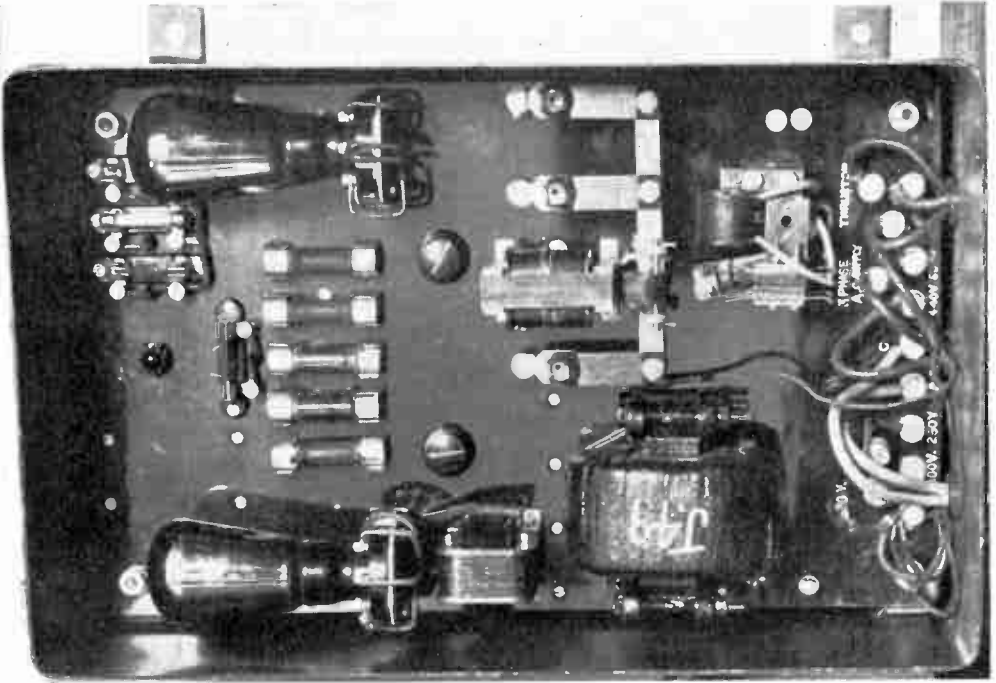

THE CONTACTOR PANEL IN DETAIL.

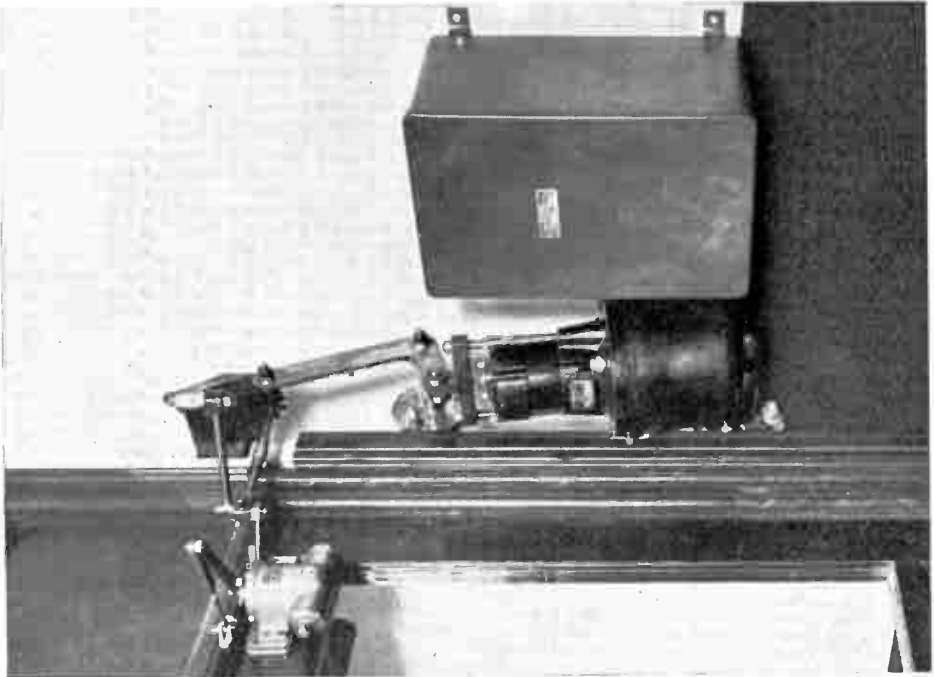

HERE WE SEE A CLOSE-UP VIEW OF THE THRUSTER AND RELAY PANEL.

Time Interval for Closing.

The device is so arranged that when any person approaches the door, and obstructs the beam of light, no operation takes

the person will have reached the door. The door will remain open for a definite time interval, and this interval can be varied by means of a three-way switch. A time

interval of the order of six seconds from the time the beam is restored to the time the door begins to close is found to be quite satisfactory. With this interval, as soon as the traffic has cleared the door by about one second, the door begins to close; its closing is effected by an automatic door-closing device.

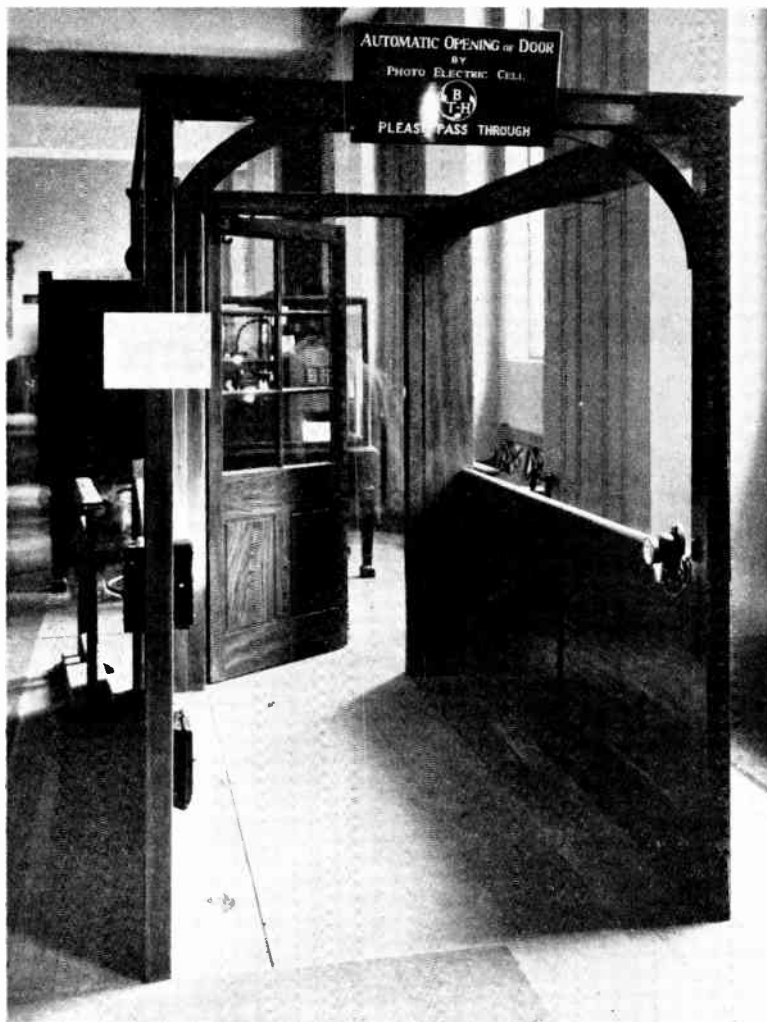

THE B.T.-H. PHOTO-ELECTRIC DOOR-OPENING EQUIPMENT.

A person approaching the door interrupts a beam of light—this sets in motion the actual mechanism for opening the door. After a certain time interval the door closes. In the illustration the door is seen in the position it would be were the person about half-way between the beam of light and the door. On the right is the projector lamp and on the left the B.T.-H. photo-electric relay. The equipment is particularly valuable in hotels, restaurants, etc.

place; immediately the beam of light is restored by the person taking a step nearer to the door, however, the door begins to open, and is fully opened in approximately two seconds, by which time

infinite number of persons, so that in the event of a stream of people approaching the door, the latter will open and remain open until one second after the last person has cleared the door.

What Happens if a Stream of People Interrupt the Beam.

Should a second person momentarily interrupt the beam of light a second or so after the first person has already set the door opening, the apparatus will operate to reset the time delay period, which will therefore expire one second after the second person has cleared the door. This re-setting of the time delay period will hold good for an

It will then close in the normal way.

What Happens if Door is Momentarily Interrupted While Closing.

In the event of the beam of light being momentarily interrupted while the door is closing it will immediately reopen, and remain open for the time delay period. It should be noted, however, that the length of this time delay period is fixed from the instant the beam of light is restored, to the instant the door begins to close. It is, therefore, obvious that if the door has just begun to close, when the beam is again interrupted, the time that the door remains open will be approximately two seconds longer, since the time taken for the door to open now becomes part of the time that the door remains fully open.

Traffic in One Direction Only.

The device described above is designed for traffic passing through the door in one direction only. In spite of the considerable force exerted by the thruster to open the door, the latter may be held closed quite easily

against the pressure of the thruster, without damage to either the thruster or the link mechanism. The door itself can always be operated manually if necessary.

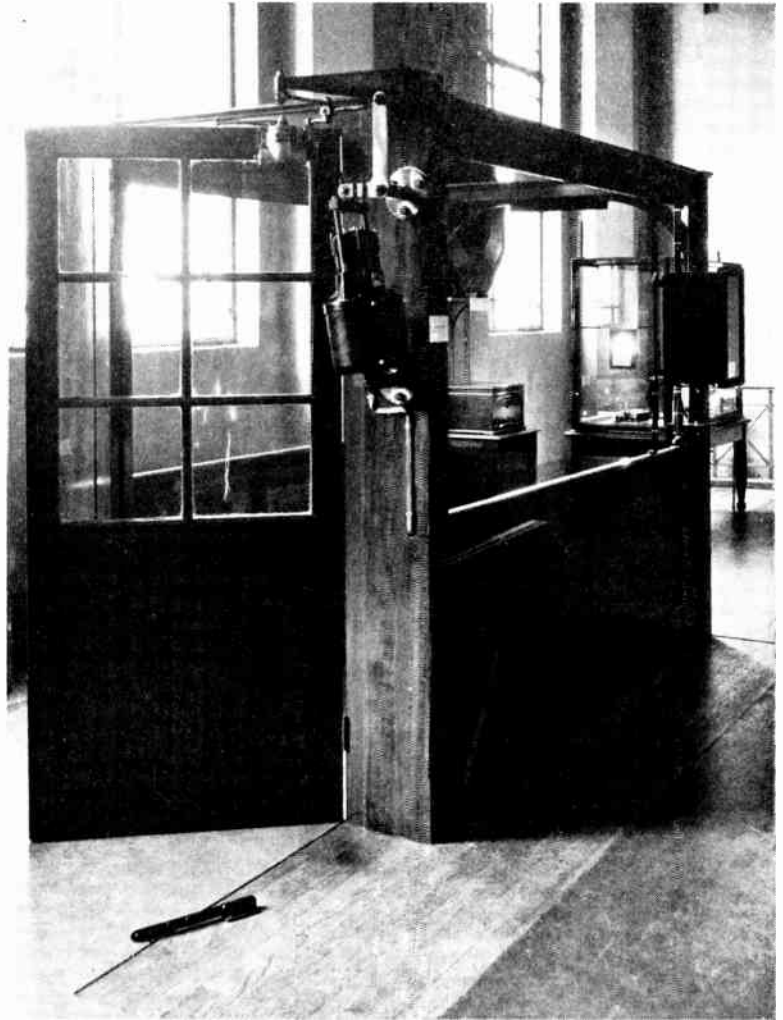

VIEW OF PHOTO-ELECTRIC DOOR-OPENING EQUIPMENT SHOWING THE B.T.H. ELECTRO-HYDRAULIC THRUSTER AND LINK MECHANISM FOR ACTUALLY OPENING THE DOOR.

On the right is the case housing the electrical control equipment.

Operating the Door from an Invisible Beam of Light.

If it is desired to operate the door from an invisible beam of light, this can easily be

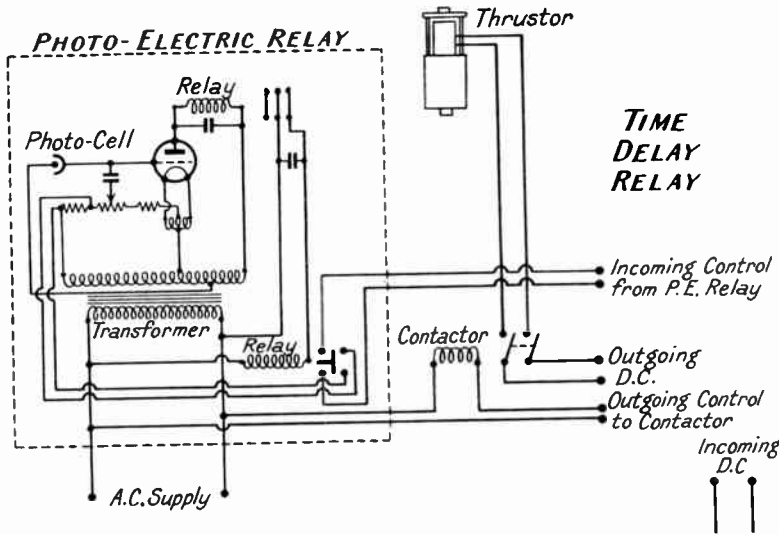

CIRCUIT DIAGRAM OF THE AUTOMATIC DOOR-OPENING DEVICE.

and contains a piston which is connected to the bolts which actuate the thruster mechanism through a cross bar and clevis.

What Happens When the Motor is Started.

When the motor is started oil is drawn through the hollow shaft from the upper part of the cylinder and forced to the underside of the piston, causing it

effected by placing an infra-red filter in front of the projector lamp lens. In this way, the beam of light cannot be seen, and the operation of the device is unaffected since the photo-electric cell is more sensitive to the infra-red rays than to the visible rays.

Load Taken.

During operation, the electrical control pillar and the projector lamp take a united load of 60 watts, and the thruster, while the door is being opened, takes a load of 140 watts.

It will be appreciated that the thruster load is intermittent, the only constant load being the 60-watt load of the control pillar and the projector lamp.

How the Thruster Operates.

The photograph on page 388 gives an external view of the thruster. Look at this for a moment and you will see that it consists of two cylindrical portions, the smaller of which is an electric motor, which drives an impeller at the base of the larger cylinder through a hollow spindle.

The larger cylinder is filled with oil

to rise steadily.

And When It Stops.

When the motor stops, the oil flows back through the impeller and hollow shaft to the upper part of the cylinder, thus allowing the piston to move downwards.

Applications of the Thruster.

It will be seen that owing to the construction of the thruster it can be applied to many different purposes where a smooth and quick thrusting action is required. At the same time, the thruster mechanism does not interfere with manual operation.

When external pressure is applied to the cross bar the oil chamber acts similar to a dashpot, i.e., it slows down but does not prevent movement.

Cost of Operating.

For a door of average weight operating 1,000 times per day, the consumption is less than 1 Board of Trade unit, which is equivalent to saying that the cost for 1,000 operations at power rate of 1d. per unit is something less than 1d. per day; this, of course, varies, depending upon the size and weight of the door.

AUTOMATIC TRAIN CONTROL

By H. GREENLY, A.I.Loco.E.

IN the majority of the reports dealing with railway collisions issued by the Ministry of Transport, the inspectors refer to the advisability of the early adoption of some form of automatic train control to prevent or minimise the damage to life and property caused by these and similar train accidents.

For many years railway engineers and operators have given much attention to the numerous devices that have been put forward either to stop the train or audibly warn the enginemen when the latter fails to pull up at an adverse signal.

Train Stops on the Underground.

On the London Underground Railways train stops, as they are called, have been in use since the lines were started, and are operated in conjunction with the electric signals. The effect of these train stops is, however, purely mechanical.

How the Mechanism Operates.

As shown in the photograph of the Westinghouse Brake and Signal Co.'s

stop, which, by the way, is a piece of apparatus made approximately 20 years ago, and which has, up to the present, made three and a half million movements

without a failure, the electrical mechanism operates an outside arm, as illustrated, in the vertical position. This arm has a transverse cylindrical knob on the top and when in this position the signal is at danger. Any train which fails to pull up in advance of this control is stopped. The arm engages the downturned handle of a cock connected to the Westinghouse airbrakesystem on the loco or motor coach and opens this cock. The release of the air applies the automatic

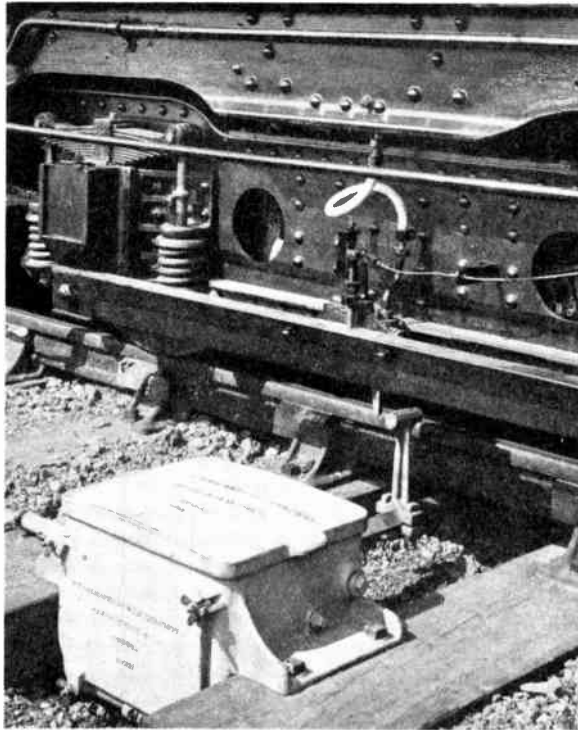

Fig. 1.—THE WESTINGHOUSE TRAIN STOP IN ACTION.

The trigger on the train is about to engage the cylindrical head of the train stop. When the signal shows "line clear" the train stop lever moves down parallel with the rails.

brake in exactly the same way as it would be put on by the accidental rupture of the train pipe or the operation of the guard's or driver's valve on the train.

Every train and every stop signal is equipped with this apparatus, and at the moderate speeds obtaining on these London suburban lines no difficulties have been encountered in the use of this simple scheme. All the rolling stock is relatively

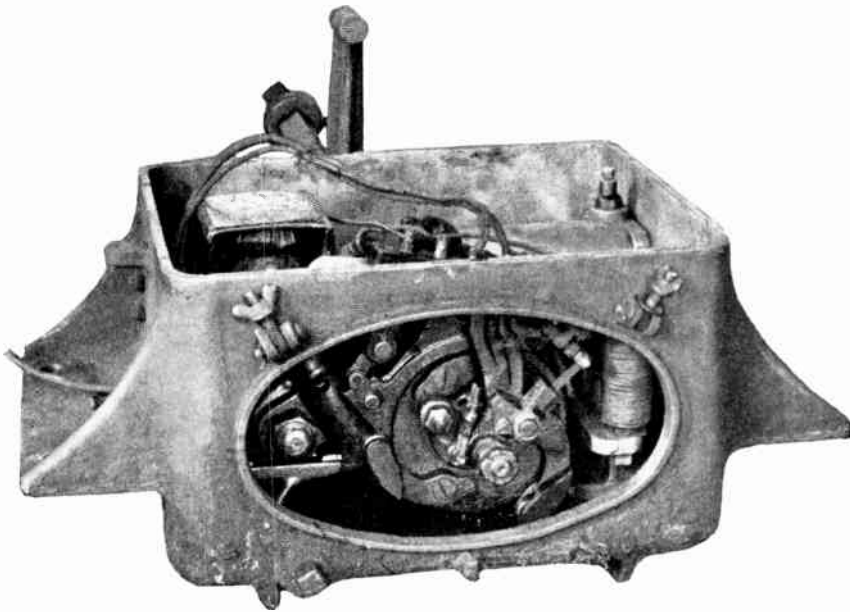

Fig. 2.—LONDON UNDERGROUND RAILWAY "METROPOLITAN" TRAIN STOP AS SUPPLIED BY THE WESTINGHOUSE COMPANY TWENTY YEARS AGO.

This electric apparatus has made approximately 3½ million movements without failure.

new and rail and vehicle clearances are rigidly standardised.

Main Trunk Lines.

On the main trunk lines speeds are very much higher and other troubles arise. However, the Government Committee appointed to consider the whole matter, with a view to a more general use of the "A.T.C.," have made out a complete case for the adoption of some well-tried system, although only six or seven accidents can be recorded in 392,000,000 train miles per annum which it was considered the employment of an automatic train control would have avoided.

THE RAMP SYSTEM.

The electrified ramp system, which has been under service condition trials on the Great Western Railway during the past 20 years, has been approved by the Committee as sufficiently reliable even under weather conditions of snow and ice. Some slight alterations in "fixed structures" and the passing out of certain more or less obsolete vehicles will, however, be required by the 4-in. clearance above the level of the rails that is necessary for the ramp scheme to make the use of this Great Western Railway system possible on all of our standard gauge railways.

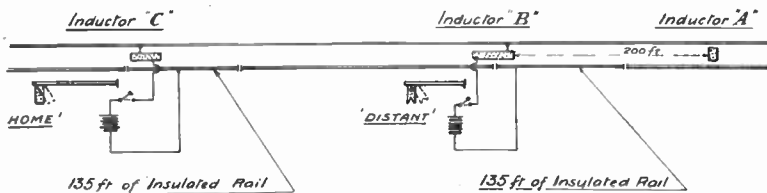

Fig. 3.—STROWGER-HUDD TRAIN CONTROL.

Diagram of track apparatus as laid down near Byfleet Southern Railway for demonstration purposes.

Southern Railway Experiments.

The Southern Railway Company are experimenting with the Strowger - Hudd control gear. This system, the apparatus for

which has been made for the American inventors by the Automatic Telephone Co. of Liverpool, is an intermittent-inductive control scheme, which depends upon the magnetic induction between the track and train elements, the latter comprising no parts operated by electrical currents or wires.

Main Line Trials.

For the main line trials near Byfleet, Surrey, the apparatus was attached to a standard home and a distant signal. For those who may not be fully conversant with the principles of railway signals, it may be mentioned that the "home" signal is an absolute stop signal and the "distant" is a signal which warns the driver of the position of the home signal which next follows. If the latter is at danger he must be prepared to stop at the "home" signal, unless he finds that it is "off" (line clear) when he gets to it.



Fig. 5.—THE LONDON ELECTRIC RAILWAY ELECTRICALLY SIGNAL-OPERATED TRAIN STOP AS SUPPLIED TO THE METROPOLITAN RAILWAY; WESTINGHOUSE PATTERN.

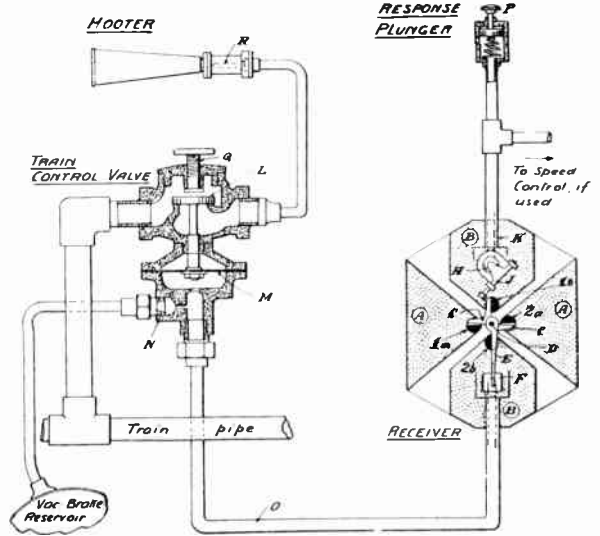

Fig. 4.—THE LOCOMOTIVE FOUR-POLE INDUCTIVE RECEIVER AND MECHANISM FOR USE WITH VACUUM BRAKE EQUIPMENT.

Essential Features of the Experimental Section.

The accompanying diagram (Fig. 3) represents the arrangement of the experimental section installed, and the essential features are the provision of three insulated sections of track with three inductors, A, B and C, and, on the locomotive or motor coach, a receiver which is influenced as the train passes over the respective inductors. The inductor A gives, in effect, a warning to the driver that he is approaching a section governed by signals and that he will soon pass a distant signal. The inductor B is placed at this signal and either continues the aforesaid warning if the distant signal is against him, or causes the warning signal to cease—thereby intimating that the signal is "off" (line clear).

The third inductor (C) is placed at or near the "home" signal. If that signal is "on" (at danger) the warning is repeated and the train pulled up. Should the signal be showing "line clear" there is no action.

The Inductor A.

The inductor A has permanent magnets fixed at right angles to the direction of travel and is constant and uninfluenced by the visual indications given to the driver by the semaphore or colour light signals. It is, therefore, always operative to influence the pole pieces of the receiver on the locomotive.

The Inductor B.

The inductor B has an electro-magnet, not a permanent one, and it is parallel with the line of the track. Normally, this magnet is de-energised when the engine enters length of track circuit shown at this inductor (the one rail of the track is common to inductors B and C, it will be noted). The local battery will be switched

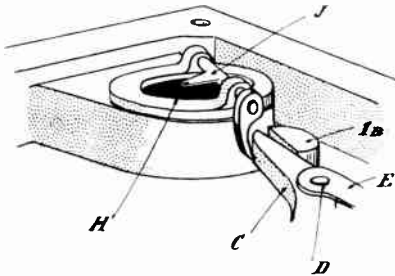

Fig. 7.—DETAIL SKETCH SHOWING THE DIAPHRAGM OPERATED BY THE ENGINE DRIVER'S RESPONSE OR ACKNOWLEDGING PLUNGER. The rocker shaft and arm resets the commutator C, bringing it back to the pole piece IB.

in, provided that the signal arm is at "line clear," and the magnet will be energised.

The Inductor C.

The inductor C is provided with both permanent and electro-magnets. The latter when energised similarly to the electro-magnet in inductor B at the distant signal, overcomes the permanent magnet and the result, as will be seen in the notes following, is the same as at the "distant."

The Receiver on the Locomotive.

The receiver on the locomotive is shown in diagram Fig. 4. It consists of four

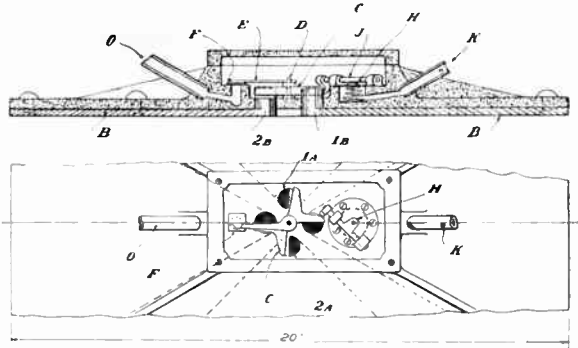

Fig. 6.—DETAILS OF INDUCTIVE RECEIVER FOR THE STROWGER-HUDD TRAIN CONTROL.

collector plates A, A, B, B, with their respective pole pieces 1A, 2A, 1B and 2B. Pivoted at D is the armature C having a spring blade E that covers the pilot valve F in the rubber hose connection O to the train control valve. The armature normally has two arms in close proximity to the pole pieces 1B and 2B and two other arms away from 1A and 2A.

The Train Control Valve.

The train control valve is fitted up above the receiver and connected to the train pipe of the automatic vacuum brake. It has a valve L which is held on its seat by the diaphragm M under normal conditions by the vacuum maintained in the vacuum reservoir of the locomotive

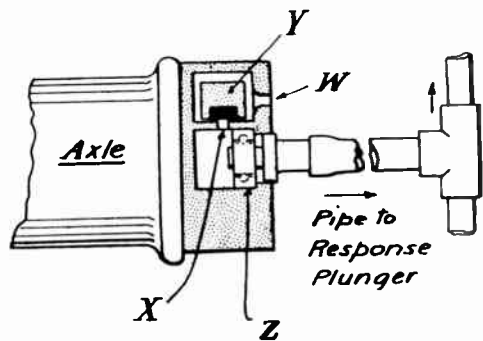

Fig. 8.—THE AXLE DRIVEN SPEED CONTROLLER WHICH CAN BE ADDED TO THE SIGNAL WARNING PART OF THE STROWGER-HUDD APPARATUS. This is useful for portions of the line where speed restrictions may be in force.

through the restricted orifice in the union connection at N. When the valve L is released, a portion of the incoming air operates the reed R of the hooter in the cab of the locomotive; the remainder enters the train pipe and makes a gradual application of the brakes.

Normal Condition of the Receiver.

Normally, the receiver is in the condition illustrated, i.e., two arms of commutator C



Fig. 10.—THE UNDERSIDE OF INDUCTOR B WITH PARALLEL-TO-TRACK ELECTRO MAGNET.

are in close proximity to the pole pieces IB and 2B. As the receiver passes over the first inductor (A) a magnetic field is thrown up so that the plates A, A are energised, the armature C is attracted to the pole pieces IA and 2A, away from IB and 2B, and the pilot valve is then opened. The area uncovered is roughly twice that of the inlet through the orifice N leading from the vacuum reservoir and thus the valve L is released.

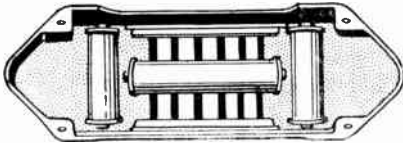

Fig. 12.—THE UNDERSIDE OF INDUCTOR C, ILLUSTRATING THE COMBINED ELECTRO MAGNETS AND TRANSVERSE PERMANENT MAGNETS.

The First Warning.

The result is a short blast by the reed (R) of the hooter in the locomotive cab and a slight reduction in the train pipe vacuum. This is of so short a duration as to scarcely affect the action of the brake: its purpose is to warn the engine driver and by the vacuum gauge it shows that the brake is working properly.

The locomotive almost immediately afterwards passes over the inductor B at the "distant" signal. If the position of the latter is at danger, the magnet is de-energised and the brakes will then be

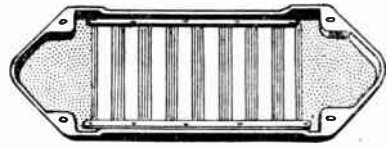

Fig. 9.—UNDERSIDE OF INDUCTOR A SHOWING TRANSVERSE PERMANENT MAGNETS.

applied and the hooter will continue to sound. Should the signal be at "line clear," the switch operated by the arm is closed. A current flows through the inductor (B) and the magnet is energised. The plates B B pick up the magnetic flux and the pole pieces 1B and 2B attract the armature. The pilot valve closes so that there is no brake application of the brake nor sounding at the hooter.

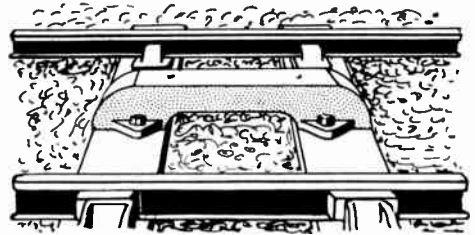

Fig. 11.—THE INDUCTOR B AS FIXED ON THE SLEEPERS.

What Happens if the "Distant" is "On."

Should the driver have been warned that the "distant" is "on" by the sounding of hooter and partial application of the brake, he will proceed cautiously to the stop signal and inductor C. If

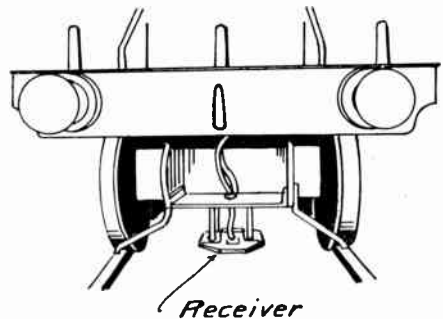

Fig. 13.—THE RECEIVER ON THE LOCOMOTIVE.

that signal is on the permanent magnets cause the 1A and 2A poles again to attract the armature and for the train control valve to be opened. In case, however, the signal indicates "line clear" the electro magnet in inductor C is energised to neutralise the permanent magnet and the pole pieces 1B and 2B hold the armature and prevent the pilot valve from opening.

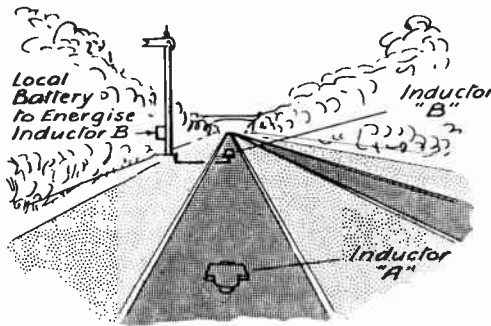

Fig. 14.—THE INDUCTORS A AND B AT A "DISTANT" SIGNAL.

Any Failure Leads to the Operation of the Train Control.

It is, therefore, evident that energy is necessary to give a "clear" signal: the absence of energy from a failure of the battery or the battery leads to the operation of the train control. This is in conformity with the strict and safe rule of railway signalling that a failure of any power or movement will lead to the danger signal being given.

The Acknowledging Plunger.

The acknowledging plunger illustrated at P in Fig. 4 is provided in the cab in order to meet the necessity for the driver to release the brake after it has been automatically applied at the "distant" so that the train may run forward to the "home," also to stop the hooter. The plunger is connected to the diaphragm H by a pipe and operates the rocker shaft and arm J so that the armature is restored to its normal position against the poles 1B, 2B. To prevent any possibility of the continuous operation of the diaphragm H, a small leak hole is provided at K. The spring resets the plunger when released by the driver.

Colour Light Signals.

With colour light signals the circuits governing the signal are connected to the

inductors, which arrangement has the merit that the inductor repeats the condition of the signal section should the signal fail. At a two-arm signal where there is an upper stop signal and a "distant" below it, an inductor of the C type would be provided, and if the control was for a stop signal the engine

man would bring his train to rest; if for a distant at the "warning," he would release himself and run forward to the "stop" signal that the distant repeated.

Locomotive Speed Controller.

The device as made includes a locomotive speed controller, which can be used for speed restrictions at curves and new works. In such cases an inductor of the A type requiring no current would be used.

This would automatically apply the brakes at any given point should the predetermined speed be exceeded and keep them applied until a lower speed is attained.

This speed controller is illustrated in the sketch Fig. 8. It is attached to an axle and runs on ball bearings. The weighted valve (V) closes outlet (X) and allows the acknowledging plunger to be used when the speed has been reduced. At higher speeds the valve (V) is kept open by centrifugal force and the operation of the plunger is of non-effect.

Track Clearance Required.

The track clearance required is 5 in. above rail level and also a clearance of 4 in. between the bottom of the receiver and the top of the inductor.

The Strowger-Hudd scheme can be applied to electrically operated trains and also for both steam and electric trains using the Westinghouse air brake.

SOME IMPORTANT A.C. MEASUREMENTS

By G. E. MOORE, A.M.I.E.E.

In this article Mr. Moore describes how some important tests can be carried out in a simple manner with apparatus of moderate cost

MOST people concerned with the practical side of engineering realise that without measurement science could not exist. Yet there is a surprising lack of appreciation of the advantages and benefits which simple tests can bring in the workaday industrial sphere. Electrical measurements can show, for example, whether existing plant and installations are efficient in terms of required horse-power, current-carrying capacity, overload possibilities, power-factor, rated and actual voltage, and so forth. Contemplated extensions and alterations can be determined with accuracy. Knowledge of general consuming conditions, and of process or departmental consumption, are important for works costing. There is special significance in tests which concern fuel input and electrical output, or the purchase of energy from an external source. The economic value of all such measurements can be of a very high order.

Scope of the Measurements.

The art of electrical measuring is a vast and, in some aspects, a very technical and difficult one. Nevertheless, there is considerable scope for engineers and others with some understanding of electrical terms and of practical conditions and who, with neither the wish, time nor apparatus to oust the legitimate testing expert, desire to increase their knowledge of the plant under their charge. It is for such as these that this article has been projected.

The details and suggestions are based upon practice. For simplicity, the conditions of national standard supply (that is 400-volt 3-phase, with 230 volts between line and an accessible neutral, and a 50-cycle periodicity) have been assumed. Direct connection of instruments in and to the line is proposed also. After experience of the tests given here one could later pass with some assurance to more elaborate methods of measurement.

Apparatus.

Needless to say, many different forms of instruments are required to measure the various electrical quantities; of these instruments there are many patterns, intended for use under various conditions; and they may be obtained from any of the several makers. It is possible to obtain really robust and accurate instruments for works use, and if one wishes for reliable results and yet funds are not lavish, it is preferable to invest in instruments one by one and thus build up a useful stock and experience at the same time.

In obtaining an instrument the purchaser should ensure that the appropriate British Standard Specification is followed by the maker, the limits of error to be for first grade in the case of indicating instruments and commercial grade for energy meters.

Points of special interest: Clear, open scales; protected means of connection; finger-tightened terminals provided with non-detachable insulated

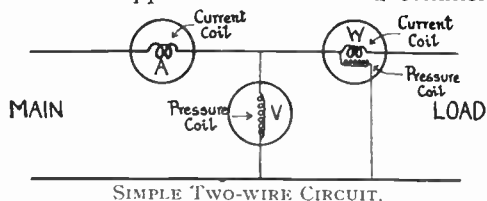

SIMPLE TWO-WIRE CIRCUIT.
Showing ammeter, voltmeter and watt-meter.

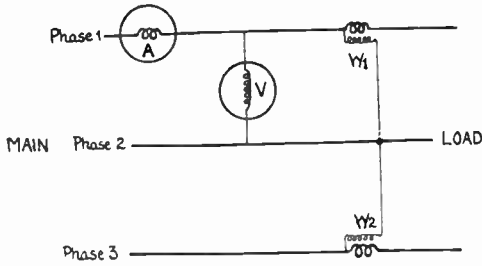

THREE-PHASE THREE-WIRE CIRCUIT.

Power = $W_1 + W_2$; or $\sqrt{3} \times V \times A \times PF$ with balanced conditions.

heads; adequate ranges to suit the work; suitable extra protection for the whole apparatus or for the glass window. There is a certain use for combination (multi-purpose) instruments, but as many tests call for simultaneous measurement of different quantities the writer does not recommend them.

Voltmeter.

Useful ranges for this are : 300 v. and 600 v. A press switch is an advantage, especially if it is of the type which, if need be, can be left "on" for the duration of the test. A range-switch is very useful as change of range can be made without connection alteration, the test being commenced with the high-range setting and this returned to when disconnecting.

Ammeter.

Several ranges are possible—more than the single range being advisable in order to obtain a good scale reading always up to large current values. 10—30—100 is one useful arrangement. Range alteration whilst current is flowing is naturally less easy for the designer to arrange.

Watt-hour Meter.

Often referred to merely as "meter," this in its commercial form is a most robust and cheap means for measuring not only energy in B.o.T. units (kilowatt hours) but also, over short or long periods of time, average power in kilowatts or watts. The usual sizes are 5, 10, 20 and 50 amperes; and 230 v. 2-wire, 400 v. 3-phase 3-wire, and 400 v. 3-phase 4-wire meters are obtainable. One's choice must

depend upon one's field of action. The meters can be relied upon from 1/20 load upwards and modern meters have overload capabilities up to double the marked load in amperes.

For lighting and similar circuits one to three 230 v. 2-wire meters are useful—the 10-amp. size covering a good range; on 4-wire conditions (3 phases and neutral) three such meters can serve more usefully than the 4-wire polyphase instrument.

On pure 3-phase circuits the 3-wire meter is advised, the 50-ampere size having a very suitable capacity. As is shown later, such a meter can also be used for the measurement of idle power and the like.

Thermal Demand Indicator.

An instrument costing roughly as much as a medium-sized single-phase meter. As usually made, the indication is in amperes and gives the maximum demand over "time-lag" periods of 15 (or more) minutes.

Various Other Instruments.

The writer has introduced the most important apparatus. Others can, however, be obtained should the need and funds permit. For example, a Power Factor Meter will indicate instantly and save calculation, but the choice of an instrument is not easy. Again, knowledge of frequency is oft-times beneficial; various types of periodicity indicators are available, but in the synchronous-motor clock, costing little more than £1, lies the means for obtaining either a long-period or short-

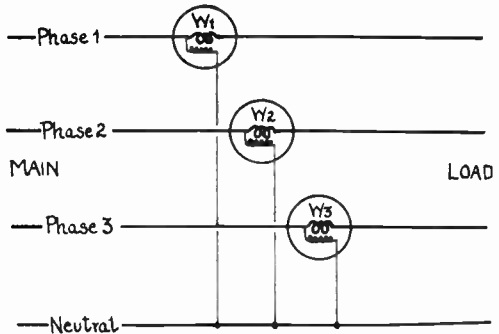

THREE-PHASE FOUR-WIRE CIRCUIT.

For balanced or unbalanced load. Power = $W_1 + W_2 + W_3$. May be treated as three two-wire circuits.

period check by comparison with a good watch or ordinary clock.

An accurate watch, having a seconds hand and preferably a stopwatch attachment also, is required for determining the time factor in many measurements. A periodic alarm has a certain value; this may be reset or restarted for the succeeding signal when responding to its call, and thus the humble alarm clock may fill the breach or an electric-bell circuit can be closed by one or more "whiskers" of telephone flex strands contacting with the hand of a clock.

Apparatus at Supply Service.

This may include indicating instruments, energy or other meters, demand-indicators, combined meters and demand-indicators, time switches for the latter or for controlling meters (for day and night rates), and so forth. The functions of these should be studied. It may be found that both total and circuit conditions are dealt with.

Certain of the tests may be carried out upon the supply-point apparatus and for many purposes the latter will serve entirely. Under no circumstances, however, must suppliers' gear be interfered with. It should be noted that, if energy is supplied and measured at high or extra-high pressure, power-transformer losses and power-factor are of special significance.

MEANS AND METHODS OF CONNECTION.

The connections for simple instruments like voltmeters are self-evident, and those for watt-hour meters are shown in diagram form on their terminal covers. Meters should preferably be mounted portably on panels or in boxes; for instance, a colliery engineer known to the writer has an elaborate outfit mounted in a box which can be placed in a coal tub and taken inbye.

As leads, both "V.I.R." and tough-rubber-sheathed cables have their respective advantages. Care should be taken to enclose all temporary leads and to place these and the instruments away from interference of *all kinds*, the electrical requirements of the Factory Acts being

followed where these apply; particularly should bare cable ends be disposed within the terminals, and all live parts under cover—the latter preferably of a non-conducting nature.

Circuits can be opened up at appropriate points for insertion of gear, e.g., at switch-fuses, D.B.'s, motor terminal boxes, inspection elbows and the like. When conduit continuity is broken temporary bonding across should not be neglected. All gear should be suitably sealed or locked.

USING THE APPARATUS.

A great advantage of mounting instruments upon a support is that means can be effectively provided for protecting them electrically. For instance, current circuits

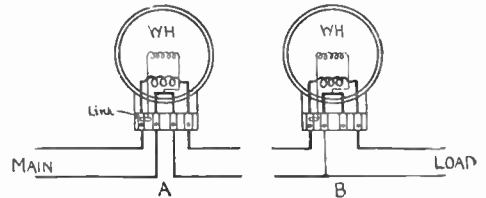

SINGLE-PHASE (TWO-WIRE) METER CONNECTIONS.
A and B are alternative methods.

can be shunted by a switch, thus enabling one to avoid overload effects due to starting-up of motors and so forth; again, H.O. cut-outs with 1-amp. (or less) fuses can protect pressure circuits and by their fuse-bridges act as test links for certain purposes (as shown in one of the diagrams).

It is assumed that instruments are in order, but one should seize all opportunities for cross-checking and otherwise watching their reliability. The maker's directions should be borne in mind—manufacturers invariably being most ready to advise. Stray field effects must be guarded against. The zero ought to be examined repeatedly, and watt-hour meters should not creep on pressure only. Good response should, if possible, be obtained. Care must be given to avoiding mistakes due to observation, to the method and to the tester.

Checking by repeat tests, by another observer's opinion, and by alternative methods, are all to the good. On variable

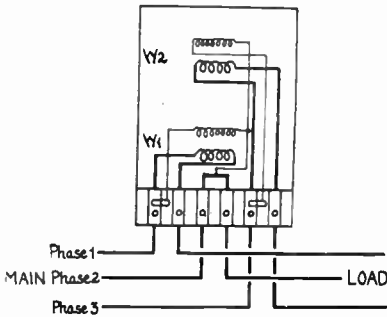

THREE-PHASE THREE-WIRE METER CONNECTIONS.
Phase 2 need not necessarily pass to and from meter, but a connection is required. Phases "come up" 1-2-3. Phase 1 element (W_1) slower than Phase 3 element (W_2) on motor load.

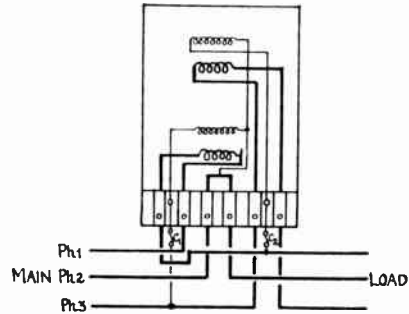

THREE-PHASE THREE-WIRE REACTIVE METER CONNECTIONS.

Note the pressure links removed and cut-outs C_1 C_2 used. Correct phase sequence is vital (i.e., as energy meter, phase 1 element the slower on motorload). Special constant of $\times 0.866$.

loads mean readings of indicating instruments may be necessary ; here one must not be misled by the fluctuations but take deliberate snap readings at definite intervals and note them for averaging purposes later. In coming to decisions results must be carefully assessed in the light of the installation conditions as well as the capabilities of the test gear and methods.

TESTS.

Reference may first be made to the simple tests for voltage, amperage and frequency, but only to emphasise that, simple though these tests are, it is surprising how significant they can be. Over-voltage is not so common as under-voltage, but harm and inefficiency follow both. Excessive current with regard to capacity, and especially as related to low power-factor, is another condition of moment, though one also encounters instances where uneconomic effects obtain through low amperages. The following measurements, though presented in simple form, are concerned with important quantities.

Energy.

There is no need to dwell upon the importance of measuring electrical consumption. It is undertaken by the watt-hour meter, which announces the consumption in kilowatt-hours (kWh., B.o.T. units) by means of a register. Some care and practice are required to read the dials, and, in cases of doubt, a sketch should be

made of the pointer positions. For short runs even the test dials (showing part-units) can be taken, the reading extending to one-tenth of the last division. Dial constants should be carefully applied.

Power.

The watt-hour meter can also be used to measure wattage, i.e., act as a form of watt-meter. Over a long period the average kW. can obviously be found by dividing the registered energy by the time in hours. Over a short period the disc revolutions may be timed in seconds ; a constant for kW.-secs. per rev. is derived from 3,600 divided by the nameplate figure for meter-disc revolutions per unit ; the average kW. for the short period being given by (Constant times Revs.)/Time in secs., i.e., kW.-secs. divided by secs.

Power Factor.

(A) In a 2-wire circuit the conditions for P.F. measurement are simple. During the test period the wattage (W) can be found by the power test, and the apparent power by the average volt-amps (V.A), the P.F. being therefore W/VA . Usually it is more or less lagging, mainly owing to motors, the poorest value being given when the latter are running light.

(B) In a 3-phase 3-wire circuit, conditions are more involved. Balance of pressure, current and phase power-factor can be assumed, when, after measuring the across-phases voltage (V), the line

KK

current (A) and the energy meter wattage (W), the P.F. is given by $W/1.732 VA$.

Again, with the same assumption of balance and also of steady load, the behaviour of each of the polyphase meter's two elements affords a criterion; by opening in turn the terminal-block pressure links (or cut-outs if these have wisely been added), the speed of each element may be taken and the P.F. found by reference to the curves shown on the right. Note that with lagging P.F. the element connected to the "slower" of the two meter currents is the slower, and that below 0.5 value it runs backwards. (This is hence a check on phase rotation.)

Utilising a Second Polyphase Meter.

Finally, by utilising a second similar polyphase meter but connecting it as shown the reactive (or idle) power can at the same time be measured by watt-hour-meter tests. With a special correction of times 0.866, the register now gives reactive *kVAh*, and the disc reactive *kVA*—the apparatus becoming a "sine meter." Those familiar with "trig." tables can readily find the phase angle, and thus the P.F. (i.e., cosine), from the tangent value given by the idle (or sine) value divided by the useful (or cosine) value of power or energy over the same period.

Maximum Demand.

This important factor in electricity tariffs is usually determined by the supply authority taking the average kW. over a time period. Thus in a commonly adopted method, a mechanism attached to an energy meter indicates the biggest advance made over a time period; for example, with an hourly period the advance in kWh. is obviously the average kW. also, while over a half-hour the average kW. would be twice the kWh.

By taking a periodic reading of an ordinary energy meter this method can be simply applied over (say) a day, or for those times during each day when peak conditions exist. Should a reactive meter also be used, simultaneous readings and advances will allow the average P.F. also to be determined; and from the values of kW. and P.F. the kVA. figure is readily obtained.

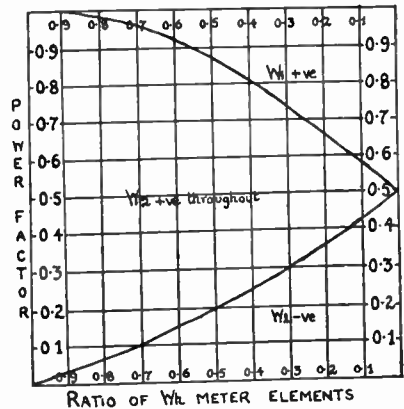

CURVE FOR DETERMINING POWER FACTOR AFTER THE SPEED OF EACH ELEMENT HAS BEEN TAKEN.

With lagging P.F. and W_1 the slower: (a) W_1/W_2 (for watts); (b) W_2/W_1 (for time per rev.).

The maximum demand merely in amperes can be found by the use of a thermal demand-indicator, resetting to zero each day, or as required, whilst the load is off; such D.I. is more sensitive to peaky conditions than the kW. form just mentioned, and it is scaled in terms of a steady load applied for its time-lag period.

Load Factor and Load Curves.

Load factor (relation of average kW. to max. kW.) and the load curve (load conditions throughout working day or other period) can be found by preceding tests.

Motor H.P. and Efficiency.

These important figures can be given by measuring the power, and with this knowledge and the maker's chart the developed horse-power and efficiency may be found. If the P.F. is measured there is this check against the maker's particulars, while, of course, means may exist (e.g., as by brake test) of finding the mechanical output also.

How a Greater Range of Loads Can be Dealt With.

A greater range of loads can be dealt with by the use of current transformers, the "clip-on" form being especially useful when the circuit must not be opened.

CALCULATING THE VOLTAGE DISTRIBUTION OVER A 10-UNIT SUSPENSION INSULATOR

AN ORIGINAL INVESTIGATION BY A. T. DOVER, M.I.E.E.

Transmission engineers will find the following investigation of great interest and practical utility. We feel sure that electrical engineers who are not specialists in this branch will also be interested to see the intricate calculations involved in the design of the suspension insulators which are now being used in connection with the grid transmission lines. The investigation was made at the request of a member of our Technical Advice Register who experienced difficulty in calculating the voltage distribution over a string of suspension insulators, and in reconciling the algebraic and hyperbolic formulæ. The constants for which the calculations are made, are those suggested by our reader.

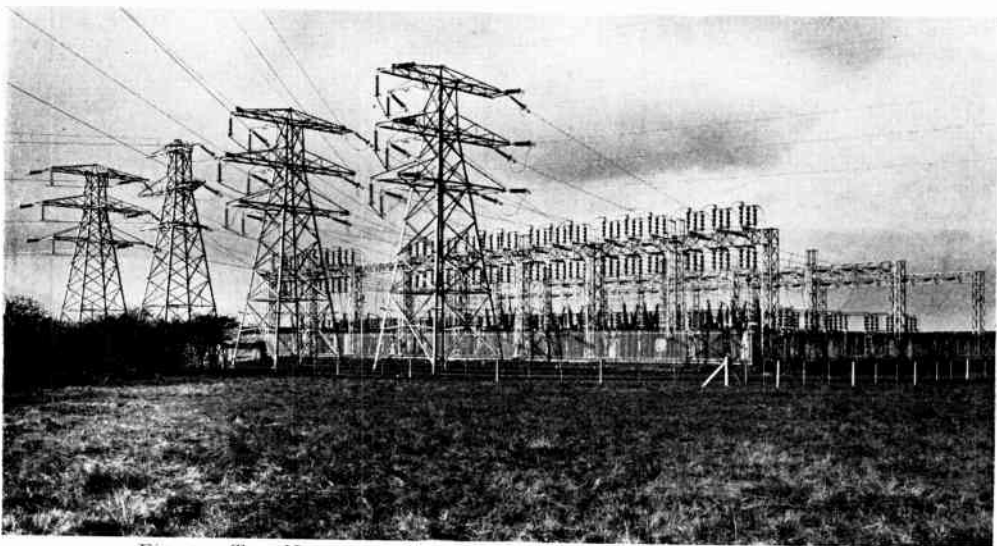

Fig. 1.—THE NORTON-ON-TEES 132,000-VOLT TRANSFORMING STATION.

All over the country may be seen the pylons of the grid where suspension insulators are used for supporting high-voltage transmission lines. To calculate the correct dimensions of these insulators is an important part of the work of the transmission engineer. The following investigation shows the complexity of the problems involved.

THE following investigation is intended to show practical methods of using the two alternative formulæ which apply for finding the voltage distribution over insulators of the type shown.

The first formula is known as Peek's formula :—

$$e_1 = \frac{E}{k} \left(\frac{C_n}{C_1} - 1 \right)$$

$$e_2 = e_1 - \frac{E}{k} - e_1 \text{ where}$$

- E = Total voltage.
- e_1 = Voltage across first unit.
- e_2 = Voltage across second unit.
- C_n = Capacity of string.
- C_1 = Capacity of one unit to earth.
- C_2 = Mutual capacity of each unit.
- $k = C_2/C_1$.

The hyperbolic form is :—

$$E_m = \frac{E \sinh [(n - m)/\sqrt{k}]}{\sinh (n/\sqrt{k})}$$

which gives the voltage at the m th insulator of the string.

It will be shown later that each of the above formulæ gives the same result, although the methods of calculation in each case are widely different.

We will first show the methods of calculation when (1) algebraic and (2) hyperbolic functions are used.

Algebraic Method of Calculating the Voltage Distribution Over a String of Insulators.

This method is based upon most elementary principles, viz.: (1) that the string of insulators is equivalent to a group of condensers, series and shunt connected, as in Fig. 2; (2) that the relationship between the voltage across a

(Note.— C_n is calculated in terms of C_1 and C_2 as shown later.)

Hence the charging current of the first insulator (No. 1) = $I - I_1$. Whence the voltage, V_1 , across this insulator is obtained from:—

$$V_1 = \frac{I - I_1}{\omega C_2} = \frac{\omega E_1 (C_n - C_1)}{\omega C_2}$$

$$= \frac{E_1}{k} \left(\frac{C_n}{C_1} - 1 \right) \dots \dots \dots (1)$$

where $k = C_2/C_1$.

The charging current of the second insulator (No. 2) = $I - I_1 - I_2$

$$= \omega E_1 (C_n - C_1) - \omega E_2 C_1$$

$$= \omega E_1 (C_n - C_1) - \omega C_1 (E_1 - V_1)$$

$$= \omega E_1 (C_n - C_1) - \omega C_1 \left[E_1 - \frac{E_1}{k} \left(\frac{C_n}{C_1} - 1 \right) \right]$$

Whence the voltage, V_2 , across this insulator is obtained by dividing the charging current by ωC_2 , i.e. :—

$$V_2 = \frac{I - I_1 - I_2}{\omega C_2} = \frac{\omega E_1 (C_n - C_1) - \omega E_1 (C_1 - (C_n - C_1)/k)}{\omega C_2}$$

$$= E_1 \left(\frac{C_n - C_1}{C_2} \right) - E_1 \left(\frac{C_1}{C_2} - \frac{C_n - C_1}{k C_2} \right)$$

$$= \frac{E_1}{k} \left(\frac{C_n}{C_1} - 1 \right) - E_1 \left(\frac{1}{k} - \frac{1}{k^2} \left(\frac{C_n}{C_1} - 1 \right) \right)$$

$$= \frac{E_1}{k} \left(\frac{C_n}{C_1} - 1 \right) - \frac{1}{k} \left(E_1 - \frac{E_1}{k} \left(\frac{C_n}{C_1} - 1 \right) \right)$$

$$= V_1 - \frac{E_1 - V_1}{k} \dots \dots \dots (2)$$

Similarly for the third insulator we should obtain :—

$$V_3 = V_2 - \frac{E_1 - (V_1 + V_2)}{k} \dots \dots \dots (3)$$

and, in general, for the m th insulator :—

$$V_m = V_{m-1} - \frac{E_1 - (V_1 + V_2 + \dots + V_{m-1})}{k} \dots \dots \dots (4)$$

Hyperbolic Method of Calculating the Voltage Distribution Over a String of Insulators.

In this case we assume that the string is so long that the series (mutual) and shunt (ground) capacitances are uniformly distributed over the whole length of the string, as represented in Fig. 3. Thus *per unit length of string* the series capacitance is C_2 , the shunt capacitance is C_1 , the reactance is $X = 1/\omega C_2$, and the susceptance is $B = \omega C_1$. NOTE.—As we

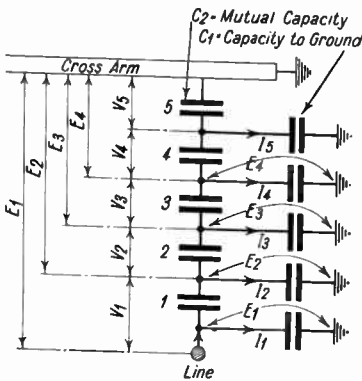

Fig. 2.—THE EQUIVALENT ELECTRICAL CIRCUIT OF A STRING OF SUSPENSION INSULATORS CONSISTS OF A NUMBER OF CONDENSERS, SERIES AND SHUNT CONNECTED.

condenser and the charging current is $I = \omega C E$, where I is the charging current, E the voltage across the condenser (the capacitance of which is C farads) and $\omega = 2 \pi \times$ frequency.

Thus, if, as represented in Fig. 1, C_1 denotes the capacity to earth, and C_2 the mutual capacity of each unit of the string, the charging currents I_1, I_2, \dots flowing to earth at each insulator are directly proportional to the voltages E_1, E_2, \dots across the condensers C_1 ; i.e., $I_1 = \omega C_1 E_1, I_2 = \omega C_1 E_2, \dots$

The total charging current I of the group is given by $I = \omega C_n E_1$, where C_n is the total capacitance of the string and E_1 the voltage between line and earth.

are dealing only with capacitances we need not use the vector notation, so that reactance and susceptance may be expressed in their algebraic forms.

At any point, *P*, Fig. 3, distant *l* from the cross-arm end of the string, let the voltage to earth be *E* and the series charging current be *I*. Then over an elemental length *dl* at *P* we have

$$\text{voltage drop} = dE = I X dl = I \left(\frac{1}{\omega C_2} \right) dl;$$

loss of current = *dI* = *E B dl* = *E* (ωC_1) *dl*. Hence at the point *P* the rate of change of voltage is:—

$$\frac{dE}{dl} = I \left(\frac{1}{\omega C_2} \right) \dots\dots\dots(5)$$

and the rate of change of current is:—

$$\frac{dI}{dl} = E (\omega C_1) \dots\dots\dots(6)$$

These, then, are the fundamental differential equations for the insulator string from which we have to obtain an expression for *E*.

The first step is to eliminate *I* from (5). This is effected by differentiating (5) and substituting for *dI/dl* from (6). Thus:—

$$\frac{d^2 E}{dl^2} = E (\omega C_1) \left(\frac{1}{\omega C_2} \right) = \frac{1}{k} E$$

where $k = C_2/C_1$.

The general solution of this equation is:—

$$E = A_1 \epsilon^{l/\sqrt{k}} + A_2 \epsilon^{-l/\sqrt{k}} \dots\dots\dots(7)$$

where *A*₁ *A*₂ are constants and ϵ is the base of Napierian logarithms.

The constants are determined by the terminal condition that at the cross-arm end of the string *l* = 0 and *E* = 0. Hence substituting these values in (7) we have *A*₁ + *A*₂ = 0.

Another equation connecting *A*₁ and *A*₂ is obtained by differentiating (7) with respect to *l* and substituting the result in place of the left-hand side (*dE/dl*) of (5). Thus from (7):—

$$\frac{dE}{dl} = \frac{1}{\sqrt{k}} A_1 \epsilon^{l/\sqrt{k}} - \frac{1}{\sqrt{k}} A_2 \epsilon^{-l/\sqrt{k}}$$

Substituting in (5), and evaluating for the condition *l* = 0, we have, on rearranging

$$A_1 - A_2 = I_e \frac{\sqrt{k}}{\omega C_2}$$

where *I*_e is the current at the cross-arm end of the string.

Hence, since *A*₁ + *A*₂ = 0, we have:—

$$A_1 = \frac{1}{2} I_e \left(\frac{\sqrt{k}}{\omega C_2} \right)$$

$$A_2 = -\frac{1}{2} I_e \left(\frac{\sqrt{k}}{\omega C_2} \right)$$

Substituting these values in (7):—

$$E = I_e \left(\frac{\sqrt{k}}{\omega C_2} \right) \left(\frac{\epsilon^{l/\sqrt{k}} - \epsilon^{-l/\sqrt{k}}}{2} \right) \\ = I_e \left(\frac{\sqrt{k}}{\omega C_2} \right) \sinh l/\sqrt{k} \dots\dots\dots(8)$$

since $\sinh x = (\epsilon^x - \epsilon^{-x})/2$.

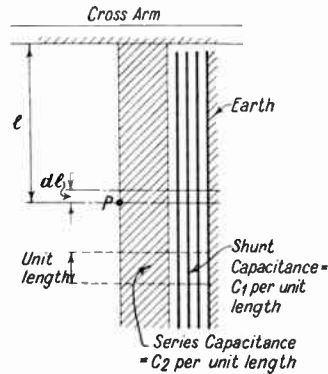

Fig. 3.—IN THE HYPERBOLIC METHOD OF CALCULATION THE CONDENSERS IN FIG. 2 ARE ASSUMED TO BE CONTINUOUS, THE CAPACITANCES BEING UNIFORMLY DISTRIBUTED AS REPRESENTED BY THE CROSS HATCHING AND VERTICAL LINES.

Equation (8) gives the voltage to earth at a point *l* in the string measured from the cross-arm.

If the total length of the string is *L*, then the voltage at the line end is:—

$$E_1 = I_e \left(\frac{\sqrt{k}}{\omega C_2} \right) \sinh L/\sqrt{k} \dots\dots\dots(9)$$

Whence:—

$$\frac{E}{E_1} = \frac{\sinh l/\sqrt{k}}{\sinh L/\sqrt{k}} \dots\dots\dots(10)$$

Interpreting these equations for the case of a string of *n* insulators, in which the insulators are numbered from the line end, as in Fig. 2, we note that *L* = *n*, and that *l* = *n* - *m*, where *m* is any

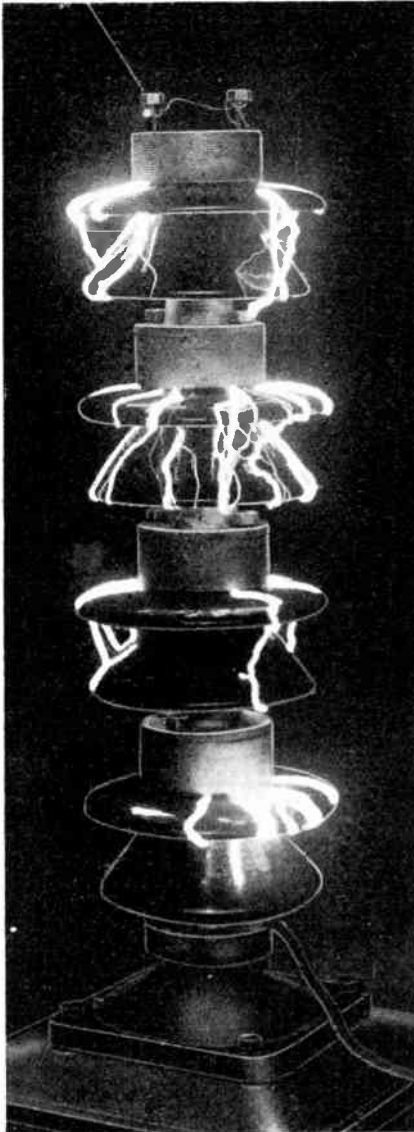

Fig. 4.—A FLASH-OVER TEST ON A BUILT UP INSULATOR IN THE RESEARCH LABORATORIES OF THE GENERAL ELECTRIC CO.

particular insulator. Equation (10) may therefore be rewritten in the form :—

$$E_{m+1} = E_1 \frac{\sinh (n-m) / \sqrt{k}}{\sinh n / \sqrt{k}} \dots \dots \dots (11)$$

where E_{m+1} is the voltage to earth at the cross-arm end of the m th insulator, and E_1 is the line voltage. Since E_{m-1} and

E_1 are in phase with each other we do not have to treat them as vector quantities, and therefore the calculations are very simple when tables of hyperbolic functions are available.

The voltage across the m th insulator is given by :—

$$V_m = E_{m-1} - E_m \\ = E_1 \left(\frac{\sinh (n-m-1) / \sqrt{k} - \sinh (n-m) / \sqrt{k}}{\sinh n / \sqrt{k}} \right) \dots \dots \dots (12)$$

Method of Calculating the Total Capacitance of a String of n Insulators.

The method is quite simple and involves only the application of the two rules for determining the joint capacitances of condensers connected in series and parallel. Thus for the parallel connection the joint capacitance is the sum of the individual capacitances ; for the series connection the reciprocal of the joint capacitance is the sum of the reciprocals of the individual capacitances.

Thus for a string of two insulators (e.g., Nos. 4 and 5, Fig. 2) the total capacitance is made up of the capacitance C_1 of No. 4 in parallel with the joint capacitance due to C_2 of No. 4 in series with the parallel-connected capacitances C_1, C_2 , of No. 5.

Thus the total capacitance of the two units is :—

$$C_{2 \text{ units}} = C_1 + \frac{1}{\frac{1}{C_2} + \frac{1}{C_1 + C_2}} \\ = C_1 + \frac{C_1 C_2 + C_2^2}{C_1 + 2C_2} \\ = C_1 + \frac{C_1 C_2 + C_2^2 + C_2^2 - C_2^2}{C_1 + 2C_2} \\ = C_1 + \frac{C_2 (C_1 + 2C_2) - C_2^2}{C_1 + 2C_2} \\ = C_1 + C_2 - \frac{C_2^2}{C_1 + 2C_2} \dots \dots \dots (13)$$

Similarly, for a string of three insulators :—

$$C_3 = C_1 + \frac{1}{\frac{1}{C_2} + \frac{1}{C_2 \text{ units}}} \\ = C_1 + \frac{1}{\frac{1}{C_2} + \frac{1}{C_1 + \frac{1}{\frac{1}{C_2} + \frac{1}{C_1 + C_2}}}}$$

$$\begin{aligned}
 &= C_1 + \frac{1}{\frac{1}{C_2} + \frac{1}{C_1 + C_2 - \frac{C_2^2}{C_1 + 2C_2}}} \\
 &= C_1 + C_2 - \frac{C_2^2}{C_1 + 2C_2 - \frac{C_2^2}{C_1 + 2C_2}} \quad (14)
 \end{aligned}$$

If we substitute a for $(C_1 + C_2)$ and b for $(C_1 + 2C_2)$, the total capacitance of a string of n insulators is given by:—

$$C_n = a - \frac{C_2^2}{b - \frac{C_2^2}{b - \frac{C_2^2}{b - \frac{C_2^2}{b - \frac{C_2^2}{b}}}}} \quad \text{to } (n - 1) \text{ terms.} \quad (15)$$

in which the term C_2^2/b occurs $(n - 1)$ times.

Numerical Calculations for a 10-unit Suspension Insulator, $k = 10$.

(1) *Calculation of the voltage distribution using the hyperbolic method.*

The voltage to earth at the cross-arm end of the m th insulator is calculated from formula (11). Thus:—

$$E_{m+1} = E_1 \frac{\sinh(n-m)/\sqrt{k}}{\sinh n/\sqrt{k}}$$

The denominator can be evaluated straightaway:—

Thus $n/\sqrt{k} = 10/\sqrt{10} = 3.162$. $\sinh 3.162 = 11.77$.

For the 1st insulator ($m = 1$), $\sinh 9/\sqrt{10} = \sinh 2.845 = 8.5717$. Whence $E_2 = E_1 (8.5717/11.77) = 0.729 E_1$. Voltage across 1st insulator = $V_1 = E_1 - E_2 = E_1 (1 - 0.729) = 0.271 E_1$.

$$C_n = 11C_1 - \frac{100C_1^2}{21C_1 - 100C_1^2} - \frac{100C_1^2}{21C_1 - \frac{100C_1^2}{21C_1 - 100C_1^2}} - \frac{100C_1^2}{21C_1 - \frac{100C_1^2}{21C_1 - \frac{100C_1^2}{21C_1 - 100C_1^2}}} - \frac{100C_1^2}{21C_1 - \frac{100C_1^2}{21C_1 - \frac{100C_1^2}{21C_1 - \frac{100C_1^2}{21C_1 - 100C_1^2}}} - \frac{100C_1^2}{21C_1 - \frac{100C_1^2}{21C_1 - \frac{100C_1^2}{21C_1 - \frac{100C_1^2}{21C_1 - 100C_1^2}}} - \frac{100C_1^2}{21C_1 - \frac{100C_1^2}{21C_1 - \frac{100C_1^2}{21C_1 - \frac{100C_1^2}{21C_1 - 100C_1^2}}} - \frac{100C_1^2}{21C_1 - \frac{100C_1^2}{21C_1 - \frac{100C_1^2}{21C_1 - \frac{100C_1^2}{21C_1 - 100C_1^2}}} - \frac{100C_1^2}{21C_1 - \frac{100C_1^2}{21C_1 - \frac{100C_1^2}{21C_1 - \frac{100C_1^2}{21C_1 - 100C_1^2}}} - \frac{100C_1^2}{21C_1 - \frac{100C_1^2}{21C_1 - \frac{100C_1^2}{21C_1 - \frac{100C_1^2}{21C_1 - 100C_1^2}}}$$

For the 2nd insulator, $\sinh 8/\sqrt{10} = \sinh 2.53 = 6.237$. $E_3 = E_1 (6.237/11.77) = 0.531 E_1$. $\therefore V_2 = E_2 - E_3 = E_1 (0.729 - 0.531) = 0.198 E_1$.

For the 3rd insulator, $\sinh 7/\sqrt{10} = \sinh 2.21 = 4.555$. $E_4 = E_1 (4.555/11.77) = 0.3865 E_1$. $\therefore V_3 = E_1 (0.531 - 0.3865) = 0.1445 E_1$.

For the 4th insulator, $\sinh 6/\sqrt{10} = \sinh 1.897 = 3.258$. $E_5 = E_1 (3.258/11.77) = 0.277 E_1$. $\therefore V_4 = E_1 (0.3865 - 0.277) = 0.1095 E_1$.

For the 5th insulator, $\sinh 5/\sqrt{10} = \sinh 1.58 = 2.3245$. $E_6 = E_1 (2.3245/11.77) = 0.1975 E_1$. $\therefore V_5 = 0.0795 E_1$.

For the 6th insulator, $\sinh 4/\sqrt{10} = \sinh 1.265 = 1.63$. $E_7 = E_1 (1.63/11.77) = 0.1385 E_1$. $\therefore V_6 = 0.059 E_1$.

For the 7th insulator, $\sinh 3/\sqrt{10} = \sinh 0.948 = 1.0965$. $E_8 = E_1 (1.0965/11.77) = 0.0931 E_1$. $\therefore V_7 = 0.0454 E_1$.

For the 8th insulator, $\sinh 2/\sqrt{10} = \sinh 0.632 = 0.6749$. $E_9 = E_1 (0.6749/11.77) = 0.0574 E_1$. $\therefore V_8 = 0.0357 E_1$.

For the 9th insulator, $\sinh 1/\sqrt{10} = \sinh 0.316 = 0.3213$. $E_{10} = E_1 (0.3213/11.77) = 0.0273 E_1$. $\therefore V_9 = 0.0301 E_1$.

$$\therefore V_{10} = E_{10} = 0.0273 E_1$$

As a check on the calculation we total up the voltage drops, and we find that the result is exactly $1.0000 E_1$.

(2) *Calculation of the total capacitance of the string (10 units, $k = 10$).*

NOTE.—The total capacitance of the string is required before the calculations of the voltage distribution can be made by the algebraic method.

The calculation is made by substituting in formula (15), there being nine (C_2^2/b) terms.

In the present case $k = C_2/C_1 = 10$, i.e., $C_2 = 10C_1$. Hence $a = C_1 + C_2 = 11C_1$; $b = C_1 + 2C_2 = 21C_1$; $C_2^2 = 100C_1^2$.

Thus the total capacitance is given by:—

This is evaluated by starting with the last term, i.e., $100C_1^2/2IC_1$, and proceeding step by step upwards. Thus $100C_1^2/2IC_1 = 4.76C_1$. Subtract this from $2IC_1$ and divide the result into $100C_1^2$. This result ($6.16C_1$) is subtracted from $2IC_1$ and divided into $100C_1^2$, giving $6.74C_1$. Repeating this process successively we obtain the quantities $7.01C_1$, $7.15C_1$, $7.22C_1$, $7.26C_1$, $7.28C_1$, $7.29C_1$. The last result is subtracted from $1IC_1$, giving $C_n = 3.71C_1$.

(3) *Calculation of the voltage distribution using the algebraic method.*

The voltage drop across each insulator is calculated by means of formulæ (1), (2), (3), etc. —

Thus, for insulator No. 1,

$$V_1 = \frac{E_1}{k} \left(\frac{C_n}{C_1} - 1 \right) = E_1 \left(\frac{3.71 - 1}{10} \right) = 0.271E_1.$$

For insulator No. 2,

$$V_2 = V_1 - \frac{E_1 - V_1}{k} = E_1 \left(0.271 - \frac{1 - 0.271}{10} \right) = 0.1981E_1.$$

For insulator No. 3,

$$V_3 = V_2 - \frac{E_1 - (V_1 + V_2)}{k} = E_1 \left(0.198 - \frac{1 - (0.271 + 0.198)}{10} \right) = 0.145E_1.$$

For insulator No. 4,

$$V_4 = V_3 - \frac{E_1 - (V_1 + V_2 + V_3)}{k} = E_1 \left(0.145 - \frac{1 - (0.271 + 0.198 + 0.145)}{10} \right) = 0.1064E_1.$$

For insulator No. 5,

$$V_5 = V_4 - \frac{E_1 - (V_1 + V_2 + V_3 + V_4)}{k} = E_1 (0.1064 - 0.02796) = 0.0785E_1.$$

For insulator No. 6,

$$V_6 = V_5 - \frac{E_1 - (V_1 + V_2 + V_3 + V_4 + V_5)}{k} = E_1 (0.0785 - 0.02012) = 0.0584E_1.$$

For insulator No. 7,

$$V_7 = V_6 - \frac{E_1 - (V_1 + V_2 + V_3 + V_4 + V_5 + V_6)}{k} = E_1 (0.0584 - 0.01429) = 0.0441E_1.$$

For insulator No. 8,

$$V_8 = V_7 - \frac{E_1 - (V_1 + V_2 + V_3 + V_4 + V_5 + V_6 + V_7)}{k} = E_1 (0.0441 - 0.00986) = 0.0342E_1.$$

For insulator No. 9,

$$V_9 = V_8 - \frac{E_1 - (V_1 + V_2 + V_3 + V_4 + V_5 + V_6 + V_7 + V_8)}{k} = E_1 (0.0342 - 0.00644) = 0.0278E_1.$$

For insulator No. 10,

$$V_{10} = V_9 - \frac{E_1 - (V_1 + V_2 + V_3 + V_4 + V_5 + V_6 + V_7 + V_8 + V_9)}{k} = E_1 (0.0278 - 0.00366) = 0.0242E_1.$$

Totalling up the voltage drops we find that the result is $0.9877E_1$, indicating that the value ($3.71C_1$) of the total capacitance, C_n , which was calculated with the aid of a slide rule, is not quite correct.

We observe that an error in the calculation of one voltage will upset the whole of the succeeding calculations. On the other hand, with the hyperbolic method each voltage is calculated independently, and, in consequence, any errors are not cumulative.

The whole of the calculations for both the hyperbolic and algebraic methods have been made with the aid of a 20-in. slide rule of the ordinary straight type.

THE EDDY CURRENT BRAKE

By H. GREENLY, A.I.Loco.E.

This device, used in railway wagon gravity shunting for goods sorting sidings, provides an efficient method of retarding wagons as they are allowed to run free from the "hump"



Fig. 1.—THE CONTROLLER AT WORK AT MARCH L.N.E.R. GRAVITY SIDINGS.

From this board all the points and crossings, as well as the eddy current brake and shunting signals, are operated. On the ground the shunters simply have to release the wagons one by one and the engine-man to push the train to be sorted to the top of the "hump." A second panel in the same cabin, and in charge of another operator, controls the eddy current rail brake.

GRAVITY shunting for goods sorting sidings has been in use for many years, and our great railways have at all times felt the need for an efficient method of retarding wagons as they are allowed to run free from the "hump" formed in the track at the bottle-neck which leads into the various sidings.

Mechanical rail-retarders have been devised—some operated by electricity, others by pneumatic or hydraulic power, in each case the braking force being applied to the tyres of the wagon and the retardation effects being dependent on

the magnitude of this force. The trouble with frictional brakes is that there is always the danger of a wagon running at high speed lifting itself over the top of the brake rails.

Principle of the Eddy Current Brake.

The latest development is the Eddy Current Brake, the operation of which is all electric, and its retarding action is electro-magnetic. The principle involved is by no means new, and it has been successfully employed in several other spheres, in railway signalling and other

apparatus. One of its best known applications is for the retard of the pick-up or drop-way movement of A.C. slow release and time element relays.

History of the Magnetic Brake.

The braking effect produced by eddy currents set up in a metal disc rotating in a magnetic field is a feature that has been known for a considerable time

but the possibility of utilising this effect for the purpose of braking railway wagons—the wheel takes the place of the metal disc—was first realised by Drs. Baeseler and Thoma, who, after carrying out some experiments, produced an eddy current rail brake which was demonstrated at the Transport Exhibition at Munich in 1925. A sketch of this brake is shown in Fig. 2.

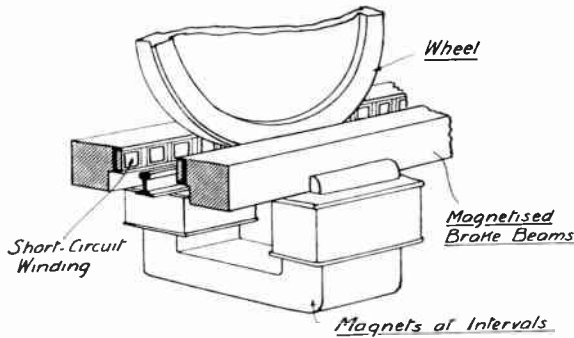

Fig. 2.—EXPERIMENTAL EDDY CURRENT BRAKE AS DEMONSTRATED AT MUNICH TRANSPORT EXHIBITION.

The "short-circuit" windings in the brake beams were sheets of copper and acted in a similar manner to the squirrel cage windings of an induction motor. The windings are developed out flat and inserted in the face of each brake beam.

The short-circuited winding stamped out of copper sheet, similar to a flattened-out squirrel-cage motor winding, was inserted in the face of each brake beam. During the entry of the wagon this winding had the effect of delaying the building of the magnetic field, due to the induction of eddy currents in the winding, and, to a

certain extent, in the wheel and brake beam. This gradual growing of the field gave a very smooth entry, absolutely free from any shock.

Proving the Principles of the Brake.

It was alleged at this juncture that the retardation effect was due entirely to mechanical friction between the brake

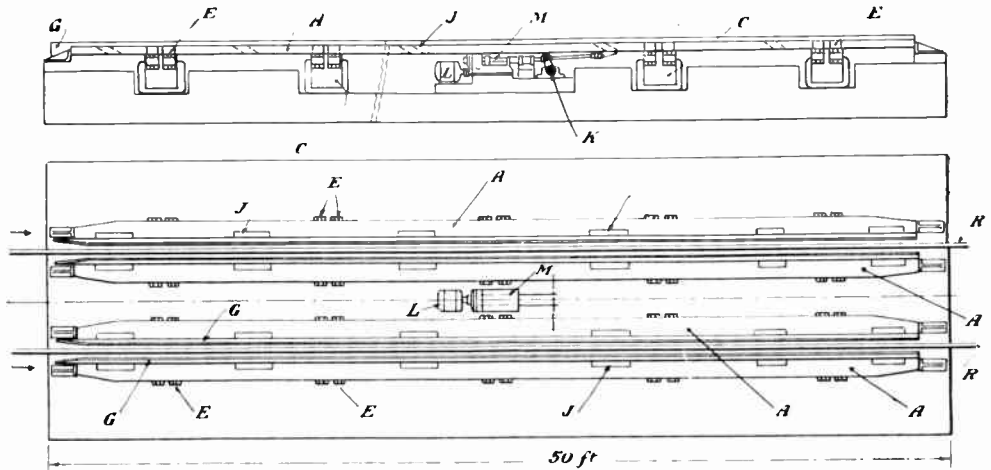

Fig. 3.—GENERAL ARRANGEMENT OF A 50-FT. DOUBLE-RAIL BRAKE ON THE WESTINGHOUSE EDDY CURRENT PRINCIPLE.

A, brake beams. C, energising magnets placed at intervals along the brake installation. E, hinges coupling up the bars and the magnets C to the connecting pole pieces. G, brake rails attached to brake beams. J, raising and lowering slides. L, raising and lowering motor. K, raising and lowering cross shaft. M, raising and lowering screw gear. R, running rails. At Whitmoor (L.N.E.R.) 70 ft. double line brakes are installed.

shoes and the wheel tyres and that no eddy currents were set up at all, so that it became essential to the development of the scheme to demonstrate conclusively that the fundamental principles upon which the brake was designed were sound.

Tests with an Oscillograph.

For this purpose a measuring coil was attached to one tooth of the Munich brake over the short-circuit winding and connected to an oscillograph. The graphs obtained showed not only that an electro-motive force was induced in the short-circuit winding, but the oscillograms indicated how the E.M.F. varied as the wheel moved through the brake.

Another Experiment that Proved Valuable.

In view of the results obtained the presence of eddy currents was incontestable; but even then it was argued that this effect was merely ancillary to the mechanical friction forces present. The latter could, however, be calculated; but to make the demonstration more conclusive a new experiment was made which allowed only the pure eddy current retardation to act. This also provided data concerning the effect of eddy currents in solid wheel tyres which proved to be very valuable in the development of the new designs which have now been brought to a successful issue.

The Full-size Experimental Apparatus.

A wheel on an axle was mounted on bearings and coupled to a D.C. electro-motor as shown in Fig. 5. The tyre rotated between the poles of a very powerful electro-magnet energised by direct current, and to eliminate all friction braking a small air gap was left on each side of the wheel. It was then necessary to energise the electro-magnet so that the magnetic field was the same as that of the actual brake. The retarding torque was determined at various speeds and with various air gaps, and the braking force calculated from this.

What the Tests Showed.

The tests showed that with all mechanical braking eliminated, the retarding effort amounted to approximately 1,400 lbs. per wheel at a speed corresponding to 60 ft. per second. This braking force was due to eddy currents action alone, and it was understood that an increased power could be expected in practice, due to eddy currents set up on the brake beams.

The Magdeburg Brake.

These experiments led to the design of

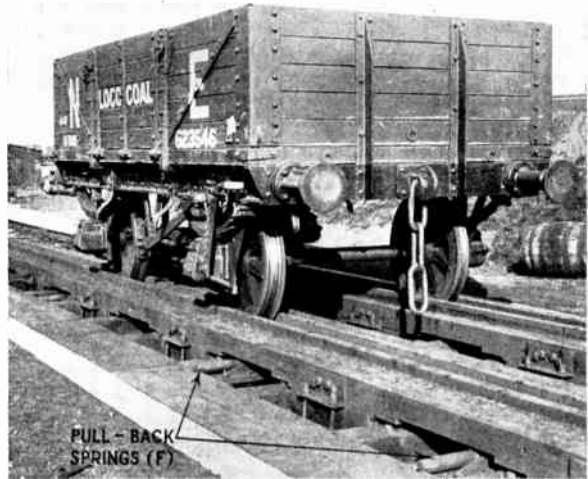

Fig. 4.—WAGON PASSING THROUGH THE EDDY CURRENT BRAKE.

The magnitude of the retardation is controlled from the cabin by the magnetising current.

a new brake installed in Magdeburg shunting yard in November, 1928, which has been working day and night ever since. From further tests, carried out on this brake under actual working conditions, improvements and modifications in design were made and the Westinghouse Brake and Signal Company have recently installed new brakes of the double rail type in the huge Whitmoor marshalling yard on the L.N.E.Rly.

Construction of the Brake.

The diagrams, Figs. 6 and 7, show a plan of and cross sections through the Whitmoor 70 ft. double rail brakes. The brake beams A extend the whole length of the retarder and are supported

at intervals by core pieces B, which themselves rest on the cores C of the electromagnets D. The beams A are not rigidly fixed, but are capable of a limited movement towards or away from the running rails, this being effected by the hinged construction shown at EE, Fig. 7.

Springs (F) are used to constrain the movement and return the beams to their normal position when the brake is unoccupied by a vehicle. The magnet cores are held down rigidly to the concrete foundations by foundation bolts. The poles between which the wagon wheels roll consist of bars G normally projecting above the beams A, as illustrated in the cross sections.

There is a small amount of wear in the parts as the poles are actually in contact with the wheel tyres, although the part played by friction in the brake is proportionally very small, and separate wearing strips, lettered H, are fixed to the bars G in order to make replacement as simple and inexpensive as possible.

Provision for Locomotives Passing Through the Brakes.

But for the necessity of allowing locomotives to pass through the magnetic brakes, the bars G might be rigidly fixed to the beams A. Provision has, therefore, been made for lowering the bars into a

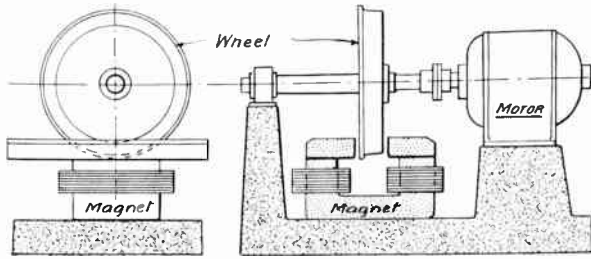

Fig. 5.—THE LABORATORY EXPERIMENTAL APPARATUS ARRANGED TO DETERMINE THE VALUE OF THE EDDY CURRENTS IN RETARDATION OF THE MOTION OF THE WHEEL.

Note that an air gap was maintained between the pole piece bars and the rotating wheel to eliminate all friction braking.

position in which their tops are level with the upper surface of the beams A.

This mechanism is shown in Fig. 3. Attached to the bars G are blocks which slide in sloping guides J, placed at intervals along the installation. The guides are fitted to the brake beams (A). The

effect of pushing or pulling the bars horizontally is to lower or raise them, and this is done by means of a motor actuating a screwed sliding mechanism, through a reducing gear. This slide is attached to the transverse lever shaft S, which operates the adjustable push rods K. This device is the only mechanical part of the brake, but it plays no part in the actual process of braking. The other moving part, the brake beams A, only alter their position laterally to adjust themselves to the so slightly varying widths of wheel tyres.

Details of the Standard Magnetic Retarder.

The overall length of the standard magnetic retarder is 50 ft., and the double rail equipment, such as that illustrated, is fitted with 14 magnets in all, seven per rail. The windings are impregnated and enclosed in a sealed sheet-metal case filled with compound to render them absolutely watertight. There is, therefore, no danger of a brake failure through the track becoming flooded, although channels are provided in the reinforced concrete foundations

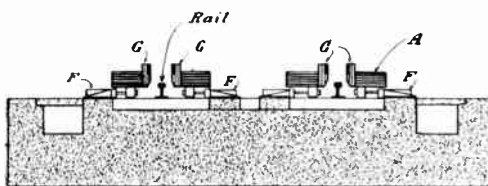

Fig. 6.—NORMAL CROSS SECTION OF BRAKE. F, pull-off spring gear. (Other reference letters same as Fig. 3.)

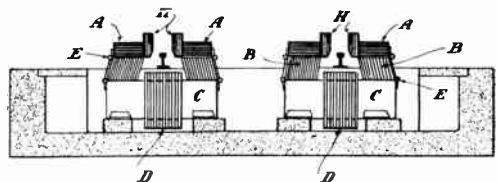

Fig. 7.—CROSS SECTION OF BRAKE AT ENERGISING MAGNETS.

D, windings of energising magnets. (Other reference letters as Fig. 3.)

for drainage as well as for laying in the necessary cables.

The Core Construction.

The cores are composed of a number of sheets of steel riveted together. The same construction is adopted for the brake beams (A), while the core pieces connecting them consist of plates loosely held together and hinged to both the brake beams and the magnet cores, as already mentioned. This loose construction permits the movement of the brake parts to allow accommodation to the varying tyre widths the brake has to encounter; but no rattling and consequent wear can occur during operation owing to the attractive action due to the magnetic fields produced.

The brake is mounted on a concrete foundation, but in some cases it may be found that a wooden substructure has advantages.

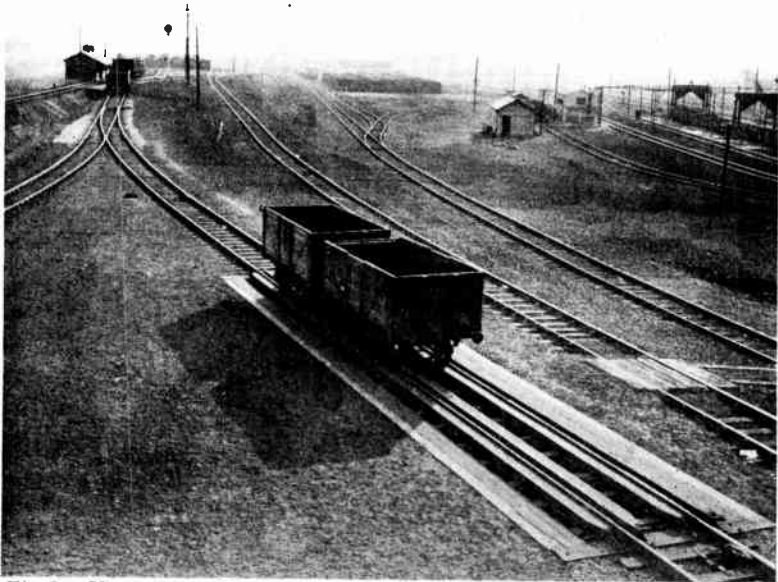

Fig. 8.—VIEW OF THE WESTINGHOUSE EDDY CURRENT WAGON BRAKE AS FITTED AT THE L.N.E.R. MARCH GRAVITY SORTING AND MARSHALLING SIDINGS.

The Action of the Brake.

When the magnet windings are energised before the wagon wheels enter the brake, a magnetic flux is set up round the cores, through the core pieces and across the gap, this, of course, tending to draw the brake beams together. The springs F are used to restrain this tendency to movement.

What Happens when the Wagon Enters the Brake.

When the wagon enters the brake, the magnetic circuit is completed through the wheel tyres. Owing to the change in the reluctance of the magnetic circuit brought about by the substitution of the large air gap by the magnetic material of the wheels

there is a tendency for a sudden and great increase of flux. This increase is, however, opposed by the setting up of eddy currents in both the tyres and the brake beams themselves, owing to the rotation of the wheels.

It is the power dissipated by these eddy currents that provides the main braking effect.

Small Proportion of Mechanical Retardation.

There is, of course, some mechanical

gripping action on the wheels on account of the great magnetic attraction. This being the case, a certain amount of friction must occur and the retardation is to some extent mechanical. This is but a small proportion, not more than 20 to 25 per cent. of the total braking force. As the wagon enters the brake the building up of the magnetic flux is delayed and the gradual building up ensures that retardation is always smooth in its action. The magnetism always holds the vehicle down to the rail and derailments are impossible. It is not absolutely necessary to use double rail brakes. Single rail retarders can be used without setting up any stress in the axles of the vehicles.

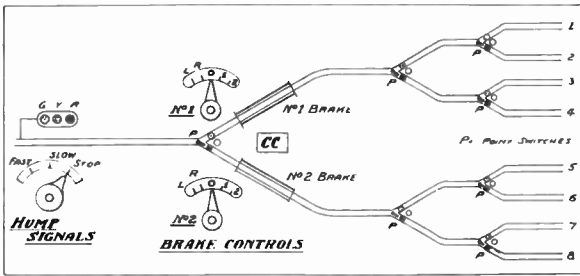

Fig. 9.—A TYPICAL COMBINED ILLUMINATED DIAGRAM AND SWITCH CONTACTS AS USED BY THE OPERATOR.

On the site the control cabin is placed as indicated at CC. G, green. Y, yellow. R, red. P, points switches. L, lower brake rail. R, raise brake rail. Nos. 1 and 2, excitation strengths. O, off.

Power Required.

The electro-magnets are wound to operate on a direct current, the maximum load current being 150 amperes, the applied voltage depending upon the size of the brakes. Should the local supply be A.C., control can be effected through rectifiers or motor generators. As the demand is very intermittent the overload capacity of the apparatus can be utilised to its fullest extent.

Gradation in Retarding Force.

It is considered preferable to obtain some gradation of braking by providing two or more definite values of excitation, and allowing the current to be cut off when the wagons have been slowed down sufficiently, rather than by providing continuous and delicate variations in excitation. Special provision is made for breaking the highly inductive circuit as rapidly as possible.

The Control Gear.

The control of the brake is simplicity itself. There are two buttons for stopping and starting the motor generator set, and one control handle for the brake. Every protection is made for faults at the brake, in the rest of the apparatus, and for faults on the part of the operator. In the case of an overloading occurring at the brake, the fact is made known by a lamp lighting, and also the continuous ringing of a bell outside the control cabin to warn the

personnel in the yard of the failure of the brake.

The Control Desk.

This desk is of sheet metal with the retarder control handles, the points operating thumb switches, and the hump signal control, together with indication lamps, all mounted on a sloping panel. This is placed at such a height that the operator may sit before it, with an unobstructed view of the territory over which he has control.

This panel may be conveniently laid out in the form of a schematic track diagram of the shunting yard. In such a case, the thumb switches controlling the points would be at their appropriate place on the diagram together with three indication lamps for each set of points. These three lamps would be a green and a red for the normal and reverse direction indication, with a white light between the two for track indication. This scheme is illustrated in Fig. 9.

Signalling.

As the engine is behind the unsorted train, pushing the train more or less slowly over the hump where the wagons are detached to continue by gravity, a signal system to the driver is necessary. This can be done by a three-colour light signal from the control cabin. This is arranged to provide for dual control by the operator and the head shunter and the control panel repeats the

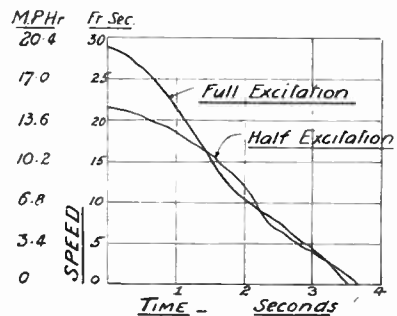

Fig. 10.—TIME-SPEED DIAGRAM, SHOWING RETARDATIONS AT TWO EXCITATION VALUES.

aspect of the actual signal. The three aspects are, "hump fast"; "hump slow" and "stop humping."

The Advantages Over Frictional Brakes.

The danger of derailment of wagons and consequent total stoppage of the yard shunting, which has been the source of trouble to users of mechanical wheel-gripping brakes, is eliminated by the eddy current brake. Tests with light empty wagons, run into the fully excited brake at the highest speeds, show not the slightest trace of lifting, in spite of the very rapid retardation of the vehicle. The action is smooth and there is absolutely no danger to delicate loadings. The possible damage to any form of goods susceptible to magnetic effects has been the subject of experiments. It was found that at a height

of 3 ft. above rail level (4 ft. 3 in. is the usual wagon floor height), the magnetic field created was not sufficient to harm the most delicate apparatus.

Constant Performance.

The percentage of braking force, due to friction being small, the performance of the eddy current brake is very constant, in spite of changing weather conditions, presence of grease, rough and smooth wheels and the number of other factors which must play an important part in any mechanical system of braking.

The two curves on the typical speed-time diagram, Fig. 10, are interesting. It will be noticed that, as would be expected, the curve for full excitation is considerably steeper than that for half-excitation.

IS A.C. SUPPLY MORE DANGEROUS THAN D.C. SUPPLY?

What Happens When You Receive an Electric Shock (D.C.).

When one comes into contact with D.C. the nerves through which the current passes are stimulated, and cause the muscles they control to contract. Then a slow electrolysis of the organs takes place, with burning where the current enters and leaves the body.

If the shock has not been too severe or affected any vital organs, recovery of the nerves on the stoppage of the current is rapid.

What an A.C. Shock Does.

With A.C. of the same voltage, the same current flows and there is the same burning. There is no electrolysis. However, with 50-cycle A.C., the nerves are excited first in one direction and then in the other 50 times a second, and just as

bending a piece of wire backwards and forwards ultimately breaks it, the nerves soon become fatigued and are then paralysed.

Peak Value of Voltages.

Besides this, the voltage of a 230-volt A.C. circuit has its peak value at about 325 volts, and so the nerves receive a shock nearly one and a half times as severe as with 230 volts D.C.

Conclusion.

Therefore because of the paralysing effect on the nerves of the A.C. current, and the fact that the shock is one and a half times as severe as from a D.C. supply of the same voltage, a "shock" from A.C. is more dangerous than one obtained from D.C. of the same voltage.

PRACTICAL NOTES ON REGULATIONS FOR THE ELECTRICAL EQUIPMENT OF BUILDINGS (I.E.E. WIRING RULES)

By D. WINTON THORPE, A.M.I.E.E.

THE CONDUIT SYSTEM

THIS system of wiring is probably the best known and the most reliable of any used to-day. We will, therefore, comment first on those portions of the Regulations which have a direct bearing on this.

Inspection and Draw Boxes.

Under Section 87 of the Regulations we come to the Sub-section xviii, which states:—

The conduits shall conform in all respects to British Standard Specification No. 31, and if used for circuits of medium pressure shall be of heavy gauge. Also inspection and draw boxes shall be of metal and rigidly connected to the conduits by means of screwing or by nuts on both sides of the wall of the box.

There is not perhaps a great deal to be said here, except that it does not do to poke the ends of your tubes through a hole in the draw-box and consider that you have made a job of it. Nor is it sufficient to put a nut on the end of the screwed tubing inside the box and draw it tight, making use of the natural tension between the secured tube and the rigid box. There is only one way to make an entry of this sort into a draw-box which conforms with the Regulations, and that is, as the Regulation states, to place a nut on each side of the wall of the box.

Mechanical and Electrical Continuity.

Sub-section xix states:—

The conduits shall be mechanically and electrically continuous across all joints therein and earthed in accordance with Regulations 96 to 103.

It is as well to remember here that conduit joints may be electrically continuous without actually being mechanically continuous and may be mechanically continuous without being electrically continuous. There is a tendency to consider that a satisfactory continuity test of the metal sheathing of an installation carries with it a guarantee that the job is mechanically continuous. This need not be the case, since a newly erected conduit with bright ends needs only a comparatively slight connection to give a satisfactory continuity test. It might be quite possible, however, for this conduit not to have been properly screwed into the sleeve or elbow. Again, if there is paint or other non-conducting material on the thread of the conduit as it is being screwed into a conduit fitting, it may very easily remove all electrical continuity, while maintaining a perfectly sound mechanically continuous job.

Electrical Resistance of the Conduit.

Sub-section xx states:—

The electrical resistance of the conduit in a complete installation, measured between the conduit at a point near the main switch and any other point of the installation, shall not exceed 2 ohms.

With the old bell-and-battery test the measurement of the resistance of the sheathing of an installation was not apparently a matter of any great moment, since it was usual to pass or condemn such an installation entirely on its capacity for ringing a bell with a given size of battery. There is, however, nowadays an increasing tendency to demand an actual reading of the resistance of the

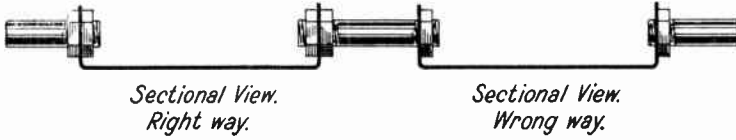

A SECTIONAL VIEW OF A DRAW-BOX.
 On the left, the conduits are shown correctly connected, i.e., by means of nuts both on the outside and the inside. The sketch on the right shows the incorrect method. It is not sufficient to put a nut on the end of the screwed tubing inside the box and draw it tight, making use of the natural tension between the screwed tube and the rigid box.

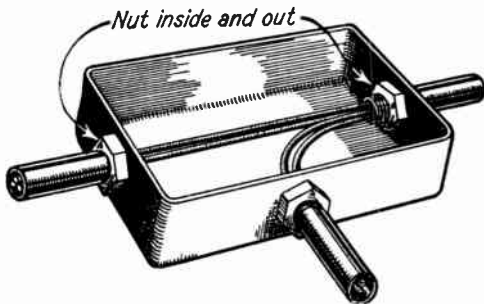

A PERSPECTIVE VIEW OF A DRAW-BOX.
 Note that there are nuts both on the inside and the outside of the box. The regulations state that the draw-box must be of metal and rigidly connected to the conduits by means of screwing or by nuts on both sides of the wall of the box.

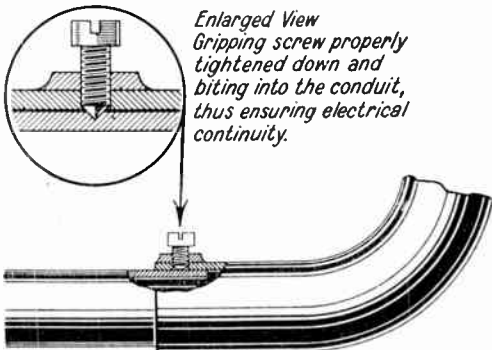

Enlarged View
 Gripping screw properly tightened down and biting into the conduit, thus ensuring electrical continuity.
 Bad joint in slip tube. The gripping screw has not been tightened down and the layer of enamel will break the electrical continuity.

HOW BAD ELECTRICAL CONTINUITY MAY BE CAUSED WHEN USING SLIP TUBE.

If there is paint or other non-conducting material on the tube it is important to make sure that the gripping screw is tightened down and is biting with the conduit.

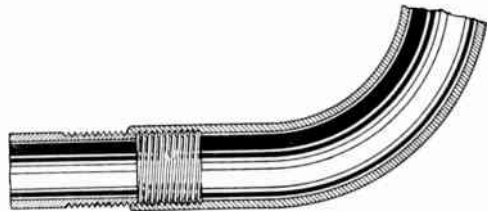

Bad joint in screwed Conduit only one thread has entered giving bad mechanical and electrical continuity.

MAKE SURE THAT CONDUITS ARE MECHANICALLY AND ELECTRICALLY CONTINUOUS ACROSS ALL JOINTS.

Here we see a bad joint in screwed conduit, only one thread having entered, thus giving bad mechanical and electrical continuity.

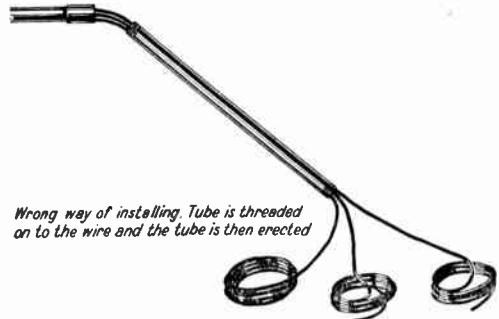

THE WRONG WAY OF INSTALLING CONDUIT.
 The wires are here shown threaded through the tube, prior to screwing or fastening the tube into the next section or to the conduit fitting. This is a practice definitely to be avoided, and the conduits of each circuit should be erected complete before the cables are drawn in.



Bush on end of conduit to prevent abrasion
 HOW TO PREVENT THE SHARP AND JAGGED EDGES AT THE END OF A PIECE OF CONDUIT FROM DAMAGING THE BRAIDING OF THE CABLE.

It is essential to put some form of bush on the end of the conduit as shown.

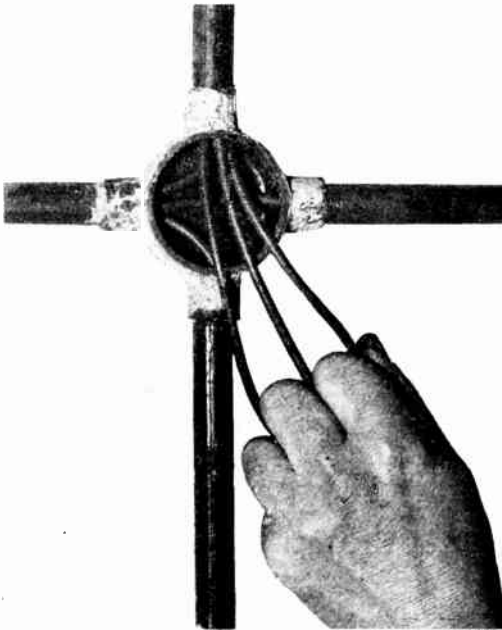

DRAWING THE WIRES INTO THE CONDUIT AT A JUNCTION BOX.

They are kept parallel to each other as they pass into the box by allowing the wires to slide through the fingers of the hand.

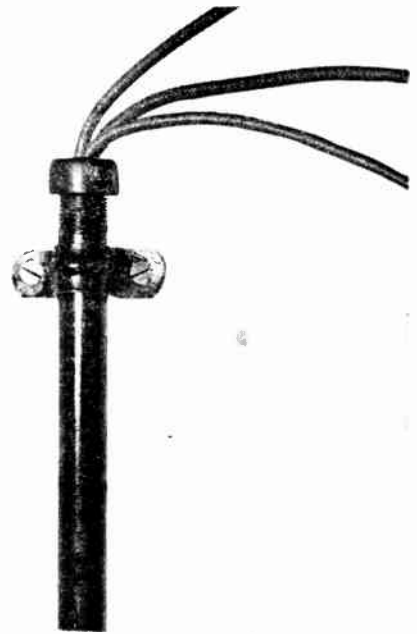

FITTING AN INSULATING BUSH.

Where the wires emerge from a run of conduit, an insulating bush made of hard rubber or ebonite is fitted on the end of the conduit.

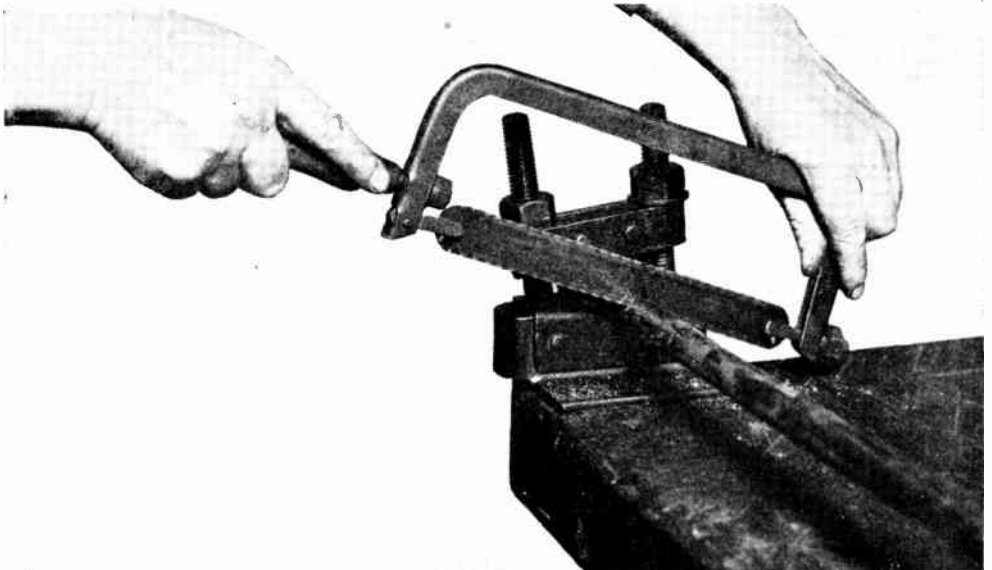

HOW TO CUT STEEL CONDUIT.

The teeth of the saw are very small and have a big set. This prevents the saw jamming in the saw cut and the teeth being stripped by the edges of the conduit. The burr caused by the saw must be carefully removed from the inside and outside edges.

sheathed circuit, and this makes it imperative to bear in mind that the Regulations do actually call for a specific maximum measurement, namely, 2 ohms.

Ventilating Outlets.

Sub-section xxi states :—

Ventilating outlets shall be provided for the conduits containing every circuit, and preferably at their highest and lowest points, to allow circulation of air through the conduit.

In all conduit installations there is apt to be a certain amount of condensation of moisture inside the tubes. This dampness will remain unless means are taken to remove it. The simplest method is to allow nature to remove the moisture by a free circulation of air, which will only take place so long as the tubes are ventilated in the manner called for in this particular section. Quite small holes will serve the purpose; they need not be more than $\frac{1}{8}$ -in. in diameter, but it is as well to see that the installation has a reasonable number of these ventilating holes.

Conduits to be Erected Before Cables are Drawn in.

Sub-section xxii :—

The conduits of each circuit shall be erected complete before the cables are drawn in.

I have never really understood why any electrician should want to be bothered with the finnicking, fiddling process of erecting cable and tubing together. Nevertheless, it is quite frequently met with, though it is expressly forbidden by this sub-section. The method which is disallowed here is that in which the wires are threaded through a length of tube which is then slipped along the wire much as a bead over an embryo necklace until the tube can be screwed or otherwise fastened into the next section, or to the conduit fitting. I suppose that one of the reasons for applying this cumbersome and inefficient method of erection is due to the fact that in this way rather more cables can sometimes be crammed into a tube than would be possible if the whole installation were to be erected first and the cables subsequently pulled in. But since this is one of the very reasons why the Regulation has been

drafted, the fact emphasises the futility of trying to disregard this sensible rule. Provided that the whole tubing installation is erected and all the cables drawn in thereafter, one may feel quite confident that there is not an undue number of cables in the tube, and further that abrasion of the cables on the sharp edges of bits of tube threaded on to them will not have had a detrimental effect.

Preventing Abrasion.

Sub-section xxiii :—

Provision shall be made at the ends of all conduits to prevent abrasion of the covering of cables emerging therefrom.

This sub-section is really self-explanatory and it virtually insists that there shall be some form of bush on the otherwise jagged ends of the conduit. After a piece of conduit has been hacksawn through, the cut end offers some remarkably sharp and jagged edges to the comparatively easily damaged braiding of the cable.

Conduit in Damp Situations.

Sub-section xxvi :—

In damp situations, and where exposed to the weather, the conduits shall be welded, brazed or solid drawn.

This is quite really an exciting sub-section, for tacitly, it appears to give permission for the use of what is known as close-joint conduit in places other than damp situations or where exposed to the weather. Now close-joint tubing is, to most engineers, anathema, and I suppose that most people would unequivocally state that these Regulations forbid its use. It does, however, appear from this Regulation that the use is not definitely barred. Nevertheless, it is as well to remember that in certain circumstances, at any rate, the use of this (to me) obnoxious tube is definitely discountenanced. Close-joint tubing, to which I have referred, is tubing which is manufactured by bending strips of metal longitudinally into the form of a tube but leaving the two edges free though adjacent. In the case of this tubing it is possible to insert a penknife blade into the seam and run it down the full length of the tube; the result is that wherever a set is made the seam gapes.

Metal Conduits not Screwed.

These Regulations sanction the use of metal conduits not screwed, provided that (Sub-section xxvii) :—

The ends of the conduits where terminating at accessories and fittings are to be adequately clamped thereto, or should be led into separate blocks, preferably of non-ignitable material.

NOTE.—Plain slip sockets do not comply with the above conditions, some form of screwed or grip joint which will give ample and permanent electrical conductivity and mechanical rigidity throughout being necessary.

This Regulation endorsed by the Note definitely and unequivocally precludes the use of slip fittings without any continuity grip fixing. The use of plain slip fittings without such grip device is, like the use of close-joint tubing, a thing which is abhorrent to most reputable engineers. In this case, however, the Regulations do definitely forbid its use.

Grip Continuity Fittings.

It must be clear that if reliance is to be placed on a straightforward slip fitting of this sort to secure electrical continuity one is likely to be very disappointed. It only needs a very few months before a film of oxide collects between the surfaces which are supposed to be in contact after which, of course, any question of electrical continuity will have entirely disappeared. The grip continuity fittings, to which reference is made in this section, are of various sorts, but the three best known depend, in the first place, upon a tangential screw which tightens up a collar at the end of the fitting, so that it grips the conduit tightly. The second sort relies on a tangential screw again, but one which is so placed that the thread of the screw bites slightly into the conduit as it passes across the tangent. The third type consists of a radial screw which is screwed down and into the conduit, making a satisfactory electrical contact.

Non-Metallic Conduits.

Provision is made next for the use of non-metallic conduits. All classes of cable specified in Regulation 76A (that is,

vulcanised indiarubber cable) may be enclosed in conduits of non-ignitable, non-absorbent, damp-proof material, provided that such conduits are mechanically continuous and strong and are installed in accordance with the conditions in sub-sections (iv), (xiii), (xiv), (xvi), (xvii), (xxi), (xxii), (xxiii), (xxv) and (xxvii).

Although it is only recently that conduits of this sort—that is to say, non-metallic conduits—have come into fashion at all in this country, they have been in use on the Continent of Europe and America for some time past. And I think it quite possible that they may at no great distant date enjoy a spell of real popularity in this country. It is, therefore, as well to remember that these Regulations do specifically provide for their use.

V.I.R. Cables in Wood Casing.

V.I.R. cables may be enclosed in wood casing provided that :—

(xxviii) *Wood casing is used only in dry situations.*

(xxix) *It is not buried in plaster or cement, nor fixed in contact with gas pipes or water pipes or immediately below the latter.*

(xxx) *The capping is secured by screws, and*

(xxxi) *If the casing forms part of ornamental woodwork, ready access is provided to the cables contained therein.*

Wood casing is a system which flourished about thirty years ago, and although it seems to have very little to commend it on purely technical grounds, yet practically it has resulted in some of the longest-lived and most reliable electrical installations that I have known. Although it is a system being killed by other more up-to-date methods, it is one which is always liable to be met with, and it is as well to keep it in mind as a possible method of executing certain jobs.

It must be remembered, however, that it is dependent on complete dryness for its efficiency, and being dry and being wood is inflammable; therefore, precautions against damp and precautions against fire must be taken with very great care.

Flexible Cords.

Here is another surprise. High insula-



THE CORRECT METHOD OF SCREWING CONDUIT TUBING.

After the tubing has been cut to the required size the burr on the outside edge of the tubing must be removed, using a draw file as illustrated below. This is a small but important operation which facilitates the subsequent screwing of the tube end.



THE CORRECT METHOD OF SCREWING CONDUIT TUBING.

This picture illustrates the use of a portable vice for holding the tubing whilst it is being cut. Note the position of the feet to steady the vice whilst in use. It will be seen that the upright of the support can be canted at an angle to afford the most convenient position for working. The picture also illustrates the correct method of holding the hacksaw. Special care must be taken not to twist the saw out of the cutting plane. This is the secret of avoiding frequent breakages of the hacksaw blade.

THE CORRECT METHOD OF
SCREWING CONDUIT TUBING.

This shows how stocks and dies are used to form a thread on the prepared end of the tubing. A few drops of oil applied to the end of the tube before screwing will be found to assist easy working.



THE CORRECT METHOD OF SCREWING CONDUIT
TUBING.

This illustrates the final operation in screwing the tubing. It shows a tapered reamer being used to remove the burr inside the tube. This is a very important operation and should on no account be omitted. If sharp edges are left projecting into the tube the insulation of the wires is liable to be chafed when the wires are being drawn through the tube. The omission of this process may easily cause a serious short circuit.

tion twin or multicore flexible cords such as are specified in Regulation 79 may, in addition to being used for pendant and portable appliances, be installed **provided** that the following sub-sections are complied with. Although the use of flexible cord in this way for ordinary installation purposes is undoubtedly hemmed in with a good number of regulations, which we shall deal with later, it is a surprising fact and, to some people, a disappointing fact, that the use of this type of wire is tolerated at all for installation purposes. However, as it is allowed, here are some of the "do's" and "don'ts" connected with its use :—

(xxxii) *It is used only for extra low pressure and low pressure sub-circuits carrying currents not exceeding 6 amperes from distribution boards.*

That means that the flex may be used for anything under 250 volts A.C. or D.C., provided that it is not asked to carry more than 6 amperes.



Close joint tube.

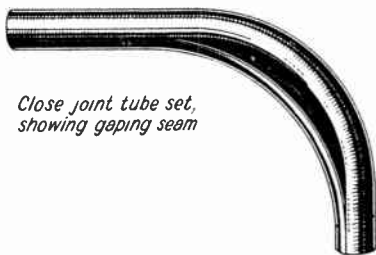

Close joint tube set, showing gaping seam

ALTHOUGH NOT ACTUALLY BARRED IN THE REGULATIONS EXCEPT IN DAMP SITUATIONS, CLOSE-JOINT CONDUIT IS NOT TO BE RECOMMENDED FOR THE REASON SHOWN ABOVE.

Close-joint tubing is tubing manufactured by bending strips of metal longitudinally into the form of a tube, but leaving the two edges free though adjacent. It will be seen that with this type of tubing it is possible to insert a penknife blade into the seam and run it down the full length of the tube; the result is that wherever a set is made the seam gapes.

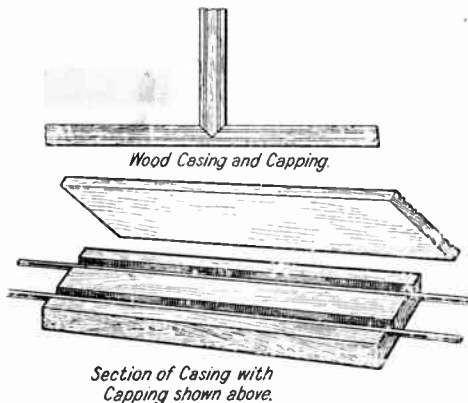

Wood Casing and Capping.

Section of Casing with Capping shown above.

USING V.I.R. CABLES IN WOOD CASING.

It is stated in the regulations that V.I.R. cables may be enclosed in wood casing provided that the wood casing is used only in dry situations; that it is not buried in plaster or cement, nor fixed in contact with gas pipes or water pipes or immediately below the latter; that the capping is secured by screws; and that if the casing forms part of ornamental woodwork, ready access is provided to the cables contained therein.

(xxxiv) *It is supported on porcelain or other equally effective insulating cleats fixed at intervals not exceeding 3 ft., such cleats being so designed and placed that the cords are securely fixed and permanently spaced away from walls, ceilings and structural metal work.*

(xxxvi) *The premises do not come within the provisions of the Factory and Workshop Acts and the Coal Mines Regulations Acts.*

(xxxvii) *It is not used in shops, warehouses, or places of public resort.*

(xxxviii) *Where passing directly through floors or division walls it is protected by non-ignitable damp-proof conduits.*

(xxxix) *Where issuing from fittings and unavoidably passing into ceilings it is enclosed in non-ignitable tubes terminating in non-ignitable junction boxes.*

Well, there you are; you may use flexible cord in certain circumstances for ordinary installation work. For myself, I shall continue to use something rather more effective and a little less dangerous.

MODERN DEVELOPMENTS OF THE SELSYN SYSTEM

FOR the benefit of those readers who may not be already familiar with the Selsyn system, it may be mentioned that it is designed to provide an electrical means of transmitting or reproducing motion of any kind such as that of a float to a distant point. The same system can be employed wherever it is desired to copy a motion.

Exact Level of Water in a Reservoir.

For example, the exact level of water in a reservoir may be indicated at a pumping station several miles away, and also at one or more other points if required, the only connecting link being three pilot wires and a common A.C. single-phase lighting supply.

The difference in water level between the head and tail races of a hydro-electric station, or between any two reservoirs, possibly miles apart, may be indicated or recorded, or both, at any convenient point, or at several points if desired.

Position of Swing or Bascule Bridge.

The operator of a swing or bascule bridge or haulage plant may know, by means of a pointer on a dial, or even by a small model in his control cabin, the exact position of his bridge or cars, even though fog, darkness, or any other obstruction may obscure his direct view.

The position of a lift may be indicated at any desired point; in fact, movement of any mechanism is capable of being transmitted electrically to any one or more points and there indicated and recorded by suitable recorders.

Perhaps one of the best known applications is for an engine room telegraph.

Two-way Signalling Device.

This equipment is a two-way signalling device, enabling the transmitted signal to be repeated to the sender, thus giving evidence of its accurate reception. It also includes a continuously ringing bell, which commences ringing on the transmission of a signal, and can only be silenced by correct acknowledgment of the signal from the receiving end.

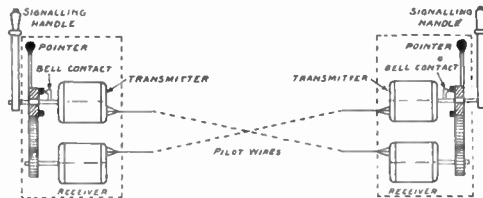

DIAGRAM OF SELSYN TRANSMITTERS AND RECEIVERS EMPLOYED IN ENGINE ROOM TELEGRAPHS.

Other Applications of the Selsyn System.

In many industrial plant it is desirable to be able to operate from a control-room valves

or other controls which may be actually located in widely different and perhaps inaccessible parts of the plant. It may sometimes even be necessary to locate a valve or control in a danger zone, where it cannot be approached safely by an attendant while the plant is in operation.

Selsyn devices enable the whole control to be centralised in a cabin together with the necessary indicators, which enables the whole plant to be under the control of one person if necessary.

Furthermore, in addition to merely indicating and recording, the Selsyns may be arranged to operate directly upon the controls of auxiliaries; for instance, the varying level of liquid in a tank may be made to control the speed of a pump or the opening and closing of a valve, etc.

Textile Printing Works.

Selsyns are being employed in textile

printing works to couple the pilot motors of two variable-speed commutator motors driving two printing machines. Under certain conditions it is necessary to couple the machines together mechanically so as to run the material through both machines in series. When operating in this way it is essential that the pilot motors controlling the commutator motor brush-gear be maintained in step one with another to prevent overloading either of the machines. The location of the latter motors is such as to render difficult any mechanical interconnection of the pilot motors.

The difficulty was solved by coupling a Selsyn to each pilot motor, and arranging an interlock switch, by means of which, on engaging the gear which couples the

presses, which will remain in step with a degree of accuracy depending upon the size of the Selsyn employed. Previously this was only attainable by means of expensive and complicated gearing and clutch mechanisms.

Paper-making Machine.

It is also possible to couple a variable speed electric motor or prime mover to another motor or other piece of machinery, electrically, in such a way that the former machine will run at a speed exactly proportional to that of the latter, irrespective of load variations, etc. For instance, a number of motors driving individual units of a sectional paper-making machine may have their speeds controlled by a master motor.

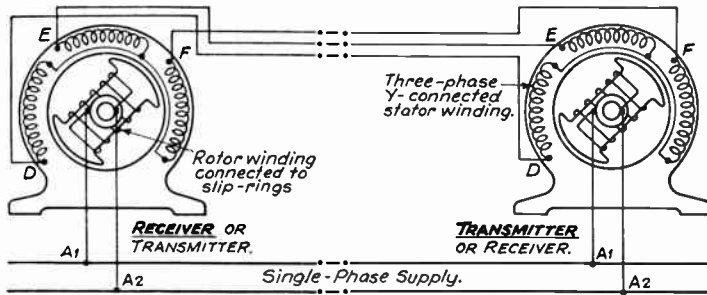

CONNECTION DIAGRAM FOR TRANSMITTER AND RECEIVER.

two printing machines, the pilot motor controls are paralleled so that operation from either push-button station affects both. At the same time the Selsyns are energised and maintain the two pilot motors in step with one another in spite of any load differences due to variation in effort required to move brushgear, etc.

Newspaper Printing Presses.

A similar principle is utilised on a larger scale in newspaper printing plants to interconnect any number of printing presses. In this application the Selsyns are of a size comparable with that of the motors driving the presses, and are sometimes built integrally with the motors. By simple electrical switching it is possible to couple together any combination of

an anode. A negative voltage of sufficient value of the grid will prevent current flowing, but at certain smaller negative values depending on the anode voltage, the valve becomes conducting and has a very low resistance, the discharge taking the form of an arc. The thyatron may thus be used as a relay, which can control large currents, but requires only voltage with practically no power for its operation.

Remote Control in Theatre Lighting Schemes.

The Selsyn may be employed to effect the remote control of some device operating upon the grid circuits. This method has been employed in theatre lighting schemes. Large amounts of lighting energy can be handled by thyatrons in conjunction with saturable core reactors. The grid control

RECENT DEVELOPMENTS. Selsyns Used in Conjunction with Thyatron Valves.

When used in conjunction with thyatron valves an even more extensive field is opened up. The thyatron is a mercury-vapour valve having a heated cathode surrounded by a grid and

is by means of small induction regulators. The induction regulators are operated from a convenient point in the theatre—generally a control box behind the orchestra and commanding a good view of the stage—through the medium of Selsyn control.

In this way it is possible to group the complete control of a large number of circuits within reach of one operator. Furthermore, it is possible for this operator to arrange lighting schemes in advance of his requirements by setting a number of dials and "fading in" at the required moment by grouping the Selsyns under master Selsyns.

It was previously necessary to operate the stage lighting from a large switchboard, generally in the "wings," from which it was difficult to judge the effect, besides requiring several operators. Groups of spotlights can also be controlled more efficiently by one operator who has the advantage of a better viewpoint to judge the effect, than individual operators stationed at each light.

Principle of Operation.

The Selsyn unit consists of a small electrical machine having a three-phase stator winding wound in slots similar to an induction motor, and a single-phase salient-pole rotor. Generally, only two poles are used, so that the system has only one position of correspondence per 360° of movement. Similar units are employed at opposite ends of the system, their stators being connected together, phase to phase, through three pilot wires. The rotors at both ends are connected to the same single-phase A.C. supply.

When the units are in the same position relative to each other, the electromotive forces induced in the stator windings

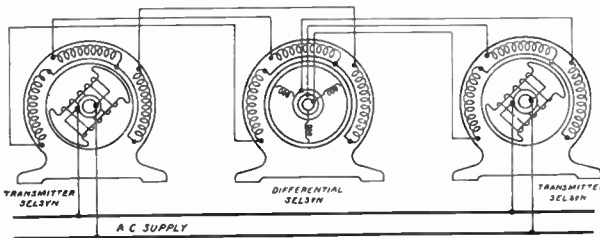

CONNECTIONS FOR DIFFERENTIAL SELSYN.

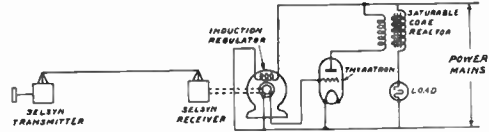

DIAGRAM OF SELSYNS USED IN CONJUNCTION WITH MAZDA THYRATRON VALVES.

oppose one another and no stator current flows. Any relative displacement will upset this balance and cause circulating currents in the stator circuits, which give rise to torques tending to restore the units to a state of mutual correspondence. The restoring torque is roughly proportional to the sine of the angle of error, and thus for small errors is approximately proportional to the error. It should be noted that, with an error of 180° the restoring torque falls to zero. In this position, however, the system is unstable, since the slightest angular deviation of either machine will set up a torque tending to increase the deviation. Hence, for any given position of the transmitter there is only one stable position of the receiver.

Where Accurate Indication is Required.

Where accurate indication is required with single Selsyns it is, therefore, necessary to keep the friction of the receiver unit low. It is, however, possible to deal with larger torques by the adoption of an auxiliary motor and contacts or thyratrons as mentioned above. When used as a signalling device in such a way that its complete travel is less than 360° the system has the advantage of being self-setting.

Self-setting Property.

On resumption of power after a shut down the receiver will at once come into coincidence with the transmitter. Larger operating torques can be obtained by gearing at the expense of this useful feature, which can, however, be overcome by the employment of two units—one as a coarse indicator and the other as a vernier, the latter being so geared that it makes a number



DIAGRAM OF SELSYNS APPLIED TO VARIABLE SPEED A.C. MOTOR DRIVE.

of revolutions for one of the coarse indicators.

This self-setting property enables one transmitter to send different signals successively to a number of receivers, by means of a selector switch. When this switch is placed so as to connect a given receiver with the transmitter, the receiver will automatically set itself into coincidence with the transmitter.

Differential Selsyn.

A second form of Selsyn unit, known as a "differential Selsyn," enables the system to be adapted to many other duties. This unit has the same type of three-phase stator as the ordinary type, but has also a three-phase wound rotor of the cylindrical type with the winding carried in slots.

If one of these units is inserted as a transformer in the stator circuits of the two main Selsyns (i.e., the stator and rotor winding of the differential unit being used as primary and secondary windings respectively) and the differential unit prevented from rotating, the two ordinary Selsyns will operate as before, except that they may now have a relative displacement when in the no-torque position, depending on the angular position of the differential unit.

If, however, one of the three units comprising the system is free to rotate while the other two are coupled to two different mechanisms, the free unit will move by an amount depending on the algebraic sum of the movements of the other two. Thus, if one, for example, be coupled to a float mechanism measuring the height of water in one reservoir, and the second be connected to a similar mechanism measuring the height of water in a second reservoir, the third unit may be made to indicate the difference in height between the two reservoirs, irrespective of any rise or fall common to the two.

Variable Speed A.C. Motor Drive.

If two of the units of a three-unit system are coupled to two moving mechanisms in such a way that they are driven round at the same relative speeds, the third unit may be arranged to remain stationary. If the speeds of the two mechanisms should now differ, the third Selsyn will revolve at a speed corresponding to the difference between the first two. It may, therefore, be coupled to some means of speed control so as to adjust the speed of one of the mechanisms and bring it back to the same speed as the other.

Thus, a number of variable speed motors may be maintained in step with one another and with a master motor, as required, for instance, in paper mill drives in which various units have to be separately driven yet all run at proportional speeds.

By varying the relative speed between any motor and its Selsyn, such as by means of conical belt pulleys, the speed of any motor in the equipment can be raised or lowered at will, but will still follow proportionally any variations in the speed of the master motor.

By the insertion of a fourth Selsyn into the concatenated system, the fourth being of the differential type, it is possible to advance or retard at will the phase of rotation of any motor without interfering with the speed proportionality. This might be useful for adjusting the "slack" between two Selsyn-synchronised machines through which a continuous band of material passes, as in multiple unit printing presses or paper mills.

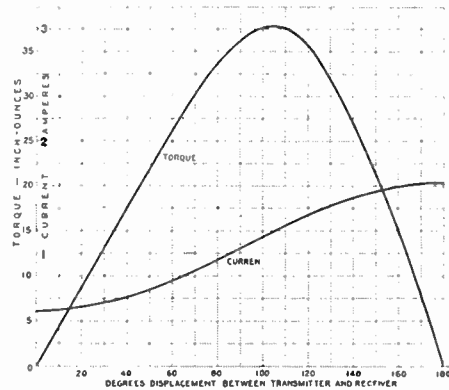

TORQUE AND CURRENT CHARACTERISTICS OF A SELSYN.

THE MERZ-HUNTER PROTECTIVE SYSTEM

By F. C. ORCHARD, A.M.I.E.E.

In this article Mr. Orchard gives a brief description of the principle and operation of a pilotless system of protection for cable or overhead lines

THIS system of protection is a pilotless one, yet provides instantaneous isolation of a faulty cable or overhead lines, and affords complete discrimination. The feeder will be disconnected from service at both ends

By inserting a differentially wound current transformer in each phase, having the two primaries of the split passing through the core in opposite directions, no current will flow in the secondary windings when the current through the primaries is balanced, because the fluxes induced by the balanced primaries will cancel each other out.

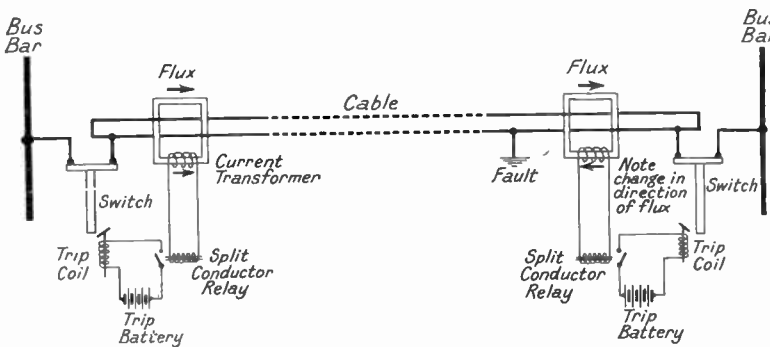

THE MERZ HUNTER PROTECTIVE SYSTEM APPLIED TO A SINGLE-PHASE CONDUCTOR.

Note the reversal of current in the transformer.

in the case of a fault, yet will not trip when fault current is passed through the feeder to a fault at some remote point.

Principle of the System.

This system of protection depends on the simple principle that two conductors having equal resistances and connected in parallel will divide the load equally between them, providing the insulation is completely sound. If now a three-phase transmission cable has six conductors—three pairs—each pair constituting one phase, being precisely similar in every respect, then each conductor in a pair will carry equal proportions of the phase current.

What Happens when a Fault Develops in one of the Splits.

When a fault develops in one of the splits, however, more current will flow through one

primary than the other of the current transformer and will upset the induced flux balance, which will in turn produce a proportionate E.M.F. in the secondary to operate a trip circuit relay.

Operating the System.

To operate this system it is necessary to use a set of three split conductor transformers at each end of the line, the secondaries of which are connected to a relay for operating a trip circuit on the circuit breaker. The value of the current to cause a relay to operate will depend on the distance of the fault from the current transformers. Should a fault arise near to the switchgear, that switch will be

tripped immediately, but the switch at the far end may not necessarily trip because the impedance of the two splits is not so very different, and the unbalance of fluxes may not produce sufficient secondary E.M.F. to operate the relay.

Reversal of Current in the Transformer.

Now look at the first illustration and note reversal of current in transformer. This difficulty was overcome by the use of current transformers having a high primary reactance of such value that the

end of the line. This type of switch has an ordinary pair of contacts on the bus bar side, but double contacts on the feeder side, one pair coupled to each split and insulated from each other. If a fault causes the split conductor relay to operate and open one circuit breaker, an infinite impedance is introduced between the two split conductors, and also the split having the fault will be the only one carrying current at the opposite end, and that switch in turn will immediately open. In this scheme, high reactance transformers are not necessary, though the fault value is still dependent upon the distance of the relay from the fault.

How Split Conductor Relays Work.

Split conductor relays work on the electro-magnet principle with a gravity-controlled armature system. The fault value for operation of the relay is usually for a difference of 25 to 50 amperes between the currents in the splits, irrespective of the length of the line.

T'd lines may be connected to split conductor feeders providing the T'd main is also a split conductor

type, and a split conductor circuit breaker is used.

Jointing Split Conductor Cables.

When jointing split conductor cables, especially on short lines, care must be taken to keep the resistance of the joints equal, otherwise differences in balance of current through splits will arise and the stability factor affected.

The Contacts.

Care should also be taken with the split conductor switch contacts, for considerable difference of resistances can be obtained by poor maintenance work.

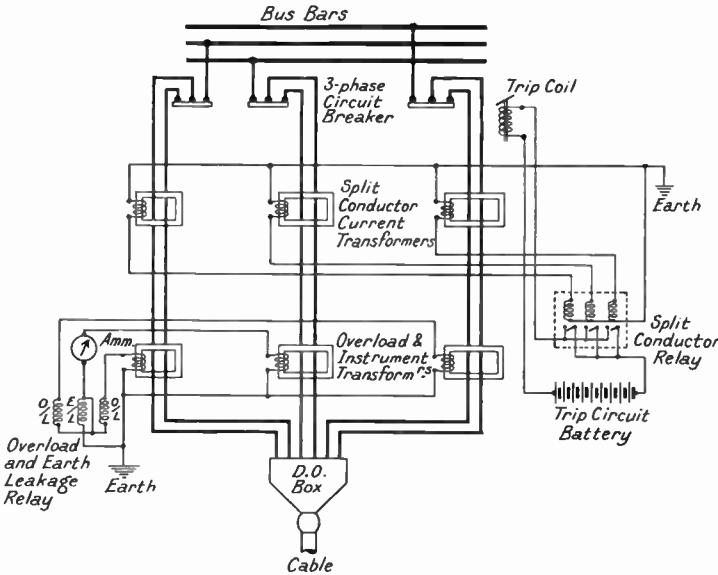

COMPLETE THREE-PHASE DIAGRAM OF SPLIT CONDUCTOR CABLE PROTECTION.

difference in impedance values between the two splits was made sufficient at low fault currents to operate the relay wherever the fault developed on the line. This method had one great disadvantage in so far as the reactance had to be designed to suit the impedance value of the feeder, so that standardisation of current transformers was impossible. Furthermore, to obtain a good stability factor, the current transformers had to be large and expensive.

Split Conductor Switches.

These disadvantages were overcome by the use of split conductor switches at each



The Editor invites correspondence from readers on any subject of general interest to members of the electrical engineering profession. Letters should be addressed to THE EDITOR, The Practical Electrical Engineer, 8-11, Southampton Street, Strand, W.C.2.

In the March issue we invited readers to send us their comments on our notes regarding the price of electric lamps. We have received many interesting letters and after due consideration we have decided to award the guinea offered for the most interesting contribution to Mr. M. E. Shoenberg, whose letter is published below. In view of the interest aroused we are also publishing a further selection of the letters sent in, and these will be paid for at our usual rates.

Lamp Prices.

SIR,—The ideal state of affairs is when the manufacturer makes the greatest nett profit, whilst giving the public adequate service. Adequate service may be defined as such service in quality, prompt replacements, and price—in the order named—as will encourage an ever increasing demand for his products.

Taking the present lamp situation, we have a product of high quality, easy to obtain, and at a price which is no restriction to its extended use.

In addition, and solely due to the fact that a good profit is made by the lamp manufacturer, the community enjoys the very considerable benefits which accrue from constant scientific research, maintained by certain well known firms.

We are, for instance, now witnessing the development of very high efficiency vapour lamps. A development which has cost, and is costing, tens of thousands of pounds, which is giving us one or two types of lamp to choose from, and which will benefit every user of lamps throughout the world.

Had we as lamp purchasers been charged sixpence, or even threepence, less per 60-watt lamp, this research would have been impossible, owing to lack of funds.

And what of our sixpences? They would have gone, for the most part, in odd packets of cigarettes or frittered away in mere nothings: and the price paid for such fritterings would have been the absolute stagnation of the lamp industry. A national calamity.

In effect, we pay a small amount towards the cost of research and improvement, each time we purchase a lamp, and we receive more than adequate value in return.

Provided a manufacturer gives high quality, prompt service and regular improvement following research, then the more profit he makes the better.

Such a firm can, and usually does, treat its staff and workmen well; it observes the recognised rates and conditions, and usually provides sports grounds and recreative clubs. It can afford to do so.

It is the thin profit firm which has to dodge doubtful stuff through, just keep within the specification, and cut its salaries and wages to the bone, and with whom it is a trial to deal. Whereas the high-profit firm will have the best staff, the best materials and insists on its clients' interests being looked after well and generously.

W. T. WARDALE, A.M.Inst.E.E. (Sheffield, 7).

Fair Return for Enterprise.

SIR,—I have read with great interest the clear and broadminded summing up of the lamp price question which appeared in the March issue of your interesting periodical, and must congratulate you on the definiteness with which you state your belief that the Lamp Manufacturers' Association is good for the electrical industry as a whole. I am surprised, however, you do not go further and include the actual users of the lamps among those who have benefited, as I am convinced that were it not for the Association, the quality of electric lamps would be far below its present high standard.

Unless an association of manufacturers adopts the disastrous policy of cutting prices below a figure that an unattached firm can profitably approach, it must offer something which the latter cannot. In the case of lamps, the extra inducement is apparently better quality, as the superiority of Association lamps over the non-Association lamps—I have tried both—in the light they give and their uniformity, is most marked.

Another point in your article upon which I would like to comment is your suggestion that "the fair price for any manufactured commodity is the price which will yield the highest nett profit to the firm or group of firms manufacturing the article." This sounds far too selfish an axiom to be fair, as to adopt it literally—at any rate, as far as electric lamps are concerned—would be

countenancing making profits at the expense of the whole electrical industry.

For instance, it is quite possible that the lamp manufacturers might consider that it would pay them best to sell half as many lamps at double the price, rather than twice as many lamps at half the price, but if they were to do this what disastrous results it would have on electric progress, since electric lighting is the foundation of the whole electrical industry, and by its restriction in this way, the whole industry built upon it would be restricted. You must agree that prices which brought about such conditions would not be fair.

In these times of interdependency, to my mind the price of a household necessity such as an electric lamp can only be fair if it takes into consideration—in addition to the manufacturers' personal gains—the welfare of the whole electrical industry and the welfare of the user, and it would appear that these principles have actuated the Lamp Association, as the present fixed prices certainly protect the retailer and are high enough to ensure the user getting a good lamp. There is undoubtedly a profit for the manufacturers, but by the time they have paid for research, advertising, delivery, packing and given the retailer his discount, I do not think we should grudge them what is left, as it cannot be more than a fair return for their enterprise.

D. K. FORSDYKE (Chislehurst).

The Viewpoint of an Electrical Contractor.

SIR,—The remarks given below are from the viewpoint of an electrical contractor, but it seems to me they should also apply to the consumer (whether a private man or an industrial user) and the *manufacturer*.

We have at present with us an association of lamp manufacturers comprising the best known firms in this country, and thus *stable* prices and *fair* trading conditions are maintained.

Electric lamp prices to-day seem fair in view of the fact that they have fallen during, say, the last 10 years very much more than the cost of living during the same period.

As one for whom it is essential to supply a reputable article in order to maintain my own trading reputation, I have convinced myself that the quality of Association lamps has improved consistently during the last few years. In other words, the public are getting to-day much more for their money than is actually represented by the lower price, because, after all, the lamp is only sold for the light it gives.

Again, from the point of view of the industrial user, it is very important for him to know that when he puts in a lamp in a certain position, which, for instance, it may be very difficult for his man to get at, that lamp will give a certain life and a certain light output.

All this has only been achieved by very considerable expenditure by the manufacturers concerned on research, and if they did not have a reasonable margin of profit, and what is more (and this is even more important), stabilised trading conditions, they would not have incurred this expenditure.

I can well remember in the old days, before

the Carbon Lamp Association was formed, the price of a lamp was below 6d.—there was nothing in it for either the manufacturer or retailer—and the public got a very inferior product, which was very expensive when running costs were taken into account.

Speaking purely from the electrical contracting side, undoubtedly the Association of Lamp Manufacturers in this country does a great deal to help the industry by its sales promotion campaigns, conducted by the Lighting Service Bureau, although this is also of ultimate benefit to the user as it results in better illumination. This, again, costs a good deal of money, and if lamp prices were to be cut indiscriminately this expenditure could not be afforded, resulting thereby in loss of business to electrical contractors, and, at the same time, lowering the standard of lighting in this country.

To sum up, a fair price for any commodity is one which enables the manufacturer to turn out a first-class product as well as give a reasonable profit to the trade distributing it, and I certainly think this applies to the Electric Lamp Manufacturers' Association of to-day.

M. E. SHOENBERG (London, N.W.6).

[The guinea prize is awarded to Mr. Shoenberg.]

A Word for the User.

SIR,—The article in the March issue of your magazine admirably sets out the many advantages of an electric lamp manufacturers' association in so far as the manufacturers and retailers are concerned, but rather neglects the cornerstone of the industry—the user.

Now, what is really a fair price for an electric lamp, or, for that matter, for any manufactured commodity? As you say, it is the price which will yield the highest nett profit to the manufacturer, and presumably you also include by this the trade distributing the article, but I think it must be clearly understood that this is always provided a really first-class product is sold to the public.

As a user, in buying an electric lamp I wish to be assured of an economical conversion of my current to light, and also a regulated period of useful burning life to minimise labour costs in replacing lamps in difficult positions.

There was a black period in the early stages of lamp manufacture when carbon filament lamps could be purchased for an almost incredibly low figure. The user was obtaining an inferior product and the manufacturer was selling at a loss. The retailer was not obtaining sufficient profit to cover his overhead charges, and accordingly users were getting very little or no service from their suppliers, with the result that the industry degenerated.

The Lamp Association was formed and prices were stabilised amongst the various manufacturing members. The retailer now has a fair profit, he has the backing of extensive advertising schemes, good, rapid delivery services, and he is educated in the ideals of quality and service which tend to assist him in the catering for their requirements.

Why should there be a difference in initial

costs of electric lamps?

This question so often perplexes the present-day user. Many makes of lamps are offered to him — those manufactured by the Association firms and retailed at standard prices and other lower-priced makes.

Let us consider the expenses borne by the Association manufacturers, such as research work to improve the quality, Lighting Service Bureaux to raise the general standard of lighting and help the users with their illumination problems, and the extensive backing offered to the retailers, are ultimately to aid the buyer who would be ill-advised to invest in an inferior product, which although effecting some small economies on original outlay, would probably incur heavy expenses throughout burning life.

Price cutting is the thorn in the side of every industry. I am sure the Association manufacturers could *en masse* undercut any outside competitors, but they continue this sane and enlightened policy of stabilised prices with the result that the lamp industry thrives under their protection, and the user benefits by receiving better value for his expenditure on lamp replacements.

L. A. MILLS (Lewisham).

A Simple Dynamo Problem.

SIR,—A laboratory experiment was carried out on a separately excited D.C. generator driven at constant speed to show the effect of armature reaction.

As resistance was cut out the load current varied from 0 up to 21 amps.

What I cannot quite grasp is why the load current should go up as the resistance is taken out. Does this not point to the fact that the bigger load you put on a dynamo (i.e., the higher res.) the less current will be used? This does not seem reasonable. F. L. (Brentwood).

A bigger load is put on a dynamo by reducing the external resistance of the dynamo, not by increasing

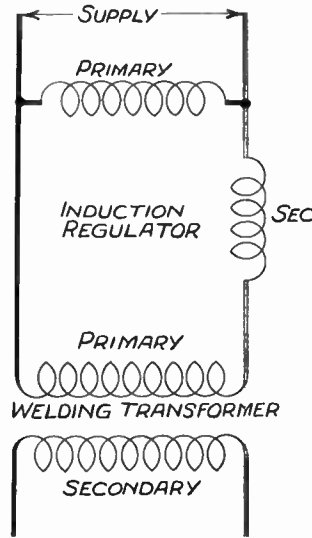

Fig. 1.—DIAGRAM OF CONNECTIONS OF AN INDUCTION REGULATOR.

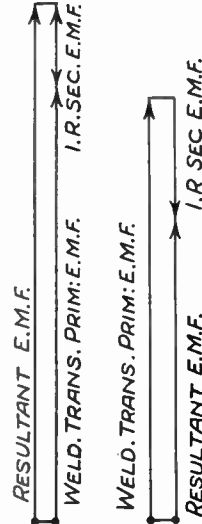

Fig. 2. — VECTOR DIAGRAMS SHOWING RESULTANT VOLTAGE OF THE WELDING TRANSFORMER.

or from the primary of the welding transformer, thus increasing or decreasing the secondary voltage and current in the same ratios. The regulator can be considered as either a transformer with a movable secondary winding, or as an induction motor whose rotor is fixed in any desired position with a gear controlled movement of either 180° or 360°.

As a fixed single-phase induction motor, the induced E.M.F. in the rotor will be in phase opposition to the stator E.M.F. If the rotor be moved in either direction as far as 90°, the rotor E.M.F. will be reduced to zero. A further 90° movement will cause the E.M.F. to rise to its full value in the opposite direction. Thus, if the secondary winding be connected in series with the primary winding of the welding transformer, the primary voltage will be increased or decreased as desired by the induction regulator secondary voltage. Diagram of connections is shown in Fig. 1. It is usually found convenient to make the stator the secondary winding, and the rotor the primary winding, the supply voltage to the rotor being led by flexible leads.

Vector diagrams in Fig. 2 show the resultant voltage of the welding transformer with the regulator voltage added and subtracted respectively. In the case of 3-phase regulators the regulator voltage is constant but is added vectorially as seen by Fig. 3.

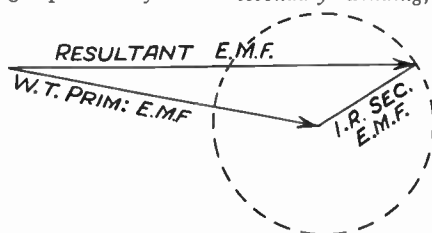

Fig. 3.—VECTOR DIAGRAM FOR 3-PHASE REGULATORS.

it. Thus, ten 100-volt lamps in parallel across the circuit form a bigger load than a single lamp, but the combined resistance of the lamps in parallel is one-tenth of the resistance of a single lamp.

Using an Induction Regulator.

SIR,—What is the principle of an induction regulator, and how could it be used upon a low voltage resistance welding machine for regulating the current?

J. F. DAVIES (Walsall).

PITMAN'S PRACTICAL BOOKS

ELECTRICAL CONTRACTING ORGANIZATION & ROUTINE

By H. R. Tamton. This book discusses the duties of the various departments of the electrical contractor's business and gives practical information which will help to increase turnover and reduce overhead costs, as well as contribute to the efficiency of the technical work.

342 pp. 12/6 net.

THE ELECTRIC WIRING OF BUILDINGS

By F. C. Raphael, M.I.E.E. Examines the various systems of wiring in present day use, and explains the installation of power, heat, and lighting circuits in modern buildings. A valuable reference work for practical men.

268 pp. 10/6 net.

ELECTRIC CABLES

By Francis W. Main, A.M.I.E.E. A concise treatise on the construction, properties, installation and maintenance of electric cables, for those in charge of workshops and factories. Second Edition.

104 pp. 2/6 net.

**SIR ISAAC PITMAN & SONS, LTD.,
PARKER ST., KINGSWAY, W.C.2**

THE BEST OF OPPORTUNITIES

More than 430,000 men have studied I.C.S. Electrical Courses since 1894. A very considerable percentage of them now hold important and well-paid positions. The reason for this is that these Courses are absolutely the best in the world, having been specially prepared and constantly revised for correspondence tuition by many experts of very high standing at a cost, exclusive of printing, of more than £80,000.

If you wish to make rapid progress in the wonderful and fascinating field of electricity, you owe it to yourself to obtain all particulars of I.C.S. Training and what it can do for you. Among our Courses are the following:—

- | | |
|--|---------------------------------------|
| Complete Electrical Engineering | Engine and Dynamo Running |
| Electrical Designers | Lift Operation and Maintenance |
| Hydro-Electric | Water-Power Electrical |
| Electric Lighting | Mining Electrical |
| Electric Traction | Practical Telephony |
| Steam Electric | Wireless Engineering |
| Gas Electric | Professional Exams. |

Write to-day for our 80-page FREE BOOKLET,

"ELECTRICAL ENGINEERING"

stating the subject in which you are most interested

International Correspondence Schools, Ltd.

238 International Bldgs., Kingsway, London, W.C.2

IMPORTANT TO ALL MOTORISTS

IN a convenient compass will be found all the practical points and special repair methods applicable to the leading makes of cars.

General methods of overhauling a car from end to end are given. Detailed notes on decarbonising, valve grinding, electrical trouble tracing.

How to deal with engine stoppages and erratic running. The maintenance of brakes, steering gear, electrical equipment and bodywork.

Under each of these headings special notes are given dealing with the particular car in which you are interested.

A SPLENDID INVESTMENT FOR ALL INTERESTED IN CAR MAINTENANCE AND REPAIR

FREE CHART

inside PART 2

Now on Sale

Giving full details of the

**DAIMLER
FLUID
FLYWHEEL**

TO BE
COMPLETED
IN ABOUT
24 WEEKLY
PARTS

MODERN MOTOR REPAIR

Obtainable at all Newsagents and Bookstalls,
or by post 1/2 from George Newnes, Ltd.,
8-11, Southampton St., Strand, London, W.C.

PART 3 ON SALE APRIL 28th.

1/- EACH

Geo. Newnes Ltd



*We teach successfully
by correspondence in
all parts of the World*

This 250 PAGE BOOK

ON SUCCESSFUL ENGINEERING CAREERS

Free
ON
REQUEST

Our Handbook "ENGINEERING OPPORTUNITIES" contains a vast amount of useful information and indicates many ways in which a successful career may be planned and followed. It is not merely a pamphlet, but a 250-page book of reference that will alter your entire outlook and earning power.

Among other things, our Handbook outlines courses in *all* branches of Engineering. Those appealing specially to Electrical Engineers include :—

I.E.E.	B.Sc.	G.P.O.	CITY AND GUILDS
ELECTRICAL ENG.			MAINS ENG.
ALTERNATING CURRENT			TELEGRAPHY
ELECTRICAL INSTALLATIONS			TELEPHONY
POWER HOUSE			WIRELESS
TRACTION			TALKING PICTURE ENG.
TELEVISION			ELECTRICITY SUPPLY
ELECTRICAL DESIGN			ELECTRICAL METERS

In the last seven I.E.E. Examinations B.I.E.T. students have returned the remarkable average Pass record of

95.72% SUCCESSES

We undertake to return full fees to any unsuccessful candidate. This is a unique and welcome departure in the Examination coaching field

"ENGINEERING OPPORTUNITIES" should really be in your hands, irrespective of your position or age, education or experience.

Send for your copy to-day—**FREE** and **POST FREE**. A specialist's advice on your particular career is also awaiting your request—without obligation.

BRITISH INSTITUTE OF ENGINEERING TECHNOLOGY

383, SHAKESPEARE HOUSE, 29-31, OXFORD ST., LONDON, W.1