

PRACTICAL COMPUTING

FOR BUSINESS AND PROFESSIONAL MICRO USERS

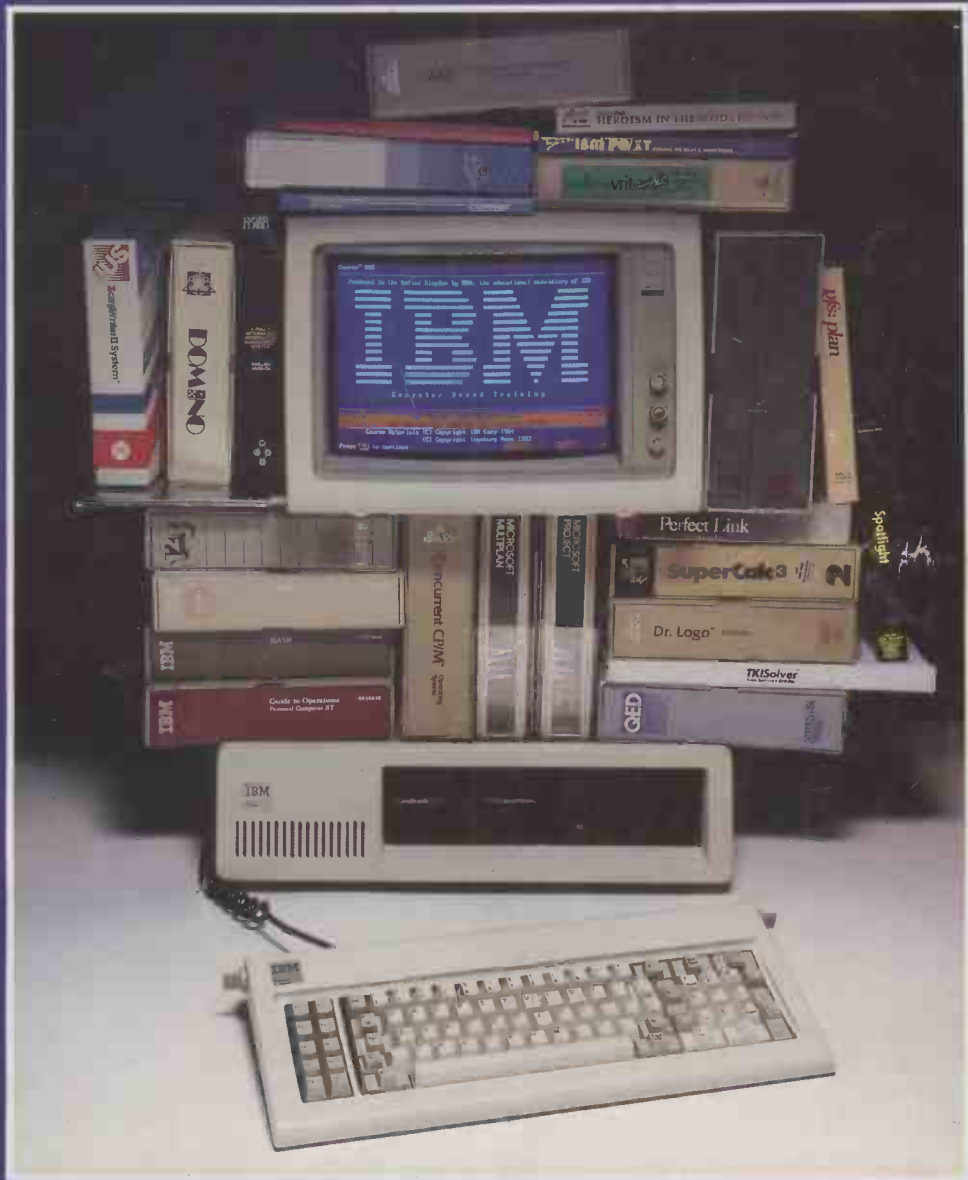

IBM SOFTWARE AND THE CASE FOR THE CLONES

HARDWARE Atari ST • New Amstrad • Tandy 200

SOFTWARE Helix • Thoughtware • Options

PLUS How to design bug-free programs

PERFECT WRITER II
REAL POWER
FOR £149

WIN A SAFARI TO KENYA

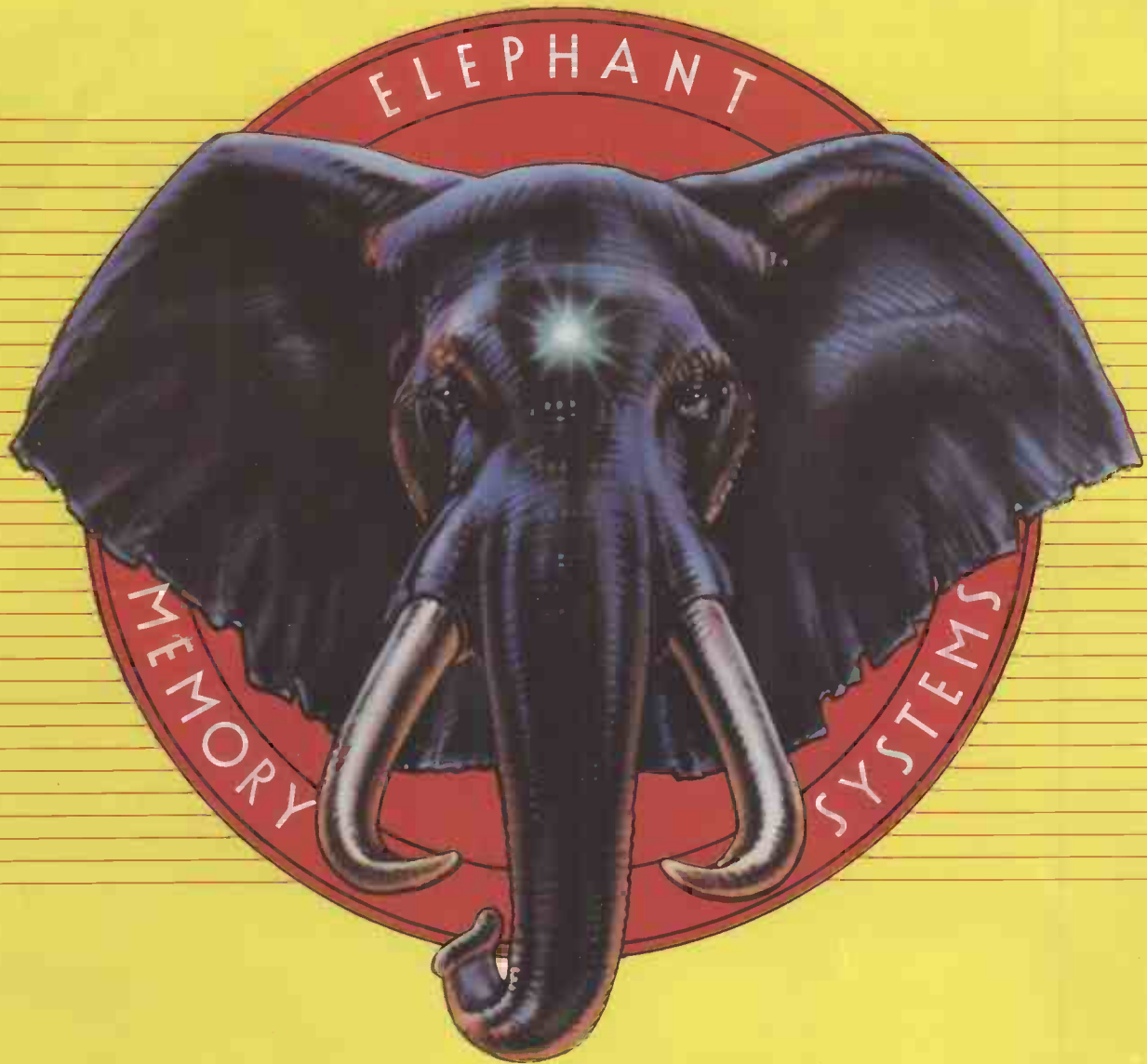

An opportunity to win a super ELEPHANT Safari for two persons – luxury accommodation, travel and all expenses paid – with every purchase of a 10-disk ELEPHANT pack made between 1st April and 30th June 1985! Look for your participating ELEPHANT Dealer's special Competition Display and pick up a simple puzzle card with your purchase. Send it to us with an ELEPHANT 10-pack top to receive, completely free, an ELEPHANT 'T' shirt and an opportunity in this exciting competition. Each subsequent 10-pack purchase and completed puzzle card gives you another opportunity – there's no limit! Should you have difficulty in obtaining ELEPHANT products, phone or write for details of your nearest Dealer.

Dennison

ELEPHANT NEVER FORGETS

Dennison Manufacturing Co. Ltd.

Colonial Way, Watford, Herts WD2 4JY, Tel: Watford (0923) 41244, Telex: 923321

France: Soroclass, 45, rue de l'Est - 92100, Boulogne

Tel. Réseau de Distribution: 606.98.99, Administration des Ventes: 605.70.78, Telex: EMS 206 436 F

Germany: Marcom Computerzubehör GmbH, Podbielskistr. 321, 3000 Hannover 51, Tel: (0511) 647420, Telex: 923818

Other Countries: Dennison International Company, 4006 Erkrath 1, Matthias-Claudius-Strasse 9, Telex: 858 6600

● Circle No. 101



IBM PC SPECIAL

This month's special section covers the IBM PC and its current dominant position in the business micro market. Why buy an IBM PC? Is there any choice? *Jack Schofield* investigates on page 96. On page 99 *Robert Piper* explains how to judge an IBMulator, and provides a comparison table to bring out the differences between IBM's machines and the major look-alikes. Finally turn to page 105 for an assessment of which packages should you consider buying as Jack Schofield offers a brief overview of the software market. **96**

INSIDE



Thoughtware Private tuition for managers — page 80.



Business software Ten classic programs — page 91.

PRACTICAL COMPUTING

JUNE 1985 CONTENTS

ATARI 520ST

The Jackintosh has finally arrived. Atari offers a complete 68000-based system for less than the cost of the Macintosh's 128K to 512K upgrade **55**

AMSTRAD CPC-664

The well-established 464 has been repackaged with a built-in 3in. disc drive. **59**

TANDY 200

Lap computers enter a new era of smartness and user-friendliness with this big-screen version of the popular Tandy 100. **60**

GOUPIL 3PC

An MS-DOS based micro from south of Calais attempts to make an impact in the U.K. **64**

HEADSTART ATS

Intertec readies a cheap 80286-based machine to take advantage of the shortage of IBM PC/ATs. Will it sell as well as the Superbrain? **68**

OPTIONS

Glyn Moody benchtests Sagesoft's fascinating new probabilistic business package, which takes over where your spreadsheet leaves off **72**

PERFECT WRITER II

Susan Curran tries the program with which Thorn EMI plans to take over the word-processing market **74**

THOUGHTWARE

A program to run on the IBM PC that could turn you into a better manager. *Glyn Moody* reports **80**

HELIX ON THE MAC

Do icons really make complicated packages easy to use? *Mike Lewis* takes a look at Helix, a powerful new database, to find out **82**

TOP TEN BUSINESS PACKAGES

Which programs are standards, and why? We look at the old faithfuls like VisiCalc and WordStar, and their contemporary rivals as essential buys **91**

APPLICATIONS — BUPA

Multi-user micros are making a valuable contribution in the medical field. We look at BUPA's approach to systems **108**

NEWS

HARDWARE NEWS

Phone companies invade micro market **15**

IBM NEWS

Multi-tasking Topview arrives in the U.K. **21**

GENERAL NEWS

Communications is the main theme **25**

SOFTWARE NEWS

Quartet Mac spreadsheet, and WP for Lotus 1-2-3 **26**

OPEN FILE

CONTENTS

Details of this month's programming features **111**

MULTIPLE CHOICE

Analysing the results from tests and surveys **112**

WORDSTAR

How to do proportional spacing **116**

WARNIER TECHNIQUES

Systematic approaches to program design **118**

BBC

122

APPLE

125

SHARP

127

END OF FILE

With Superbrain and Amstrad **128**

REGULARS

EDITORIAL

Which chip for the future? **5**

FEEDBACK

Letters and corrections **7**

INTERVIEW

Bob Abbott on security **29**

ASK PC

We answer your queries **31**

CHIP-CHAT

Ray Coles holds Forth **37**

S/W WORKSHOP

More from Mike Lewis **43**

COMMS LINK

Up-to-date BBS list **49**

THE LEVY SERIES

The idea of Continuo **89**

BOOK REVIEWS

More for the Apple II **134**

NEXT MONTH

What's in store . . . **139**

LAST WORD

A day in the life **141**

The Disk to launch a thousand programs

Here it is at last. One disk that will prove to be the solution for many business problems. A disk which will allow you to develop your own programs. Exactly the way you want.

The disk contains one of the most revolutionary programs of the year. Sycero. No matter whether you are a computer novice or a seasoned programming professional, Sycero enables you to build any type of business program.

No matter what your business.

From traditional business applications like stock control, invoicing, database management and inventory to an unimaginable number of specific industry applications.

And the beauty of Sycero is that it takes no time at all to build a simple program for yourself. When you've built one, expanding it, or building other, more complex programs, is easy.

Once you start developing your own programs you'll wonder how you ever got on before. And no longer will you have to bend over backwards to make do because the program you bought off the shelf does things differently to the way you wanted.

No matter what your business, there's now one program for the job.

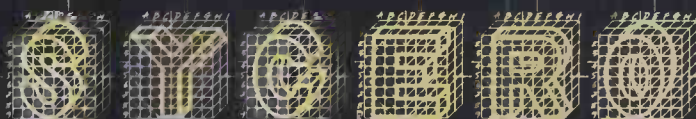

*The Businessman's
Program Builder*

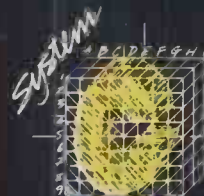

System C Limited
Tel 0622 55142

System C Limited

7 Mill Street Maidstone
Kent ME15 6XW
Tel 0622 55142

THE CHIPS ARE DOWN

THE MICROCOMPUTER market is just about to divide into two warring factions. On the one side will be micros which use the Intel 80186 and 80286 chips; on the other, 68000-based machines.

In the first camp, the major companies will be IBM, Tandy, ACT and the numberless makers of IBM PC/AT clones. Kaypro, Intertec and Durango will be among the first with AT emulators, but countless others will follow. In the second camp, the major players will include Apple, Atari and Sinclair. Together they might not give you pause for thought, but the entry of the massive AT&T corporation certainly will.

It now seems likely that AT&T will launch its new 7300 micro shortly, and this is believed to use the Motorola 68010 chip instead of the 80286. This represents a decisive departure from the Intel 8086. This represents a decisive departure from the Intel 8086 used in the AT&T 6300, which is better known in the U.K. as the Olivetti M-24. Add AT&T to the 68000 camp, and the grouping will be able to match the 80286-ers in volume of sales and in value. At least, that's the theory.

The 68000 camp has a problem, which is a chronic shortage of software. Apple's Macintosh is only just beginning to build up a software base, though it is nowhere near as comprehensive as that of the IBM PC. The Sinclair QL remains desperately short of applications software, though the systems software, languages and tools are now starting to come through. The Atari ST micros remain an unknown quantity, though the software support building up behind the scenes is impressive. However, there you have three completely separate operating systems, with AT&T about to launch a fourth, Unix.

Again, Unix is a disaster area from the point of view of personal-computer software. There is very little single-user software of the VisiCalc, Lotus 1-2-3 and Framework type, which is what people want to buy. Also, most current Unix software performs poorly and costs much more than comparable IBM PC programs.

However, it would be possible to implement Gem — the Digital Research front end that makes the Atari ST work like a colour Macintosh — to run under Unix. And experience with the QL shows that it is not hard to transfer existing 68000 programs on to other machines with the same processor. In other words, a Unix-based Gem-like multi-user environment could be a strong possibility for the future. And that would be good.

What can the 80286 camp offer to rival that? There is no easy answer. The fact is that PC-DOS and MS-DOS, which started life as a quick and dirty rewrite of CP/M, are running out of steam. The 80286 offers a new lease of life, but that may be a temporary

phenomenon. The first problem is that PC-DOS can directly address only 640K of RAM. The second problem is that PC-DOS only runs in 8086 mode even on the 80286. This means the chip itself can only address 1Mbyte instead of the full 16Mbyte. And in 8086 mode, the full multi-user/multi-tasking memory-managing power of the 80286 also remains inaccessible.

Unless something radical happens, PC-DOS is on the way up a blind alley. Offering Unix as an escape route — which Microsoft seems to want to do with Xenix — is useless if you can't take PC-DOS software along too.

The timetable for this scenario depends mainly on how quickly the price of 256K RAM chips falls, and how quickly 1Mbit chips become available in quantity. At today's prices, equipping a micro with less than 64K of RAM is sheer stupidity. This year, 128K is set to become the normal minimum. Even today most IBM PCs have 256K, and next year it should be 512K. In the foreseeable future that 640K limit — or 1Mbyte with a RAM disc — is going to look very sick indeed.

The microcomputer industry moves quickly, and yesterday's products are very speedily left behind. Not long ago, for example, buying a £2,000 business micro meant a 64K Z-80 CP/M machine or nothing. Today that's been reduced to a £500 home system from Amstrad or Tatung.

Not everyone is certain it couldn't happen again.

5 YEARS AGO...

A home computer which talks is how Texas Instruments plans to market the TI-99/4 now available at more than 20 distributors in the U.K. Texas Instruments hopes to break into new sectors of the market with a sustained advertising campaign.

Built round the TI 16-bit 9900 chip, the computer consists of a console with 16K of RAM, a sound generator, full-colour graphics and an optional speech synthesiser. As yet the system is compatible only with the U.S. television standards so the price of nearly £1,000 includes a new 14in. colour monitor. Texas Instruments consumer division general manager, Ian Davies, claims: "There is a certain utility in this. When people buy the system they will also be buying a second colour TV set".

The computer is supplied with a range of plug-in firmware modules, each with 30K of ROM, including programs for chess, grammar for children and a household finance package. A software module which will use the speech synthesiser to teach children how to read is still in the prototype stage.

For the home programmer the TI-99/4 has Basic in 14K of ROM. An RS232 adaptor is available as an accessory and floppy disc drives should be on the market later this summer.

PC Volume 3 Issue 6

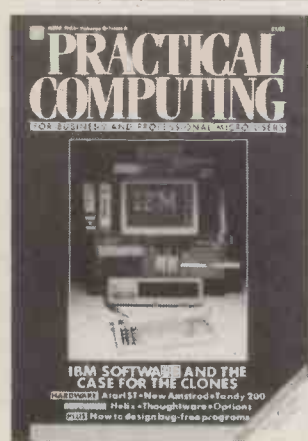

Cover feature: page 96.
Photo: Trevor Bailey.

EDITORIAL 01-661 3609
Telecom Gold 81:JET727

Editor
JACK SCHOFIELD

Deputy Editor
GLYN MOODY
Assistant Editor
IAN STOBIE
Art Editor
HUGH ANDERSON
Production Editor
JOHN LIEBMANN
Sub-editor
CAROL HAMMOND
Editorial Secretary
SUE JORDAN

Consultants
CHRIS BIDMEAD
PETER LAURIE

ADVERTISING 01-661 3612

Advertisement Manager
NITIN JOSHI 01-661 3021

Assistant Advertisement
Manager
NEIL MARCHANT 01-661 8626

Advertisement Executives
RICHARD MILBOURN
01-661 8100

JANET THORPE 01-661 3468
IAN WALKER 01-661 8425

Advertisement Secretary
JOAN BORRELL
Midlands office

DAVID HARVETT 021-356 4838
Northern office

GEOFF AIKIN 061-872 8861

Classified
LUCY O'SULLIVAN 01-661 8163

Group Advertisement Manager
SHOBHAN GAJJAR 01-661 8441

PUBLISHER **GAVIN HOWE**

PUBLISHED by Electrical-Electronic Press, Quadrant House, The Quadrant, Sutton, Surrey SM2 5AS. Tel: 01-661 3500.

Telex/grams 892084 BISPRS G.

DISTRIBUTED by Business Press International Ltd, Quadrant House, The Quadrant, Sutton, Surrey SM2 5AS.

SUBSCRIPTIONS: U.K. £15.50 per annum; overseas £30 per annum; selling price in Eire subject to currency exchange fluctuations and VAT; airmail rates available on application to Subscriptions Manager, Business Press International Ltd, Oakfield House, Perrymount Road, Haywards Heath, Sussex RH16 3DH. Tel: (0444) 459188.

Printed in Great Britain for the proprietors Business Press International Ltd by Greenaway Harrison Web Offset Division, Southend-on-Sea. Typeset by Lithotype Design, London EC1.

©Business Press International Ltd 1985

ISSN 0141-5433

Would-be authors are welcome to send articles to the Editor but PC cannot undertake to return them. Payment is at £35 per published page. Submissions should be typed or computer-printed and should include a tape or disc of any program. Every effort is made to check articles and listings but PC cannot guarantee that programs will run and can accept no responsibility for any errors.

Now you need not pay through the nose for a good face!

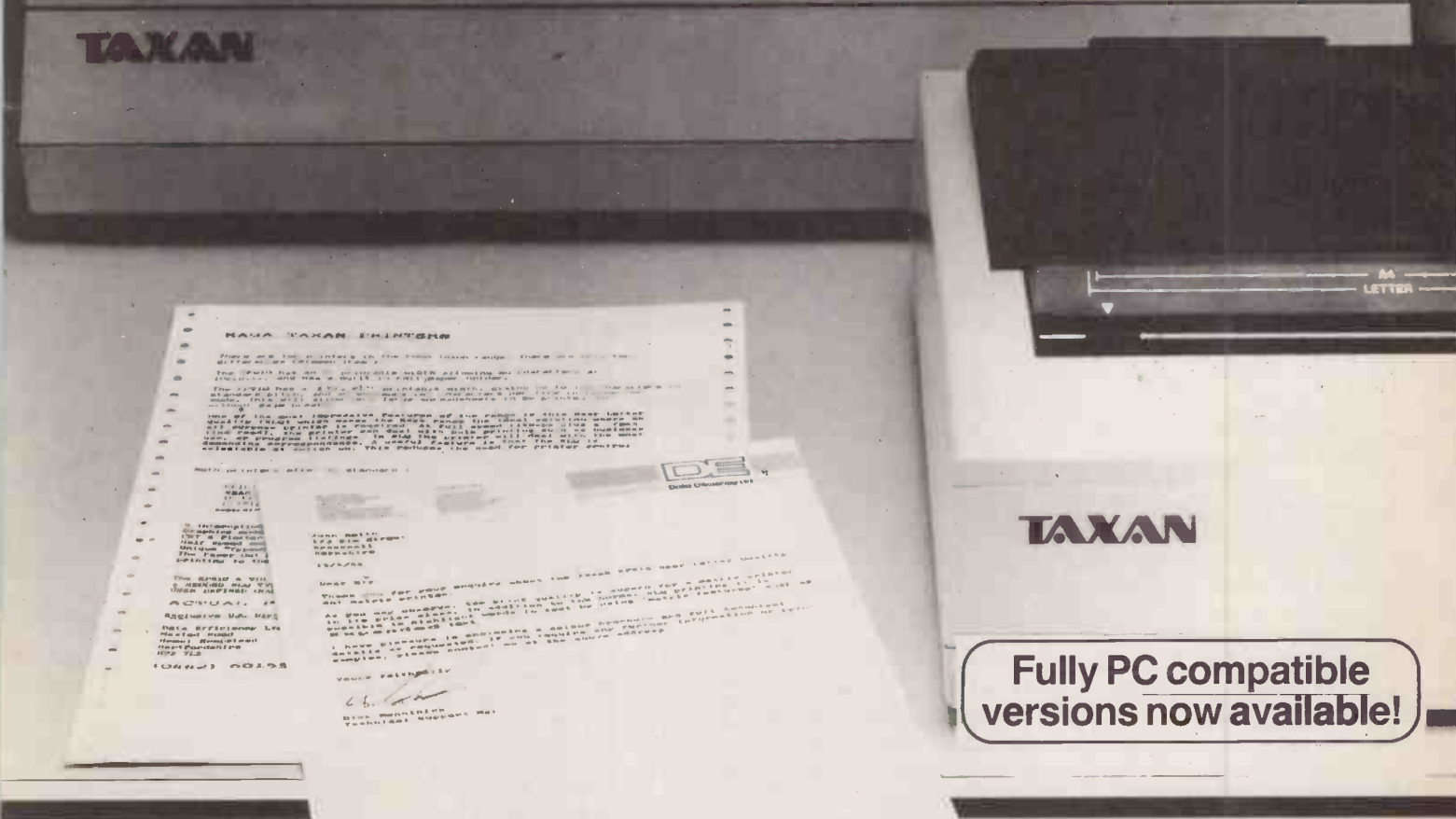

Fully PC compatible versions now available!

Because Taxan dot matrix printers combine quality, value for money and proven reliability.

* KP910 prints extra wide – 156 char/line (normal) and 265 char/line (condensed) – ideal for Spreadsheets

Print Quality

Both the KP810 and KP910 have all the standard features found in dot matrix graphics printers, but when it comes to Near Letter Quality (NLQ) printing both really excel – producing output equalling or exceeding the quality of much higher priced units.

Features

- * 140 cps print performance
- * NLQ double pass printing
- * Downloadable character sets (DRAFT standard, NLQ optional)
- * Wide choice of optional NLQ typefaces available in ROM
- * Unique incremental printing mode
- * Friction and tractor feed
- * Standard Centronics interface (serial option available)
- * Fully compatible with all popular software packages including Lotus 1-2-3, Applewriter, Wordwise etc.

Value for money

KP810 (80 column) around £339 (plus VAT)

KP910 (156 column) around £429 (plus VAT)

PC compatible versions

KP810PC (80 column) around £399 (plus VAT)

KP910PC (156 column) around £499 (plus VAT)

Prices correct at time of press

Distributed exclusively to dealers nationwide by DDL. Call us for the address of your nearest stockists.



THE NEW FORCE IN DISTRIBUTION

5 King's Ride Park,
Ascot, Berks. SL5 8BP
Tel: 0990 28921
Telex: 846303 DD LTD G.

dBase II books

I NOTE from the April edition of *Practical Computing* that your reviewer mentions that he has only seen two British books on dBase II, namely by Rose Deakin and Mario de Pace. I would like to point out to you that there is in fact a third British book in print entitled *dBase II: Developing Applications* by Tony Shaw, published by us — a review copy of which was sent to you in May 1984.

We feel that our book has a lot to offer the reader having a particular emphasis on practical examples of well-designed and properly analysed applications. Perhaps you would bear this in mind for future review in your journal.

SARAH MALLEN,
Addison-Wesley Publishers Ltd,
Wokingham,
Berkshire.

Magazine indexes

FOR SOME TIME I have been keeping an index to the various computer magazines that I regularly buy. I obviously keep this in a database program on my computer. This involves a lot of tedious typing and the titles quite often do not give any clue to the contents of an article.

I have wondered if it would be possible for magazines to provide a detailed index each month in a form that could be read by the computer. There would seem to be at least three ways of doing this:

1. In bar-code form in the magazine, though at present I think few readers have access to a bar-code reader.
2. As an ASCH text file on a Bulletin Board.
3. On Prestel, either as text on a frame in a standard format so that it could be read into a database with some simple software, or as a telesoftware file.

Having such an index would also be a useful indicator of the date of publication.

J M BRISCOE,
Fort William,
Inverness.

THE EDITOR REPLIES:

Information Alert publishes an index of most of the useful microcomputer magazines including *Practical Computing*, *Personal Computer World* and *Byte*. The 1984 cumulated edition costs £14 from them at 38 Part Street, Southport, Merseyside PR8 1HY. We will also look into the Bulletin Board idea.

FEEDBACK

Our Feedback columns offer readers the opportunity of bringing their computing experience and problems to the attention of others, as well as to seek our advice or to make suggestions, which we are always happy to receive. Make sure you use Feedback — it is your chance to keep in touch.

Write to

Feedback, *Practical Computing*,
Quadrant House, The Quadrant,
Sutton, Surrey SM2 5AS

LOGO OR APL?

I MUCH enjoyed Boris Allan's article in your February issue on APL and was particularly pleased to note his endorsement of its use in education and especially in mathematics.

I must however point out an error in his assessment of APL's list-processing capability which far from being rudimentary is in fact considerably in advance of other languages such as Logo. For example, the more recent APLs allow tables of tables — or more exactly n-dimensional arrays of arrays for the more mathematical. Logo only allows strings of strings, or more exactly one-dimensional vectors, of vectors.

In addition APL allows these lists to be acted on directly, whereas Logo insists on breaking them down into their individual elements before operating on them. Thus an APL list of lists can have arithmetic calculations performed on it as a whole. As a simple example two arrays of any complexity can be multiplied together in a single instruction. In contrast, Logo would require a loop to be set up for corresponding numbers to be multiplied together two at a time.

Logo's main advantage has been the simplicity of its turtle graphics as an introductory environment for young children. As yet no APL implementation has included turtle graphics although this would be straightforward. The reason is probably that APL has not been targeted at the young child. MicroAPL's version of APL for the Sinclair QL — also referred to in your February issue — included colour graphics.

The structures of Logo and APL have some similarity and most Logo users are quick to see the attractions of APL. If any of your readers wish to know more about APL please write to the British APL Association, 13 Mansfield Street, London W1B 0BP, or to me.

DAVID WEATHERBY,
IP Sharp Associates,
Heron House,
10 Dean Farrar Street,
London SW1H 0DX.

Software piracy

IN YOUR April issue in Feedback, Mr Hall's letter "Preventing software piracy" dismisses the software protection approach to rendering a disc uncopyable, out of hand.

In my experience, good software protection systems that have been broken, has been due to the user removing the code which looks for the unique "fingerprints" put on the disc to identify the legitimate disc. This copy-busting technique works equally well with dongles — by removing the code to check for

the dongle, no dongle is necessary to run the software program. In view of this, I favour software protection through rendering the disc uncopyable more useful than dongles, because once the protection gets broken — as it inevitably does — the software house can alter their protection system faster than it would take them to design a new dongle.

Dongles have the disadvantage — as Mr Hall pointed out — of having to be physically connected to the computer when the package needs to run, which increases the aggravation in getting a package working on the user's system.

The dongle concept does have

one major advantage over the copy protection program method, in that the internal workings of the dongle are invisible to the person attempting to break the protection. Some good ideas involving pseudo-random number generators, contained in the dongle can increase the level of protection.

I believe that the best form of protection is a fusion of the two methods, using the best of both systems. The most impressive protection I have seen uses the data and program encryption used by the copy protection program, and the pseudo-random number generation facilities of the dongle. The package consists of a program to modify the program to be protected and an access key, a small black box with some photo-sensors at one end, and an LCD display panel on the other.

Extra code is added to the program before it is encrypted, which displays a flashing pattern on the user's display and by holding the photo-sensors to the screen over the flashing pattern, a code of five letters or digits is given which the user enters via the keyboard, and the program starts. The code will always be unique, as the time and date within the computer is used to generate the flashing display, and the access key has a clock built-in.

The advantages of this system overcome all of the disadvantages of either types of protection and allow levels of security allowing access to the program only at certain times, or having a hierarchy of users, such that in a multi-user accounting system, on the personnel department, with their dongle, can access personnel records.

These access keys cost about the same as a dongle and last for about three years, using one hearing-aid battery. I suspect that there will be no need for a dongle standard as suggested by Mr Hall, as protection technology is moving away from the hard-wired approach.

NIGEL SMITH,
Formaster U.K. Corp.,
Slough,
Berkshire.

Word processing

WHILE reading Susan Curran's excellent section on word processing in April's issue of *Practical Computing*, I noticed that she seemed to be unable to persuade her printer to right-justify proportionally spaced text.

There is a cheap post-processor program on the market which

(continued on next page)

(continued from previous page) may be used to print text files created with WordStar, or with any other word processor/editor which can embed control codes in the text. It supports all of WordStar's printer control commands, plus the ability to justify both standard and proportionally spaced text to either the left, right or both left and right margins, or to centre lines. The program justifies text to both margins by choosing a suitable space width, thereby allowing output much like the format used in this magazine. Since proportionally spaced text results in a greater type density, the program reformats the text to suit the chosen display format.

The program, called Printmaster, is available from Script Software Products for £35 inclusive.

I HARDING
Script Software Products,
61 Cliffe Road,
Glossop,
Derbyshire SK13 8NT.

THE word-processing review in the April edition of *Practical Computing* contains discrepancies which we feel we must correct.

Perfect Writer II from Thorn EMI Computer Software is correctly listed by your reviewer Susan Curran as an ideal program for writers and journalists. However, in the accompanying text, it becomes clear that Ms Curran has actually used the old Perfect Writer version 1 and not Perfect Writer II which was launched in January.

Her remarks about screen display bearing little resemblance to hard copy are misleading. Perfect Writer version 1 fell into the class of word processors which were not strictly WYSIWYG. However, Perfect Writer II combines the best of both worlds. Its default mode is to print an exact reproduction of what is displayed on the screen. However, for users with more

specialised needs, Perfect Writer II will use embedded environment commands — but only when so instructed by the user. Hence the powerful embedded format technique of the original Perfect has been successfully combined with WYSIWYG to provide a word processor which pleases everyone.

ELIZABETH WARHURST,
Thorn EMI Computer Software,
Farnborough,
Hampshire.

THE EDITOR ADDS: Susan Curran's review of Perfect Writer II appears in this issue, page 74.

SUSAN CURRAN'S generally excellent reviews of word processors for different users picked a far from impressive pair in Tandy and WordStar for her "Output that impresses" section. The huge gaps between words and the extra gaps after full stops are typographically awful. I enclose a sample of what can be achieved with Spellbinder and an ordinary daisywheel: proportional spacing and justification and dynamic change of pitch and adjustment of the space allowed to any individual character.

I suspect she's not a book author, from the way she skimps that aspect of the programs she reviews. Almost all word processors allow a writer to produce and store text efficiently; but when it comes to formatting that text for automatic photosetting, some are wonderful, others are a pain in the neck. The subject is too long for a letter. It deserves an article on its own.

MALCOLM MACDONALD,
Offaly,
Ireland.

THE EDITOR REPLIES: As a matter of fact Susan Curran has written at least half a dozen books. But we are impressed with your Spellbinder sample and look forward to reading the article.

Date checker

THERE ARE two errors in the one-line date checker published in IBM Open File in your April issue, page 153. In the text, January to July is seven months not six. In the program line the multiplication sign is wrong — it should be (M>7) not (M*7) — though in this case the text is correct.

The routine does, however, allow negative and non-integer entries to be made. Both these points are easily overcome, but should be implemented for full user-entry validation.

Finally, could somebody please explain why the test will fail for the year 2100?

J CROSS,
The Cross Consultancy,
London W4.

THE EDITOR REPLIES: In spite of the fact that I entered and checked the program, both errors are mine. I must also apologise to Mr Gawlik, for getting his name wrong.

Your further points are correct, but the routine was presented as a one-line date checker, not as a full-blown date-entry routine. Century years are leap years if they are divisible by 400, but not otherwise. So 2000 is a leap year but 2100 is not and the test will fail then.

Complex numbers and matrices

IN YOUR issue dated March 1985 you published a letter enquiring about matrix and complex-number handling, to which you replied that you did not know of any version of Basic running on a micro which had adequate matrix manipulation statements built in.

May I draw your attention to XBasic from Xitan, which we use extensively in teaching. This has matrix input/output — five

statements — string or numeric assignment, scalar multiply, add, subtract, multiply, invert, transpose. All operations may be assigned back to one of the original matrices, and storage allocation is fully dynamic. Precision may be selected between four and 14 digits binary-coded decimal or, where appropriate, integer.

XBasic is available for CP/M-80, CP/M-86 and shortly for MS-DOS.

Unfortunately, SBasic has no complex number facilities — we do miss them. But then, not many micro Fortrans have either.

DR J R CALVERT,
Department of Mechanical
Engineering,
University of Southampton,

Memotech 512 and RS-128

I HAVE been very disappointed to find that you do not appear to have any coverage of one of the best machines on the market, in my opinion even better than the Spectrum and Atari in the home end of the market and superior to the Apple IIe, the Commodore and many other eight-bit machines in the business area.

I have used the Apple IIe and the Commodore for business and I have now spent over £1,500 on my selection of hardware and software. The choice needless to say was none of the above machines, but a Memotech RS-128 with twin disc drives, printer equivalent to an Epson MX-80 and monochrome screen, all as a bundle from Memotech. The machine is supplied with an excellent word processor and spreadsheet. It is capable of operating what appears to be many of the normal industry-standard CP/M programs. The drives can be configured to emulate a number of other machines, including IBM PC and Kaypro.

(continued on page 13)



MICROSURE

COMPREHENSIVE INSURANCE COVER FOR THE BUSINESS USER

Insurance against Breakdown and other causes of loss or damage to Micros, Word-Processors and other Hardware, and including Software, Data Reinstatement and Increased Costs of Working can cost

UNDER 3%

of the values insured.

THERE IS NO REQUIREMENT FOR A MAINTENANCE CONTRACT TO BE IN FORCE.

For a Quotation Request Form please telephone

**BOLTON INSURANCE
SERVICES LTD**

on 01-736 9725
or 01-628 0898

● Circle No. 106

The 'Classic' Menu Generator.

Eliminate all user contact with operating system commands. Use **MENUGEN** from Microft Technology to create menus to access all your regularly used programs.

MENUGEN is a utility which will create menus for any activity. A menu selection will run a program, call another menu, return to a previous menu, run a basic program, execute operating system commands, or exit to the operating system.

```
User Ltd. Selection Menu
1 ASPECT
2 Wordstar
3 Lotus 123
4 Disk formatting menu
5 Exit to operating system

Please type in selection number
```

FACILITIES INCLUDE

UP TO 20 MENU OPTIONS PER MENU SCREEN
UP TO 15 LEVELS OF NESTED MENU
ANY NUMBER OF LINES OF HEADINGS AND FOOTNOTES
USE OF COLOUR - FULLY USER DEFINABLE
'ARE YOU SURE?' MESSAGE OPTION AFTER ANY SELECTION
PROMPTING FOR UP TO 16 PARAMETERS AFTER ANY SELECTION
OPTIONAL PASSWORD PROTECTION ON MENU SELECTIONS
OPTIONAL LOGGING OF ALL SELECTIONS TAKEN

MENUGEN is available for most CP/M, MSDOS or PC DOS micros including IBM PC/XT/AT and compatibles, Sirius, Apricot, HP150, DEC Rainbow, and many Z80 machines. **MENUGEN** costs £48 + VAT (£55.20) for a single user licence, or £120 + VAT (£138) for a network licence, and is available from Microft Technology Limited, The Old Powerhouse, Kew Gardens Station, Kew, Surrey TW93PS. To order, or for further information, telephone 01-9488255.

MENUGEN

MENUGEN is a Trade Mark of Microft Technology Ltd and is a British product.

● Circle No. 107

The Right ✓ Software

WHAT IS RIGHT FOR...

- | | |
|---|--|
| <input checked="" type="checkbox"/> Accounting | <input checked="" type="checkbox"/> Mailing |
| <input checked="" type="checkbox"/> Catering | <input checked="" type="checkbox"/> Marketing |
| <input checked="" type="checkbox"/> Employment agency | <input checked="" type="checkbox"/> Manufacturing |
| <input checked="" type="checkbox"/> Estate agency | <input checked="" type="checkbox"/> Medical profession |
| <input checked="" type="checkbox"/> Farming | <input checked="" type="checkbox"/> Personnel |
| <input checked="" type="checkbox"/> Insurance | <input checked="" type="checkbox"/> Printing |
| <input checked="" type="checkbox"/> Stock control | <input checked="" type="checkbox"/> Retailing |
| <input checked="" type="checkbox"/> Job costing | <input checked="" type="checkbox"/> Time recording |
| <input checked="" type="checkbox"/> Legal profession | <input checked="" type="checkbox"/> Travel agency |

THE ANSWER'S MULTI-USER DATAFLEX

DataFlex. A data management system so versatile it can be adapted to most business needs. Plan the future around DataFlex and you're never tied down to a single unalterable way of doing things.

Its powerful set of software building bricks lend themselves to just about all applications where fast efficient data retrieval and manipulation are of paramount importance. Add comprehensive calculating facilities and you've really got a system for all facets of business. And, of course, DataFlex is portable. So you can move your data from PC to PC, from PC network to multi user system, from 8 bit to 16 bit, without ever having to re-key.

It really is the software for business on the move.

CALL US NOW

DATA FLEX™

(INFORMATION MANAGEMENT) SERVICES LTD
16 Anning Street, New Inn Yard, London EC2A 3HB
Telephone: 01-729 4460 Telex: 27341

All trademarks are acknowledged

● Circle No. 108

With Word, you easily

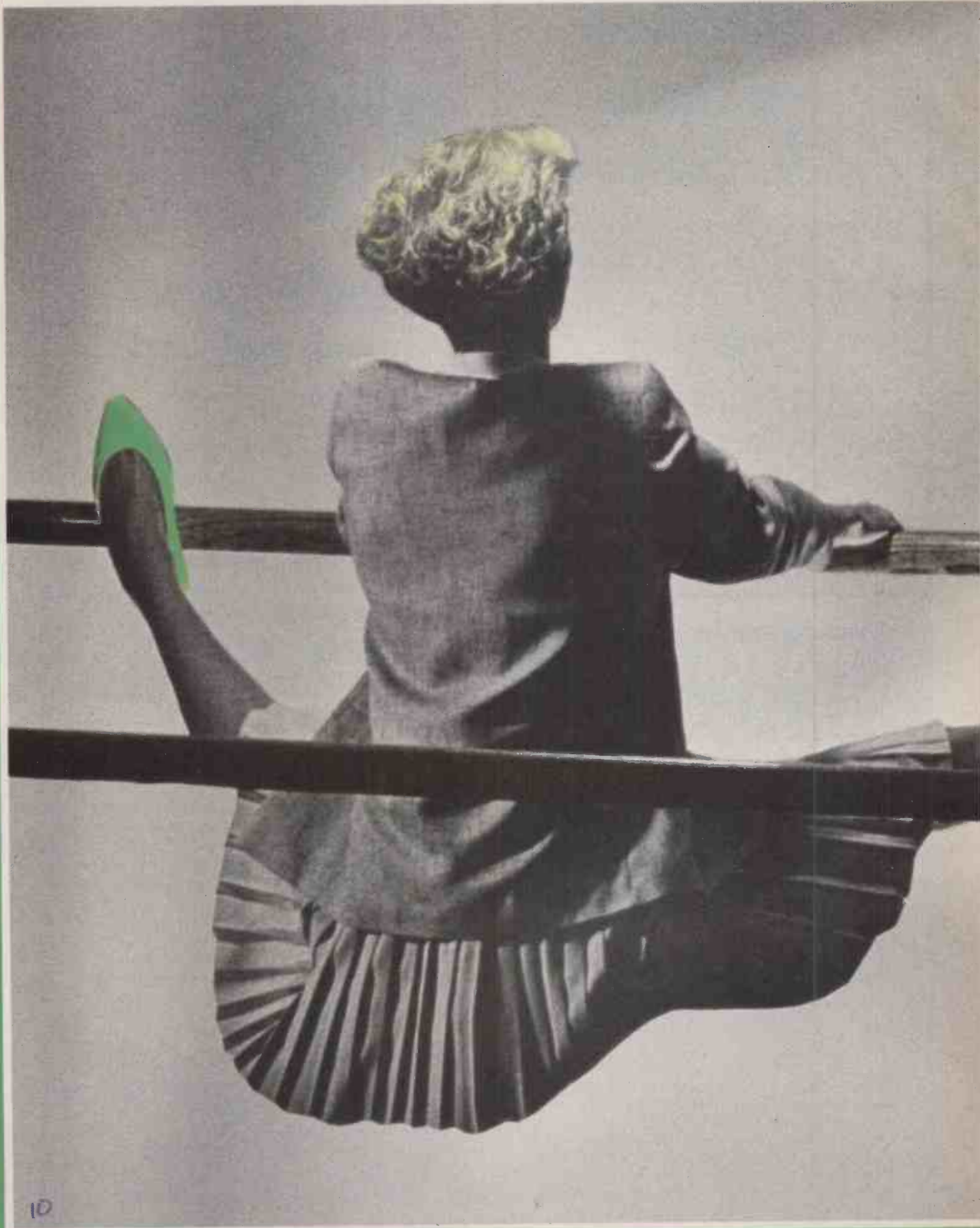

10

• M I C R O S O F T • B U S I

discover a new power.

It's not uncommon to associate increased power with increased complexity.

But with new Word, from Microsoft, quite the reverse applies.

You see, the very increase in power that makes Word the most competent all-round WP package on the market, has been primarily absorbed in making things easier.

For you.

For example, through the use of C.A.I. (Computer Aided Instruction) Word actually teaches you to use the program.

Not on a monkey see, monkey do basis, but by problem and solution, with error analysis.

There's an English spelling checker, that will recognise mistakes in over 100,000 regularly used words and rectify all those occasional little slips.

The manual has been completely rewritten, so that it's easier to understand.

And the Library command allows you to run any other program while Word is still in place.

Of course, we wouldn't forget the mouse. Or the fact that Word operates even faster now.

Because faster operation and mouse support makes Word even easier still, without sacrificing one of the functions that have made the top program in the business.

English commands, style sheets, Undo command, accurate screen to page transfer, merge facility, 7 display formats, 8 windows for easy editing and full integration with other Microsoft products.

So you see, by choosing Word, this new power passes into your hands in the best way possible.

Easily.

● Circle No. 109

New Word 2.

MICROSOFT Right. First time.

Call Microsoft on (07535) 59951 for any further information you require.
Microsoft Ltd., Piper House, Hatch Lane, Windsor, Berkshire SL4 3QJ.

N E S S · S O F T W A R E ·

INTEGRATED, HIGH PERFORMANCE, EXPANDABLE & COST EFFECTIVE

Multi-User Computer?

If you want more than one work-station you must talk to us!

Total Solution and Single Supplier

For a computer system with the sophistication to handle multiple work-stations and numerous different tasks, it is most advisable to contract a single supplier who has total responsibility for the whole system and who has a proven track record.

BROMCOM's experience and multi-layer resource, coupled with our high-level of service and on-going support for the life of your system, will allow you to buy with confidence.

Experience and Reputation

For over five years, BROMCOM have specialised in multi-user computers and earned a nationwide reputation for pioneering excellence in multi-processing technology. We have a large number of installations with systems of up to 16 users in various applications. The range covers all kinds of businesses and sizes. Much of our success is based on our ability to recommend computer solutions that work well and are extremely cost effective.

Wide Range of Applications

BROMCOM have an extensive range of applications available which can be configured to meet your exact requirements. For example:

- * Word Processing and Spreadsheets
- * Database and Information Management
- * Telex, Electronic Mail and Communication
- * Genuine Multi-user Data Processing such as:
 - Stock Control
 - Order Processing and Invoicing
 - Integrated Accounts

The most powerful, expandable and cost effective system

BROMCOM have designed the SuperStar system to be one of the most powerful computers of its type. It provides a clear and simple route for expansion and it is much more cost effective than the minicomputer solution. It owes its power and expandability to its innovative multi-processor architecture in which each user has a dedicated complete set of micro components all integrated in a desk-top unit. It may be looked upon as a "network in a box" achieving far superior speed and cost saving over conventional networks.

Reference sites to back up our claims

Over the years, BROMCOM have built up a client base covering the full spectrum of Industry and Commerce e.g. **Hill Samuel***, **British Telecom**, **Monsanto**, **Philips***, **MORI**, **BUPA***, and many, many more.

SuperStar 



*Case studies of their installations are available on request.

SuperStar is a trade mark of Bromley Computer Consultancy. CP/M is a trade mark of Digital Research. MS-DOS is a trade mark of MICROSOFT.

BROMCOM

417-421 Bromley Road, Bromley, Kent BR1 4PJ
Tel: 01-697 8933 Telex 896691 TLX1RG

Ring Round 1213

SuperStar-16 has a 16-bit Master Processor which runs IMPOS (BROMCOM designed true 16-bit controlling operating system). IMPOS supports CP/M, MS-DOS and shortly Xenix in slave processors in any combination and it is fully upward compatible with ACTION DPC/OS, Televideo MinnOST and TurboDOS.

WHAT IS MULTI-PROCESSING!

Multi-processing is the best possible technique designed to achieve cost effective and high performance multi-user computing. Very many advantages accrue over the networking of Personal Computers or Timesharing micros. It is also, probably, the most unknown and underestimated innovation of micro computer technology. BROMCOM are pioneers in multi-processing technology. They have utilised the very latest techniques to realise the full potential of that technology, e.g.

* Multi-access to a common database with record and file locking.

* Speed far superior to conventional networking or time-sharing micros.

* Cost much less than a network of PCs and comparable to timesharing micros.

* Ease and low cost of expansion. Up to 16 users each with a low cost entry, of no more than £1,000, including screen and keyboard.



16-BIT MASTER PROCESSOR

MAIN FEATURES

* Multi-processor system at its best. It is totally **BRITISH** designed and manufactured.

* **16-bit Master-processor** running at 8MHz.

* 16-bit slaves based on **iAPX 186** running @ 8MHz with up to **1Mbyte RAM**.

* Winchester/Floppy drives operate in **DMA-mode** (Direct memory access) with minimum possible access time.

* **Integral Tape Back-up** option with up to 40 Mbyte capacity.

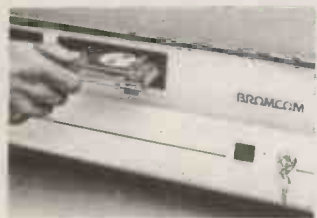

SuperStar-16 has an optional tape backup facility, totally integrated in the system and built into the desk-top unit.

SuperStar-16 must be one of the most powerful, flexible and complete systems available on the market.

For information see opposite page.

(continued from page 8)

As the machines in the Memotech series become more and more popular the potential readership will grow. If you are not featuring the machine in your magazine you will of course be losing out on a number of readers. I would therefore strongly recommend that you start to feature this machine and, I understand from the User's Club, that you may actually gain another advertiser in the form of Memotech themselves, who have given me very good support both on their hardware and software.

C J GREENWAY,
Chipping Norton,
Oxfordshire.

THE EDITOR REPLIES: We can't support all of 400 micros and their countless varieties of Basic.

However, we do support industry-standard operating systems such as MS-DOS and PC-DOS, and unlike every other magazine, apparently, we still include eight-bit CP/M.

This must be of value to the serious Memotech user with this operating system.

Altair lives on

I AM writing to draw your attention to some inaccuracies that occurred in your April Editorial "Ten years on".

The MITS Altair was capable of supporting 64K of RAM, not 256K bytes, by building and plugging in Altair 8K S-100 expansion boards.

Although it was possible to program the Altair in 1s and 0s using the front-panel switches as you state, an assembler was available on either paper tape or cassette. Before Microsoft Basic became available there was a host of other Basic interpreters including many versions of Tiny Basic.

In the late 70s North Star, produced a do-it-yourself disc controller kit for the Altair. The controller drove Shugart single-density, single-sided SA-400 drives and came complete with North Star's Disc Basic.

In the period between the Altair and the Pet and Apple, numerous machines came and went, including Imsai, SWTP, Polymorphic and many others. The advent of CP/M was extremely important and for us, meant we could make full use of the Altair in our business. By 1979 our Altair had voice input and output, twin floppies, a memory-mapped graphics display

and 64K of RAM — so nothing is really new? In those days good software was very hard to come by and the only real solution was to do it yourself.

You qualified your statement about the age of the micro by saying "the world's first real microcomputer is 10 years old". I am sure you are aware that the first microprocessor chip was introduced in 1971. It was designed by Intel for use in a Japanese programmable calculator and was later sold as a programmable replacement for random logic.

The term microprocessor was used, rather than microcomputer, because the major customers of the semiconductor houses that made microchips were in fact computer manufacturers and the semiconductor houses did not want to appear to be going into competition with their largest customers.

The first microcomputer system for commercial use was the Altair. However, this was really a development of the microcomputer systems sold by semiconductor manufacturers for microcomputer development — have a look at a photograph of an early Intel development system and the Altair — and you will see what I mean.

Our Altair was probably the best business investment we ever made. It has performed all manner of work including running the early versions of WordStar and dBase

BRIAN S CRANK,
Southborough,
Kent.

THE EDITOR REPLIES: We did not say that the Altair could only support 256 bytes of RAM, or only be programmed using switches, merely that it was in this form it was first presented to the Great American Public. However, we appreciate your fuller history. The delightful thing about *Practical Computing* readers is that they don't think the micro was invented by Sir Clive Sinclair in 1980 or IBM in 1983.

CAC not CAL

DUE TO a production error in April's Last Word we gave the impression that the programs Spacex, Granny's Garden and Argonaut are distributed by Dudley Programs. P A S Craddock has asked us to point out that Spacex and Granny's Garden are distributed by 4mations, and Argonaut by Ajax Computing.

FEEDBACK

Multi-user database systems

I WOULD take this opportunity of congratulating Peter Laurie for his superb article on the multi-user database systems in your issue of April 1985.

However, I must point out that our product is called the IBS Ultraframe and not the IBS Magnum. The Ultraframe is manufactured under licence in the U.K. by Synamics and it is an eight-bit based on the Z-80B processor and the Intel 80186 and it is a true multi-user multi-processor, and has the facility for local area network using a data point developed Arcnet which allows the networking of IBM PC and plug compatible PCs.

STEVE S GILL,
Synamics Business Systems Ltd,
London SW1.

Typing Tutors

CAROL HAMMOND wrote a comprehensive review of some of the cheaper, cassette-based typing tutors in February's *PC*. It was a pity that the summary at the end gave the impression that she had also considered and presumably dismissed other, more advanced and necessarily disc-based programs.

At their best these can offer speed, sophisticated feedback, record keeping, large amounts of varied practice material and fuller instruction. These are impossible to do conveniently on tape or on small memory machines.

It is certainly helpful to mention products which a reviewer has not been able to look at, but could you make that clear to readers?

Incidentally, we now have a two-fingers to touch-typing conversion course designed specifically for the experienced two-finger typist. Both Two Fingers and Iankey Crash Course are available under PC-DOS and MS-DOS as well as the CP/M which you mentioned, and they run on a very wide range of machines.

IAN LITTERICK,
Iansyst Ltd,
London N7.

THE EDITOR ADDS: The typing tutor review appeared in a Home Education section, and hence did not cover the more professional products. However, we always appreciate receiving extra information.

PC

communicate with compact

**AUTODIAL
MODEMS**

**MULTICOM
BUSINESS
SOFTWARE**

**AUTO ANSWER
MODEMS**

COMMUNICATION PRODUCTS DESIGNED FOR PROFESSIONALS

MULTICOM SOFTWARE

The Ashton-Tate Award Winner
4 Major Communications Systems in
One Software Package.



- Videotex Terminal Emulation (for Prestel)
- Scrolling Terminal Emulation for Telecom Gold, Easylink, etc.
- File Transfer & User to User Interaction
- IBM-PC Graphics Enhancement Option
- Customised for Use with Compact Products
- Available for Most Business Machines

COMPACT MODEM

- Low Cost Manual Dial Version
- Auto Answer Standard
- V21 & V23 Operation
- Bell Standard Option
- Simple Self Installation
- Provides Access To:
- Prestel
- Telecom Gold

FREE subscription
to **TELECOM GOLD**
for details call:

- Bureaux Services
- Mail Boxes
- B.T. Approved

COMPACT PLUS MODEM

- Autodial
- Autoanswer
- Speed Conversion
- Automatic Access To:
- Prestel
- Telecom Gold
- Bureaux Services
- Mail Boxes



- Full V21 & V23 Option
- Stored Number Facility
- DTE Autobaud
- Error Correction Option
- Simple Self Installation
- B.T. Approved

Prices — MULTICOM SOFTWARE £150
COMPACT PLUS MODEM £325
COMPACT MODEM £235
Ex. V.A.T. & Delivery

COMPACT COMMUNICATIONS LTD

FORUM HOUSE 1 MILLMEAD STAINES MIDDX.

TEL: 0276 27122 or contact your local dealer

AT&T goes for Unix

AMERICAN telephone giant AT&T has dropped the other shoe: it has finally launched its Unix system on to the desk-top microcomputer marketplace.

When the new micro was sent out to software developers it was called the PC-7300 to position it above the Olivetti M-24, which AT&T sells in the U.S. as the PC-6300. However, it is now being called the Unix PC, to distinguish it from IBM's PC.

The Unix PC uses the Motorola 68010 chip running at 10MHz; the 68010 is the latest version of the 68000 and offers virtual-memory management, so the hard disc can be treated as an extension of RAM. The Unix PC looks like something from the bridge of the Starship Enterprise, features a 10Mbyte hard disc, built-in modem with telephone-management software, a mouse and 720- by 348-pixel graphics. The version of Unix used is System V.

The major complaints about Unix are that it is out of date, unfriendly and cannot handle graphics, and that there is no good cheap software for it. AT&T has no choice but to tackle these shortcomings by including an elaborate high-resolution graphics interface, plus mouse. Also, numerous micro-computer software houses are providing packages to run on it. Microsoft is to launch Word, Multiplan and Basic; Ashton-Tate is to launch dBase II, etc. In all some 28 packages have been announced, with more to follow.

AT&T hopes the system will have enough software support for the advantage of Unix to make it worth the cost of buying a hard-disc based AT&T micro — the advantage being that it is a true multi-user multi-tasking operating system.

IBM's launch of Xenix — Microsoft's version of Unix — for the PC/XT and PC/AT suggests that this is a possible future for personal computing, after PC-DOS has run out of steam. AT&T hopes buyers will simply skip the PC-DOS stage and start with the Unix PC.



Bit-mapped graphics are handled by a dedicated 80186 chip.

VIENNA PC

THE Vienna Personal Computer is an MS-DOS based system using two 80186 processors, one of which is dedicated to driving bit-mapped graphics. It forms part of the Vienna Office, a family of office automation equipment from Northern Telecom. In addition to the personal computer, there is a multi-user system which can support up to 32 terminals, and an extensive suite of 14 software packages including word processing, spreadsheet, database, electronic mail and telex.

The basic configuration is a machine with 512K RAM, a

1.2Mbyte floppy, 10Mbyte Winchester, high-resolution screen and keyboard. It costs about £5,100. Additional features available include a mouse option and a LAN.

Although Northern Telecom sounds like a Yorkshire-based arm of British Telecom, this American company is in fact the sixth-largest manufacturer of telecommunications equipment in the world. Its revenues for 1984 exceeded \$4.3 billion, and it has over 47,000 employees worldwide.

Northern Telecom is on (05827) 63161.



128K for Atari 130XE

ON 18 APRIL Atari U.K. delivered the first of its new eight-bit micros, the 130XE, to dealers. It is essentially the same as the current 800XL, with which it is compatible. The main differences are that the 130XE comes in a smaller, neater case, and it has 128K of RAM

instead of 64K. Also, it has a new version of the Basic — Revision C — though this is a minor change. The price is £169.99.

At the moment relatively little software is available to make use of the extra RAM. VisiCalc, for example, does not. However, Atari has a new version of the disc operating system, DOS 2.5, which enables spare memory to be organised as a virtual disc, which greatly speeds up the real processing power. Matching printers and 3.5in. microfloppy-disc drives have yet to be delivered.

Contact Atari Corporation (U.K.), Atari House, Railway Terrace, Slough SL2 5BZ. Telephone: (0753) 33344.

Wristwatch terminal

achieve the apparently impossible and probably pointless in and probably pointless in electronics is the wristwatch monitor from Hattori, a subsidiary of the giant Hattori-Seiko.

The Seiko RC-1000 unit has a two-line 24-character LCD display, and 2K of RAM. Information is downloaded from micros via their RS-232 ports. Appropriate software exists for the Commodore, BBC, Apple and IBM.

In addition to telling the time, the watch/monitor offers a user-definable storage area, schedule alarm and up to 80 local times throughout the world. The schedule alarm function can memorise up to 80 items up to a year in advance; at the appropriate moment the alarm will sound and displays the relevant memo.

The Seiko RC-1000 unit will cost about £119. Details on 01-492 0561.



Hanover handful

THE Hanover Fair saw one or two interesting products apart from the Atari ST dealt with on page 55 of this issue, and the Commodore 128 on page 16.

Hitachi's CD-ROM looks likely to give us a new term to juggle with. As its name suggests, it is based on compact-disc technology, and marries this with optical-disc storage to produce a unit with a read-only capacity of 552Mbyte. This is equivalent to about 270,000 pages. Data-transfer rate is 176Kbyte per second. No definite figures have been announced, but cost is likely to be around £1,000. This makes it about 50p a megabyte, with the added bonus that you can remove the discs. Hitachi is on 01-848 8787.

(continued on next page)

Speech on EPROMs

STC MERCATOR has introduced speech synthesis boards which enable a user to burn spoken vocabulary into EPROMs. The speech output is claimed to be of near tape-recording quality.

Two boards are available, both aimed at OEMs. The SDX-300A

features a microphone which can be used for vocabulary development and speech output. It costs about £235. The £175 SDX-300 is for output only and accepts data generated with the SDX-300A. More information from STC Mercator on (0493) 844911.

(continued from previous page)

The Overlaystar is a modified ACT Apricot F1, designed for interactive use with Philips, Sony and Pioneer video discs. It generates RGB graphics over Pal video pictures. Again no price was given. The manufacturer is Schellenberg GmbH, Schwabstrasse 43, 7000 Stuttgart 1, West Germany. Telephone: (010 49 711) 618006.

Hewlett-Packard caused less of a stir with its HP 150 II, a revamped version of the touch-screen model. Now it has a 12in. screen, and four expansion slots instead of two. The touch-screen model itself is now sold as an optional extra rather than an integral part. Top of the range models include 10, 20 and 40 Mbyte Winchester. Details on (0344) 424898.



Hewlett-Packard's 150-II.

Motorola on the move

MOTOROLA'S U.S. communications arm has announced two wire-less data terminals, combining radio communications with a portable computer.

The KDT-800 is only 7.5in. by 4in. by 1.3in., weighs less than 28oz. and is claimed to be "environmentally rugged". It has a two-line 27-character LCD, full miniature keyboard, 160K ROM and 80K RAM. User applications reside in four 32K ROM modules. The dual-processor design



Bowing to the inevitable: the Commodore PC-10 IBMulator.

Commodore adds CP/M, Unix and MS-DOS

COMMODORE seems to be trying to set some kind of record for having the most different chips and incompatible operating systems across its range of machines. Two new ones were shown at the recent Hanover Fair though a third — the 68000-based Amiga — did not appear. It proved impossible to locate either the C-16 or Plus-4 micros, or to get a reply to questions about them.

The Commodore B-900 uses the Zilog Z-8000 superchip and runs the Unix-alike operating system, Coherent. The machine has 512K

of RAM, a 1.2Mbyte floppy-disc drive and a built-in 20Mbyte hard disc, with the option of a 67Mbyte disc for more serious uses. The graphics are a very high resolution of 1,024 by 800 pixels. Price is expected to be competitive at DM10,000 to DM15,000.

The Commodore 128 is three machines in one, and features both 6502-type and Z-80 processors with 128K of RAM. The C-128 boots up as a Commodore 64 with the same blue screen and number of bytes free. In this mode it is a games computer. It can then be switched to being a 128K version of the Commodore 64, but with the far superior Basic 7.0. Thirdly, it can be operated as a CP/M micro using the Z-80 chip.

It all sounds very confused and confusing. However, the C-128 looks a smart, businesslike machine. It has a good keyboard including four cursor-control keys and a numeric keypad. At an aggressive price it would certainly solve the problem of any existing Commodore 64 users who want to upgrade their machine or add CP/M, without losing access to their existing software.

Commodore has joined the PC club with its PC-10 and PC-20. The PC-10 offers the familiar combination of an 8088 running at 4.77MHz, two 360K floppies and 256K RAM expandable to 640K. The PC-20 rather confusingly has a 10Mbyte Winchester instead of a floppy. Rather more original are the prices: the PC-10 costs £1,675, and the PC-20 £2,795, which are both some way below par.

Commodore is also offering an extended three-year warranty and various leasing arrangements. Details from Commodore on (0536) 205555. 

HARDWARE SHORTS

- Free colour monitors are being shipped with all 10Mbyte and 20Mbyte Zenith Z-150 PCs. This represents a saving of over £300 to the end-user. The offer will continue until the end of June. More information on (0452) 29451.

- Hewlett-Packard's Thinkjet printer is now available with an RS-232 interface. The cost is £495. Details on (0344) 424898.

- More price reductions from Fujitsu, following the special educational prices announced in *Practical Computing* in May. For example, a 13Mbyte Winchester system now costs £3,295, a reduction of £205. More on (0628) 76100.

- Future Computers' FX-20 and FX-30 can now be upgraded to 1Mbyte RAM. The extra board costs £995. For users of 128K a second expansion RAM must first be plugged in. Details on 01-680 6040.

- The 68020, big daddy of Motorola's 68000 family, is now available as a VME board from Integrated Micro Products. Each board has a minimum of 2Mbyte of RAM. More information on (0207) 503481.

- Wang has announced a "pan-European price initiative": in practice this means that the retail price of its Professional Computer will fall by an average of 9 to 12 percent in Europe. Details on 01-560 4151.

- Perfectdata has introduced a single- and double-sided disc drive cleaning kit which consists of a disc sleeve with a lint-free porous disc. Cleaning fluid is added to two slots in its casing before insertion into the disc drive, which is then activated. The cost is £14.80 from Action Computer Supplies on 01-903 3921.

- Zenith Data Systems is offering a disc-less version of the Z-150 PC for networking. Called the ZF 151-20, it costs £1,445. More details on (0452) 29451.

- Apple Turnover is a board for the IBM PC which enables it to read Apple DOS and Apple CP/M discs. It costs £299 and is distributed by Systems Constructors on (0202) 297315.





Nashua

Nashua Computer Products,
 Floor 1, Cory House, The Ring, Bracknell, Berks RG12 1ET
 Telephone: 0344 426555

NASHUA 5¼" DISKETTES

SOFT SECTOR



PRODUCT*	DESCRIPTION	TPI	BPI	TRACKS/SURFACE	STORAGE CAPACITY (BYTES)
MD-1	Single side/Single density	48	2768	40	125,000
MD-1D	Single side/Double density	48	5536	40	250,000
MD-2D	Double side/Double density	48	5536	40	500,000
MD-1F	Single side/Quad density	96	5536	80	500,000
MD-2F	Double side/Quad density	96	5536	80	1,000,000

(Formatted products available)

10 HARD SECTOR

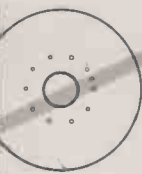

PRODUCT*	DESCRIPTION	TPI	BPI	TRACKS/SURFACE	STORAGE CAPACITY (BYTES)
MD-110	Single side/Single density	48	2768	40	125,000
MD-110D	Single side/Double density	48	5536	40	250,000
MD-210D	Double side/Double density	48	5536	40	500,000
MD-110F	Single side/Quad density	96	5536	80	500,000
MD-210F	Double side/Quad density	96	5536	80	1,000,000

(Formatted products available)

16 HARD SECTOR



PRODUCT*	DESCRIPTION	TPI	BPI	TRACKS/SURFACE	STORAGE CAPACITY (BYTES)
MD-116	Single side/Single density	48	2768	40	125,000
MD-116D	Single side/Double density	48	5536	40	250,000
MD-216D	Double side/Double density	48	5536	40	500,000
MD-116F	Single side/Quad density	96	5536	80	500,000
MD-216F	Double side/Quad density	96	5536	80	1,000,000

(Formatted products available)

*Each diskette is a certified product.

PHYSICAL OPERATIONS

Jacket outer dimensions	5.235-5.265 in. square (13.297-13.373 cm)	Disc outer diameter	1.124-1.126 in. (2.855-2.859 cm)	Operational storage temperature	50°-122°F (10°-53°C)
Thickness	0.065-0.078 in. (1.651-1.981 mm)	Nominal thickness	0.003 in. (0.0076 cm)	Relative humidity	8-80%
Material	Vinyl chloride with a non-skidding synthetic fiber lining	Material	Mylar with iron oxide Y-Fe ₂ O ₃ coating	Storage conditions	Diskettes shall be stored at room temperature at least one hour prior to using.
Disc outer diameter	5.122-5.128 in. (13.009-13.025 cm)	Coating thickness, nominal	90-130 (10 ⁻⁶) in.	Missing pulse	"O"; extra pulse—"O."
		Surface roughness	3µ in. AA max.		



· THE NEW AMSTRAD CPC 664 WITH BUILT-IN DISC DRIVE



· AVAILABLE AT BOOTS · COMET · CURRYS · DIXONS · GREENS · JOHN MENZIES · RUMBELOWS

THE LOW COST COMPUTER FOR HOME AND BUSINESS

If you know anything about computers you'll know that disc drives are up to fifty times faster than cassette when you're loading and saving programs. In fact, a disc drive makes computing faster, more reliable, more efficient and more fun. But up till now the only way to gain these advantages for a home computer was to buy a separate disc drive attachment. Now Amstrad are pleased to announce the first complete home computer with built-in disc drive: The Amstrad CPC 664.

And when you buy a CPC 664 you'll find it's not just the disc drive that's built-in.

You'll get everything you need, including a monitor (green screen or full colour). We'll even give you a free CPM and Logo disc, so all you do is plug in and you're in business.

BUSINESS OR PLEASURE

Although a disc drive will make games more fun (and there are loads of them to choose from) it also makes the CPC 664 a serious proposition for the business user.

There are accounting, word-

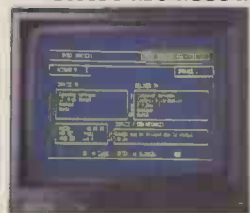

Amsoft Business Control, is a complete suite of programs for integrated sales invoicing, stock control and sales ledger for around £99. (Requires an additional FD-1 disc drive around £159 and DL-2 cable around £7).

processing, spread-sheet and database programs (to name but a few). The CPC 664 is also supplied with CP/M* to help make your business more efficient and effective by providing access to the famous range of CP/M* software.



WITH COLOUR MONITOR AROUND

• £449 •



WITH GREEN SCREEN AROUND

• £339 •

THE HOME COMPUTER THAT MEANS BUSINESS.

HIGH PERFORMANCE

• LOW COST •

The one thing you won't need a computer to work out is that the Amstrad CPC 664 represents outstanding value for money.

You only have to check the cost of buying all the elements separately (64K computer, disc-drive, monitor) to realise that the Amstrad package is very hard to beat.

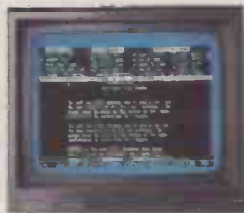

Wordprocessing with Amword can improve the productivity of everyone from unskilled typist to trained secretary. Around £23.95.

With a green screen monitor the cost is just £339. With a full colour screen it costs £449. And after you've saved money on the price of the computer itself, you go on saving on the price of software.

There are hundreds of programs for business or pleasure available on disc (and cassette) to CPC 664 users. Many from Amsoft, others from other



famous-name software houses. Few will cost you more than £49 and most will cost you considerably less.

AN EXPANDING SYSTEM

There is a complete range of peripherals available to CPC 664 users which plug directly into the built-in interfaces.

These include a joystick, additional disc drive (to double your on-line storage) and the Amstrad DMP-1 dot-matrix printer. (There's also a cassette interface so that you can use CPC 464 programs on tape). And there are many more peripherals from Amstrad and other manufacturers which can be used to enhance the CPC 664.

• AMSTRAD USER CLUB •

Join the optional Amstrad User Club and we'll keep you informed with our monthly user magazine, and information on all software as it is introduced. Your membership details

will be recorded on your personal club card, which entitles members to various privileges and offers.



Figure analysis made easy with Microspread. An easy to use spreadsheet with pull-down menus and a wide range of mathematical options. Around £49.

Please send me more information

Name _____

Address _____

Amstrad CPC 664

Amstrad, P.O. Box 462, Brentwood, Essex CM14 4EF

PC/664/1

*CP/M is a trademark of Digital Research Inc.

SPECTRUM • W.H. SMITH • WIGFALLS • AND GOOD INDEPENDENT COMPUTER STORES

It takes dedication to get to the top.



At Dysan, we're never satisfied. We know there's always a way to make things better. Even when they're already the best.

Our diskettes, for example, are the most reliable in the world. Being dedicated to progress, we pioneered more advanced manufacturing techniques to make the most advanced diskettes.

Not content with usual test procedures, we devised harder ones. We test for top performance under particularly strict conditions. So we can guarantee that all our diskettes are 100% error free.

The result is a range of diskettes that will record and retain all your data...all the time. Without fail. They're the best you can buy today.

Next time you go to buy Dysan diskettes, you'll notice we've also advanced our packaging. Now our range of 3½", 5¼", and 8" diskettes comes to you in elegant new colour-coded boxes. Designed to reflect exactly what Dysan diskettes are – simply the best.



Dysan[®]

Somebody has to be better than everybody else.

For more information on precision magnetic media that leads the world, call us now on FREEFONE DYSAN.
Or write to Dysan, 169 Basingstoke Road, Reading, Berks. RG2 0DY

A division of Xidex Corporation.

IBM LAUNCHES TOPVIEW

WHEN the IBM PC/AT was launched last autumn, Big Blue also previewed a mouse-orientated, multi-tasking, windowing program called Topview, which has now been released in the U.K.

Other companies have tried to establish such an environment on the PC. Examples include the VisiOn suite, Desq, and the world's most popular piece of vapour-ware, Microsoft Windows.

What Topview does is allow users to run several programs concurrently — the number depends on the amount of RAM available — to display different programs in windows on-screen at the same time, and to cut and paste between them.

It sounds simple enough, but Topview has nevertheless inspired a massive amount of controversy on the American computer scene. Some think it is the first part of an IBM strategy to install its own operating system on the PC, and lock everybody else out. John Dvorak wrote in *Infoworld*, April 15, "I believe the first sign is IBM's attempt to swing the market to Topview, a proprietary operating-system shell whose sole purpose is to shut down the clone makers and put the squeeze on third-party support." Strong



Topview on the AT: "Open architecture" says IBM U.K.

stuff. However, IBM U.K. says "Topview provides an open architecture that allows programmers to develop new applications which make use of [its] powerful features." And it is selling a Programmer's Toolkit to prove it.

Topview requires a PC with a minimum of 256K of RAM — 512K is recommended — and two 360K disc drives, or a floppy and a hard disc, plus DOS 2 or later. It supports Microsoft's mouse, the

VisiOn mouse, and PC Mouse from Mouse Systems. It also provides an alarm clock and calculator, and costs £156 plus VAT. The Programmer's Toolkit costs £416 plus VAT. Both are available from IBM PC dealers.

The real battle is now on between Topview and Digital Research's Gem desk-top manager. However, as wags are saying, it certainly looks like curtains for Windows.



TA goes 80186

TRIUMPH ADLER has launched a range of compatibles based on the Intel 80186 chip, which claims "a high degree of software compatibility" with two to three times the processing speed. All the models, which vary according to disc storage, offer high-resolution monochrome and graphics displays and an enhanced keyboard with a wrist rest. The TA keyboard has separate cursor-control keys and numeric keypad, plus 18 function keys instead of 10.

At the Hanover Fair, TA also showed a small version of the personal computer which is specially aimed at schools. It is smaller than a BBC model B and takes separate disc drives. The aim is to get the main industry-standard operating system into schools and colleges, rather than the odd, non-standard systems currently used. TA's personal computer for schools could be launched in the U.K. in August or September.

Contact Triumph Adler (U.K.) Ltd, 27 Goswell Road, London EC1M 7AJ. Telephone 01-250 1717.

DR Gem

DIGITAL RESEARCH'S Gem packages are now being released for the IBM PC. Usable versions of Gem itself have been shipped — this is Gem Desktop, which provides the icons and metaphorical desk-top. The package is worth at least a couple of hundred pounds, but the price is a mere £49.95. DR intends it to be irresistible.

Once you've got Gem you will also want Gem Collection, Gem Draw, Gem Graph and Gem Wordchart. Gem Collection comprises Gem Desktop, Gem Write and Gem Paint. It is the equivalent of the Apple Macintosh with Macwrite and Macpaint, and allows the integration of sophisticated word processing and graphics. Gem Collection will be available for £129.95 until August 1, after which it will cost you £229.95.

Due in July will be Gem Graph at £179.95, and Gem Wordchart at £129.95. The same programs will also be available with the Atari 520 ST — see page 55.

Contact Digital Research at Oxford House, Oxford Street, Newbury, Berkshire RG13 1JB.



Compaq comms

COMPAQ has launched a range of six communicating computers in the U.S. The Telecompaqs are, in effect, an 8086-based Desktop machine packaged as a portable with a Hayes Smartmodem, telephone, speakerphone, three disc drives and a set of utility programs. These utilities use the extra disc drive and sit in 128K of RAM while other programs are being run — it is like having two computers in one. Also a separate Z-80 is used to control the communications. Thus you can

suspend a program, autodial a database, download information to the third disc, and pop back to where you were, just as though you had not been interrupted.

The Telecompaqs cost from \$4,195 to \$6,395, with the more expensive models featuring a 10Mbyte hard disc. They are designed for American phone systems and have not been scheduled for release in the U.K.

Contact Compaq at Ambassador House, Paradise Road, Richmond, Surrey TW9 1SQ.

IBM SHORTS

- The Torch Graduate, which turns your BBC Micro into an IBM PC, is now available from 25 Lasky's High Street stores.

- Colour graphics can now be added to Compssoft's Delta through the £195 utility Delta Graph. Phone Godalming (04868) 25925.

- Intelligence U.K.'s PC Express, which doubles the speed of your IBM PC, now features a disc cache, which is claimed to improve access to floppy-disc drives by a factor of 12. Phone 01-740 5758.

- Lifetree Software, which produces the excellent Volkswriter series of word processors, has opened a European office in Amersham. Phone (02404) 5434.



Modem WS 2000: why it's the experts' choice.

You don't need to be told about the information revolution – you already know that without efficient data communications, you and your business may not survive it.

And you know that a modem will be a vital part of your survival kit.

This is why you should choose Modem WS2000 from Miracle Technology.

Quality – In concept and construction Miracle Technology sets the standards other modem manufacturers aim for.

Quite simply, WS2000 is one of the best designed, best made modems you can buy.

It is approved for PTT use in the UK and Holland, with approval pending in other European countries.

Flexibility – As a multi-speed, multi-standard modem, WS2000 enables data transfer between almost any two computers – world-wide.

WS2000 gives instant access to the vital information sources of Prestel, Micronet, Telecom Gold and a vast range of public and private databases.

WS2000 can also convert your computer to a telex terminal, giving you inexpensive 2-way international telex facilities.

WS2000 is suitable for use with a wider range of computers than virtually any other modem, and we can offer software packages for most makes.

Versatility – No other modem offers all the facilities available with WS2000.

Its unique versatility means it can be expanded by the addition of autodial and autoanswer options (presently undergoing approval testing with BAPT), plus direct computer software control of the modem and much more.

Service – A large dealer/distributor network both in the UK and abroad means you're never far from a WS2000 stockist.

And our Customer Service and Technical Departments are happy to give help and advice.

The Experts – Thousands of users depend on WS2000 – local authorities, government departments, multi-nationals,

private companies and individuals.

WS2000 is the modem chosen by the BBC to demonstrate a UK-USA datalink live on TV; selected by Cable & Wireless/Western Union for their Easylink Telex Service; taken

round the world on Operation Raleigh; in action for CBS News, sending front-line war reports around the world.

WS2000 is the modem used by people who need reliable data communications today – and every day.

WS2000, with BT telephone lead, mains power supply and comprehensive operating manual costs only **£129.95 exc.** (£154.73 inc. VAT & UK delivery) – you may also need a computer lead (£10.35 inc.) – specify computer when ordering.

A small price to pay for survival.

Order by cheque/Visa/Access/Trade or official order to:

Miracle Technology (UK) Ltd,
St Peters Street, Ipswich IP1 1XB.

☎ 0473 50304 ☐ 946240 CWEASY G 19002985

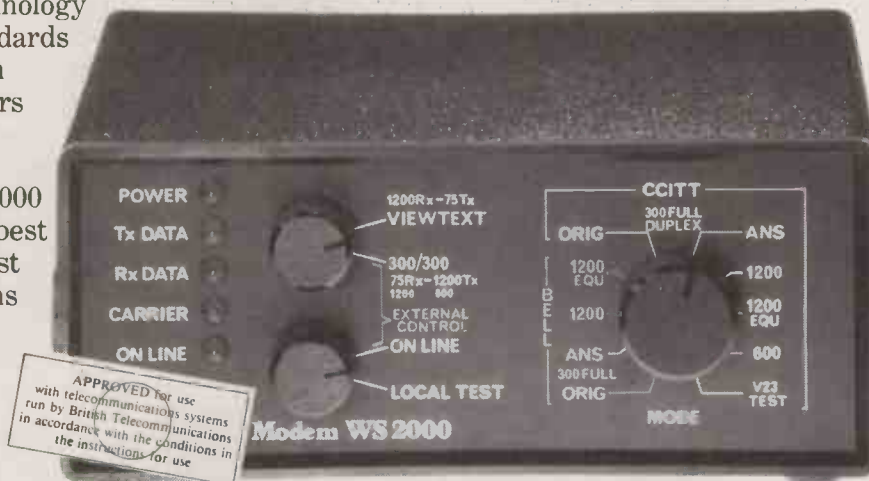

MIRACLE TECHNOLOGY
we thought of tomorrow, yesterday.

aculab LP4080

TABLETOP LASER PRINTER

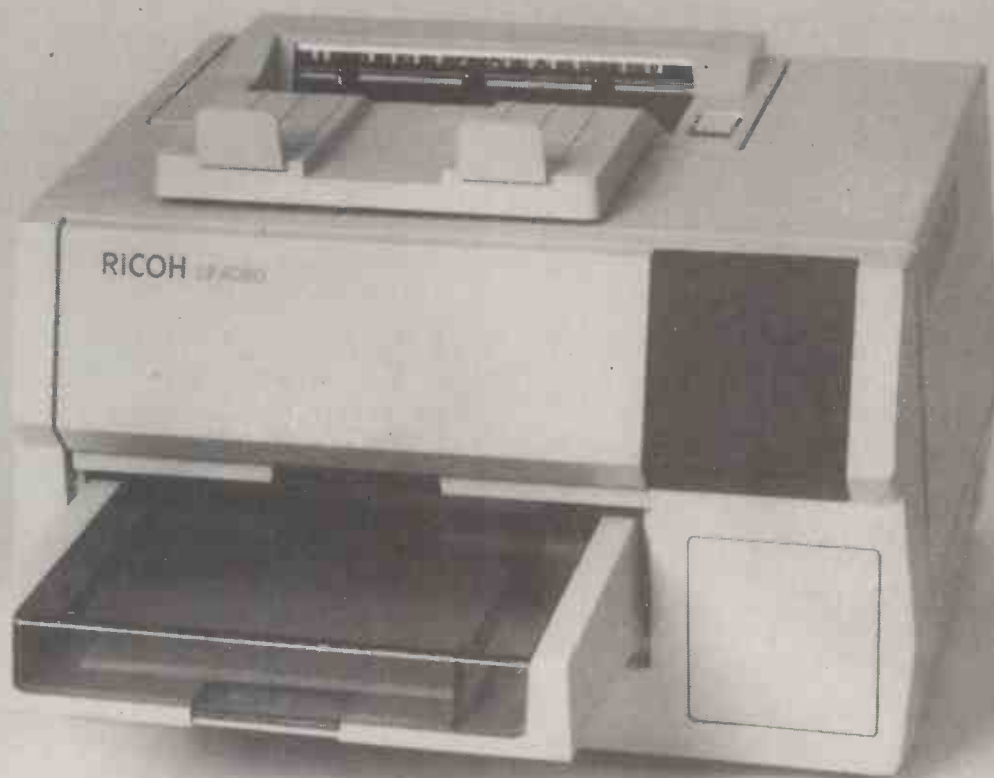

High quality and resolution (90,000 Dots/Sq. Inch)

High throughput—models from eight pages per min. (Approx. 300 CPS)

Low noise levels—suitable for modern office environment.

Industry standard and custom interfaces available.

Large capacity paper hoppers (250 sheets in and out)

Low maintenance requirements.

OEM and distributor enquiries welcomed.

● Circle No. 116

aculab

**Unit A, Station Approach,
Leighton Buzzard,
Beds. LU7 7LY
Tel. 0525 371393**

Space-saving furniture at accommodating prices



The Apollo business desk range from Opus Supplies brings a little high-style into the hi-tech age. But, with prices that start at only £100, these are desks designed to suit your computer system and your pocket.

Smart, modern, appearance combined with robust construction and practical styling ensures that Apollo desks will fit into any working environment; office or laboratory, classroom or sales area.

Sturdy steel underframes support shelving with scratch-resistant surfaces. The top shelf has sufficient room for a monitor and printer while below the lower desk top will accommodate your computer, hard or floppy disc drive and software.

You can choose left or right handed drawers for extra storage and all Apollo desk units are equipped with lockable castors.

Generous dealer, government and education discounts are available.

For full details of the Apollo range, together with the address of your nearest stockist, contact us on 0737 65080.

Opus Supplies Limited, 55 Ormside Way, Holmethorpe Industrial Estate, Redhill, Surrey.

**THE APOLLO RANGE – STYLISH DESKS
TO SAVE YOU SPACE AND MONEY.**

To: Opus Supplies Limited, 55 Ormside Way,
Holmethorpe Industrial Estate, Redhill, Surrey.

Please send details and brochure of the
Apollo business desk range (please tick)

or please send me the address of your
nearest stockists (please tick)

Name _____

Address _____

Telephone _____

Opus.
Opus Supplies Ltd.

55 Ormside Way,
Holmethorpe Industrial
Estate, Redhill, Surrey.
TELEPHONE: 0737-65080

GOLD REFINED

TELECOM GOLD is now offering different service schemes to companies and individuals. The corporate scheme has a joining fee of £300 and a minimum charge of £100 per month. For this you get any number of mailboxes plus your unique prefix, like RPL for Reed Publishing Ltd. Individuals can join under the club scheme for £40 per mailbox and a minimum charge of £10 per month. This provides a box with a public prefix like JNL for journalists.

Corporate buyers get free training, a set of manuals and various discounts. In the club scheme, individuals get a free copy of Quick Guide to Mail and pay £30 per session for any training they require.

When Gold was set up, it was

assumed that most users would be companies operating semi-closed user groups among comms-ignorant staff. The new structure shows a welcome recognition that comms-literate micro users might actually want to join the system and communicate with like-minded individuals.

Also, Gold users can now officially receive incoming telexes. A London telex bureau, British Monomarks Ltd, has been engaged to receive telexes and route them to members' mailboxes for an extra charge of 50p.

Two further improvements are first, that can now be sent from Gold to ships at sea via the Inmarsat satellite link. Second, Gold's Prime minicomputers have a one-line command for con-

verting text between upper and lower case.

So far each Gold computer has had its own little BBS system called Noticebd. Now that the number of systems has been doubled and users swapped around to equalise the loads, this has proved unsatisfactory. So Gold has introduced a common Noticebd, and users can post messages to be read from all six Primes.

Better still, customer services has taken the opportunity to introduce a new set of categories or SIGs. These could include sections for BBS, Films, Games and Lonely Hearts, as well as more usual categories such as Help, To-Buy, To-Sell and Gold. The final list has not been decided, but it is bound to be an improvement on what there is at the moment.

For information on all Telecom Gold services, phone 01-403 6777.

Micronet 800

THE PRICE of subscribing to Micronet has been increased from £8 to £10 per quarter.

A new addition to the system is Gallery, whereby any subscriber can buy up to 26 frames to display information of their own. Each frame contains the user's name and account number, leaving 26 lines in which you can be stunningly creative. Frames cost only 25p each for six months' display, and there is an editing charge of 4p per frame. The idea is to let Micronet members display their artistic talents, but with any luck the editors will get more than they bargained for.

Atari owners will be jubilant to learn that the excellent Minor Miracles modem is now available with cables and software for their micro. The kit can also be used for all 300 baud comms as well as for Micronet and Prestel.

For details of the Minor Miracles modem contact Miracle Technology on (0473) 50304. For details of Micronet telephone 01-278 3143.

Amstrad user group

AN independent user group has been started for Amstrad owners. Membership costs £8.95. For details write to the group chairman Jeffrey Green at 33 Malyns Close, Chinnor, Oxfordshire OX9 4EW.

Shows in London

THE well-established Office Automation exhibition is moving from the Barbican to join two other exhibitions, Software and The Business Computer Show, at Earls Court. All three will be held on 4-6 June. One ticket gets you into all three.

For details of Office Automation '85 phone Cahners on 01-891 5051. For the others, phone Reed Exhibitions on 01-643 8040.



TV-am, and pm

IF you'd like chips for breakfast, leap out of bed at 7.15 every Tuesday morning and they'll be served up by Charles Golding on *Good Morning Britain*. There will

be coverage of micro topics and the latest games.

Meanwhile, new series of both BBC-2's *Micro Live* and ITV's *Database* programs are currently in preparation. Watch your *Radio Times* and *TV Times* for details.

Typenet

IF YOU have a 300 baud modem and have copy you want typesetting, then phone 01-658 6942 and browse through Typenet. Alternatively, if you are on Telecom Gold, you can use .sp to spell-check your copy then dump it in Typenet's mailbox, 83:BT1001.

The service is run by Budget Typesetting, based in Beckenham. A £25 registration fee gets you the manual and some free typesetting.

If you absolutely insist on voice contact you can telephone 01-658 8754. The snail-mail address is 15 Clock House Road, Beckenham, Kent BR3 4JS. 

The Next Two Pages Could Change Your Life



At Amplex we've created two new terminals which offer advanced emulations, editing and ergonomics at prices our competitors just can't believe. (Some get fairly near our features but nowhere near our prices).



Others can match our prices but their features are limited. How about the Amplex 210? You can see it looks good. But can you also see the way its 14" amber screen tilts and swivels into the most comfortable position?



It has a detachable low-profile DIN standard Selectric-style keyboard whose slope you can adjust. It is beautifully styled and superbly engineered inside and out (otherwise it wouldn't carry the Amplex name).



It has 7 resident national character sets, 14 program function keys and an 80-character status line. With line graphics and a bidirectional printer port as standard. So too are the local editing and block mode transfer capacities



to speed up work flow. But here's where our competitors wonder what's hit them. The Amplex 210 gives you 16 resident emulations at the touch of a key. And all for the price of an ordinary terminal.

Speeding up the Mac

MAC MEMORY DISK helps you speed up the often rather sluggish Mac. It is actually a RAM disc, and requires a 512K Mac to work. It costs £34 plus VAT from P&P Micro Distributors Ltd, New Hall Hey Road, Rossendale, Lancashire BB4 6JG. Telephone: (0706) 217744.

At the start of each session you transfer the files you need on to the RAM disc, which all Mac applications then work with in exactly the same way as a real one, except at RAM speeds. At the end of the session you have to copy any updated files back on to a real disc, or you are in real trouble.



Mac Cobol — beauty and the beast

COBOL and the Macintosh might sound like a contradiction in terms, but the 30-year-old business-orientated language will probably go on for ever because so many people can program in it. Micro Focus has been putting Cobol on to different micro-computers for some time, and has excelled itself with this version for the Mac.

Mac Cobol compiles down to 68000 machine code so programs execute quite quickly. It also supports the 386 most commonly

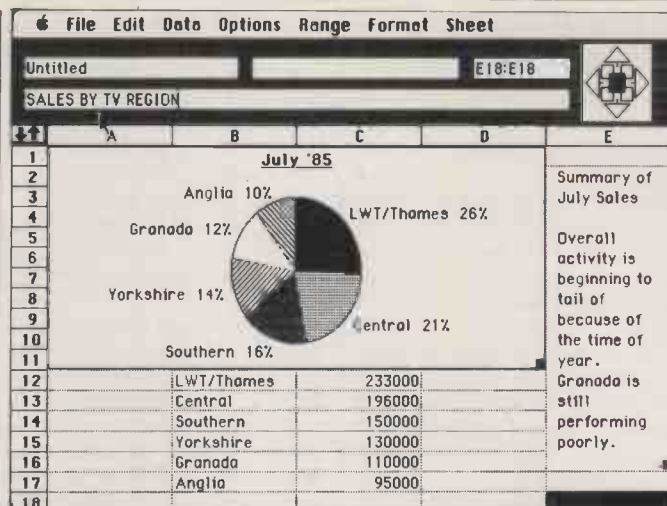

Integrated software Macstyle is here from Probe International.

QUARTET

WHILE waiting for the delayed Lotus Developments' Jazz, Mac owners could do worse than take a look at Quartet. Available now, Quartet is an integrated spreadsheet/graphics/database/text package which runs on any Mac, whether 128K or 512K — even one without an external disc drive. Obviously it is more limited than

Lotus Developments' ambitious but still awaited mega package, but on the demo version we have seen, the spreadsheet and graphics, at least, look quite good.

Quartet costs £239.95 plus VAT and is available from Probe International Ltd, 78 Victoria Road, Widnes, Cheshire WA8 9RP. Telephone: 051-423 6666.

Accounts for Amstrad

A RANGE of low-cost accounting software, has been launched for the new Amstrad CPC-664 and the existing machine with disc drive. Camsoft's range covers all the main ledgers plus invoicing, stock control and payroll, priced at £39 per module including VAT.

Details from Cambrian Software Works, Unit 2, Maenoffern, Blaenu Ffestiniog, Gwynedd, Wales LL41 3DL. Telephone: (0766) 831878.

The new Amstrad machine is previewed on page 59.

SOFTWARE SHORTS

• Turbo Pascal version 3 is claimed to compile twice as fast as version 2. The latest release of the popular Pascal compiler runs on virtually everything including CP/M-80, CP/M-86, MS-DOS and the IBM PC. The price is £69.95 and turtle graphics have been added for the IBM PC. Contact Altor Computer, The Anderston Centre, Glasgow G2 7PH. Telephone: 041-226 4211.

• Hayden Speller is a spelling checker for the Mac, fully compatible with Macwrite and Microsoft Word. The claim is that it can check a five-page document in under a minute. The price is around £73 plus VAT, from P&P Micro Distributors Ltd. Telephone: (0706) 217744.

• QDoctor helps you recover files when the Sinclair QL Microdrive corrupts them. It first verifies the file and then lets you edit it on screen. QDoctor costs £14.95 plus VAT, and is supplied on a Microdrive cartridge. Contact Adder Publishing Ltd, PO Box 148, Cambridge CB1 2EQ. Telephone: (0223) 277050.

• Latest release of Microsoft's Macro Assembler supports the full range of Intel processors, including the 80286, and runs on MS-DOS or PC-DOS version 2.0 or above. The price is £150 plus VAT, while the upgrade to existing users is available for £90. Details from Microsoft Ltd. Telephone: (0753) 559951.



You can emulate the Tele Video 910, 910+, 912, 920 or 925* And the Lear Siegler ADM3, ADM3A, 3A+ or ADM5*



You can emulate the Hazeltine Esprit 1400, 1410 or 1500* the Qume's QVT 102* and the ADDS Regent 20, 25 and Viewpoint†



You want something even better? Try the Ampex 230. It's like the 210 with different resident emulations. But what makes the 230 special is an extra row of 16 programmable keys which effectively doubles its emulations to 32.



It has a 132-column display, a 400 byte double-page memory, 9 resident national character sets, and many quality features you only find on desperately expensive machines. The Ampex 230 has everything. It lets you do everything.



There's more. In OEM quantities we'll customise the appearance and programming of either terminal to any specification.

*TeleVideo, Lear Siegler, Esprit and Qume are trademarks of TeleVideo Systems Inc; Lear Siegler Inc, Expert Systems Inc, and Qume Corporation respectively
†ADDS, Regent and Viewpoint are trademarks of Applied Digital Data Systems Inc

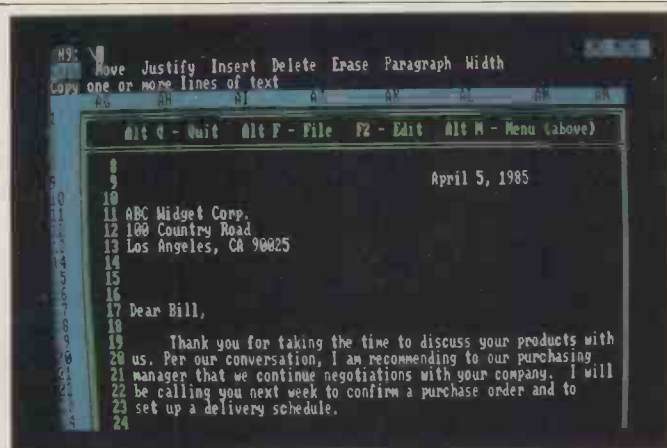

WP for Lotus 1-2-3

OPTIONWORD PLUS is a butlerware package — after the fashion of Sidekick — designed to work with Lotus 1-2-3 to provide word-processing facilities. Running at the same time as Lotus, Optionword Plus hovers in the background until called. It then takes over, replacing the standard 1-2-3 menu with a list of word-processing commands at the top of the screen. These let you copy,

move, justify, reformat between different margin widths, and incorporate sections of worksheet into text documents.

Optionword Plus requires at least 256K of RAM, and runs on the IBM PC, close compatibles and the ACT Apricot. It costs £89 plus VAT. Details are available from Optionware, 39 Hyde Park Gate, London SW7 5DS. Telephone: 01-584 3414.

Mac Basic

VERSION 2 of Microsoft's Basic for the Macintosh is a considerable step forward on the original. Mac graphics are now heavily supported, along with the mouse. Line numbers are optional and the editing is much improved. Debugging is aided by the ability to display output in one window while single-stepping through the program statements in another.

Microsoft Basic version 2.0 costs £145 plus VAT and is available now; existing version 1 users can upgrade for £50. Contact Microsoft Ltd, Piper House, Hatch Lane, Windsor, Berkshire SL4 3QJ. Telephone: (0753) 559951.

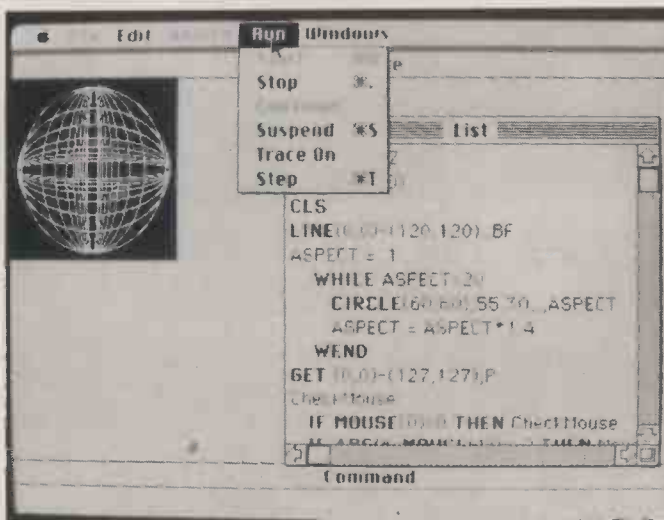

Mouse operation and graphics are supported by Basic 2.

New Calc utility for old WordStar

REKNER is a calculation utility which will work on normal WordStar files, using commands embedded in the document. You can add, subtract, multiply, or divide columns of figures vertically or horizontally, or operate on them with constants. Rekner also works with files in the standard text

formats of the CP/M-80, MS-DOS, PC-DOS or Unix operating systems.

Its price is £60 plus VAT. For more information contact MMG Consultants Ltd, 19 St. Andrews Road, Malvern, Worcestershire WR14 3PR. Telephone: (06845) 63555.

Wordwise Plus

WORDWISE PLUS is the new version of Computer Concepts' best-selling word processor for the BBC. The chief difference is greatly improved programmability since the new Wordwise includes what is virtually a text-programming language.

Wordwise Plus is supplied on ROM, along with a cassette containing a typing tutor program and mail-merging, sorting and indexing utilities written to match Wordwise. The price is £56.35

including VAT. Existing Wordwise users can get an upgrade for £24.15 and can use all their old text files.

Contact Computer Concepts, Hemel Hempstead, Hertfordshire HP2 6EX. Telephone: (0442) 63933.

Fancy Font

FANCY FONT is a utility program running on most MS-DOS and eight-bit CP/M machines which enables you to produce high-definition text in a variety of fonts using a standard Epson RX or FX series printer or close compatible.

The new version 2.0 of Fancy Font has twice the matrix density of the old version and can also justify and wordwrap text even when used with package that can't. Fancy Font will interface with most popular word-processing packages and costs £185 plus VAT.

Other versions of the program are available for the IBM PC graphics printer, the Epson MX series and the LQ-1500 printer. Contact PCML Ltd, Royal Mills, Esher, Surrey. Telephone: (0372) 67282. 



There's more. We produce both terminals with amber screens as standard. But unlike others, you can have green if you prefer at **no extra cost**.



There's more. Every terminal has a six-month warranty. And you have our worldwide service network to call on. Anywhere. Any time.



Meanwhile, everyone's still wondering how AmpeX can offer such extraordinary features at such ordinary prices.



Would you like to see the 210 and 230 in action? Would you like to play with them? Without obligation? Call Julie McClafferty on Reading (0734) 875200.

● Circle No. 118

"The 210 and 230 terminals are the first in a brand new family of high-quality low-cost AmpeX computer products. Keep watching."

AMPEX

AmpeX Corporation
One of The Signal Companies
Acre Road, Reading, Berks.
Telex 847611

THE SPECTRUM BASIC COMPILER



UP TO 40 x SPEED INCREASE

- ★ **BLAST!** is the first fully compatible OPTIMISING BASIC COMPILER for the Sinclair ZX Spectrum and Spectrum +.
- ★ **BLAST!** will compile ANY BASIC program, without alteration.
- ★ **BLAST!** will take your BASIC programs and transform them into super-efficient code running at up to forty times the speed of BASIC.
- ★ **BLAST!** can produce both native machine code and a compact p-code, for programs where space is at a premium.
- ★ When you have **BLASTED** your programs you are free to distribute or sell the results without any restriction.

SIMPLICITY ITSELF

Using **BLAST!** couldn't be simpler. Just load it with your BASIC program and press "C" to compile. In a few seconds the compiled program is ready. Just type RUN and see your software run up to forty times faster.

OPTIMISATION

BLAST! doesn't just compile your programs; it also applies a range of sophisticated optimisation techniques to enhance the performance of the compiled code. Any program can be compiled without alteration, but we think you will enjoy the wide range of extensions to BASIC built into **BLAST!** **BLAST!** features genuine integer variables, debugging facilities, program protection, and much more. It will operate in resident mode, or with tape or microdrive.

TOOLKIT INCLUDED

BLAST! provides the complete BASIC programmer's package. As well as a sophisticated compiler **BLAST!** includes a comprehensive toolkit with a full range of features including renumber, single-step, search and replace, and block handling operations. Use it to test and develop your BASIC programs before compiling them with **BLAST!**

STOP PRESS — OXFORD PASCAL

OXFORD PASCAL is now available for the SPECTRUM as well as the C64 and the BBC 'B'. To call us for details dial 100 and ask for FREEPHONE PASCAL.

Price/availability matrix		SPECTRUM	C64	BBC 'B'
BLAST BASIC		£24.95	N/A	N/A
OXFORD PASCAL	DISK	N/A	£49.95	£49.95
	CASSETTE	£24.95	£22.95	£39.95

All prices are inclusive of VAT
Please add £2.00 for postage and packing.

Please rush me my copy of

My computer is SPECTRUM BBC 64 Please supply CASSETTE DISK

I enclose £..... including £2.00 p&p Please make cheques payable to OCSS Ltd.

Name:

Address:

Postcode:

Telephone:



Oxford Computer Systems (Software) Ltd.
Hensington Road, Woodstock, Oxford OX7 1JR, England
Telephone (0993) 812700 Telex 83147 Ref. OCSSL

I N T E R V I E W

BOB ABBOTT founder and President of EDP Audit Controls

INTERVIEWED BY GLYN MOODY

Bob Abbott has spent 30 years in various branches of computing, and has worked for such institutions as the Lawrence Livermore Laboratory and the Pacific Medical Centre. His California-based firm EDP Audit Controls specialises in all aspects of security relating to computers, information, networks and tele-communications. Its services have been widely used by the U.S. Government and many large companies. A speciality is attacking supposedly secure systems in an attempt to gain unauthorised access. "I never failed to get into a system" says Abbott. Companies can pay up to \$250,000 for the honour of being broken into.



What do you think the scale of computer crime is today?

LET ME ANSWER that by making some observations on computers in the society we live in. A computer can either contain in its memory records of who owns money or it can contain the money itself. By the money itself I mean ideas, proprietary information, etc. So there is a dependency that we as a society have because the computer contains the money.

I will give you some statistics that apply to banking. If a small bank — that is to say one outlet or a couple of small branches — is deprived of its computer for two consecutive days, it will file for bankruptcy on the third day. This is data from the American banking industry. If a large bank is deprived of its data processing for six consecutive days, it will file for bankruptcy on the seventh day.

Furthermore, to take the Bank of America as an example, at the end of three days, the economy of California would be in serious difficulty and by the fifth day the Western half of the United States would be in deep financial difficulty. I cite this to illustrate that there are industries that are totally dependent on the computer in order to stay alive.

You ask about the extent of computer crime. It's very difficult to answer except that you have this strange target for potential criminals. Either because it contains the record of the money, or because it can cause harm to the company by being removed. I cannot give you statistics on it in terms of crimes committed. I really don't know. I personally believe that whatever the hackers do is small in comparison to the total extent of such activities.

An example of a computer crime recently; someone stole from a bank one reel of tape. This was one out of 25 to 30 tapes, copies of the master file, say a Visa card file for that bank. It had 10,000 to 20,000 customer credit-cards files on that tape. In addition to the balance owed it had credit limits, account numbers, addresses and all of that stuff. That tape was used by criminals to run charges in a large variety of places. So there it was not so much a case of having penetrated the computer as having obtained a product of the computer, and that information was then used with criminal intent and many merchants were abused in the process.

Who commits computer crime?

A FRIEND of mine did a study some years ago on what is the typical computer criminal. He profiled the person as being college-educated, somewhere around 30 years of age, computer knowledgeable, and motivated either out of spite or out of a desire to play games to prove to himself, and maybe to others, that he can do this. I think

that may have been an accurate description for a period of time. But I cannot believe that today, with availability of computers, and the availability of personal computers, that organised crime can afford to ignore the fact that the computer is an object to be attacked for profit. I sincerely believe that organised crime is doing something. I just do not know what.

Let me paint a picture of a totally hypothetical scenario. Let's say that you are this 30-year-old computer knowledgeable person, and you have some idea of how to steal money from some source using a computer. But in order to do this you need some money up front. Let's say you write a business plan, and you describe what you are going to do, and you develop a budget — how much it is going to cost and what you expect to clear as a result of it. Now that would be a very nice business plan that you would not take to a bank for financing but you would take to organised crime. And I think it would sell.

What is the weakest link in the computer security chain that might allow computer crime to take place? Let me first clear up something. We have been speaking of computer crime, but I also want to point that there is such a thing as computer abuse. Abuse may or may not appear directly as a crime, but it nonetheless may be disadvantageous to the company. Abuse could include unauthorised use of computer resources. For example, using your employer's computer to provide an accounting service to your own clientele after hours.

Similarly, it is the employees of the company who are one of the weakest links in computer security, because they know about the computer and they know how the computer operates. But perhaps the weakest link is for an organisation to ignore computer security as an issue that affects it. My first description that there can be either money in the computer, or that the company cannot operate without the computer, means that it is a valuable asset to that organisation, and anything that affects that asset is going to affect that company.

Therefore the company should be motivated to protect that asset. To believe that it does not have to protect its computer asset would be a very weak link. Probably the least costly first line of defence would be to make everyone aware that the security of the computer is (a) important to the company, and (b) a necessary responsibility of every employee. That is an inexpensive control and part of something that is very necessary: namely, that computer security awareness be brought to the attention of all individuals involved. 

NEW from **NEC...**



APC III
1.2MB

from only
£1499
+VAT

STANDARD FEATURES

- **SPEED:** full 8MHz 8086-2 16 bit processor (true 16 bit data).
- **CAPACITY:** two 5 1/4 inch disk drives (640K each formatted).
- **MEMORY:** 128K user ram + 64K graphics = 8K test video + 1K CMOS + 32K ROM.
- **OPERATING SYSTEM:** MSDOS 2.11 standard. Full screen ICON graphic display menu.
- **HIGH RESOLUTION:** 8 x 16 dot screen character definition (25 lines of 80 characters). 14-inch high speed screen with tilt and turn base.
- **AWARD WINNING NEC 7220 graphic controller.** 256 standard character set includes maths/Greek and graphic symbols. **ADDITIONAL 256 user-programmable shape character set.**
- **DETACHABLE KEYBOARD:** fast buffered top quality keyboard, numeric keypad, 12 function keys enabling 60 functions to be programmed, with template.
- **SERIAL RS-232:** to 9600 baud synchronous/asynchronous. **PARALLEL printer port.**
- **FOUR CARD SLOTS** for expansion boards easily accessible from rear + slot for colour graphics board + hard disk controller.
- **GW BASIC** Microsoft language standard, full graphic commands.
- **PRICE:** top value for money from:-
£1499 for professional/business/home use with TWIN 64K drives.
£2399 for 10MB HARD DISK inbuilt + one 640K floppy drive.

OPTIONAL EXTRAS

- **EXPANDABLE USER MEMORY:** in 128K units to maximum 640K RAM.
- **10MB HARD DISKS:** INTERNAL OR EXTERNAL.
- **8 COLOUR MONITOR SCREEN.**
- **VERY HIGH RESOLUTION GRAPHICS:** 640 x 400 x 8 colour or mono graphic screen, up to 192K RAM additional to user memory.
- **32 BIT HARDWARE ARITHMETIC PROCESSOR:** 8087-2 at 8MHz - fast!
- **CONCURRENT CPM OPERATING SYSTEM:** SHORTLY.
- **XENIX OPERATING SYSTEM:** SHORTLY.

SOFTWARE

ALL GENERAL MSDOS SOFTWARE.
AUTOCAD: CAD GRAPHIC DESIGN PACKAGE now available, best value hardware.
ACCOUNTS: Pegasus, Sage, Multisoft, etc.
WORD PROCESSING: Wordstar, Spellbinder, Lex, etc.
LANGUAGES: C, CB-86, CBASIC-86, Microsoft BASIC, COBOL, FORTRAN, PASCAL, PI/1, etc.
DATABASE: DBASE II, Rescue, FridayI, DataStar, Delta, etc.
SPREADSHEETS: Supercalc 2 and 3, etc.
COMMUNICATIONS: Asynch, SDLC.

Brighton Computer Centre

130 Lewes Road, Brighton BN2 3LG
(0273) 673114 Mon-Sat 10am-6pm

Please send me further details of the NEC APC III

Name

Company

Address

Tel.....

Application PC 6/85

● Circle No. 120

PRINTER SWITCHES FROM HOMESTEAD ELECTRONICS

LINK TWO OR MORE MICROS TO ONE PRINTER, PLOTTER, MODEM ETC. OR VICE VERSA

- ★ ROBUST CONSTRUCTION
- ★ SCREENED, METAL HOUSING
- ★ FULLY TESTED
- ★ BI-DIRECTIONAL
- ★ NO POWER REQUIRED
- ★ 12 MONTHS GUARANTEE
- ★ OFFICIAL ORDERS ACCEPTED
- ★ 24 HOUR DESPATCH

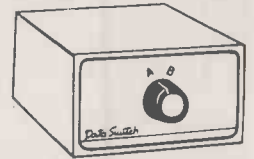

SERIAL DATA SWITCHES

RS 232/V24. 25 way 'D' sockets

LINES 1 to 8 & 20	
Model R2	2 way switch £49
Model R3	3 way switch £57
Model R4	4 way switch £65
Model R5	5 way switch £73
Model R6	8 way switch £110
Model RX	2 way cross-over £65

ALL 25 LINES

Model V2	2 way switch £65
Model V3	3 way switch £77
Model V4	4 way switch £89
Model V5	5 way switch £101
Model VX	2 way cross-over £89

PARALLEL DATA SWITCHES

CENTRONICS. 36 way sockets

Model C2	2 way switch	£79
Model C3	3 way switch	£99
Model C4	4 way switch	£119
Model C5	5 way switch	£139
Model CX	2 way cross-over	£119

IBM PC. 25 way 'D' sockets

Model P2	2 way switch	£65
Model P3	3 way switch	£77
Model PX	2 way cross-over	£89

IEEE-488. 24 way sockets

Model E2	2 way switch	£89
Model E3	3 way switch	£109
Model EX	2 way cross-over	£129

PLEASE ADD VAT AT 15%. ALL ITEMS CARRIAGE PAID
 TRADE, EDUCATIONAL & EXPORT ENQUIRY WELCOME
 CABLES ALSO AVAILABLE. EX STOCK & CUSTOM BUILT



HOMESTEAD ELECTRONICS

Trelawney Industrial Court
 Trelawney Avenue, Langley
 Slough, Berks. SL3 7UJ.
 Telephone: (0753) 44269

● Circle No. 121

HIGH TECH SOFTWARE COMPANY NEEDS HIGH FLYERS

Pathtrace Ltd is a small software company, specialising in CAD/CAM applications on microcomputers.

We are probably the fastest growing CAD/CAM company in the UK and have marketing outlets in the UK, USA, Canada, Europe and the Far East. To support the ever-increasing market demands, we need immediately four additional software staff who can demonstrate an unusually high potential, creative ability and commitment.

The rewards, job satisfaction, and prospects are excellent.

Applicants must be numerate and have solid experience of one or more high level languages, especially BASIC under MSDOS or CPM. We would normally expect applicants to have (or expect to obtain this year) a good level honours degree in a quantitative subject. We would also consider applicants with substantial practical micro experience without a degree.

Please reply directly to:

Mr N Gilbert
 Technical Director
 Pathtrace Ltd
 Pathtrace House
 91-99 High Street
 BANSTEAD
 Surrey
 SM7 2NL

● Circle No. 122

**640K
Upgrade
Free**

With IBM-PC, XT And Compaq Complete Systems

EXAMPLE PRICE

64K PC.....1139
Keyboard.....185
Second Drive.....297
Mono Adapter.....181
Mono Display.....186
DOS 2.1.....59

Upgrade to 640K FREE

TOTAL COST £2047

Phone for your configuration quote



LIMITED OFFER!

Please Phone Your Nearest Branch

NORTH LONDON 637, HOLLOWAY ROAD LONDON N19 5SS 01-281 2431

SOUTH LONDON 67, WESTOW STREET, UPPER NORWOOD LONDON SE19 3RW 01-771 6373

MIDLANDS 14, CHARLES STREET, HANLEY STOKE-ON-TRENT ST1 3AR (0782) 269 883

MICROWARE

32



▶ **LOGISTIX** (n) a powerful spreadsheet with an extensive database and containing truly superior presentation-quality graphics. *Logistix also includes: the fourth dimension — (1) time management; (2) resource allocation; (3) task scheduling; (4) project planning. Commonly referred to as '... the best idea in business software since the spreadsheet'.*

THE INDISPENSABLE PLANNING AND DECISION AID

No business remains static. You need to know not only what is going on today, but what should be happening next week, next month or next year. So you need the right kind of information in a form you can use and understand, you need to be able to analyse it in various ways and you need to be able to present it to others. Most important of all, you need to make decisions about the future. In short, you need to plan.

Logistix adds the all-important feature of time management to classic spreadsheet features, an extensive database capability and presentation quality graphics, to provide a versatile, powerful and easy to use planning and decision aid for managers and professionals.

LOGISTIX — The best idea in business software since the spreadsheet.

- ▶ DATABASE
- ▶ TIMESHEET
- ▶ SPREADSHEET
- ▶ GRAPHICS



Grafox Limited
65 Banbury Road
Oxford OX2 6PE
Tel. (0865) 516281

Why can't all our printers be like the JUKI 6100?

Because every business is different. Not everyone, for instance, needs the full sophistication of our remarkable 6100. (Though judging from the fact that it's one of the best-selling printers in the UK, quite a few people do). And not everyone has an IBM* computer (though for those that have we've just introduced the brand-new, IBM* graphic printer compatible 6100-I). No, not for us the 'take it or leave it' approach,

but a sensible, sensitive appreciation of individual needs and requirements. So whatever you want from your printer, you'll find a JUKI that's just right for you.

But just because you're concentrating on their differences, don't overlook the important fact that two things, at least, never change.

Quality and value, for instance.

In these respects, all JUKI printers are the same.

*IBM is a trade-mark of IBM Corporation.

JUKI 6100: one of the best-selling letter quality daisywheel printers in the UK. Graphic mode and full word processing support.



JUKI 2200: fully portable daisywheel printer with 2k buffer memory and full word processing support. Ideal for use at home.



JUKI 6300: high speed (40 cps) daisywheel printer with 3k buffer memory and full word processing support.



JUKI 6000: letter quality daisywheel printer designed specifically for home use.



JUKI 5520: low-cost, high quality dot matrix personal computer printer. High speed (180cps), graphic mode and optional 4-colour print function. NLQ.



JUKI 6100-I: brand-new, IBM*-compatible version of the best-selling 6100. Graphic mode and full word processing support.



JUKI

Technology true to type

JUKI (EUROPE) GMBH · Eiffestr. 74 · 2000 Hamburg 26 · F. R. Germany
Tel.: (0 40) 2 51 20 71-73 · Telex: 2 163 061 (JKI D) · Fax.: (0 40) 2 51 27 24.

Sole distributor: **MP Micro Peripherals Ltd** Intec Unit 3, Hassocks Wood, Wade Road, Basingstoke, Hants, RG 24 ONE.

Tel.: (0256) 47 3232 (32 lines) · Telex: 8 59669 MICRO PG, Facsimile (0256) 46 1570 ● Circle No. 125

Seiko presents the "MicroMainframe"



It looks like a desktop computer, but delivers true big-system power.

The Seiko series 8600 16-bit small business computer is a system that will change your perception of small computers. Because it's so big. Not in size, but in what it can do.

What it can do is give you a genuine, high-speed, multi-tasking capability, just like the big mainframe computers do.

Up to four different people can use the Seiko series 8600 — all doing different things, all at the same time. All they have to do is plug their terminals into the system, just like with a big mainframe.

This means that the Seiko

series 8600 is four computers in one. If you want it to be. Of course, it can also be used as a simple single-user system; you can expand as you please.

It can be equipped with a 10MB or 20MB or 50MB hard disk, which means you get all the memory and access speed you need, and it comes with six industry standard operating systems. Six. Including CP/M-86®, MP/M-86™, MST™-DOS, OASIS-16®, Thoroughbred™ OS and XENIX™. Which together give you instant access to literally thousands of software packages.

If you've ever heard of a

business computer that can give you all of this, you've been hearing about a big computer, not a desktop model. Seiko was the first to put it all into such a small package. We call it the series 8600. The "micro-mainframe". It's a system that you will want to see.

CP/M-86® is a registered trademark of Digital Research Inc.
MST™-DOS and XENIX™ are trademarks of Microsoft Corporation.
MP/M-86™ is a trademark of Digital Research Inc.
OASIS-16® is a registered trademark of Phase One Systems Inc.
Thoroughbred™ OS is a trademark of Science Management Corporation.

SEIKO

Desktop computers

Our smart systems make it simple

Manufactured by SEIKOSHA CO., LTD. Business Machine Division



Intelligence (UK) PLC

Network House
Wood Lane
London W12 7SL
Telephone 01 740 5758
Telex 916327 INTUK G

Please send me further information about the SEIKO Business Computers.

Name

Company

Address

Post code

Phone

Telex

CUB AND QL- THE PERFECT PARTNERSHIP

This Cub colour monitor is
TOTALLY compatible with the
Sinclair QL.

It combines outstanding
graphics capabilities with the
facility for displaying full 85
column text whilst doing full
justice to the colour potential
of the QL. Its new cabinet
with Tilt and Swivel Plinth
harmonises perfectly with the
QL's simple yet functional
appearance.

Best of all, a price of only

£ **295**

inc. V.A.T. and Tilt and
Swivel Plinth keeps your
bank balance in the black too.

SPECIFICATION

Model – CUB 1451/DQT3

14" QL monitor

RGB/TTL input

Tube Resolution (pixels) – 653 (H)

Pitch – 0.43 mm

Bandwidth – 18 MHz

Antiglare CRT



MICROVITEC
CUB
COLOUR MONITORS

Microvitec plc., Futures Way, Bolling Road,
Bradford, West Yorkshire BD4 7TU.
Tel: (0274) 390011/726500. Telex: 517717

36

AVAILABLE FROM HIGH STREET COMPUTER RETAILERS AND BRANCHES OF W. H. SMITH, BOOTS, JOHN LEWIS PARTNERSHIP, LASKEYS, CURRYS.
THE NAME 'CUB' IS A REGISTERED TRADE MARK OF MICROVITEC PLC.



● Circle No. 127

ONWARD WITH FORTH

Forth-based microprocessors look set to revolutionise microprocessor architecture.

THE FORTH language is probably the closest the computer world has ever come to alternative technology, since the unfortunate demise of my own windmill-powered abacus project, precipitated by the ill-timed introduction of the Intel 8080 microprocessor.

Forth defies nearly all the mores and conventions carefully cultivated by "normal" languages like Basic, Fortran and Pascal. To make matters worse, it can be shown that this peculiar language, beloved of eccentrics everywhere, can often outperform the competition because programs written in it usually execute faster.

Forth is a threaded-code language which relies heavily on the use of subroutine-based procedures called "words" which are themselves used to build up higher-level words which the programmer can add to the Forth "dictionary", stored in memory as a linked list. The act of programming involves the extension of the dictionary by the creation of new word entries, each defined in terms of words which are already in the dictionary. This process can be extended almost indefinitely, so that a program to find the answer to life, the universe and everything could appear in the dictionary as a single word.

During compilation the word definitions are looked up in the dictionary and a threaded list of appropriate subroutine calls is produced. The result is a conglomeration of nested subroutines, the deepest level of which is comprised of routines from the basic list of word primitives supplied by the language designers. For example, words such as +, -, *, /, Max, And, Swap, and Exit.

OPTIMISATION

In a sense, every time a program is written, the Forth language itself is extended. Unfortunately, this does lead to problems with program documentation which have tended to make the language more popular with hackers than with computer science faculties, who are more likely to prefer the visibility of languages such as Pascal. One big advantage of this approach is that new Forth-based languages can be created, each of which is optimised for use in a particular application area such as computer graphics, data logging, games and so on.

Also unusual is the language's use of postfix notation, where an arithmetic operator appears after the operands, and the use of a parameter stack upon which all calculations and operations are performed. Anyone who owns a Hewlett-Packard calculator will appreciate the advantages of those particular features.

Forth was created by Charles H Moore. In 1969 he was at the National Radio Astronomy Observatory, Charlottesville, Virginia, U.S.A. and getting very frustrated with the limitations of existing programming tools for the implementation of laboratory automation software. The language was developed for his own use, but by 1973 Moore and a number of other enthusiasts had left to set up Forth Incorporated, to spread the gospel and perhaps to make a little money in the process.

FAST AND EFFICIENT

Right from the start Forth became popular with many programmers, particularly engineers, who saw in it the basis of a fast, efficient language which could rid them of the burden of assembly-language programming for real-time applications. Some microprocessor manufacturers, too, saw Forth as a language ready to squeeze extra performance from their simple eight-bit processors, and they supported it via their development systems. Others went further and put a basic Forth dictionary and support routines into the ROM of one of their standard single-chip processors so that single-board systems could act as both software development aids and as target systems.

Meanwhile, Charles Moore himself was waiting for someone to do the sensible thing and produce a microprocessor which could directly and very efficiently run the Forth language without the burden of having to fit in with a pre-existing processor architecture and instruction set. After a long wait, Moore decided that he would obviously have to do the job himself. He has now re-emerged as a consultant to a small company called Novix in Cupertino, California which was set up specifically to develop and market a range of Forth-based microprocessors. The first of these, the NC-4000A, is now available, and what a fascinating device it has turned out to be.

High-level language programs for conventional microprocessors have to be translated into the machine language of the CPU, a process which usually generates a whole sequence of op codes for a single statement in the program. Very rarely, microprocessors have their internal microcode optimised to suit a particular language, the Pascal p-code engine from Western Digital being an example of this approach. However, what Novix has done goes a lot further.

Instead of emulating Forth primitives by rewriting the microcode of a conventional processor, Moore and his colleagues have designed their own processor from the

ground up, with the Forth operations embodied directly in the logic of the CPU. That in itself was a bold step, but while they were at it they took the opportunity to replace the conventional data bus/address bus/CPU approach of conventional chips with a new architecture that had been optimised specifically for the Forth language.

For a start there are three 16-bit buses, giving access to separate memory areas dedicated to the return stack, parameter stack, and program/data memory, plus two further buses — 16 and five bits wide respectively — giving access to I/O facilities. With five parallel data paths available, single NC-4000A op codes can perform five operations simultaneously. Better still, most Forth operations can be represented by a single 16-bit op code and executed in a single 125ns. instruction cycle, giving a performance of about 100 times that of a conventional chip running Forth in the normal way.

Since Forth relies heavily on the use of subroutine calls, the NC-4000A designers have also gone to a lot of trouble to ensure that these generally slow operations are invoked with the minimum of time-wasting overhead. The result is a call operation which executes in a single CPU cycle compared with 10 or more for a conventional chip. The operation of this feature is very simple. If the most significant op code bit is a 0 then the op code is Call Instruction and the remaining 15 bits represent the subroutine address in main memory.

16-BIT ADDRESS BUS

The 32Kword addressing range is not so restricting as it may seem, thanks to the one-for-one correlation between most high-level language operations and processor op code words. Also, since the memory address bus is 16 bits wide, the upper 32Kwords can be reserved for data storage. If the directly addressed 64Kword memory space is insufficient, provision has been made for extended addressing which is capable of reading 4Mbyte.

Subroutine returns, invoked by the Exit word, dispense with a separate op code altogether by utilising an op code bit reserved specifically as a flag for this function. A total of 17 16-bit registers are provided on-chip, all accessible within a single cycle. Special fast access to a low-memory region proves 32 more registers off-chip.

The result of this remarkable design effort is a unique device which could rewrite the book on microprocessor architecture. Even the first member of the family, which runs at a relatively pedestrian 8MHz clock rate, can perform over 10 million operations per second thanks to the highly parallel processing capability. Future members will increase this still further. An initial prototype, based on a CMOS gate array, ran a Forth implementation of the Sieve of Eratosthenes algorithm in 0.3 seconds. A comparable 68000 routine written in assembly language takes 0.5 seconds. 

<p>Tandata SMART MODEM MICRO PACK For use with the</p> <p>IBM PC</p>
<p>Tandata SMART MODEM MICRO PACK For use with the</p> <p>ICL Personal Computer</p>
<p>Tandata SMART MODEM MICRO PACK For use with the</p> <p>Columbia PC</p>
<p>Tandata SMART MODEM MICRO PACK For use with the</p> <p>Superbrain II</p>
<p>Tandata SMART MODEM MICRO PACK For use with the</p> <p>Epson QX-10</p>
<p>Tandata SMART MODEM MICRO PACK For use with the</p> <p>ACT SIRIUS</p>
<p>Tandata SMART MODEM MICRO PACK For use with the</p> <p>ACT APRICOT</p>
<p>Tandata SMART MODEM MICRO PACK For use with the</p> <p>Philips P2000C</p>
<p>Tandata SMART MODEM MICRO PACK For use with the</p> <p>Apple II, IIe and IIc</p>

Plus Televideo, Cifer, Research Machines 380Z, Amstrad, BBC Model B, Commodore 64, Commodore Pet, VIC 20... and other MS DOS, CP/M86 and CP/M micros.

Complete Communications

AUTO DIAL MODEMS

V23 1200/75 from £99.00 + VAT

V21/23 1200/75 & 300/300 from £173.00 + VAT

PLUS

MICROPACKS FOR YOUR MICRO

Matched software for Prestel, private viewdata and general communications, complete with user manual, the correct cable and graphics chip if required.

Also available for many micros, the new Tandata "View-Tex" - the most powerful communications software yet!

Tandata

Tandata Marketing Limited,
Albert Road North, Malvern, Worcs. WR14 2TL.
Telephone: 06845 68421 Telex: 337617 Tandat G
Prestel * 799 # Telecom Gold TAN 001

Please send me full details of your smart modems and micropacks.

Name _____

Address _____

Micro make and model _____

Send to Tandata Marketing Limited,
Albert Road North, Malvern,
Worcs. WR14 2TL.

PC 6

APPROVED
for use with
telecommunication systems
run by British
Telecommunications
in accordance with the
conditions in the
instructions for use

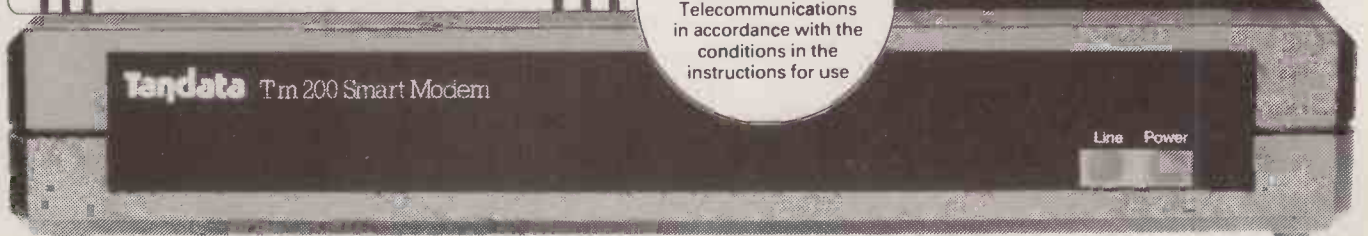

Everyone's saying it's a Great Little Printer!

Now you can afford high quality printing on plain paper, even with the simplest microcomputer system.

- * Full IBM-PC compatibility
- * Nine-pin print head * Original plus two copies * 80-132 columns at 10-17 cpi
- * Optional NLQ printing with 18 x 23 matrix * 50 cps draft speed
- * 48 international characters
- * Optional tractors * High-resolution pin-addressable graphics
- * Light and compact

The New Centronics GLP



'Fantastic value – even my students can afford it!'



'Near letter quality on plain paper – ideal for correspondence!'



'Weight only 3 kg – I can take it anywhere!'

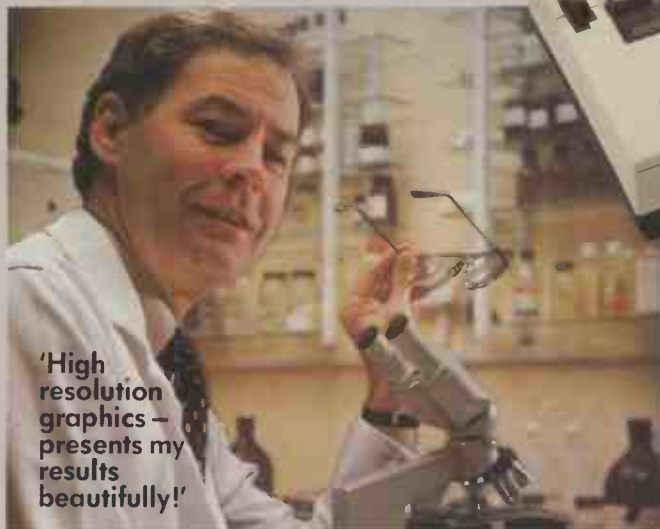

'High resolution graphics – presents my results beautifully!'



Please send full details on the GLP and the address of my nearest distributor

● Circle No. 129

Name

Position

Organisation

Address

PC 6

CENTRONICS
MORE THAN JUST AN INTERFACE

Centronics Data Computer (UK) Ltd Petersham House
Harrington Road London SW7 3HA Tel: 01-581-1011

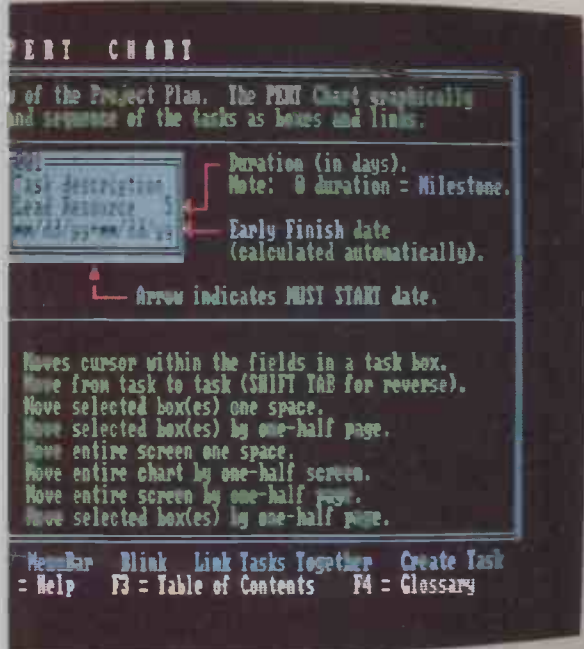

screen help a keystroke away.

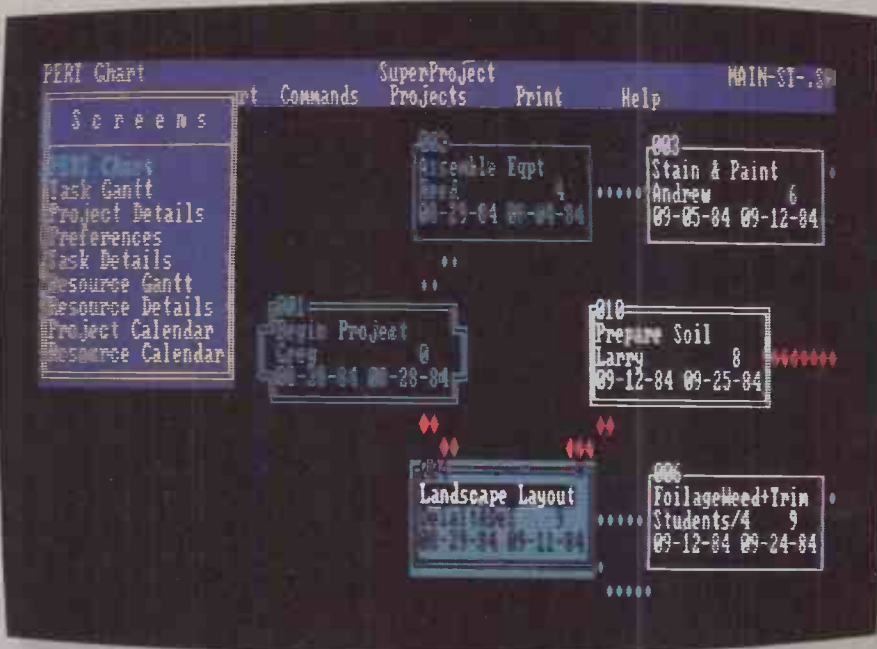

Create your entire project on screen.



so you see everything on every resource.

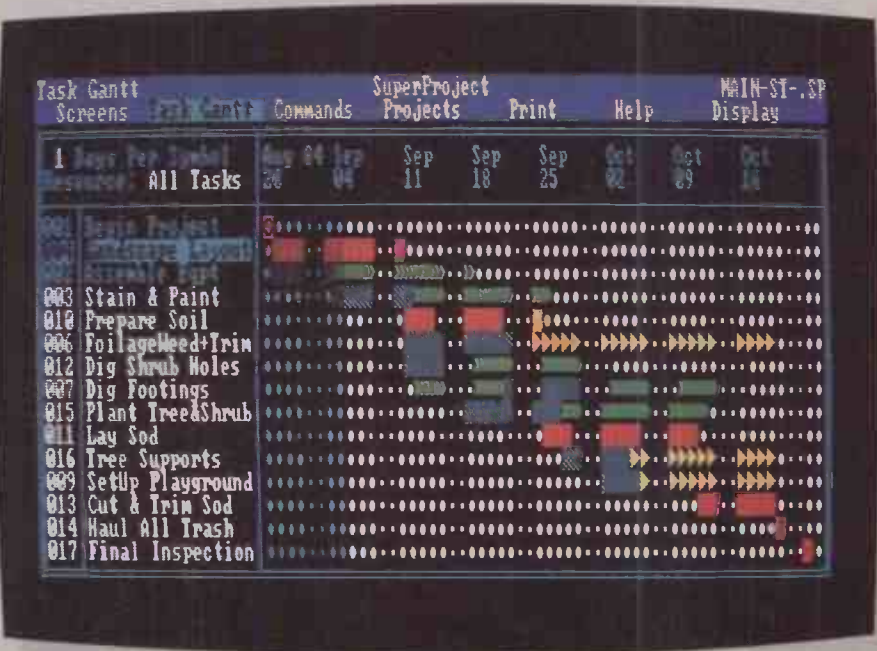

Schedule tasks over weeks, months, even years.

THE DIFFERENCE BETWEEN SUPERPROJECT AND OTHER PROJECT

It's not hard to see why SuperProject is becoming the new standard in project management software.

Bright colours and simple symbols let you know exactly where you stand, and its advanced graphics shine out even on monochrome screens.

But the real beauty of SuperProject lies in what it can do for you.

Like help you plan any project (from the smallest up to a planning problem the size of the Alaska Pipeline) right on the screen. And right to the last detail.

Schedule it seven ways to Sunday, including individual schedules and calendars for every resource.

Budget it down to the last penny, taking into account fixed, variable and total costs.

Have any change you make immediately reflected throughout the entire program.

Print every screen, even while you work.

And do it all by following simple menus or by using fast command keystrokes.



Unique project overview lets you see the big picture.



SuperProject automatically alerts you

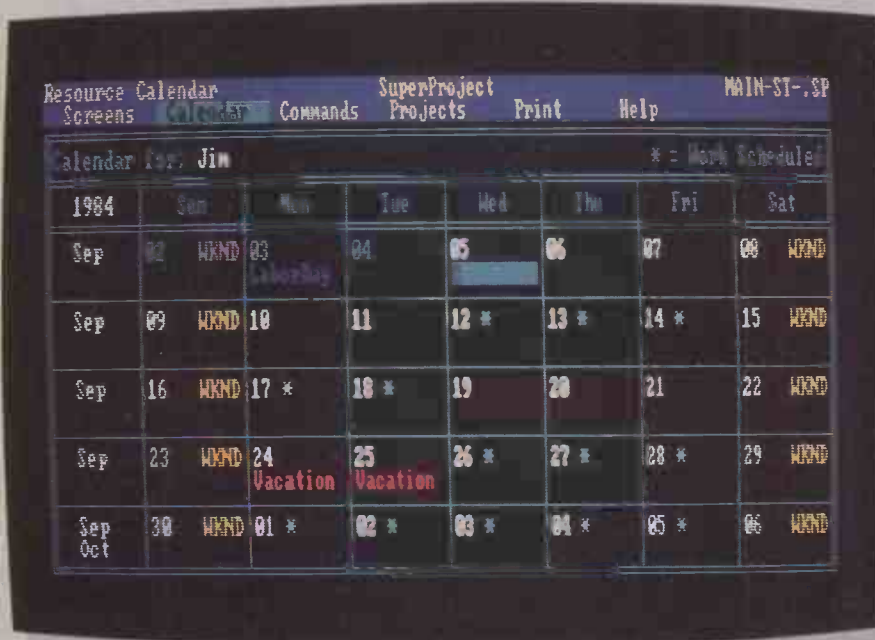

SuperProject outdates other project calendars by also providing calendars for every resource.

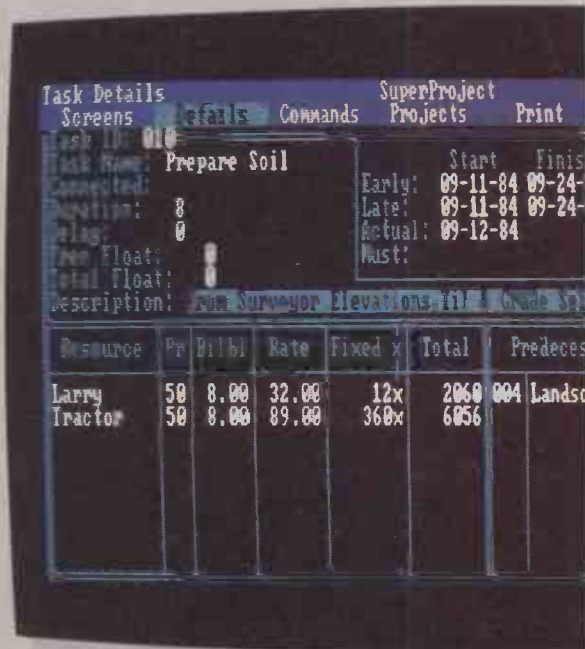

Track fixed, variable, and to

MANAGEMENT SOFTWARE IS EVEN MORE GRAPHIC THAN THIS.

To take your planning and analysis even further, you can directly transfer project information into SuperCalc 3 Release 2 and other leading spreadsheets, and produce customized reports and charts.

To see how SuperProject can give your project management a clear advantage, visit your Sorcim/IUS dealer or send for a free demo disk. After one look, you'll find it's hard to see yourself using anything else.



SORCIM / IUS
MICRO SOFTWARE

A Division of Computer Associates International, Inc.

St. Mary's House, 16-20 High Street,
Maidenhead, Berkshire. SL6 1QH.

Telephone: (0628) 70911 Telex: 847268

MAKE YOUR XT* MULTI-USER

... and get 1000s of software programs as a bonus.

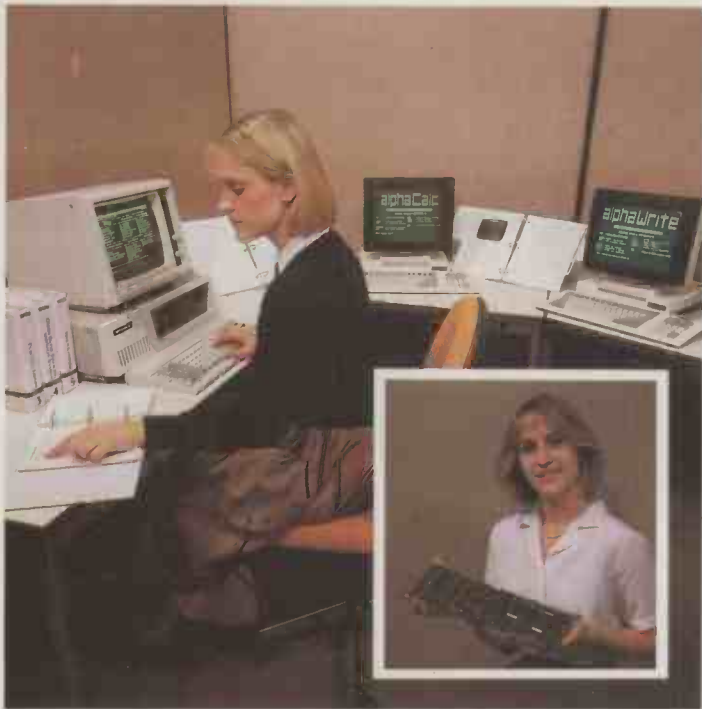

Transform your IBM XT or hard disk lookalike into a multi-user system in minutes.

For £2,400 you get the Motorola 68000-based AM170 board which upgrades your micro to a three-user system, plus Alpha Micro's AMOS multi-user and multi-tasking operating system. Your system now has the dual ability to operate as a multi-user system under AMOS or a single-user system under MS/DOS.

You can switch files between operating systems so that, for example, text created in an AMOS program can be used directly by a program running under MS/DOS, and vice versa.

Most importantly you can use the many thousands of software packages written for the IBM PC, as well as the proven multi-user business software that runs under AMOS.

And if you don't have a PC to start with, Alpha Micro can supply a full Entry Level System for this dual capability for under £5,800. Then when you are ready you can upgrade to compatible systems for 40 users.

ALPHA MICRO COMPUTER SYSTEMS

Call Alpha Micro for your nearest dealer.

Alpha Microsystems (GB) Ltd, Berkshire House, 56 Herschel Street, Slough, Berks. SL1 1PY. Tel: (0753) 821922.

*XT is a registered trade mark of IBM Corporation

● Circle No. 131

Have you put a **CLIP** in your Winchester?

CLIP — Compressed Library Interchange Program

CP/M	CP/M-86	PC DOS	MS DOS	£105.00
------	---------	--------	--------	---------

- **Backs up a Winchester on to floppies.**
- **Compresses text or data to less than half size.**
- **Large files can span multiple discs.**
- **Selective backup or retrieval, on an inclusive or exclusive basis.**

CLIP has no equal in reputation, convenience, power or economy.

EFFORTLESS BACKUP

You can save commands for later use, or type commands directly.

CLIP has its own menu, with seven prepared commands. Customise the commands if you wish, or edit the menu text with a word processor. Or keep the standard forms. All your housekeeping — save/restore/review — by pressing two keys.

CLIP comes standard with Winchester systems supplied by **Olympia, Cifer Systems, Research Machines, Philips and British Telecom.**

And is highly recommended by other major manufacturers



KEELE CODES LTD

University of Keele, Keele, Staffordshire, U.K. Tel: (0782) 629221 Telex: 36113

All prices excl. VAT, post free in U.K.
Most popular disc formats from stock.

● Circle No. 132

ENQUIRE WITHIN

Hints on constructing a free-text database.

MOST READERS of *Practical Computing* are familiar with databases: files that are designed for getting quick answers to queries and for producing reports. Their essential feature is that they are all structured in some way. It is the organisation of a database into records and fields that enables it to do its job.

But there is another type of database that is much less common on micros: the unstructured or free-text files that form the basis of most dial-up information-retrieval services. Their aim is to store magazine articles, news reports, abstracts of learned journals, legal decisions, or any other subset of human knowledge that can be regarded as information rather than mere data.

In some cases the information held on file is complete in itself. World Reporter, which is accessed via Datasolve and marketed to journalists, contains complete articles from *The Guardian* and elsewhere. Others, such as Fintel, hold abstracts or summaries of published papers.

But the aim is always the same: to help the user to locate an article or abstract according to specified combinations of words. For example, a lawyer using the Lexis legal database might be interested in all court cases containing the words "landlord" and "harassment". Searches must be possible on any words in the text, not just pre-defined keywords.

Most free-text systems allow the user to construct queries using the familiar Boolean operators: And, Or, and Not. Most also have some form of proximity matching, so you can ask for articles with, say, "taxation", "monetarism" and "unemployment" all in the same paragraph, or within so many words of each other. Another common feature is searching on the stems of words. Thus a search for "photo—" would find references to photograph, photochemical, photon, etc.

CONSTRAINTS

In designing this sort of system, there are two important constraints. First, the text retrieved by the user must be as close as possible to the text originally created, at least within the limitations of the ASCII coding system. Whatever techniques are used to compress and encode the text, they must be completely reversible.

The second constraint is that the actual search must run as quickly as possible. Any time-consuming jobs like indexing the text and manipulating the search arguments should be done off-line, either when the text is first entered into the computer or during the initial analysis of the query.

One common way of achieving these aims is to create an inverted file of the text, which acts as an index to individual words. As the example shows, the inverted file contains

one entry for each word in the original, together with a pointer to the relevant article. If proximity matching is used, the entry might also contain addresses of the word, sentence and paragraph.

The main problem with this approach is the sheer size of the index. A partial solution is to draw up a stop list of common words which can safely be excluded, such as "the", "of", "and" etc. Given that the 50 commonest English words account for nearly 50 percent of normal text, a stop list will make big inroads into the size of the index. The time needed to search the stop list is not a problem because this is done when the text is indexed, not during the more time-critical stages.

The index can be cut down further by compressing the words into six-bit characters. Since you do not need to distinguish between upper and lower case or to retain punctuation or special symbols in the index, there are only 36 possible characters in an index entry: the 26 letters and 10 digits. These are easily represented in six bits. In fact, if you elect not to index numbers five bits will suffice.

The bit manipulation needed for compression will, of course, be very time-consuming. But this is again confined to the indexing process and to analysis of the search argument. The actual search will be based on the compressed values, so there is never any need to unpack the index.

Another problem is the inevitable presence of synonyms and alternative spellings and styles within the original text. If you want to find a recipe that uses aubergine, for example, you might not think to

FREE-TEXT DATABASES: AN EXAMPLE

As an example of how files are inverted, here is an extract from a hypothetical free-text database used for abstracts of articles on modern history:

1030 The news that dwarfed the Coronation. An account of the conquest of Everest in 1953, and of how news of the event reached Europe.

1031 Roosevelt's Russian overtures. After the Yalta conference, Roosevelt recognised that the U.S.S.R. would be the most powerful nation in Europe, and this inevitably influenced his relationships with Stalin.

1032 Europe from 1919. An account of the Versailles conference and the effect it had on European politics.

The inverted version is as follows:

1919	1032	3	News	1030	2
1953	1030	1	News	1030	19
Conference	1031	7	Overtures	1031	3
Conference	1032	9	Politics	1032	17
Conquest	1030	11	Powerful	1031	17
Coronation	1030	6	Reached	1030	23
Dwarfed	1030	4	Recognised	1031	9
Effect	1031	12	Relationships	1031	26
Europe	1030	24	Roosevelt	1031	8
Europe	1031	20	Roosevelt's	1031	1
Europe	1032	1	Russian	1031	2
European	1031	16	Stalin	1031	28
Everest	1030	13	U.S.S.R.	1031	12
Inevitably	1031	23	Versailles	1032	8
Influenced	1031	24	Yalta	1031	6
Nations	1031	18			

The first number after each index entry is the article reference, which enables the system to go straight to the correct place in the text file. This is followed by a pointer to the word within the article, which is used for proximity matching by word. With longer articles, pointers to the paragraph and sentence might also be used.

The articles in the original text are in no particular order but the inverted file is in alphabetical order. Note that the inverted file does not distinguish between upper and lower case, because to do so would cause many search arguments to be incorrectly rejected.

The following is an example of the stop list that might be used with the historical database. Note that words like account, history, discussion, etc., are "stopped" because these would tell the user very little about the nature of the articles.

a	discussion	in	they
account	event	is	this
after	for	it	to
all	from	most	was
an	had	not	we
and	have	of	which
are	he	on	will
as	his	or	with
at	historical	review	would
be	history	story	you
but	how	that	
by	I	the	

In practice a larger stop list, probably running to over 100 entries, would be used. A large stop list results in a smaller inverted file and therefore much faster searches. The penalty is that the user cannot search for any of the stopped words.

(continued on next page)

(continued from previous page)

add "or egg-plant" to your query. A related difficulty is that of linked words. A search for "home" and "secretary" would find a completely different set of references than one for "home secretary".

To get round this some systems use a thesaurus, in which similar terms are grouped together. During indexing, and again during analysis of the query, any term appearing in the thesaurus is converted to the master term in its group. Thus, all occurrences of "First World War" and "World War-I" might become "Great War". Once the search argument has been compressed and passed through the thesaurus, the actual search can proceed. The system starts by looking for those index entries that match the first term in the query. It might use a binary search for this, or it could hold the index in the form of a tree structure or a hash table. As it proceeds, it creates a sub-list of all entries that match the first word.

The process is then repeated for the next word in the search argument, with a new sub-list being built. If the two words were linked with the Or operator, the two sub-lists are joined together. If And had been specified, only entries with the same article reference in both lists are retained. If proximity matching is being used, the other fields within the index entries can be examined at this point.

At the end of this process, most systems display the number of hits, this being the number of entries in the final sub-list. The

user then has two options: to ask to see the articles themselves, in which case the system can use the article pointers to get at the text, or to elect to refine the search by extending the original query. Here the system simply carries on with the search using the existing sub-list as a starting point instead of creating a new one.

Although this sort of system is typical of what you might find on a public free-text database, some services offer more complex search methods. One example is the weighted-term search. Here you specify a score or weight for each of the words you are looking for, according to the priority you want to give it. The system then ranks the articles according to the combined score of the words that it contains, and offers these to you in descending order.

FUZZY MATCHING

Another feature you might come across is called "fuzzy matching". This is an attempt to find approximations of terms. For example, the Soundex algorithm featured in last month's issue is sometimes used to find words that have similar sounds. If numeric terms are permitted, the system might use relational operators to express "less than", "between", etc.

A more powerful function is known as selective dissemination of information. Imagine that you are engaged in a promising line of research, and you ask your librarian to find out about any recent papers or books on the subject. Having collected the relevant

references, it would be very nice to instruct the librarian to continue to examine all subsequent acquisitions indefinitely and to inform you of any that meet your needs but you would have to be a very privileged library user to get that level of service.

With a computerised retrieval system, this can be achieved by storing your original request and rerunning it at specified intervals. The query could be adapted to include the publication date to ensure that only new material is selected. A few systems even include a label-addressing routine so that regular users can receive bulletins through the post without even asking for them. 

FREE-TEXT ON MICROS

Most micro owners who wish to access a free-text database will use their machines to communicate with a host system on a mainframe computer. But a number of text retrieval systems are now available on micros. Examples include:

- Aquila Telephone 01-351 2776.
Available for CP/M and MS-DOS.
- Inmagic Telephone: (0883) 35580.
Available for CP/M and MS-DOS.
- Metalogue Telephone: (0608) 41351.
Available for IBM PC and compatibles.
- Microbird Telephone: 01-253 5882.
Available for Apple II, Sirius and IBM PC.
- Micro-Cairs Telephone: (0272) 24181.
Available for IBM PC, Wang PC and Sirius.

PICK UP THE PHONE FOR THE BEST PORTABLE PACKAGE.

(0280) 816087

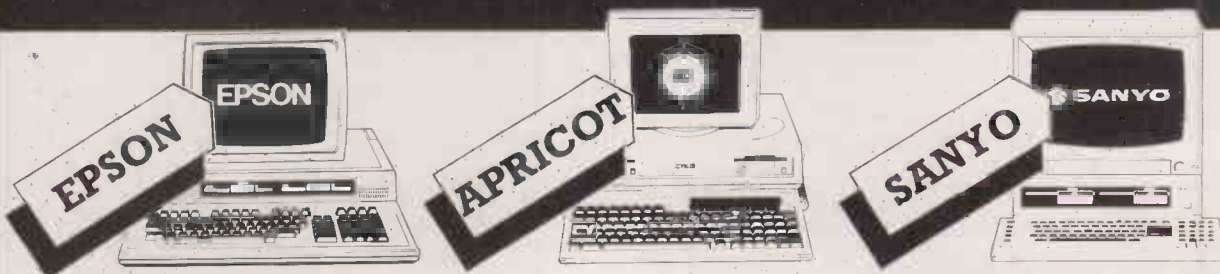

FREE SOFTWARE & TRAINING WITH EVERY SYSTEM.

Phone (0280) 816087 for more information.

- Impartial advice from trained consultants.
- On site training.
- On site servicing & fully equipped workshops.
- Complete After Sales telephone support.



FRASER
Associates Limited

Bristle Hill, Buckingham MK18 1EZ Telephone (0280) 816087



One stop.

At TABS Business Centres you'll get everything you need to run a small business system.

TABS Business Centres provide a complete range of computer products to help you run your business more efficiently.

Whether you need a simple business computer to run your sales ledger and handle your correspondence or a multi-user system with an integrated accountancy package, you will find everything you need – all in one place.

You will get free expert advice from people who understand the business world, and who have a thorough knowledge of accountancy and microcomputers.

You will also get expert training on how to use your system, a professional installation service and full support for the hardware and the software.



*IBM IBM PC 64, Monitor, Keyboard, Mono Display Printer Adaptor, DOS 2.0 + Tandem Drive.

£21.76 per week + VAT
Over 36 months rental period

IBM XT, Monitor, Keyboard, DOS 2.0, Mono Display Printer Adaptor.

£37.38 per week + VAT
Over 36 months rental period



ACT APRICOT PC, 2 Disk Drives (Double Sided), 720K + 9" High Resolution Monitor – Mono.

£21.30 per week + VAT
Over 36 months rental period

APRICOT Xi 10, 1 Disk Drive + Winchester 10Mb + 9" High Resolution Monitor – Mono.

£31.97 per week + VAT
Over 36 months rental period



OLIVETTI M24 (Typical System), Mono Display, Keyboard + MSDOS, 2 Disk Drives 360/720Kb.

£20.69 per week + VAT
Over 36 months rental period

M24 (Hard Disk System), Mono Display, Keyboard + MSDOS, 1 Disk Drive 360/720Kb, 1 Winchester 10Mb.

£41.62 per week + VAT
Over 36 months rental period

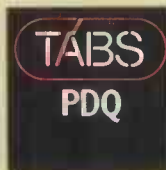

TABS PDQ 1.2, Mono Display, Keyboard + MSDOS, 2 Disk Drives 800K.

£24.44 per week + VAT
Over 36 months rental period

PDQ 10, Mono Display, Keyboard + MSDOS, 1 Disk Drive 800K + 1 Winchester 10Mb.

£41.20 per week + VAT
Over 36 months rental period

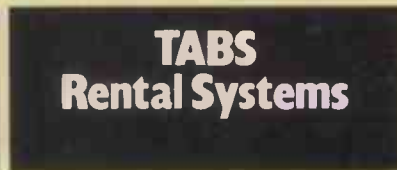

TABS Business Centres offer a Rental Plan which is ideal for companies preferring to keep their capital intact for use within the business rather than tying it up in depreciating assets. The plan allows for the system to be upgraded at regular intervals without high cancellation penalties and includes maintenance and insurance.

For your nearest one stop Business Centre 'phone:

0722-338668

* The IBM PC and XT are only available from TABS Business Centre, Salisbury and those TABS Business Centres who are IBM authorised PC dealers.

FROM £10,000 CREDIT

Simply fill in the coupon and return it to: TABS Ltd, Dolphin House, New Street, Salisbury, Wilts. Please allow 14 days for reply. The TABS RENTAL CARD is valid at all TABS Business Centres.

I WISH TO APPLY FOR RENTAL CREDIT FACILITY.

Name

Address

Tel No.

Company Business Name

Nature of Business Position

Bankers Branch

Account No. Signature

• Circle No. 134

PC 6 85



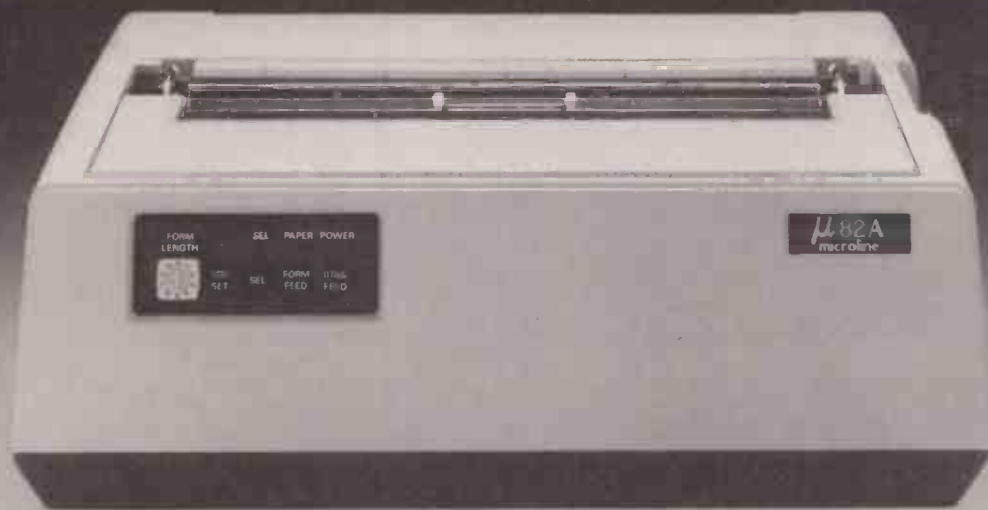

The MICROLINE 82A

FROM EXCELLENCE THE NEW OKI

Above we show you two printers (to the same scale). On the left is the OKI MICROLINE 82A - one of the most successful standard dot matrix printers ever manufactured. On the right is the printer that will become the NEW standard for dot matrix printers - the new MICROLINE 182 - from OKI.

In the past OKI have always achieved excellence in their printer products - now we believe they've reached perfection! OKI's revolutionary design concept for the new Microlines sets hitherto unparalleled standards of performance, styling - and price.

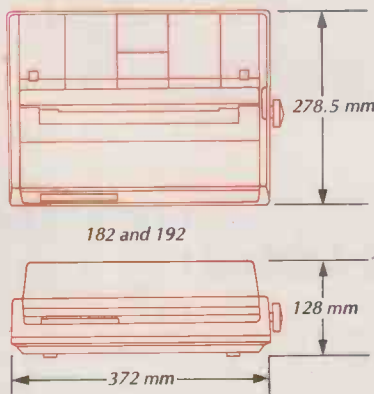

The dimensions of the larger Microline 193 are, length 524 mm, width 278.5 mm and height 128 mm. These dimensions do not include the platen and tractor unit.

The new MICROLINE 182 is the first of a whole new range of printers from OKI which fulfil all the requirements of today's printing needs. With operating noise level reduced to an almost unbelievable 58dB. and a print speed of 120 characters/second, listings, invoices and many other applications are all handled quietly, with utmost speed and efficiency. If your requirement is for high resolution computer graphics, the MICROLINE 182 will reproduce your screen images with a degree of accuracy never before seen from a matrix printer. True underlining, superscript and subscript are

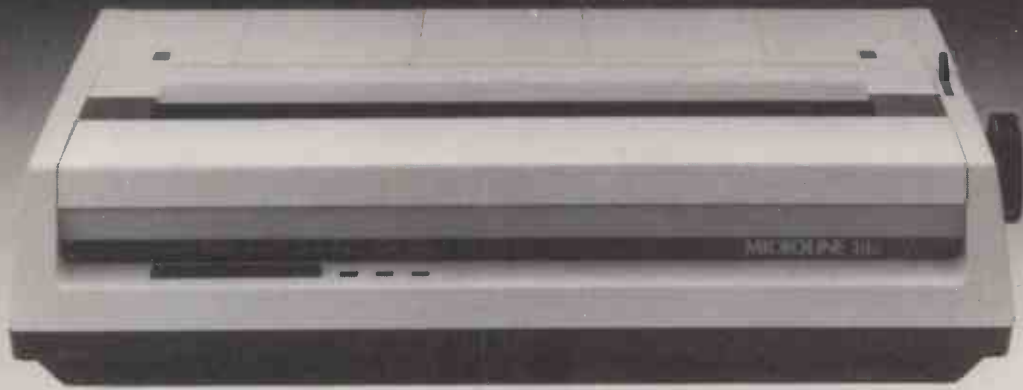

The new MICROLINE 182 to the same scale as the 82A

TO PERFECTION MICROLINES

OKI IS O.K.

also incorporated as standard. In addition a new concept in ribbon design, allows a single action 'clean hands' operation.

But that's not all - complementing the new styling and incorporating even more features are the MICROLINE 192 and 193. Both have the same incredibly high specification as the 182 - PLUS

- Even faster throughput (160 cps)
- Correspondence quality printing
- Down line loadable character font memory - with battery back-up
- Operator selectable default settings.

OKI



X-DATA

A Subsidiary of *Dyneer* Corporation

X-DATA Ltd. 750/751 Deal Avenue
Slough Trading Estate Berks SL1 4SH
Tel: Slough, (0753) 72331 Tlx. 847728

The reputation of OKI MICROLINE printers was built on excellence of quality and reliability. The new Microlines are no exception - even higher quality, greater reliability and performance bring the new generation of OKI MICROLINE printers - to near perfection.

Contact your local dealer for more details of the new generation from OKI or contact us directly at the address below. Insist on perfection.... insist on OKI.

● Circle No. 135

TurboDOS power for multi-user networking



MINSTREL 2

Designed and built in Britain

It's not easy to build an effective multi-user system. It takes experience, confidence and, above all, a superior operating system.

HM Systems possess all three qualities in large supply, and we've put them into Minstrel 2, our latest model.

Experience has shown that multiple workstations and resource-sharing call for multi processor architecture. That way, every user gets their own computer and performance doesn't suffer.

Confidence comes from using proven S100 technology. We've seen too many systems fail by being based on "next year's industry standard". We'd rather settle with this year's working solution. Wouldn't you?

Which is not to say that we're behind the times.

Our state of the art HTS 86 dual processor card was developed to provide two 16 bit computers on a single board.

This means 16 bit computing power at 8 bit prices for you.

We simply prefer evolutionary to revolutionary development.

Make no mistake, any multi user system is only as good as its operating system. Minstrel 2 uses TurboDOS® We've not come across a more flexible and powerful tool.

TurboDOS reads programs written for CP/M II,† CP/M 86, MP/M II, MP/M 86, has PC DOS emulation, and allows IBM PCs or lookalikes to share the resources of a Minstrel 2 system.

Networking is integral.

Minstrel 2 can communicate with all leading mainframes. And we can prove it.

Entry cost for a two-user system with 20Mb hard disk capacity is £6250.00. Additional workstations cost £1110.00 inclusive.

Write or call for a full colour brochure. You won't get a hard sell. With experience, confidence and the best operating system, we find the facts speak for themselves.



HM Systems HTS 86. 16 bit performance at 8 bit prices.

A. Performance comparison – number of users increasing

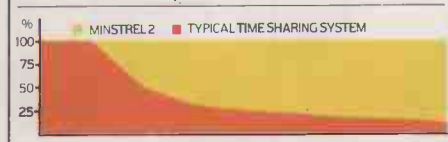

Costs rise and performance suffers when a number of terminals share a common processor. Graph B shows a network of leading stand-alone computers when compared with Minstrel 2. Graph A shows the effect on performance of timesharing compared with Minstrel 2.

B. Cost comparison – number of users increasing

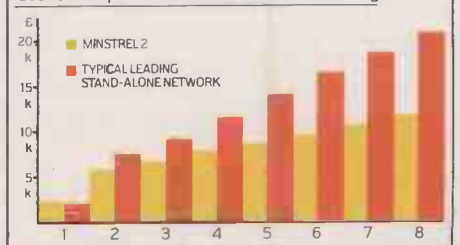

TurboDOS™ TurboDOS is the registered trademark of Software 2000 Inc.

†CP/M and MP/M are registered trademarks of Digital Research Inc.

HM Systems Limited,
220 The Vale,
London NW11 8HZ
Telephone: 01-209 0911
Telex: 266828-HMS G
Easylink: 1900 1060

HM Systems

ALL ABOARD

THIS MONTH I have printed the full list of Bulletin Boards currently in operation in the U.K. These systems provide facilities for messaging between users and often have free

programs which you may download. For a ring-back system you should call the telephone number. Listen to whether the computer answers within three rings. If it does not then hang up and call again immediately, if it does answer then continue to use the system. Remember to check times before calling.

BULLETIN BOARD SERVICES

BABBS 1 (0394) 276306

SYSOP: Tony Game
TIMES: 24 hours
SPEED: 300 baud
SIGS: Adventure Clues, CP/M, DOS, Hardware, Mac, Modem Spot, Sales/Wants
NOTES: Download and Upload area, British Apple System User Group's BBS

BABBS 2 (0268) 776956

SYSOP: Mike Jones
TIMES: 24 hours
SPEED: 300 baud
SIGS: Adventure Clues, CP/M, DOS and Prodos, Hardware, Insults and Graffiti, Jokes, Macintosh, Modems, Pascal, Sales and Wants
NOTES: Upload and Download, British Apple System User Group's BBS.

CABB — London 01-631 3076

SYSOP: Tony Dennis
TIMES: 24 hours
SPEED: 300 baud and 1,200/75 baud weekdays
SIGS: Acorn, Commodore, CP/M Lonely Hearts, Sinclair
NOTES: *Computer Answers* magazine BBS, program download area

CBBS London 01-399 2136

SYSOP: Peter Goldman
TIMES: Sundays 5.00p.m.-10.00p.m.
SPEED: 300 baud
NOTES: Otherwise known as MG-Net

CBBS Surrey (04862) 25174

SYSOP: Mike Parker
TIMES: 24 hours
SPEED: 300 baud

CBBS SW (0626) 890014

SYSOP: Boyd Hitchcock
TIMES: 24 hours
SPEED: 300 baud and 1,200/75 baud

City BB — London 01-606 4194

SYSOP: Dave Coles
TIMES: 24 hours
SPEED: 300 baud, except Wednesdays when 1,200/75 baud
SIGS: Apple, Atari, IBM, TRS-80

Distel — London 01-679 1888

SYSOP: Display Electronics
TIMES: 24 hours
SPEED: 300 baud

Estelle (0279) 443511

SYSOP: STC Electronic Services Ltd
TIMES: Office hours
SPEED: 300 baud, 1,200/75 baud on (0279) 441188
NOTES: Commercial; intended for use by STC customers; 1,200/75 baud system uses Viewdata graphics

Forum-80 Hull (0482) 859169

SYSOP: Fred Brown
TIMES: midnight-8.00a.m. all week, 5.00p.m.-10.00p.m. Tuesday and Thursday, 1.00p.m.-10.00p.m. weekends
SPEED: 300 baud
NOTES: The first BBS in Britain

Forum-80 London 01-902 2546

SYSOP: Victor Saleh
TIMES: 9.00p.m.-midnight
SPEED: 300 baud

Hamnet (0482) 497150

TIMES: 24 hours
SPEED: 300 baud
NOTES: BBS for Radio Hams

Liverpool Mailbox 051-428 8924

SYSOP: Peter Toothill
TIMES: 24 hours
SPEED: 300 baud
SIGS: Adventure, Apple, Atari, BBC, CP/M, Dragon/Coco, IBM PC, Microwave, Modems, TRS-80
NOTES: Also has area to leave messages to *Personal Computer World* magazine

Mailbox-80 West Midlands (0384) 635336

SYSOP: Jim Roden
TIMES: 5.30p.m. to 8.00a.m., all day Sunday
SPEED: 300 baud
SIGS: Apple II, Atari, BBC, Dragon, IBM PC, Osborne, TRS-80, Vic 20

Manchester BBS 061-427 1596

SYSOP: Robert O'Donnell
TIMES: 24 hours
SPEED: 300 baud
SIGS: BBC, Hackers, Jokes, Problems
NOTES: First BBS to be run on a BBC Micro with the software now being available from Pace

Manchester Open BB 061-736 8449

SYSOP: Ken Farnen
TIMES: 24 hours
SPEED: 300 baud
SIGS: Acorn, Adventures, Apple, Atari, Commodore, CP/M, For Sale/Wanted, Gossip, Hardware, Help!, Jokes, Languages, Modems, Spectrum, Tandy

MAPTEL (0702) 552941

SYSOP: Maplin Electronic Supplies
TIMES: 24 hours
SPEED: 300 baud
NOTES: Commercial BBS containing details of stock levels; customers may order supplies with a credit card

Metro BBS — London 01-341 7840

SYSOP: Peter Beaumont
TIMES: 24 hours
SPEED: 1,200/75 baud
SIGS: Adventure, Art Gallery

Micro Live BBS 01-579 2288

TIMES: 24 hours
SPEED: 300 baud
NOTES: BBC *Micro Live* programme BBS; programme notes available for downloading

Microweb 061-456 4157

SYSOP: Mike Bibby
TIMES: 24 hours
SPEED: 300 baud
NOTES: *Micro User* magazine BBS

North Birmingham (0827) 288810

SYSOP: Paul Smith
TIMES: 24 hours
SPEED: 300 baud
SIGS: Atari, BBC, Chain Letters, Hackers, Infocom, Lonely Hearts

OSI/Technical BBS 01-429 3047

SYSOP: Frank Leonhardt
TIMES: 24 hours
SPEED: 300 baud
NOTES: ring-back during day, bias toward computer projects, home-brew software under constant development

PIP (0742) 667983

SYSOP: Quentin Reidford
TIMES: hours; 9.00a.m.-midnight CCITT, midnight-9.00a.m. BELL
SPEED: 300 baud
SIGS: Adventure Clues, Apple, Apple Mac, BBC, CP/M, DOS, Fantasy Area, IBM PC, Modem Spot, MUD, Oric, Sales and Wants

Southern BBS (0243) 511077

SYSOP: Jonathan Sanders
TIMES: 24 hours
SPEED: 300 baud
SIGS: Atari, BBC, Bulletins, For Sale, Hackers, Zork

Stoke Itec (0782) 265078

SYSOP: Ian Hickman
TIMES: 24 hours
SPEED: 300 baud
NOTES: remote CP/M system

TBBS Blanford (0258) 54494

SYSOP: Leo Knaggs
TIMES: 24 hours
SPEED: 300 baud
SIGS: Apple, Atari, BBC, Commodore, Modems, Newbrain, TRS-80

TBBS London 01-348 9400

SYSOP: John Newgas
TIMES: 24 hours
SPEED: 300 baud
SIGS: Apple, BBC, C, Forth and Pascal, Chain Letters, CP/M, Diplomacy, The Wall — graffiti, Hackers Club, Modem Spot, MS-DOS, Politics, Radio Comms, Sales and Wants, Where to Eat
NOTES: Download, toy shoppe — games, adventure hints



Choosing a Computer?

To avoid the pitfalls that every business must face make certain that the system you choose will:

- Keep a firm grip on your cash
- Take maximum discounts
- Chase debtors regularly
- Keep stocks low but not too low
- Despatch invoices daily
- Prepare statements any time
- Satisfy the VAT man
- Cut payroll preparation time
- Eliminate clerical errors
- Give you all the information you need – immediately!

FREE! Before you decide, send for our FREE BOOKLET

"A Businessman's Guide to Choosing a Computer".

Written in everyday language, it will help you make the right choice. Phone Maidenhead 74661 or mail the coupon Freepost today.

Plusmark Software

PROVEN BUSINESS MANAGEMENT SYSTEMS

SEND BOOKLET

Name _____
 Title _____
 Type of business _____
 Company _____
 Address _____
 Tel. _____

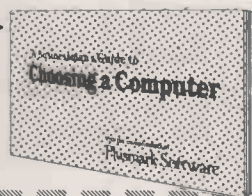

Plusmark Systems run on Altos, Apricot, IBM, ICL, Olivetti Philips, and other leading micro computers.



Post to Plusmark Business Systems Ltd., Freepost, Maidenhead, Berks. SL6 2BZ

● Circle No. 137

SWAP

MICRO TO MICRO
FILE TRANSFER
SYSTEM

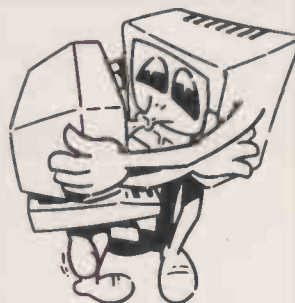

"Get your microcomputers talking to each other!"

SWAP allows you to transfer any programs and data between 2 computers of different manufacture. SWAP consists of 2 floppy disks and a cable configured for your 2 chosen computers. Here are some of the formats available:

IBM PC	IBM Compatibles	Sirius
Apricot	Apple (CP/M)	HP150
Televideo	Superbrain	BBC
Sanyo 555	DEC Rainbow	Kaypro

If your format is not in our extensive range we can usually produce it at little or no extra cost.

The price of SWAP is £158 (£135 plus VAT and postage and packing). Please specify your computers when ordering.

MERCATOR COMPUTER SYSTEMS LTD
 3 Whiteladies Road, Clifton, Bristol BS8 1NU.
 Telephone: (0272) 731079
 Telex 44220 Comtel Ref 247

MERCATOR
COMPUTER SYSTEMS

● Circle No. 138

FORTH = TOTAL CONTROL

FORTH programs are instantly portable across the most popular microprocessors.

Application Development Systems include FORTH with virtual memory, multi-tasking, assembler, full-screen editor, decompiler, utilities, and full documentation.

FORTH is interactive and very fast.

LMI Z80 FORTH - CPM 2.2 **£95**

FORTH programs are structured, modular, and easy to maintain.

LMI 8086 FORTH - CPM-86, MSDOS **£110**

LMI PC/FORTH - PC/DOS **£110**

FORTH gives control of all interrupts, memory locations, and i/o ports.

MPE-FORTH 6809 - FLEX, OS9 **£175**

LMI 68000 FORTH - CPM 68K **£225**

FORTH gives full access to DOS files and functions.

FORTH+ has 32-bit stacks and directly accesses the whole address space of the processor.

FORTH application programs can be converted to turnkey programs.

PC FORTH+ **£225**
 8086 FORTH+ **£225**
 68000 FORTH+ **£225**

FORTH Cross Compilers can generate ROMmable code for: 6502, 6809, 68000, 8080, Z80, 8086, 6800, 6801/3, 1802, Z8, 8070, Z8000, 99xxx, LSI-11

Extension Packages include floating point, cross compilers, 8087 support, colour graphics, interactive debuggers

We are the FORTH specialists, we also stock a large range of books, listings, and implementations for machines ranging from Spectrums to Macintosh to VAX.

mpe MicroProcessor Engineering Ltd

21 Hanley Road, Shirley
 Southampton SO1 5AP
 Tel: 0703 780084



● Circle No. 139

Compared to its rivals there is no comparison!

The Delta Data D2830-III Burroughs Emulation Terminal from Infomata incorporates all the features of the Burroughs TD830, MT983 and ET1100 plus all this:-

- Full Programmable Keyboard
Program up to 300 keystrokes on any single key, or download functions from your mainframe.
- Multi-Host Communications
Communicate in teletype mode to a second mainframe.
- User Friendly Easy to read English menu.
- Ten Page Display Memory Store and modify up to 19,200 characters in the terminal before sending it to your Burroughs mainframe.
- Variable Buffer Size The operator can define datacom, printer, keyboard, screen and softkey buffer sizes to meet individual requirements.
- Concatenation With Auto Bypass
Power off without affecting any other terminal in the loop.

● Addressable Printer Port A two-character printer address sends data to the printer without affecting terminal operations.

● Ergonomic Design Designed for operator comfort and convenience. Low profile keyboard 14" display, tilt and swivel base.

Before we can recommend any product to our customers, we must be sure of its quality, useability and reliability.

The Delta Data D2830-III Burroughs Emulation Terminal is one product which we will readily recommend to any Burroughs mainframe user.

Its features make it superior to any other terminal of its kind and proven reliability means years of trouble free use.

If you operate a Burroughs mainframe call Infomata today and we'll show you what the Delta Data D2830-III can do for your system.

**BUILD YOUR SYSTEM
ON OUR
EXPERIENCE.**

infomata
computer system consultants & suppliers

Gilbert Wakefield House, 67 Bewsey Street, Warrington, Cheshire WA2 7JQ. Tel: (0925) 572870. Telex: 627702.





DOES WORKING ON LOTUS 1-2-3 MAKE YOU SEE RED?

Granted, Lotus 1-2-3™ can be a fast spreadsheet.

Except when you first buy it, take out the five floppy disks, study the manual to figure out which ones do what, put the plastic Thingymejig over the keyboard, and begin reading about all the installation procedures you need to get the thing up and running.

Or if you never make a circular calculation (any simultaneous equation, even something as simple as "bonus equals 10% of profit after bonus") when doing a complicated spreadsheet.

By the time 1-2-3 calculates it correctly, you may have retired.

Or if you'd like to plot your data with a single keystroke, because it can take several minutes (including a disk change) just to start the process.

Or if you'd like to quickly create a file directory under program control. 1-2-3 can't do that at all.

What's the point of all this?

We'd like you to go down to your software dealer or send for a free demo-disk and see a new product called SuperCalc® 3 Release 2, which, unlike Lotus 1-2-3, does all of the above.

Along with a larger spreadsheet. Vastly superior graphics. Incredible speed (that becomes even faster when used with the 8087 or 80287 math co-

processors, which 1-2-3 doesn't support). And more.

For a lot less money.

All on one disk that you can run right out of the box. (Our lawyers want you to know we include an additional file disk. Which also contains the popular printing program Sideways™, so you'll never have to cut and paste wide printed reports together again. Unless you use 1-2-3.)

But don't believe us about all this. Go take a look.

After you do, one thing should become obvious.

What are you waiting for?

● Circle No. 141



SORCIM / IUS MICRO SOFTWARE

A Division of Computer Associates International, Inc.

St. Mary's House, 16-20 High Street,
Maidenhead, Berkshire. SL6 1QH.

Telephone: (0628) 70911 Telex: 847268

DON'T DEAL WITH THE REST, DEAL WITH THE BEST
 **The market leaders!...**

PARTICIPATE IN OUR SUCCESS!
 Become an ATA franchise Ring (0727) 34361 NOW and speak to Charmian Rowley!

apricot

Apricot F1e 128k RAM single 315k Disk Drive.....	848.00
Apricot F1 256k RAM single 720k Disk Drive.....	985.00
Apricot PC 256k RAM single 315k Disk Drive.....	1150.00
Apricot X15 256k RAM 5mb S/S Drive.....	1999.00
Apricot X110 256k RAM 10mb D/S Drive.....	2299.00
Apricot Monitor.....	170.00

The complete range of Apricot computers and Apricot software is available. Please phone for details.

PRINTERS AND PLOTTERS

Epson RX80.....	209.00
Epson RX80F/T.....	239.00
Epson RX100.....	379.00
Epson FX80.....	369.00
Epson FX100.....	479.00
Epson H180 Plotter.....	349.00
Centronics Horizon H80.....	375.00
HP ThinkJet Printer.....	375.00
HP LaserJet Printer.....	3195.00
HP 7470A RS232 or HP IB A4 Plotter.....	985.00
HP 7475A RS232 or HP IB A4 Plotter.....	1549.00

 **HEWLETT PACKARD PERSONAL COMPUTERS**

We have a selection of Hewlett Packard demonstration hardware and software for sale at enormous discounts. Please ring for details.

Macintosh

Macintosh 128k computer.....	1499.00
Macintosh 512k computer.....	2149.00
External Drive.....	299.00
10" Imagewriter with accs. kit.....	355.00

Macintosh

FileVision.....	134.00
Multiplan.....	141.00
Chart.....	110.00
Word.....	119.00
File.....	119.00

Full range of Macintosh Software available.

 **apple**

Apple IIC 128k RAM 80 col.....	940.00
Apple IIe 64k Computer.....	449.00
Apple III 256k Computer.....	1690.00

IBM ACCESSORIES

Hercules Graphics Card.....	355.00
Hercules Colour Card.....	178.00
Sigma Maximiser Multifunction Card.....	266.00
The NEW Quadboard.....	295.00
PC Express Accelerator Card.....	626.00
64k memory upgrade (9 chips).....	49.00
E/Buffer Printer Buffer.....	from 58.00
Torus Icon Local Area Network.....	POA

BUYING AN IBM PC THEN FIRST CONSULT



APPLE/IBM PC AUTHORISED DEALER*



FOLLOWING ALBETA'S SUCCESSFUL TAKEOVER OF ATA WE WILL CONTINUE TO OFFER THE BEST VALUE FOR MONEY COMPUTER PRODUCTS, INCLUDING THE IBM PC AND ALL IBM SOFTWARE

IBM PC SYSTEMS

IBM PC Business Starter System:	
IBM PC 128k RAM, 2 disk, monitor, keyboard.....	1799.00
IBM wordprocessor, spreadsheet, filing s/ware.....	270.00
IBM PC Office System:	
IBM PC 128k RAM, internal 10mb hard disk, 360k disk, DOS 2.1, monitor, keyboard.....	2445.00
Wordstar, Multiplan, DMS +.....	549.00

IBM PC XT Executive System:	
IBM PC XT 256k RAM, 10mb hard disk, 360k disk DOS 2.1, monitor, keyboard.....	3199.00
Multimate, dBase III, Lotus 1-2-3.....	1049.00
Accounting System:	
Pegasus (Sales, Purchase, Nominal, Invoicing Stock, etc.).....	per module 199.00

Terms and Conditions upon application.
 30 days credit available for official orders from plc's and public sector organisations subject to 5% credit charge. Please phone for details.



PRICES EXCLUSIVE OF VAT AND CURRENT AT TIME OF PRINTING.

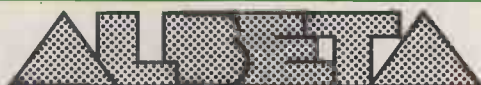

ATA IS A DIVISION OF ALBETA

LONDON 4 Albion House, 1 Back Hill, EC1 01-833 0044
*** ST. ALBANS** 9 Adelaide Street, St. Albans (0727) 34361
SOUTH WEST Cwrt-y-Gaer, Wolvesnewton (02915) 700
NORTH 32 Greenfield Ave, Parbold, Wigan, Lancs (02576) 3113
TELEX 946240 CWEASY G (Please quote REF: 19003030)

Please telephone for the latest price list

ATARI 520ST

ANOTHER QUANTUM LEAP

By Jack Schofield

The famous Jackintosh made its first European appearance at the recent Hanover Fair. Jack Schofield went prepared to scoff but came away impressed.

Imagine a Fat Mac — the 512K Apple Macintosh — but with a bigger screen, a far bigger keyboard with numeric keypad, cursor and function keys, and colour. That gives you some idea of what the Atari 520ST is like, except for two important things. First, the Atari seems faster. Second, the Atari system is about one-third of the price.

Atari U.K. has announced that the 512K micro with 720K 3.5in. floppy disc-drive, monochrome screen and a bundle of Digital Research software — Gem, Gem DOS, Gem Write, Gem Paint, Personal Basic and DR Logo — will cost only £699.99 including VAT. The entire outfit is less than the cost of upgrading a 128K Macintosh to a 512K Macintosh!

In addition, the Atari has a few more facilities than the Mac. The most important is the double-sided 3.5in. disc with 720K of storage, which means that — unlike the Mac — the Atari may actually be usable with only one disc drive.

The Atari keyboard also seems much superior to the Macintosh, though of course it is twice the size of the more transportable Apple one. The 520ST keyboard looks like a passable imitation of a DEC VT-100 terminal. It features four neat cursor keys, a numeric keypad and 10 lozenge-shaped function keys.

With DR's Gem Mac-alike front end, many operations can be done with a mouse instead of the keyboard. The Atari mouse is a small two-button type which plugs into one of the two nine-pin D-shell Atari joystick ports. Mouse output appears to match the cursor-control keys, so mouse-haters can go back to the keyboard for some operations.

Other standard ports are floppy- and hard-disc interfaces, monitor port, Centronics printer port, RS-232C serial port, and the two standard Musical Instruments Digital Interface (Midi) I/O ports. Other features on the back of the machine include a Soft Reset button and power switch.

All round, the 520ST invites comparison



The 520ST provides a Mac-like user interface and a 68000 processor for under £700.

with the Macintosh and similar micros, rather than cheaply made, home-orientated products like the Sinclair QL and Amstrad micros where performance is compromised in order to meet low price points. The overall impression is one of a serious machine that is capable of demanding use.

Five 520STs were demonstrated on the Atari stand at the Hanover Fair, including models attached to hard discs and to a Casio keyboard synthesiser. However, it was not possible to use these for more than a few seconds, nor to open up the case. The

following observations are based on conversations with Atari staff, including Jack Tramiel's son Sam.

The 520ST is a single-board design which uses the full Motorola 68000 chip, like the Apple Macintosh. This has a 32-bit architecture and a 16-bit data bus, unlike the QL which has an eight-bit data bus.

There is 512K of RAM, which is implemented as 16 256Kbit chips. The fact that 256K RAMs are now available fairly cheaply means it is no longer worth producing a 128K version of the machine using 64K

(continued on next page)

(continued from previous page)

chips, and this has therefore been abandoned. There is no room for memory expansion in the case. However, the operating system can handle 4Mbyte of RAM, and Atari says the machine could be upgraded to 2Mbyte of RAM by replacing the 256K chips with 1Mbyte ones. Texas Instruments apparently has these in production already, though of course they are not yet cheap.

The 520ST uses three custom chips to handle graphics, direct memory access (DMA) and memory management. They account for the very high speed at which the machine operates. A fourth custom chip, which Atari calls the "glue chip", integrates the functions of the other three chips, setting priorities, etc.

Some 32K of RAM is reserved for the screen display. This offers up to 512 colours with three resolution modes. Low resolution is 320 by 200 pixels like the existing Atari micros, and suitable for display on a colour TV set. Medium resolution is 640 by 200, which is the same as the IBM PC — of which more in a moment. High resolution is 640 by 400 pixels, like the Olivetti M-24.

The point about the IBM PC mode is that the 520ST has been designed to take advantage of the IBM PC software base. The CPU is, of course, different — the IBM's Intel 8088 is fundamentally incompatible with the Atari's Motorola 68000. However, Atari points out that the preferred language of Gem is C. Therefore its machine has been optimised so that any software written in C under Gem can simply be compiled to run on the 68000 instead of the 8088.

SPECIFICATION

CPU: 8MHz 16/32-bit Motorola 68000

RAM: 512K

STORAGE: 720K 3.5in. microfloppy-disc drive

KEYBOARD: 84-key QWERTY with cursor-control keys, numeric keypad and 10 function keys

DISPLAY: SM-124' monochrome screen

GRAPHICS: three graphics modes with 320 by 200 pixels in 16 colours, 640 by 200 in four colours, 640 by 400 in monochrome

SOUND: three sound channels with dynamic envelope control and noise generator; built-in Midi ports

PORTS: mouse and joystick ports, hard- and floppy-disc interfaces, Centronics printer port, RS-232C serial port

SOFTWARE IN PRICE: Gem desk-top operating system including Gem Write and Gem Paint, Personal Basic and DR Logo, all from Digital Research

PRICE: £699.99 including VAT

SUPPLIER: Atari Corporation (U.K.) Ltd, Atari House, Railway Terrace, Slough, Berkshire SL2 5BZ. Telephone: (0753) 33344

AVAILABILITY: scheduled for summer 1985



Sam Tramiel claims that the Atari 520ST offers "performance in the realm of the AT".

Obviously, programs written in old-fashioned hand-crafted assembler for the 68000 chip can be ported across to the Atari too. However, Atari's software writers felt this was likely to be less satisfactory, as the key to the machine is the use of the window-management software, pull-down menus and icons, as on the Macintosh. People who buy such a machine don't expect it to drop suddenly into an old-fashioned line editor.

As demonstrated, the Atari 520ST was a very impressive machine. But demos do not put hardware on dealers' shelves, nor racks of useful software next to it.

For the hardware, it must be admitted that the systems looked well made and well finished. It was stated that the samples were from a pilot production run, with full production of the final machines to begin in Taiwan on 22 April.

As for the software, this seemed robust enough, but was stated to be unfinished. Apparently the bundled software will now be provided on disc instead of in ROM, to allow for last-minute changes and easy updates.

It was noticeable that while there were a couple of dozen different demo discs around, there were no completed packages and only one leaflet. However, Atari claims to have 120 software houses developing programs for the machine, including a Lotus 1-2-3 clone from VIP Software. This will be called Professional, and it is claimed that it will be "a hundred per cent compatible" with Lotus to the extent that Lotus add-ons such as 2-Key Accounting will work with it.

Atari's aim was to have about 25 packages available when the machine goes on sale in the summer. It seems more likely that, as with the Macintosh and Sinclair QL micros, the bundled software will enable users to get

started, but that there will be a wait of up to a year before third-party software appears in any volume.

The Atari 520ST may be cheap but it is clearly not a games machine, and certainly not a toy. According to Sam Tramiel it offers "performance in the realm of the AT". Well, the IBM PC/AT is a £4,000 micro, and is clearly an above-average performer, so perhaps Atari is overstating the case somewhat. However, comparing my impression of the Atari ST at its launch with the Apple Macintosh at a similar launch, the Atari does not show any obvious signs of hardware inferiority, and some clear signs of superiority.

Certainly the Mac is the only obvious standard for comparison, even if the Atari does not live up to its promise. To use a football analogy, the 520ST belongs somewhere in the bottom half of the First Division, not at the top of Division Three with the Amstrad CPC-664, or in Division Four with the Sinclair Spectrum.

CONCLUSIONS

■ First impressions suggest the Atari 520ST offers by far the best price/performance ratio anywhere near the market.

■ The hardware design and construction seems highly professional, though final judgement must be withheld until production samples are available for independent testing.

■ The implementation of the software remains to be completed, and there may be problems. However, the Digital Research products such as Personal Basic and DR Logo are of proven high quality, and this inspires a certain amount of confidence.

■ At the price the 520ST could do considerable damage to either the prospects or the price of the Apple Macintosh. If it secures third-party software support, the 520ST should be a huge success.



DISKING

means business

DISKING, FREEPOST, Liphook, Hampshire, GU30 7BR. Tel (0428) 722563 (24hrs)

Unlabelled diskettes + FREE coloured diskette(s)

**SEE 10
LIBRARY BOX**
(capacity ten disks)

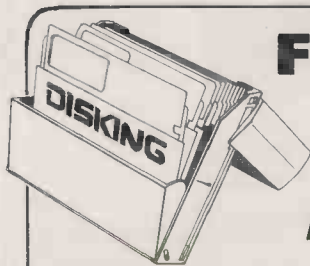

FREE
with Deals
A,F,L,R

**BUDGET 30
STORAGE BOX**
(capacity thirty disks)



FREE
with Deals
**B,G,M,S
C,H,N,T**

**BUDGET 50
STORAGE BOX**
(capacity fifty disks)

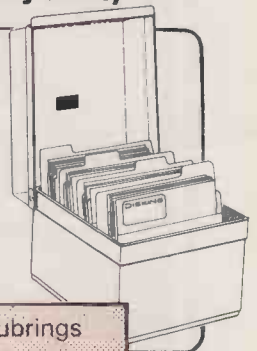

FREE
with Deals
**D,J,P,U
E,K,Q,V**

Diskettes	Prices exc VAT — All diskettes individually certified & with hubdings				
	10+1 colour	20+2 colours	30+3 colours	40+4 colours	50+6 colours
1D S/S D/D 48 tpi	Deal A 15.90	Deal B 31.80	Deal C 47.70	Deal D 63.60	Deal E 79.50
2D D/S D/D 48 tpi	Deal F 17.90	Deal G 35.80	Deal H 53.70	Deal J 71.60	Deal K 89.50
1DD S/S D/D 96 tpi	Deal L 17.90	Deal M 35.80	Deal N 53.70	Deal P 71.60	Deal Q 89.50
2DD D/S D/D 96 tpi	Deal R 19.90	Deal S 39.80	Deal T 59.70	Deal U 79.60	Deal V 99.50

ALL DEALS GET:

- FREE storage box
- FREE coloured diskette(s)* of your choice
- FREE Pack of Disking Colour Coder Felts
- FREE Blue Diskwriter Pen
- FREE Black Diskwriter Pen

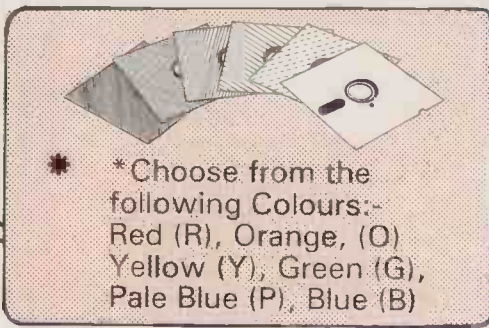

* Choose from the following Colours:-
Red (R), Orange (O)
Yellow (Y), Green (G),
Pale Blue (P), Blue (B)

● Circle No. 143

UK shipping rates inc ins.
but exc. VAT
Deals:- A,B,F,G,L,M,M,R,S
1-2 off £1.00 each, 3-5 off 80p
each 6-9 off 60p each, 10+ off
POST FREE
Deals:- C,D,E,H,J,K,N,P,Q,T,U,V
1-2 Off £2.00 each, 3-5 off £1.40
each 6+ POST FREE

Please rush me the following Deal(s):-

Qty	Deal	Colour(s) required	Price exc VAT
_____	x _____	_____	_____
_____	x _____	_____	_____
_____	x _____	_____	_____

Total goods value exc VAT _____
 Total delivery & insurance _____
 Sub Total exc VAT _____
 VAT _____
 Value of cheque to Disking _____
 Name: _____
 Address: _____
 _____ tel No: _____
 or please charge my credit card No: _____
 Access VISA & Diners cards welcome



We are main distributors for Verbatim, Memorex, Dysan and Maxell diskettes, and we sell all diskette accessories including storage boxes and cleaning kits — please telephone for price list.



Seikosha. Advanced business printers for every size of business.

Whether you're in business in a small way or running a vast Multinational, you need the most advanced, reliable, high performance printer you can buy.

And that means Seikosha.

Because Seikosha produce a range of up-to-the-minute printers to suit everyone, from the smallest to the largest volume business user.

What all Seikosha printers share in common however, is an unbeatable combination of high speeds, superb quality printing (including NLQ), low noise levels and the most advanced multi-function features you'll find today.

Of course this is no more than you would expect from the "House of Seiko".

Take the BP 5420 for example.

Fast, quiet and designed for heavy duty use, it combines high speed quality print at 420 cps (draft) and 104 cps (NLQ) with an 18K buffer. For ease of operation all user controls, plus the selector switch

for the 8 built-in fonts, are located on the front panel of the printer. Parallel and serial interfaces are standard.

Then, exclusively for the IBM PC and compatibles are the BP 5420I and BP 5200I.

The BP 5420I combines most of the features of the BP 5420 printer with all IBM characters, symbols and graphics as standard. The BP 5200I operates at 206 cps (draft) and 103 cps (NLQ) and represents one of the best value printers of its kind on the market.

Finally, the compact SP NLQ printer series meets the needs of smaller businesses.

Available from all leading computer dealers. Distributed exclusively by DDL. For details of your nearest stockists contact:



THE NEW FORCE IN DISTRIBUTION

5 King's Ride Park,
Ascot, Berks. SL5 8BP
Tel: 0990 28921
Telex: 846303 DDLTDG.

AMSTRAD CPC-664

CP/M IN THE LIVING ROOM

By Ian Stobie

Amstrad has unveiled a repackaged version of its successful home micro with a disc drive and CP/M in the price.

SPECIFICATION

CPU: eight-bit Z-80A running at 4MHz

MEMORY: 64K of RAM; 32K of ROM

DISCS: one built-in 3in. Hitachi-style 356K disc drive; optional second drive costs £159

DISPLAY: choice of colour or green 14in. monitor included in price; three screen modes give 25 lines of 20-, 40- or 80-column text, and graphics in three resolutions up to 640 by 200 dots; text and graphics can be in up to 16 different colours at a time, depending on mode

SOUND: three channels, eight octaves; built-in speaker, stereo output socket
OTHER INTERFACES: parallel printer port, cassette port, joystick port, video output socket, general-purpose expansion bus

SIZE: keyboard unit measures 580mm. (23in.) x 170mm. (7in.) x 70mm. (2.75in.); colour monitor 375mm. (15in.) x 365mm. (14.5in.) x 340mm. (13.5in.); keyboard weighs 2.4kg. (5.3lb.), the colour monitor 10.6kg. (23.3lb.)

SOFTWARE IN PRICE: Digital Research CP/M 2.2 plus utilities and Digital Research Logo on disc; Locomotive Basic in ROM

U.K. PRICE: £449 including VAT with colour monitor; £339 with monochrome monitor

MANUFACTURER: made in Korea for Amstrad Consumer Electronics plc

U.K. DISTRIBUTOR: Amstrad Consumer Electronics plc, Brentwood House, 169 Kings Road, Brentwood, Essex CM14 4EF. Telephone: (0277) 228888



Amstrad's new CPC-664 home computer is closely similar to the successful CPC-464, but with a 3in. disc drive replacing the built-in cassette. The most interesting thing about Amstrad's new offering is the price — under £350 for a disc-based CP/M system.

The CPC-664 consists of two boxes — the main keyboard unit, which also houses all the computer circuitry and the built-in disc drive, and a 14in. display monitor. Amstrad is again selling the system with a choice of either monochrome or colour monitor. The price of the whole setup with the green monochrome monitor is £339 including VAT, which rises to £449 if you go for the colour monitor. This means that a 664 system with built-in single drive is about £120 cheaper than a 464 system with a disc drive added on as a separate unit.

The disc system is to the right of the keyboard, its housing raised slightly above the general level of the keyboard unit. The empty space on the top of the disc housing is filled with a list of key numbers and colour numbers, useful to the Basic programmer.

Amstrad is one of the few manufacturers to back Hitachi's 3in. disc format as opposed to Sony's 3.5in. Both formats are more robust than the traditional 5.25in. discs, as the discs are protected in rigid plastic sleeves. While major business manufacturers seem to be backing Sony, Hitachi drives are cheaper.

The 664 is as commendably easy to set up as the original system; a third lead now connects the monitor to the keyboard, carrying a 12V supply for the disc drive. There is just one lead to plug into the mains, running from the back of the monitor.

Beneath the surface there are some changes in construction. Amstrad has incorporated the disc controller on to the main board, along with the Z-80 processor and memory chips. The keyboard is actually made quite differently, but the feel is still very good and it is easy to type on.

When you turn the system on the Basic prompt comes up. There are 42,249 bytes free to Basic, or about 1K less than on the 464, as disc system BIOS grabs 1,284 bytes. The 464 actually comes with two disc operating systems, Amsdos and CP/M. Amsdos is a simple OS already resident in ROM. CP/M you load in from disc.

Although the 664 is a 64K machine and the CP/M is genuine CP/M 2.2 from Digital Research, there are some problems. The way Amstrad allocates the memory means that CP/M's transient program area (TPA) is only 39.5K. Some existing commercial programs — for instance Supercalc — require a larger

TPA, while others, such as WordStar, need to be reconfigured to fit into the smaller available space. This means that although a vast number of programs are already written for Z-80 based CP/M systems, not all of them can in fact easily be got running on the Amstrad.

The initial range of titles for Amstrad's one software arm, Amsoft, includes a number of games already familiar from the 464, such as Code Name Mat and Roland in the Caves. Pricing is not yet finalised but each games disc will probably cost around £11, perhaps with more than one title on each disc. The 664 is also equipped with a cassette port, so you can load tape-based games.

Amsoft is offering some more serious packages, such as the Microscript word processor and Microspread spreadsheet reviewed in last month's *Practical Computing*. As yet no big-name CP/M packages are available for the system. We have seen WordStar running on an Amstrad, but Micropro has not yet come to any distribution agreement. Public domain CP/M User Group software will be available from Amstrad's own user magazine, probably for around £6 per disc.

Most existing commercial software written for the 464 should run on the new machine, as long as it makes no machine-language calls to undocumented routines in ROM. Some changes have been made to the 664's Basic, but Amsoft says user-written programs in 464 Basic will run.

The 664's version of Locomotive Basic has some new commands, notably Fill and Mask. Fill n fills in colour n from the graphics cursor to a boundary; Mask followed by a binary number enables you to define a dotted line to be used in subsequent draw commands: Mask &xx11001100 specifies equally spaced dashes. Draw, Plot and Move have been enhanced with a fourth parameter which determines how new graphics interact with graphics already on the screen. The format is now Draw x,y, colour, mode, where mode is either XOR, Or, And or normal.

CONCLUSIONS

■ The new Amstrad is a repackaged version of the original, with a disc drive built in and a few other minor but worthwhile refinements. If you know you want a machine for home use with a disc drive it is very good value.

■ For pure and simple games playing there are cheaper home computers.

■ If you are considering the Amstrad for use as a low-cost business machine it is probably best to wait until it becomes clear if major CP/M packages will be available for it.

TANDY 200

KYOCERA'S SECOND GENERATION

By Ian Stobie

A larger LCD, a built-in modem and extra software distinguish Tandy's forthcoming lap portable from its successful predecessor built by the same Japanese manufacturer.

The Tandy 200 is a descendant of the Tandy 100 battery-powered lap portable that takes two important steps forward. The liquid crystal display panel is twice the size, and a direct-connect modem is built in.

In the U.K. it is the modem which is likely to prove the main selling point when the Tandy 200 goes on sale later this year. Several other refinements improve a little on the successful Tandy 100 formula, and Multiplan is now included in the ROM software supplied with the system.

Final pricing and an exact launch date for the U.K. have not yet been fixed, but a U.K. version of the system does exist and we have had one to look at for a couple of days. Our guess is that it will sell for around £800.

Of course, we know by now to expect problems where approval of communications equipment is concerned. The modem inside the machine conforms to the European CCITT specification and it does work with the U.K. telephone system, but the Tandy 200 has not yet received BT approval. However, there is nothing to stop it being sold with an appropriate red warning triangle on it, and Tandy is likely to go ahead on this basis if necessary.

When packed up, the Tandy 200 looks more like the Epson PX-8 than the Tandy 100: a featureless cream-and-black A4-sized

box like a transistor radio. It weighs just under 4lb. and it is battery powered. Four standard AA-size batteries are concealed under a flap underneath the machine; they provide 14 hours of continuous use, according to Tandy.

The screen flips up to reveal the full-size normal-layout keyboard. It is without doubt one of the nicest keyboards I have ever used. Of course these things are subjective, but I like the way the keys depress quite easily but then stop in a damped way with a gentle click. The keyboard is very good for touch-typing and it is also quiet, which is an advantage for a machine you might well want to use in public places.

The screen itself is quite good for a large liquid crystal display, which are notorious for poor contrast. You can adjust its tilt to catch the light better, and there is an electronic adjustment too. The area actually used on display for showing things measures 4in. by 7.5in. and the characters seem to be made up from a matrix of five dots by eight. I found the display generally acceptable, but it has to be said that it is better in daylight than artificial illumination.

Unlike the Epson PX-8, which has a built-in microcassette drive, there is no obvious way of storing your files. As with the Tandy 100 you just leave them in RAM. The system comes with one bank of 24K, to which you can add two further separate banks to achieve a maximum of 72K. The RAM retains its contents even when you switch the Tandy 200 off. Alternatively, you use an ordinary audio cassette recorder, via the built-in cassette interface.

One of the advantages of having your application software in ROM is that when you turn the system on the screen comes straight up with its opening display. This shows the names of the six application programs resident in the 72K of ROM, plus the names of your own files.

You can have up to 47 files per 24K bank of RAM for your own data or programs. The number is actually determined by the space available on the screen to display the directory; the larger screen lets you have more files than on the Tandy 100, which works the same way. To run a program you move the cursor over the name of a file and hit the Enter key. After a delay of only one or two seconds you are in the application.

The Text program does not pretend to be a full word processor. It lets you type in text and copy and move chunks around the document. It is simple and quick to use, but it has its limits — no Search and Replace function,

SPECIFICATION

CPU: eight-bit CMOS 80C85 running at 2.4MHz

MEMORY: 24K of RAM expandable to 72K; 72K of ROM

STORAGE: cassette port allows storage on optional external cassette recorder

DISPLAY: fold-away LCD panel shows 16-line by 40-column text or 240- by 128-dot graphics

MODEM: built-in CCIT direct-connect, not yet approved for BT use; CCITT-style modem is built in; also works with optional acoustic coupler

OTHER INTERFACES: parallel printer port, RS-232C serial port, bar-code reader socket, system expansion bus

HARDWARE OPTIONS: takes most Tandy 100 add-ons, including mains-powered screen/disc unit with 5.25in. disc drive and display adaptor for TV or monitor

POWER SUPPLY: four AA-size batteries or 6V d.c. through mains adaptor

SIZE: 294mm. (11.5in.) × 210mm. (8.2in.) × 51mm. (2in.); weighs 1.36kg. (3lb.)

SOFTWARE IN PRICE: ROM contains Multiplan spreadsheet, Text word processor, Telcom comms software, address list and schedule programs and Microsoft Basic

U.K. PRICE: probably around £800

MANUFACTURER: made in Japan by Kyocera for Tandy Corporation of Fort Worth, Texas

U.K. DISTRIBUTOR: Tandy Corporation (U.K.), Tameway Tower, Bridge Street, Walsall, West Midlands WS1 1LA. Telephone: (0922) 64181

AVAILABILITY: no firm date, but likely to be soon

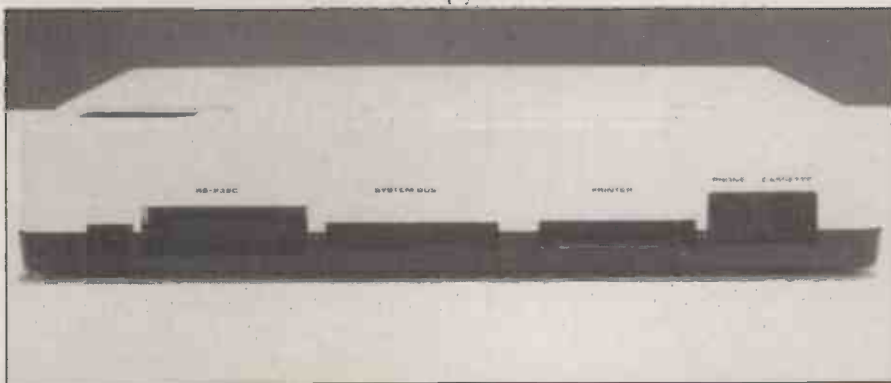

The Tandy provides RS-232C, system bus, printer, telephone and cassette ports.

for instance, and not much formatting beyond a Tab command. If you want, for instance, to double space a document you will need to write or get hold of a small Basic program to add extra Linefeeds to your file.

One improvement on the Tandy 100 Text program is the print menu, which now lets you specify lines per page and margin positions. The machine is fitted with a Centronics-style parallel port, so you can use any standard parallel printer.

It is while using Text that you notice the benefit of the larger display. Though 16 lines of 40 columns does not sound like much, the improvement over the eight-line display of the Tandy 100 is very marked. The 16 lines in effect give you an extra paragraph on the screen, which lets you see back to your last thought. When you are actually writing, as opposed to copy typing, this is very helpful. Whether it is worth paying over double the price is up to you.

The Tandy 200's software is all written by Microsoft, so it is not surprising that Multiplan is the spreadsheet contained on the systems ROM. The Tandy 200 version is obviously cut down in some respects, prin-

cipally the size of worksheet it can support, which is 99 rows by 63 columns. The screen can show 15 rows at a time, and four or five columns quite satisfactorily, depending on how wide you set your column width. A full set of Multiplan functions is provided, including things like averaging and standard deviation, and Tandy 200 Multiplan supports the SYLK file format, so you can transfer worksheets between the Tandy and Multiplan running on other machines such as the IBM PC.

Telcom is the Tandy's communications program. As well as supporting the built-in telephone modem, it also lets you use the RS-232C socket on the back of the machine for linking directly through a short cable to another nearby computer. With the modem it will find and autodial numbers you set up in an appropriately named text file. With either the modem or the RS-232 you can send information created with Text or Multiplan, and download information for them. The Tandy is obviously well suited for use with Telecom Gold, electronic mail.

On this sort of machine it is unlikely that many people will get heavily into program-

ming, as it is principally a tool, but a good Basic is provided, for those who do. It has good string handling and 14-digit numeric accuracy, so it is quite possible to write small financial or technical programs. But you are obviously limited by the available memory: much of the 24K is likely to be taken up with Text and other files. The Basic does let you program the screen with either character graphics or point setting commands, and there is a Sound command supporting the small built-in speaker, so more entertaining programs are also possible.

The Tandy 200 comes complete with three well-illustrated and compact A5 manuals: a general owners' guide plus manuals covering Telcom and Multiplan in greater depth. A smaller format is used for the Basic and quick-reference guides, as these are the two pieces of documentation you are most likely to need when travelling.

CONCLUSIONS

■ Providing the pricing is around £800, then the Tandy 200 is good value with its built-in modem. It also has an excellent keyboard. The built-in software, especially Multiplan, is worth having.

■ At this price level the chief competitor will be the Epson PX-8, which has better software but no built-in modem.

■ If you want to pay substantially less, then consider the original Tandy or its NEC and Olivetti competitors; they have screens half the size and no built-in modem, but are still quite useful if you need a portable machine. 



ANNOUNCING LONDON'S FIRST BUSINESS COMPUTER WEEK

Whether you're already using computer technology or you're contemplating your first investment, selecting the new system that will boost your business efficiency is tougher than ever.

It's not just that there's an enormous range of suppliers to choose from.

You're also faced with a thousand and one different shades of sophistication - from the low-cost micro for your accounts to integrated business systems that could revolutionise your entire operation.

Now at last there's a London event that covers all your options in one go.

The first ever London Business Computer Week.

What makes the

THE
**BUSINESS
COMPUTER
SHOW**

'Week' so comprehensive is that it's actually three shows under one roof - each addressing an area crucial to today's managers.

Setting the practical, no-jargon approach of the whole event, there's the *Business Computer Show*. Key suppliers of minis, micros, peripherals and services will show you routes to business efficiency (not wonders of science).

Meanwhile if you're looking at electronic mail, networking,

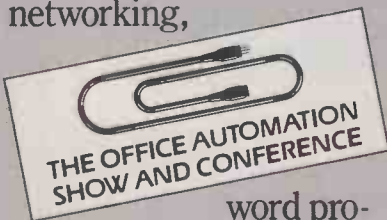

word processing - the elements of the integrated electronic office - *The Office Automation Show* should be your first stop.

It's backed by an

authoritative Conference too, courtesy of the Information and Word Processing Association.

Visit *Software '85* further down the hall and you can find out how to make



your software stretch much further. There'll be the latest packages up and running not to mention a conference if you need some really professional advice.

Visit the show that meets your specific interest - or go for the comprehensive coverage of *all* your computer options.

Send off for your **FREE** tickets to the London Business Computer Week today or ring 01-891 5051.

EARLS COURT, 4-6 JUNE 1985

L O N D O N

SPONSORS: COMPUTER WEEKLY · NATIONAL COMPUTING CENTRE · BRITISH COMPUTER SOCIETY · INSTITUTE OF DATA PROCESSING MANAGEMENT · INSTITUTE OF MANAGEMENT CONSULTANTS · PRACTICAL COMPUTING · IBM COMPUTER TODAY. - BACKED BY THE CSA.

Send to: Chatsworth House, 59 London Road, Twickenham TW1 3SZ

Please send me _____ FREE tickets for London Business Computer Week.

More information on Office Automation Conference

More information on Software '85 Conference

PC 6/85

Name _____

Job Title _____

Company _____

Address _____

Post Code _____

NO ONE UNDER 18 ADMITTED

£399 TURNS YOUR BRAINBOX INTO A REAL CHATTERBOX!



Computers are like people. They can learn from each other. But first they have to communicate. If your computer keeps itself to itself, why not introduce it to the Chit-Chat Communications Pack from Sagesoft?

Chit-Chat is a versatile data communications program that opens up a whole new range of possibilities. Data can easily be transferred, even between incompatible machines, either by direct cable connection, or by telephone, using a modem.

Chit-Chat also gives you access to electronic mail systems such as Telecom Gold, Easylink, and One-to-One plus viewdata services like Prestel. The program is simple to understand, easy to learn and use, and is currently available on IBM PC and compatibles, Apricot, Wang PC and Sharp 5600, with many more to follow.

The Chit-Chat Communications Pack at only £399 + VAT, includes the Chit-Chat program, a state-of-the-art modem, specially made to Sagesoft specifications by Thorn-EMI Datatech. No knobs or switches, just sleek good looks and simple, error-free operation. Autodial and autoanswer facilities are incorporated and the unit is entirely software controlled. An RS232 cable and power pack are included in the package.

Chit-Chat software is also available without hardware.

INCLUDES FREE
SUBSCRIPTION WORTH £100 TO

TELECOM GOLD

SAGE CHIT-CHATTM

Please send me more details of Sage Chit-Chat Communications Pack and my nearest dealer.

Name: _____

Position: _____

Company: _____

Address: _____

Tel: _____

Sagesoft Limited, NE1 House, Regent Centre, Newcastle upon Tyne NE3 3DS.
Tel: 091 284 7077. Telex: 53623 SAGESL G.

PC 6

BETTER SAGE THAN SORRY



GOUPIL

THE FRENCH ALTERNATIVE

By Bill Bennett

Despite lacking the style you might expect from a micro from across the Channel, the 3PC's modular construction and MS-DOS capability should find it some friends.

The SMT Goupil 3PC is the bright young thing of the Parisian micro-computer scene. But in stark contrast with the Emperor's new clothes paraded on Seine-side catwalks this season, the 3PC microcomputer is hard-working, has plenty of content and, at least on the surface, not a lot of style.

With around 16 percent of the French personal-computer market and a large slice of the French-speaking world opting for the machine, the Goupil sold 10,000 units last year. The machine's strictly utilitarian lines

The base unit contains the power supply and processor, and has plenty of space for extra cards.

look business-like in the office, but are too formal for the home. I suspect that bosses will love to see employees beavering away in front of such efficient machines, but will choose something with more cachet to replace the Newton's cradles in their deep-pile offices. Curiously, the Goupil's external lines were drawn up by the people responsible for the sleek shape of the TGV super-train.



It comes in a number of interconnecting boxes which fit together like Lego. The display unit and the disc unit sit on top of the main system box, and the detachable keyboard has a long piece of flex to allow it to roam all over the desk. You can locate the disc drives to the left or the right of the monitor, or if you are really adventurous you could put it somewhere else altogether.

Portability is not a word that springs to mind when describing the 3PC: it is massive. On an average desk, it leaves just enough room for a coffee cup and a telephone. Coming in four cardboard boxes, which would fill the insides of a saloon car and includes one box full of documentation, the Goupil weighs too much to be carted about. Only the burliest weightlifter would call the 3PC a luggable.

At the back are a number of interconnecting ribbon connectors, plugs and sockets. Connecting all the bits up is not difficult for the experienced user, and anyway the machine is usually installed in an office by an engineer from the Cable and Wireless company, which is under contract to provide all the maintenance and technical support.

Power for all the units comes from the base unit, so despite the modular nature of the machine there is only one mains plug to worry about. A switch at the rear of the machine is used to get the computer going. This should be a simple matter, but it betrays the problem with the machine: it is not a masterpiece of ergonomics. Reaching around the main unit to the power switch at the rear is not easy, and if you place the disc unit to the left of the screen — the most usual position — then the ribbon connectors get in the way of the switch.

LARGE SCREEN

Just what makes a good display depends on the user's taste. I prefer the large size of the 3PC's monochrome screen, though some people find that they have to move their eyes a lot to read from it. I found that for ideal use, it should sit about two-and-a-half feet in front of me, yet the micro is so large that you would need a large desk to be able to do this. I found the screen very comfortable to use, especially as the size of characters is roughly the same as those printed on the output page.

On the front of the screen unit is a power switch and a pair of knobs. One knob controls the brightness, and the other the contrast. Optimising these settings is a piece

of gateau. There are four levels of brightness for characters on the screen, and four levels of brightness for the backgrounds. This is made good use of in the implementation of WordStar and other software on the machine. In addition there is underlining,



Monitor, base unit and disc-drive boxes slot together neatly and easily.

SPECIFICATION

CPU: Intel 8088 16-bit processor
RAM: 128K or 256K, expandable to 768K
PORTABILITY: not a machine for users on the move
CONFIGURATION: keyboard, display and disc unit are separate boxes connecting to main processor box
DISPLAY: 12in. 25-line by 80-character CRT with 640 by 400 pixels high-resolution; anti-reflection green monochrome screen; eight pages of text in alphanumeric mode
KEYBOARD: detached QWERTY-layout keyboard with numeric keypad and 16 function keys; other options available for foreign-language users; 104 keys
INTERFACES: one RS-232 interface and one Centronics-style printer interface
HARDWARE OPTIONS: Intel 8087 maths co-processor; motherboard with 12 slots
PRICE: basic system 12K, twin 360K floppies and monitor costs £1,955
U.K. DISTRIBUTION: SMT International, Cambridge House, 180 Upper Richmond Road, Putney, London SW15. Telephone: 01-785 2411.

blinking and double-sized characters. You can have any colour screen you wish as long as it is green.

A separate area of memory is set aside for the screen memory, and there are eight separate pages of the text screen. These are accessed by hitting the special Screen key plus one of the first eight function keys. I tried using this feature within WordStar and got totally confused. It is really only worth having for software that is designed to make use of it.

NATIONAL KEYBOARDS

Goupil provides a different keyboard for each country it sells to. The unit is invariably the same, but with separate keytops showing all the special characters needed for the language in question. It connects to the front of the main system by a coil of wire, though it is too large to sit on your lap while typing. Twin legs at the rear can slope the already concave unit.

There are more than enough keys for most users. A total of 104 keys, including a row of 16 function keys arranged in four groups of four. Just beneath this is a long strip of Perspex which may be used to cover a sheet of paper describing the various functions assigned to the keys. To the right of the QWERTY key set is a block of 10 cursor keys and to the right of this is a numeric keypad. There are two keys that are slightly special. One key switches between various text screens — the micro can have a number of these — the other is used to boot up the machine.

One advantage of the modular approach of the Goupil system is that it allows you to mix and match components to tailor your system. It is the computer equivalent of buying clothes at Next, where everything is co-ordinated with everything else. When it comes to mass storage, the Goupil user is spoiled for choice. You can have two 5.25in. double-sided floppies, each being 360K or 720K. Old-fashioned users can opt for 8in. discs holding 1.2Mbyte, but these come in a separate flat-shaped box. Storage-hungry users will choose the 5.25in. Winchester storing 10Mbyte. I found that the discs work very fast when compared to other systems thanks to the DMA controller.

BOOTING-UP

The review system had a hard disc and a single 5.25in. floppy drive. Booting the system can be something of a hit-or-miss affair. I found that you had to wait for a while before hitting the boot-up button, otherwise the machine tried to boot off the non-present floppy drive. If this happens then the best option is to reach around the back, turn the power off, wait a few seconds for the hard disc to stop, and start all over again. The little red confidence lamp on the front of the hard-disc unit provides the usual reassurance that the disc is being accessed.

Inside the base unit is a backplane with either seven or 12 slots on it. A number of cards slot into it and there are three

(continued on next page)

BENCHMARKS

	BM1	BM2	BM3	BM4	BM5	BM6	BM7	BM8	Av.
Goupil 3PC SBasic—8088	1.0	3.5	9.6	11.0	11.5	16.6	23.6	51.0	16.0
Goupil 3PC MBasic—8088	1.0	3.8	7.9	8.3	9.3	17.0	26.3	27.3	12.6
Olivetti M-24—8086	0.5	2.0	4.6	4.7	5.2	9.4	14.8	16.1	7.2
IBM PC—8088	1.2	4.8	11.7	12.2	13.4	23.3	37.4	30.0	16.8

The table shows the time in seconds to turn the standard Basic routines, see *Practical Computing*, January 1984, page 102. When running Microsoft Basic the 3PC is a fairly average performer. SBasic is an alternative procedural Basic more familiar to users of the Flex-9 operating system, but here was run under MS-DOS.

(continued from previous page)

or more vacant slots, depending on the configuration of the particular system. Although there is a great deal of space inside the case to help cool the innards, the machine is as sturdy as a Russian tank.

Bundled software includes the familiar MS-DOS operating system. Options include the French Prologue multi-tasking operating system which comes with a number of built-in programming tools. There are two versions of basic: MSBasic, the well-known Microsoft interpreter, and SBasic, SMT's own version of the language. SBasic and MBasic both perform the Benchmarks fairly well, but as the table shows, SBasic is extra slow on BM8. The other notable point about the language is that error messages and prompts appear in French.

CONCLUSIONS

■ The Goupil 3PC is a fairly ordinary personal computer. Although it can read MS-DOS software for the IBM PC it cannot cope with PC-DOS.

■ It is faster than some other personal computers, including the IBM PC and Apricot, without being a genuinely fast machine.

■ The modular construction means that the machine should have a long working life. The networking facility will be an important selling point as the machine makes a good terminal. A wide range of options allows users to piece together a neatly tailored hardware package, though the machine itself is very bulky.

■ With so much competition in the IBM compatible market it is difficult to see how the Goupil can make real impact.



Centronics and RS-232 ports are sited at the back of the system box.

WIMBORNE FINANCIAL SERVICES LIMITED

When we purchased our computer we consulted people who "know the business". When you plan your financial future shouldn't you do the same?

We aim to offer a complete financial planning service for the individual and corporate client which includes:

- Portfolio Management; Stocks, Shares and Unit Trusts:
- Capital Transfer Tax Planning: Pension provision:
- Regular Savings Plans: School Fees planning.

We offer friendly, impartial, professional advice — without obligation.

Wimborne Financial Services Limited
 7 The Square
 WIMBORNE
 Dorset BH21 1JA
 (and in London and Harrogate)
 Members of the NATIONAL ASSOCIATION OF SECURITY DEALERS AND INVESTMENT MANAGERS

I would like further information (please tick box/es)

- | | |
|--|---|
| <input type="checkbox"/> Portfolio Management | <input type="checkbox"/> Self Employed Pension Plans |
| <input type="checkbox"/> Regular Saving Plans | <input type="checkbox"/> Directors/Executives Pension Plans |
| <input type="checkbox"/> Capital Transfer Tax Planning | <input type="checkbox"/> School Fees Plans |

Name:

Address:

Daytime Telephone Number:



Parlez-vous Tick-Tack?

the new way to communicate across language barriers

 is a unique letter-building system based on coded building-blocks

 enables you to send letters, telexes and messages automatically in foreign languages

 is available in 20 languages including Chinese, Japanese and Arabic

 can be supplied for most business micros and word-processors

 is easy to learn and fun to use — and helps you master the language

developed and produced by David Sephton, Primrose Publishing

distributed by:



GCC (Cambridge) Limited
 66 High Street, Sawston, Cambridge CB2 4BG
 Telephone: Cambridge (0223) 835330/834641
 Telex: 81594 SAWCOM

After we sell you a system we store you in our memory.

At Oryx we offer the most comprehensive and competitively priced range of micro computer hardware, software and accessories to business and the businessman.

We also offer expert advice, which is both free and plentiful.

And, perhaps most importantly, you can buy from us with complete confidence. Any system or package you purchase from us, you've the assurance of our unrivalled, full after-sales support and our technical hot-line.

Because even after we sell you a system we won't forget to look after you.



It's our business
to help yours.

SOFTWARE

ABTEX	
Pertmaster	625
Pertprinter	295
AMERICAN TRAINING INT	
ATI for Lotus 123	75
ATI for MS Word	75
ATI for Wordstar	75
ATI for dBase II	75
ASHTON TATE	
dBase II	295
dBase III	415
Framework	415
COMPSOFT	
Compsoft DMS	190
DMS Delta	450
DIGITAL RESEARCH	
Access Manager	295
C Basic Compiler	475
C Compiler	250
CP/M-86 + GSX	50
Concurrent CP/M-86	250
DR Draw	225
DR Graph	225
Display Manager	400
Pascal MT+	325
FUNK SOFTWARE	
Sideways	49
GULF DATA	
Arabrite (Arabic W/Processor)	POA
HARVARD	
Project Manager	385
Total Project Manager	425
INNOVATIVE SOFTWARE	
Smart System	650
LIFETREE	
Volkswriter DeLuxe	265
Volkswriter Scientific	425
LONDON SOFTWARE	
Personal Presentation System	350
LOTUS	
Lotus 123	350
Symphony	495
MICROPRO	
InfoStar+	338
MailMerge	120
WordStar	215
WordStar Professional	295
WordStar 2000	400
MICRORIM	
R Base 4000	425
MICROSOFT	
Basic Compiler (MS-DOS)	345
Basic Interpreter (MS-DOS)	300
C Compiler (MS-DOS)	345
Flight Simulator	50
Fortran Compiler (MS-DOS)	315
Macro Assembler	145
MS Pascal Compiler	265
Multiplan	159
Word	325
Word w/Mouse	425
MOUSE SYSTEMS CORP	
PC Paint	90
PC Mouse w/Paint	195
MULTIMATE INTERNATIONAL	
MultiMate	325
PC COMMUNICATION	
Missing Link	495
PETER NORTON COMPUTING	
Norton Utilities 2.0	69
Norton Utilities 3.0	90

SOFTWARE CONTINUED

ROSESOFT	
Prokey	105
SAGESOFT	
Sage Accounting	350
Sage Executive	645
Options	145
Chit Chat	130
SPI	
Open Access	400
SOFTWARE PUBLISHING	
PFS:File	115
PFS:Graph	115
PFS:Report	110
PFS:Write	115
SOFTWARE ARTS	
TK! Solver	315
Spotlight	99
SORCIM/IUS	
Easy Sales Pro	345
SuperCalc II	165
SuperCalc III	255
SuperProject	375
SYSTEM C	
Sycero	575
PSION	
Xchange	475

BOARDS FOR IBM/PC

AST RESEARCH	
MegaPlus 64K(C,S)	305
MegaPlus 256K	625
SixPack+64K(C,P,S)	305
SixPack Plus 384K	645
64K Chip kit	70
Preview (Mono Graphics Card)	345
HERCULES	
Colour Card	225
Graphic Card	395
INTELLIGENCE RESEARCH	
Memory Card 64K	165
PC Express 512K	995
PERSYST	
Memory Card 64K + Clock	295
Short Slot Card 384K	425
MultiFunction 384K	505
QUADRAM	
Expanded Quadboard 64K	335
Expanded Quadboard 384K	575
Quadboard II 64K	335
Quadboard II 256K	525

HARDWARE

We recommend and put together systems based on Columbia, Televideo and Zenith PC's.

HOW TO ORDER

Simply telephone 01-636 0476 to discuss your purchasing requirements. Visitors at our London office - just off Oxford Street - are very welcome.

Orders will be acknowledged and goods are normally despatched within 10 days. All major credit cards accepted. Prices exclude VAT and are subject to change without notice.

TECHNICAL HOTLINE

Or ring 01-631 4341 without obligation for advice.

ORYX SYSTEMS (UK) LIMITED. Mappin House, 4 Winsley Street, London W1N 7AR.

● Circle No. 149

Tel: 01-636 0476 Telex: 28290 ORYXUKG.

HEADSTART ATS

FIRST OF THE AT-EMULATORS

By Jack Schofield

Want a PC/AT but IBM can't deliver? The originator of the faithful old Superbrain is stepping into the gap with an 80286-based AT-compatible with networking software thrown in. It's cheaper than IBM's own product, and it looks as though you should actually be able to get your hands on one.



The Intertec Superbrain was one of the most successful eight-bit CP/M micros on the U.K. market, offering a powerful and convenient system for what was, at the time, a low price. Unfortunately Intertec failed to follow through, and its next micro, the eight/16-bit dual processor Headstart, missed out on the IBM PC compatible market completely.

However, Intertec is now trying to stage a comeback with the new Headstart ATS, based on the Intel 80286 chip as used in the IBM PC/AT. I was able to try the first machine in the U.K. on the premises of Zircon Micros, a small micro distributor based in Fulham.

The Headstart ATS looks just like the old Headstart, in that it uses the same case and keyboard. However, the area to the right of the screen is now blank, and no longer sports a 3.5in. disc drive. Inside, of course, the boards are new... though I was not allowed to open up the box for a look.

SPECIFICATION

CPU: Intel 80286
RAM: 256K, expandable to 512K, 1Mbyte or 3Mbyte
STORAGE: optional 5.25in. 720K twin half-height floppy discs; Multilan storage systems with 25Mbyte to 725Mbyte options
KEYBOARD: 104-key detached with four LEDs; optional 70-key portable keyboard snaps on to front of screen in a protective casing
DISPLAY: 12in. green screen with P-39 phosphor; 80 characters by 24 lines, switchable to 640 by 200 pixels
SOUND: one-voice speaker
INTERFACES: RS-232C compatible RS-449 serial port, Centronics parallel printer port, data bus interface, co-axial LAN port
DIMENSIONS: 400mm. (15.75in.) × 325mm. (12.75in.) × 286mm. (11.3in.); weight 13.5kg. (30lb.)
U.S. PRICES: \$1,895; discs \$495
SUPPLIER: Intertec, 123-125 Gloucester Pl., London W1H 3PJ
AVAILABILITY: U.K. deliveries scheduled for mid-summer; contact Zircon Micros, 452 Fulham Road, London SW6 1BY. Telephone: 01-385 0850

The clumsy ugly-duckling appearance of the trusty old Superbrain dwarfs the elegant and compact lines of the ATS.



Top: Headstart has the same character definition set as the IBM PC's green screen. Above left: the expansion ports lie at the back of the screen/system box. Above right: the electronics are packed tight inside the VDU casing, leaving no room for expansion cards.

The system comes in three parts, and comprises a keyboard, visual display unit (VDU) and twin disc-drive unit. The VDU is fairly compact and has a carrying handle on the back for portability. It also serves as the system box. The electronics must be packed very tightly inside, and there certainly can't be room for any standard IBM expansion cards. However, the design gives the ATS a very small footprint and leaves lots of room on your desk top.

The keyboard is correspondingly much larger than usual, with generous spacing around the cursor-control and special keys between the QWERTY layout and the numeric keypad. There are 14 function keys and six other special keys along the top.

The optional disc drives were in this case half-height Canon-made 5.25in. units in a very slim package. Why optional? The Headstart is designed as a work station, and has a built-in connection for a local area network; up to 255 can be connected to the same hard disc file-server. Individual disc drives look like a bit of an afterthought.

The system has not been designed as a transportable and would not be as easy to tote around as, say, an ACT Apricot or Apple Macintosh. However, it is far more

transportable than a traditional desk-top IBM PC or AT.

After plugging the disc drives into the back of the unit and the keyboard into the front, I was able to boot up the system. No system disc was supplied, but the ATS happily booted from either the IBM PC/AT DOS 3 system disc or from a Compaq system disc. It also loaded and ran the Basic from the Compaq disc, and the Compaq demo routines. Clearly the ATS is highly IBM PC compatible. How AT-compatible it is remains to be seen.

The ATS, like the IBM PC/AT, uses an Intel 80286 chip. The catch is that it is run in a so-called Protect mode, where it emulates the 8086. The full power of the 286 is currently not available to PC-DOS — or, indeed, to MS-DOS — which is limited in several areas, such as the amount of RAM it can address.

In use the ATS performed the same as any other IBM compatible, only faster. It seemed about as fast as the Olivetti M-24, which is more than twice as fast as the IBM PC and Compaq models. The ATS is different from the Olivetti, however, in that it provides both the standard IBM monochrome text screen and the graphics screen.

In the IBM PC each screen is driven by a different expansion card in the back, and one type of card will not drive the other type of monitor. The ATS provides both, but you have to set a DIL switch on the front to select which display you want, then reboot the system.

The screen phosphor is of the long-persistence type, which gives a very clear image but leaves a strong after-image on scrolling. Intertec claims the phosphor is the same as the IBM PC's green screen, though to me it seemed more persistent.

Perhaps this impression was created by the very high speed at which the ATS writes to the screen — which is another good point. The speed of cursor movement is noticeably very quick when editing. However, *Practical Computing* does not have a screen benchmark, and a quick Basic program run on the ATS and an IBM PC suggests the ATS is only about 25 percent quicker.

While the standard ATS has 256K of RAM, the sample I used had 512K. It was therefore possible to use the Vdisk command from PC-DOS 3 to set up a RAM disc as C: and thus speed up disc operations.

The ATS keyboard is extremely good in most respects. It is quiet, but has a good action. Most of the key-placings are sensible, except the Alt and PrtSc keys. The IBM's badly placed Backslash key has been removed from between left Shift and Z, but sited rather oddly above the right Shift key. Oddly, the / key has been moved from next to the right Shift to outside the left Shift.

The special function keys along the top are labelled — for example, Message and Network — and some have red LEDs. In the case of the sample reviewed, however, the labels did not match the functions, and I could not find a Break key at all. Presumably this will be sorted out for production models.

Intertec describe this as the "long" keyboard, and says it will also be supplying a shorter, more compact version for people who want a more portable system.

There are a number of ports on the back of the screen/system box, including Intertec's 60-pin expansion port. This will be required for adding any expansion cards. The built-in features include a parallel printer port, an RS-232C port and a plug for a co-axial cable for the Intertec network.

CONCLUSIONS

■ It was not possible to come to any final conclusions in one afternoon's use. However, the system ran standard IBM PC packages, and it ran the standard Basic Benchmarks at a reasonable speed.

■ In general it performed in the way expected of a finished product, rather than a prototype. It therefore seems likely that the Headstart ATS will arrive in reasonable quantities this summer, where it should benefit from the shortage of real IBM PC/ATs and PC Networks, to make an initial impact on the market.

■ Superbrain-lovers will certainly like it. It remains to be seen whether Intertec can win back a wider following.

PC



Extra Compatibility The A-200 is fully compatible with the IBM PC, giving access to the world's widest range of software and peripherals. It uses MS-DOS, the industry-standard operating system, and GW-BASIC, the most popular language. So it's totally in step.

Extra Speed Unlike many other PC's, the A-200 has the 8086 processor and uses a 16-bit data bus. So it's quicker thinking.

Extra Memory The A-200 has a basic memory of 256 K, expandable to 512 K, plus twin 360 K disk drives. So it's harder working.

Extra Expandability The A-200 has built-in Centronics and RS 232C interfaces, leaving 4 expansion slots for optional extras such as Winchester disks up to 140 MB and local area

networking. So it grows with your business.

Extra Desk space The A-200 has a tilt and swivel, high resolution screen and an IBM compatible keyboard layout. It's not only quieter and better looking than most PC's, but smaller and lighter too. So it won't cramp your style.

Extra Quality Canon's unrivalled expertise in optics and micro-electronics, plus a world-wide reputation for excellence in business machines, is the ultimate guarantee of quality in the A-200. So you know it won't let you down.

Extra Value At £1,875 for the A-200 monochrome package, all these extras are standard. So you do get more for your money.

IBM is a trade mark of International Business Machines Corporation
MS-DOS and GW-BASIC are trademarks of Microsoft Corporation
Centronics is a trade mark of Centronics Data Computer Corporation

A-200

PERSONAL COMPUTER

As sure as the sun rises
in the East,
this is a better value
personal computer.
Because so many extras
are standard.



POST TODAY

To: Canon (UK) Ltd., Computer Systems Division, Canon House, 2 Manor Road, Wallington, Surrey SM6 0AJ. Tel: 01-773 3173. Facsimile: 01-773 2156.

Please send me extra information about the A-200 Personal Computer.

I'd also like to know more about other Canon Computer products.

TX-50 Counter terminal

HT-5000 Handy terminal

LBP-8 Laser printer

Tick boxes

Name _____
Company _____
Position _____
Address _____
Telephone _____



Canon COMPUTER SYSTEMS

• Circle No. 150



Official Business Machines
of The Football League

OPTIONS

BEYOND THE SPREADSHEET

By Glyn Moody

It's an uncertain world. This package acknowledges the fact by letting you specify how precise your input is, and telling you how much confidence you can place in its results. Budgeting will never be the same again.

Options is an innovative package from Sagesoft that could well prove to be the first significant advance on one of micro software's biggest success stories: the spreadsheet. The combination of the VisiCalc spreadsheet and the Apple II was probably responsible for converting more people to the idea that micros were more than just toys or a passing gimmick than any other factor in the heady early days of micros.

Anyone involved in setting up budgets or forecasts could replace what had been a tedious weekend's grind of pencilling in figures with a few hours' computing. In addition, there was the wonder of the What-If? which allowed you to try out figures speculatively without needing to ditch everything you had done before. Here at last was a program that saved you time and gave you new powers of control over finances.

The pioneering work of VisiCalc was soon followed up by a host of clones, all more or less based on the same principles. Even the wave of integrated packages started by Lotus 1-2-3 still took the electronic spreadsheet as something of which the basic characteristics were almost engraved in stone. This was partly a case of leaving well alone since a genuinely new product had been found that met a hitherto unarticulated need and it seemed churlish to tinker around with it.

Yet in some respects the spreadsheet has become a tyrant rather than a servant. Now that budgets can be set up with such ease there is an increasing dependence on them. In fact there is a tendency to use them in inappropriate circumstances. For example, budgets are often required way into the future. They are easy enough to set up since all you need are a few numbers. Unfortunately, the figures that come out are no more likely to be right or even plausible just because a slick spreadsheet program produced them.

Essentially, spreadsheets are exact tools

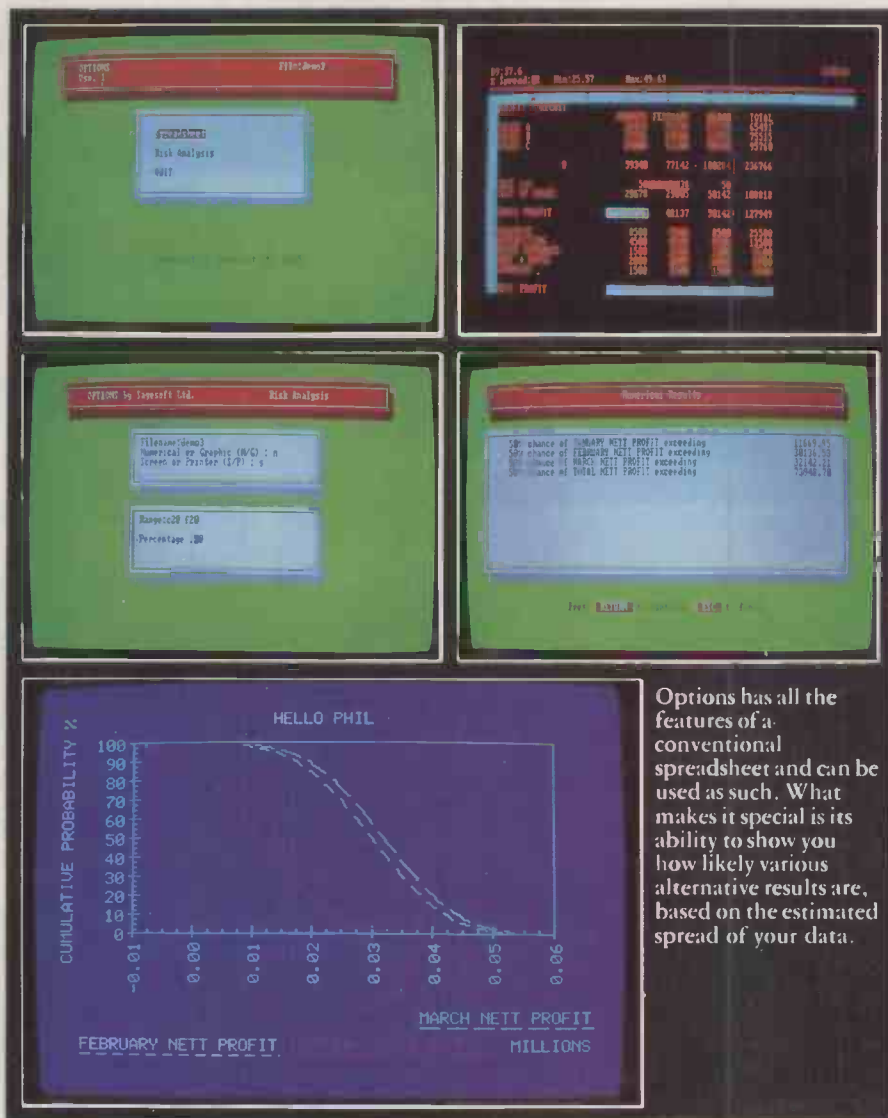

Options has all the features of a conventional spreadsheet and can be used as such. What makes it special is its ability to show you how likely various alternative results are, based on the estimated spread of your data.

that are too often used in very inexact circumstances. For situations where you are dealing with probabilities and hunches, you need a program that can accommodate such fuzzy data. Sagesoft's new Options package aims to do precisely this. The package represents something of a change of direction for the company, which is best known for its accounts software. It is intended to be the first of a new line of general products.

Superficially, Options looks like any other spreadsheet. Rows are labelled by figures, columns by letters. The bottom right-hand cell is Z99. You move around the sheet by using the cursor controls or on the IBM PC the function key f2 followed by the cell

reference. F1 contains context-dependent help information. You can enter numbers or text, and the program sorts out which is which.

The usual numerical expressions can be set up in cells, along with functions such as Sum. The main command key is f6, which calls up the short horizontal menu of Display, Range, Print, File, Notes and Quit. Display controls screen presentation, File handles loading and saving of files, and Notes allows headings and footnotes to be set up for later displays. Range allows block moves of cells and replication. One omission is the lack of a relative/absolute feature in the replication.

Options' Spread facility is what makes it a

little bit special. Recognising that the figures entered into spreadsheet budgets are normally guesses, and that it would be far more realistic to enter a range of values, Options allows you to specify a spread around the basic figures.

For example, you might guess that sales figures for one month will be £50,000. But you might also be aware that you could be out by as much as £10,000. Using Options, you can set up a spreadsheet model with the £50,000 figure as the base, but incorporate a 20 percent spread either side. This can be done for any figure in the sheet. The totals that are displayed at the end of rows and columns are all calculated with the base figure you have chosen. To take into account the fact that there is spread associated with certain figures, you quit the spreadsheet itself and move into the Analyse mode.

Giving a figure in the sheet a spread instructs Options to allow for the possibility that the actual value will vary either side of that figure by an amount proportional to the spread. For example if you specify a spread of 5 percent you are imposing very tight constraints on the allowed variation. On the other hand, if you give a spread of 75 percent you are acknowledging the possibility of a wide margin for error.

The exact way in which Options allows the figures to vary is determined by the so-called normal distribution curve. An everyday example is tossing a coin. If you toss an unbiased coin 1,000 times and record the heads and tails, then repeat the experiment many times, you would expect to find most of the ratios of heads to tails to be near 50:50, and to find decreasingly few of them as you moved away from that figure. A graph of the results would be an approximation to the normal distribution.

Options takes the same view as regards your figures. It assumes that numbers near your base value entered in the sheet itself are more likely, and those distant from it less likely. The spread you give sets the scale of the likely variation. To carry out an analysis of the spreadsheet with the uncertain data, Options carries out 1,000 separate spread-

sheet calculations. It derives different figures for them by choosing a number at random determined by the normal distribution around the base figure.

After Options has calculated the 1,000 possible versions, it collates all the information to produce a consolidated result. Before instigating the analysis you have to select certain cells the figures of which you want to analyse. Typically this would be the gross or net profit, or possibly key areas like cash reserves. The consolidated results for the pre-selected cells form yet more normal distributions. So there is a base value around which the other figures are distributed in exactly the same way as the input figures or the tossed coin.

There are two modes of presentation, numeric or graphical. The first simply gives you the probability of the selected cell exceeding a given figure. So it might happen that the input spreads result in a 99

OPTIONS		PC VERDICT			
	POOR	AVERAGE	GOOD	EXCELLENT	
Performance	<input type="checkbox"/>	<input type="checkbox"/>	<input checked="" type="checkbox"/>	<input type="checkbox"/>	
Ease of use	<input type="checkbox"/>	<input type="checkbox"/>	<input checked="" type="checkbox"/>	<input type="checkbox"/>	
Documentation	<input type="checkbox"/>	<input type="checkbox"/>	<input checked="" type="checkbox"/>	<input type="checkbox"/>	
Value for money	<input type="checkbox"/>	<input type="checkbox"/>	<input type="checkbox"/>	<input checked="" type="checkbox"/>	

Options is an innovative spreadsheet product that is very good value, even if its usefulness has yet to be established.

percent chance of making more than -£2,000 profit — that is, a loss — a 50 percent chance of making more than £8,000 but only 1 percent chance of making more than £18,000. These probabilities can be displayed graphically in the form of a curve. The basic shape of the curve will remain the same for all such calculations. The only variation will be in the figures associated with it and its steepness.

In practice Options is very easy to use. First you enter your figures, as in a conventional spreadsheet. Sagesoft has made efforts to follow standard layouts and command structures to enable practised users of other software to make the transition smoothly. Next you assign spreads to those figures which require them by pressing f4. The top command line then shows the spread, along with the minimum and the maximum.

Once a spread is entered, Options will calculate minimum and maximum from the main figure entered in the sheet. By pressing f8, you can assign a spread and the minimum and maximum values, and Options will work out the appropriate figure to be placed in the cell on the sheet. In this way you can set up sheets where the tolerance is known quite precisely.

Before the analysis can be carried out; you must highlight certain cells as the subjects of that analysis. This is done by placing the cursor over the relevant cell and pressing f5.

After quitting the spreadsheet mode by using f6, you can move the cursor down on to the Risk Analysis option. The system adopts your current file as default unless otherwise instructed. The analysis is surprisingly fast, given the number of calculations involved. Typical times for admittedly limited spreadsheets were about 10 to 15 seconds. The activity is sporadic, and is signalled by the Analysing message flickering.

When the analysis is complete, you are offered the choice of numerical or graphical analysis and also the range of cells to be displayed. Any cell that has been highlighted using f5 can be analysed. If a group of cells is chosen, up to three can be displayed at once graphically, or several numerically; although the amount of probability data available is limited by space. The analysis file is stored to disc automatically. So if an analysis is required later of a file which has already been processed, no recalculation is necessary.

However, having obtained all this information, the question remains whether it is really useful. The answer, as ever, depends on what you want to do. There is no doubt that its probabilistic approach is closer to most real-life situations. The use of the normal distribution may seem arbitrary but can be justified on the grounds of statistical theory. Further work is currently under way to allow users far greater freedom in setting up the probabilistic spread of figures. The main problem seems to be with the output. It is a little hard to see precisely how the resulting normal distributions could be made to yield directly useful financial information.

Whatever slight doubts may linger, there is no denying that Options is well produced, with a clear and helpful manual. Good use is made of colour and generally the command structure is sensible. Enhanced graphics are promised for subsequent versions. A further feature, not tested here, is the ability to transfer spreadsheets from Lotus 1-2-3 and Symphony subject to certain restrictions.

It is also remarkably cheap at £145 excluding VAT. At this price it is probably worth getting a copy even if it is mainly used as a conventional spreadsheet. Once Options is in a working environment, invaluable uses may well suggest themselves.

CONCLUSIONS

Options is an innovative package which moves one step beyond the spreadsheet. It is well produced and surprisingly cheap. Using it, you can escape from the straightjacket of conventional budgeting techniques.

Some may question whether its probabilistic analysis really produces helpful figures. But like many products, it is as useful as you make it.

It is very easy to use, requiring only a few additions to the repertoire of spreadsheet techniques.

Although it is cheap, it does require a colour system which presupposes a fairly hefty outlay.

The manual is clearly written and easy to follow.

SPECIFICATION

SPREADSHEET LIMITS: columns A to Z; rows 1 to 99

SPREAD FEATURES: probability analysis available for any cell in spreadsheet; up to three analyses can be displayed graphically at once; number of numerical analyses limited only by screen size

HARDWARE REQUIREMENTS: IBM PC, Apricot and Sanyo 550/555; Sagesoft claims all IBM PC compatibles can run Options; 128K RAM is required

PRICE: £145 excluding VAT

AVAILABILITY: now

AUTHOR AND DISTRIBUTOR:

Sagesoft Ltd, NE1 House, Regent Centre, Gosforth, Newcastle upon Tyne NE3 3DS. Telephone: 091-284 7077

PERFECT WRITER II

SECOND THOUGHTS ON EMACS

By Susan Curran

The powerful but hard-to-use Perfect Writer has been joined by a revised version for the IBM PC. Some of the old weaknesses remain, but for many users it could be an attractive and economical choice.

Perfect Writer has become well established over the past few years as a word processor, not least because it has been bundled with several cheap business micros. Though the program has some powerful features, it has begun to show its age in comparison with newer rivals.

Now the successor, Perfect Writer II, has been launched, together with revamped versions of other programs in the Perfect series. I've been an occasional user of Perfect Writer I for some time, and reviewed the new version to find out both how it compares with the original and how it stands up to the latest opposition.

Unlike PWI, which ran on CP/M machines, PWII is only available for the IBM PC and fairly close compatibles. It is distributed by Thorn EMI Computer Software, Thomson House, 296 Farnborough Road, Farnborough, Hampshire GU14 7NF. Telephone: (0252) 54333.

One advantage of the program is that it requires only 128K of RAM, while most recent word processors take rather more. It uses disc-based swap files to enable it to handle long documents. It has mouse compatibility, and can handle a colour monitor, but neither mouse nor monitor is essential. Another obviously attractive feature is the price: £149 for a three-disc package including a speller and thesaurus, which compares very favourably with much of the competition.

One of the distinguishing features of PWI was its adherence to the Emacs style of text processing, which is dependent upon long formatting instructions included in the text. There is no attempt to reproduce printed layout on the screen: instead, the original document with instructions is composed on-screen in a way which is best suited to the screen size and capabilities, and then passed through a separate formatter program before being printed.

This philosophy frees the user from the chore of adjusting format constantly on-

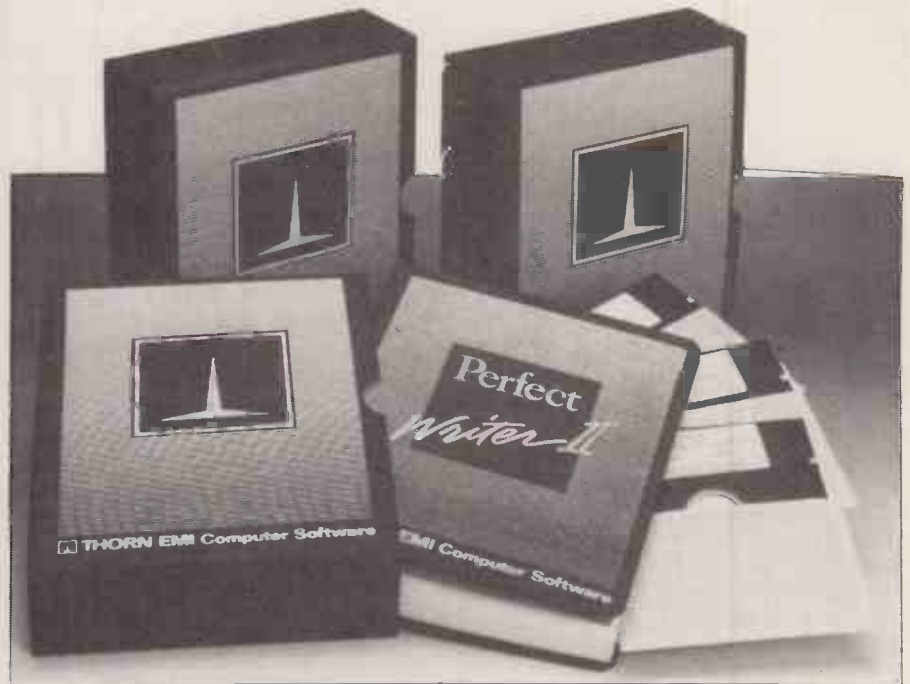

screen. It is necessary to reformat only if the text becomes so messy as to be not easily readable. The system also lends itself well to complex formatting chores such as automatic numbering and indenting of subparagraphs. But it is not as popular today as the "what-you-see-is-what-you-get" (WYSIWYG) option.

Users of the original program will appreciate why. Printing even a short memo or address becomes a long and tedious business: first type the text, then go back to the main menu, then format it, then go back to the main menu, then print it. With longer documents, the complexity of the formatting commands makes it increasingly likely that you will make a mistake or be dissatisfied with the layout choices the program makes. I've frequently found myself re-editing and then reformatting a file eight or 10 times.

WYSIWYG APPEARANCE

The designers of PWII clearly recognised how unpopular this made the program, and the Emacs philosophy, while not discarded, has now been shrouded under the impression of a WYSIWYG word processor. It is now possible to use Perfect Writer without learning the format commands at all, designing the text on-screen and having it print out just as it appears.

The program handles underlining, bold-face and justification on-screen, but it does not really compare with a fully screen-based word processor. Tab settings are limited, for example, and only one choice of fixed tab interval per document is allowed. There is no sideways scroll, so the line length is

limited to 78 characters. Text is not automatically reformatted following alterations, and the reformatting command works slowly.

In order to do anything more fancy than simple text — for instance, to set headers and footers, to use long lines, or to automatically indent paragraphs — it is necessary to come to terms with the formatting commands, and these follow the usual Emacs pattern. They are wordy to type, but tend to be self-explanatory. Choice of an environment for the text dictates how it will be printed. In PWI the default environment was Text, which means that lines will be inserted between paragraphs, for instance, on-screen justification settings will be overruled by the justification setting in the formatted print menu, and paragraphs not separated on-screen by a blank line or tab setting will be amalgamated. In the new version, the default is Verbatim which preserves the on-screen layout precisely.

In Perfect Writer I, formatted text was stored in a separate text file on disc, ready for instant printing. This apparently does not happen in PWII: instead, the formatting commands are interpreted prior to every print run.

The formatter was the weak link in the original program, and it appears little improved in this version. The program does not automatically avoid widow and orphans, so these must be handled by forced page breaks — there's no conditional page break — which will need alteration after subsequent edits. It is possible to preview the format on-screen, but not to make alterations in the preview mode: you must make

notes of the difficulties that appear and then return to the master program to work round them. This single omission at least doubles the work needed to produce an acceptably laid-out document several pages in length. The on-screen mode does mean, however, that it is possible to use the program for short memos, addresses and so on without major hassle.

The program has a very uncluttered editing screen, with just two lines reserved for system use at the bottom, and no use at all of special symbols except for the formatting commands. No ruler is displayed unless dual text windows are selected. Nor is there any indication of the length of the text, or the position of the cursor in it. I found this blankness rather disorientating. Page breaks are shown if pagination is forced — subsequent adjustments are not automatic — but there is no indication of page number.

Editing commands are handled by pop-up menus, which are neat and clear, though the entries are occasionally cryptic. It is possible to beat the menus by giving commands before they appear, and to build in a delay if you prefer, a very handy feature which speeds up use for regular users. Help facilities are provided for each menu. Cursor movement commands are good, using either the cursor keys or control-key sequences. The IBM function keys are also dedicated to common commands.

Habitues of PW1 will be disappointed to hear that almost all of the familiar command sequences have been altered in the new program. The sequences tend to be quite long, and are sometimes clumsy to type. A typical one, for instance, is `Escape/A(ppearance)/D(ocument)/I(nsert page break)`. There is an escape route from miskeyed commands, and there is a yank-back buffer for the retrieval of text deleted by mistake, which is very handy.

MULTIPLE FILES

The forte of Perfect Writer has always been its handling of multiple files and its dual text windows. It is possible to keep up to seven text files active in memory, and to view sections of any two — or two different sections of the same one. Editing can be carried out in both windows. Movement between the windows, of cursor or of text, is quick and easy, and this makes the program well suited to the needs of authors and journalists. One window could be used for notes and the other for an expansion into continuous text, for instance, or the two windows for different drafts of the same document.

The on-line thesaurus is a new feature. It works fast, at least on the hard-disc IBM PC/XT on which I tested the software, and produces around half a dozen alternatives — though some are rather too unlikely to rate that description — for any word in its dictionary. The suggestions for "word", for example, were "term", "utterance", "phrase", "expression" and "articulate".

The program will handle very long text files, and does so intelligently by swapping

FORMATTING WITH EMACS

```
@style[paperlength 10 inches]
@style[spacing 2 lines]
@header[left = "Perfect Writer II",right = "Susan Curran"]
@subheading[Perfect Writer II]
@begin[text]
```

Above are the format commands I used in printing out this review. They are all overall format commands, but embedded within them it is possible to include more specific format commands — for instance, to `@b[boldface]` or `@UN[underline]` text. I printed this sample using the program, but in a mode in which the commands are not interpreted.

Among the text environments available are:

```
@end[text]
@begin[itemise]
indent
undent — extends the first line only of each paragraph to the left
verse — resembles traditional verse layout
offset — useful for quotations
@end[itemise]
```

text between RAM and disc. Among the formatting features are automatic footnoting and indexing, and automatic arrangement of headings and sub-headings. This makes it excellent for handling long technical reports, or even novels.

PWII has good support for boilerplating and form-letter creation, including the use of alternative paragraphs in form letters to suit different types of recipient, substitution of text for named variables, and insertion of other text files. In order to produce a mass mailing, working from an address or client file, it is necessary to use Perfect Filer II, which is now well integrated with the WP program — so is Perfect Calc, which I have always appreciated as a spreadsheet. Perfect Filer II is an adequate mailing-list program which has no pretensions to be a programmable database.

Perfect Speller is exasperating. Its dictionary is nominally large, but it works on a root-and-suffix basis, rather than including proper words. Likely combinations of roots and suffixes which are in fact invalid will slip through its net. A good example is the typo I encountered in the manual: "tedius", for "tedious". Unlike its predecessor, the dictionary is based on English, not American, spelling, and it is possible to add to it. The check is fast, and on demand it is possible to correct words in context in the document. This routine also gives a word count, which the main program does not; but there are no supplementary statistics provided.

Like the original program, PWII is a very customisable program. It is possible to change most of the defaults to suit your particular house style. A wide variety of defaults or printer definitions can be kept on file — particularly handy for anyone who uses different printers for different types of document. There is no support for unusual printer features, only for boldstrike, underlining, italics, sub- and superscripts. A wide range of printers is supported.

Among the exasperating features are the virtual impossibility of changing line spacing in mid-document, and the cumbersome routine for changing margin settings.

I found the text-mark-and-copy/delete/move routine to be difficult to handle, and succeeded in seizing up the program while trying it.

A final good feature is support for the package. Thorn EMI has a U.K. hot-line for customer enquiries, which provides service for 90 days from purchase. I tried this when I had difficulty installing the program, and received a prompt and very helpful reply. The support department phoned me back twice within an hour.

Presumably it is in the hope of getting a mass market that Thorn EMI is targeting the program at first-time and small business users. This is a singularly inappropriate market for it. Though a great improvement on PW1, it is not an easy program to make the most of, and I think it better suited to experienced WP operators. Its special features will be far more useful to text originators than to boss-and-secretary teams.

There are some self-teach documents on the disc — documents, not a programmed-learning course. They are quite well designed, though they and the manual have an irritating tendency to sing the praises of the program. The manual itself is standard IBM-style, and very fat. It would be improved if it had some dividers. It is not always easily arranged for reference, but it has a good index.

CONCLUSIONS

- By trying to do everything after a fashion, the program sometimes fails to do anything really well. But it is a usable word processor with some very advanced features.

- Used in the on-screen mode, it proves a passable tool for casual users. However, it only comes into its own when proper use is made of the formatting commands.

- With its multiple file handling and its on-line thesaurus, this is an excellent choice for report writers, authors and journalists.

- Users of Perfect Writer I should find many sources of exasperation removed, though some vital weaknesses do remain.

- At £149, the program is very competitively priced and should do well.



Multi-User. Single Choice.

A good Database Manager makes a multi-user micro into a supremely powerful office tool.

Co-workers can not only store data but share it instantly among themselves. That is the whole point of having multi-user or networked micros. With Superfile, a busy office staff can automate the flow of paper easily, quickly and make it work the way they want it to.



Reliability is absolutely essential in multi-user

software. Southdata, with its advanced Superfile database management package, has more experience in this field than most other companies. Our 8 bit multi-user Superfile was first released in 1982. It works successfully under five different multi-user operating systems and is used extensively by MoD and British Telecom.

Now we are bringing this expertise to bear on the new 16 bit network and multi-user systems.

Multi-user Superfile will work under Multi-user Concurrent CP/M (MCCP/M), Omninet, 16 bit HiNet, Torus, Xenix, Unix, Idris and will work on other



systems as they become available (like Concurrent DOS on the IBM PC AT).

Of course, multi-user Superfile has all the advanced features that make the single user version so successful. Variable length records to increase data capacity. Lightning fast searching. Fuzzy matching. Direct interfaces to most



programming languages and a multi-file database. The Superforms utility gives you an easy to set up screen forms and powerful data validation. The Supertab report generator is equally simple. Superforms II will give multi-page screen forms with large text fields which are callable from programs written in most languages.

Your data is valuable. To share it efficiently you

need the very best in database software. That leaves you with just one choice - Superfile.

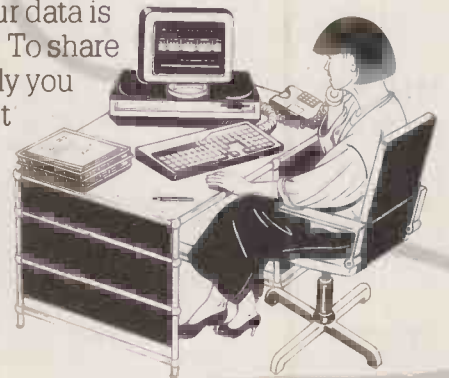

SUPERFILE DATABASE MANAGEMENT

For full details, phone or write to: Southdata Ltd, 166 Portobello Road, London W11 2EB. Tel 01-229 2724 & 01-727 7564

● Circle No. 151

PC6

The PC User Show is coming. As many new models as the Motor Show. As big a splash as the Boat Show. More pedigree names than Crufts.

1985 PC USER SHOW

Olympia 2 from 2nd-4th July.

The PC User Show. Britain's largest event for Professional Personal Computer Users. Over 300 exhibiting companies – the cream of the massive IBM PC and compatibles industry. Hardware, software, services and peripherals. It's all at the Show... and it's all compatible. One stop PC shopping. That means convenience. For you.

And there's more – for would-be personal computer users. Advice. Professional and impartial. Absolutely free – at the "PC Clinic." Sponsored by PC User magazine, Britain's leading independent guide to IBM Personal Computing.

You'll never find an easier way to select personal computers. It's all at the PC User Show. Come and get it.

Please send me information about exhibiting at the 1985 PC User Show.

Please send me details of 1985 PC User Show Seminars

Please send me complimentary tickets to the 1985 PC User Show.

I would like to apply for a regular free monthly copy of PC User magazine.

Name _____
 Job Title _____
 Company _____
 Address _____

 Post Code _____
 Tel. _____

☎ For all ticket requests within 14 days of the show opening, please use the 24-hr ticket hotline. Tel: 01-833 3721. No admission under 18 years of age. Return to: PC User Show, EMAP International Exhibitions, Durrant House, 8 Herbal Hill, London EC1R 5JB. Telephone: 01-837 3699.

emap.
INTERNATIONAL EXHIBITIONS LTD

Britain's largest event for professional personal computer users. ⁷⁷

Announcing

NEW **Cromemco** UNIX V SYSTEMS 100 AND 300

All systems include the new 50 MB Winchester with STDC cache controller, XPU 68000 processor, XMM virtual memory management controller, (Berkeley) UNIX System V and Cromix with either standard or error correcting memory.

OPTIONS AVAILABLE

- ★ Berkeley BNET (ETHERNET) interface.
- ★ Intelligent I/O handling with dedicated processor.
- ★ Floating point co-processor.

Also a wide range of interface cards including GPIB, ANALOGUE, SERIAL and Opto isolated parallel.

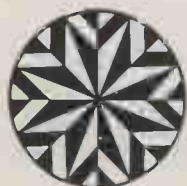
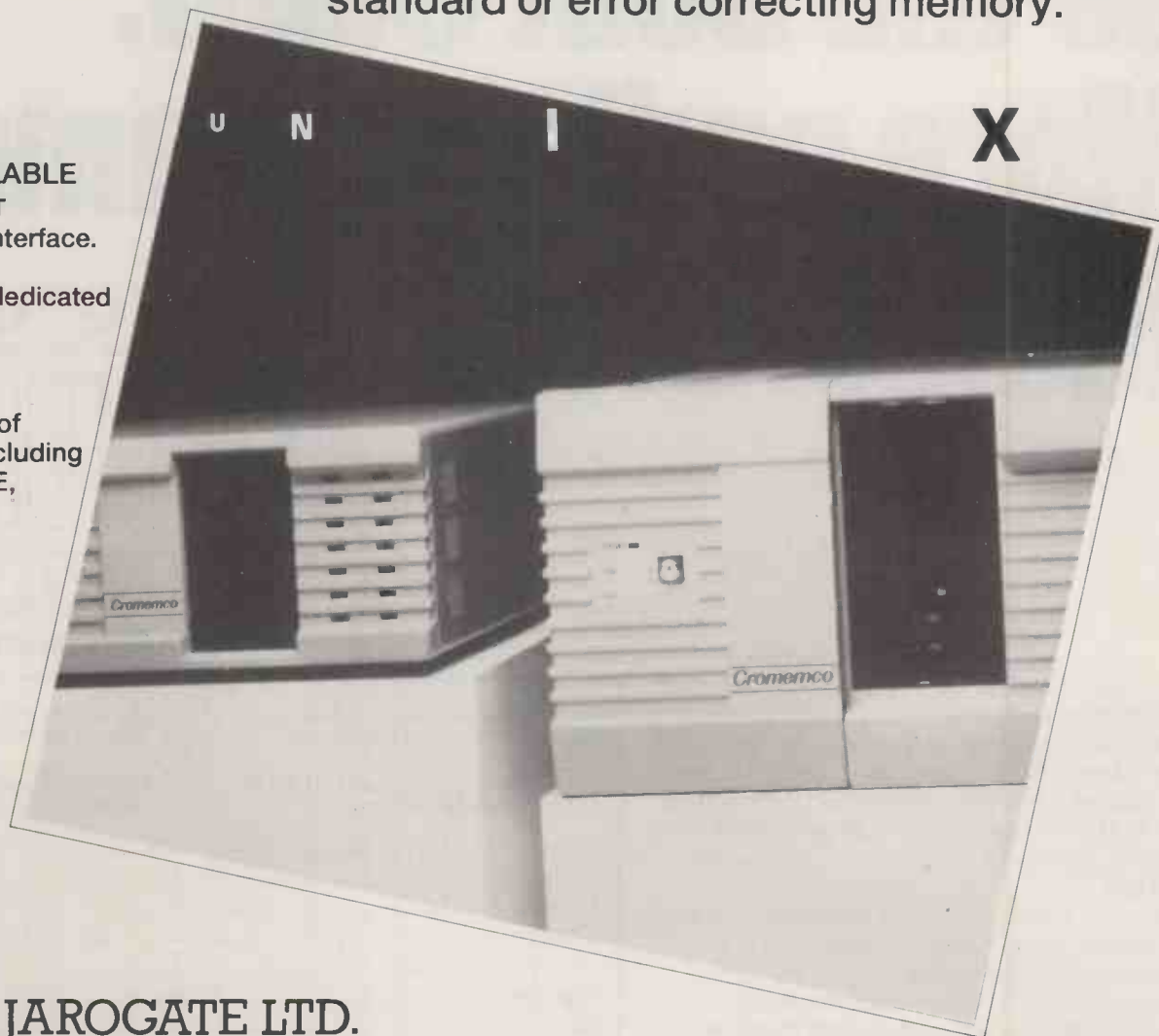

JAROGATE LTD.
the microprocessor specialists

NATIONWIDE SERVICE SUPPORT
DEALER ENQUIRIES WELCOMED

197-213 Lyham Rd., Brixton, London SW2 5PY Tel: 01-671 6321 Telex: 8950094 JAROG

BUSINESS RISK ANALYSIS

HEADS TAILS OR...

...OPTIONS?

OPTIONS takes over where your spreadsheet leaves off! Produces a thousand 'what if' results in seconds! OPTIONS picks you up where a spreadsheet lets you down. It's like no other program currently available.

Picture the scene. You've painstakingly set up a business model on your spreadsheet. All the facts and figures are there and everything looks perfect. Then the inevitable happens. The 'what if' questions start coming thick and fast.

'What if' sales vary by 8%? 'What if' material costs increase by 10%? 'What if' the unions push us into an extra 7%? 'What if' oil costs vary by 5%? 'What if' interest rates vary by 2%? 'What if' our selling costs increase by 10%? etc. etc.

And 'what if' you had a program which applied all these variables to your model and cash-flow forecast **and gave you all the answers in seconds**. Not just a single answer but the whole range of risk possibilities. Show you both numerically and graphically, the chances of achieving varying degrees of success and failure - profit and loss - related to the variables you apply. The kind of information you need to plan your business and bank managers just love to see!

OPTIONS is that program. A new concept in business risk analysis. No other program does the job with such speed, flexibility, and accuracy. OPTIONS allows you to take a model

created on your favourite spreadsheet Lotus 1-2-3, Multiplan or Supercalc and manipulate it in this powerful new way. If you have no spreadsheet no problem! OPTIONS has its own. For only £145 + VAT you can have all the answers to every 'what if' question they can throw at you. Instantaneously!

£145 +VAT

SAGE OPTIONS™

Please send me more details of Sage OPTIONS and my nearest dealer.

Name: _____ Position: _____
Company: _____
Address: _____
Tel: _____

I have a (_____) Computer

Sagesoft Limited, NE1 House, Regent Centre, Newcastle upon Tyne NE3 3DS.
Tel: 091 284 7077. Telex: 53623 SAGESL G.

BETTER SAGE THAN SORRY

PC 6

THOUGHTWARE

MERELY COMMON SENSE?

By Glyn Moody

Already widely used in the U.S., this large-scale management training program helps you find out in the privacy of your own office how good a manager you are.

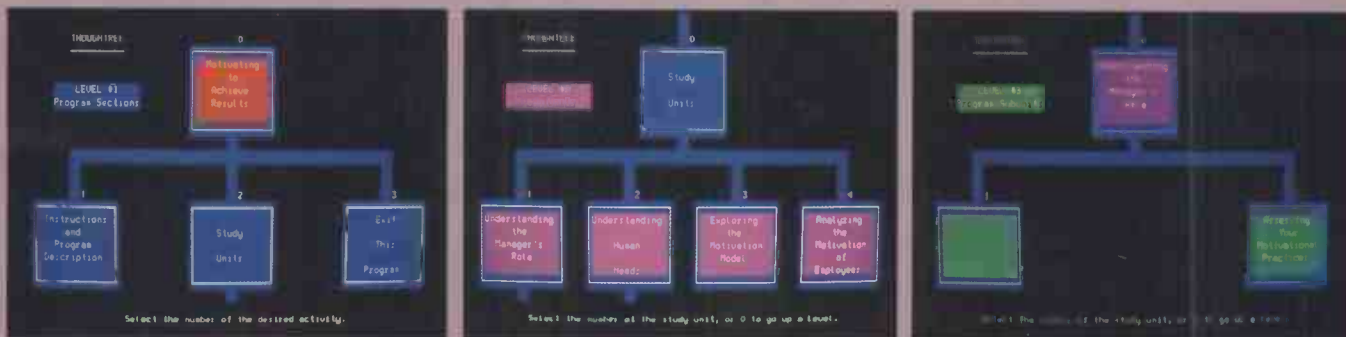

A branching menu known as the Thoughttree guides you from the opening pages to the sub-sections dealing with topics in detail.

It has been a tough two weeks at the close of a busy year. Some problems have developed and extra work has been added. Chris is the logical person to handle it. You decide to:

- Meet Chris in his office to layout the details.
- Talk to Chris about how the work can fit his needs and interests.
- Reflect on how Chris has been reacting to assignments lately.

Press A, B or C -

Thoughtware Leadership Self-Assessment
15 Statements

Statement 1.
You find time to listen to people in your work group.

Rarely	Sometimes	Often	Very Often				
1	2	3	4	5	6	7	8

Press the key of your response, then press ENTER: -

Under each topic heading you are presented with a series of multiple-choice questions dealing with case studies and assessing your own attitudes and practices.

SPECIFICATION

Eleven modules, each containing manual and discs. The three programs within the diagnostic series are Assessing Personal Management Skills, Evaluating Organisational Effectiveness and Understanding Personal Interactive Styles. Complementing these, the management training series includes Leading Effectively, Motivating to Achieve Results, Defining Goals and Objectives, Improving Employees' Performance, Performance Appraisal, Managing Time Effectively, Conducting Successful Meetings and Management by Exception.

HARDWARE REQUIREMENTS: 128K RAM IBM PC and also some compatibles

PRICE: £350 plus VAT for diagnostic modules, £450 for training modules

AVAILABILITY: now

U.K. DISTRIBUTION: Thorn EMI Computer Software. Telephone: (0252) 543333

The grandly-named Thoughtware is a series of 10 management training programs from a subsidiary of the equally imposing Alexander Proudfoot Company, a multi-million dollar American management consultancy. It is designed to allow managers to train themselves at their own pace, using interactive software on IBM PCs to replace traditional classroom techniques.

There are two groups of programs: a small management diagnostic series aimed at evaluating a manager's strengths and weaknesses, and a range of training programs



Pseudo-psychological jargon abounds.

which focus on specific aspects of management. The techniques used throughout are broadly similar. Screens of text outline the philosophy of each module. Examples are given, sometimes with rudimentary animations. Colour is used and sometimes sound enters in the form of little electronic fanfares.

An important component of the training is the use of multiple-choice questions and answers. Various work situations are presented, and you are invited to choose from three alternatives or rank on a 1 to 5 scale your reactions to particular aspects. Comments are offered by the program on both correct and incorrect answers.

At the end of series of questions, overall conclusions on your responses or comparisons with the average are displayed. Much of the strength of the Thoughtware series derives from its basis of 20 years of data on management attitudes and techniques throughout the world. The sample sizes of executives questioned are impressive: at least 24,000, and up to 100,000 for some.

In this respect Thoughtware is merely an extension of time-honoured business

training courses that are already widely used, especially in the U.S. Where it is innovative — and indeed important in terms of the likely future development of such training — is in its whole approach of using a micro to replace human tutors.

The one-to-one nature of the stand-alone micro allows a manager to work at his or her own pace. It can be done at odd moments, without disrupting already full diaries. Because people are completely absent from the whole process, there is no sense of pressure while you are taking the course, and no need to be less than frank in replies about personal management techniques.

EASY TO USE

Since the computer aspect of Thoughtware is designed to be almost totally transparent, the software itself is, for the most part, almost trivially easy to use. You reply with either numbers for the multiple-choice questions, or Y/N for yes/no. The pattern of getting the system up varies slightly. On the two modules reviewed here, *Motivating to Achieve Results* loaded straight from DOS, but *Defining Goals and Objectives* required *Basica* to be loaded first.

The only point where some concentration is required is when you need to pass to another disc, since most modules straddle more than one disc. It proved only too easy to upset the system by removing and inserting discs at the wrong point, which may put off naive computer users.

At first the Thoughtware logo comes up on the screen, then you press the space bar to take you through the introductory pages. You are then confronted by the Thoughttree. As its name suggests, this is simply a branching menu of the options open to you. To move down the tree you press the relevant number; to move up a level you press 0. Some trees extend down several levels. The manual provides a diagram explaining roughly which directions to move on the tree, but it would have been more helpful to have sketched on the screen a map of the tree, with a small sign telling you where you are. Generally the manuals are well produced, though they add little to the programs themselves.

The first branch of the Thoughttree on each module is a general introduction and overall view of the program. The second is the main study section, and contains sub-sections dealing with particular topics. For example, in *Motivating to Achieve Results*, the study units consist of *Understanding the Manager's Role*, *Understanding Human Needs*, *Exploring the Motivation Model*, and *Analysing the Motivation of Employees*.

The sub-section *Understanding the Manager's Role* splits up further into *Case Studies* and an assessment of your own "motivational practices". The *Case Studies* are short descriptions of situations, followed by a question and alternative solutions to the question. Incorrect responses draw fairly muted criticism, and you are invited to try again. Correct solutions are amplified as to why they are right. Of course such techniques beg the question of what is correct or

otherwise. Since there is no human teacher, it is not possible to argue, discuss or pursue any point further. The only consolation you have is that the answers have been distilled from large numbers of responses over many years. You either accept their validity and value, or you give Thoughtware a miss.

In operation Thoughtware emerges as rather slow. For some reason, there are disc accesses for practically every screen. The first time through, speed is not a major consideration, but when reviewing a section, or trying to take up from where you left off in a previous session, it can be tedious.

Some of the tests and course elements are quite instructive and well tailored to getting a particular point across. For example, at the end of *Defining Goals and Objectives* there is a series of tasks which provide an apt paradigm on what should and should not be done in work situations.

For the first task, a row of playing cards are displayed on the screen. After they have disappeared, you are asked questions on them. You do this with little success, since you had not been informed what exactly you were to be looking for, nor are you told whether you have answered correctly. The second task tells you what the question will

THOUGHTWARE				
PC VERDICT				
	POOR	AVERAGE	GOOD	EXCELLENT
Performance	<input type="checkbox"/>	<input type="checkbox"/>	<input checked="" type="checkbox"/>	<input type="checkbox"/>
Ease of use	<input type="checkbox"/>	<input type="checkbox"/>	<input checked="" type="checkbox"/>	<input type="checkbox"/>
Documentation	<input type="checkbox"/>	<input checked="" type="checkbox"/>	<input type="checkbox"/>	<input type="checkbox"/>
Value for money	<input type="checkbox"/>	<input checked="" type="checkbox"/>	<input type="checkbox"/>	<input type="checkbox"/>

Thoughtware is a well thought-out series of management training programs which may turn out to be the first in a line of such executive software.

be before you see the cards, and informs you when you succeed. Naturally, your score improves. The third task not only tells you the questions, but also allows you some choice as to the precise details and how long you have to answer. These three tasks mirror quite well progressively better-managed organisations, ending up with one where staff are involved in the defining of goals and setting of deadlines, and are given feedback on their performance.

This gives some idea of Thoughtware at its best. At its worst, it consists of fatuous comments like "You're right, using this approach is important" in response to multiple-choice answers. Elsewhere, there is typical American pseudo-psychology, with liberal sprinklings of terms like "self-actualisation".

Which brings us to the matter of the content. The net result of 20 years' research based on 100,000 case studies ultimately boils down to common sense. If your staff are having problems you do not threaten them immediately with the sack, but talk things over. If production is to be slowed for a while, you inform people first rather than

letting the rumour mill take over. Generally the message is that you should treat staff as fellow human beings with needs, fears and aspirations just like you.

Your first impression might be that you would have to be quite a mutt to do anything else. But a moment's reflection on the sad state of industrial relations in the U.K. over the past few years suggests that there are a lot of such mutts around.

For this reason Thoughtware may well meet a need that few senior managers have dared to articulate, even to themselves. Perhaps the biggest advantage of the programs is that they are essentially private. Unlike a classroom situation, where reputations and professional competence are at stake in public, Thoughtware allows the manager to probe gently some of the more dubious areas of his or her management techniques in the privacy of his or her own micro.

INTANGIBLE BENEFITS

Whether these programs and others like them will be widely taken up in the U.K. depends partly on the perceived cost-effectiveness. Since improvements in managerial efficiency are at best intangible benefits, and in any case may only be marginal, since no software is going to redeem hopeless cases, companies are unlikely to adopt such methods unless the average cost per manager is small.

This probably limits the immediate appeal of Thoughtware to larger companies. The basic cost of £350 for the diagnostic modules and £450 for the training modules is superficially high for programs that can be run through in less than an hour, though such an approach is explicitly discouraged by Thoughtware. Set against this is the even higher cost of management training courses, which can easily amount to several hundred pounds per day. This does not include cost of accommodation, nor the loss of the manager's time.

Smaller companies may well find that subsequent products in this sphere will be priced more aggressively. Certainly, Thoughtware is likely to be the first of many such programs. The same company is currently preparing a sales training program, as well as a cut-down version of Thoughtware itself for Yuppies keen to hone their management skills in the comfort of their own media room. It will be interesting to see what impact, if any, these training programs have on their British counterparts.

CONCLUSIONS

- Thoughtware is an interesting application of micros to interactive management training.
- Although the wisdom that it purveys may seem obvious at times, it is no less valuable for that, and is backed up by many years' research.
- The programs are well designed for the most part. They make varied use of question and answer sessions, geographical displays and case studies.
- The programs are very easy to use, though a little slow in response time due to constant disc accesses.

HELIX

ICON MEETS DATABASE

By Mike Lewis

Is this powerful database for the Macintosh really user-friendly?

Helix is a database package for the Macintosh in which command files have been entirely replaced by icons, windows, and other graphical devices. It is a big program, both physically and functionally, and at first sight somewhat daunting. Once you have got to grips with it — no easy task — you will find a beautifully designed and truly imaginative piece of software. The trouble is that it might prove just too complicated for everyday office use.

Even people already familiar with both the Macintosh and the concept of databases might find Helix a tricky program to learn. Newcomers to computing will have an uphill struggle. Do not expect too much help from the very bulky manual which waffles on about "layers of object-orientated choices" and a "continuing process of discovery" without actually telling you what Helix does. Instead it plunges into a whole new vocabulary — collections, relations, palette switches, and even black holes.

Apart from the manual, the Helix package contains three Macintosh discs, an audio cassette, sundry notices and leaflets.

and a writing pad made of glossy headed paper, the purpose of which is obscure. The whole thing comes in an oversized box and weighs nearly 3kg.

The actual Helix program fits on to a single disc, but there is very little left over for data so a second disc drive is virtually a necessity. Loading Helix takes over a minute on a 512K Mac, but at least you get all the program in at once. You can run Helix in 128K, but at the expense of some hefty overlay usage, which slows things down more than a little. The other discs in the package contain a guided tour round the program's features, which works with the audio tape and sample data files.

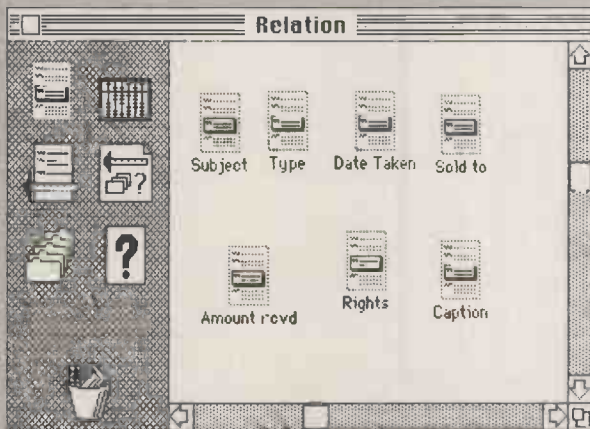

In Helix, a relation window is the pivot of an application. It consists of a scrollable portion (right) and a palette. Here, seven copies of the field icon have been dragged into the main part of the window and given names.

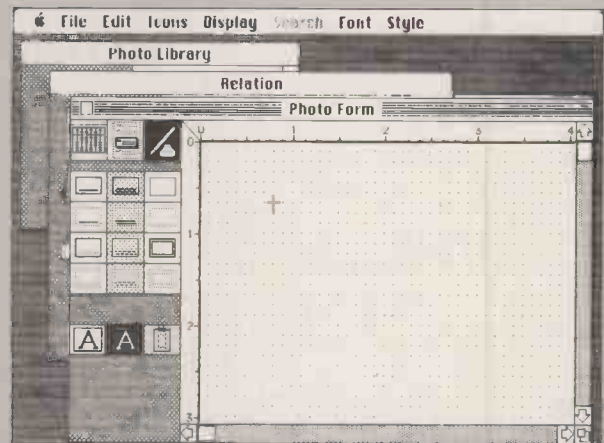

To use the fields, you must place them on a template. As the template icon is dragged into the relation window, it is automatically opened, revealing a grid (right) and a set of drawing tools.

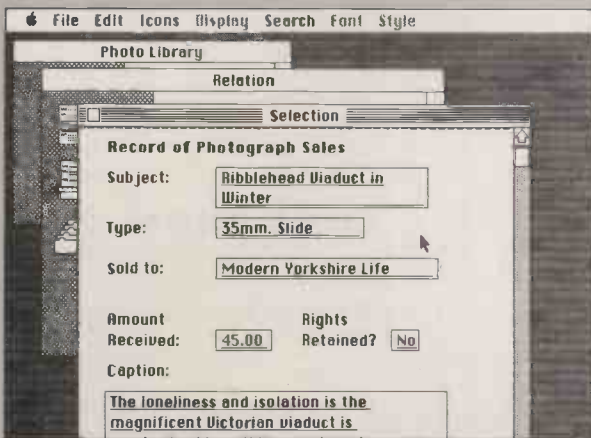

When this process is finished, you can open a selection window to reveal the data-entry form. The grid dots and the rectangles around the field labels have been removed. Note the use of different fonts.

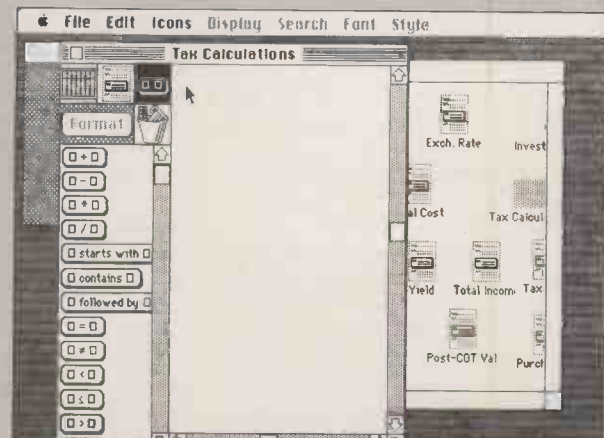

Most arithmetic and logical operations are defined in an abacus window. Here, the window has just been opened. The palette shows a few of the 52 types of tiles that can be used in calculations.



The first thing you see after Helix is loaded is a collection window. A collection is simply a group of files or, as the Helix manual puts it, "a small universe of closely related data bases". The collection window is a sort of top-level menu, from which all the subsidiary windows are opened.

All Helix windows are based on a logical and admirably consistent design, which differs somewhat from the standard Mac layout. The whole window can be dragged around the screen and resized in the usual way, but only the right-hand portion — the window proper — sports the familiar scrolling bars. The left-hand half is a palette, which typically displays a number of

icons and a wastebasket. If you think of the palette as a menu, selecting a menu option is achieved by dragging the corresponding icon into the main part of the window.

The only icon that you can pull into the collection window is the relation icon. A relation is Helix jargon for an application, and consists of six main building blocks: fields, templates, selections, indexes, queries and calculations. Dragging the icon to the collection window automatically opens the relation's own window, the palette of which holds further icons corresponding to each of these six main functions.

The first step in setting up an application

in any database is to define the data. In Helix, this is simply a matter of dragging a few field icons into the relation window. Ideally, you then name the fields and define their type: text, numbers, dates, or flags for yes/no fields. You may also choose a format for any field: for example, commas between thousands or a floating \$ sign. Alas, the package is not converted to U.K. use and so does not support floating £ signs or European date formats.

One of the nice things about Helix is that you can give a name to just about anything, including fields, forms, and even individual calculations, but you are not forced to do so unless you need to. You can also postpone deciding about data types and formats if you wish. You don't even have to work out in advance how many fields you will need. You just pull a load of icons into the window, then throw any unused ones into the wastebasket.

Although it is not obvious, setting up fields in this way does not define any files or records. The fields do not actually come to life until you put data into them, and the only way to do this is through a data-entry form, which is in turn defined by a template. This brings us to the messiest part of the whole package.

The template window is essentially a grid on which you can place data-entry boxes and descriptive text. But you cannot simply type in the text direct. Instead you have to go through a clumsy process of dragging a rectangle to the desired position, then opening it as a sort of mini-window to receive the text. At this stage, the normal Macintosh edit procedures are available. You may also select fonts and styles for the text, although Helix only leaves room on the system disc for three fonts.

Unfortunately, the text rectangles are so small that working with them is a real hassle. The mouse pointer is a cross hair in the main part of the template but changes to a standard Mac I-beam inside a text rectangle. When you are trying to grab the rectangle's own microscopic Move bar, the pointer is

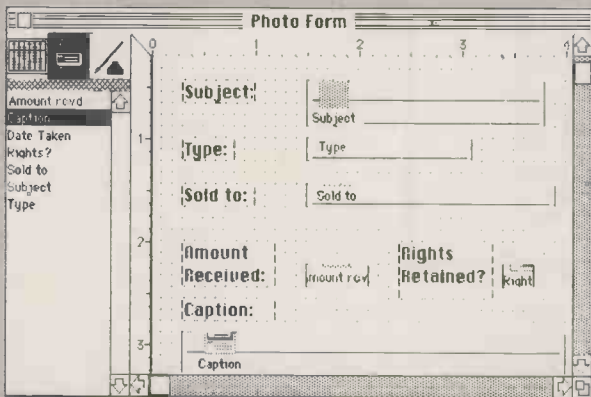

Six labels have been put in position, each with a data entry box. The data boxes are mapped to specific fields by clicking the field icon at the top of the palette, then dragging relevant names to the appropriate boxes.

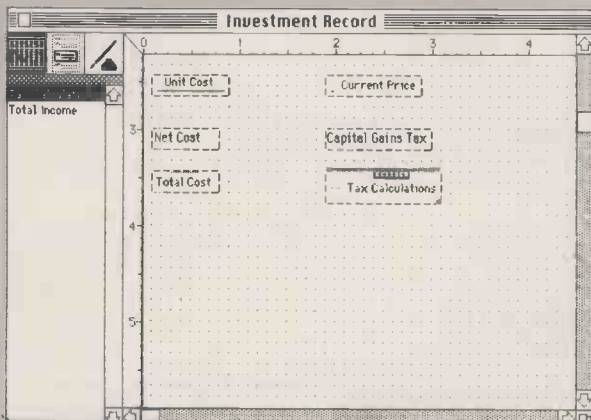

Going back to the template, the results of the calculation are now placed in the form. The palette shows all the available abacuses, and the one named Tax Calculations is dragged to the relevant box.

SPECIFICATION

DESCRIPTION: data management system supporting interactive queries and printed report writing; Helix takes every opportunity to use the Mac's visual interface to the full

HARDWARE REQUIRED: Macintosh 512K with second disc drive or hard disc; also runs on Mac HL/Lisa under Macworks

PUBLISHER: Idesta Corporation, of Northbrook, Illinois, U.S.A.

PRICE: £362 plus VAT

U.K. DISTRIBUTORS: P&P Micro Distributors Ltd, New Hall Hey Road, Rossendale, Lancashire BB4 6JG.

Telephone: (0706) 217744. Softsel

Computer Products Ltd, Softsel

House, Central Way, Feltham,

Middlesex TW14 0XQ. Telephone:

01-844 2040

(continued on next page)

(continued from previous page)

constantly flickering between its two states, and you are further distracted by the nearby flashing insertion bar. Also, if you are working near the edge of the grid, you could find yourself inadvertently scrolling the main window. All this makes the job of laying out a data-entry form into quite a struggle.

This is a pity because in many ways the template is the key feature of the database. It is the template that defines the structure of the record, and also the lengths of fields. The same field can have different lengths in different types of records, and you can alter the length without unnecessary loss of data.

Once you have completed the template, the actual entry of data comes as a relief. After you open a selection window, you see a nice clean data-entry form with all the grid dots and the text rectangles swept away. As you fill in each form, it is automatically saved to disc, and then a fresh form is presented. You can also use the Search menu to go back to previous forms and to make changes or deletions.

As its name suggests, the Search menu is really designed to be used in conjunction with queries. Opening a query icon causes Helix to display what looks like another copy of the data-entry sheet. Instead of typing information into this form, you can enter simple relationships into any of the fields. This is done through a dialogue box, which is opened by clicking the field.

This type of query is very limited. At best it can contain two conditions, each comparing the field in question to a constant, and linked to each other with an And operator. So you could ask for records where salary is greater than 5,000 and less than 10,000, but you could not look for those where salary is less than bonus.

ABACUS

If you want to use more complex queries, you must turn to what is probably the most unusual feature of Helix: the abacus. In fact, an abacus is no more or less than an expression consisting of variables and constants linked by various operators, but represented in a highly visual manner. It is built up from a set of 52 different types of modules called tiles.

For example, suppose you want to add the contents of two fields together. You open an abacus icon, revealing a window with a scrollable menu of tiles in the palette. The first of these is the addition tile, which contains two empty squares with + between them. When you drag this tile into the window, the squares turn black — those black holes mentioned earlier — meaning that you can put something in them.

Next, you click the field icon at the top of the palette. This switches the palette from a tile menu to a list of all the fields you have so far defined. You may now drag the names of the two fields that you wish to sum into the black holes. Alternatively, you can open a black hole to reveal a window into which you may insert a constant.

The result of the calculation is represented

by a downward arrow which grows out of the tile. You can move this arrow around the window so that it points into the black hole of another tile. So, in this example, the sum of the two fields could be passed to a multiplication tile, where it would be multiplied by a third value. In addition to arithmetic, there are tiles available for relational and logical operations, as well as an array of trigonometrical, logarithmic, financial and text functions. There is even an If-Then-Else tile.

Although this setup provides considerable power, it does not allow you to do anything that you cannot do much more easily in a conventional database. Moving the tiles and arrows around the window is a tedious chore. Worse, all but the simplest expressions take up more space than will fit on the screen, so you constantly have to scroll the window. I found myself longing for the cryptic but concise language of systems like dBase II.

An important point about the abacus is that the result of the expression is not actually stored anywhere. You can place an

HELIX				
VERDICT				
	POOR	AVERAGE	GOOD	EXCELLENT
Performance	<input type="checkbox"/>	<input type="checkbox"/>	<input checked="" type="checkbox"/>	<input type="checkbox"/>
Ease of use	<input type="checkbox"/>	<input checked="" type="checkbox"/>	<input type="checkbox"/>	<input type="checkbox"/>
Documentation	<input checked="" type="checkbox"/>	<input type="checkbox"/>	<input type="checkbox"/>	<input type="checkbox"/>
Value for money	<input type="checkbox"/>	<input checked="" type="checkbox"/>	<input type="checkbox"/>	<input type="checkbox"/>

Helix's highly visual approach does not entirely succeed. It is powerful and versatile, but no easier to use than a conventional database.

entire abacus icon into a template, but the calculation is repeated each time a new form is displayed. This can be very useful because it means that calculated values are automatically updated whenever you change any of the fields on which they depend. The disadvantage is that it makes it difficult to set up the sort of posting runs where transaction files periodically update master files.

Another task that is difficult in Helix is report generation. To output any kind of listing, you have to go back to the dreaded template and use something called a repeating field, a tricky and somewhat limited feature. A special report icon at relation level would have been a better approach and consistent with the design of the package.

But in spite of these omissions, Helix is an extremely versatile program. It contains many more features than there is room here to describe, and there are countless ways of joining them together. For example, given that a data-entry box can be virtually any size and that activating the box gives you access to the Macintosh editor, you can place entire word-processed documents into forms, opening the way to all kinds of mail-merge applications.

A particularly strong feature is the way in

which names are handled. Once you have named a field, form, abacus, or whatever, you never have to type the name again. Whenever you need to refer to the object, you can always access a list of existing names, then use the mouse to drag the name to where you want it. Apart from saving time, this approach means that you can choose the most meaningful names without having to remember any tricky spelling or punctuation. Whenever names lists are displayed, they are always in alphabetical order.

MAC INTERFACE

The real test of Helix is how well it uses Macintosh's much-praised user interface. After all, the whole point of the Mac style of operation is supposed to be that the icons, mouse pointers and pull-down menus should make the operation of a program more or less obvious, so that detailed manuals are no longer needed and using a computer eventually becomes intuitive.

Helix only goes part way to meeting this aim. There is no doubt that it is a visually appealing program. The screens look good, typing is kept to a minimum, and clearly a great deal of thought has been put into the design of the icons and windows. But Helix is simply too powerful to be easy to use. Whatever else you can claim for this product, intuitive it isn't.

Perhaps the worst thing about the package is that there is absolutely no separation between the functions used for setting up an application and those needed to operate it. Database products like dBase II have succeeded because they allow a knowledgeable user to set up systems which could later be handed over to non-specialist staff for day-to-day use. With Helix, all the icons are inextricably interwoven, making such separation impossible.

What the Macintosh badly needs is a database system which can take advantage of the special Mac features at end-user level, but which allows those features to be dispensed with by the semi-technical person who programs the application. I would rather face the chore of writing and entering a command file than spend hours on end dragging rectangles around templates. In many ways, Helix is a superb program, but I would be very surprised if it became the definitive Mac database.

CONCLUSIONS

■ Helix is a thoroughly versatile package which presents a logical and consistent face to the user.

■ It is a database system without a database language. Everything that would otherwise be achieved by command files or macros is instead done by manipulating a collection of icons among a dozen or so windows.

■ The price you pay for its undoubted power and flexibility is that the product can be very hard to learn. Matters are not helped by a bulky manual which is not particularly well worded.

■ Even allowing for my relative unfamiliarity with the package, I found that it took much longer to set up simple applications than it would have with traditional databases. **PC**



Top row KX1203, K12SV3, KX1201. Bottom row K12R3, K12R2. Optional 'tilt and swivel' stand shown with certain models.

Aim straight for a Taxan

When you're aiming for the best monitor around, set your sights on a Taxan.

Because Taxan are quite simply the biggest selling range of monochrome and colour monitors in Britain today.

And that's hardly surprising since every Taxan Monitor is designed and engineered for superb style and maximum performance.

Take a look at the KX1201 and KX1202 for example.

High quality, high resolution 12 inch monitors offering a choice of Green or Amber display with a long persistence option on the Green phosphor model.

With the latest non-glare flat tube for easier viewing and more than 20MHz video bandwidth, you can't do better than a Taxan monochrome monitor.

Taxan also produce a range of 12 inch RGB colour monitors that give you unbeatable price performance.

Like the medium resolution K12R2 (Vision II) and the high resolution K12R3 (Vision III).

Compact professional monitors, suitable for all popular micros. Built-in switchable RGB interface for

added versatility and both suitable for 80-column text display.

Finally, the K12SV3 (Super Vision III). A 12 inch, RGB, super-high resolution, colour monitor with three different monochrome modes. Fully compatible with IBM PC, Apple, BBC and most other personal computers it is simply the most versatile monitor on the market today.

Taxan Monitors retail at around:

KX1201G	£109 (plus VAT)
KX1202G (P39 Phosphor)	£119 (plus VAT)
KX1203A	£119 (plus VAT)
K12R2	£285 (plus VAT)
K12R3	£399 (plus VAT)
K12SV3	£429 (plus VAT)

Ring us on Ascot (0990) 28921 for the name of your nearest dealer. And find out why you should aim straight for the best-selling range of monitors around.



5 King's Ride Park,
Ascot, Berks. SL5 8BP
Tel: 0990 28921
Telex: 846303 DD LTD G.

THE NEW FORCE IN DISTRIBUTION

MEMO 2000

Send your messages to and from IBM PC, Sirius, Apricot, IBM Compatible, or via Telecom Gold, Beeline, MSX, DCX.

GET YOUR REPORTS NOW WITH GRAPHS, DRAWINGS & CHEMICAL SYMBOLS -

IN THE WAY YOU WILL BE DOING IT IN THE YEAR 2000.

FASTER than the fastest postal service. CHEAPER than the cheapest postage stamp. HANDIER than the handiest message service. With MEMO 2000 you can now send and receive memos and reports to and from anywhere in the world.



OBTAIN - instant access to files held on other computers.

CHECK - continuous checking in interrupt mode ensures constant accuracy.

NO TECHNICAL LIMITATIONS - limited only by disc capacity, not memory.

Micro Nationwide (Software) Ltd.
Brighton Marina, Brighton, Sussex.
Telephone: (0273) 600663/672505



PLUS
MEMO
SAFE

To protect your information from prying eyes.
Encryption to full D.E.S Specification.

● Circle No. 156

MM

PC PRICE BONANZA

PROFESSIONAL SERVICE

PC's & COMPATIBLES	EX VAT
APRICOT PORTABLE 256K 1 x 720K Drive	£1495
APRICOT 256K 2 x 720 Drives & Monitor	£1545
APRICOT Xi 256K 10MB & Monitor	£2195
COMPAQ 2 2x360K drives	£1795
COMPAQ PLUS 10MB	£3195
IBM PC 256K 2x360K Mono	£1865
IBM PORTABLE 256K	£1902
IBM XT 256K Colour	£3217
IBM XT 256K Mono	£2952
MACINTOSH	£1545
OLIVETTI M24 256KB 2x360KB Drives	£1690
OLIVETTI M24 256KB 10MB	£2810
OLIVETTI M21 256KB 2x360KB Drives	£1590
OLIVETTI M21 256KB 2x720KB Drives	£1810

EXTERNAL HARD DISK DRIVES

PLUS 5 20MB + 5MB CARTRIDGE	£2325
PLUS 5 30MB + 5MB CARTRIDGE	£2845
PLUS 5 40MB + 5MB CARTRIDGE	£3059

IBM MEMORY BOARDS

128K MEMORY EXPANSION	£190
256K MEMORY EXPANSION	£249

PC NET STARTER KIT	£795
--------------------	------

PC SOFTWARE

CAXTON BRAINSTORM	£1545
CAXTON CARDBOX	£2195
DBASE II	£1795
DBASE III	£3195
DMS DELTA	£1865
DMS +	£1902
DR FORTRAN 77	£3217
DR PASCAL	£2952
DR ASSEMBLER Plus Tools	£1545
FRAMEWORK	£1690
FRIDAY	£2810
KNOWLEDGEMAN	£1590
LOTUS 1 2 3	£1810
MICROSOFT WORD	
MULTIMATE V 3.2	
MULTIPLAN	
MULTIUSER ACCOUNTS per Module	
OPEN ACCESS	
PEACHTREE	
PEGASUS LEDGER MODULE	
PULSAR LEDGER MODULE	
SAGE ACCOUNTS	
SAPPHIRE DATAMASTER	
SYMPHONY	
TK SOLVER	
VOLKSWRITER DELUXE	
WORDSTAR	

PROMPT DELIVERY

EX VAT	PC PRINTERS	EX VAT
£245	ANADEX DP 6500' 500cps	£2234
£165	DRE 8850 300lpm	£2065
£235	EPSON LQ 1500 200cps (NLQ)	£895
£345	MANNESMANN MT180 160cps (NLQ)	£579
£375	MANNESMANN MT400 400cps (NLQ)	POA
£155	NEC 2050 20 cps	£625
£199	NEC 3550 35cps	£955
£280	NEC PINWRITER P2 (P)	£535
£125	NEC PINWRITER P3 (P)	£595
£345	OKI 84A (P) 200cps	£625
£135	OKI 2350P 350cps	£1435
£380	OLIVETTI DY450 45cps (P)	£880
£285	PANASONIC KP1091 120cps + NLQ	£249
£210	QUME 11/55 RO	£1370
£225	RICOH FLOWWRITER 1600 8k	£1299
£135	TOSHIBA TH2100H 192cps (P)	£1350
£225	TREND 930 200cps NLQ 80cps	£1350
£315		
POA		
£200		
£135		
£250		
£395		
£425		
£245		
£155		
£195		

MAYFAIR MICROS

BLenheim HOUSE, PODMORE ROAD,
LONDON SW18 1AJ

TEL: 01-871 2555

We accept official orders from UK Government and Educational Establishments. Mail Order and Export Enquiries welcome. Callers by appointment.

NEXT DAY INSURED COURIER DELIVERY AVAILABLE

● Circle No. 157

Pick a disk... any disk



Floppy disk incompatibility – an unpleasant fact of computer life. GEMINI M-F-B 2 SYSTEM – a pleasant computer solution.

When we introduced the original Gemini M-F-B system, we provided a lot of answers to the growing problem of disk size and format incompatibility. And now with the M-F-B 2, we can provide even more answers.

The new system continues to provide the ability to format and transfer data between any of the microcomputer formats currently available within its library of over 400 machine type and format combinations, but now goes even further.

The changes in hardware manifest themselves in a system that now provides either 10MB or 20MB of Winchester based storage and the adoption of half-height devices have allowed the inclusion of a 3.5\"/>

The software changes now provide the M-F-B 2 system with the capacity to not only hold up to 700 format combinations, but to also supply an MS-DOS suite of software enabling support of the entire IBM PC (PC, XT and AT) family, and IBM 'lookalikes'.

The Gemini M-F-B 2 now comes with a 12 month free format update service.

The 8\"/>



Making Disks Compatible

Gemini Microcomputers Ltd., 18 Woodside Road, Amersham, Bucks. England HP7 0BH. Tel: (02403) 28321. Telex: 837788

• Circle No. 158

Every option you'll ever need.

You're looking at ULTRAFRAME™, a powerful 8/16 bit multiprocessor you can configure to handle any application.

It's the one system that can tackle your toughest jobs today with the capacity to grow up to 36 users or tasks — within the same chassis.

Get 5" & 8" Winchester drives from 10-300MB (formatted). And backup systems appropriate to any system you design.

Now run both MS-DOS and CP/M software.

Our system lets you network IBM PC's, compatibles or other popular PC's into a serious multiuser business system. Tie PC's into the speed of an

S-100 buss with inexpensive boards and a coaxial cable.

Each PC can tap network resources including hard disks (10-300MB) and system printers with spooling.

The PC's gain the proven network

management capabilities of TurboDOS™. Run MS-DOS™ and CP/M 86 software plus true multiuser accounting and data base applications.

The industry's longest warranty.

We've built the ULTRAFRAME to last — and backed it with a full one year warranty. Plus, we give a level of old-fashioned factory support you won't get from anyone else. And on-site maintenance is available nationwide.

FRONT



BACK



ULTRAFRAME™



synamics

The multiuser system that also networks IBM PC's.

- **UP TO 36 USERS — IN PARALLEL.** Add 8 or 16 bit SLAVENET™ processor boards — each a complete Z80 or 80186 computer — to maintain fast, multi-user performance. Both 12 and 20 slot S-100 models available.
- **LOW COST PER USER.** Higher performance and lower cost per user than any micro network. True multi-user, multitasking operation plus shared resources.
- **MAINFRAME-LIKE CHASSIS & POWER SUPPLY ENGINEERING.** Continuous-duty cooling capacity. Solid state power supply circuitry for max. reliability.
- **FAST, HIGH CAPACITY HARD DISKS.** Full range of 5", 8" Winchester models from 10 to 2.4 GB, including new high-capacity 5" drives.
- **CHOICE OF BACKUP SYSTEMS.** Integral 5" or 8" floppies to 1.2 MB. BACKSTOP™ video archiving; BACKSTOP II™ start/stop tape.
- **FAST, MULTIPROCESSOR OPERATING SYSTEMS.** IBS p-NET™ and TurboDOS — access to all UCSD Pascal™ and CP/M™ software.

TurboDOS™ is a registered trademark of Software 900.

IBM PC is a registered trademark of IBM. ULTRAFRAME is a registered trademark of IBS, Inc.
CP/M and CP/M 86 are registered trademarks of Digital Research. MS-DOS is a registered trademark of Digital Research.

synamics

BUSINESS SYSTEMS LIMITED

78 Buckingham Gate,
London SW1 6PD.
Telephone: 01-222 4701/4707

I am interested in:

Becoming a dealer a distributor

More information

Name Address

Company

Tel No

● Circle No. 159

CONTINUO

David Levy explains how to program an entertaining game based on the classic four-colour problem.

CONTINUO is a delightful game invented by Maureen Hiron, an international bridge player. It won the Game of the Year award, and can be described most succinctly as the antithesis of the four-colour problem in mathematics. This famous problem, which was solved only with the assistance of megamips of computation, involves trying to colour a map in only four colours without any two adjacent countries having the same colour. In Continuo the object of the exercise is to create new "maps" in which the last piece moved creates as many situations as possible where adjacent "countries" have the same colour.

SIX SETS OF SEVEN

The game is played with 42 cards, each of which is a symmetrical four-by-four array of colours. Only four colours are used, red, yellow, blue and green, and no card has more than three colours. The arrangement on each card looks either like that shown in figure 1, where B represents blue, R represents red, Y represents yellow and G represents green.

All the 42 cards are different, and may be thought of as six sets of seven cards in each set. Each set has a different pair of colours for the four L-shaped parts of the card formed by omitting the colours in the corner of each card — see the Rs and Ys in the card shown in figure 1. These are green and red, green and yellow, green and blue, red and yellow, red and blue, yellow and blue.

Within each set there are seven different possibilities: for example in the set with the green and red Ls you can have all the corners yellow, all the corners blue, two corners blue and the two corners adjacent to the red Ls green, two corners yellow and two red, two corners blue and two red, two corners green and two red, or two corners green and two yellow.

At the start of the game, if there are two players, one of them takes two cards from the top of the deck and places them next to each other to create the biggest possible score. This is not added to the player's total. The score is made up from the total number of squares in each new chain of colour formed. Each new chain must include at least one square from the new card as well as at least one square from an existing card.

For example, two cards taken from the top of the pack could be arranged as in figure 2. There are two adjacent Rs, scoring two points; two adjacent Bs, scoring two points, and there are six contiguous Rs, scoring six points. So the total score for this move is 10.

After the first two cards have been arranged, the players move alternately. A move consists of taking the top card from the deck and placing it so that at least one of its edges is touching at least part of an existing edge.

The player then scores the total for whatever new chains have been made by this move, using squares from the new card as well as squares from the existing arrangement. At the end of the game the player with the highest score is the winner.

Continuo is great fun but it is more a game of perception and memory than of skill. It is possible for a player to try to place a card in every legal position and then remember which position provided the highest score and make that move, but this would make the game tedious. If you buy Continuo — excellent value at £2.95 — try to play each of your moves within a prescribed time limit. This is what makes the game really interesting and is an essential element of making it worthwhile to program the game.

The graphics display of Continuo can be handled almost irrespective of the resolution of your computer. Create a rectangular array and adopt the rule that neither player may place a card so that any part of it is outside this array. Leave an area at least the size of one card, so that you can see the next card on the screen before it is played.

For the start of the game the computer should choose two cards at random, and then arrange them somewhere in the middle of the playing rectangle in such a way as to create the maximum score. You should then be able to decide who moves first: you or the computer. When a new card appears and it is the computer's move, the card should stay out of the playing rectangle for a few seconds

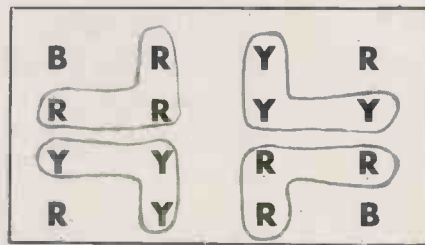

Figure 1.

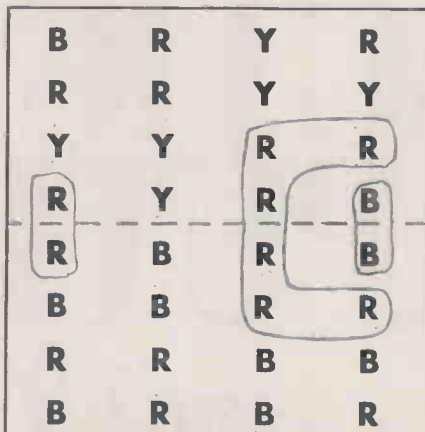

Figure 2.

before the program plays it. Making the cards slide will also look impressive.

If it is your turn to move you should have the option of positioning the card anywhere within the playing rectangle, using a joystick or cursor arrows, then swivel the card round on its axis by an appropriate keystroke. You should display the number of cards that still remain to be played on the screen as well as the current scores achieved by the players. Also you should indicate how much time has been taken so far in thinking about the current move, it is worth programming an audible warning when you have only a certain number of seconds left to the time limit.

One way to enjoy the game is to play against someone, using your computer to provide the playing area and to monitor the time taken by each of you. The program can provide a warning at, say, 10 seconds before your time is up, and if you have not completed your move at the end of the allotted time then you lose your turn. You may set the time limit to whatever you want and you can even handicap the better player by allowing him or her to have less time for each move.

PLAYING LEVELS

When playing against the program you will want to have the choice of a number of different playing levels, which can be achieved in various ways. The following ideas can also be used to provide different skill levels in other computerised games too. One obvious way to make the program play less well is to reduce its thinking time. Since the program will normally make the highest-scoring move given unlimited time, depriving it of sufficient time to consider every possibility will compel it to make the best move found so far at the moment when its time is exhausted.

Another option is for the program to deliberately make a non-optimal move. It could choose the second-best move 10 percent of the time, or 20 percent and so on. If you want it to play even less well it could choose the third-best move n percent of the time. In chess and many other games this play can be fatal, since the second-best move may well lose the game immediately — for example, if there is only one way to avoid checkmate or loss of the queen.

Another idea is to add a pseudo-random number generated over a suitable range to the score that the program finds when it counts up the total for each legal move. This will often make the program think that a non-optimal move is in fact the best. Once it plays the move it must then add the correct score, excluding the pseudo-random addition, to its current total. This technique works well in chess, and the pseudo-random number can be added to each evaluation of a terminal position on the game tree or it can be added to the backed-up score at the root of the tree. Either way, the result should be that the program will not always play exactly the same move in the same position, and the larger the range for the pseudo-random number, the worse the program will play. 

THIS WILL DO NICELY!



Now you've seen the new (and vastly improved) Practical Computing, make sure you receive it regularly every month by returning this card.

You won't want to miss what we have lined up for the future – more applications features, more on multi-user systems, more

problems answered, more on communications and more viewpoints from industry leaders.

What more could you ask for? Except to receive it regularly, of course!

PRACTICAL COMPUTING

*Get it regularly –
send the card – today!*

LEGENDS IN THEIR LIFETIME

Ian Stobie introduces our selection of 10 business packages that have become the established leaders in their field.

In this survey we look at the giants of the personal computer software scene — the packages you've really got to know about to make an informed decision, the ones virtually every dealer offers and most existing users own or know about. Some are established, almost historic, products: WordStar, VisiCalc, dBase II, Microsoft Word, Framework, Symphony and Sidekick are less than two years old but are already top sellers.

Drawing conclusions about the quality of a business software package based just on how well it has sold is dangerous. Many of today's brand leaders have established their dominance through purely fortuitous circumstance. Being first in the market with a new kind of program can gain your product a reputation which competing packages are hard put to match, as the continuing popularity of VisiCalc exemplifies. Getting it bundled free with the right machines is another way of building up an unstoppable momentum, as dBase II and Supercalc show.

SUPPLIERS

DBASE II/Framework: Ashton-Tate (U.K.) Ltd, Cofferdge Close, Stony Stratford, Milton Keynes MK11 1BY. Telephone: (0908) 568866

LOTUS/Symphony: Lotus Developments (U.K.) Ltd, Consort House, Victoria Street, Windsor, Berkshire SL4 1EX. Telephone: (0753) 840281

WORD/Multiplan: Microsoft Ltd, Piper House, Hatch Lane, Windsor, Berkshire SL4 3QJ. Telephone: (0753) 559951

SIDEKICK: P&P Micro Distributors Ltd, New Hall Hey Road, Rossendale, Lancashire BB4 6JG. Telephone: (0706) 217744. Softsel Computer Products Ltd, Softsel House, Central Way, North Feltham Trading Estate, Feltham, Middlesex TW14 0XQ. Telephone: 01-844 2040

SUPERCALC 3: Sorcim-IUS Micro Software, 16-20 High Street, Maidenhead, Berkshire SL6 1QH. Telephone: (0628) 70911

VISICALC: Software Arts International, 43 Buttermarket, Ipswich, Suffolk IP1 1BJ. Telephone: (0473) 221551

WORDSTAR: Micropro International Ltd, Haygarth House, 28-31 High Street, Wimbledon, London SW19 5BY. Telephone: 01-879 1122

But conditions in the software market have changed radically since the early days of these pioneering packages five or six years ago. The present-day dominance of the IBM PC and its clones means that there is now more of a single, unified market for software developers than ever before.

The advantage in this new market initially fell to companies like Lotus Developments, capable of pouring resources into developing and promoting each product. Straightforward single-function word processors and spreadsheets looked threatened by the so-called integrated packages, massive pieces of software such as Lotus 1-2-3 and Symphony which claimed to be able to do virtually everything.

Yet these integrated products have not carried everything before them. Partly this is because they tend to eat up system resources, which means you often end up having to buy a bigger system or extra memory on top of the substantial cost of the software itself.

Because of all the things they supposedly can do these large packages can seem dauntingly complex to the potential purchaser. Promotional material may counter this by mentioning training courses, but this just summons up an image of more complexity, more expense, more time spent unprofitably before you can get down to the job. It all somehow seems to go against the idea which lies behind the appeal of the personal computer in the first place — cutting through the complexity and doing it yourself.

There is a tendency now to move back to simpler packages. Single-function word processors are fashionable again: Multimate, Samna Word III and Word Perfect ride high in the best-seller lists. The latest integrated packages do not try to do everything. Framework can handle charts and text, but logically it is a database in the tradition of dBase II; the latest in the Supercalc family can handle graphics, but it is quite clearly at root a spreadsheet package.

What is likely to happen in the future in the business software market is crucially dependent on the way operating systems for the IBM PC evolve. There are no packages in this survey which run solely on the competing Macintosh computer — there are not enough Macs in existence at the moment to make any such package in general terms a best seller. But these Macintosh packages are very important in showing future direction.

It is also clear that the operating system will in future take more responsibility for establishing integration between different packages, allowing you to transfer data between them and probably letting you run more than one package at a time. This will probably encourage the present tendency away from giant integrated packages towards simpler ones that are quicker to learn and use.



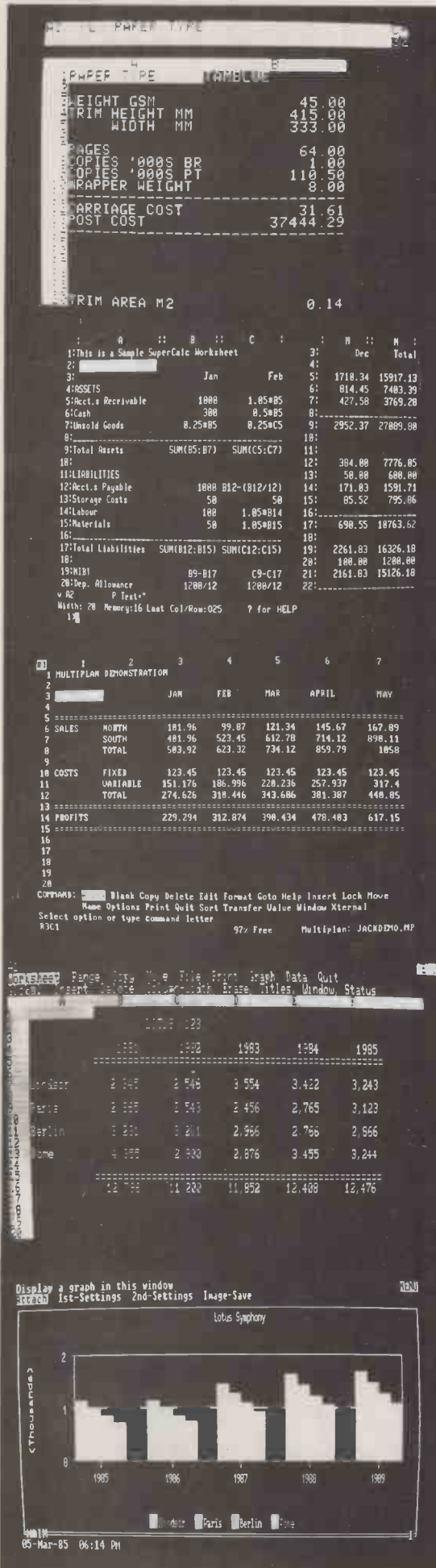

VISICALC

VisiCalc was the very first electronic spreadsheet. When it was launched for the Apple II in 1979, it revolutionised microcomputing. A vast number of copies of the program are in daily use. Unfortunately many of these are early versions, which do not have variable column widths, don't sort, and lack other important features. The most recent version of the program, Advanced VisiCalc, is probably as powerful as any other spreadsheet, but it is not as easy to use as Multiplan and it doesn't do graphics like Lotus 1-2-3 and Supercalc 3. It's still a great program, but past its best.

FOR DIF files for data exchange. Well supported. Runs on some cheap machines.

AGAINST Not as friendly as more recent spreadsheets. Lacks built-in graphics.

SUPERCALC 3

Supercalc gained its strong position in the market as the first good spreadsheet for the eight-bit CP/M micros — a market VisiCalc studiously ignored. Supercalc 1 was first bundled with the Osborne 1, and at the time seemed merely a Visi-clone, but faster. Successive releases have expanded its power greatly. Supercalc 2 added sorting. Supercalc 3, for the IBM PC and Apple micros, can handle up to 9,999 rows by 127 columns. It also offers graphs and macro facilities like Lotus 1-2-3 — and you don't need an extra colour graphics card to run it. You get the power without the price, or the hype.

FOR Handles large models. Fast. Graphics on the IBM PC's ordinary green screen.

AGAINST Cryptic command structure.

MULTIPLAN

Multiplan was the salvation of spreadsheet users who were not interested in computing. It was the first spreadsheet with on-line help, an intelligible command structure and intelligent defaults. Also it introduced names into formulae, so you could have entries like Sales - Costs instead of obscure concatenations of cells. Multiplan thus reduced the learning time as close as possible to zero. Sorting facilities and variable column widths also made it useful for tables as well. However, recalculation tends to be slow, and it lacks the powerful macros and graphics facilities of Lotus 1-2-3.

FOR Very easy to learn and use. Versatile. Versions for some cheap machines.

AGAINST No graphics or macro facilities. Handles text awkwardly. Fairly slow.

LOTUS 1-2-3

Lotus 1-2-3 is best known as a beautifully packaged marketing success. Apart from that it is a really powerful program and it is genuinely easy to use. It can crunch really big spreadsheets up to 2,048 rows by 256 columns. It handles text and data better than any other spreadsheet and it makes it easy to convert figures into your choice of chart or graph. Best of all, frequently used sequences of commands can be converted into macros and called with a single keystroke. If you need a program this powerful, the only real drawback is the amount of computer power needed to run it properly.

FOR Easy to use. Fast. Handles big spreadsheets. Powerful text and data handling.

AGAINST Expensive. Powerful micro needed to run it.

SYMPHONY

Symphony is Lotus Developments' attempt to go one better than its own 1-2-3. Word processing and communications are added to 1-2-3's spreadsheet, database and graphics. Symphony's spreadsheet can theoretically handle models up to 8,192 rows by 256 columns, although you would need to have plenty of memory to hand. The package's word processing has wordwrap and even a glossary facility, and its graphics allows you eight different chart types. But you will probably still need a conventional word processor and maybe a database package, as Symphony is really still no more than a super-powerful spreadsheet with frills. It requires 320K RAM just to run; 30K of that is free for your data but obviously it helps to have additional RAM.

FOR Powerful spreadsheet facilities. Can handle very large models.

AGAINST Time to learn. Requires plenty of RAM.

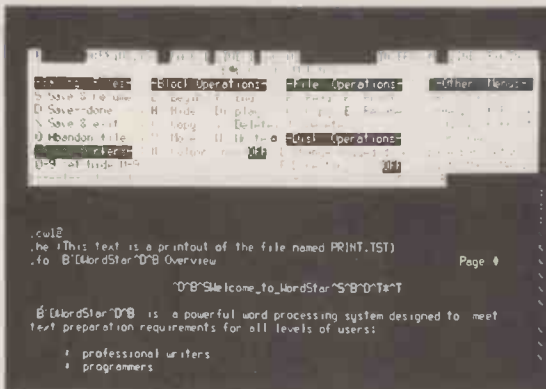

WORDSTAR

Since its introduction in 1979 WordStar has established itself as the industry-standard word processor. It scores by being very complete — whatever you want to do you can usually find some way of doing it with WordStar. The commands you have to use are not that obvious but once learned they are quick in use. WordStar runs on over 150 different types of computer, both eight- and 16-bit bit, and is bundled free with several, including the Sanyo 555 and Epson's battery-powered PX-8 portable. The latest IBM PC version of WordStar supports colour and comes with a tutorial disc included in the £295 price. Several optional programs are available to work with WordStar, including Starindex for indexing, Correctstar for spelling correction, and Mailmerge.

FOR Versatile. Available for virtually every business micro. Quick in use.

AGAINST Takes a few days to learn. Rather old-fashioned.

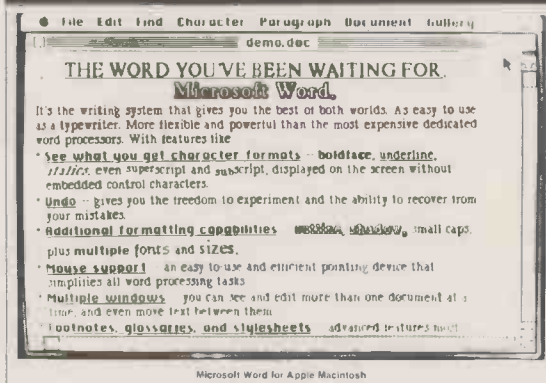

MICROSOFT WORD

Microsoft Word was the first successful attempt to produce a word processor for the mainstream business market which goes much beyond WordStar. Word can display text on the screen in a variety of type styles and sizes, and it lets you work on several documents at once, so you can compare them and copy text between them. Word has good mail-merge and boilerplating functions, and the latest version has a built-in anglicised spelling checker. Word runs on the IBM PC and close compatibles, either with or without a mouse connected, and on the Macintosh. The Mac version is a bit of a disappointment, as many of the best features are missing — for example style sheets, which provide a convenient way of reformatting passages of text with different type styles, tab settings, etc.

FOR Easy to learn. Multiple documents and type styles on-screen.

AGAINST Does not run at all on eight-bit machines.

- dBase II example
- Checks the contents of date field

```
IF &Date < 80 OR VAL(&Date,1,2) > 85;
  OR VAL(&Date,3,2) < 1 OR VAL(&Date,3,2) > 12;
  OR VAL(&Date,5,2) < 1 OR VAL(&Date,5,2) > 31;
ERASE
STORE STR(*,5) TO Found
@ 10,25 SAY 'RECORD '+CHR(14)+Found+ 'CHR(15)
@ 11,25 SAY 'DATE ERROR: Must be YYYYMMDD'
@ 12,25 SAY 'Press any key to correct
WAIT
```

dBASE II

dBase II is the clear brand leader among database packages, which is slightly surprising as it is really quite hard to use. dBase II is really a programming language, not a simple record-handling package. Where it scores is in its undisputed versatility; dBase meets the need of many users for a programming tool that works at a higher level than Basic. Using dBase, experienced users can create many kinds of business program far faster than they can with Basic or Pascal. dBase II is available on an enormous range of different eight- and 16-bit machines, and it is offered bundled free with many low-cost systems. A host of books and add-on packages are available to go with it, including dBase compilers, quick-sorting programs and program generators.

FOR Versatile. Widely available. Well supported with add-ons and training.

AGAINST Hard to learn. dBase III gives greater record size and more flexibility.

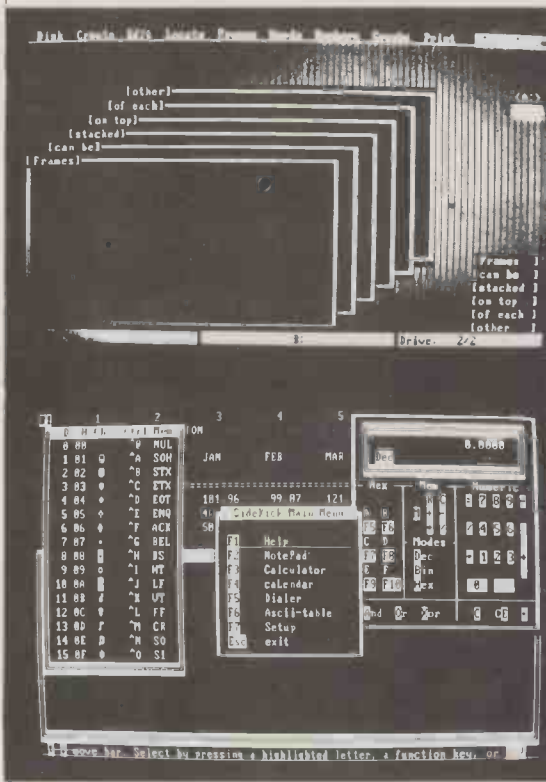

FRAMEWORK

Ashton-Tate has followed up dBase II with three other data-handling products, including dBase III and Friday. Framework is the most radical, with Macintosh-like multiple windows and pull-down menus. It incorporates word processing, business graphics and spreadsheet functions, but is still firmly based around the database concept. It can be used for writing reports, analysing data and searching interactively through data, and Framework is quite simple to use at this level. It can also be used to create application programs. Framework has a language called Fred associated with it, which supports the full panoply of string-handling, graphing, numeric and even sound functions.

FOR Fast. Programmable. Conceptually well thought-out.

AGAINST Only on IBM PC and clones. Works best with plenty of memory.

SIDEKICK

Sidekick is probably the most fun you can have with an IBM PC without actually playing a game. It's a colourful utility package that hides away in RAM along with your main program and magically appears when you hit both Shift keys together. It provides a WordStar-type notepad, ASCII list, an addressbook and calendar. If you ever find a modem it works with, it may one day offer autodial communications. It's a cheap way of making an IBM PC a multi-tasking micro; on the other hand, it's a very expensive replacement for a pencil and paper.

FOR Fast. Colourful. Cheap and fun.

AGAINST IBM only. Clashes with some other programs. No one really needs it.

ORDER NOW

THE MOST SOPHISTICATED DISC FILING SYSTEM 16K ROM EVER WRITTEN FOR THE BBC MICROCOMPUTER OPERATING ALONGSIDE YOUR EXISTING ACORN TYPE DFS ROM AND OPENING UP A NEW EXCITING PHASE AS A SUPERIOR OPERATING SYSTEM.

THE BUSINESS SYSTEM

DFS

Fully compatible with any existing DFS and Torch CPN/MCP format.

Allows 255 file names on a CP/N and CP/M type screen format. CAN'T EXTEND banished for ever, COMPACT redundant as the vacant areas on the disc are gathered to gether for economic file use automatically.

Designed to facilitate ease of use — vital in the area of business programs on the BBC. Will allow the mix of BBC and Torch CPN programs on the same disc.

£39.50 inc. VAT, full fitting instructions and User Guide. C.U.C. Members only allowed 10% discount.

ONLY AVAILABLE FROM



COMPUTER USERS CLUB

69a Hadlow Road, Welling, Kent.

Tel No: 01-311 2555

● Circle No. 161

BUSINESS SYSTEM

* **COMMODORE PC-10
 FRAMEWORK SOFTWARE
 MICROLINE 1931 PRINTER**

Complete system

£2,579+VAT

**Ring for system pack
 Tel: 061-428 2014**

**A+G COMPUTERWARE
 CHEADLE, CHESHIRE**

Over 700 PC & Apple items
RING FOR NEW LISTS

* IBM-PC COMPATIBLE

● Circle No. 190

**Unicorn
 Business Systems**



15 Ticknall Road, Hartshorne, Burton-on-Trent

COMPUTERS

APRICOT F1 + Software.....	£ 900
APRICOT PC + Software.....	£1385
AS ABOVE but with 2 x 720K.....	£1525
SANYO MBC 550 1 x 160K + Software.....	£ 590
SANYO MBC 550 2 x 160K + Software.....	£ 675
SANYO MBC 555-2 2 x 360K + Software.....	£1165
SANYO 555-4 2 x 800K + Software.....	£1205
OLIVETTI WYSE Altos.....	£P.A.O.

COMPLETE SYSTEMS: RING FOR OTHERS

<p>SANYO MBC 550 Sanyo Monitor Printer £400 Free S/ware £1095</p>	<p>SANYO MBC 555-2 Sanyo Monitor Printer £1000 Free S/ware £1645</p>	<p>APRICOT PC ACT 9" MONITOR Printer Free Software £1695</p>
---	--	---

0283 212442/0530 412333

● Circle No. 191

PLEASE NOTE OUR NEW ADDRESS
VISIT OUR NEW SHOW ROOM

MICRONIX ESB-1 32 BIT MULTIUSER COMPUTER

MX3200 System

Two user twin drive system
with 256K RAM

£1300 + VAT

Terminal £ 400 + VAT

Price includes OS9/68000
multiuser, multitasking
operating system.



★ 68008 8 MHz CPU ★ 128 RAM (expandable to 256K) ★ Up to 64K EPROM
1 Floppy disk controller for 5¼", 3", 3½" drives ★ 2 RS232 serial ports
★ Mounts directly on 5¼" drive ★ 2 x 8 bit parallel ports ★ Full debug monitor
with single line assembler and disk loader ★ Expansion bus ★ Power
requirement: +5V/1.5A, +12V/100mA, -12V/100mA.
Available as a Bareboard with Monitor ROM and IFL Chip Set £199 + VAT =
£228.85 or completely assembled £499 + VAT = £573.85 128K Expansion
Board (recommended for OS9/68000) £199 + VAT = £228.85 - OS9/68000
real time, multitasking, multiuser Operating System (similar to UNIX)
£300 + VAT = £345 C Compiler, BASIC 09, PASCAL and FORTRAN available.
Single User CP/M68K £375 + VAT = £431.25.

IBM PC/XT COMPATIBLE SYSTEMS

Buy your IBM PC/XT compatible computer in kit form and save money! Each kit consists of a
motherboard, multifunction board, colour/graphics card, floppy disc controller card, system box,
power supply and keyboard — you just put them together!

KPC-D1: 128K, single drive system kit.....	£1100 + VAT = £1265.00
KPC-D1HD: 128K, single drive, 20MB hard disk system kit.....	£2000 + VAT = £2300.00
KPC-D2: 128K, twin drive system kit.....	£1200 + VAT = £1380.00
KPC-D3: 640K, single drive system kit.....	£1260 + VAT = £1449.00
KPC-D3HD: 640K, single drive, 20MB hard disk system kit.....	£2160 + VAT = £2484.00
KPC-D4: 640K, twin drive system kit.....	£1360 + VAT = £1564.00
HD-2D: 20MB internal hard disk upgrade with controller and cables.....	£ 900 + VAT = £1035.00

Each of the above configuration consists of the following: except KPC-D1HD and KPC-D3HD which
include hard disk kit (HD-2D) in addition.

- IBM PC/XT compatible motherboard (8088 4.77MHz)
128K RAM (RAM expands to 1MB!) and 8 slots..... £300 + VAT = £345.00
- IBM PC/XT compatible motherboard (8088 4.77MHz)
640K RAM (RAM expands to 1MB!) and 8 slots..... £460 + VAT = £529.00
- Colour/graphics adapter 320x200 up to 16
foreground and 8 background colours 640x200
mono graphics..... £130 + VAT = £149.50
- Multifunction board with 0K RAM (up to 256K), 2 serial,
1 parallel, clock, ramdisk, printspool..... £130 + VAT = £149.50
- Floppy disk controller (up to 4 drives)..... £ 80 + VAT = £ 92.00
- 5.25 inch floppy disk drive 320/360K..... (each) £100 + VAT = £115.00
- 108 key professional UK keyboard..... £140 + VAT = £161.00
- Switched mode power supply..... £120 + VAT = £138.00
- System Box..... £100 + VAT = £115.00
- Hi-Res colour/mono board to replace item 2 above
4 colour 640x400, mono 720x348..... £260 + VAT = £299

CARRIAGE: system £20, system box £15, kb/driver/PSU/board £5

PERIPHERALS FOR IBM PC/COMPATIBLES

64K RAM Upgrade — set of 9 x 64K RAM chips.....	£ 20 + VAT = £23.00
256K RAM BOARD — ideal for ERICSSON PC.....	£200 + VAT = £ 230
128K RAM Upgrade for IBM PC A/T — set of 9 x 128K RAM chips.....	£100 + VAT = £ 115
256K RAM 150NS (set of 9 x 256K chips).....	£ 80 + VAT = £ 92
108 key professional English keyboard.....	£160 + VAT = £ 184
20MB internal hard disk upgrade.....	£900 + VAT = £1,035
Hi-res colour/mono board, 4 colour 640 x 400. Mono 720 x 348.....	£260 + VAT = £299

MONITORS

ICL KDS 7362 ASCII terminal.....	£400 + VAT = £ 460
PHILIPS 12" green.....	£100 + VAT = £ 115

● Circle No. 162

DOT MATRIX PRINTERS

EPSON RX80 F/T 80 column, 100 CPS.....	£240 + VAT = £ 276
EPSON-FX80 80 column, 160 CPS.....	£360 + VAT = £ 414

NEAR LETTER QUALITY (NLQ) PRINTERS

PANASONIC P1091 80 column, switch selectable 120 CPS draft/22 CPS NLQ — switch selectable for IBM PC or other Computers.....	£300 + VAT = £ 345
KAGA 810 80 column, 160 CPS draft/27 CPS NLQ.....	£260 + VAT = £ 299
PANASONIC P1092 180 CPS draft/40 CPS NLQ for IBM PC.....	£400 + VAT = £ 460

DAISY WHEEL PRINTERS

JUKI 6100 20 CPS, 2K buffer.....	£340 + VAT = £ 391
FUJITSU SP320 48 CPS, Diablo, 4K buffer.....	£980 + VAT = £1,127
Tractors and Sheet Feeders also available!	
QUEN DATA 18 CPS.....	£280 + VAT = £ 322

DISK DRIVES FOR BBC

Quality half height Japanese drives boxed and supplied with all cables,
formatter disk and DFS manual

MX152A — 400K Single 80 track, double sided, 40/80 track switch.....	£120 + VAT = £ 138
MX252A — 800K Twin 80 track, double sided, switched mode PSU, 40/80 track switch.....	£260 + VAT = £ 299

DISK DRIVE FOR APPLE II

MX150APL CHINON ½ height, direct drive.....	£120 + VAT = £ 138
---	--------------------

DISKETTES

5.25" SSDD 48 TPI, single sided (10).....	£13 + VAT = £14.95
5½" DSDD 48 TPI, double sided (10).....	£15 + VAT = £17.25
5½" DSDD 96 TPI double sided (10).....	£20 + VAT = £23.00
5½" high density 77 track for IBM AT (10).....	£50 + VAT = £57.50
3.5" single sided (10).....	£35 + VAT = £40.25
3.5" double sided (10).....	£45 + VAT = £51.75

METAL ENCLOSURES FOR SYSTEMS & DRIVES

Single drive box.....	£10 + £2.60 P&P + VAT = £ 14.49
Dual drive box — vertical or flat type (takes MX45 PSU — PSU extra).....	£20 + £5 P&P + VAT = £ 28.75
System box for ESB-1 (takes two 5¼" drives and MX100 PSU).....	£99 + £11 P&P + VAT = £126.50

VISA, ACCESS WELCOME



Ordering Information:

Prices are exclusive of VAT unless stated otherwise. Unless otherwise stated,
Postage/Carriage free within UK for advertised prices only — special or
discounted prices will attract postage/delivery charges at cost. All goods are
subject to availability and prior sale. Prices are subject to change without notice.
We accept VISA and ACCESS.

* Visit our brand new Showroom — off-street parking, nearest tube Kilburn
(Jubilee Line) OPEN MON-FRI: 9.30am — 5.30pm



1 Grangeway,
Kilburn,
London NW6 2BW
Tel: 01-625 0295/9 (5 lines)
Telex: 295173 MICROX G



THE QUESTION facing everyone who buys a micro today is not "Why buy an IBM PC?" but "Why buy anything else?" When it comes to single-user business micros, IBM has the field under its thumb. Practically all its major competitors have now retired from the field. The only company still in with a reasonable chance is Apple, whose Macintosh micro — with the essential extra disc drive and, for preference, 512K of RAM — may offer a viable alternative. The other companies that, with Apple, shared the micro market before IBM's — Commodore and Tandy — have both now succumbed to making look-alikes.

They join a plethora of rivals. Computer firms such as Olivetti, Data General, Wang, DEC, Zenith, Osborne, Victor, Philips, ITT, NCR, North Star, Sperry and two dozen more are all now either making or selling micros that are more or less compatible with the IBM PC — the ones which are less compatible tend to lie about it. IBM compatibility has even extended beyond the desk-top micro, and is sought by makers of portables and transportables too. Data General, Grid, Osborne and Compaq are names that spring to mind.

Meanwhile, companies whose products are fundamentally incompatible try to demonstrate that their micros can talk to IBM PCs in real life. Examples range from multi-user systems like the Alpha Micro to the Apple Macintosh itself. The reason for this is not that the IBM PC is just a wonderful piece of machinery. Once upon a time it was a state-of-the-art micro but that was nearly four years ago. Any serious micro

manufacturer ought to be able to better it today.

The reason for the supremacy of the IBM PC architecture is software. Software availability is, in most cases, far more important than hardware capability, because hardware without software is useless. Today, the software standard is neither CP/M nor MS-DOS. It is not even PC-DOS, the IBM PC's own operating system. The standard is the IBM PC, and that means compatibles have to emulate the hardware, not just the software environment alone.

The fact that the IBM PC sets a standard is of enormous value both to end-users and software houses. The buyer chooses an IBM PC because it guarantees the largest possible range of good-quality up-to-date software. The software writer chooses the IBM PC because it guarantees his or her programs the widest possible market. As each effect stimulates the other, so the bandwagon continues to roll.

SOFTWARE FREEZES HARDWARE DESIGN

Of course there are disadvantages to this generally happy state of affairs. The major drawback is that the hardware tends to be frozen by the sheer volume of software on the market. There is no room for radical innovations which prevent a new machine from running the standard software.

Also, smaller firms are at a disadvantage when competing with IBM. When the previous standard reigned, which if you remember was eight-bit CP/M, most of the companies in the field were on a more or less

equal footing that is, equally small. It didn't really matter much which CP/M crate you bought, as long as the disc format was not too outlandish.

Today IBM has somewhere between a third and half the total business-micro market, which gives it far greater turnover than any of its rivals. The ability to buy in bulk and manufacture in volume has enabled IBM to keep its prices competitive. Indeed, it can make life very uncomfortable for the smaller makers of IBMulators, and most of them must sooner or later go out of business. It is arithmetically impossible for 40 different companies each to get 10 percent of IBM's market share. And 1/40th of 10 percent is only 0.25 percent. Eventually, the ones that want to stay in business may find they can do better by offering something different to IBM.

In the software field, too, there are signs that the gravy train is coming to an end. There are simply too many products on the market even for good ones to make a showing. A year ago there were well over 100 word processors being sold for the IBM PC. Probably no one knows how many there are now. Worse than that, no one cares. It is simply a waste of time to try to evaluate the vast range of word processors on the market, even if the best one is actually a program hardly anyone has heard of. The most that can be expected is for the potential buyer to try out three or four of the handful of market leaders such as WordStar, Microsoft Word, Multimate, Easywriter II and Volkswriter De Luxe. Many people will buy WordStar just

(continued on page 99)

THE IBM PC STORY

When the IBM PC was launched in the United States, it represented a new approach for the world's largest computer company. Its reputation is for being conservative rather than innovative, and for machines which, while they may be value for money, are not aggressively priced. Further, IBM's huge market share was built on leasing and selling complete systems, including hardware, software and support, not on selling through dealers like many other manufacturers.

With the launch of the PC the leopard changed its spots. First, in August 1981 the IBM PC was a daring and revolutionary machine. Remember it was launched five months before the ACT Sirius 1 arrived in the U.K., and that also used the Intel 8088 as its CPU.

Second, the IBM PC was aggressively priced. The entry-level version was a cassette-based system with only 16K of RAM. This enabled IBM to advertise prices competitive to inferior Apple, Tandy and Commodore products, and secure a significant share of the serious home-computer market too.

Third, the PC was not an IBM-exclusive design. The CPU came from Intel, the operating system and Basic from Microsoft, and the disc drives from a range of suppliers such as Seagate and Tandon. This was a decisive break with IBM's tradition of designing or specifying everything in-house. It also led to the open architecture approach, since other manufacturers could follow IBM's lead in everything except the proprietary and copyrighted built-in ROM.

Fourth, IBM cultivated third-party software writers by, for example, selling cut-price machines to its own staff, supporting outside authors and soliciting user-written software. It thus deliberately generated the massive software base that now maintains the appeal of the hardware.

Fifth, the IBM PC was advertised in the micro magazines and given to dealers to sell, not reserved for IBM's own awesome sales force. This led to a friendlier approach, symbolised by the Charlie Chaplin advertising, and aggressive price-cutting to maintain the competitiveness of the machine.

The advantages of IBM's approach have brought it the massive market share it now enjoys. Nonetheless, nothing lasts for ever, and there are strong rumours that the PC is about to be replaced with a PC II. This will use either an Intel 80186 or 80286 — probably the latter — and, it is claimed, have 3.5in. disc drives. More likely IBM will stick to 5.25in. floppies, as otherwise dealers will have to double their software holdings to stock packages in both disc sizes.

However, an updated PC is now quite likely, as things that once were optional, such as floppy-disc controllers and the printer adaptor, really no longer are. IBM could reduce the chip count and the manufacturing cost by installing these on the main board, using 256Kbit RAMs and updating the design.

With a smaller, cheaper, faster and more powerful IBM PC on the way, no one should write off the world's largest computer manufacturer as past it. It isn't.

PEGASUS ACCOUNTING

Regarded by many accountants as the very best accounting software available. Pegasus comprises eight modules, most of which will operate alone or will work together in a totally integrated system. We have professional staff, in London and the Midlands, fully trained to install and support Pegasus. Prices and details on request.

PSION XCHANGE

Now, for the first time, you can buy a modular suite of programs that individually represent the latest state of development in word processing, data management, financial planning and graphics. Linked together they form an integrated software system that allows you to switch instantly between various tasks and to exchange information between programs. This exciting new software development from the British company Psion is priced at:

£495 £399

Individual module prices are available on request. Psion Xchange is currently available on IBM, Apricot and Sirius.

COMPUTER BOOKS

We sell a range of over 200 books. Included in the titles we sell are: "Getting to know your Apricot" £12.95, "dBase II for the First-Time User" £13.95, "MS DOS User's Guide" £11.05. Please ask for a copy of our booklet.

CHIT-CHAT

The new telecommunications package from Sagesoft which we feel represents outstanding value for money.

- Micro-to-micro file transfer.
 - Top of the range EMI Datatek modem.
 - Free subscription to Telecom Gold (worth £100).
 - Access to Viewdata and Prestel.
 - Electronic mail, telecommunications and telex.
- List price £399 our price £325.

BEST UK SOFTWARE PRICES?

Buy from TriSoft Ltd., the specialist software company, formed by microcomputer consultants.

- * Over 400 leading software packages (inc. Apple)
- * Independent advice in making your choice
- * Professional staff + network of consultants
- * Most formats. All programs latest versions

SPECIAL OFFERS

DBASE II £229

WORDSTAR PROFESSIONAL £265

	List Price	Our Price		List Price	Our Price
SAGE PLUS	695	495	SAGE PAYROLL	195	139
SYMPHONY	550	415	DMS DELTA 2	495	375
OPEN ACCESS	450	310	DR C COMPILER	275	218
QUICKCODE	200	149	DR ASSEM. + TOOLS	155	119
SUPERCALC III	295	199	DISPLAY MANAGER	375	299
DATAPLOT +	195	155	MS PASCAL	250	199
INFOSTAR	295	218	VISICALC	207	175
MULTIPLAN	179	135	STATPACK	345	299
MS WORD	300	239	DGRAPH	200	145
WORDCRAFT	425	359	DR DRAW	232	179
VOLKSWR DEL.	295	199	GRAPH PLAN	220	175
MULTIMATE	350	229	ESTAM	148	110
SPELLBINDER	320	220	CROSSTALK XVI	140	119
FASTPLAN II	525	395	MOVE IT	90	79
PLANSTAR	495	375	THE LAST ONE	330	245
CARDBOX	195	169	OMNIS 2	295	235
RESCUE	295	229	SUPERSORT	145	108
MILESTONE	250	179	FILE TRANSFER	95	79

SAGE ACCOUNTS £259

The new updated version (1.5) featuring many of the enhancements at only £259 (reduced from £375). Please telephone or write for details of all other Sage Accounting products and our Sage training programme.

All prices exclude V.A.T. POST FREE on orders over £150. If you see any of these products advertised at a lower price we will improve upon that offer in most cases. Please phone or write for our comprehensive price list.

DEALER AND CONSULTANT ENQUIRIES WELCOME

TRISOFT LTD

INDEPENDENT MAIL ORDER DISTRIBUTORS OF QUALITY SOFTWARE
TriSoft Ltd, Crown Square, Mallock, Derbyshire DE4 3AT. Telephone: 0629/3021

HARDWARE

We supply the full range of Apricot and Sirius computers and a wide range of printers, plotters and peripheral equipment. Please telephone or write for our latest prices.

COMPUTER-AIDED DESIGN

As specialist consultants in this field we can supply either software only or a total system configuration with full support. We are suppliers of AUTOCAD, DOODLE and a number of other CAD packages. The productivity benefits of CAD are enormous — the cost of a system is almost certainly much less than you would expect. In most cases our clients have found a system pays for itself within 3 to 12 months! For example, an Apricot xi10 with 9" monitor, the exciting new CAD package Doodle and a Roland DG XY880 plotter (high quality, high speed, HP compatible, eight pen) will cost only £3750.00. Although this price represents an attractive discount on list price, it includes full technical support by our specialist staff.

SYCERO

System C's program generator which sets a new standard for ease of use in system design for the businessman as well as the computer professional. Allows very rapid development and implementation of systems which precisely meet your requirements. A top quality product which we highly recommend.
List price £595 Our price £495

NORTH STAR DIMENSION

The only 100% PC-compatible multi-user, multi-processing system currently available. Will accept up to 12 work stations and runs all IBM "off-the-shelf" software. Tremendously cost-effective as compared to IBM PC networks; up to 60MB central storage. Entry-level, 2 screen configuration with 15MB central storage — only £5875.

● Circle No. 163

IBM PC COMPATIBLE MODEMS

A significant number of communications software packages for a variety of personal computers, not least of which is the IBM PC, use the Hayes protocol. Adoption in the UK has been limited because of the unavailability of compatible modems approved for connection to British Telecom lines.

Our range of autodialling Duplex modems may now be purchased in Hayes compatible form. The modems interwork with all known Hayes compatible software packages and obey all Hayes commands except where this would violate British Telecom rules for redialling attempts and time delays.

Duplex Systems offer a complete solution to any communications problems that may arise in the office, from connecting a printer to purchasing a complete office system capable of electronic mail, telex and facsimile:

Modems and acoustic couplers, T-switches multiplexers and buffers, interfaces for a wide selection of typewriters, interface converters, printers and terminals, telex interfaces and full message switching systems —

To find out what is possible with the latest technology contact:

DUPLEX SYSTEMS LTD.
Radford Business Centre,
Radford Way,
Billericay,
Essex CM12 0DG

Tel: 0277 841011 Telex: 995540

● Circle No. 183

3D COMPUTERS LTD.

BUSINESS MICRO SPECIALISTS

SINCLAIR QL + COLOUR
MONITOR

Word processor, spreadsheet,
database **£520**

EINSTEIN PROFESSIONAL
64K CP/M, dual disc, Monitor
Wordstar, Spellstar, Mailmerge
Report Star, Datastar **£999**

BBC B + Z80 SYSTEM
64K CP/M, dual disc, Monitor Word
Processor, Spreadsheet, Database,
Accounting, Nucleus, Languages **£1,199**

COMMODORE PC
IBM look-a-like 256K MSDOS, dual
disc, Monitor **£1,675**
Prices subject
to VAT

Complete range of printers, software, consummables. Friendly advice & service at every branch.

TOLWORTH — 230 Tolworth Rise, South 01-337 4317
SUTTON — 30 Station Rd, Belmont 01-642 2534
EALING — 114 Gunnersbury Ave 01-992 5855
NEWBURY — 26 Stanley Road 0635-30047

● Circle No. 184

to save making even this amount of effort.

Today there are countless programs of all sorts for the IBM PC, ranging from mainframe operating systems to I Ching generators, and from architectural drafting systems to nutrient analysis packages — see the Software Overview which starts on page 105. There may still be some untapped niches where an innovative product can get a toehold, but in a field which now includes over 35 different project-management packages they must be pretty hard to find.

As with hardware manufacturers, some of the software writers may soon find it more profitable to fish in smaller ponds. Packages can become profitable best sellers on obscure machines when they would never even make the news pages if launched for the IBM PC.

This is not to suggest that the IBM PC is going to lose its appeal overnight. There is no reason to suppose it will prove less long-lived than the Apple II, an old-fashioned eight-bit micro which was launched four years before the IBM PC, but which has every appearance of continuing as a best seller.

Further, IBM has already marked out the future of its machine in two interesting ways. First, it has signalled its intended upgrade path through the launch of the PC/AT. This is a fundamentally PC-compatible micro which uses the powerful Intel 80286 chip instead of the pseudo-16-bit Intel 8088. The PC/AT runs PC software in an 8086 emulation mode, which brings the 8086 and 80186 potentially within the IBM PC universe. When the 8086 mode nears exhaustion, far greater power will become available through using the full facilities of the 80286. In fact, there are strong rumours emanating from America which suggest that IBM is about to discontinue the existing PC and launch a new PC II.

Second, IBM is marketing not one personal computer but a whole range of machines. These include the PC and its enhanced version with 10Mbyte hard disc, the PC/XT. There is the Portable PC or PPC for people who want a transportable, and until recently there was — at least in America — the PCjr for home/home-business use. A real portable lap-size version of the PC is also supposed to be on the way.

MAINFRAME TERMINALS

There is a whole range of versions to tie in with IBM's minicomputer and mainframe offerings. Established models include the XT/370, which is a single-user mainframe version of the PC/XT, and the 3270PC, which combines a personal computer and 3270 mainframe terminal. Next in line is the Series 1 version of the PC which is effectively a minicomputer. Other similar products, where IBM chip-sets are installed in PCs via standard expansion cards, are expected to follow.

While a few firms may be able to give IBM a run for its money in the single-user desktop business IBM's strength in the multi-user mainframe, minicomputer and office-automation markets promises a wide range of profitable outlets for vast numbers of PCs far into the foreseeable future. 

WHICH LOOK-ALIKE?

Robert Piper has some tips on what to look for when buying an IBMulator.

In the past 18 months the number of IBM PC compatibles has grown from a very lonely two to around 40 machines. It is pleasing to be able to report that levels of compatibility offered have risen equally dramatically and it is the exception rather than the rule to review a machine that claims to be compatible and is not. This feature does not set out to cover all the machines currently available, but includes most of the famous names with a guide on how to specify a PC and what pitfalls to avoid.

Choosing a PC compatible as opposed to the IBM PC itself can be justified in two ways. First, compatibles are invariably cheaper, admittedly by differing degrees. Second, they often offer enhanced specification and performance. If a compatible cannot satisfy either of those criteria it is simply not worth looking at.

ACCESS TO SOFTWARE

The *raison d'être* for buying a PC compatible is its ability to run off-the-shelf IBM PC software. As this is such a fundamental aspect it is worthwhile covering it first before looking at the hardware in detail.

In the strictest sense there are two types of compatibility: hardware and software. The latter aspect is by far the most critical and is defined as the ability to run off-the-shelf, totally unmodified IBM PC software. This is achieved in most cases by using an identical hardware architecture to that used in the IBM. Such aspects of the IBM's design that are not covered by any copyright can be freely copied without fear of retribution from Big Blue. The machine's basic intelligence as held in ROM is, however, subject to copyright, and in the past IBM has dealt firmly with any manufacturers who have sailed too close to the wind.

But more recently compatible manufacturers have become very adept at emulating the IBM ROM without actually copying it and so offer superb compatibility without the consequent threat of legal action. It is unusual to find a compatible these days which offers anything less than 95 percent ability in this respect and none of the machines included in the table will achieve less than this figure.

Testing compatibility is still a very hit-and-miss affair which basically involves feeding as many applications packages as possible to see which load up and which do not. This superficial approach means that deep-seated problems can go unnoticed but fortunately occurrences of this type are rare. However, they have forced many of the more respectable manufacturers to issue a list of software approved and occasionally guaranteed for use on their machines.

If this system is not in operation, or the particular type of software to be used is not

covered, it is essential to see the package up and running on the chosen compatible prior to purchase. Assurances from the dealer at the time of purchase will prove little comfort if there are insurmountable problems later.

Hardware compatibility is defined as the machine's ability to accept off-the-shelf IBM-style expansion boards into its connection bus. Unfortunately, incompatibility here can prove more expensive as it is not inconceivable that both the board and computer could be damaged by mismatches. Therefore it is very important to ensure that the proposed board is approved for use with the compatible. Machines that use the full 16-bit 8086 processor may have several slots in the expansion bus which exploit the full 16-bit data path. These provide faster data access but are not normally compatible with standard boards.

Special caution should be exercised when purchasing display drivers from third-party manufacturers as these can throw up software as well as hardware compatibility problems.

One area where the IBM is beginning to look rather dated is processing speed, which can best be described as lethargic thanks to its pseudo 16-bit Intel 8088 CPU running at 4.77MHz. Many compatibles now offer an improved version of the same chip, the 8088-2, which can run at clock speeds up to 8MHz. The fastest machines use the Intel 8086, which can process data in full 16-bit chunks and also run at speeds up to 10MHz. The Olivetti M-24, for instance, uses the 8086 running at 8MHz and consequently is almost as fast as IBM's new AT.

Fast processors can cause compatibility problems and as a result dual-speed machines like the Sperry have been launched. But occurrences of this type are rare and, in any

(continued on page 102)

USING THE TABLES

The tables on the next two spreads should be used as a guide as to what is available from each manufacturer. Levels of compatibility have not been referred to as these can change due to the use of a revised ROM. However, it is safe to assume that all machines included are true compatibles exhibiting compatibility in the order of 95 percent or better.

Although it has not been included under the bundled software heading most machines will include some form of Basic interpreter in their basic system price.

The table only covers integral options and does not cover the use of external expansion chassis. The System 1 price represents an entry-level system whereas System 2 covers a more professional setup with 256K RAM and dual floppies unless otherwise stated.

DESK-TOP MODELS

	PROCESSOR SPEED	STANDARD RAM	FLOPPY DISC	HARD-DISC OPTIONS	KEYBOARD STYLE	PARALLEL PORT	SERIAL PORT	CLOCK/ CALENDAR
IBM PC & XT	8088 4.77MHz	128K	dual 5.25in. 360K	Yes (XT)	83-key IBM	Opt	Opt	Opt
OLIVETTI M-24	8086 8MHz	128K	dual 5.25in. 360K	Yes	IBM and Olivetti	Std	Std	Std
COMPAQ DESKPRO	8086 8MHz	128K	dual 5.25in. 360K	Yes	83-key IBM	Std	Opt	Std
ITT XTRA	8088 4.77MHz	128K	dual 5.25in. 360K	Yes	84-key IBM	Std	Std	Opt
SPERRY PC	8088-2 4.77MHz or 7.16MHz	128K	dual 5.25in. 360K	Yes	84-key IBM	Std	Std	Std
COMMODORE PC	8088 4.77MHz	256K	dual 5.25in. 360K	Yes	85-key IBM	Std	Std	—
TELE-VIDEO TELE PC	8088 5MHz	256K	dual 5.25in. 360K	Yes	84-key IBM	Std	Std	—
ERICSSON PC	8088 4.77MHz	128K	dual 5.25in. 360K	Yes	84-key IBM	Std	Std	—
ZENITH Z-150	8088 4.77MHz	128K	dual 5.25in. 360K	Yes	84-key IBM	Std	2	—
COLUMBIA PC	8088 4.77MHz	128K	dual 5.25in. 360K	Yes	83-key IBM	Std	2	—
VICTOR VPC	8088	256K	dual 5.25in. 360K	Yes	83-key	Std	Std	—
ADVANCE 86B	8086 4.77MHz	128K	dual 5.25in. 360K	Yes	84-key IBM	Std	Std	—
TANDY 1000	8088 4.77MHz	128K	dual 5.25in. 360K	—	90-key non-IBM	Std	Opt	—
WYSE PC	8088 4.77MHz	256K	dual 5.25in. 360K	Yes	83-key IBM	Std	2	—
CANON A200	8086 5MHz	256K	dual 5.25in. 360K	Yes later	83-key IBM	Std	Std	—
NCR PC 4i	8088 4.77MHz	256K	dual 5.25in. 360K	Yes	95-key non- IBM	Std	Std	—
AM STEARNS PC	8086 8MHz	128K	dual 5.25in. 360K	Yes	94-key non- IBM	Std	2	—
TASHKL PC-16	8088 4.77MHz	128K	dual 5.25in. 360K	Yes	84-key IBM	Std	Std	Std
CEEDATA PC-401	8088 4.77MHz	256K	dual 5.25in. 360K	Yes	83-key IBM	Std	Std	Std
SAM 2001	8086 4.77MHz	128K	dual 5.25in. 360K	Yes	83-key IBM	Std	Std	—
MBS MICROTUX MAD 1	80186 6MHz	256K	dual 5.25in. 360K	Yes	85-key non- IBM	Std	2	—
TAVA PC	8088	256K	dual 5.25in. 360K	Yes	84-key IBM	Std	—	—

EXPANSION SLOTS	MONO GRAPHICS	COLOUR GRAPHICS	MAXIMUM MEMORY	OPERATING SYSTEM	BUNDLED SOFTWARE	PRICE GUIDE—SYSTEM 1	PRICE GUIDE—SYSTEM 2	CONTACT
2	Opt	Opt	640K	PC-DOS	—	£1,691	£2,297	01-995 1441
7	Std	Std	640K	MS-DOS	—	£1,632	£2,177	01-785 6666
5	Std	Std	640K	MS-DOS	—	£2,195	£2,595	01-940 8860
5	Opt	Opt	640K	MS-DOS	—	£1,737	£2,641 colour	STC 01-300 3033
5	Std	Opt	640K	MS-DOS	—	£1,809	£3,939 hard disc	Sperry 01-961 3616
4	Std	Opt later	640K	MS-DOS	—	£1,675 dual floppy	£2,795 hard disc	(0536) 205252
1	Std	Std	640K	Teledos MS-DOS	Tele Solutions	£2,295 dual floppy	£3,695 hard disc	Computeraid (0734) 794664
5	Std	Opt	640K	MS-DOS	—	£2,129 dual floppy	£3,284 hard disc	(0634) 401721
4	Std	Std	640K	MS-DOS	—	£2,195	—	(0452) 29451
6	Std	Opt	640K	MS-DOS, CP/M-86	Perfect Suite Plus	£2,155 dual floppy	£3,019 hard disc	Icarus 01-267 6732
5	Opt	Opt	640K	MS-DOS	—	—	£3,361 hard disc	(06284) 4606
5	Std	Std	640K	MS-DOS	Perfect Suite	£1,086, 128K no monitor	£1,156, 256K no monitor	Ferranti 061-624 9552
3	Std	Std	640K	MS-DOS	Deskmate	£1,258 single disc	£1,527 dual disc	(0922) 648181
1	Std	Opt	640K	MS-DOS	—	—	£1,925 dual floppy	RTS 01-267 7541
3	Std	Std	640K	MS-DOS	—	—	£1,875	01-773 2156
7	Std	Opt	640K	NCR-DOS, MS-DOS	Instructor Tutorial	£1,799	£2,249	NCR 01-725 8337
4	Std	Std	896K	MS-DOS, BOS, CCP/M-86	Ledger, Database	£2,395 dual floppy	£4,250 hard disc	AM International (0442) 42251
5	Std	Std	640K	MS-DOS	—	—	£1,650	Tashki Computers 01-904 4467
5	Std	Std	640K	MS-DOS	—	£1,895 dual floppy	£3,355 hard disc	Ceedata 01-783 0502
5	Std	Std	640K	MS-DOS	—	£2,495	£2,745	Conguin Software 01-646 3493
1	Std	Std	640K	MS-DOS	—	—	£2,785	(07535) 68171
5	Std	Std	640K	MS-DOS	Yes (contact Compushack)	—	£1,950	Compushack 01-935 0480

(continued on next page)

TRANSPORTABLE MODELS

	PROCESSOR SPEED	STANDARD RAM	FLOPPY DISC	HARD-DISC OPTIONS	KEYBOARD	PARALLEL PORT	SERIAL PORT	CLOCK CALENDAR
IBM PORTABLE	8088 5MHz	256K	dual 5.25in. 360K	No	IBM	Opt	Opt	—
DATA GENERAL ONE	80C88	128K	single 3.5in. 720K	No	79-key non- IBM	None	2	Std
OSBORNE ENCORE	80C86	128K	dual 5.25in. 360K	No	73-key non- IBM	None	Std	—
COMPAQ PORTABLE	8088 4.77MHz	128K	dual 5.25in. 360K	Yes	83-key IBM	Std	Opt	No
ZENITH Z-160	8088 4.77MHz	128K	dual 5.25in. 360K	No	84-key IBM	Std	Std	No
TELEVIDEO IPC II	8088 5MHz	256K	dual 5.25in. 360K	No	83-key IBM	Std	Std	No
COLUMBIA VP	8088 4.77MHz	256K	dual 5.25in. 360K	No	83-key IBM	Std	Std	No
SEEQUA CHAMELEON	8088/ Z-80	128K	dual 5.25in. 360K	Yes	84-key IBM	Std	Std	No
OLIVETTI M-21	8086 8MHz	128K	dual 5.25in. 360K	No	83-key non- IBM	Std	Std	Std
SANYO 775	8088-2 8MHz	256K	dual 5.25in. 360K	No	84-key IBM	Std	—	No

(continued from previous page)

case, all software currently under production is being written with the 8086 in mind.

For applications which include a high proportion of arithmetic work it is advisable to ensure that the machine can accept an Intel 8087 numeric co-processor, a second CPU which speeds the throughput of calculations.

Most early compatibles were offered with only 128K RAM whereas nowadays 256K is considered the bare minimum for use in a



Above: The transportable Compaq.
Left: ITT's XTRA desk-top.

business environment. Advanced integrated software like Lotus Symphony requires huge amounts of memory as they hold most of the user's current work in RAM to make data transfer both quicker and easier. Many packages which are claimed to run with 256K really need more memory to get the most from them. At the moment the IBM's PC-DOS operating system and its compatible equivalent, MS-DOS 2, can only address 640K of memory so the extra often claimed by many manufacturers is useless, at least for the present.

Expansion capabilities are particularly important in the professional environment.

There are some portables which cannot accept any integral expansion boards at all, whereas some of the largest desk-tops can swallow up to seven boards with no problems. Since the advent of multi-function expansion boards, the actual number of slots is probably less important than careful advanced planning of their use. Although expensive these units can combine several functions together and consume only one slot within the machine. For instance, one unit may include a clock calendar, 512K additional memory and a serial interface.

The ports are a computer's connection to the outside world and should include as a minimum one parallel port for the connection of a local printer and one serial

EXPANSION SLOTS	MONO GRAPHICS	COLOUR GRAPHICS	MAXIMUM MEMORY	OPERATING SYSTEM	BUNDLED SOFTWARE	PRICE GUIDE— SYSTEM 1	PRICE GUIDE— SYSTEM 2	CONTACT
3	Std	Std	640K	PC-DOS	—	—	£2,341	01-995 1441
None	Std	—	512K	MS-DOS, CP/M-86	—	£2,490	£3,522	01-572 7455
None	Std	—	512K	MS-DOS	—	£1,995	£2,895	Future Management (0908) 615274
3	Std	Std	640K	MS-DOS	—	£1,795	£2,195	01-940 8860
4	Std	Std	640K	MS-DOS	—	£1,895	£2,250 320K RAM	(0452) 29451
1	Std	Std	512K	Teledos, MS-DOS	Tele Solutions	—	£2,395	Computeraid (0734) 794664
1	Std	—	640K	MS-DOS, CP/M-86	Perfect Suite	£2,065	£2,295	Icarus 01-267 6732
0	Std	Std	256K	MS-DOS, CP/M-80	Supercalc 3, Cterm Illustrator	—	£1,995	Ferrari Software (0784) 38811
3	Std	Std	640K	MS-DOS	—	£1,582	£2,028	01-785 6666
2	Std	Std	640K	MS-DOS	WordStar Calcstar	—	£2,150	(0923) 463631

port for use by a modem or other communication device. Many professional users may need a second serial port so it is advisable to budget for one and allow space for it within the machine.

There is a wide variety of mass-storage devices available for the IBM PC and compatibles but here we are confined to integral devices only. Up-market PCs combine a standard 360K floppy with usually a 10Mbyte Winchester hard disc. This setup provides an immense storage capacity coupled with vastly improved access times when compared to floppy systems. In fact, overall speed improvements offered by 16-bit processors pale into insignificance when compared to those offered by a hard disc as compared to a floppy. Some of the latest compatibles boast quad-density floppy discs offering 720K each — double the capacity of the IBM-type floppy. The only problem with these is possible initial difficulties in loading IBM software, which is invariably supplied on 360K discs.

The IBM PC keyboard is a superbly made Zenith's 8088-based Z-150.

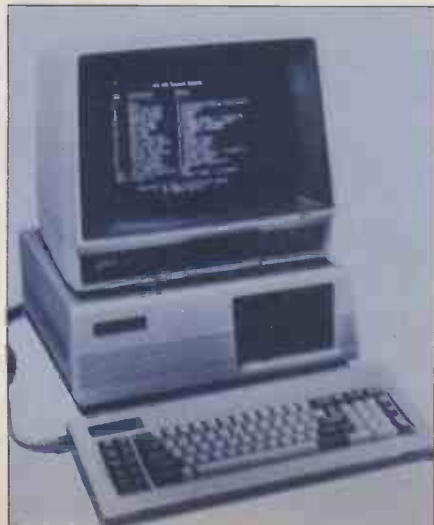

product with an excellent action, but its layout has often been criticised. Many PC-compatible manufacturers have capitalised on these shortcomings and produced enhanced versions with revised layouts and other extras. The most useful of these are an extra Return key for the numeric keypad, and status LEDs to indicate when the capitals are locked on or the dual-purpose numeric pad is locked into the numeric mode. Other manufacturers offer completely revamped keyboards with extra keys, usually enabling the cursor to have its own totally dedicated set. This feature is most useful for spreadsheet work where it would be necessary to continually switch from the numeric mode to the cursor mode while entering data. Keyboards which owe nothing to the IBM PC layout often have minor compatibility problems as the extra keys have no purpose. Software documentation will also take some translation to convert the instructions originally intended for the IBM layout.

The choice of monitors and display drivers is probably the area that needs the most care to avoid the many pitfalls. The most basic IBM monochrome PC has an excellent text display but cannot handle graphics. However, most compatibles include mono graphics as standard and many also include a colour driver, although the necessary RGB monitor will cost extra. Colour monitors and drivers, the IBM included, often produce a very coarse text display which is far from ideal for prolonged use in word-processing or spreadsheet applications. There are machines — including the Olivetti and Compaq range — which produce a fully formed high-resolution colour display for both text and graphics.



The elegant Wyse PC.

Hardware support is an aspect which cannot be overlooked, especially if the PC is to be trusted with a mass of irreplaceable data. If this is the case then it may well pay off in the long term to ensure that adequate maintenance agreements are available prior to purchase.

Costs of machines vary widely depending on specification. Value for money also varies, with the less well-established manufacturers having to offer more competitive prices to attract customers whereas multi-nationals often ask prices not far short of 90 percent of IBM's price.

Purchasing an IBM PC look-alike is now a far less hazardous affair than it was some 18 months ago thanks to vastly improved levels of compatibility. But despite this transformation it is still advisable to see the intended software running prior to purchase and ensure the manufacturer is in a position to supply the necessary long-term support for the product.

If you want it tomorrow . . .
call us today
01-455 9823

COMPUTERS/CALCULATORS/PLOTTERS

HEWLETT PACKARD		PL 5000 Portable Computer	£1190.00
HP 4 1CV (SCI Computer)	£169.95	CE 15B RS232 and Cent IF	£120.00
HP 4 1CX (Computer)	£259.00	CE 150 printer cassette IF	£125.00
HP 4 1C (Card Reader)	£163.50	CE 159 8K Add on mem with BAT	£79.00
HP 4 1C Printer B2143A	£230.00	CE 152 Cassette	£36.00
HP 4 1C Cassette drive	£290.00	PC 1251 (Computer)	£66.50
HP 16C (Hex Con)	£100.00	CE 125 (I/F for above)	£86.50
HP 15C (Adv Sci)	£100.00	Casio PB 700 (h/held Computer exp to 16K)	127.00
HP 71C (portable computer)	£410.00	Casio PB 750 New Computer	£89.50
HP 71 Printer 82162A	£395.00	Epson QX-10 (desk top comp)	£1599.00
PLOTTERS		EPSON HX20 Briefcase computer. 16K expandable. Serial and RS232 interface.	£375
HP 7470A (A4 2 Pen Plotter)	£918.00	EPSON PX-8 (portable 64K Computer/Word Processor)	£775.00
HP 7475 (A3 6 Pen Plotter)	£1550.00	Epson Modem CX21 (300 Baud)	160.00
Pixy Plotter (A4 3 Pen B Colour)	£399.00		
Epson H180 Plotter	£375.00		
SHARP PC 1500A (P/Computer with 8K ex to 24K)	£147.50		

WORD PROCESSING PRINTERS/MONITORS

7710 RS232/7730 Cent	£1440.00	BROTHER * Highly recommended*	
NEC 2000 (20 CPS)	£615.00	HR1 (16CPS)	£255.00
NEC 3530 (33 CPS)	£1300.00	HR15 (3K Buffer 18CPS)	£325.00
SILVER REED		HR25 (3K Buffer 25CPS)	£565.00
EXP 500 (12CPS)	£299.00	HR 35 (35CPS)	£695.00
EXP 770 (31CPS-2K Buffer)	£850.00	CANON Jet Printer (37CPS-7 colour)	£450.00
Sheet feeder for above	£185.05	HP Jet Printer (150CPS)	£425.00
MT EXP 500 (19 CPS)	£329.00	DIABLO	
SMITH CORONA		620 (RO)	£650.00
S/C TPI (12CPS)	£154.00	630 (ECS/IBM)	£1650.00
S/C L100 (12 CPS-cmulats Diablo 630 Protocols)	£260.00	630 (API) (IBM COM)	£1295.00
QUME 9/45 RO-FFP	£1900.00	630 (KSR)	£1840.00
12/20 (20CPS)	£499.00	Tractor (BiDi)	£195.00
11/40 RO (Also IBM-PC7)	£1185.00	FUJITSU	
TEC STARWRITER		FUJITSU WHEEL	
F10-55 CPS (serial/parallel)	£1175.00	EPSON DX 100 (13CPS)	£399.00
Tractor (Bi-Di)		Sheet Feeder	
Sheet Feeder		RUTISHAUSER	
Mechanical Sheet Feeder		Sheet Feeders and Tractors for: Qume, Diablo, NEC, Ricoh, TEC Starwriter, Olivetti, etc.	From £99.00

PHONE US FOR BEST DEAL

COLOUR MONITORS from £220			
Monochrome Monitors from	£54.00		
DOT MATRIX PRINTERS			
OKI		SMITH CORONA	
M82A (120CPS)	£240.00	Fastext 80 (80CPS)	£195.00
M92P (160CPS)	£360.00	D100 (120CPS)	£249.00
M83A (12CPS)	£389.00	SEIKOSHA from	£99.00
M84P (200CPS)	£625.00		
ANADEX*		MANNESMAN TALLY	
DP-9000 B/(180 CPS)	£850.00	MT80 plus (100CPS)	£185.00
DP-9500 B/(180 CPS)	£893.00	MT160 (F/T) (160CPS)	£399.00
DP-9625 B/(240 CPS)	£1155.00	MT180 (160CPS 32 Col)	£579.00
BROTHER		EPSON	
EP44 (16CPS)	£189.00	Epson RX80T (100CPS)	£190.00
HR 5 (30CPS)	£129.00	Epson FX80 (160CPS)	£320.00
Brother M1009 IBM (50LPS)	159.00	Epson RX80FT	£215.00
STAR range from	£156.00	Epson FX100FT (160CPS)	£425.00
CANON PW1080A (160CPS)	£274.00	Epson RX100FT (100cps)	£340.00
CANON PW1156A (160CPS)	£385.00	Epson LX1500 (200cps)	£875.00
NEC Pinwriter (132 cols) P3	£595.00	TEC 1550 (180CPS)	£575.00
MODEMS (Dacom/Master/Epson etc.) from	£79.00		
SHINWA CP80/II/FT	£165.00		

TECHNICAL ADVICE
01-455 9824

This is only part of our range, a telephone call will save you time and money

SOFTWARE

This is only a selection of programmes available — telephone us for your specific requirements.

APPLE II/e		IBM/COMPAQ	
Mailmerge V.3.3	£125.00	Wordstar V.3.35	£270.00
Wordstar V.3.31	£270.00	Mailmerge V.3.24	£125.00
Wordstar/Mailmerge/Spellstar	£406.00	Lotus 1-2-3	£325.00
ACT — APRICOT		Symphony	£450.00
Pulsar-Wordstar	£250.00	dBase II (CP/M86)	£295.00
Mail Merge	£75.00		
Superwriter	£250.00		

EXPORT ORDERS WELCOMED

GOODS FULLY GUARANTEED PRICES EXCLUDING VAT AND P + P.

Company and Government orders accepted by phone. Barclaycard Access Visa accepted by phone.

Tel.: 01-455 9823

MOUNTAINDENE

22 Cowper Street London EC2

● Circle No. 164

Its Staggering!



How many products AWS cram into their New 1985 Catalogue

Phone 01 541 1188

For your Free Copy

AWS AWS Computer Supplies, 57 Surbiton Road, Kingston Upon Thames, Surrey KT1 2HG. TELEX 859205

● Circle No. 185

UPTO 35% discount on PC Software & Accessories

Framework	£310.00	Symphony	£415.00
DBase II	£225.00	Multiplan	£279.00
Supercalc	£210.00	LOTUS 123	£299.00
Wordstar	£195.00	Word w/o Mouse	£285.00
Sidekick	£ 49.95	Dbase III	£325.00
Six Pak Plus	£280.00	Megaplus II	£280.00
64K RAM Kits	£ 44.00	I/O Plus II	£139.00

10 MByte Hard disk with controller only.....£799.95
Cartridge Drive Backup with software.....£899.95

This is only a small selection from our range. Please ring for more details.

10M Hard Disk Computer from under £2,500.00

The SAM 2001 Is fully IBM XT compatible at a fraction of the cost. Look at these features: 8088 (16 bit) processor, optional 8087, upto 256K RAM on board, floppy drive, 10M hard disk, colour/graphics adaptor, keyboard, 130W PSU, IBM style case.

Circuit Board Design without the Tedium

smARTWORK lets you create and revise PCB artwork on your IBM. Requires 192K RAM, colour/graphics adaptor and Epson printer. Demo disk £10.00, smARTWORK software £895.00, complete systems from under £4,000.

Terms: CASH WITH ORDER. Add £5.00 for post and packing, (£15.00 for foreign orders). All prices exclude VAT. Prices subject to change without notice.

CONGUIN SOFTWARE Phone 0524 381423
14 Goodwood Close, Morden, Surrey SM4 5AW

● Circle No. 186



SOFT OPTIONS

The plethora of software for the IBM PC is a problem in itself. Jack Schofield offers some advice on selecting which packages to buy.

The problem with IBM PC software is not finding it or buying it: it is choosing which of the thousands of packages to buy. Because of the number of options available, few dealers can stock more than a small selection, and may not be able to demonstrate all of those with much confidence.

Thus there is a tendency for people to go for the best-known products, as being simpler. For example, someone who wants a word processor may go through two processes. The first stage could be summarised as, "Should I buy WordStar or something else?" The second stage is, "If something else, then which of the 100-plus packages available?"

Choosing the safe option, WordStar, involves nothing more than a phone call or, at most, a trip to the nearest IBM PC dealer. Deciding on something else often means making a commitment to weeks of effort involving reading magazines, comparing notes with friends, phoning up distributors, visiting several different dealers and so on, struggling to reduce an unmanageable morass to a solid short list, and hence to a final selection.

Obviously this works against the interests of the less well-known packages, and the less financially well-endowed software houses which cannot afford the advertising needed to establish a name. It is also to the disadvantage of the user, who may end up with a package unsuited to his or her needs.

The better IBM PC word processors include Displaywrite 2, Easywriter II, Multimate, PFS:Write, Superwriter, Volkswriter and Word, as well as WordStar and WordStar 2000.

MIMICS DISPLAY WRITER

Displaywrite is the IBM program which is equivalent to the one on IBM's dedicated word processor, the Display Writer. So it is a natural choice where the two IBM machines are mixed. Multimate looks like the Wang system's word processor, and may be chosen for mixed Wang/IBM PC systems for the same reason. It is far better to have one package to learn than two.

PFS:Write, Superwriter and Microsoft Word belong to suites of programs. Like Microsoft Word, WordStar and Multimate, PFS:Write is one of the best sellers. It is part of the PFS series which includes Calc, File,

IBM users are spoiled for choice when it comes to selecting software.

Plan and Report. These programs are also sold directly by IBM as the Personal Assistant series. PFS:Write is menu-driven, and does not pretend to be one of the most powerful packages on the market. However, it is very easy to use.

Superwriter is the mate of the famous Supercalc. It is a menu-driven program, which makes it easy to use, though menus tend to get tiresome once you know a package well. Word is a very powerful modern program which can be used with a mouse. It has a similar command line and structure to the popular Multiplan spreadsheet, and thus may also appeal more strongly to Multiplan users.

Volkswriter, from Lifetree Software, was one of the first word processors written to exploit the IBM PC's features. It is reasonably powerful and very easy to use. Volkswriter de Luxe is an excellent all-round package, while the Volkswriter Scientific version is one of the few programs written to cope with printing mathematical equations and formulae. The program handles them well even when they are several lines deep.

As with word processors, so with spreadsheets: there is an embarrassment of riches. Currently the standard choice is Lotus 1-2-3, which also handles data and produces graphs. A rival is the latest Version 2 of Supercalc 3, which offers similar power but can be run using the IBM PC's standard

(continued on next page)

monochrome printer adaptor and green screen. The other major program is Multiplan, which combines a wide range of facilities with outstanding ease of use.

Not all financial-planning packages follow the original VisiCalc approach of imitating analysis paper with rows and columns of cells. Better-known modelling packages include Micro Modeller and Sapphire Mars. Another interesting package is known as FT Moneywise — FT being the *Financial Times*.

Ashton-Tate's dBase II is probably still the best-known database, and it is certainly one of the most powerful. However, it is now being challenged on both sides by other products from Ashton-Tate. Friday is a simple data-handler essentially derived from dBase II. Even more sophisticated than dBase II is the mega program dBase III.

Another database which is easy to learn and use is Cardbox Plus from Business Simulations, while potential rivals for Framework are KnowledgeMan and RBase 4000.

The PFS:File program is now becoming popular, and PFS:Report can be added on if reports are required. However, Dataease is a lot more powerful and, being menu-driven, probably as easy to use.

WORDSTAR ADD-ON

One of the underrated products on the market is Datastar, which is part of the WordStar suite. It is actually a menu-driven data entry package, and is sold along with Reportstar as part of the Infostar system. This arrangement itself is confusing enough to put you off. Reportstar may not inspire you with its brilliance, but Datastar produces ASCII files that many other databases can suck up and process in powerful ways.

With the basics covered, many people want to add either a graphics package, communications or both. When it comes to graphics, the obvious choice may be the package that works with the program that organises the data you want to graph. For example, Microsoft's Chart goes with Multiplan, Graphease works with Dataease, Fox & Geller's dGraph works with dBase II, PFS:Graph with the PFS range, and Chartstar with Micropro's WordStar range.

A program called Doodle, from Trilex, may be useful as it enables graphics, charts and drawings to be inserted into the middle of the WordStar documents — ideal for illustrating reports. IBM PC users who envy the Macintosh's freehand drawing program can find an alternative called PC Paintbrush which offers colour too. For more technical graphics work, the CAD package Autocad has established itself as the leading IBM program, while for presentation graphics it is UCN Execuision.

Communications is harder to tackle as the software may be specifically wedded to certain hardware. Many American packages, including integrated suites, create problems as they assume you have a Hayes Smart modem — and of course you haven't.

Usable British programs include Unicom's RAP and Braid's Mail Manager. RAP software can provide error-checking file

transfer on Telecom Gold as Gold's Primes run the companion software. Braid's Mail Manager can collect your mail in background mode. Ideally these packages should be provided along with the hardware and installed by the dealer. That old favourite BSTAM can also be used to transfer files over the phone line and is an invaluable package.

Considering the difficulty of selecting five or six different programs, some may be tempted to buy just one program that does everything. There are now a large number of these available but, truth be told, they are often unwieldy and no easier to learn or use than having several different products. Among the packages worth considering are Electric Desk, Framework, Open Access and Symphony. Samna Plus and the Smart system are also highly regarded, but I have not used them.

Electric Desk includes a word processor, spreadsheet and database. None of these is very powerful, but the system is mercifully easy to use. By contrast, Open Access does more and at a higher level, but you can go cross-eyed learning it. Open Access does try to help, with its pop-up menus, help screens and windows. However, no one has ever made 1.5Mbyte of code easy.

Somewhere between these two packages comes Psion's Xchange. It would be a shame not to take this integrated suite seriously simply because a version is given away with the relatively down-market Sinclair QL. The spreadsheet is reasonably good, the database is excellent and the graphing facilities are just brilliant.

Finally, of course, there are Symphony and Framework, two very strong packages that need no recommendation here.

There are a number of smaller programs which most PC users will find worth owning. At the moment the most popular of these is Borland's Sidekick, which lurks away in RAM and springs to the fore when you hit both Shift keys together. It provides a notepad, addressbook, calendar and so on, and is designed to be used while running other packages such as Multiplan. However, PC-DOS is not designed to be multi-tasking, and considering the tediousness of losing data, risks are best not taken for what



Nearly two-thirds of top-selling games are available in IBM versions.

amounts to an electronic notebook and pencil.

Borland's follow-up is Superkey, which is a similar background program that provides the facility to redefine keys and implement macros. The fact that you can program one key to execute a string of instructions can be a great boon.

An even more powerful package is PC Automator, which can almost robotise your use of the PC. If instructed, it will even pop into a word processor and correct your common misspellings.

Sideways is a program that practically every spreadsheet user will want to own, and which comes as part of Supercalc 3 Release 2. It is a well-known fact that every spreadsheet is at least one column too wide for paper of any dimensions. Sideways swivels your spreadsheet round to print it — sideways.

What Sideways is to financial planning, so Fancy Font is to word processing. It enables you to use all sorts of fancy typefaces in a range of different sizes. Some 30 fonts are provided.

Another useful disc is Norton Utilities, written by Peter Norton. It includes Disklook, which has been described as a truly wonderful program. It can sort your directories all kinds of ways, provide all sorts of information about your disc, and even draw a diagram mapping the space in use on the disc, whereabouts of hidden files, bad sectors, etc. The selection of 20 utilities can help save a normally sane person from being turned into a PC-DOS hacker, which is probably why I don't have the disc.

It seems most American users now have colour graphics and joysticks — IBM Part Number 1501300, Game Control Adaptor, £32 — and thus 65 percent of the top games sell in IBM PC versions. Examples from the current charts are Lode Runner and Bruce Lee. Gato, from Spectrum Holobyte, has climbed to number 11 in Softsel's Hot List when it is only available on the IBM.

NO GRAPHICS NEEDED

Those not so well equipped with expensive graphics options will still find many interesting games to play. At the moment, the one to have is the Hitch-Hiker's Guide to the Galaxy, which is a verbose and witty adventure version of the television series of the book of the radio show of the original idea by Douglas Adams. Because this Infocom program is text only, the IBM version is just as good as the Atari one.

Other established classics on the PC include the Zork adventure series, Wizardry from Sir-Tech, and Blue Chip's Millionaire. This beautifully packaged stock-market simulation is — according to BBC 2's *The Money Programme* — a craze even on the New York Stock Exchange.

Someone could probably write quite a funny snakes and ladders type game around the problem of selecting IBM PC software. However, in this case there would be more ladders than snakes. It may be difficult to make a final choice, but the average level of PC software is very high. Even if you do not find the perfect package, you are unlikely to end up with a bad one. **PC**

Recent deaths from cervical cancer have highlighted the importance of being able to monitor results from medical tests. Multi-user micros are helping to provide just such facilities at the nine health-screening sites throughout the country run by the British United Provident Association, better known as BUPA.

GPs refer women to the sites for checks on breast and cervical cancer, and men for heart complaints. There are also fitness assessment units and a whole-body scanner. All the data that is produced from tests is fed into computers. This permits automated searches for danger signs, sends letter to GPs and monitors responses.

Although Data General minis are used for this purpose in the main London offices, the provincial offices use multi-user micros. Micros are also used for some accounts and general purposes in London, which in turn acts as the test-bed of micro systems and provides countrywide backup. The man in charge of such operations is Barry Harris, the Systems Support Supervisor.

Recently he has been involved in purchasing Minstrel micros to replace and supplement some earlier Bromcom Superstar machines. Both are multi-processor multi-user systems. Harris is convinced of the virtues of this approach, "We tend to find that there are little groups of people in the building working on the same types of files; multi-user is ideal for that. We can have a centralised printer, the one hard disc, and the same set of files. And overall it works out cheaper than having lots of single-user systems linked together."

The Bromcom micros were purchased before Harris joined the department. "At that stage, Bromley seemed to be a good buy — nothing was really out in front. It seemed to be suitable for what they wanted to do. That was just simply running CP/M-80 programs — word processing and spreadsheets."

It was a natural step from such general programs to move on to the accounts. A purchase and nominal-ledger package from Omicron running under the Bromcom's DP/COS operating system was chosen. "We were looking for something which had as much flexibility as possible so that we could design the reports, and Omicron seemed very good. We were exempt from VAT, so we wanted a package that could ignore the VAT question."

COPYING RELIGIOUSLY

Although the Omicron package worked well, there were some teething troubles with other elements of the system. "We had one problem when we were installing the accounts system. To begin with we were using a program for compressing data on the disc. We were religiously copying our discs each night, until we had a system crash on us just before we went live — we were still doing parallel running. We went back to our discs to restore and found the program that compressed the data had corrupted it while compressing it."

This goes to show the importance of



A HEALTHY SOLUTION

Glyn Moody reports on a company with plans to develop its multi-user micro systems.

parallel runs before installing a system, and that even backup copies can fail you. Partly as a result of these experiences, BUPA now uses a tape cartridge backup system. Another factor was the sheer quantity of data that needed backing-up. "If you've got a large Winchester and you're putting a lot of files on there, it's impossible to back up on floppies," Harris says.

In the provincial centres, the Bromcom machines are used for handling all the medical information that is looked after in London by the minis. The software chosen was the Self-Contained Medical Records System (Scores) produced by an external consultancy firm. It can handle up to 20 new patient entries each day up to a total of 10,000 patients. It also offers a diary feature and various standard letters and reports.

Scores has been a big success at the Bristol and Leeds centres. "If anything goes wrong with it people are not very keen to go back to the manual system. They tend to rely on the computer so much, the manual system is a problem."

In some ways the micro has been a victim of its own success. "We have had some people getting fed up with the system if

something goes wrong and it is difficult to get down there immediately. If it is at all possible we try and solve it over the phone by transferring the program down to them. For instance we had a problem that only a report was coming out. It turned out that the program for the report printer was corrupt. So we just sent that down and reran the reports."

But often it is not as simple as that. Unfortunately, the regional offices have neither the time nor expertise to deal with such problems themselves: "If it is a major problem then it means going down there," says Harris, who normally has to go himself. "This is one of the reasons we needed a reliable computer in the provinces."

In this respect, the Bromcom had its problems. First it proved very susceptible to power-supply problems. For example, every time an old kettle was used in the London offices, it brought the Bromcom down. The problem was solved by installing a separate mains circuit. Then there were problems with the hard-disc controllers, in particular the Winchester speed varied.

Perhaps the biggest problems was with the operating system initially supplied with



Several systems are now installed in the London office, including an Apricot (far corner) and two Bromcom terminals.

Bromcom's machine, DPC/OS. On some machines this had the unfortunate habit of "seeming to forget which blocks it had used, and it would reallocate them so you ended up with your file being corrupt," Harris says. Fortunately the accounts machine seemed immune: "the problems are not the same on each computer, and we haven't had a lot of problems with the accounts one as far as writing over blocks is concerned."

For these and other reasons, Harris started looking around for a possible successor to the Bromcom. "Probably at the same time Bromcom Superstar machines formed the basis of BUPA established networks.

Bromley decided to write their own operating system, we decided to have a look around and see what else was available. We looked at Bromley's new Impos system and at a variety of other multi-user systems." Turbodos was an early favourite "because it was well known and well tried in the U.K. and U.S." Harris was keen to buy a system that would not need the same breaking in as DPC/OS.

"So we took the new Bromcom and Minstrel computers in-house for a short period. We ran the same tests on both machines, and looked at what the different machines could do. Things we looked for included overall speed of the programs, the flexibility of the machine in allowing you to change the baud rates on all the ports, whether you could have more than one spool printer.

"We found that you could on the Minstrel, but on the Bromcom you only had one spool printer and that was either serial or parallel, and then if you had another printer connected it would be directly to that user, and only that user could use it." The ability to access several printers independently was important. "In our Scores system we need one printer to run off labels, another to run off reports, and another for normal word-processing," says Harris.

Scores was originally written in dBase II and so was relatively straightforward to port across to the Minstrel. Only a few pieces of code had to be rewritten. "dBase II is fine until you start dealing with very large files and doing indexing and things like that. So the Scores system has been rewritten in C, but still using the dBase II database files, which speeds it up tremendously."

dBase II has also proved popular for other applications within BUPA's London office. "We have got a lot of staff who want to learn dBase II and do their stuff on that." Normally staff come to Harris with vague ideas that they would like to use a micro for some aspect of their work. Harris then tries to evaluate the best approach. "We might say there's a package that will do that already and we'll look into it and buy it. Or we might say it's a bit specialised and it's going to need something written just for you. Normally we haven't got time to cater

for everybody's need, so to certain people we say 'we think you should learn dBase II and see if that works'."

This side of things is likely to increase once the Minstrels are installed in the provinces. This will free the Bromcoms which are currently being used there, and they will become available for general-purpose applications in London.

But more recently, another element has been added to the picture. Harris explains: "The financial and management accountants were having problems using Multiplan on the Bromcom simply because they had run out of memory. We were looking at the new Bromcoms which ran MS-DOS and allowed you up to a megabyte of memory. Had we gone ahead and purchased those six to nine months ago then we would have continued running Multiplan on them. However, they weren't available and we needed something desperately for the budgets at the end of the year. So we bought Apricots to do that.

"Apricot seemed suitable for a number of reasons. One is that it is quite fast — the XI versions have a Winchester — it is really compact, it can be expanded and is reasonably priced for what you get. There is a program to emulate a Data General terminal which runs on the Apricot, so you can actually log Apricots into the Data General system, which makes it even more useful."

EXISTING HARDWARE

The last point was an important consideration. It meant that although the Apricots represented a new family of micros, they could be linked in to the existing hardware. Their use will be restricted to predominantly financial matters, and so will form a separate class.

Communications are increasingly important and are likely to be one of the main areas of development over the next few years. Already the London office uses telephone links to communicate with regional offices, uploading any software with problems, and downloading amended versions if necessary. Similarly, Harris communicates with the Data General from his home using the Apricot and a modem.

The benefits of computerisation at all levels seem to be accepted at BUPA's screening centres. Now it is a question of consolidating the work done so far, and welding it into a cohesive whole. Clearly communications will play a central role in this. "I think in the long term we will try and link all the centres together. Whether we can do that with Data General or a mixture of Data General, Minstrels and Apricots, I'm not sure. A lot depends on the size of the centres."

However, Harris is confident that these goals will soon be achieved. "In two years' time we will be highly computerised, and with all the centres linked together." Perhaps other screening centres throughout the country could profit from BUPA's experiences and begin to meet some of the criticism levelled at them recently. 



*** CUT PRICE MICROS ***

PLUS

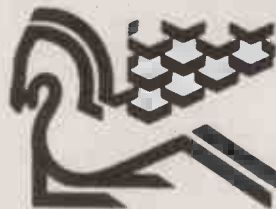

**PEGASUS
BUSINESS
SOFTWARE**

APRICOT MICROCOMPUTERS

ACT Xi 10 MEG £(VERY LOW!!)
 ACT Xi 5 MEG £(EVEN LOWER!!)
 ACT 2x720K £(LOWER THAN MAYFAIR)
 ACT 2x315K £(LOW-LO-LO)
 12" MONITORS AVAILABLE

THE PEGASUS SYSTEMS

SYSTEM 1

APRICOT WITH 2 x 720K PLUS 12" MONITOR
 PLUS SUPERWRITER WORDPROCESSING PROGRAM
 PLUS SUPERCALC FINANCIAL FORECASTING PROGRAM
 PLUS SUPERPLANNER ELECTRONIC DIARY AND
 CARDBOX SYSTEM
 PLUS PEGASUS SALES ORDER PROCESSING/INVOICING
 PLUS PEGASUS SALES LEDGER
 PLUS PEGASUS PURCHASE LEDGER
 PLUS PEGASUS NOMINAL LEDGER
 PLUS DATA CABLE TO LINK PRINTER TO COMPUTER
 PLUS 203.5" DISKS
 PLUS BROTHER HR15 DAISY WHEEL QUALITY PRINTER
SYSTEM PRICE £2796.00

SYSTEM 2

APRICOT WITH 10 MEGABYTE HARD DISK DRIVE AND
 12" MONITOR
 WITH SUPERWRITER FOR WORD PROCESSING
 WITH SUPERCALC FINANCIAL FORECASTING
 SPREADSHEET
 WITH SUPERPLANNER ELECTRONIC DIARY SYSTEM
 PLUS EPSON FX80 PRINTER
 PLUS DATA CABLE TO LINK PRINTER TO COMPUTER
 PLUS 103.5" DISKS
 PLUS 1 BOX OF FANFOLD PAPER
 PLUS ANY 4 MODULES OF PEGASUS ACCOUNTING
 SOFTWARE
SYSTEM PRICE £3596.00

WE CAN
 RECONFIGURE ANY
 PACKAGE TO SUIT
 YOUR INDIVIDUAL
 NEEDS. WE PROVIDE
 HOT-LINE SUPPORT,
 SERVICE, DATA
 INSURANCE & ON-
 SITE MAINTENANCE

THE APRICOT SYSTEMS

APRICOT Xi 10 MEG
 SUPERWRITER
 SUPERCALC
 SUPER PLANNER
 BASIC/MS-DOS/CPM-86
 FX100 PRINTER & CABLE
 BOX OF DISKS
 BOX OF PAPER
£2800

APRICOT 2x720
 12" MONITOR
 SUPERWRITER
 SUPERCALC
 SUPER PLANNER
 ANY PRINTER
 WORTH UP TO £400
£1996

SOFTWARE - UP TO 30% DISCOUNTS

WORDSTAR
 FRIDAY
 DBASE II
 OPEN ACCESS

CARDBOX
 DBASE III
 AUTOCODE
 LOTUS 1-2-3

SYMPHONY
 TOUCH & GO TYPING TUTOR
 SUPERCALC III

SUPERCALC II
 MULTIPLAN
 FRAMEWORK

OUR FULL SOFTWARE RANGE IS FAR TOO LARGE TO INCLUDE HERE PLEASE
 CALL US FOR CURRENT PRICES ON ANY SOFTWARE PRODUCT

ALL ITEMS ARE FULLY SUPPORTED AND GUARANTEED. CALL NOW FOR FREE
 ADVICE FROM OUR APPLICATIONS EXPERT. TRAINING IS ALSO AVAILABLE ON
 ANY PROGRAM OR COMPUTER.

WE OFFER FREE TRAINING WITH ANY TOTAL PEGASUS SYSTEM BOUGHT
 FROM US. OUR SYSTEMS ARE SOLD ON AN INSTALLED AND WORKING BASIS.
 WE CAN DELIVER TO ANY PART OF THE U.K. OR COURIER TO ANY TRADING
 COUNTRY IN THE WORLD.
 VAT NOT INCLUDED IN ABOVE PRICES.

BUY RENT OR LEASE
 FROM THE PROFESSIONALS



We are authorised dealers for the above
TEL: 01-800 8182
78-82 KIRKTON ROAD
LONDON N15

MCS

OPEN FILE

In Open File we offer programming tips and free software to key in — from demonstration routines to ready-to-use business programs. As well as major feature programs, every month we publish a selection of software written by our readers.

We welcome serious software for any of the micro systems listed opposite, especially short routines and utilities. Programs can be in machine code, Basic or any other language.

Submissions should include a brief description which explains what your program does, and how it does it. If possible it should be typed, with lines double-spaced. We need a printed program, which should be listed from a fully debugged, working program. Hand-written listings cannot be accepted. A tape or disc of the program helps if it is in a standard format.

When printing listings, please remember to use a new ribbon or double-intensity printing — faint listings reproduce badly. Use plain paper only, and try to list the program across either a 35-character or a 70-character width. Also, make sure all special graphics, inverse video characters or any other non-standard symbols are either

listed correctly or else include Rem statements to explain them fully.

Each program listing, tape or disc must have your name and address on it, or we cannot promise its safe return. A stamped addressed envelope is appreciated.

If you write in with a comment, correction or enquiry please state the machine and the program title.

We pay at least £10 for any programs used, or £35 per page and pro rata for part pages.

OPEN FILE MONITORS

Amstrad	Ian Stobie
Apple	Bill Hill
BBC	Nicholas McCutcheon
Commodore	Mike Todd
CP/M	Jack Schofield
IBM PC	Jack Schofield
Tandy	John Wellsman
Research Machines	Ian Stobie
Sharp	John Hooper
Sinclair QL	Glyn Moody

FEATURES

112

MULTIPLE-CHOICE TEST ANALYSER

Make the most of test results by providing extra information for both students and teachers

116

PROPORTIONAL SPACING

You can improve the appearance of printed output by customising your WordStar program

118

THE WARNIER APPROACH

A systematic method of tackling program design

BBC

122

SPRITE-DES: Designing and saving sprites on the graphics screen

APPLE

125

AUTO AID: An autodial program for modified Apple II machines

SHARP

127

MACHINE-CODE SUPERSORT: Sorting at speed on the MZ-80A

END OF FILE

128

WORDSTAR TEXT INPUT: WordStar-style commands to replace MBasic's Input
AMSTRAD DISASSEMBLER: Delving into RAM and ROM

MULTIPLE-CHOICE TEST ANALYSER

M E Williams has devised a time-saving program in BBC Basic which provides extra information for both teachers and students from the results of multiple-choice tests.

MULTIPLE CHOICE tests are widely used in schools and colleges. They frequently form part of O-level and A-level examinations, but in addition, teachers may use them to test whether a particular piece of work has been understood. As a teacher myself, I wanted to use the computer to assist in marking them.

The ideal, of course, would be completely automatic marking. That can be done, but it requires expensive machinery, such as a card reader, which is not within the budget of most of us. So for the present, results will have to be input at the keyboard. This is probably more time-consuming than traditional ways of marking MC tests, so to make using a computer worthwhile, it must offer more, such as an analysis of the students' answers.

The result of my labours is a suite of three programs which performs the following:

- Creates and stores a file of correct answers.
- Prints out blank answer sheets.
- Allows easy entry of a student's results.
- Prints on the answer sheet the student's score, percentage score, and a list of the wrong answers.
- Prints an alphabetically ordered list of students, giving marks and percentages.
- Prints a table showing how many students correctly answered each question and the percentage of students getting it right.

The last feature in particular has proved to be invaluable in providing feedback to the teacher much more effectively than the usual methods of marking.

As a final advantage, students are impressed by receiving their original test paper back marked by computer, and with the list of incorrect replies provided. It would be easy to modify the programs so that the computer adds appropriate comments on the mark achieved.

The three programs are given as listings 1, 2 and 3. They can be used by cassette- or disc-based systems, though I had disc use in mind when I wrote them. Program 1 supplies a menu. This in turn calls one of the other programs.

MULTIPLE CHOICE TEST					
STUDENT NAME _____					
MODERN HISTORY					
Q1	Q11	Q21	Q31	Q41	Q51
Q2	Q12	Q22	Q32	Q42	Q52
Q3	Q13	Q23	Q33	Q43	Q53
Q4	Q14	Q24	Q34	Q44	Q54
Q5	Q15	Q25	Q35	Q45	Q55
Q6	Q16	Q26	Q36	Q46	Q56
Q7	Q17	Q27	Q37	Q47	Q57
Q8	Q18	Q28	Q38	Q48	Q58
Q9	Q19	Q29	Q39	Q49	Q59
Q10	Q20	Q30	Q40	Q50	Q60

A blank answer sheet created by the program.

MULTIPLE CHOICE---Physics Test					
STUDENT NAME <i>M E Williams</i>					
Mechanics Revision Test					
Q1	A	Q11	E	Q21	A
Q2	B	Q12	A	Q22	C
Q3	B	Q13	B	Q23	B
Q4	A	Q14	C	Q24	B
Q5	C	Q15	A	Q25	D
Q6	E	Q16	D	Q26	E
Q7	C	Q17	F	Q27	E
Q8	D	Q18	D	Q28	A
Q9	D	Q19	C	Q29	C
Q10	A	Q20	C	Q30	A

A completed multiple-choice test.

But for space reasons, before chaining the Test Marker programs, Page has to be put down on disc systems to &1300.

Program 2 is the test-file creator. It first asks if you want to load a file of correct answers off tape or disc. You would do this if you wanted to modify the answers, or to print a sheet of correct answers for reference. If you don't want to load a file then it is assumed that you wish to create a new test and you are invited to give it a name. You can then either print a blank answer sheet or enter the correct answers for the new test.

The blank answer sheet is a screen dump of the on-screen

sheet. You should insert your own dump call into lines 440 and 1630. Screen dumps tend to be slow. For multiple copies you can photocopy the screen dump, or try making a Banda master direct from the printer. By removing the ribbon and using double strike on Epson-type printers you can obtain good quality masters. The final option is to set the machine dumping for a couple of hours.

If you are creating a new answer file then you have to enter the number of questions and the possible answers: this is usually ABCDE or 12345. If you have some other option, enter the possible letters in alphabetical

order. The correct answers are then input.

For speed of entry I took a lot of trouble with this input routine, ProcAnswers and ProcInput. The keyboard will only respond to the relevant keys and there is no need to press Return after each key press. When the answer sheet is complete, editing can be done by cycling through the answers using the Return key and then overwriting the incorrect entry. Finally, the option is given of saving the answer file on to disc or cassette.

Program 3 is the test marker and analyser. Because I wanted the program to store the names and scores until the analysis at the end, a number of arrays had to be dimensioned and a lot of space taken. With 60 candidates it is necessary to load the program at &1300 if you are a disc user; there is no problem for cassette users.

To cope with a large number it is probably best to use disc filing techniques. I wanted to avoid this, and even in these days of education cuts there are few classes of more than 60. However, because of the space problems the program is more compressed than the others and you should omit the Rems when typing it in.

There is one problem about running the program at &1300, which occurs when getting the data off disc. A couple of bytes at &17D4 get overwritten. Lines 1100 and 1160 take care of this; I have certainly had no problems.

When the program is run, it first prints the blank form on the screen and then requests the name under which the test answers are stored on disc. After reading them off disc, it is ready to mark the first candidate. The student's answers are entered in the same fashion as with program 2. When Escape is pressed the student's score is placed in the top right-hand box and you are asked whether you want the results printed. My technique is to insert the student's completed answer sheet into the printer so that it can be returned to the student with the results at the bottom. It is faster not to do this.

When there are no more to be done you are given the option of having the analysis printed. There is also the option for extra copies for colleagues or whatever. Warning messages are given to put in extra sheets if you are using single sheets of paper.

I am willing to supply the three programs together with an Epson printer dump on 40-track disc for £6.50. Send cheque or postal order to M E Williams, 11 Cressy Road, London NW3 2NB.

LISTING 1: MENU SUPPLIER.

```

100MODE7
110A$="Multiple Choice Disc"
120FOR I%=0 TO 1
130VDU&9DB1;&8DB3;
140PRINTSPC(16-LENA$ DIV2)A$
150NEXT
170READ A$:I%=1
180REPEAT
190PRINTTAB(3,I%*2+5);I%;SPC5;A$
200I%=I%+1
210READ A$

220UNTIL A$=" "
230PRINT "'Your choice ? ";
240A$="123"
250REPEAT:answer=INSTR(A$,GET$);UNTIL answer
260IF answer = 1 THEN CHAIN"SetTest"
270IF answer = 2 THEN CHAIN"SetTest"
280IF answer = 3 THEN PAGE=&1300:CHAIN"tmarker"
400DATACreate a file of answers.
405DATAPrint a blank answer sheet.
410DATAMark a set of papers.
450DATA " "

```

LISTING 2: TEST-FILE CREATOR.

```

LIST
100REM *****
110REM * TEST FILE CREATOR *
120REM * by *
130REM * M.E.Williams *
140REM *****
150:
160MODE0
170VDU23;8202;0;0;0;:FX220,0
180PROCform
190PROCanswers
200PROCfile
210PROCdump
220PROCprompt("Done.")
230END
240:
250DEFFNY_n:REPEAT:a$=GET$:UNTIL INSTR("YyNn",a$)
260IF INSTR("YyNn",a$)<3 THEN =TRUE ELSE =FALSE
270:
280DEFPROCfile
290PROCprompt("Do you wish to save this file? ")
300IF NOT FNY_n THEN ENDPROC
310PROCprompt("Under what File Name? ");PROCinput(
7,47,123)
320X=OPENOUT(In$)
330PRINT#X,title$
340PRINT#X,n_q
350PRINT#X,ans$
360FOR J%=1 TO n_q
370PRINT#X,a$(J%)
380NEXT
390CLOSE #X
400ENDPROC
410:
420DEFPROCdump
430PROCprompt("Do you want a screen dump? ")
440IF FNY_n THEN VDU20,12:REM ****insert dump call h
ere ****
450ENDPROC
460:
470DEFPROCform
480FOR x%=5 TO 65 STEP 12
490FOR y%=13 TO 31 STEP 2
500PROCbox(x%,y%,10,2)
510NEXT
520N=1:@%=1:editflag=0:done=0
530FOR x%=6 TO 66 STEP 12
540FOR y%=12 TO 30 STEP 2
550PRINTTAB(x%,y%)"Q"N:N=N+1
560NEXT
570PRINTTAB(30,0);:PROCdouble("MULTIPLE CHOICE TEST"
)
580DIMa$(60):FOR J%=1 TO 60:a$(J%)=" ":NEXT
590PROCbox(24,10,32,2):REM title box
600PROCbox(6,6,68,3):REM instruction box
610PROCprompt("Do you want to load a file? ")
620IF FNY_n THEN PROCload_file:ENDPROC
630PROCprompt("What is the test name? ")
640PROCinput(30,31,123)
650VDU12,20,26:REM CLS,default windows & colour
660PRINTTAB(40-LENI$DIV2,9)I$:title$=I$
670PROCprompt("Do you want to print a blank answer s
heet? ")
680IF FNY_n THEN PROCans_sheet:RUN
690PROCprompt("How many questions? ")
700PROCinput(2,47,58)
710n_q=EVAL(In$)
720PROCprompt("Enter the possible answers (eg ABCDE)
.")
730PROCinput(6,47,91)
740ans$=In$
750PROCprompt("Please enter the correct answers. Pr
ess <ESCAPE> when done.")

760ENDPROC
770
780DEFPROCprompt(P$)
790PROCwindow(7,4,65,1,0,1):CLS
800PROCdouble(P$):VDU10
810ENDPROC
820
830DEFPROCanswers
840REPEAT:x%=1:y%=12
850FOR num%=1 TO n_q
860PROCwindow(x%,y%,1,0,0,1):CLS:PRINTa$(num%);
870IF a$(num%)<>" " THEN editflag = TRUE
880PROCinput(1,ASC(LEFT$(ans$,1))-1,ASC(RIGHT$(ans$,
1))+1)
890VDU20:CLS:PRINTIn$;:a$(num%)=In$
900y%=y%+2:IF y%=32 THEN y%=12:x%=x%+12
910IF done THEN num%=n_q
920NEXT
930UNTIL done
940editflag=0:done=0
950ENDPROC
960
970DEFPROCbox(x%,y%,w,h)
980w%=w*16:h%=h*32:y%=32-y%
990MOVEx%*16,y%*32-16
1000PLOT1,0,h%
1010PLOT1,w%,0
1020PLOT1,0,-h%
1030PLOT1,-w%,0
1040ENDPROC
1050:
1060DEFPROCload_file
1070PROCprompt("What is the file name? ")
1080PROCinput(7,47,122)
1090c=OPENUP(In$)
1100IF c=0 THEN PROCprompt("File not found"):JJ=INKEY
(200):RUN
1110 INPUT#c,title$:INPUT#c,n_q:INPUT#c,ans$
1120VDU12,20,26:PRINTTAB(40-LENTITLE$DIV2,9)title$
1130FORJ%=1 TO n_q
1140INPUT#c,a$(J%)
1150NEXT:CLOSE #c:J%=1
1160FOR x%=11 TO 71 STEP 12:FOR y%=12 TO 30 STEP2
1170PRINTTAB(x%,y%)a$(J%):J%=J%+1
1180NEXT
1190PROCprompt("Press <ESCAPE> to continue")
1200ENDPROC
1210:
1220DEFPROCwindow(SX,SY,W,H,F,B):REM start,width,heig
ht,foregnd,backgnd
1230VDU28,SX,SY+H,SX+W,SY:COLOURF:COLOURB+128:ENDPROC
1240:
1250DEFPROCinput(LX,Lo%,Hi%):REM string length<=LX AS
C betweenLo% and Hi%
1260LOCALK%,Z%,K%=0:In$="":*FX15,1
1270IF editflag THEN 1290
1280PRINTSTRING$(LX,".");STRING$(LX+1,CHR$(8));" ";
1290REPEAT:Z%=GET:IFZ%=127ANDK%>0THENPROCdel
1300IFZ%=13 ANDeditflag THEN In$=a$(num%):K%=1
1310IFZ%=27 ANDeditflag THEN In$=a$(num%):K%=1:done=T
RUE
1320IFZ%>Lo%ANDK%<L%ANDZ%<Hi%THENPROCadd
1330IFZ%=32 THENPROCadd
1340UNTIL (Z%=13ANDK%>0).OR(L%=1ANDK%=1):ENDPROC
1350DEFPROCdel:K%=K%-1:In$=LEFT$(In$,K%):PRINTCHR$Z%;
";CHR$(8);:ENDPROC
1360DEFPROCadd:K%=K%+1:In$=In$+CHR$(Z%):VDUZ%:ENDPROC
1370
1380REM*****double letters in Modes < 7 *****
1390REM**DIMblock 9/PROCdouble(A$)
1400DEFPROCdouble(A$)
1410DIMblock 9

```

(listing continued opposite)

```

1420IFABC(A$)=&7FTHEENVDU127,10,9,127,11:ENDPROC
1430IFABC(A$)=13THENPRINTA$;':ENDPROC
1440LOCALIX
1450FORIX=1TOLEN(A$)
1460IFPOS=79 THENPRINT'
1470PROCchar(ASC(MID$(A$,IX,1)),224)
1480NEXTIX:ENDPROC
1490:
1500DEFPROCchar(C$,char)
1510LOCALAX,X%,Y%,J%,IX
1520?block=C%:A%=10:IX=block:Y%=block DIV256:CALL&FFF
1
1530FORJ%=0TO1:VDU23,CHAR
1540FORIX=2TO9:VDUblock?(J%*4+IXDIV2):NEXT
1550VDUchar,10*(1-J%),B:NEXTJ%
1560VDU11,9
1570ENDPROC
1580
1590DEFPROCans_sheet
1600PROCprompt("How many copies? "):PROCinput(2,47
,58):sheet=VAL(IN$)
1610VDU20,12,10:PRINT"STUDENT NAME ";STRING$(40,"_
");
1620FOR J%=1 TO sheet
1630REM ****call printer dump****
1640VDU2,1,12,3:REM new sheet
1650NEXT
1660ENDPROC

```

LISTING 3: TEST MARKER AND ANALYSER.

```

100REM Test Marker and analyser.
110MODE0:FX220,0
120VDU23;B202;0;0;0;
130PROCform
140PROCnext
150PROCa
160END
170DEFNyn_n:REPEAT:a$=GET$:UNTILINSTR("YyNn",a$)
180IFINSTR("YyNn",a$)<3THEN=TRUEELSE=FALSE
190DEFPROC1:PRINTSTRING$(78,"_"):ENDPROC
200DEFPROCnext
210REPEAT
220PROCp("Enter the student's name "):PROCinput(12
,64,91)
230VDU12,20,26:PRINTTAB(6,9)IN$IN$=IN$
240PROCp("Enter answers, then press <ESCAPE>")
250PROCans
260PROCpr
270PROCp("Any more? ")
280UNTIL NOTFNyn_n OR n_s=60:ENDPROC
290DEFPROCpr
300cor%=0:FORJ%=1TOn_q:IFA$(J%)=B$(J%)THENcor%=cor%+
1:r%(J%)=r%(J%)+1
310NEXT:PRINTTAB(70,9)cor%:s%(n_s)=cor%
320PROCp("Student's results printed? "):IFFNyn_nTHEN
PROCp
330PROCswap
340edit=0:done=0:n_s=n_s+1
350VDU12,20,26:PRINTTAB(70,9) " ":PRINTTAB(6,9)STRIN
G$(12," ");
360FORnum%=1TO60:IB$(num%)="":NEXT
370J%=1:FORx%=7TO67STEP12:FORy%=12TO30STEP2
380PRINTTAB(x%,y%)"Q";J%:" ":J%=J%+1:NEXTy%,x%
390ENDPROC
400DEFPROCswap
410FORJ%=1TOn_s-1
420IFn$(J%)THENtemp%=n$(J%):n$(J%)=n$(n_s-temp%):te
mp%=n$(J%):n$(n_s)=cor%:cor%=temp
430NEXT
440n$(n_s)=n$:s%(n_s)=cor%
450ENDPROC
460DEFPROCpt
470@%=5:VDU2,1,27,1,56,21:REM Epson codes
480PROC1:PRINTTAB(25)title$
490PRINTn$
500PRINT"You scored ";cor%;" correct out of ";n_q;"
(="INT(cor%*100/n_q)%"")
510PRINT"The following were incorrect."
520FORJ%=1TOn_q
530IFA$(J%)>B$(J%)THENPRINTJ% " ":IFCOUNT>70THENP
RINT
540NEXT
550PRINT':PROC1:PRINT':VDU6,3
560@%=1:ENDPROC
570DEFPROCa
580PROCp("Analysis printed? "):IFFNyn_n THENp_flag=T
RUE ELSEp_flag=0
590IFp_flag THEN PROCp("How many copies? "):PROCinpu
t(2,47,59):copy=VAL(IN$)
600VDU20,26,12,14:IFp_flag THENVDU2,1,27,1,56,15:REM
Epson codes
610@%=20:n_c=n_s-1
620PROC1:PRINTTAB(25)title$
630FORJ%=1TOn_c
640PRINTTAB(3)n$(J%),s%(J%),INT(s%(J%)*100/n_q)%" %"
650NEXT:PROC1:IFp_flag THENVDU12,3:PROCd("Paper read
y?"):VDU2
660REPEAT:SOUND1,-10,200,1:UNTILINKEY(20)<>-1
670PRINTTAB(25)title$
680PRINTTAB(14)"Question"TAB(35)"Correct"TAB(60)"Per
centage":PROC1
690FORJ%=1TOn_q
700PRINTJ%,r%(J%),INT(r%(J%)*100/n_s)
710NEXT:PROC1:VDU3
720IFp_flag THEN copy=copy-1:IF copy>0 THEN VDU12,3:
PROCd("Paper ready?"):VDU2:REPEAT:SOUND1,-10,200,1:UN
TILINKEY(20)<>-1:BOT0600
730VDU3:ENDPROC
740DEFPROCform
750N=1:n_s=1:edit=0:done=0:DIMn$(60),s%(60),a$(60),b
$(60),r%(60):b%=&1100
760PRINTTAB(27,0);:PROCd("MULTIPLE CHOICE MARKER")
770A$=STRING$(30," "):IN$=STRING$(12," "):n$=IN$;tem
p$=IN$:FORJ%=1TO45:n$(J%)=IN$:NEXT
780@%=1:J%=1:FORx%=5TO65STEP12
790FORy%=13TO31STEP2
800PROCbox(x%,y%,10,2):PRINTTAB(x%+2,y%-1)"Q"J%
810J%=J%+1:NEXT
820PROCbox(24,10,32,2):PROCbox(6,6,68,3)
830PROCload_file
840PROCbox(5,10,14,2):PROCbox(69,10,4,2)
850ENDPROC
860DEFPROCp(A$)
870PROCwindow(7,4,65,1,0,1):CLS
880PROCd(A$):VDU10
890ENDPROC
900DEFPROCans
910REPEAT:x%=11:y%=12
920FORnum%=1TOn_q
930PROCwindow(x%,y%,1,0,0,1):CLS:PRINTb$(num%);
940IFb$(num%)<>" "THENedit=TRUE
950PROCinput(1,ASC(LEFT$(ans$,1))-1,ASC(RIGHT$(ans$,
1))+1)
960VDU20:CLS:PRINTIn$;b$(num%)=In$
970y%=y%+2:IFy%=32THENy%=12:x%=x%+12
980IFdoneTHENnum%=n_q
990NEXT
1000UNTILdone
1010VDU26
1020ENDPROC
1030DEFPROCbox(x%,y%,w,h)
1040w%=w*16:h%=h*32:y%=32-y%
1050MOVEx%*16,y%*32-16
1060PLOT1,0,h%:PLOT1,w%,0:PLOT1,0,-h%:PLOT1,-w%,0:END
PROC
1070DEFPROCload_file
1080PROCp("What is the file name? "):PROCinput(7,47,
122)
1090c=OPENUP(IN$)
1100B%=!&17D4:!!&17D4=0
1110INPUT#c,title$:INPUT#c,n_q:INPUT#c,ans$
1120VDU12,20,26:PRINTTAB(40-LENtitle$DIV2,9)title$
1130FORJ%=1TOn_q
1140INPUT#c,a$(J%)
1150NEXT:CLOSE#c
1160!&17D4=B%
1170ENDPROC
1180DEFPROCwindow(SX,SY,W,H,F,B)
1190VDU2B,SX,SY+H,SX+W,SY:COLOURF:COLOURB+128:ENDPROC
1200DEFPROCinput(L%,Lo%,Hi%)
1210LOCALK%,Z%:K%=0:IN$="":*FX15,1
1220IFL%>1:PRINTSTRING$(L%,"");STRING$(L%+1,CHR$(B));
" ";
1230REPEAT:Z%=GET:IFZ%=127ANDK%>0THENPROCdel1
1240IFZ%=13ANDeditTHENIn$=b$(num%):K%=1
1250IFZ%=27ANDeditTHENIn$=b$(num%):K%=1:done=TRUE
1260IFZ%>Lo%ANDK%<L%ANDZ%<Hi%THENPROCadd
1270IFZ%=32ORZ%=46THENPROCadd
1280UNTIL(Z%=13ANDK%>0)OR(L%=1ANDK%=1):ENDPROC
1290DEFPROCdel1:K%=K%-1:IN$=LEFT$(IN$,K%):PRINTCHR$Z%;
" ":CHR$(B);:ENDPROC
1300DEFPROCadd:K%=K%+1:IN$=IN$+CHR$(Z%):VDU2:ENDPROC
1310DEFPROCd(A$)
1320FORK%=1TOLEN(A$)
1330PROCchar(ASC(MID$(A$,K%,1)),224):SOUND1,-10,200,1
1340NEXT:ENDPROC
1350DEFPROCchar(C$,char)
1360?b%=C%:A%=10:IX=0:Y%=&11:CALL&FFF1
1370FORJ%=0TO1:VDU23,CHAR
1380FORIX=2TO9:VDUblock?(J%*4+IXDIV2):NEXT
1390VDUchar,10*(1-J%),B:NEXTJ%
1400VDU11,9:ENDPROC

```

PROPORTIONAL SPACING

John and Timothy Lee reveal how at last you can get nicely spaced output from WordStar.

ON A STANDARD typewriter all of the characters are assigned exactly the same space. This is usually 1/10th inch or 10 characters per inch, though some are set for 1/12th inch giving 12 characters per inch. Teletypes and line printers are the same, and this arrangement is called fixed spacing. Most daisywheel and thimble printers can move horizontally in much smaller intervals, usually 1/120th inch, and such printers are said to be capable of incremental spacing.

If WordStar is used with the right margin justified extra soft spaces must be added to most lines to make the right edge of the text flush. If the printer used is only capable of fixed spacing, or alternatively if the printer is capable of incremental spacing but has been installed as a standard printer with fixed spacing, then extra spaces are added between the words on a line until the right margin is in the correct place. The extra spaces do show and spoil the look of the text. This is in fact what happens on the screen display.

If the printer has been installed as an incremental printer, then WordStar performs microspace justification. This means that it distributes the extra spaces evenly in intervals of 1/120th inch between the words and the characters on a line. The extra spaces are no longer very obvious and many people wrongly call this proportional spacing. The width of each character on the daisywheel or thimble is actually read from a spacing table inside WordStar, which is stored at a location called PSTab. The narrow characters such as (.) take slightly less space than normal, and wide letters M and W have slightly more space than usual. But in general the characters are all very nearly the same width.

There is an undocumented control character in WordStar that causes output to be arranged by a proportional-spacing subroutine rather than the usual microspace subroutine. This control character is ^P and consequently if you type ^P ^P then WordStar will produce proportional printing. This means that each character has a different width. For example a letter I occupies less space than a letter M, and upper-case letters are wider than lower-case letters. With true proportional spacing, a line full of i characters would contain more

characters than a line full of m characters.

However, under WordStar the width of a line is a fixed number of characters, and regardless of how narrow the characters are, WordStar cannot print more than this number of letters on a line. Usually this is not necessary because the line contains a mixture of letters, some wide and some narrow. Furthermore, changing the number of characters printed on a line would destroy one of WordStar's strong features that what you see on the screen is exactly what you print. Thus WordStar is only capable of using proportional spacing on a line, which is not the same as true proportional spacing. However, it does improve the look of text.

The spacing table which starts at location PSTab contains the spacing of each of the 96 characters on a daisywheel. In fact two values between 2 and 7 are stored for each character. The first value is the normal spacing for the letter, which is the value usually used. The second is for proportional spacing, which is only used if you have typed ^P ^P in the document. If the table value is 4, then a space of 4/120th inch is printed both before and after the letter.

We find that it is a good idea to change the character width with a .CW 9 command at the beginning of the file. This changes the spacing to 120/9 or 13.3 characters per inch. This packs the lower-case letters together better but produces problems with lines that are all capitals or centred headings that are all capitals, both of which appear overcrowded. The simplest way of avoiding overcrowded headings is to put two spaces between the words. Alternatively, you can change the character spacing with a .CW12 command, giving 120/12 or 10 characters per inch.

Unless you change the right margin to take account of the increased character width, you may get the heading lines extending beyond the usual right margin when they are printed, and centred headings will not be central on the page. Suppose that you had set the right margin to 76 for the main part of the text, with an ^OR 76 command. This would give 76 characters per line, and the .CW 9 gives a spacing of 13.3 characters per inch, so the length

of the line is

$$76 \times (1/13.3) = 5.71 \text{ inches}$$

With the changed character width of .CW 12 giving 10 characters per inch, the new value for the right margin can be calculated

$$\text{new right margin} \times (1/10) = 5.71$$

Hence the new right margin should be set to 57 with an ^OR 57 command. This will ensure that lines of capitals, or centred headings of capitals are not overcrowded. After typing such lines, and centring if required, you must reset the original values with .CW 9 and ^OR 76.

Using the proportional spacing table will enhance the appearance of text printed with the normal spacing 10- or 12-pitch daisywheel that you are currently using. But for the best results you should choose a new proportional-spaced daisywheel. These PS wheels are much more like book founts than the 10- or 12-pitch wheels because the characters vary considerably in width, whereas the 10- or 12-pitch wheels try to make all the characters the same width.

Unless your printer has been specifically made to use PS wheels as well as 10- or 12-pitch wheels then you will have problems using PS wheels. This is because the sequence of the characters on a PS wheel is different from the usual order on a 10- or 12-pitch wheel. Unless you can do something about this, your text will be scrambled. What is required is a different translation table, so that the right letters are printed. Some printers have a PS selection switch to do this, and unless your printer has such a switch you cannot use a PS wheel directly from WordStar.

You could always write your own program to do the translation or you can buy a program called Propstar for \$49.95 from Civil Computing Corporation, 2111 Research Drive, Suite 1, Livermore, Ca 94550, U.S.A. This will do the translation and more. The advantage of a PS wheel is that the character widths vary much more. Capital letters are typically one-and-a-half times wider than lower-case letters, and some letters like i and j are considerably thinner.

It may well be that the proportional-spacing values stored in the table are not the optimum values for the particular printwheel

you wish to use. If this is so, you may want to change the table values. We particularly like the appearance of the Qume Boldface PS wheel number 82254, and have altered the proportional spacing in the PSTab table to optimise the spacing for this wheel. You may alter the values to give different effects or to optimise the appearance with different wheels. We advise against changing the first setting for fixed spacing, though you may alter the second proportional value for any of the characters to optimise the spacing for the particular daisywheel used, and to meet your own taste. Do not use a value smaller than 2 or larger than 7.

To alter the space table you must install a special version of WordStar. Get to the Patcher routine which is part of the Install.Com or WInstall.Com program. To enter the Patcher when using WordStar version 3.0 or below, you simply reply "No" to "Are the modifications to WordStar now complete?" With WordStar versions 3.2, 3.3 and later, instead of typing a letter to select one of the menus, or X to exit from Install, type + to get the patcher. You will be asked

LOCATION TO BE CHANGED
(0=END)

On WordStar up to version 3.0 type PSTAB: and press Return and on version 3.2 and later type :PSTAB and press Return. On our eight-bit version, the reply is

ADDRESS: 07D8H OLD VALUE:
52H NEW VALUE:

You should type 55. The first figure 5 indicates a spacing of 5 for this character if normal spacing is used, and the second 5 gives a spacing of 5 if proportional spacing is in use. Often the two values are different.

The installation proceeds

LOCATION TO BE CHANGED (0
= END) :PSTAB+1
ADDRESS : 07D9H OLD VALUE:
43H NEW VALUE: 43
LOCATION TO BE CHANGED (0
= END) :PSTAB+2
ADDRESS: 07DAH OLD VALUE:
44H NEW VALUE: 44
LOCATION TO BE CHANGED (0
= END) :PSTAB+3
ADDRESS : 07DBH OLD VALUE:
54H NEW VALUE: 56

and so on. The addresses may be different on your version of WordStar, and will certainly be different on 16-bit versions. This does not matter at all. On WordStar versions 3.2 and later, type the colon before PSTab, not

after. A full list of the changes is given in the table. For completeness, the first four changes shown here are included in the table on the right.

The values we have used with plastic and metal print wheels are slightly different, and both are shown. Plainly you must only type one set of values. To help you to make changes for yourself, to optimise the look of your chosen print wheel, the character for which the spacing applies is also shown.

There may be a bug in your version of WordStar if it is an early 16-bit version. They accidentally omitted the PS value for capital S, so the spacing for all letters after that may be wrong. If you type the values given in the table, you will correct this bug.

Another worthwhile change before you leave the Patcher is to alter WordStar's micro-justify algorithm so that it puts more emphasis on adding microspaces of 1/120th inch to the gaps between words, rather than inserting microspaces between the letters in a word. This can be achieved by using the patcher subroutine to change the hexadecimal value of location DMJWB: or :DMJWB, from 00 to FF.

Last, a word about Propstar. This is a printing program, which you use to print a WordStar document, rather than use the P option from the WordStar main menu. Actually they provide two programs, one implements proportional spacing using a normal print wheel, and the other does the same but translates the characters so that you can use a proportional-spacing print wheel even if your printer does not have the option to use both normal and PS wheels. This program does most of the thinking for you, and may be the easy way for you to get into PS. It saves you having to patch WordStar, and for most purposes is very good. It automatically increases the spacing with uppercase letters to avoid any overcrowding.

However, it does not implement all of the features of WordStar, and at present it does not count where to insert page breaks, or where to insert headings, footings, or page numbers. The page-break problem can be overcome by using .PA commands to force page breaks, or all of the shortcomings can be overcome by printing the document in two stages. First use WordStar to print the document to a disc file, when page breaks, headings, footings and page numbers will be inserted, then use PropStar to actually print this file on paper.

	DIABLO PLASTIC WHEEL		DIABLO & XEROX METAL PS			DIABLO PLASTIC WHEEL		DIABLO & XEROX METAL PS	
	OLD	NEW	NEW	CHARACTER		OLD	NEW	NEW	CHARACTER
PSTAB:	52	56	55	special char	PSTAB +30	54	55	56	P
PSTAB +01	43	43	43	!	PSTAB +31	56	56	57	Q
PSTAB +02	44	44	44	"	PSTAB +32	56	56	57	R
PSTAB +03	54	55	56	#	PSTAB +33	54	55	55	S
PSTAB +04	54	55	55	\$	PSTAB +34	55	55	56	T
PSTAB +05	56	56	57	%	PSTAB +35	56	56	57	U
PSTAB +06	56	56	57	&	PSTAB +36	56	56	56	V
PSTAB +07	32	32	32	'	PSTAB +37	67	67	67	W
PSTAB +08	43	43	43	(PSTAB +38	56	56	57	X
PSTAB +09	43	43	43)	PSTAB +39	56	56	57	Y
PSTAB +0A	54	54	55	*	PSTAB +3A	55	55	56	Z
PSTAB +0B	54	55	55	+	PSTAB +3B	54	54	54	[**
PSTAB +0C	42	43	43	,	PSTAB +3C	56	54	52	**
PSTAB +0D	54	55	54	-	PSTAB +3D	54	54	54] **
PSTAB +0E	32	33	33	.	PSTAB +3E	56	55	55	^ **
PSTAB +0F	53	54	54	/	PSTAB +3F	55	56	55	_ **
PSTAB +10	54	55	55	0	PSTAB +40	54	45	43	' **
PSTAB +11	54	55	55	1	PSTAB +41	54	55	54	a
PSTAB +12	54	55	55	2	PSTAB +42	54	55	55	b
PSTAB +13	54	55	55	3	PSTAB +43	54	55	55	c
PSTAB +14	54	55	55	4	PSTAB +44	54	55	55	d
PSTAB +15	54	55	55	5	PSTAB +45	54	55	55	e
PSTAB +16	54	55	55	6	PSTAB +46	53	54	54	f
PSTAB +17	54	55	55	7	PSTAB +47	54	55	55	g
PSTAB +18	54	55	55	8	PSTAB +48	54	55	55	h
PSTAB +19	54	55	55	9	PSTAB +49	52	53	53	i
PSTAB +1A	43	43	43	:	PSTAB +4A	53	53	54	j
PSTAB +1B	42	43	43	;	PSTAB +4B	54	55	55	k
PSTAB +1C	54	55	56	< **	PSTAB +4C	52	53	53	l
PSTAB +1D	54	55	55	=	PSTAB +4D	66	67	67	m
PSTAB +1E	54	55	56	> **	PSTAB +4E	54	55	55	n
PSTAB +1F	54	55	55	?	PSTAB +4F	54	55	55	o
PSTAB +20	56	57	57	@	PSTAB +50	54	55	55	p
PSTAB +21	55	56	57	A	PSTAB +51	54	55	55	q
PSTAB +22	55	55	56	B	PSTAB +52	53	54	54	r
PSTAB +23	55	56	57	C	PSTAB +53	53	54	54	s
PSTAB +24	56	56	57	D	PSTAB +54	53	54	54	t
PSTAB +25	55	55	56	E	PSTAB +55	54	55	55	u
PSTAB +26	55	55	56	F	PSTAB +56	54	55	55	v
PSTAB +27	56	56	57	G	PSTAB +57	66	67	67	w
PSTAB +28	56	56	57	H	PSTAB +58	54	55	55	x
PSTAB +29	53	53	53	I	PSTAB +59	54	55	55	y
PSTAB +2A	53	54	55	J	PSTAB +5A	54	55	55	z
PSTAB +2B	56	56	57	K	PSTAB +5B	54	55	55	{ **
PSTAB +2C	55	55	56	L	PSTAB +5C	56	55	55	**
PSTAB +2D	66	67	67	M	PSTAB +5D	54	55	55	} **
PSTAB +2E	56	56	57	N	PSTAB +5E	56	55	55	~ **
PSTAB +2F	56	56	57	O	PSTAB +5F	55	55	55	special

This table shows the ASCII characters corresponding to values from 32 (20 hex) to 127 (7F hex). On proportional wheels the characters marked ** are often replaced by other symbols such as fractions.

THE WARNIER APPROACH

A systematic approach to programming pays dividends in efficient and intelligible code. Paul Andreas Overaa explains the techniques developed by J D Warnier, and applies them in a program for the BBC Micro.

OVER THE LAST few years a design technique thought by many to hold the key to the problems related to coherently tackling the design of complex programs has gained acceptance in both commercial and academic fields. One reason for the success of the method is that it can be used not only for program and system design but for general logic analysis. One set of ideas and conventions are used for the original problem analysis, the system design and any high-level or low-level programming required. The techniques, based on work originally done by J D Warnier in France, have been expanded and developed by researchers in the U.S. and in England over the last 10 years or so.

There are several reasons for the success of the methodology. Computer languages in general are not sufficiently good at communicating what a particular program does, or indeed how it does it. If somebody gives you even a 10-page Basic program and says "What does this do?", you will be unlikely to be able to answer intelligently without careful analysis of the code. Invariably it is necessary to attempt to extract from the program code itself some ideas concerning the underlying logic involved. If the program includes lots of remarks then the job of analysis is reduced but such analysis is still a significant task for all but trivially small programs. One of the major difficulties with, say, assembly language is not that the individual operations are difficult to understand but that all low-level languages are notoriously non-communicative — you just cannot tell what assembly-language programs are doing unless you analyse the code in great detail.

A recognised advantage of splitting large programs up into modules, procedures and subroutines is that these communication difficulties are reduced by creating small sections of code each of which can be examined in isolation.

Another communication aid is the flowchart. This provides a simple tool that enables the logical basis of a program or system to be shown in a pictorial fashion. Unfortunately that is all they do — they illustrate logic that is already

understood, they do not particularly help you during the actual design processes.

One area for improvements in program design techniques that has been followed with success has therefore been the search for better and more flexible ways of documenting the way in which a program design evolves. It is generally accepted that the easiest way to understand complex problems is to break them up into small manageable pieces. Each piece is then far less formidable and consequently far easier to get to grips with. Inherent in this idea is the implication that an ordered or structured approach exists which enables our understanding of the lesser parts to be integrated into our understanding of the original more complex overall picture. At the very outset it has been found advisable to separate the logical difficulties of programming and system design from the practical difficulties of coding in a particular language. Any envisaged use of computers to solve a problem requires that you find a logically correct solution before you make any attempt to actually code your computer solution — quite simply you should not try to solve the two separate problems at the same time. By isolating the program design we are able, as an added bonus, to produce a logical solution that is portable; it is independent from the computer hardware and software on which it will be implemented.

From a practical viewpoint it is obviously advantageous to develop ways of solving problems and designing logical solutions that can produce good, efficient, well-structured programs in any language you care to name. Most people benefit by having pictorial or iconic representations available to them — hence the old adage "a picture is worth a thousand lines of code". When you run into difficulties during problem solving the tendency is to fall back to iconic representations automatically. As an example, consider how many times you have been presented with a mathematical problem to solve in which you plunged straight in with some symbolic argument only to find you got stuck and rapidly resorted to a graph or diagram — an iconic model — in order to get a better

FIGURE 1. WARNIER DIAGRAM OF THE PROBLEM.

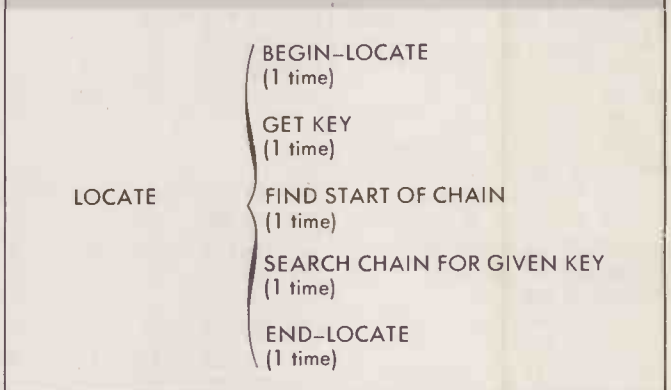

understanding of the problem itself.

These ideas produce some interesting generalities which have implications of particular benefit to us in our quest for better methods of designing and writing computer programs. First, when you solve programming problems you are frequently solving other people's problems. You may very often need to explain your solutions and your lines of reasoning to others and there is a need to ensure proper communication of your ideas. Secondly, the problems you examine will often be ill-defined or imprecisely defined. Frequently restrictions will be added to the problem while you are in the middle of finding a solution and the problem will change. With an iconic model to fall back on you are more likely to come to terms with the new restraints.

To illustrate the techniques I will take a simple problem and work through a typical development cycle using Warnier diagrams to document and guide progress. In this way it will be possible to explain the conventions being used in context.

The chain or linked list is a common data structure used to provide pathways through a data set. The BBC Micro uses a multi-list arrangement to store its non-resident variables. Variables beginning with the same letter are chained together using address pointers embedded within the space allotted for each variable. This linked list arrangement means that, providing you know the address of the start of a given chain, you can search through it to find the particular details of any selected variable. The start of each

chain is held in a look-up table whose position is not only fixed but has been arranged so that the location of the head pointer is easily calculated from the ASCII code of the first character of the variable's name. The table itself occupies memory locations &0480-04F9 but for the moment all that you need to appreciate is that the head of any particular chain can be calculated very easily using Basic's ASC() function.

The problem I want to study is to design a routine that takes a variable name and returns the address that represents the start of the variable in memory. Since we are essentially dealing with a general list-searching problem applicable to searching any list we will talk in terms of searching for a specified key, rather than specifically searching for a particular variable.

A Warnier diagram is essentially a collection of curly brackets that specify the order and the conditions under which various sets of actions are to be performed. Figure 1 shows the essential characteristics of the problem, which I have arbitrarily called Locate. We can use it to explain some conventions.

The curly bracket implies that we are dealing with a set of operations, labelled Locate, that involve identifying the key item, the finding of the start of the appropriate linked list or chain, and finally the searching of the chain. Within any given bracket the operations at the top of the bracket are performed first, those at the bottom are performed last. Notice that we have explicitly shown that the operations have a beginning and an end, although at present we have not specified any details, and also that

under each item we have given an indication of how many times the item will be performed.

Do we know anything else of relevance? Well, it is quite possible that the chain we specify may not exist. At present the diagram does not allow for such a possibility so let us now expand the existing diagram to cater for this.

Figure 2 allows for the fact that the chain may or may not exist and here we must explain some further conventions. The logical opposite of a statement can be written by placing a bar over the original statement. Hence Chain Exists means that the chain does not exist. Because in any given situation the chain will either exist or not exist then these two alternatives are shown separated by a ⊕ sign, which simply indicates that the two possibilities are mutually exclusive — they will not occur together.

We can do better than this. A chain of variables beginning with the same letter as our specified key may well exist, but again the actual item specified still may not be found within this chain. We continue to refine and expand our Warnier diagram by adding these further details. The bracket shown to the right of the "chain exists" label can quite easily be expanded and superimposed on the diagram to give figure 3.

Notice that we are refining the diagrams by describing and documenting the events in greater and greater detail. In doing this we are

FIGURE 2. INCORPORATING EXPANSION OF CHAIN EXISTS STATEMENT.

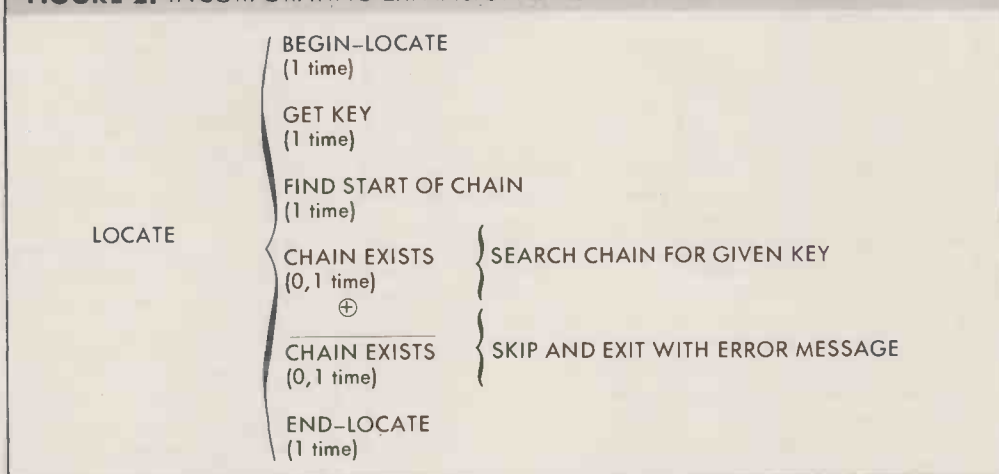

not having to rearrange our working description, we are simply superimposing new restraints and conditions on to the existing structure, which is growing as our understanding of this particular problem increases.

At this stage we are using these diagrams to help us think about the problem, to identify areas that need further expansion, and to document the growth and the coherence of our ideas. We are moving towards a complete logical description of the problem by a process of iterative refinement. Notice also that we are still dealing with a fairly general description of a routine that will search a linked list or chain-type data structure for a particular item. A given chain may not, in fact, be present, or if it

is present it still may not contain the item we are looking for. Our current logical description allows for both of these possibilities within its structure. Notice also that the description, while accurately representing the constraints of our BBC-based problem, is not specific to a particular computer language. It represents a logical solution to a particular problem that is essentially machine and language independent. The conventions we have used so far are in fact the only ones you will need for the majority of problems that you will encounter. Let's collect them together for convenience:

1. Brackets are used to define sets of operations.
2. Brackets are read and performed downwards within

any one level. The item at the top of the bracket is performed first, the item at the bottom performed last.

3. The logical opposite of a statement can be written as the original statement with a bar drawn over it.
4. Brackets written to the right of a statement indicate the operations to be performed if that statement is performed.
5. Underneath each item or statement we indicate the relative number of times the operations should be performed.
6. Within any given bracket level, statements that are mutually exclusive are separated by a ⊕ sign.

(continued on next page)

FIGURE 3. INCORPORATING AMPLIFICATION OF SEARCH CHAIN STATEMENT.

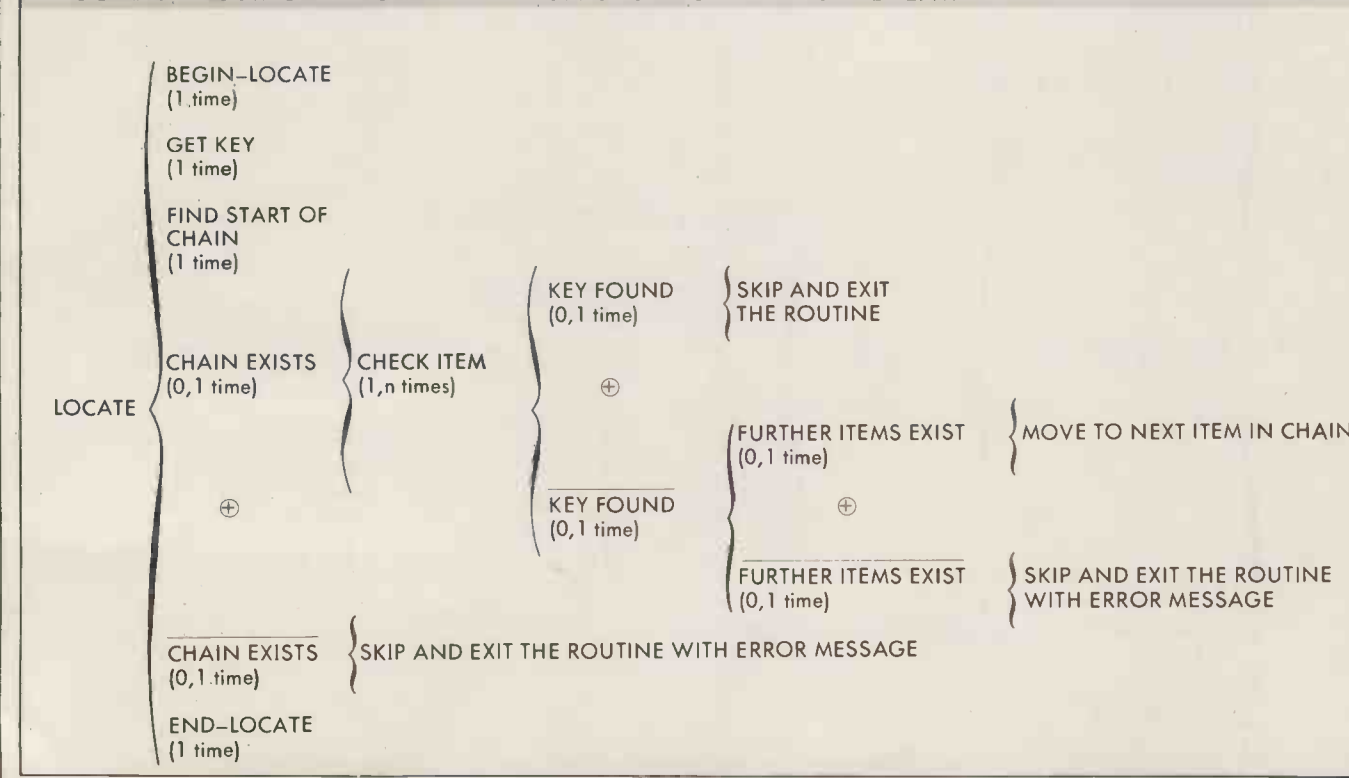

(continued from previous page)

Using these conventions we can express in English exactly what figure 3 tells us: we are dealing with a certain process, called Locate, that starts by asking for the description of a search key. If the chain does not exist then we exit the routine or procedure or whatever with an appropriate error message. If the chain does exist then we perform a set of operations called Check Item at least once and up to a maximum of an unspecified n times.

This later set of operations involves the following actions — we see if the item being looked at contains the specified key, if it does then we have found what we are looking for — so we exit the routine; if we have not found the specified key we proceed instead by asking, "are there any more items in the chain?" If the answer is No then we exit the routine with an error message, otherwise we move to the next item in the list in preparation for performing the action subset Check Item again. Remember that if the chain does exist then it is the group of actions or subset shown to the right of the label Chain Exists that are performed.

How can we tell when the analysis has been carried far enough? Easy: we look at the lowest levels, the rightmost brackets of the diagram, and at the

conditional tests we are using, and ask ourselves whether these operations could be easily coded in the language that we have chosen. If it appears that some of the operations are still not described in sufficient detail then those areas must be looked at again. Let us examine some of the operations present in our current figure 3 to show you what we mean:

Find Start of Chain . . . The BBC Micro maintains a table of head pointers that are used to locate a particular chain of variables. The reference manual tells us that the location of the head pointer for any given character is obtained by adding twice the ASCII code of the character to 400hex. In Basic we can use a function such as $&400 + 2*ASC(X\$)$ to obtain the necessary address. We can see now that two distinct operations are involved — firstly we calculate the table address, then secondly we use the contents of that entry to move to the location of the first item in the chain.

Move to Next Item . . . We need details of how the BBC arranges its chain layout. Once more the reference manuals tell us that the first two bytes of the space allotted to a given variable is used to hold an address which points to the start of the next variable in the chain. Getting the address of the next item simply involves extracting the

contents of the first two bytes of the current variable. At this stage we recognise that such an operation is going to be the same as extracting the starting address from the head pointer but we will still modify our existing diagram to indicate that moving to the first item in the chain is essentially the same operation as moving to the next item.

What about the conditional tests shown on the diagram? Can we specify equivalent Basic operations? Let's see:

Key Found/Key Found . . . This implies that we can check the characters in the key, perhaps held in a variable Key\$, against the names of the variables stored in a given chain. We need to be aware of the convention used to store the names and for that information we refer to the user guides, etc. This is the arrangement: for any given chain the first character of the name is missing — that it, it is implied. The remaining characters, including the type identifiers %, \$ and so on, are stored immediately after the two-byte Next Variable pointer space. A null (ASCII 0) character signifies the end of the name.

In Basic we can use a For-Next loop to check each character of the key against the corresponding variable-name character. This type of test is not going to provide any major problems but we will

include in our next diagram a label that explicitly shows that this set of operations are being performed.

Chain Exists/Chain Exists . . . Obviously we need to know what conventions are being used by the BBC Micro to decide whether a chain exists or not. The convention used is both simple and in common use — if the head address is zero then no chain exists.

Further Items Exist/Further Items Exist. . . A similar, equally simple, convention is used to indicate when the end of a chain has been reached: if the address pointer is set to zero then no further items exist.

We now see that in terms of the chain arrangement used in the BBC both the Chain Exists/Chain Exists and Further Items Exist/Further Items Exist pairs of conditions are based on exactly the same criteria — whether the address pointer is set to zero or not. Since it is this criterion that will actually be used to make the test we should alter the diagram labels to reflect this state of affairs.

Our next task is to incorporate these more detailed findings into our original general diagram so that the diagram reflects our current understanding of the problem we are attempting to solve. The result is shown in figure 4.

This article will be continued in next month's issue.

FIGURE 4. REVISED DIAGRAM REFLECTING SOME PRACTICAL POINTS.

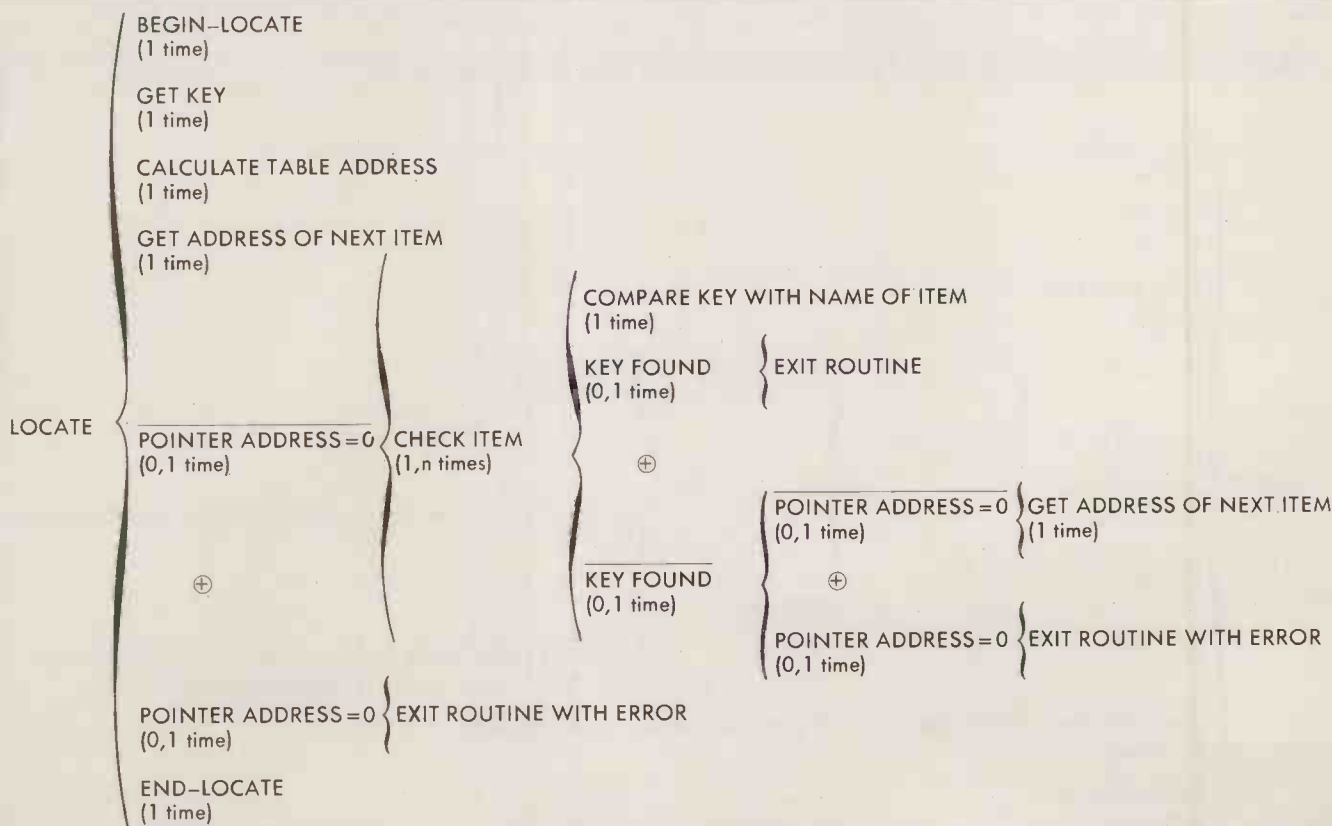

Пролетарии всех стран, соединяйтесь!

Коммунистическая партия Советского Союза



ПРАВДА

Газета основана
5 мая 1912 года
В. И. ЛЕНИНЫМ

Орган Центрального Комитета КПСС

№ 317 (24208)

Понедельник, 12 ноября 1984 года

Цена 4 коп.

ПАРТИЙНОЕ

Сердечная

Ours prints exactly what it's told to as well.

Unlike the proprietors of PRAVDA, we're all for freedom of the press. On the other hand, we're certainly not in favour of freedom for the printer. We're as critical of documents that don't say exactly what they're supposed to as anyone at the Kremlin.

That's why we'd like you to take a look at the new Epson DX100 daisy wheel computer printer.

There it is, very much on the right.

It comes from Epson and will simply not tolerate smudgy, messy type. It is also fanatical about towing the computer line as it were.

That's because it has a 5K memory buffer built in.

For those who may not know, a buffer does two things.

First, it allows the DX100 to store more than a page of text while it's still printing. Setting your computer free to do other things.

Second, the buffer makes sure that the DX100 does exactly as it's told.

A printer without a buffer can't keep up with the computer. So it has a tendency to defect. Leaving your documents with chunks missing. Rather like that.

So get yourself £475 (+VAT) and you can have an Epson DX100 of your very own.

You will then be in possession of a printer that firmly subscribes to the belief that documents are always better read than dead.

Home computers and the DX100: Spectrum QL, BBC model B and Acorn Electron are all fully compatible.

Personal computers and the DX100: Epson PX-8, HX20 portables and QX10 desktop, IBM PC, Apricot, Apple and DEC Rainbow are all fully compatible.



THE EPSON DX100 DAISY WHEEL PRINTER £475 (+VAT).

Reveal all about the Epson DX100 and where I can get one, quick.

Name

Company

Address

PC6/85

To: Epson (UK) Ltd., Dorland House, 388 High Road, Wembley, Middlesex HA9 6UH or phone Epson Freephone.

EPSON

SPRITE-DES

JON ABBOTT has submitted a program which allows you to design and save sprites on the graphics screen.

Sprites are defined multi-coloured characters which can be moved around the screen. This can be done in Basic or machine code. These programs allow you to use

eight-by-eight or eight-by-16 pixel sprites. You are allowed a maximum of eight designs, with four clones of the same sprite on the screen at any one time. The entire system, including machine code and sprite data, takes only 1K.

ProcInit sets up the function keys, enables the cursor keys to be

read using the Get statement, assembles a few bytes of machine code, initialises a 640-times table and sets up the sprite data bytes and addresses.

ProcMenu may be of general interest. It prints the options, highlighting the currently selected one, and lets the user change options by the cursor keys.

ProcEdit is the main sprite edit/create procedure. If no sprite

exists then a new entry is made in the sprite data table. A new procedure is called, ProcScreen, to display and edit the sprite selected. Use cursor keys to move about the box and FN to select colour. Clear the current design by pressing C, exit the design by pressing E.

ProcSave/ProcLoad save and load sprite definitions for editing. ProcClearall deletes the entire sprite data in memory.

SPRITE-DES

```

10 REM *****
**
20 REM * Sprite Designer Ver 1.4
*
30 REM * (C) Jon Abbott 1984
*
40 REM *****
**
50 REM
60 REM - HIMEM must be set at &2
COO
70 REM - when using sprites
80 REM
90 MODE 7:HIMEM=&2COO
100 PROCinit
110 REPEAT
120 MODE 7:HIMEM=&2COO
130 PROCmenu
140 ON C% GOTO 150,180,200,220,24
0,260
150 MODE 2:HIMEM=&2COO
160 PROCedit
170 GOTO 260
180 PROCsave
190 GOTO 260
200 PROCload
210 GOTO 260
220 PROCclearall
230 GOTO 260
240 MODE 2:HIMEM=&2COO
250 PROCdisplay
260 UNTIL C%=6
270 *FX 4
280 *FX 12
290 MODE 7:HIMEM=&2COO
300 END
310 DEF PROCmenu
320 VDU 23;8202;0;0;0;
330 LOCAL A%,G%,A$
340 FOR A%=0 TO 1
350 VDU 31,6,A%,141,132,157,135
360 PRINT"Sprite Designer ";CH
R$156
370 NEXT
380 VDU 31,10,3,133
390 PRINT"By Jon Abbott"
400 RESTORE 460
410 FOR A%=1 TO 6
420 READ A$
430 VDU 31,7,4+2*A%,129
440 PRINTA$;TAB(22)CHR$156
450 NEXT
460 DATA"Create/Edit a sprite","S
ave sprites"
470 DATA"Load sprites","Clear all
sprites"
480 DATA"Display sprites","Quit"
490 VDU 31,2,20,132:PRINT"Use ver
tical cursor keys to move to"
500 VDU 31,1,22,132:PRINT"selecti
on. Use COPY to make selection";
510 C%=1
520 REPEAT
530 VDU 31,5,4+2*C%,131,157
540 REPEAT
550 G%=GET
560 UNTIL G%=135 OR G%=138 OR G%=
139
570 VDU 31,5,4+2*C%,32,32
580 C%=C%-(G%=138)+(G%=139)
590 IF C%>6 C%=1 ELSE IF C%<1 C%=
6
600 UNTIL G%=135
610 ENDPROC
620 DEF PROCedit
630 VDU 23;8202;0;0;0;
640 LOCAL G%
650 PRINT"Enter sprite number""(
0-7)";
660 REPEAT
670 G%=GET-48
680 UNTIL G%>=0 AND G%<=7
690 VDU G%+48
700 S%=G%
710 A%=(82D70+2*G%) AND &FFFF
720 IF A%<0 Z%=(S%?&2D68)DIV 16
+8:GOTO820
730 !(&2D70+2*G%)=(!(&2D70+2*G%)A
ND &FFFF0000)OR N%
740 A%=N%
750 PRINT""What size (0/1)?";
760 REPEAT
770 G%=GET-48
780 UNTIL G%=0 OR G%=1
790 S%?&2D68=G%*128
800 Z%=G%*8+8
810 N%=N%+32+32*G%
820 PROCscreen
830 X%=0:Y%=0
840 PROCcursor
850 REPEAT
860 G%=GET
870 PROCcursor
880 IF G%>=2 AND G%<=17 PROCfill(
G%-2)
890 IF G%=67 PROCclearcurrent
900 IF G%=136 X%=X%-1:IF X%<0 X%=
7
910 IF G%=137 X%=(X%+1)MOD 8
920 IF G%=138 Y%=(Y%+1)MOD Z%
930 IF G%=139 Y%=Y%-1:IF Y%<0 Y%=
Z%-1
940 PROCcursor
950 PROCshowsprite(&4F80)
960 UNTIL G%=69
970 ENDPROC
980 DEF PROCscreen
990 CLS
1000 COLOUR 6
1010 PRINT" Sprite Designer"
1020 LOCAL B%
1030 IF Z%=8 L%=424:H%=768:ELSE L%
=64:H%=744
1040 GCOL 0,2
1050 FOR B%=0 TO 63 STEP 4
1060 PROCbox(66+B%,L%-64+B%,588-B%
H%+64-B%)
1070 NEXT
1080 PROCshowsprite(&4F80)
1090 FOR X%=0 TO 7 STEP 2
1100 FOR Y%=0 TO Z%-1
1110 ?&70=A%?((X% DIV 2)*8+(Y% MOD
8)-(Y%>7)*32)
1120 CALL unpack
1130 PROCsquare(?&71)
1140 X%=X%+1
1150 PROCsquare(?&72)
1160 X%=X%-1
1170 NEXT
1180 NEXT
1190 PROCwrite
1200 ENDPROC
1210 DEF PROCsave
1220 LOCAL F$
1230 CLS
1240 PRINT TAB(1,4)"Please enter t
he name of the sprite"" file to be
saved:";
1250 INPUT F$:PRINT"
1260 OSCLI "SAVE "+F$+" 2D68 2FFF"
1270 ENDPROC
1280 DEF PROCload
1290 LOCAL F$
1300 CLS
1310 PRINT TAB(1,4)"Please enter t
he name of the sprite"" file to be
loaded:";
1320 INPUT F$:PRINT"
1330 OSCLI "LOAD "+F$+" 2D68"
1340 ENDPROC
1350 DEF PROCclearall
1360 LOCAL A%
1370 FOR A%=&2D68 TO &2DBF STEP 4
1380 !A%=0
1390 NEXT
1400 FOR A%=&2E00 TO &2FFF STEP 4
1410 !A%=0
1420 NEXT
1430 N%=&2E00
1440 ENDPROC
1450 DEF PROCdisplay
1460 VDU 23;8202;0;0;0;
1470 FOR S%=0 TO 7
1480 PRINT TAB(0,1+3*S%);"Sprite "
;S%
1490 A%=(82D70+2*S%) AND &FFFF
1500 PROCshowsprite(&34C0+640*3*S%
)
1510 NEXT
1520 REPEAT UNTIL INKEY(-99)
1530 ENDPROC
1540 DEF PROCcursor
1550 GCOL 4,0
1560 PLOT 69,154+48*X%,H%-28-42*Y%
1570 PLOT 66,8,0
1580 PLOT 66,0,8
1590 PLOT 66,-8,0
1600 ENDPROC
1610 DEF PROCbox(X%,Y%,X1%,Y1%)
1620 MOVE X%,Y%
1630 DRAW X1%,Y%
1640 DRAW X1%,Y1%
1650 DRAW X%,Y1%
1660 DRAW X%,Y%
1670 ENDPROC
1680 DEF PROCfill(C%)
1690 LOCAL M%,O%
1700 PROCsquare(C%)
1710 ?&70=C%
1720 CALL extend
1730 M%=&55*(1+(X% MOD 2))

```



```

1740 CX=?&70*(2-(X% MOD 2))
1750 OX=A%-(Y%>7)*32+(X% DIV 2)*8+
(Y% MOD 8)
1760 ?0%=(?0% AND M%)OR C%
1770 ENDPROC
1780 DEF PROCshowsprite(Q%)
1790 LOCAL P%
1800 FOR P%=0 TO 31 STEP 4
1810 Q%!P%=A%!P%
1820 NEXT
1830 IF S%?&2D68=0 ENDPROC
1840 Q%=Q%+608
1850 FOR P%=32 TO 63 STEP 4
1860 Q%!P%=A%!P%
1870 NEXT
1880 ENDPROC
1890 DEF PROCsquare(A%)
1900 GCOL 0,A%
1910 MOVE 141+X%*48,H%-4-Y%*42
1920 PLOT 0,0,-38
1930 PLOT 81,40,38
1940 PLOT 81,0,-38
1950 ENDPROC
1960 DEF PROCclearcurrent
1970 LOCAL B%
1980 FOR B%=A% TO A%+4*Z% STEP 4
1990 !B%=0
2000 NEXT
2010 PROCshowsprite(&4F80)
2020 VDU 24,140;L%;514;H%;
2030 CLG
2040 VDU 26
2050 X%=0;Y%=0
2060 ENDPROC
2070 DEF PROCwrite
2080 LOCAL A%
2090 VDU 5
2100 MOVE 64,892;GCOL 0,7
2110 FOR A%=224 TO 227
2120 VDU A%;NEXT
2130 VDU 32,32
2140 FOR A%=228 TO 231
2150 VDU A%;NEXT
2160 MOVE 64,932
2170 FOR A%=232 TO 241
2180 VDU A%;NEXT
2190 MOVE 1114,892
2200 VDU 250,251,252
2210 VDU 4
2220 FOR A%=0 TO 7
2230 COLOUR 7
2240 VDU 31,14,6+2*A%,A%+242
2250 COLOUR A%;VDU 32,255:COLOUR 8
+A%;VDU 32,255
2260 NEXT
2270 ENDPROC
2280 DEF PROCinit
2290 PROCchars
2300 IF N%<&2E00 PROCclearall
2310 P%=&D02
2320 COPT 0
2330 .unpack
2340 LDA #0:STA &71:STA &72
2350 LDX #4
2360 .L3 ROL &70:ROL &71
2370 ROL &70:ROL &72
2380 DEX:BNE L3
2390 RTS
2400 .extend
2410 LDA #0:CLC:LDX #4
2420 .L4 ROR &70:ROR A:ROR A
2430 DEX:BNE L4
2440 STA &70:RTS
2450 J
2460 FOR A%=0 TO 31
2470 ?(&2DC0+2*A%)=(A%*640)MOD 256
2480 ?(&2DC1+2*A%)=(A%*640)DIV 256
2490 NEXT
2500 *FX4,1
2510 *FX225,2
2520 *FX226,10
2530 ON ERROR GOTO 270
2540 ENDPROC
2550 END
2560 DEF PROCchars
2570 VDU 23,224,103,130,130,130,98
,0,0,0
2580 VDU 23,225,67,164,164,164,67,
0,0,0
2590 VDU 23,226,142,136,140,136,23
8,0,0,0
2600 VDU 23,227,76,170,236,170,170
,0,0,0
2610 VDU 23,228,231,130,194,130,22
6,0,0,0
2620 VDU 23,229,71,164,166,164,71,
0,0,0
2630 VDU 23,230,85,84,36,84,84,0,0
,0
2640 VDU 23,231,192,128,128,128,12
8,0,0,0
2650 VDU 23,232,174,168,174,162,23
8,0,0,0
2660 VDU 23,233,227,132,196,132,22
7,0,0,0
2670 VDU 23,234,86,85,86,85,117,0,
0,0
2680 VDU 23,235,114,69,117,21,114,
0,0,0
2690 VDU 23,236,98,82,99,82,82,0,0
,0
2700 VDU 23,237,186,162,49,161,185
,0,0,0
2710 VDU 23,238,187,161,57,9,57,0,
0,0
2720 VDU 23,239,162,83,82,82,34,0,
0,0
2730 VDU 23,240,73,213,85,85,72,0,
0,0
2740 VDU 23,241,92,80,88,80,156,0,
0,0
2750 VDU 23,242,238,138,202,138,14
2,0,0,0
2760 VDU 23,243,232,136,200,136,13
6,0,0,0
2770 VDU 23,244,238,130,206,136,14
2,0,0,0
2780 VDU 23,245,238,130,198,130,14
2,0,0,0
2790 VDU 23,246,232,136,202,142,13
0,0,0,0
2800 VDU 23,247,238,136,206,130,14
2,0,0,0
2810 VDU 23,248,238,136,206,138,14
2,0,0,0
2820 VDU 23,249,238,130,194,130,13
0,0,0,0
2830 VDU 23,250,14,72,238,66,14,0,
0,0
2840 VDU 23,251,171,170,235,170,17
0,0,0,0
2850 VDU 23,252,184,16,16,16,16,0,
0,0
2860 VDU 23,255,31,31,31,31,31,0,0
,0
2870 ENDPROC
>

```

HATCHER

```

1 REM: 'POLY' by K. Murray 1985
2 REM: Line 10 = Main loop, rep
eated until 'Escape' or 'Break'.
3 :
4 :
10 MODE2:VDU23;8202;0;0;0;0;:REP
EAT:X%=RND(-TIME):PROCPOLY(RND(1280
),RND(1024),50+RND(350),20):UNTIL F
ALSE
11 :
12 :
15 REM: Line 20 = PROC. to cross
hatch on vertical & horisontal.
16 :
17 :
20 DEFPROCGRID:VDU29,0;0;:GCOLRN
D(4)-1,RND(8)-1:FORK%=0TO1280STEPRN
D(4)*8:MOVEK%,0:PLOT21,K%,1024:NEXT
:GCOLRND(4)-1,RND(8)-1:FORK%=0TO102
4STEPRND(4)*4:MOVEO,K%:PLOT21,1280,
K%:NEXT:ENDPROC
21 :
22 :
25 REM: Line 30 = PROC. to cross
hatch on diagonals.
26 :
27 :
30 DEFPROCDIAGRID:VDU29,0;0;:GCO
LRND(4)-1,RND(8)-1:FORK%=0 TO 2500
STEPRND(8)*8:MOVEK%,0:PLOT21,0,K%:N
EXT:GCOLRND(4)-1,RND(8)-1:Q%=RND(8)
*8:L%=0:FORK%=1280 TO -1000STEP-Q%:
MOVEK%,0:PLOT21,1280,L%:L%=L%+Q%:NE
XT:ENDPROC
31 :
32 :
35 REM: Lines 40-60 = PROC. to s
elect colours, draw polygons & rand
only select crosshatching.
36 :
37 :
40 DEFPROCPOLY(X0,Y0,R,N%):VDU29
,X0,Y0;:PROCG(RND(4)-1,RND(8)-1,RND
(8)-1):T=2*PI/N%:S=SIN(T):C=COS(T):
X1=R:Y1=0:MOVEX1,Y1:M%=1:REPEAT:MOV
EO,0:X=X1*C-Y1*S:Y=X1*S+Y1*C:PLOT85
,X,Y:X1=X:Y1=Y:M%=M%+1

```

HATCHER

K MURRAY has sent in a graphics drawing program which contains an interesting combination of circle and hatching routines. The program makes full use of the BBC's graphics capabilities to draw some attractive polygonal shapes. What is most pleasing is the varied overlaying using EOr with non-standard GCol statements. 

```

50 UNTILM%>N%:IF RND(10)<>3 ENDP
ROC
60 IFRND(8)<5 PROCGRID:ENDPROC E
LSE PROCDIAGRID:ENDPROC
61 :
62 :
65 REM: Line 70 = PROC. to togg
e between two colours of pixels.
66 :
67 :
70 DEFPROCG(O,F,S):LOCAL A,B:GCO
LO,F:A=?&359 AND &AA:GCOLO,S:B=?&35
9 AND &55:??&359=A+B:ENDPROC

```

RAMROM 15

The Sideways RAM & ROM Expansion Board for the BBC

The GCC RAMROM 15 board adds to the BBC Micro another eleven sideways ROM sockets plus the necessary hardware for sideways RAM.

FEATURES

- ★ Fully buffered board.
- ★ Rechargeable battery backup for RAMS provided as standard. Recharging circuitry is included.
- ★ The board can be powered by an external 5 Volt power supply, available as an optional extra.
- ★ The unit comes in a case of its own and resides outside the BBC Micro, giving easy access to the resident ROMS.
- ★ For those involved in development work, most of the 6502 processor signals are made available outside the BBC Micro.
- ★ Priority or selection can be assigned to either RAMS or ROMS.
- ★ ROMS can be used in RAM positions simply by changing two push-on links.
- ★ Simple installation - NO soldering.
- ★ Can be installed together with most other BBC add-on boards.
- ★ ZIF-sockets available as optional extras. Up to 15 may be housed on the RAMROM 15 at any one time.
- ★ All socket positions are software selectable.
- ★ Free Utilities Disk supplied.
- ★ Comprehensive User Manual included.

Now at a lower price

RAMROM 15.....£86.95 inc VAT (P&P £3.50 inc VAT)
 EXTERNAL PSU.....£5.75 inc VAT (P&P £1.73 inc VAT)
 ZIFSOCKETS.....£9.00 inc VAT (Free P&P with RAMROM)

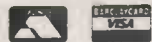

Trade and local authority enquiries welcome.
 Prices correct at time of going to press.

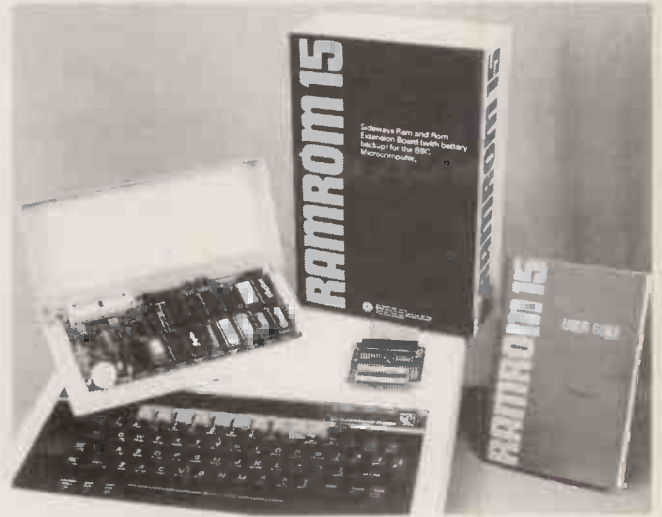

GCC (Cambridge) Limited
 66 High Street, Sawston, Cambridge CB2 4BG
 Telephone: Cambridge (0223) 835330/834641
 Telex: 81594 SAWCOM

● Circle No. 168

STARdataBASE . . .

The database

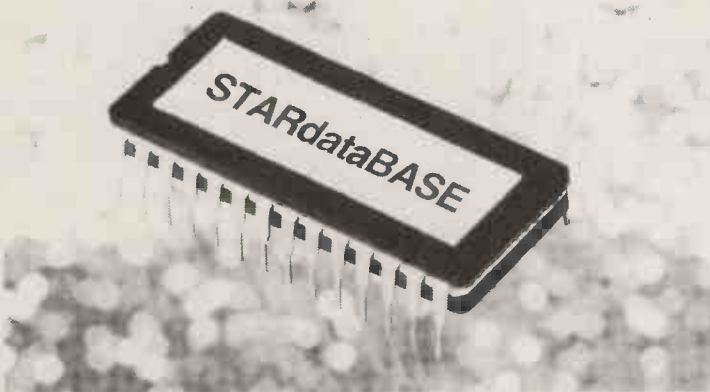

for the BBC

STARdataBASE is the fast, machine-code, true random access, database program in 16K ROM for the BBC Microcomputer, complete with over 75K of FREE extension Software.

FEATURES:

- ★ Up to 4096 records in a file.
- ★ Up to 69 fields in a record.
- ★ Up to 255 characters in a field (subject to an overall maximum of 920 characters in a record).
- ★ An entirely User-defined record layout, including a facility for colour.
- ★ Can be used with 40 and 80 track Disk Drives.
- ★ Entirely Menu-driven, extremely User-friendly.
- ★ Extremely fast search - A single record can typically be found in 1 second using the Keysearch facility.
- ★ Search conditions include the following: =, <>, <, >, and "Anywhere in the field".
- ★ Powerful facilities to edit records.
- ★ Mail-merging between documents created on Wordwise or View, and STARdataBASE records.
- ★ Print-out of the whole database or selected Subsets, in the form of Record cards.
- ★ Address label printing - (up to 8 across the page).
- ★ Fully documented routines which can be included in user-written programs and interfaced with STARdataBASE.

Now at a lower price

STARdataBASE.....£65.22 inc VAT
 Post & Packing.....£1.75 inc VAT



Trade and local authority enquiries welcome.
 Prices correct at time of going to press.



GCC (Cambridge) Limited
 66 High Street, Sawston, Cambridge CB2 4BG
 Telephone: Cambridge (0223) 835330/834641
 Telex: 81594 SAWCOM

● Circle No. 188

AUTO AID

AUTOAID will be of use to those who have a CCS-7710A serial card and a Minor Miracles WS-2000 modem with the auto-dial/auto-answer board installed. Minor Miracles only provides a program listing for the BBC Micro in its manual and from chats with other Apple users I found that most of them do not use their WS-2000

auto-dial/auto-answer boards because they do not know how to drive them. Well, wait no longer. The program asks you to enter the number you wish to dial, goes away and dials for you, and finally runs a separate terminal program stored on disc. Just substitute the name of your terminal program on line 510.

This program assumes that you have made the cable modifications indicated in the Minor Miracles AD/AA manual. This can be done by making a connecting cable as indicated in the diagram on the right.

The WS-2000 internal links are set as DTR External, CTS External and RTS Internal.

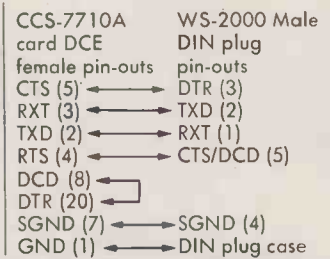

AUTO AID

```

1  REM ** AUTO DIALLER PROGRAM **      150  REM POKE49313,0 SETS TX DATA
2  REM ** APPLE + CCS 7710A CARD      160  POKE 49312,21
3  REM ** IN SLOT 2 & DCE-TO-DTE      170  REM POKE 49312,21 SETS CTS (
4  REM ** ADAPTOR ATTACHED.          180  FOR TIME = 0 TO 5
5  REM ** DATA/STOP/PARITY=8/1/0    181  POKE 40184,0
6  REM                                  182  NEXT TIME
7  REM  IN THE TIMING LOOPS:         190  NEXT OUTPUT
8  REM                                  200  PRINT
9  REM      FOR TIME=0 TO -          210  RETURN
10 REM      POKE 40184,0            220  REM * HEADER PROC. *
11 REM      NEXT TIME                230  HOME
12 REM                                  240  PRINT "TYPE IN TEL. NUMBER,
13 REM  POKE 40184,0 IS JUST A      250  INPUT N$
14 REM  WAY OF WASTING TIME AND      260  HOME
15 REM  DOES NOT HAVE ANY OTHER     270  RETURN
16 REM  EFFECT (MEMORY LOCATION     280  REM * PAUSE FOR N SEC. PROC. *
17 REM  40184 IS AN UNUSED BYTE     290  FOR TIME = 0 TO N * 100
18 REM  IN THE APPLE DOS AREA).     291  POKE 40184,0
19 REM                                  292  NEXT TIME
20 POKE 33,40: POKE 35,23: REM      300  RETURN
   SET 40X24 TEXT WINDOW.           310  REM * DIAL PROC. *
30 GOSUB 220: REM  HEADER           320  HTAB 10: VTAB 10: PRINT "D I
40 GOSUB 310: REM  DIAL              A L L I N G"
50 GOSUB 450: REM  TERMINAL MODE     330  N = 1: GOSUB 280
60 END                                340  X = LEN (N$)
70 REM * DIAL OUT PROCEDURE *        360  FOR P = 1 TO X
75 REM * RESET ACIA CHIP ON CARD     370  DIGIT$ = MID$ (N$,P,1)
84 FOR TIME = 0 TO 100               380  DIAL = VAL (DIGIT$)
85 POKE 49312,21                     390  PRINT DIGIT$;
86 NEXT TIME                          400  IF DIAL = 0 THEN DIAL = 10
90 REM                                  410  GOSUB 70
100 FOR OUTPUT = 1 TO DIAL           420  N = 0.5: GOSUB 280
110 POKE 49312,85: REM SET 7710A    430  NEXT P
   CTS (RTS DTE) LOW.               440  RETURN
120 PRINT "*";                       450  REM * CALL TERMINAL PROC. *
130 REM ** SET DIAL MARK & SPACE    460  HTAB 10: VTAB 10: PRINT "W A
   HERE:                             I T I N G "
140 FOR TIME = 0 TO 4               470  N = 5: GOSUB 280
141 POKE 49313,0                     480  PRINT : PRINT
142 NEXT TIME                         490  HOME
510 REM * THIS IS A STANDARD TER    500  REM * THIS IS A STANDARD TER
   MINAL PROGRAM FROM HERE ON T      MINAL PROGRAM FROM HERE ON T
   O END:                             O END:
510 PRINT CHR$ (4);"BRUN TERMIN    510 PRINT CHR$ (4);"BRUN TERMIN
   AL PROGRAM"                        AL PROGRAM"
520 RETURN                             520 RETURN

```

PC



At £1575 it's a portable you can take sitting down

At £1575, the Bondwell 2 is more than just a pleasant surprise. It's a true personal computer that's also a lap-held portable. A full-sized screen, integral disk drive and complete suite of software is only the start. Equivalent machines are twice the price (at least) or offer half the features.

Weighing in at 12 lbs, the Bondwell 2 fits in a briefcase. MicroPro word processing, database manager, report generator and electronic spreadsheet (worth up to £1000) are included in the price. As well as everything else you expect in a lap-held portable: rechargeable battery, qwerty keyboard, communications ports and an expansion slot.

Complementing the lap-held is its big brother, the Bondwell 16. A transportable that includes a 10 Mb hard disc and integral modem (as well as full software) for £2250.

Barbatan Limited

35 - 38 High Street
Bristol BS1 2AW
Tel: Bristol (0272) 213928

Attractive trade discounts are available.
Dealer enquiries welcome.

MACHINE-CODE SUPER SORT

THERE MUST BE hundreds of machine-code bubble sorts, but this is the first one I have come across that has been designed and coded specifically for the Sharp MZ-80A.

Dave Lane's Super Sort is set up for sorting numeric arrays. He has provided two listings. The first is a very plentifully commented hex-cum-assembler listing for those who want to understand how the sort works. The second is a Basic loader — you have to complete it yourself from the hex values in the second column of the assembler listing — which can also be used to save the machine code to tape, if you wish.

To use Super Sort from Basic type Mon to return to the monitor, then load the machine code using the L command. After loading, control will be returned to Basic with program and variables intact and you can have the contents of

any numeric array sorted by the command

```
USR(SCF00,D$)
```

once the name of the array has been assigned to D\$. The same procedure can be followed from within a Basic program provided that the program has already set aside sufficient memory, using Limit 52991, and then loaded the machine code into place.

Super Sort sorts a numeric array of up to 255 elements into ascending order, and does it quite quickly: 100 numbers in one second, 200 in five seconds and 255 in less than 10. If you were thinking that a string array sort would have been useful, think again. Any program that swaps strings about is terribly slow; what it should do is swap the pointers to elements of the string array, not the strings themselves which are contained in the elements.

BASIC LOADER

```
10 REM Super-Sort   Load/Dump
20 REM Dave Lane   05/01/1984
30 LIMIT 52991
40 PRINT"Loading data into memory takes 30 secs..."
50 LET S=52992:    REM start address
60 LET C=0:        REM checksum count
70 FOR N=0 TO 185: REM 186 bytes
80 READ H$:       REM get hex byte
90 LET D=0:       REM hex to decimal
100 FOR I=1 TO 2
110 LET D=D+INT(16^(2-I))*(ASC(MID$(H$,I,1))-48+7*(ASC
(MID$(H$,I,1))>57))
120 NEXT I
130 POKE S+N,D:    REM load into memory
140 LET C=C+D:     REM add to checksum
150 NEXT N
160 IF C<>15621 THEN PRINT"Checksum error - Recheck
data.":STOP
170 PRINT"Ready to save to tape..."
180 PRINT
190 POKE $10F0,$01: REM m/c prog
200 POKE $10F1,ASC("S"):REM name
210 POKE $10F2,ASC("u")
220 POKE $10F3,ASC("p")
230 POKE $10F4,ASC("e")
240 POKE $10F5,ASC("r")
250 POKE $10F6,ASC("n")
260 POKE $10F7,ASC("S")
270 POKE $10F8,ASC("o")
280 POKE $10F9,ASC("r")
290 POKE $10FA,ASC("t")
300 POKE $10FB,$0D
310 POKE $1102,$BA:REM size of prog
320 POKE $1103,$00
330 POKE $1104,$00:REM load address
340 POKE $1105,$CF
350 POKE $1106,$50:REM exec address
360 POKE $1107,$12
370 USR($21):REM write tape header
380 USR($24):REM write data
390 END
400 DATA 18,07,00,00,00,00,00,00
410 REM.....and so on!
```

ASSEMBLER/HEX LISTING

```
1      :Super-Sort.   Sharp MZ80A.
2      :Dave Lane   05/01/84
3      :
4      :
5      :   ORG @CF00H
6      :   LOAD @CF00H
7      :
8      :   BARRSP: EQU 4E80H   ;addr Basic array start ptr
9      :   BARRREP: EQU 4EBAH ;addr array area end pointer
10     :
11     :
12     :   storage for variables and flags
13     :   VNAME: DW @002H   ;name of array
14     :   XFLAG: DB @0H    ;exchange number flag
15     :   INLOOP: DB @0H   ;number of elements in array
16     :   NEGFLG: DB @0H  ;negative second number flag
17     :   ARRYST: DW @002H ;addr of start of array
18     :
19     :   on entry DE points to start of array
20     :   variable name and BC holds length
21     :   of name
22     :
23     :   1A START: LD A,(DE) ;first char of name into A
24     :   32 02 CF LD (VNAME),A ;then into store
25     :   0D DEC C
26     :   26 04 JR NZ,NXTCHR ;jump if another character
27     :   3E 20 LD A,20H   ;else put space char into A
28     :   1B 02 JR NMDONE ;then jump
29     :   13 NXTCHR: INC DE ;move to second character
30     :   1A LD A,(DE) ;and get it into A
31     :   32 03 CF LD (VNAME+1),A ;put space/char into store
32     :   2A BA 4E LD HL,(BARRREP) ;end of array area into HL
33     :   ED 5B 8B 4E LD DE,(BARRSP) ;and start into DE
34     :   AF XOR A ;clear carry flag
35     :   ED 52 SBC HL,DE ;length of array area into HL
36     :   34 44 LD B,H ;then copy...
37     :   3D 4D LD C,L ;...into BC
38     :   EB EX DE,HL ;transfer start into HL and
39     :   3A 02 CF FNDCHR: LD A,(VNAME) ;first part of name into A
40     :   ED B1 CPIR ;search array area for name
41     :   17 B8 LD A,B ;back to Basic, if...
42     :   B1 OR C ;...end of array...
43     :   CB RET Z ;...area reached
44     :   3A 03 CF LD A,(VNAME+1) ;second part of name into A
45     :   BE CP (HL) ;check against array name
46     :   20 F2 JR NZ,FNDCHR ;continue search if no match
47     :   23 INC HL ;move on to array size byte
48     :   7E LD A,(HL) ;and get into A
49     :   32 05 CF LD (INLOOP),A ;store array size
50     :   23 INC HL ;move HL to start...
51     :   23 INC HL ;...of first number
52     :   22 07 CF LD (ARRYST),HL ;store this address
53     :   3E 01 PASS: LD A,@1H ;set exchange number...
54     :   32 04 CF LD (XFLAG),A ;...pair flag
55     :   3A 05 CF LD A,(INLOOP) ;get array size into A
56     :   4F LD C,A ;then into counter C
57     :   2A 07 CF LD HL,(ARRYST) ;point HL to first number
58     :   MLOOP: LD D,H ;copy HL...
59     :   5D LD E,L ;...into DE
60     :   40 13 INC DE ;move DE on...
61     :   13 INC DE ;...five bytes...
62     :   13 INC DE ;...to point to...
63     :   13 INC DE ;...the next...
64     :   13 INC DE ;...number in array
65     :   AF XOR A ;set A to 0 to reset...
66     :   32 06 CF LD (NEGFLG),A ;...negative second number flag
67     :   1A LD A,(DE) ;get exponent/sign bit into A
68     :   CB 7F BIT 7,A ;check sign bit
69     :   20 05 JR NZ,SGNCMP ;...positive so skip
70     :   3E 01 LD A,@1H ;...negative so set...
71     :   32 06 CF LD (NEGFLG),A ;...negative second number flag
72     :   1A LD A,(DE) ;compare sign of second...
73     :   SGNCMP: XOR (HL) ;...number with first...
74     :   CB 7F BIT 7,A ;...number
75     :   20 20 JR NZ,NEGCHI ;jump if signs differ
76     :   1A LD A,(DE) ;exponent of second number into A
77     :   7E CP (HL) ;compare exponent of first
78     :   28 04 JR Z,EDUPWR ;jump if exponents equal
79     :   3B 20 JR C,NEGCH2 ;jump if first > second
80     :   1B 18 JR NEGCH1 ;jump if second > first
81     :   06 04 EQUPWR: LD B,@4H ;exponents same so...
82     :   E5 CPBYTE: PUSH HL ;...next 4 bytes must...
83     :   D5 PUSH DE ;...be checked and...
84     :   C5 PUSH BC ;...the registers saved
85     :   23 MOVEON: INC HL ;move to the next...
86     :   13 INC DE ;...most significant...
87     :   10 FC DJNZ MOVEON ;...pair of mantissa bytes
88     :   1A LD A,(DE) ;compare byte from sec number...
89     :   BE CP (HL) ;...with byte from first number
90     :   C1 POP BC ;restore registers...
91     :   D1 POP DE ;...before making...
92     :   E1 POP HL ;...the appropriate jump
93     :   3B 0E JR C,NEGCH2 ;jump if first > second
94     :   2B 02 JR Z,SAME ;skip if both bytes the same
95     :   1B 04 JR NEGCH1 ;jump if second > first
96     :   10 EC SAME: DJNZ CPBYTE ;try next pair of bytes
97     :   1B 20 JR NXCH ;all bytes same - no exchange
98     :   3A 06 CF NEGCH1: LD A,(NEGFLG) ;is the second...
99     :   3D DEC A ;...number negative?
100    :   1B 04 JR ?EXCH ;skip this bit...
101    :   3A 06 CF NEGCH2: LD A,(NEGFLG) ;is the second...
102    :   0A OR A ;...number positive?
103    :   20 14 ?EXCH: JR NZ,NXCH ;no exchange if either answer yes
104    :   E5 PUSH HL ;save registers and...
105    :   D5 PUSH DE ;...prepare to exchange...
106    :   06 05 LD B,@5H ;...the five-byte numbers
107    :   1A LD A,(DE) ;byte from second number into A
108    :   0B SWOP: EX AF,AF ;...save it
109    :   7E LD A,(HL) ;byte from first number into A
110    :   1A LD (DE),A ;...then into second number
111    :   0B EX AF,AF ;now shift saved byte...
112    :   77 LD (HL),A ;...into first number
113    :   23 INC HL ;move to next...
114    :   13 INC DE ;...pair of bytes
115    :   10 F6 DJNZ SWOP ;and repeat the process
116    :   D1 POP DE ;restore registers
117    :   E1 POP HL ;
118    :   AF XOR A ;set A to 0 to...
119    :   32 04 CF LD (XFLAG),A ;...reset exchange number flag
120    :   EB DEC C ;get addr of second num into HL
121    :   0D ;...end of pass reached?...
122    :   20 A1 JR NZ,MLOOP ;...no, do next pair of numbers
123    :   3A 05 CF LD A,(INLOOP) ;get array size into A since...
124    :   3D DEC A ;...now need one less comparison
125    :   0A OR A ;if this is last pair...
126    :   28 03 JR Z,LAST1 ;...don't shorten list
127    :   32 05 CF LD (INLOOP),A ;store the new size
128    :   3A 04 CF LAST1: LD A,(XFLAG) ;has the exchange flag...
129    :   0A OR A ;...been resp?
130    :   28 05 JR Z,PASS ;...if yes do next pass...
131    :   C9 RET ;...otherwise back to Basic
132    :   132
133    :   END
```

WORDSTAR TEXT INPUT

IF YOU ARE a regular WordStar user you may find this Microsoft Basic program by D J Monk convenient for inputting text in other applications. The program allows you to use the standard WordStar commands to control the cursor and do simple deletions of up to a single line. It was written on a Superbrain 1, but the code uses no cursor-addressing features and should be machine-independent.

Used as a Microsoft Basic subroutine instead of the standard Input command the program offers all the following WordStar commands

Ctrl-S — move cursor one character left
 Ctrl-D — move cursor one character right
 Ctrl-A — move cursor one word left
 Ctrl-F — move cursor one word right
 Ctrl-G — delete current character
 Ctrl-T — delete one word to right of cursor
 Ctrl-Y — delete whole line
 Any letter entered is automatically inserted in the text.
 In addition, there are some other commands not found in WordStar but which are useful

WORDSTAR-LIKE TEXT OUTPUT

```

0 'KEYBOARD INPUT USING WORD STAR COMMANDS ...BY D J Monk
10 WIDTH 255 'STOP AUTO LINE FEED/ CARRAGE RETURN
20 LS="THE QUICK BROWN FOX JUMPS OVER THE LAZY DOGS." 'LAST STRING ENTERED
30 LX=50 'MAXIMUM STRING LENGTH TO ALLOW
40 CAPS="N" 'ALLOW LOWER CASE
50 GOSUB 7000 'GET STRING
60 LS=KBS
70 GOTO 50
7000 'KEYBOARD INPUT USING WORD STAR COMMANDS
7010 'LX = MAX LENGTH OF STRING INPUT (< > DELIMITERS USED)
7020 'LS=LAST INPUT FOR RE-INSTATING
7030 '(CAPS="Y") CONVERTS TO UPPER CASE
7040 'CTRL S = MOVE CURSOR LEFT 1 CHARACTER
7050 'CTRL A = MOVE CURSOR LEFT 1 WORD
7060 'CTRL D = MOVE CURSOR RIGHT 1 CHARACTER
7070 'CTRL F = MOVE CURSOR RIGHT 1 WORD
7080 'CTRL G DELETES CURRENT CHARACTER
7090 'CTRL T DELETES WORD TO RIGHT OF CURSOR
7100 'CTRL Y DELETES WHOLE LINE
7105 'CTRL E RESTORES LAST INPUT
7110 'BACKSPACE DELETES LAST CHARACTER OR MOVES LEFT
7120 'KBS RETURNS FINAL INPUT
7130 'KS= CHARACTER INPUT
7140 CPX=1 'RELATIVE CURSOR POSITION
7150 IF LX THEN PRINT"<" + STRINGS(LX,32) + ">" + STRINGS(LX+1,8); 'PRINT DE
LIMITERS
7160 KBS="":KS=""
7170 KS=INPUTS(1) 'GET CHARACTER
7180 IF CAPS="Y" THEN IF KS="a" AND KS<="z" THEN KS=CHR$(ASC(KS)-32)
'CONVERT TO CAPITALS
7190 LKB%=LEN(KBS)
7200 IF KS=" " AND KS< CHR$(127) THEN 7340 'CONTROL CHARACTER?
7210 IF KS=CHR$(27) THEN GOTO 10 'ESC ROUTINE
7220 IF KBS="" AND KS=CHR$(5) THEN KBS=LS:PRINT KBS;:CPX=LEN(KBS)+1 'R
E-INSTATE LAST STRING IF "HERE IS" OR CTRL 'E' IS PRESSED.
7230 IF KS=CHR$(8) AND LKBX<0 THEN IF LKBX=CPX-1 THEN KBS=LEFT$(KBS,L
KBS-1):CPX=CPX-1:PRINT KS;" ";KS; ELSE KS=CHR$(19) 'B/SPACE OR MOVE ?
7240 IF KS=CHR$(13) THEN IF KBS="" THEN KBS=LS:PRINT LS:RETURN ELSE PR
INT:RETURN
7250 IF KS=CHR$(19) THEN IF CPX>1 THEN CPX=CPX-1:PRINT CHR$(8); 'CTRL
S MOVES <
7260 IF KS=CHR$(4) THEN IF CPX<LKBX+1 THEN PRINT MID$(KBS,CPX,1):CPX=
CPX+1 'CTRL D MOVES >
7270 IF KS=CHR$(1) AND CPX>1 THEN PRINT CHR$(8);:CPX=CPX-1:IF CPX>1 TH
EN IF MID$(KBS,CPX-1,1)<>" " OR MID$(KBS,CPX,1)="" THEN 7270 'MOVE CURS
OR 1 WORD LEFT
7280 IF KS=CHR$(6) AND CPX<LKBX+1 THEN PRINT MID$(KBS,CPX,1):CPX=CPX+
1:IF MID$(KBS,CPX-1,1)<>" " OR MID$(KBS,CPX,1)="" THEN 7280 'MOVE CURS
OR 1 WORD RIGHT
7290 IF KS=CHR$(20) THEN PRINT STRINGS(LKBX-CPX+1,32);STRINGS(LEN(KBS)
+1-CPX,8);:IF INSTR(CPX+1,KBS," ") THEN KBS=LEFT$(KBS,CPX-1)+MID$(KBS,I
NSTR(CPX+1,KBS," ") + 1) ELSE KBS=LEFT$(KBS,CPX-1)
7300 IF KS=CHR$(20) THEN IF MID$(KBS,CPX,1)="" THEN KBS=LEFT$(KBS,CPX
-1)+MID$(KBS,CPX+1):GOTO 7300 ELSE PRINT MID$(KBS,CPX);" ";STRINGS(LEN(
KBS)+2-CPX,8); 'DELETE WORD TO RIGHT
7310 IF KS=CHR$(7) THEN IF CPX<LKBX THEN KBS=LEFT$(KBS,CPX-1)+MID$(KB
S,CPX+1):PRINT MID$(KBS,CPX)+"";:PRINT STRINGS(LEN(KBS)+2-CPX,8); 'CTR
L G DELETES CHAR
7320 IF KS=CHR$(25) THEN PRINT STRINGS(CPX-1,8);STRINGS(LKBX," ");STR
INGS(LKBX,8);:KBS="":CPX=1 'CTRL Y DELETES LINE
7330 GOTO 7170
7340 IF LX=0 AND LKBX=LX THEN PRINT"";:GOTO 7170 'CHECK STRING LENGTH
7350 KBS=LEFT$(KBS,CPX-1)+KS+MID$(KBS,CPX):PRINT MID$(KBS,CPX);STRINGS
(LEN(KBS)-CPX,8);:CPX=CPX+1 'PRINT CHARACTER OR R/H SECTION
7360 GOTO 7170
  
```

in a Basic program:

Ctrl-E — ("here is" on Superbrain) reinstates the last input made

If the variable Cap\$ is set as Y in the main program, all characters entered will be converted to upper case. The length of string to be allowed can be limited to any length by setting the variable L% to the required length. This action also creates delimiters to the length of string in the form of < >

Cursor movement is achieved by printing or backspacing over the character, and therefore it can be used in any position on the screen. The comment lines in the listing can be omitted when typing in the program.

Variables used by the subroutine have been kept to a minimum and are as follows
 L\$ — last string entered
 L% — length of string allowed

CP% — relative cursor position

K\$ — key pressed

KBS — keyboard input

CAP\$ — convert to capitals or not

LKB% — length of KBS

The use of these variables should be avoided for other purposes in the main body of program.

DISASSEMBLER

WRITTEN IN Locomotive Basic for the Amstrad CPC-464, this program by Stephen Devine provides rapid disassembly of machine-code programs in a comprehensive and easily readable format. Output can be directed to the screen or printer and all addresses can be in either hex or decimal as required.

The program uses a very efficient algorithm to interpret each instruction. It involves splitting each byte into various segments, and examining the resultant bit patterns to determine the appropriate part of the mnemonic. The individual segments are then reconstructed to form a complete mnemonic, and any special symbols are replaced with their equivalents, which may be absolute addresses or special registers such as IX and IY.

The final mnemonic is then printed out, along with its associated bytes in both hex and ASCII, and the next instruction is then processed in exactly the same way. This method results in very fast disassembly, with speeds of up to three lines per second. In order to disassemble

the ROM the program includes a short machine-code routine which accesses the Basic ROM to fetch the required bytes, which it then stores in an array for subsequent processing by the Basic program.

When the program is run it first fills a string array with the data required during disassembly, and sets up the machine-code program in an integer array. It then prompts for the address from which you wish to begin disassembling, and this can be given in either hex or decimal.

A value preceded by a & is interpreted as a hexadecimal address. All addresses produced by the program are given in hex, except for any offsets to index registers, which will always be given in decimal. All addresses below &C000 are taken as being in RAM, while those above refer to the Basic ROM. You are asked to enter an end address for the disassembly, which must be greater than the start address. Pressing Enter alone will set the end address to &FFFF.

Enter y to the next prompt if you wish the output to be sent to the printer, or press n or Enter to direct output to the screen. The program cannot determine whether or not you have a printer connected, so use this option with care. If you get stuck, just press Esc twice and start again.

Disassembly will now begin. Each line contains: the address, in hex or decimal, of the current instruction; the bytes, in hex, of the code stored there; the instruction itself in standard Zilog mnemonics, and the ASCII equivalent of the bytes themselves. This last feature is useful when disassembling areas of text, but note that control codes and graphics characters are printed as a . symbol. Any invalid code is taken to be data and is displayed using the word Data. This also applies to the data bytes which follow some restart instructions.

The listing can be halted at any time by pressing the space bar and continued by pressing any key. When the listing is complete you will be prompted for new start and end addresses as before. To break-out of the program press Esc twice.

Although formatted for 40 columns, the program can also be run in mode 2 by changing the value in line 10. The display colours can also be changed to suit the user by altering the Ink statements in the same line.

DISASSEMBLER

Z-80 DISASSEMBLER

```

1 REM Z-80 Disassembler
2 REM (C) 1984 Stephen Devine
3 REM
10 MODE 1:BORDER 12:INK 0,12:INK 1,0
20 DIM ss(14,7),as(3),mcodeX(8),byteX(5)
30 GOSUB 5000
40 CLS
50 ON ERROR GOTO 4500
60 LINE INPUT"START ADDRESS:";start$
70 start=INT(VAL(start)):IF start<65535 THEN 4500
80 IF start<0 THEN start=start+65536:IF start<0 THEN 4500
90 decX=(ASC(start$)-ASC("0"))
100 LINE INPUT"END ADDRESS:";last$
110 IF last$="" THEN last=65535:GOTO 140
120 last=INT(VAL(last$)):IF last<0 THEN last=last+65536
130 IF last>65535 OR last<start THEN 4500
140 LINE INPUT"PRINTER (y/n)?";pr$
150 IF UPPER(pr$)="Y" THEN prX=8 ELSE prX=0
160 PRINT
170 ON ERROR GOTO 4510
180 baddr=start
199 REM Start of main loop to determine mnemonic
200 typeX=0:repX=0:nX=1
210 mcodeX(1)=@byteX(0)
220 CALL @mcodeX(0),baddr
230 nX=nX+1
240 IF dfX THEN mn$="DATA":dfX=dfX-1:GOTO 3000
250 IF byteX(nX)=876 THEN mn$="HALT":GOTO 1000
259 REM Determine if instruction is of specific type
260 IF byteX(nX)=8CB THEN typeX=1:IF repX THEN nX=nX+1:GOTO 230 ELSE 2
30
270 IF byteX(nX)=8ED THEN typeX=2:GOTO 230
280 IF byteX(nX)=8DD THEN repX=1:GOTO 230
290 IF byteX(nX)=8FD THEN repX=2:GOTO 230
299 REM Convert to binary and isolate important bit patterns
300 bs=BIN$(byteX(nX))
310 WHILE LEN(bs)>8:bs="0"+bs:WEND
320 bhX=VAL("&x"+LEFT$(bs,2))
330 bmX=VAL("&x"+MID$(bs,3,3))
340 blX=VAL("&x"+RIGHT$(bs,3))
350 bmhX=bmX\2
360 bm1X=bmX-2*bmhX
369 REM Main routine to determine mnemonic from bit patterns
370 ON bhX GOTO 510,520,530
380 ON blX GOTO 420,440,450,470,480,490,500
390 relX=bmX\1
400 IF bmX\3 THEN mn$="JR "+ss(3,bmX-4)+" V" ELSE mn$=ss(5,bmX)
410 GOTO 1000
420 IF bm1X=0 THEN mn$="LD "+ss(1,bmhX)+" W" ELSE mn$="ADD #"+ss(1,bm
hX)
430 GOTO 1000
440 mn$="LD "+ss(6,bmX):GOTO 1000
450 IF bm1X=0 THEN mn$="INC "+ss(1,bmhX) ELSE mn$="DEC "+ss(1,bmhX)
460 GOTO 1000
470 mn$="INC "+ss(0,bmX):GOTO 1000
480 mn$="DEC "+ss(0,bmX):GOTO 1000
490 mn$="LD "+ss(0,bmX)+" V":GOTO 1000
500 IF blX=7 THEN mn$=ss(7,bmX):GOTO 1000
510 mn$="LD "+ss(0,bmX)+" "+ss(0,blX):GOTO 1000
520 mn$=ss(4,bmX)+ss(0,blX):GOTO 1000
530 ON blX GOTO 550,570,580,590,600,620,630
540 mn$="RET "+ss(3,bmX):GOTO 1000
550 IF bm1X=0 THEN mn$="POP "+ss(2,bmhX) ELSE mn$=ss(8,bmhX)
560 GOTO 1000
570 mn$="JP "+ss(3,bmX)+" W":GOTO 1000
580 mn$=ss(9,bmX):GOTO 1000
590 mn$="CALL "+ss(3,bmX)+" W":GOTO 1000
600 IF bm1X=0 THEN mn$="PUSH "+ss(2,bmhX) ELSE mn$="CALL W"
610 GOTO 1000
620 mn$=ss(4,bmX)+" V":GOTO 1000
630 mn$="RST"
640 IF NOT decX THEN mn$=mn$+" ":IF bmX\2 THEN mn$=mn$+"0"
650 IF NOT decX THEN mn$=mn$+HEX$(bmX\8) ELSE mn$=mn$+STR$(bmX\8)
660 IF bmX=1 OR bmX=2 OR bmX=5 THEN dfX=2
670 IF bmX=3 THEN dfX=3
999 REM This part caters for opcodes beginning with 8CB or 8ED
1000 IF typeX=0 THEN 2000
1010 mn$="DATA"
1020 IF typeX=1 THEN 1030
1030 IF bhX=0 THEN IF bmX\6 THEN mn$=ss(10,bmX)+" "+ss(0,blX):GOTO 20
00 ELSE 2000
1050 IF bhX=2 THEN mn$="RES"
1060 IF bhX=3 THEN mn$="SET"
1070 mn$=mn$+STR$(bmX)+" "+ss(0,blX)
1080 GOTO 2000
1090 IF bhX=0 OR bhX=3 THEN mn$="DATA":GOTO 2000
1100 IF bhX=2 THEN 1250
1110 ON blX GOTO 1130,1150,1170,1190,1200,1230,1240
1120 IF blX=0 AND bmX\6 THEN mn$="IN "+ss(0,bmX)+" (C)"
1130 IF blX=1 AND bmX\6 THEN mn$="OUT (C) "+ss(0,bmX)
1140 GOTO 2000
1150 IF bm1X=0 THEN mn$="SBC HL "+ss(1,bmhX) ELSE mn$="ADC HL "+ss(1,b
mhX)
1160 GOTO 2000
1170 IF bm1X=0 THEN mn$="LD (W) "+ss(1,bmhX) ELSE mn$="LD "+ss(1,bmhX)
+" (W)"
1180 GOTO 2000
1190 IF bmX=0 THEN mn$="NEB":GOTO 2000 ELSE 2000
1200 IF bmX=0 THEN mn$="RET":GOTO 2000
1210 IF bmX=1 THEN mn$="RETI"
1220 GOTO 2000
1230 mn$=ss(13,bmX):GOTO 2000
1240 mn$=ss(14,bmX):GOTO 2000
1250 mn$=ss(11,blX):IF mn$="DATA" THEN 2000
1260 IF blX=3 AND bmX\5 THEN mn$="DT"
1270 IF bmX\4 THEN mn$=""
1280 mn$=mn$+ss(12,bmX)
1999 REM This part caters for HL and the index registers
2000 IF mn$="DATA" THEN dfX=1:nX=0:GOTO 240
2010 IF repX=0 THEN 2050
2020 r1$="":r2$="HL":GOSUB 4000
2030 r1$="e":r2$="(HL)":GOSUB 4000
2040 GOTO 2200
2050 bx=byteX(2)
2060 IF bx\127 THEN bx=bx-256
2070 dds=STR$(bx):IF bx=0 THEN dds="+"+RIGHT$(dds,LEN(dds)-1)
2080 rfx=0
2090 IF repX=1 THEN 2130
2100 r1$="":r2$="IX":GOSUB 4000:rfX=fx
2110 r1$="e":r2$="(IX+dd$)":GOSUB 4000:IF fx THEN rfx=1
2120 GOTO 2150
2130 r1$="":r2$="IV":GOSUB 4000:rfX=fx
2140 r1$="e":r2$="(IV+dd$)":GOSUB 4000:IF fx THEN rfx=1
2150 IF typeX=0 AND fx=-1 THEN nX=nX+1
2160 IF rfx=0 THEN mn$="DATA":nX=0:GOTO 3000
2199 REM Replace all V's and W's with their equivalent bytes
2200 r1$="V"
2210 IF NOT relX THEN 2280
2220 offsetX=byteX(1)
2230 IF offsetX\127 THEN offsetX=offsetX-256
2240 taddr=baddr+2+offsetX:IF taddr>65535 THEN taddr=taddr-65536
2250 IF NOT decX THEN r2$=HEX$(taddr) ELSE r2$=STR$(taddr):r2$=RIGHT$
(r2$,LEN(r2$)-1):GOTO 2270
2260 WHILE LEN(r2$)>4:r2$="0"+r2$:WEND
2270 relX=0:GOTO 2300
2280 IF NOT decX THEN r2$=HEX$(byteX(nX+1)) ELSE r2$=STR$(byteX(nX+1))
:r2$=RIGHT$(r2$,LEN(r2$)-1):GOTO 2300
2290 IF LEN(r2$)=1 THEN r2$="0"+r2$
2300 GOSUB 4000
2310 IF fx THEN nX=nX+1:GOTO 3000
2320 r1$="W"
2330 IF decX THEN r2$=STR$(byteX(nX+1)+256*byteX(nX+2)):r2$=RIGHT$(r2$
,LEN(r2$)-1):GOTO 2380
2340 r2$=HEX$(byteX(nX+1))
2350 IF LEN(r2$)=1 THEN r2$="0"+r2$
2360 r2$=HEX$(byteX(nX+2))+r2$
2370 IF LEN(r2$)=3 THEN r2$="0"+r2$
2380 GOSUB 4000
2390 IF fx THEN nX=nX+2
2999 REM Print out disassembled mnemonic
3000 addr$=HEX$(baddr)
3010 IF decX THEN addr$=STR$(baddr):addr$=RIGHT$(addr$,LEN(addr$)-1)
3020 WHILE LEN(addr$)>4-decX:addr$="0"+addr$:WEND
3030 PRINT#prX,addr$;TAB(7);
3040 FOR ix=0 TO nX
3050 bx=byteX(ix):as(ix)=" "
3060 IF bx=32 AND bx\128 THEN as(ix)=CHR$(bx)
3070 cs=HEX$(bx)
3080 IF LEN(cs)=1 THEN cs="0"+cs
3090 PRINT#prX,cs;" ";
3100 NEXT ix
3110 px=INSTR(mn$," "):PRINT#prX,TAB(20);
3120 IF px THEN PRINT#prX,LEFT$(mn$,px);TAB(25);RIGHT$(mn$,LEN(mn$)-px
);ELSE PRINT#prX,mn$;
3130 PRINT#prX,TAB(35);";":FOR ix=0 TO nX:PRINT#prX,as(ix):NEXT ix:P
RINT#prX
3140 IF INKEY$="" THEN WHILE INKEY$="" :WEND
3149 REM Update location pointer and repeat
3150 baddr=baddr+nX+1:IF baddr=last THEN 200
3160 IF prX THEN PRINT#8,CHR$(12);
3170 GOTO 50
3999 REM Replace every occurrence of r1$ in mn$ with r2$
4000 fx=0
4010 px=INSTR(mn$,r1$):IF px=0 THEN RETURN
4020 fx=1-mn$=LEFT$(mn$,px-1)+r2$+RIGHT$(mn$,LEN(mn$)-px)
4030 GOTO 4010
4499 REM Error traps
4500 RESUME 40
4510 RESUME 60
4999 REM Initialize string array and set up machine code
5000 FOR ix=0 TO 14
5010 FOR jX=0 TO 7:READ ss(ix,jX):NEXT jX
5020 NEXT ix
5030 mcodeX(0)=82100
5040 mcodeX(1)=@byteX(0)
5050 FOR ix=2 TO 8:READ v:mcodeX(ix)=v:NEXT
5060 RETURN
7999 FOR i=@mcodeX(0) TO @mcodeX(0)+20:PRINT HEX$(PEEK(i));";:NEXT
9999 REM Data for mnemonics
10000 DATA B,C,D,E,H,L,@,A
10010 DATA BC,DE,*,SP,*,*
10020 DATA BC,DE,*,AF,*,*
10030 DATA NZ,Z,NC,C,PO,PE,P,M
10040 DATA "ADD A","ADC A","SUB #","SBC A","AND #","XOR #","OR #","CP
"
10050 DATA NOP,"EX AF,AF","DJNZ V,JP V,*,*
10060 DATA "(BC),A","(BC)","(DE),A","(DE)","(W),*","(W)","(W),A"
" (A), (W)"
10070 DATA RLCA,RRCA,RLA,RLA,RAA,DAA,CPL,SCF,CCF
10080 DATA RET,EXX,JP (*),"LD SP,*",*,*
10090 DATA JP W,DATA,"OUT (V),A","IN A,(V)","EX (SP),*","EX DE,HL",DI
,EI
10100 DATA RLC,RR,RL,RR,SLA,SRA,DATA,SRL
10110 DATA LD,CP,IN,OUT,DATA,DATA,DATA,DATA
10120 DATA DATA,DATA,DATA,DATA,I,D,IR,DR
10130 DATA IM,0,DATA,IM,1,IM,2,DATA,DATA,DATA,DATA
10140 DATA "LD I,A","LD R,A","LD A,I","LD A,R",RRD,RLD,DATA,DATA
10199 REM Data for machine code
10200 DATA &c0,&06b9,&1a04,&1377,&2323,&f910,&c9

```

SAMPLE OUTPUT

```

C000 80          ADD  A,B          ;.
C001 01 00 00   LD    BC,0000       ;...
C004 4C          LD    C,H          ;L
C005 C0          RET   NZ           ;.
C006 31 00 C0   LD    SP,C000       ;1..

```



ETAFIELD

THE PROBLEM SOLVERS
PRESENT

HIGH RESOLUTION COLOUR GRAPHICS BOARD

- * RUNS DIRECTLY ON
IBM PC/XT/AT AND
OTHER IBM HARD-
WARE COMPATIBLES
- * 1000 × 1000 × 4
PIXELS
- * RUNS MOST
LANGUAGES
- * SUITABLE FOR MOST
MONITORS
- * RUNS AUTOCAD
WITH MOUSE

FOR MORE INFORMATION CONTACT
CHRIS PEARCE, ETAFIELD LTD.,
SUMMIT HOUSE, HORSECROFT RD.,
HARLOW, ESSEX CM19 5BN
TELEPHONE: HARLOW (0279) 26606

TO CHRIS PEARCE
I WANT INFORMATION ON COLOUR GRAPHICS

NAME.....

ADDRESS.....

COMPANY.....

TELEPHONE.....

● Circle No. 170

System Science

C Compilers

DeSmet C PC/MS-DOS.....	£139.00
Lattice C PC/MS-DOS.....	£490.00
C86 & optimiser PC/MS-DOS.....	£385.00
Microsoft C PC/MS-DOS.....	£460.00
Aztec C86 PC/MS-DOS.....	£235.00
Aztec C II App-DOS.....	£195.00
Aztec C II CP/M-80.....	£195.00
C/80 Software Toolworks CP/M-80.....	£ 50.00
C/80 Mathpak — floats and longs CP/M-80.....	£ 30.00
BDS C CP/M-80.....	£135.00
ECO-C for Z80 Code CP/M-80.....	£195.00

VENIX-86 full Unix for IBM PC-XT and PC-AT..... from £850.00
and many look-alikes

LISP Interpreters

LISP-80 Software Toolworks CP/M-80 & MS/PC-DOS.....	£ 50.00
MuLISP/MuSTAR CP/M & MS/PC-DOS.....	from £175.00
MuMATH CP/M & PC/MS-DOS.....	from £215.00
IQ LISP PC-DOS.....	£160.00
micro-PROLOG MS-DOS.....	£235.00

FORTH-83 from Laboratory Microsystems

Z80 Forth CP/M-80.....	£ 95.00
PC-FORTH PC-DOS.....	£ 95.00
8086-FORTH CP/M & MS-DOS.....	£ 95.00
PC FORTH +, 8086 FORTH + (32 bit address).....	£235.00
Floating point extensions.....	£ 89.00

Programmers Editors

SEE Editor for IBM-PC and Apricot.....	£ 50.00
EC Editor (windows and DOS calls) PC-DOS.....	£125.00
PMATE IBM-PC and Apricot.....	£225.00
FirstTime C (with syntax checker).....	£295.00

Pascal Compilers.....	£ call
Fortran Compilers.....	£ call
Assemblers and cross-assemblers.....	£ call

Uniform — Read & Write Many formats — for Epson Qx-10..... £ 75.00
IBM-PC, Osborne, Kaypro, Xerox 820 and others

HSC 16 bit Co-Processors for Z80 CP/M systems
— choice of 8086 or 68000 — 6 MHz. clock
— MS-DOS, CP/M-86 and CP/M-68K — 256Kb to 1.25 Mb memory
— memory available as RAM disk — fit most Z80 systems
— simple to install, simple to use. Prices from £675.00

Prices are exclusive of VAT and postage

6-7 West Smithfield, London EC1A 9JX
Tel: 01-248 0962

● Circle No. 171

COMPUTECH for  apple
Authorised dealer, service centre and
system consultancy

COMPUTECH
ACCOUNTING SOFTWARE
FOR
APPLE COMPUTERS

SALES LEDGER
PURCHASES LEDGER
GENERAL LEDGER

£295 each + VAT
PAYROLL

£375 + VAT

Phone us now to arrange a
free demonstration

Apple Dealer and Software Publisher since 1978

COMPUTECH SYSTEMS

16B, Finchley Road, London NW3 6HP. Tel: 01-794 0202

AGENTS THROUGHOUT THE UK AND OVERSEAS

● Circle No. 172

Cash & Carry COMPUTERS

at HI-VOLTAGE

Croydon's New 13,000 sq ft Computer Discount Centre

Expert Staff • Free Advice • Everything on Demonstration • Open 9am-6pm Monday-Saturday • Access & Visa cards accepted

UK's Best Printer Prices

London's Largest Range of Printers on Demonstration

DOT MATRIX PRINTERS

Brother HR5	£129.90 + VAT =	£149.38
Brother M1009	£155.90 + VAT =	£179.29
Brother 2024L NLQ	£899.90 + VAT =	£1034.88
Epson P40 Thermal AC/DC	£81.90 + VAT =	£94.18
Epson RX80	£190.90 + VAT =	£219.54
Epson RX80FT+	£215.90 + VAT =	£248.29
Epson FX80	£329.90 + VAT =	£379.38
Epson RX100FT	£349.90 + VAT =	£402.38
Epson FX100	£427.90 + VAT =	£492.09
Epson LQ1500 NLQ	£895.90 + VAT =	£1030.28
Epson JX80 Colour	£449.90 + VAT =	£517.39
Canon PW1080A NLQ	£289.90 + VAT =	£333.39
Canon PW1156A NLQ	£365.90 + VAT =	£420.79
Canon PJ1080A Colour	£479.90 + VAT =	£551.88
Panasonic KP1091 (IBM) NLQ	£255.90 + VAT =	£294.29
Shinwa CPA80	£199.90 + VAT =	£229.88
Anadex	POA Dki	POA
Data Prods. Paper Tiger	POA NEC	POA
Newbury	POA Tec	POA
Seikosha GP50S (Sinclair Spectrum)	£79.90 + VAT =	£91.88
Seikosha GP500A	£113.90 + VAT =	£130.98
Smith Corona Fasttext 80	£149.90 + VAT =	£172.39
Smith Corona D100, D200 NLQ & D300 NLQ		POA
Star SG510 (IBM) NLQ	£225.90 + VAT =	£259.79
Kaga Taxan KP810 NLQ	£259.90 + VAT =	£298.89
Kaga Taxan KP910 NLQ	£379.90 + VAT =	£436.89
Commodore MPS801	£139.90 + VAT =	£160.89

DAISYWHEEL PRINTERS

Brother HR15 (P)	£315.90 + VAT =	£363.29
Brother HR25	POA	
Brother HR35 + sheet feed	£819.90 + VAT =	£942.89
Daisystep 2000	£219.90 + VAT =	£252.89
Diablo 630	POA	
Silver Reed	POA	
Smith Corona TP1	£179.90 + VAT =	£206.89
Juki 6100	£319.90 + VAT =	£367.89
NEC	POA	
Gume	POA	
Ricoh	POA	
Tec	POA	
Epson DX100	£339.90 + VAT =	£390.89
Commodore DPS1101	£309.90 + VAT =	£356.39

PRINTER/TYPEWRITERS

Brother EP22	£109.90 + VAT =	£126.39
Brother EP44	£189.90 + VAT =	£218.39
Brother TC600	£373.50 + VAT =	£429.53
Brother FB100 Disk Drive for TC600	£161.50 + VAT =	£185.73
Juki 2200 Daisywheel (P or S)	£259.90 + VAT =	£298.89

All popular interfaces, cables, etc. available from stock. Custom cables made to order. Let our experts match your computer to the printer of your choice. Printers - All models parallel-centronics interface Serial RS232C available at same or slightly higher prices. Prices correct at copy date. Subject to change without notice due to currency fluctuations etc. E. & O.E.

MONITORS

Microvitec Colour		
1431 DS STD RES RGB	£169.90 + VAT =	£195.39
1431 DZ STD RES Spectrum	£199.90 + VAT =	£229.89
1451 DS MED RES RGB	£229.90 + VAT =	£264.39
1451 DQ MED RES QL	£229.90 + VAT =	£264.39
1451 APDS MED RES RGB/Composite	£289.90 + VAT =	£333.39
1441 DS High RES RGB	£389.90 + VAT =	£448.39
1456 LI MED RES IBM PC	£395.90 + VAT =	£455.29
1456 DA MED RES Apricot	£349.90 + VAT =	£402.39

CASH & CARRY COMPUTERS
53-59 High Street,
Croydon, Surrey CR0 10D.

COMPUTERS

Apricot (monitors extra)		
F1E 256K RAM 1 x 315K		
Disk	£739.90 + VAT =	£850.89
F1 256K RAM 1 x 720K		
Disk	£859.90 + VAT =	£1029.25
PC 256K RAM 2 x 315K		
Disks	£1225.90 + VAT =	£1409.79
PC 256K RAM 2 x 720K		
Disks	£1375.90 + VAT =	£1582.29
Portable 256K RAM 1 x 720K		
Disk	£1395.90 + VAT =	£1605.29
Xi 10 256K RAM 10Mb	£2095.90 + VAT =	£2410.29
Commodore (includes Green Screen Monitor)		
PC10 IBM Compatible inc		
Free Colour Graphics Card	£1675.00 + VAT =	£1926.25
PC20 IBM Compatible inc		
Free Colour Graphics Card	£2795.00 + VAT =	£3214.25
SX64 Portable	£478.22 + VAT =	£549.95
Sanyo MBC 555 128K RAM 2 x 160K Disks	£779.90 + VAT =	£896.89
MBC 775 IBM Portable	£1695.90 + VAT =	£1950.29
IBM	Phone	Compaq Phone

SUPERDISKS Prices per box of ten ex VAT

	SSDD	DSDD	SS96TP1	DS96TP1
	40TR	40TR	80TR	80TR
BASF 5 1/4"	£10.00	£17.80	£18.50	£21.00
3M 5 1/4"	£13.50	£19.50	£19.90	£23.40
VERBATIM 5 1/4"	£14.50	£18.40	£18.40	£24.50
DYSAN 5 1/4"	£15.90	£23.50	£23.50	£28.50
TDK 5 1/4"	£17.50	£16.90*	-	£32.00
3M/BASF 3 1/2"	£34.90	-	-	-

Add 70p for P&P per order of Disks or Ribbons

PRINTER RIBBONS (Ex-VAT Prices)

Single prices, deduct 10% for 5+	Epson 80 Series	£2.80	
Brother HR15 Corr	£2.65	Epson 100 Series	£3.40
Brother HR15 MS	£4.95	Juki 6100 SS	£1.80
Brother HR5	£2.70	Juki 6100 MS	£3.50
Brother EP44	£2.50	Juki 2200	£3.50
Brother M1009	£3.60	Kaga KP810	£9.50
Canon PW1080A	£9.50	Mannesman MT80	£5.90
CBM 801	£6.50	Seikosha GP50	£6.50
CBM 802/1526	£5.90	Seikosha GP500	£6.50
CBM DPS1101 MS	£3.50	Seikosha GP700	£18.50
Daisystep 2000	£3.50	Shinwa CP80	£5.90

Mail Order + Export + Trade
Hot Line Phone 01-686 6362



Delivery by Securicor (3 day) please add £5.00 + VAT per item. Delivery by T.N.T. (overnight) please add £9.50 + VAT per item.

Send off the coupon or order by phone quoting your Access, Barclaycard No. Phone 01-686 6362. Immediate despatch on receipt of order or cheque clearance.

Or you can Telex your order on: 946240 Attn 19001335

We accept official orders from PLC's, Government Departments and Educational establishments.

These prices correct until superceded by next advertisement.

To: Cash & Carry Computers, 53-59 High Street, Croydon, Surrey CR0 10D.

Please supply

I enclose my cheque for £..... including delivery by Securicor/T.N.T.*

or charge my Access/Barclaycard No.

Name _____ Signature _____

Address _____

PC

*Please Delete

G. W. COMPUTERS LTD

London's West End — Nationwide overnite service — More product ranges —
Probably the widest selection of networks/micros/and printers

WE OFFER ONE OF THE BEST 'SYSTEM DEALS' IN THE U.K. (save 1500.00 +)
THE NEW DBMS III.7 (series III of the world's first 'task-robot-programs')

STOP PRESS: DBMS 111.7 NOW ONLY £100.00.

G.W. COMPUTERS LTD — Tel: 01-631-4818

Mbasic & word-star compatible
1400 character record sizes
mathematical scratchpad,
record relational indexes,
translatable to any language
User-definable reporting
field protection/classification,
either-or, same as, greater, smaller
sorts alpha/numeric any window
12 online file architectures.
240 fields using cross-referencing
cross-record calculations.
'Jump-to' any record in 12 files.
User-define files/field words/sizes.
'purchasesales-analysis', 'personnel-file'

.....FEATURES.....

32000 records per filename
20 main/200 sub fields per record, field
and record related formulae.
'Jump-to' any of 3200 records per file.
random/binary/key/multiple field
search. 'If-then' questioning
file protection/password entry.
range match, not match, integer match.
sort speed 500 records per 20 seconds
endless 'either-or' matching
formulae/recall on selection criteria.
13 interrogation question types
short filing output/audit trails.
'sale-mail-shots', 'production-process-
'purchasesales-analysis', 'personnel-file'

DBMS III 7 new switch mode facility enables you to cross up to 12 different files (32000 records per file) pre-selecting any of up to 20 fields per record/file for display/print output (240 fields) in all. One massive enquiry can pass through 384,000 records

You might have two files whose records are directly related to each other, so that the first file (say containing names and addresses) refers to the second file (say financial and other information relating to the same record numbers in the first file) directly. Then you can simply choose that in file 1 you are interested in just the name and telephone numbers, whereas in file two, you are interested in the income, trading period and number of branches, information. Your enquiry can then pass through both files highlighting that information only. Actually there doesn't need to be a strict correlation between the same record numbers in different files, and you can also just on JUMP command go to any record in any of the 32000 records in any one of the twelve files and carry on cross-referencing from there onwards

DBMS'S MACROS WORK FROM THE MOMENT YOU INSERT THE 'TASK DISK' IN THE COMPUTER

Simply design your file, give its fields your words, set up your report mask, and then enter your records. Switch to 'automatic drive' and formulate any task you wish the program to fulfill, the task is stored as a macro. Take a copy of the program on another 'task disk' and from then on, the task disc will function without a single key-stroke. Think of a number of such 'task disks' such as: "stock-re-order reports", "stock-valuation reports", analysis, "patient history analysis", "research-analysis", "budgeting", "plus more?"

Not only does this program surpass most of its kind that you might buy elsewhere, but if you buy the hardware from us, then you get it — FREE . . . DBMS II (WITHOUT MACROS) AND DBMS III ARE FULLY IMPLEMENTED UNDER CPM-86 (tm) AND MS-DOS (tm) ie: <SIRIUS/VICTOR/IBM > DBMS II IS 395.00 (or 250.00 by mail order ex. training). DBMS II IS 575.00 (or 295.00 by mail order ex. training).

Contains the highest state of the art software available today

FORMS/TEXT/CALC/DBMS IV — ALL IN ONE PROGRAM THE —"KEY" — @ 575.00.

When you budget for a complete system of software you eventually end up with a host of packages like. Sales, Purchases, Nominal Data, Text, Calc, Mailshot, Invoice, Order, Workflow, Personnel, and so on. The list is endless and the outlay several thousands of pounds.

Features Design a form as wide as a window of 250 characters, long as needed. Cursor movements are left, right, up, down, delete left, delete right, tab right-left-up-down. Paint your form as you like directly on the screen.

Text. Write a letter as you see it on the screen, edit it then simply enter P to print. Calc. Set into the form, your data fields, "#####" and specific file-related activities, formulae and validation checks. Enter values and see the spreadsheet calculate itself.

Database. Search files for data to be inserted to fields specified. All the features of DBMS III, explained elsewhere in our ad.

Here's an example of an invoice you might design for your stationery . . . You could design your own spreadsheet, order form, statement, wage docket, or any other kind of form that is required to fit your existing stationery.

Quantity		Description	Cost	Tax	Total
<9>###	<10>#####	<11>##	<12>##	<13>###	
<14>##	<15>#####	<16>##	<17>##	<18>###	
Total . . . <19>#####		Tax . . . <20>###			

<??> items <1> to <5> internal command to request name, input, and then search an address file for details.
<??> items <6> to <7> request date input and validate.
<??> item <8> request agent number and validate range.
<??> item <9> request quantity, validate range.
<??> item <10> request description, search file, accept, and calculate fields <11> <12> <13>, if finished invoice then calculate fields <19> and <20>

Now comes the more valuable facility. You can provide the 'FORM' with file-related instructions, not only to request a 'console' input for file search against names, and stock, but after the invoice is finished, the fields you have selected may be passed to related files.

EG: Send fields <0>, <1>, <06>, <07>, <11>, <12>, <13>, <19>, <20>, to a sales ledger.
Then send fields <9>, <10>, <11> to product analysis file.
Then send fields <0>, <1>, <7>, <19>, <20> to V.A.T. file.
Then send fields <10>, <11>, <12>, <13> to Nominal ledger. Do you see?

G. W. COMPUTERS LTD — Tel: 01-631 4818

SYSTEM DEAL (our speciality) SAVES YOU 1500.00+

Buy any computer, any printer and 150.00 value diskettes add 85.00 for cables and testing. Add 10% for return to base warranty for 1 year (optional) add 110.00 for delivery & installation (optional) training optional extra 120.00

and get completely ***** FREE *****

cpm handbook.....50 basic exercises.....2000 sheets paper
DBMS III.7.....wordprocessing.....spreadsheet
msbasic.....diagnostics.....msort/dsort
recover.....autoload.....instant basic
library boxes.....disk/games.....DT/AS/NS sorts

***** total value 1400 + + + *****

Here's a typical example of a complete system deal

1 — TEXAS instruments pc w/256k ram/2 drives	2445.00
2 — Oki 82a or Epson rx80 printer	295.00
3 — Cables & testing	85.00
4 — Diskettes	150.00
software described above	FREE
	2975.00

We specialise in 'STANDARD MICRO-PRINTER SYSTEMS' as well as 'NETWORK SYSTEMS BASED ON A SHARED HARD DISK'.

The range of computer products (mostly ex stock) includes the most popular brands of micro-computers, printers, modems, buffers, spoolers and software.

G. W. COMPUTERS LTD — Tel: 01-636 8210

POPULAR BRANDS OF EQUIPMENT WE SELL

MICROS — Texas/I.B.M./Dec/Superbrain/Compustar
— Apple/Lisa/Compaq/Corona.
PRINTERS — Nec/Cume/Diablo/Oki/Epson/Olympia/Ricoh
— Texas/Dre/Anadex/Brother.
OTHERS — Corvus/Compustar/Sigma
— Hard disks networks and multiplexors
— Spoolers/Modems/Buffers

MAIN AGENTS ———— for TEXAS and MOTOROLA

STOP PRESS: DBMS 111.7 NOW ONLY £100.00.

TERMS & ETC

G.W. Computers Ltd [Grama (Winter) Ltd]
43/55 Bedford Court Mansions
Bedford Avenue
London W.C.1 England
Telex 892031 TWC G

Telephones:
01-636-8210
01-631-4818

Boston office tlx 94-0890

24 hour answerphones; leave address for 'infopacks'. We do not operate a reader's reply card service. Terms: C.W.O. or C.O.D. Prices exclude V.A.T., but include all non-credit discounts available. No dealers! The above lists are not exhaustive. Please call at our showroom only by prior appointment. Unless expressly agreed, all warranties are commercial 90 days return to base for parts and labour. Annual warranties and maintenance facilities available nationwide through closely related third parties.

GETTING TO THE CORE

Bill Hill tackles a range of books for the Apple and finds plenty for beginners and old hands alike.

ALTHOUGH there are hundreds of books on the Apple, authors seem to have no trouble producing more. A recent innovation is to include a floppy disc offer one at extra programs given in the book. This is quite handy because it saves having to type in lengthy listings. Many books that do not include a floppy disc, offer one at extra charge by mail order.

All the books reviewed here that cover Apple DOS have one thing in common: they mainly discuss DOS 3.3 and not Prodos. This is rather unfortunate for the beginner who has just purchased an Apple IIe or IIc since these are now shipped with the new operating system. Prodos and DOS 3.3 are similar enough that in many cases the beginner should not notice the difference, but the extra facilities offered by Prodos and the differences between the two disc operating systems will need to be covered in future editions of these books.



Rodney Zaks is a well-known author of books for micro users, and his latest offering, *Your First Apple II Program*, is aimed at the complete beginner to Applesoft Basic on the Apple II+ or IIe. This large-format book claims to be for anyone aged between eight and 88, but I think 12 to 88 would be nearer the mark, mainly because of the vocabulary used. The book is full of cartoons of Dino the dinosaur — the programmer — and the Program Snake. These cartoons, along with well-spaced text, are designed to make the learning process easier. Although the cartoons are somewhat patronising, the text is good and the programming exercises at the end of each chapter are well thought-out. I liked the first chapter especially, which explains what all the computer jargon means and points out the things that are obvious to old hands but not to a complete novice — pressing Return at the end of a line for example.

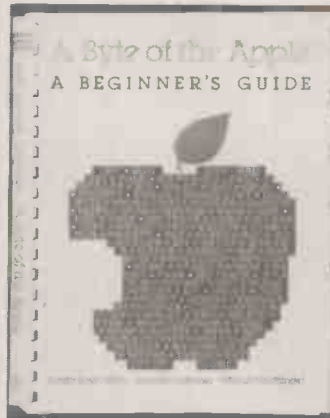

A Byte of the Apple by Linda Hyler, Sandra Crowther and Michel Eltschinger is the only spiral-bound book in this selection. It is subtitled "A Beginner's Guide", and is also the shortest: 145 pages in all. Like Zaks' book, it is aimed at the absolute beginner and the approach is in many ways similar. This book would best be used in conjunction with Apple's *Applesoft Tutorial Manual* for full benefit. It is well laid out, but at £14.50 is overpriced. The picture of the Apple IIe's keyboard is for the U.S. version, as is the picture of the motherboard, which may prove confusing to the complete beginner in the U.K. if he or she has not had access to Apple's manuals.



I have heard that nearly a quarter of Apple IIs worldwide have a CP/M card installed, and there certainly must be a demand for CP/M cards by Apple owners because there are at least five main manufacturers of these cards. So much CP/M software is available that it makes sense to have CP/M on the good old Apple II+ and Apple IIe. But which card do you choose? *The Compleat Apple CP/M* by Steven Frankel aims to answer this question. It covers the Microsoft Softcard, the Premium

Softcard for the Apple IIe, the Micropro Starcard, the PCPI Appli-Card, the ALS Z-Card II and the ALS CP/M Plus Card. Apart from descriptions of the facilities offered by the cards themselves, the book also discusses over 50 of the most popular commercial programs available, and how to put together a complete CP/M system around the Apple.

I am sure that it will be a help to anyone thinking of splashing out, but be warned that it is not the final word. A set of Benchmarks for all the cards would have been useful for example. Also some areas could have been covered in more detail: for example, Frankel correctly states that the ALS CP/M Plus Card running at 6MHz operates three times faster than the Z-Card II running at 2.5MHz on applications requiring extensive manipulations in memory, but what about disc access times? My CP/M Plus Card takes three times longer than the Microsoft Softcard to go from beginning to end of a long WordStar document. However, at £12.55 this book is a worthwhile purchase with several useful tips, but do try to talk to someone who has used the cards before deciding which one to buy.

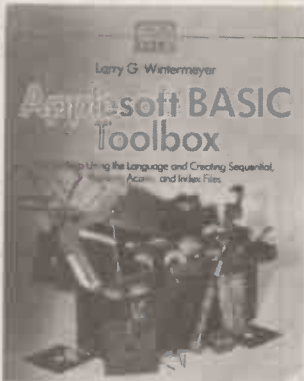

Applesoft Basic Toolbox by Larry Wintermeyer is subtitled "A Guide to Using the Language and Creating Sequential, Random Access, and Index Files". Over half of the 514-page book covers Applesoft Basic and DOS, in some cases devoting several pages to each command, in others less than a page. Most of the topics covered can be found in Apple's *Applesoft Tutorial Manual* and *Programmer's Manual*, although Wintermeyer does cover some commands in more depth, and some in much less depth than Apple — high-resolution graphics for example. The rest of the book is devoted to disc files including indexed files and includes demonstration programs. I like the way the author has provided a cross-reference listing and a detailed explanation of the programs on a line-by-line basis. This part of the book will be of interest to users wishing to learn about disc data storage techniques or develop their own database programs.

The question is whether you want to spend £10.95 for this part of the book if you already have books on Applesoft and DOS. If you do not have any other Applesoft reference books, then Wintermeyer's book might be worth considering, although I certainly do not regard it as a comprehensive guide to the language. To be fair, Winter-

meyer has obviously written this book for the person who is mainly interested in programming for data-processing applications on the Apple, and if this is your primary concern then you will find it useful. A disc containing the example programs given in the text is also available separately from the publishers.

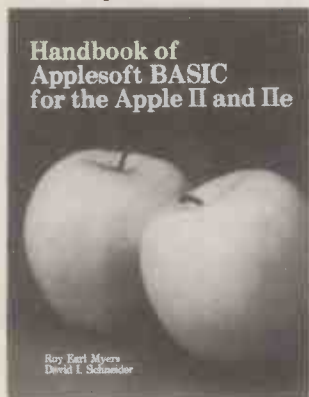

The material in *Handbook of Applesoft Basic for the Apple II and IIe* by Roy Myers and David Schneider is similar to the first part of Wintermeyer's book in that it covers material already available in Apple's manuals. The type is easy to read and there are plenty of useful Peeks and Pokes. A slight grumble is that some of the program listings do not have enough detailed explanation of what the program is doing line by line. DOS 3.3 is the disc operating system used, but the authors do mention several times that the well-known DOS 3.3 trick of using

$\text{CHR}\$(13) + \text{CHR}\(4) instead of just $\text{CHR}\$(4)$ cannot be used with Prodos. The description in the appendices of how to create shape tables is quite good. Overall this is one of the better Applesoft handbooks that I have seen — straight to the point and no unnecessary padding.



I am a sucker for books with lots of algorithms and useful tips, so I was interested to see John Campbell's *Programming Tips and Techniques for the Apple II and IIe*. Needless to say, the ubiquitous listings of sorting routines are given: Exchange, Bubble, Shell, Insertion, etc. Binary and linear searching is also covered. There are plenty of tables giving useful Peeks, Pokes and Calls, as well as tables giving Applesoft Basic routine starting addresses, and notes on the hardware — mainly for the Apple II or II+. Campbell goes into great detail and even tells you how to stop the cursor blink-

ing on the Apple II+. Useful DOS Peeks are also given among the pot-pourri of tips. My two main grumbles about this book are first that there should be more information about the Apple IIe and its differences from the II+, and secondly the price, which at £19.35 is a bit steep. However, it contains a fund of useful information and this one is well worth looking at. A disc is available separately from the publishers.

Getting the Most from your Apple II-IIe-IIc by Graham Keeler is billed as a complete course in programming the Apple II, IIe and IIc. It is written in a style rather typical of engineers — a little staid but thorough nonetheless. I think that it is an ideal book for the technically orientated student to use as an introduction to Applesoft and DOS 3.3. As with the other books mentioned above, a disc of the programs is available separately. I like Keeler's example programs; he has used examples which have interest in their own right. At £9.95 it is a reasonable buy, although the text would be enhanced by the use of a few more diagrams and better-quality photographs.

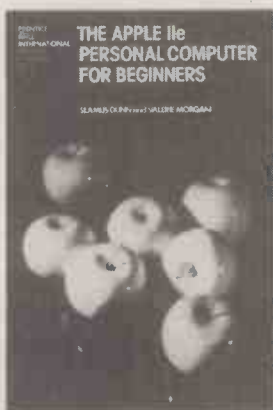

The Apple IIe Personal Computer for Beginners by Seamus Dunn and Valerie Morgan sets out to teach the beginner Applesoft Basic, and is meant to be read and used from cover to cover. At £7.95 it is cheaper than Keeler's book, but is not as comprehensive in certain areas, such as graphics.

Apple Writer II is a very popular word-processing program, and Ellen Thro has tried to explain in simple terms how to use it in *Making Friends with Apple Writer II*. The text is well laid out, and there are several useful tips for the novice. This book would make a useful adjunct to Apple's manual, but at £17.25 it seems very expensive. You should look through it carefully before parting with your hard-earned cash.

One of my favourite books is *Micro-computer Graphics* by R E Myers. This book covers Apple graphics programming in detail, including three-dimensional plots, shape tables and animation. Although Myers does not deal with pre-shifted shapes, he does cover the other material beautifully. The book is well typeset, has plenty of illustrations, and the example programs are actually impressive — no Mickey Mouse demonstrations here. If you can only buy one book on Applesoft graphics programming, buy this one.



Computer graphics is a fascinating subject, and Pip Forer's *Applied Apple Graphics* helps to whet your appetite. Retailing at £19.45 it comes complete with a DOS 3.3 disc. The applications discussed include graphs, topography, shape tables and three-dimensional plots. I was impressed with the scope of the book, although this means that many subjects are not treated in depth. Forer briefly discusses advanced topics such as pre-shifted shapes for smooth animation, and even mentions image processing and CAD/CAM. Some of the demonstration programs on the disc use routines from Penguin Software's *Graphics Magician*. One or two of the programs show that Forer has a sense of humour. I liked this book, and the "Applied" in the title is certainly justified, although if you are interested in the details of Apple graphics then Myer's book is a better buy.

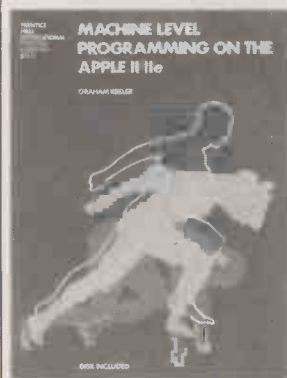

Machine-Level Programming on the Apple II/IIe is another of Graham Keeler's books. Like *Applied Apple Graphics* it includes a disc of example programs and utilities. I do not like the typeface used. It looks like it has been photographed straight from the word-processor output but at least this has kept the price down to a very reasonable £7.95. The book is intended for the experienced high-level language programmer who wishes to learn how to program in assembly language on the Apple II+ or IIe, and it serves this purpose well. However, I like the content and planning of the book a lot. Keeler also gives details of how to build an interface board for use in learning how to control I/O using machine code; the pcb may be made available if enough people are interested. All in all a useful teaching book, and a snip at £7.95 with the disc thrown in.

(continued on next page)

(continued from previous page)

Personal Graphics for Profit and Pleasure on the Apple II Plus Computer by Michael and Graham Barnett is a book very much in the vein of Roy Myers' *Microcomputer Graphics*. Like Myers, the Barnetts have packed their book full of Applesoft graphics programs, some of them very useful. They cover high- and low-resolution graphics, animation, shape tables, plotting graphs, pie charts and bar charts, high-resolution text, patterns, curve fitting, smoothing and three-dimensional graphics. I like their graph and pie charts especially with their

tick marks, numbers and labels. Apple users will know that text on the high-resolution screen involves extra software, which the Barnetts provide. I was impressed to see that they cover in some detail Bezier curve fitting, which is a very useful technique. Like the other graphics books in this review, I found the Barnetts' book a good buy and great fun. The text is well laid-out and there are lots of illustrations. A disc with the programs is available separately.

All the books reviewed up to this point have used DOS 3.3, but John Campbell's *Inside Apple's ProDOS* is intended to help

the newcomer to Prodos 1.0 to use it effectively. A fair amount of the information can be gleaned from Apple's Prodos manuals but Cambell's book is a useful addition. He covers many points in depth and includes a fully documented listing of a simple database/mailling-list program to illustrate how to use Prodos. I liked his chapter on the machine-language interface, which greatly introduces the assembly language programmer to it. If there are any points that you do not understand in Apple's Prodos manuals, then at £18.40 this book may well be of help. **PC**

GETTING TO THE CORE

Your First Apple II Program by Rodnay Zaks. Published by Sybex, 187 pages, £11.95. ISBN 0 89588 136 5

A Byte of the Apple by Linda Royer Hyler, Sandra Crowther and Michael Eltschinger. Published by Prentice-Hall International, 145 pages, £14.50. ISBN 0 8359 0543 8

The Compleat Apple CP/M by Steven Frankel. Published by Prentice-Hall International, 233 pages, £12.55. ISBN 0 8359 0800 3

Applesoft Basic Toolbox by Larry G Wintermeyer. Published by Addison-Wesley, 514 pages, £10.95. ISBN 0 201 14775 0

Handbook of Applesoft Basic for the Apple II and IIe by Roy Earl Myers and David I Schneider. Published by Prentice-Hall International, 321 pages, £19.50. ISBN 0 89303 504 1

Programming Tips and Techniques for the Apple II and IIe by John L Campbell. Published by Prentice-Hall International, 403 pages, £19.35. ISBN 0 89303 273 5

Getting the Most from Your Apple II-IIe-IIc by Graham Keeler. Published by Addison-Wesley, 254 pages, £9.95. ISBN 0 201 14655 X

The Apple IIe Personal Computer for Beginners by Seamus Dunn and Valerie Morgan. Published by Prentice-Hall International, 251 pages, £7.95. ISBN 0 13 038969 2

Making Friends with Apple Writer II by Ellen Thro. Published by Prentice-Hall International, 202 pages, £17.25. ISBN 0 13 547183 4

Microcomputer Graphics by Roy E Myers. Published by Addison-Wesley, 282 pages, £11.95. ISBN 0 201 05092 7

Applied Apple Graphics by Pip Forer. Published by Prentice-Hall International, 340 pages, £19.45. ISBN 0 13 039330 4

Machine-Level Programming on the Apple II/IIe by Graham Keeler. Published by Prentice-Hall International, 208 pages, £7.95. ISBN 0 13 541913 1

Personal Graphics for Profit and Pleasure on the Apple II Plus Computer by Michael P Barnett and Graham K Barnett. Published by Little, Brown & Co., distributed by Hutchinson Books, 192 pages, £9.95. ISBN 0 316 08164 7

Inside Apple's ProDOS by John Campbell. Published by Prentice-Hall, 303 pages, £18.40. ISBN 0 8359 3078 5

DBASE III Training Programming Software

LANTECH
Information Systems

55 Peascod Street,
Windsor, Berks.,
Tel: Windsor
58182/58013

PC SOFTWARE: OVER
40% DISCOUNT!

Just look at some of our prices!

FRAMEWORK	320	RRP 550	-41%!
SIDEKICK	53	RRP 89	-41%!
DBASE III	331	RRP 550	-39%!
DBASE II	239	RRP 395	-39%!
WORDSTAR	195	RRP 295	-34%!
PAINTBRUSH	95	RRP 139	-32%!
CIS COBOL	302	RRP 425	-29%!
LOTUS 1-2-3	304	RRP 430	-29%!
OPEN ACCESS	322	RRP 449	-28%!
SYMPHONY	413	RRP 550	-25%!

Most popular business micros supported!
Similar discounts for accessories & add-ons!
(IBM-PC prices shown excluding VAT)

Call us NOW on 0480 53044 for further details!

Elite Computer Systems

40 SAPLEY ROAD · HARTFORD · HUNTINGDON · CAMBS PE18 7YG

● Circle No. 177

Bank of Scotland's new Home Banking Service means what it says -and more.

Bank of Scotland has a reputation for innovation, but our new Home and Office Banking Service really moves banking into the twenty-first century.

Home Banking. Managing your money through your T.V. screen in your own home. Wherever you live in Britain. Seven days a week almost round the clock.

No more queues, no more delays. Now from your own fireside you can -

- instruct payment of bills up to 30 days in advance and take full advantage of any free credit period.
- switch spare cash into your Home and Office Banking Investment Account where it will immediately earn high interest.
- keep track of your finances by seeing up to the last 3 months, or 100 transactions, on each of your accounts.
- order cheque-books and statements.

Remember a Bank of Scotland personal Current Account carries no charges provided it is not overdrawn (to cover the clerical costs of setting-up and maintaining Standing Order records, an operating charge of 10p will be added to each Standing Order payment as it is made).

All this and more at your fingertips. Simple to



operate, yet absolutely secure.

What's more, since the viewdata system is **Prestel*** you also have access to any of their other information systems, covering over 800 topics. As a bonus we are offering at a

special price an adaptor which connects your T.V. and telephone into the system.

Interested? FREEPOST the coupon below and we'll send you complete details.

Banking will never be the same again.



*Prestel is a registered trade mark of British Telecommunications PLC.

Post to: Home Banking Centre, Bank of Scotland, FREEPOST, Edinburgh, EH1 0AA.

I would like to know all about Home Banking from Bank of Scotland.

Please send me your information pack.

NAME _____

ADDRESS _____

POSTCODE _____



BANK OF SCOTLAND
A FRIEND FOR LIFE

38 06 85

On Prestel Financial Services.

GALAXY WEST ONE

GALAXY

BUSINESS SYSTEMS LTD

230 Tottenham Court Road, London W1. Telephone: 01-636 7142/4102

Looking for a business system? Let us help you. Call in or phone for friendly, professional advice.



apricot x10
10MB WINCHESTER
ONLY £1995 + VAT!
PLUS

- FREE Wordprocessor (Superwriter)
- FREE Spreadsheet (Supercalc)
- FREE Super Planner

INTEGRATED ACCOUNTS PACKAGE

- FREE Invoicing
- FREE Stock Control
- FREE Sales Ledger
- FREE Purchase Ledger
- FREE Nominal Ledger
- FREE Payroll

SPECIAL INTRODUCTORY OFFER

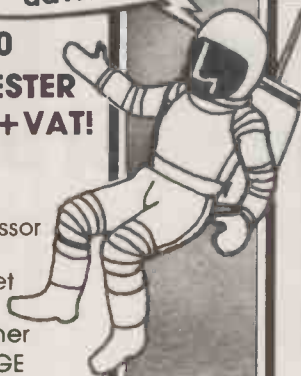

apricot PC

DUAL 315K DRIVES (630K) ONLY £1395 + VAT! PLUS

- FREE ACT 9" Monitor
- FREE Superwriter (Wordprocessor)
- FREE Supercalc (Spreadsheet)
- FREE Superplanner
- FREE CPIM 86
- FREE Concurrent CPIM 256K Memory



APRICOT PORTABLE only £1495 + VAT

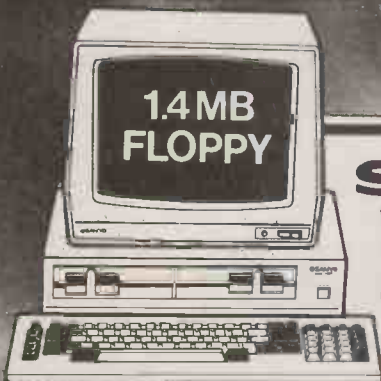

SANYO MBC
WITH 2x720KB FLOPPY DISC
ONLY £995 + VAT!

PLUS

- FREE Monitor
 - FREE Wordprocessor (Wordstar)
 - FREE Spreadsheet (Calstar)
 - FREE Invoicing
 - FREE Stock Control
 - FREE Sales Ledger
 - FREE Purchase Ledger
 - FREE Nominal Ledger
 - FREE Payroll
- Integrated Accounts Package

GALAXY BARGAINS

SANYO with 10MB Winchester floppy, 128K Ram, Wordstar & Calstar and Monochrome Monitor
£1995 + VAT

APRICOT PC: DUO 720K discs and monitor
£1595 + VAT

APRICOT Xi5: 5MB Winchester
£1845 + VAT

APRICOT F1 **£949.00 + VAT**
 PHILIPS MONITOR **£65.00 + VAT**

PLUS FREE INTEGRATED ACCOUNTS PACKAGE WITH THESE SYSTEMS

TRAINING CAN BE PROVIDED ON ALL SYSTEMS SUPPLIED

138

We also stock a wide range of Printers, Monitors, Disc Drives and Software Packages, plus many other

• Circle No. 179 Computer Systems at bargain prices.

1 YEAR WARRANTY & MAINTENANCE CONTRACTS AVAILABLE

OPENING HOURS MON-SAT 9AM-6PM

MAIL ORDERS TO: West One Galaxy Business Systems Ltd,
 230 Tottenham Court Road, London, W1.
 Cheques payable to: West One Galaxy Business Systems Ltd.

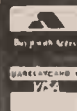

MicroSight



MicroSight I on the BBC model B includes:—

- A CCTV camera with lens and tripod.
- MicroEye vision interface 256 x 300 resolution with 8 bit video plus all cables.
- Fully documented hardware and software.
- MicroSight software package with area perimeter routines as well as disk and printer dumps.
- Hi Res software package with mode 0 display, disk and printer dumps and thresholding.
- Package using mode 2 high quality display.

MicroScale

An image processing package with editing area and perimeter calculations, dimensioning, windowing, threshold and contrast setting.

MicroEye

Vision interface 256 x 300 resolution 256 grey levels with full documentation and software for BBC Sirius, IBM, Apple, RML, CBM etc.

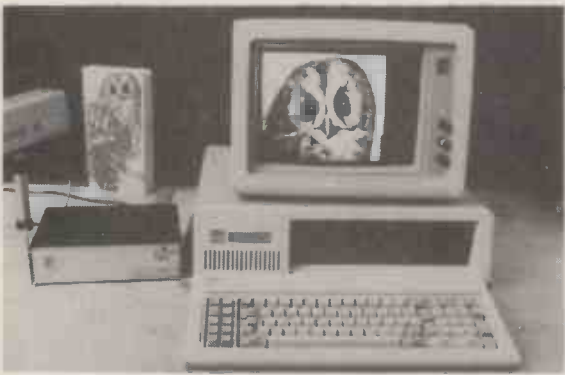

MicroScale II

Image analysis for the IBM PC with:—

- Object area measurement (absolute and %)
- Perimeter measurement to user defined scaling
- User definable and standard windows.
- Disk and printer dumps.
- Dimensioning and object counting.
- Fully documented C software.

Also available for Hewlett Packard and Sirius.

For further details contact:—

DIGITHURST The image analysis people

Digithurst Ltd.
Leaden Hill, Orwell, Royston,
Herts. SG8 5QH Telephone (0223) 208926

• Circle No. 180

SPECIAL SECTION

NETWORKS

Networking stand-alone micros has for some time been seen as the best way for the personal computer user to develop. Now the products and the software are starting to arrive. In our special section next month we'll be looking at what is available and how it works in real life. Important decisions have to be taken about which nets to support, and we may be stuck with the results for years.

REVIEWS

MIX'N' MATCH

A real mixture of products are on the bench for review next month. We plan to compare two full-function lap computers from Grid and Ericsson. For those with less cash to spare, how about a 128K 65C02-based micro for £170? Not the Apple IIc after a price cut, but the Atari 130XE. Plus, among the interesting IBM PC software is Trigger, a new package to help monitor your business.

TOP TEN

IBM PC COMPATIBLES

To follow up this month's special section, we provide a guide to the Top Ten IBMulators which you might want to buy rather than Big Blue's own machine.

Don't miss the July issue of

PRACTICAL COMPUTING

On sale at WH Smith and all good newsagents after June 12:

Contents may vary due to circumstances beyond our control and are subject to change without notice.



Express Computer Consultants Ltd.

0273 204377

**HARDWARE & SOFTWARE FOR IBM, APPLE, APRICOT, SIRIUS AND OTHERS
COMPUTER STATIONERY, MEDIA & FURNITURE. BOOKS & TRAINING SOFTWARE.**

SOFTWARE SOFTWARE Cont... HARDWARE HARDWARE Cont...

INTEGRATED WINDOWING

Framework -IBM	£350.00
Open Access-IBM	£398.50
Open Access-Apricot	£480.00
Symphony-IBM	£425.00

WORDPROCESSING

Easywriter II-IBM	£214.00
Mac Microsoft Word-Mac	£171.00
Multimate-IBM	£355.00
Volkswriter-IBM	£241.00
Wordstar Prof-IBM	£275.00
Wordstar 3.3-Apple IIe	£258.00
Wordstar Prof-MSDOS	£390.00

DATABASES

Cardbox-IBM	£176.25
Friday-IBM	£155.50
Knowledge Man-IBM	£440.00
DBase II-IBM	£280.00
DBase III-IBM	£325.00

SPREADSHEETS

Lotus 1-2-3-IBM	£325.00
Multipan-IBM	£170.00
Supercalc III-IBM	£261.25

COMMUNICATIONS

Bstam PC DOS-IBM	£135.00
Transporter-IBM	£179.00
EXPRESS-MATE/- IBM	
EXPRESS-LINK	£330.00

APPLICATIONS

Easy Jr-IBM	£311.00
BOS Modules-IBM	P.O.A.
Estimator	£268.50
Pertmaster-IBM	£587.50
Project Manager-IBM	£355.00
Tkl Solver-IBM	£303.00

LANGUAGES/OS's

C Compiler-IBM	£450.00
C Basic-CP/M86	£148.75
C Basic Compiler-PCDOS	£450.00
CIS Cobol-IBM	£373.75
Level II Cobol-IBM	£862.50
Microsoft C Compiler-IBM	£436.50
Ms Pascal-MS/PCDOS	£266.25
PL/1-IBM	£576.00
X Basic-CP/M80	£151.00

UTILITIES

Access Manager-IBM	£292.50
Display Manager-IBM	£377.00

SCIENCE/ENG./MATHS

MICROSTAT 4.1-IBM	£291.75
STATPRO-IBMXT	£1225.00

BUSINESS GRAPHICS

Chartman IV-IBM	£186.75
DR Graph-IBM	£225.00
Foxgraph-IBM	£175.00
Graphstat 1-IBM	£233.25

DESIGN GRAPHICS

Microsoft Chart MAC	£130.50
Microsoft Chart-IBM	£220.50

PRINTERS

Anadex DP9000B	£1038.20
Anadex WP6000	£2287.10
Brother HR15	£417.25
Brother HR35	£867.25
Diablo 630 (ECS)	£1936.20
Epson DX100	£431.00
Epson FX100FT	£533.43
Epson JX80 (colour)	£525.00
Epson LQ1500	£1031.20
Okii Microline 84	£746.50
Okii Microline 92	£419.00
NDK Printstar	£1125.00
NEC 2050	£824.25
NEC 7700	£1763.50
NEC Spinwriter 3550	£1193.70
Newbury 8820	£862.50
Qume 11/55 RO	£1834.20
Qume Sprint II/40RD (req I/F)	£1399.20
TEC/ITOH F10 40cps	£1021.50

PLOTTERS

HP7470A	£1045.20
Epson Hi/80	£375.00

HARD DISKS

Honeycomb V3.1-IBM	£3352.50
Xebec 10mb—Apple	£949.00
Santa Clara 12mb	£2149.70
Sysgen 11—20-IBM	£3374.00
QCS 20mb-IBM	£2046.20

MONITORS

Kaga 12" Green	£104.00
Kaga RGB Vision III	£381.50
Microvitec 14L46DI	£570.00

BOARDS for IBM

AST Megaplus II	£264.00
Baby Blue II	£523.50
Blossom 64k	£304.00
Sigma Maximisar	£314.50
Pc Net Blossom	£702.00
Quadboard 0k	£254.50
Quadboard II 64k	£327.50
Hercules	£405.50

Also

PRINTER ACCESSORIES

PARALLEL/SERIAL INTERFACES

MODEMS

COPROCESSORS

MEDIA

£P.O.A

3M, BASF, CALCULUS, DYLAN, FUJI, NASHUA, WABASH

Also

DUST COVERS, PRINTER

RIBBONS/

WHEELS, PAPER, FURNITURE.

IT'S IMPOSSIBLE.....

...TO LIST OVER 2,000 PRODUCTS IN THIS ADVERTISEMENT,
PHONE 0273-204377 FOR FURTHER INFORMATION

AT NO COST TO YOU....

...WE WILL NEGOTIATE DISCOUNTS STARTING AT 10% WITH AUTHORISED DEALERS OF IBM PC/XT/AT, APPLE/LISA/MAC, DEC, RAINBOW, APRICOT/SIRIUS ON YOUR BEHALF.



Express Computer Consultants Ltd.

EQUITY & LAW HOUSE
102 QUEENS ROAD
BRIGHTON BN1 3XF
Tel: 0273 204377

● Circle No. 181

HOOKED UP

Email, word processing and high-res graphics have combined to transform Tony Rubin's working environment. This is his account of a day in the electronic office of the mid-eighties.

08.30 I generally arrive at the office between 8.00 and 8.30, this is too early for the first delivery of the traditional paper post. However, my electronic in-trays are probably brimming with messages, notes and documents. I log in to a bulletin board which is based at a college in the University of London; we are currently talking about a collaborative project and the potential team of collaborators situated in Glasgow, Manchester, Nottingham, Ipswich and London discuss various matters on the bulletin board. Most of the information I receive is available to the whole team. There is also a mail system that allows individuals to mail messages to each other. This morning there were 12 unread messages on the bulletin board — these university types work late — and a single unread personal message. I read them all, taking a hard copy of those that may be important. I reply to the personal note and enter two general comments on the topics being discussed.

08.50 I log in to another electronic system based in Birmingham. The users of this system are mostly researchers in my domain and the system is also an electronic journal containing academic contributions that have been electronically refereed, as well as discussions on various matters pertinent to the topic area. The beauty of such an electronic discussion is that I can make any points at my convenience, in my office, and after due thought and deliberation. This can be contrasted with a face-to-face discussion where you have to constantly "think on your feet", which may not always be beneficial. This is not to suggest that face-to-face meetings are dispensable; they are very useful for certain types of information dissemination and will be very difficult to completely replace by an electronic equivalent. Tele-conferencing is just a step in this direction. I read the four messages and reply to one of them, noting that I ought to compose a more lengthy reply on another matter when I get time.

09.15 The traditional post is just being sorted in the post-room, but I have already made considerable inroads into my daily correspondence. I log on to my Telecom Gold mailbox but there is nothing there for me to read; empty mailboxes, like empty in-trays, tend to disappoint.

09.20 I continue working on an academic paper I am writing. The paper resides on our division's local area network. We have word-processing facilities which allow easy editing of work. When I first started here nearly five

years ago, we all used to write our work out in long-hand, send it to the typing pool, get it back a week or so later, correct the spelling mistakes, send it back to the typing pool and so on. The turnaround time for a paper or article is greatly reduced now we all use the system. The old argument of "we are managers not typists" has not been heard in these parts for a long time. We soon realised that we don't need to be super efficient touch and/or speed typists in order to create documents. The dependency of our division on the system is such that the occasional maintenance/upgrade days when the system is down result in some of our people sitting at their desks drumming their fingers, having forgotten what is like to compose using such archaic instruments as pen and paper.

10.00 Over coffee I peruse a printed version of the paper I am writing. I still find it easier to spot and edit mistakes when I have a hard copy in my hand.

10.20 The post arrives but the document I was waiting for hasn't. I telephone the person who promised to send it and get assurances that it was sent by first-class post two days ago. Electronic documents do not get put on the wrong train, or get lost or damaged.

10.30 My paper requires quite a complicated diagram for one of the figures. I go next door into our terminal room and turn on our Apple Lisa. This has a very good graphics facility, Lisa-draw, that allows you to draw reasonably high-resolution monochrome pictures. Labelling in various fonts is also a useful feature. The drawing office used to be the only source of good-quality drawings for published papers, as hand-drawn figures are very difficult to do and rarely good enough. Because everybody else on-site uses its services, jobs could sometimes take weeks. As few people on-site have access to a Lisa or similar machines, I consider that I am doing my bit for easing the congestion and the workload on the drawing-office staff while keeping full control of what I produce. One value of producing such material yourself is that small changes, alterations and even completely fresh ideas are easily implemented. I spend from now until lunchtime finishing my work of art.

13.45 I quickly delve into my electronic mailboxes to see if there are any responses to my messages of this morning. Nothing much doing on the first two, but somebody in one of our London offices has used Telecom Gold to request me to make a visit. All the details are included in the message, he says he sent it to me on Telecom Gold because there was no answer

when he rang me at lunchtime. I respond asking him to clarify a few details.

14.00 I read two papers pertinent to my current work. Such a task is yet to be replaced by an electronic equivalent, although I would expect that within the next few years I will be able to order copies of papers via an electronic database hooked up to a library computer. The actual paper will probably still be a photocopy sent by post, but at least the ordering will be made much more simple.

15.15 Tea-time. I open the second delivery of ordinary post, it contains two junk-mail items: advertisers' blurbs for products and services I am not remotely interested in. Although electronic junk-mail is reported to be a problem in the U.S., my experience with U.K. systems suggests that so far we have largely managed to avoid it. No doubt increasing use will result in some unscrupulous agencies sending out large mail-shots to us poor, unsuspecting users.

15.30 I remember I am giving a talk to some visitors in the near future and I need to prepare some overhead projector slides to illustrate some of my points. Within our division we have a minicomputer that has a plotter peripheral so that drawings and text in four colours can be composed on the screen and then drawn on to either paper or acetate sheets. In the past most of us would draw our overhead slides by hand. While this is perfectly acceptable, there is no doubt that slides that are produced via the computer add an air of professionalism to any presentation.

16.45 Time for one last mail-check. Replies in each of my mailboxes means an extra half an hour reading and replying. The immediacy of the medium means that the effort is very worthwhile as I will usually have replies by the next morning.

17.15 On the way home I realise how much I use electronic systems and computers in my everyday work. I mentally review my day and realise that it has been quite uneventful, quiet even, yet I have used electronic facilities and communicated with many people in a way that I would have never dreamed of even three years ago. I decide that it might be interesting for other people as yet not fully immersed in electronic technology to have a glimpse of what it is like for me and therefore may be like for them soon. Of course not all office jobs are as amenable to conversion as mine; research is a typical example. Also many managers, especially those with personal secretarial or clerical staff, might feel that many of the tasks I quite naturally and unthinkingly perform would be too time consuming or demanding for them to do. But that still leaves many people who, over the next five years, may find themselves in an environment like the one I am now in.

I get home and turn on my Commodore 64, I get out my Wordcraft disc and I start typing.

Tony Rubin is a Human Factors Researcher.

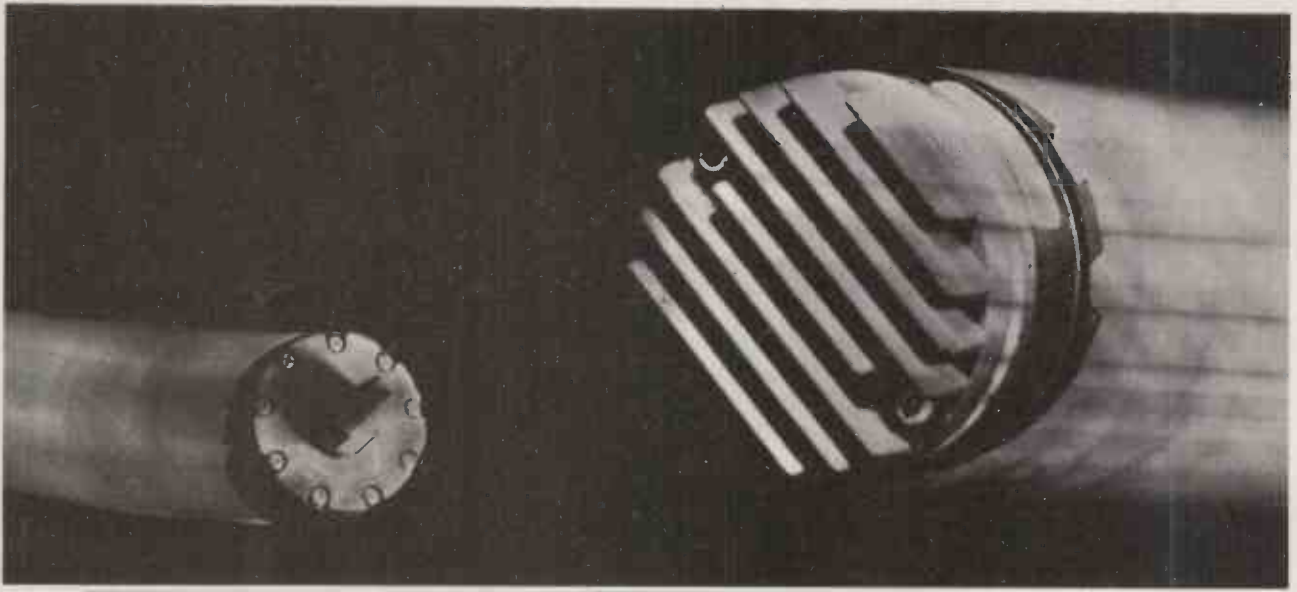

EITHER AN OKI OR HEADS WILL ROLL.

OKI IS O.K.

Imagine a head that can print 500 million characters – 1/4 million A4 pages – without falling over. Imagine an OKI 2410.

500 million characters of needle sharp quality – the OKI 2410 is the No. 1 professional standard for heavy duty applications.

It's the clearest proof of the superiority of OKI performance. Performance based on high quality and reliability, so that while other printers are falling down, OKI printers continue to give you print perfection. Perfection built in by OKI's robotic production assembly line. The robots themselves are OKI designers and characterise the futuristic thinking of the com-



X-DATA
THE NAME BEHIND
THE PRODUCTS IN FRONT

X-DATA Ltd. 750/751 Deal Avenue
Slough Trading Estate Berks SL1 4SH
Tel. Slough, (0753) 72331 · Tlx. 847728

pany. All OKI printers, including the best selling MICROLINE range, are designed and built the same way, ensuring that from the least expensive to the top of the range, OKI quality and reliability is constant throughout.

Don't forget, no-one's head has ever rolled for buying OKI printers . . .

So now that you'd like to know more about the OKI printer range, contact us at the address below and we'll send you the information you need. Better still, why not see an OKI printer in the flesh. Call in and see your local approved dealer now – otherwise heads will roll . . .

Telephone Lucy O'Sullivan 01-661 8163

ADVERTISEMENT RATES

Rates quoted below are subject to the addition of 15% VAT.

Display Rates

£16.50 per single	
Column Centimetre	
Minimum 5cm x 1 col	
One Insertion	£16.50 per scc
Three Insertions	£15.75 per scc
Six Insertions	£15.50 per scc
Nine Insertions	£15.00 per scc
Twelve Insertions	£14.50 per scc

Micro Ads.

Lineage 30p per word minimum of 20 words.
Prepayable.

Copy Date

Shopwindow advertisements for the August edition will be accepted up to 25th June subject to space being available.

Post to

Practical Computing, Classified Department, Room H211, Quadrant House, The Quadrant, Sutton, Surrey SM2 5AS.



EGHAM COMPUTER STORE FOR PORTABLE COMPUTING

SYSTEMS	NEC PC8201A	399
	Epson PX8	795
	BBC Model B	339
	Sanyo MBC 550	749
STORE	8K Chips for NEC PC 8200/Tandy 100	49
PRINTERS	NEC PC 8023 S Dot Matrix 120cps	199
	Juki 6100 Daisywheel	349
	Kaga	299
MONITORS	PHILIPS 12" 18MHz Mono	69
	CUB Microvitec Strd. Res. 14" Colour	199
	NEC 12" High Resolution Colour	399
	Fidelity MTV100 Monitor/TV	199
DISCS	CUMANA CSX 100 Disc Drive	95

LARGE RANGE OF SOFTWARE, BOOKS AND MEDIA AT LOW PRICES



COMPUTER ELECTRONICS LTD.
193 HIGH STREET,
EGHAM SURREY TW20 9ED.
TEL: EGHAM (0784) 38838

• Circle No. 300

SCIENTIFIC SUBROUTINE LIBRARY

VOLUME 1 - STATISTICS AND FITTING FUNCTIONS

Mena, SD, normal distribution, partial expectation, Chauvenets criterion, least squares fit to polynomial and arbitrary function, repetitive least squares fits, covariance matrix, chi-squared statistic, matrix inversion, solution of linear simultaneous equations.

VOLUME 2 - LINEAR PROGRAMMING

Reduction of a simplex tableau, integer programming, partial integer programming, conversational linear programming system, least cost mix problem.

VOLUME 3 - FURTHER STATISTICS

Ranking, quantiles, frequency, correlation coefficient, T, chi-squared and F distributions and their inverses, T test, chi-squared test, Wilcoxon test, linear and multiple regression, ANOVA 1-way and 2-way.

VOLUME 4 - TRANSFORMATIONS AND SORTING ALGORITHMS

Fourier and Fast Fourier transforms, numerical integration and differentiation, harmonic analysis, interpolation, coordinate transformations. Exchange sort, Quicksort, Shellsort, Tree sort.

All routines are written in BASIC for easy implementation on any machine.

Machine readable source code £75 - VAT per volume (Most disk formats + QL microdrive now available)

Manuals including full source listings with implementation notes and documentation £25 per volume

CP/M TO DEC FILE TRANSFER

Software to read and write RT-22 format RX01 diskettes under CP/M. Supplied on 8" SSSD diskette - £25 + VAT.

SINCLAIR QL TERMINAL EMULATOR

Allows the SINCLAIR QL to act as a terminal to connect to other micros, bulletin boards and mainframes - £25 + VAT Write or phone for further information on any of ur products.

MICRO LOGIC CONSULTANTS LTD.

57 Station Rd., Southwater, Horsham, W.
Sussex RH13 7HQ.
Telephone 0403 731818

• Circle No. 301

OPEN HOUSE TUITION FOR NOVICES AND OTHERS

Choose your time - day or evening
Learn at your own pace.

BASIC programming	£60
BUSINESS Packages	£70
Word -Processing introduction	£25

Brochure from:

MICROCOMPUTER ADVISORY CENTRE,
Polytechnic of the South Bank,
Borough Road,
London SE1 0AA
or ring:
01-928 8989 ext. 2468

• Circle No. 302

dBASE II - by Ashton Tate is the top selling database package. But it from AQUA Computing Ltd, the dBASE specialists.

dBASE II	£375.00
DBPlus	£125.00
DBFLIST	£30.00
DBAccel	£50.00
dBASE II User' Guide	£22.00
Everyman's Database Primer	£12.00

Any one of the last 4 items is FREE if you buy your copy of dBASE II from AQUA by July 1.

DBPlus COMPRESSES/DECOMPRESSES dBASE II files to 30/40% of original size; SORTS any dBASE II file up to 15 times faster; MODIFIES structures easily - complete with manual. Pays for itself in a few weeks.

Are your files scattered over several disks? DBFLIST compiles a master catalogue of all your dBASE files. Can save you hours of searching for that 'Lost file'.

DBAccel converts dBASE II. CMD file(s) into a single level format for much faster execution; Overlay control can be selective. Program size is limited only by available memory. Reduces running times by up to 50%.

dBASE II User's Guide is one of the best manuals on dBASE II; Has sold over 17,000 copies in the US; Written by Arthur Green, a leading US expert on dBASE courses. In stock now.

dBASE II Beginner's Guide, published by Ashton Tate, is essential for every serious dBASE II user.

For software products (DBASE II, DBPlus, DBFLIST, and DBAccel) add VAT to prices. Specify machine and diskette format (SD/DD, 5.25" or 8"). No extras for packing or postage in UK; add £5.00 for overseas. Further details available on all products. Pay by Cheque, PO, Access or VISA. Send to:

AQUA COMPUTING LTD (Dept PC5), 10 Barley Mow Passage, London W4 4PH (Phone: 01-994 6477).

• Circle No. 303

NOTICE TO ADVERTISERS VALUE ADDED TAX

Would classified advertiser's please note that 15% Value Added Tax must be added to advertisement rates quoted in this Journal.

READ AND PRINT BAR-CODES USING ANY COMPUTER

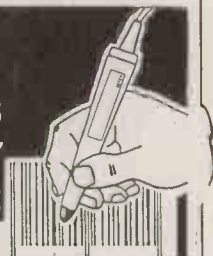

Bar-codes give a speedy and error free means of data entry and provide a foolproof method of identification for any item or document. Typical uses include stock control, libraries, filing systems, security and checkpoint verification, point of sale terminals, spare parts identification, etc. etc. Already most grocery products are bar-coded at source and many other areas of industry and commerce are following. Bar codes will soon be commonplace. Altek decoding algorithms have been developed over a period of years and are recognised as being second to none. (Others use our software under licence, in their own products.) All easily exceed the industry standard benchmarks. (90% first time read and one substitution error per million reads)

All Altek decoders are housed in a smart instrument case with "ink well" for the scanning wand when not in use. In addition they all come with software to print bar codes on a standard dot matrix printer. (Epson or compatible). A complete bar code identification system at minimal cost.

RS232 Bar-code Reader

This microprocessor based unit decodes the bar code and converts it into ASCII for transmission to the host via a RS232 port. Complete with power supply and cables.

Works with virtually any computer. Baud rate, data format and optional check digit verification selectable with DLL switches. £385.00 + VAT

NEW system for BBC micro

RDM based, interrupt driven software. Switch on and read bar codes! Nothing to load, no commands needed to start. Reads alphanumeric codes at power up and automatically inserts the data into the keyboard buffer so it is possible to control the computer entirely via barcodes! Decodes ALL these formats: EAN13, EAN8, UPC-A, CODE-39 & INTERLEAVE 2/5. As supplied to Acorn. £249.00 + VAT.

CBM/PET & APPLE 2

Lowest cost system. Disk based software decodes the bar code format of your choice and is easily interfaced to BASIC or Assembler. A full specification bar code identification system as used by many private & public sector laboratories, industrial & commercial organisations. £199.00 + VAT. (Not suitable for Apple running CP/M ... Use RS232 system 1)

Phone or write for further details. Please state area of interest and what computer is to be used.

62



ALTEK INSTRUMENTS

Enterprise House 44-46 Terrace Road
Walton on Thames Surrey KT12 2SD
Phone (0932) 244110 Telex 295800 CWAOL

SHOP WINDOW

TURBO PASCAL

Extended Pascal for PC DOS, MS DOS, CP/M86 and CP/M-80. Includes full screen editor, floating point arithmetic, full string handling features, random access data files, compiles faster than IBM or MT+ Pascal, requires less than 35K of disk space, 250 page manual and FREE spreadsheet program written in Turbo Pascal.

** ONLY £54.95 **

TURBO TOOLBOX

A specially crafted set of tools designed to compliment the speed and power of TURBO PASCAL. Whether you're writing a database, an address book or any application that requires a sort or search then you'll appreciate TOOLBOX. Also whatever software you're creating can include its own terminal installation module.

** ONLY £54.95 **

All prices fully inclusive for prepaid orders

CONGUIN SOFTWARE
14 GOODWOOD CLOSE, MORDEN,
SURREY, SM4 5AW

No callers please

Phone 0524 381423

● Circle No. 304



If you read serious computing literature or are on the lookout for specialist software you should be using our book and software supply service.

Send a large stamped addressed envelope or an international reply coupon for checklists on artificial intelligence and robotics, graphics, and databases — or £1.20 for our current catalogue (refunded on first order).

Computer Books & Software
St. Mary's Centre
Henderson Street
Edinburgh EH6 6DD
Telephone: 031-553 5947

95

● Circle No. 305

THE SIMPLE SOLUTION

For the best deal on Micros, Printers and other peripherals, call us now Typical package: Apricot P.C., Epson FX80 Monitor and Accounts package. R.R.P. £2688 + VAT

OUR PRICE £2089 + VAT including delivery

4, Falkland Drive,
Kingsteignton,
Newton Abbot
TQ12 3RH

Telephone: Newton Abbot (0626) 64544

98

● Circle No. 306

FORTH = TOTAL CONTROL

FORTH 83 — Professional FORTHS from Laboratory Microsystems. Screen editor, assembler, utilities, full documentation. Special version for IBM PCs and 100% compatibles. State disc format with order. CPM-80 £95+VAT, CPM-86/MS/PCDOS £190+VAT.

QL FORTH-83 — screen editor, macro-assembler, decompiler, turnkey compiler, binary overlays, floating point, colour, graphics, sound, 'hash cache' fast compiler, and 70 page manual — £29.95.

NEWBRAIN FORTH in PROM — includes screen editor, full integration to NEWBRAIN i/o handlers, Z80 macro-assembler, floating point, graphics, decompiler, utilities, and manual — £51.75.

DRAGON FORTH cartridge — split screen editor, sound colour, decompiler, overlays, joystick and timer support, full documentation, and complete source code — £35, CoCo version £45.

Do-it-yourself FORTH. Installation manual — How to do it, model, definitions, editor — £7. Source code: 6502, 6800, 6809, 8080, Z80, 8086/8088, 9995, 1802, 68000, Z8000, VAX, Apple II, LSI-11 — £7 each.

Implementations for Spectrum to VAX, and a range of FORTH books.



MicroProcessor Engineering Ltd
21 Hanley Road Shirley
Southampton SO1 5AP
Tel: 0703 775482

31

● Circle No. 307



MICROMODS LTD.,
53 ACTON RD., LONGEATON, NOTTINGHAM
NG10 1FR. Tel: 0602-724264

32

● Circle No. 308

COMPUTER AND PERIPHERAL REPAIR AND SERVICE

Business and Personal
Computers, Printers, VDUs, etc.
Fast Turnround Competitive
Prices

HAMMOND AND MEADES

Unit 10
The Maltings
Stanstead Abbots, Herts.
Tel. 0920 871624

93

● Circle No. 309

REALISE YOUR FULL POTENTIAL LIFE-LINE



SELF ANALYSIS
CAREER COUNSELLOR

FOR ANY SPECTRUM COMPUTER
(IBM/MS and BBC coming soon)

Understand yourself and others using this brilliant new programme!

LIFE-LINE will reveal:

- YOUR TRUE CHARACTER
- THE CHARACTER YOU TRY TO PROJECT
- YOUR SELF-IMAGE

LIFE-LINE can help you:

- CHOOSE THE RIGHT CAREER
- ACHIEVE MORE
- UNDERSTAND OTHERS
- IMPROVE YOUR RELATIONSHIPS

LIFE-LINE is simple to use, amazingly accurate, and comes complete with an instruction manual written by St. John A. R. Young B.A. (Psych.) LIFE-LINE is designed for use in the home, school or college — anywhere that people matter

Price £14.95 inclusive of VAT and Postage.

All enquiries SAE please

Barclay/Access orders accepted by telephone

WILLIAM
STUART
SYSTEMS Ltd

Quarley Down House, Cholderton
N. Salisbury, Wiltshire SP4 0DZ
Tel: 098 064 235



● Circle No. 310

FREE BOOK CATALOGUES

... of independently selected books on specific micros, languages, electronics, etc. Savings on purchases offered to regular subscribers. For FREE catalogues write to:



DEPT B,
COMPUTER & ELECTRONICS EDUCATION,
233-243 Wimbledon Park Road,
London SW18 5RJ
(stating area of interest)

● Circle No. 311

CAPTURE THE FUTURE WITH YOUR MICRO

Are you bored with games?
Do you find manuals difficult and frustrating?
Do you want the advantage of programming skills?
Do you want your own 'expert' to show you how to do it?
Then you need 'TAKING CONTROL OF YOUR MICRO'

- Easy and enjoyable steps to practical BASIC.
- Examples to see and exercises to do.
- Feedback Modules give you Personal Guidance.
- Structured for home, school and college.
- For BBC Spectrum and Commodore micro-computers.

TAKING CONTROL OF YOUR MICRO gives you the help you need to gain the skills, advantages and benefits in TOMORROWS WORLD.

Price only £25.00 includes delivery UK. Please state your micro.

Contact:

SS Software, 18 Fernbank Drive, Eckington, Sheffield
S31 9HG. 101

Don't be left behind. Make 1985 your year to leap ahead.

● Circle No. 312



A strategy game for two players running on the IBM PC, Advance 86B or similarly PC compatibles with BASICA. State disk capacity when ordering. Price £14.95 inclusive of post & packing. Send cheque/P.O. payable to DS & WA Newby, 4 Sherwood Way, Langley, Southampton SO4 1ZQ.

Newby — Data — Services

● Circle No. 313



If you read serious computing literature or are on the lookout for specialist software you should be using our book and software supply service.

We catalogue new books and software products from leading publishers three times a year. Our latest 28-page list contains details and abstracts on nearly 300 titles. To obtain a copy send £1.20 (refunded on first order) to:

Computer Books & Software
St Mary's Centre
Henderson Street
Edinburgh EH6 6DD
Telephone: 031-553 5947

77

● Circle No. 314

THE LAST ONE (TLO) PROGRAM GENERATOR

Allows anyone to write stand alone, quality programs to use or sell. Active User Club exists. Most 8-bit computers £201.25; 16-bit £258.75.

Send for booklet and details from:
UK Distributors

100

VANCE ASSOCIATES LTD
Church Lane, St. Sampson,
Guernsey. Tel. 0481 49783

● Circle No. 315

TRS-80 MODEL OWNERS! Want to start your own business using your micro? Send sae for list of programs for business ideas. IDS Ltd., 315-319 High St., Chatham, Kent ME4 4BM. Tel. 0634 815804. 158M

AMSTRAD USERS — 150+ software titles available, also many accessories discounted. Sae for details. The Software Club, 26 Beechley Drive, Cardiff. 160M

SHOP WINDOW

HEWLETT PACKARD 110. Portable, new, never used, 272K. RAM. 385K. ROM. Full size keyboard, LCD display, £2,500 o.n.o. Phone R. Todd, Southampton 223607 (after 6pm). 168M

CP/M USER groups disk. Libraries. 300+, volumes, £1.50/vol. Copying free. Also disk format translation, £6.50/DSK. Most formats possible. SAE or phone R. Smith, 138 Holtye Rd., E. Grinstead, Sussex RH19 3EA. (0342) 313883. 169M

SHARP MZ-700 and MZ-711 owners. Brand new and original programs for sale. S.A.E. for complete list by return to: Maysoft (DMB), 50 Thompson Avenue, Colchester, Essex CO3 4HW. 170M

JUKI DAISY Wheel Printer 6100. Brand new £300. Dual disk drivers, Teac 55E S/S. 80 track, brand new, £295. Ten blank 3m 5 1/4" diskettes, single side new, £12. Ring: Aldershot 315520 Evenings. 171

IT'S A SUPERSTAR Multi-User/Multi processor computer. 4-6 users file/record locking. 40M-byte hard disk. Wordstar/Mailmerge/Superthought etc. Offers invited on Chelmsford 269622. 178M

APPLE II. 64K. Twin Disk Drives, (Dos 3.2) and Printer, DP-800 Accessories, Graphics, Tablet and Interface Card, Music Card, Speech Card, Software for above and Contributed Programs, V3, 4 & 5. All Manuals also Pascal. Software and Users. Manual. All good condition, £750. Phone: Gt. Missenden (02406) 3686. 173M

RARE BLACK Box micros. Bought, sold, exchanged and repaired. Ring: (0628) 71243 (Maidenhead). 181M

COMMODORE 8096, 8250, full working order, £950. 4032, 4040, 3022. F.W.O. plus wordpro, 50 disks, £495. 01-950 9455 (24 hours), Watford. 174M

OLIVETTI M24. Single disk, no software, nearly new, sale due to business failure. Open to realistic offers. Phone (0763) 71100. 175M

TRS-80. Model 3, 48K, one disk, high-res graphics, colour plotter/printer, electrostatic printer, all leads, manuals, etc. Must sell quickly! £1,000. (0966) 32521. 176M

COMPLETE BUSINESS micro system. £550 the lot! 1981 Superbrain, 1982 Epson printer, Software: C Basic, Datastar, Supersort, Wordstar. Demo at Burnham, Bucks. Phone: (06286) 63674. 177M

BBC MOD B Cumana. 40 track, dual disc drives, sideways, RAM with Elite, "The Key", Replica, Paintbox, Random/A, filing system, BCPL, Pascal Forth Assembler (ADE) compiler. Watford DFS, toolkit, D/Doctor, many more, £700. 172M

SOFTWARE. Probably your cheapest inclusive source. Eg, WordStar 2000 £340, WordStar Professional £285, Lotus 1-2-3, £355 including VAT, carriage. Call Scimitar Business Services. (0705 823052, evenings) to discuss your requirements. 179M

SHARP MZ80A. Expansion unit, P6 printer, 5 languages, 160 programs, £450. Phone: Sunbury 86490. Evenings. 180M

APPLE MAC, Lisa/2, Apple 2c, Apple 2e, and all peripherals, Kaga monitor £75, Apple 2c monitor £87, plus software extras, all unused, boxed as new, with full guarantee. Ring Nigel, 0203 503042. 161M

DISK COPYING SERVICE

Moving data and program files from one machine to another is often made difficult because different manufacturers have adopted different disk format standards.

We can copy your files to and from over 250 disk formats including CP/M, CP/M-86, MS-DOS, PC-DOS, ISIS, APPLE, SIRIUS, TORCH, APRICOT, HP150, DEC RT-11, and IBM BEF.

Disks are normally despatched on the day they are received.

Our charge is £10.00 + disk + VAT. Special prices for quantities.

For more information call us.

GREY MATTER

4 Prigg Meadow, Ashburton, Devon TQ13 7DF. TEL. (0364) 53499

Circle No. 316

When replying to Classified advertisements, readers are recommended to take steps to protect their interests before sending money.

SELL WITH

PRACTICAL COMPUTING

SHOP WINDOW

MICRO ADS. Order Form

Classified Rates

Lineage 30p per word
Minimum 20 words prepayable.

Display Adverts.

Rate per single column
Centimetre: £16.50
Minimum 5 cm
SERIES Discounts
Available on request.
Contact: Claire Notley on
01-661 8163.

Method of Payment

Cheques etc should be made payable to BUSINESS PRESS INTERNATIONAL LTD. and crossed.
I enclose herewith cheque/PO for

£.....

Post to:

Cut out the order form and return together with your remittance to:
Classified Department,
Practical Computing,
Room H211, Quadrant House,
The Quadrant, Sutton,
Surrey SM2 5AS.

Conditions of Acceptance

Micro Ads are accepted from Private readers only and must be submitted on (or a photocopy of) this order form. All Advertisements must be prepaid.

Please insert the following advertisement in Practical Computing

LINEAGE

			LINEAGE		
			Cost per insertions		
			1 ins.	15% VAT	TOTAL
			£6.00	£0.90	£6.90
			£7.50	£1.13	£8.63
			£9.00	£1.35	£10.35
			£10.50	£1.58	£12.08
			£12.00	£1.80	£13.80
			£13.50	£2.03	£15.53
			£15.00	£2.25	£17.25

Box No. Required YES/NO

No. of Insertions
(50p discount for 2 ins.)

NAME (Please include initials)

ADDRESS

THIS FORM SHOULD BE RETURNED BY 25TH JUNE FOR THE AUGUST ISSUE

Company Registered Number: 151537 (ENGLAND). Registered Office: Quadrant House, The Quadrant, Sutton, Surrey SM2 5AS.

SHOP WINDOW

ARE BUSINESS COMPUTERS A MYSTERY TO YOU?

RING
01-337 4541

INTEGRATED
ACCOUNTS

WORD
PROCESSING

MSDOS
CP/M
BASIC

EPSON QX16

REMOVES THE MYSTERY

The computer with both 8 and 16 bit processors, CP/M, MSDOS, and IBM compatability; to run all the best programs. It must be the easiest machine to use and it's so fast.

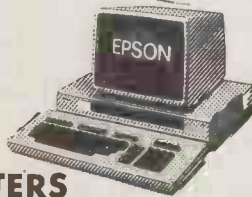

CONCORDIA COMPUTERS

6 CENTRAL ROAD, WORCESTER PARK, SURREY KT4 8HZ

● Circle No. 192

X T CONVERSION KITS FOR IBM® AND COMPATIBLES

NEW FAST CONTROLLER!

WESTERN DIGITAL 1002 SWX-2

ST-506 STANDARD.....£249

MR 521 HALF HEIGHT, 5 1/4"

10MB WINCHESTER DRIVE (FORMATTED)

2-HEADS, AVERAGE 85cms ACCESS.....£399

MR 522 HALF HEIGHT 5 1/4" 20 MB

WINCHESTER DRIVE (FORMATTED)

4 HEADS, AVERAGE 85ms ACCESS.....£579

SET OF CABLES FOR ABOVE.....£25

RAM CHIP SALE!!!

4164 64K DRAM 150Ns.....£2.35 each

41256 256K RAM 150Ns.....£5.99 each

(for upgrade Olivetti-M24, Compaq Deskpro etc)

Prices exclude VAT and delivery. For terms see our other advertisements.

DIGITASK
BUSINESS SYSTEMS LTD
58, MAPLE DRIVE, EAST GRINSTEAD, WEST SUSSEX, RH16 3UR

TEL: (0342) 24631-313427
TLX: 957547



● Circle No. 193

PRACTICAL COMPUTING

Advertisement Index

A		Dennison	IFC	J		Opus Supplies	24
3D Computers	98	Digitask	146	Jarrogate Ltd	78	Oryx Systems	67
A&G Computerware	94	Digitask Business Systems	131	Juki (Europe) GmbH	34	Oxford Computer Systems	28
AWS Computer Supplies	104	Digithurst Ltd	139	K		P	
Aculab	23	Disking International	57	Keele Codes Ltd	42	Pathrace Ltd	30
Albeta Ltd	54	Duplex Systems Ltd	98	L		Plusmark Business Systems	50
Alpha Micro	42	Dysan	20	Lantech Information System	136	Practical Computing	90
Ampex GB Ltd	25/26/27	E		M		S	
Amstrad Consumer Electronics	18/19	Elite Computer Systems	136	Master Systems	14	Sage Soft	63, 79
B		EMAP	77	Mayfair Micro	86	Seikosha Co Ltd	35
Bank of Scotland	137	Epson (UK) Ltd	121	Mercator Computer Systems	50	Sorcim	40/41
Barbatan	126	Etafield Ltd	130	Micro Computer Services	110	Sorcim	52/53
Bolton Insurance Services	9	Express Computer Consultants	140	Microft Technology Ltd	9	Southdata Ltd	76
Brighton Computer Centre	30	F		Micro Nationwide	86	Synamics Business Systems	88
Brom Com	12/13	Fraser Assoc.	44	Micronix	95	System C	4
Business Computer Show	62	Fujitsu Micro Computer Systems	OBC	Micro Peripherals	IBC	System Science	130
C		G		Micropro	107	T	
Cannon Business Machines	70/71	GCC (Cambridge)	124	Microprocessor Eng Ltd	50	TAB's	45
Cash & Carry Computers	132	GCC Cambridge	66	Microsoft	10/11	Tandata	38
Centronics Data Computer	39	Gemini Microcomputers	87	Microvitec PLC	36	Trisoft Ltd	98
Computech Systems	130	Grafax	33	Microware	32	U	
Computer (Hardware & Software) Supplies	94	GW Computers	133	Miracle Technology	22	Unicorn Business Systems	94
Concordia	146	H		Mountaindene	104	W	
Conguin Software	104	HMSystems	48	N		West One Galaxy	138
D		Homestead Electronics	30	Nashua Computer Products	17	Wimbourne F	66
Data Flex	9	I		O		X	
DDL	58, 85, 6	Infomata Ltd	51	Okidata	142	X-Data	46/47

If you thought great achievements had stopped, take a look at the Fujitsu Micro 16s.

In 1969, Neil Armstrong was the first man on the moon. A great achievement for mankind.

Yet great achievements didn't stop 16 years ago. Fujitsu's achievements in mainframes, telecoms, chips and micros have made us Japan's number one computer company.

Now we announce another great achievement - the Fujitsu Micro 16s that gives you computer performance that is out of this world. The FM 16s is capable of expanding to a five terminal multi-tasking, multi-user configuration with total flexibility and the minimum of hardware redundancy. It runs under our latest Concurrent CP/M, CP/M 86, MS-DOS and P-System operating systems.

The entry level business system comes complete with WordStar, SuperCalc 2, Personal Basic and GSX - and all at under £1950*.

The FM 16s - one of the great achievements from Fujitsu.

* Price as at April 1985.

148

Fujitsu Micro 16s

Both 16 bit and 8 bit processors for 16 and 8 bit software programs.

Multi-user (up to 6 stations total). 128K Byte RAM expandable to 1MByte.

Two 5¼" Floppy Disk drives, IBM format.

Graphics capability.

Several operating systems and free bundled software.

Note: The following trademarks are registered:
 WordStar - Micropro International
 SuperCalc 2 - Sorcim/IUS Micro Software
 CPM, Personal Basic, GSX - Digital Research Inc.
 MS-DOS - Microsoft Inc.
 P-System - Softech/UCSD

● Circle No. 103

FUJITSU Mikroelektronik MICRO COMPUTER SYSTEMS

Hargrave House Belmont Road
 Maidenhead Berks SL6 6NE
 Tel: 0628 76100 Telex: 848955



Send today for your information pack.

Name _____

Position _____

Company _____

Address _____

Tel. No. _____ PC 6

Tick Dealer End-user



FUJITSU MICRO COMPUTER SYSTEMS
 Hargrave House Belmont Road
 Maidenhead Berks SL6 6NE