

# Practical Computing

October 1979

An ECC Publication Volume 2 Issue 10

**160-page issue**

**The Electronic Home**

**Business systems for the rag trade**

**We review floppy disc systems**

**Inside talking computers**

**Build a scoreboard**



Ask for our  
free colour  
brochure

DIAL  
NOW

031-225 2022  
(24 HOURS ANSWERING)

# MicroCentre are the UK Cromemco experts



#### Sample catalogue prices:

*System Two computer	1995
*System Three computer	3293
*Z-2H computer	4998
Extra 64K memory	893
3101 visual display unit	1147
3355 daisywheel printer	2297
HDD 11-mbytes hard disc	4022
ANSI Cobol compiler	55
ANSI Fortran IV compiler	55
16K extended Basic	55
Word processing system	55
Database management	55
Macro relocating assembler	55

Prices exclude VAT and  
delivery

MicroCentre also supply peripherals, applications software, and multi-user timesharing systems; a PROM programmer; analogue-digital interface; and much more. On site maintenance can be arranged throughout the UK.

\*Computer systems include fast 4MHz Z80A micro, S-100 bus (21 slots), 64K memory, dual floppy discs, peripheral interfaces, etc. CP/M compatible operating system CDOS free with software.

With our in-depth experience and total commitment to the reliable Cromemco range we are Cromemco's leading UK distributor. Rely on us, as many others do, for expert support with your routine or special micro-computer applications.

## Micro Centre

Complete Micro Systems Ltd.  
132 St. Stephen Street,  
Edinburgh EH3 5AA.  
Tel: 031-225 2022.

*Photo features Cromemco System 3 computer, 3101 VDU, and 3355 daisywheel printer.*

● Circle No. 101

Managing Editor  
Dennis Jarrett

Editor  
Peter Laurie

Computabits Editor  
Nick Hampshire

Staff Writer  
Kay Floyd

Production Editor  
Harold Mayes

Advertisement Manager  
Erica Gruffydd

Advertisement Department  
Tom Moloney  
Tina Roberts

Subscription Manager  
Annabel Hunt

Company Secretary  
Carole Fancourt

Managing Director  
Richard Hease

Editorial: 01-359 8451  
Advertising: 01-359 8151

Production and Subscriptions:  
01-359 7481

Practical Computing is published by ECC as a subsidiary of WHICH COMPUTER? Ltd at its registered office, 30-31 Islington Green, London N1

and printed by Edén Fisher Ltd, Southend-on-Sea.

Distributed to newsagents by Moore Harness Ltd., 31 Corsica Street, London N5 and to specialist shops by Practical Computing Ltd.

Subscription Rates:  
Single copy: 50p.  
Subscriptions: U.K., £6 per annum (including airmail postage).  
Europe (excluding U.K.), £12;  
Elsewhere in the world: £18.

©Practical Computing 1979  
ISSN 0141-5433.

Every effort has been made to ensure accuracy of articles and program listing. Practical Computing cannot, however, accept any responsibility whatsoever for any errors.

## PRESTEL

The Post Office data highway for home and office .....63

## REVIEW I

A comparison of floppy disc systems for Pet, Apple II and Tandy .....57

## REVIEW II

The SGS-ATES Z-80 training system .....60

## ARTIFICIAL INTELLIGENCE

An introduction to LISP, a favourite language for AI .....82

## THE TALKING COMPUTER

We disembowel the TI Speak and Spell and review the Microspeech board .....92

## TWO SMALL BUSINESS SYSTEMS

The good news and the bad news .....79

## MICRO-MOUSE

First announcement of the U.K. and European championships, to be held next year .....123

## FOURIER ANALYSIS — PART II

In Computabits .....124

## ALL THIS AND MORE

FEEDBACK .....49  
Your letters and our replies

PRINTOUT .....52  
News from industry

FICTION .....74

WEST COAST NEWSLETTER .....77  
The Grim Reaper at work

ELECTRONIC SCOREBOARD .....89  
A Pet application

M5 .....97  
A tiny Language for the Nascom

VERIFICATION .....101

PET CORNER .....109

APPLE PIE .....113

TANDY FORUM .....115

DIARY .....123  
What's happening next

MICROCOMPUTER BUYERS' GUIDE ..134  
Our invaluable listing of what's available

GLOSSARY .....156  
What all those funny words mean

ADVERTISEMENT INDEX .....157

NOVEMBER ISSUE ON SALE OCTOBER 17

# aculab Ltd

> ACULAB 735, a fully self-contained interface for IBM 735 output golfball typewriters.



- > Parallel model accepts 7-bit ASCII data via Centronics compatible connector.
- > Serial model accepts RS232/V24, Baud rate selectable. (Parallel model may be retro-fitted with serial board).
- > Programmed for 7 different typehead layouts, covers all common golfballs and an ASCII ball, switch selectable.
- > Stop/Go switch, Online/Offline switch, also Online/Offline under software control.

> Parallel.....£155-00 + VAT  
 > Serial.....£205-00 + VAT

**aculab** Ltd.

24 Heath Road,  
 Leighton Buzzard, Beds.  
 LU7 8AB

For further information  
 Telephone. 0525-371393.

● Circle No. 102

## MICRO 44 . . .

Announces their New Range of

# EXIDY SORCERER SOFTWARE

Also customised programming and software consultancy and support on all micros.

Contact Andy Marshall at:

**MICRO 44, 44 Arthurs Bridge Road,  
 Woking, Surrey or  
 Phone: (04862) 66084.**

● Circle No. 103

## S100-the British way

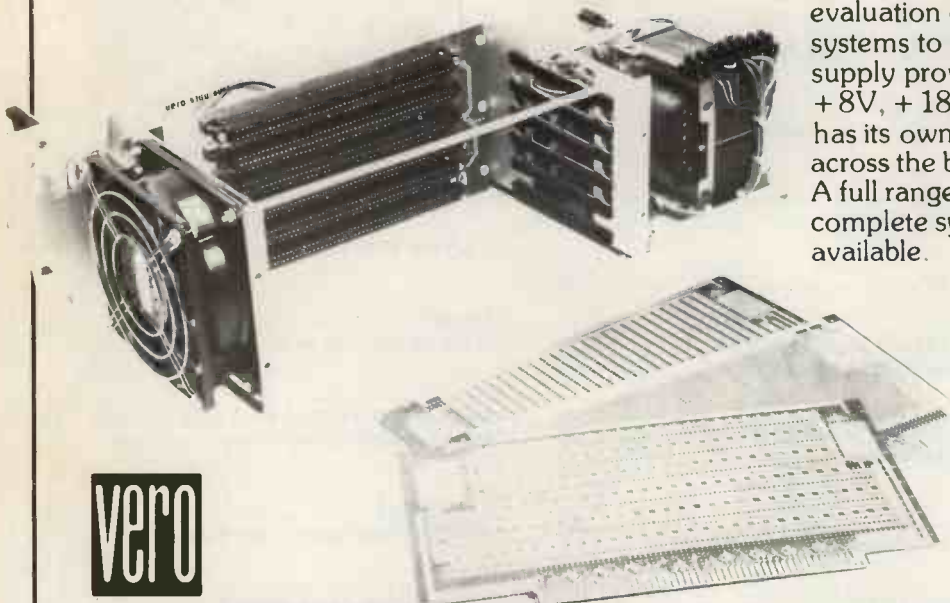

**VERO**

**VERO ELECTRONICS LTD RETAIL DEPT.**  
 Industrial Estate, Chandler's Ford,  
 Hampshire SO5 3ZR  
 Tel: (04215) 62829

The Vero S100 Sub Rack is a 19" rack mountable development kit, complete with its own power supply and backplane motherboard, for the construction and evaluation of microprocessor based systems to the S100 format. The power supply provides three voltage levels — +8V, +18V and -18V. The Sub Rack has its own cooling fan providing airflow across the boards and the power supply. A full range of allied items to enable a complete system to be constructed are available.

ORDER CODE	ITEM DESCRIPTION
188-2341H	S100 Sub Rack
06-0095L	S100 Dip Board
06-2337L	S100 High Density Board
06-2338F	S100 Square Pad Board
15-1630K	Compatible Connector (Solderlug)
15-1632L	Compatible Connector (Miniwrap)
09-2340H	S100 Extender Board
48-8345K	Mk. II D Series Case
75-2867G	Keyboard Console
79-1729L	Verewire Wiring Kit

● Circle No. 104

# The Cromemco

# Z-2H

**NEW**  
from Comart

**Z-2H**  
*Computer System*

A B

 **Cromemco**

**11 Megabytes of hard disc storage in a fast, new, table-top computer.**

- Fast Z80A 4MHz processor
- 11-megabyte hard disc drive
- Two floppy disc drives
- 64K RAM memory
- RS-232 serial interface
- Printer interface
- Extensive software available

Contact us direct or call your nearest Comart dealer

CAMBRIDGE  
CAMBERLEY  
ILFORD

LEEDS

LONDON  
LUTON  
MANCHESTER

NEWBURY

NEWPORT  
NOTTINGHAM

SHEFFIELD  
SOUTHAMPTON

**CAMBRIDGE COMPUTER STORE**, Cambridge (0223) 68155

**MICROBITS**, Camberley Surrey (0276) 34044

**THE BYTE SHOP**, Ilford Essex (01-554 2177

also at Tottenham Court Road London 01-636 0647

**HOLDENE LIMITED**, Leeds (0532) 459459

also at Wilmslow, Cheshire (0625) 529486

**DIGITUS LIMITED**, London W1 01 636 0105

**ISHERWOODS**, Luton, Bedfordshire (0582) 424851

**MICROCOMPUTERMART**, Manchester (061-832) 2269

also at West Park, Leeds (0532) 788466

**NEWBEAR COMPUTING STORE**, Newbury Berks (0635) 30505

also at Stockport, Cheshire (061-491) 2290

**MICROMEDIA**, Newport, Gwent (0633) 50528

**COMPUTERLAND LIMITED**, Nottingham (0602) 40576

also at Birmingham (021 622) 7149

Manchester (061-834) 0220

Glasgow (041 332) 2468

**HALLAM COMPUTER SYSTEMS**, Sheffield (0742) 663125

**XITAN SYSTEMS LIMITED**, Southampton (0703) 38740



## comart specialists in microcomputers

Comart Ltd., P.O. Box 2, St. Neots, Huntingdon, Cambs, PE19 4NY. Tel: (0480) 215005 Telex: 32514

● Circle No. 105

# Microcomputers from the world's largest full-line manufacturer

# Olivetti

## SUPERBOARD II & CHALLENGER I

Including the first Mini Floppy system for less than £1000

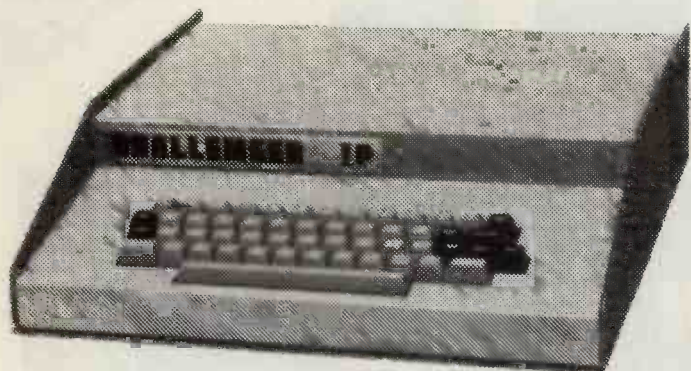

What can be said that hasn't been said already in many magazine reports. Add together the support given freely by the official dealers and the following features and you have unbelievable value for money.

- ★ A full 8K Basic by Microsoft
- ★ The fastest Basic available
- ★ 4K RAM as minimum
- ★ Easy low cost expansion
- ★ Ultra powerful 6502 processor
- ★ Full upper/lower case keyboard
- ★ Amazing graphics
- ★ Free demo tape
- ★ Fully assembled
- ★ Standard interfaces

Just needs +5V at 3 amps power supply and your T.V. to have a powerful economical computer. This is the one board micro that everyone talks about. The C1P is the same with a power supply and rugged metal case.

## CHALLENGER II

The personal and professional computers



C2-4P



C2-8P

The personal computers that have the options that other companies can only talk about, like N.T.S.C. colour, sound and AC remote control. The Challenger II-8P is for the serious personal computer users who want the best of home computers with the expansion normally associated with business computers. Indeed the C2-8P with dual 8" floppy disk drives is ideal for business/educational/industrial users.

- ★ A minimum of 8K Basic, 4K RAM
- ★ Standard interfaces
- ★ Video display of 32 rows by 64 columns screen resolution of 256 by 512 elements.
- ★ Upper/lower case, graphics and gaming elements.
- ★ Ultra-fast Basic for spectacular video animation.
- ★ N.T.S.C. colour, sound and AC remote control options.
- ★ Fully assembled and tested
- ★ BUS oriented construction
- ★ C2-8P can support more in case expansion than its four nearest competitors combined.
- ★ Expands to a complete business system.
- ★ C2-8P is the only personal class computer that can be expanded to support a hard disk.

With all this the Challenger II should be the highest priced?

Wrong: The Challenger II is priced below several models advertised in this magazine.

# SCIENTIFIC

## CHALLENGER III

No compromise business computers

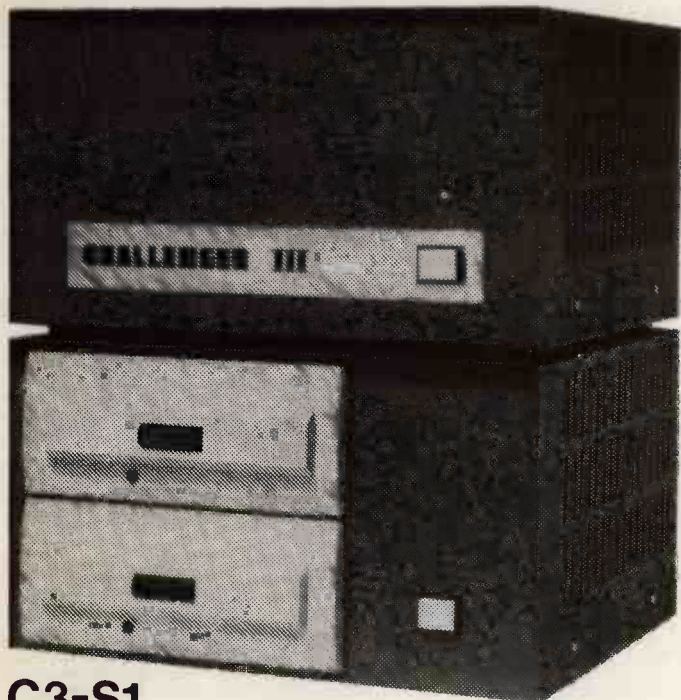

C3-S1



C3-B

HAZELTINE MONITOR / OKI-DATA PRINTER

The Ohio Scientific dealers don't sell TOYS to do REAL business computing or other demanding applications because they know that needs a REAL computer. With the many systems around on the micro-market none can match all the facilities offered with the Challenger III.

1. Not one, not two, but THREE micro-processors, the ultra fast 6502, Z80 and 6800 allowing greater flexibility for programming with CP/M, Cobol, Fortran, Basic etc., etc.
2. A minimum of 500,000 characters on-line disk storage with two full size 8" floppy disk drives for greater reliability and speed of operation.
3. Greater disk storage expandability for keeping all the data necessary in a commercial environment. The fast hard disk systems are the lowest priced of their kind.
4. Greater memory expansion from the minimum of 32K up to 768K RAM.
5. Multi-terminal and multi-tasking capabilities like the Mini and Mainframe computers which can cost many times more.
6. A range of Data Based Management System programs that can only be used with a real business computer.
7. Manufactured with up-to-date micro-electronic technology with components that have been tried and tested for high reliability.
8. Supported by official dealers who provide a complete service and will assist you in obtaining the right system for the right price.

These are some of the many good reasons why the Challenger III is so popular throughout the western world. It is not cheap, it's a quality product designed for the features necessary for a commercial environment, but then again is the computer you want for the home or for the company?

### STANDARD SYSTEMS

	Price
<b>Challenger I</b>	
Superboard 11 4K computer on board	£235.00
CIP 4K Superboard in case and power supply	£299.00
CIP MF 16K CIP with mini-floppy and OS-65D V3.0	£995.00
CIP DF 16K CIP with dual mini-floppy and OS-65D V3.0	£1368.00
<b>Challenger II</b>	
C2-4P 'professional portable' computer	£459.00
C2-4P MF 20K C2-4P with mini-floppy and OS-65D V3.0	£1275.00
C2-4P DF 20K C2-4P with dual mini-floppy and OS-65D V3.0	£1634.00
C2-8P 4K mainframe class personal computer	£638.00
C2-8P DF 32K dual 8" floppy personal/business system	£2168.00
<b>Challenger III</b>	
C3-S1 32K dual floppy in 2 cases	£2998.00
C3-OEM 32K dual floppies in 1 case	£2998.00
C3-A 48K dual floppies, 16 slot, rack, OS-65U	£4251.00
C3-B C3-A with 74 megabyte hard disk	£9985.00
C3-C C3-A with 29 megabyte hard disk	£7988.00
Plus all the supporting products. (Prices are subject to VAT and delivery)	
Some dealerships available and OEM prices. Apply to your nearest dealer.	

These dealers are the official factory authorized distributors for Ohio Scientific Inc.

<b>Calderbrook Technical Services</b> 1 Higher Calderbrook Littleborough Lancs	Tel: (0706) 79332
<b>U-Microcomputers</b> P O Box 24 Northwich Cheshire CW8 1RS	Tel: (0606) 75627
<b>Millbank Computing</b> East Lane, Kingston-Upon-Thames Surrey KT1 2NN	Tel: 01-549 7262
<b>The Byte Shop Ltd</b> 426-428 Cranbrook Road Gants Hill, Ilford, Essex	Tel: 01-518 1414
<b>International Distributors:</b> American Data-Home and Office Computer 1013-15th Street N.W. Suite 300 Washington D.C., 20005	Tel: (202)466-46612
Also Luxembourg	Tel: 48.50.01

● Circle No. 106

# Here at last!

Super software from the world's leading microsoftware supplier.

## DIGITAL RESEARCH

- CP/M\* FDOS** — Diskette Operating System complete with Text Editor, Assembler, Debugger, File Manager and system utilities. Available for wide variety of disk systems including North Star, Helios II, Micropolis, iCOM (all systems) and Altair. Supports computers such as Sorcerer, Horizon, Sol System III, Versatile, Altair 8800, COMPAL-80, DYNABYTE DB8/2, and iCOM Attache. Specify desired configuration ..... **£75/£15**
- MAC** — 8080 Macro Assembler. Full Intel macro definitions. Pseudo Ops include RPC, IRP, REPT, TITLE, PAGE, and MACLIB. Z-80 library included. Produces Intel absolute hex output plus symbols file for use by SID (see below) ..... **£55/£10**
- SID** — 8080 symbolic debugger. Full trace, pass count and break-point program testing system with back-trace and histogram utilities. When used with MAC, provides full symbolic display of memory labels and equated values ..... **£45/£10**
- TEX** — Text formatter to create paginated, page-numbered and justified copy from source text files, directable to disk or printer ..... **£45/£10**
- DESPOOL** — Program to permit simultaneous printing of data from disk while user executes another program from the console ..... **£30/£1**

## MICROSOFT

- Disk Extended BASIC** — Version 5, ANSI compatible with long variable names, WHILE/WEND, chaining, variable length file records ..... **£155/£15**
- BASIC Compiler** — Language compatible with Version 5 Microsoft interpreter and 3-10 times faster execution. Produces standard Microsoft relocatable binary output. Includes Macro-80. Also linkable to FORTRAN-80 or COBOL-80 code modules ..... **£195/£15**
- FORTRAN-80** — ANSI '66 (except for COMPLEX) plus many extensions. Includes relocatable object compiler, linking loader, library with manager. Also includes MACRO-80 (see below) ..... **£205/£15**
- COBOL-80** — ANSI '74 Relocatable object output. Format same as FORTRAN-80 and MACRO-80 modules. Complete ISAM, interactive ACCEPT/DISPLAY, COPY, EXTEND ..... **£325/£15**
- MACRO-80** — 8080/Z80 Macro Assembler. Intel and Zilog mnemonics supported. Relocatable linkable output. Loader, Library Manager and Cross Reference List utilities included ..... **£75/£10**
- EDIT-80** — Very fast random access text editor for text with or without line numbers. Global and intra-line commands supported. File compare utility included ..... **£45/£10**

## XITAN (software requires Z80\*\* CPU)

- Z-TEL** — Text editing language. Expression evaluation iteration and conditional branching ability. Registers available for text and commands. Macro command strings can be saved on disk for re-use ..... **£40/£12**
- ASM** Macro Assembler — Mnemonics per Intel with Z-80 extensions. Macro capabilities with absolute Intel hex or relocatable linkable output modules. New version 3 with added features ..... **£40/£12**
- LINKER** — Link-edits and loads ASM modules ..... **£40/£12**
- Z-BUG** debugger — Trace, break-point tester. Supports decimal, octal and hex modes. Dissassembler to ASM mnemonic set. Emulation technique permits full tracing and break-point support through ROM ..... **£45/£12**
- TOP** Text Output Processor — Creates page-numbered, justified documents from source text files ..... **£40/£12**

- A4 package** includes Z-TEL, ASM, LINKER, Z-BUG, TOP ..... **£155/£30**

## EIDOS SYSTEMS

- KISS** — Keyed Index Sequential Search. Offers complete Multi-Keyed Index Sequential and Direct Access file management. Includes built-in utility functions for 16 or 32 bit arithmetic, string/integer conversion and string compare. Delivered as a relocatable linkable module in Microsoft format for use with FORTRAN-80 or COBOL-80; etc. .... **£275/£15**
- KBASIC** — Microsoft Disk Extended BASIC with all KISS facilities, integrated by implementation of nine additional commands in language. Package includes KISS.REL as described above, and a sample mail list program ..... **£495/£30**

## MICROPRO

- Super-Sort I** — Sort, merge, extract utility as absolute executable program or linkable module in Microsoft format. Sorts fixed or variable records with data in binary, BCD, Packed Decimal, EBCDIC, ASCII, floating, fixed point, exponential, field justified, etc. etc. Even variable number of fields per record! ..... **£125/£15**
- Super-Sort II** — Above available as absolute program only ..... **£105/£15**
- Super-Sort III** — As II without SELECT/EXCLUDE ..... **£75/£15**

- Word-Master Text Editor** — In one mode has super-set of CP/M's ED commands including global searching and replacing, forward and backwards in file. In video mode, provides full screen editor for users with serial addressable-cursor terminal ..... **£75/£15**

- Word-Star** — Menu driven visual word processing system for use with standard terminals. Text formatting performed on screen. Facilities for text paginate, page number, justify, center, underscore and PRINT. Edit facilities include global search and replace, read/write to other text files, block move, etc. Requires CRT terminal with addressable cursor positioning. .... **£255/£15**

## SOFTWARE SYSTEMS

- CBASIC-2** Disk Extended BASIC — Non-interactive BASIC with pseudo-code compiler and runtime interpreter. Supports full file control, chaining, integer and extended precision variables etc. .... **£75/£10**

## GRAFFCOM SYSTEMS

- PAYROLL** — Designed in conjunction with the spec for PAYE routines by HMI Taxes. Processes up to 250 employees on weekly or monthly basis. Can handle cash, cheque or bank transfer payments plus total tracking of all year to date figures. Prints emp master, payroll log, payslips and bank giros. Requires CBASIC-2 ..... **£475/£15**
- COMPANY SALES** — Performs sales accounting function. Controls payments of invoices and prints sales ledger and aged debtors report. Suitable for any accounting period. Comprehensive VAT control and analysis of all sales invoices. Requires CBASIC-2. .... **£425/£15**
- COMPANY PURCHASES** — Performs purchase accounting function. Controls invoices, credit & debit notes. Prints purchase ledger, aged creditors report and payment advices. Comprehensive VAT control and analysis of all purchases. Interfaces with the NAD system. Requires CBASIC-2. .... **£425/£15**
- NAD** — Complete control of all your names & addresses including suppliers, clients, enquiries etc. Assign your own coding system and select all output via the report generator. Will print anything from mailing labels to directories. Requires CBASIC-2. .... **£225/£12**

\*CP/M is a trade name of Digital Research  
\*\*Z80 is a trademark of Zilog, Inc.



Software for most popular 8080/Z80 computer disk systems including  
**NORTH STAR HORIZON, VECTOR MZ, OHIO SCIENTIFIC,  
 CROMEMCO, PROCESSOR TECHNOLOGY, RAIK BLACK BOX,  
 DYNABYTE, SD SYSTEMS, RESEARCH MACHINES, ALTAIR,  
 EXIDY SORCERER, IMSAI, HEATH, and 8" IBM formats**

**STRUCTURED SYSTEMS GROUP**

- QSORT** — Fast sort/merge program for files with fixed record length, variable field length information. Up to five ascending or descending keys. Full back-up of input files created. Parameter file created, optionally with interactive program which requires CBASIC. Parameter file may be generated with CP/M assembler utility ..... **£50/£12**

**GRAHAM-DORIAN SOFTWARE SYSTEMS**

- APARTMENT MANAGEMENT SYSTEM** — Financial management system for receipts and security deposits of apartment projects. Captures data on vacancies, revenues, etc. for annual trend analysis. Daily report shows late rents, vacancy notices, vacancies, income lost through vacancies, etc. Requires CBASIC. Supplied in source code. .... **£300/£25**
- INVENTORY SYSTEM** — Captures stock levels, costs, sources, sales, ages, turnover, markup, etc. Transaction information may be entered for reporting by salesman, type of sale, date of sale, etc. Reports available both for accounting and decision making. Requires CBASIC. Supplied in source code. .... **£300/£25**
- CASH REGISTER** — Maintains files on daily sales. Files data by sales person and item. Tracks sales, overruns, refunds, payouts and total net deposits. Requires CBASIC. Supplied in source code ..... **£300/£25**

**MICRO FOCUS**

- CIS COBOL** — Version 3 is ANSI 74 subset with extensions which offer powerful interactive screen formatting and built in cursor control. Version 4 additionally offers full level 1 ANSI for Nucleus. Table Handling, Sequential Relative and Indexed I/O, Inter-Program Communication and Library  
 ..... Version 3. **£295/£25**  
 ..... Version 4. **£395/£25**
- FORMS** — Interactive utility to create CIS COBOL source code to perform CRT screen handling in application programs. Supports full prompt text, protected fields and input validation against data type and range expected ..... **£65/£10**  
 When purchased with CIS COBOL ..... **£55/£10**

**OTHER**

- tiny C** — Interactive interpretive system for teaching structured programming techniques. Manual includes full source listings ..... **£45/£30**
- C Compiler** — Supports most major features of language, including Structures, Arrays, Pointers, recursive function evaluation, linkable with library to 8080 binary output. Lacks data initialization, long & float type and static & register class specifiers. Documentation includes "C" Programming Language book by Kernighan & Ritchie ..... **£65/£10**
- Z80 Development Package** — Consists of: (1) disk file line editor, with global inter and intra-line facilities; (2) Z80 relocating assembler, Zilog/Mostek mnemonics, conditional assembly and cross reference table capabilities; (3) linking loader producing absolute Intel hex disk file for CP/M LOAD, DDT or SID facilities. .... **£50/£12**
- DISTEL** — Disk based disassembler to Intel 8080 or TDL Xitan Z80 source code, listing and cross reference files. Intel or TDL/Xitan pseudo ops optional. Runs on 8080. Standard CP/M and TRS-80 CP/M versions available ..... **£35/£7**
- DISILOG** — TEL to Zilog/Mostek mnemonic files. Runs on Z80 only. .... **£35/£7**

- TEXTWRITER II** — Text formatter to justify and paginate letters and other documents. Special features include insertion of text during execution from other disk files or console, permitting recipe documents to be created from linked fragments on other files. Ideal for contracts, manuals, etc. .... **£45/£3**
- WHATSIT?** — Interactive data-base system using associative tags to retrieve information by subject. Hashing and random access used for fast response. Requires CBASIC ..... **£70/£15**
- XYBASIC** Interactive Process Control BASIC — Full disk BASIC features plus unique commands to handle bytes, rotate and shift, and to test and set bits. Available in Integer, Extended and ROMable versions.  
 Integer Disk or Integer ROMable ..... **£165/£15**  
 Extended Disk or Extended ROMable ..... **£215/£15**
- SMAL/80** Structured Macro Assembled Language — Package of powerful general purpose text macro processor and SMAL structured language compiler. SMAL is an assembler language with IF-THEN-ELSE, LOOP-REPEAT-WHILE, DO-END, BEGIN-END constructs ..... **£40/£10**
- Selector II** — Data Base Processor to create and maintain single Key data bases. Prints formatted, sorted reports with numerical summaries. Available for Microsoft and CBASIC (state which). Supplied in source code ..... **£105/£12**
- Selector III** — Multi (i.e., up to 24) Key version of Selector II. Comes with applications programs including Sales Activity, Inventory, Payables, Receivables, Check Register, Expenses, Appointments, and Client/Patient. Requires CBASIC Supplied in source code ..... **£155/£12**  
 Enhanced version for CBASIC-2 ..... **£185/£12**
- CPM/374X Utility Package** — has full range of functions to create or re-name an IBM 3741 volume, display directory information and edit the data set contents. Provides full file transfer facilities between 3741 volume data sets and CP/M files ..... **£125/£8**
- Flippy Disk Kit** — Template and instructions to modify single sided 5 1/4" diskettes for use of second side in singled sided drives ..... **£6**

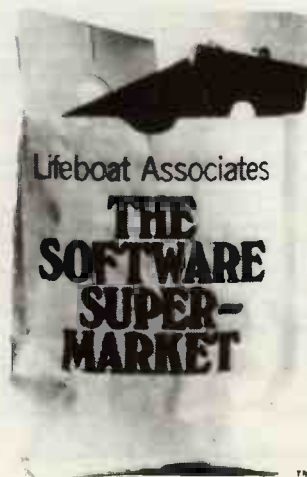

Orders must specify disk type and format, e.g. North Star Horizon single density.

Add VAT to orders for software (not manuals alone). Add 50p per item postage and packing (minimum £1).

All orders must be prepaid (except COD or credit card). Make cheques POs etc. payable to Lifeboat Associates.

Manual costs are deductible from subsequent software purchase.

The sale of each proprietary software package conveys a license for use on one system only.

Lifeboat Associates, 32 Neal Street, London WC2H 9PS. 01-379 7931 <sup>TM</sup>The Software Supermarket is a trademark of Lifeboat Associates

● Circle No. 107

# Great news from Heath.



## WH-89 All-In-One computer.

The new All-In-One computer from Heath has the power, versatility, and built-in peripherals needed to meet the demands of the business user.

- \*'intelligent' video terminal \*Z80 microprocessors.
- \*floppy disk storage system.
- \*basic 16K RAM (expandable).

Easy to program. Simple to operate. It is capable of a multitude of high-speed functions and speaks the language of today's most popular software.

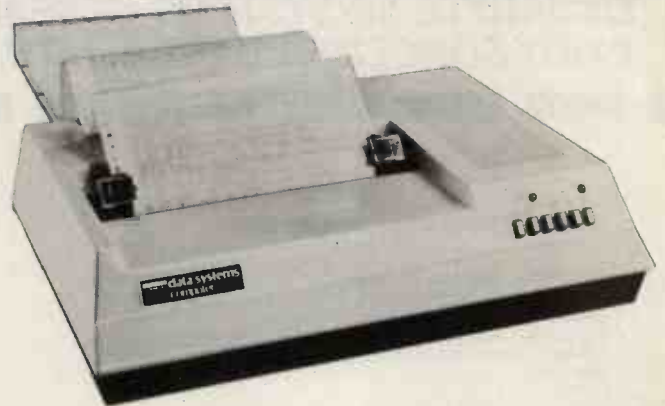

## WH-14 serial printer.

With a compact table-top configuration, the WH-14 is designed for a broad variety of uses in both the personal and business computing field.

- \*5 x 7 dot matrix impact printing \*96 character ASCII
- \*upper and lower case characters \*microprocessor-based electronics.

It combines speed, flexibility and ease of use with any computer providing standard RS-232 C or 20mA current loop interface connections.

For complete specifications of these and all Heath Data System products contact:

Heath (Gloucester) Limited, Dept. (PCH10), Bristol Road, Gloucester, GL2 6EE. Telephone: (0452) 29451.

## Heath data systems

● Circle No. 108

## From Microdigital TEXAS 99/4 The people's computer

### The remarkable TI-99/4 Home computer.

Superior colour, music, sound and graphics — and a powerful extended BASIC all built in. Plus a unique, new Solid State Speech Synthesizer and T.I.'s special Solid State Software.

The T.I.99/4 was designed to be the first true home computer — skilled computer users and beginners alike will be able to put it to effective use right away. You can begin using the TI Home computer minutes after unpacking it; simply snap in a Solid State Software Module, touch a few keys and step-by-step instructions appear on the screen — so you or any member of your family can use and learn about the computer from the computer. Texas Instruments has taken those features you've been wanting — plus some you may not have heard about yet — and included them in one incredible, affordable computer system. The T.I.:99/4 gives you an unmatched combination of features and capabilities including:

- \*Powerful TI-Basic: Accuracy and power for demanding technical applications, yet easy to use for the beginner. 13-digit, floating point Basic, with special features and extensions for colour, sound and graphics.
- \*16-colour graphics capability — Easy to use, high resolution graphics with special features that let you define your own characters, create animated displays, charts, graphics . . . and more, with a resolution of 256 x 192 individually addressable points.
- \*Music and sound effects: Provides outstanding audio capability. Build three-note chords and adjust frequency, duration, and volume quickly and simply.

#### Console:

CPU: 9900 family, 16 bit microprocessor, plus 256 byte scratchpad RAM.

#### Memory:

Total combined memory capacity . . . . . 72K Bytes  
Internal ROM . . . . . 26K Bytes  
Internal RAM . . . . . 16K Bytes  
External ROM (Plug-in software modules) . . . . . Up to 30K Bytes

#### Keyboard:

Staggered QWERTY Layout, full travel with overlay for second functions.

#### Sound:

5 Octaves, 3 simultaneous tones plus noise generator.

#### Colour: 16

Graphics resolution: 256 x 192.

#### Input/Output:

Composite video and audio output for monitor. Interface for 2 audio cassette



recorders. 44-pin peripheral connector with system memory and address signals available. Mini-earphone jack. Hand controller interface.

#### Built in software:

14K Byte T.I.BASIC, equation calculator and control software.

Size: 25.9"38.1"7.1 cm.

#### Display:

Uses colour monitor, 24 lines of 32 characters.

#### Optional accessories:

##### Solid state speech synthesizer:

Approx 250 English words built in. Accessible from T.I. BASIC. Accommodates add-on modules to broaden vocabulary.

##### Remote controls:

Eight position with slide mounted action button.

##### Solid state software modules:

These are plug in pre-programmed software modules with a variety of financial, education, and entertainment programs.

E.G. Video Chess, football, video games, physical fitness, pre-school learning, graphics etc.

Delivery: Limited quantities in September, volume October.

#### Prices:

	Nett	Val	Total
Console . . . . .	569.57	85.43	655.00
Modules . . . . .			15-40.00*
Joysticks . . . . .			25.00*
Speech synthesizer . . . . .			45.00*

\*please note these are estimated prices only.



25 Brunswick Street, Liverpool L2 0BJ  
Tel: 051-236 0707 (Mail Order) 051-227 2535 (All other Depts)

● Circle No. 109

**MICRO  
COMPUTERS  
FROM  
COMART  
COME LIKE  
THIS!**

**comart**

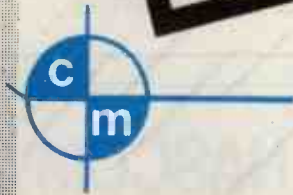

**comart**

**SPECIALISTS IN  
MICROCOMPUTERS**

**URGENT**

**SPECIALISTS IN  
MICROCOMPUTERS**

**comart**

**We care about what leaves  
our factory. After all it's got  
our name on it.**

The next time you want  
reliable microcomputer  
products - single card  
computers, floppy disk  
systems and disk systems -  
take a look at what we put in  
our boxes.

**A Comart Computer Catalogue will  
show you.**

Write to



**comart**

**Comart Ltd., P.O. Box 2, St. Neots,  
Huntingdon, Cambs.  
Or telephone (0480) 215005.**

# The NEW Datac BD80

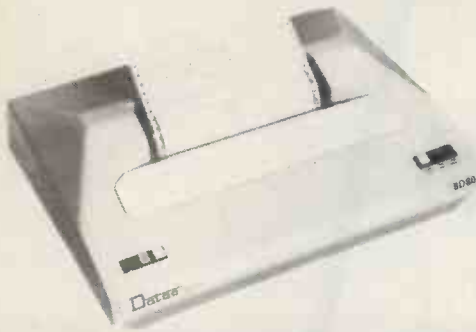

## offers all these features:

- 80 columns on 9.5 in-wide ordinary sprocket paper.
- 84 lpm - 112ch/sec.
- RS232C and buffered parallel interfaces as standard.
- Over 900 character buffer standard - 2K extension optional.
- 96-character set standard - 192 set optional.
- P controlled bi-directional, versatile and reliable.
- Stand and keyboard optional.

for only **£595** (excl vat)

# Datac LIMITED

**"The Printer People"**

Tudor Rd, Altrincham, Cheshire, WA14 5TN  
Tel: 061-941 2361/2

● Circle No. 111

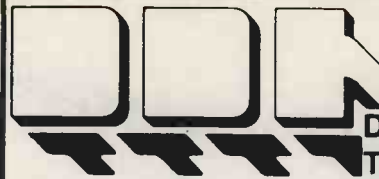

**DATA DESIGN  
TECHNIQUES LTD**

12 Leeming Rd  
Borehamwood  
Herts. WD6 4DU

58-60 Northfield Rd  
Kings Norton  
Birmingham B30 1JH

5-6 Lower Church St  
Chepstow  
Gwent NP6 5HU

01-207 1717

021-459 5959

029-12 2193

Glasgow 041-221 9761

Telex 49280

AVAILABLE EX-STOCK:

**ANADEx DP8000**  
**112 cps PRINTER**  
**INTRODUCTORY OFFER** **£525**

**TALLY 1602 160 cps**  
**BI-DIRECTIONAL PRINTER** **£1650**

**TELEVIDEO 912 VDU** **£595**

**NATIONWIDE MAINTENANCE  
ON ALL THE ABOVE  
PLUS**

**COMMODORE PET, ITT 2020,  
APPLE, MSI 6800, ALL LEADING VDUs,  
AND HARD COPY PRINTERS**

● Circle No. 112

# Just a little bit more...

# NASCOM-2

### Compare its features:

- \*Z-80A 4MHZ. CPU: The most powerful 8-bit processor on the market.
- \*8K Basic: resident on board, MICROSOFT Basic, the industry standard, with extensions for on-screen editing, graphics, machine code interfacing. Optimised for speed (see benchmarks below).
- \*Full 57 Key Licon solid state keyboard: switch mechanisms are contactless, high reliability professional units for long trouble free life. Keyboard is mounted separately to avoid straining main P.C.B.
- \*Total of 20K on-board memory: 2K monitor (Nas-Sys 1), 1K Video RAM, 1K Work space RAM, 8K Microsoft Basic, 8K user RAM.
- \*Kansas City cassette interface: for reliable storage of programs and data at 300 or 1200 baud, with full checksum error detection.
- \*Nas-sys monitor: A powerful 2K machine code monitor provides an ideal environment for learning about and developing machine code programs. Nas-sys uses a blinking non destructive cursor, with 22 commands. ASCII terminals are fully supported via the serial interface; users can add their own I/O drivers via the system I/O vector table to support other devices.

### Nas-sys commands are:

- |                                    |                             |
|------------------------------------|-----------------------------|
| A—Hex arithmetic                   | N—return to normal          |
| B—set breakpoint                   | O—Output to P.I.O.          |
| C—Copy                             | Q—Query input port          |
| E—Execute                          | R—Read tape                 |
| G—Generate                         | S—Single step               |
| H—Operate as half duplex terminal. | T—Tabulate memory           |
| I—Intelligent copy                 | U—activate user I/O drivers |
| J—Execute at FFA                   | V—Verify tape               |
| K—set keyboard options             | W—Write tape                |
| L—load from tape                   | X—set external device       |
| M—Memory modify                    | Z—execute at FFD            |

\*On board P.I.O. — An uncommitted P.I.O. (MK 3881) giving 16 programmable I/O lines with handshake.

\*On board RS-232-C will interface directly into any standard teletype — allowing use of BASIC or Nas-sys from the teletype.

\*Full on-screen editing: a complete screen editor with cursor movement (UP, DOWN, LEFT, RIGHT), insert and delete, backspace etc.

Screen display of 16 lines x 48 characters: Stable, clear display to British television standards. Full 128 ASCII character set; option for further 128 graphics characters.

\*Fully buffered NASBUS compatible: Well defined bus structure with a range of expansion cards; including (shortly) a floppy disc system with CP/m — the industry standard operating system.



Nascom-2	Nett 295.00	Vat 44.25	Total 339.25
Power supply	24.50	3.68	28.18
Nascom-2	Nett 295.00	Vat 44.25	Total 339.25
Power supply	24.50	3.68	28.18
10 C15 cassettes	4.44	0.66	5.10
Z-80 Programming manual (Mostek)			4.50
Z-80 Microcomputer handbook			6.95
Practical microcomputer programming the Z-80			20.00
Sargon-8K Z-80 Chess program (book)			9.50

### PERSONAL COMPUTER WORLD BENCHMARK TESTS

	APPLE II	NASCOM 2	RM. 380Z	PET
BM 1	1.5	1.1	1.4	1.7
BM 2	3.2	5.4	6.5	9.9
BM 3	7.3	11.1	13.2	18.4
BM 4	7.2	11.6	13.9	20.4
BM 5	8.9	12.6	15.0	21.7
BM 6	18.6	19.3	22.3	32.5
BM 7	28.2	27.6	31.6	50.9
BM 8		5.2	6.2	12.3



**25 Brunswick Street, Liverpool L2 0BJ**  
Tel: 051-236 0707 (Mail Order) 051-227 2535 (All other Depts)

● Circle No. 113

# WHY BUY A MICRO-COMPUTER FROM

# **PETALECT** ELECTRONIC SERVICING LTD.

## BECAUSE

- 1) Established company trading since 1971
- 2) Electronic servicing is our speciality
- 3) We have in house programmers/systems analysts
- 4) We have our own service engineers
- 5) We will demonstrate the PET at your premises
- 6) We can customise the PET to your requirements
- 7) We can arrange finance
- 8) We offer, after the three-month warranty, a service contract from £69.50
- 9) You benefit from our experience of having sold over 150 micro-computers to industrial, educational and business, personal users.
- 10) We specialise in programs and interfaces for weighing applications for average weight control and counting etc.

8K £550.00 + VAT.  
16K £675.00 + VAT.  
32K £795.00 + VAT.

All 'PETS' sold with a Basic Tutorial Tape

New Large  
Keyboard 'PETs'  
Now in Stock



In our showroom we sell  
Books, Programs etc.

## Also available:

24K Memory Expansion Boards (disk-compatible)  
only £320 + VAT

PET-compatible dual floppy disk unit  
with advanced operating system  
only £840 + VAT

Large Extension Keyboard for the PET £89.50 + VAT

Telephone for complete system prices.

Wide Range of Printers Available.

If you require any more information or demonstration regarding the PET 2001/8 or any associated equipment, programs, etc., please contact Mr. P. J. A. Watts or Mr. D. W. Randall at:

**PETALECT ELECTRONIC SERVICES LTD**  
33/35 Portugal Road,  
Woking,  
Surrey.  
Tel. Woking 69032/68497

**Shop at:**  
**PETALECT**  
Chertsey Road,  
Woking,  
Surrey.  
Tel. Woking 20727/23637

● Circle No. 114

# Programs for easy learning.

Part of the Heathkit Continuing Education series, our self-instruction courses are the complete, low cost way of learning all there is to know about computing techniques.

Each course is split into progres-

sive sections and contains audio visual material, text, and parts for practical experiments.

## Digital techniques

Teaches you the operation of digital logic circuits, integrated circuits,

Boolean Algebra, Flip-Flops and Registers. Everything from TTL and CMOS to ROMs, PLAs, micro-processors and computers.

The optional trainer rounds out your education and provides 'hands-on' experience.

## Microprocessor

Designed to give you in-depth knowledge of these advanced systems the course covers microprocessor basics, computer arithmetic, programming and much, much more.

And the optional computer trainer lets you get 'hands-on' experience.

## Basic Programming

This course teaches you how to program your computer using the popular BASIC language. Covering all formats, commands, statements and procedures, it uses programmed instructions backed by text and 'hands-on' computer experiments.

For full details of these and all Heath courses contact:  
Heath (Gloucester) Limited,  
Dept. (PCE 10), Bristol Road, Gloucester,  
GL2 6EE. Tel: (0452) 29451.

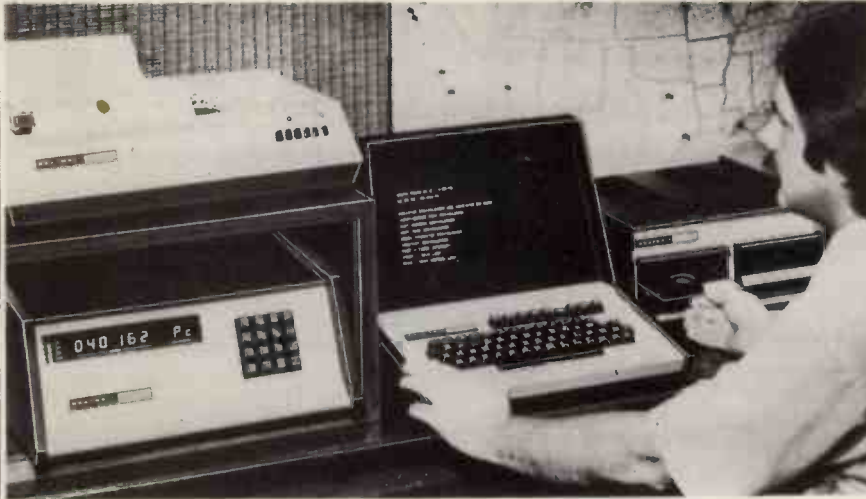

## Heath data systems

● Circle No. 115

## Simplicity. Sophistication

 **apple II plus,**  
at Microdigital

### Apple II Plus

APPLE II PLUS will change the way you think about computers. That's because it is specifically designed to handle the day to day activities of education, business, financial planning, scientific calculation, and entertainment. APPLE II PLUS is appealing and comfortable (like other appliances that make your life easier), and it brings to personal computing a new level of power through hardware and software sophistication.

The APPLE II PLUS is faster, smaller and more powerful than its predecessors, and it's easier to use too, because of advanced, built in features like:

- \*PALSOFT  
A fast, extended 10K BASIC with 9-digit precision and graphics extensions.
- \*HIGH RESOLUTION GRAPHICS  
On a matrix of 280 x 192 individually addressable points.
- \*AUTO-START ROM  
With power on boot of application programs, reset protection and improved screen editing.
- \*INTERNAL MEMORY EXPANSION TO 64K BYTES  
For big system performance at a low cost.
- \*EIGHT EXPANSION SLOTS  
To let the system grow with your needs.

APPLE-II PLUS, 16K RAM .....	Nett	Val	Total
	830	124.50	954.50

### Apple Pascal

APPLE PASCAL TM is the new extension to microcomputer power. PASCAL TM incorporating UCSD PASCAL TM, offers extended features in a complete interactive package employing today's most sophisticated structured programming language. It provides advanced capabilities that boost performance and cut development time for large business, scientific, and educational programs.

This software package provides the most powerful set of tools yet available for the microcomputer programmer.

\*EDITOR  
A fast, screen-oriented editor for program development and word processing applications.

\*COMPILER  
Standard PASCAL plus full set of extensions for strings, disc files, graphics and system programming. Hi-res graphics "Turtlegraphics", as originated at MIT.

INIT turtle, PENCOLOR, TURNT0, TURN, MOVE, TEXT-GRAF, GOTOXY Procedure for cursor addressing.  
FUNCTION Keypress tells whether character available.  
Library routines include: RANDOM, RANDOMIZE, PADDLE, BUTTON, TTLOUT, KEYPRESS etc.

### \*RELOCATABLE ASSEMBLER

Permits relocatable assembly language routines to be generated and linked to Pascal programs.

### \*SYSTEM UTILITIES

Includes desk calculator-performs basic calculations and parameter — allows examination and modification of system environment.

### Floppy Disks

Gives your system immediate access to large quantities of data. The subsystem consists of an intelligent interface card, a powerful Disk Operating System and one or two mini-floppy drives.

#### Features

- Storage capacity of 116 kilobytes/diskette.
- Data transfer rate 156K Bits/second.
- Individual file write protection.
- Powered directly from Apple II.
- Full disk capability with systems as little as 16K bytes of RAM.
- Fast access time — 600 msec (max) across 35 tracks.
- Powerful disk operating software.
- Load and store files by name.
- BASIC program chaining.
- Random or sequential file access.

	Floppy Disk Subsystem		
Nett	Val	Total	
425.00	63.75	488.75	
375.00	Second disk drive and connecting cable	431.25	
	56.25		

### Parallel Printer Interface Card

Allows you to connect almost any popular printer to your Apple. A BASiC program can produce hard-copy output as easily as it prints to the TV monitor screen. Command interpretation and printer control details are handled by the firmware built into the card, to eliminate user programming requirements.

Nett	Val	Total
110.00	16.50	126.50

### Communications Interface Card

Allows your Apple to "talk" (through a modem) with other computers and terminals over ordinary telephone and load programs over the phone, send messages to remote terminals or access your office computer from the comfort of your home.

	Communication interface Card		
Nett	Val	Total	
110.00	16.50	126.50	

### High Speed Serial Interface Card

Allows Apple to exchange data with printers, plotters and computers in serial format at up to 19.2 K Baud.

	High Speed Serial interface Card		
Nett	Val	Total	
110.00	16.50	126.50	

 **MICRODIGITAL**

25 Brunswick Street, Liverpool L2 0BJ  
Tel: 051-236 0707 (Mail Order) 051-227 2535 (All other Depts)

● Circle No. 116

# The complete business mind

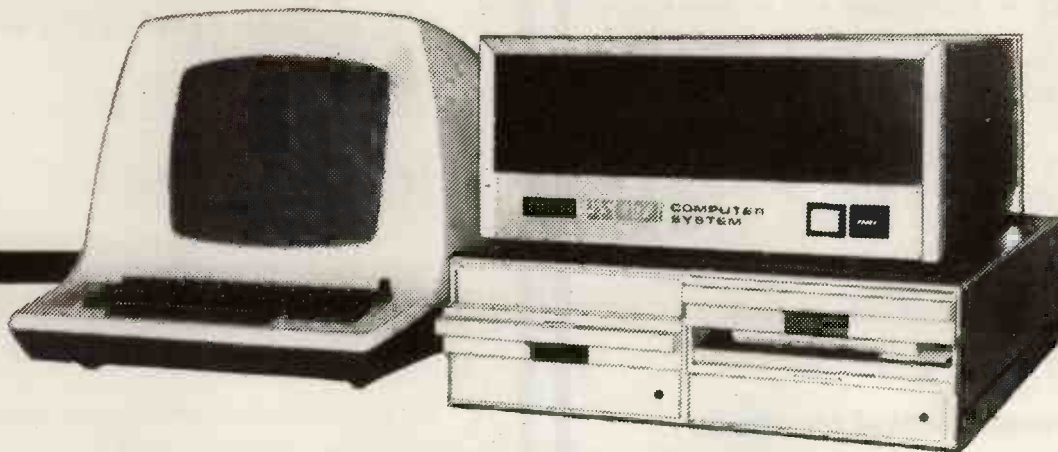

## for £3,000

A desk-top stock control, accounts, sales and invoices department at the touch of a switch. No need for a computer to see the savings that means!

This technological miracle is just one of a whole range currently on view at Computer Workshop showrooms, at prices ranging from £500 to £10,000 plus.

Phone for an appointment, or visit now and surprise yourself at what micro-computers can do for you and your business.

# CW

## COMPUTER WORKSHOP

Micro-Computer Mart Limited, 29 Hanging Ditch, Manchester M4 3ES. Tel: 061-832 2269  
and

Micro-Computer Mart (Leeds) Limited, 251 Otley Road, Leeds LS16 5LQ. Tel: (0532) 788466

● Circle No. 117

## £100! off 8K PETS

Hurry — Hurry — Hurry

EX-DEMO — Exhibitions etc — few hours use only — mostly indistinguishable from new. Come to Charing Cross and select yours now — Securicor £10.

Beginners courses London-Southampton day or evenings — small classes or individual tuition — one computer to each student.

Day courses run on your premises — we supply everything — (inc weekends)

Telephone 01-839 3894 for details.

**TLC World Trading Ltd**  
34 Craven Street  
London WC2

● Circle No. 118

# EQUINOX 300

A powerful multi-user  
multi-tasking  
multi-language

16-bit microcomputer time-sharing system

supporting

- BASIC
- LISP
- PASCAL
- Floppy discs
- Hard discs

including a powerful Text Formatter,  
Assembly Language Development System  
and disc-based Sort utilities.

Priced from under **£5,000**

Write or phone for further information.

**EQUINOX COMPUTER SYSTEMS LTD**

"Kleeman House" 16 Anning Street,  
New Inn Yard, London EC2A 3HB.  
Tel: 01-739 2387/9. 01-729 4460.

● Circle No. 119

## NEW LOW BOOK PRICES AT MICRODIGITAL

Your Home Computer — J. White — £5.10

Microprocessors: from chips to systems — R. Zaks — £7.50

The Home computer revolution — T. H. Nelson — £2.75

Getting Involved with your own computer — L. Solomon & S. Velt — £4.76

Understanding microcomputers and small computer systems — N. Wadsworth — £7.95

Illustrating Basic — a simple programming language — D. Alcock — £2.25

Basic BASIC: an introduction to computer programming in the BASIC language — £4.80

Advanced BASIC: applications and problems — both by J. S. Coan — £4

Basic with style — Nagin and Ledgard — £3.60

Microcomputer programming: 6502 — R. Zaks — £7.95

6502 Applications book — R. Zaks — £8.95

Volume 1 Fundamental Algorithms — D. E. Knuth — £9.50

Software Tools — Kernighan and Plauger — £7.20

Programming Proverbs — H. Ledgard — £5.50

Microprocessor interfacing techniques — R. Zaks — £7.50

Cheap Video cookbook — D. Lancaster — £4.30

Microcomputer problem solving using PASCAL — K. L. Bowles — £7.84

Best of BYTE Vol. 1 — Helmers et al — £8.95

Best of Creative Computing Vol. 1 — AHL et al — £6.95

Best of Creative Computing Vol. 2 — AHL et al — £6.95

Scelbi-Byte Primer — Helmers et al — £9.95

The Best of Micro — Tripp et al — £5.50

Clarcia's Circuit Cellar — S. Clarcia — £6.40

8080 Programming for logic design — A. Osborne — £5.95

Z-80 Instruction book — Scelbi — £3.50

Practical microcomputer programming: the Z-80 — W. J. Weller — £20

Sargon Z-80 Chess Program — D. and K. Spracklen — £9.50

The Z-80 microcomputer handbook — W. Barden — £6.95

Z-80 Programming for logic design — A. Osborne — £5.95

Z-80 Programming manual — Mostek — £4.50

Programming the 6800 microprocessor — Bob Southern — £8

6800 Programming for logic design — A. Osborne — £5.95

APL — an interactive approach — Gilman and Rose — £9.50

A guide to SC/MP programming — Drury — £4

A Guide to KITBUG — Drury — £1

Basic computer games — D. H. Ahi — £5.50

How to build a computer controlled robot — T. Loofborrow — £6

Starship simulation — R. Garrett — £5.10

Some common Basic programs — A. Osborne — £6.30

Computer programs that work — Beech et al — £2.55

The mind appliance: home computer applications — T. G. Lewis — £4.75

PCC reference book — PCC — £4.95

Microprocessor lexicon — £2

Microprocessor encyclopedia Vol. 2. Bit-slice machines — R. Zaks — £7.45

Phone in your  
Access/Barclaycard  
Number on  
**051-236-0707**

or complete  
this order  
form

PLEASE  
SEND ME:

I ENCLOSE:

CHEQUE/POSTAL ORDER NO.....  
BARCLAYCARD NO.....  
ACCESS CARD NO.....  
NAME.....  
ADDRESS.....

COMPLETE AND POST TO



**MICRODIGITAL LTD.** 25 BRUNSWICK STREET  
LIVERPOOL L2 0BJ Tel: 051-236 0707

● Circle No. 120

PRACTICAL COMPUTING October 1979



# 'We stock 20 different makes of computer. So our only vested interest is customer satisfaction'

*Bill Cannings, Managing Director*

Businesses can only improve their efficiency with computers if they buy exactly the right kind of equipment and software for their needs. The problem can be in matching their needs with what the market can supply at any one time.

At the Byte Shop and Computerland we have the widest range of computers available from any single source. We have deep-rooted systems know how going back over 10 years, so you get not only a refreshing breadth of choice, but also high level impartial advice from computer specialists on what to buy.

Our business is computers and only computers, so you will be talking to people who really understand their subject. Once you have taken the decision to visit us, you are already a good way towards choosing the right computer for your needs.

**Branches at:**

**Ilford**

426 428 Cranbrook Road,  
Gants Hill, Ilford, Essex IG2 6HW  
Tel. 01-554 2177

**London**

48 Tottenham Court Road,  
London W185 4TD  
Tel. 01-636 0647

**Birmingham**

94 96 Hurst Street,  
Birmingham B5 4TD  
Tel. 021-622 7149

**Nottingham**

92a Upper Parliament Street  
Nottingham NG1 6LF  
Tel. 0602 40576

**Manchester**

11 Gateway House,  
Piccadilly, Manchester  
Tel. 061-236 4737

**Glasgow**

Magnet House  
Waterloo Street  
Glasgow Tel. 041-332 2468



**THE BYTE SHOP LTD**  
**COMPUTERLAND LTD**

● Circle No. 121

# MATROX

## FROM SHELTON

Shelton Instruments offers a highly-diversified selection of modules and PC boards by Matrox Electronic Systems, allowing customers to solve display problems rapidly and cost-effectively. These ready-to-use subsystems are available in self-contained modules for any microprocessor, or on PC boards but compatible with DEC LSI-11, PDP-11, Intel Multibus, S100 and others.

CRT DISPLAY CONTROLLERS (Alphanumeric)		£
<b>Alphanumeric Modules</b>		
MTX-816	8 lines×16 columns CRT controller module	128
MTX-1632	16 lines×32 CRT controller module	162
MTX-1632SL	16×32 CRT controller module (external sync)	162
PV-1	Up to 16×64 user programmable VRAM (in/ex)	213
MTX-2064	20 lines×64 columns CRT controller module	213
MMD-2480	24 lines×80 columns CRT controller module	284
<b>Printed Circuit Boards (Alphanumeric)</b>		
MTX-1648/SL	16×48 (Prolog bus, ext sync)	213
MTX-2480	24×80 CRT controller (gen. purpose)	284
ALT-2480	24×80 CRT controller (S100 bus plug-in)	213
STD-2480	24×80 CRT controller (STD bus plug-in)	284
ZTL-2480	24×80 CRT controller (Zonic bus plug-in)	284
EXO-2480	24×80 CRT controller (Exorciser plug-in)	356
MSBC-2480	24×80 CRT controller (SBC-80 bus plug-in)	356
MSI-2480	24×80 CRT controller (LSI-11 bus plug-in)	356
MDC-2480	24×80 CRT controller (PDP-11 bus plug-in)	356
<b>CRT DISPLAY CONTROLLERS (Graphics)</b>		
<b>Graphic Modules</b>		
MMD-256	256×256 dot raster module (+5V only)	428
MMD-256D	256×256 dot raster module (+5V, 12V)	356
<b>Printed Circuit Boards (Graphics)</b>		
MTX-256	256×256 dot raster (gen. purpose)	428
ALT-256	256×256 dot raster CRT controller (S100 bus)	284
STD-256	256×256 dot raster CRT controller (STD bus)	356
ALT-512	512×256 dot raster CRT controller (S100 bus)	428
EXO-512	512×256 dot raster (Exorciser bus)	495
MSBC-256	256×256 (SBC-80 bus or general purpose)	644
MSBC-256/512	256×512 (SBC-80 bus or general purpose)	788
MSBC-1024	256×1024 (SBC-80 bus or general purpose)	995
MSBC-512	512×512 (SBC-80 bus or general purpose)	995
NSBC-512	512×512 raster with vector plot (SBC-80)	1,076
MSI-256	256×256 (LSI-bus, plug-in)	644
MSI-256/512	256×512 dot raster (LSI-11 bus, plug-in)	788
MSI-512	512×512 dot raster (LSI-11 bus)	995
MSI-1024	256×1024 dot raster (LSI-11 bus)	995
MDC-256	256×256 dot raster (PDP-11 bus)	644
MDC-256/512	256×512 raster (PDP-11 bus)	788
MDC-512	512×512 raster (PDP-11 bus)	995
MDC-1024	256×1024 raster (PDP-11 bus)	995
RGB-256-4	256×256 raster, 4 bit/pixel, color/grey (PAL or NTSC), (SBC-80 bus or general purpose)	1,148
RGB-256/3	256×256/3 bit/pixel; color/grey; exp	995
<b>CRT DISPLAY CONTROLLERS (Alphanumeric and Graphic combined)</b>		
MSBC-24/320	Single board 24×80 alphanumeric; 320×240 raster graphics CRT display controller (SBC-80 or general purpose)	995
NOTE: Combined alphanumeric and graphic display can also be obtained by combining other standard Matrox alpha and graph controllers (i.e. ALT-2480 and ALT-256 or ALT-512; MMD-2480 and MMD-256; MSI-2480 and MSI-512, etc.)		
<b>COLOR CRT CONTROLLERS</b>		
Multiple standard graph cards can be combined to obtain color. Up to 24 bits per pixel can be obtained, 256×256 or 512×512 resolution.		
NOTE: RGB-256/4 is single board 256×256×16 color CRT controller.		
<b>µP DISPLAY CONTROLLERS (INTEGRATED CIRCUITS)</b>		
MTX-A1	Single chip I/O display/keyboard controller 5×7 dot LED's up to 32 character, 64 keys	35.28
MTX-B1	Single chip I/O display/keyboard controller 14, 16 segment LED, 32 characters, 64 keys	35.28
MTX-A1 and MTX-B1 in quantities of 10K are £8.64 each.		
<b>SOFTWARE AND DOCUMENTATION</b>		
MTX-Alpha	ALT-2480 alphanumeric software (S100;8080A)	20
MTX-Graph	ALT-256 graphics software (S100; 8080A)	20
SBC-Alpha	MSBC-2480 alphanumeric software (SBC; 8080A, 8085)	20
SBC-Graph	MSBC-256 graphics software (SBC; 8080A, 8085)	20
MDC-Graph	MSI/MDC-256 graphics software (LSI-11/PDP-11)	20
MAN-////	Hardware manuals for diff. products (schematics inc)	7.20
NOTE: Software package includes manual, source listing (machine language) including comments and algorithms and paper tape (object code).		

DELIVERY 4-5 WEEKS

**SHELTON INSTRUMENTS LTD**  
**22/24 COPENHAGEN STREET,**  
**LONDON N1 0JD Tel: 01-278 6273**

● Circle No. 122

# BUY AN ELF II

## microcomputer

### for less than

## some TV games

Kit only  
**£79.95**  
 +  
 VAT.

### ELF II BOARD WITH VIDEO OUTPUT

ADD-ONS	EX VAT
* POWER SUPPLY (6.3V AC) for ELF II	5.00
* ELF II DE LUXE STEEL CABINET (IBM Blue)	23.00
* GIANT BOARD KIT System/Monitor, Interface to cassette — RS232, TTY etc	35.00
* 4K STATIC RAM board kits (requires expansion power supply)	69.44
* Expansion power supply (required when adding 4K Rams).	19.00
* ASC11 Keyboard Kits 96 printable characters etc	50.58
* ASC11 d/lux steel cab (IBM Blue)	15.02
* KLUGE prototype board (build your own circuits)	12.83
* 86 pin Gold plated connectors each	4.00
* ELF Light pen writes/draws on TV screens	6.50
* Video graphics board 32/64 characters by 16 lines on TV/monitor screens	69.95
* ELF 11 Tiny basic on cassette	13.50
* ELF 11 Buy/monitor powerful systems monitor/editor	13.50
* T. PITMANS short course in programming manual (Nil VAT)	4.00
* T. PITMAN short course on tiny basic manual (Nil VAT)	4.00
* RCA 1802 users manual (Nil VAT)	4.00
* On cassette text editor assembler/disassembler each	16.95
SAVE 10% AND BUY ALL THREE TOGETHER	P&P
All units can be supplied wired and tested	£2.00
Send S.A.E. for comprehensive brochure	

**NEW: GAMES ON TAPE send for list**  
 Order to:—

DEALER  
 ENQUIRIES  
 WELCOME

**Newtronics, 138 Kingsland Road**  
**London E2 8BY**  
**Tel: 01-739 1582**  
**DEPT. PIC**

Sole U.K.  
 Agents

● Circle No. 123

## Another Crofton First

### Brand New Full Specification

# 10" Metal Cased Industrial Video Monitor

**£118.80**  
 Inc. to Personal Callers - Subject to availability.

Video Bandwidth 8MZ (3db down).  
 Ideal for Computer Terminal or General Video Monitor.  
 Complete With Own Power Supply.  
 Input Sensitivity IV Composite.

The unbeatable  
**CROFTON 6800 MICRO**  
 is probably the best  
 value for money today

\* Including Tiny Basic and on board Prom Programmer  
 — KIT\* —  
**£220**  
 + VAT & P/P

POWER SUPPLY £20 EXTRA + VAT & P/P

**CROFTON**  
**Electronics Limited**  
 35 Grosvenor Road, Twickenham  
 Middlesex • Tel: 01-891 1923

● Circle No. 124

# Sumlock

Sumlock Electronic Services (M/cr) Ltd.

Manchester

Petsoft and Commodore Software Stockists

PET	PRICE	AVAILABILITY
-----	-------	--------------

2001-4	£460.00	Current
2001-8	£550.00	Current
2001-16N	£675.00	Current
2001-32N	£795.00	Current

Petact business programs demonstrated during business hours



## Plus all these add-ons for your PET 2001

### PRINTERS

Teletype 43 with keyboard	£995.00	Current
Teletype 43 without keyboard	£970.00	Current
PET 2023	£550.00	No further orders
PET 2022	£645.00	Orders accepted
ANADEx with PET interface	£700.00	Current

### FLOPPY DISK UNIT

PET 2040	£795.00	Current
DISKMON	£840.00	Current
24K Memory Expansion for Diskmon	£320.00	Current

### EXTERNAL CASSETTE DECK

C2N	£ 55.00	Current
PET DUSTCOVERS (Plain)	£ 6.00	Current
PET DUSTCOVERS (Printed)	£ 6.50	Current

**PET/BASIC training manuals available from £3.00**  
**Sumlock printer interface IEEE to RS232c from £100.00**

## NOW YOU CAN BEAT THE LANGUAGE BARRIER AND CONQUER EUROPE



The LEXICON LK3000 the pocket-sized computer at a price that suits your pocket.

**ALL PRICES INCLUSIVE OF VAT**

The same silicon chip technology that revolutionised the calculator market has now given birth to the world's first pocket size translator. The LK3000.

Designed like a miniature computer, the LK3000 is a highly sophisticated terminal, its programs contained in different language modules which simply slot into the back. French, German, Italian, Spanish, Portugese, Swedish, etc.

These interchangeable modules are programmed with hundreds of words, phrases and word permutations on each module.

What's more, the LK3000 not only translates English into different languages, it also works in reverse to enable a foreign language to be translated into English. So that in the time it takes to find a single word in the average dictionary, you can spell out an entire sentence and have the exact English translation travel across a visual display before your eyes.

So, if you want to communicate in several foreign languages, figure your household expenses, work out your taxes or convert pounds to kilograms, contact:

# Sumlock

Manchester

Royal London House  
196/8 Deansgate  
Manchester M3 3WE  
Tel:061-834 4233.

Sumlock Electronic Services (M/cr) Ltd.

● Circle No. 125

# NorthStar

## ALLAN ASHLEY ENTERPRISES

PDS Program Development System for 8080 or Z80 computers. PDS supports full Z80 code favouring Inter-type mnemonics. £55/£10

The following is a list of source modules compatible with PDS:—

MODULE	FUNCTION	REQUIREMENTS	
ALPHSORT	High speed alphabetic sort	None	£10.00/1
NUMRSORT	High speed numeric sort	None	£10.00/1
FPPACK	BCD floating point arithmetic	None	£10.00/1
FOURIER	Fast Fourier transform	FPPACK	£10.00/1
MINV	Matrix inversion	FPPACK	£10.00/1
MATPED	Matrix product	FPPACK	£ 7.50/1
RATPOL	Rational function and utilities	FPPACK	£ 7.50/1
SQRT	Square root	FPPACK	£ 5.00/1
TRIGS	Sine, cosine, TAN, ATAN	FPPACK, RATPOL	£10.00/1
LOGEXP	Exponential, logarithm, yx	FPPACK, RATPOL	£10.00/1
FPIOP	Floating point I/O	None	£10.00/1
FORMAT	Formatted floating point output	None	£ 7.50/1
NFILES	North Star disc handler	None	£10.00/1
INOPS	Integer multiply-divide	None	£ 6.00/1

The complete set of modules listed above ..... £49/£10

**EZ-80 — A tutorial on the PDS Z80 instruction set.** £12/£3

**REGENT — Disc disassembler, generates source file compatible with EDIT and the MAKRO Assembler in PDS.** £12/£3

**HDS — Hybrid Development System.** Permits easier interfacing between assembly code routines and North Star BASIC. £27/£3

**CDS — Compiler Development System.** The CDS BASIC compiler enables portions of North Star BASIC programs to be compiled into assembly language to achieve increased speed and to protect proprietary sections of code. Requires PDS and HDS. £55/£10

## BYTE SHOP OF WESTMINSTER

North Star BASIC Time Sharing package. £24/£8

## DIGITAL RESEARCH

CP/M — General purpose Disc Operating System. £75/£15

MAC — Macro Assembler. £55/£10

SID — Symbolic Instruction Debugger. £45/£10

TEX — TEXT formatter, Enhanced version of CP/M editor, ED. £45/£10

DESPool — Spooler for CP/M. £30/£1

## INFORMATION UNLIMITED

**WHATSIT — Interactive data-base management system** using associative tags to retrieve information by subject. Also available at no extra cost, a modified version (by Interam) which supports cursor addressing and printer output. £35/£15

## MICRO MIKES

4/5 SHARE — General purpose interrupt driven, bank switching timesharing system for the North Star Horizon computer. £25/£2

CSUB — Common SUBroutines for North Star BASIC. £25/£2

## MICROSOFT

Disc Extended BASIC. £145/£25

FORTAN-80 — ANSI '66 (except for COMPLEX) plus many extensions. £195/£25

COBOL-80 — ANSI '74 Pseudo-compiler with relocatable object runtime package. £310/£25

## MICROPRO

WORDMASTER — Super text editor for CP/M. £250/£20

## WORDSTAR

Menu driven visual word processing system for use with standard terminals. £75/£15

## MICRO WORLD

MASP — Micro Automatic Spooling Program for North Star disc systems. £40/£5

## NORTH STAR

UCSD PASCAL development system includes an editor, compiler, debugger and file handler. Requires 48K RAM. £20/£15

PAS-AUX — Auxiliary package for above, includes an assembler and utilities. £20

## NSSE/NSUG . . . HUNDREDS OF PROGRAMS FROM MONOPOLY TO PILOT

NSSE — North Star Software Exchange discs (currently 13 discs in library). Each disc costs £4.

Set of thirteen. £45

NSUG — North Star User's Group discs (currently 45 volumes in library). Each disc costs £4.

Set of forty-five. £145

NSUG/NSSE directory listings (directory listings of all NSSE and NSUG discs, currently 58 discs). £1

## ORGANIC SOFTWARE

TEXTWRITER II — Word Processor/Text Formatter for North Star CP/M users. £45/£3

## SOFTWARE WORKS

INVENTORY-2 — Sophisticated inventory package with order entry, requires minimum 32K RAM and two disc drives. £65/£10

## SOFTWARE SYSTEMS

CBASIC-2 Disc Extended BASIC for North Star CP/M users. £65/£15

## SURF COMPUTER SERVICES

MARELIN — Text/Word Processing system that runs under North Star DOS. £27/£3

The above software is supplied on North Star compatible minifloppy discs. Please be sure to specify the density mode you require (releases 1-4: single density, release 5: dual density), the first price given is for software only, followed by the price for documentation.

Prices are correct at time of going to press, and are exclusive of VAT @ 15% and postage & packing (add 75p). Please send S.A.E. for full details.

Available soon: Applications software, including General Ledger for Incomplete records, Accounts Receivable and Payable, Payroll, Hotel packages and more. Software products are being continually added to our range, so please enquire about software products not listed above.

Telex: 925859

Telephone: 01-834 0261/2733

Interam Computer Systems Ltd.

59 Moreton St., Victoria, London SW1



DISKS : LTT : MEMORY : DISKS : LTT : MEMORY : DISKS : LTT : MEMORY

## GODBOUT Computer Products

Alpha Micro/Altair/Cromemco/Imesai/North Star/Polymorphic, etc. S-100 Bus computer compatible memory and other products.

SOME PRODUCTS FROM OUR CATALOGUE e.g.—

	Kit	Ass
Econoram 2708, 16K EPROM# (No EPROMS).	£45	£65
Econoram 11a 4MHz, 8K Bytes	£80	£99
Interfacer 2 full RS 232# S100	£99	£125
Econoram IV, 4MHz, 16K Bytes	£150	£169

**EXTRA LOW PRICES ON QUALITY DISKS**

(Verbatim, Scotch, Memorex, etc.) Diskettes stocked for most micro-computers:

Apple, Cromemco, Tandy, Vector Graphic etc. (soft sector mini)

North Star, Polymorphic, Wang etc. (10 sector mini)

Altair, Micropolis etc. (16 sector mini)

DEC, Cromemco, Prime, etc. (soft sector floppy, 8in.)

Pack of ten disks, £19. Carton of ten packs (100 disks), £175

All prices given include postage and packing (overseas add £10). Just add VAT (presently 15%). Send 9p stamp for details.

Quantity discounts available on application. Credit terms (nett 30 days) given to large companies and government establishments.

Mail Order 'phone: 01-828 1785

**LTT ELECTRONICS**  
8 Waldegrave Road  
London SE19

● Circle No. 127

## New Low-cost Printer from PHL

### Anadex DP8000

- 80 Columns
- 112 cps - 84 lpm bi-directional
- 1K Print Buffer
- Dual Interface - Serial & Parallel
- 96 ASCII set, 9 x 7 matrix



**From Only £540**

Also available

<p><b>Visual Displays</b></p> <p>Lear Single</p> <p>ADM 3A from only £571</p> <p>ADM 3A Graphics from only £1396</p> <p>ADM 31 from only £809</p> <p>ADM 42 from only £1149</p> <p><b>Keyboard Printers</b></p> <p>Teletype 43</p> <p>Pin Feed from only £799</p> <p>Friction Feed from only £918</p> <p>Typewriter Terminal from only £825</p> <p>Portable Models from only £899</p> <p>Digital</p> <p>LA 36 from only £849</p> <p>LA 34 from only £811</p> <p>LS 120 from only £1479</p>	<p><b>Printers</b></p> <p>Texas 810 from only £1392</p> <p>SCI Rotary Printer from only £747</p> <p><b>Data Storage</b></p> <p>Technan</p> <p>950 Microdisc Range from only £955</p> <p>815 Datasettes from only £667</p> <p><b>Other Items</b></p> <p>AJ 211 Acoustic Coupler from only £199</p>
--	---

**PHL** PERIPHERAL HARDWARE LIMITED  
Armfield Close, West Molesey  
Surrey England Telex 922175  
Sole UK distributor

South      North      Ireland

**01-941 4806      Wetherby 61885      Dublin 971854**

● Circle No. 128

# Compucorp announce the latest addition to its 600 Series Desk Top Computers the 655-665



## 655-665 MODULAR SYSTEMS

- ★ Large 12" Video Display.
- ★ Diskettes 147k or 315k-5 $\frac{1}{4}$ "-(1-4).
- ★ Hard Disks 10 meg or 20 meg.
- ★ Full keyboard with 40 user defineable keys.
- ★ Interfaces include: IEEE. R.S. 232 (V.24). A/D and D/A. Parallel, S100 and many others.
- ★ 48k or 60k memory.



**From £2,595**

including 48k Memory  
Screen (20 lines x 80  
Characters) Keyboard  
Disc Drive, Serial Input/  
Output Port, Basic  
Compiler and Demon-  
stration Software.

*The 655-665 have been designed for a variety of environments. This unique modular design lets you install it in a variety of ways.*



## 600 SERIES INSTALLATIONS INCLUDE

JEWELLERS – BAKERIES – CAR HIRE –  
WINDOW MANUFACTURERS – ENGINE  
DESIGN – INSURANCE – BUTCHERS – SHOE  
TRADE – MOTOR CAR SPARES – FARM –  
BUILDING INDUSTRIES – HARDWARE SHOPS  
(RETAIL) – WINE MERCHANTS – ENGINEERS  
and many others.

## SOFTWARE INCLUDES

WORD PROCESSING – STOCK CONTROL  
and INVOICING – PAY ROLL – SHEET  
CUTTING – NOMINAL LEDGER – SALES/  
PURCHASE LEDGER – JOB COSTING –  
INSURANCE QUOTATIONS – INCOMPLETE  
RECORDS – DEBTORS/CREDITORS –  
ACCOUNTING – ESTATE AGENTS –  
EMPLOYMENT AGENCIES, ETC.

*We are especially looking for Dealers  
and Distributors. Telephone or write to us,  
we will be pleased to pass on to you our  
experience of Micro Computers.*

## Compucorp

BARNET HOUSE,  
120 HIGH STREET,  
EDGWARE, MIDDX.  
Tel. 01-952 7860

# MICROSPEECH

Does your computer speak to you?  
'WEHL IHT KAN DOO WIHTH MEE!'

## Features

- Single PCB plugs directly into an SWPTc 6800 bus.
  - 9 parameter vocal tract model.
  - Realtime software converts any stored phonetic code to speech.
  - Computer Games.
  - External input for special musical effects.
  - Adds speech output to existing BASIC programs.
- ## Microspeech package
- Speech synthesizer board (assembled & tested).
  - MSP2 Software on floppy disc or cassette.
  - Hardware & Software manual.
  - Speaking BASIC software option.

**TIM ORR DESIGN CONSULTANT**  
55 Drive Mansions,  
Fulham Road,  
London, SW6

## Make your computer talk

Just by entering phonetic text (as in the sentence at the top of the page). Microspeech with the MSP2 software can make your computer speak. MSP2 uses only 4K of memory. Every extra 1K of buffer space can store 90 seconds of speech.

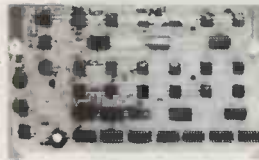

It speaks for itself

**COSTRONICS ELECTRONICS**  
13 Pield Heath  
Avenue, Hillingdon,  
Middlesex

● Circle No. 130

BUILD THE

12,000 ALREADY SOLD



## NASCOM I COMPUTER

★ British Design ★ UK Best Selling Kits  
FULL AFTER SALES SERVICE & GUARANTEE

We are the Sole Approved London Stockist and National Distributor

FREE MODULATOR and B-BUG

### FEATURES

- ★ Supplied in kit form for self-assembly
- ★ Full documentation supplied
- ★ Fully screened double-sided plated through hole printed circuit board
- ★ Full 49 key keyboard included
- ★ 2K x 8 Ram
- ★ 1K x 8 monitor program in Epram
- ★ Powerful Mostek Z80 CPU
- ★ 16 x 48 character display interface to std un-modified T.V.
- ★ T.V. display memory mapped for high speed access
- ★ On board expansion to 2K x 8 Eprom



★ On board expansion for additional 16 I/O lines  
★ Memory may be expanded to full 60K

### EXPANSION

- ★ Expansion buffer board £32.50
- ### MEMORY KITS (inclusive all hardware)
- |     |      |
|-----|------|
| 8K  | £86  |
| 16K | £140 |
| 32K | £200 |
- ★ I/O board with decoders and all hardware except ICS will accept up to 3 PIOs, 1 CTV and 1 UART ..... £35

### OTHER HARDWARE

- ★ 3A power supply for up to 32K expansion ..... £19.90
- ★ 3A power supply for up to 32K expansion Mk II ..... £24.50
- ★ 8A power supply for larger than 32K expansion ..... £60.00
- ★ Expansion card frame ..... £29.50
- ★ E PROM programmer ..... £40.00
- ★ E PROM Eraser ..... £25.00
- ★ Keyboard cabinet ..... £3.50
- ★ Programming manual ..... £4.00

### SOFTWARE

- ★ 1K x 8 monitor program providing
  - ★ 8 operating commands, supporting Mem examine/modify, tabulate, copy, break, single step execute tape, load, tape dump
  - ★ Reflective monitor addressing for flexible monitor expansion through user programs
  - ★ Monitor sub-routines include—delay ASCII coding, binary to hex conversion, clr screen, scroll up, string print, cursor shift and many others
- NEW T-4 operating system in (2) 2708 EPROMS upwards compatible from T2 and B-BUG** ..... £26.00
- Tiny Basic ..... £26.00  
Super Tiny Basic (with editor and machine utility routines) ..... £36.00  
Zeap assembler editor ..... £32.00

★ VAT 8% ALL ITEMS EXCEPT BOOKS ★ DEMONSTRATIONS CONTINUOUS DAILY  
★ WE WELCOME EXPORT—EDUCATIONAL AND INDUSTRIAL ENQUIRIES ★ FREE BROCHURE—SEND SAE 9½ x 6½ STAMP 12p.



**HENRY'S**  
Phone (01) 723 1008

All mail to:  
Henry's Radio  
404 Edgware Rd  
London W2



● Circle No. 131

# New Low-Cost ASCII Keyboards-Ex Stock Delivery.

KB771 — Latest addition to the range — ideal for the VDU-builder 71 Keystations incorporating separate numeric/cursor control pad and installed in a custom-built steel enclosure with textured enamel finish. Case dimensions: 17 1/4" x 7 1/4" x 3 1/4" Total weight: 4Kg.

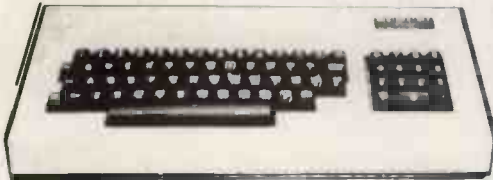

Price £95.00 (mail order total £115.00) 25-way D-Type connector for KB771 £4.25 (mail order total £5.46)

## NEW KEYTOP/KEYSWITCH KITS — ASCII CHARACTER SET BRAND NEW SURPLUS

Pack of 58 keytops and keyswitches comprising 49 "Qwerty" set TTY format + 9 Edit/Function keys.  
PRICE: £15.00 (mail order total £18.98)

## NEW SHUGART FLOPPY DISC DRIVES

SA400 Minifloppy — 110KB capacity, 35 tracks, transfer rate 125Kbits/sec. AV access time, 550msec. Power requirements +5VDC +12VDC.  
PRICE: £195.00

SA800 Floppy — 400 KB capacity, 77 tracks, transfer rate 250Kbits/sec. AV access time 260msec. Power requirements +24DC +5VDC —5VDC.  
PRICE: £395.00

KB756 56-keystations, mounted on PCB  
KB756MF, as above, fitted with metal mounting frame for extra rigidity

### Optional Extras:

- |                          |        |        |
|--------------------------|--------|--------|
| KB15P Edge Connector     | £ 3.25 | £ 4.31 |
| KB701 Plastic Enclosure  | £12.50 | £15.24 |
| KB702 Steel Enclosure    | £25.00 | £30.48 |
| KB710 Numeric Pad        | £ 8.00 | £ 9.78 |
| KB2376 Spare ROM Encoder | £12.50 | £14.95 |
| DC-512 DC/DC Converter   | £ 7.50 | £ 9.20 |

Mail order total  
£49.50 £58.65

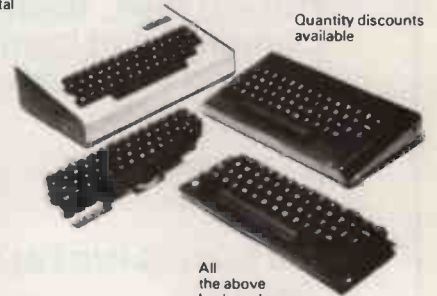

Quantity discounts available

All the above keyboards are fully TTL-compatible, providing the full 128 ASCII character set, and requiring +5V — 12V Power Supply. Full technical data and circuit diagrams supplied.

## SEAELECTRO PATCH BOARDS

Programme boards for switching and interconnecting input/output circuits. 11 x 20 XY matrix. Interconnection is by means of shorting Skip and component holding pins (not included). Dimensions: 7 1/4" x 5 1/4" x 1".  
PRICE: £12.50 (mail order total £15.53)

## Reconditioned EDITING VDU SAVE £100!

HAZELTINE H-2000A NOW ONLY £395.00  
HAZELTINE H-2000B NOW ONLY £495.00

Superb specification includes full edit capability, direct cursor addressing, standard V.24 (RS232) interface. 90 days' warranty.

- ★ Teletype Compatible
- ★ 12" Diagonal Screen
- ★ TTY Format Keyboard
- ★ 27 Lines of 74 characters
- ★ 64 ASCII Character Set
- ★ 5 x 7 Dot Matrix
- ★ 5 Switch-selectable Transmission Speeds up to 9600 baud.
- ★ Switch-selectable Parity
- ★ Standard CCITT V.24 Interface
- ★ Direct Cursor Addressing
- ★ Full Edit Capability
- ★ Detachable Keyboard
- ★ Printer Port
- ★ 90-day Warranty

We also specialise in: DEC minis — PDP8 and PDP11 processors, add-on memory, peripherals and spares. Hard copy terminals — ASR33 and KSR 33 Teletypes, Data Dynamics 390, Texas Silent 700. Send for complete lists.

A copy of our trading conditions supplied on request.



**Electronic Brokers**

49/53 Pancras Road London NW1 2QB Tel: 01-837 7781. Telex 298694

● Circle No. 132

# All Systems Are Not Created Equal

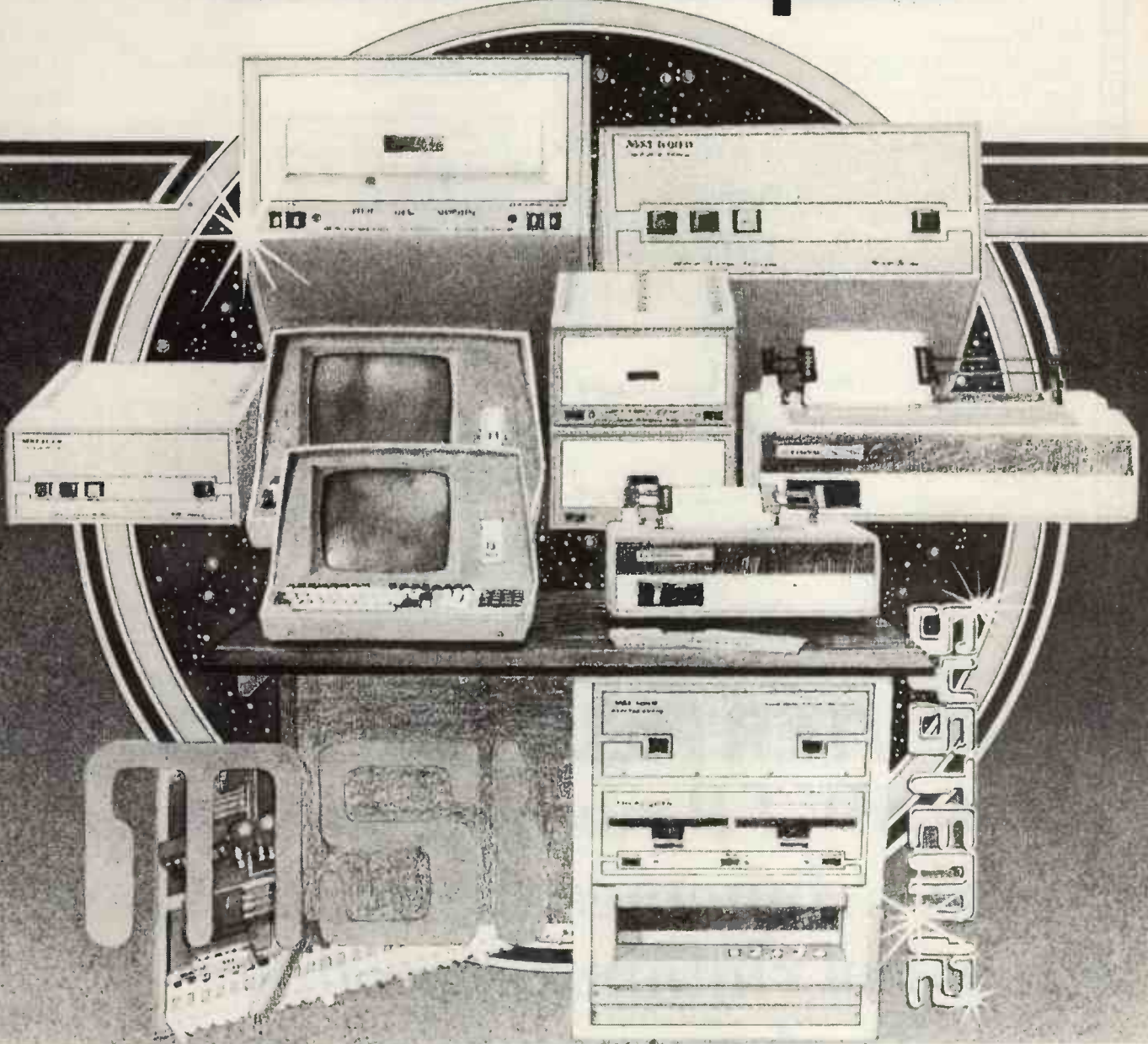

Your computer application is unique. It differs from all others. It is because not all applications are equal that MSI has developed a variety of computer systems.

At the heart of every MSI System is the powerful MSI 6800 Computer, one of the fastest and most versatile available. Depending on the System you select, the MSI 6800 has from 16K to 56K of RAM. Mass memory storage in MSI Systems range from 315K bytes in the System 1 to over 10 megabytes in our most powerful System 12.

In addition to the computer and memory subsystem, MSI Systems include a CRT terminal and high speed character printer. The System 12 is housed in a compact desk unit.

As with hardware, computer software is not always created equal. Since there are a myriad of programs available, MSI offers a choice of Operating Systems for use with your MSI Computer System. Of course, our favorite is MSIDOS, but we offer the powerful SDOS operating system as well. All MSI Systems will support the other software products associated with each operating system.

MSI also has a variety of software programs including a complete Accounting Package and a Multi-User Basic program capable of supporting up to four users.

MSI Systems are currently being used in a broad spectrum of personal, scientific, educational, professional and business

situations. In addition to our Systems, we can supply you with individual components for personal and OEM use. All MSI System components are available, some in kit form.

Write or call us for more information about MSI Systems and products and the name of your nearest MSI dealer.

**seed**

STRUMECH ENGINEERING,  
ELECTRONIC DEVELOPMENTS,  
PORTLAND HOUSE,  
COPPER SIDE, BROWNHILLS.  
(0827) 4321 TLX 335243

● Circle No. 133



**NEWBEAR MAIL ORDER:** 40 Bartholomew Street, Newbury, Berks. Tel: 0635 30505  
**NORTHERN SHOWROOM:** 220-222 Stockport Road, Cheadle Heath, Stockport. Tel: 061 491 2290

### GAMES

Chess & Computer . . . . .	D. Levy . . . . .	£ 7.16
Chess Skill in Man and Machine . . . . .	P. Frey . . . . .	£11.84
32 Basic Programs for the Pet . . . . .	. . . . .	£ 9.95
Game Playing with Computers . . . . .	D. Spencer . . . . .	£10.20
Basic Computer Games . . . . .	D. Ahl . . . . .	£ 5.50
Star Ship Simulation . . . . .	. . . . .	£ 5.10
Game Playing with Basic . . . . .	D. Spencer . . . . .	£ 4.10

### BASIC

Learning Basic Fast . . . . .	De Rossi . . . . .	£ 6.30
Basic Basic . . . . .	J. S. Coan . . . . .	£ 5.00
Advanced Basic . . . . .	J. S. Coan . . . . .	£ 5.50
Illustrated Basic . . . . .	D. Alcock . . . . .	£ 2.25
The Basic Workshop . . . . .	Hayden . . . . .	£ 6.60
Basic with Business Applications . . . . .	Hayden . . . . .	£ 5.56
Introduction to Basic . . . . .	J. Morton . . . . .	£ 6.50
Beginning Basic . . . . .	P. Gosling . . . . .	£ 2.95
Introduction to Basic . . . . .	P. Hartley . . . . .	£ 1.95

### NEW BOOKS

Fundamentals of Computer Algorithms . . . . .	. . . . .	£15.00
Computer Mathematics . . . . .	. . . . .	£ 8.58
Top-Down Structured Programming Techniques . . . . .	. . . . .	£12.76
Microcomputer Design . . . . .	. . . . .	£ 8.99
A Directory of Microcomputing . . . . .	. . . . .	£10.00

### Z80 BOOKS

Z80 Programming for Logic Design . . . . .	A. Osbourne . . . . .	£ 5.95
Z80 Technical Manual . . . . .	Zilog . . . . .	£ 4.00
Z80 P10 Technical Manual . . . . .	Zilog . . . . .	£ 2.75
Z80 Programming Manual . . . . .	Zilog . . . . .	£ 4.50
Z80 Microcomputer Handbook . . . . .	W. Barden . . . . .	£ 6.99
Practical Microcomputer Programming (Z80) . . . . .	Weller . . . . .	£23.96
Z8000 Product Specification . . . . .	. . . . .	£ 3.75

### 6800 BOOKS

6800 Programming for Logic Design . . . . .	A. Osbourne . . . . .	£ 5.95
6800 Assembly Language Programming . . . . .	A. Osbourne . . . . .	£ 6.95
Using the 6800 Microprocessor . . . . .	. . . . .	£ 5.65
77-68 6800 Microprocessor . . . . .	. . . . .	£ 7.50
6800 Software Gourmet Guide Cook Book . . . . .	Scelbi . . . . .	£ 7.95
Practical Microcomputer Programming (6800) . . . . .	Weller . . . . .	£17.56
The 6800 Microprocessor . . . . .	. . . . .	£ 3.60
D.N. 4 Definite description of the 6800 Instruction Set . . . . .	. . . . .	£ 1.50

### PASCAL

Pascal: User Manual & Report . . . . .	Springer-Verlag . . . . .	£ 5.52
Problem Solving Using Pascal . . . . .	Springer-Verlag . . . . .	£ 7.84
Programming in Pascal . . . . .	P. Grogono . . . . .	£ 7.50
A Practical Introduction to Pascal . . . . .	A. Addyman . . . . .	£ 3.50

### 6502

The Best of Micro 6502 Journal . . . . .	. . . . .	£ 5.99
Sym Reference Manual . . . . .	. . . . .	£ 7.50
Sym Programming Manual . . . . .	. . . . .	£ 7.50
First Book of Kim . . . . .	. . . . .	£ 7.00
6500 Hardware Manual . . . . .	. . . . .	£ 7.50
6500 Programming Manual . . . . .	. . . . .	£ 7.50
Programming the 6502 SYBEX . . . . .	Zaks . . . . .	£ 7.95

### TERMS

Official Orders Welcome.  
 Barclaycard or Access Welcome.  
 Minimum official order £10.00  
**"BY RETURN ORDER SERVICE"**

● Circle No. 134

# COMPUTER FIELD MAINTENANCE

*Keeps SWTP running smoothly*  
*Keeps Cromemco running smoothly*  
*Keeps Sol running smoothly*  
*Keeps Horizon running smoothly*  
*Keeps Abacus running smoothly*  
*Keeping things running smoothly*



## Computer Field Maintenance

*A CWT company, a Member of the IAL Group.*  
 Excell House, Trust Industrial Estate, Wilbury Way  
 Hitchin, Herts SG4 0UZ  
 Tel: (0462) 51511 Telex: 826649

● Circle No. 135



# BIRMINGHAM

# COMPUTER CENTRE

**COMMODORE  
OFFICIAL DISTRIBUTORS**



2001 — 4K  
2001 — 8K  
2001 — 16N  
2001 — 32N  
Floppy Disc  
Printers

All models now in stock  
★ Discount Prices ★  
including New Keyboard  
and Green Screen

KIM-1 + Motherboards, etc

★ 30%

Discount on Business Programs  
with complete systems

 **AUTHORISED  
DISTRIBUTORS**



Apple 16K £810 Barrels of Software including  
Additional 16K Word Processor  
RAM £100 Sales Ledger  
Applesoft ROM £110 Management Information  
RS232 Card £110 Information Retrieval  
Printer Card £140 Large variety of games etc.  
Disc Drive with  
Controller £425

★ **Special Introductory Offer** ★



**APPOINTED  
DISTRIBUTORS**



**The Exidy Sorcerer**

Word Processing, Cobal, Fortran  
Plug-in ROM cartridges  
S100 Expansion Unit  
Cassette Interface  
Powerful Z-80 CPU  
"A real Business Machine"

★ **New low price from £650** ★

**CAMDEN BD830  
MAIN DISTRIBUTORS**

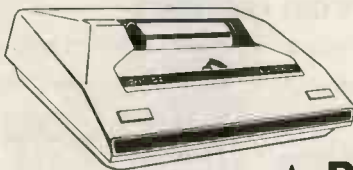

Tractor feed 120 CPS bi-directional  
Parallel and serial inputs standard  
Full upper and lower case  
New model with standard 2K buffer  
3K buffer optional  
Professional business printer  
Compatible with most systems

★ **Pet — Apple — Exidy — TRS-80 — etc** ★

★ Nascom 1-2 ★ Betsi ★ Kimsi ★ PSU ★ Monitors ★

★ Large stock of books — magazines — programming aids ★

★ Petsoft — Pet Act — Grama (Winter) — Computastore etc ★

★ First class C15 tapes — Mini Discs — Printer paper — all at special prices ★



HP terms available from £100 deposit 12-24-36 months



**Camden Electronics  
First Floor,  
462 Coventry Road,  
Small Heath,  
Birmingham B10 0UG**

**Showroom open daily**

**Mon-Sat 9.30-6pm**

**Sales — Service satisfaction**

**Phone (021) 773 8240**

● Circle No. 136

# GPW ELECTRONICS

S 100 Selection		Kit	Assembled
GPW 201	8080A CPU with vector interrupt	£64.00	£97.00
GPW 302	Z80 CPU (2MHz) inc. 2708 & Power Jump	£87.60	£120.00
GPW 303	Z80 upgrade kit to 4MHz	£34.30	
GPW 305	Z80A CPU (4MHz) inc. 2708 & Power Jump	£96.07	£128.06
GPW 501	8K Static Ram. 250ns.	£116.00	£144.00
GPW 502	8K Static Ram. 450ns.	£97.00	£126.00
GPW 503	Memory Board. 8K Ram, 8K Rom	£97.00	£126.00
GPW 506	EPROM Board, up to 16K of 2708 (not supplied)	£45.00	
GPW 601	Farbell Floppy Disk Controller	£123.00	£158.00
GPW 701	Series/Parallel Interface (2xS, 1xP)	£74.00	£114.00
GPW 801	Video Interface VB1B	£76.00	£109.00
GPW 850	Tape Interface with DMA	£71.00	£104.00
GPW 901	Card Extenders	£19.70	

Large range of S100, other boards, chips and components available.

## Computer Selection

### Exidy Sorcerer

16K with TV Modulator £760.00  
 32K with TV Modulator £859.00  
 S100 Expansion Box £210.00  
 Micropolis S100 Floppy (143K) £499.00  
 Micropolis S100 Dual (630K) £1200.00

### Tandy TRS-80

4K Level I £375.00  
 4K Level II £448.00  
 16K Level I £480.00  
 16K Level II £519.00  
 16K Expansion kit £70.50

We can also supply PET, CompuCorp and Gamma Systems.

## Software

We are the Central Southern England distributors for Gemsoft and A J Harding.

## Books

Large range in stock including the highly recommended Rodney Zacs and Adam Osbourne series.

Prices include post and packing. Please add VAT. CWO ACCESS AND BARCLAYCARD.

**146a London Road, North End,  
 Portsmouth, Hampshire.**  
 Telephone Portsmouth 693341 Telex 86526.

● Circle No. 137

**ProTechnic**  
 computer  
 consultants

MULLIONS  
 YARWELL  
 PETERBOROUGH

Hardware by

**EQUINOX**  
**SWTPC TEXAS**  
**DIABLO**

Software by **SOURCE (UK)**

ACCOUNTS : PARTS : MAIL : SBASIC [FOR SWTPC SYSTEMS]

One Day Courses each Month

- Introduction to Micros.
- Business Applications.

**PROTECHNIC**

0780- 782746 / 782913

● Circle No. 138

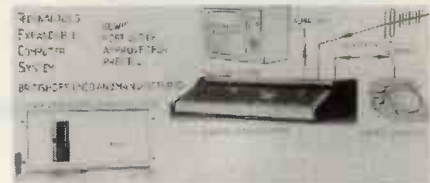

## TECS: FEATURES

- \* VIEWDATA AND PRESTEL DATABASE ACCESS
- \* FULLY EXPANDABLE COMPUTER SYSTEM
- \* MEMORY-MAPPED TV DISPLAY RAM
- \* 24ROW x 40 CHARACTER, ALPHANUMERIC AND GRAPHICS (224 individual symbols) DISPLAYED IN SIX COLOURS PLUS B&W, ON UNMODIFIED COLOUR T.V.
- \* EXPANSION TO FULL 64K MEMORY
- \* SUPPORTS BOTH 5 1/4" and 8" FLOPPY DISCS
- \* RS232 PORT AS STANDARD
- \* 3K TECS MINI-BASIC, INTEGER VERSION WITH COLOUR DISPLAY
- \* 8K TECS BASIC; FULL FLOATING POINT VERSION
- \* TECSBUG: POWERFUL MACHINE CODE MONITOR
- \* TECSOFT RANGE OF SOFTWARE TO EXPLOIT THE FULL POTENTIAL OF THE TECS SYSTEM
- \* FULL FACILITY TELETEXT RECEPTION (CEEFAX, ORACLE)
- \* KANSAS CITY STANDARD CASSETTE INTERFACE
- \* FULL DOCUMENTATION PACK
- \* ALL SYSTEMS CAN BE EXPANDED LATER;

SYSTEM	TECS BASIC	BUILT
SYSTEM T1 TELETEXT, 3K BASIC KIT		
4K USER RAM	£895	£1175
SYSTEM T2 TELETEXT, MONITOR, 8K BASIC, 4K USER RAM	£1115	1405
SYSTEM T2a AS T2 but +16K RAM	£1335	£1635
SYSTEM T2b AS T2 but +32K	£1435	£1735
SYSTEM T2c AS T2 but +48K	£1535	£1835
SYSTEM T4 'PRESTEL SYSTEM' TELETEXT, PRESTEL, 4K RAM, 3K BASIC	N/A	£1955

(KITS AVAILABLE DIRECT FROM TECHNLOGICS ONLY.) PLEASE SEND FOR FURTHER DETAILS (LARGE S.A.E., 13P STAMP PLEASE) OR ORDER NOW (SPECIFY RACK OR TABLETOP VERSION) FROM YOUR DEALER OR IN CASE OF DIFFICULTY DIRECT FROM TECS SALES DEPT.,

**TECHNLOGICS LTD.,**  
 8 EGERTON STREET, LIVERPOOL L8 7LY Tel:  
 051-724 2695

ALL ORDERS DEALT WITH IN STRICT ROTATION, CARRIAGE AND INSURANCE PAID. ALL PRICES SUBJECT TO 15% VAT.

● Circle No. 139

# XITAN SYSTEMS

THE SOUTH'S PREMIER MICROCOMPUTER SUPPLIER.

WE SUPPLY SYSTEMS — LOOK AT THESE TYPICAL CONFIGURATIONS!

\*LOOK AT THESE  
NEW PRICES\*

System A 32K Commodore PET + Commodore model 2040  
Dual floppy drives and cable. £1,610



System B NORTH STAR HORIZON, 32K RAM, dual  
double-density drives, 2 serial, 1 parallel port,  
DOS and BASIC, high-quality brand name 24 x  
80 char VDU £2,065



System C CROMEMCO System 2, 4MHz Z-80, 64K RAM,  
dual minifloppies, 21 connectors, 1 serial, 1  
parallel printer port, CDOS 1.07 and Extended  
Disk BASIC High-quality brand name VDU  
etc £2,735

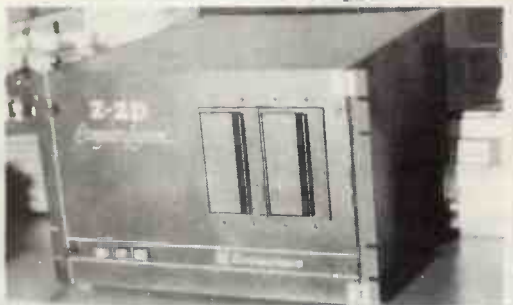

System D CROMEMCO Z-2, 4MHz, 1 megabyte floppy disk  
storage, 64K RAM, 3 serial ports, 2 parallel ports,  
CDOS 1.07 and BASIC, High-quality 24 x 80 char  
VDU £4,285



System E CROMEMCO System 3 (the "Rolls Royce") 64K  
RAM, 4MHz, 1 megabyte floppy disk storage, 1  
serial and 1 parallel printer port, high-quality  
brand name 24 x 80 char VDU etc, including  
CDOS and BASIC £5,710



*We supply Centronics, Teletype 43 and Diablo Printers, plus the normal range of ancillary equipment. CPIM for Cromemco and Horizon systems is available from us, as well as Microsoft Fortran, Tex etc.*

**23 Cumberland Place, Southampton SO1 2BB.**

**Tel (0703) 38740 Tues-Sat**

● Circle No. 140



## APPLE II.. £810

DISC DRIVE WITH CONTROLLER £425.00

## NORTH STAR HORIZON

HRZ-2-32 32K + DUAL DISK DRIVE . . . . .	£1480
HRZ-1-16 16K + SINGLE DISK DRIVE . . . . .	£1135
CP/M FOR HORIZON . . . . .	£ 115
PASCAL FOR HORIZON . . . . .	£ 70

### HEAD OFFICE & MAILORDER:

40 Bartholomew Street, Newbury, Berks.  
 Tel: 0635 - 30505 Telex: 848507 NCS  
 NORTHERN SHOWROOM:  
 220-222 Stockport Road, Cheadle Heath, Stockport.  
 Tel: 061-491 2290

## DPS-1

For education, industry, research and all professional uses, including hardware and software development, low cost OEM Systems, teaching applications etc.

- ★ Mainframe with front panel
- ★ 30 Amp 8v power supply
- ★ 20 slot motherboard with active termination and shielding between bus lines
- ★ Guaranteed operation at 4MHz

Price with 4MHz Z80 CPU Board . . . £ 695

Please send for details of the full range of Ithaca Intersystems S100 products.

## SORCERER from £650.

TELETYPE 43 . . . . .	From £875
ANADEx . . . . .	£575
BD80 . . . . .	£595

### TERMS

Official Orders Welcome.  
 Please add 15% VAT on all prices.  
 Barclaycard and Access Welcome.  
 Send or Phone (0635-30505) for Catalogue and Booklist.

● Circle No. 141



## RE-FURBISHED IBM SELECTRIC TYPEWRITER TERMINALS

From £695 + VAT.

Built in RS232 interface allows it to be connected to an Apple II, Pet, TRS-80.

In addition to its function as an on-line terminal, the unit can also serve as a standard Selectric office typewriter.

- Labour and parts 30 days.
- 30 days approval for postal orders.
- Maintenance agreement available.

For further information contact:

Vlasak Electronics Ltd., Thames Building,  
 Dedmere Road, Marlow, Bucks.  
 Tel: Marlow 74789. Telex: 847008.



## Three reasons why you should buy our computer.

**1.** It is manufactured in England to an exceptionally high standard - so we can give 12 months material and labour warranty.

**2.** Its performance is outstanding, transfer rate between disc drive and computer is guaranteed not less than 1 sector per 0.166 seconds. Analogue to digital conversion cards available. Also including a facility for additional V.D.U's.

**3.** Total Software Business Package at approximately £1,200.

Vlasak Electronics Limited, Thames Building, Dedmere Road, Marlow, Bucks. Tel: Marlow (06284) 74789. Telex 847008.

Dealers enquiries welcomed. We are also a main dealer for Apple 2 and PET.



● Circle No. 142

# Why wait for a kit computer when you can buy a fully built & tested Superboard III off the shelf?



Ohio Scientifics

## SUPERBOARD III

Now only **£188** + VAT

Full 8K basic and 4K user RAM Built and tested  
Power supply and R.F. Converter P.O.A.

We are passing on our savings from the rise in the £  
(Delivery within 7 days)

The machine can be economically expanded to assist in your business, remotely control your home, communicate with other computers and perform many of the tasks via the broadest lines of expansion accessories in the microcomputer industry.

This machine is super easy to use because it communicates naturally in BASIC, an English-like programming language. So you can easily

instruct it or program it to do whatever you want, but you don't have to. You don't because it comes with a complete software library on cassette including programmes for each application stated above. Ohio Scientific also offers you hundreds of inexpensive programs on read-to-run cassettes. Program it yourself or just enjoy it, the choice is yours.

### Features

- Uses the ultra powerful 6502 microprocessor
- 8K Microsoft BASIC-in-ROM
- Full feature BASIC runs faster than currently available personal computers and all 8080-based business computers.
- 4K static RAM on board expandable to 8K
- Full 53-key keyboard with upper-lower case and user programmability
- Kansas City standard audio cassette interface for high reliability
- Full machine code monitor and I/O utilities in ROM
- Direct access video display has 1K of dedicated memory (besides 4K user memory), features uppercase, lower case, graphics and gaming characters for an effective screen resolution of up to 256 by 256 points. Normal TV's with overscan display about 24 rows of 24 characters, without overscan up to 30 x 30 characters.

### Extras

- Available expander board features 24K static RAM (additional mini-floppy interface, port adapter for printer and modem and OSI 48 line expansion interface).
- Assembler/editor and extended machine code monitor available.

### Commands

CONT	LIST	NEW	NULL	RUN		
Statements						
CLEAR	DATA	DEF	DIM	END	FOR	
GOTO	GOSUB	IF...GOTO	IF...THEN	INPUT	LET	
NEXT	ON...GOTO	ON...GOSUB	POKE	PRINT	READ	
REM	RESTORE	RETURN	STOP			

### Expressions

Operators  
-, +, \*, /, ↑, NOT, AND, OR, >, <, <<, >>, =, <=, =  
RANGE 10<sup>-32</sup> to 10<sup>+32</sup>

### Functions

ABS(X)	ATN(X)	COS(X)	EXP(X)	FRE(X)	INT(X)
LOG(X)	PEEK(I)	POS(I)	RND(X)	SGN(X)	SIN(X)
SPC(I)	SQR(X)	TAB(I)	TAN(X)	USR(I)	

### String Functions

ASC(X\$)	CHR\$(I)	FRE(X\$)	LEFT\$(X\$,I)	LEN(X\$)	MID\$(X\$,I,J)
					VAL(X\$)
			RIGHT\$(X\$,I)	STR\$(X)	

Plus variables, arrays and editing facilities.

Fully built and tested. Requires only +5V at 3 amps and a videomonitor or TV and RF converter to be up and running.

## What the magazines say

"The Superboard represents good value with plenty of potential"  
Practical Computing June '79

"Certainly one of the most exciting (computers) on the present market"  
Practical Electronics June '79

"A useful machine.....represents value for money"  
Computing Today June '79

Dealer Enquiries welcome at Morgan St. address

Watford Electronics  
33/35, Cardiff Road,  
Watford, Herts.  
Tel: Watford 40588/9

Videotime Products  
56, Queens Road,  
Basingstoke, Hants RG21 1REA  
Tel: 0256 56417

Lotus Sound  
4, Morgan Street,  
London E3 5AB  
Tel: 01-981 3993

● Circle No. 143

# DEMACAN LTD

Computer Systems

COMPLETE SYSTEMS FOR SCIENTIFIC AND BUSINESS USE BASED ON ITT 2020 (APPLE II) OR PET COMPUTERS

Our MINICAM system with its flexible, modular interface to 6502 and 6800 series computer systems offers a total product approach to data acquisition and control.

New (Palsoft) ITT 2020 Computers, Disks, Printers, etc. — ex-stock at the new lower prices. Also a large range of intelligent interfaces, printers, etc. available, including 11 MB hard disks.

Just in from the States: PET Machine language guide. (BASIC entry points, etc. etc. — for old and new PETs). **£6.75**

For further information please contact:

Tel: 0272 621920

**DEMACAN LTD**  
2 West Priors Close  
Westbury-on-Trym  
BRISTOL BS9 4DD

● Circle No. 144

## ANNOUNCING

S100 Teletext Format. Colour VDU card with keyboard. Port to operate with colour monitor: from the company that designed and built the BBC Ceefax formatting terminals.

**KITS £149, BUILT AND TESTED, £209 +VAT**

### S100 OFF AIR RECEIVER AND MODULATION CARD

To operate with VDU card and enable OFF AIR reception and display via a TV set.

Available in October. Enquiries from dealers welcome

**LEENSHIRE LTD.**  
13 Cathedral View,  
Winchester, Hampshire  
SO23 8PR  
Tel: 0962 3675

● Circle No. 145

## WE OFFER A COMPLETE SERVICE!

When you buy a computer from us — we don't give you the box and wave goodbye.

We realise this is a major purchase for a Company and take the time to find out your requirements, design your computer system and write the software, or if you prefer to write your own, we will always be available to advise you.

You can buy a wide range of fully-documented packages — Word Processing/Purchase & Sales Ledgers/ Stock Control/Incomplete Records/Medical Systems/Teaching Programs etc. on Microcomputers such as—

**APPLE II** from £810 (16K)  
A complete business system 48K  
Apple, 2 Disk Drives, VDU & Printer £2,650

**MICROSTAR** from £4,950  
Multi-user/Multi-task  
1.2/2.4 or 4.8 mb.  
A complete system with 2 VDUs & Printer £7,000

**ALPHA MICRO** from £9,950  
From 1 to 32 terminals.  
From 10 mb. to 90 mb. disk storage.  
16-bit processor, Multi-user operating system.

**We stock a full range of VDUs, Printers, Computer Stationery, Diskettes, Disk Boxes etc.**

all prices ex VAT.

Come and see us to discuss your requirements and have a demonstration.

# MICROSOLVE

Microsolve Computer Services Ltd.  
125 /129 High Street, Edgware, Middlesex.  
Tel: 01-951 0218

M1 junction 4 /20 mins from Central London.

e.g.  
**LOW COST PRINTERM**  
matrix printer £695  
**LEAR SEIGLER**  
200A matrix printer £1,650  
**QUME Sprint 5**  
daisywheel printer £2,115.

● Circle No. 146

# P.E.T NEWS

# PET BOOM IN BRITAIN!

## AUTHORISED PET COMMODORE DEALERS

**Birmingham**  
Camden Electronics  
021-773-8240

**CPS (Data Systems)**  
021-707-3866

**Taylor Wilson Systems**  
Knowle (056-45) 6192

**Bolton**  
B & B Consultants  
0204-26644

**Bournemouth**  
Stage One Computers  
0202-23570

**Bradford**  
Ackroyd T/W &  
Add M/C  
0274-31835

**Brentwood Essex**  
Direct Data Marketing  
0277-229379

**Bristol**  
Bristol Computer Centre  
0272-23430

**Sumlock Tabdown**  
0272-26685

**Cambridge**  
Cambridge Computer  
Store  
0223-68155

**Cardiff**  
Sigma Systems  
0222-21515

**Colchester**  
Dataview Ltd  
0206-78811

**Derby**  
Davidson Richards  
0332-366803

**Durham**  
Dyson Instruments  
0385-66937

**Edinburgh**  
Micro Centre  
031-225-2022

**Exeter**  
A.C. Systems  
0392-71718

**Grimsby**  
Allen Computers  
0472-40568

**Hemel Hempstead**  
Data Efficiency  
0442-57137

**Hove**  
Amplicon Micro Systems  
0273-720716

**Leeds**  
Holdene  
0532-459459

**Liverpool**  
Dams Office Equipment  
051-227-3301

**London N14**  
Micro Computation  
01-882 5104

**Rockliff Bros**  
051-521-5830

**THE  
PET 4K  
COMPUTER  
at  
£450 (+VAT)  
it's got to  
be  
Britains  
best buy!**



## Why the PET is the number one Personal Computer

**The Self Contained PETS**  
The self contained PET models 2001-4 and 8 come complete with TV screen, keyboard and built-in cassette deck as well as the computer circuitry. They are simply plugged into any 13 amp mains and no special knowledge is needed for running standard programs — over 200 of which are available on cassettes.

**The Big Memory PETS**  
The BIG MEMORY PETS contain the same main features as for the 2001-4 and 8 models except that they incorporate a full typewriter size keyboard and have larger internal memory of 16K and 32K bytes RAM respectively.

## Professional Printers

High specification printers can print onto paper all the PET characters — letters, numbers and graphics. A tractor feed model has the advantage of accepting mailing labels, using standard pre-printed forms. The only connections required are an A/C lead and PET connecting leads. The PET is programmable, allowing the printer to format print and it accepts 8 1/2" paper giving up to four copies.

## Dual Drive Floppy Disc

The Dual Drive Floppy Disk is the latest in Disk technology with extremely large storage capability and excellent file management.

The Floppy Disk operating system used with the PET computer enables a program to read or write data in the background while simultaneously transferring data to the PET. The Floppy Disk is a reliable low cost unit, and is convenient for high speed data transfer. Due to the latest technological advances incorporated in this disk.

a total of 360K bytes are available in the two standard 5 1/4" disks. Only two connections are necessary — an A/C lead and PET interface lead.

## Software and application areas for PET

There are a large number of programs that can readily be used with the PET. Personalised programming is available from many Authorised Dealers. Over 200 programs are now available from Commodore and other software suppliers for the PET. Popular program titles include Stock Control, Statistics, Payroll, Strathclyde Basic Course, Chess, Lunar Landing and Education Packs.

**FOR THE COMMERCIAL USER**  
The Commodore PET offers for the first time a really cost effective business computer for use in Accountancy, Statistics, Stock Control, Payroll, Invoicing etc.

## FOR THE SCIENTIST AND THE LABORATORY

PET has a comprehensive set of scientific functions making it a far superior tool to the best programmable calculators. PET interfaces directly with hundreds of laboratory instruments. PET is an ideal industrial and commercial controller.

## FOR THE EDUCATIONAL WORLD

The extensive basic language makes PET an ideal tool for teaching computer programming. Programs can be written to "tutor" the user (pupil) in almost any discipline, including BASIC itself. And, of course, the PET can be used to take care of school records, exam results, attendance figures etc.

## IN THE HOME

The PET is an extremely creative and instructive learning medium of the future for young and old alike. There are also large numbers of entertainment programmes available including chess and space games.

**London E2**  
Ragnarok Electronic  
Systems  
01-981-2748

**London EC1**  
Sumlock Bondain  
01-253-2447

**London NW4**  
Da Vinci Computers  
01-202-9630

**London SW14**  
Micro Computer Centre  
01-876-6609

**London WC1**  
Euro-Calc  
01-405-3113

**London WC2**  
TLC World Trading  
01-839-3893

**Manchester**  
Cytek  
061-832-7604

**Sumlock Electronic  
Services**  
061-834-4233

**Matlock**  
Low Electronics  
0629-2817

**Morley, W. Yorks**  
Yorkshire Electronic  
Services  
0532-522181

**Norwich**  
Sumlock Bondain  
0603-26259

**Nottingham**  
Betos Systems 0602-48108

**Oxford**  
Orchard Electronics Ltd  
Wallingford (0491) 35529

**Plymouth**  
J.A.D. Integrated Services  
0602-62616

**Preston**  
Preston Computer Centre  
0772-57684

**Reading**  
CSE Computers  
0734-61492

**Southampton**  
Business Electronics  
0703-738248

**Symtec Systems**  
0703-37731

**Sunderland Tripont  
Associated Systems**  
0783-73310

**Woking**  
P.P.M.  
Brookwood (04867)-80111

**Petalect**  
04862-69032

**Yeovil**  
Computerbits  
0935-26522

**North Scotland**  
Thistle Computers  
Kirkwall (0856)-3140

**Northern Ireland**  
Medical & Scientific  
Lisburn (08462)-77533

**Phone about PET now!**

**CALL YOUR LOCAL AUTHORISED DEALER or in case of difficulty contact:  
COMMODORE SYSTEMS DIVISION  
360 Euston Road, London. Tel: 01-388-5702**

● Circle No. 147

NorthStar 

COMPATIBLE HARDWARE

	£Kit	£Ass.
NORTHSTAR		
Horizon-0-0k	475	650
Horizon-1-16K-D	995	1265
Horizon-1-32K-D	1125	1445
Horizon-2-16K-D	1245	1575
Horizon-2-32K-D	1375	1755
Z80A CPU card	145	175
Hardware Floating Point card	195	215
Set of 4 ECs and card guides	15	30
Parallel Port	29	45
Serial Port	29	45
Dual density controller with Rel. 5 S/W	225	275
16K dynamic memory card	225	275
32K dynamic memory card with parity features	375	425

**OTHER MANUFACTURERS**

Morrow SwitchBoard I/O card (2P + 2S)	125	155
Heuristics 20S Speech recognition card	n/a	145
Heuristics 50 Speech recognition card	n/a	225
Solid State Music PROM card with textool	85	135
Morrow DISCUS 2D controller	POA	POA
Morrow DISCUS 2D system, includes 1 drive	n/a	POA

**PERIPHERALS**

Intertec Intertube II VDU (uses Z80 & 6K EPROM)	n/a	575
Elbit DS1920, model 30 VDU	n/a	730
Digital Equipment LA36 DECwriter terminal	n/a	850
Digital Equipment LA34 terminal	n/a	825
NEC Spinwriter 55cps letter quality printer	n/a	1475

All prices given are exclusive of VAT (presently 15%) and carriage, and are correct at time of going to press. Educational and OEM terms are available on request. Please send 12p stamp for full details.

Telex: 925859

Telephone: 01-834 0261/2733

Interam Computer Systems Ltd.

59 Moreton St., Victoria,

London SW1



● Circle No. 148

**WORD PROCESSOR  
COMPLETE WITH PRINTER  
FOR £1,195**



Based on TRS-80 Level II, 12in. wide screen, 64 characters (A4) wide, upper/lower-case, superb Electric Pencil software, Anadex 8000 dot matrix printer or Qume daisywheel printer (option).

General business software also available to run on the above system.

Complete with Anadex printer 16K	£1,195
As above with expansion box & 48K	£1,445
Qume daisy printer in lieu Anadex	£995
Dual floppy disc drives	£575

All prices ex. VAT.

Phone/write for further details or demonstration.

**LONDON COMPUTER STORE**  
43, GRAFTON WAY, LONDON W1.  
Tel. 01-388 5721.

● Circle No. 149

**Micro-Facilities**

127 High Street  
Hampton Hill  
Middlesex TW12 1NJ

**01-979 4546**  
**01-941 1197**

**MIDDLESEX & SW LONDON**

As dealers for North Star Horizon and Commodore PET Microcomputers we provide a fully comprehensive service for all types of user:

★ Personal ★ Business ★ Education ★ Industry ★ Scientific

We offer both a large range of software and the choice of supporting peripherals.

**Software Packages**

Sales Ledger Purchase Ledger  
General Ledger Stock Control  
Incomplete Records  
Loan Accounting Mail Order  
Payroll Job Costing  
Text Processing CP/M

**Systems & Programming**

A professionally experienced team of consultant analysts and programmers offer you a complete service for specifying, designing, writing and testing programs to your exact requirements. Our packages can be tailored to your needs at

very low cost. Our programmers can write in BASIC, COBOL, RPG, or FORTRAN.

**Financing**

In addition to purchasing, we offer you the choice of Rental, Leasing or H.P. (subject to references).

Furthermore if you already have a micro system then why not ask us about part exchange.

Commodore PET computers are available for hire from £4.75 per day, disks interfaces and printers are extra.



NORTH STAR HORIZON



COMMODORE PET

If you have a computer problem then ask Micro-Facilities for the solution.



Association of Independent  
Computer Specialists

● Circle No. 150



# MacroFloppy<sup>TM</sup> goes twice the distance

Micropolis is rapidly becoming the industry standard in 5¼" floppy disc drives; they have been shipping double density drives for over 2 years, thus proving their outstanding reliability and performance.

By completely reassessing the engineering involved in 5¼" floppy disc drives, and using the most modern technology available, Micropolis achieve a formatted density of 315K bytes per single sided unit.

## Starter system

The 1041/1 Macrofloppy system includes a 143K byte double density drive with S100 controller card, MDOS and BASIC with a comprehensive manual.

This unit will successfully add on-line disc storage to a wide range of S100 computers at an unbeatable price per byte.

Add to your **Cromemco, North Star, Vector Graphic, Sol, Poly 88, Sorcerer, etc.**

Fully assembled, tested and burnt-in unit  
£439.00

Optional regulator for S100 raw power  
£14.00

## Also available

A full range of hardware and software including:

Mains powered add-on 143K bytes (Also suitable for **Tandy** expansion interface)  
£399.00

Single drive 315K byte system  
£663.00

Twin drive 630K byte system  
£1159.00

CPM  
£100.00

**North Star** compatible operating system  
£35.00



Dealer enquiries welcome  
Ring Reading 85464 for further details



## SINTROM MICROSHOP

14 Arkwright Road, Reading, Berks RG2 0LS  
Tel: Reading (0734) 85464  
TELEX: 847395 CABLES: SINTROM READING

● Circle No. 151

## CAMBRIDGE COMPUTER STORE

We can help you select the right system for your application. Here in Cambridge your choice won't be limited — we'll demonstrate as comprehensive a range of microcomputers as you'll find anywhere in the U.K.:

**TANDY TRS-80**  
**COMMODORE PET**  
**APPLE II**  
**N-S HORIZON**  
**CROMEMCO**  
**SORCERER**  
**ACORN**  
**NASCOM-1**

Stop Press: dramatic reduction now in prices of TRS-80, APPLE II and HORIZON systems. Where possible we deliver off-the-shelf, to any location.

The store is open 6 days a week from 9-5.30 with demonstration systems always in operation. We offer a professional standard of advice and after-sales support and we're ready to discuss your application any time.

## CAMBRIDGE COMPUTER STORE

1 Emmanuel Street, Cambridge (0223) 68155

● Circle No. 152

# EPROMS — EX-STOCK

## 5-volt single supply 2K x 8

**Contact Nelson Computer  
Services Ltd  
on Rossendale  
(07062) 29125**

● Circle No. 153



### TRANSLATOR

An instant translator of words and phrases from the world's major languages

Use this amazing Hand Held Microcomputer translator as a

- Personal interpreter when you travel
- Valuable learning aid when you study
- Quick reference in most often needed phrases
- Metric system converter
- Calculator

Basic Unit £169 Each language Module £34 (French, Spanish, Italian, Greek, German). Calculator Module £29.95  
 Prices inc. VAT & Delivery nationwide

### APPLE - EXIDY - ITT - HORIZON

These special prices apply for a limited period

#### apple II plus

16k ..... £830    32k ..... £879    48k ..... £920  
 Disk Drive (with controller) .... £425

#### exidy sorcerer

8k ..... £650    16k ..... £760    32k ..... £859  
 S100 Expansion Unit .... £199

Micropolis Dual Disk Drive (630k Bytes - software included) .... £1,140

One Drive (Mini Floppy - 315KB) .... £669

All the above prices are exclusive of VAT

Part exchange welcome



# CENTRALEX LONDON

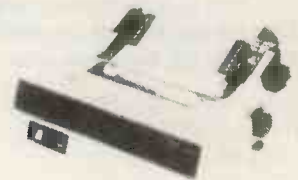

### PRINTERS AND VIDEO MONITORS

#### printers

Centronics 779 ..... £748  
 Anadex DP 8000 .... £569  
 Integral IP-125 ..... £499  
 IP-225 ..... £599

#### video monitors

Hitachi 9" ..... £129  
 Hitachi 12" ..... £199

All the above prices are exclusive of VAT

### SOFTWARE - PROGRAMMING - TRAINING

#### software

Hundreds of Programmes and Software Packages available (Sales Ledger, Purchase Ledger, Payroll, VAT, Data Base System, Word Processing, COBOL, Fortran, Stock Control, Medical Records, Educational Programmes, etc)

#### programming

Systems Analysis, Design, and Programming assignments undertaken

#### training

A comprehensive range of courses and seminars available.

**Free Delivery Nationwide - Credit Cards Accepted -  
Terms Arranged**

**Centralex-London Ltd.** PO Box 111, Sidcup Kent,  
 DA15 9BR (callers by appointment only)

**01-309 7799    01-300 0380**  
 (24 hours answering)

● Circle No. 154

SOFTWARE FROM **LPE**

**SUMMER HOLIDAY BONUS:** For the purchase of 2 or more software packages, and paying by cheque, P.O. or cash, give yourself a 10% **DISCOUNT!**

SOFTWARE FROM **LPE**

Computers Plus Inc.,	FMS-80 (File Management System) Demo Pack (includes manual & demo disc) £35.00
Computer Services	Bidirectional driver for Diablo Hytype printers for use on CP/M, CDOS & IMDOS systems. BI-DIRECT Complete System Manual only £65.00 £15.00
CP/M User Library	40 Volumes (8" only) £4.00 each
Creative Computing Cassettes:	<b>Pet</b> CS-1001 Logic Games - 1 CS-1002 Number Games - 1 CS-1003 Logic Games - 2 CS-1004 Graphic Games - 1 CS-1005 Graphic Games - 2 CS-1006 Conversational Games - 1 CS-1007 Board Games - 1 CS-1008 Sport Games - 2 CS-1201 Simulations - 1  <b>Apple II</b> CS-4001 Space Games - 1 CS-4002 Sports Games - 1 CS-4003 Strategy Games - 1 CS-4201 CAI Programs - 1 CS-4301 Know Yourself  <b>Evidy Sorcerer</b> CS-5001 Graphics Games - 2  <b>OSI Challenger 1P &amp; Superboard II</b> CS-6001 Graphics Games - 3  <b>SOL-20</b> Coming Soon <b>TRS-80</b> CS-2001 Games - 1 (level 1) CS-3001 Board Games - 1 CS-3002 Space Games - 3  Each of these are £6.50 CS-3033 Adventure £12.50 CS-3201 Ecology Simulations - 1 £19.50
Creative Computing Discs:	for CP/M CS-9001 BASIC Games, Volume 1, disc 1 CS-9002 BASIC Games, Volume 1, disc 2 CS-9000 Both discs purchased together  These cost £12 each, or £20 if purchased together.
Digital Research	Operating Systems: On 5" On 8" Name Discs Discs CP/M for North Star £105.00 N/A CP/M for MDS-800 N/A £65.00 CP/M on Cromemco N/A £85.00 SID £55.00 £50.00 MAC £65.00 £60.00 TEX £55.00 £50.00 DESPOOL £36.00 £32.50 CP/M Manuals only £25.00 TEX Manual only £12.00 SID Manual only £12.00 MAC Manual only £15.00 DESPOOL Manual only £5.00 CP/M Disc only £85.00 £45.00 SID Disc only £50.00 £45.00 MAC Disc only £55.00 £50.00 TEX Disc only £50.00 £45.00 DESPOOL Disc only £32.50 £30.00

Information Unlimited Inc.,	WHATSIT for North Star Horizon £50.00 APPLE 2; 48K £72.00 APPLE 2; 32K £59.00 CP/M £75.00
L.P Enterprises	Diablo Driver runs 300/1200 baud with autoload For CDOS £25.00 For CP/M £25.00
Micah	CP/M for CDOS Users Program to Expand CP/M system to be compatible with Cromemco CDOS S/W. £59.00
Michael Shrayer	Electric Pencil A) SS II for TTY etc., £175.00 b) DS II for a DIABLO £215.00 c) TRS-80 Cassette £75.00 d) TRS-80 disc (on cassette) £130.00
Micropro	WORD-MASTER manual only £90.00 TEX-WRITER £25.00 Manual only £45.00 WORD-STAR £15.00 Manual only £300.00 £25.00
	SUPER-SORT Version 1 £150.00 Version 2 £120.00 Version 3 £90.00 Manual only £25.00
Northshare	** A Multi-User system for Northstar User's Disc only £32.00 Manual only £27.00 £10.00
Automated Simulations	Starfleet Orion Game for PET 8K, TRS-80 (level 2 16K) £15.00 APPLE 2; TRS-80 (24K) £17.50
Osborne associates	Some Common Basic Programs for PET on cassette with book £10.00 £15.00
Software Systems	CBASIC Disc & Manual £85.00 CBASIC Disc Only £75.00 CBASIC Manual Only £15.00
Software Works	On North Star Discs Inventory - 1 £50.00 Inventory - 2 £75.00 Mail Room £50.00 Housekeeper £35.00 Preventative Maintenance £75.00 FIX-IT £20.00 Manuals Only £10.00
Structured Systems Software	Accounts Receivable (Sales Ledger) Disc & 222 Page Manual £395.00 Accounts Payable (Purchase Ledger) Disc & 177 Page Manual £455.00 General Ledger (Nominal Ledger) Disc & 150 Page Manual £495.00 Inventory (Stock Control) T.B.A NAD (Name & Address System) £45.00 QSORT (Sort Utility) £55.00 Demo disc for SL, PL, NL, CAR, AP, GL £25.00
Tiny-C Associates	Tiny-C language for 8080, Z80, 8085 systems Manual with Source-Code £35.00 Disc containing all files both source & object code £35.00

**STOP PRESS:**  
To be announced soon a Multi-User, Multi-Tasking operating System for use on Z80 Systems with a minimum RAM of 64K; maximum of 16M RAM.  
**STOP PRESS:**  
More Coming  
  
\*\*Please specify if single or double Density 5" discs required.  
add £1.50 for Postage & Insurance; plus VAT.

**HOW TO ORDER**  
Add £1.50 for postage and Insurance, plus VAT (15%).  
Payment must be in sterling and drawn against a British bank. Make cheques payable to: LP Enterprises, Room P.C., 313 Kingston Road, Ilford, Essex, IG1 1PJ.

CREDIT CARDS accepted  
BARCLAYCARD VISA/ACCESS/DINERS CLUB/  
AMERICAN EXPRESS  
Phone: 01-553 1001 for Credit Card orders (24 hr answering service)

THIS LIST CANCELS ALL PREVIOUS PRICE LISTS: EFFECTIVE JULY 1979  
DUE TO FLUCTUATIONS OF THE DOLLAR, PRICES SUBJECT TO CHANGE WITHOUT NOTICE.

PC	All Orders must be Prepaid:
Indicate Payment Method; and underline items required.	Total Enclosed £ .....
..... My cheque, P.O., I.M.O. is enclosed in Sterling on U.K. Bank	
..... Charge to Barclaycard/Visa/Access/Diners/American Express	
Credit Card No .....	Expiry Date .....
Name .....	
Address .....	
	POSTCODE .....
Signature .....	

Send SAE for our range of books and magazines.  
Prices subject to change without notice  
**TRADE ENQUIRIES WELCOME**

● Circle No. 155

## OUR 1979 CATALOGUE

including the first edition of

### STOP PRESS

- \* LATEST LOW PRICES
- \* FASCINATING NEW ITEMS
- \* SPECIAL OFFERS  
a bargain on their own
- \* LOWEST PRICES EVER FOR TTL
- \* FREE 45p WORTH OF VOUCHERS

RAM  
2102A-2  
1024 x 1 250ns  
1.19  
16 For £16.96

CATALOGUE  
40p

C.P.U.  
8080  
£5.49

JUST SEND  
S.A.E. FOR  
STOP PRESS

E. PROM  
1702  
£5.57



USE OUR "ORDER-RING" LINES  
VAT INCLUSIVE PRICES P + P 25p



## CHROMASONIC electronics

56 Fortis Green Road,  
Muswell Hill London N10 3HN  
Telephone 01-883 3705/2289

● Circle No. 156

**MICRO COMPUTER CENTRE,**  
314 Upper Richmond Road West,  
East Sheen, S.W.14 876 6609.  
Business Specialists/Authorised Dealers for

### PET

#### Computers

Standard PET with integral cassette and  
calculator type keyboard. 8K bytes of memory £550.00  
PET with 16K bytes of memory and large  
keyboard. External cassette optional £695.00  
PET with 32K bytes of memory and large keyboard.  
External cassette optional £795.00

#### Printers

Whymark 201 - 20 columns complete with interface £400.00  
Datac BD80 - 80 columns £750.00  
1-way Interface £106.00  
Teletype 43 - 132 columns - Upper and  
Lower Case Keyboard £900.00  
2-way Interface £186.00

#### Memories

16K Memory Extension for 2001 - 8K £276.00  
24K Memory Extension for 2001 - 8K £337.00

#### Disc Drives

Compu/Think Twin Floppy Disc Drive - double  
sided discs - 100K per side £833.00  
Pet Twin Floppy Disc Dual Drive including cable £815.00  
Cassette Recorder £55.00

The above prices are exclusive of VAT. All the above  
items are IN STOCK at time of going to press.

We stock all PET accessories and handbooks PETSOF  
and PETACT Programs.

● Circle No. 157

# SYSTEMATICS INTERNATIONAL LIMITED

Specialists for microcomputer systems and software development for business invite enquiries  
from PROFESSIONAL DEALERS who wish to sell in specific territories in the U.K.

ITT 2020 microcomputer systems and/or

**MICROSTAR 45 multi-tasking, multi-user microcomputer systems.**

A full range of business/financial/accounting software is available, together with a comprehensive  
software development/technical/promotional support service.

Applications should be made to Ronald Young, Managing Director.

Telephone 01-723 0171, or write to:

P.O. Box 832,  
London W2 2LL.

Telex 99431 S ig

**Essex House  
Cherrydown  
Basildon  
Essex**

● Circle No. 158

# Buy a System...Not just a "Pretty Box"

The SD System\* — From about 97p per hour (40-hour week)

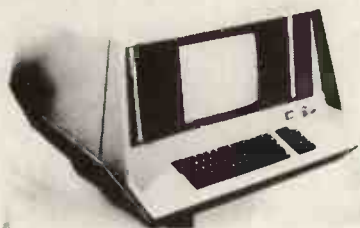

**\*The SD System includes:**

SDS-200 Microcomputer T.I. 810 Printer (or equivalent)  
i.e., NEC SPIN WRITER £1,899. SDS 200 £4,750, T18 10  
£1,499

**The SDS-200 TOTAL System features:**

**System Hardware**

The SDS-200 gives you features that are not found in systems costing thousands more. State-of-the-Art Engineering. Quality Production and Full Reliability testing make the SDS-200 a dependable, compact and easy to operate data processing system.

- Up to 256K Bytes RAM
- Full Keyboard with Special Accounting Key Pad
- Large 12in. Video Display Screen
- Full Cursor Control including Addressable Cursor
- Blinking, Underlining, Reverse and Protected Fields
- Uses 8in. Flexible Diskettes for Permanent Storage 2 Mbyte on-line
- Forward and Reverse Scrolling
- Capable of up to 160 Special Characters
- Expandable with Memory and Peripheral Equipment
- Will Operate as a Remote Batch Processor for Large Systems
- S 100 industry standard bus
- 4 spare S100 slots.

**System Software**

A range of Business Programs are available from CAP-CPP written in Microcobal. The system will support all normal high level languages including:—

- Fortran
- Cobol
- Basic
- CP/M

**Authorised dealers are:**

Anglo American Computers Ltd  
Milburn House, Suite D, Dean Street  
Newcastle-upon-Tyne.  
Tel: 0632 29593

Apple Computers  
Anfield, Glenalmond  
Perthshire 073-888 267

**A Total System**

SD Systems knows that small businesses do not keep full-time programmers on staff. We also know that individually designed business programs can be expensive on a one-time basis. That is why we offer the SDS-200 and compatible business software.

**Leasing Available**

The SDS-200 is available by leasing. This gives the small business the opportunity to select the method of acquisition that best fits their needs.



**SDS-200 Expandable**

The SDS-200 is designed in a manner to give you expansion capabilities. As your needs change the computer system that you select today should be able to change with you. By the addition of memory and peripheral equipment, the SDS-200 can expand to fit your needs.

Bell Computing Ltd  
1 Froghall Lane, Warrington  
Tel: 0522 411271 (33137)

Codified Computer Systems Ltd,  
69 Calabria Road,  
London N5 1HX  
Tel: 01-226 1319.

**UK Distributor:**

## AIRAMCO LTD

Unit A2, 9 Longford Avenue, Kilwinning Ind. Est.,  
Kilwinning, Ayrshire KA13 6EX.

(0294) 57755

Telex 779808

Dealer enquiries invited

# SLOUGH MICROSHOP

We stock:

Commodore PET  
Exidy Sorcerer  
North Star Horizon

Full demonstration equipment available now.

Extra services include:

A complete hardware maintenance service

A software service; tailor-made or packaged software available

Call in at our shop

120 High Street,  
Slough, Berkshire

Tel: Slough 22855

● Circle No. 160

# WE HAVE MEMORIES

AM2708	1K x 8 EPROM
TMS2516	2K x 8 EPROM
TMS2716	2K x 8 EPROM
2102L	1K x 1 SRAM
2114-2	1K x 4 SRAM
4060	4K x 1 DRAM
4096-16	4K x 1 DRAM
4116-3	16K x 1 DRAM
Z-80 CPU	4MHz
Z-80 PIO	4MHz



Send S.A.E. for full list and prices

**STRUTT**  
Electrical and Mechanical  
Engineering Ltd.  
Electronic Component  
Distributors

3c Barley Market Street,  
Tavistock,  
Devon PL19 05F  
Tel: Tavistock (0822) 5439  
Telex: 45263

● Circle No. 161

## NEW from NEWTRONICS

### 'EXPLORER 85'

Microcomputer kit

Low Cost with On-Board

S100 expansion at

£295 + VAT



The 'EXPLORER 85' is inexpensive with all the advantages of a powerful board plus potential for infinite expansion.

- \* Uses New Fast INTEL 8085 cpu, 100% compatible with 8080A software but 50% faster than 8080A cpu.
- \* Powerful 2K monitor.
- \* 4K user RAM expandable to 64K.
- \* Provision for 8K PROM or EPROM.
- \* Buffered & decoded S100 expansion on board (up to six S100 boards).
- \* Cassette interface (with motor control & cassette file structure) RS232: 20ma loop: four 8-bit & one 6-bit I/O ports.
- \* Programmable 14-bit binary counter/timer.
- \* Separate ASCII/Video Terminal features: a full 128-character set upper-lowercase, full cursor control, Greek symbols for Maths, 75 ohm video output convertible to baudot output, selectable baud rate, RS232 or 20mA loop, I/O. 64 or 32 characters by 16 lines (monitor or TV)
- \* And lots of other features.

LEVEL 'C'	S100 main frame expander kit. Increases the number of S100 slots to 6. Includes all sheet metal, 5-slot extender board, board-guides & brackets. Fits into EXPLORER cabinet. (Less S100 pin connectors).	32.80 2.00
LEVEL 'E'	Add 8K sockets, power supply regulator & decoupling components for popular 2716 or 2516 EPROMs (EPROMs not included).	5.00 free
DE LUXE STEEL CABINET FOR EXPLORER 85		33.50 2.00
DE LUXE STEEL CABINET FOR VIDEO KEYBOARD TERMINAL		15.00 2.00
POWER SUPPLY IN STEEL CABINET		25.00 2.00
GOLD-PLATED S100 BUS CONNECTORS		4.00 free
RF MODULATOR 8KHz required when using TV set aerial socket.		6.00 free
INTEL 80805 Users' Manual		6.00 free
8K 'MICROSOFT' BASIC ON CASSETTE TAPE	The most versatile and popular Basic ever written. Complete with documentation.	53.00 free

Dealer enquiries welcome. For full details send S.A.E.

PAYMENT BY:— Cheque; Access; Barclaycard, etc. FOR 'PHONE ORDERS CALL 01-739 1582

Access/Barclaycard No. .... Exp Date .....

Signature .....

Print Name .....

Address .....

Sole agents .....

Computer div' of H.L. Audio Ltd., Dept. P/C  
138 Kingsland Road, London E2 8BY  
Tel: 01-739 1582

● Circle No. 162

# PET — S100/Z80/CPM COMPATIBLE SYSTEMS — SWTP G W COMPUTERS LTD

This is how your business appears on the screen

A complete Business Program Package (version one) free with the purchase of a 32-40K computer system.

Approx 60 entries ★ updates require only 1-2 hours weekly and your entire business is under control.

## \* PROGRAMS ARE INTEGRATED

- 1=ENTER NEW NAMES/ADDRESSES
- 2=\* ENTER/PRINT INVOICES
- 3=\* ENTER PURCHASES
- 4=\* ENTER A/C RECEIVABLES
- 5=ENTER A/C PAYABLES
- 6=ENTER/UPDATE STOCKS REC'D
- 7=ENTER ORDERS REC'D
- 8=EXAMINE/UPDATE BANK BALANCE
- 9=EXAMINE SALES LEDGER
- 10=EXAMINE PURCHASE LEDGER
- 11=EXAMINE INCOMPLETE RECORDS
- 12=EXAMINE PRODUCT SALES WHICH ONE (ENTER 1 TO 24)

## SELECT FUNCTION BY NUMBER

- 13=PRINT CUSTOMER STATEMENTS
- 14=PRINT SUPPLIER STATEMENTS
- 15=PRINT AGENTS STATEMENTS
- 16=PRINT VAT STATEMENTS
- 17=PRINT WEEK/MONTH SALES
- 18=PRINT WEEK/MONTH PURCHASES
- 19=PRINT YEAR AUDIT
- 20=PRINT PROFIT/LOSS ACCOUNT
- 21=UPDATE ENDMONTH FILES
- 22=PRINT CASHFLOW ANALYSIS
- 23=ENTER PAYROLL
- 24=RETURN TO BASIC

EACH PROGRAM GOES IN DEPTH TO FURTHER EXPRESS YOUR REQUIREMENTS.

FOR EXAMPLE (9) ALLOWS: a. list all sales; b. monitor sales by stock code; c. invoice search; d. amend ledger files; e. total all sales.

## THINK OF THE POSSIBILITIES, AND ADD TO THOSE HERE IF YOU WISH

Price for above: Version 1 (excluding programs 19, 20, 22, 23) — £275 plus VAT; (including version 2 £375) plus VAT; Version 3 (including sorts and incomplete account handling) — £475 plus VAT; Version 4 £575 or full listing plus manual to be typed-in on most computer systems; Version 1 £175. Barclaycard enquires welcome.  
Hardware systems tailored to your requirements (SWTP and PET) from £600 to £5,000 approx. Above package is intended to work with processor twin-floppy and printer. 5 x 1/4in soft-sectored spaced disks £3.00 plus P&P

HARDWARE SYSTEMS, PET-6502,  
IMS — Z-801 SWTP — 6800.



## PET DISK USERS!!!

### MULTI-MODE AND FUNCTION PROGRAM

#### SELECT MAIN MODALITY

- 1 = GENERAL
- 2 = ADDRESS
- 3 = STOCKS
- 4 = ORDERS
- 5 = BANKS
- 6 = COSTING
- 7 = PROCESS
- 8 = RENTALS
- 9 = DECISIONS
- 10 = SHARES

WHICH?

### THE ADDRESS MODE HAS SEVERAL FUNCTIONS. FOR EXAMPLE:

#### SELECT WHICH YOU REQUIRE

- 1 = EXAMINE ADDRESS
- 2 = ADDS 2 ADDRESS
- 3 = AMEND ADDRESS
- 4 = DELETE ADDRESS
- 5 = PRINT LISTING
- 6 = COMBINE NUMERICS
- 7 = CHANGE MODE
- 8 = RETURN TO MAIN LIST
- 9 = RETURN TO BASIC

WHICH?

### —EXAMINE MODE—

- 01 = NUMBER
- 02 = NAME
- 03 = ADDRESS 1
- 04 = ADDRESS 2
- 05 = ADDRESS 3
- 06 = ADDRESS 4
- 07 = ADDRESS 5
- 08 = PHONE NO
- 09 = DISC CODE
- 10 = AGENT NO
- 11 = O'HEAD CODE
- 12 = CREDIT LIMIT

WHICH NO?

"ALL = 99999 FINISH = 0"

Create your own modes, combine your own numerics, program requires approx. 20K bytes disk space ... £100

Please telephone for appointment — Tony Winter on 01-636 8210

**GRAMA (WINTER) LTD 21B Dryden Chambers  
(G W COMPUTERS LTD) 119 Oxford St., London W1.**

Also at 89 Bedford Court Mansions, Bedford Ave., WC1.

● Circle No. 163

# ABEL

ABEL COMPUTER SYSTEMS LTD  
5 Hanlith, Wilnecote, Tamworth, Staffs.

REAL VALUE FOR MONEY

## MINI-FLOPPIES

HIGHEST QUALITY CERTIFIED  
Single-Sided, Single-Density  
(suitable for Apple, Pet, etc.)  
£2.70 + VAT £3.10.

## Apple Software

### 1. INTEGER BASIC UTILITIES

- RENUMBER (all or part of program)
- CROSS REFERENCE  
Find lines in which a variable is used.
- CROSS REFERENCE PRINT  
Print all variable names and the lines in which they are used.
- MERGE part of one program into another.
- HEX DUMP of part of core to screen or printer.

ALL ON ONE DISKETTE AT £10 (includes VAT)

### 2. GAMES VOL 1 — 8 assorted includes:

THE MAZE; AMBUSH; MINEFIELD; BULLS AND COWS  
ALL ON ONE DISKETTE AT £10 (includes VAT)  
Add 30p p&p to total order.

● Circle No. 164

## MK 14 SOFTWARE

Suitable for most SCIMP Configurations

MIKOM (Commercial Systems) Ltd.

Suppliers of Software to Government Departments, Universities, Schools and Industry.

NOW ANNOUNCE the 'MIKOM SERIES 600'

Programs to run in the 600 Bytes available on board the standard MK 14

The MIKOM SC/MP HEX ASSEMBLER

Produces faster more efficient code, is more flexible, needs less memory (< 300 bytes) and costs far less than Basic. Operates through a hex keyboard and display — is faster and more accurate than hand assembly — no tedious offset calculations to make — allows corrections and amendments in minutes — produces compiled code (no interpreter needed) — greatly simplifies programming — is indispensable to Amateur and Professional alike — hundreds of satisfied users.

COMPLETE WITH 21 PAGE MANUAL, INSTRUCTION AND CODING SHEETS. STILL ONLY £5 Inclusive

Cheque or P.O. to

MIKOM (Commercial Systems) Ltd.,  
1 HYTHE BRIDGE STREET,  
OXFORD OX1 2EW

THE MIKOM SUB ROUTINE COLLECTION

Select the ones you need to make up your own package from our very wide range which includes — Decimal Complement and Add — Decimal Multiply and Divide — Various Display Formats — Decision Table Processors — Comparison Tests — Tape Interfaces of Assorted Qualities — Block Move Instructions — Insertion Processing.

MIKOM COMMERCIAL PROGRAMS

The Payroll Suite: wage slips, PAYE, overtime, bonus, weekly summary sheet, coin analysis etc. — weekly cash accounts — VAT and yearly accounts — % mark up — stock keeping and taking — sales and invoicing — many more; all complete with a supply of documents and instructions.

MIKOM GAMES PROGRAMS

The fabulous 'Mars Mission'; this will really test your skill as a navigator — try a game of Golf or Cricket — a very realistic Greyhound Derby, run your own Tote — a flutter at Roulette perhaps — or a trip to the Moon — Clay Pigeon Shoot, Experts can pull two — all complete with score or log sheets.

THE MIKOM HEX KEYBOARD

Plug-compatible with the MK 14 — Burgess micro switches for performance and long life — including reset key — splash proof, easy to keep clean — very light positive feel — sturdy panel, easy to mount — easily modified to suit most kits — make your keying in fast and accurate for only £16 all inclusive.

THE MIKOM CABINET

Work station, fun station, call it what you will. The wife will like this one — Handsome Real Wood Veneer, Oak, Mahogany or Teak — will accommodate any kit — Sleek modern Ergonomic design — display window for up to 8 by 3/4 in — positive location for forms on writing surface — takes almost any size keyboard — overall size approx. 42 by 42 by 27cms. With sloping front. Get it all together for only £24 all inclusive.

For further details send large S.A.E. Please state particular requirements and memory size available.

● Circle No. 165

# NEW FOR PET

SOME PROGRAMS YOU REALLY SHOULD HAVE IN YOUR LIBRARY

FIVE CARD  
STUD POKER  
£8 inc

This is certainly the best Poker game we've ever seen. It should not be confused with those where you only bet against the odds of completing a hand. PET ACTUALLY PLAYS AGAINST YOU and a very poker-faced, cunning game too! If you are already a poker player then you won't be able to leave this alone. If you don't play yet, be warned — you'll be hooked in minutes. The graphics are superb of course. Brief rules are included for non stud players. Even we can't leave this one alone — and that's saying something!

AIR TRAFFIC  
CONTROL  
£5 inc

Can you keep your cool? After a few minutes with this simulation you'll see the problems Air Traffic Controllers have. Your screen is the radarscope and information is given of Flight Numbers and Heights. You have to give orders for aircraft to lose or gain height or alter course to avoid collisions — after you've requested a SQUAWK of course. And sometimes it gets very busy up there!

DESKTOP  
£8 inc

This is really for the PET sitting on the businessmen's desk. It's the ideal program to leave running between other program work. There are four functions. The time is displayed and at a touch will alter to show the time in twelve different world cities. The program also has a perpetual calendar and will display dates for any month entered. It will also give the number of days between any two dates. To round the program off it will give a number of common metric conversions.

TENPIN  
BOWLING  
£5 inc

A fascinating game for two players. PET keeps the score in the traditional manner and a continuing score is kept for a series. The graphics are good and the game is compulsive. Warning — keep away from the children or you'll never get at your PET.

ALL ON GOOD QUALITY CASSETTES  
GET THEM FROM YOUR PET DEALER OR DIRECT FROM US  
(PLEASE STATE IF YOUR PET IS 8K OR 16K+)  
LANDSLER SOFTWARE 29A TOLWORTH PARK ROAD  
01 - 399 2476/7 SURBITON SURREY KT67RL

With most games programs ones reactions tend to be — 'That's clever' but within 10 minutes one wouldn't mind if it was never seen again. Our intention is to publish only the best and most compulsive games. If you think you have written such a game or simulation we should like to hear from you.

● Circle No. 166



we're taking  
the lid off the  
computer  
business

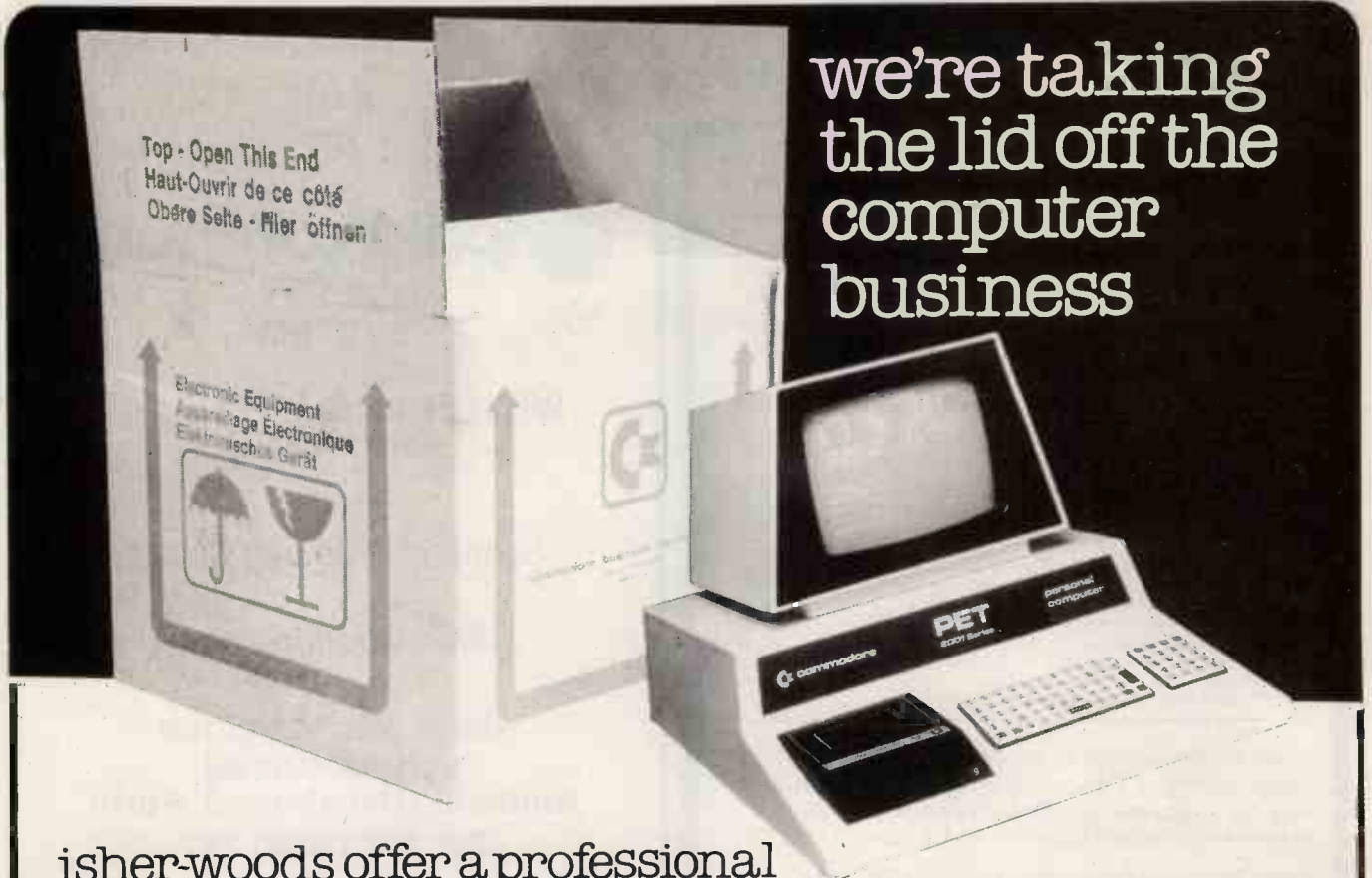

sher-woods offer a professional service, tailor made to fit your personal requirements

With the help of Commodore Systems and the PET® Computer sher-woods can offer both the technically minded and the business man ready made or tailored solutions to most of your particular problems. The Commodore PET® comes in 4 different memory sizes and is priced from as little as under £500 (ex. VAT) for the 4K version. We can supply 8, 16, and 32K versions from stock, fully tested and guaranteed. Floppies and printers are on order.

If you have a PET® or are considering buying one then we can look after it for you. We give a fixed price labour charge of £20 + parts at list price + VAT, irrespective of the fault; just deliver to our door and we'll put it right.

If you just want the parts then we can supply them from our "CHIP SHOP". Maintenance contracts are obviously available for those who prefer "on site" cover.



**sher-woods**

Computer Systems Group

110/112 Leagrave Road, Luton Tel: (0582) 424851/39570

Sellers of PET® and other fine computer systems.

● Circle No. 167

# Sigma Technical Press

the UK software publisher

**NEW** — from SIGMA for NASCOM: Z80 INSTANT PROGRAMS : Machine code routines for NASCOM-1 and other Z80 systems by J. Hopton (G3WMP). 36 fully tested programs from delays through displays to games for the simplest NASCOM-1 or similar Z80 systems. Test your system and build your confidence. Book £7.50 Complete NASCOM - 1 Cassette £10.00

**AND** - our catalogue of books and software is one of the best in the UK. Ask for your copy or start by ordering these:

Computer Programs That Work! (24 BASIC Programs)	£3.15
Consumers Guide to Personal Computing & Micro's	£5.30
Basic BASIC : an Introduction to Programming	£5.90
Game Playing with BASIC	£4.70
How to build a Computer Controlled Robot	£5.30
The Mind Appliance : Home Computer Applications	£4.70
BASIC with Style : Programming Proverbs	£4.10
Microprocessor Basics (wide survey)	£7.10
Microprocessor Data Manual (30 sources)	£5.30
Microprocessors : New Directions for Designers	£7.10
How to Profit from your Personal Computer	£5.30
The Systems Analyst: How to Design Systems	£7.10

Prices include postage & packing in Europe and VAT where applicable. Official orders accepted from UK only for orders over £5.00. Outside UK, payment required in advance in Sterling on UK bank.

Sigma Technical Press; FREEPOST, 23 Dippons Mill Close, Tettenhall Wood, Wolverhampton WV6 7BR.

● Circle No. 168

BUY  
AN



SYSTEM

WITH FULL SUPPORTING  
SOFTWARE

from

Scotland's leading dealer

Demonstrations from:

**Peter MacNaughton  
and Associates**  
Annfield Glenalmond, Perth  
Tel: (073 888) 267

● Circle No. 169

## The Rohan Computing Collection.....

Rohan computing, in addition to their normal software and systems consultancy services, now offer the following range of computer equipment for sale. As far as possible Rohan computing try to hold these items in stock ready for immediate delivery. Nationwide on site maintenance for all Rohan computing equipment.

**Qume** The Qume is ideal as a general purpose printer or for adding word processing facilities to an existing micro-computer. Print only and keyboard versions available. The keyboard version can double as a spare typewriter. RS232 interface adaptable for the PET, APPLE, etc. XON/XOFF protocol available. Word processing package/driver available for CP/M based systems. Other versions in preparation.

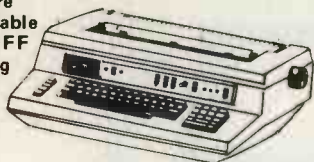

**Digital Decwriter IV**. The best desk top matrix printing terminal available. Typewriter styling. 10,12,13.2,16.5 characters per inch. All sizes very legible. 2,3,4,6,8,12 lines per inch. Optional tractor feed and numeric keypad. RS 232 interface.



**PET** Commodore PET microcomputers. The PET is the ideal low cost computer for teaching yourself programming, educational use and time consuming calculations in science, industry and commerce. Graphic display excellent for histograms etc.  
\*8k PET with integral cassette and minikeyboard  
\*16 & 32k PET's with full sized professional keyboards.  
\*2022 matrix printers  
\*2040 floppy disc units.



**CIFER** Cifer 2600 Series VDU's. Superbly engineered and made in Britain. \*12 inch screen.  
\*7 x 11 character matrix  
\*9 x 12 matrix for graphic characters  
\*62 or 100 key detachable keyboards  
\*Printer port  
\*VT52 emulation  
\*Line drawing set



\*RAIR Blackbox, Teletype 43s, Tally high speed matrix printers also available.\*

# Rohan

Phone Richard on SOUTHAM (092681) 3541 for prices and delivery.

Rohan Computing, B.A.S.S. (Engineers) Sales Limited, Kineton Road, Southam, Warwickshire CV33 0DQ

● Circle No. 170

## DPS-1 MAINFRAME

Introducing the DPS-1 the full IEEE S100 bus computer system from Ithaca Intersystems — the S100 experts.

FOR EDUCATION, INDUSTRY, RESEARCH and all professional uses, including hardware and software development, low cost OEM systems, teaching applications etc.



A MINI COMPUTER using MICRO technology at a ridiculous MICRO Price!!! The front panel with a backplane and power supply accepts S100 bus boards from many manufacturers.

# InterSystems

Just look at these professional features!

- ★ FRONT PANEL (we won't ask you to debug our hardware, but we will give you the tools to debug yours!) Has lights and switches to allow inspection and control of addresses and data. Other features include programmed input switches, and output lights, Examine next, deposit, deposit next, single or slow step (0.1 to 1000 IPS), hardware breakpoint on any data or address byte, repeat instruction and many other hardware diagnostic facilities.
- ★ 30 Amp, 8V power supply, 5 Amps on  $\pm 16v$  rails (all rails are separately fused)
- ★ 20 slot IEEE S100 Motherboard with active termination and shielding between bus lines
- ★ Guaranteed operation at 4MHz.

The DPS1 comes as a mainframe with front panel, Motherboard, power supply and 4MHz Z80A cpu board. The system is truly modular allowing the user to build up the system he requires in his own time.

S100 boards from a number of manufacturers will plug into the DPS1 IEEE S100 bus.

Just add S100 Memory Boards — S100 disk controller boards — S100 I/O boards — S100 video and/or graphics boards — S100 EPROM boards

All Ithaca Intersystems OEM products including K2 disk operating system and PASCAL on 8" floppy drives will run in the DPS-1.

Fully assembled and tested

DPS-1 with S100 4MHz Z80 cpu board £695  
DPS-1 less S100 4MHz Z80 cpu board £645

## SOFTWARE for your S100 system

### PASCAL/Z The new language for Micros £131.25

Runs under K2 operating system.

- ★ Compiler that produces Z80 macro assembler code
- ★ NO NEED for slow run time P-code Interpreter.
- ★ Comes complete with Macro assembler.
- ★ Produces binary object modules — small and fast.
- ★ Modules are re-entrant and can be put into ROM.
- ★ IMBED, TRACE and ERROR debug facilities.
- ★ Recursion



### K2 OPERATING SYSTEM £56.25

8" disk based operating system — distributed on Shugat compatible 8" floppy disk  
★ TED — 52 command character orientated text editor with macros. ★ PIP — File and directory handler. ★ ASMBLE — full Z80 2 pass assembler. ★ HDT — Hex debug tool. ★ OCI — Utility overlay/command decoder. ★ SYSGEN — System builder. ★ COPY — disk to disk file copier. ★ DUP — disk duplicator.

### ASMBLE/Z Z80 Macro assembler £37.50

★ Full 2 pass Macro Assembler. ★ IF and ELSE — 255 nesting levels. ★ Produces symbol table. ★ Relative jumps.

## OEM S100 boards from the experts!



Board Type	Assembled and tested
8K Static RAM board (450ns)	£123.75
8K Static RAM board (250ns)	£146.25
Z80 cpu board (2MHz)	£131.25
Z80 cpu board (4MHz)	£153.75
2708/2716 EPROM board	£63.75
Prototype board (bare board)	£18.75
Video display board (64x16, 128U/L Ascii)	£108.75

### New products from Ithaca audio!

Product	Assembled and tested
High density graphics (1024 x 512 points)	£660.00
Disk controller (up to 4 single or double sided drives)	£131.25
I/O board (serial and parallel outputs)	£210.00
S100 front panel (as used in DPS1)	£245.00
Analogue I/O board	£295.00

Over 15,000 boards delivered worldwide

AVAILABLE SOON: ZBC-1 Single board computer for OEM market. Available in basic through to fully expanded. 4MHz Z80A, 64K RAM, memory mapped 4K screen buffer, composite video, up to 16K power on EPROM monitor, 4 parallel ports, 2 serial ports, 4 channel counter timer. 1 off £895 — please phone for a quote for your needs. (quantity discounts available).

## PASCAL MICRO DEVELOPMENT SYSTEM

*Are you still waiting for one?*

ITHACA Intersystems HAVE JUST ANNOUNCED AN IEEE S100 SYSTEM WITH A TRUE PASCAL COMPILER

FOR RESEARCH and DEVELOPMENT LABORATORIES and TEACHING APPLICATIONS

### The PASCAL System



- DPS1 Mainframe with hardware front panel.
- Z80 4MHZ Microprocessor.
- 64K Static RAM.
- 8" Shugat Floppy Disc Drive, Power Supply and Controller.
- K2 DOS Operating System.
- Pascal Compiler and Macro Assembler.
- I/O Board with RS232 port.

*While the others are talking about it, we are delivering!*

### CONTACT THESE UK DEALERS

NEWBEAR COMPUTING STORE (Newbury) (0635) 30505 Telex: 848507      SIRTON PRODUCTS (Surrey) 01-660 5617      All prices quoted are exclusive of VAT.  
DATAVIEW LTD. (Colchester) (0206) 78811      TRANSAM (C. London) 01-402 8137 Telex: 444198  
CODIFIED COMPUTER SYSTEMS (North London) 01-226 1319

## UK & EUROPEAN DEALER ENQUIRIES INVITED — CONTACT

ITHACA Intersystems  
(formerly ITHACA AUDIO of New York)

EUROPEAN SUBSIDIARY  
58 Crouch Hall Road, London N8 8HG. UK.  
Telephone: 01-341 2447      Telex: 299568

Circle No. 171

# ROBOX LTD



FOR PET AND APPLE IN SCOTLAND

We stock the famous  
PETSOF SOFTWARE SUPERMARKET

\* ALL THIS AND MORE FROM ROBOX \*  
Peripherals, field service and software consultancy  
service available

We supply ex-stock the ANADEX DP8000

ROBOX, Scottish Agents for Kingston Computers

Interfaces

Floppy discs

Memory expansion

Bus connectors

ROBOX, Agents for CBM, Texas

and Casio range of calculators

Full range in stock



*Dealer enquiries welcome*

ALL THIS FROM ROBOX.COME AND SEE US.

KIRKINTILLOCH: 84 TOWNHEAD 041-776 4388/1253

GLASGOW: ANDERSON SHOPPING CENTRE

ABERDEEN.

## ROBOX LTD

● Circle No. 172

### ALMARC PRESENTS:

MORE FROM VECTOR GRAPHIC

Now Vector Graphic give you more for your money with  
the 48K dynamic ram board and the System B

#### THE VECTOR GRAPHIC MZ

- \* 4MHZ Z80A CPU
- \* 48K ram
- \* 630K Bytes disk storage
- \* Serial port and two parallel ports
- \* Prom/ram Board with monitor
- \* MDOS Operating system
- \* Z80 Assembler
- \* Basic Interpreter

Price £2300.00 plus VAT



#### THE VECTOR GRAPHIC SYSTEM B

- \* Complete Vector MZ system plus:-
- \* Vector Mindless terminal
- \* Flashwriter 2 video board (24 x 80)
- \* Software driver on prom
- \* MZOS North Star compatible DOS
- \* CP/M configured by Almarc

Price £2850.00 plus VAT

Plus a large range of CP/M compatible software including Fortran, Cobol, Macro  
assemblers etc.

**Contact: ALMARC DATA SYSTEMS LTD.**

**29 Chesterfield Drive, Burton Joyce, Nottingham.**

**Telephone 0602 248565**

● Circle No. 173

# Thinking Computers?

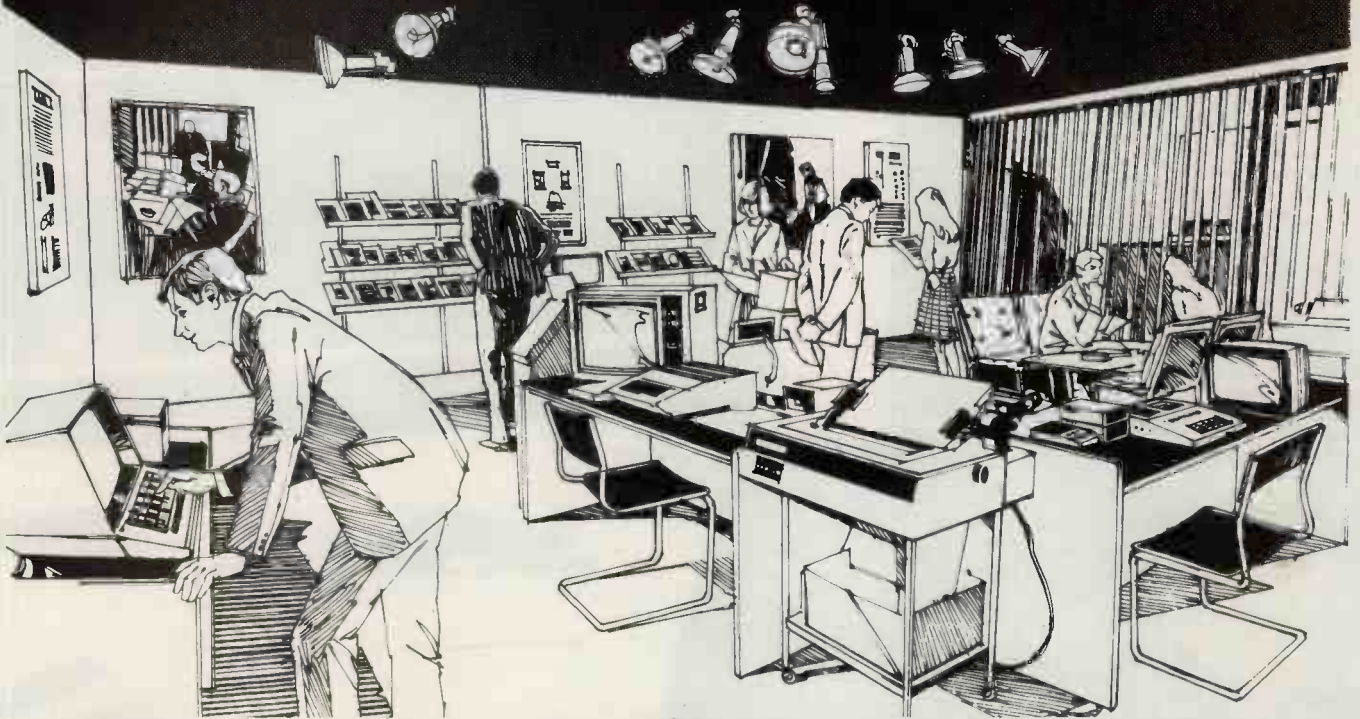

## Then come to the number one micro-computer centre

If you're wondering if a micro-computer can help you, we are here to advise you. At Lion House—London's leading centre for micro-computers—you'll find:

- \* Experts who'll explain the equipment in a way you can easily understand, showing how and where it applies to *your* work.
- \* Demonstration areas where you can get immediate experience of using micro-computers yourself.
- \* Probably the biggest range of software in the UK.
- \* Programmes can be tailored for your particular commercial needs by our In-House Analysts and Programmers.
- \* Total service—including the availability of full maintenance after you've bought an installation.
- \* Leasing and H.P. facilities immediately available.
- \* A computer book section with publications that give you new insight into the world of micro-computers.

**How will micro-computers help you?** In thousands of ways—only a few can be mentioned here...

MICRO-COMPUTERS FOR BUSINESS



**For business and professional,** the versatility of compact micro-computers means that all the benefits of big computers are made available to all at low cost. The businessman can now computerise his accountancy, his stock control, his records and much more—cutting his overheads and improving his efficiency.

**For the home,** micro-computers have innumerable uses and considerable value too—sometimes in unexpected ways.

MICRO-COMPUTERS FOR THE HOME



Budgeting ... investments ... controlling heating or security ... storing information on things like recipes ... designing complex and fascinating games ... education ...

**Come and see.** We invite you to visit us and investigate the possibilities and the potential. If you're too far away, phone or write and we'll send you more information. **You need a micro-computer. We can supply it.**



## LION MICRO-COMPUTERS

SMALL COMPUTERS—TO MAKE YOUR BUSINESS BIGGER

Lion Computer Shops Ltd, Lion House, 227 Tottenham Court Road, London W1 (First Floor). Telephone: 01-637 1601.  
Telex: 28394 Lion G.  
Open 9 to 6, Monday to Saturday (Thursday to 7).



● Circle No. 174

# THE EXPANDABLE GENERAL-PURPOSE MICROCOMPUTER

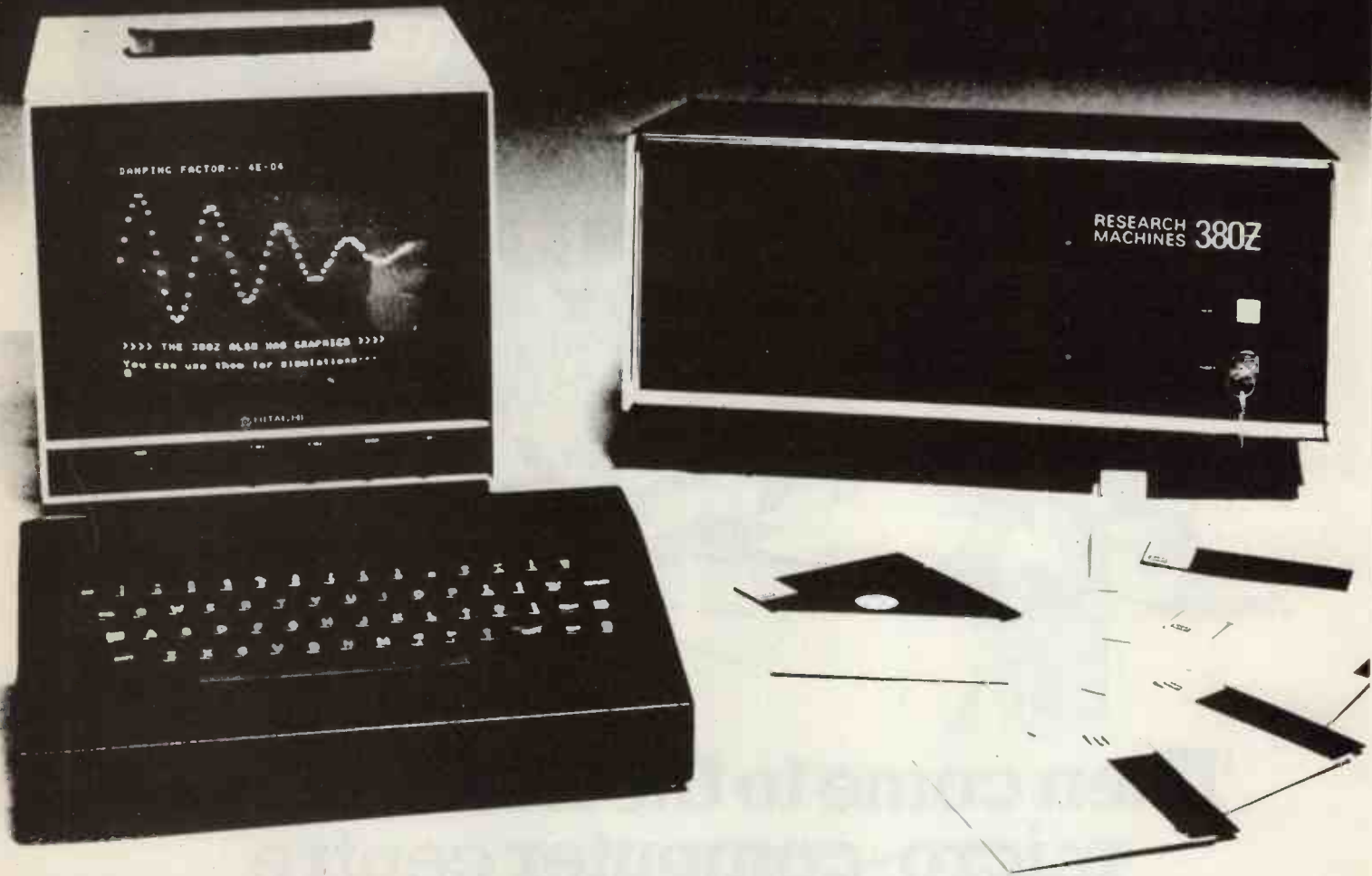

## THE RESEARCH MACHINES 380Z A UNIQUE TOOL FOR RESEARCH AND EDUCATION

Microcomputers are extremely good value. The outright purchase price of a 380Z installation with dual mini floppy disk drives, digital I/O and a real-time clock, is about the same as the annual maintenance cost of a typical laboratory minicomputer. It is worth thinking about!

The RESEARCH MACHINES 380Z is an excellent microcomputer for on-line data logging and control. In university departments in general, it is also a very attractive alternative to a central mainframe. Having your own 380Z means an end to fighting the central operating system, immediate feedback of program bugs, no more queueing and a virtually unlimited computing budget. You can program in interactive BASIC or run very large programs using our unique Text Editor with a 380Z FORTRAN Compiler. If you already have a minicomputer, you can use your 380Z with a floppy disk system for data capture.

What about Schools and Colleges? You can purchase a 380Z for your Computer Science or Computer Studies department at about the same cost as a terminal. A 380Z has a performance equal to many minicomputers and is ideal for teaching BASIC and Cesium. For A Level machine language instruction, the 380Z has the best software front panel of any computer. This enables a teacher to single-step through programs and observe the effects on registers and memory, using a single keystroke.

### WHAT OTHER FEATURES SET THE 380Z APART?

The 380Z with its professional keyboard is robust, hardwearing equipment that will endure continual handling for years. It has an integral VDU interface—just plug a black and white television into the system in order to provide a display unit—you do not need to buy a separate terminal. The integral VDU interface gives you upper and lower case characters and low resolution graphics. Text and graphics can be mixed *anywhere* on the screen. The 380Z also has an integral cassette interface, software and hardware, which uses *named* cassette

files for both program and data storage. This means that it is easy to store more than one program per cassette.

Owners of a 380Z microcomputer can upgrade their system to include floppy (standard or mini) disk storage and take full advantage of a unique occurrence in the history of computing—the CP/MTM<sup>®</sup> industry standard disk operating system. The 380Z uses an 8080 family microprocessor—the Z80—and this has enabled us to use CP/M. This means that the 380Z user has access to a growing body of CP/M base-software, supplied from many independent sources.

380Z mini floppy disk systems are available with the drives mounted in the computer case itself, presenting a compact and tidy installation. The FDS-2 standard floppy disk system uses double-sided disk drives, providing 1 Megabyte of on-line storage.

Versions of BASIC are available with the 380Z which automatically provide controlled cassette data files, allow programs to be loaded from paper tape, mark sense card readers or from a mainframe. A disk BASIC is also available with serial and random access to disk files. Most BASICs are available in erasable ROM which will allow for periodic updating.

If you already have a teletype, the 380Z can use this for hard copy or for paper tape input. Alternatively, you can purchase a low cost 380Z compatible printer for under £300, or choose from a range of higher performance printers.

<sup>®</sup>CP/MTM Registered trademark Digital Research.

380Z/16K System with Keyboard £965.00

380Z/56K complete with DUAL FULL FLOPPY DISK SYSTEM  
FDS-2 £3,266.00

380Z Computer Systems are distributed by RESEARCH MACHINES, P.O. Box 75, Chapel Street, Oxford. Telephone: OXFORD (0865) 49792. Please send for the 380Z information Leaflet. Prices do not include VAT @ 8% or Carriage

● Circle No. 175

# Optimism

IN SPITE of our own depressing news, which came as a saddening blow to all of us at *Practical Computing*, and to those many people who knew, liked and admired Wim Hoeksma, one has to report that the mood in the micro business in one of sturdy optimism.

The start of the full public service of Prestel is an event which may well, from the future, seem as crucial in the history of our civilisation as, say, the opening of the first railway line or the first circumnavigation of the globe. Prestel and what it brings eventually will transform our methods of communication and through them all the ways in which we work and live.

## Confidence

It will soon have a great impact on microcomputing, too, as it offers a real-time marketplace for software and data. Much of this issue is devoted to explorations of Prestel, what it is and how it works.

On a more parochial front, this is our largest issue and we take that as a sign that we are doing something properly, even if we are not quite sure what it is. We are happy, too, that the micro business, on a commercial level, is as prosperous as it is. On a personal level, it is pleasant to move among people who enjoy what they are doing, who are confident about the future, who serve a somewhat higher calling than mere personal enrichment. Those may sound

pompous and vague compliments but their substance is real enough and more apparent, perhaps, to someone who entered the micro business recently from the outside world.

In the real world there is a good deal of doom and woe. Very few people enjoy what they are doing or have much hope that they will continue doing even that for very much longer. As one would expect, while microcomputing technology swells and buds, the husks of the old technology wither and go sour. It is not pleasant to live through the death of the two-hundred-year-old Industrial Revolution; yet that is what is happening around us.

All is suspicion and irritability. People are digging their fingers and toes into the dirt as their familiar piece of industrial landscape slithers inexorably over the edge and into the chasm of history.

## Opportunities

Among us, however, things seem in somewhat better state. There are so many opportunities to be taken that one can almost say that jealousy and suspicion are in abeyance, which is a most unnatural state of affairs. If one fellow is doing one thing, there are plenty of others for the next fellow to do instead.

There is, of course, some grief to come. Just as the British Isles normally receives its weather from the west, so the computer business has its booms and depressions. From California, as Tom Jackson

reports in his West Coast Newsletter, the Grim Reaper is already at work in those parts. Several well-known micro manufacturers have closed their doors and others are tottering. It does not require great prescience to prophesy closed doors here, too, as agents and makers of the weaker machines are gathered. Sad as this will be in individual cases, it can only strengthen the business as a whole, leading to greater standardisation, better service, more widely-usable software.

## The Mouse Grand Prix

ELSEWHERE in this issue, we announce the first European Amazing Micro Mouse Competition. It is hoped the contest will take place in mid-September, 1980 at Imperial College, London. *Practical Computing*, in conjunction with Euro-Micro and the IEEE, is sponsoring it. May the best mouse win.

## Software products

We intend to run a feature in parallel with our hardware *Buyers' Guide* which lists software offerings. As before, we will simply reproduce, in condensed form, what suppliers tell us. Those who wish to participate, please send details of their software products to *Software Buyers' Guide* at this address.

## Wim Hoeksma, 1940-1979

WIM began his career in computing as an OR specialist with Phillips and then Inveresk Paper, where the experience whetted his appetite for consultancy, yet career development was never his prime concern.

What Wim brought to everything he touched was an energy and enthusiasm which carried his colleagues and clients along in a powerful tide. His intuitive understanding of people gave him a special ability to motivate those who worked with him — no-one worked for Wim — and the results were always exciting and original. It was a talent which during his eight years in Scicon Consultancy took him

from consultant to general manager status.

His sense of humour was



prodigious and he often used it as a weapon to deflate hubbub and pomposity, a habit which

never especially endeared him to those conscious of their own authority. He loved to analyse complex human situations and find an equally tortuous and preferably amusing path towards a neat solution which would leave all parties feeling they had triumphed.

His sheer drive during a spell in ICL Dataskil as international marketing manager produced the rapid success which was called for, as well as even more opportunity to indulge his passion for international motor racing. It was, however, typical that he should "throw everything in the air" — to use one of his

favourite phrases — to help Richard Hease create *Practical Computing* in 1978. He discussed the risky business of journalism with his wife Jane until finally they convinced each other that, as usual, he was doing the right thing.

Wim's wide and varied circle of friends was indicative of his life-enhancing qualities. All of them gained from his friendship and all are saddened by his premature loss, for he was without doubt an extraordinary man. His two sons have much to be proud of. — John Ockenden.

Thanks for everything. *Practical Computing* will be a permanent tribute to you. — Richard.

**FULL RANGE OF  
TEXAS  
TERMINALS**

**RAIR**

30-32 Neal Street, London WC2H 9PS  
Telephone 01-836 4663



**SILENT 700  
Portable Terminals  
From £1105**

● Circle No. 176 on enquiry card

Range of microprocessor controlled lightweight terminals featuring a field proven thermal printing technique giving silent printing at 30 cps. Options include built-in acoustic couplers and a non-volatile magnetic bubble memory capable of storing 20K to 80K characters. This feature allows full editing of data prior to transmission.

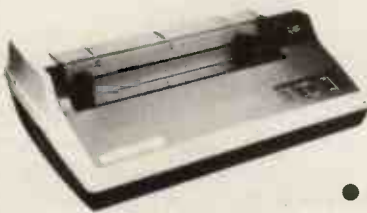

**MODEL 810  
Desk Top Printer  
£1450**

● Circle No. 177 on enquiry card

Microprocessor controlled printer operating bi-directionally at 150 cps. Standard features include auto line feed, auto perforation skipover, and a choice of vertical line spacings. Communications are via an EIA RS232C interface at speeds up to 9600 baud. Options include compressed font, forms control and parallel or current loop interfaces.



**DECWRITER 111  
Keyboard Printer  
£1650**

● Circle No. 178 on enquiry card

Microprocessor driven terminal operating at up to 9600 baud, printing bi-directionally at 180 cps. Major features include firmware selectable character widths and line spacing, tabulation and margins. The IK FIFO buffer and 'smart' printing facility give optimised 1200 baud communications through EIA or current loop interfaces.

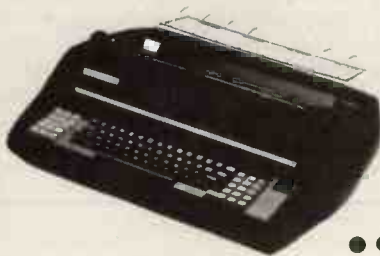

**HYTERM  
Text Printer  
Terminals  
From £1900**

● Circle No. 179 on enquiry card

Range of microprocessor controlled 'daisy-wheel' terminals for text processing applications, printing at 45cps over 158 columns with a wide range of interchangeable type fonts. Many advanced features including IBM2741 compatibility, graphics capability, 'absolute' tabbing, and variable character/line spacing.



**DECWRITER IV  
Desk Top Terminal  
£850**

● Circle No. 180 on enquiry card

New desk-top microprocessor driven terminal, operating at 300 baud, printing at burst speeds up to 45 cps. Major features include firmware selectable character sizes, horizontal and vertical spacing, tabulation and margins. The keyboard feels like a typewriter and the 9 x 7 matrix print head produces clear printing.



**H1400 VDU's  
Low cost  
Video Terminals  
From £550**

● Circle No. 181 on enquiry card

Two new low cost VDU's featuring full cursor controls and a 24 x 80 screen displaying high resolution upper case characters using a 5 x 7 dot matrix. Keyboard generates all 128 ASCII codes and may be provided with a numeric keypad. The terminal interfaces through an RS232 interface at rates up to 9600 baud. H1500 series features upper and lower case characters using 7 x 9 dot matrix integral numeric keypad, buffered editing, and printer port.



**Our Feedback columns offer readers the opportunity of bringing their computing experience and problems to the attention of others, as well as to seek our advice or to make suggestions, which we are always happy to receive. Make sure you use Feedback—it is your chance to keep in touch.**

## Simulation

WE WERE interested to read your article on computer simulations in history teaching, since we have been experimenting with CAL programs in this area for several years. We believe that this is the first occasion on which publicity has been given to the use of computer simulations in teaching history to younger students in school.

We have found that there is a range of computer activities of which simulation is only one and that they can be applied to other subject areas. The main restriction, we have found, is the lack of hardware to make the packages available for use.

Your article made us wonder to what extent work on CAL was being developed and by whom, and what difficulties had been encountered? The simulations we have run in school have been very successful in generating student enthusiasm. What have others found?

**B. Hutchings,**  
**P. Ayre,**  
**A. Payne,**  
**Oriel Grammar School,**  
**Gorleston,**  
**Gt. Yarmouth.**

## Integers

IN your June issue a reader queried the differences between INT(X), FIX(X) and CINT(X). The difference between the first two is fairly easy to show, as by definition INT(X) always returns an integer less than X, so that:

$$\text{INT}(-2.9) = -3$$

whereas FIX truncates the first digit giving:

$$\text{FIX}(-2.9) = -2$$

The difference between the FIX and CINT functions is normally less important but occurs when dealing with numbers larger than 32767 or smaller than -32768. This is because CINT converts the argument into a 2-byte integer while INT returns the integer part of a number as a number of the same type. This means that with real numbers INT will work for values outside the normal limits for integers.

**R. J. Hamlett,**  
**Loughton,**  
**Essex.**

## The young idea

WE WERE pleased to receive a review copy of the Central Program Exchange's first catalogue of programs for schools and colleges. It consists of descriptions of some 30 classroom-tested programs. They fall into two main groups — simulations of experiments which are too dangerous, time-consuming, tiny, or far-flung for the classroom, and more conventional mathematical and CAL material.

The simulations include malaria control, fruit fly genetics, atomic orbitals, farm management, the flight of projectiles and events in a shop. The mathematical programs include a handful of statistical procedures and a demonstration of the workings of mortgages. There is a self-testing program for consolidating third-form French and one to test knowledge of English parts of speech.

The programs are written in either a subset of Basic or Fortran IV and, the editors say, "cover a wide range of abilities and a wide range of subjects."

The Director of CPE is Dr. G. Beech, Dept. of computing and mathematical sciences, The Polytechnic, Wulfruna Street, Wolverhampton WV1 1LY.

## Schools' user group

SINCE there is a lack of communication between school computer users in London, we would like to start a magazine to fill the gap. Our interests are the 380-Z and the ILEA RSTS time-sharing system, and we would hope to provide a forum for the exchange of software, ideas, correspondence, useful tips and problem-solving. Anyone interested?

**Computer Club,**  
**Burlington Danes School,**  
**Dane Building,**  
**Du Cane Road,**  
**Hammersmith, W12 0TY.**

## Mailed fist

I READ the review on MAIL-III. I take constructive criticism but the review is bad, irresponsible and unreasonable. The writer does not understand programming and its limits. May I ask a question? Can anybody produce a mailing list with similar functions to MAIL-III in 16K and TRS-DOS 1 disc system?

The reviewer should consider the limit of the program software and hardware — especially memory; can other people write similar or better programs with the above limits? Is the price worth it and the program useful compared to other similar programs?

We have, another 32K version (MAIL-V) which we think is the best mailing list for the TRS-80.

I hope your readers are smarter than the reviewer. We shall have many favourable reviews in most of the national magazines in the U.S.

**Tony Pow,**  
**Micro Architects,**  
**96 Dothan Street,**  
**Arlington, MA 02174.**

## One man's meat

IN FEEDBACK in the May issue, Jennifer Adams wrote perceptively of her fear that society will suffer from insularity as microcomputers encroach on social relationships. She saw the human-computer relationship as one-way, lacking the full subtlety of two-way, human-human relationships.

I believe the fear is groundless because she over-estimated the social standing of computers. She equated the computer as a social being with a human being, but in reality no such equation exists. The computer is a machine which merely does what someone has told it to do; it amplifies the human programmer's ability to think.

The human-computer relationship is the

mental analogy of the physical human-car relationship. A car enables its driver to travel further and faster with less apparent effort, and a computer enables its programmer to follow a line of thought further and more quickly.

She saw her children absorbed totally in playing games on her husband's Pet. She deduced that children like computer games because they are freed of the frustrating distractions of a human opponent's behaviour so necessary to learning valuable social skills.

Children have always been fascinated by toys. My baby daughter has moments of total concentration to the exclusion of all social interaction with her parents when she plays with her building bricks. The human-building bricks relationship is, then, also one-way.

Jennifer's children may focus their attention exclusively on the Pet now, but that does not prevent them progressing to more complex relationships later. Game-players know that games involving one player are less interesting than games involving more than one. Bridge is more challenging than solitaire.

The learning process always involves total concentration on the task in hand during the early stages. Continuing my car analogy, one has to think only of the raw learner-driver's behaviour. There are people who never really progress beyond the one-way relationship — e.g. the car-worshipping owners who lovingly polish their vehicles every weekend — but most people transcend this period of single-mindedness. They progress to the human-human-via-machine and other more complex relationships.

The phenomenal rise in computer clubs is clear evidence that the simple human-computer relationship is not the only possible one. Of course club members talk about computers, but that is the excuse for normal human-human relationships in all their subtlety.

*Practical Computing* provides another human-human communication channel. By its very existence, Mrs. Adams' letter proves that society will gain, not suffer, as a consequence of the advent of personal computing.

**T. J. Grant,**  
**Waddington,**  
**Lincoln.**

## VAT query

WITH the rise of VAT to 15 percent, a microcomputer has jumped in price by a substantial amount. In the States, however, micros are generally half the U.K. price. I would like to know if I can save upwards of £200 by buying from the States, or whether Customs duties would swallow that saving?

**W. Drummond,**  
**Ballymena,**  
**Co. Antrim.**

● In principle you can save money. In practice, the work needed to negotiate an import through an airport and U.K. Customs almost cancels any advantage.

(continued on p 51)

# PUT MORE THAN ENTHUSIASM INTO YOUR HOBBY...



## ...the SHUGART Minifloppy<sup>®</sup>

When you buy the Shugart minifloppy you are buying the leading miniature floppy in the business at no extra cost.

You gain performance and

reliability at a price competitive with cassettes.

And you have the backing of the number one in low cost disc storage technology.

Order from your local computer shop or send for details now.

**CPU**  
PERIPHERALS

Shugart Distributors

**"Down-to-Earth Technology"**

Copse Road, St. Johns, Woking, Surrey GU21 1SX  
Tel: Woking (04862) 73883 Telex 859592

Please send me further information about Shugart's full range of products

Name \_\_\_\_\_

Address \_\_\_\_\_  
\_\_\_\_\_  
\_\_\_\_\_

PC1

● Circle No. 182

## Aim on target

HAVING used an AIM-65 regularly since it was first introduced into this country, I still consider it to be "the best-engineered cheap 6502-based system" available and must therefore write to disagree with remarks made by Vincent Tseng in the July issue of *Practical Computing*, particularly his observations regarding the inconsistency of the machine on loading and playback.

Using a cheap cassette recorder fitted with automatic record level control and Microdigital quality data cassettes, I have found recording and playback remarkably consistent with no troubles or difficulties. The only modification has been the fitting of a 1K resistor across the tape recorder output.

**Michael Abrams,**  
PACE Electronic Developments,  
Penketh,  
Warrington, Cheshire.

## Cutting ways

AS A SUPPLIER of magnetic media to computer users, I feel a word of caution is required regarding Norman A. Law's "cutting solution" in *Feedback*, June issue.

Although the production and certification process of floppy diskettes differs slightly from manufacturer to manufacturer, in general the following takes place. A wide web of magnetic oxide-coated material is punched into the doughnut shape of the floppy diskettes. Then some form of surface cleaning is carried-out.

In some cases, manufacturers even apply an overcoat to replace or supplement the lubricant already in the mix when the oxide coating was applied originally. After this treatment, the diskette normally is placed in a plastic jacket, similar to the one in which it is finally delivered and placed in a drive for testing.

If the first side is not 100 percent error-free; it is turned over and the second side tested. If the first side is error-free, no testing is normally done on the second side.

So where the diskette is intended as a single-sided unit, either it has not been tested on both sides for errors or it has been tested and one side found defective. Even where certain manufacturers certify their diskettes after insertion in the final jacket, the same circumstances apply. The testing equipment for certification is expensive and very few users want to get involved in that area. Thus the chances of the 'B' side being error-free are small.

Another point, not generally made known, is that the surface finish of the two sides is significantly different. One side is set up for wear resistance to the load pad, the other to the magnetic head. If the diskette is reversed, there is the possibility of particles of oxide coating from the load pad side of the diskette depositing on the magnetic head, which could result in greatly-increased head-wear or interfere with signal recovery on other diskettes.

Developments are taking place constantly by drive and diskette manufacturers to overcome the wear problem created by friction between the head, diskette and load pad.

The biggest argument against "flipping" the floppy is the method it uses for contamination control. One of the features of the floppy diskette contributing to its high data reliability is the wiping material inside the jacket which keeps the diskette surface clean. This material is soft and porous and accumulates a fair amount of dust and other foreign material.

If the diskette is turned over, the direction of rotation of the diskette to the inner liner is

reversed and some of the foreign material picked up by the liner may become free to enter the diskette head area, causing errors. Therefore you detract from the data reliability of the diskette in its normal mode if you turn it over.

Another problem is the alteration in level of the diskette with respect to the head when the diskette is inverted. When the door is closed after insertion of the diskette in the slotted guide, the diskette contacts the drive spindle and the head. If the diskette is reversed, the 0.010in. flap normally on the side towards the head is then on the opposite side. The diskette position is 0.010in. closer to the head and the diskette turntable.

Depending on the clearance on the guide track the diskette follows as it is inserted in the drive; the initial engagement position is changed 0.010in. from normal. This either may cause the jacket to bend, giving higher running friction to the diskette, or it can interfere with proper clamping action on the diskette drive spindle. This can lead to premature diskette wear or under-speed operations, with resultant data errors.

Finally, one of the original reasons for the offset index hole was to allow for easy identification of which side was up. Put in inverted, the floppy diskette would not work. With the addition of the second index hole it is possible — where the identification label is not controlled by software, as is the case on certain systems — to confuse the sides of the diskette and subsequently to get wrong data inputs. Extra care will circumvent this problem but it is defeating one of the original design features.

Summing-up, if you want to use both sides of a diskette, buy one which has been tested and initialised for use on both sides. Only then can you be assured of a better-than-average chance of it operating in a normal, error-free manner. Because something can be done does not mean it is the wisest course of action in most circumstances.

**Alan Honeysett,**  
Michael Collins' Business Forms Ltd.,  
Richmond, Surrey.

## All change

I HAVE just sold my 8K Pet and bought a 16K one, and am writing to give a warning to readers who may be contemplating a similar change.

There are differences between the machines, particularly in the memory map, and a number of programs which relied on POKE & PEEK, even those from Pet Users' Club newsletter, published by Commodore, no longer work. The real "Keyboard" is fine, if a little noisy, and there is a good monitor built in, which will save and load machine code programs.

Further, the lower-case/graphics POKE \$59468,14 has changed, so that now you get lower-case normally and shift for capitals, like a typewriter. This is fine, except if your programs have many instructions in them; then this will all have to be changed.

Commodore does not seem to want to help. When I asked for a list of memory map changes, the company said perhaps it might publish a conversion program. Promises, promises. For everything else I was referred to the new manual — loose leaf and full of errors. Printing errors, errors of fact, and bad grammar. It is also dull and unclear.

Can any of your readers help me with prog-

ram conversion, please? Is anyone in my area interested in setting-up a club?

**Peter Dolphin,**  
Petersfield, Hampshire.

## Directory call

I WOULD be very interested to know of any directory of PEEK/POKE commands, as those I know I have encountered almost by accident. For example, the lower-case letter POKE 59468,14 and POKE 59468,12 I discovered by listing a commercial Pet program in which I had noticed the lower-case letters.

I suspect there may be many more such commands for which I could find uses but do not know where to find them. Can you help?

I have worked out roughly the screen position and character commands, by trial and error — one example of this is given in the manual. Also, if there is any way of eliminating an occasional, annoying habit of when INT(X) equals, say, 32 — it gives a value of 32.000001 — I should be very glad to hear of it.

**Mark Anderson,**  
Lesmahagow,  
Lanark.

I THINK readers may be interested in a problem which we met with our 16K Nascom-1 using the CC Soft Level C (4K) Basic Interpreter.

We were getting spurious Basic error messages when there was no syntax error, or any other error. We tried the RAM test program supplied with the expansion board kit and from this we thought the D7 line was permanently '1' until I tuned a radio receiver to 2MHz (Z-80 clock frequency) while the unit was operating.

I "heard" the data within the MPU since our unit was acting as a strong radio transmitter, and we were able to pick up the signals 10 yards away. A word of warning, therefore. Check (i) that the unit is sufficiently earthed; (ii) sufficiently screened; (iii) that no earth loops exist.

Once we screened our unit and laid out the various units, the errors in the RAM test were reduced considerably and we hope to eradicate them completely when we have built a proper PSU, as opposed to the two lab PSUs we are now using.

**John Collis,**  
Bristol Polytechnic.

● Using a radio to check dataflow, say from a cassette recorder, is a fairly common technique. Unscreened boards using TTL logic, however, radiate large amounts of RF energy and mutual interference can be possible in certain situations.

## Readers' programs

We are always pleased to receive readers' programs for possible publication. Games especially are welcome. To avoid type-setting errors, we intend in future to reproduce only computer printout. To economise on space, readers who propose to send listings should print them no more than 28 characters wide, including spaces. Longer lines will, of course, run over.

We can publish only material which does not infringe copyright. If you propose to adapt an existing board game, for instance, it is your responsibility to obtain copyright clearance for publication from the copyright holders. □

# H-P introduction lives up to its name

HEWLETT-PACKARD has introduced a new programmable calculator which it calls the "hand-held computer" and it certainly seems to live up to that tag.

The HP-41C has a user-



H-P 41C.

## Trade body

TWENTY-TWO representatives of companies in the microcomputer business met recently in London to form a steering committee which will lead, it is hoped, to a trade association.

Tim Keen, of Keen Computers, is the chairman; Colin Stanley, of HB Computers, is treasurer; and Tim Moore, of Newbear, is secretary.

Anyone with views on the constitution, aims and objects should write to Heather Hodgson, 47 Cresswell Road, Newbury, Berkshire. □

## Instant access to Prestel

INSTANT ACCESS to Prestel can be yours with the Cherry Electrical Products Viewdata Keyboard. It plugs into a television set via a five-pin (Din) plug. An additional V24 interface socket is provided at the back of the unit so that you can receive data from the central Prestel computer, using a standard modem.

definable keyboard and memory allocation and is designed to receive a series of optional add-on devices; its 12-character alphanumeric display is the first from Hewlett-Packard to use liquid crystal technology.

The basic keyboard functions can be changed to gain access to 130 pre-programmed mathematical and scientific functions or a combination of those and personal routines.

Four I/O ports on the device can connect additional memory modules, a magnetic card reader, plotting printer, special applications modules and an optical reader for bar codes. They are all optional features.

Other peripherals include

an alphanumeric keyboard which can communicate with the user, and a continuous memory which retains user-entered data and programs while the machine is switched-off. They are available instantly when it is switched on again.

The memory allows the user to select an optimum blend between a maximum of 448 bytes of program memory or 63 data storage registers. That basic memory can be expanded five-fold with the addition of plug-in memory modules.

The HP-41C was available in the U.K. from the beginning of September and costs £190 for the calculator, £135 for the card reader and £260 for the printer. □

## Norfolk's first is one of three newcomers

THREE new computer stores have opened recently, two in London and one in Norwich. Logic Box in Westminster supply Pets, Hewlett-Packard and Compelec machines. It has the advantage of being able to call on software house Beyts Logic, its sister company, which will back-up the hardware with applications software, especially for the small business user. The new showrooms are in Palmer Street, Westminster, near Caxton Hall.

Adda Computers microshop will concentrate on Pet, Apple and Nascom hardware. Software support will include systems design, programming and engineering services.

Adda expects its customers from numerous small businesses in west London, local colleges and user departments of large corporations. The showroom is at 17-19 The Broadway, Ealing, W5, and is open from 9am-6pm Monday to Friday and from 10am-4pm on Saturday.

Norfolk's first computer shop has been opened by Sumlock Bondain, hardware specialists for East Anglia. The shop is an agent for Pet, Adler and Compucorp microcomputers.

Sumlock Bondain says that "sales are well-supported by advice and expertise, together with full service facilities and software back-up". Cal-

## Licences for Intel

RAPID RECALL has been able to supply all Intel software off-the-shelf recently, and has been authorised to issue Intel software licences. This software now includes PL/M, Fortran, Basic, iCIS Cobol, iSIS, RMX-80, plus assemblers and other packages.

Among the new packages is an editor for use on Intellec systems, called Credit and known as MDS 360; a disc extended Basic interpreter, MDS 320; a Fortran-80 runtime software package, the iSBC-801; and the iCIS Cobol compiler written by Microfocus, known as the MDS 380.

Rapid Recall will supply the software to existing and new Intellec development system users. □

culators will also be added to the microcomputer range.

The company says it will provide East Anglia with a microcomputer centre, particularly for first-time users, where they will not be baffled by "terminology or sold a computer if it will not meet their needs".

The shop is at 32 Prince of Wales Road, Norwich. □

## Learn in comfort

MEKTRONIC CONSULTANTS will teach you all about microcomputers in the comfort of your own office in its Microprocessor Teach-in for Managers.

The course is essentially non-technical and is given by engineers for engineers and managers. The Compucolor II is used alongside other visual aids.

The one day teach-in covers what microprocessors are, how they can be used, what specific applications can be expected to cost, and discussions of clients' particular problems. The fee is £225 per group, plus travel and VAT. □

## GR-Pascal is offered by Golden River

BICESTER/BASED software house Golden River has developed a version of Pascal to run on the RCA CDP 1802 processor.

GR-Pascal, as it is called, makes significant improvements in operating speed and program code efficiency by fully utilising the 1802 16 on-chip 16-bit registers. Since Pascal makes extensive use of stacks, the on-chip registers

can act as multiple program/data pointers.

The compiler runs in 1802 manufacturers' hardware with minimum 20K RAM plus a floppy disc and utilities. Minimum target systems can be from 2K upwards of program code, including full 16-bit arithmetic package for signed integer variables. It is written in Pascal and has additional optional features such as provision for assembler code, hexadecimal numbers and disc I/O facilities.

A typical 200-line Pascal program will compile into 3K of ROM or EPROM, including 2K of kernel program, common to all target systems.

Golden River plans to have an 1804 mask programmed with the 2K Pascal kernel in ROM. The application-specific program can then be stored in an external 1K or 2K EPROM. The single chip will sell initially for around £40 in one-off quantity, although you will still need the compiler software in the first instance. □

## Business micros

DATRON of Sheffield has an idea to involve more local businessmen with the microcomputer.

It will give seminars, advertised locally, and specialise in a certain subject in which the businessmen are interested. The seminars will be aimed at middle management from companies who have not yet invested in a computer. They will take place in a morning or afternoon, for only a nominal charge.

Topics covered will include the microcomputer market and how it applies to business and other specialised areas.

"We want to open businessmen's eyes to micros", says Stewart Smith, head of the Datron Microcomputer Division, who will be lecturing. □

## TVJ Launches its Lifeboat software

TVJ MICROCOMPUTERS ETC has opened its second office in Bristol, signed to sell the well-thought-of Lifeboat Associated software, and has new items for the TRS-80.

The Tandy specialist can offer a Micropolis disc for the machine, containing almost 400K, at a cost of £1,195. That compares favourably to Tandy disc drives, four of which offer 307K for £1,400 — or £2,000 at the Tandy recommended retail price.

Microcomputers Etc sells the Radio Shack speech synthesiser which works with any Level II model from 4K to 48K. It is programmed in

Basic and has documentation and a demonstration cassette. It costs £345.

One interesting development is a printer interface cable which plugs into the back of the Level II keyboard for output to any Centronics printer, causing the expansion interface to become redundant. No software is required for this Microcomputers Etc product, and it sells for £55.

Other products include the Percom FA400 and Shugart SA400 disc drives, the Heath WH14 and Micro Printer printers. Microcomputers Etc has also become an official dealer for Compucolour II. □

## Minicam for Pet

A DATA ACQUISITION system for the Pet or any other 6800- or 6502-based computer, has been designed by Renton Harper, microcomputer software specialists.

The Minicam provides a bus-structured system having an 8-bit address bus and a 16-bit data bus. Each function in each interface module is allocated an address by the user, allowing up to 255 functions to be controlled.

The system has nine modules, including a 3U rack and PSU with room for up to 12 modules, each 1in. wide, a dual 16-bit scaler or pulse counter and Pet software.

More information from Renton Harper on (0272) 621920. □

## Jumpers

BREADBOARDERS may be interested to hear of a complete kit of jumper wires for use on Lektrokit Electronics breadboards. Each kit contains 350 wires and is complete in a plastic box with separate compartments for each type of wire.

Fourteen lengths are included, from small with 0.1in. span for linking adjacent holes on the 0.1in. matrix, to others with a span of 5in. All the jumper wires are solid, tinned 22awg with PVC insulation sleeving. □

**THE new miniature 40-column line printer, S-100 bus, line printer interface, telephone modems and TRS 80 keyboard with numeric keypad from TVJ.**



## Disc-based packages on offer from Washington

PERIPHERAL PEOPLE in Washington has decided to market two disc-based packages developed for its own business. They can be supplied on cassette and copied to disc or on a customer-supplied DOS formatted disc.

The first of the programs is Mailroom, intended for a 32K

machine. It costs \$30 and is complete with documentation. The program starts by initialising a list and permits review and edit of files which can be sorted by county or post code with duplication checks. When a file becomes too big counties can be separated and made into new files. The package

will LPRINT either mailing labels or in tabular form for filing.

The Electric Secretary is intended for a 16K TRS-80 and costs \$50. It has only upper-case characters but with a "simple modification" it can print lower-case as well. A recommended printer is the Diablo Hy-Type I.

Written in Basic, the software seems easy enough to use. You can assign a file name and enter text once only. The file can be reviewed, revised, re-worded, and corrected. Automatic page formatting and justification occurs when the document is printed-out. An additional advantage is that it produces camera-ready copy.

The Peripheral People can be contacted at PO Box 524, Mercer Island, Washington, 98040. □

## Explorer arrives

A NEW MICROCOMPUTER, the Explorer 85, is to be sold in the U.K. by Newtronics. The machine uses the 8085A processor whose MPU is software-compatible with the many 8080-based programs, while offering a faster speed and lower chip count.

The Explorer is designed to form the centre of a main-frame system. Its basic board has room for 4K RAM, 8K ROM/EPROM, two fully-buffered and decoded S100 bus sockets, ROM I/O chip to hold the system monitor, two 8-bit I/O ports and cassette file interface.

The system is in different levels but for £297 plus VAT you can obtain kits for levels A, B and D, as well as a video terminal board with ASCII keyboard for direct access to a TV or video monitor.

Further details are available from Newtronics, 138 Kingsland Road, London, E2. □

## TECS gains PO stamp of approval

THE REVOLUTIONARY TECS system has met the requirements for connection to Post Office lines for Prestel, with only a few minor adjustments.

After a visit to the Post

Office a production model was accepted and the changes have been incorporated in the system.

"No problems are envisaged in updating units already sold to add Prestel facilities, provided that the units are returned to Technalogs for checking and certification prior to use", director Laurence Cook says.

Designed and manufactured by the British company, the TECS system represents something of a breakthrough in the world of the personal computer. It enables you to read Teletext/Prestel and buy a cheap computer all in one. Prices start at £360 for the basic model and rise to £1,200. □

## Refined

FOLLOWING the success of its original touch sensitive keyboard (*Practical Computing*, May, 1979), Star Devices has introduced a Mk II version with several refinements. They include a back-printed, wipe-clean polyester sleeve over the touch pad area.

The Mk II, assembled, burnt in and tested is said to have an operational life in excess of 250 million operations. Price for the keyboard is £37.50 plus VAT. □

Zilog Z-8000 development module.

## Z-8000 has wide range of applications

THE 16-bit microcomputer is here at last, as the Zilog Z-8000 Development Module proves. It will aid the user in evaluating and developing hardware and software for

Z-8000 microprocessor-based products.

It features a Z-8002 processor, 2K word EPROM monitor, 16K words of RAM, dual serial interfaces, 32 programmable I/O lines with handshake control, four programmable 8-bit counter/timers, jumper-selectable CPU clock rates and wire-wrap area to allow addition of custom interfaces or special application. Memory can be expanded by adding 16K RAM and 2K EPROM components.

The board accommodates a wide range of applications, and communicates with the outside world through two RS232 interfaces. The monitor program, contained in 4K of EPROM, provide the necessary debugging commands, I/O control and host interface for the Z-8000 Development Module.

Prices and availability on request from Zilog dealers. □

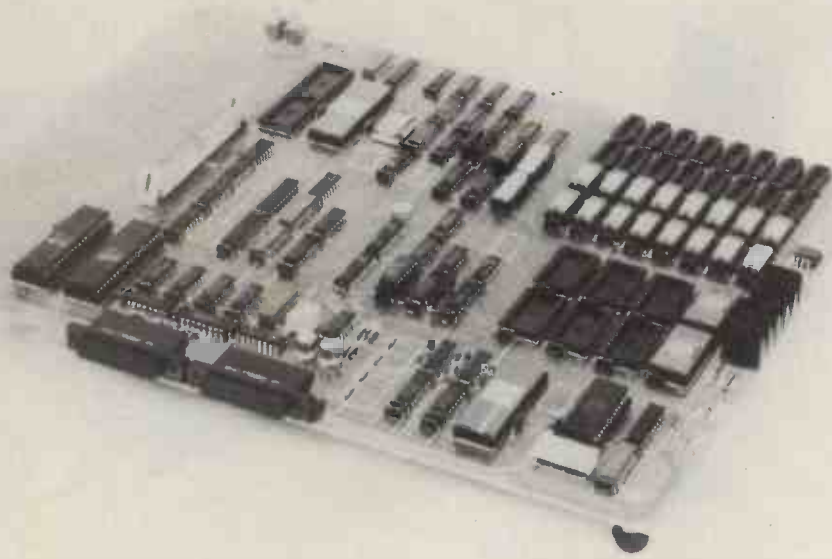

# RAIR

- High speed 8085 microprocessor ●
- Priority interrupts and DMA ●
- 64K bytes of RAM memory ●
- Transparent ROM bootstrap loader ●
- Integral dual minifloppy disks ●
- Programmable serial I/O interfaces ●
- Advanced floppy disk operating system ●
- Serial and random file processing ●
- Macro assembler with symbolic debugging ●
- Extended BASIC interpreter ●
- Relocating FORTRAN IV compiler ●
- ANS 74 COBOL compiler ●
- Comprehensive range of peripherals ●
- UK wide on-site maintenance ●
- Quantity and OEM discounts ●
- Leasing and rental facilities ●

## New features

- Double sided/density disks (260K bytes/drive) ●
- High speed hardware arithmetic unit ●
- Multi-user operating system support ●
- Dual-drive add-on (over 1M byte on-line) ●



## BLACK BOX MICROCOMPUTER

30-32 NEAL STREET COVENT GARDEN LONDON WC2H 9PS TELEPHONE 01-836 4663

# Keen Computers take you into the future with the Apple II



Apple II 16K	830.00
Additional 16K Ram	90.00
Applesoft Rom	110.00
RS232 Card	110.00
Colour Card	90.00
Disk Drive and Controller	425.00
Disk Drive W/Ot Controller	375.00
Speech Lab	140.00
Apple Clock	165.00
Printers from	350.00

Prices subject to change without notice.

Software Packages are available for most business applications.

A few are:-

Word Processor, Information Retrieval, Incomplete Records Accounting, Sales Ledger, Order Entry Invoicing, Management Information, and a variety of Statistical Packages, Games, and others.

**Keen Computers**  
**5b The Poultry**  
**Nottingham**  
**Tel: 0602 583254**  
**Telex 37297**



# Disc comparisons

FOR a cheap, easy and relatively safe method of storing data and programs, using cassette tape is satisfactory, but there are disadvantages. Access to programs and data is very slow, since the data transfer speed is about 40 bytes per second and access time — getting the cassette head to where the data is — takes anything from one second to five minutes; and only sequential files can be handled.

This may be satisfactory for home use but for commercial application it is impracticable. The next step up from cassette is a minifloppy disc system. A system of that kind should have an access time of less than one second and data transfer speed from 5K-25Kbytes/sec. In consequence, even the worst disc system

will be more than 100 times faster than cassette.

The systems chosen for comparison are the Apple II, the Pet and the Tandy. It does not mean that the three are the best available. It is because they are the most popular machines and tend to be sold to the first-time user with cassettes. The four main points to be considered are:

- The disc operating system (DOS)
- Documentation
- Ease of use
- Software, maintenance and availability.

Each system, of course, has its own special features and eccentricities and they will be highlighted within the relevant sections.

## Apple II

The version used for this comparison was the latest which Apple has just released, DOS 3.2. The hardware comprises an Apple II with 48K of RAM, a portable television set, a disc controller card and one minifloppy disc drive.

Assembly was relatively simple. The cable from the disc drive was fitted on to the disc controller card which allows for the control of two disc drives. It was plugged into expansion slot 6 inside the Apple. No extra power supply is needed, as all the power is taken from the Apple via the controller. Besides plugging-in the Apple and switching-on there was nothing more to do.

The general impression of the system is of simplicity. Booting DOS from Basic was done by loading the Master disc and typing PR#6 (RETURN). The result was the running of the greetings program which displayed a message giving the version information and notification of copyright and a return to integer Basic. To get into floating point Basic, type FP (RETURN). The operation of the Apple was as if nothing had happened except the addition of the disc I/O instructions.

The next step was to create a slave disc. The Master disc was write-protected and, therefore, useless for storing data or programs. In fact, some of the demonstration programs would not work because they had to write back to the disc. The first requirement was to have a greetings program in core. It is possible to use the greetings program from the Master disc but there is nothing to prevent you writing your own. Then type INIT (RETURN).

### All commands

The system asked for the name of the greetings program and then formatted the disc, taking about two minutes.

The slave disc created contained DOS and the greetings program. The term "slave" disc is used because it is specific to this size of system. It could be used on a larger system but the extra memory would be wasted. It was possible to change the slave disc into a Master disc

using a utility program provided with DOS.

The Basic provided all the standard commands — RUN, LOAD, SAVE, KILL, RENAME, LIST, CATALOG — along with two slightly more advanced features:

**EXEC.** This instruction allows execution of commands and command sequences from a file which contains these commands; e.g. a file could be loaded, listed and run by executing a file which contained the instruction LOAD (FILENAME), LIST, RUN.

**MON.** This command is useful for debugging programs with disc I/O statements. It allows you to see the variables and Basic statements involved with disc I/O as they are executed.

The two types of data files allowed were sequential and random. The file-handling for both was very similar, since both were controlled by PRINT and INPUT statements. To open a file for sequential write the following instructions were needed:

```
PRINT DS + "OPEN FILE1"
PRINT DS + "WRITE FILE1"
where DS = (CTRL-D)
```

### Apple disc.



All subsequent print instructions wrote to the file. The same was true for sequential read, except that subsequent INPUT statements read from the file.

With random access files only two extra parameters were needed — record length and record manner. Otherwise the format was the same.

### Ideal method

For a first-time user the method of file-handling is ideal; it does not involve learning a special set of I/O instructions as they are based on the PRINT and INPUT statements. There are problems involved, however, with more complex programming, specifically multi-file access.

Consider the operation of merging two files into one new file. It is necessary to read both files before merging them into the new one. As it is possible to have only one file open in one mode, i.e. read or write, at any time, at least one of the files must be read fully into core first and then closed before the other file can be accessed. This is the biggest criticism of the system and is a fairly major one.

On the other hand, the documentation supplied with the system was of a high

*(continued on next page)*

(continued from previous page)

standard. To describe most documentation supplied with micro systems as unintelligible would not be stating the case too strongly. Not so with Apple. It was well laid-out, easy to read, in a sensible order so that one is taken through step by step and has that all-important ingredient which so many manufacturers omit — an index. Not only was it excellent for a first-time user but it also contained almost all the information one could ever want to know, including detailed circuit diagrams. Apple has exceeded even its own high standards.

As for space available, DOS occupied 10K of RAM plus ½K extra for each file open. This means that, for a usable system, at least 16K of RAM is needed and 24K if high-resolution graphics are needed. The capacity of each disc was 116K.

Some other features which Apple has included were the disc volume number and the "lock" option. It was possible to give each disc a volume number which could be tested for in a Basic program. The "lock" option allowed you to protect individual records against deletion or over-writing.

Using a single-disc system caused no real problems, except that copying data files involved writing extra software. Copying Basic files could be done simply by loading them and saving them back to another disc. There is a copy program available for multiple systems.

On the whole, the Apple II, system was a pleasant experience. It was easy to assemble, easy to understand and easy to use. Apart from the difficulties of multiple file-handling, there seemed very little cause for complaint.

## Tandy

With the Tandy, two versions of DOS were used — TRSDOS LEVEL 2.1 and NEWDOS+. The second DOS is an

### Tandy disc.



## Price comparison

Apple II 16K RAM	£895
Upgrade to 32K RAM	£100
2 × minifloppy	£850
Centronics 779 tractor printer	£890
	£2,754 + VAT
	= £3,157
Tandy 16K RAM	£645
Upgrade to 32K RAM	£325
2 × minifloppy	£700
Centronics 779 tractor printer	£890
	£2,560 + VAT
	= £2,944
Pet 32N	£750
Dual minifloppy	£745
3022 tractor printer	£605
	£2,100 + VAT
	= £2,415

enhancement of TRSDOS, is from Canada and is marketed through Microcomputers Etc in Camberley, Surrey. TRSDOS has an error or two in it, which NEWDOS corrects. The system comprises the Tandy with 48K of RAM, VDU and four disc drives, although only two were used.

Getting into DOS was simple. The system disc was loaded in drive O, the system was powered-up and there was nothing more to do. It was possible to enter either disc Basic or normal Level II Basic by typing BASIC (ENTER) or BASIC 2 (ENTER) respectively. Return to DOS was facilitated by typing CMD "S" (ENTER).

## Extra instructions

The disc BASIC was good with several extra instructions on Level II; &H (allows definition of a Hex constant), &O (allows definition of an Octal constant), CMD "D", CMD "R", CMD "S", CMD "T" (various system commands), DEF FN, DEF USR, INSTR, LINE INPUT, MID\$, TIMES\$, USR. The disc I/O

statements were very much like Basic plus which made the file handling powerful.

The file types allowed were sequential and random. For sequential files the following instructions were available:

PRINT n, PRINT USING n for writing to disc,  
INPUT n, LINE INPUT n for reading from disc,  
where n is the channel number.

Sequential files were easy to create and manipulate. The only problem occurred when trying to extend an existing sequential file in TRSDOS. It did not appear to be possible. With NEWDOS+ there was an extra mode of opening a sequential file to extend it.

Random file manipulation was even better. The Basic statements were GET, PUT, FIELD, LSET, RSET, CVD, CVS, cvi, mkd\$, MKI\$, MKS\$. For anybody with a knowledge of Basic plus, it takes very little more than a quick read of the manual to master random access techniques. For a newcomer it may take some time but once mastered, this set of instructions is a powerful tool.

## Above average

The documentation was above average. It was well-laid-out, full in its explanations and in a logical order. It also contained circuit diagrams for the hardware enthusiasts, as well as a chapter of technical information. The only real grouse was the lack of a full Basic summary.

The DOS had a large set of powerful instructions and utilities. Besides the obvious ones such as listing a file, formatting and making back-ups, there were others not found within other DOSs:

DEVICE — gives a list of devices in use  
AUTO — allows a definition of a DOS command to be executed on power-up.  
TAPEDISK — allows a system tape to be copied onto disc

DOS and the disc Basic take up about 10K of user RAM and each file open takes about 280 bytes. Each disc can hold up to 85K of information — reduced to 55K if a disc also holds the system. Note that the system required a system disc to be loaded permanently in drive O, as it reads instructions from the system disc as they are used. Also, it is possible to buy a set of Micropolis disc drives specially modified for the Tandy which can take 77-track discs, more than doubling the present capacity, again from Microcomputers Etc.

In general, the machine looks a good buy. Tandy seems to have managed to move away from the "wiring jungle" approach although, for four drives, you will need plenty of plug sockets. It has some refinements such as searching all drives if a file is not found on the specified drive. It, too, looks good value for money.

## Pet

Of the three systems, Commodore was the last company to produce a disc system. Even now, Pet discs tend to be rare



### Pet disc.

— not through lack of demand but because of supply problems. The system used was the Pet 32N, the large keyboard version, and Commodore dual 2040 minifloppy discs.

Commodore seems to have stayed with its philosophy of plug-in-and-go, in that setting-up the system presented no more problems than plugging-in a television. That was what you had to do — plug in the Pet and the disc drives connect the Pet and the disc drives via the IEEE interface with the special cable provided, switch on and the system is ready for use.

Existing Pets are compatible with the disc system. New ROMs are supplied with the disc drive — take out the old ones, plug in the new, and go.

### Manipulation

Getting into DOS was a little harder. The disc drive is an intelligent peripheral in that it contains two 6502 processors and 6K of RAM. The DOS operates by sending commands to the disc processors which execute them and returns any error. The first requirements were to load the system disc, open the command/error channel and initialise the disc. It was done with the following command:

PEN 1, 8, 15, "in"

The first parameter is the logical file number; the second the device number, the third the secondary address for the command/error channel. The fourth parameter is the instruction to initialise the discs where n is the drive number (0 or 1). An unspecified drive number defaults to both drives.

The next step was to load a utility program called "DUM". It allowed manipulation of most of the disc commands — NEW, INITIALISE, VERIFY, HISTORY, DIRECTORY, COPY, RENAME, SCRATCH.

That was one of the impressive parts of the system, allowing full disc maintenance within one program. The "HIS-

TORY" option was one of the unusual ones, giving information on creation dates and disc identity, allowing full protection of the disc.

Another interesting software utility was a program loaded when the system was initialised, called "DOS support 3.1." It allowed input of symbols for commands; for instance "/" in the first position of a line was taken as the LOAD instruction, and obviated the need for the quotes and the device number, the only parameter needed being the file name. It was clever and the machine code subroutine occupied only 400 bytes of RAM. It was also possible to turn this utility on and off by using the following instructions:

POKE 1022, 128 to turn the utility off.  
POKE 1022, 8 to turn the utility on.

The Basic was the usual high-quality Microsoft Basic with the extra file-

handling features being sent to the disc drives via command strings. It was the command strings and the various nomenclature and syntax difficulty which caused most of the problems.

Creating sequential files was reasonably straightforward. Once the file was opened in either sequential read or sequential write, access was via the PRINT and INPUT statements. Creating random files was almost impossible.

Looking at the commands available — Block read, Block write, Block execute, Block allocate, Block free, Memory read, Memory write, Memory execute, user — the random file access looked flexible and powerful. Unfortunately, it was hampered by two major faults, cumbersome parameter definition and documentation which was badly written.

The first problem is one that any reasonable programmer can overcome. The problem over documentation is inexcusable. How can Commodore expect a first-time user to understand documentation which is jumbled, incomplete and misleading?

It was difficult enough for experienced programmers to make any sense out of the system. Unless the documentation is improved drastically the system becomes unusable for anybody intent on programming with complex file-handling in mind.

This is unfortunate, as the system on the whole looks good. The DOS, being controlled by the disc unit, takes-up no user RAM, leaving the full 32K available. Back-up from Commodore is probably second to none. The experience of programmers in Pet Basic can be seen by the amount of software available for the Pet. This system is a new one and perhaps it is unfair to criticise it too harshly. It is being sold, however, and therefore ought to be of good quality.

### Conclusions

● All the disc operating systems have their merits. The Apple DOS version 3.2 is easy to use and excellent for a first-time user. It is slightly limited in its file-handling capabilities, although good programming may be able to overcome this.

● The Tandy DOS is neat and very powerful if NEWDOS+ is used. Beware of errors in TRSDOS, though. The Pet DOS looks the most powerful and flexible of the three but it is complex and rather messy to use.

● As far as ease of use and setting-up the systems are concerned, all are good and there is little to choose between them.

● Documentation for the Apple and the Tandy are ahead of anything else available on the market. The Apple is slightly better, being slightly more readable and containing more information. It can only be hoped that the Pet documentation improves drastically.

● Naturally, all machines tend to have their own bias, the Apple being more suited to scientific and educational use, the Pet and the Tandy geared more to business and commercial use, with all three happy in the home computer market. This is another point to consider when deciding which machine to buy.

● As for the amount of software available, all have software libraries which are still expanding. Disc application programs are slightly more rare but a good deal of work is being done on converting programs from cassette to disc, as well as writing new software — for example, the much heralded PETACTION programs.

● Support for your system is probably best supplied by Commodore and Tandy, as they have the largest number of dealers. Availability of machines is good for the Tandy and the Apple. For the Pet there is backlog, although they are becoming more readily available now. □

# Training for the Z-80

IN THE LAST few months a number of self-study training systems for microprocessors/computers have been introduced. The SGS-ATES Nanocomputer NBZ80 is one of them, based around the Z-80. What does this training system set out to do, and does it achieve it? And are there any other ways of achieving the same objectives?

Worthy of note was the concern and service from SGS-ATES (U.K.); hopefully the same level of service and help would be available to all customers.

The NBZ80 is a single-board computer with the Z-80 CPU, 2K of monitor EPROM and 4K of dynamic RAM. It has as its input device a detachable keyboard/display unit — like a calculator — with eight 7-segment LED displays and a hexadecimal keyboard with some extra control and operation keys. It was supplied with an optional power supply — very neat and compact — and a substantial tutorial book.

Because this system claims to be a training system, this review has to take this into account; therefore it will be different from a normal equipment review. The effectiveness of the total system will be taken into account, including the equipment and the manual, but because of the important claims made for the educational aspects, it will be more stringent when dealing with them.

## Getting warm

The first thing noticed was the lack of any setting-up instructions. The manufacturer is looking into this, with a view to supplying a sheet of setting-up notes. The instructions given were very brief, and seemed simple. Connect the PSU to J1 — it can go only one way — and attach the keyboard via J6 with the ribbon cable header/plug in the correct orientation.

Dutifully I did so, and there was nothing, except that I noticed that the power supply was getting warm.

Using a meter and checking the circuit diagrams — supplied as blue prints — showed that the -12V and -5V were not present, as they were connected to ground at J1 connector. According to the circuit diagrams, J2 connector had the correct corresponding pin-outs. So J2 was tried and fortunately all was well.

On pressing the 'Reset' key — there is no power-on re-set — the Nanocomputer is initialised displaying the 'PC' (program counter) mode, pointing at address 0000. The keyboard unit has, aside from the eight 7-segment LEDs, 14 single LED indicators showing the display or operational mode. To select the mode, it is simple to use the left and right arrow-control keys which will shift and rotate the modes in the order of the LEDs in the

direction indicated by the arrows on the keys.

By holding down those keys, the mode is shifted continually, which is a useful feature, but the speed of rotation appeared to be a little too fast to be able to stop accurately and consistently on the chosen mode.

I had trouble with the first keyboard supplied. The display quality was very poor, due to the fact that some of the segments and LED indicators, which were supposed to have been off, remained half-lit, and in subdued lighting that became confusing.

A replacement keyboard was delivered and showed an improvement but the fault was still there. It should be noted that they were supposed to have been pre-production keyboards and I was supplied

has 4K bytes of RAM on board.

There will not be many people who will want to program 4Kbytes by hexadecimal machine code entry, since it certainly cannot be classed as enjoyable.

The Nanocomputer is based on an SGS-ATES standard Z-80 microcomputer card, with the special 2K of monitor in EPROMs. This simple and, perhaps, crude method of operation might be valid for the training and educational aspects, which leads conveniently into training and educational aspects and documentation.

The Nanocomputer has a 300-page paperback-sized training manual and that makes it different from other systems. The manual is titled *Z-80 Microprocessor - Book 1 - Programming*. The authors, Nichols, Nichols & Rony,

## Vincent Tseng goes back to school with the SGS-ATES Nanocomputer training system.

with a full production one toward the end of my review, which had the fault rectified. The production sample had a different key layout and the keys were very stiff and hard to press, which I found disappointing.

The change mode (←&→) keys allowed access to display and made it possible to change the address, memory contents, registers, stack pointer flags and set up to four breakpoints. There is the capability to single-step the program in memory, and also to load and dump to an audio cassette. All the basic, but useful, facilities are there. Operating the system was very easy to learn because it was very basic and nothing special. The monitor in

write the *Bug Books* published in the U.S.

SGS-ATES, in fact, commissioned the people to produce the manual specifically for the Nanocomputer Training System. Chapter one deals with binary and hex codes and chapter two with definitions of microcomputers, program, instruction mnemonics and so on. Chapter three is an introduction to some Z-80 program instructions.

## Key operations

Not until chapter four does one find more "meat". This section deals with the key operations of the Nanocomputer. It is, however, a strange mixture of writing for absolute beginners and parts where a good deal of experience and knowledge are called for. For example, experiment No. 1 in chapter four is devoted to the operation of the left and right arrow change mode keys, which would probably insult an 11-year-old, since most people can easily master the use of a calculator and simple instructions would have been more than adequate.

Contrast this with the audio cassette dump (DP key) and load (LD key) instructions in the same chapter. Although they are adequate in detail, if brief, they assume a working knowledge of the operation of the microcomputer and experience of using mass storage media.

Experiment No. 5 uses two diagnostic utility routines in the monitor EPROMs. Although the memory test is described, the start address is associated with the label "MEMTUT" and is supposed to be listed in the master symbol table in

## Specification

CPU: Z-80 @ 2MHz  
Memory: 2x 2708-type EPROMs, 4Kbytes of dynamic RAM in 8x 4027s.  
User interface: Entry by hex keyboard (calculator type), eight 7-segment LED displays and 14 LED-mode indicators for display.  
Mass storage: Audio cassette interface (switch changeable to 20mA Teletype interface)  
Software: 2K monitor in EPROMs.  
Documentation: Training manual (300 pages).

two 1K 2708-type EPROMs did things well but seemed a little "old-fashioned".

By limiting the vital user interface to 7-segment LEDs and a hexadecimal calculator-type keyboard, the operation and potential of the system is restricted severely. This puts the Nanocomputer into the class of single-board machines produced about two years or more ago, in the same kind of group as the Kim-1, Intel SDK and Motorola MEK, despite the fact that the Nanocomputer

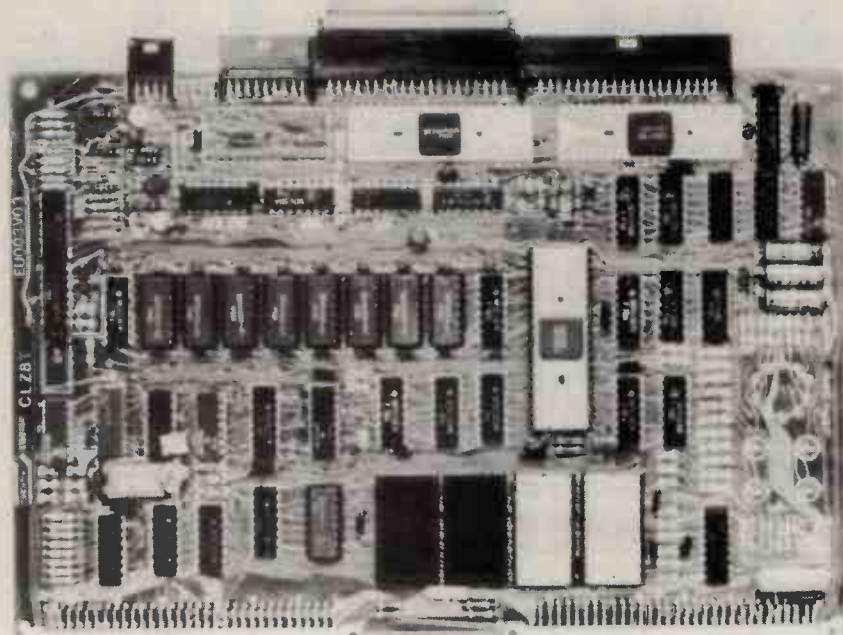

Appendix F (it is not). SGS-ATES (U.K.) was unable to supply me with that address in time for this review.

## Experiments

The remaining chapters deal with programming the Z-80 in hexadecimal machine code. Starting with some extremely simple program examples in chapter five, the authors then go into more detail, with experiments on transfers between memory and registers, addressing modes, program control transfers, logical instructions, bit manipulation, shift and rotate, and finally on arithmetic and block instructions.

The manual with its experiments gives the user a working knowledge of the hex machine code of the Z-80, but tends to be a little inconsistent in the levels of complexity, although not as marked as the examples shown in chapter four.

Some chapters also have useful summary reviews on the subjects covered and some do not. Although a similar working knowledge probably could be gained by working one's way conscientiously through a standard Z-80 programming manual, the experiments of the system make it more interesting, and this can be a very important factor in helping a student.

## Opportunity missed

A working knowledge of the machine code of a microcomputer, however, does not constitute true computer programming experience. That is where the Nanocomputer training system misses a few important points. It misses the oppor-

tunity to teach the principles of computing and programming.

Most people who will eventually program microcomputers will not be doing so in hex machine code. So knowledge of the workings and machine code of the microprocessor should not be the first objectives for beginners, but more in the practices, principles and techniques in computers and computing.

## For programmers

The type of knowledge gained with this system probably would be more useful to a programmer who wants to work on Z-80s but the manual does not appear to be aimed at such people.

There is an audio cassette interface for mass storage. A recommended recorder, a Grundig C350 automatic, was supplied for test. Both dump and playback worked well. I wrote a RAM memory check program, which writes two-byte patterns alternately to RAM between two set limits, then checks the accuracy of the pattern stored. Such a pattern was stored and checked in about 3½Kbytes of RAM (free RAM area) then dumped on to tape.

The RAM area was cleared and checked by using 00 and 00 as the test pattern, then the just-recorded tape was loaded back. Restoring the recorded test bytes and running the checking part of the routine only verified that the recorded and loaded data were identical. The tape recording was not to any recognised standard format.

The cassette interface is a curious mix of sophistication and primitiveness. There is remote control of the recorder

but there is no file management and, even worse, there is no return to monitor after a dump or load. The important point, though, is that the system worked reliably under test.

The Nanocomputer is also available in Super Nanocomputer form, which includes a double-card frame holding the computer board and PSU, as well as a solderless breadboard system with some toggle switches and LEDs. This allows convenient experiments for interfacing to external devices, in conjunction with an additional manual, Book 3.

The Nanocomputer can be changed into the CLZ80 personal computer system by changing the monitor EPROMs and the addition of a UART, VDU and the like. The training manuals will be made available separately.

## Conclusions

● The Nanocomputer Training System at £350 without PSU is not cheap. As a piece of equipment it is somewhat outdated and somewhat crude in operation.

● The manual makes learning about the Z-80 instruction set more interesting but will not teach programming. In the Super Nanocomputer form it looks a more attractive, but also more expensive, proposition.

● It should be noted that the manual is specific to the Nanocomputer only in one section — chapter four; all the other chapters can apply to almost any Z-80-based computer which allows access in hex machine code. □

# MIDWICH

## Nanocomputers

DEALER ENQUIRIES WELCOME

AS REVIEWED IN THIS ISSUE

Part No.	Description	Price
NBZ80	Z80 based nanocomputer. 4KB RAM memory for user programmes. 2KB Monitor on EPROM. Includes a calculator style keyboard/display station, instruction book, and Z80 programming Manual.	260.00
NBZ80S	Same as NBZ80 but includes card cage, power supply, breadboard and kit for experiments (NEZ80 + K1Z80), and Volumes 1, 2, and 3 of the training manuals.	455.00
NEZ80	Breadboard which interfaces with the NBZ80 and provides the display, logic, and commands to perform programming and Z80 interfacing experiments. Supplied with Volumes 2 and 3 of the training manuals.	130.00
NPZ80	Mini power supply and card cage combined. Supports NBZ80 + NEZ80 and one other board.	90.00
NPZ80/1	Cable kit for breadboard experiments on NEZ80.	10.00
K2Z80	Active and passive component kit, including 2 x M2708 EPROM which holds the software for the experiments in volume 3.	22.00
RCZ80	Cassette recorder for user programmes.	45.00
W10Z80	Lead to connect RCZ80 to NBZ80	9.00
<b>Training Manuals</b>		
Volume 1	Z80 Programming.	10.00
Volume 2	Digital Electronics	10.00
Volume 3	Z80 input/output and interfacing.	10.00

Special Price for Volumes 2 and 3 if purchased with NBZ80 14.00.

NEW LOW PRICE

## Europlus Apple II

The new **EUROPLUS APPLE II** is an enhanced **APPLE II** featuring: -

- **AUTO-START ROM** - permits direct entry into application programmes from disc at switch on. Also includes a reset protect function and improved screen editing
- **PALSOFT ROM** - Applesoft on a ROM saving RAM capacity and the need to buy an Applesoft firmware card.
- **NEW LOW PRICE!!!** only £810 for the 16K version

**PASCAL** The new Europlus Apple II language system including the revolutionary new language 'Pascal' is due in this month.

**DIGITAL PAL COLOUR CARD** Ring us for the latest information on price and delivery.

- 16K Europlus Apple II 810.00
- Disc Drive with Controller 425.00
- Disc Drive without Controller 375.00
- 16K Add-on Memory 90.00
- Hi-Speed serial Interface 110.00
- Paralell interface 110.00
- Comms card 140.00
- Applesoft Firmware card 110.00
- Centronics card 140.00
- Clock card 140.00

ALL THE ABOVE ITEMS ARE AVAILABLE EX-STOCK AT PRESENT.

ALL PRICES EX. VAT.

# MIDWICH

Further information from  
**Midwich Computer Company Limited**  
 209b High Street Waltham Cross Herts EN8 7AY  
 Telephone Waltham Cross (97) 29310

● Circle No. 185

PRACTICAL COMPUTING October 1979

# THE DATA WORLD OF TOMORROW

This month *Practical Computing* looks at the different ways that instant information on any subject will be available to the home and office.



By Easter, 1980 there should be Prestel centres in London, Birmingham and Manchester, with dataplex links to many other telephone centres.

By the end of 1980, the Post Office hopes to have capacity for 70,000 business and 200,000 residential users; the system will be available to 62 percent of the telephone-using population. The immediate commitment is to an investment of £23 million and it is promised that the speed of development will be far faster than that of the last major telephone innovation, Subscriber Trunk Dialling.

At the end of July, 1979 the total number of pages in use was 136,000.

Peter Sommer puts his ear to the egg-shell and reports electronic movement within. He is deputy editorial director of Granada Publishing and a freelance writer on electronic matters. The views expressed are his own.

IT SEEMS a characteristic of long-predicted technomiracles — and in this case it's the computer-based information-service-in-every-home — that when they arrive finally the vast majority of the public don't grasp the fact. The glowing box of tricks is exhibited and the near-universal conclusion reached that, while interesting, it won't work, or will never really replace that to which we're all accustomed.

All the time, of course, not only is it working, but those few who understand the fact are already taking it to its second stage of evolution. That is precisely what is happening now to Prestel. Its potential importance lies in the following interlocks:

- It offers frequently-updated information to a mass lay audience in textual form, and ultimately many of the physical facts and intellectual ideas humans use are expressed in collections of words. In social terms it is more important than the stand-alone home microcomputer.
- It is derived from a simple extension of well-tried existing technology — the telephone system as data transmitter; a modest adaptation of the domestic TV to display selected data and graphics; and the mainframe computer with multi-user access, large data storage, and rapid retrieval — sheer number-crunching isn't important here.
- While the system provides for mass dissemination, the information on it is not subject to central control; the analogy is with the postal or telephone services, rather than, say, TV or news papers.

### **New force**

- Potentially it is cheap, though there will be a problem in persuading some users how expensive gathering conventional 'free' information can be. It is also easy and inexpensive to put up information as a provider; no large capital resources are required.
- It is user-friendly and the first obviously computer-based system the lay public will perceive as working for it and improving the quality of life. All those arguments about 'information is power' will assume new force; potentially, Prestel is as important as the successive revolutions of literacy and printing.
- It will have profound effects on the future of many existing computer technologies, especially those intended for commerce and industry.
- It will also have a profound effect on existing forms of information-provision — magazine, book and newspaper publishing, and most of all, advertising. Few existing communications media will disappear but their roles will be changed and many publishing managements and trades

# **Prestel — the start**

unions seem to have no notion of what lies before them.

The facts that viewdata in its most advanced prototype — the Post Office system Prestel — is as yet not fully-formed, that extensions to its use are still not clear; that there is doubt as to the exact speed of its development — and indeed doubts as to the precise pattern of that development; that one day it may be not only the Post Office which runs public-access information computers; that one day, too, domestic television may be supplanted as a viewing medium in favour of a more purpose-orientated display device alter very little the claims set out.

### **Misunderstood**

Seers have been forecasting the information revolution long enough; the point is that Prestel is the essential breakthrough. So important is it already proving that predictions of developments in a range of activities are having to be re-written by pushing them through the 'window' which Prestel makes. And though misunderstood by conventional publishers and computer scientists alike, the revolution is taking place.

To understand the diversity of the Prestel scene and the arguments and worries which concern the Prestel community, as it calls itself, you need to know something of the history of the viewdata idea.

The Post Office Research Centre, now at Martlesham, has a wide brief. One of the persistent concerns of the Post Office is that the extent of its investment in lines and switching devices is determined by daytime business use. The search is always on, therefore, to increase domestic usage at night, hence advantageous rates and Buzby advertising campaigns. Thus any new toy from Martlesham may be examined by the PO marketing men for its value in residential exploitation.

In the late '60s and early '70s much interest was expressed in the Viewphone but the economics were unsatisfactory. So when Sam Fedida showed his TV-and-telephone line data transmission system in 1972-74 it was regarded initially as something for the home. It was only a little later, following sufficient market research and discussions with hardware suppliers and potential information providers, that it was realised that there could not be from the outset a mass domestic market.

What has happened, in fact, is that while the long-term aim is to reach the audience in the home, it has become obvious that the establishment of the system — the bearing of costs involved in developing cheap adaptors to existing TV

technology, the set-up expenses of display bases, the justification in the short-term of the Post Office investment — will depend on the business community, in particular medium and small businesses, because the really large ones already have computers.

So the Post Office has not solved its problem of extending off-peak usage of its existing investment; in fact, for the short term of the next five years or so, if Prestel succeeds, there will be an increased need for lines and exchanges — not that such a frank analysis is shared by the Post Office Corporation.

Several important developments, however, have happened along the way. In 1975, compatibility was achieved with the data and graphics standards of Teletext, the off-air information system interlaced between existing video frames of TV transmissions. Teletext is limited in practical terms to about 200 pages per vision channel, because of delays in access time, and lacks the interactive feature of viewdata; but it's free. Thus the TV industry has had a chance to develop some of the technology which will be needed, and to sell it before Prestel went public. Sales of Teletext sets, though, have been disappointing — 9,000 units in 1978.

### **Experiments**

More recently, experiments have been carried-out so that individual frames sent contained not letters and graphics for instant display but instructions to be manipulated by a local microprocessor at the reception end. The name for this is tele-software and it is associated with the name of W. J. S. Overington. It carries with it the potential of passing whole programs down the line for such purposes as business procedures and computer-assisted learning, or of manipulating the existing Prestel base more effectively and cheaply than by the conventional addressing of the numeric pad.

This has led the way to the development of intelligent or 'smart' terminals. To manipulate the simpler programs, a microprocessor and RAM are sufficient. The Liverpool company, Technalogs, has already demonstrated what is clearly a stand-alone micro, complete with disc drive, if required, which is Prestel- and Teletext-compatible.

Another important development has been the attempt to automate the re-formatting of existing computer files to viewdata standards and structures, thus vastly lowering the cost of putting up certain Prestel programmes. This system, Preview, is not without teething troubles and is as good only as the flexibility of the original database allows, but it includes clever routines drawn from conventional computer typesetting technology — the arrangements for line-breaks, the avoidance of widowed lines, careful selection of column arrangement — and it



## What the new jargon means

**Viewdata:** generic term for service for channelling information from information providers to the public via the telephone network and displaying it in standard graphics on a TV screen.

**Prestel:** proprietary name of Post Office viewdata service.

**Teletext:** generic term for the transmission of data on spare lines of the broadcast television service. Teletext uses the same graphic set as viewdata. It is non-interactive and limited to about 200 frames per channel. Ceefax is the BBC teletext service, and Oracle the IBA service. All viewdata sets can receive Teletext but not vice versa.

**Videotex:** international generic term to cover both viewdata and Teletext.

**IP:** Information Provider, or viewdata publisher. The IP, like the user, is a client of the Post Office. An *Umbrella IP* takes a block of pages, 1,000 or more, and re-lets in smaller quantities.

**Page:** the fundamental unit of the viewdata system, the level at which text is stored, and the lowest level accessible by the user. Each page can contain up to 26 frames.

**Frame:** the basic unit of the display, and hence the database.

**Filial:** a page which emerges as a choice from a main page; there can be a maximum of 10 from any single page and each can parent 10 filials of its own.

**Routing page:** a page whose primary function is to take the user from an access point to a page with useful information on it — an end page.

**End-page:** the concluding page of any enquiry and usually the one with the most valuable information on it. End pages may contain facilities to enable the user to go straight to other related courses of enquiry.

**Response frame:** a particular facility which enables the user to signal back to the IP, perhaps for further information or to signify purchase.

**Private viewdata:** viewdata-compatible computer system used solely in-house.

**Closed user group:** IP-created database on public service but with access restricted by a variety of devices to specialised users.

**Intelligent terminal:** the normal user terminal has direct command facilities only; an intelligent or 'smart' terminal contains a microprocessor and memory, which might be able to execute a limited number of procedures dictated to it by telesoftware or could amount to a fully-independent, stand-alone microcomputer complete with disc drive, which is compatible with viewdata requirements.

**Telesoftware:** generic term for the transmission of data instructions as opposed to display pages via viewdata or Teletext; requires a suitable microprocessor and memory in user's TV.

**Preview:** proprietary name of Langton Information Systems, signifying an automatic re-formatting package for existing databases to viewdata requirements.

**AVIP:** Association of Viewdata Providers: the IP trade association.

**INSAC:** company set up by National Enterprise Board responsible for overseas marketing of viewdata.

obviously has enormous potential.

High-speed updating of existing information in the Prestel base is also important and Langton and GEC are offering services. Soon, and provided the necessary consents and legal problems are cleared, access to other telephone-line-transmitted databases and to the international Telex service will be possible as well.

Already viewdata standards are sufficiently important for companies to set up in-house computer systems fully compatible with the public service — known as Private Viewdata. International marketing carried out by INSAC, the National Enterprise Board-funded venture, is well advanced, with contracts signed with the Netherlands, Germany, Switzerland, Hong Kong, and GTE in the United States, among others. The French seem rebellious, promoting a system with many similar features which is not, however, directly compatible. The Canadian system, Telidon, which has high-resolution graphics, looks as though it will accept viewdata, though its own graphic set will not resolve on viewdata equipment.

Away from the business and international scene, one of the more significant developments in terms of the original Prestel remit of heading rapidly for the domestic audience has been the coin-op terminal presented by Cherry Leisure, a company hitherto in the arcade game business. During the trial there have been five public terminals but it is planned to place them in stores, hotels, pubs, clubs, common rooms, and even community centres.

The terminals contain special pro-

cedures for handling charging and can deny certain facilities available to the business and residential user — passwords, response frames and eventually, if necessary, pages above a certain unit cost.

Research has gone ahead, too, on the Information Provider side. Much has been learned about the design of databases, bearing in mind that most people will be addressing the computer by numeric pad alone and will have no training, and wouldn't want to take any.

There have been changes in the structuring of the IP community, too, with some early IPs dropping out and new ones arriving or setting themselves up as umbrella organisations.

## Coalition

The Prestel community which now exists is a strange coalition of interests. The Post Office, mainframe computer hardware and software specialists, the TV manufacturing industry, and an amorphous collection of IPs, some of them well-established in print publishing, some from the public information services, some who have information which will be useful if it can be transmitted in sufficient detail quickly and cheaply but haven't tried to do so until now, and many who fit none of those categories.

There is now a trade association, AVIP, which have so far recruited about 50 percent of all IPs. AVIP negotiates with the Post Office over tariffs and facilities — more than 50 'improvements' are under discussion — and is in the process of talking to the Advertising Standards Authority, examining copyright protection, and developing a code of conduct for members.

From a technical point of view, viewdata is relatively unsophisticated, a fact which has misled a number of computer experts to under-estimate its importance.

The fundamental unit is a frame of 24 lines each of a maximum of 40 characters, a fairly low level of resolution by VDU standards and a direct result of the birth of the system as a domestic beast.

Every enquiry begins at a generalised access page, obtained either from the Prestel directory incorporated in the system or from the printed versions provided four times a year from Eastel, IPC and Fintel (for business). If used properly, they can lower access cost. The access page will give a menu or contents list and directs you to strike your keypad according to the option you wish to follow through.

You will find yourself trundling through a series of routing pages as the object of search becomes increasingly defined. If you are searching alphabetically, for example, the ABC will be divided initially into up to 10 groups.

As an alternative to this method of using the alphabet, the Caxton Encyclopaedia uses a number-for-letter routine something like the old telephone dial in which groups of three letters are always associated with one specific digit — abc = 1, def = 2, and the like.

The strength of the computerised information file, of course, is that there are many ways of arranging a search for information, narrowing from the general to the very specific. Not only this, but there can be, as in real life, a multiplicity of paths to the same conclusion. What you've now reached, typically paying a

(continued on next page)

(continued from previous page)

line charge during each routing stage for the privilege, is the "end-page" which has real information on it, though these days most IPs try to include information of a kind on routing pages also, to sustain and reward your interest. Charges for end pages are usually higher, typically 0.5p to 1.5p, averaging about 1-2p for residential material and 2-5p for business applications, but with a probable maximum of 50p.

### Filials

Each end page may continue on to further frames — accessed by means of # — or may present a choice of further pages, which are called filials. There can be up to 10 from any one end page, and the filials can create further filials. At each level the Prestel page number, which may have started as three digits, acquires another digit, with continuation frames indicated by lower-case letters of the alphabet, making a total of 26 possibilities. At the moment, Prestel will tolerate a maximum of nine-digit numbers. It is also possible, of course, to route back to a higher level, thus creating loops.

There is also another kind of frame, the response frame, which enables the user to signal back to the Prestel computer and in turn to the IP.

Response frames can be used for seeking more information from an IP — a brochure, for example, or for ordering goods from a wholesale warehouse.

One of the tests of a database is if you've arrived at an end page, what happens next? Many end pages naturally will generate in the user's mind further enquiries — more information in the case of an encyclopaedia-type database, or near-alternatives for the temporarily dissatisfied in the case of listing-type contents.

In fact, many writers of databases talk of starting with the end pages and then

# How it operates

devising routes to them; for each route to a page there should be a route away which follows the same motivation. Other designers talk of viewdata as a writing medium in which you start with the index and then fill it.

The point which is missed is that one of the essentials of the exercise is simplicity of use and ease of setting-up. The real world isn't about idealised models but making things work effectively and economically; viewdata's importance is in getting the mix right and getting recognised as a set of accepted standards. The limits, however, are there:

- 960 characters per frame means no more than 150-odd words and usually about half of that.
- An overall database must not be too large; reaching an end page would be impossibly tedious and expensive for the user, though telesoftware and the availability of alphanumeric addressing could change this.

### Telesoftware

- The system can't think in terms of units smaller than the single frame, so that games, detailed individual-orientated enquiries — say of the legal or welfare-rights variety — and computer-aided learning become very expensive if conducted at ½p a frame, which means ½p for each step. Again, telesoftware will come into its own here, because the Prestel computer will feed the program to your own intelligent terminal and then be cut off.

As a result of these constraints, as well

as the purely commercial ones of costing database set-up and frame rental against likely revenue, Prestel is suited only to certain types of information provision. The electronically-stored novel, when it arrives to supplant the paperback, will not come via viewdata in its present form and will not be viewed on a domestic TV screen.

The character set is an extended ISO7 code generated on 10 × 7 dot matrix; graphics are formed from 3 × 2 squares grouping occupying a character position; any combination can be selected. Curves and diagonal vectors can only be approximated. There are seven colours, flashing, and double-height facilities and foreign fonts, including cyrillic, will be available.

### Calling sequence

The Prestel computer at the Post Office end during the pilot trial is the GEC 4080 with software written in Babage and Coral with a 2 × 64K store unit, 19.6Mb disc and controller and 170Mb disc and controller. There are 104 user ports. The transmission rate is 1,200 bits/second receive, 75 bits/second transmit from user terminal, full duplex. Future expansion aims at the use of more GEC 4080s — there were three scheduled for commission by September.

The typical calling sequence is:

- A call "initiate" button on the keypad to get dial tone from the exchange.
- Dialling the computer, which usually will be automatic.
- Conventional ring-tone, followed by a steady 1300Hz tone to indicate answer.
- Terminal switches-on.
- As a security device, manual input of a pass number and even password may be requested; for domestic users this will be automatic.

The user is then free to roam, using his numeric key-pad.

The typical viewdata receiver is an ordinary set capable of transmitted TV

### A specimen Prestel page from the Stock Exchange.

STOCK EXCHANGE 520a 0.5p

STOCK EXCHANGE SERVICES ON PRESTEL

Key 0 for general information about The Stock Exchange issued by the Public Relations Department

Key 1 for a description of the share price information service

All the above pages priced at ½p each

Key 3 for the main index to the share price information service.

Key 4 for details of other Stock Exchange pages on Prestel (FT Index, currencies etc).

Information pages priced at 2p each.

## The Stock Exchange

London EC2N 1HP Tel 01-588 2355

### Front page from the world's first electronic newspaper — apart from Ceefax — published by the Birmingham Post and Mail.

VIEWTEL 202 202a 0.5p

# Viewtel

# 202

0 NEWS INDEX

WHAT'S ON:

1 LONDON

2 BIRMINGHAM KEY NUMBER

THE WORLD'S FIRST ELECTRONIC NEWSPAPER

THE BIRMINGHAM POST & MAIL LTD.  
28 Colmore Circus - Birmingham B4 6AY  
Telephone 021-236 3366 Extension 202

reception but with isolation circuits to separate TV from a telephone line; an integral modem — it is delay in getting PO approval for their designs of these two elements which is delaying some manufacturers; input and memory control; memory to store accepted information; character generator; synchronisation; keypad. Obvious additions are local processing power; the "smart" terminal; alphanumeric addressing. Certain business terminals may lack the broadcast reception facility, but that is a pity — it also denies access to Teletext.

Much inputting from the IPs is done today from a dedicated IP editing terminal which uses the Prestel computer in real-time. The trend, however, is towards off-line preparation of frames on smart terminals which can warn the writer of violation of Prestel protocols.

A tour through the Prestel pages during this summer revealed the system with all its glorious potential and shortcomings. It was the period of the test service. The pilot trial had ended and a statistically-chosen sample of around 1,500 lay customers should have had sets in London, Birmingham and Norwich homes, though only 800 were in operation.

Now sets, other than those in IP offices or an special trial, will be available to business users. Sets could also be seen in a few public libraries and in TV rental showrooms, and coin-operated machines are in certain hotel lobbies and a handful of department stores.

### Market research

What was "up" partly reflected a desire to make the most of this Post Office-sponsored opportunity for market research. Some pages were easier to interpret as statements of intent — or the electronic equivalent of staking a claim — than as achievements; IPs advertising and demonstrating their services, or perhaps trying to frighten the competition.

There was also a great deal of obvious experimentation — with database structuring, with graphics, with telesoftware.

The first commercially-successful IP operations are likely to be those like the motor components supplier who will let his garage customers see a viewdata form of his warehouse stockholding list to reduce delays in ordering parts. GKN is doing the same for screws. In some cases it will be worth the while of the IP to give viewdata sets to customers.

That conclusion was reached by New Opportunity Press, which specialises in graduate recruitment. For its Careerdata venture it put sets into the offices of a number of University Appointments Boards.

Following-through the business theme, it is not surprising to find solid financial databases from Fintel and *The Economist*. In the case of the former, there was already a substantial prior database and the Stock Exchange already has its own



**A Pye push-button Teletext remote controller. It is an ordinary TV controller with a decimal keypad.**

computer communications system ready for re-formatting.

There are legal databases, varying from simple consumer guidance to the operation of Infolex, which is a closed user group, though its pages had not yet been technically cut off from public gaze. Infolex has rejected the opportunity to provide a complete retrieval service, reckoning that what its clients — mostly solicitors — need most is an updating service on case and statute law; users can then check the references themselves — very cost-effective for IP and user alike.

### Scientific

An equivalent scientific information service would be desirable. One exists potentially in the form of ISI Scitel but because it has to generate its material specially for viewdata — and perhaps because there's less money in pure science — its number of frames is small — about 300, with 50 or so changed weekly.

A search through the *TeleWhich?* version of the Consumers' Association Car Reports to find the pluses and minuses of a particular car of a specific year costs around 20p. If one looked at several cars the cost would be slightly less if you were checking broadly similar alternatives.

*TeleWhich?* has more to offer than selections from the old files of the magazine. There are the first signs of a legal advice service — adoption procedure was one

example; and it may also act as an umbrella IP for the National Consumer Council.

The success of these ventures will depend partly on money from public sources, and not only to create the databases. The audience most in need of them is also the group least likely to own viewdata, even in the longer term. So viewdata sets would need to be made available in libraries, community centres, and so on.

The coin-op set is only a partial solution. One hopes that Government expenditure cuts will not cripple the social service aspect of Prestel. The public libraries have funded an ASLIB research scheme to see how Prestel is used in public libraries, and to investigate librarian attitudes.

Turning to the more commercial operations destined for the general market, there's plenty of experiment and some interesting material but when you analyse who is backing Prestel and who is not, the results are surprising. For example, there are two newspapers, *Viewtel*, run by the Birmingham Post & Mail, and *Eastel*, from Eastern Counties Newspapers — no Fleet Street giants, apart from the *Financial Times*.

*Viewtel* takes the technology seriously and its pages are very readable, though it is disconcerting to see the Midlands slant to the news.

*Eastel* rapidly is becoming an umbrella IP; for example, some of its pages are sublet to Granada TV Rental, which entered the game too late to get its own allocation.

### Different approach

The problem a newspaper has to face is that there is plenty of competition. On a viewdata set, the free services of *Ceefax* and *Oracle*, for a start, then the regular vision and sound output of ITN and BBC-TV News, and all the printed newspapers and magazines. If they are to make sense Prestel newspapers have to identify some exceptional qualities and then concentrate on them.

For similar reasons, one supposes, some of the big magazine publishing groups are playing it differently as well. IPC has information drawn only from a handful of its enormous list of titles, although it obviously believes sufficiently in the medium to put out the magazine *Viewdata and TV User* — on paper.

Link House has a number of pages advertising its consultancy facilities and a skeletal version of *Exchange and Mart*.

A few book publishers, parts of larger groups, have a nervous presence, mostly in the form of book-guide listings.

One reason for the poor showing of the conventional print publishers in the present Prestel database is that for most of them the computer has been essentially a tool for handling stock control and processing invoices.

It was interesting, talking to IPs and

(continued on next page)

(continued from previous page)

viewdata managers, to see which senior managements were obviously backing the technology and understood it, and which had put someone in a broom cupboard at the end of a corridor in an annexe — just in case.

Yet many of the frames are clearly only there to demonstrate or carry-out experiments; games of the kind thoroughly familiar to computer buffs — and not even very sophisticated versions — which cost ½p a throw. Quizzes at ½p an answer, right or wrong. The IPs offering them tend to be those who can afford to think in the very long term — Baric, the Barclays Bank and ICL-owned facility; Mills & Allen, who are doing a vast amount of experimentation, including an attempt at a user-structured “debate” on law-and-order under a Post Office editorial development contract; and Guinness Superlatives, a publisher whose profitability rests on having a back-list of only 10 titles, all best sellers.

Some of the experiments are extremely interesting. CAP is trying a telesoftware program which simplifies use of the railway time-table; there are already a number of timetables and flight- and hotel-availabilities databases which will be viable very quickly.

## Exciting

CAP and Mills & Allen have been working on computer-assisted learning. The program I tried was about arithmetic processes using electronic logic. The principles of CAL are well known, as are the advantages and disadvantages. For a start, it is expensive to write good programs because of the long development-time. Further, it is often desirable for the machine-tutor to have a routine for monitoring the rate of progress of the pupil. While CAL is feasible technically with telesoftware, it may be that some kinds will be better on the stand-alone computer. If CAP succeeds and if the resources are found to develop proper programs, the potential is exciting.

Perhaps the databases aimed at the public most likely to give a quick return are those advertising consumer durables. Comet, Currys and GUS mail order companies all have a strong presence, and so do credit cards Access and Barclaycard.

There is no one organisation in charge of Prestel. Anyone watching the system to see how it develops has to remember that it is an extraordinary partnership of groups not used to working with each other.

The ingredients in the viewdata mix are the number of IPs, the number of pages, the number of users, and the number of user ports.

Few people want to commit themselves to a date when one can expect domestic viability for Prestel, or when socio-economic group C has it in its homes, but certain common views recur, and they

tend to give rise to some anxiety.

The scenario we have to accept is that contrary to the first domestic-orientated Post Office thoughts, initial expansion depends on the community of small- to medium-sized businesses. If a company can find a sufficiently worthwhile specific database related to its business, the £1,200 price tag on a viewdata receiver is chickenfeed, and in any case tax-allowable — much like the stand-alone microcomputer, of course.

Once it has access to the Prestel database it will then explore ever more widely into its further reaches. So TV manufacturers get the volume to enable them



**She's pregnant — now she grapples with the electronics. If she presses 6 on the TeleWhich? Pregnancy Advice menu, it's twins — for only 1p per page.**

to iron-out the problems before going for full mass production. That, in turn, will enable them to reduce prices so that the viewdata element in a set is only £50-70 above the price of a conventional broadcast receiver.

IPs then gain enough revenue to encourage them to expand their frames and to start to tailor them more for the mass audience. On that basis one could talk of domesticisation in 1983-85 — very few forecasters seem to chose 1984 as their target.

## Rental

The present emphasis on business could also prompt TV manufacturers to develop “smart” business-orientated terminals at the expense of early production of cheap mass-market “dumb” receivers, though in the long run, of course, such elements as alphanumeric addressing, telesoftware, and linkages with Telex and other databases will have domestic applications.

One thing which could alter the pattern

would be a feeling of really positive commitment from TV rental companies, since 60 percent of all TV sets in Britain are rented. The rental companies, however, seem to be cautious, too.

Rather, the line some of them seem to be taking is to be like everyone else, and explore the possibilities of the business market, by persuading businessmen to rent, not buy. This means that they will be renting not only TV sets, but whole business packages.

With offices in general on the brink of another electronic revolution — word processing and its associated electronic filing and memo transmission — those TV rental companies are committing themselves to a handful. Yet it seems they would rather follow that path than push for an immediate expansion of the domestic aspect of Prestel marketing.

The other potential modifier of the scenario would be fulfilment of Post Office hopes to produce its own add-on viewdata adaptor for £100. News on this front is, at the moment, scant.

## Commitment

Out of all this one critical figure emerges. Assuming the Post Office keeps to its present time-table, and assuming that manufacturers have no major difficulties with component supply or PO approval for their equipment, the Prestel community as whole feels there must be 100,000 sets by the end of 1980.

If that does not happen, there will be a loss of overall confidence. Many commercial IPs in the game for long-term reasons will begin to question their investment. So, too, will those semi-public bodies which aim to provide consumer advice and information, leaving the purely business-orientated IPs and their customers as main users of the technology.

It may even be, in the worst case, that the Post Office eventually will have to examine its commitment to the maintenance of the Prestel team and the provision of GEC 4080s. Viewdata as such would not die then; what would happen is what looks to be the likely pattern for the United States — each viewdata user would have to access not one computer system where everything can be found, but several, by the dialling of a succession of telephone numbers, and with a multiplicity of billing. The computers could be owned by IP conglomerates on the analogy of today's magazine publishing groups.

There are good reasons for not wanting this to happen. Viewdata strength must be in its simplicity of use, its near-universal accessibility to the public, the cheapness of putting-up information which could depart if the computer ceases to be a public facility, a common carrier, and belongs to one of a tiny group of industrial giants, and the variety of information on it. □

# Your own private network

PHILIPS has recently launched a minicomputer-based viewdata system aimed at the business market. It offers "some benefits to the business user over and above other information-handling techniques" and "an unprecedented opportunity for cutting-out the tremendous amount of time wasted in hunting for information".

It appears that Philips realised how tedious and time-consuming it could be trying to move through the Prestel system to the page desired, because it has added two new facilities to alleviate the problem. To reduce the work in moving back and forth between pages within one section it has allowed the user to select his new page by keying-in a single digit rather than having to return to the index page every time.

The other feature, the "keyword search", is more general and allows the user who knows what he is looking for to have the desired page displayed by entering some of the title of the page as a keyword. This is presumably not a full keyword search because the system cannot search pages for the input word.

## Security

The other features are intended to provide business users with the tool necessary to make the system useful in their environment. The question of security is provided for by "dynamic routing page compilation", as Philips calls it. In plain English, users are allowed to view pages only contained in the indices which their authorisation code allows them to view. The creation and amendment of pages is no longer a task which can be sensibly restricted to a central control, so a special editing keyboard has been provided to enable the user to perform these operations at his terminal, providing his authorisation code permits. To enable non-programmers to edit pages there is an editing process in which step-by-step instructions are given to ensure that no mistake can be made in data input. One can but hope that this foolproof system does not fall within the range of Shaw's principle — "Build a system that even a fool can use and only a fool will want to use it".

There are more enhancements on the way and they include the linking of the Philips WP5000 word processor, archiving on to video disc and the storage of pages on dictating machines.

If the system were set up within a company, it could expect to see a con-

siderable reduction in paper flow, since about 90 percent, of the paperwork in the office is internally-generated correspondence. The time saved by the reduction of information storage and retrieval effort, on the other hand, is fairly low — around six percent per secretary — and any increase in productivity due to this could well be outweighed by the extra effort necessary when correlating several pages of information — a difficult task when only one page can be seen at a time.

One area in which the system produces benefits is that of making items of information available in different locations. In

phone numbers and this could easily be supplied.

For the access to be distributed to a company's customers requires that there should be a different security system so that those customers cannot see or alter any information they should not. This means that, under the present security scheme, each customer should have his own order index and, once the order has been accepted, that it should be moved to another index.

A 'per page' or 'add-only' type of security system could deal with this problem more efficiently, as it would allow all the orders to be grouped in one index, and

**The introduction of Prestel terminals makes it possible for organisations to store and exchange electronic information inside themselves and with other organisations. B. Skittrall of the Computer Systems Laboratory, Queen Mary College, looks at the possibilities. Although GEC has done the most work on private viewdata systems, and several other companies have a stake in the area, the Philips system will be discussed here since it is familiar to the author and the problems are general to all.**

the past this has been achieved by distributing several copies of the information but that is expensive in the clerical time taken in copying and, with the existence of several copies, there is a tendency for different locations to get out of step with updates and so produce inconsistencies. A viewdata system solves both of those drawbacks by distributing an image of the information whenever it is requested.

The fact that the terminals are not extremely expensive opens up the greatest possibilities for a system, because the terminals may then be distributed to the sources of the information to be collected, removing one problem of computer systems — having to transcribe data to get it on to the machine.

Then, instead of having an order department which receives orders and enters them on the machine, the department can look at orders which have been entered on the machine by the customers. It may seem expensive to have to supply a terminal to each customer, but if the terminal may be used to communicate with the customer's other suppliers, the costs can be spread and so be somewhat lower than first considered.

All that is necessary to enable use of a terminal with many suppliers is to provide the capacity for several dial-up tele-

hence make it easier for the order department to process them.

The provision for editing and the future link with a word processor are both potential sources of increased efficiency. By allowing the user to add his own variables into a skeleton page, they provide the ability for users to fill-in forms and hence enter data on to the system in a manner specified by a member of the company — always assuming the user co-operates.

## Local storage

This has no earth-shattering effects with the Philips system but it allows users who are familiar with a viewdata system to enter the information required on to a system, even if they are not familiar with the requirements.

Although information is available constantly over the telephone network it is not always convenient to have to dial the central computer every time information is required. To reduce the expense involved in having a dedicated telephone line and the cost of using it, local storage stations may be built. A station would not be a costly item, since it needs only a normal terminal, a small amount of logic, some secondary storage — a floppy disc, for example — and a microprocessor.

*(continued on page 71)*

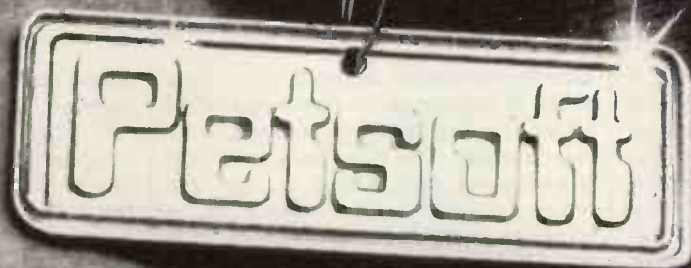

# PETSOFT 1st AGAIN!

**1st** **CURSOR** The  
Cassette Magazine for Pet owners  
Each issue contains at least five brand new programs. Plus, editorial coverage, new product announcements, reviews and programmers hints. £36 for ten issues mailed direct to you.

**1st** **76 PROGRAMS**  
for only **£15**  
Specially adapted for the PET from Adam Osborne and Associates best-selling book "Some Common Basic Programs". 76 essential mathematical and Financial programs on one cassette.

**1st** **PET PROGRAMMERS TOOLKIT** ... AVAILABLE OCT.  
10 powerful routines that greatly enhance PET BASIC, all on a single plug-in ROM chip. New commands include Re-number, Trace, Help, Find, Unlist, Delete, Append, Auto and Dump.  
**£55+V.A.T.** for 16 and 32k PETS  
**£75+V.A.T.** for 8k-PETS with old ROMS

**1st** **150**  
Pet Programs  
in the  
new Catalogue

including: Word Processor	£25
Assembler	£25
Critical Path	£15
Micro Chess	£14
French Vocab	£10
Music	£10
Debtors Letters	£15
Backgammon	£8
Restaurant Finder	£5
Payroll	£25
Program Development Aid System	£15
Stock Control	£15
Mailing List	£15
PET BASIC Tutorial	£15
Games Pack	£7
<i>PLUS V.A.T.</i>	

**1st** **PETACT**  
*POWERFUL*  
Business Packages ...

**PURCHASE ACCOUNTING**  
Handles Purchase Ledger, prepares a list of outstanding balances and prints remittance advices

**SALES ACCOUNTING**  
All the facilities for maintenance of Sales Ledger, prepares list of outstanding balances and prints statements. Cassette systems from £225+V.A.T. Disk versions from £350 includes training course.

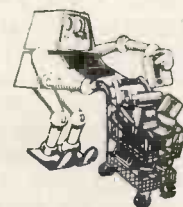

Petsoft programs are available on cassette or disk for all models of the **COMMODORE PET**  
See them at over 200 computer stores, or contact us direct.

*CREDIT CARD orders are accepted by telephone.*

PET is the trademark of **commodore** who recommend **PETACT Business Systems**



**Petsoft** Part of the **ACT**  
Computer Group  
Raddlyffe House, 66-68 Hagley Road,  
Edgbaston, Birmingham B16 8PF  
Telephone 021-455 8585 Telex 339396

My name is .....

I live at .....

Postcode .....

Please rush me a copy of your new catalogue of software for the Pet.

● Circle No. 186

(continued from page 69)

The microprocessor would have software for two purposes. First, so that it can receive pages from the various systems and, second, so that it will allow the user to view the data collected in a similar manner to that employed when using his viewdata system direct. The software may not provide the same dialogue facilities as the minicomputer-based system but the degree of sophistication required would not be so great, because the local storage terminal would keep only the pages referenced frequently by the users at the station, and so the users may be expected to remember most page titles or numbers.

The logic required would need to use a few of the signals from the terminal's Prestel/Teletext logic boards — incoming data lines and strobes — and take the data received through some buffering into the microprocessor, which in turn would pass it to the storage device as requested.

An alternative method of obtaining the data would be to allow the user to request that a page be saved when he has it displayed on his screen. In this case the computer system could examine the terminal memory and store its contents. Since the display conventions used by *Ceefax* and *Oracle* are similar to that used by Prestel, those sources of information

may also be used for data collection providing that their logic is available.

If, on the other hand, there was already a microcomputer system available with an ordinary terminal, the same kind of service could be provided with the inclusion of some additional circuits. They would have to include the synchronisation and page identification software which is included in the viewdata terminal, as well as the circuitry to interface with the telephone lines, in both directions.

### Three boards

For a Teletext-type system this would entail about three boards — one for a receiver, one for the logic and one for the interface to the machine — and for a viewdata system things would be about the same, since, although data comes direct-down the telephone line and not as part of a television signal, the interface would have to be able to send the parent viewdata system information over the telephone line as well as receive it.

The introduction of private viewdata networks would do more than introduce a new machine into the office. The first thing it does is to enable information to be captured at source and hence to remove the necessity for transcription to

bring it into the office data base. As a consequence of this devolution of data capture, computers are brought nearer to the man in the street and hence the way is paved for further computerisation.

Finally, it is in the potentials of further computerisation that the next steps can be taken. It seems wasteful that information is being captured by the viewdata system but it must be re-entered on to another system for other purposes — e.g., accounting. The reason is that the viewdata system treats data as pure text rather than as items which have a meaning; if the data instead were stored as meaningful items, then other programs could use them in their manipulations and calculations.

This could be done with the system as it stands, providing that the information was always entered in a standard format and so could be accessed as such by other programs. Unfortunately, it is not possible to enforce a fixed format with a viewdata system and so users would have to be relied upon to keep to the format requested.

In short, although a private viewdata system goes a long way towards producing the paperless office, it would require a knowledge of the meaning and content of its data items before it can move towards an automated office. □

# Link your micro to the system

THE LINKING of microcomputers with viewdata terminals could be the first step towards producing the cheapest small computers yet. At the same time it makes possible a new form of software distribution.

At the small end of the computer market, a number of microcomputer-based systems are available which consist simply of a VDU screen, processor, memory and cassette or diskette backing store. Thanks to very large scale integration, processor and memory costs have fallen to a level which makes them only a small percentage of the total system cost.

### Sticking points

The costs of VDU screen/keyboard and diskette drives therefore become highly-significant factors in determining total production cost. Their high cost is due partly to their mechanical components, the keyboard in the case of the VDU, and the entire mechanism in the case of diskette drives.

Despite the fact that non-mechanical alternatives for human input and backing store have been talked about for a long time — voice for instance, recognition devices and bubble memory — it seems that it will still be some time before such

system with a viewdata terminal, to produce a new concept — the intelligent viewdata terminal programmable as a computer system.

The result of this integration will be a system similar to those described, but

**Andrew Coleman of the software house CAP-CPP looks at the new way of publishing programs.**

things are available commercially. In the meantime, the VDU and diskette drive are the sticking points for cost reduction.

Viewdata-type systems, if they are as successful as is hoped, have the potential for changing the cost equations radically. The extra electronics which turns a simple television set into a viewdata terminal is now microprocessor-controlled. That gives greater flexibility than the TTL technology used in earlier viewdata sets, and gives the possibility, among others, of integrating a complete microcomputer

with the VDU replaced by a viewdata television set, and with a communications link added.

The next potential change to these small computers is related to the use of software and the way in which it is distributed. There are two main ways of selling software with a computer system — through plug-in memory (e.g. PROM) or on disc or tape.

A typical split in small systems is that  
(continued on next page)

the basic operating system and possibly the language interpreter will be in memory, and the application programs will be held on diskette or cassette. With the arrival of public viewdata bases an additional possibility emerges — that of loading application software from the remote database instead.

The process of loading software via a communications medium from a different computer is known as telesoftware. One of its effects is that the cassette or diskette drive on the microcomputer is no longer needed for loading programs. For some applications, therefore, it can be eliminated entirely, giving the cheapest possible programmable computer system.

The ways in which intelligent viewdata terminals can be used are far too numerous to be listed, but a few examples are worth mentioning. The intelligent terminal without file store is obviously the ideal entry level for a personal computer, with the ability to play TV games, calculate tax liability, compare methods of credit, and the like.

### Home programs

The home user would be able to write his own programs or load simple programs from the viewdata centre and execute them. The same terminal, without file store, could be used in the commercial environment as a data entry terminal, using Prestel as the network system; the validation programs required would be either loaded down from Prestel or provided in RAM.

The terminal with diskette drives becomes a workstation for serious business Prestel users. A local database of information frames can be built from the

main centre and from local information; keyword indices can be held locally to improve access to remote viewdata centres, and the communications link allows connection to information databases other than viewdata.

The terminal with diskette drives is, of course, also a small business system capable of running all the normal applications such as sales ledger packages, automatic filing systems and so on.

Telesoftware does not benefit only the terminal user who no longer needs a file store. For the software retailer and distributor it provides a new way of shipping the product. The benefits of this new method are significant:

- Distribution costs are slashed. Instead of providing multiple copies of diskettes or tapes, a single copy of the software is placed on Prestel and users take their own copies.
- Documentation can be provided on the same medium and can be kept up-to-date more easily.
- Charging for the software can be done by way of membership of a closed user group, or through the Prestel method of charging for individual frames of information.
- User response facilities can provide an answer-back 24-hour maintenance service for queries and complaints.

There are limitations, of course. The transmission speeds used for Prestel mean that only small programs could be distributed in this way. Other viewdata systems, e.g. the French version of Prestel, already use twice this transmission speed.

The possibility of people writing software specifically for sale on Prestel means that other requirements must be

met. In particular, the software must be provided in a machine-independent form — it must be written in a portable language — if a single copy is to suffice for all potential users.

Anti-piracy provisions must be available if the software is being sold, to protect the vendor's investment. The provision of these facilities has already been shown to be feasible.

So much for the theory, but how close are we to such systems in practice? The first prototype intelligent viewdata terminals were constructed by the software house CAP-CPP in 1978. Live demonstrations of telesoftware and some of the applications mentioned were made by CAP to the Post Office in August, 1978, and to the American administration, computer and communications industry at the White House in January, 1979. The technical problems have, therefore, been addressed.

### Vicious circle

The biggest remaining question mark is an economic one, and is the question which has hung over the Post Office Prestel service for some time. To have viewdata terminals — both standard and intelligent types — at a low enough price to be accessible to the domestic consumer, they must be produced in very large quantities. The demand for very large quantities is dependent on low prices.

This vicious circle can be broken only by someone taking the gamble of going into mass production to bring down prices, or by some outside financing. Until this happens, viewdata systems will remain more of a service for the commercial and business world than for the domestic consumer. M

Novatel, the STC purpose-built viewdata business terminal.





# Now, the complete MK 14 micro-computer system from Science of Cambridge

## VDU MODULE. £33.75

(£26.85 without character generator) inc. p & p.

Display up to ½K memory (32 lines x 16 chars, with character generator; or 4096 spot positions in graphics mode) on UHF domestic TV. Eurocard-sized module includes UHF modulator, runs on single 5 V supply. Complete ascii upper-case character set can be mixed with graphics.

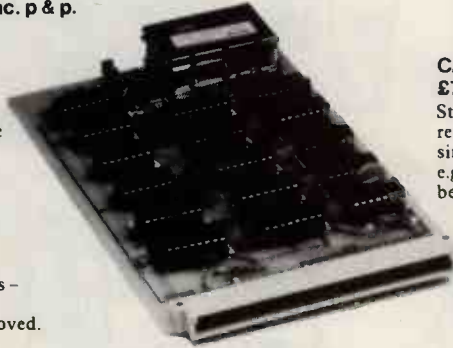

## CASSETTE INTERFACE MODULE.

£7.25, inc. p & p.

Store and retrieve programs on any cassette recorder. Use for serial transmission down single line at up to 110 baud (teletype speed), e.g. over telephone line, and to communicate between two or more MK 14s.

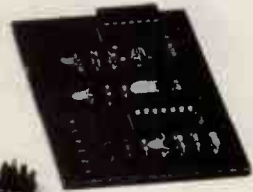

## POWER SUPPLY. £6.10 inc. p & p.

Delivers 8 V at 600 mA from 220/240 V mains - sufficient to drive all modules shown here simultaneously. Sealed plastic case, BS-approved.



## MK 14 MICROCOMPUTER KIT

£46.55 inc. p & p.

Widely-reviewed microcomputer kit with hexadecimal keyboard, display, 8 x 512-byte PROM, 256-byte RAM, and optional 16-lines I/O plus further 128 bytes of RAM.

Supplied with free manual to cover operations of all types - from games to basic maths to electronics design. Manual contains programs plus instructions for creating valuable personal programs. Also a superb education and training aid - an ideal introduction to computer technology.

Designed for fast, easy assembly; supplied with step-by-step instructions.

## PROM PROGRAMMER.

£11.85 inc. p & p.

Use to transfer your own program developed and debugged on the MK 14 RAM to PROM (74S571) to replace SCI0S monitor for special applications, e.g. model railway control. Software allows editing and verifying.

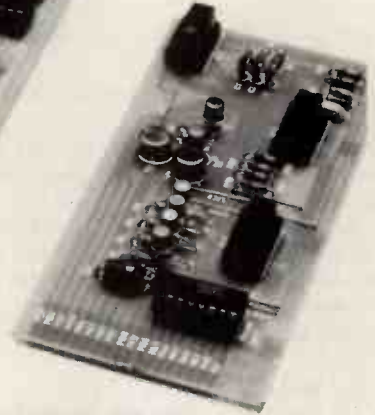

To order, complete coupon and post to Science of Cambridge for DELIVERY WITHIN 14 DAYS. Return as received within 14 days for full money refund if not completely satisfied.

To: Science of Cambridge Ltd, 6 Kings Parade, Cambridge, Cambs., CB2 1SN.

Please send me:

- MK 14 standard kit @ £46.55.
- Extra RAM @ £4.14 per pair.
- RAM I/O device @ £8.97.
- VDU module including character generator @ £33.75.
- VDU module without character generator @ £26.85.

- Cassette interface module @ £7.25.
  - PROM programmer @ £11.85.
  - Power supply @ £6.10.
  - Full technical details of the MK 14 System, with order form.
- All prices include p and p.

I enclose cheque/MO/PO for £ \_\_\_\_\_ (total).

Name \_\_\_\_\_

Address (please print) \_\_\_\_\_

Delivery within 14 days.

PC/10/79

# Science of Cambridge Ltd

6 Kings Parade, Cambridge, CAMBS., CB2 1SN.  
Tel: 0223 311488.

● Circle No. 187

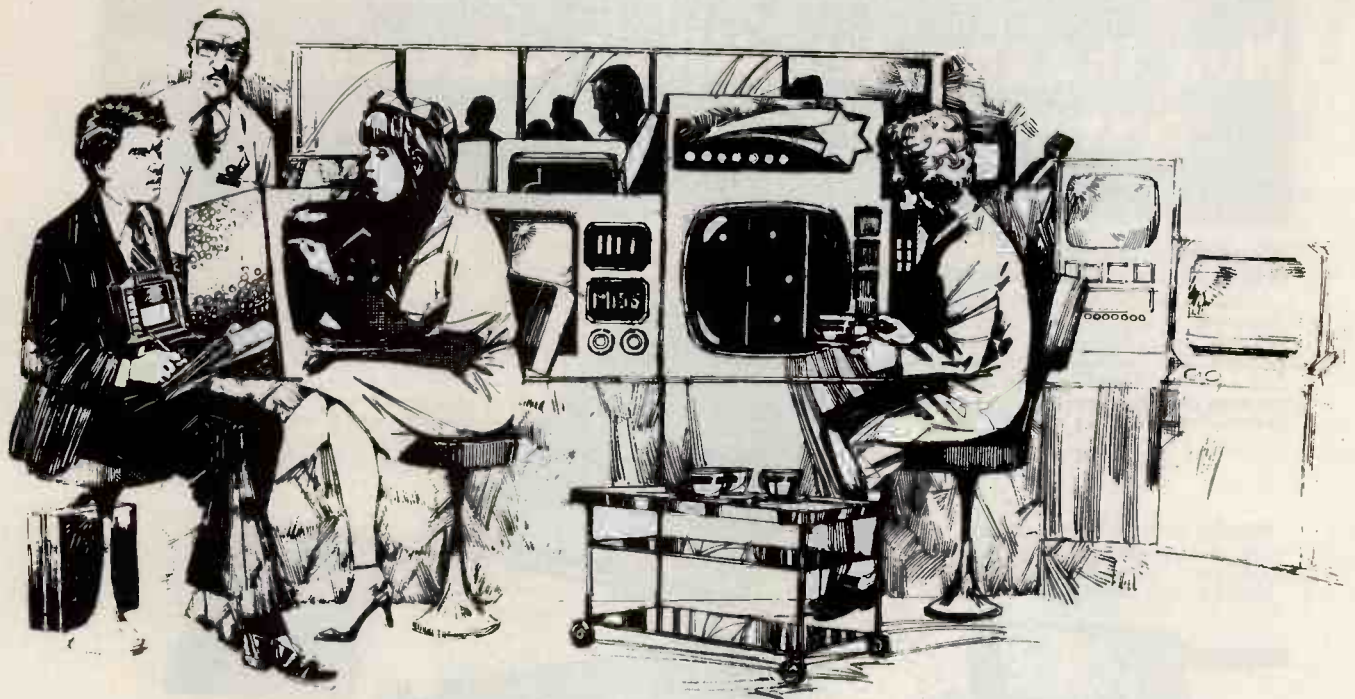

# Understudy

HE WAS alone on the lurching bus and had to put up with its chatty conversation.

"Nice weather for the time of year," the bus said. Somebody had hammered a ballpoint pen through its speaker grill; the tone was a trifle odd. Carson was in no mood for inanities and the day was absurdly hot for early spring: "It's snowing," he said.

There was a pause. The stuffy interior smelt of urine; the conductor who had sloped off and left the bus unmanned had much to answer for.

"I see in the news they have the employment figures up to 20 million," the bus offered.

"Shut up," said Carson without emotion.

"I see in the news they say these nucleonic computers will replace electronics; a likely story, the unions will never stand for it . . ."

"I think I get off here."

"Goodbye, sir or madam, it's been a pleasure meeting you," said the bus graciously as it halted and Carson stepped out.

TT Engineering's new factory was a long, low building with mysterious wings and spurs wandering off into the hinterland. It

**by David Langford**

looked ordinary, even boring, but it was supposed to house an amazingly-advanced and efficient human/computer workforce. Certainly TTE productivity was equalled by little else in the country which was why Carson was here.

"Paul Carson, *Daily Flag*," he said to the woman at the reception desk, who looked like a fashion model. She smiled, pressed a key on the terminal in front of her. "The manager will see you in a minute."

While the promised minute and several others passed, Carson checked his recorder. There was an art to trapping the correct phrases which he and the text editor could convert later to sparkling journalese, aimed unerringly at the lowest common denominator of *Flag* readership.

A tall man in ultra-suave clothes entered the reception hall,

radiating efficiency and expensive after-shave. Under his arm was clamped a wad of machine-printed notes.

"Good afternoon, Mr Carson," said the man with about as much genuine friendliness as the chat program on the bus. "I'm John Steen, the manager. We're really delighted to have you here and hope we'll be able to tell you all you need to create a fine feature on TTE."

"Thank you," said Carson cautiously. He would prefer evidence of, say, some flagrant violation of the labour quotas; but any old story would do to preserve his own job.

"Of course, it's our productivity which has made everybody sit up and take notice, eh?" said Steen. Of course it's our productivity which makes you stinking reporters think we're under-employing and using cheap automation — that was the unspoken message.

## Double meaning

Carson tried a double meaning of his own. "The public is very interested in your successful worker relations and their high degree of involvement." The key issue was involvement. A few firms had tried employing 200 dustpan-wielders and tea-makers to fill the quota while leaving the real work to cybernetics. The notion had led to massive disputes and eventually to the union agreement — in effect, unofficial legislation — requiring "involvement" of the workforce so that their skills were used properly . . .

"I suppose you'll want to look at the shop floor," said Steen.

"If I may," said Carson politely.

"It's our showpiece."

It didn't look like a shop floor at all. It looked like a giant amusement arcade — except that the blue-overalled men and women playing the machines were sitting, not standing.

"Looks like . . . an amusement arcade," said a puzzled Carson.

Steen smiled broadly. "I was betting you'd say that. Everybody says that. This, Mr Carson, is the ultimate in workshop safety; everything is remote-controlled from this hall, so our workers need never risk high voltages, dangerous tools or heavy machinery."

Carson looked over the shoulder of the nearest man. Red and green squares were swimming on the screen; the man was fiddling with buttons and bringing them into some sort of alignment.

"What's going on there?" he asked Steen.

"Him? I think he's mmm, checking tolerances on completed machinings."

"I know this sounds repetitious, but it looks more like some sort of video game . . ."

Steen snapped his fingers and smiled again. "There you have it. The reason why this sort of work interfacing has never been successful before is that watching a video monitor and pressing buttons is damned boring. Our big software investment is in programs which convert the workshop data into video analogues which are always *interesting*, which hold the mind like a space-battle game. The workers love it."

Carson blinked a couple of times. He felt that he was missing some point. "They play video games and *that* operates the production line?"

"They use their skills as they always did; our interfacing system merely ensures that the job is never boring or dangerous, you see."

### Flood of statistics

The manager strode down the long, well-carpeted hall and let loose a flood of statistics, in the manner of managers everywhere. His wad of printout was 20 pages thick, and he seemed ready to recite it all. TTE multiprocessor automation, it seemed, ranked just below the discovery of fire in Man's ascent towards godhood. The automatic fault-location (tell-me-three-times) had a poetic beauty which Shakespeare could never have attained, while the flowcharts of the engineering processes were worthy of the Sistine Chapel.

Carson would have liked to drop ostentatious pinches of salt into the mike grid of the recorder slung about his neck. He contented himself by murmuring "Oh yes," in the flattest tones possible, and by letting his attention wander again and again over the workers' shoulders. Some of the games — the control linkages, he reminded himself — looked so fascinating that he wanted to elbow the operators aside and try for himself.

"Very dedicated, your people," he said after a time. "Hardly any of them have even looked up since we came in."

"Yes; the system works," said Steen, offering a cigarette as though it were a prize for the most stunningly obvious remark of the day.

"But I still don't quite see . . ."

A low, pleasant tone sounded from hidden speakers, and the seated men and women looked up at last, as with perfect synchronisation a squad of white-coated people pushed in trolleys carrying familiar-looking urns.

"Let's not disturb the tea-break," said Carson above the sudden chatter as queues formed instantly at each trolley. "I'd like to look at the machines all this is controlling, if that's O.K."

Steen's face went blank for an instant. "No, no," he said smoothly, "you mustn't miss having a word with the lads. And lasses, of course. Don't they expect that of you at the *Flag*?"

### Revenge

It wasn't really the human-interest angle which Carson was seeking but he accepted the inevitable and listened as a selection of those present told him their names, very, very clearly — one even insisted on spelling his out — and explained how extraordinarily skilled were the things they did at their little consoles. Steen blandly introduced person after person to this celebrated newspaperman until Carson's head reeled and he suspected an insidious revenge for his lack of enthusiasm for statistics.

Then the tea-break ended; the consoles were manned without delay; and Carson was led away to peer through heavy wired-glass panels at a vast and insanely active machine shop where remote-controlled arms swung metal sheets and blocks with fearful precision among the jungle of lathes, drills and stamping

presses which functioned without visible operators.

The impassive eyes of TV cameras were everywhere. It was impressive; and it had to be safe, because there were no frail human bodies to be caught and crushed by implacable machinery. Steen pointed-out a remotely-controlled robot which was making repairs to one inactive laser cutter; even service engineers, it seemed, worked their healing wonders from afar.

Presently Carson was in the open air again, underwhelmed and waiting for his bus. He should have been overwhelmed by the wonders of technology, if Steen was to be believed; in fact, he was wondering which part of the tour had left the nasty taste in his mouth.

The bus arrived. It was the same one, still smelly and devoid of a conductor, and it said "Nice weather for the time of year" — almost before Carson had poked his credit card into its inviting slot.

"Your conversation tape needs changing," he told it, searching for a clean seat.

"I see in the news the employment figures . . ."

Carson wasn't listening. He thought he had pinpointed the give-away moment; the moment when Steen's face had gone blank and, out of the blue, he had urged a series of tedious interviews.

Why?

"I see in the news they say these nucleonic computers are going to replace electronics," said the bus, and Carson put his fingers in his ears.

Steen had not wanted him to go straight to the machine shop. Because something odd was happening there?

The workers controlled that production line through those fantastic video-game interfaces; amazing, incredible, what will they think of next. And so what?

Carson jerked upright. He gnawed his lip. Suppose the production line had been in full operation. In full operation while the workforce was still at its tea-break. Suppose that the massive software investment was running the whole of TTE while the required quota of workers was merely kept amused all day by — yes, sophisticated amusement-arcade games. Naturally Steen would keep visitors from the machine shop until the break was over. Naturally.

He laughed uncertainly. The notion was absurd.

Then he was thrown hard into the solid, metal-framed seat in front of his own. The top of the seat caught him in the chest and left him gasping helplessly.

### Goodbye

"Goodbye, sir or madam, it's been a pleasure meeting you," said the bus even less distinctly than before. To Carson's frantic imagination, the synthetic voice had an air of menace. He struggled to his feet on the now sloping floor, and saw that the bus had left the road at a sharp curve — no doubt to avoid the cyclist who, without a backward glance was pedalling furiously into the distance.

"Goodbye, sir or madam, it's been a pleasure meeting you."

In irritation, Carson tugged at the door. It would not open.

"Goodbye, sir or madam, it's been a pleasure meeting you."

Eventually he escaped through the emergency door and left the bus saying its endless goodbye while he took the long walk into town. By the time he arrived at the *Flag* office it was too late to file his story on TTE's wonders. Fortunately, as it proved, his text editor's emergency routines had saved things — contacting TTE's data network via telephone and extracting a bundle of facts indistinguishable from those related by Steen.

Then the text editor, which was a damned good one, had itself converted all this to sparkling journalese and slotted it into the *Flag* just before press time.

Reading the story next day, Carson had to admit that it could hardly have done a better job had the data input come from himself.

After a little more thought, he told himself firmly that his notion about TTE was totally incredible. 

# SORCERER™

Now becomes a professional word processor...as well!



The Sorcerer Computer is a completely assembled and tested computer system ready to plug in and use. The standard configuration includes 63 key typewriter-style keyboard and 16 key numeric pad, dual cassette I/O, with remote computer control at 300 and 1200 baud data rates, RS232 serial I/O for communication, parallel port for direct Centronics printer attachment, Z80 processor, 4K ROM operating system, 8K Microsoft BASIC in separate plug-in Rom Pac™ cartridge, composite video of 64 chars 30 lines, 128 upper/lower case ASCII character set and a 128 user-defined graphic symbols, up to 32K on-board RAM memory, operators manual,

BASIC programming manual and cassette/video cables, connection for S100 bus expansion unit.

The Word Processor Pac creates, edits, re-arranges and formats text. Features include auto wraparound, dynamic cursor control, variable line length, global search and replace, holding buffer for re-arrangement of text, right justification, line width and line to line spacing, underlining or boldfacing, text merging and a macro-facility permitting tasks such as form letter typing, multiple column printing or automatic forms entry.

NOW CONTACT YOUR LOCAL DEALER



OR SEND COUPON FOR FURTHER INFORMATION



### PRICES

	£
8K Sorcerer	650.00
16K Sorcerer	760.00
32K Sorcerer	859.00
630K Dual Disc Drive	1,200.00
143K Single Disc Drive	500.00
S100 Expansion Unit	210.00
Line Printer	850.00
Video Display	240.00
Development Pack	70.00
Technical Manual	8.95
Daisywheel type printer	1,900.00
Word processing pack	80.00
Video/disc unit	1,800.00
16K Memory expansion	110.00

### LANCASHIRE

051-2272535 MICRODIGITAL 25 Brunswick St., Liverpool L2 BJ

### WEST YORKSHIRE

0535 65094 BASIC COMPUTING Oakville, Oakworth Rd., Keighley

### SHEFFIELD

0742-668767 E.S. MICROCOMPUTERS 7 Berkley Precint, Ecclesall Rd., S11 8PN

### NORTH WALES

0248-52042 TRYFAN A/V SERVICES 3 Swifts Bldgs., High St., Bangor, Gwynedd

### AVON

0272-292375 ELECTROPRINT 5 Kingsdown Parade, Bristol BS6 5UD

### NORTHANTS

0536-83922 H.B. COMPUTERS LTD., 22 Newland St., Kettering

### LONDON & Counties

### BERKSHIRE

0635-30505 NEWBEAR COMPUTING STORE, 40 Bartholomew St., Newbury RG14 5LL

0753 22855 SLOUGH MICROSHOP, 120 High Street, Slough

### KENT

01-300 0380 INFORMEX 61 Harland Avenue, Sidcup, DA15 7NY

### SURREY

0276-34044 MICROBITS 34b London Rd., Blackwater, Camberley

01688 0088 EMG MICROCOMPUTERS LTD. 30 Heathfield Road, Croydon

0276-62506 T. & V.J. MICROCOMPUTERS 165 London Rd., Camberley

### CHESHIRE

061-445 8588 MICROPUTE 7 Westbourne, Manchester M20 8JA

Geoff Wilkinson,

FACTOR ONE Computers Ltd

11-17 Market Place, Poynton, Cheshire

Tel: 107361 66336 or 66565

Name \_\_\_\_\_

Address \_\_\_\_\_

Tel. No. \_\_\_\_\_

THE LONG-PREDICTED weeding-out process is now in full swing among many established companies in the microcomputer industry. In recent months, a number of pioneers have run into financial difficulty and have been forced into bankruptcy. Digital Group and Imsai are still doing business, but have been forced to re-organise under court supervision. Poly-Morphic, maker of the Poly 88, has managed to recover from court-supervised re-organisation and is back on its feet again.

Now, however, the Grim Reaper has laid his scythe to Processor Technology, maker of the famous Sol system and one of the first companies to manufacture S-100 boards as accessories for the Altair computer.

The dissolution of Processor Technology leaves a large number of users in the field, each of whom has investments of thousands of dollars, wondering how long they will be able to rely on their equipment and its software. The company has no further commitment to service or support or to provide any further documentation.

## Service centre

In an attempt to save Processor Technology users from total abandonment, the Processor Technology User Society, PROTEUS, is trying to amass all possible documentation and manuals and is looking for ways to make such information available to users. In addition, the society plans to organise a service centre using factory-trained technicians. The society also hopes to encourage independent manufacturers of Sol accessories to make another production run by assuring them that they will still find a market. Information on PROTEUS efforts can be obtained from PROTEUS, 1690 Woodside Rd., Suite 219, Redwood City, California 94061.

If we look at the origins of companies like Processor Technology, Imsai, Apple, and TDL — later known as Xitan — we see that they usually grew around a few young, very bright engineers and technicians. That was the beginning of the hobby and personal computer industry.

Many still remember the day that Steve Wozniak, one of the founders of Apple Computer, stood up at a meeting of the Homebrew Computer Club in Palo Alto and thanked those who had helped him get his home-built computer working. That computer was to become the Apple II and in less than four years the company it started would achieve a yearly sales figure of more than \$100 million.

It can be said safely that none of those companies produce bad products. Their troubles have been rooted in finance and in management. One of the key moves made by Steve Jobs and Wozniak, when they saw that Apple had the potential for phenomenal growth, was to decide not to try to retain total control of the company.

## The days of the reaper

The opposite was the case with TDL and Processor Technology, where the technical founders of the company retained their positions as executives and corporate officers as the firm grew. Experience has shown that they were not equal to the demands a large and growing market put on them. When the competition became intense, they folded.

Tom Williams, editor of the West Coast small systems paper, *The Intelligent Machines Journal*, sends this tale of nemesis.

Jobs and Wozniak sought an experienced entrepreneur in Mike Scott and relinquished a large portion of their ownership in exchange for his expertise and investment capital. Scott said at the outset that he would approach Apple as if it were a \$100 million per year company, and that is exactly what it became.

While other companies were dealing willy-nilly to a market which seemed boundless, Apple was doing serious market research and planning its strategy. Obtaining adequate financing to implement grandiose plans was the key. Apple did it by negotiating marketing arrangements with firms such as ITT and Dow Jones, and then presenting carefully thought-out business plans to sources of venture capital.

## Competition

The groundwork helped Apple weather the chaotic days of the infant industry in a competition which would enable it to face the second blow which was sure to come — competition from firmly established, large corporations, chief among which was Tandy, maker of the TRS-80.

As soon as the microcomputer market began to shift from the hobbyist to the small business customer, the big boys became interested, and competition assumed a different order of magnitude. The Tandy TRS-80 was sold and advertised in configurations aimed at the large user, the educator and the small business customer. Tandy also had what the smaller companies had to struggle to establish — vast capital, manufacturing facilities, and, vitally important, a wholly-owned worldwide distribution network.

A few OEM companies in Silicon Val-

ley found what appears to be the proper formula. Altos Computer Systems, a name not generally known, acted on the premise that a general-purpose system with disc mass storage, 32K to 64K of memory, able to time-share with four terminals or fewer, and sell for less than \$10,000 was the answer. Of course, technology, especially development of low-priced Winchester discs, had to be ready to fill the bill. Altos, however, has been using the formula for a year and a half and is doing \$5 million per year from a single building in Santa Clara.

The latest Tandy entry into the market seems to be following the same formula. The TRS-80 Model II is clearly targeted at the business customer. The basic unit has 32K of RAM and one 8-in. disc drive housed in a single cabinet. A disc add-on unit in a separate cabinet can add up to three more drives to the system and memory is expandable to 64K.

Many configurations and upgrades are

possible. An example of a high-level configuration consists of the basic unit with 64K of RAM, a Centronics printer, and three disc drives, all of which are double-density, mounted on a customised desk. The system sells for less than \$8,000.

The radical departure from TRS-80 Model I is that Basic is no longer resident in ROM but is loaded from disc. That frees the system to accept a variety of languages and operating systems without sacrificing address space which would be reserved for Basic.

The only factor missing from the TRS-80 Model II formula is multi-tasking and that seems to have been taken care of from a different source. Gary Kildall of Digital Research, creator of the popular CP/M operating system, says that he is developing a new version to be called CP/M 2.0.

## Colourful

In any case, the new TRS-80 will attract all kinds of sophisticated software development by a hoard of independent authors and among them will doubtless be time-share operating systems.

The engineers and entrepreneurs of Silicon Valley are among the most colourful and creative figures of American business. Their initiative and daring has created an entire industry where none existed four years previously.

What we are witnessing is no doubt an inevitable development, but it spells an end to a manifestation of what has long been an American fantasy — the dream of dazzling success through innovation and hard work. It came true for many in the microcomputer boom and in the process it started a technological revolution which will affect our lives profoundly. □

# Logic box

**NOW IN WESTMINSTER!**  
PETS, Compelec, Hewlett  
Packard . . . and more . . .



We sell most of the latest range of Commodore, H.P., Compelec equipment, plus Petsoft, Petact, business software, discs, stationery, voltage suppressors, desks, chairs and more. And we offer user seminars.

Logic Box Ltd.  
Planer Building  
Windmill Rd.  
Sunbury, Middx.  
(09327) 86262

Telex: 928185

Logic Box Ltd.  
31 Palmer St.  
(by Caxton Hall)  
London S.W.1.  
(01) 222 1122

## £1 a day keeps your Apple in play

### A 48K Apple II microcomputer will cost you less than £1 per day under our lease or lease/purchase facilities



£28.84 per month for 48K Apple II.

## Software not Soft Talk

During the last 18 months many Accountants have profitably used Padmede's Disc-Based Incomplete Record Accounting System. Many unique features are included e.g. analysis by Nominal Ledger and Account Codes, input direct from bank statement, selective code reporting, multiple runs of final accounts, etc. Hardware and software price £4,250.

Other software developed and installed with users includes:—

- Time and Cost Recording.
- Stock Control.
- Payroll.
- Job Costing.
- Order Processing.
- Sales Ledger
- Word Processing

For more information contact:—  
Padmede Ltd., The Tuns, High Street,  
Odiham, Nr. Basingstoke, Hants.  
Tel. Odiham (025-671) 2434.

● Circle No. 189

● Circle No. 190

# Winter story fully clothed in success

TONY WINTER is chairman and managing director of Grama (Winter), a clothing manufacturer who deals principally with the big Oxford Street stores in London. He works with corduroy, velvet and some tweeds, supplying separates to 160 shops, including Selfridges, Dickins & Jones, and most of the other big names you care to mention. He is the sole supplier of velvet and corduroy ties to Burtons and will tell you that "in velvet jackets and ties, I'm the keenest in the U.K. garment trade".

I visited him at his luxurious flat off Tottenham Court Road, a stone's throw from his office in Oxford Street. He keeps his computer in a small room, lined with leather-backed books and period furniture. It seemed an incongruous setting for a microcomputer but Winter explained that it was safer to keep it at home, as well as being convenient, a sentiment perhaps not shared wholly by his beautiful ex-model wife who can't drag him away from the thing when he's supposed to be relaxing.

Winter broke away from a family clothing business four years ago to set up on his own. He had a clear idea of what he wanted to do with his business, defining his market and products early. He based himself in Regent Street, with two secretaries, a clerk and an accountant, subcontracting the manufacture of the clothes. He was losing £300 to £400 a week on overheads while he was trying to establish himself.

## Nightmares

Winter knew he would fail if he didn't do something about this problem. He had heard a little about computers and thought that one of the new microcomputers could help. He approached Commodore in the U.S. and asked for a Pet to be sent directly to him, as they were not then available in the U.K. Unfortunately, it wasn't sophisticated enough to handle almost the entire running of his business and Winter started looking for another, larger machine.

He encountered, the SW1PC 6800 and, on further investigation, thought it could do the job. He bought the machine from the Byte Shop for £2,500.

The hardware configuration was a 20K CPU, now upgraded to 40K, double minifloppy disc drive, a CT-64 monitor and a Teletype 43 printer. There was very little software with the machine, and certainly none of it was able to run his business. So that proved to be his biggest problem with the system. There was nothing on the market to meet his

requirements or his budget and finally he wrote his own.

Winter suffered a few nightmares when he took delivery of the computer. "I thought it didn't work when I built it. I couldn't get it to do anything. For the first few weeks I was in a complete panic whenever I saw or thought about this monster sitting in the corner of my home".

He read and analysed the manual which he received with the machine and found one program, a telephone book, which enabled him to grasp the fundamentals of programming. Having been a student of philosophy for 10 years and having an interest in logic helped him to

age when you include the menu options of each section, and updates to all files require only about one or two hours a week. It is all based on numbers, so a minimum input is required, and operation is easy.

Winter claims that the package will "run up to four companies, eight bank accounts, 50 agents, 999 customers or suppliers, 1,000 stock items and 200 employees, depending on disc storage size. If address files are smaller, stock files can be enlarged".

It was not until a friend from the world of computers saw the program working that Winter realised its value: He was told

**Kay Floyd tells the story of a man who bought a computer to help run his business. The computer saves him up to £20,000 a year on overheads, has doubled his turnover, means that he spends only two hours a week updating his records, has given him time to finish his second degree, turned him into a competent programmer, and has led him to open the first computer shop in London's Oxford Street. This is how he did it.**

understand the basics of programming. "I had a natural inclination towards it which helped enormously", he said.

Still, the little program wasn't helping to run his business. He had to return to SWTPC for help. It sent one of its consultants to see him and to write some useful software for the machine.

"He did a program for me", says Winter, "and I could see, as he was writing it, that he was making mistakes. I helped him to put them right. I was paying around £100 a day and decided that it wasn't worth it.

"I thought that I could do just as well, so I persevered with my own programming and solved each problem as it arose". From that humble beginning, Winter went on to create Bus(iness) 1, a complete package which will run any business competently with a minimum of effort. "It was very difficult", he says. "Without enthusiasm, you'd give up very easily and throw the whole thing out of the window."

## Own design

Bus(iness) 1, on which he runs his company, is entirely his design and does not necessarily refer to the garment trade. The package contains 30 programs, including payroll, cashflow, profit and loss accounting, stock control, invoices, sales ledger, updating address files, to name a few.

There are some 60 entries in the pack-

that he could sell it for around £1,000. Not only for the work which had gone into it but also because there were plenty of people who needed that kind of software.

That convinced him to market it commercially and he will sell it to anyone for £275 plus VAT, or, amazingly enough, if you buy a system from him, he will throw in the software.

## Turnover doubled

He is not aiming the package at any specific market or business category. The only proviso he makes is that anyone who buys the machine and the package should have a turnover which justifies a £3,000 purchase. He feels that it would be particularly useful for mail order shops who want to keep an up-to-date eye on stocks.

So, once Winter had the necessary software to run his business, he moved immediately into cheaper premises in Oxford Street and reduced his staff to one — a manager to handle despatches. That saved him £300 a week. Now the software has been running he reckons that he has "doubled the turnover and reduced overheads by one-quarter".

If the business had continued to grow at the same rate, and without the computer, he would probably have been employing some 12 people by now. The computer is representing a saving of between £10,000 to £20,000 a year.

*(continued on next page)*



Tony Winter demonstrates the capabilities of Bus(iness)1 in the elegant surroundings of his London home.

(continued from previous page)

An added bonus, and another example of how it saves Winter money, is that he uses it for printing the labels he attaches to finished garments before they are sent to a store for retail sale. He used to

spend £2,000 a year on printing; now it costs around £300 using the computer.

The interest generated by Bus(iness) 1 has resulted in a new interest for the rag trade entrepreneur. After he finished his degree, the first computer shop in Oxford

Street was opened. GW Computers will sell the SWTPC 6800 and the 16K and 32K Pets. "The business is lifting-off far too rapidly", he says. "I have sold some computers before it has been opened officially".

He is modifying Bus(iness) 1 to run in 20K and also converting it to the 6502 processor. The package will run on both sizes of Pet machine.

Winter now spends two to three hours a week updating his records. This means he is free to spend a whole day with one of his 160 customers and know that his time and attention will not be demanded by the more mundane aspects of running a business.

He admits that he has had a few problems with the system, but "all of them stem from ignorance on my part", he says. Fortunately, SWTPC has an office around the corner from Winter's flat, so he can call at any time for spare parts and advice. He has progressed so quickly with the machine that he can now "get out a soldering iron and repair or replace most things alone".

Certainly, this is one of the most successful application stories of recent months. Let us hope it gives heart to those who may be in a similar position to Winter at the start of a venture. But, as he says, "You need enthusiasm" if you're to make it work. □

## And now the bad news

WHEN two or three whose business is to do with microcomputers are gathered together, one is likely to say the others, "The future of microcomputing lies with small business systems," and the others will purse their lips, look wise, nod their heads and mutter, "Indubitably," or "Without a doubt."

This is how things went in the office until one day we felt we had been through the loop once too often, and it was time for a practical trial of this universally-accepted proposition. So we found a small business system and found a small business, put the two together, and waited for the reaction.

In view of what happened next, we will draw a discreet mask over the name of the unfortunate people who supplied the system. We have no reason to think it works any worse, or, to put it more honestly, any more awfully than anyone else's. It was just bad luck that we happened to suggest the scheme to that company rather than some other firm.

The small business, however, has no reason to hide its head. If it could not get to grips with the system, then that is the fault of the system. The firm we selected, Tigermoth Ltd, sells children's clothes in two shops and by mail order. It is run by

two competent and busy women, Barbara Laurie, to whom the editor is married, and her partner, Carola Ritchie.

Like any retail business, Tigermoth operations depend for profitability on a quick turnaround of money invested in stock. Barbara says, "We have been thinking for some time about using computers; like everyone else, we are bombarded by people trying to sell them to us. If we could get a system which could tell you day by day how much money you had in the bank, how much you owed, which could do VAT and income tax figures straightaway, it would be a great help.

### First shock

"We've thought about computerised stock listing, because our staff spends time counting the stock, but we have so many stock lines that it really looks impossible to capture the data in the first place any more easily than writing by hand, as we do now. So we were interested in an accounting package, and willing to try this one. In fact, I was approaching a VAT return, which we have to do three-monthly, so I was interested to see how it would cope.

"The first shock was that the man who was going to bring it asked us to set aside

a day for him to explain. I suppose from one point of view a day isn't much, but from ours . . . We always have about 20 hours' work to do in a day, so this didn't bode very well. We set aside a Monday, however, and he brought his gear.

"I'd never seen a microcomputer before, and I hadn't realised how big it was. There was the computer, a printer and television thing, and a disc drive. We had to clear about half our main mail order room to make room for it. So we did that. Then we drew up our chairs, and he explained how to use it. He explained clearly and he said we understood particularly quickly, but it still took the whole day. Then he said — and this was a real stopper — that we should put aside about £30 for telephone calls for help to his office, and that it would take about two weeks to master the system.

"Next morning, however, I sat down with the books and typed-in the last three months' VAT inputs. That went fairly satisfactorily, except that I don't type, so the keyboard is very hard work for me; but I could see that you could get used to it.

"Then I ran the bit of program which added it all up and it came to a completely wrong total — being rather a sus-



picious character, I'd done it all by hand already, which took less time than typing-in the details.

"So I rang the office for help and they were busy and I rang again and they were still busy and I rang again and the man who knew was out, but he would ring back. So I left it and did something else.

"After two hours they rang back. It didn't help that the telephone was on another floor from the computer, so I had to make notes and run up and down, but in the end it emerged that the silly figures he'd put in the day before to demonstrate the system were still in the file and had been added to my real figures. Could we erase just those from the file? Not a chance. In the to-ing and fro-ing we managed to erase the whole file with my whole morning's work.

"Back to square one. Sit down again and re-enter 200-300 items from the

manual for an entirely different machine, that's why,' he said smugly, "and I'm sure he was right.

"By this time I was completely fed up with the whole thing. I was in a tearing temper, I'd wasted two valuable days' work, and all I had to show for it was a splitting headache. In the end I deducted the joke figures from the VAT totals by hand and they came to the right amount. So I suppose that was something.

"And the computer had some very good games on it which the children liked, so it wasn't entirely wasted. But as it stood, it was a very dear buy for £3,000. If I had that money to waste and a month to spare to waste it in, I'd go to the West Indies."

When the substance of these remarks was relayed to the supplier of the system, the reply was: "We knew there was something wrong when we had no telephone

simple, it's all there in front of you.

"Even if the system had worked perfectly, there would still be drawbacks. I can take all the firm's books and my calculator in a box to the country and do the accounts sitting in the garden. Or I can do them in bed. I don't have to worry that the ink will suddenly erase itself from the page but there's no telling what those wretched discs will do.

"I enjoy writing everything neatly and getting the sums right. I'm sure that one would get used to the computer, but it's bulky, its keyboard is difficult for me, I wasn't brought up — as my children have been — with television, so I don't like looking at the screen all day; it gives me a headache.

"This trial taught me that changing to a computer would be a far bigger proposition than I ever dreamed it would."

This particular system seemed at fault because there were no adequate software manuals. The software seemed to have been written with far too little attention to the possible bafflement of a naive user. It needs a great effort of imagination to understand what someone else does not know, and what difficulties his ignorance may lead him into.

In the past computers cost huge amounts of money and computer systems could be written in a high-handed way because their users had to make the effort to understand them. That has produced an elitist profession of programmers, who regard it as natural that outsiders would find their art incomprehensible. If small business systems are to make a mark in the world, however, their software has to be transparently lucid. If anyone of reasonable intelligence cannot make a program run, then the programmer is entirely to blame.

It was doubly unfortunate that among the files of this system there was an occasional plaintive little message "Fred", the screen would say; "I can't get this bit to run. Can you?"

## Tender care

Perhaps a new trade, more akin to a journalist who must anticipate a reader's ignorance and deal subtly with it before moving to weightier matters, is needed. With the spread of small systems using a moderately standard language, Basic — or perhaps Pascal — we may expect that in a few years people like the directors of Tigermoth will be writing their own systems, or using systems written by other drapers for their own use, rather than relying on the word of harried ex-mainframe programmers who are desperate to get some product sold and some money coming in.

To work well, it seems, small business systems need tender loving care and a long gentle period of proving and adaptation, which can be given only by the one hand which knows the business inside out, that of its owner. □

**The editor of Practical Computing tried a small business system on two women who run a medium-sized children's clothes business. This is the story of their troubles.**

bought ledger. If only I had so much spare time. But it was done and I was ready to run the VAT program again. To get that, you had to bring up a menu of programs and in the meantime I'd forgotten which program I wanted. They all looked much the same, so I picked one and pressed the menu number. It said 'enter date', which seemed odd because I didn't see the relevance, but I entered the date and it said 'Press Ctrl I for Index.' which I did and it said 'syntax error.' So I pressed M for menu and it said 'syntax error', so I turned the whole thing off and started again. Or, at least, tried to.

## Different manual

"The man who brought it had scribbled on a piece of paper how you got the wretched thing going, but that bit of paper had got buried and I looked it up in the manual. There was 1,000 pages of manual, so that took an hour, but in the end I found it and it said 'Put program disc in slot 5, type #Ctrl P, Return.' I did that and it said 'syntax error.'

"I rang the office and it was busy. I read through the paperwork again and it said 'If you have problems, type "Reset, 3DØG RUN" and away it will go.' Of course it didn't, and by this time I was in a real temper.

"I rang the office three more times and finally got through. I said to the voice: 'I typed 3DØG RUN and nothing happened,' and the voice just laughed. Another voice came along and I explained again. He said: 'Of course you don't type "#Ctrl P", you just type "Ctrl P". Naturally it won't work if you do that.

"Why, then," I asked through clenched teeth, "does that manual say #?" 'It's the

calls from Mrs Laurie after the first two days. Whenever we install a new system, we warn the switchboard to expect at least two calls a day for the first two weeks and we keep someone in the office to deal with them.

## Not a solution

"The real trouble was that Mrs Laurie wasn't sufficiently motivated. We asked her to try the 'system', she didn't particularly want to, and she didn't want to enough to persist with it. To be honest, we find that people must have a real problem before a computer is a solution. If they're getting along happily, as Mrs Laurie seems to be, the computer is a problem and not a solution.

"The kind of person who needs us is a one-man business where the one man is working all day making money and has to sit up nights doing his books. Then it's really worthwhile coming to us, because if he doesn't he'll be dead."

It seemed to us that, as so often, there was justice on both sides. It is unfortunate, however, that enthusiasts for small business systems don't make it plain how much hard work has to go into mastering them. It is also unfortunate that, in this case at least, the programs seemed to have been written by professional programmers who did not give enough thought to the difficulties of inexperienced users.

As Barbara Laurie says: "It's all very well them saying that it will take me only two weeks, and that it has to be me because I wouldn't want employees messing about with sensitive information, but suppose I get run over by a bus? At the moment, Carola — anyone — can pick up the books and work out our position. It's

WOULD YOU like to write a program which will converse with you in English, or a program to solve one of those problems about how long would it take 10 men to dig a 5ft hole if four men — or a program to help you understand your Agatha Christie novels? If so, the language you need is called LISP.

Many languages are used in programming computers. This is not a historical accident; it is genuinely easier to write a certain type of program in a language designed for the job. It is like groups of specialists using their own jargon when talking to each other; they could talk in layman's English but the jargon makes conversation simpler and more concise. In this way Basic has become established on microcomputers, Cobol is the normal data processing language, and Fortran is used in scientific work. The area in which LISP excels is artificial intelligence.

Let us look at a classic artificial intelligence program called DOCTOR. Figure

# The thinking computer's language

been replaced by a confusion of parentheses.

Rather than look further into the DOCTOR program, we will look at figure 2, which shows a simpler session at a computer, working in LISP. The parts of the text underlined were typed by the programmer. The session is an interchange of questions and answers. The programmer types a question in LISP form after the  
EVALUATE:

*finding answers* — evaluating expressions — while most programming languages are concerned with *doing* things one after another.

Going on with the session, the programmer asks for the value of X. X has not yet been given a value, and LISP makes that clear. The next expression has the value ASTRING but it also has the side effect that X is given a value. The programmer asks for the value of X again, it is ASTRING.

Next, in line 5, there is some more complicated arithmetic and we can begin to see why all those parentheses are there. Each matching pair of parentheses and the enclosed items make up a unit to be evaluated; in LISP this unit is called simply a list.

**MIKE GARDNER describes the language LISP — List Processing Language — which is much used in Artificial Intelligence work.**

1 is a transcript of a conversation between a "psychiatric patient" (me) and the program (written in LISP and running on an Apple II computer). The program was trying very hard to find some Freudian significance in the replies.

## Extended easily

The program is not very sophisticated. It looks for key words and returns — the programmer hopes — an appropriate response. There have been versions written in Basic, but in LISP the program is elegant enough to be extended easily to more significant natural language understanding applications. Here is a part of the program:

```
(COND
  ((MATCH ('*WORRIED *L) S)
   (PRINTL '(HOW LONG HAVE YOU BEEN
    WORRIED))
   (PRINTL (SUBST 'YOUR 'MY L))) ...
```

Here is how it works; don't worry about the details. S contains the whole of the patient's reply. MATCH is a function which looks through S for the word WORRIED. If it finds it, the rest of the reply is stored in L. The first PRINTL then prints the beginning of the computer's next question. The second PRINTL prints the remainder of the reply with every MY changed to YOUR. You can see how this works by comparing my first reply in the transcript to the question which follows.

This fragment of a LISP program looks somewhat different from the average Basic program. The line numbers, "X = X + 1" and FOR loops of Basic have

prompt, and the computer replies

VALUE IS:  
and then the answer. The question is called an "S-expression" in LISP jargon and finding the answer is called "evaluating" the expression. The first expression asks for the sum of the numbers 4 and 5. The value is 9 — no surprise. LISP is always concerned with the process of

## Repertoire

The first item in the list tells LISP what to do. For example, PLUS means "add up", SETQ means "set a value". This action is carried-out on the remaining

Figure 1. A conversation with the DOCTOR program.

```
APPLE : TELL ME WHAT WORRIES YOU
PATIENT : I AM WORRIED ABOUT FINISHING MY ARTICLE ON TIME
APPLE : HOW LONG HAVE YOU BEEN WORRIED ABOUT FINISHING YOUR
ARTICLE ON TIME?
PATIENT : SINCE THE BEGINNING OF THIS WEEK
APPLE : LET'S TALK ABOUT THE PEOPLE IN YOUR LIFE
PATIENT : MY MOTHER IS VERY GOOD TO ME
APPLE : TELL ME MORE ABOUT YOUR FAMILY
PATIENT : MY FATHER IS INTERESTED IN MODEL TRAINS
APPLE : HOW DO YOU GET ON WITH YOUR FATHER
PATIENT : HE WON'T LET ME DRIVE THE TRAINS
APPLE : EARLIER YOU SPOKE OF YOUR MOTHER
PATIENT : YES
APPLE : PLEASE DO NOT BE SO SHORT WITH ME
PATIENT : COMPUTERS DO NOT INTEREST HER VERY MUCH
APPLE : SO COMPUTERS DO NOT INTEREST HER VERY MUCH
DO MACHINES FRIGHTEN YOU?
PATIENT : NO
APPLE : PLEASE DO NOT BE SO SHORT WITH ME
PATIENT : YOU ARE REPEATING YOURSELF
APPLE : I AM AFRAID OUR TIME IS UP. NEXT PLEASE
```



items in the list. Back to line 5 in figure 2. PLUS has two things to add up, the 3 and the TIMES expression. The TIMES expression has to be worked-out first before PLUS can do its job. Complex LISP expressions can be built this way.

So far, LISP has given answers to some simple questions. What makes LISP a real programming language is the capability of adding to its repertoire of functions. In the session of figure 2, the programmer decided that he would like an easy way of subtracting two from a number. In line 6, he defines a new function called TWOLESS to do that. Thence, TWOLESS can be used in the same way as PLUS, TIMES and SETQ, as line 7 demonstrates.

This is an extremely important attribute of LISP. It is possible to define powerful, sophisticated functions in LISP which can be used as easily as the ordinary functions like PLUS and TIMES. The MATCH function used in the DOCTOR program is a good example. MATCH is a lengthy LISP program, built from basic LISP functions and other specially-defined functions.

Most computer programs deal with information about the real world. For example, a business might have a computer file of its customers' names, addresses and account details. Even before computerising that data the company probably will have devised a formal procedure for dealing with it. To gain the maximum from the computer system, it is usually necessary to formalise the procedure further and to restrict the categories of information stored.

## Novels

To add an interesting but unforeseen fact — for example, that J Smith & Co is a subsidiary of F Bloggs Ltd — could involve major surgery on the program and the data. Artificial intelligence has to take a more flexible approach, for two reasons.

Firstly, the business software can rely on some assumptions about the data — for example, that people's names are usually fewer than 20 characters long, or that a name and address is sufficient to contact a customer — it is not necessary to know whether he owns a yacht in the Mediterranean. Secondly, the operations to be carried-out on business data are well defined; the relationships between various items can be built into the structure of the program.

To illustrate how LISP can cope with information which is less structured, we'll consider a program which helps in reading "whodunnit" novels. The information we might like to remember is:

A list of the people involved.

Their physical appearance and characters.

A summary of the significant events and clues.

Who suspects whom, of what, why, and how sure they are.

When we start the book, we do not know how many characters there will be. Fortunately, the basic data structure in LISP is the list — in fact, LISP stands for LISt Processor. A list can contain any number of entries. At some stage our list of characters in LISP form might be; (SUSAN MARQUIS PROFESSOR GARDENER)

LISP is adept at adding to, deleting from and searching lists like this one.

Perhaps we read in the book that "a tall, bearded man ran down the track to the boathouse". Our program should help us work out who it could be. We already know that a name like PROFESSOR can have a value; in figure 2, X was given the value ASTRING. In LISP, it is easy to associate any number of properties with a name. When the book

Our PUT expression now looks like this;  
(PUT 'SUSAN 'SUSPECTS  
((MARQUIS MURDER LYING) (GARDENER  
THEFT)))

and we know that Susan thinks that the Marquis is a murderer and a liar, and that the gardener is a thief. We could go on to

Figure 2. A short computer session using LISP. Parts typed by programmer underlined.

```
EVALUATE : (PLUS 4 5)           1.
VALUE IS : 9
EVALUATE : X                     2.
VALUE IS : UNDEFINEDVALUE
EVALUATE : (SETQ X 'ASTRING)      3.
VALUE IS : ASTRING
EVALUATE : X                     4.
VALUE IS : ASTRING
EVALUATE : (PLUS 3 (TIMES 5 3))    5.
VALUE IS : 17
EVALUATE : (DEFINE TWOLESS (X)  
            (DIFFERENCE X 2))      6.
VALUE IS : TWOLESS
EVALUATE : (TWOLESS 45)           7.
VALUE IS : 43
```

tells us that the professor has dark hair we could record the fact by evaluating;  
(PUT 'PROFESSOR 'HAIRCOLOUR 'DARK)

If we wanted to discover the colour of the professor's hair later, the question,  
(GET 'PROFESSOR 'HAIRCOLOUR)  
would give it to us.

The problem of recording who suspects whom leads us into really interesting data structures. We now need to link the suspects, the crimes and the clues. The first stage is to keep a list of who suspects whom. For example, if Susan suspects the Marquis and the gardener;  
(PUT 'SUSAN 'SUSPECTS '(MARQUIS GARDENER))

will remember the fact. Note that the SUSPECTS property is a list, not a single word like DARK. In fact, we also want to remember of which crimes each person is suspected. Instead of the word MARQUIS we could have a list of the form  
(MARQUIS MURDER LYING)

add the reasons and relate them to the list of events.

The techniques for storing information in LISP is becoming clear — it is a combination of assigning properties to names and constructing nested lists. This is very general and powerful.

## Same form

You may have found already that it is difficult to tell the difference between programs and data in LISP. This is not surprising, because they have exactly the same form. LISP function definitions are nested lists, like our list of suspects and crimes. This gives LISP additional freedom; a LISP program can write or modify another program and then use it. This is used to advantage in dealing with computer algebra. For example, there are LISP programs to simplify algebraic

(continued on next page)

(continued from previous page)

expressions. Given the LISP expression:  
 (TIMES 3 (PLUS (TIMES X 2) (TIMES Y O)))  
 they would reply that this is the same as  
 (TIMES X 6)

and given that X had the value 4 would return the final value 24.

LISP is the only language, other than machine code, which has this equivalence between programs and data. Coupled with access to the computer operating system, this allows a complete programming environment to be built in LISP. An editor, compiler, filing system and debugging can be built on top of any LISP system, with no constraints on how novel the method of operating the computer becomes. These are particularly

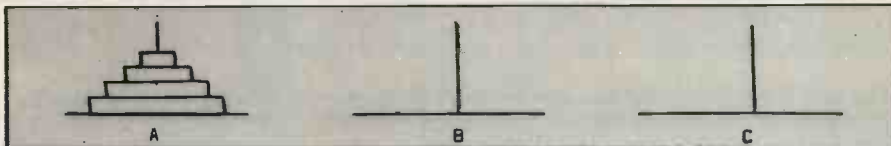

Figure 3. The Tower of Hanoi problem.

exciting possibilities on a microcomputer, which already has the advantage of very personal interactive computing.

A system which can generate such general data structures as our "whodunnit" SUSPECTS list must have similarly flexible means of handling them. The principle which applies here, and at all levels of artificial intelligence programming, is if a problem is too difficult, break it into smaller parts and apply the same method to the parts.

That way, so long as ultimately you reach a simple situation which can be handled, the initial complexity of the problem doesn't matter. This idea, translated into programming terms, is called recursion. We will see how LISP applies the principle to solving the Tower of Hanoi problem.

The problem is illustrated in figure 3. You have three pegs, one of which holds a pyramid of discs. You must transfer the pyramid from peg A to peg B, moving one disc at a time and never putting a larger disc on top of a smaller one. Figure 4 shows the essential part of the LISP program to do this. The function MOVE will move N discs FROM one peg TO another using the third as a SPARE.

If we had only one disc to move, the solution would be trivial — move it from one peg to the destination. Now we have the simple situation we can handle. In the program it is represented by the function TRANSFER-ONE. If there are more than one disc the strategy is as follows:

Move all but the bottom disc on to the spare peg.

Move the bottom disc on to the destination peg.

Figure 5. An integration problem which a computer would find easy.

$$\frac{x^4}{(1-x^2)^{3/2}} dx = \arcsin x + \frac{1}{3} \tan^3(\arcsin x) - \tan(\arcsin x)$$

Move the pile on the spare peg on to the destination peg.

We can manage the second task because it is another case of transferring one disc, but what about the first and third? We need a program to transfer a set of discs from one peg to another. Luckily that is exactly the program we are trying to write. With some juggling of which pegs are FROM, TO and SPARE, we can use MOVE to carry-out the first and third tasks. Note that these MOVES are easier than the original MOVE because one fewer peg has to be transferred.

The LISP program uses the COND (for CONDitional) function to test whether there is only one peg to be moved. If so, TRANSFER-ONE is used.

Otherwise the three-step process is performed, MOVE, TRANSFER-ONE then MOVE. SUB1 is a function which subtracts one from a number. All that needs to be added to make this program work is a definition of TRANSFER-ONE and another higher-level function to initialise the pegs and then call MOVE.

Now we have seen some of the LISP strong points, what about its weaknesses? One fundamental problem arises from

```
(DEFINE MOVE (FROM TO SPARE N)
  (COND
    ((EQUAL N 1) (TRANSFER-ONE FROM TO))
    (T (MOVE FROM SPARE TO (SUB1 N))
      (TRANSFER-ONE FROM TO)
      (MOVE SPARE TO FROM (SUB1 N))))))
```

Figure 4. Definition of central part of LISP program to solve Tower of Hanoi problem.

the flexibility of LISP data structures. Occasionally, LISP has to halt and tidy-up its data area. This takes a significant amount of computer time, between half-a-second and six seconds on a microprocessor. The result could be a strange pause in a computer game.

Certain operations in LISP are rather inefficient. String handling — e.g. finding the middle three letters of the word CATASTROPHE — is very slow. Finding, for example, the fifth member of a list is also slow compared to the means of finding the fifth element of an array in Basic.

Using LISP for extended arithmetic is tedious. For example, the Pythagoras



equation in Basic and LISP are:

```
BASIC Z = SQR (X * X + Y * Y)
LISP (SETQ Z (SQR (PLUS (TIMES X X)
  (TIMES Y Y))))
```

Most of these problems have been attacked by extensions to LISP by researchers with special needs. The result is that there are a number of dialects of LISP, for example MLISP, which has special facilities for algebraic expressions.

Like Basic, LISP programs are normally interpreted rather than compiled — they are stored and executed in a form similar to the way they are typed-in rather than converted into the computer machine code.

The major use of LISP is as a research tool in the field of artificial intelligence. There are, however, applications outside this area. In mathematics, LISP programs can perform integrations better than any human. Figure 5 gives an example the program would find easy.

LISP made a contribution to the

Apollo moon exploration programme. The geological examination of the many moon rocks led to a problem in handling the data. An important LISP program called LUNAR was written to answer questions like:

How many breccia rocks contain more than 10 percent mica?

What are their specimen numbers?

The program was in two parts. The first analysed the English question, using the rules of grammar and ideas about what the question probably concerned. The output was a question in a standard form. The second part took this question and applied it to the LISP style database. □

Mike Gardner sells his LISP package for the Apple II on cassette or disc (Apple DOS) at £30 plus VAT. Write to Owl Computers, 41 Stortford Hall Park, Bishops Stortford, Herts. Tel: 0279 52682.

Jeff Orr and Graham Knott are now offering:

# Analogue to Digital Conversion for your Pet

# £166

VAT Complete

## Petset 1

- ★16 Channel
- ★Complete with Pet interfacing
- ★100 microsecond per channel conversion time
- ★0.5% accuracy
- ★Comprises AIM 161, screw terminal board, Pet interface boards, power supply

### The AIM 161

is also

available for

use on Apple etc. or any microcomputer with 8-bit input

and 8-bit output ports **£130** + VAT Complete

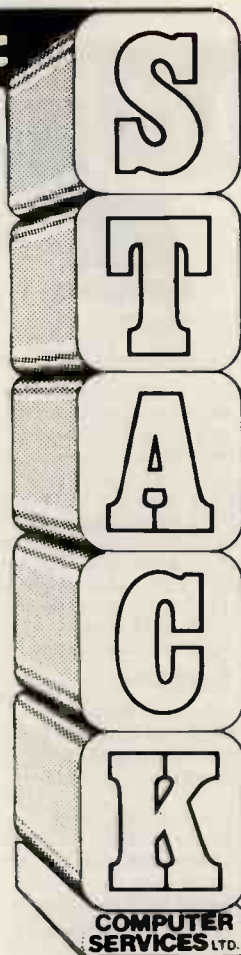

#### TECHNICAL SPECIFICATION

##### AIM 161

The AIM 161 is a 16 channel analogue to digital converter, designed to work with most micro-computers. It may be connected to the host computer directly, through the computer's 8-bit input and output, or via one of the various DAM system special interfaces.

##### Analogue Port Specification

The AIM 161 offers 16 channels allowing operation within the following basic parameters:

##### Normal Working

Input voltage, V<sub>in</sub>, conversion range:

0 to 5.12 Volts

Reference voltage, V<sub>ref</sub>:

-0 or 5.12 Volts

##### Absolute Maximums

Input voltage, V<sub>in</sub> (Max):

-3 to 5.4 Volts

Input current, I<sub>in</sub> (max):

2 microamps

##### Conversion Data

Time per channel, T<sub>c</sub>:

100 microseconds

Counts per channel:

256

Output range (per channel):

00-FF(hex)

0-255(decimal)

000-377(octal)

0000 0000-1111 1111(binary)

##### Accuracy

While the conversion is normally accurate within

.5%, in extreme cases this may extend to an

absolute maximum of .7%.

##### PETSET 1

This unit consists of 5 modules and is a complete ready-to run system for analogue data capture on the COMMODORE PET (all models). Whilst the AIM 161 can be used on any 8 bit microcomputer with the requisite I/O ports the PETSET 1 as the name suggests is specifically for the PET.

##### Modules

##### 1) IEEE PORT CONNECTOR

This PCB is used to connect the IEEE-488 bus of the PET to the AIM 161 for the issuing of Analogue line selects from the Pet. The IEEE Port is reproduced on the rear and side of the board so that the user is provided with an additional IEEE-488 port. The PCB is of open construction to facilitate additional linking.

##### 2) USER PORT CONNECTOR

This PCB is used to input the digitised signals from the AIM 161 to the PET and as with (1) the port is reproduced on the rear, the construction is open, and board is linked to (1) by a short ribbon cable.

##### 3) AIM 161

This is a cased unit, as usually no linking is done here. The AIM 161 is connected to the other boards by a ribbon cable. The unit contains the address decoding and the ADC chip.

##### 4) MANMOD

This is an open PCB which plugs directly into the AIM 161 unit and provides screw terminal connections for V<sub>ref</sub>, Gnd and analogue lines, for each of 16 channels.

##### 5) PSU

A small "calculator" style mains unit providing raw DC. to the AIM 161 which provides its own regulation.

##### USAGE

Very simple to use through basic or machine code e.g. to read a port in Basic.

POKE 59426,4—e.g. set address for line 4  
POKE 59426,255 —end address, start conversion  
?PEEK (59471)—capture data

(59426 is GPIB on IEEE-488)

(59471 is I/O on User port)

RING US FOR SPECIALIST REQUIREMENTS OR INFORMATION



PHONE US ON

# 051-924 1125

All prices are +VAT at 15% and include carriage. Please make cheques payable to Stack Computer Services Ltd.

for details of our catalogue or write

### Stack Computer Services Ltd.

### 1 Westward View, Waterloo, Liverpool L22 6RB

● Circle No. 191

**TVJ**

For Hardware, Software, Peripherals, Consultancy and Competitive Prices.

**MICROCOMPUTERS ETC**CAMBERLEY (0276) 62506  
BRISTOL (0272) 425077**PET**  
**Pet 2001**  
**From £435** **commodore**  
Authorised DealersNEW PET 2001 with large keyboard.  
From £ 630.00

PET 2001-16N (16K RAM and New Large Keyboard)	£630.00
PET 2001-32N (32K RAM and New Large Keyboard)	£750.00
PET 2001-4 (Standard PET with 4K memory)	£435.00
PET 2001-8 (Standard PET with 8K memory)	£515.00
PET 2040 (Dual Drive mini-floppy 343K User Storage)	£745.00
CBM 3022 (80 col. Printer with PET graphics—tractor feed)	£605.00
IEEE/RS232 Serial Interface 'A' Output only	£106.00
IEEE/RS232 Serial Interface 'B' Input/output	£186.00
IEEE-488/Centronics type parallel Interface	£45.00
PET C2N External Cassette Deck	£53.00
Interface to S100 (4 slot motherboard)	£112.00
IEEE to Pet Cable	£19.00
IEEE to IEEE Cable	£24.00

**Sorcerer**Now with the  
S100 Bus Expansion  
Interface and Dual  
Drive mini-floppy Disk **inc.**  
Authorised  
Dealers

Sorcerer 16K RAM (inc. UHF Modulator)	£740.00
Sorcerer 32K RAM (including UHF Modulator)	£840.00
Exidy Video Monitor (High Resolution)	£240.00
Exidy Dual Drive mini-floppy Disk (630K storage)	£1195.00
Exidy S100 Bus with Interface+Motherboard+PSU	£200.00
Exidy Mini-floppy Disk Drive (143K Storage)	£495.00
CP/M for Sorcerer on Disk	£145.00

**APPLE II/ITT 2020 /EUROAPPLE**

Computer with PALSOF in ROM (16K RAM) B/W	£799.00
Computer with PALSOF in ROM (16K RAM) Colour	£895.00
Apple mini-floppy Disk Drive (116K storage)	£425.00
Parallel Printer Interface Card	£110.00
High Speed Serial (RS232C) Card	£110.00
RAM Upgrade (16-32K, 32-48K) (Kit £80)	£ 85.00

**Advanced Systems**Altair, Equinox, Billings, Heath, Rair, Horizon. P. O. A.  
Installations to include hard disk, and multi tasking**Terminals** (Most Brands)

Pentland V1, 80 char./24 lines 2 page memory £550.00

**Ansaback** 'Phonemate' Telephone Answering Machine, voice operated twin cassette £190.00**Software**

<b>Petsoft COMPUSETTES</b> <b>Personal Software</b>	<b>GEMSOFT</b>
<b>Lifeboat Associates</b> (Authorised Dealerships, Send for Catalogues)	
PILOT (for TRS 80) text orientated language	£18.00
COMAC - Computerised Accounting for TRS 80	£50.00
STOCK CONTROL (TRS 80) Inventory, P/O & Invoicing	£125.00
CP/M for TRS 80	£95.00
CBASIC for TRS 80 & Sorcerer	£75.00
Estate/Employment Agency Systems, Fortran 80, Cobol 80, Pascal	

**Etc.**

Diskettes 5 1/4 (blank) boxed (min. order 10) each	from £3.00
C12 Cassettes (Min. order 10) each	£0.41
CBM KIM 1 Microcomputer System	£94.00
Computalk Speech Synthesis for S100	£350.00
Books - Large range of Microcomputer related books & magazines.	

If you don't see it - ask if we have it.

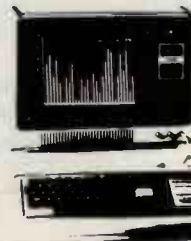
**TRS 80**  
**From £350**

Now available:

**TRS 80 Numeric Keypad**  
**Voice Synthesizer**  
**S100 Interface**

TRS 80, 4K Level 1 (Keyboard with 4K memory+ VDU+Cassette drive+240v PSU)	£365.00
TRS 80, 4K Level II (as above but with Level II basic)	£425.00
TRS 80, 16K Level II (as above but with 16K memory)	£499.00
TRS 80, 4K Level I - Keyboard+240v PSU only	£350.00
TRS 80, Expansion Interface with 16K RAM	£275.00
TRS 80, Expansion Interface with 32K RAM	£360.00
Shugart Mini-floppy Disk Drive (including PSU)	£315.00
Micropolis Mini-floppy Disk Drive (including PSU)	£350.00
Percom FD200 Mini-floppy Disk Drive (inc. PSU) 110v.	£299.00
Micropolis Dual Drive (394K) (including PSU)	£1195.00
TVJ 232T Serial Interface for TRS 80	£45.00
TRS 80 Screen Printer (text+graphics) (110V)	£445.00
Centronics Parallel Printer Interface for TRS 80	£45.00
TRS 80 Voice Synthesizer	£345.00
TRS 80 Numeric Key Pad supplied & fitted	£69.00
New Radio Shack Micro Printer	£245.00
Radio Shack Phone Modem	£160.00
NEWDOS Super-enhanced TRSDOS	£49.00
Level III Super-enhanced BASIC	£34.00
RSM Assemble/Monitor on Disk	£19.95
MICROCHESS or SARGON CHESS Cassette/Disk	£14.00
UHF Modulators (encased with leads for 625 lines)	£20.00
RAM upgrade (4-16K, 16-32K, 32-48K) supplied and fitted at our premises (Kit £80)	£ 85.00
Switchable selection of Level I or Level II (ROMS required)	£25.00
Automatic volume control (AVC) for CLOAD	£25.00
'Electric Pencil' text/word processing package (on cassette)	£65.00
'Electric Pencil' text/word processing package (disk version)	£109.00
'Electric Pencil' keyboard mod. to give lower case with text/word processing package.	£28.00
S100 Interface for TRS 80 (6 slots)	£375.00
'Library 100' - 100 progs for TRS 80 on cassette (Level II)	£39.00

NOW AVAILABLE

**CompuColor II**

Computer with colour Monitor, Keyboard and Integral Disk Drive	
From only	£1058.00
Second Disk Drive	£316.00
Programmed Diskette albums available from	£ 9.00

**Printers**

Teletype 43 KSR Serial Printer	£825.00
Teletype 33 KSR Serial (110 Baud) Reconditioned	£550.00
Centronics 779 parallel (friction feed)	£750.00
Centronics 779 parallel printer (tractor feed)	£825.00
Centronics 701 parallel printer, Bi-directional+tractor (Reconditioned)	£1375.00
Centronics Micro printer (20, 40, 80 columns selectable)	£395.00
PRINTERM 879 Pin feed (100c.p.s. bi-directional)	£695.00
HEATH WH 14	£510.00
TRENDCOM 100 (40 c.p.s. bi-directional, thermal)	£243.00
QUME or DIABLO daisy wheel serial printers	P. O. A.

PRICES EXCLUDE VAT, FREIGHT &amp; HANDLING. SEND OR PHONE FOR PRICE LIST &amp; BROCHURES (All prices correct at time of compilation)

Directors: Dr. R. V. King, BA, MIEE.  
S. G. Johnson, BSc. (Hons.)  
T. S. Johnson, ABIBA, ACMB, FBSC, MBIM  
A. S. Barton, ACII, ABIBA, CdrPAF.**T & V JOHNSON (MICROCOMPUTERS ETC) LTD.**Member of the TV Johnson Group of Companies  
165 London Road, Camberley, Surrey GU15 3JS  
48 Gloucester Road, Bristol BS7 8BHBranches at: Birmingham, Bristol, Edinburgh, Leeds, London, Louth,  
Newmarket, Nottingham, Oxford, Byfleet, Wokingham.CAMBERLEY (0276) 62506  
BRISTOL (0272) 425077

Telex 858893

Hours of business 9.30-5.30 Mon-Fri. 9.30-1.00 Sat.

+ Ansaback eves and w/ends.

# Everything you always wanted to plug into your PET, APPLE or TRS-80\*

TRS-80  
HARDWARE

TRS-80  
SOFTWARE

## DOUBLE DENSITY DISK STORAGE FOR THE TRS-80 (220% capacity of Radio Shack's)

TRS-80 owners can now increase their on-line mass storage capacity to 200K bytes. How? By using the 77 track Micropolis model 1033-II dual drives.

Cost: only £1195 for two drives, to give 394K on-line.

How does it work? By writing on 77 tracks (instead of the conventional 35) with precision head positioning.

How do I use it? TVJ Microcomputers Etc. provides you with a special program to let your TRS-80 DOS know there are extra tracks. This program was written especially by Randy Cook, author of TRS-80 DOS.

Will the double density disk work with my Radio Shack drives? Yes, except of course for copying an entire 77 track disk to a 35 track drive.

### NEW

Radio Shack Voice Synthesizer for TRS 80 provides the ability to speak in English and limited foreign languages. Capable of producing 62 phonemes (sound units) that are the building blocks of spoken language. Includes audio amplifier and speaker. . . . . £345.

TRS 80 Printer Interface Cable — allows you to connect a parallel printer (e.g. Centronics 700 series) directly to your Level II Keyboard, i.e. Expansion Interface not required. . . . . £54.

TRS 80 Numeric Keypad Mod. — Calculator Style Numeric Key pad which sits to the right of the standard keypad; has keys for 0 to 9, decimal point and ENTER. Both Keyboards active at the same time. . . . . £69.

Radio Shack Microprinter for TRS 80, 40 column 2½" electro-static Printer, switch selectable RS232 Centronics Parallel and TRS 80 BUS Interfaces . . . . . £245.

TRENDCOM Printers for TRS 80, PET or APPLE. 40 cps, 40 column Thermal Printer . . . . . £243.

TRS 80 Interface for Trendcom Printer . . . . . £29.

PET/APPLE Interface for Trendcom Printer . . . . . £49.

### APPLE

SPEECHLAB — provides voice control for the Apple. Train your Apple to understand and act upon the spoken word (inc. microphone) . . . . . £165.00

REAL TIME CLOCK — 1/1000 sec. to 388 days with interrupt;

Software controllable, Rechargeable Battery back-up when A/C power off . . . . . £165.00

GRAPHICS LIGHT PEN. . . . . £165.00

PASCAL CARD — Powerful new language for the Business User . . . . . P.O.A.

COMMUNICATIONS CARD, allows APPLE to exchange data with a remote computer over ordinary telephone lines through a modem . . . . . £140.00

AC line controller — allows APPLE to monitor and control AC devices remotely . . . . . £270.00

T & V JOHNSON (MICROCOMPUTERS ETC) LTD.  
Member of the TV Johnson Group of Companies  
165 London Road, Camberley, Surrey GU15 3JS  
48 Gloucester Road, Bristol BS7 8BH

DATA MANAGEMENT/REPORT GENERATOR — easily formats disk files, allows entry, edit, delete & list of records; and retrieves data for display or calculation on screen or printer . . . . . £200.

ELECTRIC PENCIL — powerful word processor allows full cursor movement, insert/delete, string search, block movement, adjustable line length, justification (on cassette) . £65.

LOWER CASE MOD KIT FOR ABOVE . . . . . £28

DISK BASED WORD PROCESSING PACKAGE. . . £124.95

RSM-2D DISK MONITOR — powerful system manipulates disk data, has Z-80 breakpoint routine. . . . . £25

ESP-1 EDITOR/ASSEMBLER . . . . . £29.95

RSM-IS MACH, LANGUAGE MONITOR tape base. £23.95

DCV DISK CONVERSION UTILITY — use with TAPE-DISK utility to save system tapes on disk (i.e.) Pencil. £9.95

UTILITY PACK 1 — a) Libloader merges from tapes

b) Renumber (spec. mem. size); Statement analysis for debussing.....£9.95 ea. all 3 for £24.95

SARGON CHESS — 16K lv II — the 1978 champ . . . . £14

MICROCHESS 1.5 by Jennings — 4K any lev . . . . . £14

LIBRARY 100 — an assortment of 100 programs for. . £39

MAZE — random maze on the TRS-80 graphics. . . . £14

Ask about our COMPLETE BUSINESS SYSTEM

FORTRAN IV FOR THE TRS-80! Finally, for high speed calculations on your micro, MICROSOFT's FORTRAN can

speed up those computation-bound programs. Complete package includes compiler, relocatable assembler, text

editor, and linking loader. . . . . £244.

CP/M + CBASIC for TRS-80 . . . . . £170.

NEW DOS — TRSDOS with corrections & enhancements £25

NEW DOS+ — As above but with further facilities:- KBFIX,

RENUM, Screen to Printer one step, DOS commands from

BASIC, Level I in II, SUPERZAP, Disassembler, Open 'E'

to end of sequential file, Load and Save faster, List

variables . . . . . £49.

### PET

JOYSTICK PACKAGE — complete with connector, software, instructiond . . . . £39.95 single, . . . . £59.95 dual.

MICROCHESS 2.0 by Jennings . . . . . £14

ASTROLOGY/NATAL PACKAGE — sophisticated chart computation with PET graphics . . . . . £14.95

SUBS — best graphics yet — drop depth charges on the subs below you and rack up points. Complete adjustability for many same variations. . . . . £19.95

SUPER MAZE — 2 games in 1: Tunnel vision lets you travel through the maze in perspective with graphics, also Kat'n'

mouse chase. . . . . £19.95

74 COMMON BASIC PROGRAMS on 1 tape . . . . . £15

19 different games at . . . . . £9.95

PETACT BUSINESS SYSTEMS. . . . . P.O.A.



Branches at: Birmingham, Bristol, Edinburgh, Leeds, London, Louth, Newmarket, Nottingham, Oxford, Byfleet, Wokingham.

● Circle No. 192

# U. K. — Micro Supplies — SCOTLAND

03374-795

## FLOPPY DISCS MICROPOLIS

1041-1 315K drive + controller Cable + BASIC, ASSEMBLER, + EDITOR only	£595.00
1015-11 315K drive — add-on other products on application	£395.00
DS525-10 Pack of 10 5¼ in. floppy disk	£30.00

## S100 BOARDS

SD Sales 32K Ram 375 ns Assm. +tested	£355
JADE Z80 2 mhz Assm. +tested	£140
MIKOS 15 slot Mother Board Assm. +tested	£110
MIKOS 2 Parallel/2 Serial Assm. +tested	£130
MIKOS 16K Erom (No 2708's) Assm. +tested	£110
MIKOS Extender Board Assm. +tested	£47
MIKOS Real time clock 2 interrupt Assm. +tested	£120
DSEL P.S.U. Kit +8v ±16v 4A Assm. +tested	£175

## V. D. U.s LIER SIEGLER

ADM 3A Introductory Offer	£560.00
---------------------------	---------

## SOFTWARE

CP/M for Micropolis	£90
MACRO for above	£60
TAILORED Software for all applications	

## PRINTERS CENTRONICS

Centronics 779	£785.00
Centronics 701	£1210.00
Centronics 703	£1894.00

## SYSTEMS

U.K. DISTRIBUTOR for  
SDS-200 (SD Sales) also HORIZON,  
CROMEMCO, DATA SYSTEM 800, 801

FULL SERVICE & BACK-UP FACILITIES AVAILABLE

Telephone for all Non-Listed items  
OEM & DISCOUNTS on Application

ACCESS BARCLAYCARD  
Delivery at cost — Prices exclude VAT

**DATA SYSTEMS SUPPLIES LTD.**

SHORE HEAD ROAD, INDUSTRIAL ESTATE,  
NEWBURGH, FIFE, SCOTLAND.

**03374-795**

● Circle No. 193

## INTEGRATED SMALL BUSINESS SOFTWARE

- ISBS -

FAST AND EASY TO USE ISBS MEANS INCREASED EFFICIENCY  
AND PROFITABILITY - PUT IT TO WORK FOR YOUR BUSINESS

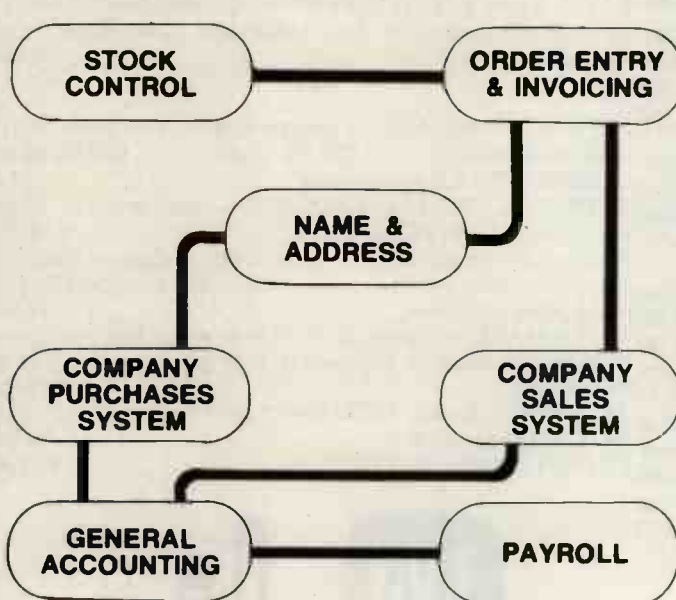

ISBS

	£
STOCK CONTROL	350
ORDER ENTRY & INVOICING	350
NAME & ADDRESS SYSTEM	250
COMPANY PURCHASES SYSTEM	450
COMPANY SALES SYSTEM	450
GENERAL ACCOUNTING	400
PAYROLL	500

Packages supplied on floppy disk with easy to follow Reference Manuals — NO PREVIOUS COMPUTER KNOWLEDGE REQUIRED TO OPERATE. ISBS runs on 48K Northstar Horizon, Rair Black Box or other systems supporting CP/M\* — plus VDU and 132 col printer. Complete suite or individual packages available now and are fully supported.

Other software packages available include Time Recording Systems, Finance Control and many others. Special application software undertaken for Northstar & Black Box and also complete TURNKEY SYSTEMS.

\*CP/M registered trademark of Digital Research.  
Costs shown exclusive of VAT.  
Dealer enquiries welcome.

**GRAFFCOM**

52 SHAFTESBURY AV. LONDON W1.

01-734-8862

● Circle No. 194



# Shooting for a bullseye

THE OLYMPIC GAMES next year will use as much computer power as any large computer services company to record and display the results of the many events. Not many amateurs will have that amount of power available, of course, but a small club can easily handle the scoreboard requirements of a local sports meeting.

The Scottish Amateur Computer Society did that at the end of February, when it ran a Society project to provide 'electronic scoreboard' facilities at the annual Scottish Universities' Rifle-Shooting Championships.

The project used a computer and VDU to replace a large hand-written scoreboard and included additional running totals and individual leaders' displays. The SURC competition is a

would have been safer to use two or three files with a checkpoint number included, allowing the program to select the oldest file for over-writing. A smaller system could write checkpoints to tape, with the operator changing cassettes after each batch of scores had been saved. A re-start was achieved by reading back the checkpoint file.

If we had been using a flip-flop between two files, the program could again

would be easy to write a program to accept commands such as DISPLAY GLASGOW; but the instruction sheet to go with the program would be longer than the program, and would be too complicated for wide acceptance.

The tried and tested 'menu' format is easy to write, to teach, and to use, and allows some useful extensions to a 'wordy' command language.

The main menu in our case displayed the following functions:

- 1 TAKE A CHECKPOINT
- 2 RESTART FROM CHECKPOINT
- 3 DISPLAY ALL TEAMS
- 4 DISPLAY MEMBERS OF A TEAM
- 5 ALTER TEAM NAMES
- 6 ALTER MEMBERS' NAMES
- 7 RE-ENTER SCORES
- 8 ENTER NEW SCORES
- 9 LIST INDIVIDUAL LEADERS

**Have you ever wanted an electronic scoreboard? This is how W. Davidson, of the Scottish Amateur Computer Society, hit the bullseye.**

specific application but the techniques used could form the foundations of a wide range of scoreboard systems. The main limitation of the system to be described is that it handles team events with accumulating points, rather than the one-against-one type of competition.

The rifle shooting project covered concurrent sections:

- A main team of eight, each competitor returning three scores.
- A women's team of four, two scores each.
- The highest individual aggregates from the two team events.

The program we used treated each team as a single unit, splitting it into the 'main' and 'women's' section after the eighth team member. Each composite team was displayed as a single VDU page, with a list of the teams entered on a separate page. Each team display included team name, up to 12 members' names — each with up to three scores and total — and the running totals for both team sections. The individual totals were also selected and sorted to list the winners of the Individual Champion parts of the competition.

## Re-start facility

We also needed data entry facilities at the start of the competition and we had to update scores as the results were passed from the adjudicators.

The competition was a full-day event, with results in batches every 10 minutes. It would have been disastrous if a power cut had happened in the last few minutes of the day, losing all data entered. To ensure against this, we included a 'checkpoint re-start' facility. After each batch of scores was entered, all scores and names were written to a floppy disc file.

We took a calculated risk by using only one file, over-writing it each time; it

decide which one to use. If the checkpoint number is the last thing written, the correct file will be read back even if the system fails while a checkpoint is being taken.

A scoreboard program should be used by the competitors and competition staff, not the authors of the program. So a simple and unambiguous command format is needed, together with extensive error-detection and reporting routines. It

Organisation of the scoreboard menu.

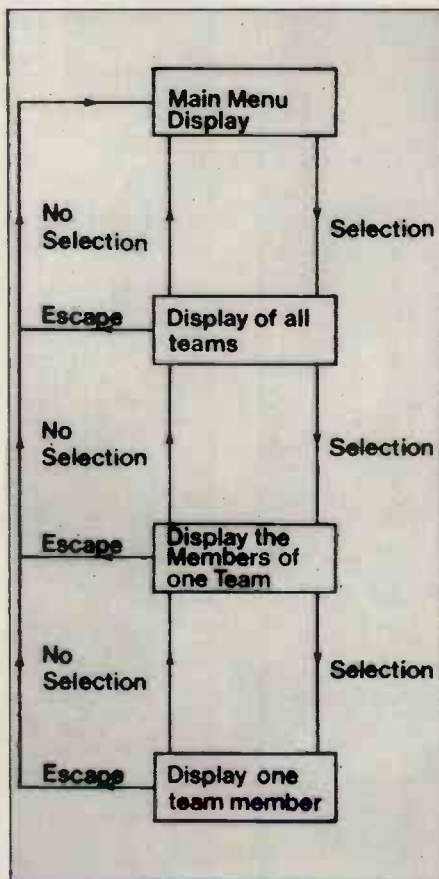

It then asked for a single-digit reply. As we were expecting non-technical users, we always displayed a reminder that the RETURN key must be pressed when the reply was complete.

It is obvious that most functions need to be told which team is to be used, so the team display produced by function 3 also serves as a menu to select a team for further operations.

The same applies to the list of team members, which is also used to select an individual when changing scores or names. The function number from the main menu is used to select which options, if any, are available from these displays.

## Command routine

Once a team is selected, control remains with that team until RETURN is pressed with no selection made. This allows several scores in the same team to be updated without going back to the main menu each time. The ESCAPE key is used to return directly to the function list from any point in the program, without having to step back through several displays.

To save time, and to allow users to become expert in displaying and altering scores, the command format was extended in two ways. The team and individual selections allowed a single number; or the response could be ALL. This was used to process each team or individual in turn, returning to the appropriate menu only when the display loop was complete.

A command input subroutine was written to allow several commands to be entered at once. A line of input was saved

(continued from previous page)

(continued from previous page)

in a buffer, and commands returned to the main program one at a time. The subroutine prompted for more input if the buffer was empty when called. This allowed, say, 4/3 to be entered in reply to the function list, to display the members (function 4) of team 3. The slash was used to separate commands, and was removed by the subroutine.

This technique has proved very useful in other applications, particularly where optional input is required. Basic is usually upset if two values are to be input but only one is entered. When a subroutine is used to buffer input lines and a call returns a null string, any variables not entered can be assumed to have a default value.

Although the SURC competition is very much a social occasion as well as a competitive meeting, we felt it advisable to protect the input functions from unauthorised tampering. We had to ensure against accidental misuse, as well as unlikely cheating. The secure functions

required a password to be entered correctly before the function started.

The NOECHO function of our Basic was used to prevent the passwords being displayed while they were being entered. The re-start function was protected by its own password. A number of competitors tried to follow the typist's fingers but even after six hours of detective work nobody came within one letter of the correct replies.

Extensive error-detection was required to catch entries of letters where numbers were required or numbers out of range. These routines displayed a message to indicate what input was expected and also cleared the command buffer so that further commands would not be interpreted as the correction. As can be seen from the flowcharts, the error routines allowed the user to continue from where the error was detected.

Function 7, RE-ENTER SCORES, was needed because of possible typing errors; but in addition the rules of rifle-shooting competitions allow competitors

to challenge the scoring of their targets. When a successful challenge is made, the recorded scores must be changed.

The program keeps count of how many scores have been entered for each individual so that new scores are displayed in the correct position; but for changes the user must specify which score is to be changed. If the latest score for an individual is changed to zero, the count is decremented.

The display of individual leaders proved to be the most interesting part to write. A full sort of up to 100 scores would have taken a very long time, especially in Basic, but only the top six scores from each team section were to be listed. This was the only part of the program where we had to look seriously at the response time. The algorithm we used was broadly:

- Allow for eight scores and sets of array subscripts to be saved.
- Set saved scores to zero initially.
- Compare each score in turn to the lowest saved score.

Flowcharts for the scoreboard program. In accordance with good flowcharting practice, Davidson has drawn one chart to one page, with continuation boxes — the downward-pointing arrows — to lead from one exit point to the corresponding entry.

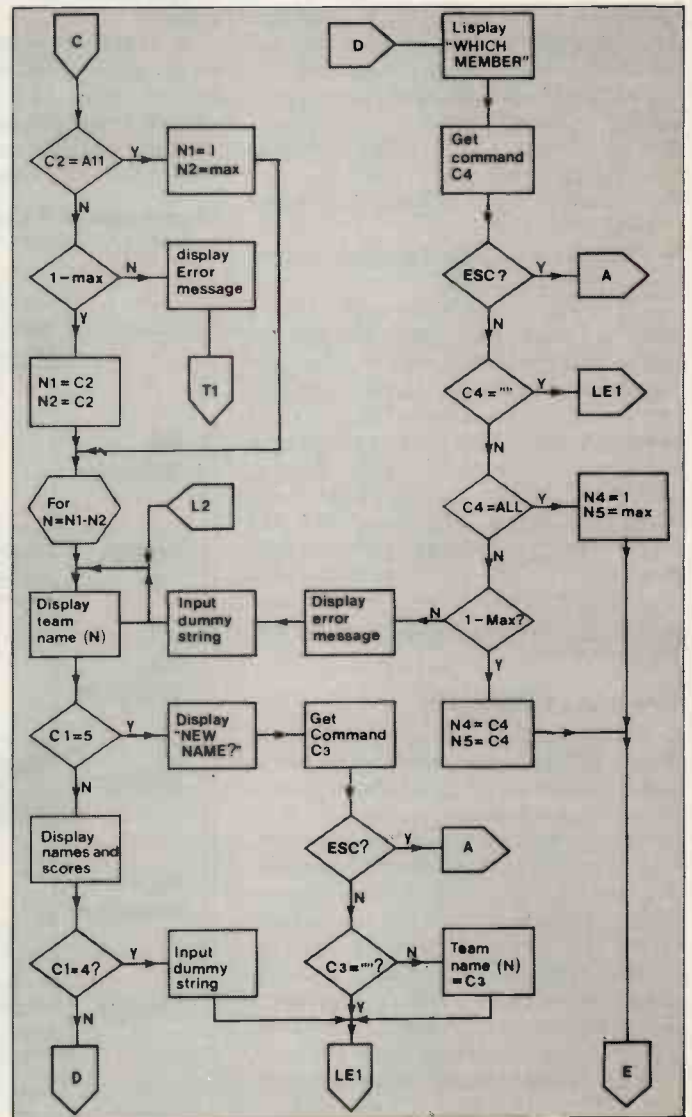
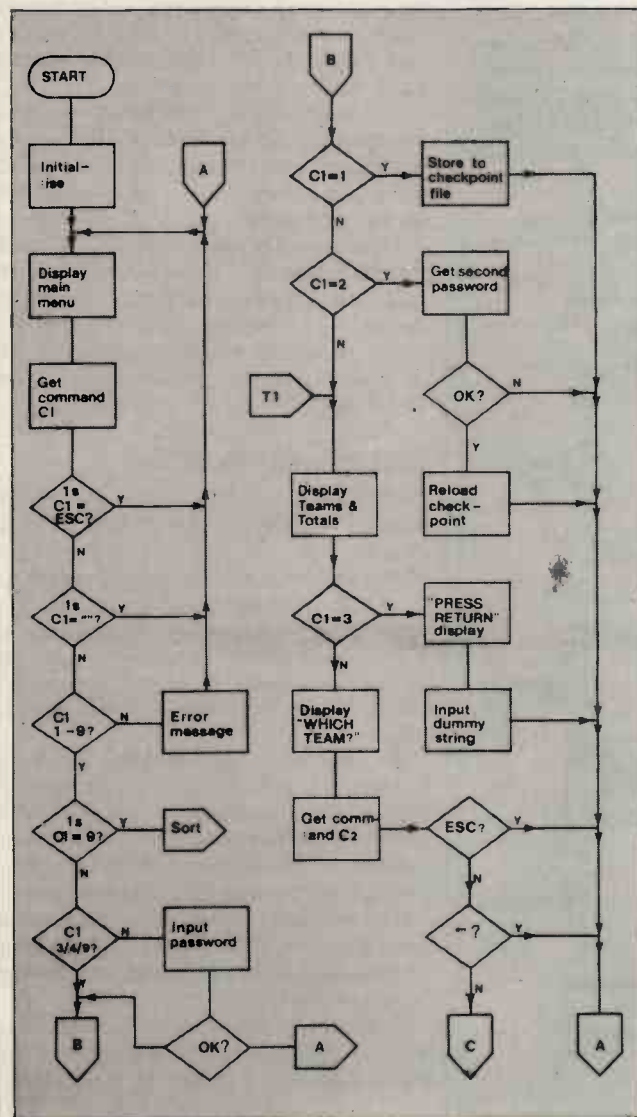

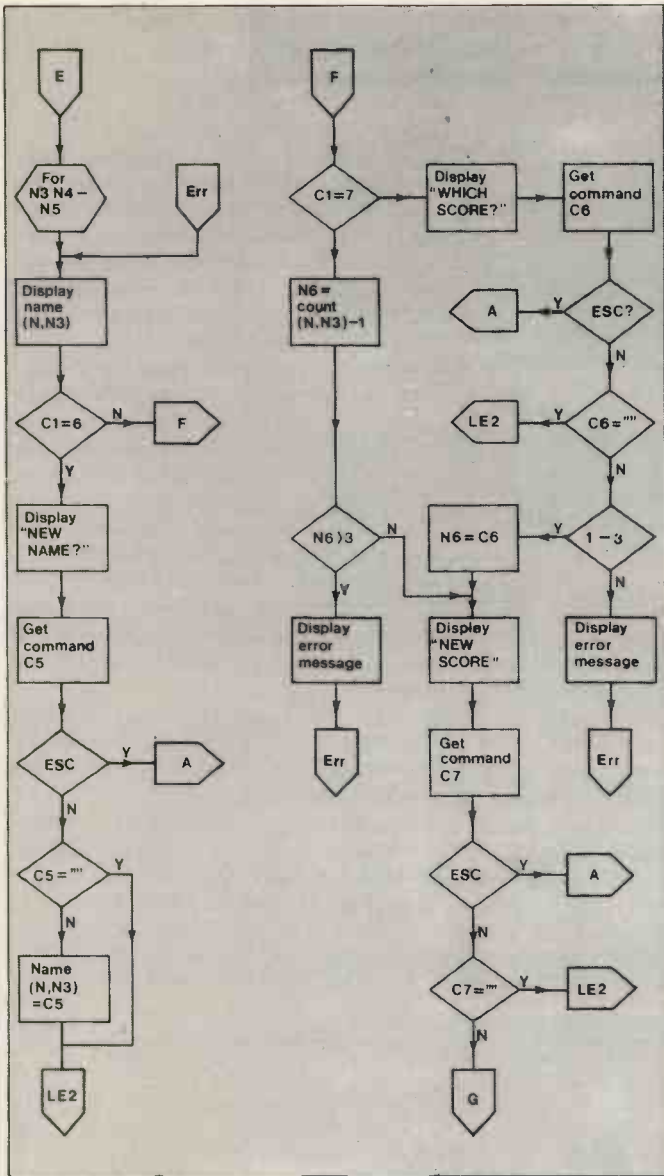

(continued from previous page)

- If greater, replace lowest entry in save table with current score: replace corresponding array subscripts: sort saved scores.
- Use saved array subscripts to display team and individual name.
- Do the above for the 'main' and 'women's' sections of the competition.

This meant that only the inner loop of a ripple sort was required and it was executed only when a new entry on the leaders' display was found. It was still fairly slow, due to the large number of subscripts being used, but the 30 seconds taken at the end of the day was much quicker than the normal manual search and involved much less effort.

### Adaptable

The flowchart shows the overall control structure without paying too much attention to the specific requirements of the universities' shoot. By changing the routines to display the teams and alter scores, the same program could be used to handle a number of competitions.

The project was well received by the competitors and the organisers, the only complaint of any note being that our VDU screen was not big enough. This type of project could be of benefit to many clubs, as it provides a means of making itself useful to the public and can introduce people to a computer as something other than a Frankenstein monster which delivers enormous gas bills and final demands for £0.00. M

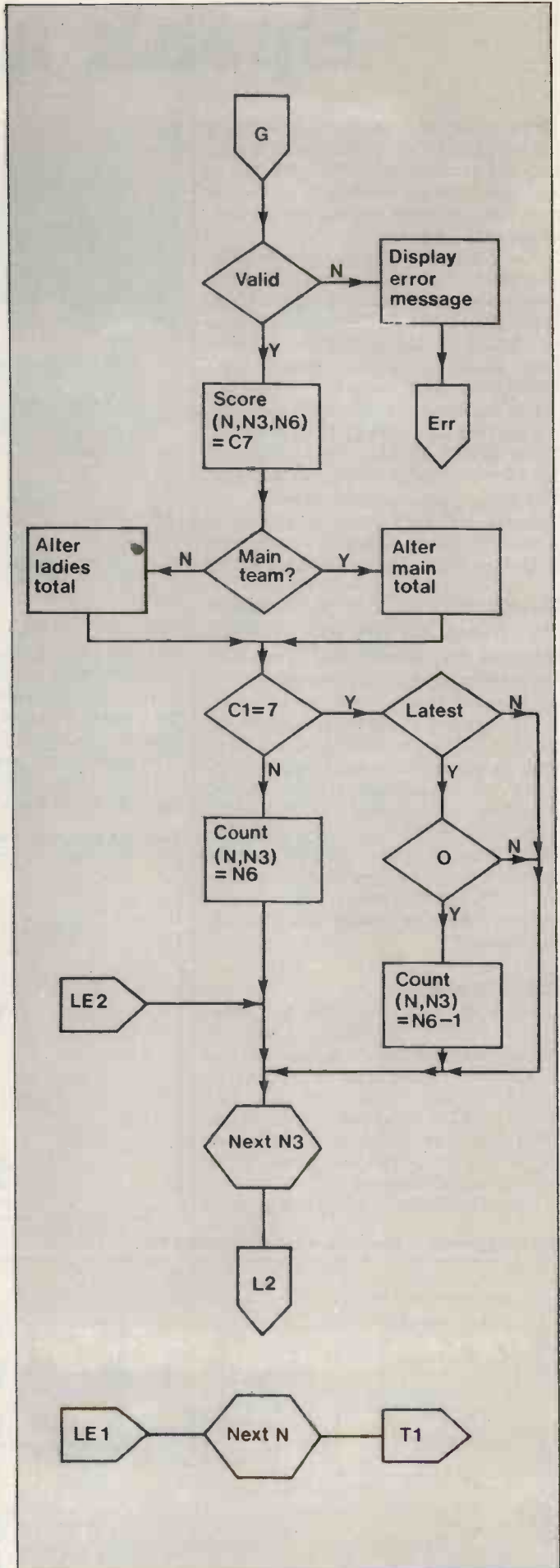

# Speak and Spell

**SPEAK AND SPELL** is an electronic teaching aid designed to assist children with spelling and pronunciation. The unit has an alphabetic/control keyboard, a fluorescent alpha-numeric display, and a synthetic speech output.

There are several modes of operation, one of which is a spelling test. The child presses the "GO" command and the unit says "SPELL WORLD". The child types in "WURLD" and "ENTERS" the spelling. Back comes the spoken reply "WRONG, TRY AGAIN, WORLD". When the word has been spelt correctly, the machine says "THAT IS CORRECT, NOW SPELL PULL". That is repeated for 10 words, after which the unit says how many were answered correctly.

Speak and Spell has a vocabulary of about 200 words, expandable with extra plug-in modules. The machine has a fixed



frame is predicted as a weighted linear combination of the previous frame, plus filter excitation. The current frame of data is a function of the previous frames multiplied by the prediction weightings. Thus, current data is determined by the last 10 sets of coefficients which are used to predict the next frame.

Unlike a direct conversion technique, where the data is used only once, linear prediction uses its coefficients several times and so defines its end-product with more accuracy for the same amount of data storage.

It has been suggested that the TI system was developed originally for the U.S. Air Force, which wanted to be able to call pilots' attention to emergencies which the instrument panel might not signal quickly enough to someone looking out of the window.

So a dulcet lady would coo: "Honey, your engine is on fire. You really must do something about it now, or Mama will be cross". Or something.

Speak and Spell seems — TI is somewhat evasive — to have 256K of ROM, giving about a word per K of ROM.

The TMS1000 can address up to 2.1 megabytes of ROM which could generate 240 minutes of speech, using 20,000 words. The data from the ROM is pro-

**Consultant Tim Orr looks inside the Texas Instruments talking teaching toy, Speak And Spell, and finds some clever firmware.**

vocabulary and so you cannot type in any word and expect it to speak it. It is possible, however, to generate phrases by using the individual letters of the alphabet, for example, "I C U R O K" and "L O I M O K" — I see you are OK, Hello, I'm OK. The intelligibility of the speech is good but a few words are indistinct, although that may partly be caused by the American accent and the tiny loudspeaker.

## Hardware

Inside the unit there are four integrated circuits — a TMCO270, which is the controller for the whole machine, two TMCO350 ROMs and a TMCO280 which produces the speech. The TMCO270 is a modified version of the TMS1000 microcomputer. It addresses the ROMs to extract the stored linear predictive coefficients.

Linear prediction is a data compression

technique. In the Speak and Spell machine, linear prediction is used to produce speech by controlling a mobile digital filter which is an analogue of the vocal tract. Frames of data generated every 20 milliseconds drive the digital filter and so determine the spectrum peaks.

Those frames of data are, in turn, derived from linear prediction. Each

**Formant effects on resonance of vocal tract.**

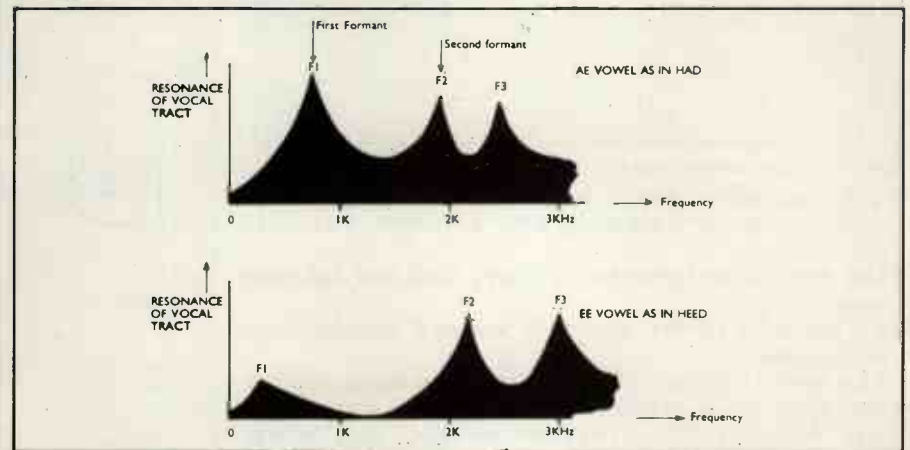

**Block diagram of a generalised speech synthesis system.**

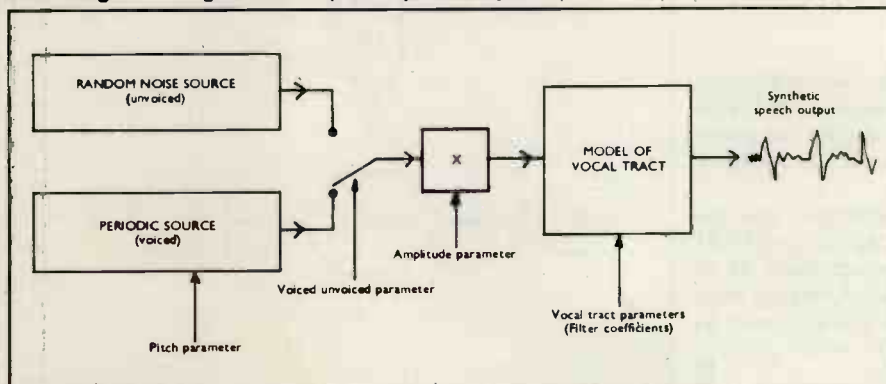

cessed by a linear predictive decoder, generating 12 parameters which drive a speech synthesiser model. The synthesiser produces data which then drives an 8-bit DAC at a sample rate of 10KHz. That data is converted into the "synthetic speech" analogue voltage which powers a miniature loudspeaker.

The speech bandwidth is 4KHz, the 10KHz sampling frequencies being filtered-out partly by the transformer and loudspeaker. An alphabetic/control keyboard is used to input data and an eight-figure alphanumeric display gives a visual readout of entered information.

There are many possible methods of producing a speech output. The speech could simply be converted to an 8-bit code and stored in a ROM. This method can produce high-quality speech but it is very extravagant on storage. For example, one second of speech would require 80K bits for a 4KHz bandwidth signal, which is 18 megabytes for 30 minutes — compared to 0.26 megabytes for Speak and Spell, giving 10:1 compression.

To overcome the problem, some kind of data compression is usually used, which generally requires the implementation of a speech synthesis model. Natural speech is produced by an acoustic filter — the vocal tract — which modifies the spectrum of an oscillator (the vocal cords). As the shape of the vocal tract elements (the velum, tongue hump, and lips) alters, so does the filtering which changes the character of the acoustic signal; it becomes articulate.

Also, increasing the tension of the vocal cords increases the pitch. This type of sound is known as "voiced" speech. "Unvoiced" speech can also be generated by replacing the oscillator with a noise source which produces fricatives (SS, SH, F, TH) and aspirated speech.

## Resonance

The most important mechanism in the production of speech is the vocal tract resonance. It is the frequency response of the tract which varies as the words are mouthed. The peaks in the response are known as formants (F1, F2, F3) and they characterise the sound as speech. Note the different formant structures between the vowels.

A speech synthesiser is an electronic analogue of the vocal tract. It has a noise source, a periodic oscillator, and a controlled model of the vocal tract resonances. This model can be implemented with a set of controlled formants, channel vocoders, and linear prediction coefficient (LPC) devices. Although the first two methods require a lower data storage and are in some ways more flexible, the LPC method gives the most natural speech output.

The coefficients which are read from the ROM drive the linear predictive decoder which, in turn, generates 12 parameters to control the speech synthesiser. Two parameters are used to determine the pitch, the voiced/unvoiced decisions and amplitude; and the other 10 determine the positions of the spectral peaks (the formants). The filter model is a 10-stage digital lattice filter which outputs an 8-bit code (10KHz sampling frequency) to a DAC which, in turn, produces an analogue voltage representing the speech.

## Generating coefficients

The LPC method uses a fixed vocabulary of words, which can be strung together to construct phrases. The coefficients are produced by analysing natural speech. The speech signal is converted into a digital code, and is then processed by a digital speech analyser to determine the formant structure and the nature of the excitation waveform.

There is a great deal of redundancy in speech, as in a sustained vowel, where a waveform may be repeated several times without significant change. These phonetic elements may be repeated by re-addressing the same locations in ROM, thus reducing greatly the data storage requirements. Also, it is often necessary to hand-edit the analysed data to improve upon the synthetic speech quality. The analyser produces 12 parameters which drive a linear predictor encoder, from which the LP coefficients are produced.

## The future

There is a vast growth in machine intelligence and intersection, which is being helped along by all forms of electronic "talkers". Fixed vocabulary products will be very easy to implement some day. You will be able to buy large vocabulary ROMs — 1,000 words would be a handy size — which would connect to a standard speech synthesiser and microcomputer. For the present, I have heard that the new TI home computer may have a speech output option. Perhaps then we will be able to have a pocket-sized verbal speech translator.

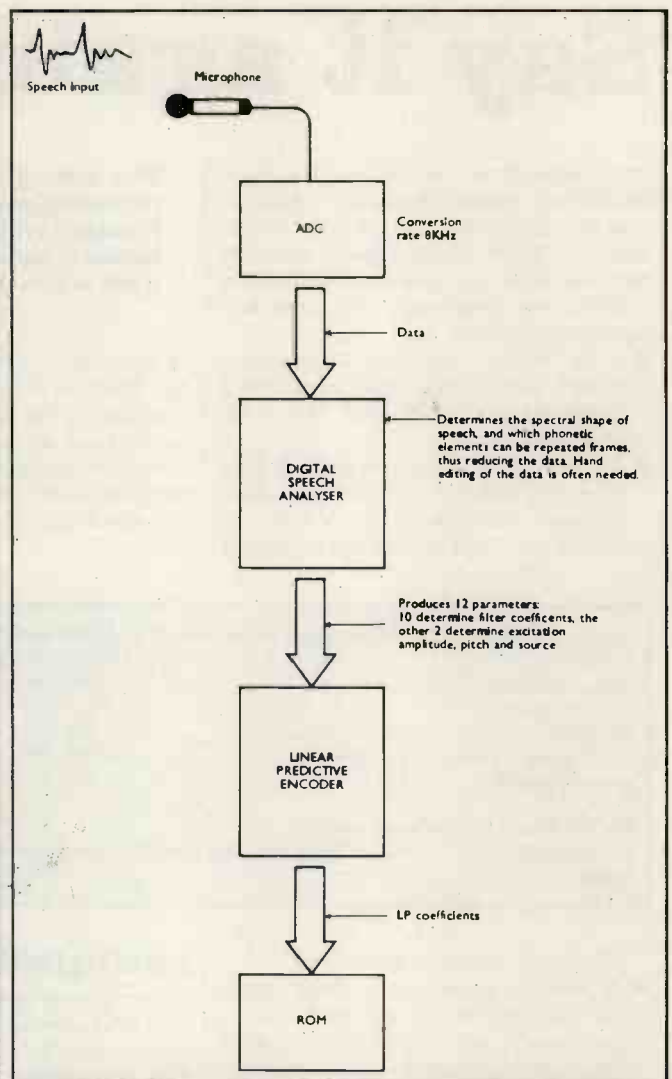

Process needed to encode a speech message in linear predictive parameters.

Block diagram of Texas Instruments Speak and Spell.

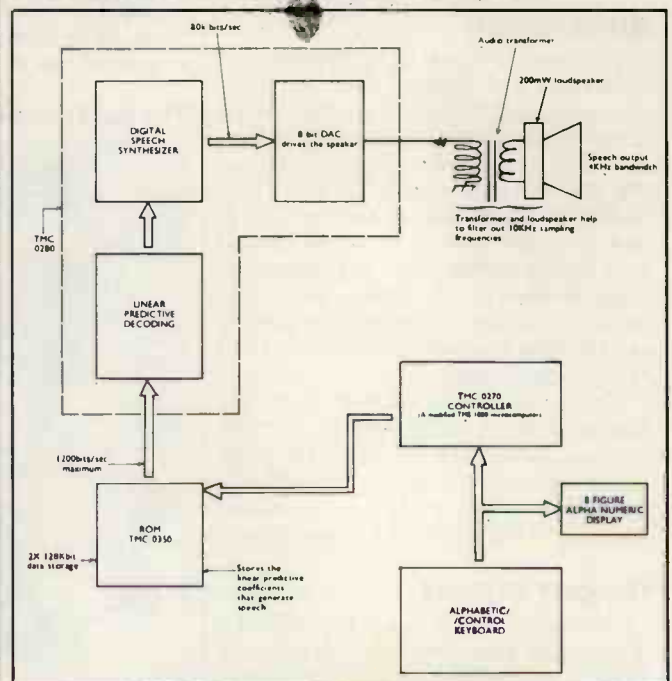

# Say it again, 6800

MICROSPEECH is a microprocessor peripheral which produces synthetic speech using the 'synthesis-by-rule method', where the computer converts phonetic code text into data which then controls the electronics. The complete package consists of:

- A PC board containing all the electronics, which plugs into the standard SS50 bus of SWTPC and MSI 6800 microcomputers.
- A translator program on disc — Flex operating system — or cassette, which converts phonetic code, similar to normal text, into parameters to control

The talking computer is now, for better or for worse, becoming commonplace. Bob Marshall explores the workings of the Microspeech synthesiser board, designed by Tim Orr and Richard Monkhouse. It can sound like an Englishman, a Japanese, a phaser gun or a tram crash. You write your machine code and take your choice.

of an ordinary gramophone amplifier. If the machine has to do quiet, civilised speaking in the office then the circuit in figure 1 will do well, with the advantage that it filters-out some of the extraneous pops and hisses generated by data on the bus which reproduce so clearly on a hi-fi system.

tank battles, racing cars crashing, or even the distant song of a bird at dawn.

## Phonetic code

Because words are not often spelt as they sound, it is necessary to have some way of telling the synthesiser exactly what sound is required. It is achieved by grouping together phonemes to form words. Some examples of the use of this code are:

ENGLISH	PHONETIC
Go and get the spanner	GOW/AAND/GEHT/DHET/SPAANET
My brain hurts	MIY/BRAYN/HERTS

As well as the phonemes, six control characters can be used to add expression — by varying the pitch.

## Standard translator

The standard Translator (MSP2) is, in effect, a monitor-type program which allows loading, saving and playing of phonetic text. It also permits the user to enter text and to display the contents of the text buffer on the VDU. Approximately 90 seconds of phonetic code speech can be stored in 1K of memory.

Optionally, those with discs and the SWTPC Flex operating system may purchase Speech Basic. It is a version of SWTPC Flex Basic, retaining all the standard features, including sequential disc data files, but additionally has the facility to 'speak' an output as well as display it. It is achieved by routing the data

Figure 1. Amplifier for Microspeech board based on M 380 audio IC.

Parts list:	Radiospares No.	Radiospares price
mains transformer	207 201	£2.36
audio transformer	217 624	£1.82
LM 380	306 819	£0.95
Loudspeaker 8 ohm	248 943	£2.11
speaker cabinet	248 971	£4.50

The other parts are generally available.

To make sure the LM 380 does not oscillate, take care to return the loudspeaker to the OV power supply.

the speech synthesis electronics.

- A manual containing a brief introduction into speech synthesis, plus a guide to the software involved and the use of phonetic code.

Also available is an audio demonstration cassette with examples of Microspeech 'versatility'. A modified version of SWTPC 8K disc basic may also be obtained.

## Electronics

The speech model is a three-format synthesiser with separate nasal and fricative branches; that is to say the speech sound is constructed by filtering a fundamental waveform — this determines the pitch of the speech — with three mobile filters known as formants 1, 2, and 3. Small bursts of noise are filtered by a fourth mobile filter to produce the fricative sounds ('F', 'TH', 'SH'), and nasal sounds are synthesised by filtering the fundamental waveform with a fixed NASAL resonator.

The formants are derived from the fundamental by being passed through three peaky low-pass filters, whose centre frequency is controlled dynamically by the software. The result is an electronic analogue of the mouth, throat and larynx.

## Output signal

The audio output signal appears on a 3.5mm jack socket at a level of typically 1vpp. It can be fed into the 'AUX' input

## Intelligibility

One person described the character in the Microspeech board as a 'whining monotonous little stiff'. If you get tired of him, you can resort to machine code and program the board yourself. Although that sounds difficult, details are given in the manual.

In that way the voice can be changed to Japanese or Italian, or one can even break away from speech and an infinite variety of sound effects — space wars,

## The hardware of Tim Orr's Microspeech synthesis board.

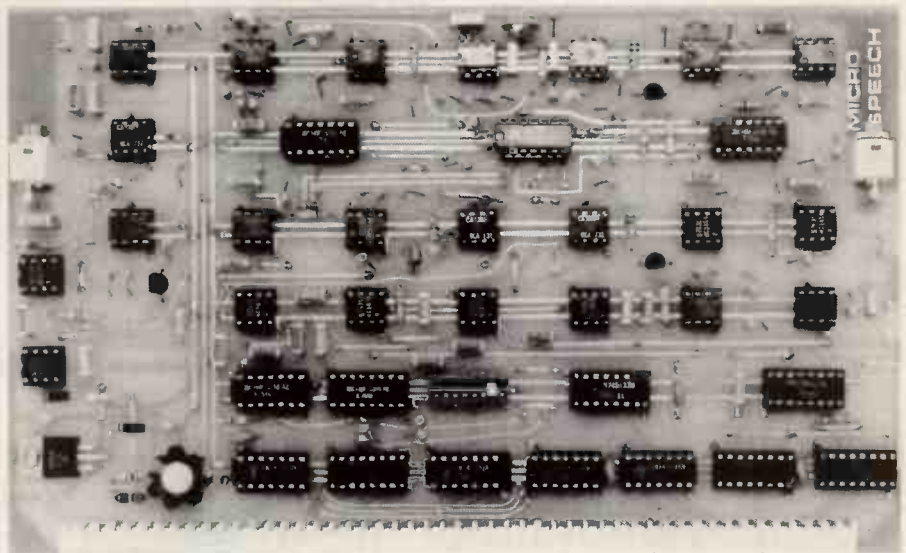

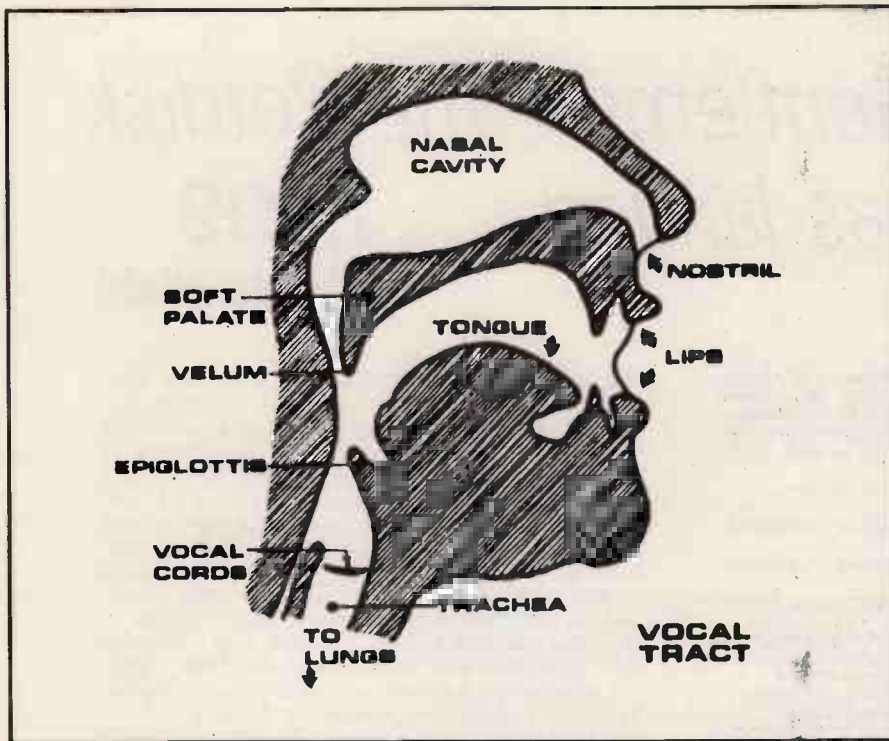

for the speech synthesiser via channel 3; e.g., to say "out of stock" the following statements might be used:

400 PRINT#3, "OWT/OV/STOK/ ^"

Note the phonetic spelling and also the UP ARROW; tells the speech sub-routines to 'speak' the text which has been accumulating in the buffer, which can hold up to 256 characters.

One can think of many areas where one might use 'speech basic', for example

accounting, where the prompts for date, account number, amount, and the like could be spoken instead of displayed.

### Increased efficiency

That may lead to increased efficiency on the part of the operator. A retail stocktaking system might use a voice recognition board with playback through a synthesiser, so that a girl could walk around a stockroom calling "Jumpers, style 5, number 9" with spoken

confirmation from the computer.

The manual contains a brief but informative section on the methods of speech synthesis and a few comments on the general layout of the electronics, together with a larger section on the programs provided with the system, and includes examples of their use, together with hex dumps of both MSP2 and Speech Basic. Omitted from the manual, however, is any mention of how to connect the output of Microspeech to an amplifier/loudspeaker system, although future manuals will have a page devoted to this.

### Using the system

Using MPS2 is simple once you have grasped the nuances of the phonetic code and the effect of the control characters, but one criticism is that in the early stages, when you do not know how a certain statement will sound, there is no way of changing a line once it has been input, except re-typing the line.

Some kind of minimal editing facility would have been a great help. This criticism applies equally to Speech Basic, although it would be easy to write a small Basic program to allow such simple editing.

Also omitted from the manual is that it is necessary to have a board in I/O port #3. It is not used but the software works by routing all speech output to the Microspeech board via port 3 and you will get an error if there is no card plugged into the port 3 slot on the I/O bus.

### Conclusion

● The quality of the spoken output is fairly good and once you have become used to the 'accent', it is almost completely intelligible. □

Diagram of an electronic model of the human vocal tract.

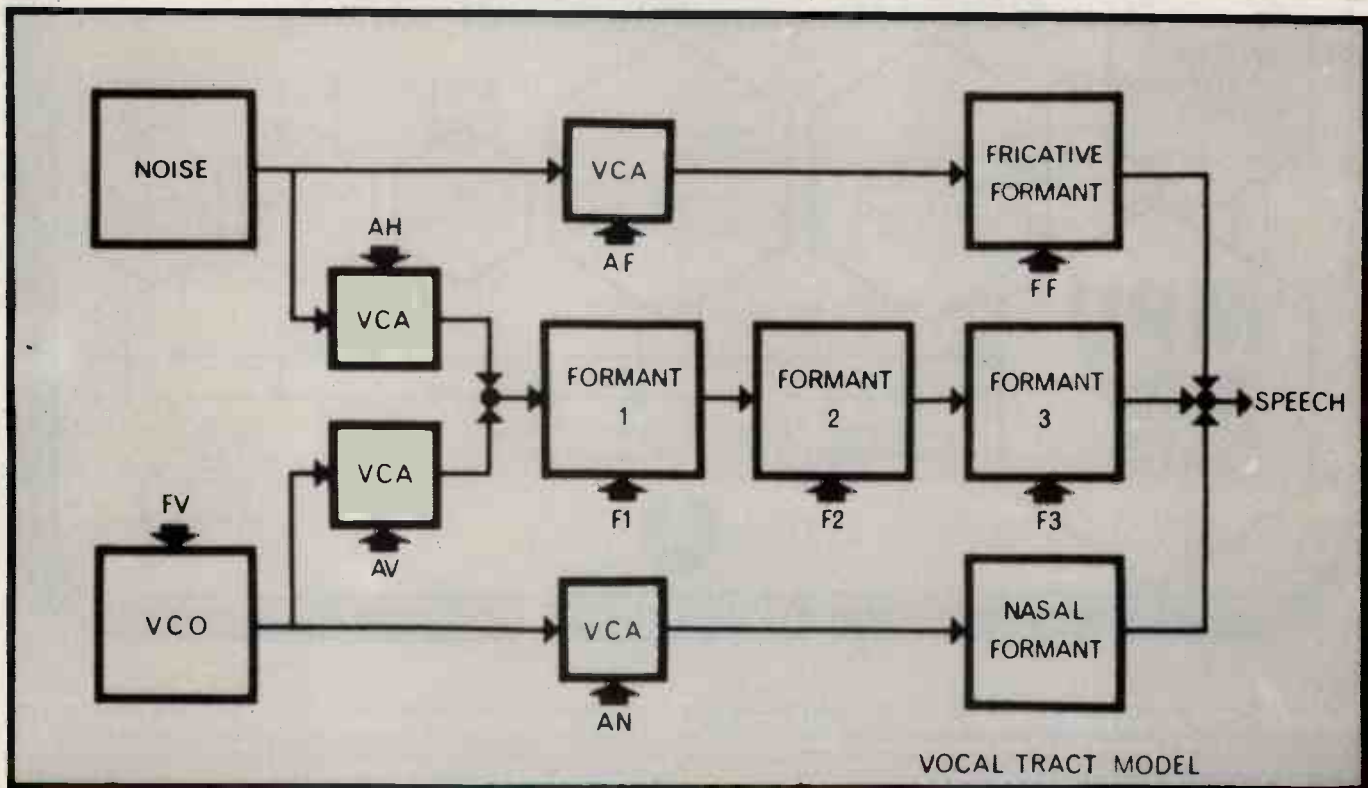



# Gentlemen, the Petdisk has landed . . . **£499** (single disk)

The U.K.-designed and manufactured Novapac disk system for Commodore's PET\*, first seen at Compec '78, is (after extensive industrial evaluation), now available to the domestic user. Its unique saddle configuration continues the integrated design concept of your PET, with no trailing wires or bulky desk-top modules.

- \* Novapac may be used with any available RAM plane.
- \* May be used with latest versions of PET.
- \* Data transfer takes place at 15,000 char/sec - effectively 1,000 times faster than cassette!
- \* Storage capacity is 125 K/bytes (unformatted) on 40 tracks per diskette side.
- \* Dual index sensors permit dual-side recording for 250 K/bytes per diskette.
- \* Easy operation full-width doors prevent media damage.
- \* System expandable to 1/2 Mbyte on-line storage (4 drives).
- \* Dual head and 2D versions provide 2 Mbytes on-line.
- \* Industry Standard IBM 3740 recording format for industry-wide media compatibility offered only by NOVAPAC.
- \* Dedicated Intel 8048 microprocessor and 1771 FDC minimise PET software overhead.
- \* Local hardware and software support available, including applications packages for small business use.

The sophisticated Disk Operating System is disk-resident, which allows for future DOS-enhancements without hardware alterations. PDOS supports multiple file handling, allocating disk space dynamically to each as and when necessary. Any file may occupy from 1 to 600 sectors as required, at up to 16 non-contiguous locations on the disk, PDOS may be used alone, or within a BASIC program and offers user-specified password security for any file. Multiple access-modes simplify BASIC program construction, and the user may generate tailored DOS modules.

**Novapac dual-disk system** complete with PDOS and BASIC demonstration programs on disc **£899 + VAT**.

Available from the manufacturer or selected dealers.  
Terms: 50% with order, balance on delivery.  
Full cash with order is subject to 5% discount.  
VAT-FREE Export arranged (Must be shipped by us).

## analog electronics

47 Ridgeway Ave,  
Coventry  
Tel: (0203) 417761

● Circle No. 195

## THOMSON-EFCIS

### ... a European second source for the 6800 microprocessor family

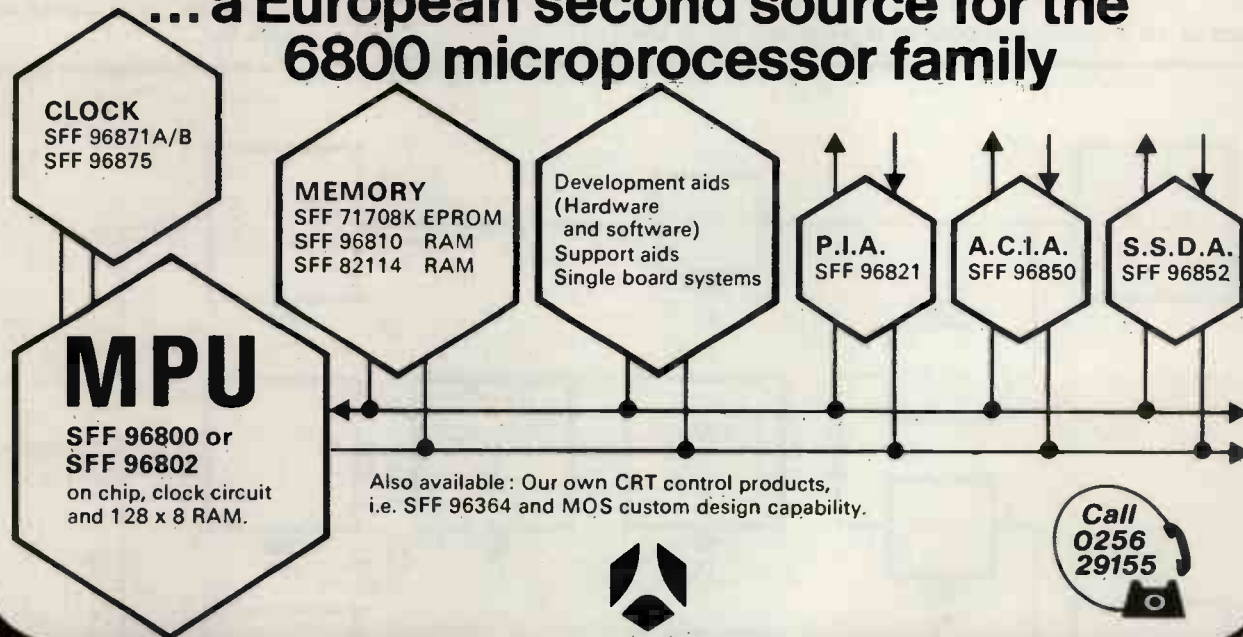

**THOMSON-CSF**

Thomson-CSF Components and Materials Ltd., Ringway House, Bell Road, Daneshill, Basingstoke RG24 0QG Telephone: 0256 29155  
Available from these Thomson-CSF distributors: Barlec Ltd., 219 London Road, East Grinstead, Sussex. (0342 24383). Lock Distribution, Neville Street, Middleton Road, Oldham, Lancs OL9 6LP. (061 652 0431). A. Marshall (London) Ltd., 42 Cricklewood Broadway, London NW2. (01-452 0161). Omni Components Ltd., 59 Vastern Road, Reading, Berks. (0734 594834). Semiconductor Specialists (UK) Ltd., Premier House, Fairfield Road, Yiewsley, West Drayton, Middx (08954 46415) Woolley Components Ltd., Tudor Road, Broadheath, Altrincham, Cheshire (061 941 1911).

● Circle No. 196



# High-level language for less-than-£200 micro

**THE NEED** to master hexadecimal or opaque assemblers deters many people from low-cost microcomputers. M5 is a usable high-level language for one of the most popular less-than-£200 micros. We are having it reviewed but in the meantime it is worth printing the ideas, aims and techniques employed in its design.

M5 was written at Cambridge University by Raymond Anderson. It is available solely from Microdigital, the Liverpool computer store whose offerings include the Nascom-1. Microdigital will provide M5 free with any Nascom it sells. Others can have a cassette with the language and documentation for £10.

M5 interpreters have also been written for the Motorola 6809 and Data General Nova, and in ALGOL 68 and BCPL for an IBM 370 implementation.

THE M5 LANGUAGE was designed to allow numerical manipulation programs to be written quickly in medium-level notation on microcomputers with very little free memory. On most of these machines, the only alternative to such a tiny language would be machine code.

An M5 system, complete with a monitor and editor (E5) capable of running interesting programs will fit comfortably into the 900 bytes of user RAM in the standard Nascom 1. When more memory is available, programs can be run under the expanded version, M6.

The main constraint on the initial design was size. Not only did the code for the interpreter have to be as compact as possible but also the source code and workspace had to occupy the minimum amount of RAM possible. An interpretative approach meant that no space was used by the object code which would be generated by a compiler, and clearer error diagnostics could be given.

In most high-level languages the difficult and time-consuming phase is lexical analysis, in which the source text split into symbols made up by the characters is difficult and time-consuming. Symbols such as:

```
BEGIN
IF
CALL
SKIP
PROC
GOSUB
<=
:=
*
```

are often multiple characters and have different meanings depending on their context.

In M5, the majority of operators and

other symbols have only one or two characters, so less time is spent thinking what to do and more time is available for processing. The code to interpret the source can also be smaller.

For M5, the characters available at a normal keyboard are sufficient for all operations. There is no need for an APL-like character set.

Arithmetic expressions can be abbreviated using reverse Polish notation (RPN) which is easy to evaluate interpretatively and which does not need parentheses. The RPN stack idea is very handy for comparisons and leaves the top item readily accessible at all times.

### Variables and constants

M5 has 27 variables called explicitly by one-character names — A to Z and @. Each of those locations holds an integer, which is initialised to 8224 (4040 Hexadecimal).

There is also a 'virtual' variable called the 'current' variable or x. This is the variable on the display or at the top of the stack on a RPN calculator. Before variables can be manipulated, they must become current, which means they must be put in the x variable. This is done simply by stating its name:

```
ABC
```

x takes value in AB and C in turn, finishing up containing the value in C.

The current value is stored in a variable by using the 'store' operator, the equals sign, so:

```
=A=Z=ui
```

puts the number in x into A,Z and @ and x still contains the same value.

### Input/output

Getting numbers in or out of the machine is done by treating the terminal like a variable called '?'. Quoting '?' causes a prompt at the terminal and the system waits for a number to be entered. When entered, the number becomes the new current value.

Storing to '?' by using '=' causes the value of x to be displayed on the terminal. So:

```
A=? B=? ?=C
```

will display A and B on the terminal, then ask for a number which will be stored in C as well as becoming the new x.

Using '=' anywhere in a program has no effect except for printing x. This is useful when debugging a program.

### Operators and arithmetic

The operators £ and & operate on x. They decrement and increment x respectively. This program takes in a number and prints-out the next number:

```
? & =?
```

This one prints the next two numbers:

```
? & =? & =?
```

Now we come to the use of the stack to evaluate expressions. This is crucial to

(continued on next page)

(continued from previous page)

proper understanding of M5 and M6, and when it is exploited it is a very powerful tool.

The stack can be thought of as a pile of numbers, one above the other. Initially it is empty, but by using the 'push' operator, a comma, we can put a copy of *x* on the top of the stack. We will call the top number on the stack *y*.

Consider the execution of 5 , , 3 ,

**Step 1**

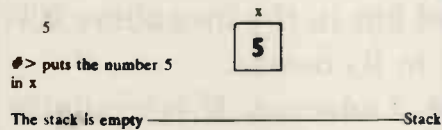

**Step 2**

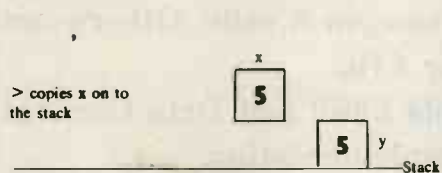

**Step 3**

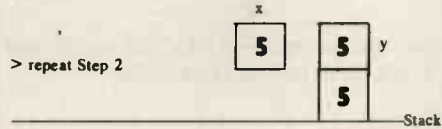

**Step 4**

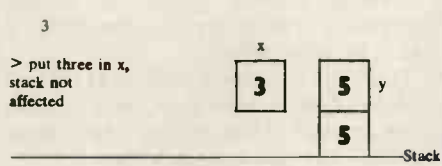

**Step 5**

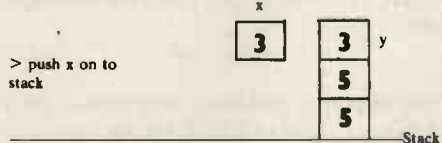

The diadic operators plus, minus, times and divide put the result of *y* operator *x* into *x* and remove the top item of the stack.

Following the above program by + \* + will have the following action:

**Step 6**

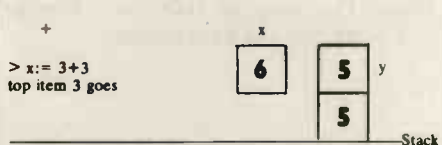

**Step 7**

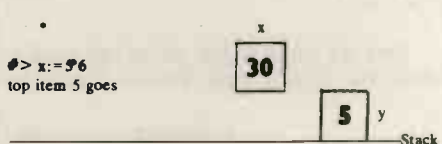

**Step 8**

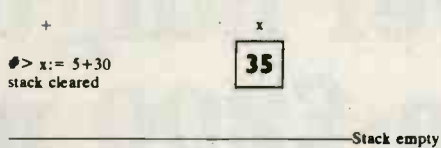

So we can see that:

5 , , 3 , + \* +  
puts (3+3) \*5+5 in x  
The operators are:  
+ x:= y+x so 2, 3 + is 5  
- x:= y-x so 9, 5 - is 4  
/ x:= y/x so 15, 5 / is 3  
\* x:= y\*x so 2, 3 \* is 6

Here are some examples:

A , B \* = ? Display A\*B  
? , ? + = ? Request two numbers and display the sum  
? , \* = ? Request a number and print the square  
A , B + , C + , 3 / = M Put (A+B+C)3 in M

The variable @ is special in that after a division, the remainder is stored in @ and if there is a multiplication overflow the top 16 bits are put in @, 1 + and , 1 - are equivalent to & and £ respectively.

**String output**

A string of characters will be displayed on the terminal if those characters are enclosed in quotes and placed in the program at the desired point. The M5 program:

"WAKE UP!"

produces the same result as this BASIC code:

10 PRINT "WAKE UP!"  
20 END

The last character of a program may be omitted if it is a quote, so the program:

"WAKE UP!

will work correctly.

Messages carry on from where the last message, number or input terminated.

12345 =? " IS LESS THAN: " & =?

produces

12345 IS LESS THAN: 12346

New lines may be included:

"NEW"  
prints  
NEW  
LINE

**Jumps and loops**

A conditional branching and looping structure enables a program to repeat sections of code. M5 uses conditional jumps and labels. A label is an open parenthesis followed by an identifying character, for example:

(A (Q ( : or ((

A jump symbol consists of a closing parenthesis followed by a condition code and a destination.

)UA )ZG )X\* )N: )GC

Valid codes are given in the table, together with their conditions. If the condition is TRUE, execution continues after the label with identifying character matching the destination field. If it is FALSE, execution continues normally after the jump symbol.

Condition code	Example of use	Condition for jump to occur
U	)UJ	Jump always occurs (unconditional)
N	)NJ	x is not zero
Z	)ZJ	x is zero
E	)EJ	x is equal to y
X	)XJ	x is not equal to y
G	)GJ	x is greater than y
L	)LJ	x is greater than or equal to y
M	)MJ	Jump to M5 Monitor: no destination is required.

For example.

(A "DOG BITES") UA prints DOG BITES DOG BITES... ad infinitum: and (L ,999)XL "POLICE, FIRE OR AMBULANCE" will keep asking for a number until "999" is entered. It then prints an appropriate message.

(A ? )ZE ,100 )EO 192 )ED 999 )XA "POLICE" )UA  
(O "THE OPERATOR" )UA  
(D "DIRECTORY ENQUIRIES" )UA  
(E "FINISHED"

Note that as a safeguard in cases such as:

(A , , )UA

Stack overflow is prevented by keeping only the top one or two numbers on the stack when a jump occurs. This should cause no problems.

**Editor and monitor**

The E5 editor takes up about 100 bytes in the main program and accepts the following commands:

- R Move cursor to first character in program
- > Move cursor one character right
- < Move cursor one character left
- N Move cursor to beginning of next line
- D Delete this character and move to next
- I Insert the following string terminated by a semi-colon, before the cursor
- (CR) Display modified text
- W Return to M5 monitor

These allow easy editing of programs up to about 300 characters long.

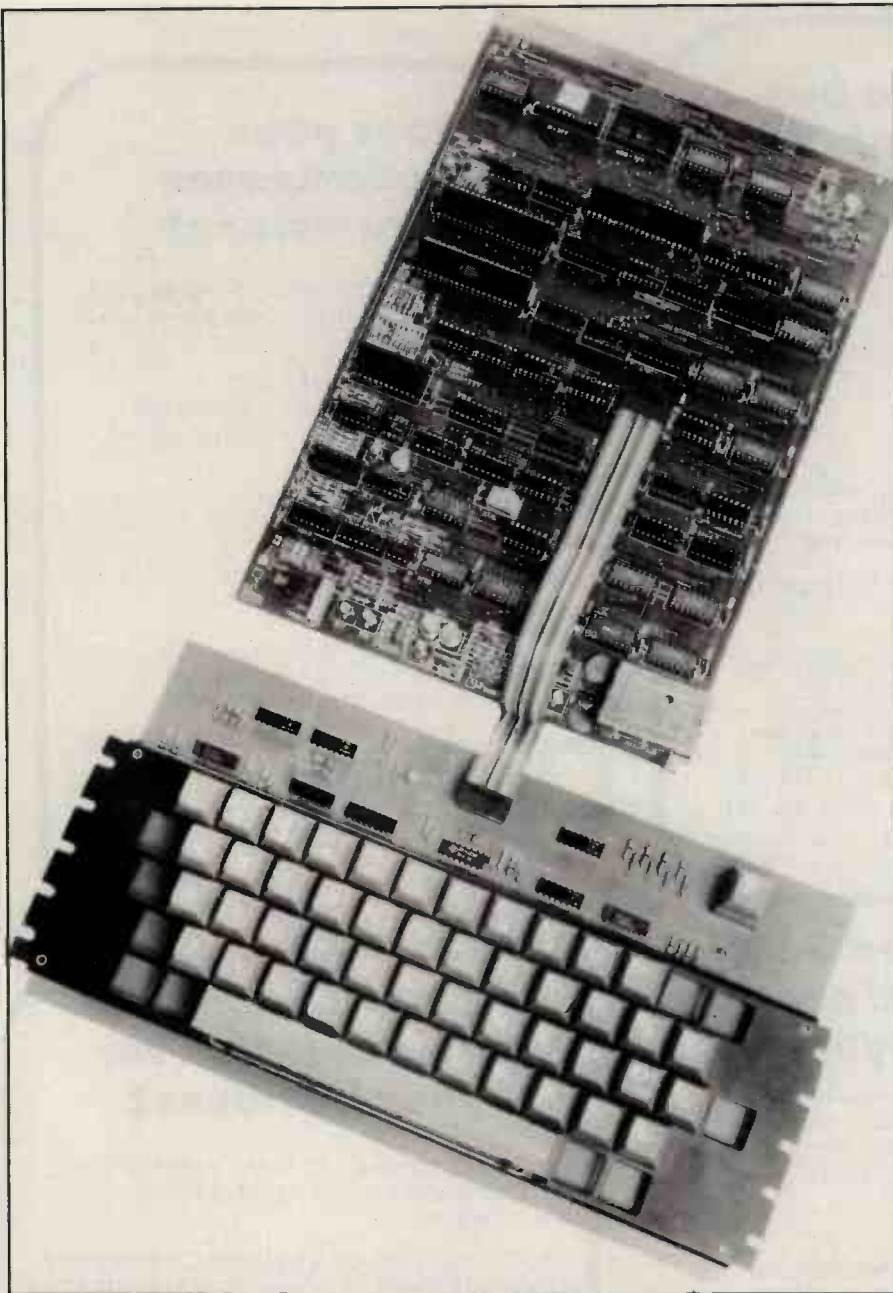

Nascom-1.

The M5 monitor has the commands:

I Input a new program terminated by a semi-colon  
 L List the program  
 E Edit the program (Causes prompt E:)  
 R Run this program

Error messages during execution give the location and cause of error:

SYM ERR x x is an invalid symbol  
 ID ERR x Trying to store invalid variable x  
 JID ERR x Could not find label x  
 JCON ERR x Invalid condition code x  
 ERR x Other error at x

An added bonus is that when the editor is entered, the cursor is initialised to point where execution terminated. This means that it points to the location of errors, ready for corrective editing.

## Expansion — M6

M5 was designed to allow future expansion, and M6 is already being written to use the spare ROM socket on the Nascom. It has the following extra features:

- subordinate call and return (recursive)
- array handling
- DO loops
- character I/O
- Hexadecimal I/O
- random number function
- tape I/O
- machine code linkage

The extra space will allow the speed to be doubled or better with large programs. The E6 editor will be more comprehensive; and all M5 programs will run under M6.

## FI: Memory allocation on the Nascom-1

Memory location

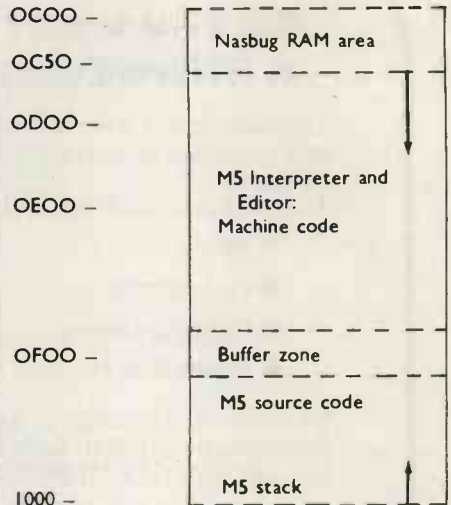

## Comparisons with T BASIC

Program B1 is a simple benchmark in Basic. Program M1 is the same program translated into M5. The M5 program takes 4.5 seconds to execute using a Nascom-1 M5 Interpreter; the Basic code takes about four times as long.

B1

```
300 PRINT "S"
400 K = 0
500 K = K + 1
600 A = K / 2 * 3 + 4 - 5
700 IF K < 1000 THEN 500
800 PRINT "E"
900 END
```

M1

```
"S"
O = K
(L K & = K
,2/,3/,4+,5- = A
K ,1000 )GL
"E"
```

#> — which can be written:

```
"S" O=K(LK&=K,2/,3/,4+,5- =AK,1000)GL "E"
```

Program B2 is a fast prime number generator written in Basic. For 100 primes, it takes about six seconds. The M5 version, program M2, takes three seconds, despite the fact that it does not use an array. It makes use of the feature which stores the remainder in @.

## Program B2

```
10 DIM A(100), B(270)
16 LET M=0
18 LET A(1)=2
20 FOR J=2 TO 100
30 LET M=M+1
35 IF B(M)=1 THEN 30
40 LET N=M+M+1
45 LET A(J)=N
50 FOR X=M TO 270 STEP N
54 LET B(X)=1
57 NEXT X
60 NEXT J
70 END
```

## Program M2

```
1=T 99=C 2=?
(N T&&=T 1=G (A G&&=G T,G,G)GP @ )NA )UN
(P " " T=? C=C )NN
```

To finish, here is a neat square root program written by an M5 fan. It takes numbers from 0 to 65535 and prints the integer part of the square root. The method is the Newton-Raphson iteration:

```
256=M ? = N (X N, M I, M)UX (S = ?
```

## Do you want to buy a MicroComputer?

Digitus stocks a wide selection of micros and provides expert advice, sizing and design.

Test some robust, proven computers:

- Apple 11
- Cromemco
- DG MicroNova
- North Star Horizon

Choose from a range of peripherals: Shugart, North Star, Sanyo, Sony, Lear Siegler, Cifer, Centronics, Teletype.

Discuss and select a system to fit your present and future needs.

# Digitus

Call, write or visit:  
Digitus Ltd  
Dumbarton House  
68 Oxford Street  
London W1  
Tel: 01-636 0105

● Circle No. 197

PS Also provided:

*micro skill, software, books and training.*

## Does your MicroComputer need software?

Digitus supplies application programs, systems, and tailor-made software systems.

We specialise in business and administration programs for Z80/8080 and MicroNova computers including:

- Wordprocessing
- Mailing
- Sales Ledger
- Purchase Ledger
- Nominal Ledger
- Stock Control

Also supplied: systems software for Z80/8080 including CP/M, Extended Basic, Fortran and Interactive Cobol.

# Digitus

Call, write or visit:  
Digitus Ltd  
Dumbarton House  
68 Oxford Street  
London W1  
Tel: 01-636 0105

● Circle No. 199

## Do you need help to design and process your MicroSystems?

Through its MicroSkill Register of over 200 professionals, Digitus provides experienced programmers, designers and engineers to develop systems on most micros including:

- Z80/8080
- LSI 11
- 6502
- MicroNova
- 6800

Some of the Register people have their own machines. Others work on customer or Digitus equipment.

Whether you require a small program written or a large system designed and engineered, Digitus MicroSkill can provide support.

# Digitus

Call, write or visit:  
Digitus Ltd  
Dumbarton House  
68 Oxford Street  
London W1  
Tel: 01-636 0105

● Circle No. 198

PS Applications to join the Register are welcomed. Please send C.V. and two professional references.

## Do you want a MicroSolution for your business?

Some people want to buy equipment and software and bolt it together for themselves.

Others want to buy a solution, a complete system to meet their needs economically and reliably.

Digitus provides MicroSolutions for business, administration and professional practices.

We analyse your requirements, specify systems, choose suitable equipment and software, tailor it to fit your people and organisation, hold hands during transition, train operators and managers, arrange regular maintenance and support.

In short, provide a total MicroSolution.

# Digitus

Call, write or visit:  
Digitus Ltd  
Dumbarton House  
68 Oxford Street  
London W1  
Tel: 01-636 0105

● Circle No. 200

## Verification technique

A COMPUTER provides the facility to process information at high speed, faster than a human operating a manual or mechanised information processing system. In a manual or mechanised system, a human may be able to detect or suspect an error in data and take appropriate action. In a computerised system, it is not possible to see the data being processed, and steps must therefore be taken to ensure that data entering such a system is 'clean'.

In many business systems, data originates in some paper form which is checked manually and then submitted for input. Having been checked, the data is encoded on to some suitable media which in a small system might be floppy discs. At some point a check must be made to ensure that the data recorded is identical to the original. This checking operation is known as verification and might be done in any of the following ways:

A copy of the encoded data is printed and compared manually with the source documents. Although being simple, this method is not very satisfactory, since mistakes could be made at the

comparison stage or when the file has to be updated with corrections.

The data is encoded twice and a program is then used to compare the files and print a list of the differences. Neither is this technique very satisfactory, as it is possible to encode the same piece of erroneous data on both files and the processing time is longer.

The data is encoded on to a file and then the data is keyed-in a second time. As the keys are pressed for the second time, the data is compared to that on the file. If there is a match, the data is written to a second file, otherwise the operator has to decide which version is correct and it will be copied to the second file. This is the commonest verification technique in practice.

The data is keyed-in an item at a time and after being entered the operator has to indicate if the data is identical to the source. If it is, the data is written to a file; otherwise the operator will make corrections. When the operator is sure the amendments are correct, the data is written to the file. This technique produces only one file, whereas the others require two, but it is not as secure as

the method immediately preceding.

The following program shows how the last might be used for creating an address file. The user is required to enter five lines of address data and then check if it has been entered correctly. If it has, RETURN is pressed, the data is written to a file, and the next set of data may be entered.

If it has not, then N or any word starting with N is entered and the user has to choose which line is to be corrected. After correction, the complete set of data is displayed and again the user has to indicate if it is correct or not.

The lines to be corrected are selected individually by number 1 - 5 but if the data needs to be displayed without making a correction, it can be achieved by entering 0 as the line number. A line length test has been included to ensure no line of data will exceed the length of the gummed labels on which it will eventually be printed.

This technique, although simple to implement, is dependent on the user for its accuracy, as the person must compare the data entered to the source and not press RETURN without checking fully.

Listing 1.

```

CREATE ADDRESS LABEL FILE

LINE 1 ? THE EDITOR
LINE 2 ? PRACTICAL COMPUTING
LINE 3 ? 2 DUNCAN TERRACE
LINE 4 ? LONDON N1
LINE 5 ?

IS THIS CORRECT?

LINE 1 ? THE EDITOR
LINE 2 ? WHICH COMPUTER
LINE 3 ? 2 DUNCAN TERRACE
LINE 4 ? LONDON N1
LINE 5 ?

IS THIS CORRECT? N
WHAT LINE IS TO BE CHANGED? 2
LINE 2 SHOULD BE? WHICH COMPUTER

    THE EDITOR
    WHICH COMPUTER
    2 DUNCAN TERRACE
    LONDON N1

IS THIS CORRECT?

LINE 1 ? MR. P. WOOLLEY
LINE 2 ? ENFIELD DATA PROCESSING EDUCATION SERVICES

THE MAXIMUM LINE LENGTH IS 30 CHARACTERS

LINE 2 ? E.D.P.E.S.
LINE 3 ? 25 ARMFIELD ROAD
LINE 4 ? ENFIELD
LINE 5 ? MIDDLESEX EN2 0DH

IS THIS CORRECT? N
WHAT LINE IS TO BE CHANGED? 0

    MR. P. WOOLLEY
    E.D.P.E.S.
    25 ARMFIELD ROAD
    ENFIELD
    MIDDLESEX EN2 0DH

IS THIS CORRECT?

LINE 1 ? END

END OF LABEL INPUT

READY
    
```

Listing 2.

```

10 PRINT "CREATE ADDRESS LABEL FILE"
20 PRINT
30 OPEN "LABELS" FOR OUTPUT AS FILE 1
40 DIM DS(5)
50 REM --INPUT--
60 PRINT
70 FOR C=1 TO 5
80 PRINT "LINE":C;
90 INPUT DS(C)
100 IF DS(C)="END" THEN 450
110 IF LEN(DS(C)) < 31 THEN 160
120 PRINT
130 PRINT "THE MAXIMUM LINE LENGTH IS 30 CHARACTERS"
140 PRINT
150 GO TO 80
160
170 NEXT C
180 PRINT
190 INPUT "IS THIS CORRECT?":AS
200 IF LEFT(AS,1)="N" THEN 250
210 REM --COPY TO FILE--
220 FOR C=1 TO 5
230 PRINT #1 DS(C)
240
250 NEXT C
260 GO TO 60
270 REM --MAKE CHANGES--
280 INPUT "WHAT LINE IS TO BE CHANGED?":L
290 IF L=0 THEN 390
300 IF L > 0 AND L < 6 THEN 310
310 PRINT "LINE 1,2,3,4 OR 5"
320 GO TO 260
330 PRINT "LINE"/L;"SHOULD BE":;
340 INPUT DS(L)
350 IF LEN(DS(L)) < 31 THEN 390
360 PRINT
370 PRINT "THE MAXIMUM LINE LENGTH IS 30 CHARACTERS"
380 PRINT
390 REM --DISPLAY LABEL--
400 PRINT
410 FOR C=1 TO 5
420 PRINT " ";DS(C)
430
440 NEXT C
450 GO TO 170
460 REM --PUT END ON FILE--
470 PRINT #1 "END"
480 CLOSE 1
490 PRINT "END OF LABEL INPUT"
500 END

READY
    
```

# Postgraduate Diploma Courses

## Computing Operational Research

**PART-TIME** (two evenings a week), two-year courses starting October, 1979.

The courses stress commercial and industrial applications and are aimed at graduates **without** formal qualifications in the chosen field of study. Non-graduates with suitable work experience may apply.

A full-time (one-year) Computing Diploma and Diplomas in Statistics and Mathematical Education (part-time) are also available.

For full details contact

Department of Mathematics,  
Polytechnic of North London,  
Holloway Road, London N7  
8DB. Tel: 01-607 2789, ext.  
2309.

**The Polytechnic  
of North London**

## COMPUTERS FOR HOME BUSINESS EDUCATION



### Exidy Sorcerer

8K - £747.50 16K - £874.00 32K - £987.75  
S100 Expansion Box 6-slot - £241.50  
Micropolis Dual Disc Drive - £1,380.00  
Centronics 779 Printer - £920.00



### PET 2001 House Trained

PET 2001 4K - £529.00  
8K - £632.00 DUAL DISC DRIVE  
16K - £776.00 £851.00

APPLE II (b&w) 16K RAM £964.50 Disc drive & controller £488.75  
5¼ in. disks £4.90 ea. 8 in. disks £5.90 ea.

Plastic Print Wheels IBM etc. £5.95

NASCOM 1 kit £189.75 or Built & Tested

£247.25

NASCOM 2 kit £339.25 or Built & Tested

£396.75

Ohio SUPERBOARD II 8K Basic, 4K RAM Built & Tested

£263.35

COMPUKIT UK101 8K Basic, 4K RAM+Power Supply Built & Tested

£303.00

TRS 80 Level II 16K RAM, Computer only

£460.00

16K Memory expansion kits (APPLE - SORCERER - TRS 80) only

£69.00

3A Power Supply kit £23.00 or Built & Tested

£28.75

TRS 80 Library 100—100 Programs on Cassettes

£46.95

2K BASIC for NASCOM 1 used in place of Nasbug or B-Bug

£22.90

Large range of computer etc. books. Send for List

SAE with all enquiries — All prices inclusive

SUPPLIERS TO BUSINESS, EDUCATION & HEALTH AUTHORITIES



# N.I.C

27 Sidney Road, London N22 4LT  
01-889 9736

● Circle No. 201



# P.I.P.S.



## COMPUTER SERVICES

North-East England Dealers for a range of Microcomputers and Printers

### HARDWARE:

APPLE II

ZENTEC ZMS-70

AIM 65

ACORN

### PRINTERS

ANADIX

DIABLO DAISYWHEEL

### SOFTWARE:

INVOICING PACKAGE, CASHFLOW PACKAGE, DENTIST PACKAGE

Selection of Software from Keen Computers Ltd

Tel: John Page on (0632) 482359 482984 to discuss your requirements.

# NEWCASTLE-UPON-TYNE

● Circle No. 202

## The Users' Guide to North Star Basic

By Robert R Rogers, Published 1978 by Interactive Computers (distributed in the U.K. by LP Enterprises); spiral-bound, board covers; 241 pages; price, £10.

ROGERS wrote this as a blow-by-blow account of how he came to use and to understand North Star Basic. He starts with the arrival of his hardware, a Sol-20 microcomputer, and takes the reader through to using some of the more extended facilities of the Basic language.

The book follows his own learning path, pointing out and emphasising particular areas which caused problems for him. It takes a structured approach to presenting not only the North Star Basic but also the command structure of the North Star disc operating system.

In general, this line works well. It produces a humane and balanced introduction, at the same time leaving the reader enough scope to have the fun and hands-on experience of taking understanding of the machine and the language a stage further.

Incidentally, it should be pointed out that North Star Basic is a mini-floppy version which runs, as an interpreter, under the North Star Disc Operating system (DOS) and that DOS is supported by a number of microcomputer manufacturers.

### In depth

The basic language statements of Basic are covered in some depth, with meaningful examples to illustrate the power and limitations of each statement type as it is introduced. The range and format of variable use is covered particularly well, with emphasis on string variables.

A substantial part of the book is devoted to the use of data files, which makes a pleasant change from most Basic texts. The standard READ/DATA statements are covered elsewhere, but this particular section deals with both sequential and random access files. Rogers makes the point that all data stored on disc is stored as files, be it a user program, the operating system or data. It is how those files are viewed and used which determines the usefulness of data files.

One oddity in North Star Basic is that data files, used in a Basic program, must be created and/or deleted when in DOS. Rogers details helpfully the quickest method of jumping from Basic to DOS and back again.

The files section is well thought-out and the author has done a good job of explaining

what can be a difficult concept to grasp for the first-time user.

The ODS subsections deal with saving and re-loading Basic programs, file manipulation from disc to disc or on a single disc, and some tips derived from Rogers' own problems. He advocates the use of back-up copies for your programs but also for the operating system as well. Those are sentiments with which we most certainly agree.

At the tail, he has four very useful chapters, the first of which covers decimal to hexadecimal conversion. Rogers details a 32KB memory map with addresses shown in both hexadecimal and decimal.

### Secrets

Then there is a list of "secrets" he has managed to find by one means or another — helpful items not detailed in the North Star manuals. Among them is information on how to print to an external printer in Basic, a procedure which we regard as a flaw in the North Star Basic.

The final two chapters contain an explanation of some of the enhancements available in the "next" release of DOS and Basic — this is probably the version now marketed, in fact — plus a set of program listings.

### Conclusion

● For anyone who has, or is intending to buy, a microsystem using North Star Basic, this book is highly recommended. There is a lack of good North Star documentation and this goes a long way towards filling the gap.

● As an introduction to Basic in its own right, it is pleasant to see a layman writing a good, enjoyable and easy-to-follow book. — J.W.

## Microcomputer Problem-Solving Using Pascal

By Kenneth L Bowles. Published 1977 by Springer-Verlag; hardback, 563 pages; price 22.50DM (approx £6)

PASCAL is available on at least 50 makes and models of machine, most of them micros. Devotees claim it is considerably superior to Basic in almost every way, the exception being in the speed of learning required. Further, it is simpler to understand and debug than Cobol, Fortran or Algol, although it does not have the same depth of facilities. For devotees of the structured programming technique it is ideal.

Although the subject of this book is ostensibly Pascal, the



author roves around several allied subjects, such as structure diagrams, structured programming techniques, sorting, programming methodology, and applications of computers.

There is no possibility of the reader being confused. Without a hint of verbosity, the text explains all concepts in two or three ways — the author undoubtedly does this unconsciously and it is received in the same way. He peppers the text with scores of examples, and they are relevant, comprehensive, amusing and easy to follow. Further, he assumes little or no mathematical ability — highly unusual for an academic computer scientist — on the part of the reader.

One extra bonus the author provides is his name and address. Why is it a bonus? Because he has written Pascal compilers for a range of micros and minis, and is prepared to make them available and give advice to people who want to take advantage of Pascal. To obtain this information you will have to buy the book.

### Conclusion

● This book is an absolute bargain, even for those not very interested in the subject. It succeeds on almost every level — it is a model of clarity, readability, aesthetically pleasing presentation, and verbalised intelligence.

● The reader is treated as a responsible individual and becomes infected with the author's enthusiasm for all aspects of computing.

## Star Ship Simulation

By Roger Garrett. Published 1978 by Dillithium Press (distributed by ISBS); paperback, 122 pages; price, £5.10.

DO YOU remember the school bully who would entice you with a bag of sweets, only to snatch them back as you reached eagerly for one? Well, that's the feeling you might have after reading this book.

It is not a ready-to-run program. The unwary reader, starting

at the beginning, gets a parade of *Star Trek* delights, only to find them snatched away in the final chapter which is headed "implementation".

It would have been kinder to put the last chapter at the start of the book. We would have liked to know from the outset that our humble micro could never swallow enough bytes to let us implement it.

As the author admits finally, the simulation was "obviously designed with a multi-operator mode in mind". To implement the game outlined in the book requires seven "players", each with a VDU. It seems an understatement to say that "the hardware for this simulation will be a major consideration".

The bells-and-whistles system would, of course, be real-time *Star Trek*, and no doubt by adjusting the variables you could run a simulation which would go on for ever. In fact, this appears to be the object of the exercise, since no indication is given that there are winners or losers.

Nor is there any indication of memory or disc capacity required. The figures given in the description include arrays of 1,000 for celestial objects, although "it would be simple to limit this to, perhaps, 20" as the author concedes eventually when talking about implementing on a limited amount of memory.

### Impressive

It's an impressive specification, however, with seven major functions — simulation controller, communications, navigation, science, engineering, medical and helm. Each has Major Functions Objectives listed. For example, the engineering module maintains the statue of the shuttlecraft, transporters, energy supply, space/warp and impulse engines, main craft structural damage, turbo-elevators and so on. It allows the engineer to specify the distribution of energy to the various sections of the ship.

Ultimately, of course, you with your micro could produce only a pale shadow of the scheme Garrett outlines. Even then the odds must be that it would be no better than something already on the shelf of a software shop.

In its other coat, this book is presented as an introduction to simulation and structured programming and in that light the first 18 pages are good at their job.

### Conclusion

● If you have an IBM 370 and two light years to spare you might choose this — pointed ears would help. Otherwise, it's only an intellectual exercise. □



# Pandora's Box

**Peter Laurie visits a back-room London suburban laboratory which may change television production as we know it.**

ONE of the central predictions of those who believe in the microelectronic revolution is that it will dissolve big businesses into a mass of electronically-interlinked cottage industries. It's gratifying, therefore, to find something like this already happening in the Ealing cottage — or, to be perfectly accurate, terraced house — of David Graham. Graham is a BBC TV producer on a year's unpaid leave, which he has spent trying to make the TV studio obsolete. Before that he produced a series for *Nationwide* called *Consumer Unit* and was deputy editor of the *Money Programme*. He says:

"Although TV is the medium of our time, it's embedded in huge corporate entities. What appears on the screen is very often the personal vision of one man, but to put it there, he has to set vast machines turning.

"As TV is organised at the moment, a programme can consist of four kinds of things — live TV pictures from a camera in a studio; recorded TV pictures from a scene shot in a studio or on location with a mobile camera and video recording machine; graphics — text or drawings shown to a TV camera in the studio; and film which has to be turned into electronic TV before it is transmitted.

"If you want to make TV accessible to far more people than today's elite pro-

ducers, the main thing to dispense with is the studio. If you want to interview someone, you can set up a camera almost anywhere and put them in front of it. You don't need film for most shows, and it's very expensive.

## Now inexpensive

"Portable VTR machines are now inexpensive, so location recording is no difficulty. The one remaining problem is graphics and text, which today is done by having an artist draw the material and putting it in front of a camera in a studio. If it has to move — say you have a bar graph showing how national spending on teddy bears has changed over the last five years — you have someone crouching in the studio pushing pieces of coloured cardboard up and down through slots. To back him up, you need a tremendously expensive and complicated studio installation and organisation, with its lighting, control boxes, floor managers and God knows what.

"It occurred to me that if you could make it possible to do graphics straight on to the screen and then on to a VTR machine, you could avoid all that and almost have a TV studio on a table top."

When I visited Graham in Ealing, that was almost what he had. His set-up con-

sisted of a mixture of digital and analogue electronics.

"For the moment," he says, "digital TV needs so many bits — something like 100 million per second — that it isn't really practical. The way to cope is to deal with TV views of the outside world as analogue signals, and to be able to add to them digital graphics you generate yourself."

He had a small black and white TV camera, replacing, for reasons of economy, a colour camera. In a real set-up, it and two others could be used for talking heads, or to look at graphics, such as news photographs, paintings, maps and the like.

Its signals were fed into a colour synthesiser, so that the operator could assign different colours to levels of grey in the input image.

Using this, the operator can colour his graphics any way he fancies. The signal from the synthesiser goes to a two-way video mixer, which combines the camera signal with a graphics signal from a microcomputer. This is where the magic starts.

The micro — Graham has been experi-

Picture above: Left to right, colour synthesiser, ITT 2020, artwork pinned to camera, black-and-white TV camera, TV monitor.





Typical news photograph and effects possible using the colour synthesiser, which assigns different colours to different levels of grey.

menting with both the Apple II and ITT 2020 — eliminates the need for the services of a graphics studio and for a TV studio to show the graphics to a camera. The operator can generate captions for talking heads from the keyboard, using standard Teletext alphanumeric characters.

He can write, or draw on a library of, simple standard programs to do graphs, bar charts and so on. He can use the graphics input from the computer to make the video mixer dissolve from one TV image to another, using some complicated pattern.

"For instance," Graham says happily, "in a few minutes I wrote a little program which makes the screen gradually turn white in random white squares. You can tell the video mixer to show scene A on portions of the screen where the computer output is black, and scene B where it's white. The effect is known in the trade as a 'random matrix dissolve.' It's very fashionable and done at the moment by tremendously expensive hardware which can't do anything else. Computing people think nothing of it but TV people are knocked out."

Graham reckons a neighbourhood TV

station could be equipped, using a micro-based graphics system, for about £100,000, and with that could transmit a regular news magazine. "If you reckon that it would provide employment for about five people, a capital investment of £20,000 in the tools of one's trade isn't unreasonable."

## No finance problem

How has he financed his equipment? "No problem really — I've bought things which are rather difficult to obtain and can be re-sold for at least 80 percent of their cost. My bank manager was happy to lend me the £8,000 I've spent so far."

What are the snags? The main one, so far, is that the colour graphics board doesn't produce a properly-shaped TV line signal. It's good enough for a hobbyist — it gets a colour on to the screen but it doesn't produce the right combination of precisely-defined waveforms broadcast-quality TV needs. With help from several people and a few extra boxes of electronics, the problem has been solved.

As so often happens in modern affairs, the technical bits are the easy ones. If Graham is successful — and there is no

good reason one can see why he shouldn't be — his system will make a great deal of the monolithic machinery of today's TV broadcasting unnecessary. He says:

"It's as if painting had got stuck at the stage of public murals and artists could do nothing unless a prince came along to give them a wall on which to paint. What painting was to earlier centuries, TV is today. Anyone should be able to do it."

That simple assertion, of course, conceals some deeper problems. Because TV is so powerful, societies need political control over the contents of TV programs. In the West, that is done almost automatically because the apparatus of TV is so expensive. It costs so much that any organisation able to provide it must be locked into society in many other ways already, or it couldn't have the money initially; but when that automatic financial control no longer operates, then one can expect TV makers to find themselves exposed to much stronger political pressures than they are today.

The back upstairs bedroom of Graham's Ealing house may be a Pandora's box; what flies out when it's opened may surprise him and many others. ■

Graham's first graphics efforts — a winking face, a random matrix dissolve, a bar chart program.



# If you buy the wrong personal computer, you can't re-program your bank account!

Buying a personal computer is not an easy task.

So many people selling them neglect the little things that enable you to get the most from your computer, such as documentation, spares, add-ons and maintenance. We believe that these 'details' are essential. We are the only British company to put all our time and energy into the personal computer market and are in the best position to advise you on your initial purchase and keep you fully informed about all the new developments relevant to your computer.

Personal Computers Limited — *the name of the game.*

Say 'hello' to a graphics Apple II



A business Apple II



# Personal Computers Limited

194-200 Bishopsgate, London EC2M 4NR.  
Tel. 01-283 3391

**Apple Software Bank**  
Free membership to all Apple owners  
POST TO: Personal Computers Ltd, 194-200 Bishopsgate,  
London EC2M 4NR.

NAME .....  
ADDRESS .....

# Practical Computing Back Issues

If you are interested in microcomputers you will want to read the *Practical Computing* reviews of the machines in which you are interested. Each month *Practical Computing* carries at least one hands-on test of a popular microcomputer for use in business, the home, schools and colleges. Each review contains the kind of information you need—technical data and unbiased critical comment on the strengths and weaknesses of each system.

Each issue is packed with essential reading on microcomputers, including all our regular monthly features: Book and cassette reviews; Glossary of computer terminology; Computabits; Pet Corner (February onwards); Apple Pie (May onwards); Tandy Forum (March onwards); serialised *Illustrating Basic* (October 1978 onwards).

All this makes *Practical Computing* the invaluable source for the whys, wherefores, hows, ifs and buts of microcomputing.

October 1978

Review 1: Commodore Pet I. Review 2: VDUs—Computer Workshop CT-64, Strumech Engineering ACT-1. Music on a KIM; Micro v Calculator; VAT accounting complete program Part 1.

November 1978

Review: Tandy TRS-80. Projects for KIM: Pet goes to school; VAT accounting complete program Part 2; Complete game program—Mastermind; Software Dynamics Basic computer review.

December 1978

Review: Research Machines 380Z. Choosing your first computer; ITT interview. Complete games programs—Battleships, Racing Cars and Monsters; A microcomputer reservation system.

Playing with the Pet in the Panther

Turning IBM typewriters into terminals

Learn typing by computer

January 1979

Review: Nascom I. Convert an IBM typewriter into a terminal Part 1; In-car computing—Pet in the Panther DeVillie; Report from the Los Angeles Computer Faire; Pascal v Basic.



February 1979  
Reviews: Cromemco Z-2D. Low-cost peripherals; Systems for estate agents and doctors; A £1000 payroll system; IBM typewriter conversion Part 2; Complete game program—Warlock Warren.



March 1979  
Review: Single-board computers for less than £50. Low-cost stock-control systems; IBM typewriter conversion Part 3; New monthly column—Tandy Forum; Complete game program—NIM



April 1979  
Review: North Star Horizon Business accounting systems; Apple II design story Part 1; Computerised school meals; Finance for school computing; Build your own frequency meter; Star Trek game



May 1979  
Reviews: Eddy Sorcerer, Science of Cambridge Mk 14; Printers for less than £1000; Order processing/invoicing packages; Retire with your computer; Apple II design story Part 2; Slalom game.

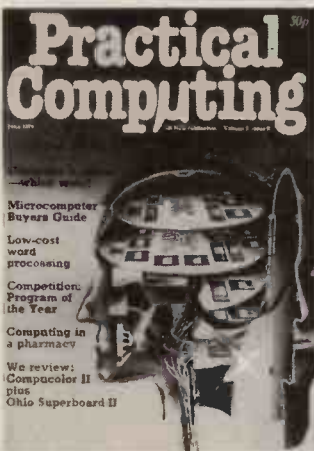

June 1979  
Reviews: Compucolor II, Ohio Superboard II. Low-cost word-processing; Computing in a pharmacy; Designing a small business application Part 1; Computer v Brain; Zombie game.

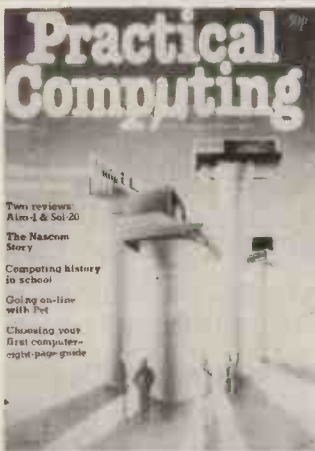

July 1979  
Reviews: AIM-65, SOL-20. Choosing your first computer; Interfacing Pet with a mainframe; Nascom story; Designing a small business application Part 2; Biorhythms program.



August 1979  
Reviews: Pet II, KIM. Pros and cons of PASCAL; Microcomputer user groups; Designing a small business application Part 3; Interfacing Pet with a mainframe Part 2; Life game program



September 1979  
Reviews: Powerhouse 2, Acorn, Anadex and Heathkit printers. Artificial intelligence; Build your own joystick; Computer scene in the North-West; Mathematics on a Pet; Self-teaching games program.

Only the above issues are still available. To keep your copies of *Practical Computing* in good condition and convenient for reference you will need a special binder. In blue, with *Practical Computing* in silver-steel lettering on the spine, each holds twelve issues comfortably. Fill in the coupon opposite and return it with your remittance to *Practical Computing*, 30-31 Islington Green, London N1 8BJ.

# MAXIMUM CAPACITY COMMERCIAL SYSTEM

INCREDIBLE £1995† VALUE!!

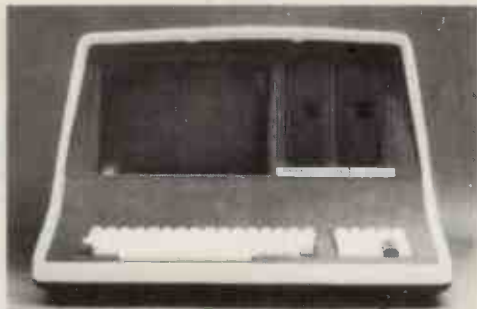

THE PERFORMANCE LEADER!!

THE PRICE LEADER !!!

## INTERTEC SUPERBRAIN™

Dual Z80A 4MHz Vector Interrupt  
64K RAM plus 1K 2708 PROM Bootstrap  
TWO Double Density 5" Floppy Disk

### ●CP/M\* Disk Operating System: The Industry Standard and Most Powerful

- Makes Thousands of Inexpensive Compatible Applications Programs Available From Scores of Suppliers (Including Us)
- Comes With: Powerful Editor, Assembler, Dynamic Debug Tool, Disk Formatter — We Also Have Low-Cost High-Performance Business Software
- BEWARE of One-Source Non-Standard Operating Systems Offered by Others — Be Free to CHOOSE, Not at the Mercy of One Supplier!
- ANSI Standard FORTRAN, COBOL, BASIC, APL, APPLICATIONS SOFTWARE Available From Any and All CP/M Software Houses at Affordable Cost

### ●S-100 Bus VIA Direct Connection — Cost Effective Flexible Expansion

- Makes Scores of Competitive Hardware Boards & Functions Available From Dozens of Manufacturers: Be Free to CHOOSE, Be Independent!
- Unlimited Practical Expansion: 2 DSDD 8" Floppies 2·4Mbyte; 8-120Mbyte Hard Disk; Colour VDU, Plotter, Modem, Mainframe Interface, etc. Using Optional S100 Extender
- MAKES EXCELLENT DISTRIBUTED PROCESSING COMPUTER ON ANY MAINFRAME

### ●TWO High Quality Commercial Grade BASF 5" Diskettes: 160K Each (320K Total)

- 2 Double Density Minifloppies; Add Two More Inexpensively; Data Files File Security, File Copy, Convenient Operation in All Applications

### ●VDU High Resolution, Fully Programmable, Dual Keyboards of Highest Quality

- Full Upper/Lower Case ASCII 128 Set With Limited Graphics; 64 User Definable Function Keys, Programmable Cursor & Reverse Video
- 25 Lines by 80 Characters 8×8 in 8×12 Field; Easy Reading Full Size 12" Screen; Numeric and Control Keypad Separate

### ●DUAL Z80A PROCESSORS — TWO Board Modular Easy-Maintenance System

- Disk and Processor Use Separate Z80s: Computing Can Continue During Disk Operations etc.; Transparent Bootstrap Allows Full 64K Memory
- Two Boards: Computer, VDU & Power Supply: Simple Servicing by Board Replacement — On service Contract or Send in Boards Yourself

### ●All In ONE Smart Portable Lightweight Console (45 lb): Just Add A Printer!

- Any Size Printer, Any Function: £300 — £2500; Std., Daisy, Two Colour, Full Graphics ON Standard RS-232 CCITT Serial or TRS-80 Parallel

### ●Can You Find Another Commercial System Which Outperforms This One?

●Make No Mistake About It — The Others Are Mere Students and Cannot Compete With This Year's Honour Graduate, Intertec Superbrain: Top of All Classes!

### ●All Enquiries Invited From Commercial End-Users and Dealers

## ICARUS COMPUTER SYSTEMS

E Floor, Milburn House, Dean Street, Newcastle on Tyne (0632) 29593, 28632

See us at Booth 55 International Business Show 1979  
23rd October-1st November National Exhibition  
Centre, Birmingham

† Yes, that's the one-off price, NOT the Delivery Date !!!  
\* Registered Trade Mark of Digital Research Corporation of California, U.S.A.

● Circle No. 204



These pages represent an independent collection of news and views for owners of the Commodore Pet. If you wish to contact Pet Corner, send articles or ideas directly to us. We are not connected with Commodore or with the official Commodore-run Pet Users' Club, though we wish it well. We give space to Mike Lake, of the Independent Pet Users' Group (IPUG).

## Challenge

KESWICK Chess Club secretary was quoted in a local newspaper as saying that "microcomputers were just chess-playing Daleks", and suddenly found the club being challenged to pit its skills against six Pets.

The challenge was from David Fabri, a tutor at the local further education college, who set up the machines with the Microchess-2 program, written by Peter Jennings, and which finished fourth in the 1978 World Microcomputer Chess Championship.

The venue was a local hotel, but at the end of the evening, the Pets were second best. The humans beat them 5-1.

## Test your reactions

THE FOLLOWING program from Micro Systems in North Humberside was designed to measure the response time of an individual to a given stimulus. It can, of course, be used as a source of amusement but also for serious experimental investigation. For instance, it would be interesting to compare the results obtained by various groups of people of different age groups. A further interesting comparison could be made by test-

```

10 DDUB 500
20 DETA4
30 IFAS="THEN20
40 PRINT:PRINT" *** OR YOUR MARKET ***"
50 TRND(17+1000)
60 FGB=170000+TRND(17)
70 T=1
80 PRINTCHR(147)
90 DETA4
100 IFAS="THEN90
110 B=11-T
120 DDUB(500)
130 PRINT:PRINT"YOUR REACTION WAS"BI"SEVENTHS OF A SEC"
140 PRINT
150 IF(100)THEN100
160 PRINT" YOU MUST HAVE COME TO SLEEP"
180 PRINT:PRINT" HAVE ANOTHER TRY"
190 GOTO 10
195 IFC(1)THEN 210
199 PRINT" THAT WAS RATHER A POOR RESPONSE"
200 GOTO250
210 IF B<25)THEN240
220 PRINT" THAT WAS AN AVERAGE RESPONSE"
230 GOTO350
240 IFC(1)THEN270
250 PRINT" THAT WAS A GOOD RESPONSE"
260 GOTO350
270 IF B<5) THEN 300
280 PRINT" THAT WAS A VERY GOOD RESPONSE"
290 GOTO350
300 IFC(1)THEN330
310 PRINT"TOO GOOD, YOU MUST BE PARTICIPATING - RESULTS IGNORED"
320 GOTO20
330 PRINT" YOU ARE CHEATING - RESULT IGNORED"
340 GOTO20
350 END
360 N=48
365 PRINT:PRINT" NO. OF ATTEMPTS"BI" AVERAGE TIME "JBT(BI/A)
370 GOTO20
380 PRINTCHR(147)
390 PRINT" PERSONAL REACTION TEST PROGRAM"
400 PRINT"
410 PRINT:PRINT" INSTRUCTIONS"
420 PRINT"
430 PRINT
440 PRINT" WHEN YOU ARE READY PRESS ANY KEY OR"
450 PRINT"THE KEYBOARD, AFTER A DELAY OF ABOUT"
460 PRINT"10 SECONDS THIS SCREEN WILL GO BLANK."
470 PRINT"THIS IS YOUR SIGNAL TO PRESS ANY KEY."
480 PRINT"ON THE KEYBOARD AS QUICKLY AS YOU CAN."
490 PRINT"THE COMPUTER WILL CALCULATE YOUR"
500 PRINT"REACTION TIME IN SIXTIETHS OF A SECOND."
510 PRINT
520 PRINT
530 PRINT" IT IS UP TO YOU NOW - GOOD LUCK!"
540 RETURN
READY.
    
```

ing the same groups of people, both before and after taking alcohol, or at different times of the day.

As a guide for readers, the best score obtained by the author was 11 although a score below 15 can be considered as good.

It was intended that the instructions contained in the program be self-explanatory. The only point in practice which has caused confusion is when some people have not read the instructions carefully and do not realise that they have to press a key to start the game running and bring up the ON YOUR MARKS message.

## Switching device

WEGO COMPUTERS has a sequential switching device which can power-up a Pet and its peripherals in any logical sequence chosen by the user. The device will power-down in the reverse order.

Five outlets are available as standard, but more are obtainable on special order. Price is £46.55 plus VAT from Wego on (0883) 49235.

## Writing music

It is a simple matter to buy a ready-made "organ" and pre-written music programs, but it is more fun to make your own organ, and to write your own music. The hardware is a radio, preferably battery-operated, and it is connected to pins M and N of the user port, via two resistors, as described previously in Pet Corner, the leads going to the audio section input and earth of the radio, writes Rex Tingey.

The program to convert Pet into an organ is simplified here, giving keyboard K as a centre note (C) with four playable keys either side. This is chosen because it is easiest to write in the key of C when sharps and flats are seldom involved in the basic melodies. My full program can give a middle octave, a lower octave, and a top octave to a top C plus a few more top notes, using the keyboard across twice from A to + (plus) and in addition using the QWERTY line through to / (divide) for the intermediate sharps and flats; but I have kept it simple.

Pressing keys which have not been programmed take the last note played, pause, and then replay a short burst, and switch off, repressing the key gives a "staccato" effect. This applies to every key which has not been programmed to give its own particular note, apart from the shift keys which are non-effective and

the Run/Stop which breaks the run, and requires a typed RUN-Return. All the keys which are programmed produce their own note which is sustained until another key is pressed. The screen display is unchanging during play.

## Organ program

The program has three POKES59467,0, which switches-off the notes. Do not try to SAVE a program without invoking this poke or your cassette player will lock-on in whatever mode you try, and refuse to be switched-off by any means but the mains, the program being lost.

So on RUN/Return the run starts at 10, switching-off any sound; 20 simplifies the time-consuming pokes, converting the values to single letters, and 90 re-sets the value of Z\$ from the keyboard, but is also a minor loop, nesting inside the major loop.

It is two steps separated by the colon, returning to the first step until a key is pressed, thus keeping silence until a key

### THE ORGAN

```

10 POKE 59467,0
20 A=59467:B=59466:C=59464
90 GET Z$:IF Z$=" "THEN 90
100 POKE 59467,0
110 POKE A,16:POKE B,15
150 IF Z$="F"THEN POKE C,177:GOTO 90
160 IF Z$="G"THEN POKE C,157:GOTO 90
170 IF Z$="H"THEN POKE C,149:GOTO 90
180 IF Z$="J"THEN POKE C,125:GOTO 90
190 IF Z$="K"THEN POKE C,117:GOTO 90
200 IF Z$="L"THEN POKE C,104:GOTO 90
210 IF Z$=";"THEN POKE C,93:GOTO 90
220 IF Z$="4"THEN POKE C,87:GOTO 90
230 IF Z$="5"THEN POKE C,78:GOTO 90
1000 POKE 59467,0:GOTO 90
    
```

is pressed or sustaining the present value of Z\$ if a programmed key has been pressed. If an unprogrammed key has been pressed, the search runs up to 1000; the poke switches-off the sound at 100, pips the sound as the unchanged value of Z\$ passes the POKE C to switch-off at 1000. Subsequent presses of unprogrammed keys passes the remembered value of Z\$ through the steps to sound the note as a pip.

A new note entered passes 100 to switch-off the previous note before finding its home to switch-on the note with the poke C, returning to 90 to sustain the note. A full range of notes and the appropriate pokes was published in Pet Corner (April, 1979) to enable you to program the full keyboard, but do not forget to POKE 59467,0 before SAVE-

(continued on page 111)

# Select Pet, Apple or Nascom in West London.



Choosing the computer most suitable for your needs can be difficult at the best of times. And when it comes to the final selection from today's three top-value micros it doesn't get any easier.

We won't promise to make your decision for you, but a combination of your requirements and our professional expertise will ensure you get a system that's right for you.

So why not drop in to discuss your personal computing needs with us? Naturally we can arrange a demonstration, but better still try a machine yourself.

When you've chosen your hardware remember that's not the end of the tale. We can provide software packages, tailored business systems and even games. Plus of course systems and programming support, maintenance and finance.

Adda Computers, 17-19 The Broadway, Ealing, London W5 2NH. Telephone: 01-579 5845.  
Open 09.00-18.00 Monday to Friday.  
10.00-16.00 Saturdays.

Entrance between W H Smith and Burtons

**adda**

**we add up to a great deal.**

PETACT PETSOFT  
COMPUTASTORE  
software available

● Circle No. 205

## PETAID

**PET USERS and budding PET PROGRAMMERS —  
Feel Like Giving Up? Our Advice is — Oon't!  
Get PETAID and write good commercial software in  
HOURS NOT WEEKS.**

**PETAID Version 1** is a file based utility program designed to help people develop their own file based programs in a fraction of the time it takes to write them in Basic. Weeks of Programming become Hours. All your programs will perform to the same high standard. All your programs will operate as professionally written commercial software.

### With PETAID CREATE Your Own:

Suppliers Files  
Customer Files  
Mailing Lists  
Personnel Files  
Address Book  
Amenities File  
Diary File  
Price Lists  
Parts List  
Stock File  
Sales Lead Lists  
Patient Registers  
Etc Etc

### Incorporated in the PETAID Package is:

- a powerful search function which allows the user to search his database on his own defined basis
- a powerful set of commands — AND, OR, NOT, GREATER THAN, LESS THAN, EQUAL TO
- embodied is a string search function which enables the user to locate records based on a string contained somewhere within the record

The above features and commands may be used in conjunction with one another with no limit on the number of defined operands apart from practicality.

### NOW AVAILABLE!

— Tape based version £80 — Commodore Disk based version £120 (Seq. files) —  
— Documentation £10 —

### FUTURE Versions of PETAID:

1. Random Access 2. Print generators 3. Search & Extract an index/new file/print  
4. Sort Utilities 5. Transaction Handling 6. Word Processor package  
7. Other commercial packages.

# STAGE ONE COMPUTERS

6 Criterion Arcade  
Old Christchurch Road  
Bournemouth  
Tel. 23570

● Circle No. 206

(continued from page 109)

ing. When programming, full use can be made of the graphics on the screen, which is static.

## Composing

Once the organ is operational, it becomes interesting to compose programs for the Pet to play. The organ is used for "writing" the music, by finding the correct sequence of notes from the keyboard and listing the order symbol by symbol on a pad of paper, and then allocating each a sequence number. For example, the first four lines of *Good King Wenceslaus* are found to be:

```

1 2 3 4 5 6 7 8 9 10 11 12 13 14
K K K L K K G H G H J K K *
15 16 17 18 19 20 21 22 23 24 25 26 27 28
K K K L K K G H G H J K K *
29 30 31 32 33 34 35 36 37 38 39 40 41 42
5 4 : L : L K H G H J K K *
43 44 45 46 47 48 49 50 51 52 53 54 55 56 57
G G H J K K L 5 4 : L K 4 K *
```

This information is then written in terms of the keyboard symbols:

```

K = 1, 2, 3, 5, 6, 12, 13, 15, 16, 17, 19, 20,
    26, 27, 35, 40, 41, 47, 48, 54, 56
L = 4, 18, 32, 34, 49, 53
G = 7, 9, 21, 23, 37, 43, 44
H = 8, 10, 22, 24, 36, 38, 45
J = 11, 25, 39, 46
: = 31, 33, 52
4 = 30, 51, 55
5 = 29, 50
* = 14, 28, 42, 57
```

and the program is written around the allocated numbers using a loop incrementing by one, thus accessing the notes, one by one, in their correct sequence, but not dependent on their position in a step.

No attempt has been made to form strings, chains or even multiple lines — for two reasons. In the first place, mistakes can easily be made in this type of exercise, and an easily-"LISTed" program is most easily checked for mistakes and the mistakes rectified by work on a single element without upsetting any dimensions.

## Automatic loop

Secondly, all the details are laid open upon listing for re-writing a successful program to become another tune with the minimum of work, just altering the sequence numbers and some GOTOs, with the minimum of effort to produce the program for a new melody.

The automatic tune loop has to be designed differently from that of the organ because access to notes is no longer a "GET" from the keyboard, but a sequential looping which operates in its own time and will play the complete tune so rapidly that most notes have no time to develop and are not produced.

To produce an audible note, a timing loop must be added, nested within the major loop, and used each time the major loop is used. Further to this a longer pause is required at the end of music lines, which may be considered as a pause after a line of poetry, or lyric.

There are two options for a timed loop; using real-time — which is the clock — or

using looped print statements which take time to print-out and delay execution of the program. The second option is good, producing a minor flutter in the sound but disturbing the screen with the scrolling effect. The elegant way is to use real-time.

With the Pet there are two options with accessing time. The first is TIMES which counts in whole seconds as its smallest unit — not really suitable for music. The other unit of time available is the "jiffy" which is a period of 1/60th of a second, but not accessed as easily as TIMES — or TIS, which works just as well — and the books I have give no details of access other than "?TI".

I found, however, that by making an assignment statement LET T=TI, the present value of T could be used; the value of T being previously zeroed by TIS="000000".

Thus a counting loop using TI is a good way to provide a fixed sustain for a musical note but care must be taken to avoid "equals", using only "greater than" to end the loop, and "smaller than" to continue it; the "equals" may miss the point.

Two minor loops using this principle are nested sequentially in the major loop to control note sustain and pause sustain. They are preferred at the end of the program so they are "LISTed" easily for fine timing adjustment.

Be wary of "IF...THEN" statements in loops at the ends of programs; sometimes they refuse to GOTO low numbers back at the beginning of programs. If they give trouble, refer the THEN statement forward to a higher address number at which the simple "GOTO low number" resides; this always works.

The POKE statements, producing the notes, are repeated for every required note, switching-off the previous note, and the new note on; the intermediate pokes may seem to be repeated unnecessarily, statements of the poke's value at the start of the program being all that is required. If these are removed, the sound quality changes for the worse.

## Program

The program as listed gives the first line of the carol (which is the second line as well), and starts with the same "switch off sound" poke, followed by the assignment statements at line 90. Line 100 initiates the zeroing of the major loop, which continues back to 120.

The loop picks-up the address of a note or a break on each forward run. The end break has a different address, 650, which zeroes the value of A before entering the timing loop. The first timing loop is linked to the second, the second loop being the note sustain.

The program can be improved in several ways which become obvious when a four-line melody is played. The notes further along the list take more time to be accessed and sound later than they

should; advantage can be taken of this by re-arranging the list so that run-together notes are at the beginning of the list, and those requiring more separation at the end.

Another improvement could be to have a number of timing loops to give various periods of sustain. The notes list would then require converting — if A=16 THEN N=2 : GOTO 590, for example — the value of N being used to direct a particular note to a particular time loop, through a step further along the program.

When programming the graphics for the screen, it is a good idea to put up "POKE 59467,0 before recording", as a reminder, or all the work could be wasted. I have included the line pause (226) which is required here and also the end of verse pause (250), which is not. Line 1000 is not essential as the program stands.

```

THE MUSIC
10 POKE 59467,0
90 X=59467:Y=59466:Z=59464
100 A=0
120 A=A+1
122 IF A=1 THEN 590
124 IF A=2 THEN 590
126 IF A=3 THEN 590
128 IF A=5 THEN 590
130 IF A=6 THEN 590
132 IF A=12 THEN 590
134 IF A=13 THEN 590
162 IF A=4 THEN 600
174 IF A=7 THEN 560
176 IF A=9 THEN 560
188 IF A=8 THEN 570
190 IF A=10 THEN 570
202 IF A=11 THEN 580
226 IF A=14 THEN 500
250 IF A=15 THEN 650
500 POKE 59467,0:GOTO 680
560 POKE 59467,0
562 POKE X,16:POKE Y,15
563 POKE Z,157:GOTO 700
570 POKE 59467,0
572 POKE X,16:POKE Y,15
573 POKE Z,140:GOTO 700
580 POKE 59467,0
582 POKE X,16:POKE Y,15
583 POKE Z,125:GOTO 700
590 POKE 59467,0
592 POKE X,16:POKE Y,15
593 POKE Z,117:GOTO 700
600 POKE 59467,0
602 POKE X,16:POKE Y,15
603 POKE Z,104:GOTO 700
650 A=0:GOTO 500
680 TIS="000000"
682 T=TI
683 IF T > 20 THEN 700
684 IF T < 20 THEN 682
700 TIS="000000"
710 T=TI
720 IF T > 10 THEN 120
730 IF T < 10 THEN 710
1000 POKE 59467,0:GOTO 120
```

# ***EUROC — Simplicity is the watchword***



***EUROC*** is a new, simple-to-use, fast, powerful microcomputer system for business. It's British, the program tried and tested.

***EUROC*** is already being talked about by bankers, accountants and businessmen. See it on Stand 642, Hall 2 at the International Business Show — National Exhibition Centre, Birmingham, 23rd October-1st November.

***EUROC*** hardware is manufactured exclusively for Euro-Calc Ltd. by Plessey Microsystems Limited. ***EUROC*** will be on permanent display at Euro-Calc's branches at 55, High Holborn, London WC1 and at 224, Tottenham Court Road, London W1.

*For further information and trade-distribution enquiries, talk to Peter Ingoldby, Euro-Calc Ltd., 55, High Holborn, London WC1, telephone 01-405 3223, or Anthony Manton, at 224, Tottenham Court Road, London W1, on 01-636 5560.*



## Improvement

THE NEW Apple DOS 3.2 is, you will no doubt agree, a vast improvement on the previous version. Not only is the software better but the manual is much improved. For those who have no version of the new DOS, a utility pack is available from your nearest dealer, containing a new master disc and the new manual. Those who are already using DOS 3.2 probably will have met a bug in one of the demo programs, "Random". Ken Hopkins has 'fixed' it successfully as:

```
Change line 130 to: 130 INPUT NS, BL, ST
Change line 200 to: 200 PRINT RDS; FL; ", R"; R;
INPUT NS, BL, ST: PRINT DS
```

## Discounts

DISCOUNTS on various products are becoming available to user group members, in addition to those published already. Microsolve Computer Services of 125-129 High Street, Edgware, Middlesex and H B Computers have offered to discount media supplies to members. These are available on production of membership card. For more details, contact the dealers.

## Error trapping

JIM STEEDMAN has pointed to an error in the program by G. Phillips, published in August, which finds expressions, statements and variables in a particular program. The corrected version (from line 3000) is given:

```
3000 A = 2049: X = PEEK (2053): FOR
      J = 1 TO 10000: FOR K = A +
      4 TO A + 255: P = PEEK (K)
3001 IF P = X THEN GOSUB 3005
3002 IF P < > 0 THEN NEXT K
3003 A = 256 * PEEK (A + 1) + PEEK
      (A): IF A > 0 THEN NEXT J
3004 END
3005 FOR L = 1 TO 239: Y = PEEK
      (2053 + L): IF Y = 0 THEN PRINT
      256 * PEEK (A + 3) + PEEK
      (A + 2): RETURN
3006 IF Y = PEEK (K + L) THEN NEXT
      L
3007 RETURN
9999 END
```

## New bits

MICROCOMPUTERS are making a tremendous impact on society, to the extent that almost every business wants to install a computer for its own use. One problem, however, exists because the amount of backup-store available on floppy discs is rarely sufficient for, say, serious stock control or accounting purposes. Keen Computers of Nottingham is to import a 10-megabyte hard disc suitable for use with the Apple.

The Winchester disc is made by Corvus Systems of California and utilises the



Apple disc operation system. Complete with power supply, controller, interface card and necessary software, it plugs directly into an Apple and can be used in exactly the same way as a floppy disc.

Compatibility with DOS commands and applications is accomplished by maintaining 82 physical volumes on disc which are sector-by-sector compatible with Apple volumes. All those volumes are concurrently "on-line", so that any application program can utilise the entire database by simple use of standard DOS syntax. Should you still have insufficient storage space, a slave disc can be added easily.

## Colour card

Keen Computers Ltd also has available a new colour card for the Apple, manufactured to its own design. The card does not modulate the signal leaving the Apple, but decodes it to get a Red, Green and Blue signal, which is passed to a slightly-modified TV set.

Advantages of such a system are a much clearer picture and sharper colour, and the ability to change the colour of the text as displayed on the screen. The card will be on sale soon at around £90 plus VAT and a modified 14in. Sony colour TV will cost approximately £300 plus VAT. The TV will still pick-up BBC and ITV signals.

Graphics Display Systems Ltd has a hand-held Polaroid hard-copy camera system. It uses a Polaroid oscilloscope camera with a suitable hood to produce sharp, high-resolution black-and-white or colour photographs of a VDU display. Selling from £128, the device should prove to be useful for quick hard-copy, especially of graphics. More information from John Davidson, 76 Hemingford Road, Cambridge (0223 51645).

## Supertalker

Another new product for Apple is the Mountain Hardware Supertalker. This peripheral system allows the Apple to output exceptionally high-quality human speech through a loudspeaker under program control. The words are digitised

into RAM through the system microphone.

Speech data in RAM — or on floppy disc — may then be manipulated like any other stored data. The Supertalker is complete with microphone, loudspeaker, easy-to-use software, demo programs and documentation.

## Applications

IN THE coming months I would like to run a series of articles devoted to what you are doing with your Apple. I know of an Apple in a car and another controlling a chemical engineering plant. If you have an unusual application, please let me know.

Similarly, if you can foresee an application but lack the necessary skill to develop it, write to me and I will see what advice can be found.

## Growing

WHEN something like a user group expands, it does so rapidly and can easily catch one on the hop. Apple Group membership is approaching 70, an increase of something like 40 in the last five or six weeks.

We are very pleased with the way the group is growing and in the interest shown in it by Apple users.

## Industry

WITH Microsense taking responsibility for the import of Apples to the U.K., there is a two-tier dealer network, with the previous importers acting as regional or main dealers, each of those companies having its own dealer network already in existence.

To the user and the prospective user, Apples will now be cheaper — the colour card having been made optional — and in consequence much more readily available.

There have been other developments. The formation of the Computer Retailers' Association to aim for a high standard of retail service for users of all microcomputers, and a separate organisation, the Apple Dealers' Association, whose inaugural meeting was held in August.

## Similar roles

The Apple Dealers' Association aims to protect and enhance its members' investment in Apple, the company reputation and products, and the users' application of Apple products.

Both organisations are playing a similar role to that of the user group, albeit in a slightly different way, and the Apple Dealers' Association has offered its support to the user group.

One advantage is that users now have three means of redress in the case of complaint and three sources of advice in an emergency.

# DATRON MICRO CENTRE

Microcomputers – Peripherals – Software – Books

**Cromemco**

**ITT 2020 apple II**

**commodore**



## WHY PAY MORE?

"Construction never less than excellent" (Practical Computing Feb. '79)

System 2 – Dual Disc – 64K – £1995  
 System 3 – Dual Disc – 32K – £2995  
 System 3 – Dual Disc – 64K – £3293  
**Z – 20 II MB Hard Discs + Dual Floppies  
 64K – £4998**

Plus VDU's, Printers.

Software:—

Database, Word Processing, 16K Basic,  
 Fortran, Cobol at £65.00.

Cromemco-Appointed Dealer



Complete Business System including software and printer from £3500 or

16K prices for both  
 32K ITT 2020 and Apple are  
 48K falling so ask for latest prices

plus Discs, Printers and Interfaces.  
 Software:—

Sales Ledger, Purchase Ledger,  
 General Ledger, Payroll and Stock Control,  
 Text Editing, Statistical Packs,  
 Information Retrieval etc.

Appointed Dealers



The well-established PET with integral keyboard and screen.

4K – £460  
 8K – £550  
 16K – £675  
 32K – £795

Plus all popular games and  
 VAT

– £15  
 Address book – £6  
 Current Account – £12  
 Stock Control – £12  
 Payroll – £25  
 Invoicing – £20  
 Basic Tutorial – £15

Send s.a.e. for full list.

plus Centronics, Lear Siegler and Teletype Peripherals + National Maintenance by CFM Ltd.

## Books

Our Most popular titles:—

<b>Introduction to Personal and Business Computing</b>	£5.45	<b>Basic Basic</b>	£6.50	<b>ITT 2020 Handbook Set</b>	£20.00
A comprehensive and simple introduction		One of the most widely sold		<b>Cromemco Catalogue</b>	£1.00
<b>Microprocessors-Chips to Systems</b>	£7.95	<b>Advanced Basic</b>	£6.00	from Single card to System 3	
Basic text for Technically Minded		What it says			
<b>Introduction to Microcomputers</b>		<b>How to Program Micros</b>	£6.95		
Vol 0 – The Beginners Book	£5.95	Assembly Language for 8080, 6800 & 6502			
Vol 1 – Application Techniques	£6.30	<b>Z80 Prog. for Logic Design</b>	£6.30		
<b>Microcomputer Primer</b>	£6.35	For programmers and logic designers			
How they work for beginners		<b>Some Common Basic Programs</b>	£6.45		
<b>Microprocessor-Interfacing</b>		76 programs, finance, maths etc.			
<b>Techniques</b>	£7.95	<b>Basic Computer Games</b>	£5.50		
Introduces basic concepts		Why not? Complete listing and sample run, plus description			
<b>Z80 Microcomputer Handbook</b>	£6.95	<b>Computer Quiz Book</b>	£5.45		
Essential information on Z80		Test your knowledge			
<b>Illustrating Basic</b>	£2.25	<b>Fun with Computers and Basic</b>	£5.45		
Serialized by Practical Computing		Intro. to Computers and Basic			
<b>How to Profit from your Personal Computer</b>	£5.50	<b>The Best of Byte</b>	£8.45		
Professional, Business and home applications		From first 12 issues			
<b>6502 Applications Book</b>	£8.95	<b>The Best of Creative Comp.</b>	£6.95		
Practical applications techniques for the 6502		Vol. 1 or Vol. 2			
<b>Z80 Assembly Language Programming</b>	£6.30	<b>General Ledger</b>	£10.95		
Comprehensive coverage		<b>Accounts Payable/Receivable</b>	£10.95		
<b>Instant Basic</b>	£7.20	Complete testing source listing File layouts, formats all in Basic.			
The fun way to learn					

**NEW!**

**Computer Capers** £5.95  
 Tales of electronic thievery  
 embezzlement and fraud!

**David Lien. The BASIC Handbook** £11.00  
 Virtually an encyclopedia! A must!

**A. Colin Day. Fortran Techniques** £2.25  
 Spec. ref. to non-numerical applications

**Murray Laver. Intro. to the Uses of Computers** £3.50  
 Includes appreciation of problems  
 computers can handle outside purely  
 mathematics

**D. W. Barron. An Introduction to the Study of Programming Language** £2.95  
 A comparison

**Donald M. Monro. Basic BASIC** £2.00  
 Not to be confused with J. Coan's title.  
 A must! A bargain!

**Martin Whitbread. Microprocessor Applications in Business and Industry** £10.00  
 Must for decision makers.

Send s.a.e. for full list.

Cheque Enclosed  or

Charge £..... to Card No:—



MAIL, PHONE or TELEX YOUR ORDER – 24 HOUR SERVICE  
 Please send me .....

.....

Name (as on card) .....

Cardholder's address .....

Signature .....

Hardware prices plus p. & p. Add 12p insurance on books if required.  
 ADD 15% VAT to all items except books. Prices correct at going to press

**DATRON**

INTERFORM LTD.

Datron Micro Centre,  
 Latham House,  
 243 London Road, Sheffield. S2 4NF

Telephone. 0742 585490  
 Telex 547151

● Circle No. 208

## Packaged software

WE HAVE received the new A. J. Harding catalogue. This supplier is a keen specialist vendor of TRS-80 programs and we have asked for some for review.

Items from the new list include Level I in Level II RAM for £14.95 — no conversion necessary. There is a complete payroll system at £24.95, which uses a separate tape for each employee; we are told this isn't as cumbersome as it might sound.

An unusually modular inventory controller also caught the eye; it is not a load-and-go program — more a suite of subroutines to be incorporated into your own code. It costs £19.95.

Harding also has "one of the best series of monitors in the industry", a machine code duplicating program called COPYSYS and a £7.95 fix for "keyboard bounce" which solves the irritating double-character entry bug.

Harding's earlier list is still available, too. Both are obtainable from 28 Collington Avenue, Bexhill-on-Sea, East Sussex.

## A little extra

IF YOU POKE 16405, 0 at the beginning of a program, writes Stephen Toop, it disables the keyboard. This is very useful to avoid pressing of keys in a demonstration or when dumping to tape. You then POKE 16405, 1 at the end and the keyboard is back to normal.

## Baker's half-dozen

THIS IS from Steve Baker of Redhill, with answers where we know them.

"When reading literature concerning programs written for the TRS-80 in Z-80 assembler, I find frequent references to a program called TBUG. How does this program relate to the Level II SYSTEM command? Does it load and save programs in the same format as required by the SYSTEM? Where could I get a copy?"

● *TBUG is a Tandy machine code monitor supplied on cassette; it allows one to edit, load and dump machine code. The disadvantage so far has been unhelpful documentation but we hear that in the States a good new manual has been released which makes TBUG a more desirable item.*

"I heard recently that Tandy has produced a TRS-80 Technical Manual with much interesting material. Could you review it sometime?"

● *Yes, we are trying to obtain a copy. Meanwhile, watch for David Lien's books.*

"What, you ask, is the difference between FIX(X), INT(X) and CINT(X). I suggest you re-read the Level II manual.

"FIX (X) chops off the fractional part of any result. For example:

TANDY FORUM is devoted to the Tandy TRS-80. We will be using it to pass on news about the TRS-80 and its supplier and product announcements from Tandy and other vendors of compatible equipment. Above all, these are pages for users, and would-be users, of this personal computer. We want you to send tips, queries, moans and comments, and we want this page to become a market-place for TRS-80 information.



FIX (2.2) = 2.0  
FIX (-2.2) = -2.0

CINT (X) reduces the number to the integer below X:

CINT (2.2) = 2.0  
CINT (-2.2) = -3.0 (less -2.2)  
INT (X) is the same as CINT except that it returns a single-precision result whose fractional part is zero. This means that it can cope with arguments outside the range of 16-bit integers.

"Does anybody know anything about the so-called Level III Basic as offered by A. J. Harding in the June, 1979, issue?"

● *We are looking for reader opinions. Meanwhile, we intend to review it.*

"One general complaint I have about your column is the inaccuracy and gen-

eral inefficiency of the program fragments you publish. In July you printed a routine to output a moving message. A program should perform initialisations before entering a FOR loop rather than repeating the assignment each time round. You will find that the routine runs faster if you move the statement.

AS = "YOUR MESSAGE":

outside the enclosing FOR...NEXT construct.

In this case the increase in speed is probably unimportant but as your column is read by a number of beginners in the art of computer programming, I feel a better example could be set. Otherwise, keep up the good work.

## Square pegs

FREDDIE NICHOLLS of Optronics comments on the difficulties some people are having with his Squares and Rectangles program. His still works, so try the code again if you want to.

Nicholls also included some comments on availability of products we have mentioned. He stocks the *BASIC Handbook* by David Lien, reviewed enthusiastically by us in May. He also has in stock the TRS232 printer interface mentioned in the April issue.

Optronics has apparently tweaked the accompanying software to give a selectable printer line length and a USR subroutine which does a graphics-less screen print. Try T. V. Johnson if you want to look at an alternative RS232 interface, incidentally — 0276 28333.

Optronics is bringing some interesting TRS-80 magazines from the States, too. We can recommend *Softside* in particular: it is packed with games. We have been subscribing direct to the States for some time. The Optronics price for it is £12 per annum.

The address of Optronics is 50 Holly Road, Twickenham, Middlesex — 01-892 8455.

```

1 REM SQUARE & RECTANGLE PROGRAM WRITTEN BY F.W.NICHOLLS OF O P T R O N I C S TEL 01
3 CLS
5 PRINT"ENTER START & FINISH OF HORIZONTAL LINES.(0 TO 127)":INPUTA,B
6 PRINT"ENTER START & FINISH OF VERTICAL LINES.(0 TO 47)":INPUTC,D
7 CLS
8 Y=C
10 FORX=ATOB:SET(X,Y):NEXTX:Z=Z+1:IFX=BGOTO20:GOTO10
20 Y=D:IFZ=26GOTO40
30 GOTO10
40 X=A
50 FORY=CTOD:SET(X,Y):NEXTY:IFY=DGOTO60:GOTO50
60 X=B:GOTO50
70 END
    
```

# HERE'S TREMENDOUS VALUE FROM COMPUTER CENTRE

## MINI KIT

The lowest priced CP/M Z80 Micro in U.K. Add your power and terminal. Minifloppy 16KB, RAM, Z80, CTC, Serial + Parallel I/O, S100 motherboard, connectors, manuals CP/M system FREE BASIC and ALGOL. Optional two drive case illustrated and power supply £149



**£786**

## S100 KITS



**8K Static Ram Kit**  
4MHz has run in Northstar, Cromenco, etc. £79 ass. £94

**64K Dynamic Ram Kit**  
4MHz runs with 8080, Z80, uses 16kbit chips £449 ass. £499

**SBC 100 Single board Z80**  
S100, Z80, CTC, USART 1K RAM, 4 ROM, Serial and Parallel I/O. £155 ass. £215

**Eprom Programmer Kit**  
for 2708, or 2716 Eproms S100, Eprom sockets £99 ass. £145

	kit	ass.
Also S100		
16K Econoram IV		
4MHz	175	199
8080A with vector interrupt	69	104
IO4 2 Serial/Parallel	89	124
Tarbell disc controller	125	160
Versafloppy disc controller	99	140
VDB 80x24 Video	185	245
Motherboard (11 slot)	19	—
Prototype board	18	—

## MEGABYTE

**MEGABYTE MICRO KIT**  
CP/M disc based micro in kit form! Just add power and a terminal. Kit includes: Drive, 8in double sided double density, Z80, CTC, Serial and Parallel I/O, 16K ram (expandable to 64K), CP/M systems, connectors, manuals. Case and power supply extra £149. Assembled and Dual Drive versions available.



**ONLY AVAILABLE from us at this SPECIAL PRICE**  
**£998**

## SDS 100

Z80, 12" VDU, 1M. Byte, twin drives, Serial + Parallel outputs, numeric pad, CP/M system



**£3650**

## TRS 80

**16K bytes upgrade kits** - these are the IC's that even work in the 48 k expansion. Excellent instructions, screw driver and common sense extra!

**£69**

## MINI FLOPPY

Double/single density hard or soft sector used for TRS80 North Star etc.



**£189**

## 8 INCH DRIVE

**DRI 7100 (Shugart Compatible)** single/dual density. British Made Assembled + Guaranteed. Double sided version. £375

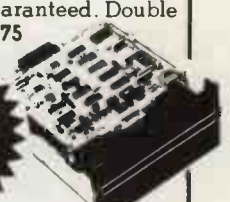

**£299**

## CP/M SOFTWARE

**CP/M Operating system + 6 manuals + Basic - E** £64  
Extensive User group £4.50  
Library includes Basic 8" DISC compilers/interpreters Algol-60, Pilot, Stoic, utilities and games. 10 copies £35

### Proprietary software:

Microsoft Basic £180  
Fortran £280  
CIS Cobol £380  
UCSD  
Pascal £150

All advertised items generally in stock. Cash with order ensures same day despatch. Add 2% postage and 15% VAT to advertised prices.

Send:  Catalogue (please tick)

Send .....

I enclose cheque for £ .....

Name .....

Address .....

# COMPUTER CENTRE

THE DISCOUNT COMPUTER STORE

9 De la Beche Street, Swansea, SA1 3EX. Tel: 0792 460023 Telex: 48638

● Circle No. 209

## Alternative

IF THE KEYBOARD of the level II TRS-80 is considered as memory — which is how the CPU treats it — the PEEK function can be used to scan key depressions, writes Paul Buttner. The advantage of this is that PEEKing the correct memory location(s) returns a non-zero decimal value so long as a key remains depressed as opposed to the latched, 'one-shot' effect of INKEY\$).

For example, PEEK(14426) will return decimal 8 if the " " key is depressed, 16 for " ", 32 for " " and so on. If more keys must be scanned, other locations should be PEEKed and the values returned tested — all inside appropriate program loops, of course.

By testing locations and keys, it should be straightforward enough to write programs incorporating responses to depression of any key (except BREAK) with response duration controlled by key push duration — incrementing/decrementing variables, controlling video display graphics, and so on.

The keyboard, incidentally, is mapped to locations 3800H to 38FFH (14336 to 15359 decimal).

As PEEKing the keyboard returns only partial codes for keys, duplication may well occur — two keys can give the same PEEK value at one address, for instance; but this shouldn't be a real problem — there are plenty of keys to choose and it can be avoided by PEEKing more than one address.

## Meter solution

I WAS interested to read in your June issue the suggested use of a "plug-in" VU Meter to allow reliable tape loading on the TRS-80.

For those not wishing to pay for a VU Meter or requiring a method of calibration for this technique, this method of setting the correct volume might be of interest, writes R J Hamlett.

A normal AM, MW portable radio is placed by the right-hand end of the

keyboard. The computer is put into an infinite loop, i.e. 10 GOTO 10, and the set tuned until the sound picked up from the computer is at its clearest. The machine is then re-set and a tape load attempted.

When the tape starts to load, a characteristic humming noise will be heard from the radio. A little experimentation with the volume control on the recorder then shows that if turned down too far for a load to take place, this noise stops suddenly and if turned up too far, the note changes as clipping takes place becoming much "harsher". The system can then be adjusted for any tape by altering the volume until the correct note is heard.

I have recently been using a Tandy SCT-12 cassette deck for loading and recording tapes and found that this gives far greater reliability in loading with all tapes, whether pre-recorded, recorded on a CTR-80 or recorded on the SCT-12 itself.

This deck has standard "line" inputs and outputs and to use it or similar decks, a booster amplifier is needed on replay and the two line inputs have to be connected together to give mono recording.

The circuit for the amplifier is attached. Since this method of cassette loading has been adopted the problems have 99 percent disappeared — no faults yet. The only disadvantage is the lack of automatic on/off switching for the deck, though the 9V supply for the amplifier can be switched by the machine's relay to save batteries.

## Harding's hints

WE ENDED the last column by emphasising how important it is to install voltage transient suppression in your computer equipment. There are two methods which can be adopted. A single suppressor may be installed at the mains outlet and all the computer mains leads plugged into it; this will provide protection from transients arising from external sources. Alternatively, smaller in-line devices may be

used, which gives not only protection from external transients but also from those generated within the equipment.

A major event recently was the circulation by a major U.S. software manufacturer of a technical bulletin in which it is stated that tape programs can be damaged permanently by the CTR-80 recorder supplied with newer TRS-80s, if the computer, for any reason, switches-off the recorder motor during a program load.

I obtained a CTR-80 and carried-out some tests as a result of which I found that it is possible to damage the program in this way, but only if the computer is completely switched-off during the load.

With the CTR-80 specimen I used, stopping the motor by way of pressing the re-set button had no effect on the validity of the program data. Power-down during a load is, of course, very bad procedure and would not come under the heading of "normal usage", so one cannot blame Tandy; but it is a matter of which CTR-80 owners should be aware.

## Clock challenge

BRUCE WILLIAMS rose to the clock challenge with this program:

```

10 REM WORKING CLOCK, TRS-80 LEVEL 2 BASIC
15 REM TO FINE TUNE TIMING ADJUST
    UPPER VALUES OF J IN 590, 600
20 DEFINT A, J, H, M, R, S, DR: = 01745: FV=2, 42
30 CLS: R=50
40 FOR A=0 TO 354 STEP 6: GOSUB 1020: NEXT A
45 R=51: FOR A=0 TO 320 STEP 30:
    GOSUB 1030: NEXT A
50 PRINT@51, "H M S": PRINT@94, "12"
51 PRINT@501, "3": PRINT@864, "6"
52 PRINT@456, "9": PRINT@480, "*"
53 PRINT@173, "1": PRINT@308, "2"
54 PRINT@692, "4": PRINT@813, "5"
55 PRINT@787, "7": PRINT@652, "8"
56 PRINT@268, "10": PRINT@146, "11"
100 PRINT@896, "ENTER HOUR": INPUT HT
110 HD=HT*30
120 PRINT@896, "ENTER NEXT MIN": INPUT MT
130 MD=MT*6
210 IF MD>180 THEN A=MD+15 ELSE A=MD
220 STD=15
230 FOR R=10 TO 22 STEP 2: GOSUB 1020
240 NEXT R
310 A=MD: STD=6
320 FOR R=24 TO 38 STEP 2: GOSUB 1020
330 NEXT R
390 IF AN=1 GOTO 500
400 PRINT@896, "HIT ENTER TO START": INPUT
410 PRINT@896, "HIT S TO ADVANCE 1 SEC":
420 PRINT@940, " F TO RETARD 1 SEC":
430 AX=1
500 STD=6: R=40
510 FOR A=0 TO 354 STEP 6
520 GOSUB 1020
530 PRINT@114, HD/30, MD/6, A/6, " "
580 IF A=354 AND ABS(MD-270)=90 GOTO 700
590 IF A=354 THEN FOR J=1 TO 20:
    NEXT J: GOTO 700
600 FOR J=1 TO 59: Q$=INKEY$:
    IF Q$="" THEN 630
610 IF Q$="S" THEN A=A+6: GOTO 630
620 IF Q$="F" THEN A=A-6
630 NEXT J
700 NEXT A
800 MD=MD+6: IF MD>180 AND MD<360 GOTO 810
810 IF MD=180 GOTO 210
820 IF MD=360 THEN MD=0: HD=HD+30
830 IF HD=360 THEN HD=0
840 GOTO 210
1020 RESET(64+SIN((A-STD)*DR)*R,
    22-R*COS((A-STD)*DR)/FV)
1030 SET(64+SIN((A+DR)*R, 22-R*COS((A+DR)*DR)/FV)
1040 RETURN
    
```

CIRCUIT OF BUFFER-AMP USED TO CONNECT SCT-12 TO TRS-80 ON REPLAY

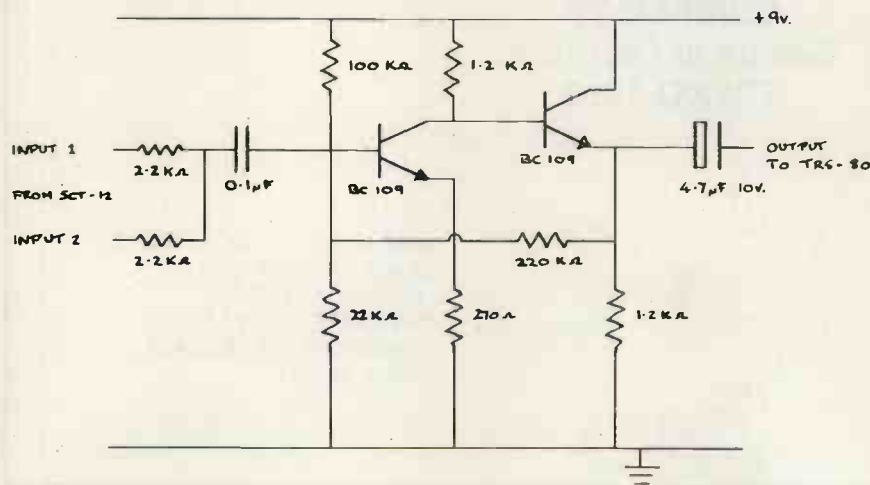

## Get Started Right With **Dynabyte**

Buying a computer for your business is a major decision. You want to be sure that it will handle your needs now, and in the future.

That's why we feature Dynabyte computers and disk storage systems. We'll help you put together a system tailored for your needs, based on Dynabyte's proven reliability and large data-handling capacity.

You can use Dynabyte's own accounting, word processing, and other programs, and you can also choose from hundreds of other CP/M software packages.

Let us help you get started right — with Dynabyte.



**Dynabyte** Computers are all business  
Inside and Out — You can depend on it

**COMPEC 79**  
See us at Olympia  
STAND 1062

**AREA DEALERS:**

ZYTEL  
MICROWAVE MODULES LTD  
BROOKFIELD DRIVE  
AINTREE, LIVERPOOL L9 7AN  
Telephone 051-342 4011  
Telex 628608

ZYTEL  
P.M. ELECTRONIC SERVICES  
2 ALEXANDER DRIVE  
HESWALL, WIRRAL  
MERSEYSIDE L61 6XY  
Telephone 051-342 4443  
Telex 627371

# DYNABYTE



**DYNABYTE** UK/EUROPE  
INTERNATIONAL

25 PARK ROAD, FALS GRAVE, SCARBOROUGH, N. YORKS, YO12 4AH  
TELEPHONES 0723/65559, 0723-73338. TELEX 52317 DYNBYT 'G'  
(DEALERSHIP ENQUIRIES — CONTACT BILL MILLER, CHAIRMAN)

**EDUCATIONAL GAMES**

**COMPUTERS**

**SOFTWARE**

**SYSTEMS**

**PRINTERS**

**PERIPHERALS**

**CONSULTANCY**

**TV GAMES**

**CALCULATORS**

**ANNOUNCING**

**B & B CONSULTANTS**

**DISCOUNT**

**DELIVERY**

**SYSTEMS**

*Send large stamped  
addressed envelope  
for menu to:  
B & B Consultants,  
124 Newport Street,  
Bolton, Lancs. or  
Tel. Bolton  
(0204) 26644*

*DEFINITELY NO  
SERVICE CHARGE ON  
OUR MENU; THE  
PRICE YOU SEE IS THE  
PRICE YOU PAY*

**ALL OUR  
PRICES  
INCLUDE  
CHIPS**



# The High Performance Floppy Disk System That's Not High Priced.

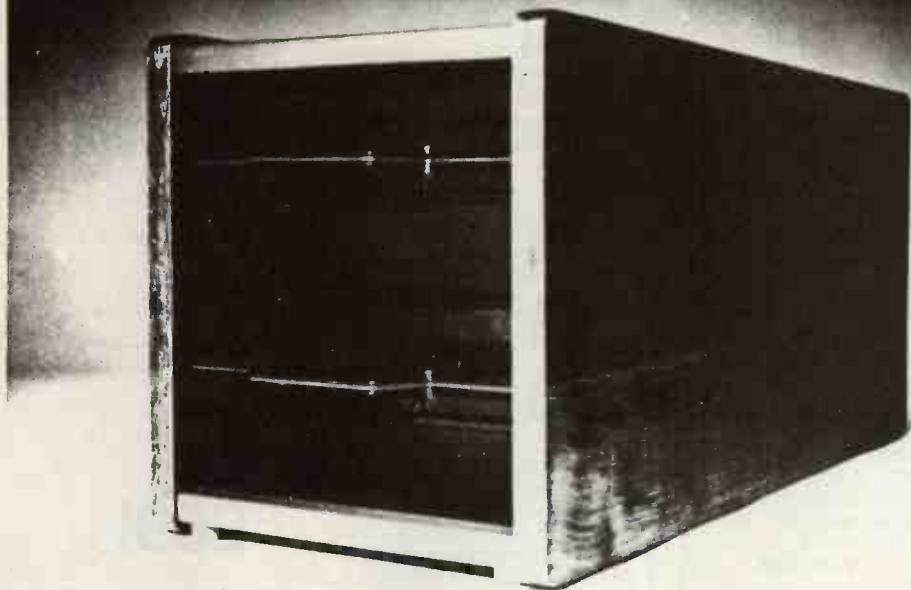

The Megabox provides over one megabyte of disk storage for the TRS80, SORCERER and all S100 systems

## FEATURES

- \* DUAL 8" FLOPPY DRIVES
- \* DOUBLE HEADED OPTION FOR 2 MEGABYTES
- \* DOUBLE OR SINGLE DENSITY RECORDING
- \* IBM 3740 COMPATIBLE
- \* CP/M\* OPERATING SYSTEM
- \* RS232 SERIAL INTERFACE

### TRS80

The unit plugs directly onto the TRS80, the unit also includes its own expansion capability for an additional 32K of RAM. A special version of CP/M for the TRS80 is included.

### SORCERER

The unit plugs directly onto the expansion box, with an automatic boot strap loader.

### S100

The Disc controller plugs into the S100 bus and is compatible with all Z80 and 8080 systems.

CP/M is supplied with all systems

The price for the 1 megabyte system is **£1350.00** and the 2 megabyte system is **£1750.00** (all prices excluding VAT)

ROSTRONICS ARE THE SOLE DISTRIBUTORS OF ALL MICROMATION PRODUCTS  
DEALER ENQUIRIES ARE INVITED FROM UK + EUROPE

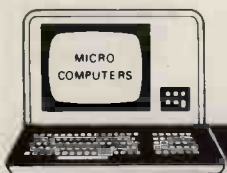

# ROSTRONICS LIMITED

118 WANDSWORTH HIGH STREET,  
LONDON SW18, ENGLAND  
Telephone: 01-870 4805  
Telex: 8813089 INTPRM G

● Circle No. 212



**EUROMICRO 80 in London from September 16-18, 1980 will be the scene of the European finals of the Amazing Robot Micromouse Maze contest. Microprocessor-controlled robot "mice" will race against the clock through a maze, or will show their prowess in an "open world" environment.**

The contest is divided into four classes:

- The best learning maze runner. Each mouse is allowed 10 minutes to explore the maze and must then make a timed run. The maze is designed to penalise dumb wall followers and short cuts are there to be found.
- The fastest first run. The mouse must run through the maze without prior experience. For this and the previous class the mice must be "caged" before the maze is unveiled.
- A "free world" course. The interior walls are removed, leaving an arena in which are placed targets and obstacles which must be sensed and found or avoided.
- A virtuoso display. Specialist robots will have five minutes to display their abilities — anything goes.

There will be valuable prizes in all four sections, including for the first section a free trip to the U.S. provided by Commodore Ltd. In addition to the major prizes, awards will be made for elegant



design features and innovations. BBC TV *Tomorrow's World* is likely to cover the event.

The construction of the maze is based upon the design by IEEE — SPEC-TRUM, which first ran a similar contest in the U.S. The walls are white with red tops, 2in. high and 1/2in. thick.

Passageways are 6 1/2in. wide so that the pattern is based on an array of 7in. squares. The total size of the maze will not exceed 14ft. square, with one entrance. The exit will be at the centre of the maze.

Robots must be self-contained and self-powered and must have no outside assistance. They must not cross walls of the maze, and any superstructure must not exceed 10in. in length or breadth. There is no height limit but beware of toppling.

All prospective entrants should write to **Micromouse Contest, Practical Computing, 31 Islington Green, London N1.** They will be sent further details, including information about possible sponsorship.

## Diary

### October

- **5** **Microprocessors — their impact and technology.** Venue: London. Quick, but apparently good introduction to the subject, given by a respected lecturer with good qualifications in this area. Aimed at computer staff but probably of use for the more sophisticated user, too. Fee: £50. Organised by Keith London Ltd.
- **8-12** **Fundamentals of the 9900.** Venue: St. James' Hotel, London. A one-week course for engineers who intend to design microprocessor-based systems. Assumes that delegates have little or no knowledge of microprocessors. Starting with basic principles, the course takes you through the operation of microprocessors, together with the components required to build a system. Opportunity to develop simple programs. Fee: £250, exclusive of VAT. Organised by Bleasdale Computer Systems. Further details from Course Registrar. Telephone: 01-540 8611.
- **8-12** **Microcomputers for the uninitiated.** Venue: London. Five-day course for people with a "wide variety of backgrounds". Basic principles of microcomputers, practical work, hardware and Basic software. Fee: £125, including lunches, course material and refreshments. More information from the Course Co-ordinator, Babcock Controls Training College, 165 Great Dover Street, London SE1. Tel: 01-407 6373.
- **15-17** **Programming 8-bit microcomputers.** Venue: Worthing. Provides a background in programming 8-bit microcomputers with particular reference to the Z-80 and

8080 processors. Intended for engineers investigating or implementing a microcomputer-based system. Three-day non-residential. Fee: £120 plus VAT. Organised by MSS. More information, (0903) 34755/6.

- **16** **Microcomputer course.** Venue: Eurocrest Hotel, Wembley, Middlesex. Includes Basic programming, systems, flowcharting, machine code and practical sessions programming the Pet. A limited number of places, so it is first come, first served. The fee, £34.50, includes lunch, refreshments and documentation. Contact: L. & J. Computers, 3 Crundale Avenue, Kingsbury, London NW9. Telephone: 01-204 7525.
- **18** **Microcomputers 79.** Venue: National Exhibition Centre, Birmingham. One-day conference subtitled "a layman's guide to microcomputers in business" and described as a "seminar and exhibition" which "will illustrate the uses, cost-effectiveness and advantages of microcomputing". Had some success in London last March. Speakers include Robert Stanley, of Altergo, and representatives from Burroughs and National Semiconductor. Fee: £60 plus VAT, includes lunch and refreshments. More information from Mills Micro, 01-247 0691.
- **25** **Co-operation or conflict?:** Venue: London. Ideal seminar for those interested in the social implications of computers. It will examine the barriers to acceptance by both sides of industry and look at the consequences of failure to find solutions to the problems. "This subject is vital to the U.K. economy and is of relevance to every manager and employee," says the organiser, NCC. Fee: £102.60.

## MICROTEK COMPUTER SERVICES



Agents for North Star Horizon. Personalised software for small business applications. Stock control, budget control, client information, VAT and accounting packages.

**50, Chislehurst Road,  
Orpington, Kent  
Tel 66-26803  
evenings 0474-872630**

● Circle No. 214

## IF YOU NEED . .

**HIGH SPEED CASSETTE  
PROGRAMME DUPLICATION  
AND THE SUPPLY OF TOP  
QUALITY CASSETTES . . .**

Why not ring us on 01-399 2476/7 and let us quote you for your next requirements.

**MEDIATAPE LIMITED, 29a Tolworth  
Park Road, Surbiton, Surrey.**

01-399 2476/7

● Circle No. 215

## SORCERER the professional microcomputer

We are London stockists for complete systems from £2,000 including word processing/mailling list/ledgers and other Business Systems.

**EMG 119, 30 Heathfield  
Road, Croydon,  
Surrey.  
01-688 0088.**

● Circle No. 216

## SOUTHAMPTON Your Pet Dealer

FREE £50 software or accessories from large range of COMMODORE and PETSOFT.

8K and 16K versions in stock. Hire available from £20p.w. (returnable). Technical support and servicing.

## SUPER-VISION

**13 St. James Road,  
Shirley, Southampton.  
Telephone: : Southampton (0703)  
774023.**

● Circle No. 217

# Pet Fourier transplants

IN PART TWO of this two-part series on Fourier analysis and synthesis using the Commodore Pet computer and Basic, we look at how a waveform dissected using the program in Part One can be re-constituted, albeit imperfectly.

In Part One we discussed the idea that any periodic waveform can be described as a series of sinewaves, each of whose frequencies is at an integer multiple of the fundamental. Tones containing many harmonics tend to sound more interesting than those with only a few.

Compare, for instance, the timbre of a flute, which is almost pure sinewave, with that of an oboe, in which the opening and closing of the reed produces a wide range of harmonics. It is a general rule that waveforms in which there is an abrupt change in level, such as a square wave, ramp or pulse train, tend to contain a greater proportion of harmonics at the higher frequencies than those in which the changes are gradual writes Nick Hampshire.

That, then, is the effect of the reed snapping shut due to the back pressure in the body of the instrument. The length and volume of the instrument determines how the pressure builds-up and hence the frequency of the note we hear. The situation is complicated further by the general shape and design of the instrument which accentuates some of the harmonics while attenuating others, leading to distinctive "colourations" in the final tone.

## Infinite range

There is an infinite range of possible periodic waveforms, but three parameters describe completely any one in terms of its harmonic sinusoidal content. First, the number of harmonics which constitute the wave form. A sine or cosine wave has only one harmonic, the fundamental. Most waveforms will be composed of an infinite series of harmonics. Fortunately, the low order ones usually contribute most to the final shape.

Some wave-shapes contain a high proportion of their energy at the higher harmonics and they will suffer more distortion in passing through a limited bandwidth amplifier than a waveform whose harmonics trail-off quickly.

Secondly, the relative amplitude of each harmonic is an essential factor in calculating the form of the result. Most "artificial" waveforms, such as square, triangle, ramp and rectified sinewaves, will show a progressive reduction in effect of the higher harmonics.

While the harmonics of a square wave

drop off almost linearly, those for a triangle wave decrease according to a square law. So the third harmonic of a square wave — there is no second — will be 30 percent of the fundamental but only 11 percent in the triangle.

"Natural" waveforms, such as the human voice or musical instruments, seldom show a neat geometric shape to their harmonic series, but will be more interesting because of it. The third and final parameter is the phase angle of each harmonic. As each new harmonic is added to the current waveform, every point where two troughs or two peaks super-impose, the resulting waveform will be accentuated; where a trough and peak overlap, the result is diminished.

So, for the synthesis program one must first load into memory the harmonic amplitude and phase angle of the first  $n$  harmonics, where  $n$  is sufficiently large to give a good approximation to the desired result. The next stage is successively to add each harmonic to the output waveform buffer (WV) until it is fully synthesised.

At each step it is useful to be able to plot the resulting waveform on the Pet screen. Also, as an option, to print the part-synthesised result to a hard-copy printer via the IEEE port. As our main interest is to investigate audio waveforms, a further option allows the user to POKE the resultant waveform into a buffer in the Pet memory and then to play it back through a suitable D - A converter and amplifier.

At the end of the run the user has the option to print to the hard-copy device a list of the harmonic parameters and a bar chart showing their relative amplitudes.

## Primary aim

As the primary aim of this program is to show the effects of filtering on a waveform, the use is asked to enter a filter coefficient before each harmonic is added. If the filter coefficient is in the range zero to one, the harmonic is attenuated. If it is greater than one, it is accentuated or amplified.

When either the harmonic amplitude or the filter coefficient is zero, the result contains none of that harmonic and the program invites the user to proceed immediately to the next harmonic in the series. To facilitate experimentation the user may synthesise a new waveform with different filter parameters using the same harmonic amplitudes and phase angles.

Figures 1 to 4 show the system in action. There are two methods to obtain



\*SQUARE WAVE (ALL-PASS)  
 LOWER BOUND= -99.8026729  
 UPPER LIMIT= 99.8026728

THERE ARE 50 POINTS

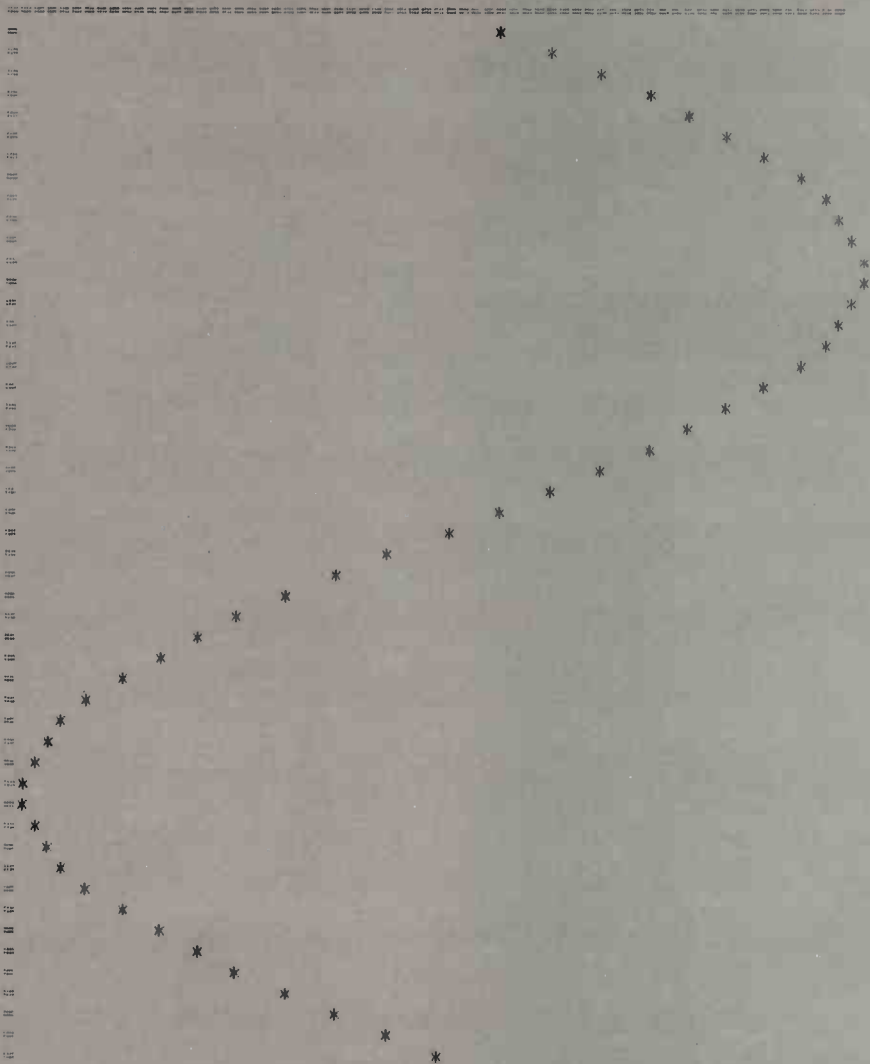

Figure 1.

the raw data — amplitude and angle. The first is to use the analysis program given in Part One. The second is to calculate it from the series formula, which for a square wave is:

$$\frac{4}{\pi} \left( \frac{\sin x}{1} + \frac{\sin 3x}{3} + \frac{\sin 5x}{5} + \dots \right)$$

The harmonic amplitudes are calculated easily as being one unit of the fundamental ( $\sin x$ ), one-third of this at the third harmonic ( $\sin 3x$ ), one-fifth at the fifth, and so on. If we take the amplitude of the fundamental as 100, then it will be 33.3 for the third, 20 for the fifth.

The sample contains up to the 29th harmonic ( $3 \cdot 448$ ), as shown in table 1. It is easy to calculate any amplitude with this method ( $99\text{th} = 1.01$ ).

Phase angles are not so obvious from the series formula but they are all the same for a square wave, and the

waveform is synthesised with all phase angles set to zero.

Figure 1 shows the fundamental frequency. It is, of course, a sinewave, with a period equal to that of the final waveform. This is equivalent to passing a square wave through a perfect low pass filter with the cut-off set just between the fundamental and the third harmonic frequency.

Figure 2 shows the effect of adding the third harmonic. The peaks have been flattened-out and the sides steepened. By the time the ninth harmonic is added, the square wave is recognised easily, even though there is a considerable amount of ripple (figure 3).

After all 29 harmonics (figure 4) the tops are nearly flattened, with slight over-shoot and ripple. One could go on adding harmonics forever. A reasonable

(continued on next page)

## SALE

**SECONDHAND SERVICED  
 ASR TELETYPE 33's**  
 £330 + VAT.

Also available. Fitted Silencing cover for above 10-30 c.p.s. DI/AN KRS/ASR 10-120 c.p.s. LogAbax LX180 KSR Acoustic Couplers

Enquiries to:

Derek Lade  
 ADP Network Services Ltd  
 179-193 Great Portland Street  
 London W1N 5TB  
 Telephone: 01-637 1355

● Circle No. 218

## COMPUSTAT

**Continuous Stationery  
 for the Micro Computer**

All sizes of listing paper stocked.  
 Specialists in the preparation of  
 Printed continuous stationery



Design Service available  
 Spacing Charts £1.00 C.W.O.

Commercial prices to all.

Phone or write for a  
 quotation to Miss Berry.

01-520 6038

63 ORFORD ROAD,  
 LONDON, E.17.

● Circle No. 219

## INTELLIGENT ARTEFACTS

S100 16K static RAM boards in  
 stock

— INCREDIBLE VALUE £200  
 Z80 CPU cards 4MHZ £100

We import direct from U.S.A., under-cutting all competition on PETS, Ohio Scientific, S100 etc.  
 Phone for prices: Arrington (022020) 689

Intelligent Artefacts Ltd,  
 Cambridge Road,  
 Orwell, Nr Royston, Herts

● Circle No. 220

## Q-Com Electronics Ltd.,

169, Black Haynes Rd., Selly Oak,  
 Birmingham B29 4RE Tel: 021-643 1945  
 Peripheral suppliers for the  
 Commodore PET

Please Memories 32K only:  
 PETITE £369  
 INPET £319  
 IEEE-488 Serial Output Interface  
 Self-powered £110  
 Non-powered, non-addressable £75  
 Terminals:— Televideo TVI-912 VDU £595  
 DEC LA36 £820  
 DEC LA36 with IEEE Interface £870  
 SAE for full details.

TERMS: All prices plus VAT. All orders cash with order, carriage extra. 90 days warranty on all goods. Visitors by appointment only please.

● Circle No. 221

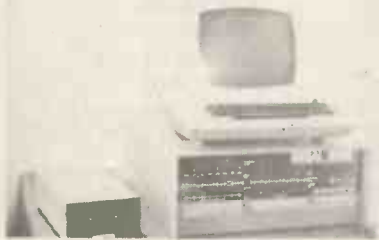

## MICRO SYSTEM

### Features:

- \* IMSAI 8080 CPU
- \* NORTH STAR DISK
- \* 24K STATIC RAM
- \* ADM3 12in VDU
- \* System complete and ready to operate under North Star DOS and Basic
- \* £2,500 (interest free HP available)

**COMPUTER MART LTD.,**  
38 St. Faith's Lane,  
Norwich (615089)

● Circle No. 222



## COMMODORE PETS

Free £100.00 file and record management program with every PET sold (limited period only).

Selection of Printers and Floppy Disks.

Large selection of software + programming service available.

Few secondhand PETs available, e.g. 8K from £400.00 + VAT.

Call at: Davinci Computers Ltd., Classic Offices, Rear of Classic Cinema, Hendon Central, London NW4. Tel: 202 9630

\*\*\* Wanted \*\*\* Part Time Programmers. Call above address

● Circle No. 223

## NEW LOW OHIO PRICES

4K Superboard	£235
8K Superboard	£275
Challenger IP	£360
Challenger IP with mini floppy	£995
Extra mini floppy drive	£385
610 expansion board with 8K	£265

All prices exclusive of VAT but include modulators

Please send SAE for details  
CTS 1 Higher Calderbrook,  
Littleborough,  
Lancs., OL15 9NL,  
Tel: Littleborough  
(0706) 79332 any time.

● Circle No. 224

(continued from previous page)

time to stop, however, is when the resolution of the graph falls below the value of the component added, or, as in this case, sooner.

People familiar with audio filters will notice that the effects of the low-pass filtering program are not identical to those observed with a conventional low-pass filter. There are many reasons for this. No electronic filter has an infinite attenuation at an arbitrary cut-off point. So some higher-frequency component will always leak through.

Furthermore, electronic filters invariably shift the phase angle of the various components. It would require only a small modification to the program to investigate the effect of phase shift in the synthesised waveforms.

Figure 5 shows the effect of a high-pass filter on the same data. There is zero harmonic content — total attenuation — at the fundamental, third, fifth and

seventh harmonic, and then zero attenuation from the ninth to the 29th, where the sample ends.

## Predictable

The effect is predictable, since the higher-frequency components constitute those portions of the waveform which change most rapidly. They are the sides of the squarewave and it has been effectively differentiated into a sharp pulse. The points have been joined by hand to improve legibility. The total energy of the waveform has been reduced considerably; the points cluster about the zero line in the centre of the graph.

Overall amplitude is diminished from -90 to +90 to -42.4 to +42.4, although the plotting routine always normalises the smallest value to the bottom and the largest to the top of the graph.

The main program runs from statement 130 to 710. The user first sets-up the data

Figure 2.

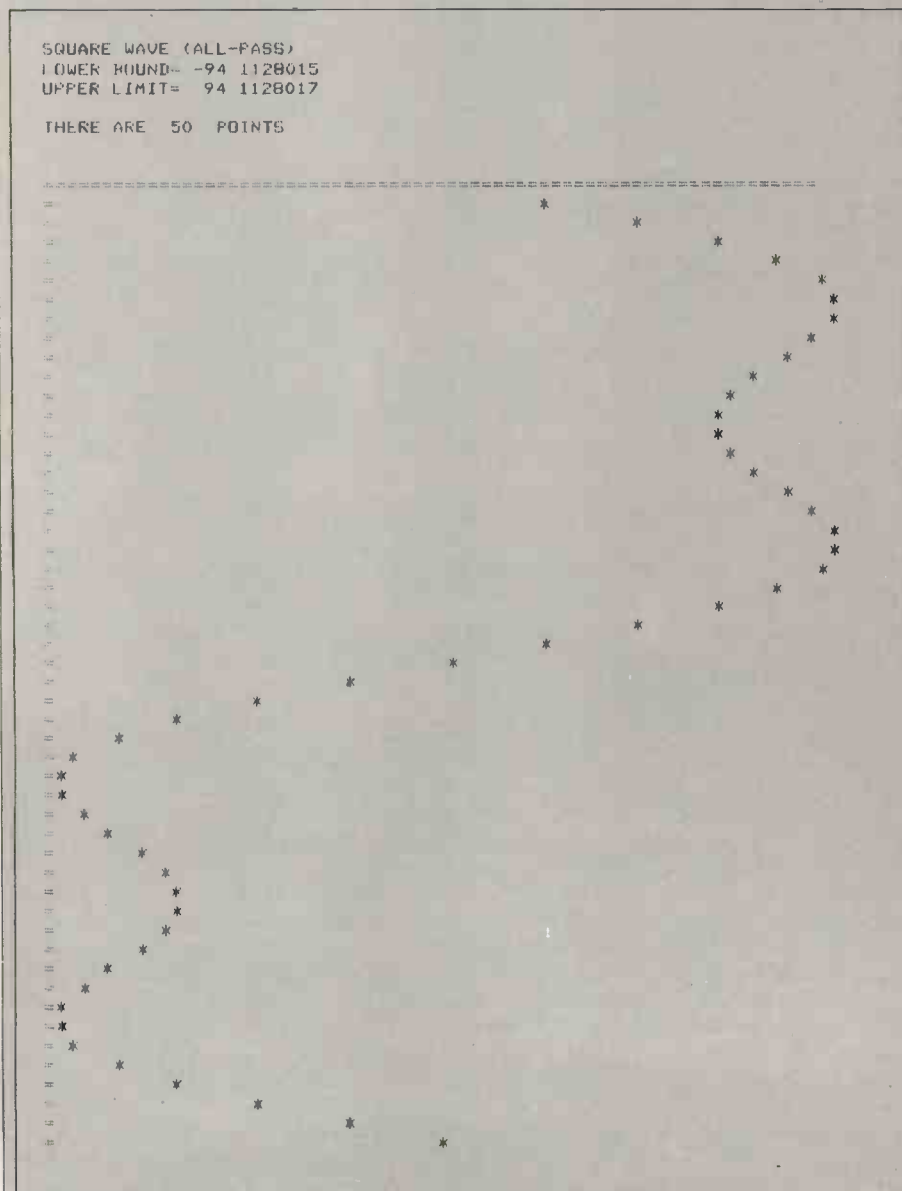

SQUARE WAVE (ALL-PASS)  
 LOWER BOUND= -90.0904598  
 UPPER LIMIT= 90.0904594

THERE ARE 50 POINTS

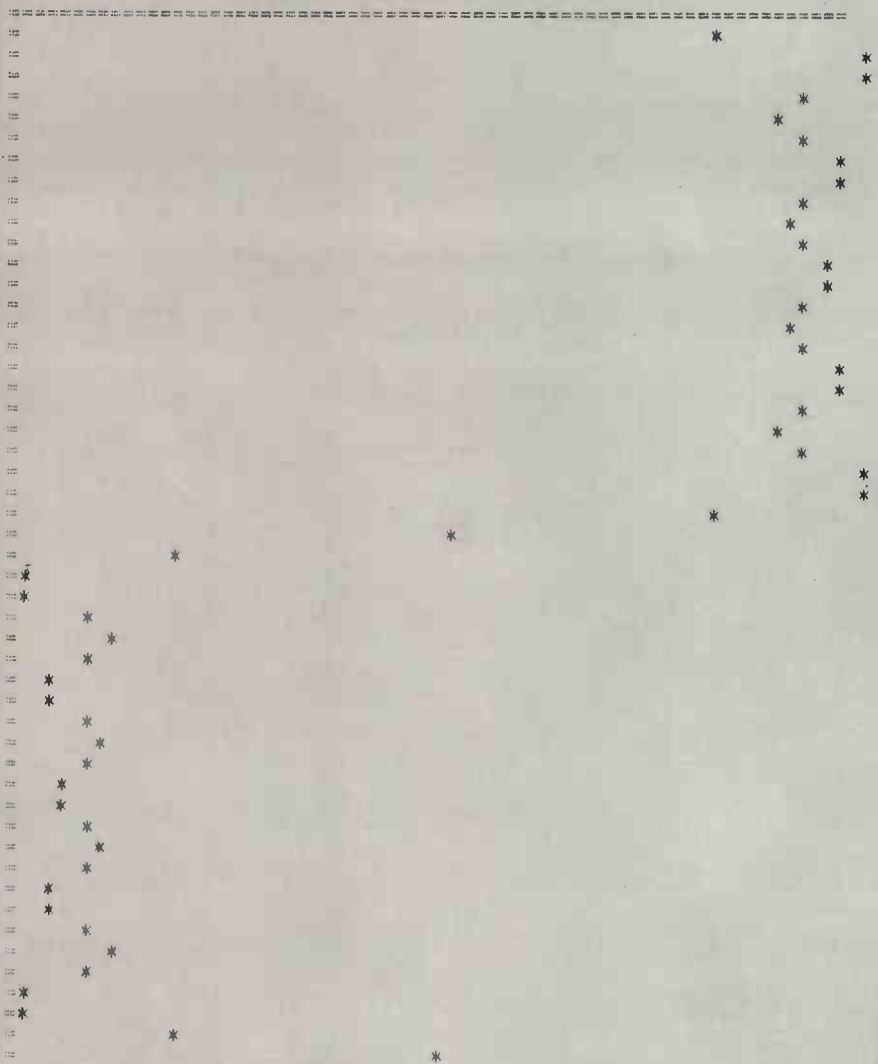

Figure 3.

arrays by specifying how many sample points the waveform is to have — this need not be the same as in the analysis program — and the total number of harmonics. This should always be fewer than half the number of points. "Run title" is a string assigned to the name of the waveform being investigated.

Stage two is to input all the harmonic amplitudes and phase angles. Rudimentary data validation ensures that the harmonic amplitude is positive and that the phase angle is in the range  $-\pi + \pi$ . Should either of those tests fail, the user is invited to re-type the values.

"Filter title" (335) will act as a reminder of how the waveform is being modified. WV is zeroed (340-370), as the synthesised waveform will be added successively into the array of point values.

The program inner loop (380-610) adds each sinewave component into WV

(490-530) in turn. Those elements are multiplied by the filter coefficients. MT, which were input at 440-450; they are also in an array so that tables of parameters can be printed later. Negative filter coefficient values are disallowed.

As each harmonic is added, the user can plot a graph of the result on the Pet (550-560) by calling subroutine 3000. This is almost identical to the version given in Part One but with a slight efficiency increase and a different header to print the run and filter titles.

As before, the user may also print a hard-copy graph (510-580), again using code (subroutine 4000) similar to that in Part One. Figures 1 to 6 are examples of graphs produced in this way.

By checking only the first character of the answers to each of the option questions Y\$, both "Y" and "YES" — and

*(continued on next page)*

## CASH & CARRY

- \* PET 2001 8K & 32K
- \* PET Serial Interfaces
- \* PET Parallel Interfaces
- \* PLESSEY 24(32)K Memory
- \* CENTRONICS 779 Printers

Also some ex-demo/hire units available.  
 (with full warranty).  
 Phone John Handy, 042 050 374.

● Circle No. 225

## BIAS POWER SUPPLIES

FOR SYSTEM 64K EXPANSION

### BIAS 1 for general micro use

+5v @ 10amps ±12v @ 2amps  
 -5v @ 1amp KIT £42.50

### BIAS 2 for analogue/peripheral use.

± 12v to 25v @ 3amps.  
 Adjustable. KIT £37.40

### BIAS 3 for S100 systems

+ 8v @ 10amps  
 ± 18v @ 3.5amps. KIT £40.20

Over Voltage Protection — optional  
 B1 — £12; B2 — £7; B3 — £9

HEAVY ALLOY CASE 150×150×200  
 includes switches, connectors, predrilled £12

Assembled & Guaranteed add £10

Mail order to: **TOOTING COMPUTING**  
 p & p 157 ROBINSON ROAD  
 £2.50 LONDON SW17

Prices excluding VAT.

Tel: 01-543 1398

● Circle No. 226

## COMPUTECH FOR APPLE SYSTEM. APPLICATIONS SOFTWARE

Professional business software packages now available are turnkey systems with comprehensive manuals, built-in validity checks, interactive enquiry facilities, user options, satisfying accountancy, Inland Revenue and Customs and Excise requirements on diskette with DOS space 3.2.

Not adaptations, written specifically as packages for the Apple System.

**COMPUTECH SYSTEMS**  
 168 Finchley Road, London, NW3 6HP. Tel: 01-794 0202.

Dealer enquiries welcome.

● Circle No. 227

# SHOP WINDOW

## HUMBERSIDE MICROPROCESSOR SERVICES THE COMPLETE INDEPENDENT SERVICE

Application areas:-  
Business, process control, education,

Personal Computing

We can provide for you:-  
Consultancy, training, supply,  
maintenance and software to suit  
your individual requirements

Including

Commodore PET  
M6800  
Compec 202  
and full ancillary equipment.  
Microprocessor Services,  
139 Beverley Road,  
Hull  
Humberside.

For further details ring (0482) 23146

● Circle No. 228

## EXTEND - A - PET

SELF-CONTAINED MEMORY EXPANSION

16K	only	£190
24K	only	£235
32K	only	£280
2114 - 2114 - 2114-		
450 ns	only	£3.95

EXCLUDING VAT & DELIVERY

## OPEX DESIGN

11 GORSE ROAD, CORFE MULLEN, DORSET.  
Tel: 0202-698559.

● Circle No. 229

## TRS-80

Don't make a move until you  
have our list of hardware/  
software at hand. e.g. 40-column  
high-speed printer with key-  
board, scrolling lists, forget those  
interfaces no expansion box  
required. £335 inc. VAT + deliv-  
ery. Sample print included with  
list.

Thinking about disk? We offer a  
better system for less. Not think-  
ing about disk? We offer many  
enhancements to the basic sys-  
tem.

Send for the list.

**M. P. AUTOMATION,  
FREEPOST, LEEDS.**

● Circle No. 230

## MICROCOMPUTER LEASING?

Software for Incomplete Records  
Accounting on the Commodore  
PET?

Apply to: MEGAPALM LTD  
(Commodore PET Specialist Dealer)  
'Downderry', Halton Road, Nether  
Kellet, Carnforth, Lancashire, LA6  
1EU. Tel: Carnforth 3801.

● Circle No. 231

(continued from previous page)

"X YETI" probably — are taken as affirmatives and any other character or string as the negative. This is a great improvement over the "YES" answer required always by the code in part one.

Being able to hear the waveform produced is a bonus; subroutine 5000 is new and worth looking at in some detail. An area at the top of user memory has been reserved as a buffer into which the elements of WV will be placed, having been normalised suitably (5010-5120) to be between zero and 255.

Usually the top of memory is used by the Basic interpreter to store strings used in the program. When the Pet is first powered-up, a test pattern of bytes is stored into memory from the lowest locations until the first location which fails to return the value written into it. This location is then taken as the top of user memory. Top-of-memory address is stored in locations 134 and 135. The Pet can be

fooled into thinking it is a smaller machine than it is by changing the value stored in those two locations (1-3).

Having set up the buffer, a call is made to a short machine code routine (5160) with a SYS() call which dumps the buffer out repeatedly to the user port for digital-to-analogue conversion. A suitable D-A converter design was given in *Practical Computing*, January, 1979 on page 67.

The machine code (listing 2) is three nested loops, and is stored in the unused tape buffer 2 at 826. The waveform length is stored in location (6704). The X-register is used to point to each of the points in the buffer from 6705 and its value transferred to the user port in loop ROUND to BNE ROUND.

This is repeated 255 times by loading the Y-register with 255 and counting down to zero, in the loop NCYCLE to BNE NCYCLE. The outer loop OCYCLE to BNE OCYCLE repeats that pro-

Figure 4.

SQUARE WAVE (ALL-PASS)  
LOWER BOUND= -89.9371946  
UPPER LIMIT= 89.9371935

THERE ARE 50 POINTS

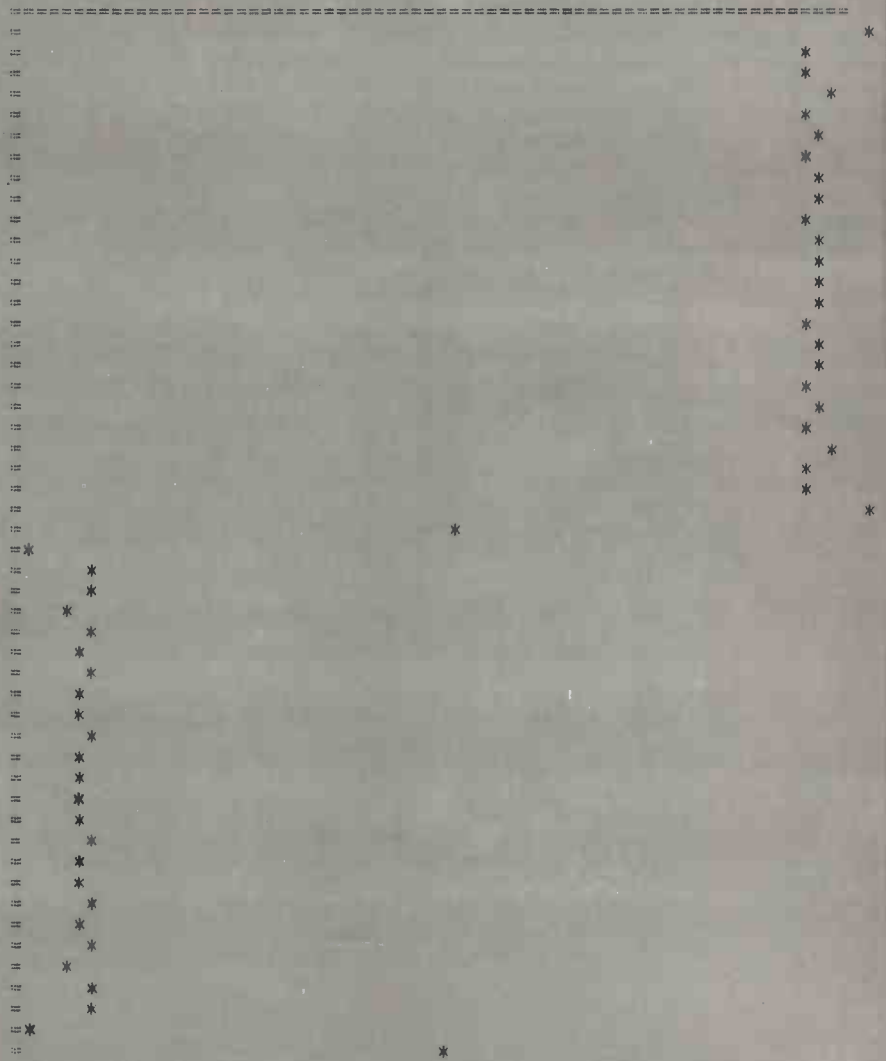



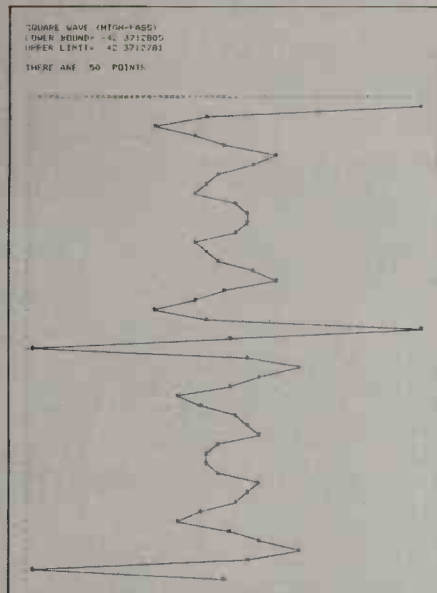

Figure 5.

cess TIMER times. The length of time the sound is produced depends on the two variables LENGTH and TIMER.

Larger arrays WV(LENGTH) cause the waveform not only to sound for a longer time but also at a lower frequency — about 150Hz for 200 points, 600Hz for 50 points. Time-wasting instructions can be put between DELAY NOP and RTS to lower the frequency.

It is unfortunate that a fixed period tone-generation scheme had to be used. To compensate for it, routine 5000 allows the user to hear the waveform as many times as is desired. Our first idea was to make the output routine repeat forever but to check periodically the contents of Pet location 525.

Location 525 indicates to the system how many characters still remain in the keyboard input buffer. If this is set to zero before the machine code is called, one could interrupt the waveform by pressing any key, thereby incrementing location 525. The disadvantage of this scheme is that the keyboard is scanned during an interrupt routine every 1/50th of a second as the monitor re-scans. This, in turn, means that the tone would be modulated with a 50Hz signal.

To cure this, all interrupts are switched-off in the 6502 processor with an SEI instruction. A CLI instruction at the end of the code restores the processor to its proper status.

When all the harmonics are added and the waveform is synthesised totally, the user has two more options before quitting the program altogether (710) or trying-out the data with a new filter-envelope shape (670-700).

First, a resume may be printed (630-640) which contains a list of all the harmonic amplitudes, phase angles and filter coefficients used in the last run. Table one shows an example of this routine (6000).

The slightly unusual form of the print

statements is designed to protect the user from vagaries in the IEEE to RS232 interface. The second option is to print, on the hard-copy device, a bar chart showing the relative amplitudes of all the harmonics after filtering, as in figure 7 (650-660).

Subroutine 6500 generates the bar chart in a similar manner to the code in Part One which displayed the relative amplitudes there.

To prevent re-typing all the data each time, an option is given to repeat the whole process, changing only the filter values. It would be equally possible to change the INPUT statements of 250 to a READ and to store the parameters in Basic DATA statements.

If the user wishes to alternate between the analysis program of Part One and the synthesis program here, care should be taken to re-set the Pet before the analysis program is entered. The analysis program uses the whole machine and crashes with large numbers of sample points if the locations 134 and 135 are not restored to their proper values.

Try the effect of two particularly interesting types of waveform. First, the rectified sinewave. Modify the analysis program by adding a statement at 1135. To generate a half wave rectified signal add 1135 IF WV(1)<0 THEN WV(1) = 0; this removes the negative half of the signal. To generate a full-wave rectified signal add 1135 WV(1) = ABS(WV(1)). This inverts the negative hump so that it becomes positive.

These waveforms are particularly interesting because they contain only even harmonics in the series. All the other waveforms we have looked at, in Part One and Part Two, contain either both even and odd or only the odd harmonics. A full wave rectified signal is defined as:

$$\frac{2}{\pi} - \frac{4}{\pi} \left( \frac{\cos 2x}{1.3} - \frac{\cos 4x}{3.5} + \frac{\cos 6x}{5.7} + \dots \right)$$

(continued on next page)

Figure 6.

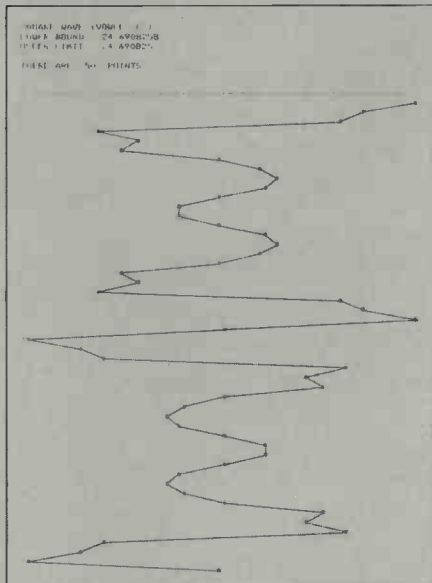

## TOPMARK Computers

dedicated to  
**APPLE II**

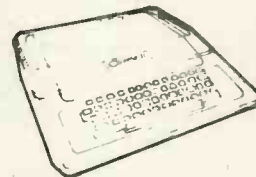

Simply the best!

Full details from Tom Piercy on Huntingdon (0480) 212563 or circle enquiry card.

● Circle No. 232

## TRS-80 System

All items stocked, Barclaycard, Access & American Express are welcome, or apply for your own RADIO SHACK Charge Card. U.K. Delivery by Securicor. Direct and Personal Exports.

**RADIO SHACK LTD.**  
188 Broadhurst Gardens,  
London NW6 3AY.

Tel: 01-624 7174 Telex 23718

● Circle No. 233

## LB ELECTRONICS

**WE HAVE MOVED TO—  
11, Hercies, Hillingdon, Middx.  
(Just off the A40).**

We stock RAMs, EPROMs, Keyboards, Disc Drives and one-off computer peripherals. We stock Pet 8K and many everyday components and surplus equipment TTL, CMOS, LINEAR, LEADS, Cannon D type, plugs/sockets etc, etc.

We are open Monday, Thursday, Friday, Saturday 9.30-6. Tel. Uxbridge 55399.

Sorry but no catalogue yet. We keep *Practical Computing* magazine.

● Circle No. 234

## SOFTWARE CAPABILITY

High-quality business applications software is required for microcomputer distribution company selling wide range of equipment.

We are also seeking a suitable software company in London area for general support. Send appropriate details to:

**Zipend Limited,**  
23 Middleway,  
London NW11 6SN.

● Circle No. 235

# SHOP WINDOW

## FLOPPY DISKETTES

5 1/4" and 8" single and double sided/density. Available from stock at competitive prices.



Also all other computer media and supplies, including

- Cassettes
- Ribbons
- Print Wheels
- Storage Systems
- Computer Files
- Stationery

Michael Collins Computer Supplies Limited.  
52, Canbury Passage, Kingston, Surrey.  
Telephone: 01-549 9441

● Circle No. 236

## Computer Supplies (SWANSEA)

PET		TANDY	
4K	£460	4K	£375.00
8K	£550	4K, level II	£448.00
16K	£675	16K	£480.00
32K	£795	16K, level II	£519.00
Twin Discs	£795	Disc Drive	£415.75
Printer	£645	Roll Printer	£925.00
Cassette Deck	£ 55	Trac Printer	£1,045.00
Kim 1	£ 99.50	Zero interface	£199.00
Dust Cover	£ 5.30	16K interface	£304.00

Latest news, newly-appointed Apple dealers.

RentaPet from £20 weekly (South Wales only). All prices show ex-VAT. Petsoft, Petact and AJ Harding dealers. Tailor-made systems and software. Quotations for your business or educational needs from:

Radio Supplies Ltd  
80 Gower Road, Sketty.  
Telephone: Swansea (0792) 24140.

● Circle No. 237



### GDS-1000s hard-copy camera . instant . low cost . colour or b/w

- Comprises a professional-format Model 7000 Polaroid Hard-Copy Camera and "mini-studio", automatic alignment and ambient light excluding, optical hood.
- Polaroid hard copies (3 1/4 in. x 4 1/4 in.) are impressive — clear, sharp and high resolution.
- Easily operated by anyone.
- Established in the scientific and computing world for graphics, alphanumeric, TV and colour display hard-copy.
- Send make and model number of your VDU TV with a cheque for £148.50 (£22.50 VAT, p&p) for displays up to 14 in. diagonal.
- Or contact John Davidson for full details and samples.



GRAPHIC DISPLAY SYSTEMS LIMITED  
76, Hemingford Rd., Cambridge  
CB1 3BZ. Telephone: Cambridge (0223) 51645.

● Circle No. 238

HARMONIC/FILTER SPECTRUM OF:-  
SQUARE WAVE (VOWEL 'E')

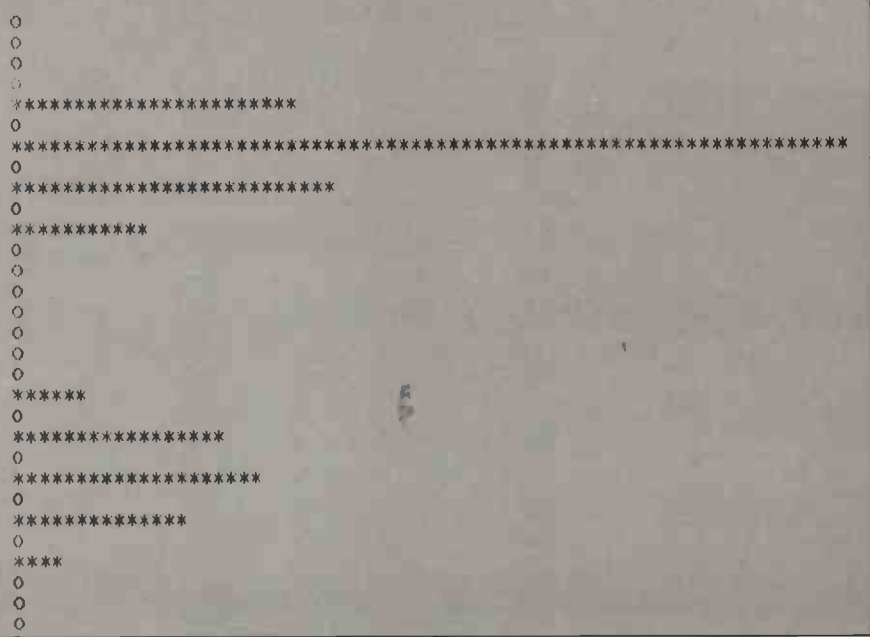

Figure 7.

(continued from previous page)

The second, and much wider, class of interesting waveforms are all the possible pulse waves. They are rich in harmonics and narrow pulses especially so. Investigate the effects of pulse-width and also the position of the pulse in the cycle. As an initial modification to the analysis program try 1220 TM = N0/10.

In some pulse configurations the harmonics seem to trail away to nothing, but this is deceptive; they are, in fact, part of a comb-spectrum, one which "bounces" like a rubber ball thrown obliquely against the ground.

As a final experiment, we decided to see if it would be feasible to synthesise a human voice sound (figures 6 and 7, table 1). The vowel sound "e" was chosen and we adopted a much-simplified model of the vocal system. Firstly, there is a voicing sound from the vocal cords — simu-

lated here by the harmonics of a square wave.

Two hundred points were taken to give an output frequency of about 150Hz, approximately that of a man's voice.

Two filter formants were superimposed on this, one around the seventh harmonic and one around the 22nd. This looks satisfactory on paper but it has to be said that the result did not sound much like the human voice.

There are several possible explanations. A square wave is a bit too rich in harmonics, since the glottal waveform is nearer a ramp with the bottom chopped off. Also, the filter bands are in the wrong place — 1KHz and 3.3KHz as opposed to about 400KHz and 2KHz. More work is obviously required in this direction but once it is successful, other vowels should be simulated easily by shifting the relative positions of the lower and higher band-pass filters.

Table 1.

HARMONIC	AMPLITUDE	PHASE ANGLE	FILTER
1	100	0	0
2	0	0	0
3	33.3	0	0
4	0	0	0
5	20	0	.25
6	0	0	0
7	14.3	0	1
8	0	0	0
9	11.11	0	.5
10	0	0	0
11	7.1	0	.25
12	0	0	0
13	7.692	0	0
14	0	0	0
15	6.667	0	0
16	0	0	0
17	5.882	0	0
18	0	0	0
19	5.263	0	.25
20	0	0	0
21	4.762	0	.75
22	0	0	0
23	4.348	0	1
24	0	0	0
25	4	0	.75
26	0	0	0
27	3.7	0	.25
28	0	0	0
29	3.45	0	0
30	0	0	0

Listing 2.

```

CODE TO POKE 'LENGTH' BYTES IN
A BUFFER STARTING AT 6705 TO
THE USER OUTPUT PORT AT AUDIO
FREQUENCIES
PORTDD #59459
PORTIO #59471
TIMER #6703
LENGTH #6704
SBUFF #8705
START OF PROGRAM
#N033A
#N033A
START SEI ;DISABLE INTERRUPTS
033A 78 LDA #2
033B A9 02 STA TIMER
033C 8D 2F 1A DCYCLE LDU #4FF
0340 A0 FF DCYCLE LDU #4FF
0342 A2 00 NCYCLE LDX #0
0344 BD 31 1A ROUND LDA SBUFF,X
0347 BD 4F EB STA PORTIO
034A 20 60 03 JSR DELAY
034D EB INX
034E EC 30 1A CPX LENGTH
0351 D0 F1 BNE ROUND
0353 88 DEY
0354 D0 EC RNE NCYCLE
0356 CE 2F 1A DEC TIMER
0359 AD 2F 1A DNE TIMER
035C D0 E2 BNE DCYCLE
035E 58 CLI
035F 60 RTB
;USE DELAY TO LOWER FREQUENCY
0360 EA NOP
0361 60 DELAY
0362 RTS
SECOND PASS FINISHED O.K.
SYMBOL TABLE
10
PORTDD E643 PORTIO E84F
TIMER 1A2F LENGTH 1A30 SBUFF 1A31
START 033A DCYCLE 0340 NCYCLE 0342
ROUND 0344 DELAY 0360
END OF ASSEMBLY

```



## Listing 1.

```

1 REM LIMIT PET TO 6.7K MACHINE
2 POKE134, 44: PI=3.14159265
3 POKE135, 26
4 DATA 826
5 DATA 120, 169, 5, 141, 47, 26, 160, 255, 162, 0
6 DATA 189, 49, 26, 141, 79, 232, 32, 96, 3, 232, 236, 48, 26
7 DATA 208, 241, 136, 208, 236, 206, 47, 26, 173, 47, 26
8 DATA 208, 226, 88, 96, 234, 96
9 DATA -1
19 PI=3.14159265
20 REM MACHINE CODE LOADER
30 READ AD
40 READ BY
50 IF BY<0 THEN 100
60 POKE AD, BY
70 AD=AD+1
80 GOTO 40
100 REM SET-UP
110 CH=4: REM PRINTER CONTROL
120 PW=67: REM PRINTER WIDTH
130 PRINT"FOURIER SYNTHESIS PROGRAM"
140 PRINT"===== "
150 INPUT"RUN TITLE"; RT$
160 INPUT"NUMBER OF POINTS"; NO
170 INPUT"NUMBER OF HARMONICS"; NH
180 DIM WV(NO), HA(NH), PA(NH), MT(NH), TP(NH)
200 PRINT"FOR EACH HARMONIC INPUT:"
210 PRINT"1ST - HARMONIC AMPLITUDE (>=0)"
220 PRINT"2ND - PHASE ANGLE (=-PI TO PI)"
230 FOR I=1 TO NH
240 PRINT I; " HA, PA";
250 INPUT HA(I), PA(I)
260 REM VALIDATE DATA ITEMS
270 IF HA(I)>=0 THEN 300
280 PRINT"NEGATIVE HARMONIC AMPLITUDE - REDO"
290 GOTO 240
300 IF PA(I)>=-PI AND PA(I)<=PI THEN 330
310 PRINT"PHASE ANGLE OUT OF RANGE - REDO"
320 GOTO 240
330 NEXT I
335 INPUT"FILTER TITLE"; FT$
340 REM ZERO WV
350 FOR I=1 TO NO
360 WV(I)=0
370 NEXT I
380 PRINT"BUILD UP WAVEFORM"
390 FOR I=1 TO NH
400 PRINT"HARMONIC "; I;
410 IF HA(I)>0 THEN 440
420 PRINT" HAS NO COMPONENT"
430 GOTO 610
440 PRINT"HA= "; HA(I); " PA= "; PA(I);
450 INPUT" FE="; MT(I)
460 IF MT(I)>0 THEN 490
480 GOTO 610
490 REM ADD HARMONIC TO WV
500 FOR J=1 TO NO
510 Q=I*J*(2*PI/NO)+PA(I)
520 WV(J)=WV(J)+(SIN(Q)*HA(I))*MT(I)

```

(continued on next page)

## SMALL-MINDED PEOPLE

programmers and  
would-be programmers

with or without  
two years' experience

(probably with BASIC  
and/or COBOL)

to work for a small but  
ambitious (and expanding)  
software and systems house.  
Good money. Lots of mini  
and micro projects—and the  
chance to play with the latest  
micro systems: we review them  
regularly for Practical  
Computing.

**AST Ltd**  
Staple Inn Buildings North  
High Holborn  
London WC1V 7PZ  
01-242 4127

● Circle No. 239

## WE PROGRAM MICROS

\*Occasionally for Ohios\*  
\*Periodically for Pets\*  
\*Also for Apples\*

## S Software Services

14 Herbert Street, Dublin 2, Ireland.  
Tel: 765197.

● Circle No. 240

### \*\*BRITISH S100\*\*

15-slot Motherboard (S100) with power socket	£29
S100 Edge Connectors	£3
Card Guides (per pair)	25p
Card Cage Kit (painted)	£10
Base Tray & Spacers (drilled)	£6
Transformer 8V x 20A, 13V x 2A, 13V x 2A, 26V x 4A	£30
Transformer 8V x 20A, 12V x 2A, 12V x 2A	£15
10V 100,000 UF Capacitors	£20
18A bridge rectifiers	£6
Power supply (S100) board) + 5V x 2, + 24V x 2, + 12V - 12V	£22
Components (power supply)	£48
Power supply board built & tested	£105
Extra quiet fan	£16
Complete power supply, motherboard & base	£330
Box to house all the above	£70
7200 DRI double-sided, double-density drive	£420
All prices include VAT at 15% P+P extra.	

### BYTRONIX

83, West Street, Farnham, Surrey  
Tel (0252) 726814

● Circle No. 241

## KEEP YOUR (TRS-80) COOL

...with a low-cost, quiet-running blower unit. Although designed for the TRS-80 it can be adapted for use on other micros.

Price, inclusive of VAT, p +p £29.90.

C.W.O. - Allow 28 days for delivery. Order from

**Perlit Engineering Development Ltd,**  
Balgay House, Inchture,  
Perthshire.  
Tel: (082-886) 242.

● Circle No. 242

## COLOUR YOUR NASCOM!



### DAZZLING COLOUR GRAPHICS FOR NASCOM 1

Genuine bit-addressable "pixel" system for straight-forward programming of pictorial or mathematical functions.

8 Colour display plus 8 colour independent background facility. Full documentation with FREE SOFTWARE: powerful sub-routines for vector generation, demonstration program for animated effects. All runs in Nascom 1 without expansion. Complete with UHF Colour Modulator for operation with normal colour TV set. Superior design allows connection to most other micro-processor systems - send us diagrams etc of your b & w video circuitry for free advice. Don't be fooled by the price: this is a top quality product which will transform your computer.

NOW AVAILABLE FOR £45 Inclusive of VAT and postage. LIMITED PERIOD AT

**WILLIAM STUART SYSTEMS Ltd**

Dower House, Billericay Road, Herongate, Brentwood, Essex CM13 3SD. Telephone: Brentwood (0277) 810244

● Circle No. 243

# TRS 80 SOFTWARE

WE HAVE THE LARGEST TRS-80 SOFTWARE LIBRARY IN THE COUNTRY LEV II AND DISK PROGRAMS FROM

**TRS-80 Software Exchange**

**Taranto & Associates**  
COMPUTER SYSTEMS SERVICES

**OSBORNE & ASSOCIATES**

AND ALL LEADING SOFTWARE HOUSES

Send S.A.E. for lists to:  
MICROCOMPUTER APPLICATIONS  
11 Riverside Court, Caversham,  
Reading, RG4 8AL

● Circle No. 244

(continued from previous page)

```

530 NEXT J
540 REM USER DISPLAY OPTIONS
550 INPUT "DO YOU WANT A PET GRAPH"; Y$
560 IF LEFT$(Y$,1)="Y" THEN GOSUB 3000
570 INPUT "DO YOU WANT A PRINTER GRAPH"; Y$
580 IF LEFT$(Y$,1)="Y" THEN GOSUB 4000
590 INPUT "DO YOU WANT TO HEAR WAVEFORM"; Y$
600 IF LEFT$(Y$,1)="Y" THEN GOSUB 5000
610 NEXT I
620 PRINT "END OF RUN"
630 INPUT "DO YOU WISH TO PRINT RESUME"; Y$
640 IF LEFT$(Y$,1)="Y" THEN GOSUB 6000
650 INPUT "DO YOU WISH TO SEE FILTER ENVELOPE"; Y$
660 IF LEFT$(Y$,1)="Y" THEN GOSUB 6500
670 PRINT "DO YOU WISH TO TRY A DIFFERENT"
680 PRINT "FILTER CONFIGURATION THIS DATA";
690 INPUT Y$
700 IF LEFT$(Y$,1)="Y" THEN 335
710 END
3000 REM SUBROUTINE TO PLOT PET GRAPH
3010 GOSUB 4500
3020 PRINTRT$; " ("; FT$; ")"
3030 PRINT "LOWER BOUND= "; MN
3040 PRINT "UPPER LIMIT= "; MX
3050 FOR L=1 TO 39
3060 PRINT "#";
3070 NEXT L
3080 PRINT
3090 TW=MX-MN
3100 FOR L=1 TO NO
3110 PRINT "#";
3120 SP=INT(((WV(L)-MN)/TW*36)+0.5)
3130 IF SP>0 THEN 3160
3140 PRINT "*"
3150 GOTO 3170
3160 PRINTSPC(6*SP); "*"
3170 NEXT L
3180 RETURN
4000 REM SUBROUTINE TO PLOT PRINTER GRAPH
4005 OPEN CH,CH
4010 GOSUB 4500
4020 PRINT#CH,RT$; " ("; FT$; ")"
4030 PRINT#CH,"LOWER BOUND= ";MN
4040 PRINT#CH,"UPPER LIMIT= ";MX
4050 PRINT#CH
4060 PRINT#CH,"THERE ARE ";NO;" POINTS"
4070 PRINT#CH
4080 PRINT#CH
4090 FOR L=1 TO FW
4100 PRINT#CH,"=" ";
4110 NEXT L
4120 PRINT#CH
4130 TW=MX-MN
4140 FOR L=1 TO NO
4145 PRINT#CH,"=" ";
4150 SP=INT(((WV(L)-MN)/TW*FW)+0.5)
4160 IF SP>0 THEN 4190
4170 PRINT#CH,"*"
4180 GOTO 4200
4190 PRINT#CH,SFC(SP); "*"
4200 NEXT L
4205 CLOSE CH
4210 RETURN
4500 REM FIND LARGEST (MX) & SMALLEST
4501 REM (MN) VALUES IN WV
4510 MX=WV(1)

```

```

4520 MN=WV(1)
4530 FOR L=1 TO NO
4540 IF WV(L)>MX THEN MX=WV(L)
4550 IF WV(L)<MN THEN MN=WV(L)
4560 NEXT L
4570 RETURN
5000 REM SOUND WAVEFORM IN WV
5010 GOSUB 4500
5020 POKE 59459,255:REM PORT OUTPUT
5030 BF=6704
5040 REM LOADS POINTS TO RAM AT 6705
5050 TW=MX-MN
5060 FOR K=1 TO NO
5070 VL=INT(((WV(K)-MN)/TW*254)+0.5)
5080 IF VL=0 AND VL<=255 THEN 5110
5090 PRINT"POINT ";K;" OUT OR RANGE ";VL;" ERROR"
5100 RETURN
5110 POKE BF+K,VL
5120 NEXT K
5130 REM NO OF POINTS TO LENGTH
5140 POKE BF,NO
5150 REM JUMP TO ROUTINE
5160 SYS(826)
5170 INPUT"DO YOU WANT TO HEAR IT AGAIN";Y$
5180 IF LEFT$(Y$,1)="Y" THEN 5160
5190 RETURN
6000 REM PRINT HA, PA & FILTER CO-EFF
6005 OPEN CH,CH
6010 PRINT#CH,"DATA FOR ";RT$;" (";FT$;")"
6020 PRINT#CH," HARMONIC AMPLITUDE ";
6030 PRINT#CH," PHASE ANGLE FILTER"
6040 PRINT#CH
6050 FOR L=1 TO NH
6055 PRINT#CH," ";
6060 PRINT#CH,LEFT$(STR$(L))+", 10);
6070 PRINT#CH,LEFT$(STR$(HA(L))+"", 14);
6080 PRINT#CH,LEFT$(STR$(PA(L))+"", 14);
6090 PRINT#CH,LEFT$(STR$(MT(L))+"", 14)
6100 NEXT L
6110 CLOSE CH
6120 RETURN
6500 REM DISPLAY FILTER/HARMONIC BAR CHART
6505 OPEN CH,CH
6510 PRINT#CH,"HARMONIC/FILTER SPECTRUM OF: -"
6515 PRINT#CH," ";RT$;" (";FT$;")"
6520 PRINT#CH
6530 TP(1)=HA(1)*MT(1)
6540 MX=TP(1)
6550 FOR L=2 TO NH
6560 TP(L)=HA(L)*MT(L)
6570 IF TP(L)>MX THEN MX=TP(L)
6580 NEXT L
6590 FOR L=1 TO NH
6600 IF TP(L)>0 THEN 6630
6610 PRINT#CH,"0"
6620 GOTO 6680
6630 SP=INT(((TP(L)/MX)*PW)+0.5)
6640 FOR N=1 TO SP
6650 PRINT#CH,"* ";
6660 NEXT N
6670 PRINT#CH
6680 NEXT L
6690 CLOSE CH
6700 RETURN
    
```

READY.

Special Offer!

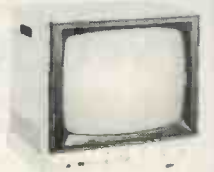

Limited to first consignment only at special offer price of £187 (normally at least £230) this Standalone, high-resolution visual display unit includes all these features:-

- \* 12in CRT implosion protected, monochrome OR GREEN PHOSPHORS
  - \* Better than 700 lines at centre, at least 80 characters across
  - \* High-resolution graphics. 190 dots horizontally
  - \* Constant stability, high brightness, perfect locking
  - \* Excellent, world-wide market penetration, famous make
  - \* Fully guaranteed, proper service backing.
- 10 in. model also available, same specification £142.56 + VAT.  
Money back if not delighted (10 days)

Cash with Order to:-  
InterScan Division  
Hamble Wilkes Ltd.  
23 Acre Lane,  
Carshalton,  
Surrey.  
Tel: 01-669 4611.

Dimensions (12in Screen)  
(W.H.D)  
320 x 318 x 255mm.  
(12½ x 12½ x 10 in.)  
Weight 10.5kg (22.5 lbs.)  
9in & 17in also available.

● Circle No. 245

## EXIDY SORCERER

in the  
**MIDLANDS**  
contact  
Midland Microcomputers  
Nottingham (0602) 298281  
for all your hardware and software requirements

● Circle No. 246

### MOTOROLA 5in./9in. DISPLAY MODULES



#### M1000/M2000 SERIES

- \* Modular construction
  - \* Solid state
  - \* 5in. (12.7cm) and 9in. (22.8cm) CRT
  - \* 12V DC operation
  - \* TTL or composite video input
  - \* 650 lines resolution
- M1000 £131.94 + VAT  
M2000 £154.58 + VAT  
Delivery ex-stock

We also stock Motorola 12in. and 15in. (full-page) monitors.

For further details contact:  
**CRAMER COMPONENTS LIMITED,**  
HAWKE HOUSE, GREEN STREET,  
SUNBURY ON THAMES,  
MIDDLESEX.  
Telephone: 01-979 7799  
Telex: 923592

● Circle No. 247

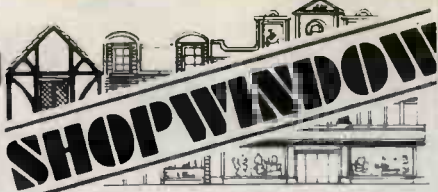

## Vets for Pets

Anita Electronic Services (London) Ltd. are specialists in the repair and service of Commodore Pets.

We offer a fast on-site service, or alternatively repairs can be carried-out at our workshops should you wish to bring in your Pet.

Pet maintenance contracts are available at very competitive prices. Trade inquiries welcomed.

For further information tel. or write to:-

John Meade  
Anita Electronic Services,  
15 Clerkenwell Close, London EC1  
01-253 2444

• We also specialise in the repair of all makes of office equipment.

● Circle No. 248

Stockists of Commodore  
and Petsoft software  
also accessories for your

## PET MICROCOMPUTER

For instance:

Pet Dustcover £6.00  
Pet Head Demagnetiser £4.00

Prices include VAT, but please  
add 0.50p per item for post.

Intex Datalog Limited,  
Eaglescliffe Industrial  
Estate,  
Eaglescliffe,  
Cleveland TS16 0PN  
Telephone (0642) 781193

● Circle No. 249

## TELETYPES TEKTRONIX 611 DISPLAYS

A few of each, well maintained and re-conditioned.

KSR Data Dynamics 20mA Teletypes ..... £300  
Tektronix 611, 6 3/4in. x 9in. Storage Displays ..... £700

Or let us have your offers, however humble.

Contact: John Davidson or  
Robert Harding,  
Department of Applied  
Mathematics,  
University of Cambridge,  
Silver Street,  
Cambridge, CB3 9EW.  
Telephone: (0223) 51645.

● Circle No. 250

# BUYERS' GUIDE

The Buyers' Guide is a summary of low-cost computers available in this country. It appears each month; we add new computers and amend existing information, as required, to keep it up-to-date. Systems are listed by manufacturer.

If a computer has been reviewed by *Practical Computing*, the date of the appropriate issue is indicated.

## ACORN COMPUTERS

Acorn. Single Eurocard-sized microcomputer with 6502 processor, 1KB RAM, 16-way I/O. Max size: a second Eurocard adds hex keypad and CUTS cassette interface. Monitor and machine-code programming now. Basic and disc operating system in the future. "Highly cost-effective basis for a computer or an industrial development system". Available from Acorn (0223) 312772 or Microdigital (051) 236 0707. £74.75 kit, £86.25 assembled

## APPLE COMPUTERS

Apple II. Min size: 16K memory; 8K ROM; keyboard; monitors; mini assembler; colour graphics; Pal card; RF modulator; games; paddles and speakers; 4 demo cassettes. Max size: Expandable to 48K memory; floppy discs and printers are now available. Two versions of Basic, PASCAL; Assembler; games; business packages. An American system regarded as suitable for any kind of applications. Maintenance contracts offered. Personal Computers Ltd (01-283 3391) is the sole U.K. agent but has a distributor network of 20 dealers. (Reviewed July, 1978.) Around £1,000

## ATTACHE

Attache. Min size: system with 10 slots, S100 bus, 8080 processor and 16KB housed in desk-top case with built-in keyboard. Max size: 64KB, parallel printer interface, two single- or double-density 8in. floppies, video screen. Disc Basic; business applications produced by Moncoland, the sole U.K. agent. Distributors include Keen, GBH, Alba, and Lion. From £1,737. Full business system about £5,000

## BRUTECH ELECTRONICS

BEM-CPU1: Single-board processor with 6502 and no RAM. Applications software. Available from Data Precision Equipment (04862 67420). (Reviewed March, 1979.) £133 exc VAT

## BYTRONIX MICROCOMPUTERS

Megamicro. 8080A/Z-80 processor. 64K. Double-sided discs, two-page addressable VDU, 140 cps printer. Software includes Basic, Fortran, Cobol and Pascal, all running under CP/M. Applications include automatic letter writer, sales ledger and stock control, payroll and bought ledger. Self-diagnosis utilises. Aimed at business and university user. Available from Bytronix (0252) 726814. From £6,080.



## COMART

**Microbox.** Chassis with three to six PCB sockets for S100 boards, plus fan. Several S100 boards available. Aimed mainly at OEM industrial users and perhaps the serious hobbyist. It will take Cromemco, North Star and other processors. Available from Comart (0480 215005). £255

## COMMODORE SYSTEMS DIVISION

**Pet.** Single unit containing screen, tape cassette and keyboard. Floppy disc, printer and full-size keyboard are options, as are external cassettes. Basic; games; business packages. The British subsidiary of Commodore Systems of the U.S. sells Pet for home, educational and small business applications. About 80 distributors. £460-£795 exc VAT

**Kim-1,** processor (6502 chip); small calculator-type keyboard; LED six-digit display; built-in interfaces for audio-cassette and Teletype; 1K RAM; 2K ROM (can add up to 64K). No software available, but it has three good manuals. An American import which gives Pet-type capabilities with a maximum configuration. For the hobbyist but used mainly as an evaluation board for the 6502 chip. Twelve to 15 dealers. (Reviewed October, 1978.) £99.95

## COMPELEC ELECTRONICS

**Series 1.** Z-80 processor 512MB floppy, 32KB, Centronics printer, VDU. Up to 4MB disc and 64KB. CP/M, Basic, Cobol, PASCAL, Fortran IV, Assembler, Business and word processing packages available. From Compelec (01-580 6296), which is also sole supplier of Altair systems. *Less than £5,000 for basic system*

## COMPUCOLOR

**CompuColor II.** Packaged system including 13in. eight-colour display with alphanumerics and graphics, 72-key detachable keyboard, 8KB, and built-in mini-floppy. Max size: 32KB. Extended disc Basic in ROM, graphics programs and games. The system now ranks fourth behind Pet, TRS-80 and Apple in personal computer sales. Abacus (01-580 8841) is sole U.K. agent and is arranging distributors, including the Byte Shop and Transam. (Reviewed June, 1979.) *From £1,390*

## COMPUCORP

**610;** desk-top unit using Z-80 and incorporating screen, 150KB floppy, 48KB. Up to 60KB memory, four floppies, printers. Basic, Assembler, DOS, text editor, file manager; business packages. Nine dealers. *From £3,890*

## COMPUTER CENTRE

**Mini kit:** Z-80 CPU, CTC, USART, serial and parallel I/O, 16 bytes memory, Western Digital disc controller, SA400 5in. drive plus CP/M, cables and connectors. *Mini kit: £786*

**Maxi kit:** As above but with DRI 7100 8in. drive instead of 5in. drive. All (33) volumes of CP/M user group library available for cost of media. Library includes utilities, games. Basic compilers/interpreters and Algol compiler. Microsoft Basic, Cobol, Fortran also available. Computer Centre (02514 29607). *Maxi kit: £886*

## COMPUTER WORKSHOP

**System 1.** Typical size: 40K memory; dual 8in. floppy discs, total storage capacity 1.2MB; Ricoh daisywheel printer. *System 1, £5,000 plus; System 2, around £3,000*

**System 2.** Typical size: 24K memory; dual minifloppy discs of 80K bytes each; Centronics 779 dot matrix printer; VDU.

**System 3.** 12K memory, cassette interface; 40-column dot matrix printer. Editors, Assemblers, Basic, games, information retrieval package. The systems were designed and built in Peterborough and are suitable for educational and small business users and perhaps the more serious hobbyist. Twenty-five dealers. *System 3, from £1,300*

## CROMEMCO

**Single-card computer.** 4MHz Z-80 CPU, S100 bus, 1KB RAM, sockets for 8K ROM. 20mA/RS232 serial interface and parallel bi-directional interface. Basic in ROM and Z-80 monitor. For OEM and industrial users; used with backplane for "full computer capability". Datron Interform and Comart are agents, the latter with 12 distributors. (Reviewed February, 1979.) £247-£281

## APPLE II IN SCOTLAND

Why not call and see the fantastic Apple II, the finest micro currently available?  
**Complete hardware, software and peripheral service available, inc. discs, printers and colour monitors.**  
**Call us for hands-on demonstration without obligation**



Also available the following top-quality products for Nascom  
**Nascom I** including all available expansion.  
**Nascom II.** Orders taken for this fantastic new product.

**High Speed Tape Cassette Interface.** Comes complete with instructions showing how to interface to Nascom giving "normal" and high speed operation. 300, 600, 1200, 2400 baud. At the highest speed this will load our 8K basic in about half a minute. Price (Kit) £17.50+VAT.

**8K Tape Basic.** The best basic yet written for Nascom. Fully floating decimal point. Complete with all documentation. Price £35.00+VAT.

**Brand New Product.** Chiptester. Converts Nascom to a super powerful I.C. tester. Plugs into existing ports. Send now for full details.

Also newly arrived. Totally new games to play on any standard Nascom. Send for full details, prices, etc.

**Five exciting new games for Nascom I** (no expansion required. Compatible T2, T4, B-Bug monitor). Cassette and printed booklet giving full details. Price £10+VAT.

**Software and Books ideal for schools and colleges now available.**

**STRATHAND  
44 ST ANDREWS SQUARE  
GLASGOW, G1 5PL**

Tel: 041-552 6731 Telex: 777268  
**CALLERS WELCOME**

Telephone orders taken. Access, Barclaycard and cheque.



● Circle No. 251

## M-ONE MINI COMPUTER FOR SALE

Complete system comprising VDU, CPU, two dual-density disc drives, Centronics 700 printer and Stock Control software has been replaced by mainframe. Used successfully by growing company for two years. Originally purchased from Computer Ancillaries (CAL) now marketed by LS). Computers. Other software packages now available. All serious offers considered. Ring 0825 4166 for more details.

● Circle No. 252

**SIGNDATA**

BUYING A COMPUTER? CONFUSED? CALL SIGNDATA NOW! WHETHER YOU WANT A HOBBY-KIT (TRS-80); A FLOPPY DISC BUSINESS SYSTEM (MEGAMICRO) OR THE MICRO-CELL MAINFRAME; CALL US NOW! YOU WON'T BELIEVE HOW HELPFUL WE ARE. SIGNDATA 01-837 8927.

**SIGNDATA**

● Circle No. 253

## NASCOM SOFTWARE

FOR EXPANDED SYSTEMS (8K upwards).

Level C Basic — Full Floating Point Arithmetic. Supplied on cassette £12.50 or in 4x2708 Eproms £42.00.  
Debug with Superstep — for machine code debugging £5.00.  
Relocator — relocates and re-addresses machine code programs £4.00.  
Octal Loader — handles true and split octal £3.00.  
Superstartrek — runs using Level C Basic £4.50.  
Superstartrek — runs using Nascom's 2K Basic £4.50.

FOR STANDARD SYSTEMS

Level A Basic insert in place of your monitor Eproms. Supports ALL normal Tiny Basic commands. Supplied in 2x2708 Eproms £21.50.

ALL products are fully documented.

CCSOFT (Southfields)  
83 Longfield Street, London SW18  
Tel: 01-870 4891

● Circle No. 254

Z-2. Min size: chassis, 30A power supply, motherboard, Z-80 processor, 16KB memory. Max size: 512KB, 21 sockets, three mini-floppies or four 8in. floppies. Basic, Fortran, Cobol, assemblers. For serious hobbyists, OEMs, educational applications, and industrial/scientific users.

£372 (in kit form) to more than £4,000

System Two. Min size: factory-assembled system with 32KB, dual 90K minifloppies, dual printer interface, serial interface. Max size: two additional floppies, 512KB, up to seven terminals. CP/M-compatible operating system (CDOS), Fortran, Cobol, Basic, assemblers, word processing, database manager. Multi-user system for software development, or scientific/industrial/business users.

£1,995 upwards

System Two/64. New configuration featuring mini-diskette drives and 64K bytes memory. Software and applications as System Two.

£1,995

System Three. Min size: 32KB, dual 256KB floppies, dual printer interface, 20mA/RS232 serial interface, Z-80 processor. Max size: two additional discs, 12KB, seven terminals, multi-channel A/D and D/A interface, PROM programmer. Software as for System Two. Described as appropriate for small to medium business, scientific and industrial users — "rivals minicomputers at more than twice the price".

£2,995 to more than £8,000

System Three/64. New configuration featuring dual 8in. diskette drives; Z-80A processor; 64K of 4MHz memory; console and printer interfaces. Macro Assembler, Fortran IV, Extended Basic, Cobol, Multi-user Basic. Prices quoted by Micro Centre (031-225 2022).

£3,293

## EQUINOX

Equinox 300. Min size: 48K memory; dual floppy discs giving 600K bytes of storage; 16-bit Western Digital m.p.u. Max size: up to 256K memory; up to four 10MB hard discs. Basic, Lisp, PASCAL, Macro Assembler, Text Processor. All software bundled. The system is a multi-user, multi-tasking, time-sharing system for two to 12 users. Application software available for general commercial users. Sole distributors Equinox Computers Ltd (01-739 2387).

£5,000-£40,000 plus

## EXIDY

Sorcerer: based on Z-80. 16K and 32K; cartridge and cassette interfaces; 79-key keyboard; 256-character set (128 graphics symbols), 12in. video monitor; expandable with Micropolis floppy discs. Basic, Assembler and Editor; games, word processor. Other pre-packaged programs plus EPROM pack for your own programs on cartridges. Factor One is sole distributor for U.K. (Reviewed March, 1979.)

From £760 without VDU to £1,200 with floppy discs

## HEATHKIT

H8. Min size: 4K. Max size: 65K. 8080A processor 8-bit kit with "intelligent" front panel, octal keyboard and display, built-in speaker and power supply. ROM monitor, Benton Harbor 50-pin bus. Numerous optional extras include VDU and disc drive for virtually unlimited expansion. Software: full system software provided on audio cassette includes Benton Harbor Basic, extended Basic, text editor, assembler and console debugger. Entertainment, hobbyist, education and home applications. Available from Heath (0452 29451).

£321.92 inc VAT & p&p

H11. Min size: 12K. Max size: 32K. Fully wired and tested Digital KD11F board with 16-bit LSI CPU. Built-in paper tape reader. Many accessories. PDP-11 software includes Basic and Focal, editor, re-locatable assembler, linker, absolute loader and debug. Marketed as a personal computer. Available from Heath.

£1,183.15

## HEWART MICROELECTRONICS

Mini 6800 Mk II. IK monitor; IK user RAM, IK VDU RAM; CUTS. Upper- and lower-case VDU with graphics option. 128-byte scratchpad; decoder/buffer; power supply; Basic in ROM; monitor command summary. SWTPC programs; Newbear 6800; Scelbi 6800 Cookbook. Markets are small business, education and home user. Cash with order to Hewart. (0625) 22030.

From £127.50 plus VAT

6800S. 16K dynamic RAM; IK Mikbug-compatible monitor; room for 8K Basic in ROM; upper- and lower-case graphics; single floppy disc drive; printer and high-speed tape interfaces. "Mountains of software available." Test tape with CUTS test tones, test message and games with kit.

From £275 plus VAT

## DIGITAL MICROSYSTEMS

DSC-2. Min size: 32KB, but 64K standard; Z-80; over 1MB floppy disc on two single-sided 8in. drives; four programmable RS232 and one parallel interface. CP/M and Basic included in price. Extended Basic, Fortran, Cobol, text processing, Macro Assembler, Link

From £4,465





Loader, business packages and CAP-PPP business software. Add-on rigid disc system (14 and 28MB) available soon. Modata (0892 39591) is sole U.K. distributor; dealers being appointed.

## IMSAI

VDP 40: 32K or 64K RAM memory; 9in. display screen, standard keyboard. Two 5¼in. floppy disc drives; serial I/O. Full software support, and packages available for the VDP 42, which has larger disc capacity. Packages for VDP 80 could be converted for smaller systems. This would be from about £700 per package. Two main dealers in the country.

£4,507 for 32K model. £4,950 for VDP 42

## ITT

2020. Identical to Apple II. Min. size: 4K memory; 8K ROM; keyboard, monitor, colour graphics, mini assembler; Powell card; RF modulator, games, paddles and speaker; Max size: 48K with floppy discs and printers. Basic, Assembler, games, business packages. Generally suited to any type of application. Fifteen wholesalers, including Fairhurst Instruments.

From £827 to £3,003 for 48K, two floppies and printer

## LUXOR

ABC 80. Min size: 35K with keyboard, CPU, 12in. screen and cassette. Max size: 40K RAM with discs. Z-80 processor, loudspeaker with 128 effects, real-time clock. Options: printers, plotter, discs, module cards, digitiser, modem. 60 compatible I/O memory boards. Software: Basic with resident editor; assembler; games; business and educational packages. Personal computer aimed at home market, small business and education. CCS Microsales is U.K. agent and is looking for distributors.

£795 plus VAT

## MICRONICS

Micros. Typical size: 1K monitor; 47-key solid state keyboard; interfaces for video, cassette, printer and UHF TV; serial I/O, dual parallel I/O ports; 2K RAM; power supply. 2K Basic; British-designed and manufactured system. Claimed to be the cheapest data terminal — a system with an acoustic coupler and VDU for £1,020. Prospective applications for small businesses, process controllers and hobbyists. Manufacturer is sole distributor (01-892 7044).

From £400, assembled

## MICRO V

Microstar. Single box with twin 8in. floppy discs, 64K RAM, three RS232 serial inputs, STARDOS operating system enables system to have three VDUs, plus a fourth job running simultaneously. Word processing software available. Packages being developed include invoicing system, payroll, accountancy type system. Price includes a reporter generator language. Imported by a Data Efficiency subsidiary, Microsense Computers, Microsolve is London agent; other distributors being arranged.

£4,950 machine and software

## MIDWEST SCIENTIFIC INSTRUMENTS

MSI 6800. Min size: 16K memory Act I terminal; cassette interface. Max size: three disc systems — minifloppy system with triple drives of 80 bytes each and 32K memory, large floppy system with up to four 312K-byte discs and 56K of memory mounted in a pedestal desk, or hard disc system with 10MB and 56K. Basic interpreter and compiler; editor; assembler; text processor on small disc system. American-designed system being manufactured increasingly in the U.K. Sole U.K. agent is Strumech (SEED) (05433 4321) but a distributor network is being established.

Basic system: £1,100 (£815 as kit); Minidisc, £2,500; floppy disc £3,200; hard disc, £8,000-£12,000

## NASCOM MICROCOMPUTERS

Nascom I. Min size: CPU; 2K memory; parallel I/O; serial data interface; 1K monitor in EPROM. Max size: CPU; 64K memory; up to 16 parallel I/O ports. Mostly games, but also a dedicated text editor system written by ICL Dataskil. Nascom is working on large versions of Basic, and 8K Microsoft Basic should be available soon. Eleven distributors in U.K. Nascom is negotiating to increase the number. (Reviewed January, 1979.)

£165 exc VAT

## NATIONAL MULTIPLEX

Pegasus. Min size: 48K; Z-80; double-density floppies (320KB); S100 bus; 12in. CRT; 58-key keyboard; two serial and one parallel interfaces; bi-directional printer. Options: 8in. drives; 1-2MB additional drives; digital recorder 9,600 baud. Assembler, Cobol, Fortran,

£2,700 exc VAT

## DYLE HOUSE BUSINESS COMPUTING SYSTEM 2000

### £5000

#### FEATURES

- Dual 8 in. discs providing 2.5 mega-bytes of storage
- 140 cps 132 char. printer
- 80 char. x 24 line terminals
- Full Z-80A power & system within the terminal
- Multi-cluster terminals (superb multi-user power)
- Dyle House business basic & disc operating system
- Accountancy suite free
- Payroll suite free
- Parts control suite free
- Typist & clerks not required
- Microbol — available OEM
- Word processing — soon

For:

Sales acknowledgments  
Sales Invoices  
Delivery Notes  
Purchase Orders  
Customer Statements  
Remittance Advice

### START YOUR OWN BUSINESS

#### KIT PRICES — CASH

The full Z-80A computing terminal, fully programmable screen, 16K EPROM, 32K RAM & all peripheral drive hardware and logic. Will drive RS232 or parallel printer, mini or 8 in. drives, single or double-sided, dual or single density with programmable sector size 128 bytes to 1024 bytes.

**PRICE £1,050**

All Dyle House software free plus multi-terminal support.

DRI 7200 8 in. disc drive units, box and power supplies — all to plug directly into above.

**PRICE £625**

**Dyle House Ltd,  
Brook Crescent,  
Chingford, London E4  
01-529 2436**

● Circle No. 255



## NICOMTECH

Cornish and West Devon distributor for the Apple II and range of accessories.

Amateur radio software available for PET, APPLE, 2020 and TRS-80.

European Distributor for MICROTRONICS MORSE and RTTY software for PET and TRS-80.

Sales/purchase ledger systems available.

North Star Horizon systems.

Phone Nigel Huntley on (075 55) 2066.  
Address: 212 St. Stephens Road,  
Saltash, Cornwall.

● Circle No. 256

## MINE OF INFORMATION LTD

1 FRANCIS AVENUE, ST ALBANS AL3 6BL  
ENGLAND

Phone: 0727 52801 Telex: 925 859

### SELECTED COMPUTER BOOKS

OSBORNE — Volume Zero: The Beginner's Book. £5.40.

OSBORNE — Volume One: Basic Concepts. One of the world's best-selling textbooks enhanced by free MoI list of pedantic corrections. £5.90.

ZAKS — C201 Microprocessors: From Chips to Systems. £8.90.

ZAKS — C202 Programming the 6502. Including errata. £8.90.

ZAKS — D302 6502 Applications Book. £7.90.

AHL (ed.) — BASIC Computer Games. Latest revised edition using Microsoft Basic. £5.90.

POOLE/BORCHERS — Some Common BASIC Programs. Seventy-six tested programs in finance, maths, statistics. £6.50.

PET Cassette — Some Common BASIC Programs. £8.05. (advertised elsewhere at £15)

LIEN — The BASIC Handbook. £11.00.

BARDEN — Z80 Microcomputer Handbook. £8.90.

LEVENTHAL — Z80 Assembly Language Programming. One of the best new books. £8.90.

This is just a selection from our current range in stock. Send for latest catalogue.

● Circle No. 257

## Dyna-Byte

fully assembled  
burned in S100

16K Dynamic	RAM	£198
16K Static	RAM	250ns £271
16K Static	RAM	450ns £266
32K Static	RAM	250ns £506
32K Static	RAM	450ns £470

80 × 24 video terminal, just add keyboard and monitor £177.

Cable set for video terminal £7.20

Post free. Add VAT to all prices.

S.W.C. Electronic distributors. P.O.  
Box 30, London E.4.

● Circle No. 258

Extended Basic. General business package available as well as text editing and mailing list. All run under CP/M. Suitable for education, business and home users. London Computer Store (01-388 5721) sole supplier.

## NETRONICS

**Elf II:** single-board computer in kit form or assembled. RCA Cosmac 1802 processor, hex keyboard, 256 bytes RAM; options include up to 64KB, ASCII keyboard, cassette and RS232 I/O, and video output. Machine code or Tiny Basic. Promoted as a teaching system in minimal form, but expandable for more general use. Sole U.K. distributor HL Audio (01-739 1582).

Basic kit £79.95.  
Assembled £99.95.  
I/O board £35

**Explorer 85:** Min size: 4K. Max. size: 64K. 8085A processor, VDU board, ASCII keyboard, S100 expansion. Cassette, RS232, TTY interface on board. I/O ports, programmable timer. Disc software, Microsoft Basic on cassette. 8080 and Z-80 software can be used. Aimed at hobbyist, OEM and small business. Available from Newtronics (computer division of HL Audio).

From £297 plus VAT.

## NEWBEAR

7768. CPU board, 4K memory, cassette and VDU interfaces. Range of Basics and games, British-manufactured system for hobbyists. Expandable to 64K memory available only in kit form. From Newbear; also from Bearbag dealers, Microdigital, Microbits.

From £45

## NORTH STAR

Horizon. Min size: 16K memory; Z-80A processor, single minifloppy disc drive (180KB). Max size: 56K memory, four minifloppy disc drives (180KB), any acceptable S100 peripheral boards. Basic (includes random and sequential access), disc operating system and monitor. Options: Basic Compiler, Fortran, Cobol, Pilot, PASCAL and ISAM. The system is suitable for commercial, education and scientific applications. Application software for general commercial users. Twenty distributors. (Reviewed April, 1979.)

£995 to £2,500

## OHIO SCIENTIFIC

**Ohio Superboard II:** Min size: 6502 processor, 8K Basic in ROM; 2K monitor in ROM; 4K RAM; Cassette I/F, full keyboard; 32 × 32 video I/F, 8K Basic in ROM; Assembler/Editor; American single-board system with in-board keyboard. Aimed at hobbyist/small business. Ohio makes games, personal maths tutors, and business programs. This and other Ohio products have six U.K. distributors. (Reviewed June, 1979.)

From £298

**Challenger C24P:** similar to Superboard but with a 32 × 64 character set. Supplied as two separate boards with open slots for expansion. The 'professional portable'; similar to Superboard but packaged and ready to use. Aimed at small business, education, research.

£343 to £1,204

**Challenger C28P:** similar to 4P but expandable to include two 8in. floppies, allowing use of Ohio software. Personal computer for larger business/commercial programs. Aimed at small business, education and research.

£435 to £1,900

**Challenger C3.** Min size: 32K RAM, dual 8in. floppies, triple processor architecture (6502A, Z-80, 6800). Max size: 768K RAM, 74MB hard disc, multiple terminals, printers. Can run virtually all 6502, 6800, 8080 and Z-80 code. Runs Basic, Cobol and Fortran under OS CP/M. Full business software packages available, including word processing and database management. Multi-programming available.

£2,450 to £13,000

## PERTEC

**System 1300.** Min size: 32K memory; dual minifloppy discs 71 bytes each, formatted; serial interfaces. Max size: 64K memory; four serial ports. Basic (single and multi-user), Fortran, Cobol. The hardware for Compelec Altair systems is from Pertec but the software is Anglo-Dutch. Sole distributor Compelec (01-580 6296).

£3,000-£5,500

## POWERHOUSE MICROPROCESSORS

**Powerhouse 2:** desk-top unit using Z-80 with 5in. built-in VDU and built-in mini cassette. 16K or 32K RAM, full keyboard, real-time clock, two spare slots. RS232 interface. Software: Disc and cassette operating system, programmable keyboard, 16K PROM, extended Basic. Options: 14K Basic, X-Y graphics, 2K monitor, larger screen,

£1,480-£1,760



discs. Compatible with all computers. Aimed at OEMs and expert users such as scientists or researchers. Applications include real-time process control, engineering calculations. Availability: Pow-erhouse only (0442) 42002. Reviewed, September 1979.

## PROCESSOR TECHNOLOGY

**Sol. 808-based S100 microcomputer** packaged with cassette and video interfaces (including graphics), keyboard with numeric pad, and 16KB RAM. Basic, assembler, word processors. Floppy disc systems available. Several distributors including Comart (0480 215005), which can offer nationwide maintenance contracts. (Reviewed July, 1979.)

From £1,750  
(excluding monitor  
and cassette).  
Complete floppy  
disc systems with  
word processing  
about £5,000

## RAIR

**Black Box.** Min size: 32K memory dual minifloppy discs, 80K bytes each; two programmable serial I/O interfaces. Max size: 64K memory; eight serial interfaces; 1MB disc storage (or 10MB hard disc); range of peripherals. Basic, Fortran IV; Cobol. Hardware distributors are being signed and agreements made with software houses to add software. A warranty and U.K.-wide on-site maintenance is given. From manufacturer (01-836 4663) and systems houses.

From £2,300

## RESEARCH MACHINES LTD

**380-Z.** Min size: 4K memory; 380-Z processor, keyboard. Max size: 56K memory. Options: cassette, single or dual minifloppy discs, dual 8in. double-sided discs (1MB); serial interfaces; parallel interfaces; analogue interface; printer available. Basic Interpreter, Z-80 Assembler; interactive text editor; terminal mode software; data logging routines; CP/M, DOS, text processor, CBasic, Fortran, Algol, Pilot, Cobol, CP/M users' club library. Sold principally to higher and secondary education, and for scientific research, data processing and data logging. Available from Sintel and the manufacturer. (Reviewed December, 1978.)

From £830-£3,500

**280-Z.** Board version of 380-Z system, 4K or 32K (identical in performance to the 380-Z). Interfaces, software as for 380-Z.

4KB version at  
£398; 32KB for £722

## RCA

**Cosmac.1802** micro with hex keypad and output to TV screen. Assembler and machine code programming; options include Tiny Basic. Available by mail order from HL Audio (01-739 1582).

Kit £79.95.  
Assembled £99.95  
exc VAT

## ROCKWELL

**Aim-65:** Kim-compatible with full keyboard and on-board printer. 1K or 4K RAM. The 4K version is described as a development system rather than a personal computer. Assembler, editor. Basic. Available from Pelco and Microdigital. (Reviewed July, 1979.)

1K - £249.50  
4K - £315

## SCIENCE OF CAMBRIDGE

**Mk14:** SC/MP processor, 256 bytes user memory; 512-byte PROM with monitor program; hex keyboard and eight-digit, seven-segment display; interface circuitry; 5V regulator on board. To this can be added: ¼K RAM (£3.60); 16 I/O chip (£7.80); cassette interface kit (£5.95); cassette interface and replacement monitor (£7.95); PROM programmer (£9.95). No software provided but a 100-page manual includes a number which will fit into 256 bytes covering monitors, maths, electronics systems, music and miscellaneous. Based on American National Semiconductor chips. Science will soon have a VDU interface and large manual on user programming. Mail order from manufacturer (0223 312919) and by selected dealers. (Reviewed May, 1979.)

£39.95 basic

## SDS

**SDS 100.** Single unit containing 32K memory (expandable to 46K); up to 8K PROM; twin double-sided floppy disc drives of 500 bytes each, serial and parallel RS232 interfacing; keyboard; 12in. video display; power supplies; SD monitor program; line printer available. CP/M, 8080 assembler, E Basic, Editor supplied with system; M Basic, Fortran, Cobol available for business use, industrial process monitoring and control (with additional hardware). All CP/M games and business packages. Sole supplier Airamco (0294 65530).

From £3,750

## SEMEL

**Semel 1.** Min size: 4K with CPU, keyboard and monitor. Max size: 64K with single floppy disc unit, printer, VDU and keyboard. Can

£1,950 with Basic

# SORCERER'S APPRENTICE

Wide range of software available for the Sorcerer.

**Basic** — illustrates use of all Basic instructions .....£6.50

**RENUMBER** — renumbers your Basic programs .....£6.50

**WHITE** — sets graphics to display characters on white background.£6.50

**LINK** — Links programs together; renumbers as required .....£9.50

**CHARACTER** — program to set user-defined graphics .....£6.80

**DRAW** — Allows freehand drawings on screen; can be saved on tape .£4.60

**MATHS** — sets problems of varying difficulty .....£4.60

**3-D NOUGHTS AND CROSSES-STARTREK** — even bigger! 32K£18.30

**STATISTICS** — comprehensive package .....£17.75

Many other programs of all types — please send SAE for full list.

Computer quality cassettes, with case .....50p each

(above prices include VAT).

**WE PUBLISH PROGRAMS — All kinds of software wanted, top royalties paid. Please send copy for inspection.**

**EXIDY PRODUCTS** — full range supplied.

**PRINTERS—**

Teletype 43 from £850 + VAT.

Centronics 779 tractor £850 + VAT.

Centronics 753 £2050 + VAT.

**EX-LEASE BARGAIN — Word-processing quality golf-ball printer, complete with interface and software .....£750 + VAT.**

## MICROPUTE

7 Westbourne Grove,  
Manchester M20 8JA  
Tel: 0625 612818

● Circle No. 259

# SHOP WINDOW



## WHYMARK

### PAPER ROLLS & INK RIBBONS

Accessories for all printers using LRC Dot Matrix Print Heads: Viz ANADEX, DATEL, SOUTH WEST TECH, SYNTTEST, R.I.L., and WHYMARK range

- \* INK RIBBONS (Purple or Black) £2.59 each + 0.25p.p. £25.00 box 12 + £1.00p.p.
- \* 1 PLY PAPER ROLLS 3 7/8" £0.86 each + 0.50p.p. £18.40 box 24 + £1.30p.p.
- \* 2 PLY PAPER ROLLS NCR COPY £2.15 each + 0.50p.p. £46.00 box 25 + £2.00p.p.
- \* SELF ADHESIVE LABEL ROLLS 3 1/4" x 1 1/4" (1000 labels) £6.35 each + 0.75p.p.
- \* PRE PRINTED LABEL ROLLS price on application

All Prices include VAT at 15% Please send cash/cheque with order, Goods dispatched day after receipt of order

WHYMARK INSTRUMENTS,  
6 HOLMESDALE ROAD, REIGATE,  
SURREY. RH2 0BQ

Tel. enquiries (04254) 77012

● Circle No. 260

## CAREERS

Computer Consultant to join new venture to liaise sale of computer software programming from India.

Equity, profit participation and directorship offered to correct person.

The successful applicant can start on a part-time basis.

Telephone 01-402 1826.

Mr V. Khanna  
228 Quadrangle,  
Cambridge Square,  
Hyde Park Estate,  
London W2

## MICRO ADS

are accepted from private readers only, pre-paid and in writing, 20p per word, minimum charge £2.

Save £132.50 on Commodore Pet 2001-8K. Unused and still in original packing. Mistaken impulse purchase. Now £500 for quick sale. At this price you collect! Telephone TRENEAR-HARVEY Office 01-437 9666 Home (025126) 3399.

Stacks of memory! 4K-Bit static M.O.S. R.A.M. N.E.C. UPD 410D-2 (100ns) £9.70 ea. + 30p. p&p 8-data P. Town, 30 Wolsey Drive, Walton-on-Thames, Surrey KT12 3AZ. Tel: 21078.

SWTP's 6800 Computer SWATBUG monitor 24K fast RAM AC 30 tape interface CT-64 terminal, all up and running. Make me an offer. Ring 0253 733 369.

As new 16K Apple II with Applesoft Card, Cassette etc. Hardly used. Owner going abroad. £975 — 01-351 0639 after 8 p.m.

NASCOM-1 3K Super Tiny Basic (2708s) with Documentation. £30. Phone 0702-218662.

For Sale: Teletype KSR33 Good Condition £200. Telephone 01-888 7841.

be coupled to any external device and controls up to 8x250K floppy disc units. Four configurations available. Options: Light pen attachment; 12V DC power supply; remote terminals. Software: Editor, Assembler, debug, full file-handling capabilities in Basic. Fortran and Cobol available on 64K machine; user-defined programs written and compiled by agreement; word processing. General-purpose unit for use as a terminal controller. Suitable for small business and OEMs. Available from Semel exclusively (0822) 5439.

## SORD

M100. Min size: 16K RAM; 4K ROM monitor; full keyboard plus function keypad; two-channel joystick dual cassette I/F; 11K EBasic on cassette; video; graphics; printer; S100 bus; converters; speaker; 24-hour clock. Max size: 48K RAM; 8K ROM; black and white or colour graphics; mini-floppy discs. Suitable for OEMs, small business, education, laboratory and scientific and home computing. Main distributor is Dectrade, but for London and South contact Midas Computer Services (0903) 814523.

From £726

M222. Min size: 64K RAM; VDU; full keyboard; numeric keypad; graphics; real-time clock; 70K minifloppy disc drive; audio cassette interface; two serial ports; programmable 110 to 9,600 baud; three S100 slots; power and interface for two external minifloppy drives; ROM bootstrap. Max size: 70K byte minifloppies; black and white or colour graphics; bar code reader; TMS-1000 development system. EBasic interpreter; compiler EBasic; matrix Basic; Fortran; Cobol; assembler editor; re-locatable linker/loader; debugger. Application software includes word and graphics processor; business demonstration packages and games.

From £3,450-£4,123 including desk and printer

M223. Min size: 64K RAM; hardware as M222 plus one or two 350K byte minifloppy drives. Max size: Four 350K minifloppies; up to four 11.4Mb hard discs; range of S100 devices. As M222 plus Cobol-80, CAP-CPP BOS MicroCobol. Application software includes word and graphics processor; personal information processing system; games; CAP-CPP range of MicroCobol software.

From £3,775-£4,448

## SYNERTEK

Sym 1: 6502 chip and keypad with memory available in 4K blocks up to 64K. Port expansion kit, TV interface card, RAM expansion kit, cassette and Teletype interfaces. Any Kim software, Basic interpreter, Assembler/Editor. American, meant to be the foundation system for every small business and hobbyist users. Available from Newbear (0635 49223).

From £160 plus VAT.

## TANDY CORP.

TRS-80. Min size: Level I 4K memory; video monitor; cassette; power supply. Max size: Level II 48K up to 350K on-line via floppy discs; line printer; tractor feed printer and quick printer; floppy disc system. Modern, telephone interface soon available. Basic; some business packages. Level I aimed at the hobbyist and education market and Level II at small business applications. Hundreds of dealers. (Reviewed November, 1978.)

Level I - £499  
Level II - from  
£578-£4,700

## TRANSAM COMPONENTS

Triton: British-made kit computer. Up to 65KB. Full graphics capability, 64 characters. Power supply; cabinet. Communications interfaces. Tiny Basic or 2K Basic, 1KB monitor plus new option 4K firmware on board. Available from manufacturer. (01-402 8137).

£286 kit with 5KB

## ULBRICH AUTOMATION

Powerhouse II. 16K or 32K RAM. Z-80 processor. RS232 interface; 5in. built-in VDU; full keyboard; built-in mini cassette; real-time clock. Software: Programmable keyboard in 16K PROM; 2K monitor system; DOS; Extended Basic. Options: larger VDU; discs; 14K Basic; Tripoli interface; X-Y graphics; IEEE interface. Compatible with all computers and peripherals. Applications: file management, off-line data processing and assembling capabilities. Suitable for OEMs and expert users. Available exclusively from Powerhouse Microprocessors Ltd. (0442) 42002, which will also manufacture it next year.

## VECTOR GRAPHIC

48KB RAM, Z-80 micro: 63K bytes, mini-discs are standard. Options: graphics. Monitor, MDOS, Basic; business packages from dealers. Several distributors.

£2,300

**PROGRAMS FOR YOUR  
APPLE II, PET, SORCERER,  
COMPUCOLOR, TRS-80,  
SUPERBOARD**

**the  
software  
house**

**APPLE II PROGRAMS**

DISC 1 (7 games)	£15.00
DISC 11 (8 games)	£15.00
CS4001 Space Games	£ 5.70
CS4002 Sports Games	£ 5.70
CS4003 Strategy Games	£ 5.70
CS4201 CAI Programs	£ 5.70
MA1 APPLE TALKER	£15.00
MA2 APPLE LIS'NER	£17.50
MA3 TALKING CALCULATOR	£13.00
MA4 TIC TAC TALKER	£16.00
MA5 APPLE 21 (HI-RES)	£11.00
MA6 BEST OF BISHOP DISC	£20.00
MA7 FORTH (linked language)	£40.00
MA8 FASTGAMMON	£12.00
MA9 MUSIC KALEIDOSCOPE	£10.00
MA10 STARWARS/SPACEMAZE	£12.00
MA11 BLOCKADE RUNNER	£ 9.00

**8K PET PROGRAMS**

CS1001 LOGIC GAMES	£ 5.70
CS1002 NUMBER GAMES	£ 5.70
CS1003 LOGIC GAMES II	£ 5.70
CS1004 GRAPHIC GAMES I	£ 5.70
CS1005 GRAPHIC GAMES II	£ 5.70
CS1006 CONVERSATIONAL GAMES	£ 5.70
CS1201 SENSATIONAL SIMULATION	£ 5.70
TIME TREK	£12.00

**NEW FOR THE APPLE II**

STOCKLOCK — Stock control for single disc operation	£50.00
CITY MANAGER — manage a very realistic city	£10.00

**SOUNDWARE UNIT for TRS-80, PET or COMPUCOLOR**

£22.00

**SEND FOR OUR CATALOGUE — IT'S FREE!!!**

**TRS-80 PROGRAMS**

**LEVEL I**

CS2001 GAMES (5)	£ 5.70
------------------	--------

**LEVEL II**

CS3002 SPACE GAMES	£ 5.70
CS3003 ADVENTURE (2 versions)	£ 8.50
ANDROID NIM (WITH SOUND)	£ 9.00
SNAKE EGGS (WITH SOUND)	£ 9.00
LIFETWO (WITH SOUND)	£ 9.00
BEEWARY (WITH SOUND)	£ 9.00

These 4 programs are by Leo Christopherson and are produced under licence from 80-NW Publishing Co. The graphics on these programs are SUPERB!

CP/M on disc for TRS-80	£99.00
MUSIC MASTER	£13.00
PILOT (tape)	£11.50
16K upgrade kit	£65.00
STAR TREK III	£13.00
AIR RAID (arcade quality graphics)	£13.00
RE-NUMBER	£12.50
FORTRAN	£195.00
RSM 2D M/lang.monitor/disassem.	£23.00
<b>SORCERER GRAPHIC GAMES</b> (CS5001)	£ 5.70

**COMPUCOLOR PROGRAMS**

DUNGEONQUEST & FREEBOOTER	£16.00
SPACE 2020	£16.00
LIGHTNING COMMAND	£16.00
all on disc for 16K.	

These will soon be available for APPLE too

**TO ORDER**

either photocopy page & circle the programs required or give title plus remittance. ALL prices include 15% VAT. Programs with CS prefix are produced by us under licence from "CREATIVE COMPUTING"

NAME: .....	Remittance enclosed	£
ADDRESS: .....	Plus 50p P & P	.50
.....		_____
.....	Total enclosed	_____

WE ALSO DISTRIBUTE THE MAGAZINE "80-US" FOR THE TRS-80 ON A SUBSCRIPTION BASIS. PUBLISHED BI-MONTHLY, THIS CONTAINS BUSINESS & GAMES PROGRAMS, SOFTWARE & HARDWARE INFORMATION & REVIEWS. YEARLY SUBSCRIPTION £10.00 inc. P & P. FREE SAMPLE COPY TO USERS' GROUPS.

**NOTE OUR NEW ADDRESS — 146 OXFORD STREET, LONDON, W.1. Tel: 01-637 2108**

Our showroom is open from 9.30 till 5.30 Monday to Friday.

# EQUINOX 300

A powerful multi-user  
multi-tasking  
multi-language

16-bit microcomputer time-sharing system

- supporting
- BASIC
- LISP
- PASCAL
- Floppy discs
- Hard discs

including a powerful Text Formatter,  
Assembly Language Development System  
and disc-based Sort utilities.

Priced from under **£5,000**

Write or phone for further information.

## EQUINOX COMPUTER SYSTEMS LTD

"Kleeman House" 16 Anning Street,  
New Inn Yard, London EC2A 3HB.  
Tel: 01-739 2387/9 01-729 4460.

● Circle No. 262

## HEAVY DUTY PRINTER

FOR

PET · SWTP · HORIZON · APPLE  
TRS-80 · SORCERER · CROMEMCO  
**ANADEX D.P 8000**



80 COL. FAST 112 CPS  
BIDIRECTIONAL PRINTING.  
VERY GOOD PRINT  
QUALITY UPPER/LOWER CASE. £ SIGN.

**COMPLETE** WITH PLUGS, CABLES & 500  
SHEETS OR PAPER

READY TO GO **£550 + VAT**  
FOR PETS, ALL ABOVE + INTERFACE **£575**

Also available:

COMPLETE BUSINESS SYSTEMS **£2700**  
DIABLO HYTERM 1620 **£1800**

Write or Phone for further details or demonstration

**LONDON COMPUTER STORE**  
43 GRAFTON WAY

Off Tottenham Crt. Rd., London W.1  
01-388 5721 OPEN 11-7 Mon-Fri 11-4 Sats.

● Circle No. 263

# AT LAST!!!

## SOFTWARE FROM THE PROFESSIONALS AT AN ACCEPTABLE PRICE

### Packages available now for the TRS80

#### Sales Ledger — From **£150**

(OPEN ITEM LEDGER/AGE ANALYSIS/STATEMENTS/INVOICES/VAT/DAY BOOKS & MORE)

#### Purchase Ledger — From **£100**

(OPEN ITEM LEDGER/AGE ANALYSIS/REMITTANCE ADVICES/VAT/DAY BOOKS & MORE)

#### Stock Control — From **£150**

(ISSUES/RECEIPTS/STOCK MOVEMENT REPORT & MORE)

#### INVOICING — **£75**

(INTEGRATING STOCK CONTROL & SALES LEDGER)

#### PAYROLL — **£200**

(WEEKLY, MONTHLY, CASUAL STAFF/BONUS PAYMENTS/ YEAR END STATISTICS & MORE)

**COMING SOON:** NOMINAL LEDGER. 12 MONTH WARRANTY ON ALL PACKAGES — TAILORED SYSTEMS TO YOUR REQUIREMENTS

**TRIDATA MICROS LTD.**

Smithfield House, Digbeth, Birmingham B5 6BS  
Tel: 021-622 1755 or (093 34) 53105.

● Circle No. 264



## HOW TO SOLVE SYSTEMS PROBLEMS WITHOUT HAVING TO WATCH YOUR LANGUAGE ZILOG'S MCZ FAMILY. FROM AROUND £4000

The MCZ computer family using Zilog's famous Z80 CPU can solve your problems (or your customers' problems) more efficiently and economically than ever before.

Just look at what Zilog offer.

To start, the Zilog system is multi-lingual. Every model has a full five language capability. You can move your programs in any language up and down the family at will.

*Pascal.* Rapidly becoming a favourite.

*Cobol.* For business use — and it's the highest level implementation of Cobol available on a computer in this price range.

*Fortran.* Outstanding performance for scientific use at an attractive price.

*Basic.* Zilog's version has been extended for both business and scientific applications.

*PLZ.* Zilog's own family of systems implementation language.

The key to the MCZ family's success is it's RIO operating system with features normally found only on very high priced computers.

- ★ Device Independent I/O
- ★ Mid-file record insertion or deletion
- ★ Interactive and batch command input
- ★ Full set of utilities
- ★ Macro assembler
- ★ Text editor

The range includes the MCZ 1/05 — a low cost floppy disk model, the table-top MCZ 1/20 or MCZ 1/25 rack mounting floppy disk computers and the highest performer, MCZ 1/35 cartridge disk version with 10 MBytes of storage.

Zilog UK Ltd, Babbage House, King Street, Maidenhead, Berks. Tel: Maidenhead (0628) 36131. Telex: 848609.

Software packages available now include order entry, payroll, purchase, sales and nominal ledgers, stock control, formatting and many more.

To back this up, Zilog offer full maintenance on software and hardware.



For full details of all you need to stay well ahead in tomorrow's world, call Zilog. Now.



**Zilog**

Welcome to tomorrow's world

● Circle No. 265

# A Man's Best Friend is his HB COMPUTER



A very wide range of items stocked including:-

PET/APPLE II/ITT 2020/SCORCERER

COMPUTHINK DISK SYSTEMS

IEEE/RS232 INTERFACES

7 PRINTER OPTIONS VDU TERMINALS

Call for professional advice or send for stock list.

**HB COMPUTERS LTD** 22 Newland Street, Kettering, Northants. Telephone: (0536) 83922 & 520910 Telex: 341297

● Circle No. 266

## **MICRO MEDIA SYSTEMS** *CONSULT THE EXPERTS*

Announcing **COMPUCOLOUR II**

**Plus** — EQUINOX 300 — CROMEMCO — NORTH STAR HORIZON. —  
COMMODORE PET. — MICROSTAR 45.

We supply a complete range of peripherals to suit the range listed, including Texas, Elbit, Teletype, Diablo, Adds Cifer, Infotom, DEC.  
(O.E.M. terms available). Send S.A.E. for our Booklist.

Accounting suites — Payroll — Mailing list — Ledger program — Pert — Perspective drawing —  
Stock control — Simplex linear programming — Planets (Management Game) PLUS A COM-  
PLETE BESPOKE PROG. SERVICE.

*WE ARE CURRENTLY RUNNING A SERIES OF ONE DAY SEMINARS. RING US FOR DETAILS.*

**Micromedia Systems, 14 Chepstow Road, Newport, GWENT. NPT 8EA.**  
Tel: (0633) 841691/50528/63310.

● Circle No. 267



# TERADDEC

MicroSystems

MICROMATION

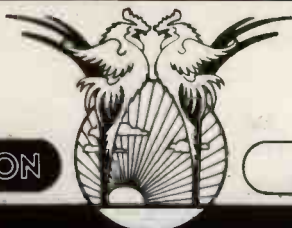

43 Qualitas, Roman Hill Bracknell,  
Berkshire RG12 4QG  
Tel: (0344) 51160

Central Data

VISA

## Micromation has done for the S-100 bus what IBM did for the floppy disk.

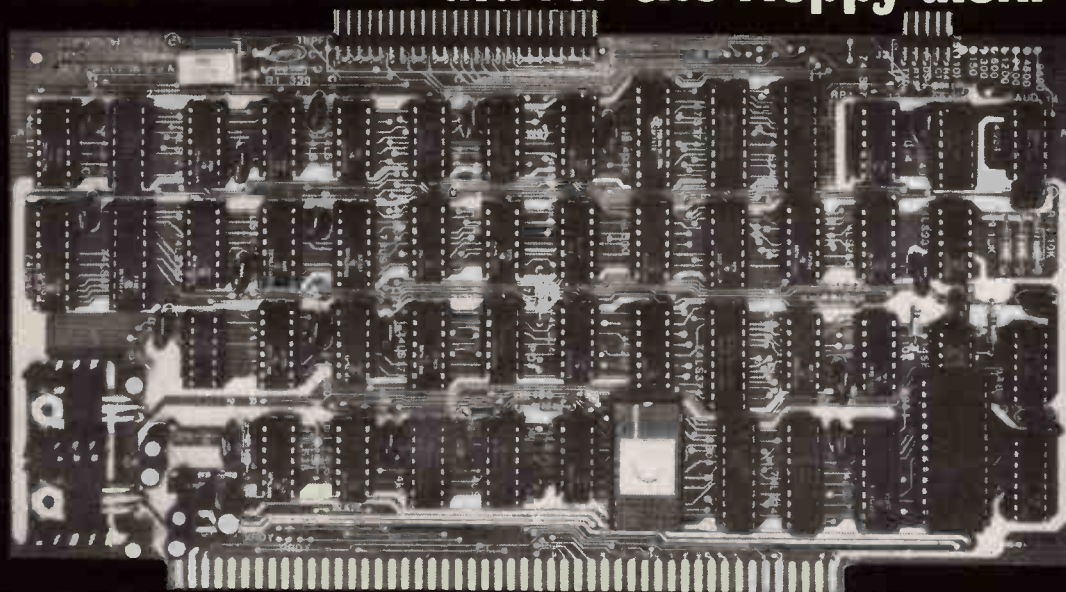

## Reliably doubled capacity.

### Double Capacity

The DOUBLER — Micromation's latest advance in floppy disk technology — doubles the capacity of floppy disk systems. Over 500 KBytes are recorded on each side of an 8" disk. This means bigger files for more powerful systems.

### Double Speed

Data transfer with the DOUBLER is twice as fast — 500 Kbits per second. And since there is twice as much data on each track, your drive steps only half as much — so your system runs faster than it ever has before!

### Increased Reliability

That's right — even better reliability. Why? Because we did it the IBM way. IBM designed 2D formatting — so it has to be reliable. Micromation's innovative, state-of-the-art design incorporates write precompensation electronics and a phase lock oscillator on a single, all digital, S-100 circuit board. So we guarantee the DOUBLER will be more dependable than your present single density controller — and we guarantee the DOUBLER for a full year.

### Unbeatable Convenience

It couldn't be easier to step up to double density. The DOUBLER operates automatically in either single or double density. Just insert a diskette and you're running properly. You can transfer files between single or double density diskettes without any software or hardware changes — or even operate with one single and one double density diskette. Installation is a snap. There's a hardware UART on board and the software is all ready to go. An onboard 2708 EPROM contains the bootstrap. There's even jump-on-reset circuitry so you can operate without a front panel. And, of course, we include utilities to format diskettes.

### Universally Versatile

The DOUBLER will operate with all industry-standard mini and full-sized drives. And it will work in any 8080 or Z-80 S-100 computer operating at 2 to 4 MHz. The DOUBLER will support up to four double or single headed drives.

### Fully Compatible

The DOUBLER is compatible with CP/M version 1.4. If you have a CP/M 1.4 system, just add our CBIOS — or you can buy our ready-to-boot version. Install the new controller, connect any terminal to the RS-232 interface, and boot off your new double-sized, double-speed system. You still can use all your old software without any changes.

### Completely Affordable

All Micromation products are fully assembled, thoroughly tested, include complete documentation, and are priced for value:

DOUBLER double density controller	£ 285
MEGABOX dual drive double density system	£ 1350
ZEPHER — Per Sci double density system	£ 1535
Z-PLUS — MEGABOX 32 KZ-80 computer	£ 2550

### Available

The DOUBLER is available NOW.

All prices are correct at the time of going to press and do not include delivery or VAT. Office hours 9 — 6 Mon—Sat. Please phone for appointment. 24 hour answering service. OEM & Dealer Enquiries Invited.

● Circle No. 268

THE BEST COMPUTER PROGRAMS ARE BASED ON A FLOWCHART. TRY OUR FLOWCHART FOR THE BEST VALUE WITH FIRST-CLASS ADVICE & SERVICE.

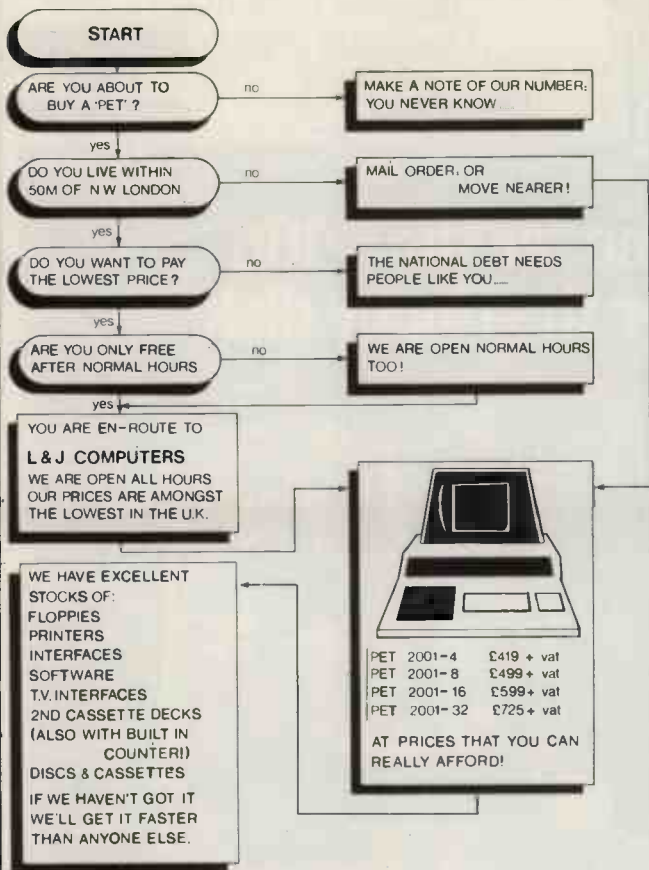

IF YOU WANT TO LEARN TO PROGRAM BEFORE (OR AFTER) YOU BUY YOUR OWN MICRO-COMPUTER, WE CAN HELP YOU HERE TOO! WE ARE RUNNING A ONE DAY INTENSIVE PROGRAMMING COURSE IN WEMBLEY (MIDDX) ON 16TH OCTOBER, WE HAVE ONLY A FEW PLACES LEFT, COMPETITIVELY PRICED AT £30+VAT, IT CAN GIVE YOU A FLYING START. PRICE INCLUDES HOTEL LUNCH, USE OF MACHINES, ETC. PHONE OR WRITE FOR DETAILS/PROGRAMME/APP FORM.

SYSTEM OF THE MONTH

32K PET + FLOPPY DISC DRIVE + INTERFACE + 779 CENTRONIC PRINTER

M.R.P.: £2585+VAT. OUR PACKAGE PRICE: ONLY £2299+VAT

WILL ADEQUATELY SERVICE MOST SMALL COMMERCIAL NEEDS. WE WILL TAILOR MAKE SOFTWARE FOR YOU AT REASONABLE PRICES.

WE HAVE SOME SUPERB "HOME-GROWN" SOFTWARE INCLUDING:

- STOCK CONTROL / INVOICING: (YOU CAN'T INVOICE WHAT HAVEN'T GOT!)
- ESTATE AGENTS LIST (WITH SORT & SEARCH)
- SMALL DENTIST USAGE

ALL OUR PROGRAMS CAN BE TAILORED TO MEET INDIVIDUAL REQUIREMENTS.

WE ACCEPT: VISA ACCESS: BARCLAYCARD CARD BACKED CHEQUES CASH FOREIGN CURRENCY

DON'T DELAY - PHONE TO-DAY!

**L & J COMPUTERS** 01-204 7525  
3 CRUNDALE AVENUE, KINGSBURY, LONDON, NW9 9PJ

● Circle No. 269

# A.P. Ltd

## Hardware

The *MAPLE*, our own micro-APL computer. Also APL VDUs, terminals.

## Software

Word processing, financial modelling, graphics, statistics, etc. *Custom-written software* is our central function — our analysts produce stable APL systems in a *small fraction* of the time that anyone else can, using conventional languages. Own your own *APL interpreter* — we have source code for a micro-APL implementation.

## Courses

*APL language* — a thorough grounding;  
*APL implementations* — an overview of practical APL;  
*APL for Analysts* — a much neglected aspect of APL;  
*Writing an APL Interpreter* — for the serious micro-systems programmer.

## Books

We have a wide selection of APL books.

For details on any of these areas, telephone Chester (0244) 46024 /21084 between 10am-8pm weekdays, or write to A.P. Limited, FREEPOST, Chester CH3 5YZ.

● Circle No. 270

# Happy Memories

21L02 450ns 83p	2114 450ns £5.25
4116 300ns £7.90	21L02 250ns £1.00
2114 250ns £5.75	2708 450ns £7.50
TRS-80 16K	Memory Upgrade Kit: £74.50
S100 16K	250ns Static TAM Kit:
£207.60 With 4K	£86.25 8K £126.75

Low Profile Pins:	8 14 16 18 20 22 24 28 40
DIL Sockets Pence:	10 11 12 16 17 19 21 27 37

Our new shop is now open at the address below. We shall be stocking a wide range of items to interest all those of you who are building or plan to build your own microcomputer. Why not pay us a visit? We are open from Mon to Sat 10 to 6 and often much later

We stock a range of books covering fundamentals through to advanced topics (like games)

We are NASCOM dealers for the South Coast.

Do-it-yourself with our range of wire wrapping aids and materials from the O.K. corral, or Box-it-yourself with a Vero enclosure after Soldering-it-yourself with Antex.

Our stocks are rapidly increasing; please write or call for latest lists of available products. We welcome your suggestions for stock lines. What do you find difficult to obtain? (We know about buffers).

Please add 20p p&p to all orders less than £10 in value. Cheques or P.O.s payable to 'Happy Memories'. Access or Barclaycard orders may be telephoned 24hrs a day.

Prices quoted include VAT at 15%

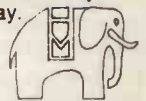

19 Bevois Valley Road, Southampton, Hants. SO2 0JP  
Tel: (0703) 39267

● Circle No. 271

# ENSIGN

13-19 MILFORD STREET, SWINDON  
WILTSHIRE SN1 1DW  
Tel: (0793) 42615 Telex: 449703

Make more time available  
to enhance the quality of your life  
and improve your business.

HARDWARE - SOFTWARE - CONSULTANCY - MEDIA - STATIONERY ETC.

For less than 25p an hour for just one year you can  
**COMPUTERISE YOUR BUSINESS NOW!**

**EVERYTHING YOU REQUIRE TO START  
COMPLETE - READY TO OPERATE.**

Incl. VAT, Pkg. & Delivery. Nothing extra to pay.

## £2,300

- MICROCOMPUTER WITH 48K RAM (Memory)
- DUAL DISK DRIVES (Storage up to 400K)
- DOS DISKETTE (Disk Operating System)
- BOX OF 10 BLANK DISKETTES
- PRINTER WITH TRACTOR FEED
- BOX OF CONTINUOUS STATIONERY
- EVERYTHING COMPLETE WITH MANUALS

**+ FREE Programs worth over £500  
on Diskettes in a Library Case +**

comprising:

SALES/PURCHASE LEDGERS QUOTE/ORDER/INVOICE  
BANK RECONCILIATION STOCKS / SHARES ANALYSIS  
STOCK CONTROL MAILING LIST GAMES PACKAGE

This package illustrates how to solve many of your business problems.  
They may or may not be suitable for your type of application but they will  
help you develop your own software for virtually any type of business.  
Worth over £500 this package is enclosed FREE.

### SOFTWARE

Programs suitable for all types of business. Standard  
Packages priced from £100 (inc. VAT).

- Sales Ledger ● Purchase Ledger ● Nominal Ledger ●
- Quoting ● Ordering ● Invoicing ● Mailing List ●
- Bank Reconciliation ● Stocks and Shares Analysis ●
- Stock Control ● Text Editor (Word Processing) ● Payroll ●
- Graphic Analysis ● Biorhythm ● Graphic Printouts ●
- Anniversaries ● Holiday Records ● Birthdays ●
- ● ● Comprehensive Games Packages, etc. ● ● ●

### CONSULTANCY

Please write or telephone if you require advice on  
BEGINNING or EXPANDING your computer installation.  
Software programs customised to your requirements.

**OUR BUSINESS EXISTS ON IMPROVING YOUR BUSINESS.**

We are continually adding new products to our range and would be  
pleased to receive your enquiries. ● Quantity Discounts available.

MICROCOMPUTERS	ex. VAT	inc. VAT
4K Level 2 TRS 80 (K/bd, VDU, T/Rec)	434.78	500.
16K Level 2 TRS 80 (K/bd, VDU, T/Rec)	500.00	575.
16K ITT 2020 (C/W PALSOFT ROM)	760.87	875.
32K ITT 2020 (C/W PALSOFT ROM)	826.10	950.
48K ITT 2020 (C/W PALSOFT ROM)	891.31	1025.

### MEMORY UPGRADE KITS

16K TRS 80 and 16K ITT 2020	65.22	75.
-----------------------------	-------	-----

### INTERFACE

0K TRS 80	195.66	225.
16K TRS 80	260.88	300.
32K TRS 80	347.83	400.

### DISK DRIVES

Dual Computhink with cable	565.22	650.
Single ITT 2020 with cable	369.57	425.
Single Micropolis	347.83	400.
Disk cable (2) & Disk cable (4)	P.O.A.	—

### PRINTERS (Tractor & Friction Feed)

F/F Centronics 779	739.13	850.
T/F Centronics 779	869.57	1000.
F/F Anadex DP8000	478.26	550.
T/F Anadex DP9500	869.57	1000.
T/F ITT 2020	739.13	850.
T/F IPP 404	608.71	700.

Printer Cable	P.O.A.	—
Printer Interface ITT 2020	108.70	125.
Nestar Cluster System	P.O.A.	—
Colour TV ITT 340	247.83	285.

### MEDIA LIST

5¼" Verbatim	from (Qty 10)	21.74	25.
5¼" Dysan	from (Qty 10)	26.09	30.
8½" 3M	from (Qty 10)	30.44	35.

Blank 5¼" & 8½" Diskettes, Soft/Hard Sected, Formatted/ Unformatted.  
We have Diskettes to suit many systems. When ordering please quote:  
SYSTEM MANUFACTURER, MODEL, MEDIA TYPE, AND DISK SIZE.  
Available in smaller or larger quantities.

### STATIONERY Listing Paper, Continuous Forms, Labels.

Post/Packing/Insurance extra. Delivery by Registered Post, Securicor, etc.  
Price List correct at time of going to Press, subject to change without notice. E.& O.E.  
Standard Warranties apply. ● Authorised Tandy and ITT Dealer.

Please send Full Details & Price Lists

My requirements are for:

HOME  HOBBIES  STUDENT  BUSINESS

Name: .....

Street: .....

Town: .....

County: .....

Post Code: .....

Telephone: .....

Name of Co: .....

Position: .....

PO/Chq No: .....

(Payment by Barclaycard/Access can be arranged at 6% extra charge).

Requirements	Description	inc. VAT
Microcomputer	.....	
Upgrade Kit	.....	
Interface	.....	
Disk Drive	.....	
Printer	.....	
Cable/Interface	.....	
Cluster System	.....	
Colour TV	.....	
Media	.....	
Stationery	.....	
Software	.....	
Post/Pkg/Ins	(please tel. for cost) .....	
PC	TOTAL: .....	

● Circle No. 272

## OPENING OFFER

on cash or HP sales until the end of October '79

A FREE CASSETTE UNIT WITH,

OR £57.50p OFF

ANY PET COMPUTER

In exchange for one copy of this advertisement per computer  
Price includes VAT

**F  
O  
R  
P  
E  
T  
M  
I  
N  
G  
C  
O  
M  
P  
U  
T  
A  
T  
I  
O  
N**

Incomplete records system  
Sales and purchase ledger  
Programs for business, maths, games and programming aids

COMPUTERS

TAPES + TAPE UNITS

DISKETTES + DISK UNITS

PRINTERS + STATIONERY

BOOKS

**COMPUTATION**

8 Station Parade,  
Southgate, N14  
01-882 5104

● Circle No. 273

## THE ANADEX SLAVE PRINTER

*A truly commercial computer printer  
at a personal computing price.*

*Some of the features:*

- ★ 80 columns, 112 cps
- ★ 84 lines per minute, bi-directional
- ★ 100 million characters printhead life
- ★ Sprocket feed, multi-copy
- ★ V24 interface

Special offer to *Practical Computing* readers £495.

● Circle No. 274

Also DECwriter LA34s available from £825.

● Circle No. 275

# COMPUTRADE

Silverwood House, Oxshott Road, Leatherhead, Surrey  
Tel. No. 03723 79143

# MEREFIELDS (ELECTRONICS LTD)

Don't be sad and blue, when you're let down.

Call on us and we'll find a way to help you, and ourselves.

We specialise in memory products — LOW POWER SCHOTTKY — T.T.L. — C-MOS etc.

Sales only, two MFGs and DSTBs (including retail shops).

**BEST WISHES MEREFIELDS LTD.**

Graham Bell House,  
Roper Close,  
Canterbury, KENT.  
Tel: (0227) 64442 53933.  
Telex: 965780 G.B.

● Circle No. 276

**G**eveke  
electronics  
presents!

# The Choice for

## PRINT

DIABLO

1640



1650

SUPERB QUALITY PRINT WITH THE  
NEW DIABLO RANGE

TWO MATRIX PRINTERS  
ACKNOWLEDGED AS INEXPENSIVE  
YET FUNCTIONAL

DEC LA34



TELETYPE 43

TEC 502

## or DISPLAY



TEC Model 70

ELEGANT DESK-TOP STYLING  
WITH THOROUGHbred PERFORMANCE



CLEAN & SIMPLE STYLING  
- A DEPENDABLE WORKHORSE

# 1 or 100

THE BEST DEAL AT:



**G**eveke  
electronics

RMC House  
Vale Farm Road  
Woking Surrey GU21 1DW

Telephone 04862-71337  
Telex 859531

**G**eveke  
electronics

Offices and Service Centres in:  
Amsterdam, Brussels, Dusseldorf,  
Frankfurt, Hamburg, Lyon,  
Munich & Paris.

RING US TO FIND OUT TODAY'S  
PRICES & DELIVERY  
**04862 - 71337**

● Circle No. 277

# INNOVATIVE TRS-80 SOFTWARE

**NEW!!**

**INFINITE BASIC**

**NEW!!**

"Infinite Basic" adds over 70 new commands to your Level II or Disk Basic. Furthermore, these are modularised so that any combination may be loaded at any time, which makes the package very memory efficient. A sampling of the additions includes *complete* string functions, left & right justify, truncate, rotate, text justification, reverse strings, verify, string searches etc., etc. Complete Matrix functions are also included with inverse, transpose, simultaneous equations, multiply scalars, vectors; reshape, expand and delete arrays; change arrays in mid-program, zero and move arrays etc., etc.

"Infinite Business" is an add-on package to the above and includes multiple precision-packed decimal arithmetic, eliminating round-off errors with a 127-digit maximum accuracy. Also includes binary search of sorted arrays, automatic page headings and more!

Infinite Basic . . . £29.95. Infinite Business . . . £16.95. Both plus VAT & 50p p&p.

Send large SAE (12½p) for our current catalogue of TRS-80 Software.



**A.J.HARDING (MOLIMERX)**

28 COLLINGTON AVENUE, BEXHILL-ON-SEA, E.SUSSEX.

TEL: (0424) 220391



● Circle No. 278

## TERODEC

MicroSystems



43 Qualitas, Roman Hill Bracknell,  
Berkshire RG12 4QG  
Tel: (0344) 51160

MICROMATION

Central Data

VISA

SOFTWARE

### OSBORNE & ASSOCIATES

CBASIC-2 Version. Runs either on CP/M or CDOS 1.07

- Accounts Payable & Accounts Receivable..... £80
- General Ledger ..... £80
- Payroll with Cost Accounting. .... £80

### MICROPRO

- WORD-STAR — Menu driven visual word processing system for use with standard terminals. Text formatting performed on screen. Facilities for text paginate, page number, justify, centre, underline and PRINT. The most complete, totally integrated, word processing system software you've ever seen on a microcomputer. **£285**

We also supply CP/M and CBASIC-2

TERODEC supply a full range of hardware and software that represent the best in quality, price and delivery. Our product range includes the CROMEMCO CS-2 and CS-3, printers from DECISION DATA and VDUs from TVI and SOROC. Our latest addition to the range are products from MICROMATION. The Z-PLUS is a complete 1 Mbyte Floppy Microsystem that defies comparison.

All prices are correct at the time of going to press and do not include delivery or VAT. Office hours 9 — 6 Mon-Sat. Please phone for appointment. 24 hour answering service. OEM & Dealer Enquiries Invited.

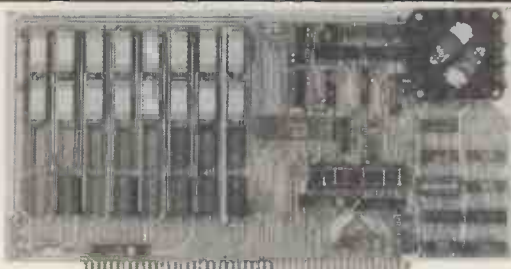

Central Data

## New RAM Prices.

From The Dynamic Memory Company.

- Deselectable in 2K increments — the deselect allows 2K areas of memory to be switched off to avoid memory overlap
- Z-80 and 8080 compatible at both 2 MHz and 4 MHz
- Fully socketed — allows the user to expand the board
- Power saving Dynamic RAM with invisible refresh
- Plug selectable addressing
- S-100 compatible
- Reliable — one year guarantee.

16K — £150                      32K — £220

48K — £290                      64K — £360

4 MHz Boards at £5/16K additional

● Circle No. 279

# Get it right ...

The right machine **PET**

## The right programs **Computastore**

**PAYROLL** This flexible PAYROLL system makes wage calculation fast, easy and accurate. It prints paylips, totals, coin analysis, and year end totals. Updates for tax and NI changes available.

**PETE** Go on-line with this unique software package which turns your PET into an intelligent RS-232 terminal with user definable transmission parameters.

**ASSEMBLER** Really fast Assembler written in machine code, assembles up to 500 lines per minute on the Commodore Disk. It allows 200 symbols on an 8K PET (1000 on larger PETs).

**DISASSEMBLER** Can even display the PET's ROMs, and search them for strings of characters or patterns of hexadecimal bytes. Outputs to screen or printer.

**KEYBOARD** Big keyboard terminal or printer (e.g. TTY 43) can now be used as a dumb terminal for keying in BASIC programs or data for your PET. The PET can even be in a different location! Also, speeds up data entry for 8K PET owners with keyboard/printer.

**Cassette and Commodore Disk versions available for old and new ROM PETs.**



**Computastore**  
Software that means business

Ask your local PET dealer or  
Computastore for a demonstration

Computastore Ltd, 16 John Dalton Street,  
Manchester M2 6HG Tel: 061-832-4761.

● Circle No. 280

The microcomputer for those who need more than the minimum. The right processor for business, scientific and educational use. Proven applications include Games • Educational • Word Processing • Invoicing • Stock Control • Sales Ledger • Purchase Ledger • Mailing • Scientific.

# THE NEW HORIZON

## Languages

Powerful Basic including sequential and random access disc files • formatted output • strings • line editor • machine language CALL • many other facilities. Optional additional software (under CP/M operating system) includes BASIC

## The Horizon computer includes:-

### Specification

Zilog Z80A MPU • S-100 bus (12 slots) • Solid well-built case • Up to four Shugart mini-floppy disc drives, 180KB each • Serial port for CRT or Teletype • Real-time clock on motherboard •

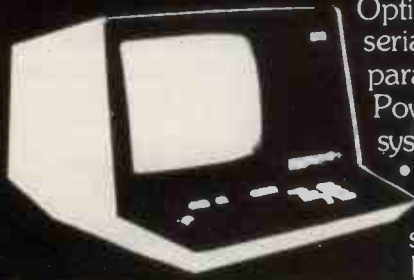

Optional additional serial port and parallel port • Powerful operating system and monitor • Access to wide range of S-100 special application boards.

compiler, FORTRAN and COBOL.

Horizon Z80A computer with 2 double-density disc drives and 24K RAM £1,823 (exclusive of VAT and carriage).



Equinox Computer Systems Ltd.  
"Kleeman House"  
16 Anning Street,  
New Inn Yard,  
London EC2A 3HB.  
Tel: 01-739 2387/9.  
01-729 4460.

● Circle No. 281

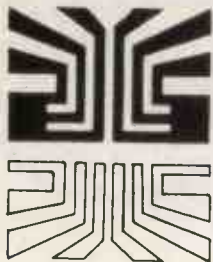

## Small Systems Engineering Limited

62 NEW CAVENDISH STREET, LONDON W1M 7LD  
TELEPHONE: 01-637 0777. Telex: 8813085 ABACUS

SUPPLIERS OF PET MEMORY BOARDS AND INTERFACES THROUGHOUT EUROPE  
COMMODORE APPROVED

### NEW CUSTOM CHIP INTERFACES

- Custom chips allow any character codes
- Option to print U/L case as PET Screen
- Parallel versions for PR40, ANADIX, CENTRONICS etc.
- Fully addressable for PET Disc compatibility
- Custom Character Sets — One week delivery
- Parallel . . . . . £106 Serial . . . . . £120

### PET INTELLIGENT TERMINAL SOFTWARE PACKAGE

A software package which, in conjunction with an interface B enables the PET to operate as an intelligent terminal. £100

### TV/VIDEO MONITOR INTERFACE

— Video and UHF output (plugs into TV aerial socket) £35

### IEEE 488/CENTRONICS TYPE PARALLEL INTERFACE

— Low cost unit without IEEE address decoding  
— Also suitable for Anadex DP-800 Printer £45

### PET MEMORY BOARDS

Internally mounting memory boards — also available with EPROM sockets: 24K — £328; 32K — £432

### IEEE — 488/RS232C SERIAL INTERFACE TYPE B

- Fully Bidirectional — PET Disc compatibility
- Switch selectable and Crystal Controlled Baud Rates
- Lower case printing
- Full operating instructions and sample programs supplied
- Boxed units complete with connectors £186

### Available now:

#### COMPUCOLOUR II MODEL 3

- 13" 8-Colour CRT, 8080 Microprocessor
- 16K extended disk BASIC in ROM
- 71-key detached keyboard
- 84K RAM memory for user programs
- 64 characters per line by 32 lines per page
- Special graphics package with 128 x 128 point plotting
- Built-in mini-floppy disk drive
- 50 pin bus
- RS-232 I/O port for serial printers, etc. £1,058

TERMS: All prices Ex. VAT. Please make C.W.O. Cheques payable to: SMALL SYSTEMS ENGINEERING LTD. Post and package (includes SECURICOR delivery): £5 All goods supplied under 90 days' warranty.

● Circle No. 282





# Don't Be Left Behind You Too Can Discover microPOWER

## EXIDY – Main Dealer

The Sorcerer Business System £2999 + VAT  
32K Computer with 8K BASIC Rom Pac  
80 Column Printer  
9" Monitor  
Dual Disk System – 633 Kb  
S100 Expansion Unit  
CP/M & CBASIC  
Graphics facilities, pre-defined and user defined.  
63 key ASCII Keyboard and 16 key numeric pad.  
Various disk systems available to over 1 megabyte.  
ROM PACS available now – ASSEMBLER, WORD PRO-  
CESSING, EPROM.  
Cooling fan for S100 units £16.75.  
Manuals ex-stock.  
8K, 16K and 32K machines.

## CROMEMCO

Z2 and Z3 Systems.  
Outstanding professional machines.  
Fast Z80 CPU with 21 card motherboard.  
Software support includes COBOL, FORTRAN IV, 16K EXTEN-  
DED BASIC, MULTI-USER OPERATING SYSTEMS, DATA  
BASE MANAGEMENT SYSTEM.  
Now on short delivery.

## PRINTERS – All Ex-Stock

DOLPHIN BD80. The best in its price range.  
The 80 column printer with many features. £595.  
PRINTERM 879 Matrix Printer 120 cps. £695.  
OKI DP100 – 132 column 275 cps 125 lpm. £2400.

## DISK DRIVE UNITS

SHUGART  
MICROPOLIS  
NORTH STAR  
PERSCI

## VDU's

BURNT HILL BH 720. Graphics, text, underline, protection,  
blink and invert £795.  
ELBIT DS 1920 £575.  
ELBIT DS 1920X. The new improved cost conscious compatible  
terminal £750.

## MONITORS

Professional quality 9" £145 and 16" £175 (ideal for teaching).

## SHOWROOM and OFFICES

34B London Road, Blackwater,  
Camberley, Surrey.  
Telephone: 0276 34044. Telex 858893

**COMPUTER BOOKS** – We carry a large stock of Micro books.  
Orders sent out same day except in cases of very high demand,  
when we will inform you of delay.  
Extensive catalogue available – Micro, Mini and Mainframe.

**SOFTWARE** – On cassette and disk and written to customer  
requirements.

**MEDIA** – Floppy Disks 5" from £25 box of 10  
8" from £32 box of 10  
Library Cases 5" £2.99  
8" £3.49  
Computer Cassettes C12 £4.00 for 10

## BEAR BAGS – AREA DISTRIBUTOR

Build your own 6800 based computer. Active user group.  
Bear Bags and PCB's always in stock.

## PRINTER PAPER

12" x 9.25" Single part plain, tractor feed with tear-off edges.  
Ideal for word processing – each page A4 size.  
Per box 2000 sheets £14.00.  
Other sizes available.

Orders taken for pre-printed continuous stationery, to your exact  
company requirements.

## WORK STATIONS

Made to fit your hardware configurations.

All prices + VAT and P/P.

Maintenance contracts available.  
Leasing and H.P. arranged through leading finance houses.

Feasibility studies to help you decide on the system that is right  
for you.

Customer support and technical back-up.

## ACCESS, BARCLAYCARD and TRUSTCARD.

Personal Callers Welcome.  
Please phone first if you require a personal demonstration.  
Mail orders and official orders accepted.  
Quantity discounts available.

open Monday - Friday 9 a.m. - 6 p.m.

Saturday 10 a.m. - 5 p.m.

On Main A30

# RESEARCH RESOURCES LTD.

Microcomputers for education, science and technology



- PET, Vector and SWTP
- Fortran, Pascal, Cobol, CBasic, Multi-user PILOT
- Exclusive to RRL: Lab-Basic, SAM (Statistical analysis) A-to-D, D-to-A converters.
- Showrooms at 40, Stonehills, Welwyn Garden City, Herts. Tel: Welwyn Garden 26633 (24 hours).

● Circle No. 284

## AIM 65 £249.50 + VAT

### FEATURES INCLUDE:

- \* 20 COLUMN PRINTER
  - \* 20 CHARACTER ALPHANUMERIC DISPLAY
  - \* FULL 54 KEY TERMINAL-STYLE KEYBOARD
  - \* TTY INTERFACE
  - \* TWIN CASSETTE INTERFACE
  - \* RAM — 1K TO 4K OPTIONS
- OPTIONAL EXTRAS INCLUDE:

- 8K 'BASIC' INTERPRETER ROM — £70.00
- 4K ASSEMBLER ROM — £59.50
- POWER SUPPLY — £41.83
- CASE (Including Power Supply) — £78.00
- EXPANSION MOTHERCARD — £136.50

AIM 65 comes to you fully built and tested with a full alphanumeric keyboard, 20 character display and a 20 column printer — for keeping a permanent record of all your work. Available in 1K- and 4K-byte RAM versions. AIM 65 is designed around the 6502 CPU, which has 64K address capability with 13 addressing modes. This is the microprocessor at the heart of many other, more costly, systems such as PET and APPLE.

AIM 65 has a 4K ROM-resident monitor program for all peripheral control and user programming functions. Spare sockets are included for expanding on-board program memory via user PROM-based programs and/or Rockwell assembler, text editor and BASIC interpreter plug-in options. AIM 65 has a connector for external access to system bus for memory and

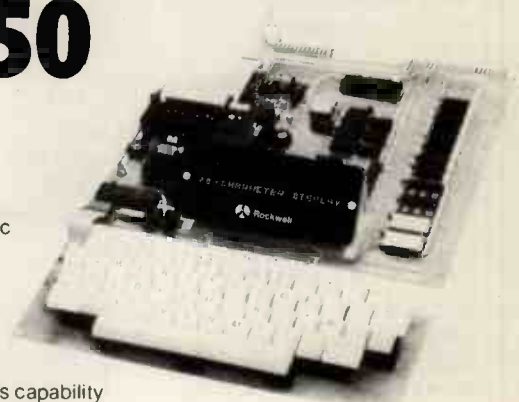

I/O expansion, a separate connector for interfacing a teletype and two cassette recorders. There is a user-dedicated Versatile Interface Adaptor, featuring three 8-bit, bidirectional ports (two parallel, one serial) and two 16-bit interval timer/event counters — thus allowing the user to interface his own system, without extra interface devices in many cases. AIM 65 is probably the most effective, low-cost microcomputer development system available — an invaluable educational aid to first time users and an ideal general purpose micro-computer for the engineer.

AIM 65 is available in the UK from PELCO ELECTRONICS LTD at £249.50 + VAT, complete with User's Manual and Schematic, R6500 Programming and Hardware Manuals and a handy pocket reference card.

● Circle No. 285

## Pelco (Electronics) Ltd

Enterprise House 83/85 Western Road HOVE East Sussex BN3 1JB  
Tel: Brighton (0273) 722155

Buy it with your Access or Barclaycard.



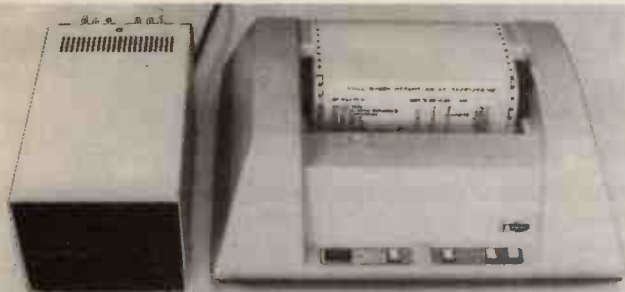

## OUR PET PICTURE IS NOT HERE

A Pet in the middle will galvanise this 'Computhink' disk drive and 'Anadex' printer into the finest micro-based business system we know. Especially if our COMPFER software is on it!

### 'Hardwearing' Software.

As we write quality software for many applications we look for the best in hardware. So we are: OFFICIAL PET DEALERS AREA ANADEX DISTRIBUTORS COMPUTHINK DISK DEALERS and deal in other quality equipment such as NASCOM & SWTPC.

### Prices?

Well — the new adjustable Anadex printer, 80 lines per minute, 80 characters full width with self testing facility and optional plug-in PROMS for special character and mode production is now supplied by us complete with parallel interface for a new reduced price of **£610**. Just plug into your Pet and go!

We sell the KIM at **£99.95** with a purpose built sturdy and reliable power supply for **£24**.

### Seen it before?

The text printed on the printer above is one of the facilities of our stock control package as seen on B.B.C's 'Look North'. We are rapidly achieving a reputation as standard setters in micro-application software.

### Still not impressed?

We have designed our own A/D converter with Fourier analysis software now in use internationally, we have a large stock of books and magazines and we have Pet interfacing to Oertling balances with software for Department of Trade standard quality regulations.

### IEEEEE?

Our IEEE parallel divider gives you two arms to your Pet IEEE port for **£12.50**

### Pet Life begins at PR-40

Hard copy for **£250!** Using ordinary till roll paper, prints results and program listings for your Pet.



### Preston Computer Centre

6 Victoria Buildings,  
Fishergate, Preston.

Tel: 0772- 57684

All the above prices are exclusive of V.A.T.  
Access and Barclaycard accepted.

# NEWS FLASH!

## 'PETS' at highly competitive prices

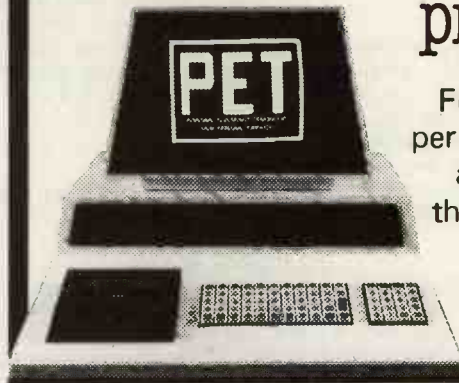

For a limited period Logitek are offering the following equipment at 12% below list price.

Computers.	R.R.P.	Our Price
Pet 2001 - 8K	£550	£485
Pet 2001 - 32K	£795	£699
Floppy Disc		
Pet 2040	£795	£699
<b>Printers</b>		
Pet 2023		
Friction Feed	£550	£485
Pet 2022		
Tractor Feed	£645	£565
External Cassette		
Decks	£55	£48

All above prices subject to 15% v.a.t.

### MAIL ORDER

All advertised items generally in stock.

Add 15% VAT & 2% for carriage to all the above prices.

Please send .....

.....

I enclose cheque for £ .....

Name .....

Address .....

.....

..... Tel No. ....

E.I.C. Electronics Ltd.,  
30 Kelvin Ave., Hillington  
Industrial Estate, Glasgow  
Tel: 041-882 1661/2/1166

# A PRACTICAL GLOSSARY

Continuing the terminological gamut from N to O

## North Star

North Star Computers is an independent Californian company which has become one of the best-liked and most successful of the personal computer manufacturers. Its Horizon computer is a neat box packaged with a Z-80A microprocessor, SI00 bus, and built-in minifloppy drives. We reviewed it in April, 1979.

## Notation

A way of expressing concepts in written or printed symbols. Alphanumeric notation is the way we communicate spoken language. Boolean notation is the collection of symbols, characters and other hieroglyphs used to put over the way Boolean algebra works.

## Nova

The top-selling computer from the world's number two mini maker. The first Data General NOVA appeared in the early 1970s. The present version has more facilities and a much lower price, but the same internal design ideas are used. A classic mini.

The DG microNOVA is a microprocessor implementation of the same design.

## ns

Abbreviation for nanosecond (qv).

## NS

Note the upper-case. This is an abbreviation sometimes used for National Semiconductor. So is Nat-Semi.

## Null

An instruction meaning "do nothing", used usually in computer-terminal communications.

## Null string

A string with nothing in it and different from no string at all.

## Number-crunching

Performing clever calculations quickly. In practice, computing tends to be in two flavours, number-orientated or alphanumeric, and they have very different characteristics. Alphanumeric work, like most business applications, usually means many files, and much I/O — to and from files, to and from terminals — very little and not very complicated computation. Scientific and technical computing is generally the complete opposite — small amounts of stored data and not a great deal of I/O, but big, complicated numbers and much complicated calculation. Big numbers and sophisticated calculation is what number-crunching is all about.

A *number cruncher* is a computer designed specifically for that kind of work. Usually they are powerful, expensive and very large; classic applications include meteorological calculations, NASA work, and the kind of tricky maths required in nuclear power.

## Number system

Impressive-sounding reference to the numeric basis for computation and logic. *Binary*, *octal* and *hexadecimal* are all favourite number systems used by computer designers — they have the bases 2, 8 and 16 respectively.

## Numeric

It means comprising numbers only. You knew that, didn't you?

## Object code

'Source code' or 'source programs' are what the programmer writes. The 'source language' will generally be one of the well-know mnemonics like Basic or Cobol, or it might be a *low-level* language (assembler). Anyway, before it is acted upon by your computer it has to be translated into a form the computer can understand, and the results of that translation are called object code.

You won't necessarily have an object code version of your program. With an *interpreted* language, like most versions of Basic, each program instruction is translated and acted upon directly, so there is no homogenous intermediate form. A *compiler*, however, always produces an object program; you write the source code, compile it, and get an object program which is incomprehensible to you.

The object program, incidentally, will almost always be in *machine language*. Some big and cumbersome machines produce object code which isn't exactly at the binary-digits stage of machine code; but forget about them — you'll never be able to afford one anyhow.

## OCR

Optical character recognition — sometimes optical character reader. There's no standard definition.

## OCR wand

A clever hand-held device which can read characters and convert them into computer input. Recognition Equipment was the company which pioneered the technique, which obviates the need for a special separate (and usually bulky) OCR reader.

## Octal

To the base 8; compare *binary* (base 2) and *hexadecimal* (16). In *octal* notation the numerals 0 to 7 are used to

encode all possible three-bit combinations from 000 to 111; *hex* is much more popular, though — it uses 0 to 9 and A to F to encode all possible four-bit combinations.

## OEM

Original Equipment Manufacturer. A manufacturer or system supplier buying components or subsystems from other manufacturers to incorporate in a product which is then sold on to an *end-user*. In practice, people in the computer business frequently use the term OEM to refer to the manufacturer who makes the things bought by the middleman.

Either way, the important things to note are the OEM products are usually sold to those middlemen in quantity, at a discount on one-off prices, and with little or no vendor support. This three-pronged strategy is how mini-makers like Digital Equipment and Data General become rich; most of the business of the semiconductor giants like Zilog, Intel and Texas Instruments, is also in this vein.

## Off-line

Not connected directly to the computer. Remember those nasty punched cards? A data preparation clerk who has to transcribe human-readable information into computer-readable information might well do that on an off-line unit called a card punch which makes the holes in the cardboard. Or you might be able to switch your printer off-line — without unplugging it — so that it doesn't suddenly start pulverising your finger with printed output while you're re-loading it with paper.

## Office computer

Jargon for a computer which might be used in an office. In practice, that means a relatively cheap and fairly small computer — say between one and four VDUs, one matrix printer, an invisible processor, and file storage on floppy discs or, perhaps, 10-megabyte rigid discs. The average office computer is a single-user, desk-style workstation driven by a micro, with two floppy disc drives and a price tag below £12,500.

## OMR

Optical mark recognition, or optical mark reader — take your pick. We like 'recognition'. It is a technique which puts data into the computer by detecting the presence or absence of a mark. You need special forms and the person filling them in marks the appropriate boxes OMR is much simpler than OCR, since the OMR reader has only two con-

ditions from which to make a choice. OMR input is used widely in automating some exam marking — obviously you have exam paper which give multiple choices to select from; and in ordering — salesmen with many product lines or a number of pre-defined selectable options usually have pre-drawn forms to fill in.

## On-line

Indicates equipment connected to and communicating with a computer. The opposite of *off-line*.

## OP CODE

Or Opcode. It's the operation code, part of an *assembly language* instruction which indicates the operation to be performed. Other parts might specify the memory locations, data, and/or I/O ports involved.

## Operand

Someone who can still hum all of *Carmen* through a *Who* concert? No. It's the data used by a computer instruction; usually it's that part of the instruction which contains the data.

## Operating system

There are two broad categories of software involved in computing — system software and applications software. The applications programs enable you to apply the computer to something — they do whatever it is you want your computer to do. Playing games, switching-off the central heating, producing invoices — all those are applications.

What we call system software fits between your applications programs and that heap of hardware on which they run. The system software takes away from you the need to know how every electronic action relates to every step in the execution of your program.

The operating system is the principal example, but not the only one, of system software. It is a complex program, or group of programs, with the computer. There are no hard and fast rules about what it does and does not do. Here are some other attempts at definition.

"An integrated collection of computer instructions which handle selection movement and processing of programs and data needed to solve problems." That's a bit restricted, because operating systems also manage and control internal operations of electronic hardware.

"Software required to manage the hardware resources of a system and its logical resources, including scheduling and file management." That's better, provided you know what all the big words mean. □

# COMPLETE COMPUTER SYSTEMS (CCS)

## PRESENT the ABC80

Zilog Z80A microprocessor, the ABC 80's brain.

Professional keyboard of Swedish standard.

12" black-and-white TV screen. Displays capitals and small letters, digits, figures and diagrams. Room for 24 lines of 40 characters each.

Built-in graphic mode. Uses 64 different graphic symbols.

Program memory. 16K BASIC of ROM, 16K bytes of RAM. 2K Monitor in ROM. 1K Picture RAM.

Loudspeaker. 128 different sound effects. Can be used to provide alarms or other signals.

Cassette memory for storing programs and data. Fast winding in both directions.



Built-in real-time clock for timing.  
**price £759.00 (provisionally).**  
Available from U.K. importers

**CCS MICROSALES**  
22 WESTSIDE  
68 FORTIS GREEN  
LONDON N2 9EN  
Tel: 01-444 7739

V-24 jack for connecting to a telephone modem so that you can communicate with other computer systems via the public telephone network.

46/80 Bus for connecting peripherals such as floppy-disk units, printers, plotters, measuring instruments etc.

● Circle No. 287

## CCS Microhire

Still the Leading Microcomputer Hire Company with the best range of equipment: Apple II; PET; Exidy Sorcerer; SEED System One/MSI 6800; NASCOM/MICROS; Research Machines 380Z and Tandy TRS-80.

Over 500 million Bytes (half megabytes memory) available for hire in units from 4K to 48K.

Send for our NEW PRICE LIST giving the most attractive prices yet.

and **CCS MICROHIRE**  
**FREEPOST** (soon at 7, The Arcade)  
**LETCWORTH**  
**HERTS SG6 4YA**

● Circle No. 288

# Advertisement Index

Abel Computer Systems	40	Electronic Brokers	22	MacNaughton, P.	42	Research Resources	154
Aculab	4	Ensign Computers	147	Mathematical Models	146	Robox	44
Adda	110	Equinox Computer Systems	16, 142, 152	Merefields	148	Rostronics Computer Centre	121
Airamco	37	Euro-Calc	112	Microbits	153		
A J Harding	150	Factor One Computers	76	Micro Centre	2	Science of Cambridge	73
Almarc Data Systems	44	Four on Four	4	Microcomputation	148	SEED	23
Analog Electronics	96	Geveke Electronics & Automation	149	Micro Computer Centre	36	Shelton	18
		GPW	26	Micro Computer Mart	15	Sigma Technical Press	42
B & B Consultants	120	Graffcom	88	Microdigital	10, 12, 14, 16	Sintron Microshop	33
Bass Engineers (Sales)	42	Grama (Winter)	39	Micro Facilities	32	Slough Micro Shop	38
Byte Shop, The	17	Happy Memories	146	Micromedia (Systems)	144	Small Systems Engineering	152
		HB Computers	144	Microsolve Computer Services	30	Software House, The	141
Cambridge Computer Store	34	Heathkit	10, 14	Midwich Computer Co	62	Stack Computer Services	85
Camden Electronics	25	Henry's Radio	22	Mikom	40	Stage One	110
CCS Microhire	157	Informex	34	Millbank Computing	6, 7	Strutt Electrical & Mechanical Engineering	38
Chromasonic Electronics	36	Interam Computer Systems	20, 32	Muller (Anglo American) Computers	108	Sumlock Electronic Services	19
Comart	5, 11	Inter Systems	43			Systematics International	36
Commodore Systems Division	31	Isher-woods	41	Nelson Computer Services	34		
Comp Computer Components	158, 159	Keen Computers	56	Newbear	24, 28	T & V Johnson (Microcomputers) Etc	86, 87
Compucorp	21	L & J Computers	146	Newtronics	18, 38	Technologies	26
Computastore	151	Landisler Software	40	NIC Models	102	Terodec MicroSystems	145, 150
Computer Centre	116	Leenshire	30	North London Polytechnic	102	Thomson CSF	96
Computer Field Maintenance	24	Lion Computer Systems	45	Padmede	78	Tim Orr	22
Computer Workshop	160	Logic Box	78	Pelco (Electronics)	154	TLC World Trading	16
Computrade	148	London Computer Store	32, 142	Peripheral Hardware	20	Transam	122
CPU Peripherals	50	Lotus Sound	29	Personal Computers	106	Tridata Micros	142
Crofton Electronics	18	LP Enterprises	35	Petalect	13		
		LTT Electronics	20	Petsoft	70	Vero Electronics	4
				PIPS	102	Vlasak Electronics	28
Datac	12			Preston Computer Store	155		
Data Design Techniques	12			Protechnic	26	Xitan Systems	27
Data Systems Engineering	88			Rair Timesharing	8, 9, 55	Zilog (U.K.)	143
Datron Interform	114			Research Machines	46		
Demacan	30						
Digitus	100						
Dynabyte (Belvedere)	118, 119						

## TRS80 EXPANSION INTERFACE

Upgrade your system as your needs increase. Contains sockets for additional 16K or 32K RAM and a disk controller for up to 4-mini-disks. Software selectable dual cassettes can be used. Features a Centronics parallel port, real time clock, and a connector for an RS-232C interface or whatever. Requires Level-II Basic. 220/240V AC.  
0 RAM £229 16K RAM £458 32K RAM £687



## ANADEX DP8000

ONLY £540 + VAT  
PET Connector — £49



The DP 8000 prints the 96-character ASCII set in single or double width at 84 lines per minute. • The unit operates bi-directionally to print a 9 x 7 matrix on multiple copy, pin-feed plain paper. • This model accepts RS-232C or current loop serial data at baud rates switchable from 110 to 9600 and Parallel Bit data input at over 1000 characters per second. • Other features include Out of Paper Detector, Top of Form Programming and Skip Over Perforation Control.

- Standard storage capacity of 256 characters
- Other features include Out of Paper Detector, Top of Form Programming and Skip Over Perforation Control.

## THE NEW ITT APPLE (2020)



ITT  
MICRO COMPUTER

- ★ Full colour — UHF output ★ Audio cassette tape interface ★ Up to 48K RAM on board ★ BASIC in ROM (graphics commands include COLOUR = VLIN, HLIN, PLOT and SCRIN) ★ Built in loudspeaker ★ Buckets of software available ★ Disk System (110K byte per drive — includes controller) only £425 + VAT **EX-STOCK**

## THE TRS80 (Special Scoop) Low Priced, Ready to Go!



£399 + VAT

**EXTENDED WARRANTY BY COMPUCARE**

PLUGS INTO YOUR OWN TV  
Use your own cassette

LEVEL II BASIC WITH 16K USER RAM provides you with possibly the most powerful micro around. All our TRS80s are fully converted to English Television Standard and include a U.K. Power Supply, Cassette Leads, Sample Tape, Level I & Level II programming manuals, and special lead that enables you to connect direct into your own television.

Special features of Level II Basic enable you to: — Set or reset any point on the screen — Test for the presence of a point on the screen (these features enable easy animation) — Save or load data from cassette under program control — File handling capabilities on cassette using named files. — Graphics blocks as standard — design your own pictures and many many more features for only £399 + VAT

## PET COSTS LESS AT COMP and it's a pedigree

8K — Comes complete with integral cassette deck. Full manuals supplied. Powerful 8K Microsoft Basic in ROM. Masses of software available — £499 + VAT

16K — Same as above but with new improved keyboard and cassette supplied as extra. Machine code monitor on board so you can program in 6502 machine code — £590 + VAT

32K — for a little extra get 32K memory providing greater storage capacity for programs or data — £690 + VAT

External Cassette deck for 8K, 16K or 32K — £55 + VAT complete with cable and connector.



**EXTENDED WARRANTY BY COMPUCARE**

## HITACHI PROFESSIONAL MONITORS



9" — £129 + VAT  
12" — £199 + VAT

- Reliability Solid state circuitry using an IC and silicon transistors ensures high reliability.
- 500 lines horizontal resolution Horizontal resolution in excess of 500 lines is achieved at picture center.
- Stable picture Even played back pictures of VTR can be displayed without jittering.
- Looping video input Video Input can be looped through with built-in termination switch.
- External sync operation (available as option for U and C types)
- Compact construction Two monitors are mountable side by side in a standard 19-inch rack.

## video 100

12" BLACK & WHITE  
LOW COST VIDEO  
MONITOR



- Ideal for home, personal and business computer systems
- 12" diagonal video monitor
- Composite video input
- Compatible with many computer systems
- Solid-state circuitry for a stable & sharp picture
- Video bandwidth - 12MHz + 3DB
- Input impedance - 75 Ohms
- Resolution - 650 Lines Minimum in Central 80% of CRT; 550 Lines Minimum beyond central 80%.

Only £79 + VAT

## SORCERER SPEAKS YOUR LANGUAGE

For personal or business use. The best value for money around. ★ 512 by 256 point screen resolution ★ 16K or 32K User RAM ★ Centronics Parallel Port ★ RS232C Serial Port ★ Composite IV peak to peak video output T.V. output supplied as extra. ★ 64 programmable graphics + 64 standard PET graphics ★ 79 key keyboard including 16 key numeric keypad. ★ Expansion bus for connection to S100 Expansion Box.  
16K Sorcerer — £690.00 + VAT  
32K Sorcerer — £790.00 + VAT  
S100 Expansion Box — £210 + VAT



**EXTENDED WARRANTY BY COMPUCARE**

Word Processing Pac and Development Pac now available.  
Word Processing Pac — £70 Development Pac — £70

## Break the language barrier £138 + VAT



At a price equivalent to learning one language, LEXICON offers you, English, Spanish, French, German, Italian and Greek. The LK3000 comes to you with the person to person module which contains 6 languages, deluxe carrying case and a charger adaptor using its own power source which will give you 4-5 hours continuous use, and can easily be re-charged from the mains supply, wherever you may be in the world. Every additional module carries a concise and understandable instruction book. Your deluxe carrying case has room for two additional modules.



(Part of the Compshop Ltd. Group)

Compucare is a company that has been set up to provide servicing and maintenance for the popular makes of micro-computers i.e. Sorcerer, Pet, Apple, TRS80, Nascom, Komputik. Our charges are £7 per hour plus parts. Because of the extensive range of spare parts stocked you can usually expect your micro to be repaired within 10 days for an average charge of £14 labour. Emergency 24 hour repairs can be handled for a £10 surcharge where possible. Komputiks and Nascoms unsuccessfully constructed will be charged a standard £25. Maintenance contracts for these machines are available, see your local dealer for a Compucare Maintenance Application Form.

Please add VAT to all prices — Delivery at cost, will be advised at time of purchase. Please make cheques and postal orders payable to COMP, or phone your order quoting BARCLAYCARD, ACCESS, DINERS CLUB or AMERICAN EXPRESS number. OPEN — 10am to 7pm — Monday to Saturday CREDIT FACILITIES ARRANGED



JUST COMPARE OUR CASH AND CARRY PRICES!

SEND LARGE S.A.E. FOR OUR FREE '79 CATALOGUE

EUROPE'S FASTEST SELLING ONE BOARD COMPUTER —  
JUST CHECK THE SPEC'S.

SAMPLE TAPE  
WITH EXTENDED  
MACHINE CODE MONITOR  
AND DISSASSEMBLER  
INCLUDED FREE

AS SEEN IN  
P.E. AUGUST, SEPTEMBER  
OCTOBER 1979

# COMPUKIT UK101

## LOW COST SUPERBOARD IN KIT FORM

The CompuKit UK101 has everything a one board 'superboard' should have.

- \* Uses ultra-powerful 6502 microprocessor.
- \* 50Hz Frame refresh for steady clear picture (U.S.A. products with 60Hz frame refresh always results in jittery displays)
- \* 48 chars by 16 lines — 1K memory mapped video system providing high speed access to screen display enabling animated games and graphs.
- \* Extensive 256 character set which includes full upper and lower case alphanumerics, Greek symbols for mathematical constants and numerous graphic characters enabling you to form almost any shape you desire anywhere on the screen.
- \* Video output and UHF Highgrade modulator (8Mz Bandwidth) which connects direct to the aerial socket of your T.V. Channel 36 UHF.
- \* Fully stabilised 5V power supply including transformer on board.
- \* Standard KANSAS city tape interface providing high reliability program storage — use on any standard domestic tape or cassette recorder.
- \* 4K user RAM expandable to 8K on board £49 extra.
- \* 40 line expansion interface socket on board for attachment of extender card containing 24K RAM and disk controller. (Ohio Scientific compatible).
- \* 6502 machine code accessible through powerful 2K machine code monitor on board.
- \* High quality thru plated P.C.B. with all I.C.'s mounted on sockets.
- \* Professional 52 Key keyboard in 3 colours — software polled meaning that all debouncing and key decoding done in software.

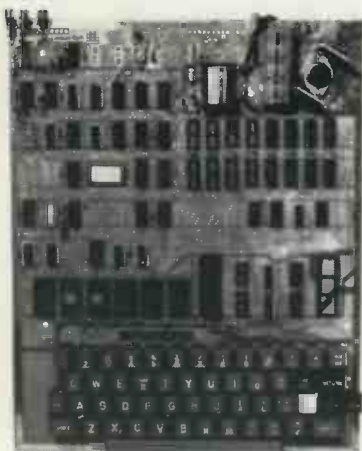

\*8K Microsoft Basic means conversion to and from Pet, Apple and Sorcerer easy. Many compatible programs already in print.

**SPECIAL CHARACTERS**  
@ Erases line being typed, then provides carriage return, line feed.  
Erases last character typed.  
CR Carriage Return — must be at the end of each line.  
: Separates statements on . line.  
CONTROLIC Execution or pri-ting of a list is interrupted at the end of a line:  
"BREAK IN LINE XXXX" Is printed, indicating line number of next statement to be executed or printed.  
CONTROLIO No outputs occur until return made to command mode. If an Input statement is encountered, either another CONTROLIO is typed, or an error occurs.  
? Equivalent to PRINT

Simple Soldering due to clear and concise instructions compiled by Dr. A.A. Berk, BSc.PhD

NO EXTRAS NEEDED JUST HIT 'RETURN' AND GO.

Build, understand, and program your own computer for only a small outlay.

KIT ONLY **£219** + VAT including RF Modulator & Power supply. Absolutely no extras.

Available ready assembled and tested, ready to go for **£269** + VAT

**COMMANDS**  
CONT LIST NEW NULL RUN  
**STATEMENTS**  
CLEAR DATA DEF DIM END FOR  
GOTO GOSUB IF.GOTO IF.THEN INPUT LET  
NEXT ON.GOTO ON.GOSUB POKE PRINT READ  
REM RESTORE RETURN STOP  
**EXPRESSIONS**  
**OPERATORS**  
+ \* / % NOT.AND.OR. > < <> >=< <=> RANGE 10<sup>-32</sup> to 10<sup>+32</sup>  
**VARIABLES**  
A,B,C,...Z and two letter variables  
The above can all be subscripted when used in an array. String variables use above names plus \$.e.g.A\$

**FUNCTIONS**  
ABS(X) ATN(X) COS(X) EXP(X)  
LOG(X) PEEK(I) POS(I) RND(X)  
SPC(I) SQR(X) TAB(I) TAN(X)  
FRE(X) INT(X)  
SGN(X) SIN(X)  
USR(I)  
**STRING FUNCTIONS**  
ASC(X\$) CHR\$(I) FRE(X\$) LEFT\$(X\$,I)  
RIGHT\$(X\$,I) STR\$(X)  
LEN(X\$) MID\$(X\$,I,J)  
VAL(X\$)

### EXTRAS AVAILABLE SOON

**COLOUR ADD-ON** enables you to choose your foreground and background colour anywhere on the screen. Flash any character on the screen at will. Full documentation and parts in kit form.

**AD-A-RAM EXTENDER CARD** provides up to 32K Dynamic RAM Expansion, 8 Eprom sockets for 2708's or 2716's. Parallel Port (centronics compatible) and an RS232C serial port.

## WIN YOURSELF AN ANADEX DP8000 LINE PRINTER

There's never enough good software around. That's why COMPUKIT LTD. are sponsoring a software contest. There are 2 categories:

- 1) Business and Education
- 2) Fun and Games

One lineprinter will be awarded to the winner of each category.

Send or bring along to the address shown below the following:

- 1) The program on cassette in the format used by the COMPUKIT UK101
- 2) Any documentation that you have for the program (source listing not necessary)
- 3) This coupon signed by you accepting the rules and conditions of the competition.

**RULES:**

- 1) Entries, including documentation, must be printed by computer or typed double spaced, with your name on every page.
- 2) Send or bring your entries to the address shown below.
- 3) Entries must be received by midnight on 29/2/80, any received after this time are void.

Winners will be notified by post before 31/3/80.

4) You warrant by your signature that all programs and documentation material included is entirely your own creation, and that no rights to it have been given or sold to any other party, and you agree to allow COMPUKIT LTD. to use, publish, distribute, modify, and edit it as it sees fit.

- 5) All entries become the property of COMPUKIT LTD. No entries will be returned nor any questions answered regarding individual entries.
- 6) Judging will be by a selected panel chosen by, and including representatives of COMPUKIT LTD. Judges may assign programs to any of the categories as they see fit. Decision of the judges is final.
- 7) Employees of COMPUKIT LTD, its dealers, distributors, advertising agencies and media are not eligible to enter.

Name \_\_\_\_\_

Address \_\_\_\_\_

I agree to abide by the above mentioned rules.

Signature \_\_\_\_\_

**COMP** COMPUTER COMPONENTS

14 STATION ROAD, NEW BARNET, HERTFORDSHIRE TEL: 01-441 2922 (Sales)  
CLOSE TO NEW BARNET BR STATION — MOORGATE LINE 01-449 6596  
OPEN — 10am to 7pm — Monday to Saturday TELEX: 298755



All Products Ex-Stock Please check availability

(Part of the Compshop Ltd. Group)

# The World's Most Powerful 8-bit Microcomputer



Two types of central processor are available for use in your system. The standard /09 has a maximum random access memory (RAM) capacity of fifty six thousand (56K) bytes. It can have as many as eight input/output (I/O) devices such as terminals, printers, etc. attached. This capacity is adequate for business systems requiring up to four terminals and two printers. If the application involves moving large amounts of data, or scientific and engineering calculations, our larger CPU should be used.

The S/09 CPU has a maximum RAM memory capacity of 384K bytes. It is normally supplied with 128K bytes of memory which can be expanded to 256K, or 384K by adding additional memory arrays. This CPU will support up to 16 I/O devices.

Both CPU's are designed around the Motorola MC6809 microprocessor. This is the most powerful eight-bit microprocessor available.

## Featuring the world's most powerful MPU—the Motorola MC-6809

The MC6809 has more addressing modes than any other 8-bit processor. It has powerful 16-bit instructions, and a highly efficient internal architecture with 16-bit data paths. It is easily the most powerful, most software efficient, and the fastest 8-bit general purpose microprocessor ever.

The greatest impact of the Motorola MC6809 undoubtedly will be software related. Ten powerful addressing modes with 24 indexing submodes, 16-bit instructions and the consistent instruction set stimulate the use of modern programming techniques, such as structured programming, position independent code, re-entrancy, recursion and multi-tasking.

C/09 CPU 56K **£1,050 + VAT**

CS/09 128K **£2,100 + VAT**

/09 board (will directly replace existing SWTPC processor board) **£195 + VAT**

## CT-82 Terminal



- ★ Software function controls
- ★ 56-key "Cherry" keyboard
- ★ 12 key numeric or cursor control pad
- ★ 128 control functions
- ★ Graphics capability
- ★ User programmable character sets
- ★ Software selectable Baud rates (50-38, 400)

**£595 + VAT**

Write or telephone for latest brochure including 16MB disc and new printer range.

# SWTPC

**Southwest Technical Products Co.**

# CW

**Computer Workshop**

38 DOVER STREET · LONDON · W1X 3RB · Telephone: 01-491 7507 · Telex: 268913