

50p

# Practical Computing

May 1979

An ECC Publication. Volume 2 Issue 5

**116 pages  
on what's  
happening in  
microcomputing**

**How to make  
your micro  
make music**

**Printers for  
under £1,000**

**Two Reviews:  
Exidy Sorcerer  
& Science of  
Cambridge MK14**

**Plus: Books,  
games, education  
and business  
applications**





***“...the trouble with off-the-shelf microcomputer systems is you have to have an off-the-shelf application.”***

The Arrows Formula One racing team couldn't get a ready-made microcomputer system for their application so they came to Scicon. They wanted a device that would monitor certain critical parameters on their racing car hurtling round the track at nearly 200 mph.

We designed and built them their system the complete system, both hardware and software which they are now using during practice at every Grand Prix.

So, if you can't get a micro system off-the-shelf for your application, whether its for a data logging role like the Arrows' system or for process control or data communications... remember Scicon.

Scicon Consultancy  
International Ltd.  
Sanderson House  
49-57 Berners Street  
London W1P 4AQ  
Telephone 01-580 5599

You could be eligible  
for a £2000 DoI grant.

**SCICON  
MICRO  
SYSTEMS**



Managing Editor  
Dennis Jarrett

Features Editor  
Robert Walczy

Computabits Editor  
Nick Hampshire

Staff Writer  
Kay Floyd

Production Editor  
Harold Mayes

Advertisement Manager  
Erica Gibson

Advertisement  
Department  
Tom Moloney  
Tina Roberts

Subscription Manager  
Annabel Hunt

Publisher  
Wim Hoeksma

Company Secretary  
Carole Fancourt

Managing Director  
Richard Hease

Editorial: 01-278 3111  
Advertising: 01-278 3143

Production  
and Subscriptions: 01-278 9517

Practical Computing is published by ECC as a subsidiary of WHICH COMPUTER? Ltd at its registered office, 2 Duncan Terrace, London, N1, and printed by Bournehall Press Ltd, Welwyn Garden City. Distributed to newsagents by Moore Harness Ltd, 31 Corsica Street, London N5 and to specialist shops by Practical Computing Ltd.

Subscription rates: Single copy: 50p. Subscriptions: U.K., £6 per annum (including postage); overseas, £12 (including airmail postage)

©Practical Computing 1979  
ISSN 0141-5433.

Every effort has been made to ensure accuracy of articles and program listing. Practical Computing cannot, however, accept any responsibility whatsoever for any errors.

## MAKING MUSIC WITH MICROS

How to make your micro play your tune .....46

## PRINTERS FOR LESS THAN £1,000

Guide to low-cost printers, comparing prices and capabilities .....51

## REVIEW I—EXIDY SORCERER

Our full review of the microcomputer system ideal for many applications .....43

## REVIEW II—SCIENCE OF CAMBRIDGE MK 14

Full review of this very low-priced micro .....40

## BUSINESS APPLICATION SYSTEMS

Order processing and invoicing. Our series on ready-made computer systems for small businesses continues with a review of more application packages .....85

## PROGRAM OF THE YEAR AWARD

Practical Computing is looking for the 1979 programs of the year in a number of categories, with cash prizes for the winners .....81

## APPLE II DESIGN STORY

We conclude the revealing interview with Steve Wozniak, the man who invented and built the Apple II computer .....66

## EDUCATION—AND THE MICROPROCESSOR

Dr Bob Cook of Sheffield's Newfield School examines the role of micros in education .....83

## SLALOM GAME—COMPLETE PROGRAM

Another great game for you to play on your system .....88

## RETIRE WITH YOUR COMPUTER

How the microcomputer can help you to retire gracefully .....86

## PROJECT

Computabits tells you how to control stepping motors with Kim-1 .....91

## BUYERS' GUIDE

Our monthly guide to the microcomputers available is more complete than ever, in an improved format. ....105

## ALL THIS AND MORE

FEEDBACK .....29	BOOK REVIEWS .....76
Your letters and our replies	Read all about what to read
PRINTOUT .....35	COMPETITION RESULTS .....78
All the news and the views	All the winners
PET CORNER .....55	CASSETTE SOFTWARE REVIEW .....89
Tips and ideas for the Pet	DIARY .....102
TANDY FORUM .....61	All the latest events
What you can do with Tandy	GLOSSARY .....111
SHOPPING IN SWANSEA .....62	What the words mean
APPLE PIE .....65	ADVERTISMENT INDEX .....112
Now Apple users have their regular page	
ILLUSTRATING BASIC .....69	
Teach yourself programming continued	

JUNE ISSUE ON SALE MAY 16—ORDER NOW

# THE EXPANDABLE GENERAL-PURPOSE MICROCOMPUTER



## THE RESEARCH MACHINES 380Z A UNIQUE TOOL FOR RESEARCH AND EDUCATION

Microcomputers are extremely good value. The outright purchase price of a 380Z installation with dual mini floppy disk drives, digital I/O and a real-time clock, is about the same as the annual maintenance cost of a typical laboratory minicomputer. It is worth thinking about!

The RESEARCH MACHINES 380Z is an excellent microcomputer for on-line data logging and control. In university departments in general, it is also a very attractive alternative to a central mainframe. Having your own 380Z means an end to fighting the central operating system, immediate feedback of program bugs, no more queueing and a virtually unlimited computing budget. You can program in interactive BASIC or run very large programs using our unique Text Editor with a 380Z FORTRAN Compiler. If you already have a minicomputer, you can use your 380Z with a floppy disk system for data capture.

What about Schools and Colleges? You can purchase a 380Z for your Computer Science or Computer Studies department at about the same cost as a terminal. A 380Z has a performance equal to many minicomputers and is ideal for teaching BASIC and Cesium. For A Level machine language instruction, the 380Z has the best software front panel of any computer. This enables a teacher to single-step through programs and observe the effects on registers and memory, using a single keystroke.

### WHAT OTHER FEATURES SET THE 380Z APART?

The 380Z with its professional keyboard is robust, hardwearing equipment that will endure continual handling for years. It has an integral VDU interface—just plug a black and white television into the system in order to provide a display unit—you do not need to buy a separate terminal. The integral VDU interface gives you upper and lower case characters and low resolution graphics. Text and graphics can be mixed *anywhere* on the screen. The 380Z also has an integral cassette interface, software and hardware, which uses *named* cassette

files for both program and data storage. This means that it is easy to store more than one program per cassette.

Owners of a 380Z microcomputer can upgrade their system to include floppy (standard or mini) disk storage and take full advantage of a unique occurrence in the history of computing—the CP/MTM\* industry standard disk operating system. The 380Z uses an 8080 family microprocessor—the Z80—and this has enabled us to use CP/M. This means that the 380Z user has access to a growing body of CP/M base-software, supplied from many independent sources.

380Z mini floppy disk systems are available with the drives mounted in the computer case itself, presenting a compact and tidy installation. The FDS-2 standard floppy disk system uses double-sided disk drives, providing 1 Megabyte of on-line storage.

Versions of BASIC are available with the 380Z which automatically provide controlled cassette data files, allow programs to be loaded from paper tape, mark sense card readers or from a mainframe. A disk BASIC is also available with serial and random access to disk files. Most BASICs are available in erasable ROM which will allow for periodic updating.

If you already have a teletype, the 380Z can use this for hard copy or for paper tape input. Alternatively, you can purchase a low cost 380Z compatible printer for under £300, or choose from a range of higher performance printers.

\*CP/MTM Registered trademark Digital Research.

**380Z/16K System with Keyboard £965.00**

**380Z/56K complete with DUAL FULL FLOPPY DISK SYSTEM FDS-2 £3,266.00**

380Z Computer Systems are distributed by RESEARCH MACHINES, P.O. Box 75, Chapel Street, Oxford. Telephone: OXFORD (0865) 49792. Please send for the 380Z information Leaflet. Prices do not include VAT @ 8% or Carriage



We've come a long way since the quill pen ....  
microcomputers are now taking the drudgery  
out of office life ....

providing safe and constant control of  
industrial processes ....

helping further our knowledge by monitoring  
scientific experiments and .... well you may  
have yet another application.



Comart specialise in microcomputers —  
from single-card computers to multiuser systems.  
Analogue interfaces, floppy discs, digital, VDU  
and printer interfaces are all in our range.  
Software from Assembler, Basic, Fortran, Cobol  
to Word Processing and Data Base Management.

**Why not discover the Comart Catalogue of Computers — NOW**

Contact us at :-

**COMART LTD., P.O. Box 2, St. Neots,  
Cambridgeshire. PE19 4NY.**

**Tel: Huntingdon (0480) 215005.**

**Telex: 32514.**

Comart Computers are also available from regional dealers :-

Microcomputermart Ltd., Manchester. Tel: 061 832 2269	The Byte Shop, Ilford, Essex. Tel: 01 554 2177
Cambridge Computer Store, Cambridge. Tel: 0223 68155	Xitan Systems Ltd., Southampton. Tel: 0703 38740
New Bear Computing Store, Newbury, Berks. Tel: 0635 49223	Holdene Ltd., Leeds. Tel: 0532 459459
Isherwoods (Personal Computer Systems) Ltd., Luton, Beds. Tel: 0582 424851	

# PETALECT ELECTRONIC SERVICES LTD

## PET 2001/8 Microcomputer

WHY BUY A MICROCOMPUTER FROM US?

BECAUSE:

1. Established company trading since 1971
2. Electronic servicing is our speciality
3. We have in-house programmers/systems analysts
4. We have our own service engineers
5. We will demonstrate the PET at your premises
6. We can customise the PET to your requirements
7. We can arrange finance
8. We offer, after the three-month warranty, an annual service contract from £69.50
9. You benefit from our experience of having sold over 150 Microcomputers to industrial, educational and business, personal users.

VISIT OUR SHOWROOM AT:

34 Chertsey Road, Woking, Surrey.

We supply the full range of C.B.M. PET Microcomputers. We also supply:

Dual Floppy Disks	£820
24K Memory Boards	£320
All types of Printers	from £450

All types of Printer Interfaces; Electronic balance Interfaces; Programs from C.B.M., Petsoft, Gemsoft.  
We also offer a full consultancy and programming service.  
We are developing a number of our own business packages for all applications. Books on Basic, Programming, Interfacing etc.  
Full range of KIMs available  
Tandy & ITT 2020 available  
Maintenance, Hire purchase facilities, as well as ACCESS and BARCLAYCARD, available.

**Factory:** Telephone: Woking 69032/68497/20727

**Shop:** Telephone: Woking 23637

● Circle No. 104



## THERE'S MORE TO LUTON THAN CAMPARI AND THE AIRPORT

There's the Commodore PET, the APPLE II, the North Star Horizon, Processor Technology's Sol, Cromemco's Z2, Z2D and System 3. Together with disc drives and terminals and printers and VDUs and all manner of accessories and books and magazines. Almost everything the Personal Computer lover could wish for. So put away the holiday brochures and come along to—

**i**sher-woods

PERSONAL COMPUTER SYSTEMS

110 Legrave Road - Luton - Tel (0582) 424851 - Just off the M1.

With acknowledgements to David Campari and Luton Airport.

● Circle No. 105

PRACTICAL COMPUTING May 1979

# Britain is a nation of PET lovers

THE No. 1  
Personal  
Computer  
in the  
U.K.

Hobbyist  
Commercial  
Scientist  
Education

NOW FROM  
**£450**  
plus V.A.T.  
(4K model)

for the first time  
user and the professional  
check out the PET, the world's  
most popular personal computer

- \* **AVAILABLE** in either 4K, 8K, 16K\* or 32K\* RAM.  
(\*with large typewriter style keyboards.)
- \* **CAPABLE** - just like a traditional computer.
- \* **UNDERSTANDABLE** - fast, comprehensive and powerful - BASIC is one of the easiest computer languages to learn, understand and use. Machine language accessibility for the professionals.
- \* **PERSONAL** - easily portable and operated - just "plug in" and go. Unique graphics make fascinating displays.
- \* **EXPANDABLE** - built in IEEE-488 output, 8K RAM expandable to 32K, parallel user port 2nd. Cassette interface.
- \* **SERVICEABLE** - easily serviced - only 3p.c. boards all readily accessible.

Commodore PRINTERS and DUAL DRIVE FLOPPY DISCS now available.

Contact your local dealer for a demonstration, also for memory expansion and peripheral details, also list of readily available software.



AUTHORISED COMMODORE  
PET DEALERS

**Birmingham**  
Taylor Wilson Systems Ltd  
Knowle (05645) 6192

**Bolton**  
B & B Consultants  
0204-386485

**Bristol**  
Sumlock Tabdown Ltd  
0272-26685

**Cardiff**  
Sigma Systems Ltd.  
0222-21515

**Derby**  
Davidson-Richards (Int) Ltd  
0332-366803

**Durham**  
Dyson Instruments  
0385-66937

**Grimsby**  
Allen Computers  
0472-40568

**Guildford**  
P.P.M.  
0483-37337

**Hemel Hempstead**  
Data Efficiency Ltd  
0442-57137

**Liverpool**  
Dams Office Equipment Ltd  
051-227-3301

**London W.C.2**  
TLC World Trading Ltd  
01-839-3893

**London EC1**  
Sumlock Bondain Ltd  
01-253-2447

**Manchester**  
Cytek (UK) Ltd  
061-832-7604

Sumlock Electronic Svcs.  
061-228-3507

**Morley (W. Yorks)**  
Yorkshire Electronic Svcs.  
0532-522181

**Newport**  
G.R. Electronics Ltd  
0633-67426

**Northern Ireland**  
Medical & Scientific  
08462-77533

**Nottingham**  
Betos (Systems) Ltd  
0602-48108

**Reading**  
C.S.E. (Computers)  
0734-61492

**Southampton**  
Symtec Systems Ltd  
0703-37731

Business Electronics  
0703-738248

**Swansea**  
Radio Supplies (Swansea)  
0792-24140

**Thame, Oxon**  
Memec Systems Ltd  
084-421-3149

**Woking**  
Petalect Ltd  
048-62-69032

**Yeovil**  
Computerbits Ltd  
0935-26522

In case of difficulty call **COMMODORE SYSTEMS DIVISION**  
360 Euston Road, London. Tel. 01-388-5702



# EQUINOX 300

A powerful multi-user  
multi-tasking  
multi-language

16-bit microcomputer time-sharing system

- supporting
- BASIC
- LISP
- PASCAL
- Floppy discs
- Hard discs

including a powerful Text Formatter,  
Assembly Language Development System  
and disc-based Sort utilities.

Priced from **under £5,000**

Write or phone for further information.

## EQUINOX COMPUTER SYSTEMS LTD

"Kleeman House" 16 Anning Street,  
New Inn Yard, London EC2A 3HB.  
Tel: 01-739 2387/9. 01-729 4460.

● Circle No. 107

# SLAVE MARKET

GET YOUR

# PET A SLAVE

Slave Printers from **£546**

## Rubide Ltd

2a Southend Road  
Beckenham Kent

01-658 5906

● Circle No. 108

# DE BOER

## ELECTRONIC PROJECT CONSTRUCTION KITS

We can supply kits for a large range of electronic construction projects. These include Audio, Games, Computers and Test Equipment. All our kits include circuit boards, components and full instructions.

**Lab Power Supply** £33.45

2.5 Amp, 5-20 Volts, short circuit protection.

**Universal Digital Meter** £17.75

Digital Replacement for pointer instruments.

**1/2 GHz Frequency Counter** £104.50

Frequency counter with programmable offset facility.

**Function Generator** £29.75

Sine, Square and Sawtooth outputs.

**3 1/2 Digit DVM** £24.00

Display auto zero facility.

**TV Scope** £34.48

Converts your television to give an oscilloscope display.

For further information please send SAE.

Please make cheques payable to de Boer Elektronika.

All prices include VAT; please add 50p for P & P.

ORDER FROM: de Boer Elektronika, 2 Lynn Road,  
Grimston, Kings Lynn, Norfolk, PE32 1AD.

Telephone: 04856-553



**de boer  
elektronika**

Kleine Berg 39-41 Eindhoven  
Nederland. tel 040-448229

● Circle No. 109

# AIM 65

**£249.50** + VAT

### FEATURES INCLUDE:

- 20 COLUMN PRINTOUT
- 20 CHARACTER ALPHANUMERIC DISPLAY
- FULL 54 KEY TERMINAL-STYLE KEYBOARD
- TTY INTERFACE
- TWIN CASSETTE INTERFACE
- RAM — 1K TO 4K OPTIONS

### OPTIONS INCLUDE:

- 8K BASIC INTERPRETER ROM
- 4K ASSEMBLER/EDITOR ROM

AIM 65 comes to you fully built and tested with a full alphanumeric keyboard, 20 character display and a 20 column printer — for keeping a permanent record of all your work. Available in 1K- and 4K-byte RAM versions, AIM 65 is designed around the 6502 CPU, which has 64K address capability with 13 addressing modes. This is the microprocessor at the heart of many other, more costly, systems such as PET and APPLE. AIM 65 has a 4K ROM-resident monitor program for all peripheral control and user programming functions. Spare sockets are included for expanding on-board program memory via user PROM-based programs and/or Rockwell assembler, text editor and BASIC interpreter plug-in options. AIM 65 has a connector for external access to system bus for memory and I/O expansion, a separate connector

for interfacing a teletype and two cassette recorders. There is a user-dedicated Versatile Interface Adaptor, featuring three 8-bit, bidirectional ports (two parallel, one serial) and two 16-bit interval timer/event counters — thus allowing the user to interface his own system, without extra interface devices in many cases. AIM 65 is probably the most effective, low-cost microcomputer development system available — an invaluable educational aid to first time users and an ideal general purpose micro-computer for the engineer. AIM 65 is available in the UK only from PELCO ELECTRONICS LTD at £249.50 + VAT, complete with User's Manual and Schematic, R6500 Programming and Hardware Manuals and a handy pocket reference card.



## Pelco (Electronics) Ltd

Enterprise House,  
83-85 Western Road, Hove, Sussex BN3 1JB  
Telephone: Brighton (0273) 722155

Buy it with your Access or Barclaycard.

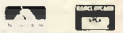

● Circle No. 110



# THE BRITISH MICRO



## RAIR BLACK BOX MICROCOMPUTER

- High speed 8085 microprocessor
- Priority interrupts and DMA
- 64K bytes of RAM memory
- Transparent ROM bootstrap loader
- Integral dual minifloppy disks
- Programmable serial I/O interfaces
- Comprehensive range of peripherals
- UK wide on-site maintenance
- Advanced floppy disk operating system
- Serial and random file processing
- Macro assembler with symbolic debugging
- Extended BASIC interpreter
- Relocating FORTRAN IV compiler
- ANS 74 COBOL compiler
- Quantity and OEM discounts
- Leasing and rental facilities

RAIR RAIR RAIR RAIR RAIR RAIR

30-32 NEAL STREET COVENT GARDEN LONDON WC2H 9PS TELEPHONE 01-836 4663

● Circle No. 111



Introducing the personal  
computer you've waited for.

The Exidy Sorcerer.

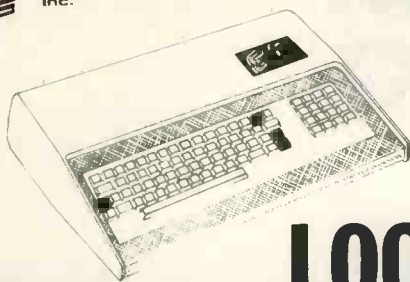

**LOOK AT THESE FEATURES**

16K £760

32K £859

add 8%  
VAT

- \* WORD PROCESSING, COBAL, FORTRAN etc
- \* PLUG IN ROM CARTRIDGES
- \* WORKS WITH NORMAL TV
- \* S100 EXPANSION UNIT
- \* CASSETTE INTERFACE
- \* Z80 CPU
- \* 32K RAM ON BOARD
- \* A REAL BUSINESS MACHINE

The Sorcerer Computer is a completely assembled and tested computer system ready to plug in and use. The standard configuration includes 63 key typewriter-style keyboard and 16 key numeric pad dual cassette I/O, with remote computer control at 300 and 1200 baud data rates, RS232 serial I/O for communication, parallel port for direct Centronics printer attachment, Z80 processor, 4K ROM operating system, 8K Microsoft BASIC in separate plug-in Rom Pac™ cartridge, composite video of 64 chars - 30 lines, 128 upper/lower case ASCII character set and a 128 user-defined graphic symbols, up to 32K on-board RAM memory, operators manual, BASIC programming manual and cassette/video cables, connection for S100 bus expansion unit giving access to the spectrum of exciting and useful peripheral devices, such as Floppy disk drives, voice recognition/synthesis battery back-up board in case of power failure, additional memory boards, E-PROM cards give you the facility to program and re-program your own ROM memories etc. etc. This is the most useable and flexible system that's now available to the home and business user at such a low price.

please make cheques and postal orders payable to JADE  
phone your order quoting ACCESS or VISA number  
for technical information or advice phone 0736 66565

Supplied by - Factor One Computers

**JADE**

17 Market Place, Penzance, Cornwall.

● Circle No. 112

## MINE OF INFORMATION LTD

1 FRANCIS AVENUE, ST. ALBANS AL3 6BL TELEPHONE 0727 52801

TELEX 925 859 ELWOOD G ENGLAND

Write or telephone or telex for the latest MoI catalogue of British and American books

## MICROCOMPUTER BOOKS

Selected for relevance, accuracy and value for money in conjunction with our very own

## MICROCOMPUTER CONSULTANCY

Authorised for **MAPCON** scheme  
Category A: Study reports and/or software

TELEX 925 859 ELWOOD G ENGLAND

## MINE OF INFORMATION LTD

1 FRANCIS AVENUE, ST. ALBANS AL3 6BL TELEPHONE 0727 52801

● Circle No. 113

## MICRO TRADE-IN

### Does Your Micro Meet Your Needs?

If it does not or you simply want to change it, drop us a line.

We buy or allow trade-in on good factory-built microcomputers.

Write to:

**Micro Trade-in,  
FREEPOST,  
WELWYN GARDEN CITY,  
HERTS.**

32K Systems; 140-200Kb Disc £1,970

Apple/ITT 2020; Exidy Sorcerer; PET 2001, SEED System One.

64K System with VDU, fully keyboard 16 special functions, numeric keypad 350Kb Disc £3,500; 700Kb Disc £3,850.

64K System:  
1.2 megabyte Disc, 4-partition multi-tasking BASIC (no VDU) £4,950

also available from: COMPLETE COMPUTER SYSTEMS, 22 Westside, 68 Fortis Green, London N2

● Circle No. 114

PRACTICAL COMPUTING May 1979



The exciting new  
**TRITON**  
Personal Computer  
exclusively from:

# TRANSAM



**Complete kit of parts available only £286 (+ VAT)**

**Basic in Rom:** a powerful 2k Tiny basic resident on board, makes Triton unique, easy to use and versatile.

**Graphics:** 64 Graphic characters as well as full alpha numerics.

**Single Board:** Holds up to 8k of memory, 4k RAM and 4k ROM, supplied with 3k ROM and 2k RAM.

**Memory Mapping:** 2 mode VDU I/O or memory mapped for animated graphics.

**Cassette Interface:** crystal controlled Modern tape I/O with auto start/stop + "named" file search.

**UHF TV Interface:** On board uhf modulator, plugs into TV aerial socket.

**Comes Complete** with KEYBOARD, CASE, POWER SUPPLY, THRO-HOLE PLATED QUALITY P.C.B. FULL DOCUMENTATION POWERFUL 1k MONITOR & 2k TINY BASIC PLUS ALL COMPONENTS INCL. IC SOCKETS. NOTE TV SET & CASSETTE NOT INCLUDED.

**Expansion:** Expand your Triton simply and easily with our new 8-slot motherboard complete with its own P.S.U. takes 8 plug-in Euro cards. Plug-in 8k RAM card now available.

**All components can be bought separately and eleven packs can be purchased on an easy-to-buy scheme. See catalogue. The P.C.B. alone is £50 + VAT plus £1 for packing and postage.**

**VAT rate is 8% on all kit components.**

## TRANSAM

**TRANSAM COMPONENTS LTD.**  
12 CHAPEL STREET, LONDON, NW1  
TEL: 402 8137

Next to Edgware Road Tube Station (Met. Line)  
Triton Computer is the Trade Mark of  
TRANSAM COMPONENTS LTD.

## EXPANSION MOTHERBOARD Kit £50 8K STATIC RAM CARD Kit . . . . £97

Full details available in our brand new 1979 computer products catalogue, so order your copy right now!

I am interested in the Triton

Name \_\_\_\_\_

Address (please print) \_\_\_\_\_

\_\_\_\_\_

\_\_\_\_\_

\_\_\_\_\_

\_\_\_\_\_

\_\_\_\_\_

To: TRANSAM COMPONENTS LTD., 12 CHAPEL STREET, NW1  
Please send me the following

1 A copy of your latest catalogue I enclose 30p + S.A.E. 9 x 7

2 A copy of the Triton Manual I enclose £5 + 70p P & P



3 A complete kit of parts for Triton Computer, £286 + VAT + £4 P & P

4 A Printed Circuit Board £50 + VAT & £1 P & P

TOTAL ENCLOSED £. . . . .

Cheque, Money Order, etc.

BARCLAYCARD, ACCESS, VISA & MASTER CHARGE ARE WELCOME. SEND YOUR CARD NUMBER WITH ORDER

## Keen Computers Ltd,

We are looking for dealers to retail our Microcomputer-based business systems.

Ideally you will already be established in the microcomputer trade or be supplying business equipment.

Interested?

Please contact:

DR. T. KEEN.

Keen Computers Limited  
5 The Poultry, NOTTINGHAM.

Telephone: (0602) 583254.

● Circle No. 116

## £1 a day keeps your Apple in play

**16K Apple II . . . £985, or £26.98 for 60 months under our lease/purchase facilities.**

Full range of commercial applications includes:

- Stock control
- Order processing
- Integrated accounting
- Incomplete record accounting
- Rental control
- Management reporting

Apple II's are affordable.

**PADMEDE** makes them useable.

### PADMEDE COMPUTER SERVICES

The Tuns, High Street, Odiham,  
Nr Basingstoke, Hants.  
Tel: Odiham (025-671) 2434

● Circle No. 117

## computer centre

	Kit	Ass.
8K bytes ECONORAM II (450 n.s.)	£79	£94
8K bytes SSM 250 (250 n.s.)	£95	£129
16K bytes ECONORAM IV	£175	£199
8080A CPU with vector interrupt	£69	£104
SBC 100 Z80A, serial + parallel, ROM/RAM	£155	£224
I04 2 Serial/Parallel	£89	£124
VBI-B VIDEO	£79	£104
MOTHERBOARD MT3 11-Slot Board		£19
PIS 100 Edge Connectors	—	£3.50
S100 Prototype Board	—	£19
TARBELL Disc Controller	£125	£160
VERSAFLOPPY Disc Controller	£99	—
SA400 MINIFLOPPY Disc Drive	—	£190
DRI 7100 8in. Disc Drive	—	£295
DRI 7200 8 in double-sided Disc Drive	—	£355
Z80 Starter kit	£155	—

Ring 02514 29607 for full catalogue.

Mail Order Address: 20 Durnsford Avenue,  
Fleet, Hants, GU13 9TB.

## THE DISCOUNT MICRO STORE

### S100 Hardware CP/M Software

#### Computer Centre Mini Disc Kit £786

S100, Z80 micro, 16K bytes memory, MINIFLOPPY drive, programmable baud rate serial I/O, parallel, PROM monitor and boot, CP/M operating system, cables, connectors, 10 manuals.  
Add your power supply and terminal.

#### Computer Centre Maxi Disc Kit £886

As Mini Disc Kit above but with DRI 7100 8 inch Disc Drive.

CP/M Disc Operating System  
+BASIC-E and seven manuals £64  
CP/M U.S. User Group library FREE with  
(8in. floppy disc, 33 volumes) media £4.50 ea.

Also available for CP/M: Microsoft BASIC, FORTRAN and COBOL

All items currently in stock.  
Add 2% postage (min. 25p), Add 8% VAT.

● Circle No. 118



**ORDER BY POST  
FROM THE WIDEST  
RANGE OF  
MICRO-COMPUTERS  
IN BRITAIN...  
OR VISIT OUR  
STORES**

# the BYTE SHOP Ltd

**A WIDE VARIETY OF  
SYSTEMS AND BOOKS  
AVAILABLE  
'OFF THE SHELF'**

## SOUTHWEST TECHNICAL PRODUCTS — FOR 6800 USERS

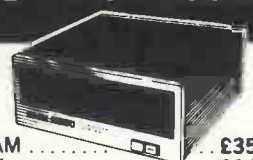

- MP-68CPU, 4K RAM ..... £355
- 8K additional RAM ..... £140
- 560KB twin disk system ..... £1,400
- 160KB twin mini floppy system ..... £860
- CT-64 V.D.U. upper/lower case, monitor ..... £455
- PR-40 40-column printer ..... £250
- Cassette interface ..... £100
- GT-61 Graphics Board ..... £105

A favourite with schools and colleges — low priced system that can grow.

Attractive low-priced software!

## FOR THE PROFESSIONAL — CROMEMCO



- Z-2 system: fully assembled ..... £575
- Z-2 system: Kit ..... £395
- Disk system from ..... £1,425
- CS-3 System 3, 32K, dual disk, expandable ..... £4,175
- 4 MHz Single card computer ..... £345
- Bytesaver board with PROM Programmer ..... £135
- 16K PROM card ..... £135
- Analogue Interface ..... £135
- Disk — BASIC, FORTRAN, ASSEMBLER, COBOL, etc. etc. each — ..... £85

A rugged well-engineered system designed for hard use. Expandable to 512K, 21 Boards. Excellent software support CP/M AVAILABLE

## OHIO SCIENTIFICS



- Challenger IP ..... £395
- C2-4P ..... £585
- C2-P 20K + 5" disk ..... £1,560
- C3-SI 32K + two 8" disks ..... £3,250
- C3-A 48K + two 8" disks ..... £5,850
- C3-B 48K + 74 M-byte hard disk ..... £12,350
- Dual-sided disk enhancement ..... £682.50

Ohio Scientifics

## Super board II

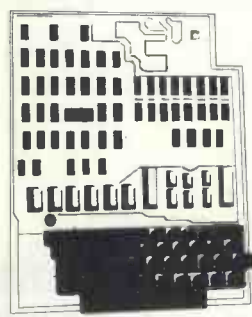

**4K user RAM  
Full 8K basic  
Built and tested**

**£263.84**

## COMMODORE SYSTEMS

PET 2001 -8 ..... £550

PET MKII — Full Keyboard Plus Basic ..... £675

Pet Cassette Deck ..... £55

PET Disk Drives ..... £740

PET Printer ..... £550

Software from ..... £3.00

Kim-1 ..... £99.95



## NORTH STAR COMPUTER PRODUCTS



NEW HORIZON-I dual density ..... £1330

Additional mini floppy ..... £325

Additional 16K static memory 4MHZ ..... £315

Printer interface ..... £70

Extended BASIC and DOS included in above

Double Density Disks now available separately CP/M Horizon ..... £130

## NEW SYSTEMS

ITT 2020 EX STOCK

- 16K RAM integer basic ..... £950
- 32K RAM integer basic ..... £1114
- 48K RAM integer basic ..... £1278
- DISK II floppy subsystem ..... £425
- EXIDY SOCERER 32K ..... £850
- \$100 expansion unit ..... £275
- Disk Drive & Control Card ..... £699

- Nascom-1 kit ..... £165.00
- Buffer board ..... £32.50
- 32k RAM ..... £200.00
- 16k RAM ..... £140.00
- 8k RAM ..... £85.00
- P.S. Unit ..... £24.50

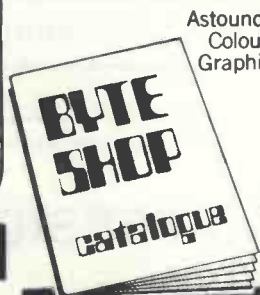

Astounding Colour Graphics

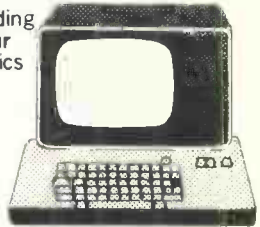

AN AMAZING SYSTEM BUT A COMPUTER IN ITS OWN RIGHT! DISK DRIVE BUILT IN!

## MAIL ORDER

Please send me .....

(if preferred, attach order on separate sheet to coupon)

Name .....

Address .....

- I enclose cheque for £ .....
- Please debit my Diners Club/ American Express/Access/Barclaycard Account no. ....

Please add 8% VAT to all items except books

The Byte Shop Ltd  
426-428 Cranbrook Road, Gants Hill,  
Ilford Essex. Tel: (01) 554 2177

All prices correct at time of going to Press PC

VISIT US AT: LONDON — 48 TOTTENHAM COURT ROAD. (01) 636 0647  
BIRMINGHAM — 94-96 HURST ST., BIRMINGHAM NOTTINGHAM — 92A UPPER  
PARLIAMENT ST. 0602-40576 OPENING SHORTLY AT: LEEDS, MANCHESTER, GLASGOW.

● Circle No. 119

# MATROX FROM SHELTON

## TV GRAPHIC AND ALPHANUMERIC VIDEO RAMS

Intel SBC-80, LSI-11, S100 and general purpose cards, modules and LSI ICS. Some can be operated together for colour or TV picture + Alphanumerics or graphics + alphanumerics.

Eg:	£ 1-off
MTX 1632 16 rows 32 chars module	£162.00
ALT 250 x 256 graphics (S100)	£284.00
MSBC—2480 SBC—80 24 row 80 char	£356.00
MDC—512 (PDP-11) 512 x 512 graphics	£995.00
MTX—A1 uPC controller—KBD + LEDs	£ 28.00

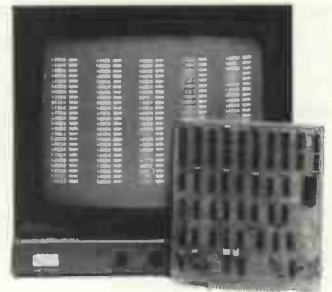

**SHELTON INSTRUMENTS LTD.,**  
22/24 Copenhagen Street, London N1 0JD Tel: 01-278 6273

● Circle No. 120

## PROFESSIONAL BUSINESS PACKAGES PERSONAL COMPUTERS FOR BUSINESS

Realistic applications software available now with microcomputers, including the new ITT 2020 (a development from the Apple which has improved memory organization and UHF modulator for TV monitor), Apple II and DTC Microfiles.

**\* SALES \* PURCHASES \* GENERAL LEDGER \***

Also for early release, PAYROLL, INVENTORY and POINT OF SALE. These systems operate in a real time environment, provide on demand transaction processing, analysis, aged debtors, minimal disk storage requirements, formatted screens, configuration adjustment by user for multi-disk and multi-volume files, validated input and comprehensive operating instructions **Dealer enquiries are welcome.**

### COMPUTECH

SYSTEMS

168 FINCHLEY ROAD, LONDON NW3 TEL: 01-794 0202

● Circle No. 121

PRACTICAL COMPUTING May 1979



DIODES/ZENERS			
QTY.			
1N914	100v	10mA	.05
1N4005	600v	1A	.08
1N4007	1000v	1A	.15
1N4148	75v	10mA	.05
1N4733	5.1v	1 W Zener	.25
1N753A	6.2v	500 mW Zener	.25
1N758A	10v	"	.25
1N759A	12v	"	.25
1N5243	13v	"	.25
1N5244B	14v	"	.25
1N5245B	15v	"	.25

SOCKETS/BRIDGES			
QTY.			
8-pin	pcb	.20	ww .35
14-pin	pcb	.20	ww .40
16-pin	pcb	.20	ww .40
18-pin	pcb	.25	ww .95
20-pin	pcb	.35	ww .95
22-pin	pcb	.35	ww .95
24-pin	pcb	.35	ww .95
28-pin	pcb	.45	ww 1.25
40-pin	pcb	.50	ww 1.25
Molex pins	.01	To-3 Sockets	.25
2 Amp Bridge		100-prv	.95
25 Amp Bridge		200-prv	1.50

TRANSISTORS, LEDS, etc.			
QTY.			
2N2222	(2N2222 Plastic .10)		.15
2N2222A			.19
2N2907A	PNP		.19
2N3906	PNP (Plastic Unmarked)		.10
2N3904	NPN (Plastic Unmarked)		.10
2N3054	NPN		.45
2N3055	NPN 15A 60v		.60
T1P125	PNP Darlington		1.95
LED Green,	Red, Clear, Yellow		1.15
D.L.747	7 seg 5/8" High com-anode		1.95
MAN72	7 seg com-anode (Red)		1.25
MAN3610	7 seg com-anode (Orange)		1.25
MAN82A	7 seg com-anode (Yellow)		1.25
MAN74	7 seg com-cathode (Red)		1.50
FND359	7 seg com-cathode (Red)		1.25

9000 SERIES			
QTY.		QTY.	
9301	.85	9322	.65
9309	.35	9601	.20
9316	1.10	9602	.45

MICRO'S, RAMS, CPU'S, E-PROMS			
QTY.		QTY.	
8T13	1.50	2107B-4	4.95
8T23	1.50	2114	9.50
8T24	2.00	2513	6.25
8T97	1.00	2708	10.50
74S188	3.00	2716 D.S.	34.00
1488	1.25	2716 (5v)	59.00
1489	1.25	2758 (5v)	23.95
1702A	4.50	3242	10.50
AM 9050	4.00	4116	11.50
		6800	13.95
MM 5314	3.00	6850	7.95
MM 5316	3.50	8080	7.50
MM 5387	3.50	8212	2.75
MM 5369	2.95	8214	4.95
TR 1602B	3.95	8216	3.50
UPD 414	4.95	8224	3.25
Z 80 A	22.50	8228	6.00
Z 80	17.50	8251	7.50
Z 80 PIO	10.50	8253	18.50
2102	1.45	8255	8.50
2102L	1.75	TMS 4044	9.95

C MOS	
QTY.	
4000	.15
4001	.15
4002	.20
4004	3.95
4006	.95
4007	.20
4008	.75
4009	.35
4010	.35
4011	.20
4012	.20
4013	.40
4014	.75
4015	.75
4016	.35
4017	.75
4018	.75
4019	.35
4020	.85
4021	.75
4022	.75
4023	.20
4024	.75
4025	.20
4026	1.95
4027	.35
4028	.75
4029	1.15
4030	.30
4033	1.50
4034	2.45
4035	.75
4037	1.80
4040	.75
4041	.69
4042	.65
4043	.50
4044	.65
4046	1.25
4048	.95
4049	.45
4050	.45
4052	.75
4053	.75
4066	.55
4069/74C04	.35
4071	.25
4081	.30
4082	.30
4507	.95
4511	.95
4512	1.10
4515	2.95
4519	.85
4522	1.10
4526	.95
4528	1.10
4529	.95
MC 14409	14.50
MC 14419	4.85
74C151	1.50

LINEARS, REGULATORS, etc.			
QTY.		QTY.	
MCT2	.95	LM323K	5.95
8038	3.95	LM324	1.25
LM201	.75	LM339	.75
LM301	.45	7805 (340T5)	.95
LM308	.65	LM340T12	.95
LM309H	.65	LM340T15	.95
LM309K (340K-5)	1.50	LM340T18	.95
LM310	.85	LM340T24	.95
LM311D	.75	LM340K12	1.25
LM318	1.75	LM340K15	1.25
LM320H6	.79	LM340K18	1.25
LM320H15	.79	LM340K24	1.25
LM320H24	.79	LM373	2.95
7905 (LM320K5)	1.65	LM377	3.95
LM320K12	1.65	78L05	.75
LM320K24	1.65	78L12	.75
LM320T5	1.65	78L15	.75
LM320T12	1.65	78M05	.75
LM320T15	1.65		
		LM380 (8-14 Pin)	1.19
		LM709 (8-14 Pin)	.35
		LM711	.45
		LM723	.40
		LM725	2.50
		LM739	1.50
		LM741 (8-14)	.35
		LM747	1.10
		LM1307	1.25
		LM1458	.65
		LM3900	.50
		LM75451	.65
		NE555	.45
		NE556	.85
		NE565	.95
		NE566	1.25
		NE567	.95

TTL			
QTY.		QTY.	
7400	.10	7482	.75
7401	.15	7483	.75
7402	.15	7485	.55
7403	.15	7486	.25
7404	.10	7489	1.05
7405	.25	7490	.45
7406	.25	7491	.70
7407	.55	7492	.45
7408	.15	7493	.35
7409	.15	7494	.75
7410	.15	7495	.60
7411	.25	7496	.80
7412	.25	74100	1.15
7413	.25	74107	.25
7414	.75	74121	.35
7416	.25	74122	.55
7417	.40	74123	.35
7420	.15	74125	.45
7426	.25	74126	.35
7427	.25	74132	.75
7430	.15	74141	.90
7432	.20	74150	.85
7437	.20	74151	.65
7438	.20	74153	.75
7440	.20	74154	.95
7441	1.15	74156	.70
7442	.45	74157	.65
7443	.45	74161	.55
7444	.45	74163	.85
7445	.65	74164	.60
7446	.70	74165	1.10
7447	.70	74166	1.25
7448	.50	74175	.80
7450	.25	74176	.85
7451	.25	74180	.55
7453	.20	74181	2.25
7454	.25	74182	.75
7460	.40	74190	1.25
7470	.45	74191	1.25
7472	.40	74192	.75
7473	.25	74193	.85
7474	.30	74194	.95
7475	.35	74195	.95
7476	.40	74196	.95
7480	.55	74197	.95
7481	.75	74198	1.45
		74221	1.00
		74367	.95
		75108A	.35
		75491	.50
		75492	.50
		74H00	.15
		74H01	.20
		74H04	.20
		74H05	.20
		74H08	.35
		74H10	.35
		74H11	.25
		74H15	.45
		74H20	.25
		74H21	.25
		74H22	.40
		74H30	.20
		74H40	.25
		74H50	.25
		74H51	.25
		74H52	.15
		74H53	.25
		74H55	.20
		74H72	.35
		74H74	.35
		74H101	.75
		74H103	.55
		74H106	.95
		74L00	.25
		74L02	.20
		74L03	.25
		74L04	.30
		74L10	.20
		74L20	.35
		74L30	.45
		74L47	1.95
		74L51	.45
		74L55	.65
		74L72	.45
		74L73	.40
		74L74	.45
		74L75	.85
		74L93	.55
		74L123	.85
		74LS00	.30
		74LS01	.30
		74LS02	.30
		74LS04	.30
		74LS05	.35
		74LS08	.35
		74LS09	.65
		74LS15	.85
		74LS16	.95
		74LS164	1.20
		74LS123	1.20
		74LS195	.95
		74LS244	1.70
		74LS367	.95
		74LS368	.95
		74S00	.35
		74S02	.35
		74S03	.25
		74S04	.25
		74S05	.35
		74S08	.35
		74S10	.35
		74S11	.35
		74S20	.25
		74S40	.20
		74S50	.20
		74S51	.25
		74S64	.15
		74S74	.35
		74S112	.60
		74S114	.65
		74S133	.40
		74S140	.55
		74S151	.30
		74S153	.35
		74S157	.75
		74S158	.30
		74S194	1.05
		74S257 @123	1.05
		8131	2.75

CABLE ADDRESS: ICUSD  
TELEX #

HOURS: 9 A.M. - 6 P.M. MON. thru SUN.

# INTEGRATED CIRCUITS UNLIMITED

7889 Clairemont Mesa Blvd. • San Diego, California 92111 U.S.A.  
NO MINIMUM

COMMERCIAL AND MANUFACTURING ACCOUNTS INVITED  
ALL PRICES IN U.S. DOLLARS. PLEASE ADD POSTAGE TO COVER METHOD OF SHIPPING.  
ORDERS OVER \$100 (U.S.) WILL BE SHIPPED AIR NO CHARGE.

PAYMENT SUBMITTED WITH ORDER SHOULD BE IN U.S. DOLLARS.  
ALL IC'S PRIME/GUARANTEED ALL ORDERS SHIPPED SAME DAY RECEIVED.

CREDIT CARDS ACCEPTED:

Phone (714) 278-4394 BarclayCard / Access / American Express / BankAmericard / Visa / MasterCharge

### SPECIAL DISCOUNTS

Total Order	Deduct
\$35-\$99	10%
\$100-\$300	15%
\$301-\$1000	20%

# APPLE II TAKES ROOT IN SCOTLAND

We are now equipped to deal with your computing requirements North of the Border.

Think about it—an Apple II is only a local phone call away.

For your complete system requirements or even just a demonstration contact us now... and be ahead of the rest.

**GATE MICROSYSTEMS**  
**PITKERRO HOUSE**  
**BALDOVIE TOLL**  
**DUNDEE**  
**TEL: (0382) 74390**

● Circle No. 123

## The complete supplier \*RANGE\*PRICE\*DELIVERY\*



The 132 character per line display



Also ADM-31 ADM-42



2 page display, full editing features.



Semi intelligent, up to 8 pages of memory.

### ALSO AVAILABLE

Anadex DP 8000 Printer	from £575	Teletype 43 Portable Terminal	from £ 995
Digital DECwriter II		Teletype 43 ASR	from £1649
LA 36	from £849	Lear Siegler ADM 3A	
Digital DECwriter III		Graphics VDU	from £1395
LS 120	from £1695	AJ 211 Acoustic Coupler	from £ 197
Lear Siegler 200 Series	from £1685	DLC 3000 Paper Tape Terminal	from £ 920
SCI Rotary Printer	from £ 739	Techtran 950 Range Microdisc	from £ 995
Teletype 43 Keyboard Printer	from £ 869		
Teletype 43 Typewriter Terminal	from £ 995		



South 01-941 4806 North Wetherby 61885 Ireland Dublin 971854

PERIPHERAL HARDWARE LIMITED  
Armfield Close, East Molesey  
Surrey England Telex 922175

● Circle No. 124

## AGE OF AFFORDABLE COMPUTING HAS FINALLY ARRIVED PEGASUS—THE COMPLETE SYSTEM



Complete System £2,700 EX VAT.

Z80 MPU ● 48K RAM ● DOUBLE-DENSITY SHUGART SA400 DRIVES 32K. ● S100 BUS ● 12 in. CRT ● 24 × 80 CHRS ● 58-key keyBOARD UPPER-/LOWER-CASE. ● CP/M ● 2 SERIAL ● 1 PARALLEL ● HEAVY-DUTY ANADEX 80 COL. 112 CPS BI-DIRECTIONAL PRINTER ● OPTIONS 8 in. DOUBLE-DENSITY DRIVES 1-2 MB (£400). 2 ADDITIONAL DRIVES 5 in. OR 8 in. ● DIGITAL RECORDER 9,600 BAUD. ● SOFTWARE: BUSINESS PACKAGES ● WORD PROCESSING. MAILING LIST.

PROFESSIONAL SERVICE—LARGE VARIETY OF SYSTEMS & EQUIPMENT ALSO SUPPLIERS OF PET, APPLE, HORIZON, VDUs, PRINTERS, BOOKS & MAGS.

## LONDON COMPUTER STORE

43, GRAFTON WAY (OFF TOTTENHAM COURT RD) W.1. 388'5721 OPEN 11-7 MON-FRI 11-4 SATS.

● Circle No. 125

PRACTICAL COMPUTING May 1979



# microBITS

**EXIDY SORCERER**—A COMPLETE BUSINESS SYSTEM UNDER £3000 + VAT 32K Machine with Z80 processor and 8K PROM BASIC. 128 character ASC11 keyboard and superb graphics.

DOUBLE DRIVE configured MICROPOLIS DISK SYSTEM with MDOS or CP/M 630Kb. Professional quality monitor, various sizes up to 16". Printer—optional 80 or 132 column printer. Software packages are available or can be written to your own specification.

The system can be expanded to suit your own applications.

## **UNDER £1000—BASIC SYSTEM**

32K Machine, 10" professional monitor (not a converted TV), quality cassette recorder, necessary cables, manuals etc.

Price £999 + VAT.

Sorcerer Prices from £650 (8K)

**CROMEMCO Z2**—The powerful one—ASSEMBLER, MACRO ASSEMBLER, FORTRAN, COBOL, DATA BASE MANAGEMENT, WORD PROCESSOR.

Prices from 395 (Z80 Single Board Computer)

**NORTH STAR HORIZON**—The popular computer for the business user. Expandable to 48K, 3 diskettes and hardware floating point. Basic system 16K RAM, serial interface, EXTENDED BASIC, DOS, CP/M, mini diskette and power supply. Prices from £1330.

**SOL 20**—The professional terminal computer renowned for its high quality capacitive keyboard and Word Processing application. Minimum 16K RAM, monitor, serial and parallel interfaces. EXTENDED BASIC, FORTRAN, FOCAL, ASSEMBLER, EDITOR, GAMES, mini floppy disks.

Prices from £1785

SOL\*STAR WORD PROCESSOR from £2500

**77/88 BEARBAGS**—The well supported 6800 based kit from Newbear. Active user group.

**PRINTERS**—CENTRONICS, ANADEX, OK11, TREND.

**MONITORS**—Professional quality 9", 10", 12", 16" (ideal for teaching).

**CHIPS AND COMPONENTS**

**TAPE RECORDERS**—SONY & HITACHI £34.95 and £39.95

**C12 COMPUTER CASSETTES**—45p each or 10 for £4.00.

**COMPUTER BOOKS**—For professionals, hobbyists, businessmen and newcomers. Catalogue now containing updates—over 500 titles—Micro, Mini and Mainframe. Quantity discounts available.

# microBUSINESS

THE COMPLETE SERVICE

**Feasibility studies**—undertaken by our senior consultant analysts with long experience of commercial data processing.

**Software** packages available and/or specially designed and written for your own applications.

We can supply *work stations* for your computer hardware, standard configurations or made to measure.

Insurance, maintenance, HP facilities. BARCLAYCARD, TRUST-CARD, ACCESS.

Universities, Colleges and Schools—official orders welcome.

**OFFICES & SHOWROOM** open Monday-Saturday 10.00a.m.-6.00p.m.

Personal callers welcome (Please phone first)

**34B London Rd., Blackwater, Camberley, Surrey. Telephone (0276) 34044 Telex 858893**

# SMALL SYSTEMS ENGINEERING LTD.

(Incorporating R. BAILEY ASSOCIATES)

62 New Cavendish Street, London W1M 7LD, Tel: 01-637 0777, Telex: 8813085 Abacus

## THE LARGEST SUPPLIER OF PET MEMORY BOARDS AND INTERFACES IN EUROPE PET MEMORY BOARDS

Sole official U.K. Agent for PME memory boards.  
We provide approved technical back-up, up-grade and service facilities for these boards in the U.K.

Internally mounting memory boards available in 2 configurations:  
—24K . . . £412.50 —32K . . . £475

### IEEE-488/RS232C SERIAL INTERFACE

- Full IEEE address decoding, RS232C or 20mA loop output.
- Switch selectable Baud Rate, Crystal controlled Baud Rate timing.
- Boxed units complete with connectors, full operating instructions, and sample programs supplied
- Serial Interface B, input and output . . . £186
- Serial Interface A, output only . . . £106
- Lower Case Printing option . . . £10

### IEEE-488/CENTRONICS TYPE PARALLEL INTERFACE

Low cost unit without IEEE address decoding.  
Also suitable for Anadex DP-8000 Printer . . . £45

### ANALOG INPUT/OUTPUT

- IEEE-488, 16 Channel, 8BIT A-D . . . Price to be announced
- IEEE-488, 16 Channel, 8BIT D-1 . . . Price to be announced

### CUSTOM INTERFACE DESIGN

Interfaces designed for special applications. Interfaces supplied so far include Analog Input/output, XY plotter, stepper motor control.

### PET INTELLIGENT TERMINAL SOFTWARE PACKAGE

A software package which, in conjunction with an Interface B enables the PET to operate as an intelligent terminal. The software implements full IBM or DEC protocols . . . £100

### TV/VIDEO MONITOR INTERFACES

- Video Monitor output only . . . £29.50
- Video and UHF output (plugs into aerial socket of domestic TV) . . . £35

### IEEE-488 TELEX PUNCH AND INTERFACE

- 50 chars/sec. Telex punch . . . Price to be announced

## OHIO SCIENTIFIC

Small Systems Engineering is an official distributor for OHIO SCIENTIFIC products including:

### CHALLENGER I (available March 79)

- Superboard II 4K computer on a board . . . £298
- CIP 4K Superboard in case and power supply . . . £415
- CIP MF 16K CIP with mini-floppy and OS-65D V3.0 . . . £1,235

### CHALLENGER II

- C2-4P 4K "professional portable" computer . . . £620
- C2-4P MF 20K C2-4P with mini-floppy and OS-65D V3.0 . . . £1,595
- C2-8P 4K mainframe class personal computer . . . £825
- C2-8P DF 32K dual 8" floppy personal/business system . . . £2,670

The **SUPERBOARD II** includes 8K BASIC in ROM up to 8K of RAM on board, full keyboard, cassette interface and video display interface. The **CHALLENGER C2-4P M4** includes 20K of RAM, 1" mini-floppy drive, full keyboard and TV monitor, software supplied. Includes:

- Business disk,
- Education disk,
- Personal disk,
- Games disk.
- OS-65D V3.0 program development disk

BASIC and assembler run under the OS-65D V3.0 disk operating system. All systems supplied with full documentation.

### Also available:

#### COMPUCOLOUR II MODEL 3

- 13" 8-colour CRT, 8080 Microprocessor.
- 16K extended disk BASIC in ROM.
- 71-Key detached keyboard.
- 8K RAM memory for user programs.
- 64 characters per line by 32 lines per page.
- Special graphics package with 128 × 128 point plotting.
- Built-in mini-floppy disk drive.
- 50 pin bus.
- RS-232 I/O port for serial printers, etc. . . . £1,248.70

TERMS: All prices EX. VAT. All orders C.W.O. Cheques should be made payable to SMALL SYSTEMS ENGINEERING LTD. Orders should include £2.50 P&P per unit. All goods supplied under 90 days warranty.

● Circle No. 127

# TRS80 SPECIALISTS

- \* BUSINESS SYSTEMS ON PERMANENT DEMONSTRATION
- \* TAILOR-MADE BUSINESS PROGRAMMES
- \* 24hr MAINTENANCE CONTRACTS

Disc drives, printers etc at discount prices.  
Most popular books and magazines in stock including TRS 80 Newsletter.

### SPECIAL ITEMS

- The Basic Handbook by David Lien £10
- C-20 computer-certified cassette tapes £4.70 for 10
- 16k TRS80 upgrade kits with full instructions, £80.00 Minidiskettes £3.20 ea. or box of ten, £30.00

## ROBINSONS COMPUTER CENTRE

118 Wandsworth High Street, London SW18  
Tel: 01-870 4805 Telex: 8813089 (Interprem)

Send stamped addressed envelope for list including discount book prices.

● Circle No. 128

## Ohio Scientifics

### Superboard II

Full 8K basic and 4K user RAM  
built and tested

£263.84 + VAT



### Standard Features

- Uses the ultra powerful 6502 microprocessor
- 8K Microsoft BASIC-in-ROM
- Full feature BASIC runs faster than currently available personal computers and all 8080-based business computers
- 4K static RAM on board expandable to 8K
- Full 53-key keyboard with upper-lower case and user programmability
- Kansas City standard audio cassette interface for high reliability
- Full machine code monitor and I/O utilities in ROM
- Direct access video display has 1K of dedicated memory besides 4K user memory, features upper case, lower case, graphics and gaming characters for an effective screen resolution of up to 256 by 256 points. Normal TV's with overscan display about 24 rows of 24 characters, without overscan up to 30 × 30 characters.

ATARI Video Computer—£138.85 + Vat

New Cartridges—Code Breaker, Hunt & Score Brain Games

Full data on request—Despatch Costs inclusive



**VIDEOTIME PRODUCTS**  
25 High Street, Overton, Hants  
Tel. (0256) 56417 Telex. 858747



● Circle No. 129



*Why have a separate Microprocessor + VDU + Discs + Interfaces when you can have a complete system, beautifully packaged and ready to use by simply turning on only one switch.*



\* The 610 and the 625 are already being used in practical environments for applications such as Payroll (with up to 3,000 employees); Incomplete Records (3,700 transactions per client and almost 450 Nominal Accounts); Stock Control/Invoicing; Estate Agents (2,000 properties, 500 clients held on disc at one time); Accounting. We also have pleasure in introducing our brand new Word Processors package which has already gained acceptance against dedicated word processors.

\* Complete back-up service available.

The 600 Series uses

- \* Z80 Microprocessor
- \* Extended Basic and Assembler with one of the most complete File Management Systems available enabling identical packages to work on the 610 and 625.
- \* Up to 60K internal memory.

The 600 Series has complete range of Interfaces and peripherals available to include:-

- \* 160 cps dot matrix printer
- \* 1k Cmos and Real-time clock
- \* RS232/V24 Interface
- \* IBM-compatible tape
- \* 220 Volt uninterruptable Power Supply
- \* A/D and D/A Converter for process control
- \* Up to 4 min. floppy drives at 315k bytes each, totalling 1.2 MEG(625)
- \* 10 and 20 meg. cartridge disc
- \* 32 bit parallel interface
- \* IEEE interface for instrumentation
- \* S-100 Bus

\* Price of the 600 Series starts from £3,890 and includes

\* 48k RAM Memory; 150k Floppy Disc; VDU; Full Operating Software to include Basic; Assembler; File Management; Disc Operation System and Text Editor

\* DEALERS REQUIRED

\* SUBSTANTIAL OEM AND DEALER DISCOUNTS AVAILABLE

**COMPUGORP LTD., Circle House South, 65-67 Wembley Hill Road, Wembley, Middlesex. Tel: 01-903 5444**



## HAPPY MEMORIES

21L02 450ns 80p 2114 450ns £5.25  
 21L02 250ns 95p 2114 300ns £6.00  
 4116 250ns £8.75 2708 450ns £6.75

TRS-80 16K Memory Upgrade Kit £75  
 Full instructions included

S100 16K Static RAM Kit 450ns £195  
 Bank select, 4K boundaries, all sockets,  
 components and instructions included  
 with 4K £81: with 8K £119: with 12K £157

ASCII Keyboards from the USA £48.50  
 59 keys, 128 characters, alpha-lock, repeat,  
 pos and neg strobe, send SAE for data sheet

Science of Cambridge Mk 14 set of 18  
 Texas low-profile sockets £2.80

Texas low-profile DIL sockets:  
 pins 8 14 16 18 20 22 24 28 40  
 pence 10 11 12 17 18 20 22 28 38

Antex Imm bits CCN or CX17 45p

Call or write for 74LS price list

VAT included. 20p p+p under £10 order

5 Cranbury Terrace, Southampton  
 Hants SO2 0LH Tel. (0703) 39267

● Circle No. 131



## Rockliff

Micro Computers  
 Liverpool

**PET** 4K £460 8K £550  
 16K £675 32K £795

### PET Printers

PR40 (with Software Interface) £250  
 PR40 Paper Rolls (10) £6  
 Teletype 43 £900  
 Listing Paper (1000 6" x 12") £6  
 Kim 1 £92

### PET extra memory

Plessey Petite 24K £???

Add-in Board 24K £320  
 Twin Floppy Unit £840  
 Pet T.V. / Monitor Interface £25

**Rockliff** C15 Cassettes (10) £3.99  
 Quality Tapes  
 with Cases C60 Cassettes (10) £4.30

Ask for our list of software packages including  
 Rockstock, Payroll and Ledger

Please add 8% VAT to all prices

2 Rumford Street **051-521 5830**  
 Liverpool L2 8SZ

● Circle No. 132

## LIBRARY 100

### for the TRS-80



A complete library of 100 programmes for the TRS-80 Level II. The 5 cassettes are attractively packaged in a plastic binder which also holds the full documentation. All programmes were specifically written for the Library and, as a bonus, include a Tiny version of the Pilot language, to give your TRS-80 the added dimension of a new language. Less than 50p a programme !!

**Finance:** Present Value of a Future Sum—Simple Interest for Days—Future Value of a Present Sum—Amortization Schedule—Interest Rate: Compound Interest—Interest Rate: Installment Loan—Days Between Dates—Term of an Installment Loan—Present Value of a Series of Payments—Real Estate Capital Investment—Nominal and Effective Interest Rates—Internal Rate of Return—Future Value of Regular Deposits—Regular Deposits for Future Value—Depreciation Amount: Rate, Salvage Value, Schedule—Bond Present Value—Bond Yield to Maturity—Sale—Cost—Margin—Day of the Week—Moving Ad.

**Educations** Multiplication & Division—Add—Subtract—Fraction & Decimal—States & Capitals—States & Order of Entry—States & Abbreviation—Inventors & Inventions—World Capitals & Countries—Urban Areas & Population—Authors & Books—Presidents & Order—States & Largest City—Basenum.

**Graphics:** Left Right—Random Ad—Graphic—Blocks—Fireside—Snow—Step Ad—Step Ad 2—Launch—Ratrace—War Game—Weird—Herring—Blinker—Snoopy.

**Home:** Message Board—Expense Account—Nutrition—Mileage—Remember—Phone Codes—Night Check Off—Drunkometer—Perpetual Calendar—Babysitter—Calculator—Bartender—Christmas List—Vacation Check Off—Conversion.

**Games:** Speedy—Odd One—R. Roulette—Star Blazer—Search—Spyship—Tiger Shark—Jumble 2—Sting Ray—Stars—Sketch—Flipper—Scissors—Horse—Doomsday—Craps—Jumble 1—Mem. Quiz Letters—Mem. Quiz Numbers—Wheel of Fortune—Decision—Unjumble—Fifteen—Towers—Life—Star Trek—Race Track—Count—Roachrace—Gypsy.

£46.95 (inc.)

**A. J. HARDING**

28 Collington Ave., Bexhill, E. Sussex. Tel: (0424) 220391

● Circle No. 133

## MICRO COMPUTER COURSES

Seminars on microcomputers.  
 Applications for the computer  
 lay man

Learn how to use a micro on our three-day practical course for small groups in London; includes an introduction to Basic.

Learn what a micro can do for you and how to choose one; suitable for management as well as users.

Beyts Logic Ltd.  
 Windmill Road, Sunbury,  
 Middx. U.K.  
 Telephone (09327) 86262  
 Telex 928185

**BEYTS  
 LOGIC**

● Circle No. 134

PRACTICAL COMPUTING May 1979



# IF YOU CAN'T BEAT THEM:-

## VECTOR GRAPHIC INC



VECTOR V18A slot Motherchassis accepts the wide range of Vector S100 cards and makes an ideal base to build a microcomputer system. Computing power is available to perform a wide range of tasks from industrial control to small business.

£350

PR2 12K PROM/RAM card holds a comprehensive monitor program for system testing and configuration. Normal operation is in conjunction with a serial terminal via I/O card.

£160

FLASHWRITER, memory mapped VDU with graphics, allows a system to be built without a terminal or I/O card. Specify version EV of monitor program.

£150

I/O, Switchable 110 to 9600 baud serial interface plus two 8-bit parallel I/O ports.

£125

High resolution graphics interface bit-maps 8K of RAM to 256 x 256 points, or 128 x 128 with 16 level grey-scale.

£150

Z80 Processor card	£140	8080 Processor card	£120
8K Static RAM 4MHZ	£140	16K Static RAM 4MHZ	£300
Analogue Interface	£70	Precision analogue interface	£250
Rackmount 18 slot motherboard	£150	Rackmount power supply	£90

8K Computer System £895

## MICROPOLIS



Micropolis disk drives employ higher standards of engineering to pack either 143K or 315K bytes per diskette, formatted. Supplied complete with controller card, cables, manual and software they plug directly into the S100 bus; 8080 or Z80.

Extended disc BASIC, mnemonic editor and assembler are provided, to run under the powerful MDOS operating system.

Add-on units are supplied to extend the system to four drives and one drive per system may be powered from the S100 bus.

143K System S100 powered	£439	143K Add-on S100 powered	£279
143K System Mains powered	£499	143K Add-on Mains powered	£339
315K System S100 powered	£649	315K Add-on S100 powered	£349
315K System Mains powered	£699	315K Add-on S100 powered	£399
Twin drive System 630K	£1159	Twin drive Add-on 630K	£859
S100 bus regulator	£14	Diskettes per five	£24

Unmounted drives available from £225

# JOIN THEM!

## VECTOR MZ



# £2300

Combining the best features of the VECTOR GRAPHIC computer and twin MICROPOLIS 315K byte drives. The Vector MZ produces, in one package a powerhouse of Microcomputer ability.

The VECTOR PROM monitor bootstraps directly to either MDOS, for housekeeping and Assembly language operation, or to BASIC to run high-level user programs. Provision is made to immediately attach a printer, for example one of the extensive range from Centronics sold by Sintrom, enabling use of the powerful printer-related features in the MICROPOLIS Software.

Applications Software for the VECTOR MZ now in preparation will perform a wide variety of business functions; stock control, invoicing, ledger and mailing lists. Further applications exist as a microcomputer development system, and low cost replacement for minicomputer control and instrumentation.

VECTOR MZ configuration includes:

Twin disk 630K minifloppy.  
Full Micropolis disk software.  
Z80 4MHZ 32K processor.  
1 Serial port, 2 Parallel ports.  
12K PROM RAM card with extended monitor.

And will support:

Flashwriter, Graphics interface, Analogue interface  
Additional RAM, additional minifloppy drives.

Centronics Microprinter	£398
Centronics 779	£780
ADM3A VDU	£620



PRICES EXCLUDE VAT  
ALL EQUIPMENT FULLY ASSEMBLED AND TESTED  
OEM AND DEALER ENQUIRIES WELCOME

DEMONSTRATIONS IN OUR SHOWROOM

Sintrom Microshop

14, Arkwright Road,  
Reading, Berks. RG2 0LS.  
Tel: Reading (0734) 84322  
TELEX: 847395  
CABLES: SINTROM READING

## INTRODUCING THE SLAVE

*A truly commercial computer printer at a personal computing price.*

Some of the features:

- ★ 80 columns, 112 cps
- ★ 84 lines per minute, bi-directional
- ★ 100 million characters printhead life
- ★ Sprocket feed, multi-copy
- ★ V24 interface
- ★ Only £575
- ★ One-off OEM discounts available

**Special PRACTICAL COMPUTING introductory offer which ends January 30, 1979** **£546**

# COMPUTRADE

Silverwood House, Oxshott Road, Leatherhead, Surrey

Tel. No. 03723 77374

North: 061-477 4960

Midlands: 0533-536077

South-East: 01-658 5906

● Circle No. 136

NOW OPEN  
BIRMINGHAM'S  
COMPUTER  
STORE



AUTHORISED  
COMMODORE  
DISTRIBUTOR

Systems Demonstrated Mon.-Sat. 9am-6pm  
S.A.E. for details of full range of products.

PET 2001-8K	£550
PET 2001-16N	£675
PET 2001-32N	£795
PET Printer 2023	£550
PET Floppy Disc 343K	£740
Dual drive	
PET External Cassette Deck	£55
Expander Printer	£420
PET Soft. Large Sel from	£3

### PET MICROHIRE SERVICE NOW AVAILABLE

Full range of Business Programs.  
KIM 1 2K ROM 1K RAM £99.95  
VIDEO MONITORS Fully cased £69  
High Quality. Cassettes 10 for £5

Full range of Books & U.S. Magazines  
Byte, Kilobaud 6502 etc.

Add 8% to all orders.

Add £6 for Securicor if required.

**CAMDEN ELECTRONICS**  
462 Coventry Road, Birmingham.  
Tel: 021-773 8240

● Circle No. 137

The action-packed show for the electronics enthusiast now includes the Midlands among its venues. If hobby electronics is your interest or your business, then Midlands Breadboard is tailor-made for you.

**MIDLANDS**

**BREAD  
BOARD**

**1979**

Crammed with the gear that constructors need. Circuit boards, components, audio kits, d.i.y. computer systems, electronic musical instruments — you'll find it all here. And you can buy it on the spot — or browse at your leisure. Demonstrations and competitions (exciting prizes!) keep the show humming with activity.

P.S. There's a London Breadboard too, December 4-8th, Royal Horticultural Halls — come to both!

I want to visit the show. Send me more details nearer the date.

Please send me details now of exhibition space.

Name .....

Position .....

Company .....

Address .....

Telephone ..... Telex .....

Return to: Trident International Exhibitions Limited  
Abbey Mead House, 23a Plymouth Road,  
Tavistock, Devon. PL19 8AU

Telephone: 0822 4671 Telex: 45412 TRITAV

**Bingley Hall, Birmingham,**  
**23-26 May, 10 am-6pm**  
**Admission: £1 Adults**  
**75p Students**

● Circle No. 138

PRACTICAL COMPUTING May 1979



# JADE Computer Products

## MEM2

### 16K Static RAM Board

S-100, fully buffered, with PHANTOM and bank addressing capabilities, can be addressed at 4K boundaries.

250ns Kit	\$356.25
450ns Kit	\$312.50
250ns A&T	\$437.50
450ns A&T	\$406.25

### EPROM BOARD KITS

EPM-1 (uses up to 4K or 1702)	\$74.94
JG8/16 (uses 2708 or 2716)	\$87.44

### "IMSAI"-TYPE CARD GUIDE SPECIAL:

Regular Price 38¢ each

**SPECIAL: 10 for \$1.25**

### MICROPROCESSORS

F8	\$21.19
Z80 (2MHz)	\$25.00
Z80A (4MHz)	\$31.25
COP1802CD	\$22.44
6502	\$14.94
6800	\$21.19
6802	\$31.25
8008-1	\$16.19
8035	\$25.00
8035-8	\$26.25
8080A	\$12.50
8085	\$28.75
TMS9900TL	\$62.44

### 8080A SUPPORT DEVICES

8212	\$ 3.63
8214	\$ 5.81
8216	\$ 3.44
8224 (2MHz)	\$ 5.38
8224-4 (4MHz)	\$12.44
8226	\$ 3.44
8228	\$ 8.00
8238	\$ 8.00

### USRT

S2350	\$13.69
-------	---------

### UARTS

AY5-1013A	\$ 6.56
AY5-1014A	\$10.31
TR1602B	\$ 6.56
TMS6011	\$ 7.44
IM6403	\$11.25

### BAUD RATE GENERATORS

MC14411	\$12.50
14411 Crystal	\$ 6.19

### 6800 PRODUCT

6810P	\$ 5.00
6820P	\$ 8.25
6821P	\$ 8.25
6828P	\$14.06
6834P	\$21.19
6850P	\$10.81
6852P	\$13.75
6860P	\$11.56
6862P	\$15.00
6871P	\$35.94
6875P	\$10.94
6880P	\$ 3.13

### KIM SUPPORT DEVICES

6502	\$14.94
6520	\$12.50
6522	\$11.56
6530	\$19.94
6530-002	\$19.94
6530-003	\$19.94
6530-004	\$19.94
6530-005	\$19.94

### CHARACTER GENERATORS

2513 Upper (-12+5)	\$ 8.44
2513 Lower (-12+5)	\$ 8.44
2513 Upper (5 volt)	\$12.19
2513 Lower (5 volt)	\$13.69
MCM6571 up scan	\$13.69
MCM6571 A down scan	\$13.69

### PROMS

1702A	\$10.00
2708	\$12.44
2716 (5+12) TI	\$31.25
2716 (5v) INTEL	\$75.00
2758 (5v)	\$29.25

### DYNAMIC RAMS

416D/4116 (250ns)	\$15.63
2104/4096	\$ 5.00
2107B-4	\$ 4.94
TMS4027/4096 (300ns)	\$ 5.00

### STATIC RAMS

21L02 (450ns)	1-15	\$ 1.50
21L02 (250ns)	1-15	\$ 1.88
2101-1	1-15	\$ 3.25
2111-1	1-15	\$ 4.06
2112-1	1-15	\$ 3.69

### FLOPPY DISK CONTROLLERS

1771B01	\$49.94
---------	---------

### KEYBOARD CHIPS

AY5-2376	\$17.19
AY5-3600	\$17.19
MM5740	\$22.50

## Rockwell AIM-65: The Head-Start In Microcomputers

A KIM-1 compatible machine with on-board printer and a real keyboard!

\$468.75 w/1K RAM  
\$562.50 w/4K RAM

4K assembler/editor in ROM:	\$100.00
8K BASIC in ROM:	\$125.00
Power supply:	\$ 74.93
Case for AIM-65:	\$ 62.43



**Special Package Price: \$748.75**  
AIM-65 (4K), Power Supply, Case, and 8K BASIC ROM

## EXPANDOR'S BLACK BOX PRINTER

This 64-character ASCII impact printer with 80-column capability is portable and uses standard 8 1/2" paper and regular typewriter ribbon. Base, cover and parallel interface are included. Assembled and complete with manual and documentation. **only \$599.00**



(90 day manufacturer's warranty)

**TRS-80 Interface Cable for Black Box Printer**  
with mating connectors: **\$60.00**  
(must be used with expansion module, +8v 1 amp power supply required.)

Power Supply for TRS-80/Black Box Printer **\$61.25**

## Sale!

### DYNAMIC RAM BOARDS EXPANDABLE TO 64K 32K VERSION • KITS

Uses 4115 (8Kx1, 250ns)  
Dynamic RAM's, can be expanded in 8K increments up to 32K.

8K	\$198.75	24K	\$311.25
16K	\$248.75	32K	\$373.75

**64K VERSION • KITS**  
Uses 4116 (16Kx1, 250ns)  
Dynamic RAM's, can be expanded in 16K increments up to 64K.

16K	\$311.25	48K	\$593.75
32K	\$461.25	64K	\$718.75

### S-100 MOTHER BOARDS

<b>9-SLOT "LITTLE MOTHER"</b>	
Kit	\$107.00
Assembled & Tested	\$123.75
Bare Board	\$ 43.75
<b>13-SLOT "QUIET MOTHER"</b>	
Kit	\$118.75
Assembled & Tested	\$137.50
Bare Board	\$ 50.00
<b>22-SLOT "STREAKER"</b>	
Assembled & Tested	\$186.25

### JADE SOBOA with full documentation

Kit	\$125.00
Assembled & Tested	\$186.25
Bare Board	\$ 37.50

## JADE Computer Products

4901 W. ROSECRANS AVENUE  
Department "U" 3  
HAWTHORNE, CALIF. 90250  
U.S.A.

Telephone:  
(213) 679-3313

Telex:  
18-1823



Discounts available at OEM quantities. All prices above are quoted in U.S. \$ F.O.B. Hawthorne, Calif., U.S.A. To expedite shipments please include International money order or bankers check payable against any U.S. bank in U.S. \$, or use your Barclay, Access or American Express credit card (Include card number, expiration date, and signature). Add 20% of total order for shipping & handling.

### WRITE FOR OUR FREE CATALOG

All prices subject to change without notice.

Call for discounts on larger quantities

## Jade Memory Expansion Kits for TRS-80 and Apple!

4116's—8 for \$106.25

(16K x 1, 200ns) includes dip plugs and instructions

### ★ TRS-80 Kit ★

(16K x 1, 300ns) includes connectors and instructions

**\$112.50**

## JADE Z80

with provisions for ONBOARD 2708 and POWER ON JUMP

<b>2MHz</b>	
Kit	\$168.75
Assembled & Tested	\$231.25
<b>4MHz</b>	
Kit	\$187.44
Assembled & Tested	\$249.94
Bare Board	\$ 43.75

## STATIC RAM BOARDS

<b>JADE 8K</b>	
Kits:	450ns \$157.44
	250ns \$187.19
Assembled & Tested:	
	450ns \$174.69
	250ns \$212.19
Bare Board: \$ 31.25	
<b>16K — Uses 2114's (low power)</b>	
Assembled & Tested:	
	RAM 16 (250ns) \$168.75
	RAM 16B (450ns) \$231.25
<b>16K with memory management</b>	
Assembled and Tested:	
	RAM 65 (250ns) \$468.75
	RAM 65B (450ns) \$406.25
<b>32K Static</b>	
Assembled & Tested:	
	250ns \$993.75
	450ns \$906.25
	250ns Kit \$718.75

## ★ STATIC RAM SPECIALS ★

<b>2114's, low power (1024x4)</b>			
	1-15	16-99	100 +
450ns	10.00	8.69	6.88
250ns	11.25	10.00	8.13
<b>TMS4044/MM5257, low power</b>			
450ns	10.00	9.38	8.13
250ns	12.44	10.94	10.00
<b>4200A (4Kx1, 200ns)</b>			
	12.44	10.63	10.00

## DISK DRIVES

**MINI DISK DRIVE \$368.75**  
Model B51 by Micro Peripherals, Inc. will operate in either single density (125KB, unformatted) or double density (250KB, unformatted) modes, up to 40 tracks, with a track-to-track access time of only 5ms.

**SA801R \$618.75**  
Shugart single-sided 8 in. floppy disk drive.

**DM 2700-S \$937.50**  
Includes SA801R disk drive, 10 in. x 10 in. x 16 in. cabinet, power supply, data cable, fan AC line filter.

## VERBATIM FLOPPY DISKS

<b>5 1/4 in. Minidiskettes</b>	
Soft sector, 10 sector, or 16 sector	\$5.50 each or
box of 10 for \$50.00	
<b>8 in. Standard Floppy Disks</b>	
Soft Sector	\$5.94 each—10 for \$53.13



## LINBURG ELECTRONICS LTD

QUALITY SEMICONDUCTORS WITH FULL INDUSTRIAL SPECIFICATION

MOTOROLA		74LS TTL	
MC6800P CPU	£8-20	74LS00	19p
MC6810 RAM	£3-20	74LS01	19p
MC6820 PIA	£4-50	74LS02	19p
MC6850 ACIA	£4-50	74LS03	19p
MC6875 CLOCK	£3-80	74LS04	20p
D2 EVALUATION KIT	£176-00	74LS08	20p
(MEK 6800 D2)		74LS10	20p
		74LS14	74p
		74LS20	22p
<b>ZILOG</b>		74LS27	32p
280 CPU 2.5MHZ	£14-00	74LS30	26p
Z80 CTC	£9-00	74LS32	26p
Z80 PIO	£9-00	74LS42	88p
		74LS47	£1-00
<b>PROMS</b>		74LS73	42p
2708 1K x 8 EPROM	£6-75	74LS74	30p
2716 2K x 8 EPROM	£17-00	74LS75	40p
(TEXAS TRIPLE SUPPLY VERSION)		74LS90	54p
		74LS93	54p
<b>SUPPORT CHIPS</b>		74LS154	£1-36
MC1488 V24 Tx	£1-40	74LS155	57p
MC1489 V24 Rx	£1-40	74LS174	80p
8216 BUS DRIVER	£3-00	74LS367	54p
AY-5-1013 UART	£4-83		
7 in. FLOPPY DISCS (SINGLE DENSITY, SINGLE SIDED)	£7-00		

PLEASE ADD 30p POSTAGE AND PACKING AND THEN ADD 8% V.A.T.

**LINBURG ELECTRONICS LTD**  
DEPT PC, MOSS WAY DONIBRISTLE INDUSTRIAL ESTATE, HILLEND DUNFERMLINE, SCOTLAND  
TEL:- (0383) 823222

**Linburg**

● Circle No. 140

## GAMES GAMES CASSETTE GAMES IN PET BASIC

**TORPEDO RUN**—Solo simulation of the destruction of the Death Star. Out-maneuvre and battle tie fighters until the vent comes into range. Drop your Proton torpedo and the Death Star explodes. Full graphics. . . . .£8-00

**FINAL FRONTIER**—Solo Star Trek adventure combining functions on most other Star Trek games. Multiple-choice command including built-in range-finding computer. Full graphics. Can be replayed instantly. . . . .£8-00

**YAM**—(Yahtzee) Classic dice game using 5 dice. 2 versions on one tape: 1 for up to 6 players; one for up to 4 players with 4 columns each. . . . .£6-00

**PONTOON**—Solo version of the well-known card game. Good graphics; betting facility; Splitting and Burning possible. . . . .£5-00

**MAN-EATER**—Surround and capture the shark before he chomps your swimmers. Skilful game of deduction, with graphics. . . . .£4-00

### COMPUTER GAMES & BOOKS

**BASIC COMPUTER GAMES**—101 games in Basic. Microcomputer edition. . . . .£5-50

**BEST OF CREATIVE COMPUTING Vo. 1**—328pp compendium. . . . .£6-95

**BEST OF CREATIVE COMPUTING Vo. 2**—328pp compendium. . . . .£6-95

**BEST OF BYTE**—Taken from first 12 issues of 'Byte' mag. Theory, applications, speculations, projects, software systems etc. 384pp. . . . .£8-95

## SCIENCE FICTION & FANTASY BOARD GAMES

**DUNGEONS & DRAGONS**—Creative adventure role-playing game of wizards, heroes and monsters. . . . .£7-50

We stock a vast selection of Science Fiction and Fantasy games. Visit our shop or send an SSAE for full lists.

All prices include postage and packing (UK only)  
TRADE ENQUIRIES WELCOME

Games Workshop, 1 Dalling Rd, London W6 01-741 3445

## Games GAMES

● Circle No. 141

# Euro-Calc Ltd

224 TOTTENHAM COURT ROAD, LONDON W1. TEL: 01-636 8161

For electronic calculators and watches.

We have the largest range in London at the most competitive prices.

Export and Personal Export Tax, free facilities arranged.



HEWLETT PACKARD \* CASIO  
\* SHARP \* TEXAS  
INSTRUMENTS \* OLIVETTI \*  
SEIKO \* SINCLAIR \*  
COMMODORE \* SANYO \*  
NATIONAL PANASONIC, ETC.

We stock the

**COMMODORE  
PET 2001-8**

**APPLE II**

**ITT 2020**

**COMPUCOLOUR**

**NORTH STAR  
HORIZON**

and

**TEXAS SR60a**

microcomputers with a full range of hardware and software options.

● Circle No. 142

PRACTICAL COMPUTING May 1979

# L.P. ENTERPRISES

Room PC  
313 Kingston Road, Ilford  
Essex IG1 1PJ, England

A COMPREHENSIVE SELECTION OF MICROCOMPUTER BOOKS AND MAGAZINES  
FOR THE HOBBYIST, EDUCATIONALIST, PROFESSIONAL AND RETAILER

Introduction to Microcomputers	
Volume 0 The Beginners Book	£5.95
Volume 1 Basic Concepts	£6.30
Volume 2 Some Real Microprocessors (without binder)	£18.95
Volume 2 Some Real Microprocessors (with binder)	£24.70
Volume 3 Some Real Support Devices (without binder)	£11.95
Volume 3 Some Real Support Devices (with binder)	£17.70
Updating subscription (6 issues) for Vol. 2	£18.95
Updating subscription (6 issues) for Vol. 3	£18.95
Updating subscriptions for Vol. 2 and 3	£30.00
1 Updating issue (Specify for Vol. 2 or 3)	£4.00
I Binder (specify for Vol.2 or Vol. 3)	£5.75
6800 Programming for Logic Design	£6.30
8080 Programming for Logic Design	£6.30
Z80 Programming for Logic Design	£6.30
Basic Computer Games	£5.50
What To Do After You Hit Return	T.B.A.
8080 Galaxy Game	£7.95
The Colossal Computer Cartoon Book	£3.95
Computer Rage (A Board Game)	£6.95
Artist and Computer	£3.95
Games with a Pocket Calculator	£1.75
Games, Tricks and Puzzles for a Hand Calculator	£2.49
Z80 Instruction Handbook	£3.50
8080 Programmers Pocket Guide	£1.95
8080 Hex Code Card	£1.95
8080 Octal Code Card	£1.95
Dr. Dobbs Journal: Vol. 1	£10.00
Best of Byte	£8.95
Scelbi Byte Primer	£9.95
Best of Creative Computing: Vol. 1	£6.95
Best of Creative Computing: Vol. 2	£6.95
Best of Micro	£5.50
8080A/8085 Assembly Language Programming	£6.45
6800 Assembler Language Programming	£6.45
8080 Software Gourmet Guide and Cookbook	£7.95
6800 Software Gourmet Guide and Cookbook	£7.95

## MAGAZINE SUBSCRIPTIONS

	U.K.	Overseas
	price	price
Subscriptions start within 3 weeks		
MICRO-6502 Journal (12 per year)	£11.50	£12.50
Personal Computing (12 per year)	£16.00	£17.00
Interface Age (12 per year)	£20.00	£20.50
Dr. Dobbs Journal (10 per year)	£13.00	£13.50
Computer Music Journal (4 per year)	£10.50	£11.00
Peoples Computers (6 per year)	£8.00	£8.50
BYTE (12 per year)	£21.00	£21.00
Creative Computing (12 per year)	£16.00	£16.50
Calculators and Computers (7 per year)	£10.00	£10.50
Kilobaud (12 per year)	£20.00	£21.00
73 (12 per year)	£20.00	£21.00

Microprocessors from Chips to Systems	£7.95
Microprocessor Interfacing Techniques	£7.95
Z80 Microcomputer Handbook	£7.50
T.V. Typewriter Cookbook	£7.50
T.T.L. Cookbook	£7.50
CMOS Cookbook	£7.95
IC OP-AMP Cookbook	£9.50
RTL Cookbook	£4.25
IC Timer Cookbook	£7.50
The Cheap Video Cookbook	£4.30
Introduction to Personal and Business Computing	£4.95
Getting involved with Your Own Computer	£4.75
Your Home Computer	£7.95
How to Profit from your Personal Computer	£5.50
Reference Book of Personal & Home Computing	£4.95
Hobby Computers are Here	£3.95
New Hobby Computers	£3.95
Understanding Microcomputers and small Computer Systems	£7.95
Users Guide to North Star BASIC	£10.00
Instant BASIC	£7.50
Basic BASIC	£6.50
Advanced BASIC	£6.00
My Computer Likes Me ... When I speak in BASIC	£2.75
Introduction to PASCAL	£4.00
SCELBAL-High Level Language + Supplements	£20.00
Accounts Payable & Account Receivable	£10.95
Payroll with Cost Accounting	£10.95
General Ledger	£10.95
BASIC Software Library	
Vol. 1: Business and Games Programs	£17.50
Vol. 2: Maths, Engineering, Statistical Programs	£17.50
Vol. 3: Advanced Business Programs	£26.95
Vol. 4: General Purpose Programs	£7.95
Vol. 5: Experiments Programs	£7.95
Vol. 6: Miniature Business System	£32.50
Vol. 7: Chess/Medbil/Wdpros Programs	£29.95
Some Common BASIC Programs	£6.30
Computer Programs that Work (in BASIC)	£2.55
First Book of Kim	£6.50
8080 Standard Monitor	£9.95
8080 Standard Editor	£9.95
8080 Standard Assembler	£9.95
Special Package: 8080 Assembler, Editor, Monitor	£20.00
Bar Code Loader for 6800, 8080, Z80 and 6502	£1.75
Tiny Assembler for 6800 systems	£5.75
MAGAZINE BACK ISSUES	
Micro-6502 Journal	£1.50
Personal Computing	£1.75
Interface Age	£2.25
ROM	£1.75
Dr Dobbs Journal	£1.75
Computer Music Journal	£3.50
Peoples Computers	£1.75
BYTE	£2.25
Creative Computing	£1.75
Calculators & Computers	£1.75
Kilobaud	£2.25
73	£2.25
Magazine Storage Box (Holds 12)	£1.25

THIS LIST CANCELS ALL PREVIOUS PRICE LISTS: EFFECTIVE JANUARY 1979  
DUE TO FLUCTUATIONS OF THE DOLLAR, PRICES SUBJECT TO CHANGE WITHOUT NOTICE

## HOW TO ORDER

Tick required items or write letter.  
Please note our prices include postage and packing, but not insurance, if wanted add 12p for every £10 of books ordered. Make cheques PO's etc payable to:—

L.P. Enterprises.

CREDIT CARDS accepted  
BARCLAYCARD/VISA/ACCESS  
DINERS CLUB/AMERICAN EXPRESS

Phone 01-553 1001 for Credit Card order (24-hr answering service).

N.B. Diners Club orders cannot be accepted by telephone.

Send to address above	All Orders must be Prepaid
Indicate Payment Method:	Total Enclosure £.....
..... My cheque, P.O., I.M.O. is enclosed in <b>Sterling on U.K. Bank</b>	
..... Charge to Barclaycard/Visa/Access/Diners/American Express	
Credit Card No .....	Expiry Date .....
Name .....	
Address .....	
	POSTCODE .....
Signature .....	

All publications are published in U.S.A. and shipped air-freight by L.P. Enterprises. In unusual cases, processing may exceed 30 days. Trade enquiries welcome.



# GEMSOFT

Original programs for PET.  
Supplied on high-quality C12 cassettes.

**ZAP THE KLINGONS!**—The dreaded Klingons are at it again. Blast them out of the Universe with the USS Enterprise, before they destroy you. A fast-moving game, with excellent graphics and full instructions . . . . . £6-00.

**DROPOUT**—Try to get the ball through the maze without hitting the walls, and as if that isn't enough, there are holes all over the place the ball can fall down, in which case you Drop Out! Varying skill levels. Try it, you'll love it . . . . . £6-00.

**CROSSWORDS 1-3**—As far as we know, the only program of its type anywhere. Play crosswords with the PET, 3 different crosswords on each cassette, with more to follow. Excellent graphics . . . . . £6-00.

**APOLLO SPACE PROGRAM**—This multi-load program is the history and flight of the Apollo Moon program and lunar graphics. Using the Pet graphics to the full, it gives you animated drawings and lots of fascinating information . . . . . £8-00.

**OIL RUN**—Fire your torpedoes at the oil tankers, dodging the mines in the process. Unfortunately, however, the torpedo aimer is drunk! Good graphics . . . . . £4-50.

**HEXCONV**—This programming aid will examine storage locations in 80-byte blocks; convert hex to dec. and vice-versa; examine single bytes in hex, dec, ASCII and binary, and alter storage in 8-byte blocks; includes conversion table . . . . . £10-00.

More programs available, and more in preparation. Send SAE for full list. Programs are dispatched immediately, and all prices include postage, packing and VAT (U.K. only).

Super-quality screwed C15 cassettes (the same type we use for our programs) £4-20 for 10 (inc. library cases & labels. P & P 25p).

#### TRADE ENQUIRIES WELCOME

Word processing programs & general business programs tailored to your needs.

**GEMSOFT**:- "Alverstone Lodge", Wych Hill Lane, Woking, Surrey. Telephone: (04862)-60268.

## SPECIAL OFFER !

FROM

# THE LONDON PET CENTRE

AT

## CHARING CROSS

80% List price for perfect 2001 8Ks against firm orders now for the new 16K & 32 keyboard models with Commodore printer & floppy disc unit when available.

90% for 8Ks purchased from us after 1 April '79.

#### LIMITED OFFER

Write or Telephone Catherine Donne for details quickly —*NOW*.

Full range of software & PET.  
Compatible Hardware on display.  
Conveniently close to Charing Cross mainline station.

#### TLC WORLD TRADING LTD

34 Craven Street, London W.C.2

Telephone. 01-839 3894

(HP Available).

● Circle No. 144

● Circle No. 145

## KIM 1 New Low Price

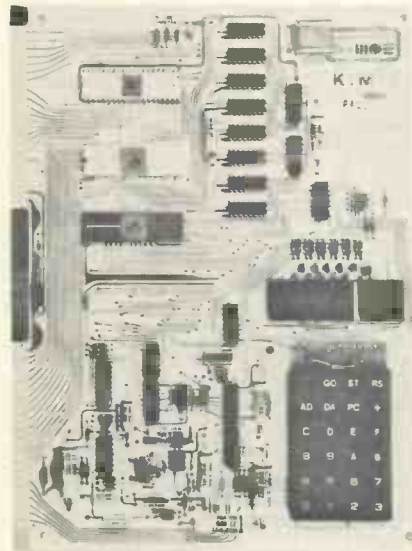

# Marshall's for Microprocessors and associated components

We distribute the fabulous KIM System — the ready to use microprocessor system — a new concept in microcomputers. Not a kit but supplied fully tested, wired and guaranteed. Expandable memory that grows with your system — not just an evaluation kit. Starting with KIM 1 at £108.00 VAT incl. you get immediate capability which can be expanded to a complete system capable of addressing up to 65K bytes of memory.

We also stock PET and a comprehensive range of ROMS, RAMS, PROMS, EPROMS, 74LS series, 74C series, microprocessor support components, the National SC/MP Microprocessor and the MEK 6800 DII kit. In addition to these we stock an extensive range of discrete semiconductors, passive components and DIL switches, etc.

Send for details to: MARSHALL'S ELECTRONICS Kingsgate House, Kingsgate Place, London NW6 4TA Tel: 01-624 0805  
Retail Sales London: 40 Cricklewood Broadway, NW2 3ET. Tel: 01-452 0161/2. Telex: 21492  
London: 325 Edgware Road, W2. Tel: 01-723 4242. Glasgow: 85 West Regent Street, G2 2QD.  
Tel: 041-332 4133. Bristol: 1 Straits Parade, Fishponds Road, BS16 2LX. Tel: 0272 654201.

**NEW 1979 CATALOGUE NOW AVAILABLE** 50p post paid or 40p to callers.

● Circle No. 146





# Pet program supermarket

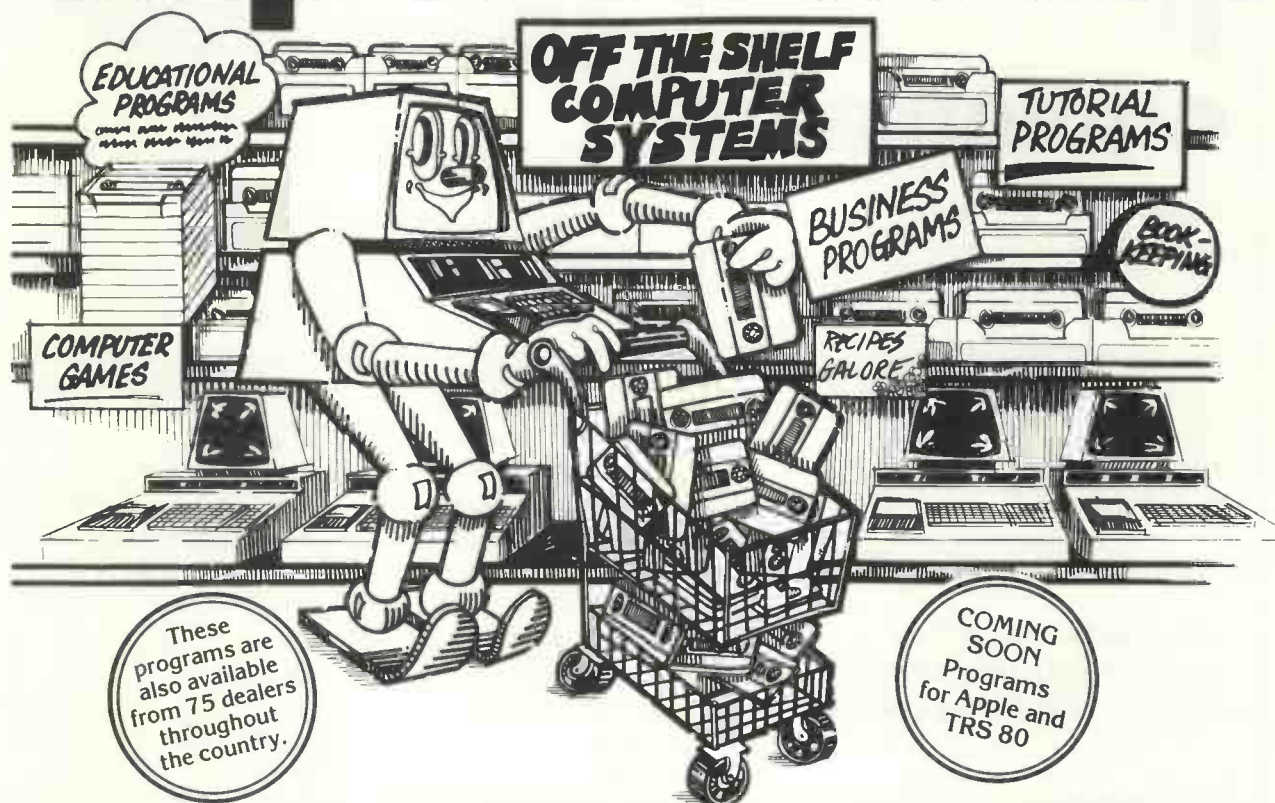

At last a whole menu of programs to feed your PET at prices which knock the bottom out of traditional software costs.

Our 16 page catalogue lists nearly 130 programs from £3 to £50 (including VAT). These cover Business Routines, Programming Aids to help you make the most of your PET and some super games to play with it. Here are just a few examples.

**TRY THESE PROGRAMS AT YOUR NEAREST PET DEALER** All our prices include VAT.

Addressbook £6	Estate Agent Pack £25	Microchess £14	Tax 78/79 £8
6502 Assembler/Editor £25	Graphics Package £12	Music £10	VAT Pack £17.50
Astrology £10	Invoicing £20	Payroll £25	
Backgammon £8	Linear Programming £8	Percentage Costing £49.50	
Bridge Challenger £10	Linear Regression £5	Pet Basic Tutorial £12	
Civil War £7.50	Line Renumber £8	Sales Analysis £10	
Data File Handler £12	Mailing List £15	Statistics £7	
Discounted Cashflow £8	Merge £8	Stock Control £12	
		Super Startrek £8	

For further details of these and the other 110 programs in our free catalogue, complete the coupon or call us today. We also accept credit card orders over the telephone.

**Petsoft** Specialists in personal computer programs,

5-6 Vicarage Road, Edgbaston, Birmingham B15 3ES.  
Tel: 021-454 5348 Telex: 339396.

Petsoft A member of the **ACT** Computer Group.  
PET is the trade mark of Commodore.

5-6 Vicarage Rd. Edgbaston, Birmingham B15 3ES.  
**MY PET NEEDS FEEDING** Please rush me a copy of your free 16 page catalogue of PET programs without obligation.

**Petsoft**

To \_\_\_\_\_

My name is \_\_\_\_\_

My PET lives at: \_\_\_\_\_



## Publisher's Letter

FROM a survey we completed recently of the number of microcomputers with an initial cost of less than £1,250 which are now in use in business, education and home environments in Britain, we estimate that there are now about 30,000 such computers installed. That number, of course, is growing at a tremendous rate.

They are being used for a wide variety of interesting and useful applications of the type you read about every month in *Practical Computing*. There are plenty more potential applications waiting for the right equipment, as instanced by the tremendous response to our most recent competition (for results see page 78).

As a reader of *Practical Computing* you will appreciate the usefulness of these computers and how they improve the quality of life in areas as diverse as teaching the mentally handicapped, improving financial reporting and planning school meals. Microcomputers are here to stay and the lives of more and more people are beginning to be affected by them.

In the circumstances, it is disquieting that there is still so much public apprehension about computers. There is far more awareness of multi-million pound gas bills caused by data processing errors than there are about paralysed school children being helped by micros to pass their A levels.

All of us involved in this field should do what we can to give computers a better image to the lay public. There is a tremendous role for computer clubs to play here. In the States, local clubs have set-up foundations solely for this purpose, and I was interested to meet Joe Rogers, vice-president of the Personal Computing Foundation of Houston, which "is a non-profit organisation devoted to informing and educating the general public in personal computing".

The Foundation is financed by donations, and its members are happy to help people obtain the best results from their computers. They take every opportunity to spread the word about the benefits small computers are providing. It seems to be one American example which would be well worth following.

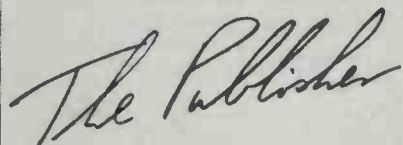

Our Feedback columns offer readers the opportunity of bringing their computing experience and problems to the attention of others, as well as to seek our advice or to make suggestions, which we are always happy to receive. Make sure you use Feedback—it is your chance to keep in touch.

### Pet behaviour

I AM a final-year psychology student and am an interested observer of the new behavioural patterns emerging within the family, as a consequence of my husband having bought a Pet computer for our home.

It seems to me that a basic fact concerning the human-computer relationship is that it is one-way. I do not doubt that the flow of information is two-way but I maintain that it does not constitute a true relationship. The computer provides information; in no way does it take into account the effect that it may have on the receiver. This new kind of relationship may be detrimental to the learning of normal behavioural patterns.

To give a specific example relevant to the Pet situation, man has always played games, partly because the process of problem-solving is stimulation, and partly because of the challenge it provides when competing with other people.

Pet, however, now acts as the opponent and as such all the subtleties of the relationship are missing. I have noticed how my children have learned very quickly to play various games which hitherto were of no interest to them—apparently because the learning situation is enhanced, feedback is immediate, and the frustration of waiting for the opponent to make a decision is absent.

For the young child, 'self' is a dominant factor, and as attention is focused on his own game-playing, the situation is inherently rewarding. But one of the benefits of game-playing is that the child learns how to behave with and towards others, how to cope with success and failure, and what effect it has on others. In the human-computer relationship, the child does not learn these valuable social skills.

It may be that as microprocessors encroach on human relationships even further, they may have a beneficial effect; people will certainly have access to more information and of a greater variety than before. I hope that the variety will encourage man to become less narrow-minded and more aware of others.

On the other hand, future generations may become less interested in others; and they certainly will have less opportunity to learn how to behave in social relationships. This may make for a more insular society, where challenges come from within self rather than from others.

Personality is not only a product of inherent traits but also develops through experience and interactions with others. I fear that unless man is aware of himself, not only as an individual but also as a social animal, society will suffer as a consequence.

Jennifer Adams,  
Streetly,  
Sutton Coldfield

### Records accounting

I HAVE been looking for some time for a software program suitable for incomplete records accounting but have so far failed to find any suitable for microcomputers. Do you have any information on the subject?

P. Finlay,  
Stratford,  
London E15

● There are many packages for incomplete

records accounting, ranging from cassette systems for Pet or TRS-80 at one end to turnkey microcomputer systems costing between £5,000-£12,000. This is an area which we intend to look at, though not in the immediate future.

### Beginner

I AM an O & M officer in a large computer-using company. In my job I am in increasing contact with computers, so I decided the best way to understand their basic principles was to build and use my own microcomputer and I could have fun doing it. Not knowing which way to turn, I bought your magazine, which gave me an insight into the obviously massive world of microcomputers and a few 'leads'.

I would be very grateful if you could recommend a good kit I could build. My knowledge is minimal and my needs are as follows:

- a computer able to handle both simple and more sophisticated games, with me being able to handle the programming.
- a VDU.
- tape input.
- ability to handle domestic accounts.
- potential for expansion without having to replace expensive units, as my enthusiasm is bound to become even more untrained.

Could you also recommend any books I could read on building, using and programming for the beginner, with a comprehensive dictionary of the baffling terminology.

W. Athinger,  
Manchester, 20

- We suggested a few titles including Rodney Zaks' *Introduction to Personal and Business Computing* and James White's *Your Home Computer*.

### Harrow group

YOUR READERS may be interested to know about the ACC Harrow group, which has been meeting regularly for several months. The meetings take place on alternate Wednesdays at 7pm in room 135 of Harrow Technical College and give both professional and amateur users the chance to get together and discuss their problems, and to advise those thinking of buying a system.

A software project is under way and a hardware group is being formed to build, initially, an EPROM programmer. We welcome anyone interested in microcomputers to visit us or to contact me on 01-950 4771.

Bazyle Butcher,  
Watford

### Satisfied

IN THE March issue Glossary, 'Foreground' is defined, but just as there are some people who insist that '0' means letter 'O' (when everyone knows it is a zero), so there are some who use 'foreground' and 'background' in exactly the opposite sense to you.

Not only that but there is a completely unrelated third definition to each word (see *Penguin Dictionary of Computers*).

Having had to learn Basic from a Hewlett-Packard manual, and having read several Basic handbooks since, I feel that your

(continued on page 31)

## TERMINALS FOR YOUR MICRO

# RAIR



### H1400 VDU Low Cost Video Terminal £550

● Circle No. 149

New low cost VDU featuring full cursor controls and 24x80 screen displaying high resolution upper case characters using a 5x7 dot matrix. Keyboard generates all 128 ASCII codes and unit interfaces through an RS232 interface at transmission rates up to 9600 baud. H1500 series features upper and lower case characters using 7x9 dot matrix integral numeric keypad, buffered editing, and printer port.



### DECWRITERS Keyboard Printers From £850

● Circle No. 150

Industry standard dot matrix keyboard printers featuring 132 column upper and lower case printing on standard listing paper at printing speeds of continuous 30cps or 180cps. KSR and RO versions available with a wide range of optional features.



### MICRODISC Minidisc Storage Terminal £950

● Circle No. 151

File oriented mass data storage minidisc terminal featuring random access by file name to 200,000 characters stored per diskette, interfacing through terminal and modem/CPU RS232 interfaces at up to 9600 baud. Powerful string search and editing options.



### HYTERM Text Printer Terminals From £1900

● Circle No. 152

Range of microprocessor controlled 'daisy-wheel' terminals for text processing applications, printing at 45cps over 158 columns with a wide range of interchangeable type fonts. Many advanced features including IBM2741 compatibility, graphics capability, 'absolute' tabbing, and variable character/line spacing.



### DATACASSETTE Cassette Storage Terminal £750

● Circle No. 153

Magnetic tape cassette unit storing 150,000 characters per cassette, communicating at up to 2400 baud through terminal and modem/CPU RS232 interfaces with full local and remote device control. ECMA, TI and NCR format compatibility options available.

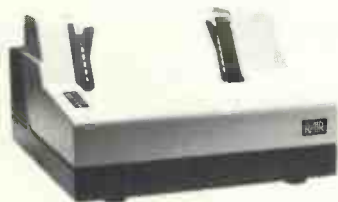

### LX100 SERIES Desk Top Printers From £1000

● Circle No. 154

New low cost range of desk top serial printers, printing over 80 or 132 columns at 100 or 180cps on standard listing paper using a 7x7 or 7x9 dot matrix. Options include VFU, second paper feed mechanism, 9x9 matrix with italic or expanded printing, buffered serial RS232 interface.



*continued from page 29)*

serialisation of *Illustrating Basic* is one of the clearest descriptions of the language I have seen. Once one is accustomed to Donald Alcock's personal style—which could take all of five minutes—his explanations are clear, his examples relevant, and his notes and warnings on the restrictions imposed by different dialects of Basic more useful than any others I've met.

Sgt. M. Bruce,  
BFPO 21

## Noughts and crosses

I WAS very impressed by the noughts and crosses game published in February and immediately ran the program on my TRS-80 (Level II 16K). After a time I discovered a bug in the program. If you play square 7 and 3, the computer takes 5 and 8; but if you then take square 1, instead of taking 2 to win, the computer will take 4 to block you. You can take 2 and win. The following modification takes care of the minor problem:

```
Add to line 80      K=0 PA:=-1:
and to line 870     K=3:
and to line 960     K=1:
and continue
1130 IF F=2 THEN M(PA)=-1:F:1
1135 RETURN
```

```
1150 IF PO=P THEN IF M(P+K)=-1:F=1
      M(PO)=-1:F=1:RETURN
1160 IF PO=P THEN IF M(P+K)=O THEN
      PA=PO:F=2:RETURN
1170 IF M(P)=-1 THEN M(PO)=-1:F=1:RETURN
1180 IF M(P)=O THEN PA=PO:F=2:RETURN
1190 M(PO)=-1:F=1:RETURN
```

Thank you for a most informative and interesting magazine.

David Sellwood,  
Leigh, Lancs.

## Nascom fan

As a newcomer to computing I have been buying your magazine since issue 2. I find that I am beginning to understand more as time passes but would appreciate more beginner-type articles—particularly on the software side.

I have a Nascom-1 and hope to expand this as my increasing knowledge permits. I am writing to support your idea of a page for Nascom owners. Although I would not be able to contribute much at present, I certainly would like to see such a development for the following reasons:

- there is now a large number of Nascom owners.
- we are supporting home-produced equipment (to some degree, anyway).
- it will provide more programs relating to Z-80.
- The Nascom system is now becoming increasingly versatile.

C. Bowden,  
Truro, Cornwall

## Petsoft payroll

I ENJOYED the February issue of *Practical Computing* and felt that your comments on our payroll program were both fair and accurate.

Nowhere in the article, however, did it mention the names of the publishers, authors or distributors. For the record, they were all us. I would be grateful if you could include a note of this fact, as we have received a number of enquiries from readers asking whether we could supply this program.

Julian Allason,  
Petsoft,  
Newbury

## Tape standards - 1

I WAS interested to read the article on the proposed new Tape Cassette Standard by Bert Martin in the February issue. Since

purchasing a Nascom-1 late last year, and being the owner of a Philips N2229 audio-visual tape cassette machine, I have been thinking about ways and means of improving the speed and convenience of data transfer between the computer and the N2229. I had come to similar conclusions to Bert Martin.

The Philips machine has, I believe, some advantages over the more expensive stereo machines listed by Martin—it is cheaper; its track width is double that of a stereo machine, thus improving the signal-to-noise ratio and reducing the probability of drop-out; its input for recording slide-changing pulses also provides for the remote control of the tape drive motor; it is claimed by the makers to have a very rapid response to the sensor start/stop control.

One possible drawback to the N2229 is that it records only two tracks (sound and control) and thus can be used only on one side if the control track is to be retained. Personally I don't think this is a serious problem.

The frequency response of the normal channel is better than 10KHz, thus allowing a high data rate to be recorded—say of the order of 2,400 baud, or 10 times the Nascom rate. The re-wind and fast-forward speeds are approximately 25 times the normal tape speeds.

I have had some experience with Hewlett-Packard desk-top computers, in particular the 9821A which has a built-in cassette unit. The ability to label and record files from the keyboard, and later to call up files by number at the fast tape speed, is a great advantage; I think such a feature should be allowed for in any proposed new specification.

When long programs or large amounts of data are being transferred, though, it is surprising how tedious the waiting before proceeding with the job becomes. This emphasises the need for any specification to provide for the highest rate of reliable data transfer, and for the rapid location of the start of any particular file.

One further aspect of microcomputer use is the need to make hard-copy. The high capital cost of printers is likely to deter many enthusiasts. To postpone such an investment, I have considered the use of a Polaroid camera with a suitable mounting frame to ensure reliable pictures of the video display.

The Polaroid Instant 30 (£20 approx) or the R100 (£40 approx) using the black and white film-pack type 107 (34p per exposure size 85mm x 73mm) would allow some 1,000 photos to be taken before the cost of a printer is approached.

The characters would be about 4mm x 2mm (the capital letters on your page are approx 2mm x 2mm). A close-up lens would be required to focus down to about 400mm for a 12in. screen. Some arrangement to assure optimum exposure from the auto exposure system may also be required.

The copying rate would be about 20 characters per second from the Nascom display.

It is my intention to develop both these systems after my Nascom-1 is working properly and I have gained some experience in its use.

I would be willing to co-operate in the development of the proposed cassette system by passing on the results of my work with the N2229.

K. Russell,  
Sunbury-on-Thames,  
Middlesex

## Tape standards - 2

RE Bert Martin's article on the proposed cassette standard, my company has spent some time and money working on a cost-effective system with a reasonable degree of success.

We recorded a 'clock' on the top track and

data pulses—not tone bursts—on the bottom. Each word is recorded twice with the usual parity checks. The amps (our own) drove a CPU input port direct; the amps cost less than most people spend on tone filters.

De-coding is done by a simple software program which also allowed the tape to be read in reverse. Bit 8 was used as the tape direction indicator; bit 7 was clock and bit 6 the data. Bits 5, 4 and 3 can provide not only multi-machine inputs but also allow multiplexing of simultaneous transmissions.

Being independent of frequency, the tape speed has an enormous tolerance. Our Z-80 system was able to receive data at 1.5K bits per second with infrequent errors. Each program or file had a leader consisting of a number of tone pulses recorded at the search speed—the data was beyond the amp cut-off during search.

It is a very simple matter to strip-down a cheap mono cassette recorder, abandon the capstan drive, fit an end-of-tape direction reversing mechanism, and induce the whole thing to run at the two required speeds. It is also easy to purchase and fit a stereo head and replace the electronics with some which will handle logic signals; this includes 'record', which we managed to do satisfactorily using only half of a 4011 and a few resistors—DC bias, of course.

In fact, once you have had the courage to abandon the text books and all that's dear to the hi-fi man, you will find the whole thing really easy.

Our systems are rather specialised, and don't use ASCII, Basic or the S100. As such, our software would be of little use to most but if anyone is really interested in trying one, I would be pleased to furnish details—all of them. You see, we have rather lost interest since we developed our eight-track car-type cassette system.

If this system, including a ROM for the software, costs you more than £50 in all, you have robbed yourself.

John Allen,  
Portsmouth,  
Hants.

## Looking to Ohio

I AM 16 years old and I want to buy a Challenger IP computer made by Ohio Scientific. My father is a bit uneasy about sending \$349 to the States for it, so could you please tell me if you know of any company in England selling the same computer?

Can you also recommend to me any other personal computers, which run on Basic, are reasonably cheap, and are ready-built? I am very inexperienced when it comes to the hardware side.

R. Goli,  
Wolverhampton

● Ohio has a main U.K. distributor, Abacus Computers Ltd, (01-637 0777). Abacus has arranged several local distributors around the country and will be able to put you in touch with your nearest one. Be warned, though—the price won't be anything like \$349.

## Award winner

THANK YOU for your kind response to my letter about word processing. It has since occurred to me that your readers might be interested in the award-winning SCRIB from Bobst Graphic of Switzerland.

It is a micro for journalists—built-in screen printer, transmitting unit and excellent word processing unit. A write-it-and-send-it-down the-blower-straight-to-the-composing-room-from-the-public-phone-box-in-Timbuktu kind of dream for the roving reporter, it attracted much attention, and collected an award, at the Wescom '78 exhibition in Los

(continued on page 33)



# INTRODUCING DUAL DRIVE MINIFLOPPY FOR PET!

**£833**  
+ VAT



(Phone for your nearest dealer)

- DUAL MINI FLOPPY DRIVE WITH 100K PER DISK SIDE FOR TOTAL 200K ON LINE
- DESIGNED FOR COMMERCIAL SPEED REQUIREMENTS
- FAST LOADING SPEED

- DISKMON™ (DOS) AUTOMATICALLY REORGANIZES FREE DISK SPACE AFTER SAVE OR ERASE
- DISKMON IS RESIDENT IN ROM VIA DISK CONTROLLER BOARD PLUGGED INTO EXPANDAPET™
- DISKMON ADDS 14 COMMANDS TO BASIC INCLUDING DISK DATA FILES
- DISKMON COMMANDS SUPPORT COMMERCIAL PRINTER OFF PARALLEL PORT SUCH AS CENTRONICS 779
- FULL DISK SOFTWARE SUPPORT
- FORTRAN & PLM COMPILERS
- 90 DAY MANUFACTURER'S WARRANTY ON HARDWARE
- READY TO USE ON DELIVERY, WITH FULL INSTRUCTIONS AND UTILITY DISKETTE
- CALL OR WRITE FOR ADDITIONAL INFORMATION
- Ex STOCK
- THIS SYSTEM IS FULLY SUPPORTED BY SOFTWARE FROM THE MANUFACTURER
- DELIVERY NOW

DKH641 — DUAL DRIVE SYSTEM, COMPLETE WITH DISKMON ..... £833 + VAT

DKL067 — DISKMON ASSEMBLER LISTING/DOS ..... £19.95

ASM789T — PET-ASSEMBLER ON CASSETTE ..... £19.95

ASM789D — PET-ASSEMBLER ON DISKETTE (5.5 inch) ..... £39.95

LNK456 — AUTOLINK LINKING LOADER ON DISKETTE ... £39.95

FOR300 — FORTRAN COMPILER ON DISKETTE ..... £59.95

PLM400 — PLM COMPILER ON DISKETTE ..... £39.95

★★ BUSINESS PACKAGES STARTING IN 1st QUARTER 1979 ★★

• THIS SYSTEM REQUIRES EXPANDAPET MEMORY (MINIMUM 16K— SEE BELOW)

## INTERNAL MEMORY EXPANSION FOR PET!

### EXPANDAPET™

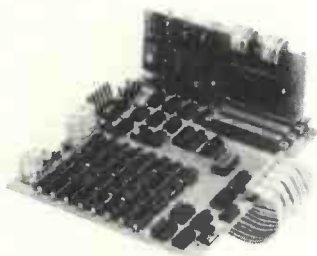

32K UNIT ALLOWS 8K OF ASSEMBLY LANGUAGE SUBROUTINES ACCESSED VIA THE USR COMMAND

OPTIONAL PLUG-IN BOARDS  
SERIAL I/O BOARD P.O.A.  
S-100 I/O BOARD P.O.A.  
4K EPROM BOARD P.O.A.

### INTERNAL MEMORY EXPANSION UNIT

- MOUNTS EASILY INSIDE YOUR PET
- EASY TO INSTALL (15 MINUTES)
- NO DEGRADATION OF PET SYSTEM
- USES LOW POWER DYNAMIC RAMS
- 90 DAY PART & LABOUR 1 YR-RAMS
- 30 DAY MONEY BACK GUARANTEE
- MOUNTING SLOTS FOR 4 BOARDS
- CALL/WRITE FOR ADDITIONAL INFO
- DEALER INQUIRIES INVITED

**EXPANDAPET PRICES**  
16K (+ 8K PET = 24K) ..... £261 + VAT  
24K (+ 8K PET = 32K) ..... £320 + VAT  
32K (+ 8K PET = 40K) ..... £374 + VAT

### MUSIC BOX

Turns your PET into a programmable musical instrument. You can record and play up to 90 pages, 16 notes per page, change tempo, key, etc.

£37.50 inc. VAT & P&P

### T.I.S. WORKBOOKS

A set of 5 workbooks to give you a full understanding of all the ins and outs of your PET more fully than any previous manuals.

£15.95 per set, inc. P&P

Lots of software and other goodies.  
Send large SAE

## OHIO SCIENTIFIC SUPERBOARD II

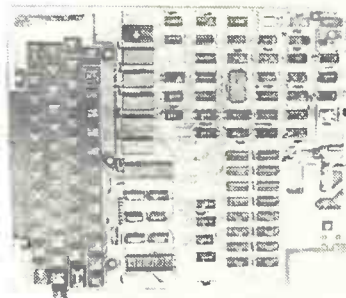

£263 plus VAT

### Standard Features

- Uses the ultra powerful 6502 microprocessor
- 8K Microsoft BASIC-in-ROM
- Full feature BASIC runs faster than currently available personal computers and all 8080-based business computers
- 4K static RAM on board expandable to 8K
- Full 53-key keyboard with upper-lower case and user programmability
- Kansas City standard audio cassette interface for high reliability
- Full machine code monitor and I/O utilities in ROM
- Direct access video display has 1K of dedicated memory (besides 4K user memory), features upper case, lower case, graphics and gaming characters for an effective screen resolution of up to 256 by 256 points. Normal TV's with overscan display about 24 rows of 24 characters, without overscan up to 30 x 30 characters.

### Extras

- Available expander board features 24K static RAM (additional mini-floppy interface, port adapter for printer and modem and OSI 48 line expansion interface).
- Assembler editor and extended machine code monitor available.

Fully built and tested. Requires only +5V at 3 amps and a videomonitor or TV and RF converter to be up and running. Phone or write for delivery dates. Full one year warranty.

**LOTUS SOUND, 4 MORGAN ST., LONDON E3 5AB**  
(Dealer Enquiries Invited)

Tel: 01-981-3993 Telex: 261426 Attn: Lotus Sound

(continued from page 31)

Angeles. I'm not sure if it is available in England.

More power to your Printout. By the way, I don't have shares in Bobst Graphic.

G. Peter Winnington,  
Orzens,  
Switzerland

## For MK14 users

As a Science of Cambridge Mk 14 owner, I would be obliged if any of your readers could put me in touch with a users' club. If no such club exists, I should be interested to exchange Mk 14 experiences with other Mk 14 owners.

How about an article on the most economical cassette recorders to use as a storage medium—can inexpensive models be used, or are there certain basic requirements which these machines do not fulfill? And how much care needs to be taken when using recorders? How often does the head need demagnetising?

J. G. Walton,  
Newton,  
Derbyshire

## Numeral input

I AM in the process of establishing the use of an Apple II for a small business application. As you know, this machine has a Qwerty keyboard with the numerals along the top.

I should like to know whether you are aware of anyone selling a separate numeral keyboard which could be wired to the Apple to improve the hand motion when the input is mainly digits.

A. C. Maule,  
Harrogate

● We do not know of any specific supplier but suggested two potential sources.

## Mix'n-match

As a Nascom owner, I was delighted by the recent mention in Printout of the possibility of a Nascom page and I am sure that this will prove to be very popular.

Although I have recently taken a subscription to *Practical Computing*, I am a little disappointed in the contents. My criticism centres on the hardware side of your magazine most of which seems to be aimed at the enthusiast building-up a system by buying add-on units from one particular firm.

There are, however, people who like to mix'n-match their own systems, either for personal preference or for cheapness and versatility. I even hear that there exists a strange breed of masochists who like to design and build things from scratch or is this just a rumour?

What such individuals require is hard technical information, particularly in relation to interfacing. To give a concrete example, I must have seen RS232, 20mA Loop and S100 in print thousands of times, but not once have I ever encountered a detailed exposition of any of these formats.

K. B. Cusson,  
Doncaster

● We are planning more 'hobbyist' articles, including a discussion of these standard interfaces.

## Manchester plea

I WOULD like to compliment you on its general content and layout. Doubtless it can be improved, but as far as a newcomer to the computing world is concerned, it seems to do what is required of it.

I read that various parts of the country have Pet users' groups and the like. Is there such a group serving the northern half of the Greater Manchester area? After all, the sales of these machines in the area must be large by

now; and from discussions with some owners I find that there are many mutually-experienced problems which refer either to lack of experience of the operative, or machine errors, or machine instruction manual errors, or commercially-available programmes being unsuitable or inadequate for the tasks in hand.

In many cases, the inadequacies and difficulties will be sufficient to deter people from buying the machines once the news gets round and the novelty value fades. This would be a pity from everyone's point of view, whether as manufacturer, dealer, journalist or user of the contraptions.

The only real solution to the general problem is the proliferation and exchange of knowledge in the field. This is obviously where your magazine has its best and growing market, but while magazines are excellent in their way, they cannot replace entirely personal contact between experienced people who share the same problems. They can, of course, supplement the contact and reduce the need without eliminating it, and for this reason I wish you continued success.

R. F. Doran,  
Bacup,  
Lancs.

## Tandy problem

I WAS glad to see the Tandy Forum. A reading of your first effort has raised a question and a problem, though.

Who is publishing the *Guide to TRS-80 Information*? Your article gives the address but not the author or publisher. I don't know to whom to send my cheque in Oak Park.

I can't get Freddie Nicholls' 'square' program to run with my Level I 16K configuration. When I hit RUN I get two horizontal lines of the correct length, separated by the correct vertical distance, but no vertical lines appear to complete a square.

Timothy Meno,  
Eastcote,  
Middlesex

● The *Guide* is published by F. Huebner, Box 37206, Oak Park, MI 48237.

## Addictive

I WAS very interested in the two articles on epic games in your February issue, both of which referred to Willie Crowther's game *Adventure*. Unfortunately, the appeal of it is limited severely by the coding being in non-standard Digital Fortran and the core requirement is very large.

Recently I have removed the first of these restrictions from a new version of *Adventure*—with more caves, features and fun—by writing it in standard Fortran.

Although I reduced the core requirements wherever possible when programming, a more substantial reduction could probably be made by using Nick Hampshire's suggestion of 'text packing'. Does anyone have a working scheme to do this, or is anyone interested in developing such a scheme?

With the proliferation of microcomputers with limited RAM, there could be a wide application for a good text packing scheme.

If anyone is interested in running my *Adventure II* they could get in touch with me. I am particularly interested at the moment in getting it to run on a smaller machine to see if fine-tuning of the program output is necessary to accommodate any delay in program response.

I must issue a word of warning, though, to anyone who has not played *Adventure*. It can be very addictive, so unless you are very strong-willed or have plenty of spare time, think twice before getting involved.

In Feedback in your March issue you give

the address of a computer club in Sussex; have you the address of one near Bedford?

Jack Pike,  
Chawston,  
Beds.

● No, we haven't, but both the Independent Pet Users' Group and the Amateur Computer Club have groups around the country. It would be worth contacting Mike Lake of IPUG, (19 Littleover Lane, Derby) or Mike Lord of ACC (7 Dordells, Basildon, Essex). We are trying to put together a new, improved directory of user groups and computer clubs, so anyone with a contribution to make could contact us.

## Jargon program

I OFFER for publication the attached program and sample runs. As a regular reader of your magazine. I have become disappointed at the lack of impenetrable jargon, especially in your correspondence column.

To help readers in their search for "the original cliché", the meaningless profundity, I have devised this program, which automates the process fully. The ABG will be an invaluable aid to all those with nothing to say, and an urge to say it.

The program was written in a Hewlett-Packard Basic, which has a few quirks worth pointing out:

Line 150—DIM A\$(17)—gives a string variable 17 characters long, not 17 subscripted strings.  
Line 310—this Basic does not allow RND(X) when X does not have a value assigned. Also, RANDOMIZE statement may be necessary in other Basics to prevent the program always starting in the same place.

Apart from these features, the program is fairly simple—and could be simplified even further, for example by placing the subroutine in the main program body.

```

10 REM ****AUTOMATIC BUZZPHRASE
GENERATOR****
20 REM ***A P SHELBOURNE, FEB 79***
30 REM
100 REM **** CONTROL AND PRINT
SECTION****
110 PRINT
120 PRINT "AS OF NOW, AT THIS MOMENT IN
TIME, THE CURRENT"
130 PRINT "AND CONTEMPORANEOUSLY
FUNCTIONAL BUZZPHRASE IS"
140 PRINT
150 DIM A$(17)
160 Z=1
170 FOR I=1 TO 3
180 GOSUB 300
190 REM ****RANDOMISES AND READS
LIST*****
200 PRINT A$;
210 NEXT I
220 PRINT
230 PRINT
240 PRINT "HAVE A NICE DAY!"
250 GOTO 600
260 REM
300 REM ***RANDOMISING SUBROUTINE***
310 X=1
320 A=Z+INT(10*RND(X))
330 REM ***THE FOLLOWING DATA CONSISTS
OF 3 LISTS OF 10 WORDS****
340 REM ***OF 3 LISTS OF 10 WORDS****
350 DATA "ONGOING","OVERALL",
"SYNCHRONISED"
360 DATA "COMPATIBLE","MEANINGFUL",
"OPTIMAL"
370 DATA "SYSTEMATISED","VIABLE",
"INTEGRATED"
380 DATA "RESPONSIVE","STRUCTURAL",
"ORGANISATIONAL"
390 DATA "THIRD-GENERATION",
"TRANSITIONAL","REAL-TIME"
400 DATA "RECIPROCAL","OPERATIONAL",
"DIGITAL"
410 DATA "LOGISTICAL","INCREMENTAL",
"SCENARIO"
420 DATA "CONCEPT","PROGRAMMING",
"HARDWARE"
430 DATA "SITUATION","CONTINGENCY",
"SOFTWARE"
440 DATA "FLEXIBILITY","OPTIONS",
"CAPABILITY"
450 FOR J=1 TO A
460 READ A$
470 NEXT J
480 Z=Z+10
490 RESTORE
500 RETURN
510 REM
600 END
    
```

A. P. Shelbourne,  
London, SW18



**TVJ**

# MICROCOMPUTERS ETC

For Hardware, Software,  
Peripherals, Consultancy  
and Competitive Prices.

(0276) 62506



## PET Pet 2001 From £435

NEW PET 2001 with large keyboard.  
From £ 630.00

- PET 2040 £ 695.00  
Dual drive mini-floppy 343K Net User Storage
- PET 2001 16N £ 630.00
- PET with 16K bytes of memory and new large keyboard
- PET 2001 32N £ 750.00
- As above but with 32K memory
- PET 2001-4 Standard Pet with 4K memory £ 435.00
- PET 2001-8 Standard Pet with 8K memory £ 515.00
- PET 2023 £ 515.00
- 80 column dot matrix printer with PET graphics
- PET 2022 £ 605.00
- As above with tractor feed.
- IEEE/RS232 Serial Interface 'A' Output only £ 106.00
- IEEE/RS232 Serial Interface 'B' Input/Output £ 186.00
- IEEE-488/Centronics type Parallel Interface £ 45.00
- PET C2N External Cassette Deck £ 50.00
- Interface to S100 (4 slot motherboard) £ 112.00



Sorcerer Now with the  
S100 Bus expansion  
interface and dual drive  
mini floppy disk.

- Exidy dual drive mini floppy disk £1200.00
- 630K Net User Storage
- Exidy S100 Bus with Interface +motherboard+PSU+case £ 200.00
- Sorcerer 16K Ram £ 740.00
- Sorcerer 32K Ram £ 840.00

### Ansaback

'Phonemate' Telephone Answering Machine, voice operated twin cassette £ 190.00

### Disk Drives

- Shugart Mini floppy disk drive (incl PSU) £ 350.00
- Micropolis Mini floppy disk drive (incl PSU) £ 350.00
- SMS STD floppy dual drive (+controller+PSU+Case for 2.5 megabyte) £2500.00
- Pertec 10MB Top Load Hard Disk System (with controller+disk basic) £6400.00

### APPLE II

- ITT 2020 incl PAL Modulator (16K RAM) £ 895.00
- RS232C Serial Interface for Apple II Motherboard POA
- Parallel Input/Output Interface for Apple II Bus POA

## ALTAIR

300 Multi User Multi Tasking system +floppy & hard disk options (demonstrations of practical business applications at Camberley) POA

### Software

## Petsoft COMPUSSETTES Personal Software

- (authorised dealerships - send for catalogues)
- PILOT (for TRS 80) text orientated language £ 18.00
- Estate Agents/Employment Agency Systems -
- CP/M - Fortran 80 - Cobol 80 - Pascal

If you don't see it - ask if we have it.



## TRS 80

From £350

- TRS 80 16K Level I Keyboard with 16K memory +VD +VDU+Cassette drive £ 595.00
- TRS 80 16K Level II - as above but with Level II basic £ 665.00
- TRS 80 4K Level I - Keyboard +240V PSU only £ 350.00
- TRS 80 4K Level II - Keyboard +240V PSU only £ 420.00
- TRS 80 Expansion interface with 16K Ram £ 325.00
- TRS 80 Expansion interface with 32K Ram £ 435.00
- RS232C Serial Interface for TRS 80 £ 45.00
- Screen Printer for TRS 80 (text+graphics) £ 400.00
- Disk Drives for TRS 80 - see disk drives
- UHF Modulators (used with leads & PSU for 625 lines) £ 25.00
- RAM upgrade (4-16K 16-32K 32-48K) Supplied & fitted at our premises
- Upgrade to increase speed from 1.78MHZ to 2.66MHZ £ 13.00
- 'Beeper' audible tone for CSAVE/CLOAD & key functions £ 40.00
- Switchable selection of level I or Level II (Level I & Level II roms required) £ 25.00
- Automatic volume control (AVC) for CLOAD £ 25.00
- 'Electric Pencil' text/word processing package C/W lower case mod. (Supplied & fitted) £ 93.00
- 'Electric Pencil' text/word processing package (on cassette) inc documentation £ 65.00
- S100 Interface for TRS 80 POA
- 'Library 100' - 100 programs for TRS 80 on cassette £ 39.00

### Printers

- TELETYPE 43KSR £875.00
- Keyboard send/receive Serial printer for PET or TRS 80

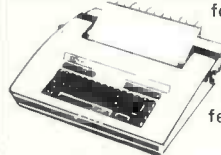

(Interfaces or friction feed extra)

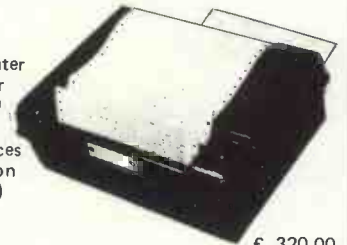

- Expander Black Box £ 320.00
- 80 column impact printer
- Centronics 779 parallel printer £ 790.00
- Centronics 701 parallel printer, Bi-directional+tractor fed £1375.00
- Centronics micro printer (40 columns) £ 330.00
- QUME 'Sprint 5' daisy wheel serial printer - as new, (pinch+tractor feed+other options included) £2095.00

### In/Out

- Altair 6801/2 Analog/Digital convertor board S100 £ 382.00
- Altair 6804 Process control interface 8 output relays/12 Input channels. S100 board £ 275.00
- Phone Modem £ 115.00
- (For Pet/TRS 80/Sorcerer/Apple see headings)

### Terminals

- Soroc IQ120 VDU/Keyboard -80 char/24 lines £ 660.00
- Cypher CUB VDU+separate keyboard £ 380.00

### Etc.

- Diskettes 5 1/4 (blank) Boxed (Min order 10) each £ 3.00
- C60 Cassettes (Min order 10) each £ 0.40
- Computalk - Speech synthesis S100 Board £ 350.00

### JADE Authorised dealers.

PRICES EXCLUDE VAT, FREIGHT & HANDLING. SEND OR PHONE FOR PRICE LIST & BROCHURE

Directors: Dr. R.V. King, BA, MIEE  
S.G. Johnson, BSc. (Hons)  
T.S. Johnson, ABIBA, ACMB, FBSC, MBIM  
A.S. Barton, ACII, ABIBA, CdipAF



T & V JOHNSON (MICROCOMPUTERS ETC) LTD.  
Member of the TV Johnson Group of Companies  
165 London Road, Camberley, Surrey GU15 3JS

Branches at: Birmingham, Bristol, Edinburgh, Leeds, London, Louth, Newmarket, Nottingham, Oxford, Byfleet, Wokingham.

**(0276) 62506** Ansaback eves + wends  
Telex: 858893

Eves. Basingstoke (0256) 24787 & Farnham (0252) 721094  
(+ ansaback during office hours)

Hours of business 9.30 - 5.30 Mon-Fri. 9.30 - 1.00 Sat.



## CompuColor II available now in the U.K.

THE COMPUCOLOR II personal computer is now available in quantity in the U.K. Launched by CompuColor Corporation of Georgia about a year ago, the model has been seen rarely in this country because of distributorship problems.

Abacus is the official importer and a contract has been signed whereby Abacus will receive an agreed percentage of all manufacture for sale here.

CompuColor II has jumped rapidly to fourth in the hobby-

ist popularity stakes in the U.S. and ranks after Tandy, Apple and Pet. No doubt it will soon become a firm favourite in the U.K.

The basic model is the CompuColor II Model 3 which costs £1,390, and standard features include a 13-in. eight-colour display, a 72-key detached keyboard, a built-in minifloppy disc drive and 8K RAM for user programs, with Basic as its language.

Other features on Model 3

include 16K extended disc Basic in ROM, a VDU giving 64 characters per line by 32 lines per page, and graphics with 128 × 128 point plotting, I/O ports including one RS-232 serial asynchronous channel for printer or modem, and discs with a 51.2K bytes/side capacity. Operating instructions and a sampler floppy disc containing a variety of programs complete the system.

The 8K version is expandable but you can go straight for the 16K and 32K versions. Options on the keyboard comprise expansion up to 101 and 117 keys. Ready-made software will also be available, including games and business packages.

The microcomputers are on sale now and can be seen at several retail outlets, including the Byte Shop in Gants Hill and Trans-Am of Chapel Street, London.

Hopefully, someone will soon be starting a users' group in the U.K. for this much-heralded machine. In the meantime, you may be interested in writing to CompuColor in the U.S. for a copy of its monthly newsletter. Contact Susan Sheridan, manager, Technical Publications, CompuColor Corp., PO Box 569, Norcross, Georgia, 30071.



## Studying impact of micros

A SPECIAL one-day conference and micro exhibition to explore how microcomputers will impact data processing management is to be held on May 23.

Organised by *Practical Computing* and the Institute of Data Processing Management, topics to be covered are: Microcomputers—introduction and review of the present microcomputing scene, by Richard Hease, managing director, *Practical Computing*; how the microcomputer has already effected data processing management in the U.S., by Joe Rogers, vice-president of the Personal Computing Foundation, Houston; the office of the future, by Alan Patterson, Logica; the impact of microcomputers in traditional data processing areas, by Commodore, manufacturers of the Pet; and an application of microcomputers in a large organisation, by Robert Bittlestone, Roneo Vickers.

Cost of one-day event is £7 for members of IDPM and £10 for non-members; it includes a buffet lunch.

Venue is the Bloomsbury Centre Hotel, London, and tickets are available from The Institute of Data Processing Management.

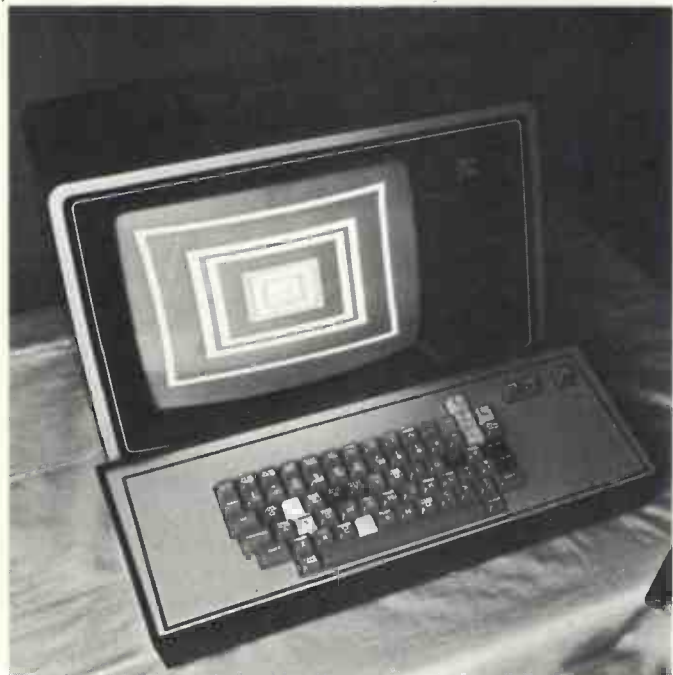

## Attache shows its parentage

ONE OF the neatest desk-top microcomputers we have seen, the Pertec Attache, is new to the U.K. this month.

It is in an elegantly-styled white case with a full 64-character ASCII keyboard, the well-liked configuration of the very successful Apple II. The processor is a 2MHz Intel 8080 and the standard features include 10 S-100 slots in the compact cabinet.

In a sense the Attache is Pertec's first microcomputer. The systems sold here with some success by Compelec derive directly from the Altair designs acquired when Pertec took over MITS.

The Attache shows that parentage, notably by using the

S-100 bus and Intel processor, but in other respects it appears to be a different design.

The system includes 16KB memory, a video interface, and the usual cooling and power supply. At 25lb, it probably qualifies as portable, too. The price is £1,737.

You will probably want to add your own video screen and some external storage. There is a Kansas City cassette interface but much more attractive is the Attache floppy disc subsystem—it costs another £1,700 and gives you twin 8in. floppies storing 310KB apiece, though not in IBM-compatible format.

A double-density disc subsystem costs £2,200. You will

also need an easy programming language and there is a disc Basic for £41. A printer can be plugged into the serial interface provided; alternatively, you might pay £208 for a parallel printer interface, which will probably be a better bet.

So by our calculations you could put together a neat and reasonably powerful Attache system with, say, 32KB memory and dual single-density floppies for about £3,850. For another £1,500 or so you could have a screen and a decent printer.

The sole U.K. agent, Moncoland, has also made some attractive business packages available at low prices. All modules cost £30 apiece and

that means you can have a complete order processing system—order entry, stock control, customer records, and invoicing—for £120.

The same price would buy an accounts-payable suite with purchase ledger, cheque payments, VAT, and buying records. There are also groups of applications covering sales and nominal ledger and payroll—with personal records too; that is unusual.

Moncoland is arranging distributors. We know of four—Keen Computers in Nottingham, Alba in Renfrew, Lion House in London, and GBH in Cardiff. We understand there are a few distributorships still available.



# Looking for faster management aids

SIPHER DESIGNS has a micro-processor consultancy package (MCP) which has been tailored to provide clients with an "objective assessment of how microprocessor technology could help solve specific problems or improve their individual business or manufacturing operations".

Each study will help the understanding of new technology and Sipher hopes that

once this knowledge has been grasped, you will be able to think of ideas on how to make the best use of computers. It also hopes to identify areas where the technology could be applied most successfully.

A consultancy approved under the Department of Trade and Industry MAPCON scheme, Sipher will look for benefits such as savings in raw materials and energy through

more efficient manufacturing processes, quality and reliability, reductions in stock levels, shorter operator learning times and machine setting times.

Better and faster information for management and control, the ability to undertake operations or processes previously considered too difficult, hazardous or costly, and better health and safety conditions will also be examined.

The consultancy says that a typical four-to-six-weeks' study, producing a formal presentation of the final report, identifications of microprocessor solutions and an estimate of probable costs and time-scales, will cost around £2,500 plus VAT and expenses. A proportion will be covered by the DoI.

So far, Sipher has only one customer, although others have been approached, and it is now awaiting replies.

# Nasco's £1 million order for chips

NASCO, Nascom Microcomputers parent company, has reorganised its semiconductor distribution business, following the runaway success of the Nascom-1.

Nasco buys all the components which make the popular computer kit and placed an order recently worth almost £1 million with Mostek for chips. It was reputedly the biggest order placed by a British firm for this type of component.

This is reflected by the competitive price structure of its semiconductor range and has helped the Nascom-1 fall again in price to £165, excluding VAT.

Nasco will offer a wide range of semiconductors and TTL, especially low-power Shottky. Apart from standard CMOS devices, many of the more specialised MOS devices used within the digital industry are

available, together with memory products, microprocessors and peripheral products from most of the big names in the business.

Staff increases in the sales and marketing divisions are on the way to promote a more direct selling drive. More information from Nasco on (02405) 75151.

# Lincoln society prospers

A FASCINATING letter reached us from Lincoln from Michael Lyne, chairman of Lincoln Microprocessor Society.

Two issues ago we mentioned the forthcoming inaugural meeting, and it seems to have gone well.

"It was a foggy and unpleasant night yet our most optimis-

tic hopes for attendance were easily surpassed; between 300 and 400 people crowded into the hall and extra chairs had to be sent for", writes Lyne.

The public was most interested in an exhibition of microcomputer and of micro-electronic devices contributed by local firms. The College of Technology mounted "a comprehensive display to show the possibilities and emphasise the complication of applying microelectronic control in a number of applications".

Dr John Todd of the City Hospital, Nottingham, demonstrated a 'lung function calculator' which he and two

# Drive for members

THE MEMBERSHIP drive by the Intel MDS Users' Group has attracted some 50 new members.

Membership is free, the group being an informal organisation of Intel MDS users, including representatives of many large companies such as EMI, GEC, Hawker Siddeley, ITT, Plessey, the Post Office, Pye, and STC, plus several smaller companies and educational establishments; a few European organisations are also represented.

The group is keen to expand its membership further. Any organisation or individual wishing to join should contact Lewis Hard on 0234 41685.

The group intends to launch a small newsletter in the near future to provide a "common information platform", as well as information about members' products and services. It will also keep members up-to-date with new Intel products and developments.

# Micro keyboard

STAR DEVICES of Newbury, has a low-cost ASCII-coded keyboard designed specially for microprocessors.

This data input terminal features seven-bit parallel ASCII-encoded output with positive and negative strobe edges, full ASCII character set, auto repeat, audio feedback, low-profile plastic case and requires 5V at 200mA.

Optional extras include serial RS232 output, 20mA current loop, parity check bit, on-board 5V regulator, and open collector outputs, active high or low.

The all-in price for the unit is £37.50, including VAT and post and packing, a handbook and edge connector. Further details from Star Services, PO Box 21, Newbury, Bucks.



colleagues built in six months at a hardware cost of £300.

Membership of the society is now more than 70 and increasing. Requests apparently include a session for women on the future of microelectronics in the home, the trade union point of view, an evening in depth on a single computer and a series of evenings specially for the under-18s.

Membership secretary is Elizabeth Nurser, The Chancery, Minster Yard, Lincoln.

# Ready for change

THERE ARE plans for Sumlock Bondain to replace the North Star Horizon 32K processor being used in its Book-Keeper installation in the near future.

The present configuration, which has the unit built into a neat desk-type unit, will not be changed substantially in appearance as a result.

Sumlock Bondain can be contacted on 01-253 2447/8.



## British debut following extensive testing

THE IES Datacorder data capture unit and data processing terminal is now available in the U.K.

The machine is to be marketed by Office Services Swindon (OSS), part of the Computer Services Centre group.

It has already been successful in the U.S. for three or four years and OSS received its first model more than nine months ago, but extensive testing delayed its debut into the British market.

The Datacorder is a programmable microprocessor, equipped with the Z-80, and is described by OSS as a "complete desk-top computer system". It can be used as a stand-alone unit, a data processing terminal or a data capture unit.

It incorporates an 80-character printer which can be used as a communications terminal, allowing direct output from the central computer. Other standard features are an ECMA/ANSI cassette recorder, a 40-character display screen, typewriter and calculator keyboards and full telecommunications facilities.

Its 16K RAM is expandable to 64K and the unit, compatible with virtually all mainframe and minicomputers, has full standard RS-232 interface.

The machine is programmed in a special language called Quick. This, we are assured, is fast, interactive and very simple. It is designed for the

compilation of conventional input programs including normal validation, verification, editing and formatting. It is also possible to use the Datacorder for invoices, orders and shipping documents.

Datacorder also supports Extended Basic for stand-alone processing, which means that you can run complex engineering and business applications, such as compound interest and regression analysis.

The programs are stored on an ordinary cassette and loaded into memory. A blank cas-

sette is then inserted for data capture and the machine takes the operator step by step through the program, using a question-and-answer routine which ensures that data is entered in the correct sequence. Floppy disc storage facilities are in the pipeline.

The unit is very compact and weighs 26lb. One of its main advantages is that you can add any make of peripheral to it, or hook it to any type of mainframe. The price for a one-off unit will be around £2,700.



### IES Datacorder



## Third-generation TTL from Texas

TEXAS INSTRUMENTS has introduced the third generation transistor transistor logic (TTL) integrated circuit series, which it expects eventually to replace all existing standard TTL series, low-power Schottky and CMOS support circuits.

The two models are the advanced Schottky TTL series which comprises high-speed circuits and the advanced low-power Schottky TTL series, with circuits which consume significantly less power than

similar ones on the market.

The advanced Schottky is twice as fast as the last generation and the ICs feature switching speeds of 1.5 nanoseconds. That is the time it takes for each of the basic digital electronic building blocks (a gate) within the integrated circuit to process computer binary data from gate input to gate output. Each gate data conversion consumes an average of 22 milliwatts or 22-thousandths of a watt power.

The advanced low-power Schottky TTL circuit features one milliwatt power consumption per gate and switching speeds of four nanoseconds. They are intended for use with minicomputers, terminals and electronic office equipment in which low-power consumption, rather than high speeds, increases efficiency.

Initial introduction will include 65 circuit functions in the two series. SN74ALS samples are already available

## Conversion chance

AN OLD Teletype plus £188.50 equals an 8K Basic computer. Well, that is the latest news from Ohio Scientific dealer U-Microcomputers.

Its 500 board has all the ingredients—MOS 6502 processor, 4 or 8K RAM, 8K Basic in ROM, 48-line OSI bus, machine code monitor and serial interface—to turn Teletypes or other serial terminals into computers in their own right.

All you will need initially for the conversion is a backplane to couple-in the OSI bus. To get the system operational you must also have a +5V/-9V power supply.





## Excuse to visit Paris in the spring

A GOOD EXCUSE for visiting Paris in the spring is the micro-computer show which Sybex, the French-American publishing house, is organising from May 15-17.

Micro/Expo '79 promises to be one of the biggest shows in Europe for the micro world and is proof that personal computing is booming in Europe.

It will be the fourth show to be run. It has apparently

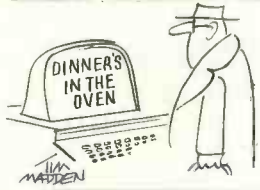

## Horizon dealers

OUR REVIEW of the North Star Horizon computer in last month's issue listed all the dealers for Equinox selling the system.

Another major distributor is Comart Ltd, PO Box 2, St Neots, Cambridgeshire PE19 4NY. Tel: (0480) 215005.

The company has also set up a wide range of dealers. They include:

Microcomputermart Ltd, Manchester. (061-832 2269); The Byte Shop, Ilford, Essex (01-554 2177); Cambridge Computer Store, Cambridge (0223 68155); Xitan Systems Ltd, Southampton (0703 38740); New Bear Computing Store, Newbury, Berkshire (0635 49223); Holdene Ltd, Leeds (0532 459459); Isherwoods (Personal Computer Systems) Ltd, Luton (0582 424851). □

doubled in size and attendance every year, so, as 5,000 people attended last year, the organisers must be expecting 10,000 this year.

In addition to the exhibition, a series of conferences will be held at the same time. The programme is organised around three themes—personal computing, new products, and industrial applications. The conference was so successful last year that the hundreds of people wanting to gain entry caused considerable headaches to security staff. According to one report, police had to be called to deal with "several hundred people trying to force their way in to the already-crowded hall".

One of the forces behind the show is man-about-micro Rodney Zaks, well-known to micro buffs for his *Introduction to Personal and Business Computing*.

The exhibition will feature a

comprehensive range of all products and services related to the microprocessor and microcomputer field.

Micro/Expo '79 will be held at the Centre International de Paris, at the Porte Maillot (handy for the airport). □

## Leasing

MAZUMA, of Ingatestone, Essex is leasing small systems to small businesses and personal applicants for a minimum of one year. At the end of the agreed period, you may continue to rent equipment indefinitely for a nominal charge, or you can buy it outright at a residual value.

Mazuma stresses that the offer is a financial arrangement not to be confused with short-term hiring, and it is therefore unsuitable for someone who wants to hire a personal computer for a short time. □

## Home games centre

PHILIPS is launching a home computer games centre which will retail at less than £150, plus £10 per program package.

The unit, called the G7000, has a full alphanumeric keyboard, which is most unusual for a computer with only 1K byte of ROM and each cassette has 2K bytes of plug-in ROM.

The Intel 8048 microprocessor-based machine is a video games unit.

There will be eight cartridges available immediately and **Philips G7000**

some will contain more than one game. They will include such pastimes as baseball, American football, lunar landing, racing cars, air-sea warfare, and word and logic games like Mastermind.

On a more serious note, a mathematics cartridge and a teach-yourself-Basic cartridge, in very simplistic terms, will also be available.

With colour graphics, it will reach the consumer via a network of retail outlets. □

## New group in London

A USERS' GROUP has been set up in South-East London. The group, called Selmic—South-East London Microcomputer Club—aims to provide a platform for the exchange of ideas and give expertise, advice and assistance to novices.

Meetings will be held at the South-East London College where laboratory facilities have been loaned. Special interest groups will be set up, for people in education and small businesses, people with the same machine types and people with a limited knowledge of computers.

The meetings will be held at the college in Breakspears Road, Lewisham Way, London SE4. For more information contact John Williamson, chairman, on 01-850 4195 or Hugh Gilhentie (treasurer) on 01-303 4968. □

## Portables only

PORTABLE MICROSYSTEMS is a recently-formed company which intends to deal exclusively with portable computer equipment.

A range of services and products will be offered to "large and small industrial groups", including many hardware and software configurations, and if there is nothing suitable, the company will design and build a product especially for you.

The founder of the company is Mike Ayres, who claims "more than 20 years' experience" with ICL, Plessey, Olivetti and Ampex. □



# The Attaché Business System

The only system designed and supported exclusively for business applications



***Who but Attaché can offer full supporting software at prices you can afford?***

***For example—Order Entry, Stock Control £160 the lot.***

Basic system: Case + CPU + Turnkey monitor board + 16K RAM (capable of expansion to 64K)	£1,466-00
Video Board	£ 271-00
16KB Static RAM	£ 347-00
Printer Interface Card	£ 208-00
Floppy disc system 2 × 310Kb diskettes + controller + box	£1,701-00
Basic Interpreter	£ 41-00

**Attaché business systems can be obtained at the following:-**

- Alba Computer Supplies & Services Ltd., 8 High Street, Renfrew (see John Coleman)
- Computer Hardware Ltd., 113 Clonskeagh Road, Dublin 6 (see Liam McAlasdair)
- GBH Data Services Ltd., Dumfries Chambers, St. Mary's Street, Cardiff (see Geoff Higgins)
- Keen Computers, 5 The Poultry, Nottingham (see Tim Keen)
- Lion House Ltd., 227 Tottenham Court Road, London (see Lawrence Sarkin)

There are still a few more distributorships left  
Interested? Contact Moncoland 11/12 Pall Mall, London SW1

***Attaché—More than a hobby with us.***

● Circle No. 157



TO MANY prospective owners of a microcomputer, the thought of acquiring their own computer for less than £50 must be appealing. The problem, though, is that at this price level the only way to obtain a microcomputer is to buy a kit; and the problem with a kit, of course, is building it.

If you possess a fine-tipped soldering iron, you are halfway there. If you also have a leaning toward registers, hexadecimal arithmetic and chips—rather than floppy discs and high-level languages—then one possibility is the MK14 kit from Science of Cambridge.

## MK14 is one route you can choose to computing for less than £50

THE MK14 is based on the National Semiconductor SC/MP processor, an established 8-bit micro. It includes a PROM monitor, 256 bytes of RAM, a hexadecimal keyboard and a LED display, for £43.55.

To that must be added a power supply for about £5 and an edge connector. To allow easy replacement of the PROM monitor you will also need two sockets. Many prefer to socket all their chips, and if your experience is limited, this would be an advisable outlay of £2.50 or so.

The MK14 is complete with an 88-page instruction manual, divided into two parts. Part one gives general details of the system, together with step-by-step instructions on assembling it and some generally useful hints on soldering techniques.

It also outlines the internal operation of the processor and the various opcodes available.

Part two contains listings of a variety of programs, including the monitor, and

notes on how to use them. Some of the programs, however, require extra hardware to make them work.

Apparently a larger programming manual is in preparation. We hope this will give more detail on programming for the inexperienced owner.

The manual also contains two removable pages, one illustrating the layout of the components on the circuit board, the other a schematic of the system. The component layout, unfortunately, has the

**‘If you follow the assembly procedure detailed in the manual, construction is straightforward, apart from problems with the keyboard.’**

component list on the reverse side, which means turning the paper each time a component has to be identified; that is an unnecessarily clumsy piece of organisation.

If you follow the assembly procedure detailed in the manual, construction is straightforward, apart from problems with the keyboard. It shouldn't take more than two or three hours.

Assembling the keyboard, though, requires some patience. The test MK14 had a keyboard with plastic keys which fit into a metal lattice, and metal contacts are held on to the board by a self-adhesive separator. Some juggling was necessary to prevent keys and/or contacts falling out.

We gather ours was a pre-production

model; current versions should have an indented separator to hold the contacts in place. We understand that all kits will now have ready-assembled keyboards.

Fixing our keyboard to the component board called for additional patience. The

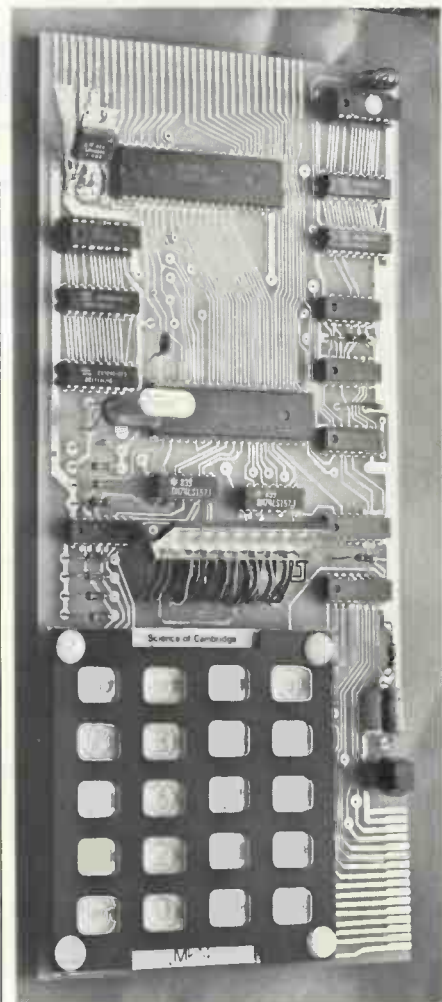

### Cost

Basic MK14 system	£43.55
Power supply	4.95
Two sockets (minimum)	0.30
Edge connector	0.95
Rubber feet	0.20
	£49.95

A complete set of sockets would cost approximately £3.30, making a total of £54.05.

### Extras

Cassette interface	£9.99
RAM (256 bytes)	£3.88
RAM I/O	£8.42
Revised monitor	£9.99
PROM programmer	£9.99
Blank PROMs	£9.99
TV interface (available end of 1979)	£99.99



buttons provided were too large for the holes. Careful pruning with a sharp knife, plus some enlargement of the holes with a small drill, gave a perfect fit.

At that point we also added some rubber feet so that the MK14 did not rest on the component pins.

After a final check on component orientation, the power supply was connected. The LEDs should have lit up like a Christmas tree but they remained blank. Touching the LED strip, however, brought a LED alight, so it was obvious that the display was not properly connected.

Several attempts later, all the LEDs still would not light. Having decided that the standard connector between display and component board was causing the problems, it was removed and put to one side. Display and board were then joined, using single wires between each pair of connection points—a more cumbersome method, but it worked. On applying power, all the LEDs lit, displaying dashes as expected.

Six LEDs are used. Four give the current memory address, the other two the contents of that address. Data is entered

**It will probably appeal more to those with a hardware background than to the keen programmer.**

via the keyboard; it has 16 hex keys—0 to 9, A to F—and four special keys labelled GO, MEM, TERM and ABORT.

Those four allow different memory locations to be read or written to, so that a short program may be entered quickly and run. Keying-in longer programs becomes tiresome, though, especially if the power supply is disconnected accidentally, as was ours on two occasions. The need for permanent storage then becomes apparent.

So you might think about cassette. Science of Cambridge also manufactures a cassette interface kit which allows a domestic cassette recorder to be used for storing programs and data. It is simple to build and uses several of the lines on the edge connector, together with input and output to and from the cassette recorder.

The interface uses LEDs to signify when data is being read from or written to the tape and so gives visual indication that data is being transferred. Up to 256 bytes may be transferred at a time, using the software provided; this must be entered via the keyboard unless you buy a revised monitor.

This replacement obviates the necessity to enter the interface software. It also provides some other useful routines, such

as single-stepping through a program for editing.

The monitor is in two colour-coded PROMs which replace those containing the old monitor, hence the need for at least two sockets. Unfortunately we re-

**Apparently a larger programming manual is in preparation. We hope this will give more detail on programming for the inexperienced owner.**

ceived no documentation with the monitor and have not been able to test it.

Two other items may also be added to the main component board—an extra 256 bytes of RAM and a 16-line Input/Output device which contains a further 128 bytes of RAM.

The RAM I/O is a flexible device which allows any of the 16 lines to be input or output or grouped together for eight-bit parallel data transfer under program control. Hand-shaking for devices is also available by configuring the lines in the relevant manner.

The RAM I/O, therefore, greatly expands the capabilities of the MK14, as a wide number of circuits may be constructed to use it. The manual gives one example, a function generator, which will generate different waveforms, depending on the data supplied.

### Other views

PREPARING this review, we collected opinions from about a dozen readers who are less than enthusiastic about MK14 or, more accurately, about Science of Cambridge Ltd.

We do not know how widespread the criticisms are, though we suspect that they represent a small proportion of what is by now a very large number of users. The most detailed and most aggressive comments we heard have since been resolved and, to a large extent, were demonstrably frivolous. Still, it is important to summarise the principal criticisms:

- *delivery*: most of the complainants said they had to wait some time before their kit arrived (it is sold on mail order).
- *non-performance*: some kits arrived with faulty components—and our display was less than perfect.
- *poor response*: kits about which there are complaints can be returned to Science of Cambridge, but in some cases that resulted in very long delays before a replacement was sent.
- *poor documentation*: the instructions do not

### Conclusions

- The MK14 proved easy enough to build in its basic form apart from the irritating keyboard, the deficiencies of which are apparently being alleviated somewhat in current models.
- It will probably appeal more to those with a hardware background than to the keen programmer. As it stands you don't get a lot of system—what do you expect at that price?—and you will certainly be tempted to add more PCBs. Connecting additional boards requires some hardware knowledge, particularly for the RAM I/O. The new programming manual suggests, however, that Science of Cambridge expects more programming in due course.
- The cassette and TV interfaces which the manufacturer promises should add greatly to the usability of the MK14. At the moment you should expect pleasure from building it rather than using it.
- It takes some imagination to find applications for the basic MK14 which would not be cheaper and more appropriate on one of the low-cost programmable calculators. Of course, the manufacturer disagrees strongly with this.
- Still, the basic MK14 is capable of reasonable expansion, bearing in mind its low price and, on the face of it, represents good value for money at the present time.

apparently give enough information on detecting and recovering blunders, and the programming information was inadequate for some.

We invited Science of Cambridge to comment, and received the following response:

“We do not deny that we have been beset by component supply problems and we apologise to those people who have been kept waiting.

“We have had very few component failures and any repairs which exhibit symptoms of original component failure are repaired free of charge.

“A recent batch of 100 which we had to supply ready-built contained only two which did not work first time, and they were due to IC pins being bent over on insertion.

“It is extremely difficult to provide a fault-finding guide, as almost any component failure or solder bridge gives rise to the same fault indication on the display. We provide a considerable amount of fault-finding guidance over the telephone which can be very time-consuming, hence the difficulty in reaching us.”



# Keen Computers, Spread Their Wings

## Hardware

You've heard about the new **attache**—we stock it. We are the Midlands distributors of the sophisticated **attache** business computer from America: This is a purpose designed business computer supplied complete with monitor, dual 8" floppy disks and printer. We also stock the **Apple II**—the best micro for its price available in the U.K.

Attache	£5,895	Printer card	£110	Axiom micro printer	£350
Apple II 16K	£985	Communications card	£110	Axiom printer/plotter	£699
16K Memory	£160	Decwriter II	£1,050	Memory upgrade kit now available for Apple II, ITT and Tandy	
Disk & controller	£425	Centronics 779	£850		
Applesoft ROM	£110				

## Software

We have a full range of software for the Apple II, available on disk or cassette:

Incomplete Records Accounting	Matrix Inversion
Addressing & Mailing program	Information Retrieval
Word Processor	Co-resident assembler
Chequebook	Regression
Shape-create	Standard deviation
Variance	Correlation
Data Testing	Distribution

Personal Software MICROCHESS for the Apple II computer, Tandy, and the Pet.

**Keen Computers Ltd,**  
**5 The Poultry,** (off Market Sq)  
**Nottingham**  
**Tele: Nottm**  
**583254/5/6**

● Circle No. 158



# Ready-to-go Sorcerer is source of attraction

A solidly-built, low-cost personal computer from a specialist in the 'arcade' games business attracted a good deal of attention when it appeared last Summer. The Exidy Sorcerer is a ready-to-go micro-computer in the same vein as the Apple II, TRS-80 and Pet but it has one very unusual feature—a plug-in chunk of pre-programmed ROM.

EXIDY is the third largest U.S. manufacturer of coin-operated or domestic video games. Bally and Atari, the top two, have produced home computers recently which start from the 'entertainment centre' angle of micro-based games running on a TV set.

Exidy opted for a much more computer-like computer, eschewing the game paddle in favour of a solid professional keyboard and making its initial software a Microsoft Basic rather than a selection of games.

The Sorcerer appeared a year after the TRS-80 and Pet and the designers were probably able to detect some of the shortcomings of those systems. The obvious examples are the much-maligned keyboard of the Pet and its use of the IEEE instrumentation bus for connecting extra peripherals; the TRS-80 has a real keyboard but lacks a numeric pad and is built with a plastic case.

The Sorcerer is in a neat, suitcase-styled cardboard box, complete with straps and buckles printed on. The basic Sorcerer unit looks like an enlarged keyboard assembly, with a QWERTY layout and a numeric keypad.

## Solid feel

Inside is a Zilog Z-80 with up to 32K bytes of RAM and a non-board monitor. Interfaces are provided for video output, dual audio cassettes, and an eight-bit parallel I/O port—a standard 25-pin connector at the back of the unit, which is where all the sockets are located; the parallel port allows quick and easy attachment of a printer. The cassettes are also attached by a 25-pin connector in the back.

There is also an RS232 serial interface and a 50-pin edge connector for the Exidy expansion unit. At the side is the slot for the ROM-PAC.

The unit is very well-designed and particularly well laid-out. It has a much more solid feel to it than most of the systems we have reviewed to date. All the rear connectors are clearly labelled; the keyboard is easy to use and is the same substantial unit used on Hazeltine VDUs.

Our system was loaned by one of the principal U.K. importers of the Exidy Sorcerer, Factor One. It had 32KB RAM.

There are two unusual features to the



Sorcerer. One is the multi-way keyboard. It was not explained particularly well in the user documentation but there are as many as five key modes.

For a start, there is lower- and upper-case, using the SHIFT key for capitals. Using a GRAPHIC key gives access to the 64 Pet-style graphics characters. Then it becomes clever, because with SHIFT LOCK and GRAPHIC engaged at the same time you can create your own graphics characters. Those you have to set up in memory as specific bit patterns but once that has been done you can reference them by using the SHIFT/

GRAPHIC keys with an alphanumeric character.

In addition, when you are in Basic or the Sorcerer's command mode, you can set up complete Basic statements or commands to be referenced by a single keystroke with GRAPHIC engaged. That can certainly speed program entry.

The ROM cartridge is trade-marked as ROM-PAC. It is about the size of an eight-track tape cartridge but instead of tape it contains pre-programmed system software in ROM. The ROM-PAC has a bare edge-connector which slides into a mate.

## Slide-in connector

The ROM-PAC supplied with our system contained an 8K Microsoft Basic. Others available are an EPROM pack—create your own microcoded software, £35; and a word processor—£70 but we have not yet tried it. Colour graphics and games are said to be in the pipeline.

The availability of system software in this form makes the Sorcerer very flexible. All other computers we have tested with software in ROM have it as an integral part of the system, making it difficult or impossible to change. The alternative is to supply software on cassettes, which

(continued on next page)

## Prices

These prices were quoted by Factor One, which supplied the test system. Prices at the other principal U.K. source for Sorcerer, Comp Computer Components, are about the same.

Sorcerer with 8KB	£650
Sorcerer with 32KB	£859
12in. display monitor	£240
EPROM pack	£35
Word processor	£70
\$100 expansion unit	£210
Micropolis minifloppy drive (315KB)	£680
Dual drives	£1,200



### Sorcerer keys with graphics symbols

(continued from previous page)

means it has to be loaded each time the system is used. That wastes time and, with the current state of low-cost tape cassettes, is, to say the least, error-prone.

We had no trouble in setting-up the system. With the ROM cartridge plugged-in, powering-on took us straight into Basic.

As the display allows 30 lines of 64 characters, a good-quality monitor is essential for serious use, though as an alternative you could use a standard television with an RF modulator for regular use.

### Documentation

There were two manuals supplied with the system. One was titled *A Guided Tour of Personal Computing* and included how to get the system up, an introduction to programming—yet another flowchart of how to go to sleep—descriptions of Basic and the monitor, and a number of technical appendices. The second manual was an introduction to the ROM-PAC Basic.

Both manuals were useful when we were setting-up the system; they are clearly written and well-produced. Because they were written for the beginner, though,

they would not be very effective as reference manuals. They contained some unusual tips—"During a thunderstorm it is advisable to unplug your Sorcerer from the main electrical power . . . do not use alcohol to clean the case".

One of the annoying features is that both have to be read to find out how to use the standard Basic; for example, the *Guided Tour* contains a full description of number formats which is not included in the Basic manual.

As the manuals are short and cover a wide range of information—from the definition of software to a description of the cassette interface—the user surely will find that there are gaps in the information supplied. There are other manuals available, we understand, but we have not seen them.

### Standard Basic

The Basic supplied on the ROM cartridge is described as standard (Altair) 8K Basic. Points which we liked about it were:

- Variable names are not restricted to one letter.
- String arrays are supported.
- Multiple statement lines and multiline statements are allowed.

- Instructions can be entered with a single key-stroke using the special characters.

On the other hand this is not the easiest Basic to use:

- There is no line editor—make a change and you re-type the whole line.
- If you press CLEAR to erase the screen, the next time you type RUN you will get a syntax error message.
- No syntax checking is done until a program is run.
- The LIST command does not allow single lines or line groups to be displayed.
- A FOR without a NEXT does not give an error message.
- There is no easy way of outputting to a printer on the serial or parallel port.

If you start the system—or press RESET—without the ROM cartridge in the system you enter the monitor. This allows memory to be examined and changed, tapes to be loaded and dumped, and includes a memory test. One use of the monitor is to change the graphics characters; they are defined by an 8 × 8 matrix and the use of them gives a resolution of 512 × 240 points.

As with many personal computer sys-

### Neat and clean layout at the back of the box

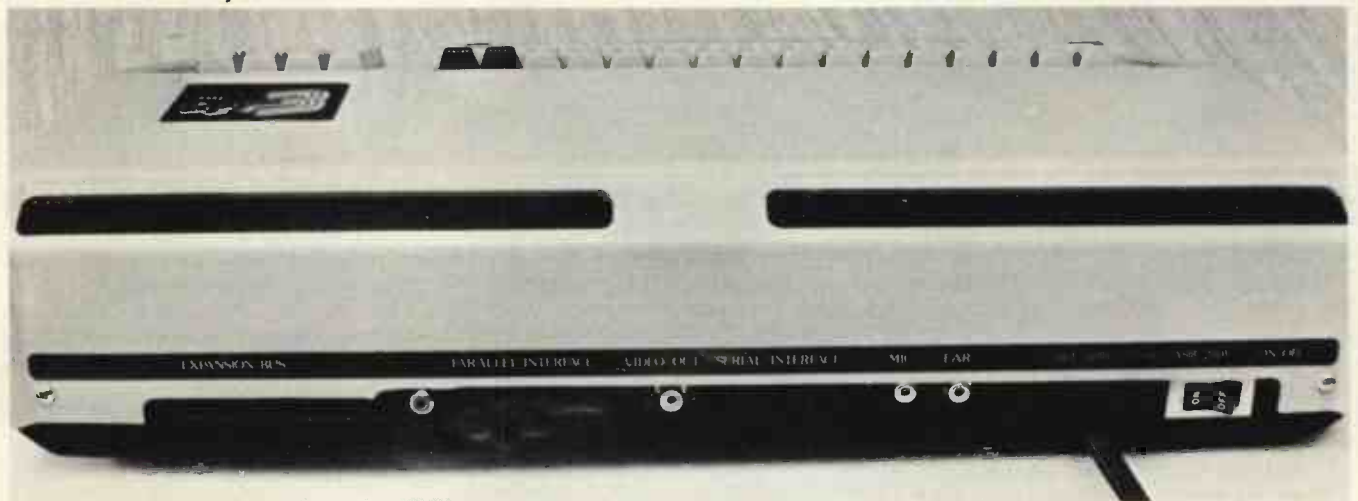



tems, much emphasis is placed on the graphics capability of the Sorcerer. Although the system has an extensive character set, and though it allows the user to define his own graphics characters, there is no software which simplifies the use of them—for example, to generate lines or curves. Much hard work has to go into the use of graphics.

## Cassette system

The cassette interface uses a standard audio tape recorder. The MIC and EAR sockets are connected to a pair of sockets on the back of the Sorcerer by cables supplied with the system.

The manuals contained straightforward instructions on saving and loading programs; we had few problems doing this—we were using a portable Sony recorder. As with the Pet, the Sorcerer always tells you what is going on. If you ask the system to load a particular file it will search the tape for it, tell you what other files it finds, and tell you when it is loading it. As part of the monitor there is a FILES command which lists the files and heading information on a tape.

According to the *Guided Tour* manual, the cassette can be run at 300 or 1,200 baud. We think ours was running at 300 baud—it certainly seemed to be fairly

slow. The manuals did not give sufficient information on how to change the speed.

Apart from the parallel and serial interfaces with the system, there is an expansion interface which can be plugged into a six-slot Exidy expansion unit. It utilises the S100 bus, so the system can use all those S100-compatible devices.

Exidy also sells the Micropolis disc unit, which can be used with the Micropolis operating system or CP/M;

we intend to check these later.

Remember that the Basic in the ROM cartridge is called 'standard Basic' and allows multiple-character variable names? Well, the Micropolis Basic allows only single-character names. If you write lots of programs for the cassette system using ROM-PAC Basic, the business of upgrading to a floppy disc system may mean re-writing all your programs, so beware of so-called standards.

## Conclusions

- Exidy Sorcerer is well-made, has an excellent keyboard, and a good expansion capability.
- The ROM cartridge concept is an impressive and effective means of supplying system software.
- The cassette system is one of the best we have used with a standard audio recorder.
- The basic system has serial, parallel and expansion interfaces.
- The standard Basic was disappointing. With the exception of difficulty of addressing a printer and lack of a

PRINT USING statement there were no major omissions, but it was different to use—no line editor, no system checking on entry, inadequate LIST command.

- The two manuals supplied with the system would be satisfactory for a beginner but not particularly useful as reference manuals.
- Expansion capability is good but be wary of 'standard' Basics.
- At less than £1,100 for a 32KB system, we think the Sorcerer is fair value for money. □

## Practical Computing evaluation

	Yes/No NA	1	2	3	4	5
Ease of construction (where applicable)	NA					
Quality of documentation			✓			
Dealer support/maintenance				✓		
Can handle 32K of memory	Y					
Quality of video monitor (consider resolution and screen size)			✓			
SS-50 Bus	N					
S-100 Bus	Y					
Sockets for chips	N					
Numeric, calculator-type pad on keyboard	Y					
Large amount of removable memory, randomly accessible	Y					
Cassette tape recorder capability: Own	Y					
Built-in recorder	N					
Floppy disc capability	Y					
Communications capability (can talk to other computers)	Y					
Speed of instruction cycle	4MHz					
Ease of expansion					✓	
Low power consumption	Y					

	Yes/No N/A	1	2	3	4	5
Assembly language	N					
Basic language				✓		
Other languages	Y					
Compatibility with other systems				✓		
Reputation of manufacturer						✓
Appearance						✓
Portability					✓	
No. of software applications packages available	N				✓	
Hobby use						✓
Business use				✓		
Educational use						✓
Suitability for: Commercial applications				✓		
Home applications						✓
Educational applications						✓
Ability to add printer(s)	Y					
Ability to add discs	Y					
Ability to add other manufacturers' plug-in memory	Y					

### Ratings

1 = poor; 2 = fair; 3 = average; 4 = good; 5 = excellent.  
N/A = not applicable.

# MUS MIC PLE



other machines the timing must be done by software.



The software delay uses a timed loop, the timing coming from the microprocessor clock; since the delays are for a very short period, this program is written in machine code. It consists simply of loading a memory location or index register with a value which determines the delay time decrementing that value by one and branching back to the decrement instruction if the value stored in the memory location or index register is greater than zero.

So if the processor has a clock frequency of 1 MHz and each loop takes 10 clock cycles, 100 loops would give a delay of one-thousandth of a second and therefore a frequency of 500 cycles per second.

## Programmable timer

If one was writing a frequency-only music program for the Pet, then one would use the capabilities inherent in the I/O hardware to generate the delay. The user port on the Pet uses a 6522 VIA chip which incorporates a programmable timer—the 6530 on the Kim also has the same capability.



This allows the programmer to generate a tone of a particular frequency by writing an appropriate delay value into the timer register of the 6522. Before doing this, however, the VIA must be initialised; we are using the timer to clock output pulses on to the CB2 pin from a circulating shift register within the 6522.

The shift register is thus first set in the

PEOPLE have been programming computers to play music for almost as long as there have been computers. It is a subject which is attracting a great deal of popularity among amateur computer users for a variety of reasons. It is an easy subject to break into since, with only minimal expertise and expenditure, anyone can program a computer to give quite an impressive performance.



Yet the subject is so vast that only a handful of the potential techniques have been explored. This opens the possibility of the amateur doing truly original research into the serious performance of music by computer. You don't need a sophisticated or expensive computer—much very original and exciting work has been done on machines as simple as the Kim I. All that is required is a blend of programming ability and a modicum of knowledge of musical theory.

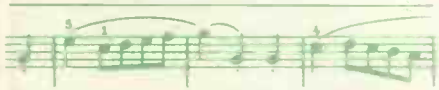

The basis of all sound, which obviously includes music, is the production of a variable pressure wave within the medium through which the sound is travelling. The sound we hear is due to three components of that pressure wave. The first and most important is the frequency or "tone" of the sound, which can vary between 10 and 8,000 cycles per second—frequencies outside that range are

not audible to the human ear.

The second is the amplitude of the wave—the loudness of the sound; and, thirdly, the shape of the waveform or 'timbre'—it is this component which allows us to discriminate between the sound of, say, a piano and a trombone.

The simplest computer music programs control the frequency component. The

---

by Nick Hampshire

---

resulting output is acceptable but very "buzzy" and somewhat similar to that produced by a cheap electronic organ. This is due to the fact that the output is usually a square wave of constant amplitude; the methods used, however, are interesting and worthy of looking at in greater depth.

The sound is produced by a loudspeaker attached via an amplifier to a single line of a computer output port, all the tone generation being done by the computer. A tone of a particular frequency is generated by turning the output line on and off a fixed number of times per second. This is done by a timed delay, so that the program delays, turns on the output line, delays, turns it off, delays, turns it on, and so on. Each tone is thus associated with a particular delay time.

## Software delay

The method used to generate this variable delay depends on the computer being used. Some, like the Pet and Kim, have timers built within the I/O circuits, allowing the timing to be done by hardware; in



# SIC RO, ASE

free-running mode, where each shift is initiated by an output from the timer. The shift register is then loaded with eight bits of data, four 1s and four 0s arranged as 11110000, so that for four timer output pulses the output is high and for the next four low, giving one complete waveform cycle.



All that remains is to load the timer with a value between 1 and 255, with 255 loaded into the timer and a 1MHz

```

Listing 1
:SYSTEM LOCATIONS
ACR = $ E84B      :REGISTERS OF 6522 ON PET
SR  = $ E84A
TIM2= $ E848
:VARIABLES
YTEMP              :TEMPORARY Y REGISTER
TEMPO              :DELAY COUNT FOR TEMPO
:
1900
1901
:
1910 A9 10      :SETUP      LDA # 10
1912 8D 4B E8      STA  ACR
1915 A9 F0      LDA  # F0
1917 8D 4A E8      STA  SR
191A A0 00      LDY  # 00
191C B9 00 1A      GETNOTE    LDA  NOTE,Y
191F 8D 48 E8      STA  TIM2
1922 F0 20      BEQ  END
1924 C8          INY
1925 B9 00 1A      GETDUR    LDA  DUR,Y
1928 C8          INY
1929 AA          DUR      TAX
192A 8C 00 19      STA  YTEMP
192D A9 03      LOOP      LDA  # 03 :Adjust for tempo
192F 8D 01 19      STA  TEMPO
1932 A0 FB      LOOP1     LDY  # FB :Microsecond delay
1934 88          LOOP2     DEY
1935 D0 FD      BNE  LOOP2
1937 CE 01 19      DEC  TEMPO
193A D0 F6      BNE  LOOP1
193C CA          DEX
193D D0 EE      BNE  LOOP
193F AC 00 19      RESTORE   LD   YTEMP
1942 D0 D8      BNE  GETNOTE
1944 A9 00      END      LDA  # 0
1946 8D 4B E8      STA  ACR
1949 8D 4A E8      STA  SR
194C 8D 48 E8      STA  TIM2
194F 60          RTS
:
1A00              :START OF SCORE TABLE
    
```

clock. One bit will be shifted on to the CB2 pin every 255 clock cycles and one complete waveform every eight shifts, or once every 2,040 clock cycles, to give an output frequency of 490.196 Hz. Loading the timer with 100 would give an output frequency of 1,250 Hz.

The ability to generate a delay and therefore a tone of the desired frequency is obviously a long way from a full music program. To do this we need to produce a specific sequence of tones or notes, where each note lasts for a specific length

of time—the duration of the note—to give a musical score.

Each note and its accompanying duration are laid out as a table, with the first note at the top and the last note at the bottom. Each note takes the form of a number which, when loaded into the timer register or the delay loop, gives rise to a note of the correct frequency.



The duration is performed by a delay loop like the one used in the software tone generator, but this time capable of delaying several seconds if necessary; the length of the delay is determined by a number stored in the duration part of the score table.

### Position pointer

After each note has played for a specific duration, a pointer to the current position in the note table is incremented and the sequence repeated with the next note, until all the notes in the score have been played.

Figure 1 illustrates this process and listing 1 gives a machine code version of this program written for the Pet with an amplifier on the CB2 pin. Figure 2 gives note and duration values for use by listing 1, and figure 3 gives the score for Auld Lang Syne.



This, however, is a very crude method of music generation, since there is no control over the other components of

(continued on next page)

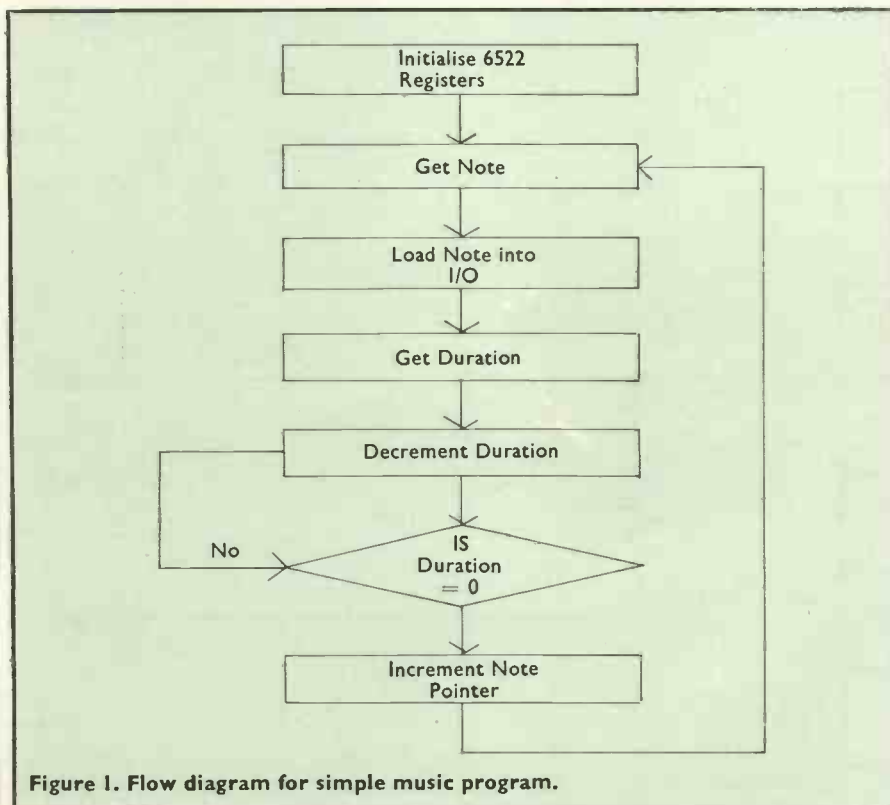

Figure 1. Flow diagram for simple music program.

(continued from previous page)

sound, amplitude and timbre—a square-wave output cannot give those two qualities. To give this precise control over frequency, amplitude and timbre we must use a digital-to-analogue converter, which

**Figure 2. Note and duration values for use by listing 1.**

Notes	D = 2348Hz = Hex 35 on note table
C	= 2217Hz = 38
C	= 2093Hz = 3B
B	= 1975Hz = 3F
A	= 1867Hz = 43
A	= 1760Hz = 47
G	= 1661Hz = 4B
G	= 1568Hz = 4F
F	= 1480Hz = 54
F	= 1397Hz = 59
E	= 1318Hz = 5F
D	= 1244Hz = 64
D	= 1174Hz = 6A
C	= 1108Hz = 71
C	= 1046Hz = 77

Durations	1 = =40 Hex on note table
3/4 =	=30
1/2 =	=20
3/8 =	=18
1/4 =	=10
3/16 =	=0C
1/8 =	=08

converts a binary number from an eight-bit I/O port and converts it to a corresponding DC voltage.

A simple D/A converter can be constructed from a resistor network, such as that in figure 4, and its output fed to an amplifier.

The purest and simplest musical waveform is a sine wave which gives a sound or timbre like a piccolo or flute, and to reproduce this sound the computer must be capable of generating a variable-frequency sine wave. If we draw a graph of a sine wave with the axis being time and amplitude, and divide the time axis into

equal intervals, each interval will have a particular value for the amplitude.

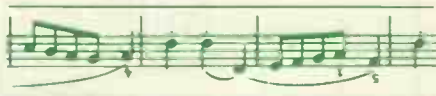

The sine wave could thus be represented as a table of values and by going down the table sequentially and setting the voltage to that value, the wave could be re-constructed electrically. Thus, to produce a fixed-frequency waveform from a computer, all we need to do is store a table of the digitised values representing that waveform and load them one by one into the D/A converter. When the computer has read through the table, it starts all over again from the top.

The frequency of the waveform depends on the length of the table and the time taken by the computer to load each value into the D/A converter. Since the program will be in machine code, the most convenient size of table will be 256 bytes, or one page, since this requires a single byte pointer which will re-set automatically to zero after byte number 256.



If the table length is fixed and the time taken to load each byte of data into the D/A converter is constant, how do we vary the frequency? The trick is to use a variable increment for the frequency table pointer. So far I have assumed that every entry in the table is loaded into the D/A

**Figure 3. Score table for listing 1 to play Auld Lang Syne, first few bars.**

Beginning	Address	IA00	note	9F	duration	10
			77		18	
			77		08	
			77		10	
			5F		10	
			6A		18	
			77		08	
			6A		10	
			5F		08	
			6A		08	
			77		10	
			77		10	
			4F		10	
			47		30	
			47		10	
			4F		18	
			5F		08	
			5F		10	
			77		10	
			6A		18	
			77		08	
			6A		10	
			5F		08	
			6A		08	
			77		10	
			8E		10	
			8E		10	
			9F		10	
			77		30	

converter. If, however, we load only every other entry, the output is double the frequency. This allows a variable-length table but retains the advantages of the fixed-length 256-byte table.

The frequency range is wide-ranging, from the lowest or fundamental frequency, using all 256 table entries, to a frequency 128 times greater—this is dictated by the Nyquist Sampling Theorem, which states that the maximum frequency cannot be greater than half the sampling rate.

The variable increment is achieved by adding a variable to the table pointer which could be greater or less than 1 and, since this variable defines the frequency, it can be our note input. The note dur-

**Figure 4. Circuit for Digital to Analogue converter**

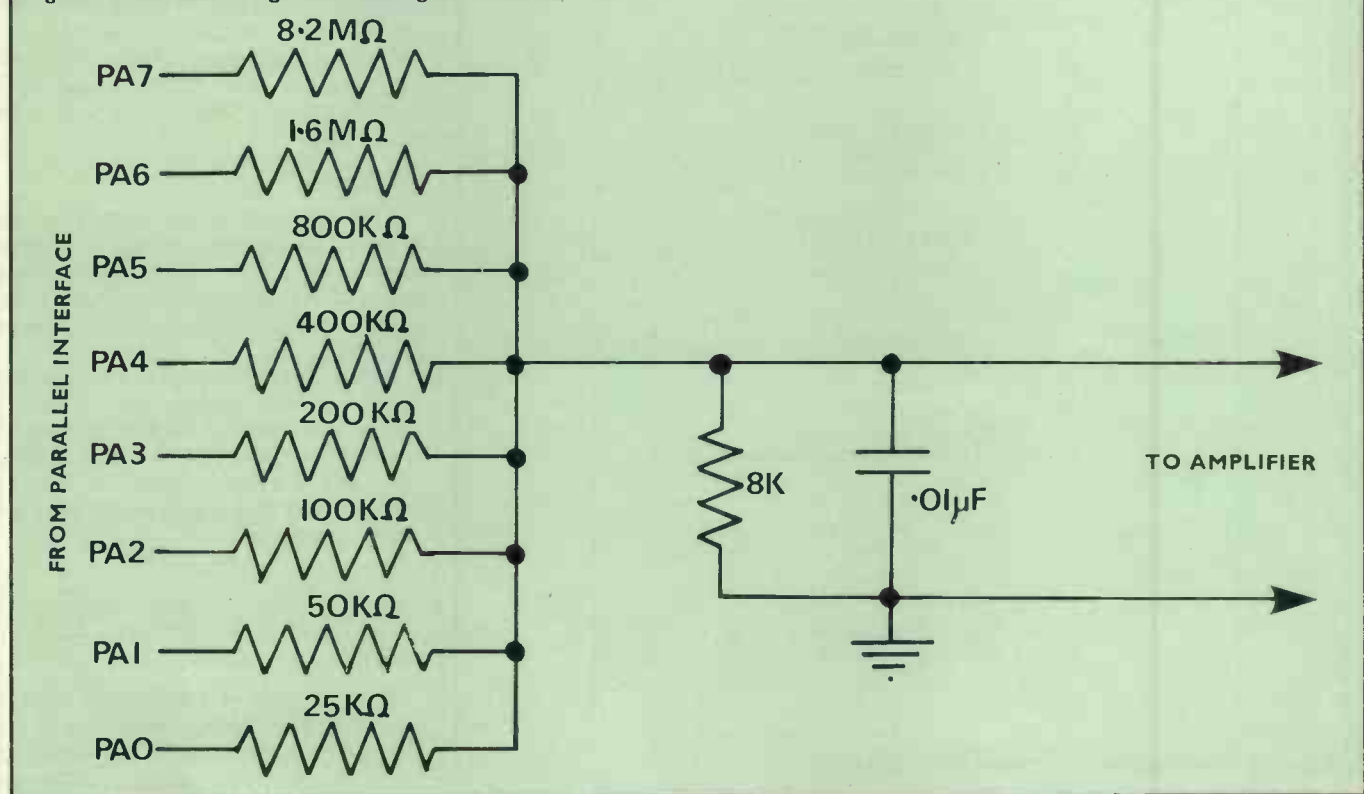
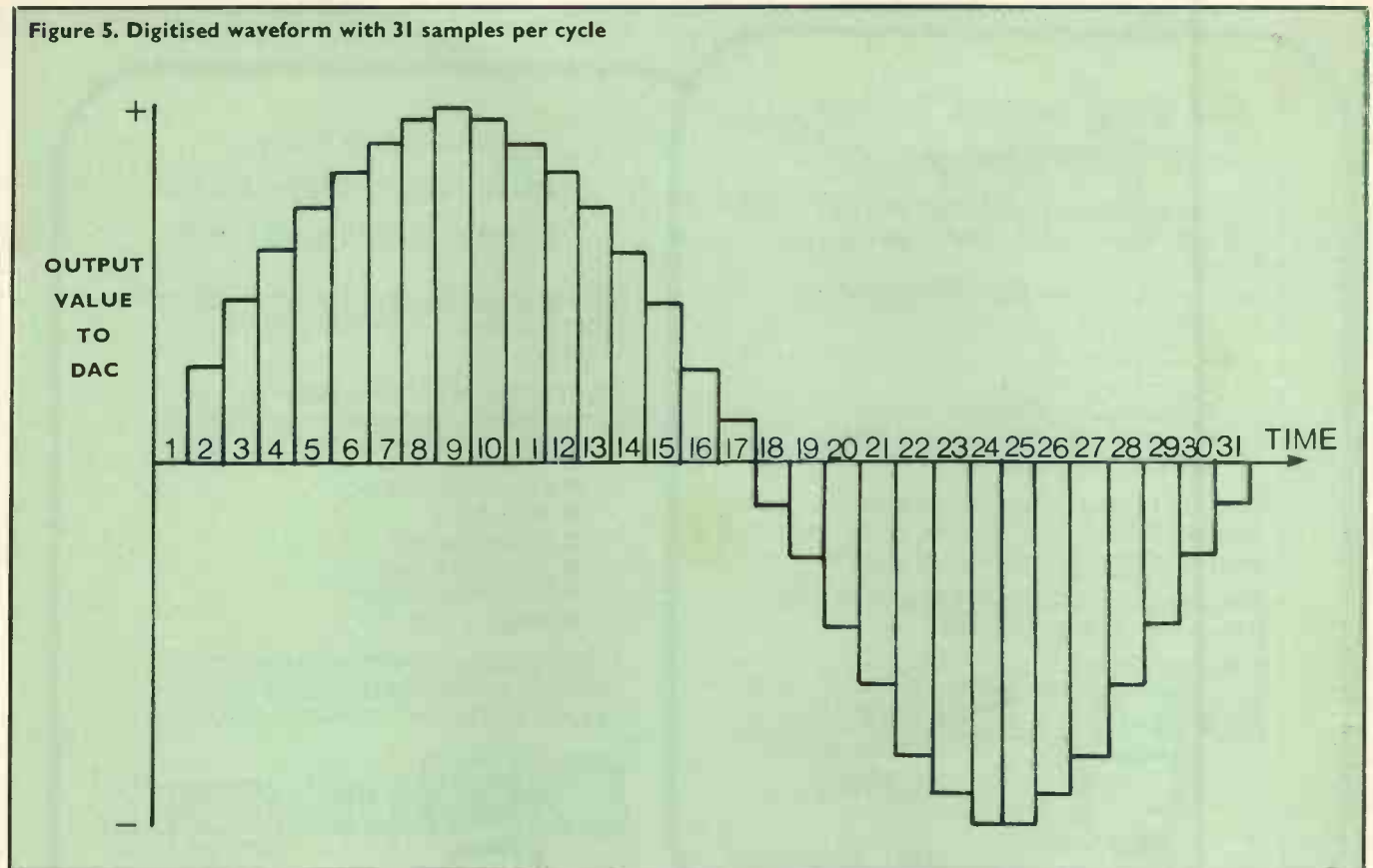



Figure 5. Digitised waveform with 31 samples per cycle



ation can be produced in a similar manner to that used in the square-wave music generator.

By using waveform synthesis and a D/A converter the computer can produce music with any required timbre by varying the waveform table. This table can be created by digitising an existing waveform, or created mathematically either from a simple function like a sine or by using the techniques of Fourier synthesis for more complex waveforms.

This allows the programmer to create theoretical musical instruments and then hear how they will sound without having to build one. This could be of great interest to the instrument maker and composer.



The last component required for high-quality synthesised music is a control of the amplitude or loudness. This is extremely simple. All that is required is to multiply each value output to the D/A converter by a constant between 0 and 1. If the constant is 1, the output is of full amplitude; if of 0.5, the amplitude is reduced to half the maximum. Each note in the score thus consists of three components—the note, the delay or duration and the amplitude.

The principles proposed so far will enable the computer to produce music of fairly high quality but it can play only a

single instrument at a time. If we could simulate three or four instruments playing together, the resulting sound would be far more impressive.



If we have, say, four instruments, the output of the four consists of four waveforms, each instrument having its own special timbre, each perhaps at different frequencies, sometimes all playing together, at other times as solo, duo or trio.

Feeding this sound into an oscilloscope, we can see that the resulting waveform is not four separate waveforms but a single wave of very complex shape.

### Two sources

To see what is happening we must go back to looking at sound as a pressure wave in, say, air. With two sources of sound, occasionally a high-pressure wave from one instrument may coincide with a low-pressure wave from another; the result is that they cancel each other and the resulting wave would be of normal pressure and thus have no sound.



What is happening is that the waves from each instrument are being added together so that if two high-pressure areas

coincide, the resulting wave has the average pressure of the two. Thus to generate a computer quartet we would use four waveform tables and four scores to produce a value for each instrument for output to the D/A converter.

Instead of doing so, the four values are added together and divided by four to produce the average value; it is this which is output to the D/A converter.

The number of instruments which the computer can play simultaneously is limited to about four by the speed of the processor; with more instruments one is forced to reduce the maximum sampling rate, thereby reducing the range of frequencies available.

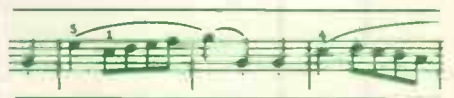

I have given a few ideas on how to get your computer to play music of a reasonable quality and I hope to hear from some of you who have tried writing your own programs.

There is considerable scope for modification and invention. You could display each note as it is played on a VDU screen, a feature which would make an ideal teaching aid. By using a random number generator and a table of weighted probabilities, the computer could be programmed to compose its own score.

Another variation would be to use the computer to control a light show in conjunction with the music generation. □

## Do you want to buy a MicroComputer?

Digitus stocks a wide selection of micros and provides expert advice, sizing and design.

Test some robust, proven computers:

- Apple 11
- Cromemco
- DG MicroNova
- North Star Horizon
- Processor Technology SOL
- Exidy Sorcerer

Choose from a range of peripherals: Shugart, North Star, Sanyo, Sony, Lear Siegler, Cifer, Centronics, Teletype.

Discuss and select a system to fit your present and future needs.

# Digitus

Call, write or visit:  
Digitus Ltd  
Dumbarton House  
68 Oxford Street  
London W1  
Tel: 01-946 5916

PS Also provided:  
micro skill, software, books and training.

## Does your MicroComputer need software?

Digitus supplies application programs, systems, and tailormade software systems.

We specialise in business and administration programs for Z80/8080 and MicroNova computers including:

- Wordprocessing
- Mailing
- Sales Ledger
- Purchase Ledger
- Nominal Ledger
- Stock Control

Also supplied: systems software for Z80/8080 including CP/M, Extended Basic, Fortran and Interactive Cobol.

# Digitus

Call, write or visit:  
Digitus Ltd  
Dumbarton House  
68 Oxford Street  
London W1  
Tel: 01-946 5916

## Do you need help to design and process your MicroSystems?

Through its MicroSkill Register of over 200 professionals, Digitus provides experienced programmers, designers and engineers to develop systems on most micros including:

- Z80/8080
- LSI 11
- 6502
- MicroNova
- 6800

Some of the Register people have their own machines. Others work on customer or Digitus equipment.

Whether you require a small program written or a large system designed and engineered, Digitus MicroSkill can provide support.

# Digitus

Call, write or visit:  
Digitus Ltd  
Dumbarton House  
68 Oxford Street  
London W1  
Tel: 01-946 5916

PS Applications to join the Register are welcomed. Please send C.V. and two professional references.

## Do you want a MicroSolution for your business?

Some people want to buy equipment and software and bolt it together for themselves.

Others want to buy a solution, a complete system to meet their needs economically and reliably.

Digitus provides MicroSolutions for business, administration and professional practices.

We analyse your requirements, specify systems, choose suitable equipment and software, tailor it to fit your people and organisation, hold hands during transition, train operators and managers, arrange regular maintenance and support.

In short, provide a total MicroSolution.

# Digitus

Call, write or visit:  
Digitus Ltd  
Dumbarton House  
68 Oxford Street  
London W1  
Tel: 01-946 5916



# Hard-copy units in the £1,000 price bracket

HAVING dealt with single-board computers and VDUs for less than £1,000 in the last two months, we now concentrate on hard-copy printers in the same price range.

As you become more involved with your system, you begin to realise that hard-copy is not a luxury but a necessity. In program development, you realise that program listings disappear from the edge of the screen and you need to see all the code in front of you.

Even if you operate without a printer during the development stage of your system, once you are ready to go live you will almost certainly find the absence of hard-copy facilities a severe handicap. For example, if you are producing invoices and have to keep transcribing details from the screen, it negates two of the main reasons for buying a computer system—speed and accuracy.

Having recognised that you need a printer, your problems are only beginning. For what do you look and who is in the market?

## Newcomers

There are some newcomers to the market for low-cost printers, some offering a dedicated product which would not work very efficiently on competitive machines, such as Commodore with its Pet printer, while others, such as Anadex, Axiom, and Heathkit offer printers which may be attached to most machines.

Otherwise the traditional suppliers are Centronics, a specialist company manufacturing printers exclusively, and the communications specialists such as Trend and Transtel, supplying 'teleprinters' for use as receive-only (RO) devices in Telex transmission.

Most of the products offered invariably will be matrix printers—with the alpha-

betic and numeric characters formed in a matrix of dots, say seven high by five across, rather than by means of wholly-formed characters with a printhead sweeping across the paper.

In a 7×5 dot matrix printhead, seven impact needles are arranged vertically, their total being the height of a character. If for example, an 'E' is to be printed, as the printhead begins moving all the needles will be activated in the first position; only the top, bottom and middle needles in the second and third positions; and only the top and bottom needles in the fourth and last position.

## Cost factors

The process is ideal for conversion to 'soft logic' and most printers now on the market boast microprocessor control. Some of the printers offered are of the non-impact type—thermal or electrostatic printers, such as the Centronics Microprinter, the SCI Model 1110-S, and the Axiom EX801/820. Advantages claimed for them are quietness, speed and reliability. On the debit side are the cost of specially-sensitised paper and the lack of multiple copying facilities.

Total cost of ownership, therefore, must be considered against the initial financial outlay for a printer. The costs include annual maintenance charges, paper and ribbon stationery, and printhead replacement or re-furbishing.

One term you are likely to encounter is vertical forms of format unit (VFU). It is a method of telling the printer the length of a form. The simplest VFU is probably the pre-set type in which the operator selects one of several standard form

lengths. Older systems use an external punched paper tape loop, with different tape lengths corresponding to different form lengths, but modern VFUs normally are set under software control.

Continuous stationery can be moved through the printer by means of friction-feed as in the case of teleprinters, or sprocket-feed, in which case perforated paper is required. The edge perforations are engaged in the sprocket teeth situated either at the ends of the platen—the bar against which the print head needles strike the paper—or above it.

Some printers have upper-case characters only, while others will offer upper- and lower-case as standard, or as an option only. Where lower-case is offered it should be established whether this includes descenders for letters such as g, j, p, q and y; that requires normally a nine-needle printhead where a seven-needle printhead would otherwise be used.

## Operating speeds

Operating speeds will be quoted in characters-per-second (cps) but that is usually the maximum rate and is affected by factors such as baud rate and buffering technique. The larger the buffer, the greater the volume of data which may be transmitted from the computer at high transmission speeds. That may be highly desirable in time-sharing minicomputers but in the case of dedicated microcomputers it is something of a luxury.

Details of such terms as column-widths, interfaces, ASCII codes, baud rates and parity checking were given in last month's review of VDUs.

## Anadex

ANADEX offers two printer models which might be of interest to hobbyists. The DP-8000 80-column and the DP-1000 40-column dot matrix printers sell for £575 and £465 respectively, plus VAT, to end-users.

Both models offer a choice of three interfaces—serial RS232C or 20mA current loop, or parallel. Transmission speeds on serial interfaces range from 110 to 9,600 baud by means of an integral selector switch. Input character codes of 10 or 11 bits are accommodated.

A Data Terminal Ready (DTR) hand-shake signal is generated to indicate when the internal buffer can accept data. Three lines (240 characters) of FIFC storage are

provided. An optional buffer of 2,048 characters extra capacity for VDU dumps and other applications is available for £35.

The parallel interface accepts input data at a maximum closed loop rate in excess of 1,000 characters per second. Input data and all interface control signals are TTL (Centronics) compatible.

Characters are formed in a 9×7 dot matrix from a 96 ASCII character set. Anadex claims a printhead life expectancy of 100 million characters and a nominal speed of 112cps.

The DP-8000 will accept fan-fold, sprocket-fed paper 9.5in. wide for original plus three copies, loaded through the bottom or rear of the printer.

Other features include an out-of-paper detector, programmable forms length and skip-over perforations control to inhibit printing on the last 15 lines, up to eight vertical tab positions, and switchable double-width printing.

The DP-1000 has most of the foregoing features but is a 40-column printer and can be supplied with a tally roll take-up mechanism. With this feature and the use of pressure-sensitive, multiple-copy paper, one printed copy may be torn off as required and a record copy is rolled-up internally.

Anadex Ltd, Dorna House, Guildford Road, West End, Woking, Surrey. Tel: (09905) 6333.

(continued on next page)

(continued from previous page)

## Centronics

CENTRONICS Data Computer (U.K.) launched the Microprinter-S1 early in 1977. Featuring a seven-bit serial RS232C interface and standard ASCII 96 upper- and lower-case character set, the S1 operates at rates from 50 to 9,600 baud and produces copy on aluminium-coated paper by discharging an electronic arc to penetrate the coating—less than one micron thick. Toners and ribbons are not required.

The printed characters, unlike those resulting from thermal printing, are impervious to light, temperature and humidity. The finished printed page, Centronics says, may be reproduced on any office copying machine. Up to 80 columns may be printed on 4½ in. roll paper. The S1 is equipped with a 192-character FIFO buffer and is factory-set for transmission at 1,200 baud (120cps), no parity, and one stop bit.

Standard features include software-selectable condensed and elongated characters (5, 10 or 20 characters per inch), software-controlled underlining, and out-of-paper audio alarm.

Another printer which falls just within the £1,000 limit is Model 779, costing £995 with standard parallel interface. A serial

interface will add around £80.

The 779 operates at 60cps at a print density of 10 characters per inch or 100cps at 16.5cpi. Characters are formed in a 5×7 dot matrix from a 64-character ASCII set.

Forms handling is by means of pinch roll feed on roll paper up to 9.8 in. (250 mm) diameter mounted at the rear of the printer. A ribbon cartridge contains a continuous ribbon in a mobius loop,

which means that both sides are used on alternate passes over the printhead.

Operator controls include print switch, forms thickness, vertical and horizontal forms positioning, print density and power on/off.

Centronics Data Computer (U.K.) Ltd, Petersham House, Harrington Road, London SW7 3HA. Tel: (01) 581 1011.

Price: £475 with serial interface, £395 with parallel interface.

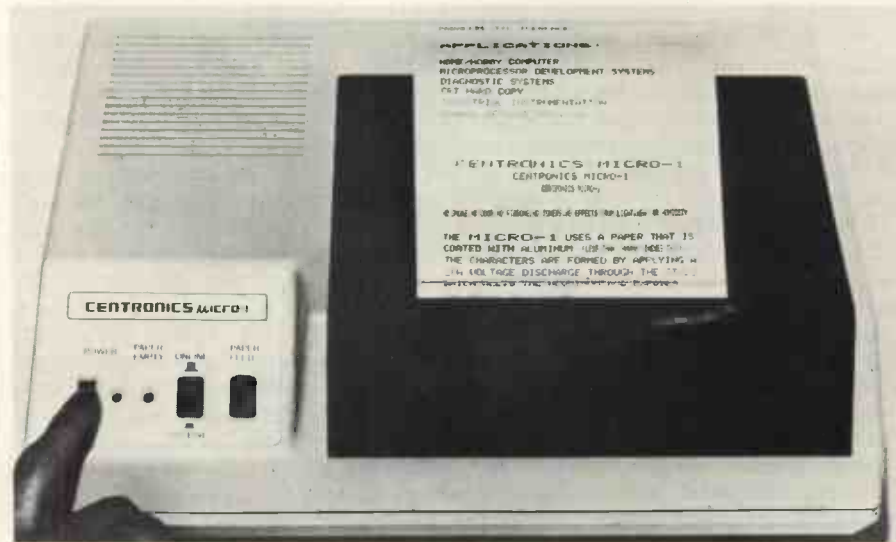

## Commodore Systems

COMMODORE SYSTEMS began U.K. assembly of the Pet Microprinter in September, 1978 at Eaglescliffe.

Model 2023 supersedes the 2020, having been re-designed to offer significantly better quality and a highly-reliable printhead. The printer (80 columns 7×6 needle matrix impact) produces an average printing rate of 93cps.

It is designed as a dedicated Pet printer,

printing all Pet graphics, including reverse and lower-case characters, and double-width capital letters. The printer is micro-



processor-controlled and thus is capable of accepting format statements under program control for small business and engineering applications. Price: £594.

Model 2022 is a tractor-feed taking 8½ in. plain paper and producing up to four copies for business applications such as mailing labels, standard customised forms, and salary cheques. Price: £696.

Commodore Systems Division, 360 Euston Road, London NW1. Tel: (01) 388 0621.

## Heathkit

THE H14 is designed for use with H8 and H11A computers but can be used with most computers through its serial RS232C or 20mA current loop interface.

It uses a normal inked ribbon and impact matrix printhead to produce reports on regular paper. Characters are formed in a 5×7 dot matrix in upper- and lower-case with a 96-character ASCII set. Standard spacing is 10 characters per inch (80 columns) and selectable by hardware or

software, with switchable 16.5 characters per inch spacing (132 column). Twelve characters per inch spacing is software-selectable only.

Standard line-spacing is six lines per inch, with eight lines per inch selectable by software. Maximum printing rate is 165cps and the printhead temperature is monitored after each line and then limited by slowing or stopping the printing. The maximum throughput is determined by print density and ambient temperature.

The sprocket paper feed takes edge-

punched continuous fanfold stationery from 3 to 9.5 in. wide. For forms control, 11 in. form is selected at power-up.

The asynchronous bit-serial interface transmits data at rates from 110 to 4,800 baud with one start, eight data and two stop bits on 110 baud, and one stop bit on all other baud rates. The line buffer has a capacity of 256 characters.

Heath (Gloucester) Ltd, Gloucester GL2 6EE. Tel: (0452) 29451.

Price: £382-68.

## Peripheral Hardware

MODEL 1110-S, designed and manufactured by SCI Systems Inc, is marketed here by Peripheral Hardware. It employs a new revolving printhead to achieve a print rate of 2,200cps, and, fitted with an integral 3,264-character buffer (24 lines by 36 columns), the contents of which may be printed in less than 1.5 seconds on 4 in. wide aluminium-coated paper. Peripheral hardware claims that at speed it only takes

79 seconds to print Shakespeare's Hamlet.

The printing mechanism, available separately for OEM purposes, contains three matrix brushes in a revolving printhead and has only nine moving parts. The print cartridge can be replaced in a few seconds and a life of 25 million characters is claimed.

Supplied with CCITT-V24 (RS232C) or 20mA current loop interface, 5×7 dot

matrix characters are printed 10 to the inch horizontally and seven to the inch vertically in black on a silver background from a 64-character ASCII set. Options provide for a 96-character ASCII set and 7×9 dot matrix characters.

Peripheral Hardware Ltd, Doman Road, Yorktown Industrial Estate, Camberley, Surrey. Tel: (0276) 62711.

Price: £745.



## Personal Computers Ltd

THE AXIOM EX-801 is available from Personal Computers, the U.K. agents for Apple. It is an intelligent printer, designed around the Intel 8048 microprocessor, and offering 256-character buffering, 96-character ASCII set expandable to 256 characters, with user-programmable fonts, reverse printing, three character sizes for 80-, 20- and 40-column formats, and full-duplex capability.

A choice of serial RS232C or 20mA

current loop, or parallel ASCII interfaces is available, together with options of a 128 ASCII character set, up to 2K bytes of user-programmable ROM (UV erasable type) which may be used to call subroutine blocks, and buffer expansion to 2K characters.

Each EX-801 has a case, power supply, character generator, low paper detector, bell, built-in self-tester and paper-roll holder. High-speed electrosensitive printing takes place at up to 160cps. Price: £349; switchable serial/parallel interface £110.

Model EX-820 is a plotter version of the EX-801 with high-resolution graphics generated by user commands in software. The user can define the size of each graphic field and can choose from three pre-programmed horizontal dot resolutions up to 128 dots per inch. Once the fields have been designed, the EX-820 formats graphic and alphanumeric printouts automatically to specifications. Price: £699, including Apple interface card. Personal Computers Ltd, 194-200 Bishops-gate, London EC1. Tel: (01) 283 3391.

## Transdata

MODEL 313 operates at a 30cps and has a 64-character buffer to allow data input during carriage return. The standard model uses a 96-ASCII upper- and lower-case character set and options are available for APL and CCITT No 2 (Baudot) codes. Characters are produced on to thermally-sensitive paper by an electronic process whereby the characters are formed from a matrix of 35 elements.

The platen assembly forms an electromagnet which is energised each time printing occurs by holding the metal head against the paper with equal pressure for the whole length of the platen. This eliminates maintenance adjustments of the printhead-to-paper position.

Transdata claims that the 313 has been designed to eliminate preventative maintenance and that no routine adjustments, lubrication or checks are required. The user may choose between RS232C or 20mA current loop serial interfaces.

Transdata Ltd, 11 Garrick Street, London WC2 E9AR. Tel: (01) 240 2713.



## Transtel

MODEL AH has a standard serial CCITT V24 interface or, if required, an audio frequency modem, switch-selectable to operate at any three standard speeds up to 30cps.

Five- and six-level telegraph codes are available in addition to eight-level (8-bit) ASCII codes in 64, 96 or 128 character sets with upper- and lower-case, national character variations, weather symbols and bold or expan-

ded characters by on-line control.

Characters are formed in a 5 × 7 or 5 × 5 dot matrix on original plus up to two copies of plain or pressure-sensitive paper in rolls or fanfold of up to 5in. diameter and six or 8½in. wide. A printhead life of 300 million characters is claimed, as is a sound level of 60db at a distance of one metre.

Other features include last-character visibility, half-line spacing (forward or reverse), 10 or 11 characters per inch and 6

or 4.4 lines per inch spacing, automatic carriage return and line-feed, underlining, odd or even parity checking, and 20-character answer-back option.

A number of accessories are offered such as low paper switch, power line filter, fanfold adaptor, paper winder and pedestal.

Transtel Communications Ltd, Swinton House, 324 Grays Inn Road, London WC1. Tel: (01) 278 3115. Price: £895.

## Trend Communications

THE TREND 800 uses standard teleprinter paper in rolls up to 5in. in diameter for printing on originals and up to three copies. Paper storage is contained completely within the printer.

Operating at up to 30cps, characters are formed in a 7 × 5 dot matrix with black/red printing provided by the use of a standard typewriter ribbon, at 10 characters per inch on 80 columns.

The user may select from one of two character sets, either CCITT International Telegraph Alphabet code 2 (5-level) with

one or one-and-a-half stop bits, or code 5 (8-level) with one or two stop bits, all with odd or even strap-selectable parity. Optional answer-back is available in 31 characters.

The standard interfaces are CCITT V28/RS232C, double current, 20mA single current loop, and parallel. Serial interfaces are switchable from full- to half-duplex for transmission rates from 50 to 300 baud.

Character-viewing is provided by automatic advance on the platen on a pause in printing. When printing continues, the

platen returns to its original line. An audible warning is sounded 10 character positions before end of line, and a paper-low indicator is included as standard. Forms control is by means of friction feed.

Operator controls power on/off, on-line/off-line, baud rate selection, print adjustment for multiple copies, and paper advance lever.

Trend Communications Ltd, St John's Estate, Tylers Green, High Wycombe, Bucks HP10 8HW. Tel: (0494) 40171. Price: £870.

The microcomputer for those who need more than the minimum. The right processor for business, scientific and educational use. Proven applications include Games • Educational • Word Processing • Invoicing • Stock Control • Sales Ledger • Purchase Ledger • Mailing • Scientific.

# THE NEW HORIZON

## Languages

Powerful Basic including sequential and random access disc files • formatted output • strings • line editor • machine language CALL • many other facilities. Optional additional software (under CP/M operating system) includes BASIC

compiler, FORTRAN and COBOL.

Horizon Z80A computer with 2 double-density disc drives and 24K RAM £1,823 (exclusive of VAT and carriage).

## The Horizon computer includes:-

### Specification

Zilog Z80A MPU • S-100 bus (12 slots) • Solid well-built case • Up to four Shugart mini-floppy disc drives, 180KB each • Serial port for CRT or Teletype • Real-time clock on motherboard • Optional additional serial port and parallel port • Powerful operating system and monitor • Access to wide range of S-100 special application boards.



Equinox Computer Systems Ltd,  
"Kleeman House"  
16 Anning Street,  
New Inn Yard,  
London EC2A 3HB.  
Tel: 01-739 2387/9.  
01-729 4460.

## For North Star Horizon systems and software contact the people with experience:

### LONDON

Eurocalc Ltd., 55/56 High Holborn, London. W.C.1. (Tel: 01-405-3113).

### Lion House Microcomputers,

227 Tottenham Ct. Road, London. W.1. (Tel: 01-580-7383).

### Sumlock Bondain Ltd., 15 Clerkenwell

Close, London. EC1R 0AA. (Tel: 01-2532447).

### HUNTS

Micropower, 26 High Street, Great Paxton, Huntingdon, Cambs. PE19 4RF. (Tel: 0480-213785).

### SURREY

Radix 2 Technology Ltd., 92 Wimbledon Hill Road, Wimbledon, S.W.19. (Tel: 01-946-8887).

### MIDDX

Jacobs Computer Systems Ltd., 36 Bengeworth Road, Harrow, Middx. HA1 3SE. (Tel: 01-908-1134).

### HANTS

Claissie-Allen Computing, 5 Upper High Street, Winchester. (Tel: 0962-69368).

### DORSET

Micro Systems Specialists, Market Place, Sturminster, Newton, Dorset. DT10 1BB. (Tel: 0258-72946).

### SOUTH WALES

Micro Media Systems, 12 Clarence Place, Newport, Gwent. (Tel: 0633-50528).

### LANCS & NORTH WALES

Cortex Computer Centre, 25/35 Edge Lane, Liverpool. (Tel: 051-263 5783).

### CAMBS

Wisbech Computer Services Ltd., 10 Market Street, Wisbech, Cambs. (Tel: 0945-64146).

### LINCS

Loveden Computer Services, 167 Bartowby High Road, Grantham, Lincs. (Tel: 0476-72000).

### KENT

Microtek Computer Services, 50 Chislehurst Road, Orpington, Kent. (Tel: 66-26803).  
Tor Business Systems, 83 Timberbank, Vigo Village, Meopham, Kent. (Tel: 0732-822956).

### ESSEX

Micro Software Systems Ltd., Stanhope House, High Street, Stanford-le-Hope. (Tel: 03756-41991/2).

# EQUINOX

## COMPUTER SYSTEMS LTD.

"Kleeman House" 16 Anning Street,  
New Inn Yard, London EC2A 3HB.  
Tel: 01-739 2387/9 01-729 4460.





These pages represent an independent collection of news and views for owners of the Commodore Pet. If you wish to contact Pet Corner, send articles or ideas directly to us. We are not connected with Commodore or with the official Commodore-run Pet Users' Club, though we wish it well. We give space to Mike Lake, of the Independent Pet Users' Group (IPUG).

Some people apparently are unclear about the way Pet Corner operates. Here are the facts. In the editorial office we have an in-tray marked Pet pages. Into it goes all the news items and other Pet-orientated information we obtain. The bulk of the input is provided by Mike Lake, of IPUG, though he is by no means the sole source.

WE HAVE a Pet, we talk to many people with Pets, we receive press releases about Pet-compatible products, and we see Pet items from user group magazines around the world.

We have described Mike as the focus for the Pet pages because he is well-placed to channel Pet information to us. He does not edit the pages, though, and if you have a contribution, you can send it directly to us.

All clear? Incidentally, all of this also applies to the Tandy and Apple pages.

### Calling all inventors

SOME Pet users are now meeting a serious problem with the user port. By the time you have added a parallel printer, a TV interface, the output for a sound generator, a light pen and all the other goodies, you will be a little tired of plugging and unplugging connectors. Add to this the risk of doing damage to the Pet when trying new ideas and you have a serious problem.

Ideally, we would like to have all these gadgets plugged-in together and be able to select one or combinations of them at any one time. The switching device should also isolate the Pet from any nasties which might creep in from the outside world.

If this device could also display the status of the user port points—by LEDs perhaps—and buffer the output, we would all be happier, assuming a reasonable price, of course. If anyone dreams-up anything suitable, please let us know. We could either publish the circuit or have a prototype made.

### News about IPUG

IPUG membership is now about 250 and still growing. Members seem to be divided equally between those in small businesses, education and hobbyists. With the price of Pets falling and with the new 4K Pet at £496, there could soon be many more private owners as well—after all, it is certainly the easiest way to learn about microcomputers.

The group is now offering a program exchange library for non-copyright material. It still has a renumberer, a parallel

printer drive routine and a music program at £2.50 each.

Because of the wide spread of membership, certain individuals have agreed to act as regional organisers. If you live near them, they would certainly tell you more about IPUG and its activities. Remember membership is £2.50 for 1979 payable to IPUG and sent to Mike Lake at 9, Littleover Lane, Derby.

**South-east** : John Nuttall, The Presbytery, West Street, Shoreham-by-Sea, Sussex.

**North-east** : Jim Cocalis, 20 Worcester Road, Newton Hall Estate, Durham.

**Herts** : Brian Bloomfield, Little Orchard, Hill Farm, Radlett, Herts.

**Hampshire** : G A Parkin, Robert May's School, West Street, Odiham, Hampshire.

**Berkshire** : A J H Walter, 7 Parkside Road, Thatcham, Newbury, Berkshire.

**Liverpool** : John Stout, 6 College Avenue, Formby, Lancs. L37 3JJ.

If anyone would like to volunteer to help in other regions, Mike would certainly like to hear from them.

Mike has also been arranging discounts for members:

- Intex Datalog of Eaglescliffe is offering five percent off all purchases, including a dust cover for the Pet at £4.95. This must surely be a good buy; if you have not opened your machine lately, look inside—dust seems to be everywhere.

- Rockcliffe Bros of Liverpool will give 10 percent discount to group members on all books purchased there.

- The Independent Pet Users' Group is keen to make contact with any other groups formed around other machines using the 6502 processor. There is much information which could be shared between the groups, especially on machine code programming.

The Independent Pet Users' Group is keen to make contact with any other groups formed around other machines using the 6502 processor. There is much information which could be shared between the groups, especially on machine code programming.

### Replies

Replies to some of the questions on the February Pet pages:

- **TV interfaces:** HB Computers in Kettering offers one at £45.99, DAMS of Liverpool

has one at £25. We have seen neither so cannot comment on their performance.

- **Connectors:** HB Computers also has Pet connectors at £3 for 80-way, £1.60 for 12-way, and £2.55 for 24-way. As far as we know they do not have covers.

- **The cassette unit:** CBM has found a way to solve the partial erasure problem and the method, originating from its people in London, is being evaluated in the U.S. We'll try to keep you posted.

### Floppies and printers

AT the recent Microsystems exhibition, Commodore displayed its new dual floppy system for the first time and Mike examined it. It has a capacity of 340K on two discs and is connected to the Pet through the IEEE port. The system was shown attached to the new 32K Pet which includes the full-size keyboard.

In use, the floppy proved to be fast and easy to use. Commands to it are similar to those for other IEEE devices, so users will find it very easy to adapt. Inside the box is an impressive array of electronics, including two microprocessors and 8K of disc operating system in ROM. This, of course, means that the floppy makes no demands on the Pet memory and leaves the full 32K on the Pet available for Basic programs.

At the show, Commodore demonstrated the loading of programs and the organisation of sequential files. Random-access files are promised for the production version of the system; whether this will require an enhancement of the present Basic is not yet clear. Obviously you wouldn't want to pay almost £800 for sequential filing, though—you would buy a faster cassette-type unit.

The unit on display suffered one or two minor hardware problems; an error light kept showing and embarrassing everyone, and there are still obvious shortcomings in the Disc Operating System. They should be fairly easy for Commodore to sort out, though. The price is £799 including VAT.

Commodore was not able to show the printer at the exhibition but latest photos and specifications would seem to indicate that it will be worth waiting for, even at the increased price of £696 for the tractor

(continued on page 57)

# You'll laugh when you see how easy choosing a small business computer can be.

## Computer Guides- Guide to Small Business Computers 1979.

The complete directory/handbook that makes selecting the right small business computer for you simpler, faster and more cost-effective.

Written for the non-technical businessman this annual publication provides all the latest facts about small business systems on the market now.

It also interprets these facts so that you can compare and judge these systems against your own criteria.

Choosing the wrong small business computer can lead to expensive mistakes. The guide to Small Business Computers will save you time and money.

**Contents** 160 pages, 81 suppliers listed, over 250 configurations listed and priced.

**Introduction** Including significant steps in selection and installation.

**Suppliers Guide** H.Q. contact and address, regional offices, major European offices, systems available, brief notes on company/systems.

**System Guide** Tabulated data - notes on interpretation and other important guidelines relating to: confidence in supplier cost of acquiring system, support, ease of use, cost of applications, availability of languages and packages, growth paths/upgrading on-line facilities, interfaces to other systems.

**Consultants Guide** How to choose and use a consultant, listing of consultants.

**Critical features** Specification for tender, through shortlisting to contract, dealing with data communications, future developments.

**Case Studies**

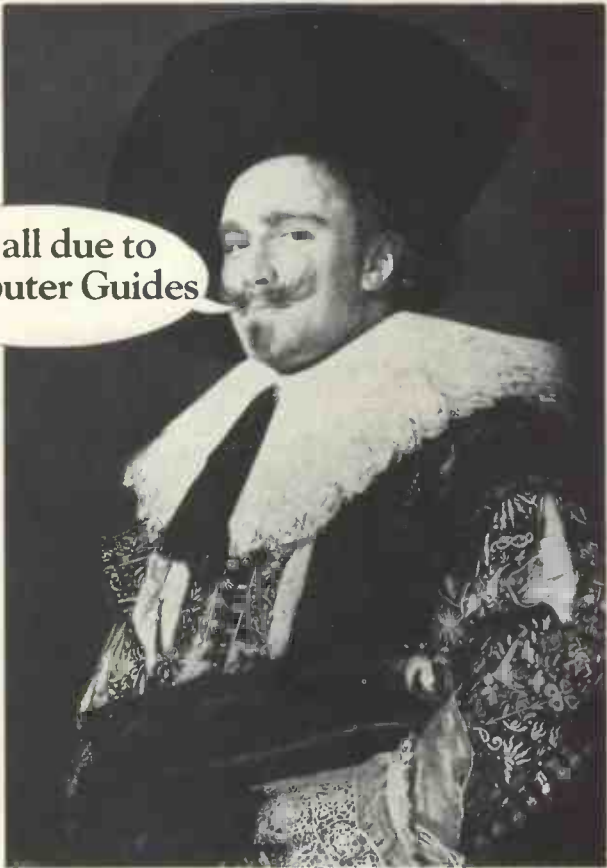

It's all due to  
Computer Guides

Price £24

Please send me \_\_\_\_\_ copy(ies) of the Guide to Small Business Computers 1979.

I enclose a cheque for \_\_\_\_\_

Please invoice my company for \_\_\_\_\_

Please charge my credit card No. \_\_\_\_\_

Name \_\_\_\_\_

Company \_\_\_\_\_

Address \_\_\_\_\_

Post now to Computer Guides Ltd  
2 Duncan Terrace London N1 8BJ  
Telephone 01-278 9517

PC





# COMPUTING BOOKS

## POPULAR COMPUTER TITLES

Arnold, R., Modern Data Processing	£6.60
Boyle, J., Digital Computer Fundamentals	£12.85
Clifton, H., Business Data Systems (a Practical Guide to Systems Analysis; Data Processing)	£6.00
Dijkstra, E., Discipline of Programming	£15.10
Fry, T., Computer Appreciation	£3.50
Fry, T., Further Computer Appreciation	£4.25
Hansen, P., Operating System Principles	£16.30
Hansen, P., Architecture of Concurrent Programs	£16.00
Hill, F., Digital Systems, Hardware Organisation and Design	£9.00
Motil, T., Digital System Fundamentals	£7.60
Peathan, J., Design of Digital Systems	£7.90
Rosen, A., Word Processing	£11.50
Wirth, N., Systematic Programming	£12.75
Wirth, N., Algorithms + Data Structure = Programs	£16.20

## COOKBOOKS

Tracton, K., BASIC Cookbook	£4.10
Lancaster, D., TTL Cookbook	£7.00
Lancaster, D., RTL Cookbook	£4.65
Lancaster, D., CMOS Cookbook	£8.20
Jong, W., IC Op Amp Cookbook	£10.00
Lancaster, D., T.V. Typewriter Cookbook	£7.75
Lancaster, D., Cheap Video Cookbook	£7.00
Jong, W., IC Timer Cookbook	£7.50
Lancaster, D., Incredible Secret Money Machine (a how to cook book for setting up your computer or technical business)	£4.95

<b>Altman, L., Microprocessors</b>	<b>£10.65</b>
Gives a general overview of the technology design ideas and explains practical applications.	
<b>Altman, L., Applying Microprocessors</b>	<b>£12.00</b>
Follow volume which takes you into the second and third generation devices.	
<b>Aspinall, D., Intro to Microprocessors</b>	<b>£6.40</b>
Explains the characteristics of the component.	
<b>Barden, W., Z-80 Microcomputer Handbook</b>	<b>£7.65</b>
<b>Barden, W., How to Buy and Use Minicomputers and Microcomputers</b>	<b>£7.15</b>
Discusses these smaller computers and shows how they can be used in a variety of practical and recreational tasks in the home or business.	
<b>Barden, W., How to Program Microcomputers</b>	<b>£7.00</b>
This book explains assembly language programming of microcomputers based on the Intel 8080, Motorola MC6800 and MCS Technology MCS6502 microprocessor.	
<b>Barna, A., Introduction to Microcomputers and Microprocessors</b>	<b>£7.50</b>
Provides the basic knowledge required to understand microprocessor systems. Presents a fundamental discussion of many topics in both hardware and software.	
<b>Bibbero, R. J., Microprocessors in Instruments and Control</b>	<b>£12.45</b>
Introduces the background elements paying particular regard to the dynamics and computational instrumentation required to accomplish real-time data processing tasks.	

## BASIC LANGUAGE

Albrecht, B., Basic for Home Computers
Allcock, D., Illustrating Basic
Coan, J. S., Basic Basic
Coan, J. S., Advanced Basic
Gosling, R., Beginning Basic
Kemeny, J., Basic Programming
Nagin, P., Basic with Style
Schoman, K., Basic Workbook
Sirion, D., Basic from the Ground Up

Graham, N.  
Hobbyists  
Haviland, N.  
Building su  
calculator c  
Heiserman,  
puters  
Hilburn, J.  
Software an  
Complete a  
gramming o  
roprocessor  
Klingman, E.  
Outstanding  
text is both  
treating ove  
tion device  
microelectr  
Korn, G. A.  
Systems for  
This book  
applications  
Lesea, A., N  
Leventhal, I  
Lewis, T. A  
tions

Bursky, Microcomputer Board Data Manu  
Bursky, D., Microprocessor Data  
Includes complete description of the p  
circuits, architecture, software, etc.  
Duncan, Microprocessor Software Enginee  
Freiberger, S., Consumers Guide to Perso  
Microcomputers  
Frenzel, L., Getting Acquainted with Micro  
This is an invaluable book for those who w  
about hobby and personal computing.  
Gilmore, C. M., Beginners Guide to Micro  
Rao, G. U., Microprocessors and Micro

A completely up-to-date report on the s  
microprocessors and microcomputers wri  
leading experts. It thoroughly analyses o  
equipment including associated large  
hardware and firmware.  
Rony, P. H., The 8080A Bugbook: Microc  
& Programming  
The principles, concepts and applications  
computer based on the 8080 microproc  
emphasis is on a computer as a controller  
Scelbi, 6800 Software Gourmet Guide and  
Scelbi, 8080 Software Gourmet Guide and

Order from



£4.75  
 £2.20  
 £7.50  
 £7.50  
 £4.75  
 £6.10  
 £4.00  
 £3.70  
 £6.00

**JAMES MARTIN BOOKS ON COMPUTER SYSTEMS**

Martin J. Principles of Data-base Management £16.50  
 Martin J. Computer Data Base Organisation £20.00  
 Martin J. Security — Accuracy & Privacy in Computer Systems £20.85  
 Martin J. Design of Man-Computer Dialogues £19.00  
 Martin J. System Analysis for Data Transmission £22.60  
 Martin J. Telecommunications and the Computer £22.30  
 Martin J. Design of Real-Time Computer Systems £16.50  
 Martin J. Programming Real-Time Computer Systems £13.85

N., Microprocessor Programming for Computer £7.00  
 N. P., The Compulator Book £6.20  
 per calculators and minicomputer hardware with chips.  
 D. L., Miniprocessors from Calculators to Com- £4.85  
 L., Microcomputers, Microprocessors, Hardware, and Applications £16.95  
 and practical introduction to the design, pro- operation, uses and maintenance of modern mic- ers, their integrated circuits and other components.  
 E., Microprocessor Systems Design. £16.95  
 g for its information on real microprocessors, this an introduction and a detailed information source er a dozen processors, including new third genera- s. No prior knowledge of microprocessors or onics is required for the reader.  
 A., Microprocessor and Small Digital Computer Engineers and Scientists £19.00  
 covers the types languages, design software and s of microprocessors.  
 Microprocessor Interfacing Techniques £7.50  
 Intro to Microprocessors £16.70  
 G., Mind Appliance Home Computer Applica- £4.75

Libes, S., Small Computer Systems Handbook £5.75  
 The Primer written for those new to the field of personal home computers.  
 Lippiatt, Architecture of Small Computer Systems £4.35  
 Moody, R., First Book of Microcomputers £3.85  
 (the home computer owners best friend)  
 McGlynn, D. R., Microprocessors—Technology, Architecture & Applications £8.40  
 This introduction to the 'computer-on-a-chip' provides a clear explanation of the important new device. It describes the computer elements and electronic semiconductor technolo- gies that characterise microprocessors.  
 McMurrin, Programming Microprocessors £5.50  
 A practical programming guide that includes architecture arithmetic/logic operations fixed and floating point computa- tions, data exchange with peripheral devices, computers and other programming aids.  
 Ogdin, P. H., Software Design for Microcomputers £7.00  
 Ogdin, P. H., Microcomputer Design £7.05  
 Peatman, J. B., Microcomputer Based Design £19.00  
 This book is intended for undergraduate courses on micro- processors.  
 Adams, C., Beginners Guide to Computers and Micro- processors with Projects £5.60  
 Understanding building programming and operating your own microcomputer.

al £5.40  
 £5.40  
 processor. Support  
 ing £13.50  
 ial Computing and £5.50  
 rocessors £7.10  
 ant to know more  
 rocessors £4.75  
 rocessor Systems £20.50  
 state of the art of  
 ten by one of the  
 currently available  
 scale integration  
 mputer Interfacing £7.60  
 of an 8-bit micro-  
 oressor IV chip. The  
 Cookbook £7.80  
 Cookbook £7.80

Scelbi, Understanding Microcomputers £7.60  
 Gives the fundamental concepts of virtually all micro- computers.  
 Soucek, B., Microprocessors and Microcomputers £18.80  
 Here is a description of the applications programming and interfacing technique common to all microprocessors. It concentrates on detailed description of representative micro- processor families and includes explanations of digital codes, logical systems and microcomputer organisation.  
 Spracklen, D., Sargon £9.75  
 A computer chess program in Z-80 assembly language.  
 Tracton, 57 Practical Programs & Games in Basic £6.40  
 Programs for everything from Space war games to Blackjack.  
 Waite, M., Microcomputer Primer £6.25  
 Introduces the beginner, to the basic principles of the micro- computer. Discusses the five main parts of a computer— central processing unit, memory input/output interface and programs. The important characteristics of several well known microprocessors are given and a chapter is given on programming your own microcomputer.  
 Ward, Microprocessor/Microprogramming Handbook £6.00  
 Authoritative practical guide to microprocessor construction programming and applications.  
 Veronis, Microprocessor £12.85  
 Zaks, R., Introduction to Personal and Business Computing £7.50  
 Zaks, R., Microprocessors from Chips to Systems £7.50

● Circle No. 161

59

**TECHNICAL BOOK SERVICES**  
 PO BOX 79,  
 MAIDENHEAD, BERKS. SL6 2EG

*A division of Strathearn  
 Publishing Ltd.*

21 Mincing Lane, London, EC1

# OHIO SCIENTIFIC

Microcomputers from the world's largest  
full-line manufacturer



## The C2-4P Mini Floppy

20K RAM

Basic + Assembler

Personal, Games, Small

Business & Educational Disks

90K Mini Floppy Storage

Printer Interface

OS 65D V-30 Operating System

International Distributors:

**American Data-Home and  
Office Computer,**

1030-15th Street, N.W., Suite 300,  
Washington, D.C., 20005

Tel: (202) 466-6612

Telex 64405

See your nearest auth-  
orised dealer for full  
price list and  
catalogue, of  
Challenger I, II, III,  
series.

### **Abacus Computers Limited**

62 New Cavendish Street  
London W1 Tel: 01-580 8841

### **The Byte Shop Ltd**

426-428 Cranbrook Road,  
Gants Hill, Ilford, Essex  
Tel: 01-518 1414

### **Calderbrook Technical Services**

1 Higher Calderbrook

Littleborough Lancs  
Tel: (0706) 79332

### **COMP Computer Components**

14 Station Road  
New Barnet Herts EN5 1QW  
Tel: 01-441 2922

### **Linn Products**

235 Drakemire Drive  
Castlemilk Glasgow  
G45 95Z Scotland  
Tel: 041-634 3860

### **Mutek**

Quarry Hill, Box Corsham  
Wiltshire SN14 9HT  
Tel: 0225-743289

### **Thames Personal Computers**

13 Wilmot Way Camberley  
Surrey Tel: 0276-27860

### **U Microcomputers**

PO Box 24 Northwich  
Cheshire CW8 1RS  
Tel: 0606-75627



# Disc route with Percom

IF YOU are toying with the idea of floppy discs on your TRS-80—and who is not?—you could do worse than look for the name Percom.

Percom Data Co has a double-sided minifloppy drive which is fully-compatible with the Tandy single-sided drive and about \$100 cheaper. It uses the Pertec FD-200, a reputable enough mechanism, and all you need from Tandy is TRSDOS release 2.1 and a 16K TRS-80 with Level II Basic.

You will also need a ribbon cable which Percom also sells. Percom does not like the standard Radio Shack disc connection and the Percom manual describes the Tandy cable as "not arranged in accordance with good engineering practice".

Percom also sells dual- and triple-drive versions, with which there is a free Percom cable.

The problem, of course, is that you will need a U.S. connection to buy the unit and possibly a converter to run it off the U.K. mains. Even so, prices look good—\$399 for the single drive (stores about 140KB), \$795 for dual drives. The cable, incidentally, will add about \$25.

We hear Percom is looking for U.K. agents. Meanwhile, we have an address for a Dutch distributor—Compu 2000, Chrysanstraat 4, 1031, Amsterdam, or you can contact the manufacturer direct at 318 Barnes Drive, Garland, TX 75042.

## Wobblers

We highlighted Nigel Dibben's troubles in March, and he has been documenting some more glitches on which readers might like to comment. Let us know if you also have any of these bugs.

- Try this after two hours' running:

```
10 FOR I = 1 TO 100: PRINT @ SQR(9):: NEXT
```

The answer should be 3, but Nigel reckons that one try in five gives an overflow error and one in 10 gives the odd response .660938

- Try it with LOG(9). The correct answer is 2.19722; one attempt in 10 produces —.82819 for Nigel.
- Exponentiation (up-arrow) gives similar results.

```
FOR X=1 TO 1000: PRINT@325,X,SIN(X): NEXT
```

Nigel's system has locked into loops at X=34, X=68, X=8.7 and various other values. In a series of 12 runs trying to pin down the error the results were:

```
?SN ERROR in sine line at eg X=34 .....6 times
Return to power-up (MEMORY SIZE?) .....5 times
Closed loop, need to reset .....once
```

- This isn't a check but a warning; memory can sometimes be garbled for no apparent reason. For example, Nigel once gained the following two lines:

```
66NTP RESET
13878 :GOTO440
```

The latter could have been deleted by typing 13878 and ENTER; but the first one, in which the number had been over-printed, was of a higher number and blocked the program. All however, is not lost:

```
Type in a new line immediately before the garble with a
distinctivetextlike:100 REM XXXXXXXXXXXXXXXXXXXXX
Look for this in the memory by entering:
FOR J=17129 TO 25000: PRINT PEEK(J):: NEXT
You will eventually find something like:
...88 88 88 88 0 100 75 74 129 130 29 29 29 64
This is an actual example. The line 0 is an end-of-line
marker; 100 and 75 are LSB and MSB of the line pointer
(start location of the next line pointer); 74 and 129 are
the LSB MSB of the offending line number (i.e. 33098). 130 is
line text (130 is code for RESET).
DELETE 33098. It will now be possible to DELETE
13878 and then repair the damage to the program.
```

## Circles

WE HAD two interesting attempts on the circle-drawing front in response to Freddie Nicholls' request in the March page. Here's one from Nigel Dibben:

```
5 CLS
10 INPUT"ORIGIN IS TOP LEFT CORNER: ENTER
COORDS OF CENTRE, RADIUS AND
ECCENTRICITY (1 FOR CIRCLE)":XC,YC,E
20 A=2/3/R: AT=A: E=E*2.3: REM CORRECTS
FOR SHAPE OR GRAPHIC BLOCKS
30 X=XC+R*E*SIN(AT): Y=YC+R*COS(AT)
40 IF X 128 AND X = 0 AND Y 48 AND Y = 0
SET (X,Y)
50 AT=AT+A: IF AT 6.3 THEN 30
55 REM 6.3 IS ABOUT 2 * PI
60 IF A 0 THEN X=XC: Y=YC: A=0: GOTO 40
70 IF INKEY$=CHR$(31) RUN ELSE 70
After the centre has been set, press CLEAR to rerun.
```

This is also his, not quite so neat but a little faster:

```
5 CLS
10 INPUT "XC,YC,R,E": XC,YC,R,E
20 FOR XC0 TO 127
30 Z = R*R - (X-XC) * (X-XC) : IF Z(0) THEN
70
40 D = E* SQR(Z) /2.3
50 GOSUB 200
60 D = -D : GOSUB 200
70 NEXT
80 X=XC: D=0: GOSUB 200
90 IF INKEY$ = CHR$(31) .RUN ELSE 90
200 Y=YC+D: IF Y) = 0 AND Y(48 SET (X,Y)
210 RETURN
```

You input centre co-ordinates which can be off-screen, radius and eccentricity—setting E=1 produces a perfect circle, E=2 produces an upright ovoid, E=.5 an elegant flat oval.

This is from Bob Williams and also seems to work:

```
5 CLS
10 PI=3.142: FY=2.42
20 PRINT,"CIRCLE DRAWING PROGRAM"
30 INPUT "HOW MANY CIRCLES — UP TO
10":N
50 PRINT "THE SCREEN IS 128 UNITS WIDE
AND 116 UNITS HIGH"
60 PRINT "MAXIMUM RADIUS FOR A
COMPLETE CIRCLE IS 57"
70 PRINT "BUT YOU CAN SELECT ANY
RADIUS YOU LIKE"
80 PRINT "AND ANY CENTRE YOU LIKE ON
OR OFF THE SCREEN (TOP LEFT CORNER
= ORIGIN; +Y IS DOWN)"
90 FOR I = 1 TO N
100 INPUT "KEY RADIUS, X,Y": R(D), X(D), Y(D)
110 NEXT I
120 CLS
130 FOR I = 1 TO N
140 FOR A = 0 TO 2 * PI STEP PI/(3*R(I))
150 SX = INT (X(I)+SIN(A)*R(I)): IF ABS
(SX-63.5) >63.5 GOTO 180
160 SY = INT (Y(I)/FY-R(I)*COS(A)/FY):IF ABS
(SY-23.5) >23.5 GOTO 180
170 SET (SX,SY)
180 NEXT A
190 NEXT I
200 GOTO 200
FY is the scale factor: the screen is 58 'x' units by 24 'y'
units so FY = 58 ÷ 24 = 2.42
```



Bob suggests designing a clock with moving hands, based on a subroutine containing this. Do that successfully and we will print it.

He also has a tweak for the Nicholls' square-drawing program, again based on the 58/24 / 2.42 axis correction factor. If you change variables C and D in lines 8, 20 and 50 of the program to INT(C/2.42) and INT(D/2.42) respectively you should be able to get a *scale* drawing. For example, try INPUT A and C as 10 and B and D as 50.

This circle-drawing solution from A. Ellefsen of Ingatestone also looks neat. It is written for a Level II machine with 4KB memory:

```
10 CLS:INPUT"ENTER DIAMETER":D:CLS
15 FOR X=.02 TO 0.5 STEP 2/D
20 SET(SIN(X)+1)*.5*D,(COS(X)+1)*.2*D)
30 NEXT
40 IF INKEY$="" THEN 40 ELSE 10
```

He has used the idea in wallpaper design programs with random side lengths and screen positionings; it also looks good for 'filled-in' rectangles alternating between set and re-set commands.

## Video wobble

AN ESSEX reader comments on the variation from one TRS-80 to another in the stability of the video picture. A test for your machine is to white-out the screen. On a good machine the picture will wobble at most only slightly on the edges of the frame and will not be upset by any but the most powerful RE interferences.

A poor machine under similar conditions will be so unstable that graphics containing more than 75 percent white cannot be used.

A friend has reported that replacing the video cable with low-loss co-ax removes the ghosting on the characters and helps reduce the wobble but this involves opening the video unit and is the kind of modification which destroys guarantees. □

# Scotland's first computer shop

● PROUDLY PRESENTS ●

## Pet computers ... £460

● PLUS CBM PERIPHERALS ●

CBM 2023 printer .....	£550
CBM 2022 printer .....	£645
CBM 2040 floppy disk (360K) .....	£740
Second cassette deck .....	£55

● NOW AVAILABLE ●

## Apple II from £985

● PLUS APPLE PERIPHERALS ●

Floppy disk unit (116K) .....	£425
Extra drive (116K) .....	£375
AXIOM printer-120 lines/min .....	£349
Printer, communications cards .....	£110

● ALSO IN STOCK ●

## Cromemco System Three - £3,444 Cromemco System Two - £2,294

● WITH ●

Full range of Cromemco peripherals Fortran IV,  
ANSI Cobol, Extended Basic Data Base  
Management, Word Processing, etc.

● PRICES EXCLUDE VAT ●

# MicroCentre

132 St. Stephen Street

Edinburgh 3

(5 mins. walk Princes St.)

Tel: 031-225 2022

COMPARE OUR PRICES....

—THEN DROP IN FOR A DEMO

## Skelly is last stop to U.S.

ALAN THOMAS' father founded Radio Supplies by pushing a barrow round the streets of Swansea to sell wireless sets. Little did he know that one day his business would be selling the most sophisticated equipment available in the U.K.

The shop flourished, was handed from father to son, and now Alan Thomas can claim proudly to be the first Tandy dealer appointed in Wales.

Radio Supplies is on the outskirts of Swansea, at 80 Gower Road, Sketty. As well as Tandy, it also supplies Pet and Apple II systems.

The bulk of business is still from the shop's radio and television interests. Thomas did not need, financially anyway, to become involved with microcomputers, and one would not have thought that there was a great call for them on the outskirts of Swansea. So why did he do it?

"I saw the Horizon programme, *The Chips are Down*, on television one night", he says, "and it had a great influence on me. The next morning I said to my wife 'Microcomputers, they are the thing'."

With his mind made up that it was to be a serious venture, Thomas enrolled for a computer course at the local university, to learn something about the new product he wanted to sell.

### Enlightened

"I came out feeling more enlightened. I was eager and ready to get my hands on the things", he said.

He became a Tandy dealer last April and orders were received as soon as the machines were available.

"I put the computers in the window and that was how I met John Cox, our programmer. He walked past the shop and almost did a backward somersault. Finding a computer on sale in Skelly was the last thing he expected".

Cox is a lecturer in computing at the Polytechnic of Wales and with his partner, Roger Willis, has his own software consultancy, Computer Development Services. Cox is responsible for all the software—except the ready-made programs—sold with Thomas' systems.

So far he has developed programs for small businesses, including estate agents, and has written payroll and dedicated programs for paper and PVC cutting, which requires a high degree of accuracy.

### Natural addition

After the Tandy system had proved successful, the "Pet seemed a natural addition", says Thomas. "We then contacted ITT, because I was fascinated with the Apple II system. We haven't seen the latest production, though, because of supply problems.

Thomas is selling around 10 computers a month—not bad for someone who has been in the business for a year. Customers are from all over the U.K., not just Wales.

As well as selling computers, Thomas also does a good trade in manuals, software cassettes and peripherals, such as the add-on memory for Pet and, more recently, disc drives for the Tandy.

Thomas has become something of a computer freak. "I love the enthusiasm about it all, particularly from the magazines and hobbyists. My father and I are both radio hams, and the fact that programs are being developed for radios is really exciting. I would like to put part of the business on to a computer.

"We have a large colour TV rental interest and there's the payroll. The main reason we haven't done it yet is because of the software. By the end of the year, though, we hope to have it up and running".

The future looks bright for Thomas and Radio Supplies. "We're not sure where we'll go from here", he says "but there's no doubt the business will grow because of microcomputers". □

● Circle No. 163



# Put more than enthusiasm into your hobby . . .



## The Shugart minifloppy

When you buy the Shugart minifloppy you are buying  
the leading miniature floppy in the business at no extra cost.

You gain performance and reliability at a price competitive with cassettes.

And you have the backing of the number one in low cost disc storage technology.



**for the quality professionals expect**

order from your local computer store

**Shugart Distributors**

Total support-technical service,  
training and maintenance

CPU Computers Limited, Copse Road, St. Johns, Woking, Surrey GU21 1SX Telephone: 04862 73883. Telex: 859592

● Circle No. 164

# a digitizer adds another dimension

The Bit Pad computer digitizer converts graphic information into digital form for direct entry into a computer. By touching a pen like stylus or a cursor, to any position on a drawing, diagram, photograph, or other graphic presentation, the position co-ordinates are converted to digital equivalents.

- Bit Pad interfaces with almost any micro computer.
- Bit Pad consists of a 15" sq. digitizer tablet (11" sq. active area), a stylus, and a controller cabinet.
- Bit Pad costs only £450 (excluding VAT). Fill in the coupon and we will send you full information and details.

Terminal Display Systems Ltd. Hillside, Whitebirk Industrial Estate, Blackburn BB1 5SM, Lancs. England

Send to: Department CPPC, Terminal Display Systems Ltd., Hillside, Whitebirk Industrial Estate, Blackburn BB1 5SM, Lancs. England.

Name .....

Address .....

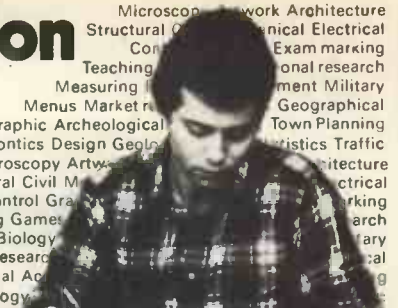

● Circle No. 165



## THE TOTAL SOLUTION FROM ALMARC

OF COURSE!

Now Almarc & Vector Graphic offer the complete solution to your computing needs for £2300.00\* . . . The Vector MZ needs only the addition of a V.D.U. and it's ready to go. Completely assembled and fully tested the Vector MZ Offers the following features as standard:-

- \* S-100 bus
- \* 4 MHz Z80A processor
- \* 158 instructions
- \* two quad density Micropolis floppies—over 630k bytes on line
- \* serial port
- \* two parallel ports
- \* 32K static ram
- \* 12K prom/ram board with extended monitor
- \* Extended disc Basic

Simply connect your peripherals (Elbit V.D.Us & Centronics printers are available from Almarc) and your up and running and, because the MZ uses the S-100 bus, you can plug in a massive range of add on units.

Ring or Write for a demonstration to:-

Almarc Data Systems Ltd.,  
29 Chesterfield Drive,  
Burton Joyce,  
Nottingham. Tel: 0602 248565.

\* Discount terms available.

CPN now available  
on the Vector MZ

● Circle No. 166

BUILD THE 12,000 ALREADY SOLD



### NASCOM I COMPUTER

★ British Design ★ UK Best Selling Kits  
FULL AFTER SALES SERVICE & GUARANTEE

We are the Sole Approved London Stockist and National Distributor

FREE MODULATOR

FEATURES

- ★ Supplied in kit form for self-assembly
- ★ Full documentation supplied
- ★ Fully screened double-sided plated through hole printed circuit board
- ★ Full 48 key keyboard Included
- ★ 2K x 8 Ram
- ★ 1K x 8 monitor program in Eprom
- ★ Powerful Mostek Z80 CPU
- ★ 16 x 48 character display interface to std un-modified T.V.
- ★ T.V. display memory mapped for high speed access
- ★ On board expansion to 2K x 8 Eprom

EXPANSION

- ★ Expansion buffer board . . . £25
- MEMORY KITS (inclusive all hardware)
- 8K . . . . . £85
  - 16K . . . . . £140
  - 32K . . . . . £200
- ★ I/O board with decoders and all hardware except ICS will accept up to 3 PIOs, 1 CTV and 1 UART . . . . . £35

OTHER HARDWARE

- ★ 3A power supply for up to 4K expansion . . . . . £19.90
- ★ 3A power supply for up to 4K expansion Mk II . . . . . £24.50
- ★ 8A power supply for larger than 32K expansion . . . . . £50.00
- ★ Expansion card frame . . . . . £29.50
- ★ E PROM programmer . . . . . £40.00
- ★ E PROM Eraser . . . . . £25.00
- ★ Keyboard cabinet . . . . . £3.50
- ★ Programming manual . . . . . £4.00

★ VAT 8% ALL ITEMS EXCEPT BOOKS ★ DEMONSTRATIONS CONTINUOUS DAILY ★ WE WELCOME EXPORT—EDUCATIONAL AND INDUSTRIAL ENQUIRIES ★ FREE BROCHURE—SEND SAE 9½ x 6½ STAMP 12p.



£165 + 8% VAT  
POST FREE

- ★ On board expansion for additional 16 I/O lines
- ★ Memory may be expanded to full 60K

SOFTWARE

- ★ 1K x 8 monitor program providing
  - ★ 8 operating commands, supporting Mem examine/modify, tabulate, copy, break, single step execute tape, load, tape dump
  - ★ Reflective monitor addressing for flexible monitor expansion through user programs
  - ★ Monitor sub-routines include—delay ASCII coding, binary to hex conversn, clr screen, scroll up, string print, cursor shift and many others
- NEW T-4 operating system in (2) 2708 EPROMS upwards compatible from T2 and B-BUG . . . . . £25.00
- Tiny Basic . . . . . £25.00
- Super Tiny Basic (with editor and machine utility routines) . . . . . £35.00
- Zeap assembler editor . . . . . £32.00



**HENRY'S**

Phone (01) 723 1008

All mail to:  
Henry's Radio  
404 Edgware Rd  
London W2



● Circle No. 167

# MICROSOLVE

If you need advice on which Microcomputer to buy WE CAN HELP YOU. We are specialists in writing packages and tailor-made software.

We are North London dealers for the best micros on the market:

**APPLE II (ITT 2020) from £950** a complete business system incl. printer and software £3,500.

**MICROSTAR 45 from £4,950** multi-user, multi-task, at its price there is nothing to match this new computer.

Software for APPLE II:

*Payroll—Invoicing/Debtors Ledger System—Incomplete Records—Purchase Ledger System—Medical Billing/Case History—Financial Modelling—Stock Control—Schools Commerce Teaching Package—Equipment Rental System—Schools Physics Teaching Package*

Software for MICROSTAR 45:

*Word Processing—Payroll—Other software available on request*

Come and see the computers and discuss your requirements. We promise a personal service.

H.P. or leasing terms available.

Microsolve Computer Services Ltd. 2nd Floor, 125-129 High Street, Edgware, Middx. Telephone 01-951 0218



# Source for ideas and help

THIS is a new column which hopefully will run on a regular basis but that depends largely on you and the amount of response we receive.

Obviously, the first problem to be overcome is communication. The purpose of this feature is ideas and help. You can contribute. This is a users' page. What we need are ideas—on programming improvements, on hardware and so on.

Problems you encounter may not be peculiar to you but it is likely others will have met them also, and we may all benefit from their discussion. We are not averse to printing any complaints you may have about Apple, either.

Moves are afoot to set up the U.K. Users' Group on a national basis. Such groups exist for the Pet and Tandy TRS-80, so why not for the Apple II? It is one of the biggest-selling micros in the U.K., after all, and many hobbyists use it, as well as people using it commercially.

## Library aim

What will the group do? Primarily, we hope to provide an information exchange for Apple users, as well as some kind of clinic to handle minor hardware problems and programming advice. A newsletter on a regular basis should be feasible, provided enough contributions are forthcoming.

What else? A program library is one suggestion in our office at the moment.

An essential pre-requisite will be some kind of meeting. This will be of interest to all concerned and should really get the group started. No date has been fixed, as this will really depend on the amount of interest shown. At the moment, June appears to be the earliest possibility. With Apple users all over the U.K. it will have

**THE Pet and Tandy pages we have begun in recent issues have obviously proved acceptable as far as readers are concerned. This month we start a regular page devoted to the third member of the top-selling triumvirate in personal computing.**

**We have invited Andy Witterick of the U.K. Apple Users' Group to kick off and you can treat him as the focus for contributions, c/o Practical Computing at 2 Duncan Terrace, London N1 8BJ. The users' group, incidentally, is run from the offices of Keen Computers.**

to be somewhere central; probably not London—users in the North are likely to have to travel, so it looks like the Midlands. Perhaps the group needs a regional structure?

Now it is up to you to contact Andy Witterick, 5 The Poultry, Nottingham (telephone 0602 583254). He will send you a membership application form.

The bad news. To cover costs, there will be a membership fee; the group hopes to keep it to £5 or so.

## News and views

THE MARKET in the U.K. being something like two years behind that in the States, plenty of imported bits and pieces are starting to appear here. One of the manufacturers, Mountain Hardware, has produced an Apple clock which will remind enthusiastic programmers to stop for tea. We have no information about delivery but its doubtful whether it will be immediate.

They are available, though—Keen has one. It keeps the time and date in 1/1000-second increments continuously. Calendar clock and event-timer functions are

accessed easily from Basic, using routines carried in on-board ROM.

Mountain Hardware reckons the clock is indispensable; it is certainly useful. The clock is crystal-controlled for accuracy and has an additional re-chargeable battery to keep it ticking during down-times.

Something which has been annoying many people is delivery on the Apple. We have been told that its new factory is now on-line, so delivery problems and delays should soon be resolved.

Hands up all those who bought an Apple with a minimum of memory and now want more. Many of you—right? Well, upgrade kits are now available. Each contains 16K RAM, an assembly manual, and a RAM tester on cassette.

## Simple task

Putting it together is simple since the chips are of the plug-in variety. Cost of the kit is £120 and it should now be available at your local dealer or from Keen Computers, Nottingham.

I noticed a moan in the February Pet Corner about the 6502 software manual being too advanced for many people who want to begin machine code programming. So, for would-be masochists, here's a plug for Rodney Zaks' *Programming the 6502*. Like the rest of his books, it is not only well-written but, more important, comprehensible.

## Superchip

AN ORGANISATION in Texas called Eclectic Corp has what sounds like a handy add-on for Apple. Modestly called the Superchip, it's a plug-in \$125 mod which provides instant enhancement of Apple output.

It has a 'character edit' cassette which allows you to define your own symbols easily—for music? foreign alphabets? maths? games?—while providing a bag-full of other goodies. They include full ASCII with lower-case, vertical text and graphics mixed with horizontal text and graphics, reverse video, and, if you really insist, upside-down text.

Eclectic is at 2830 Walnut Hill Lane, Dallas TX 75229. Check shipping charges before ordering.

## Pursuit

HERE IS a short game on 'pursuit' lines written by Ray Poynter. It's in Applesoft and that's all I'm going to say, except that it is good.

LIST

```
10 TEXT : HOME
11 INPUT " ENTER COPS AND ROBBER
SPEEDS :D,H: REM 1,1.2 WI
LL MEAN ROBBER'S ESCAPE,1.2,1
WILLMEAN COPS WIN
12 H = H / D
13 INPUT " ENTER DISTANCE :D:DIST

15 HGR2
30 TH = 0
40 N = 0
50 ST = ATN (1) / (D * H + D + 1
0)
55 REM ST = STEP
60 X = 0:Y = 0
70 HPLLOT 95,95
1000 TH = TH + H * ST
1010 S1 = COS (TH) - X
1020 S2 = SIN (TH) - Y
1023 REM PLOTTING USING 190 -95
*X-95 ALLOWS US TO MOVE ORIG
IN TO CENTRE
```

```
1025 HPLLOT 190 - 95 * COS (TH) -
95,190 - SIN (TH) * 95 - 95
```

```
1026 REM PLOT NEXT STEP IN CIRC
LE
```

```
1030 R = SQR (S1 ^ 2 + S2 ^ 2)
```

```
1035 REM R=DISTANCE FROM COPS T
O ROBBER'S
```

```
1040 IF R < .1 THEN 2000
```

```
1050 X = X + S1 / R * ST
```

```
1060 Y = Y + S2 / R * ST
```

```
1070 HPLLOT 190 - 95 * X - 95,190
```

```
- 95 * Y - 95
```

```
1075 REM CALCULATE DIRECTION OF
```

```
ROBBER'S FROM COPS AND PLOT
```

```
COPS ONE STEP CLOSER
```

```
1080 IF N < DIST THEN N = N + 1:
```

```
GOTO 1000
```

```
1500 POKE - 16303,0: POKE - 16
```

```
300,0: HOME : VTAB 6: HTAB 6
```

```
: INVERSE : PRINT "THE VILLI
```

```
AN ESCAPES"
```

```
1510 FOR J = 1 TO 5000: NEXT
```

```
1520 NORMAL : POKE - 16304,0: POKE
```

```
- 16299,0: POKE - 16297,0:
```

```
END
```

```
2000 POKE - 16303,0: POKE - 16
```

```
300,0: HOME : VTAB 6: HTAB 6
```

```
: INVERSE : PRINT "": "THE VI
```

```
LLIAN IS APPREHENDED"
```

```
2005 FOR J = 1 TO 6000: NEXT
```

```
2010 NORMAL : POKE - 16304,0: POKE
```

```
- 16299,0: POKE - 16297,0
```

THE first part of our interview with Steve Wozniak, founder of Apple Computers and principal designer of its products, ranged last month over the background to Apple and its meteoric rise. Our interviewer, Robin Bradbeer, then extracted from Steve some views and opinions about the microcomputer world.

**RB:** Steve, you said you regarded Apple 2 as 'the first non-kit computer'. Do you want to elaborate?

**SW:** Well, now of course there's the Commodore Pet and the Radio Shack TRS-80. We don't really think those two have equalled our machine, certainly not in its capability.

**RB:** Surely they're slightly different concepts?

**SW:** They are based on the same principle—a low-cost computer for the home, ready-to-use, plug-in-and-go, good manuals. Many of the newcomers fall down on good documentation; even so we didn't have good manuals in the beginning ourselves. We have them now—there's no substitute for good documentation.

Honestly, though the capability of the other two machines is just not as great. The development software available was just not as great, the application software was not in such good shape, the machines have video display limitations, they don't have colour, they don't have high-resolution graphics. I still say we have the best graphics of any of the small computers.

### Similar approach

**RB:** How about the hobby machines following the S-100 approach?

**SW:** Processor Technology is an interesting case; the Sol took a similar approach to the Apple 1. It was a keyboard which you just plugged into the video terminal. With Apple 1 you didn't get a case; you do with Sol but it's based on a S-100 bus, and that's the ways things will go. Remember the original Altairs were based around teleprinters, because that was how it had been for years. Now it's video which really caught on in the hobbyist world. The Sol is basically an 8080 system with the Processor Technology VDM board and a keyboard all in

# APPLE DESIGN THE MICRO C

a nice case. It was the hottest thing going because that's what people wanted.

I think the term is 'friendly'; Sol looks like an integrated computer system. In fact, the Apple 2 almost beat it, and when it came out it had a little more going for it than the Sol. It had a plastic case, it was well-designed, it looked more together, it had colour graphics, of course, and it had the right RAMs.

**RB:** You really pushed Apple 2?

**SW:** I admit it—"Here it is, the first computer really suitable for the home". The first advertisements showed the Apple 2 in somebody's kitchen and people started buying it; that really put us on the road. It really wasn't until we came out with our disc that our sales really took off. We were the only people really delivering a complete disc system.

### Disc important

**RB:** What do you think of the idea of having the disc integral with the system rather than with the Compu-color 2?

**SW:** Yes, I like it. There are many advantages. The disc is so important, though. I remember when Shugart first came out with the floppy disc;

I was still with H-P and we didn't even have the Apple 1 designed.

We looked at the Shugart manuals to design a very simple interface but we never really got round to it until two years later, when we wanted to expand the Apple 2 peripherals. We felt that a disc was what it really needed, so I pulled out the old design and finally incorporated it. The floppy disc is really the way to use the system. The minifloppy is a real credit to Shugart and its ingenuity. It was the first low-cost peripheral of that power that really gives you a good system, and it's so important for a personal computer that it makes sense to build it in. Yes, I like the Compu-color approach; the concept is really good if they can get the manufacturing and reliability right.

### Graphic ideas

**RB:** It looks as though they have taken a few of your ideas and incorporated them, the colour graphics in particular?

**SW:** Well, Compu-color had a machine out about the same time as the Apple 2. It was a different style from the one it has now; it had rather more capability. The colour scheme is rather different. They have a built-in CRT so they are able to generate higher resolution and more

### Steve Wozniak





# ER MUSES ON OMPETITION

colours. They have dedicated more video RAMs to the system.

CompuColor originally wanted to come out with an \$800 system which had very limited colour graphics. But for some reason they haven't been able to sell. I think there are problems with the disc being so close to the CRT—perhaps they have shielding problems, I don't know. If that machine had been built with Apple ideas, then I think it would have been a real winner.

What the world is really looking for is the machine with the best video resolution and the best colour possible. When you think about it, all it is is RAMs. It's not more complicated, it's just how much RAM you want to spend money on—and RAM is getting so cheap.

**RB:** *What do you think the next generation of computers will have? For example, what do you consider the minimum RAM content of any personal computer?*

**SW:** Well, 16K is our minimum now. No-one in their right mind would order a 4K Apple. Disc operating systems call for quite a bit of RAM. The TRS-80 and the Pet are in a rather difficult position because they were not really designed for upgrading like that to a helpful memory capacity, but Apple 2 was designed to plug 48K into the main board. That was unheard of. I think we can see the time when we'll want more than 64K and that's going to be a real problem with some of the current microprocessors.

## More storage

**RB:** *What do you think about the 16-bit micro?*

**SW:** Well, we could go to one for Apple. But then you have problems with some of the current 16-bit machines which don't really address any more memory than the 8-bit micros. The Intel 8086, for instance, uses a segmentation scheme but you are still stuck with about 65K bytes in any one segment.

**RB:** *Zilog is talking about a lot more storage than that on the Z-8000, I believe?*

**SW:** Yes, they use a 23-bit addressing system with various different addressing modes. In fact, that's probably the first big step forward. But then if it's available you want 256K bytes. If I generate an instruction which refers to a data field offset from some base register by up to 64K, I can use a normal 16-bit offset. If I exceed that, however, I can use a 23-bit offset and address as much memory as I want.

## So hot

**RB:** *When you were with H-P did you meet its 16-bit microprocessor?*

**SW:** Before I left I saw a description of one called the MC<sup>2</sup> that was in SOS. At the time they were talking about 7MHz operating speeds although I think it's been reduced a little. The addressing modes and the instruction set looked to be very similar to other microprocessors around.

If it had been released as a "hobbyist" type product it would have been so hot; it would really have caught on because it was so powerful. But H-P used it only for internal use. There must be a couple of different processors running around the divisions of H-P.

**RB:** *Isn't it a shame H-P doesn't sell its processor products outside the company?*

**SW:** Yes. When I was beginning to get into processors H-P had SOS and NMOS 16-bit chips going and would have been way ahead.

H-P isn't a components manufacturer, though, and it would probably have been a bad move to enter the microprocessor component market. When the Z-80 appeared it was an advance on the other products around and Zilog went into the black within one year of producing it. It really sold like hot cakes. Zilog has a really good pulse on the market and where it is heading.

**RB:** *Do you think that the memory management approach is one good way of handling 16-bit machines?*

**SW:** The Z-8000 is still a 16-bit bare address machine with a segment register. At least you have the large offsets available in the instruction set,

if you were coding in absolute. Now nobody really codes in absolute any more.

**RB:** *Will you stay with 6502-based products—the first two machines both used this microprocessor?*

**SW:** That was a total accident.

**RB:** *As it was the first chip you picked up, would you have done the same thing if somebody had given you a 6800?*

**SW:** It didn't really matter. My first version of the Apple I was designed with the 6800 but then I read in a magazine that the 6502 was a little better, and it was also sold over the counter. Any microprocessor with a reasonable instruction set could have been used.

**RB:** *Do you think that that was the way most personal computer manufacturers chose their processors?*

**SW:** Yes. Most of the small computer manufacturers were starting when the Altair came out; Altair used the 8080, and many followed them. When I say the 6502, I thought that it was really nifty, and I wanted to do something which hadn't been done before. It was largely accidental. But when the large companies step in they think about it—they are more concerned about the supply than the raw performance.

## Popularity

**RB:** *The 6502 is becoming more and more popular. Is this because people like you are using it, or is it because it is just a good processor?*

**SW:** Well, Apple has done an awful lot for the 6502. Now three companies are making it—Rockwell, Synertek and, of course, MOS Technology—it is getting around the OEM world.

**RB:** *How significant is Europe in your marketing?*

**SW:** Europe is a significant proportion of our sales, most of the systems going into small businesses. In the U.S. it's more of a market for personal computers in the home. The TV video systems are different. PAL we can live with—it's not too different from NTSC—but the French system SECAM is another thing altogether. It's a pity the world doesn't use the same standard, though it's doubtful if we'll ever get one video standard, the same as we probably won't get one standard bus structure. □



# I BUY MY LIGHT READING AT MICRODIGITAL

## MERSEYSIDES MICROCOMPUTER SHOP

Microdigital sell the widest range of Microcomputer books in the Country—backed up by a return of post service!

We accept Access and Barclaycard and welcome telephone orders at any time of the day.

### BOOKWORM

#### Microcomputer Programming, 6502 Zaks—£7.95

A superb introduction to the techniques and tricks of programming the 6502 micro, used in the APPLE, PET, ACORN, SYM, etc. Completely self-contained, it can be used by the novice to learn programming, or anyone who wants to make more effective use of the 6502.

#### Basic, Basic—J. Coen—£6.50 and Advanced Basic—J. Coen—£6.00

These two books give you the complete picture of the Basic language. Both texts begin with short, complete programs and progress to more sophisticated problems.

#### Basic with Business Applications—Lott—£8.40

An excellent introduction to Basic for the small businessman.

#### The First Book of Kim Butterfield—et al—£7.16

Games, system programs, how to expand your Kim—essential reading for the KIM freak.

#### Programming Proverbs—Ledgard—£5.56

An excellent little book. The principles of good programming with numerous examples to improve programming style and proficiency.

#### The Design of Well-Structured and Correct Programs—Alagic and Arbib—£10.24

This text synthesizes ten years of research in top down program design and verification of program correctness. It shows how these techniques may be used in day to day programming with the Pascal language.

#### 57 Practical Programs and games in Basic Traction—£6.36

Programs for your APPLE, SORCERER or PET including an excellent Star Wars game.

#### Computer Lib—Nelson—£5.95

The classic work on all computers big or small, it brings the reader through the past ten and into the next ten years of computer science.

#### Chess Skill and Machine—Frey—£11.84

The classic work on computer chess. Includes the intimate details of one of the World's strongest programs—Chess 4.7.

#### How to Build a Computer Controlled Robot—J. Loalbarrow—£6.36

This book details the step by step directions for building a computer-controlled robot named "Mike" controlled by Kim-1 microprocessor, photographs, diagrams and tables help to direct you in the construction. "Mike" moves under his own control avoiding all objects placed in his way, stops starts and changes direction on voice commands.

#### Scientific and Engineering Problems Solving with the Computer—Bennett—£15.96

A superb book—the exercises run the gamut from random process to the dynamics of motion, from entropy in language to the Watergate problem, you'll discover BASIC applications in lasers, and in the Fourier Series, and the law(!)

#### Star Ship Simulation—Gorrel—£5.10

Everything you need to program the ultimate star game complete with a control console connected to your computer.

#### The First West Coast Computer Faire—£9.56

A mine of hard to find information on such diverse subjects as computer music, bit-slice system to implementing high level languages.

#### Practical Microcomputer Programming: the Z80—Weller—£23.96

A much needed text on the techniques and tricks of programming the Z80. Includes complete listings of powerful Editor/Assembler and debugger.

#### A Guide to SC/MP Programming—Drury—£4.00

Essential reading for the MK. 14 owner! Deals with programming the SC/MP at a level anyone can understand.

#### Microcomputer Problems Solving using Pascal—Bowles—£7.84

Pascal is rapidly becoming the language of the microcomputer! The author pioneered its implementation on a Microcomputer and as such is uniquely qualified to write this text. A superb book!

#### Pascal user Manual and Report—Wirth—£5.52

The official reference manual on Pascal.

#### APL—an Interactive Approach—Gilman—£9.50

An industry text on this powerful, interactive language.

#### SARGON—Z80 Chess Program by D. and K. Spracklen—£11.96

An excellent, well documented 8K chess program, it won the 1st microcomputer chess championship with 5/5. The book contains a source listing and quite incredibly detailed annotation. Essential reading for anyone planning to write their own program.

#### Computer Data Directory—£3.98

Hard to find information on the Stateside scene.

#### Small Computer Systems Handbook—Sol Libes—£6.76

A practical introduction to the personal computer by one of Americas leading authors.

#### Basic and the Personal Computer—Dwyer—£10.36

An excellent introduction to the programming language Basic as it applies to the Personal user.

#### Basic Computer Games—AHL—£5.50

102 Games for your APPLE, SORCERER or PET complete with listing and sample runs.

#### Games Playing with Basic—D. Spencer—£5.56

In game playing with Basic the author writes in a non technical style allowing almost everyone to understand computerised game playing. He includes the rules of each game, how each game works, illustrative flowcharts, and diagrams, and the output produced by each program.

#### Game Playing with Computers—D. Spencer—£13.56

Sharpen your programming skills with this collection of over 70 games, puzzles and mathematical recreations. The book includes over 25 game playing programmes.

#### The Cheap Video-cook book—D. Lancaster—£5.10

Techniques of cheap video with complete hardware designs and debugged soft-ware for a 7 chip V.D.U.

#### T15 Workbooks 1-5 for PET

The information commodore does not tell you. Absolutely essential for the PET owner.

- 1. Getting started with your PET £3.00
- 2. PET strings and arrays £3.00
- 3. PET graphics £3.00
- 4. PET cassette £3.00
- 5. PET miscellaneous £3.00

**The Best of Byte vol. 1.** £8.95  
Reprints from the first year of Byte magazine—hardware reviews, hardware designs, and 'how to do it', software.

#### What to do after you hit return—£7.00

PCC's first book of computer games in BASIC.

#### The best of Micro Vol. 1—£6.95

Reprints of the first six issues from MICRO: The 6502 journal.

#### Hard to find information on KIM-1

PET  
APPLE  
AIM—£65 ect.

All prices include VAT and Carriage

Phone in your  
Access/Barclaycard  
Number on  
**051-236-0707**

or complete  
this order  
form



PLEASE  
SEND ME:

OPENING HOURS: 9.5.30 Monday to Saturday.  
Friendly, expert staff always  
on hand!

#### I ENCLOSE:

CHEQUE/POSTAL ORDER NO.....  
 BARCLAYCARD NO.....  
 ACCESS CARD NO.....  
 NAME.....  
 ADDRESS.....

#### COMPLETE AND POST TO



**MICRODIGITAL LTD.** 25 BRUNSWICK STREET  
LIVERPOOL L2 0BJ Tel: 051-236 0707



# ILLUSTRATING BASIC

## ( A SIMPLE PROGRAMMING LANGUAGE )

WE CONTINUE our series of articles on how to program in Basic, probably the most widely-used programming language for small computers.

For the series, we have obtained the serialisation rights for one of the best books on the subject, *Illustrating Basic* by Donald Alcock.

★

Each month, we are publishing a part of the book, so by the end of the series you will have the complete book.

It is written with a distinct informality and has a rather unusual presentation; but it is this style, we believe, which makes it one of the most easy to read tutorials.

★

Alcock *Illustrating Basic*. Chapter 2. © Cambridge University Press. Reprinted by permission.

★

### CONTENTS

#### PREFACE

1. COMPONENTS OF THE LANGUAGE	2
2. INPUT & OUTPUT, EXPRESSIONS AND FUNCTIONS	15
3. CONTROL	39
4. ARRAYS	59
5. MATRICES	75
CONTINUED FROM LAST MONTH	
MATRIX ADDITION AND SUBTRACTION	80
SCALAR MULTIPLICATION OF MATRICES	82
TRANSPOSITION $\approx$ THE ROWS TURN INTO COLUMNS	84
ZER, CON & IDN $\approx$ MATRICES FULL OF 1's & 0's	86
MATRIX MULTIPLICATION $\approx$ "INNER PRODUCTS"	88
CHAPTER 5 TO BE CONTINUED NEXT MONTH	
6. COMPLETE EXAMPLE PROGRAMS	101
7. COMMANDS AND SIGNING ON	111
8. FILES OF DATA	119
9. SYNTAX	127
INDEX	132

# MAT A = B + C

10 DIM A(3,2), B(3,2), C(3,2), D(2,3), E(3,3)

	1)	2)
A(1,	4.3	0
A(2,	8.5	4
A(3,	9.4	4.3

	1)	2)
B(1,	1.5	-2.7
B(2,	3.6	7.8
B(3,	8.4	4.3

	1)	2)
C(1,	2.8	2.7
C(2,	4.9	-3.8
C(3,	1	0

	1)	2)	3)
D(1,			
D(2,			

	1)	2)	3)
E(1,			
E(2,			
E(3,			

SUPPOSE YOU WANT EACH ELEMENT OF ARRAY A(,) TO BE THE SUM (OR DIFFERENCE) OF THE TWO CORRESPONDING ELEMENTS IN ARRAYS B(,) AND C(,). YOU COULD ACHIEVE THIS AS FOLLOWS:

```

200 FOR C = 1 TO 2
210 FOR R = 1 TO 3
220 LET A(R,C) = B(R,C) + C(R,C)
230 NEXT R
240 NEXT C
    
```

*MINUS SIGN IF THE DIFFERENCE IS WANTED*

BUT YOU COULD DO THE WHOLE THING WITH A SINGLE "MAT" INSTRUCTION LIKE THIS:

```

100 MAT A = B + C
    
```

*OR MINUS*

ARRAYS B(,) AND C(,) WOULD BE UNDISTURBED: ARRAY A(,) WOULD END UP AS SHOWN AT THE TOP OF THIS PAGE.

NOTICE THAT A,B & C ON LINE 100 HAVE NOTHING TO DO WITH THE ORDINARY VARIABLES A,B & C; THE WORD "MAT" TELLS BASIC YOU MEAN ARRAYS A(,), B(,) & C(,).

IF THE CURRENT DIMENSIONS OF THE TWO ARRAYS NAMED ON THE RIGHT OF THE EQUALS SIGN ARE NOT IDENTICAL THEN BASIC REFUSES TO OBEY THIS INSTRUCTION.

```

110 MAT A = B + D
    
```

*DIM B(3,2) VS D(2,3)*



THE ARRAY NAMED ON THE LEFT OF THE EQUALS SIGN MUST HAVE DIMENSIONS AT LEAST AS GREAT AS THE *CURRENT* DIMENSIONS OF THE ARRAYS NAMED ON THE RIGHT. THUS LINE 130 BELOW IS WRONG; LINE 140 IS ALLOWED BUT WOULD CAUSE *BASIC* TO RE-DIMENSION ARRAY E(,) SO THAT IT HAD 3 ROWS AND 2 COLUMNS; IT WOULD THEN BE A MISTAKE TO REFER TO E(3,3). IMPLICATIONS OF RE-DIMENSIONING ARE DISCUSSED ON PAGE 79.

```
130 MAT D = B + C
140 MAT E = B + C
150 LET E(3,3) = 13
```

IN SOME (BUT *NOT* ALL) *BASICS* YOU ARE ALLOWED TO HAVE THE NAME OF AN ARRAY ON BOTH SIDES OF THE EQUALS SIGN; FOR THE SAKE OF "PORTABILITY" DON'T DO IT.

```
160 MAT A = A + A
170 MAT A = A - C
180 MAT A = C - A
```

DON'T  
RISK IT

THE FORM OF THIS INSTRUCTION MAY NOT BE VARIED. DON'T TRY ADDING EXTRA SIGNS AND LETTERS.

```
190 MAT A = -B + C
200 MAT A = B + C + F
210 MAT A = (-)B
```

MAT A = C - B

MAT X = B + C  
MAT A = X + F

MAT A = (-)B  
SEE OVERLEAF

# MAT A = ("SCALAR" EXPRESSION) \* B

```
10 DIM A(3,2), B(3,2), C(4,3), D(2,2)
```

	1)	2)		1)	2)		1)	2)	3)		1)	2)
A(1,	15.6	4.5	B(1,	5.2	1.5	C(1,				D(1,		
A(2,	-9	0	B(2,	-3	0	C(2,				D(2,		
A(3,	6	-6	B(3,	2	-2	C(3,						
						C(4,						

SUPPOSE YOU WANT EVERY ELEMENT OF ARRAY A(,) TO BE THREE TIMES THE VALUE OF THE CORRESPONDING ELEMENT IN ARRAY B(,). YOU CAN ACHIEVE THIS FAIRLY SIMPLY AS FOLLOWS:

```
200 FOR C = 1 TO 2
210 FOR R = 1 TO 3
220 LET A(R,C) = 3.0 * B(R,C)
230 NEXT R
240 NEXT C
```

BUT YOU COULD DO THE WHOLE THING WITH A SINGLE "MAT" STATEMENT LIKE THIS:

```
100 MAT A = (3.0) * B
```

ARRAY B(,) WOULD REMAIN UNDISTURBED AND A(,) WOULD NOW BE AS SHOWN AT THE TOP OF THIS PAGE. EVERY ELEMENT HAS BEEN SCALED BY THE SCALAR (i.e. NON-VECTOR or NON-MATRIX) EXPRESSION IN BRACKETS.

NOTICE THAT A & B ON LINE 100 HAVE NOTHING TO DO WITH THE SIMPLE VARIABLES A & B; THE WORD "MAT" TELLS BASIC YOU MEAN ARRAYS A(,) & B(,). BUT INSIDE THE BRACKETS A & B WOULD BE SIMPLE VARIABLES; LINE 130 BELOW WOULD HAVE EXACTLY THE SAME EFFECT AS LINE 100 ABOVE; (A/B) REPRESENTS THE SCALAR QUANTITY (3.0).

```
110 LET A = 6
120 LET B = 2
130 MAT A = (A/B) * B
```



THE ARRAY NAMED ON THE LEFT OF THE EQUALS SIGN MUST HAVE DIMENSIONS IN THE "DIM" STATEMENT AT LEAST AS BIG AS THE CURRENT DIMENSIONS OF THE ARRAY NAMED ON THE RIGHT. THUS LINE 140 BELOW IS WRONG: LINE 150 IS ALLOWED BUT WOULD CAUSE BASIC TO RE-DIMENSION ARRAY C(,) SO THAT IT HAD 3 ROWS AND 2 COLUMNS: IT WOULD THEN BE A MISTAKE TO REFER TO C(4,2). IMPLICATIONS OF RE-DIMENSIONING ARE DISCUSSED ON PAGE 79.

```
140 MAT D = (0-5) * B
150 MAT C = (-1) * B
160 LET C(4,2) = 13
```

IN SOME (NOT ALL) BASICS YOU ARE ALLOWED TO NAME THE SAME ARRAY ON BOTH SIDES OF THE EQUALS SIGN: FOR THE SAKE OF "PORTABILITY" DON'T DO IT:

```
170 MAT A = (-X) * A
```

DON'T DO IT!

THE EXPRESSION IN BRACKETS MAY BE AS COMPLICATED AS YOU LIKE AS LONG AS IT REPRESENTS A SINGLE SCALAR VALUE:

```
180 MAT A = (-X + SQR(3 * B(2 * I, J))) * B
```

THE FORM OF THIS INSTRUCTION IS STRICTLY AS SHOWN IN THE HEADING OPPOSITE. SOME ERRORS OF FORM ARE ILLUSTRATED BELOW:

```
185 LET X = 3
```

```
190 MAT A = X * B
```

```
192 MAT A = -(X) * B
```

```
194 MAT A = (X) * (Y) * B
```

```
196 MAT A = B * (X)
```

THIS IS THE FORM FOR "MATRIX MULTIPLICATION. SEE PAGE 88"

MAT A = (-X) \* B

MAT A = (X \* Y) \* B

MAT A = (X) \* B

# MAT A = TRN(B)

10 DIM A(3,2), B(2,3), C(3,3), D(2,2)

	1)	2)
A(1,	4.2	-3.8
A(2,	15.6	8.7
A(3,	0	-4

	1)	2)	3)
B(1,	4.2	15.6	0
B(2,	-3.8	8.7	-4

	1)	2)	3)
C(1,			
C(2,			
C(3,			

	1)	2)
D(1,		
D(2,		

**S**UPPOSE YOU WANT THE ROWS OF ARRAY A(,) TO BE THE SAME AS THE COLUMNS OF ARRAY B(,) IN OTHER WORDS YOU WANT A(,) TO BE THE TRANSPOSE OF B(,). YOU COULD COPY THE ELEMENTS ONE BY ONE LIKE THIS :

```

200 FOR I = 1 TO 2
210 FOR J = 1 TO 3
220 LET A(J,I) = B(I,J)
230 NEXT J
240 NEXT I

```

NOTE THE POSITIONS  
OF SUBSCRIPTS:  
(J,I) & (I,J)

BUT YOU COULD DO THE WHOLE THING WITH A SINGLE "MAT" INSTRUCTION LIKE THIS :

100 MAT A = TRN(B)

ARRAY B(,) WOULD BE UNDISTURBED; ARRAY A(,) WOULD END UP AS SHOWN AT THE TOP OF THIS PAGE.

**N**OTICE THAT A & B ON LINE 100 HAVE NOTHING TO DO WITH THE SIMPLE VARIABLES A & B; THE WORD "MAT" TELLS BASIC YOU MEAN ARRAYS A(,) & B(,).

**T**HE ARRAY NAMED ON THE LEFT OF THE EQUALS SIGN MUST HAVE DIMENSIONS IN ITS "DIM" STATEMENT AT LEAST AS BIG AS THE CURRENT DIMENSIONS OF THE ARRAY NAMED ON THE RIGHT. THUS LINE 110 OPPOSITE IS WRONG; LINE 120 IS ALLOWED BUT WOULD CAUSE BASIC TO RE-DIMENSION ARRAY C(,) SO THAT IT HAD THREE ROWS AND TWO COLUMNS (NB. NOT 2 ROWS & 3 COLUMNS) AND IT WOULD THEN BE A MISTAKE TO REFER TO C(3,3).



IMPLICATIONS OF RE-DIMENSIONING ARE DISCUSSED ON PAGE 79.

110 MAT  $D = \text{TRN}(B)$   
 120 MAT  $C = \text{TRN}(B)$   
 130 LET  $C(3,3) = 13$

**Y**OU MAY NOT NAME THE SAME ARRAY ON BOTH SIDES OF THE EQUALS SIGN: IN OTHER WORDS YOU MAY NOT TRANSPOSE A MATRIX ON TOP OF ITSELF:

140 MAT  $B = \text{TRN}(B)$

BUT SOME BASICS DO ALLOW THIS. AS AN EXERCISE IT MIGHT AMUSE YOU TO WRITE A ROUTINE FOR REPLACING AN ARRAY BY THE TRANSPOSE OF ITSELF BUT WITHOUT COPYING IT FIRST TO SOME OTHER ARRAY (IN OTHER WORDS YOU SHOULD TRANSPOSE THE ARRAY "IN-SITU"). IT IS TRICKY BUT NOT IMPOSSIBLE.

**T**RANSPOSITION IS A USEFUL OPERATION IN MATRIX ALGEBRA: IN PARTICULAR FOR TRANSFORMING COORDINATES FROM ONE SET OF AXES TO ANOTHER. THE SIMPLEST EXAMPLE OF THIS IS ILLUSTRATED BELOW.

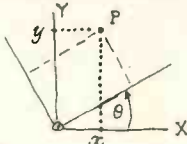
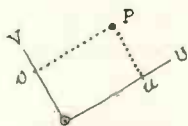

THE COORDINATES OF POINT P RELATIVE TO U & V ARE  $u$  &  $v$  RESPECTIVELY. WHAT ARE THE COORDINATES OF P RELATIVE TO AXES X & Y?

USING TRIGONOMETRY:

$$x = u \cos \theta - v \sin \theta$$

$$y = u \sin \theta + v \cos \theta$$

WHICH MAY BE WRITTEN IN MATRIX FORM AS BELOW:

$$\begin{bmatrix} x \\ y \end{bmatrix} = \begin{bmatrix} \cos \theta & -\sin \theta \\ \sin \theta & \cos \theta \end{bmatrix} \begin{bmatrix} u \\ v \end{bmatrix} \dots (1)$$

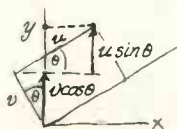
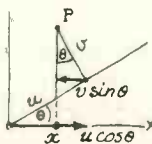

ALSO USING TRIGONOMETRY IT IS JUST AS SIMPLE TO FIND A PAIR OF EQUATIONS YIELDING  $u$  AND  $v$  IN TERMS OF  $x$  AND  $y$ :

$$\begin{bmatrix} u \\ v \end{bmatrix} = \begin{bmatrix} \cos \theta & \sin \theta \\ -\sin \theta & \cos \theta \end{bmatrix} \begin{bmatrix} x \\ y \end{bmatrix} \dots (2)$$

NOTICE THAT EACH OF THESE SQUARE MATRICES IS THE TRANSPOSE OF THE OTHER.

IT IS GENERALLY TRUE OF ORTHOGONAL AXIS TRANSFORMATIONS THAT TO REVERSE THE TRANSFORMATION YOU SIMPLY TRANSPOSE THE TRANSFORMING MATRIX. IN TEXT BOOKS MATRICES ARE OFTEN INDICATED BY LETTERS IN BOLD TYPE AND TRANSPPOSITION BY A PRIME. THE TWO EQUATIONS ABOVE MIGHT BE SHOWN AS:  $\mathbf{X} = \mathbf{T}\mathbf{U}$  AND  $\mathbf{U} = \mathbf{T}'\mathbf{X}$ .

# MAT A = ZER

```
10 DIM A(3,4), B(2,3)
```

	1)	2)	3)	4)
A(1,	0	0	0	0
A(2,	0	0	0	0
A(3,	0	0	0	0

	1)	2)	3)
B(1,	1	1	1
B(2,	1	1	1

**Y**OU MAY MAKE ALL ELEMENTS OF AN ARRAY ZERO LIKE THIS:

```

200 FOR R = 1 TO 3
210 FOR C = 1 TO 4
220 LET A(R,C) = 0
230 NEXT C
240 NEXT R
    
```

BUT YOU COULD DO THE WHOLE THING WITH A SINGLE "MAT" INSTRUCTION LIKE THIS:

```
100 MAT A = ZER
```

WHERE "ZER" IS SIMPLY A WORD SHORT FOR ZERO, AND LETTER A HAS NOTHING TO DO WITH THE SIMPLE VARIABLE A. THE WORD "MAT" TELLS *BASIC* YOU MEAN ARRAY A(,).

## TAKE CARE

WITH THIS INSTRUCTION AND WITH "CON" AND "IDN" DESCRIBED BELOW. THE ARRAY NAMED ON THE LEFT OF THE EQUALS SIGN IS ASSUMED BY SOME *BASIC*S TO RETAIN ITS *CURRENT* DIMENSIONS WHICH MAY BE SMALLER THAN THOSE IN ITS "DIM" STATEMENT. SO UNLESS THIS IS THE VERY FIRST "MAT" INSTRUCTION TO BE OBEYED IT IS SAFER TO USE THE ALTERNATIVE FORM:

```
110 MAT A = ZER(2,3)
```

EXPRESSIONS ALLOWED HERE

WHICH HAS THE EFFECT OF RE-DIMENSIONING THE ARRAY NAMED ON THE LEFT OF THE EQUALS SIGN AS WELL AS SETTING ITS ELEMENTS TO ZERO. IMPLICATIONS OF RE-DIMENSIONING ARE DISCUSSED ON PAGE 79. IF YOU DO USE EXPRESSIONS FOR DIMENSIONS, MAKE CERTAIN (PERHAPS USING "INT") THAT YOUR EXPRESSIONS YIELD INTEGRAL RESULTS. SOME *BASIC*S USE THE *NEAREST* INTEGER TO THE RESULT BUT OTHERS TAKE THE *INTEGRAL PART* OF THE RESULT.



# MAT A = CON

THE ONLY DIFFERENCE BETWEEN THIS INSTRUCTION AND "MAT A=ZER" IS THAT THE RESULTING ARRAY IS FULL OF 1'S RATHER THAN 0'S.

```
120 MAT B = CON(2,3)
```

"CON" IS SHORT FOR *CONSTANT*. YOU CAN SET ALL ELEMENTS TO ANY CONSTANT IN TWO "MAT" INSTRUCTIONS.

```
130 MAT A = CON(2,3)
140 MAT B = (-5)*A
```

ALL ELEMENTS  
OF B(,) SET  
TO -5

# MAT A = IDN

"IDN" IS SHORT FOR *IDENTITY*. (AN "IDENTITY MATRIX" IN MATRIX ALGEBRA IS ANALOGOUS TO *UNITY* IN ORDINARY ALGEBRA; THIS IS DEMONSTRATED ON PAGE 91.) THE IDENTITY MATRIX HAS 1'S ON THE *DIAGONAL* (WHERE ROW & COLUMN SUBSCRIPTS ARE EQUAL) AND 0'S OFF THE *DIAGONAL* (WHERE SUBSCRIPTS ARE *UNEQUAL*). HERE IS ONE WAY TO PROGRAM IT:

	1)	2)	3)
A(1,	1	0	0
A(2,	0	1	0
A(3,	0	0	1

```
200 FOR R = 1 TO 3
210 FOR C = 1 TO 3
220 LET A(R,C)=1-ABS(SGN(R-C))
230 NEXT C
240 NEXT R
```

BUT YOU CAN DO IT WITH A SINGLE "MAT" INSTRUCTION:

```
150 MAT A = IDN(3,3)
```

IDENTITY MATRICES  
ARE ALWAYS SQUARE

YOU MAY LEAVE OFF THE DIMENSIONS AND HAVE JUST "MAT A=IDN" BUT ONLY IF THE *CURRENT* DIMENSIONS OF A(,) ARE EQUAL.

YOU MAY ALSO HAVE *EXPRESSIONS* FOR DIMENSIONS INSTEAD OF WRITTEN INTEGERS AS ABOVE. FOR EXAMPLE "MAT A=IDN(X,2\*Y+3)". BUT THE RESULTS OF BOTH EXPRESSIONS MUST BE THE SAME WHEN BASIC EVALUATES THEM BECAUSE THERE IS NO SUCH THING AS A *NON-SQUARE* IDENTITY MATRIX. FURTHERMORE YOU SHOULD MAKE CERTAIN YOUR EXPRESSIONS CAN ONLY YIELD INTEGRAL RESULTS FOR THE REASONS GIVEN OPPOSITE.

# MAT R = A \* B

HERE IS A SIMPLE ILLUSTRATION OF "MATRIX MULTIPLICATION" WITHOUT THE USE OF A "MAT" INSTRUCTION.

THERE ARE 3 SALES-PEOPLE EACH SELLING 4 PRODUCTS; THEIR WEEKLY ACHIEVEMENT IS TABULATED LIKE THIS:

SALES-PEOPLE	PRODUCT			
	MAGLETS	SCROPEERS	GIMPLES	NUCKERS
MR. HOGG	5	2	0	10
MS. BURNTBRA	3	5	2	5
M. CHAUVIN	20	0	0	0

WEEKLY SALES: FORM A(3,4)

PRODUCT	PRICE LIST: B(4,2)	
	PRICE	COMMISSION
MAGLETS	1.50	0.20
SCROPEERS	2.80	0.40
GIMPLES	5.00	1.00
NUCKERS	2.00	0.50

"INNER PRODUCTS"

THE LIST OF PRICES AND SALES COMMISSIONS (IN MONEY; NOT AS A PERCENTAGE) IS TABULATED LIKE THIS:

SO THE MONEY BROUGHT IN IS:

MR. HOGG  $5 \times 1.50 + 2 \times 2.80 + 0 \times 5.00 + 10 \times 2.00 = 33.10$   
 MS. BURNTBRA  $3 \times 1.50 + 5 \times 2.80 + 2 \times 5.00 + 5 \times 2.00 = 38.50$   
 M. CHAUVIN  $20 \times 1.50 + 0 \times 2.80 + 0 \times 5.00 + 0 \times 2.00 = 30.00$

AND THE COMMISSIONS EARNED ARE:

MR. HOGG  $5 \times 0.20 + 2 \times 0.40 + 0 \times 1.00 + 10 \times 0.50 = 6.80$   
 MS. BURNTBRA  $3 \times 0.20 + 5 \times 0.40 + 2 \times 1.00 + 5 \times 0.50 = 7.10$   
 M. CHAUVIN  $20 \times 0.20 + 0 \times 0.40 + 0 \times 1.00 + 0 \times 0.50 = 4.00$

IF THIS WERE PUT ON THE COMPUTER THE WEEKLY SALES ACHIEVEMENT COULD BE STORED IN ARRAY A(,), THE PRICE LIST RESIDING IN ARRAY B(,), AND THE RESULTS SENT TO ARRAY R(,) PRIOR TO PRINTING. THE PROGRAM MIGHT CONTAIN THE FOLLOWING CODE:

```

10 DIM A(3,4), B(4,2), R(3,2)
20 MAT R = ZER(3,2)

200 FOR I = 1 TO 2
210 FOR J = 1 TO 3
220 FOR K = 1 TO 4
230 LET R(J,I) = R(J,I) + A(J,K) * B(K,I)
240 NEXT K
250 NEXT J
260 NEXT I
  
```

Annotations:  
 - 200: COLUMNS OF B(4,2) = COLUMNS OF R(3,2)  
 - 210: ROWS OF A(3,4)  
 - 220: COLUMNS OF A(3,4) = ROWS OF B(4,2)

↑  
THE SAME RESULTS  
↓

	1)	2)
R(1,	33.1	6.8
R(2,	38.5	7.1
R(3,	30	4

THE COLUMNS OF R(,) WOULD THEN CONTAIN THE "LONG-HAND" RESULTS ABOVE.



THE CODE FROM LINE 200 TO 260 COULD BE REPLACED BY THE SINGLE "MAT" INSTRUCTION:

```
100 MAT R = A * B
```

THE ROWS OF  $A(,)$  ARE CUMULATIVELY MULTIPLIED BY THE COLUMNS OF  $B(,)$ . WHAT GOES INTO  $R(r,c)$ ?  
ANSWER: THE INNER PRODUCT OF THE  $r^{\text{th}}$  ROW OF  $A(,)$  AND THE  $c^{\text{th}}$  COLUMN OF  $B(,)$ .

FOR THIS "MAT" INSTRUCTION TO WORK AT ALL IT IS IMPERATIVE FOR ARRAYS TO HAVE CURRENT DIMENSIONS MAKING THEM "CONFORMABLE".

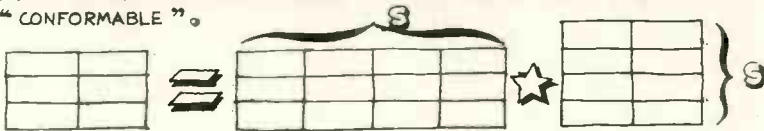

$$R(r,c) = A(r,s) \star B(s,c)$$

NO OF ROWS  
IN RESULT

"SAME"  
"INSIDE"  
DIMENSION

NO OF COLUMNS  
IN RESULT

IN THE EXAMPLE OPPOSITE:  $A(,)$  HAS DIMENSIONS (3,4) AND  $B(,)$  HAS DIMENSIONS (4,2), SO THE "4" ON THE "INSIDE" MAKES  $A(,)$  &  $B(,)$  CONFORMABLE. BUT IT WOULD BE TOTALLY WRONG TO HAVE:

```
110 MAT R = B * A
```

IN ORDINARY ALGEBRA  $a \times b = b \times a$  BUT IN MATRIX ALGEBRA  $b \times a$  MAY NOT EVEN EXIST. IN THIS EXAMPLE LINE 110 IS COMPLETE NONSENSE.

PROVIDED THAT  $A(,)$  &  $B(,)$  ARE CONFORMABLE, ARRAY  $R(,)$  IS RE-DIMENSIONED TO HAVE AS MANY ROWS AS THE CURRENT FIRST DIMENSION OF  $A(,)$  AND AS MANY COLUMNS AS THE CURRENT SECOND DIMENSION OF  $B(,)$ . IF THESE DIMENSIONS EXCEED THOSE IN THE "DIM" STATEMENT FOR  $R(,)$  THEN BASIC REPORTS AN ERROR AND STOPS WORK. OTHER IMPLICATIONS OF RE-DIMENSIONING ARE DISCUSSED ON PAGE 79.

YOU ARE NOT ALLOWED TO VARY THE SIMPLE FORM OF THIS INSTRUCTION AND YOU MAY NOT NAME THE SAME ARRAY ON BOTH SIDES OF THE EQUALS SIGN.

```
120 MAT P = A * P
```





# Introducing Acorn

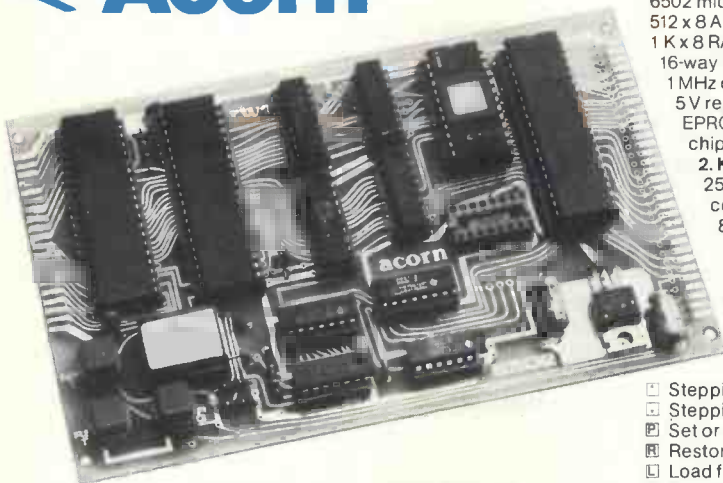

## A professional MPU card

Designed as a general purpose industrial controller based on the 6502 MPU, this card is complemented by a matching Eurocard hex keyboard and CUTS standard cassette interface, to create the new...

# Acorn Microcomputer



This compact stand-alone micro-computer is based on standard Eurocard modules, and employs the highly popular 6502 MPU (as used in APPLE, PET, KIM, etc). Throughout, the design philosophy has been to provide full expandability, versatility and economy. Take a look at the full specification, and see how Acorn meets your requirements

## Acorn technical specification

The Acorn consists of two single Eurocards:

### 1. MPU card

6502 microprocessor  
512 x 8 ACORN monitor  
1 K x 8 RAM  
16-way I/O with 128 bytes of RAM  
1 MHz crystal  
5 V regulator, sockets for 2 K EPROM and second RAM I/O chip.

### 2. Keyboard card

25 click-keys (16 hex, 9 control)  
8 digit, 7 segment display  
CUTS standard crystal controlled tape interface circuitry

### Keyboard Instructions:

- M Memory Inspect/Change (remembers last address used)
- Stepping up through memory
- Stepping down through memory
- Set or clear break point
- Restore from break
- Load from tape
- Store on tape
- Go (recalls last address used)
- RST Reset

## Compact, easy to use Acorn Monitor includes the following features:

- System program
- Set of sub-routines for use in programming
- Powerful de-bugging facility displays all internal registers
- Tape load and store routines

## Acorn - with real expandability!

The standard Acorn is fully expandable to 65 K of memory, and the Acorn bus is available on the 64-way edge-connector. Whether you're a beginner in the field, an ambitious home computer buff, a development engineer, a teacher or a businessman, the Acorn and its family of modules will provide a practical solution in virtually every situation.

Future expansion for Acorn includes the following software and hardware.

## Software

Basic Interpreter, assembler, dis-assembler, editor, TTY and disk operating system.

## Hardware

Memory-mapped VDU system (with upper and lower case ascii graphics and hardware scroll) floppy disk controller for 5¼ in and 7 in disks, a memory card with 8 K bytes of static RAM (2114) and 4 K bytes of EPROM (2716) a PROM programmer (for all types of PROM usable on ACORN a full ascii keyboard, a backboard for the ACORN bus, and a Eurocard racking system.

## Acorn Operating Manual

With Acorn, you'll receive an operating manual that covers computing in full, from first principles of binary arithmetic, to efficient hex programming with the 6502 instruction set. The manual also includes a listing of the monitor programs and the instruction set, and other useful tabulations; plus a selection of 12 interesting and educative program samples.

## Acorn, as a kit or fully assembled, the choice is yours with this coupon!

With such flexibility at such a price, the ACORN package is one you'll want to make the most of, soon. Whether you're a hobbyist, computer technician, R&D engineer or a computer user, Acorn provides you with a highly cost-effective basis for a computer or an industrial development system.

To get your Acorn, just complete this coupon, enclose a cheque (or an official company order) and send it to us. If Acorn doesn't meet your highest expectations, return it to us as received within 14 days, for a full cash refund.

Acorn comes with a comprehensive guarantee covering replacement of any faulty components, plus an expert service facility.

Take another look at Acorn's spec, check the price again, then send your order today!

**Acorn Computers Ltd,  
4A Market Hill, Cambridge, Cambs.  
Cambridge (0223) 312772.**

## Order form

Send to: Acorn Computers Ltd,  
4A Market Hill, Cambridge, Cambs.  
Please send me the following:

(qty) Acorn Microcomputer(s)  
(Acorn MPU card with 1 K RAM and keyboard card with cassette interface, in kit form, with assembly instructions) at £65.00 plus £5.20 VAT

(qty) Acorn Microcomputer(s),  
as above, assembled and tested at £75.00 plus £6.00 VAT

(qty) Acorn controller(s)  
(minimum configuration MPU board with 6502, RAM I/O, TTL logic and capacitor-controlled clock at £35.00 plus £2.80 VAT (Post and packing free on all orders) Please allow 28 days for delivery.

I enclose a cheque for £.....  
(indicate total amount) made out to Acorn Computers Ltd.

I enclose an official company order

Please send me further details of this and other Acorn options

Name \_\_\_\_\_

Address \_\_\_\_\_



# Another runner from the Nelson stable

## The Home Computer Revolution

by Ted Nelson (published by the author; distributed in the U.K. by The Computer Bookshop; paperback, 224 pages; £2.75).

WHEN the history of home computing is written, Ted Nelson will probably receive more than a passing reference. He was responsible for an early and highly-effective piece of propaganda called *Computer Lib/Dream Machine*—it's a tabloid publication which you start reading as *Computer Lib* but turn it round and you have a complementary but different book called *Dream Machine*.

It is impossible to review that but try showing it to unconvinced guests/lovers/parents/teachers and it is sure to elicit at least some reaction. Nelson is more style than content, though, and this review of his second much more conventional book will give some idea of what he is like.

### Evangelist

We invited an anglicised American to read it. His immediate reaction was to recall his youth in the States—specifically the 'religious evangelism' phenomenon there—with men and women proclaiming Jesus as their saviour and their key to heavenly happiness in mass meetings called revivals.

Have we telegraphed too soon his impression of this book? Correction—it's not a book, it's a tract.

Nelson publishes his own books and this one looks professional enough. He declares that he is "thought by some to be a spokesman for the coming social revolution of home computers and computer graphics".

He is a man of very strong opinions. They are exciting opinions, expressing his impassioned beliefs in the microcomputer, the personal computer, the home computer—he calls them "dinky computers" but we can't all be perfect. If he talks the way he writes, and the style indicates

that he does, he must be very uncomfortable, or invigorating, to have around.

He writes exclusively about the U.S. market—the biggest, most dynamic, most creative, most consumer-orientated in the world, all of which is true. He says it will absorb 10 million of these 'all-purpose machines' by 1980—from 50,000 in 1977; an interesting prediction.

He says that pent-up demand, suppressed maliciously or unintentionally by major manufacturers, will account for this. His comments about IBM particularly are especially vitriolic.

What does Nelson see as the uses now of very small computers?

- Animated cartoons and pictorial games.
- Sending letters (via screens or cassettes).
- Automatic telephone dial-up (or stacking incoming or outgoing calls).
- Audio control of the household sound system.
- Household control of appliances.
- Personal planning, (daily, weekly, monthly schedules, menus).
- Speech recognition.
- Music synthesis.

And what about the next five years?

- Computers in your pocket.
- The games get 'serious' (his heading).
- Creative facilities and alternative choices.
- Control of audio and visual equipment in your home.
- Photography, automotive use, home heating.
- Electronic mail.
- Magic environments (his heading again).

Spot the applications which are not self-indulgent. This is a social revolution? An introspective and introverted personality would become even more so in Nelson's new world. How does the personal computer bring people closer together, understand one another's problems, make the world a true global village?

### Fireworks

The unstated theme running through the book is the avoidance of people and how to keep

them at a distance, preferably at the other end of a wire, fibre optic strand or laser beam.

That is not to say that his predictions will be wrong but it would be sad if most of them are correct, or if there are no other developments or implications. His ideas are fireworks, his enthusiasm is infectious but his emphasis is misplaced.

### Conclusion

- In spite of our reservations about the opinions expressed in this book, its sheer pyrotechnic vitality forces us to recommend it. Beware of the revivalist meeting tone, though.

### Small Systems Computer Sourcebook

edited by J. C. Boonham (Rococo Press, 1978; 148 pages; A4 softback; £6.50).

WITH a never-ending stream of microprocessor products coming to the market, it is time a reference book should attempt to extract order out of chaos. The *Sourcebook* aims to do that—and it's British.

It is edited—and the word deserves the stress—and it consists of a thick sandwich of manufacturers' technical data between an introduction to microcomputer technology, and a few thoughts on them and a glossary of terms.

It also has ambition to spare. "Every effort has been made to introduce newcomers to computing to the essential elements and special terminology of the subject. . . will save hours of searching for all those involved or wishing to become involved with mini (or micro) computers."

The book is beautifully and professionally produced, which makes a pleasant change from many micro-biased publications. It is organised, sensibly, into hardware and software; there are attempts to categorise hardware into

microprocessors, microcomputers, evaluation and development kits, peripherals and bulk storage devices.

### Distinctions

The software breakdown is also reasonable and distinguishes operating systems, editors and utility programs, assemblers, high-level languages, and (most essential) games.

Despite an abundance of indices our reviewer found information extremely hard to find. The presentation is disappointing and the difference between American creativeness, if a little too brash sometimes, and British enthusiasm is highlighted clearly by the overwhelming small black print.

Information, too, varies between adequate and almost non-existent. One supposes that this is not the editor's fault—more a reflection on the manufacturers' literature.

Another major failing is the almost total lack of costings, apart from a section on the cost aspects of both hardware and software, which is much too general. It is a fast-moving business, of course, and costs change quickly, but the introduction claims that the section on cost aspects "presents a very good guide to current prices"; we think it doesn't.

### Staggering range

The editor could easily have divided the various products into expense categories, as with food guides. At the moment one could be forgiven for thinking an Apple costs the same as a PDP-11/03.

The complete lack of criticism limits the potential market of the book to those who are reasonably familiar with a number of microcomputer systems.

All of that, though, is subsidiary to a consideration of what information is in the book. For a start, there are summaries of 200 hardware items—minicomputers, home computers, microcomputers,



add-on boards for memory and peripheral control, micro-processor development systems. The range is staggering, from a reasonably big mini like the Honeywell Level 6/43 at one end to Ohio Scientific EPROMs at the other.

Along the way there is a plethora of names and products of which you will not have heard. On the other hand, you will look in vain for Tandy TRS-80 or the Commodore Pet—absolutely baffling omissions, we thought.

The section on software is more impressive, not so much in terms of its scope—the games section is slim to the point of emaciation, since Pet and TRS-80 are excluded—but more as an unusually concise summary of what software there is.

### Conclusion

● If you need to reference individual products, the *Sourcebook* is a fine summary. It is well-printed but poorly-presented, and in no way is it for the novice.

### An Introduction to Personal and Business Computing

by Rodnay Zaks (published by Sybex, 1978; paperback, 242 pages; £5.75\*).

IT WAS NOT always the case but there are now many books in the microcomputer field, and naturally they all claim to be the best of their kind.

Sadly it is sometimes difficult to ascertain exactly what kind that is. Most of the books do not make it clear at whom they are aimed, and some imply they are aimed at one section of the market and are, in fact, aimed at a totally different one.

Books on microcomputers almost invariably claim they are aimed at the hobby market but most are far too detailed for that.

There is considerable scope for a definite introduction to small computers, and *Practical Computing* has reviewers beavering away all over the country on various candidates.

Rodnay Zaks ought to be a good contender. He is a per-

sonable, youngish Frenchman who lives in Paris and California, knows the denizens of Semiconductor Valley intimately, has designed micro-processors and complete systems, and now runs a publishing and lecturing outfit, Sybex.

He also writes many of the books Sybex publishes, and all-in-all that puts him on the crest of the microroller.

### Little omitted

His latest offering is refreshingly clear, too. It is larded with helpful photographs and diagrams which give the reader a good feel for the subject. For a change it errs towards the simplistic rather than the esoteric and to our eyes it omits little as an introduction to personal and business computing.

We have some reservations, though. First, there are some typographical errors which not only are irritating but in some cases make the text incomprehensible.

For example, in discussing check digits, it has 'N' printed where it should have 'n' and that makes the remainder of the paragraph almost impossible to understand.

Further, a number of terms are used which are not explained—"fusible link technology" receives our award for brain-numbing phrase of the year.

### Preferences

One of the reviewers also objected to some of the personal preferences on view. For example, "One says nibble for four bits"; this reviewer does not, but not everyone who read the book for us agrees.

After all, why shouldn't one say 'nibble' for four bits? Who needs to use a term meaning four bits anyhow? And who decides the standards? If the micro world wants to call four bits a nibble, why shouldn't it?

The only other real criticism is that the book is aimed specifically at the American market. Not only is it biased towards American systems, many of which are not available in the U.K., but also all the prices are given in dollars.

That is not merely a parochial objection, as anyone who has tried to convert the U.S. price of a Pet into sterling has discovered.

The economics of personal

computing are very different in the States, and that fact can affect many of the conclusions Zaks makes. There is still a need for a British introduction, looking at things from the relatively-expensive and still embryonic state of the U.K. end of personal computing.

That aside, we think it is a fine book. Its structure is particularly good. The chapters lead the reader by the hand through a fictitious computer-based society at home and at work—"all of the facilities described can be implemented technically today"—into a hands-on first-taste of using a Tandy-like home computer; past some blessedly short chapters on technology, how micros work, and the essentials of programming.

### Conclusion

● This is a good book, recommended as a basic introduction. Not quite as soft perhaps as James White's elegant *Your Home Computer*. Buy both, if you can afford them, if you're just getting started.

\* The book is available widely from specialist bookshops. This is the price from *The Computer Bookshop* but we have seen it occasionally for 50p less.

### The BASIC Handbook

by David A. Lien (published by Compusoft Inc, 1978; 360 pages; \$14.95).

DAVID LIEN is a lecturer and technical writer; among other things his credits include one of the *Users' Manuals* for the Tandy TRS-80, a fine low-level introduction to this Basic-based microcomputer.

*The BASIC Handbook* is a good idea. Subtitled 'an encyclopaedia of the Basic language', the book covers every commonly-used Basic statement, function, operator and command. Each has a page to itself and the book is arranged alphabetically.

So it starts with 'A'—"used in the TRS-80 Level 1 and other variations of Palo Alto Tiny Basic as an abbreviation for the ABS function"—and it ends with 'WAIT', "used in some computers to suspend program execution for a specified time".

That's not all, of course. For

each entry there is a description telling you what it is, what it does, and whether it is specific to only a few computers. Then there's a short test program and sample run, so that you can check whether your computer recognises this word; if there are any programming limits about crafty use of the word they are also given.

### Clear and precise

Lien's aim was to provide a book to let you run practically any Basic program on practically any popular computer, or at least to tell you why the program won't run. As the introduction says, "top priority will be given to that information which will help users solve this incompatibility problem".

In general, the handbook is highly successful. Some of the programs we have been sent by readers wouldn't run when we keyed them into our own PDP-11; the handbook helped us determine why, and in most cases showed an alternative route to the programmer's intended result. The explanations and the layout are both clear and precise; it's a book that is easy to use.

Lien covers "all or nearly all of the functions" in 50 Basic dialects. In addition, the book includes some of the characteristics of 24 other Basics. There is only one significant quibble about this stunningly comprehensive list—the Digital Equipment Basic and Basic-Plus are omitted, even though Basic-Plus-2 is in the second group of partially-covered implementations. The PDP-11 and the RSTS operating system are used widely; these Basics, which run under RSTS, are also very popular.

We also encountered a handful of Basic words for which the explanations could be fuller and we've sent Compusoft our notes—with the book you get a comment form to return. We could not find any omissions, though.

### Conclusion

● A good and wide-ranging supplement to Basic texts. Recommended. You might have to write to the States for it—the address is PO Box 19669, San Diego, CA 92119—though a U.K. distributor is being signed. □

# Winner's effort is impressive

**CHOOSING** the winners of the *Practical Computing* Christmas competition was no easy task for the judges. With prizes worth more than £5,000 at stake, there was a large entry. Almost 200 valid projects had to be examined.

The judging was done in three parts. First, the editorial staff read all the entries and created shortlists for each of the three categories—education, business, and domestic.

That reduced the list to some 24 projects in each group, and they were re-evaluated to produce the nine finalists—three in each of the categories.

Those nine were invited to prepare system flowcharts. The final selection was made by Dennis Jarrett, managing editor, working with Brian Collier of Dicoll, the principal prize contributor and the man whose company will be putting together the top prize, the LSI-11 system.

Each of the finalists was assessed by four criteria:

- **Originality:** we were interested in imaginative projects showing originality either in the application to be handled or the way the problem was solved, and preferably both.
- **Credibility:** some entries were simply implausible. Note that we made a distinction between credibility and practicality; some perfectly sound, believable applications were tackled in a totally unrealistic way.
- **Clarity:** a significant and usually under-rated aspect of putting together computer systems is the fact that the computerisation will have to be explained to someone. In this case, of course, it had to be explained to us, and we marked down entries on which we had to work for comprehension.
- **Practicality:** this was the hurdle at which most entrants fell badly. All the winners and runners-up have ideas which in our opinion could be put on a small computer without too much difficulty.

## Business

**Mike Stanley** of Wrexham wins the top prize for his **MONITOR** system. **MONITOR** is one of the most convoluted acronyms we have met. It stands for **M**ulti **O**ngoing **I**nformation **T**echnique for **O**nline **R**etrieval. We did not allow that to effect our assessment of this carefully-thought-out application of computers to the taxi business.

Mike works in a private hire firm and his system is a set of modules to look after the organisation, operation and accounting of the firm on an interactive basis.

It is a good application for a small computer. It was presented impressively on the flowcharts, it makes excellent use of the computer, and, above all, it looks as though it will work, and work well.

The runners-up are **G Bligh**, Portland, Dorset and **David Green** from Basildon, Essex. Bligh had a very topical application—searching for and controlling oil slicks. From his work with H M Coastguard, he was able to advocate a case for the use of small computers at local coastguard stations to calculate the search area

for marine casualties and oil pollution, and to assess subsequently the best course of action to deal with slicks.

Green proposed the use of a micro-computer to facilitate some of the calculation and management tasks which have to be performed on cargo ship by the officers who run it.

Since the use of on-board computers has so far been restricted largely to navigational aids, we found his ideas for calculating cargo loading and weight distribution an intensely practical use for a low-cost computer.

Other applications he would computerise include propeller efficiency—the most efficient trim to obtain the maximum thrust; real distance calculations, perhaps with accurate ETA; sightings; and perhaps some simple local weather forecasting.

## Education

This category covered systems for education—for computer-assisted learning and for computer-aided school management. We did not place entries from schools automatically into this group. Some entries in it were not from schools, and many entries from schools figured in the two other categories.

The winner was **J R Ennals**, head of history at Sweyne School, Rayleigh, Essex. His project is computer simulation of historical situations for teaching purposes, a project apparently well-advanced at the school. We were impressed because of the thought which had gone into the project; not the least of its spin-offs are some interesting thoughts about the relationship between game-playing, logic and language structure.

Ennals sent details of four interesting games, covering the Norman Conquest, Russian Revolution, Wedgwood Potteries, and a simulation of the Voyages of Discovery in the 15th and 16th centuries.

**Mary Russell** of Kingston-upon-Hull was only just beaten by the Ennals entry. Mary was not 15 years old when she put together her proposal for the use of computers in remedial education, and the way she had approached the problems belied her youth and inexperience.

She appreciated the potential for instant response by the computer, seeing it providing quick and positive feedback in a situation where learning and teaching are both difficult. Vocabularily, grammar and arithmetic are three highly-amenable areas Mary listed for computerisation.

The other runner-up was **Elizabeth Moore**, of Theale, Berkshire. Believing

that the most important years of the life of a developing child are between birth and the age of six, she sought uses for a small computer in the nursery and infants' schools.

The aim is to monitor the progress of each child, relating it to past experience and then designing further learning experiences in the future. Elizabeth characterised this as 'computer-assisted management of learning' and we think it could work to a child's benefit.

## Domestic

We were seeking uses for computers in the home but we widened the term 'domestic' to include some systems clearly nothing to do with business or education.

Our winner falls into that class. **Janet Hill** submitted it on behalf of a group of sixth-form pupils at Stratford-on-Avon Grammar School for Girls. With another school in Stratford, they surveyed the facilities available locally for the disabled.

The entry was a proposal to computerise the information, using it as an instantly-available electronic directory.

Janet emphasises the speed of access to information and the ease of updating, two factors we also regard as important for this socially-valuable computer application. As for the practicality of it, the system would be maintained and operated by the school team with enquiries received by telephone.

**Claire Gaeth** lives only two miles away from our office in north London. Her entry offers diet management for diabetics. Balancing food values can be a complex problem, since an excess of blood sugar can be very serious for a sufferer.

Claire is diabetic and so knows the difficulty. Her entry was probably the best-presented entry on the shortlist and her flowcharts were almost detailed enough to allow coding to start instantly.

The entry from **Nigel Greenwood** of Heckmondwike, Yorkshire represents a complete contrast, though it was also presented beautifully and the clarity of the exposition does him great credit.

His system is an integrated domestic computer organised to look after most of the paperwork of the home—everything from address book to household bills—while at the same providing some sensible central functions, like a clock with displays around the house as required, and, of course, TV games.

This was one of many entries on this subject. We chose Nigel's for the shortlist because it was tackled so comprehensively and so well documented. □



# 1979 MICRO-COMPUTER SHOW

INCORPORATING THE  
DIY COMPUTER FAIR

## Bloomsbury Centre Hotel, London, 5-7 July

In addition to the Exhibition, which will display a wide range of the latest microcomputer products, there will be three one-day seminars. Brief details are as follows:

### Thursday 5 July. Microprocessors in light industry.

Basic information for the businessman, who is contemplating the use of micros to improve productivity and his product.

### Friday 6 July. Personal Computers in Business.

How a small business can be administered more efficiently and profitably by the use of personal computers.

### Saturday 7 July. Do-it-yourself Computers.

For the Home Computer enthusiast and hobbyist. Presentations given at this seminar are likely to be of a more technical nature than the previous two days.

### Speakers will include:

Portia Isaacson (USA), Adam Osborne (USA), Howard Kornstein (Intel), Keith Baker (University of Sussex), John Coll (Oundle School), Mike Gurr (BOC), Guy Kewney (Computing), Clive Loveluck (Ulster Management Centre), Barry Standring (Intext).

Seminar registrations may be made for one, two or all three days. Please note that all exhibition stands have now been sold.

### Admission to the Exhibition will be by ticket only - £1 each.

On Saturday, the DIY Computer Fair day, children under 14 will be admitted for 50p each. Seminar participants will be given a complimentary exhibition ticket. A special offer of 3 tickets for £2 is available on tickets purchased in advance. All ticket requests (3 or more) *must* be accompanied by a stamped addressed envelope.

# online

Online Conferences Limited  
Cleveland Road, Uxbridge, England UB8 2DD  
Telex: 261173. Cables: Online Uxbridge  
Phone: Uxbridge (0895) 39262

- Please send full seminar details  
 Please send.....exhibition tickets  
 I enclose cheque/P.O. plus S.A.E.

Name \_\_\_\_\_ Position \_\_\_\_\_

Company \_\_\_\_\_

Address \_\_\_\_\_

Phone \_\_\_\_\_

PC

● Circle No. 171

# THOMSON-CSF

## Available now - the most economical VDU board yet using the SFF 96364

SFKE X 68364-1-1

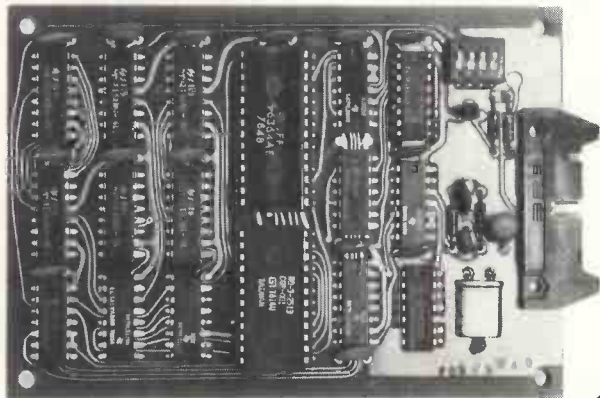

One-off price only £69<sub>plus VAT</sub>

Don't let the low price fool you! This is not a kit, but a fully assembled and tested board. The Thomson-CSF CRT Processor Chip is the secret behind it. Character entry and Cursor control functions are performed automatically. All normal Cursor commands as well as more sophisticated functions such as Erase page, Erase to end of line, etc., can be executed. Text automatically scrolls when Cursor reaches bottom of page. Display format is fixed at 16 lines of 64 characters for optimum efficiency.



**THOMSON-CSF**

Thomson-CSF Components and Materials Ltd., Ringway House, Bell Road, Daneshill, Basingstoke RG24 0QG Telephone: 0256 29155

Available from these Thomson-CSF distributors: Barlec Ltd., 219 London Road, East Grinstead, Sussex. (0342 24383). Lock Distribution, Neville Street, Middleton Road, Oldham, Lancs OL9 6LP. (061 652 0431). A. Marshall (London) Ltd., 42 Cricklewood Broadway, London NW2. (01-452 0161). Omni Components Ltd., 59 Vastern Road, Reading, Berks. (0734 594834). Phoenix Electronics (Portsmouth) Ltd., 139-141 Havant Road, Drayton, Portsmouth, Hants. (070 18 73441). Semiconductor Specialists (UK) Ltd., Premier House, Fairfield Road, Yiewsley, West Drayton, Middx (08954 46415) Spenco Electronics (Phoenix) Ltd., Kelvin Industrial Estate, East Kilbride, Scotland (035 52 36311). Woolley Components Ltd., Tudor Road, Broadheath, Altrincham, Cheshire (061 941 1911).

● Circle No. 172

## NORTH STAR \* HORIZON

DOUBLE DENSITY PERFORMANCE  
at SINGLE DENSITY PRICES.

- \* One Double Density Mini Floppy (180K Bytes)
- \* 16K Fast RAM
- \* Serial I/O Interface
- \* DOS/BASIC
- HRZ-16W £1330
- \* Z80A Based S100 Bus Expandable System

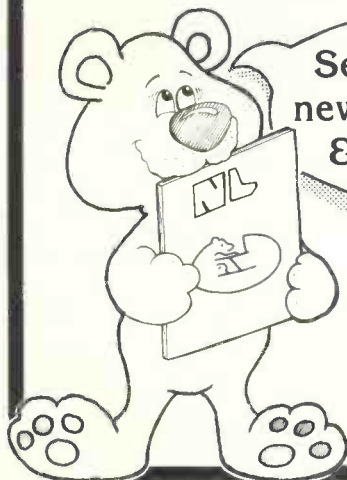
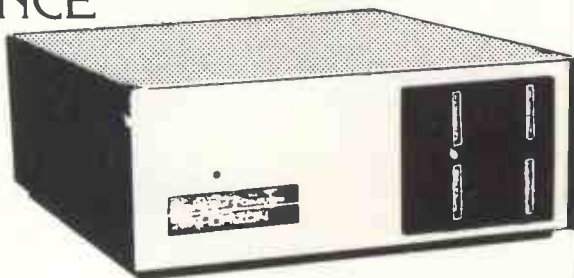

Send for our  
new catalogue  
& price list

**Anadex Printers**  
**DP8000 at £575**  
**Teletype 43 from £869**  
**Exidy Sorcerer from £650**

NEWBEAR COMPUTING STORE

Head Office: Bone Lane, Newbury, Berkshire.

Telephone Newbury (0635) 49223

Northern Office: 2A Gatley Road, Cheadle. Tel 061-491-2290

● Circle No. 173



# Program of the Year Award



*Practical Computing* welcomes you to its first Program of the Year Award, in which you have a chance to write a program and make some money in the process.

### Awards

Two classes of awards will be given:

- A Grand Prize—to the best overall entry.
- A first prize in each of the five categories listed below, plus an extra prize awarded to the best entrant under 18 on June 15, 1979.

The Grand Prize winner will receive *The Practical Computing Program of the Year Challenge Cup* and a cheque for £100.

First Prize winners will receive the *Category Winners' Cup* and a cheque for £50.

First Prizes will be awarded for the following categories:

1. Business and administration
2. Sciences and mathematics
3. Computer Art
4. Games and simulations
5. Education projects

In all there will be seven winners—the Grand Prize and the Best Under-18 Entry plus the five First Prizes.

### What you have to do

The judges are looking for good programming projects. By this we mean a program (or groups of programs) characterised by:

- an imaginative and/or useful application—we do not want elegantly-coded programs which do nothing
- full documentation—we need some evidence of a thoroughly thought-out approach.

### How to enter

A project may be submitted by an individual or a team and any number of entries may be submitted, provided each conforms to the rules and provided each includes the following:

- a completed *entry coupon*.
- A complete *description* of the program, which must conform to the *Guidelines for Documentation*. You must keep one copy for yourself, as no entries can be returned.
- The program must have been tested thoroughly and run successfully on a computer, and entries should be accompanied by a listing of the program and samples of the output produced.

### Guidelines for Documentation

The documentation must be good enough to allow someone else to use the program easily; as well as being complete and comprehensive, it must also be readable, preferably typed.

The program description must be organised as follows:

#### Cover page

Program title, entrant's name and address.

#### Single-page summary

Program title, category, the computer and programming language used, the configuration needed to run the program (how much memory is necessary, types of input/output needed, auxiliary storage requirements), and an outline of the purpose or objectives of the program, the problem it solves, and its restrictions or limitations. Include any features

which distinguish this program from others of the same type.

#### Statement of the problem

This section states what the problem is, though not HOW you solve it, which follows on your next page.

#### Program description

This is a statement of how the problem was solved, what methods you used, the number of instructions involved, and the time required to run the program on your computer. You should include a flowchart using standard flowcharting symbols and techniques.

#### Input/Output

Sample input formats and fully-documented output samples for the reports produced should be included.

#### Operation

This section covers the operation of your program. If it requires any user intervention during the run, or any special preparation before it, this should be noted here; your file formats, if you use them, should also be included.

#### Appendices

We must have a listing of the source program, sample input/output forms, and the results of several runs which show the features of your

program. Please do *not* send punched cards, floppy discs, or paper tape.

All documentation and supporting data of your project should be bound—for example in a cardboard folder or ring binder. Please remember that we consider the documentation of projects to be as important as the development and debugging of the program.

All entries become the property of *Practical Computing* and cannot be returned. World rights transfer to *Practical Computing*. Royalties will, of course, be paid if the programs are marketed subsequently, subject to agreement with the authors.

All projects will remain confidential until the end of the competition. The winners will be published in the September issue of *Practical Computing*. The judges' decision is final and no correspondence will be entered into.

All entries must be received by Friday, June 15, 1979.

Competition entry coupon

Name.....

Address.....

Date of birth (if under 18).....

Project category(ies).....

All entries must be accompanied by this coupon.

# Unmistakable.



## APPLE II

### Try a comparison test.

Look at the features of Apple II. It still has 8 I/O ports, high and low resolution graphics, a mini assembler, A/D paddles, fantastic Basic, Disks and the best documentation in the business.

### Intelligent interface cards.

They're neat. The high speed serial card, printer card and communication card all have elegant documentation. There is also easy-to-use software that mean taking B.C.D. from instrumentation, connecting your favourite printer or talking to a time-sharing computer, is child's play. Apple makes things easy.

### Plus:

\* Say hello to Apple and let Apple talk back. Explore voice recognition, computer voice recognition and computer voice production. You can now have large vocabularies.

- \* Perhaps you'd like to be reminded that it is a special day or would like to chase overdue accounts. Apple clock card is simply the best. It is the most advanced on any personal computer.
- \* Draw graphics with the light pen.
- \* Make chips for your own software with the Eprom burner. Apple naturally has spare sockets for this.
- \* Make interfaces with the prototyping boards.
- \* Use Apple's incredible 'programmers aid' hardware option. More thought and care from Apple for you to use.

And there's more yet more to come from our friends at Apple. Phone Personal Computers' distributors and get to know them. They're busy, successful, highly qualified professionals and the best in the business.

# Personal Computers Limited

Personal Computers Limited 194-200 Bishopsgate, London EC2M 4NR. Tel. 01-283 3391

Tim Keen, Keen Computers Ltd., Nottingham. Tel. 0602 583254  
Stanton Smith, Microsolve, Edgware. Tel. 01-951 0218  
Trevor Brownen, Crystal Electronics, Torquay. Tel. 0803 22699  
Trevor Williams, Padmede Ltd, Odiham, Nr. Basingstoke. Tel. 02-5671 2434  
Bruce Everiss, Micro Digital Ltd., Liverpool. Tel. 051-236 0707  
Claude Cowan, Cambridge Computer Store. Tel. 0223 68155  
George Sinclair, G.A.T.E. Microsystems, Dundee. Tel. 0382 74390

Peter McNaughton, Perthshire. Tel. 07388 8267  
Robin Woods, Isher-Woods, Luton. Tel. 0582 424851  
Tom Piercy, Topmark Computers, Huntingdon. Tel. 0480 212563  
Steve Cooper, Creative Vision, Leeds. Tel. 0532 458444  
John Page, P.I.P.S. Computer Services, Newcastle. Tel. 0632-482 359  
Alan Wood, Apple Corner, London. Tel. 01-580 5304



# New pattern for learning

THE EXPLOSIVE GROWTH of the use of the microprocessor in industry, with automation of many processes now done partly or wholly by hand, will have a great influence in the qualities required of people working with automated systems.

Many traditional skills will be supplanted—others will be required. As a result we must re-think radically how we educate children, especially those not destined for higher education; equally important, we will have to consider how we should re-train our existing workforce.

There will be a steady rise in numbers of 18-year-old students over the next four years, up to a peak of around 950,000. There will then follow a rapid decline to approximately 600,000 by the early 1990s, a decrease already being anticipated in primary schools.

There is, however, more to these statistics. It would appear that the fall in birthrate is concentrated in those areas of the population involved in unskilled or semi-skilled jobs; there is no equivalent drop among professional families.

The inference is a severe drop in the large working-class family and, bearing in mind an approximate correlation in the jobs of parents and children, this should manifest in the early 1990s as a sharp drop in unskilled school leavers aged 16 and over, with little or no drop among those aspiring to higher education.

## Acute problems

Over the next decade, however, there will be acute problems. Many school leavers at 16-plus are unable to find jobs now and the situation will worsen over the next few years, with school-leavers representing a larger and larger proportion of unemployed.

Britain supposedly has a complete educational system in that for any industrial or scientific activity of the nation we can point to a sector of the system which provides the appropriate expertise. Unfortunately, some activities are catered for far better than others.

Consider one example where the system works well—medicine. The student takes O and A levels at school, followed by a degree at university and a period in a teaching hospital.

In the case of a professional engineer, the training at school and university is equivalent to that of the doctor, but frequently the industrial training (post-degree) is neglected or even omitted. The

system works well, up to a point, and then fails.

Finally, take the case of those not destined for higher education, people who leave school after O levels or CSE. Those aspiring skilled craftsmen receive the worst possible deal from our educational systems; their examination subjects are far removed from the skills required to achieve professional competence.

At A level, physics is a deep and difficult subject, opening exciting vistas

---

by Bob Cooke

---

into the fundamental nature of matter. For the non-specialist, however, courses tend to be watered-down versions of what is, in essence, a vocational subject. This is broadly true of any non-vocational version of vocational subjects taught at school to non-specialists.

## Re-training

Industrialists have bemoaned the lack of 'practical' career-orientated courses in schools. Yet in the present economic climate it is almost impossible to finance this type of education, which, by its very nature, must be 'equipment-orientated' and therefore capital-intensive.

Perhaps some way could be found to persuade local business groups, chambers of commerce, educational foundations and the like to back such schemes.

An aspect of education often overlooked is re-training during a person's working life. Lip-service is paid to it but almost nothing is done and very little money is available. It could be that the strength and efficiency of middle management in France and Germany is a tribute to the fact that those countries pay a great deal more heed to the need for re-training.

Automation on a large scale is inevitable, as was the Industrial Revolution, and future historians will no doubt take the same view. Massive investment in automation is necessary if our industry is to be competitive; it is also desirable from a social point of view because many repetitive and tedious jobs are ideal candidates for automation.

The frequently-held views that automation is (a) complicated, and therefore (b) expensive, leading to (c) unreliability, are no longer valid; especially with the advent of the microprocessor, cheap and reliable

automatic control is now within the grasp even of small companies.

There are those in industry who are concerned that widespread use of automatic processes will lead to greater unemployment. Clive Jenkins has estimated that by 1990 approximately one million clerical workers will have lost their jobs because of micro-based word processing.

Other areas Jenkins regards as susceptible include printing, manufacturing and retailing. Banking and insurance would need only 60 percent of the present workforce by 1990, and the motor industry would also be effected seriously.

Jenkins has some suggestions to combat some of this unemployment, particularly by an increase in the staffing of service industries like the National Health Service, and split-shift working with increased leisure time and more adult education.

It is interesting to note that by 1990 we will be in a period of sharp population decline as far as 16- to 18-year-olds are concerned. By comparison with the mid-'70s, a higher proportion will be academically able, so fewer will be available for unskilled work.

## Progressive

The ideal scenario has planned automation introduced progressively to compensate for the lack of unskilled labour. At the same time, increased productivity will create more wealth to re-train skilled workers to handle automated machines.

At present, the Government takes the view that the threat to employment from applications of microprocessors is by no means certain, and failure to apply the micro will inevitably lead to loss of jobs. It argues that if we do not implement the new technology with sufficient speed, our international competitors will damage the economy of the U.K. seriously.

As cheaper and more easily-serviced automatic systems are introduced, the steady increase in wealth which should result will increase the supply of specific types of specific jobs—skilled workers to attend to automatic machines, highly-skilled workers to make them, software professionals to program them to function efficiently and to make them as versatile as possible.

How can the schools prepare pupils of all abilities for the age of the micro? What can be done to prepare those whose jobs will be in jeopardy?

The first steps must introduce pupils to microprocessor design applications, and at all levels of complexity, bringing together some subjects which may already be taught, such as computer studies and electronics.

Unfortunately, such subjects are taught

(continued on next page)

Dr. Bob Cooke is a teacher in Advanced Physics at Newfield School, Sheffield. He is concerned about the lack of public awareness regarding the microprocessor revolution. He is the owner of a Nascom-1 and an avid computer hobbyist. He has written one other paper on the impact of microprocessors in remedial education. The paper printed here is entitled *The Education Implications of the Microprocessor*.

# ELF II

featuring the amazing

## RCA COSMAC

1802 microprocessor

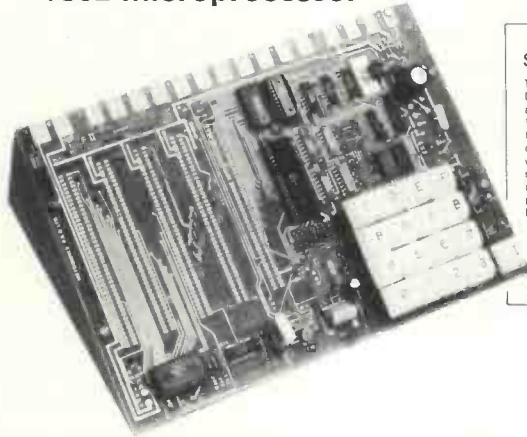

# £99.95

PLUS 8% V.A.T.

### SPECIFICATIONS

The £99.95 ELF II computer features an RCA COSMAC COSMOS 1802 8-bit microprocessor addressable to 64K bytes with DMA interrupt, 16 registers. ALL 256 byte RAM expandable to 64K bytes. professional hex keyboard fully decoded so there's no need to waste memory with keyboard scanning circuits. built-in power regulator, 5 slot plug-in expansion bus (less connectors), stable crystal clock for timing purposes and a double-sided, plated-through pc board plus RCA 1851 video IC to display any segment of memory on a video monitor or TV screen along with all the logic and support circuitry you need to learn every one of the RCA 1802's capabilities.

YOU can own an ELF 11 personal computer for just £99.95. STOP reading about computers and get your hands on an ELF 11 and Tom Pittman's Short Course. ELF 11 demonstrates all the 91 commands which an RCA 1802 can execute, and the Short Course speedily instructs you how to use them.

ELF 11's VIDEO OUTPUT makes it unique among computers selling at such a modest price. Attached to your Video/Monitor ELF 11 allows you to display alphanumeric readout, graphics or video games.

### ELF 11 EXPLODES INTO A GIANT

ELF 11's 5-Card expansion buses allows you to expand as your need for POWER grows. Plug in the GIANT MONITOR BOARD for I/O with cassette, ASC11 Keyboard, TTY, RS232-C etc. ADD up to 16K RAM onboard or more. Build your own circuits with a KLUGE prototype board.

Expanded ELF 11 is perfect for engineers, business, industry, scientific and educational purposes. TINY BASIC cassette tape makes programming the ELF 11 even easier. Use with your ELF 11; Commands include: SAVE: LOAD: +, -, x, (); LET: IF/THEN: PRINT: GOTO: GOSUB: RETURN: END: REM: CLEAR: LIST: RUN: PLOT: PECK AND POKE: 26 variables (A-Z) comes fully documented and includes alphanumeric character generator for direct display on your TV.

ELF-BUG MONITOR cassette lets you debug programs at lightning speed. It displays contents of all registers on your TV at any point in your programs. Also displays 24 bytes with full addresses, blinking cursor and auto-scrolling A must for the serious programmer.

FOR FURTHER DETAILS CONTACT DEPT.

**HL AUDIO** 138 KINGSLAND ROAD  
LONDON E2 8BY

Tel: 01-739 1582

PLEASE SEND ME  TICK. COMPLETE AND POST TO ABOVE ADDRESS

- |   |                     |
|---|---------------------|
| <input type="checkbox"/> RCA COSMAC ELF 11 Kit, complete with instruction & operating manual . . . . .  | INCL VAT<br>£107.95 |
| <input type="checkbox"/> ELF 11 Wired & Tested complete with power supply, RCA 1802 Users manual & T. Pittmans Short Course . . . . .   | £161.15             |
| <input type="checkbox"/> Power Supply for ELF 11 . . . . .  | £5.40               |
| <input type="checkbox"/> GIANT BOARD Kit for cassette I/O: TTY, RS232-C I/O, 8 bit P I/O, decoders for 14 separate I/O instructions and systems monitor . . . . .   | £39.96              |
| <input type="checkbox"/> GIANT BOARD Wired & Tested . . . . .   | £64.75              |
| <input type="checkbox"/> 4K RAM BOARD Kit addressable to any page to 64K . . . . .  | £97.15              |
| <input type="checkbox"/> 4K RAM BOARD Wired & Tested . . . . .  | £124.15             |
| <input type="checkbox"/> KLUGE Prototype board accepts upto 36 IC's . . . . .   | £15.95              |
| <input type="checkbox"/> 86 pin Gold Plated Connectors (1 required for each add on cards) . . . . .   | £5.40               |
| <input type="checkbox"/> RF Modulator to use with TV . . . . .  | £3.00               |
| <input type="checkbox"/> ASC 11 Professional Keyboard Kit with 128 ASC11 upper/lower case set. 96 printable characters. Onboard regulator, parity logic selection and choice of 4 handshaking signals to mate with most computers . . . . . | £63.33              |
| <input type="checkbox"/> ASC11 Keyboard Wired & Tested . . . . .  | £98.15              |
| <input type="checkbox"/> DE-LUXE METAL & PERSPEX CABINET for ELF 11 . . . . .   | £29.82              |
| <input type="checkbox"/> DE-LUXE METAL CABINET for ASC11 KEYBOARD . . . . .   | £19.83              |
| <input type="checkbox"/> EXPANDED POWER SUPPLY, required when using 4K RAM . . . . .  | £19.78              |
| <input type="checkbox"/> TINY BASIC cassette Tape . . . . .   | £14.68              |
| <input type="checkbox"/> ELF-BUG monitor cassette Tape . . . . .  | £14.68              |
| <input type="checkbox"/> Tom Pittmans "Short course on Microp' & Comp" Prog'm manual . . . . .  | £5.00               |
| <input type="checkbox"/> Tom Pittmans "Short course on Tiny Basic . . . . .   | £5.00               |
| <input type="checkbox"/> RCA 1802 Users manual . . . . .  | £5.00               |

ALL PRICES QUOTED INCLUDE VAT

ADD £2.00 P & P for orders over £15.00.

I ENCLOSE . . . . .

CHEQUE/PO No: . . . . .

BARCLAY CARD No: . . . . .

ACCESS CARD No: . . . . .

NAME . . . . .

ADDRESS . . . . .

or phone

or phone

DEALERS' ENQUIRIES WELCOME

(continued from previous page)

by different departments—computer studies by a science or maths department and electronics under the auspices of craft or science. Both subjects should reasonably be brought together under a new department—of technology—which could offer other subjects more in keeping with industry demands.

It would have benefits at all levels, from an introduction to automated processes for the potential skilled worker to writing complex programs for the more academic student. The stress on applications would be welcomed by industry if we are to believe Sir Monty Finneston's Committee of Enquiry into the Engineering Profession.

How can we prepare these people who will lose their jobs as a result of micro-processor application? A society which employs automatic processes to the best economic effect inevitably will need fewer people per machine; but with a growing economy which should result from automation, more machines will be required.

Such people will also require re-training to a more skilled level. A machine-tool operator may be replaced by a tape-controlled machine but those in charge of it must be fully-acquainted with its operation; and the associated software will require systematic maintenance by trained professionals.

On a more academic level, for Britain to attain a prosperous position, we will have to train designers of automatic machinery and automated factories.

### New areas

To summarise, there is a strong argument for the formation, in schools, of autonomous technology departments. Their functions would be to provide a series of studies including computers and programming, control systems, automatic control and electronics; the courses would be available at all levels to cover the eventual operator of automatic machine tools, as well as the system designer.

The examining boards, who are usually very slow to change, must also be made aware of new subject areas—O and A levels in Control and Automation?

The new departments will be funded directly by local authorities or by donations from foundations or industry. Perhaps the established arts and humanities departments should have reduced budgets, so that a strong unified approach to microprocessor technology may begin.

### References

- Edwards, Sir Samuel; The Urgency of Education—*New Scientist*, June 8, 1978.  
 Jenkins, Clive; Article in *Computer Weekly*, September 21, 1978.  
 School Technology Forum, Report No. 17, September, 1978.  
 A School Approach to Technology, Curriculum Bulletin No. 2, Schools Council, 1966.  
 Technology and the Schools, Working Paper No. 18, Schools Council, 1968.

● Circle No. 175



# Ordering and invoicing

FOLLOWING the last two months' surveys of stock control and accounting software and systems, this month we look at order processing and invoicing.

In most companies those functions are inseparable from the sales ledger (accounts receivable) and stock control functions. It's easy to see why. An order is having your customer ask for some goods and services for which he will pay you some money—or an equivalent in service.

In most cash/goods-across-the-counter transactions, you say: "I would like three cartons of chocolate biscuits, please". If they are available they are brought to the counter, a total cost is rung on the cash register and the amount is required from you.

In the run-of-the-mill corner shop, you hand over the cash, and a receipt and the biscuits are passed to you. In another shop, you may not want to pay cash, so you

hand over your appropriate charge card.

In both cases, a sale has been made, one going immediately into 'cash' in the sales ledger, the other into 'accounts' receivable'. In both cases, too, stock has been reduced. Order processing and invoicing have been performed.

Ideally, order processing should:

- Check the customer's credit—has he established a reputation for prompt payment or has he lodged an amount from which the cost can be deducted?
- Check whether the item wanted is available—if it is, deduct the amount sold from the stock-in-hand; if not, back-order more and tell the customer about it; there is one more option between those two, i.e., the item is in stock but the total in the stock-in-hand will fall below a 'safe' level if the item is withdrawn, so a decision has to be

made whether to supply the item or back-order it.

- Calculate VAT, discounts.
- Value everything ready for printing an invoice.
- Update the sales ledger with the appropriate values.

Invoicing, on the other hand, is simplistic and is usually an integral part of the order-processing cycle. What is needed is a form on which the relevant data for the customer is printed neatly and is easily understood, with a polite exhortation to pay.

There is the tangled dependency of the order processing/invoicing/sales ledger/stock control functions. We have tried to extract only the two in which we are interested but beware that frequently those two often will operate properly, or not at all, without the other pieces of the system. We have noted this where we could in the following summaries.

## INVOICING

Micro Software Systems, 242 Heath Road, Grays, Essex.

THIS SOFTWARE is part of the Stock Controller Suite which Micro Software sells

for £850, excluding VAT. The Stock Controller Suite is an extensive set of software for inputting stock data, amending files, and generally keeping track of stock and re-order levels.

The invoicing section of the software

draws the invoice form on the VDU and the user fills-in the missing information—date, customer number, item number, and quantity. When the invoice is correct, it is printed-out and the stock levels adjusted.

## ORDER ENTRY/INVOICING

Wilcox Computers Ltd, Rackery Lane, Llay, Wrexham, Clwyd.

TO RUN on the Wilcox Series II (with 32K RAM, two floppies, VDU and printer), the software and hardware together cost about £8,200 (plus VAT).

The order entry section uses customer and stock files to do a customer credit check, a stock availability check, check for discount rates, calculate VAT, and handle non-stock items—when stock normally is not carried but obtained for a

particular order.

Invoices are produced either while an order is being processed or saved for later printing. Special features include a message facility, VAT summary, AUTHORIZATION printout on the invoice where the total exceeds the customer credit limit, and credit note printing.

## VIDEO-ORDER and VIDEO-BILL

Video Software Ltd, Stone Lane, Kinver, Stourbridge, Worcester DY7 6EQ.

AS WITH VIDEO-STOCK, VIDEO-PURCHASE and VIDEO-DEBT—reviewed in the March and April, 1979 issues of *Practical Computing*—the VIDEO-ORDER and VIDEO-BILL software packages are supported on the machine-independent VIDEO operating

system. The price of the software varies from £1,000 to £5,000, depending on options chosen.

With VIDEO-ORDER, orders are entered via the VDU and placed in the Outstanding Orders File. Orders may then be released for despatch manually or automatically. Despatch notes may be printed. Available for display on the VDU are the

details of individual outstanding orders or the outstanding orders of a specific customer or product.

VIDEO-BILL can be operated on a pre-despatch or post-despatch basis. The user can display customer ledger accounts and product details, including stock levels. Pricing, discounting, and VAT calculations can be made. The hard-copy print-out is the invoices.

## INVOICING DEBTOR LEDGER SYSTEM

Microsolve Computer Services Ltd, 125-129 High Street, Edgware, Middlesex HA8 7HF.

DESIGNED to run on an Apple II with 48K, two floppy discs, a VDU monitor, and matrix printer, the invoicing debtor ledger

system costs £3,500 (excluding VAT).

The invoicing section is embedded in another system, debtor ledger this time. The system maintains a customer file and a products file from invoices produced automatically.

It also handles process payments from customers and makes invoice adjustments for returned goods, bad debts and the like.

The system has a maximum capacity of 3,400 invoices—raised per month plus unpaid carry-forward from the previous month.



# Writing a new chapter

10 IF AGE <40 GOTO NEXT ARTICLE

20 IF AGE >60 READ ON

A PERSON approaching retirement age is bombarded with help and advice culminating in a sheaf of papers from the pensions office within a few months of the appropriate birthday.

It is difficult to appreciate what all the fuss is about—you don't feel any different and your mirror reports that you look very unlike a pensioner. Then the fateful day arrives when you have to stop working. Suddenly, a chapter in your life closes, a chapter in which events to a large degree have been influenced by other people.

## Own choice

Now you have to begin to write a new chapter in which the events will be of your choosing. Inwardly, you know that you have only a limited time to complete that chapter.

Admittedly, there are a thousand-and-one things to be done which have been left undone for lack of time—decorating, turning-out the attic, gardening, helping in the house. At a guess, they will occupy

about three to six months, then you will be at a loose end again.

The easiest and most tempting course is to take it easy; re-furbishing memories of people you worked with and may

---

by Ken Hall (retired)

---

never see again, of victories won and contracts lost, of quotations, prices, and events from donkey's years ago.

What is more difficult, but more lasting and rewarding, is to live for the future but that requires a positive effort. In computer terms clear the screen, wipe the tape clean, make a determined effort to clear part of your memory and fill it with new ideas.

It would be easy to suggest that owning a microcomputer is no more than an old man's foible but that is to underestimate the work involved. You have to learn a new language, in your own time and by yourself.

You may have to search into that deep store of remembered facts to find again your knowledge of mathematics, trigonometry and geometry. It is no use going back to your old school textbooks but

the sound grounding we old codgers had in the basics is just the right preparation for a beginner in computing.

It is just possible that you might like to take up electronics at the point where you left 'wireless' many years ago but the construction of even the simplest computer, however small, is far different from the making of a two-valve amplifier for a crystal set. It is probably better to go for a ready-to-work computer rather than to mess about trying to assemble a delicate and intricate kit.

What are you going to do with a microcomputer when you have bought it?

## Exciting

First, you have to learn the language your particular computer understands, so it is essential that you make sure the apparatus you buy has a very simple and complete set of tuition instructions. Stick to that and master it; don't go to the library and borrow books on the subject—their language may be different from that used by your computer and this can be terribly confusing.

The next stage will undoubtedly be playing games. Toddling down the road for a weekly game of crib with old Harry can become a bit of a bore and it can be



difficult to vary or break-off the connection. Your computer will not be offended if you give it a miss for a week, or change your game from Backgammon to Vingt-et-un or Star Wars.

What will be even more exciting will be to write your own games programs. How about creating a programme for two-up or Noughts and Crosses, Tippet, Fox & Geese or Nine-men-Morris? That would really tease you and stretch your skills to the maximum.

Life is about fighting, even after retirement, and those who give up the fight pass on. What better stimulus than to go to bed with the problem of a stuck program and wake up to know that you can crack it completely?

## Many options

All that may not so far justify the purchase of a micro, even when you have written programs to deal with your household expenses, your pension and the last stages of your mortgage. If you have bright grandchildren, though, you will not lack company as they arrive to play on Grandad's new computer. You could even persuade yourself that you are contributing to their education.

Most people in our age group with enough interest in the future to read this magazine and to consider the acquisition of a computer will already have some kind of hobby. With a computer you can update the value of your stamp collection,

listing those items you still cherish and transferring them from one list to another as you buy them.

Wine-makers can record their most successful recipes, the progress of fermentation and the state of the cellar. Gardeners can plan the rotation of crops for years ahead and check progress.

Handymen can design the next piece of work, composing it on the computer screen in every detail. Sporting types can record games won and lost, evaluating their handicaps as they go. Gamblers can write a program to allow for form, the going, past performance and jockey effect right to the last minute, with a view to improving on previous expensive hunches.

Will you be able to make something on the side from the use of a computer? Why not try? First you must master the technique completely, prepare programs and make them work. Then there may be someone in your area who needs some help—a small employer with payroll and tax, a shopkeeper with VAT problems, a beginner in computing who just needs a little push to get over a sticky patch. For all of these you have to be good at the job, very good—there must be no possibility of error or bungling.

So, invest in a microcomputer. Choose your machine with great care after looking at all the alternatives and reading all the reviews you can find. Seek advice from a number of suppliers—and don't

hurry over that part of the process. Make sure that you understand fully the basic instructions and make use of back-up books and tapes. If you plan to expand your system, check that compatible equipment is easily available.

When you get your own computer home and set it up, lock yourself away for a time with it. Study hard, work at it, ignore the disparaging remarks of others and don't spread it around that you are a computer person until you have mastered it completely. Then you can blossom as the local computer expert.

## Rewarding

You will have a hard time initially; you may even despair but you have plenty of time available in which to crack the problem. You have expertise in dealing with difficulties and you will certainly have a lot of fun.

Computer programming used to be considered a young person's field and any computer exhibition will be full of bright young minds spouting learned ideas in strange languages. Nevertheless, there are older people who are exploring what computers have to offer, and finding it very rewarding. In fact, it is just the thing for someone who has been cut adrift from a previous existence and is looking for a new, exciting, and teasing life.

So —

**999 IF AGE > 60 GOTO COMPUTERS**



### Expand your Pet to its full capability with these professional peripherals

#### Dual floppy disk unit

A COMMERCIAL GRADE DISK SYSTEM FOR THE PET

- Up to 800K Bytes on Line Mass Storage
- High Speed D.O.S. in ROM
- Effectively doubles PET operating system commands
- Complete documentation allows use of full resources
- Handles up to four disk drives
- Includes Commercial Printer Support
- Adds 16 commands to PET basic
- Automatic self reorganisation of free space on disk after each save or erase command
- Free space is never fragmented

PRICE £840.00 + VAT

#### Expandem memory expansion board

General purpose expansion system for PET and other 6502 Computer Systems (e.g. KIM, SIM, AIM).

- 24K to 32K Low Dissipation RAM
- Mounting slots for 4 option cards
- All necessary cables and brackets
- Disk Controller
- Parallel I/O
- Sockets for Eprom
- Flexible Serial I/O
- S100 I/O Driver

24K Board £320.00 + VAT

### Plessey Petite add-on memory From Europe's largest memory board supplier

Stand-alone, plug-in memory expansion. Available in 8K, 16K, 24K, and 32K versions. Complete in case with built-in P.S.U.

24K £449.00 + VAT



PET 2001-4 4K Bytes of Memory £460.00 + VAT

PET 2001-8 8K Bytes of Memory £550.00 + VAT

PET 2ND Cassette Unit £55.00 + VAT

PET Sound Box Plugs direct into 2nd Cassette Port complete with Demo Software £12.98 + VAT

PET Dust Covers To protect your PET—(Four Colours) Rust, Blue, Beige, Green £8.33 + VAT

PET TV Interface Plugs direct into user port Superb Specification £45.29 + VAT

### Software

Estate Agency: Very cheap, very effective: method of showing properties to customers. Automatic deletion. Printed copies for prospective purchasers (Now available on disk). £25.00  
Mail List: Printout all your mailshots, names and addresses; printout on self-adhesive labels; disk only, £15.

Payroll: Complete suite, abundant storage on disk. End-of-year summary; coin analysis; two payslips; excellent value; disk only, £50.

We supply all Commodore, Petsoft and Compuette programs. We should be glad to quote for dedicated software applications.

R.H. Mastermind: Surely the best Mastermind ever. 3 Games levels. £5.00

R.H. Shape Matching: Match up two different shapes to score. You against the other guy. You will have to be sharp for this one. £5.00

Access and Barclaycard accepted for Telephone and Postal Orders.

All prices include post and packing (insured post extra).

We should be glad to discuss your problems or requirements relating to technical matters, software, etc—in-house software experts available.

Dealer enquiries invited for all our stock items.

U.K.-wide service by our specialist technical staff. Maintenance contracts available after our one-year guarantee at 7½% of capital purchase price.

All new equipment sold by us carries a 12 months' guarantee

# HB COMPUTERS LTD

Computers for Business & Home

22 Newland Street  
Kettering Northants  
Telephone (0536) 83922/  
520910

● Circle No. 176

# How to ski the safe way

DO YOU fancy yourself as an Ingemar Stenmark? The object of Slalom is to guide a 'skier', represented by a highly-mobile asterisk, through a series of gates in the shortest possible time.

The skier moves in diagonal steps, bouncing off any boundaries he hits but passing through the gates which close behind him immediately.

You can use the keyboard to reverse the up-down or right-left direction in which the skier

by Lewis Corner

is moving. With skill and judgment, the skier's performance can be improved substantially.

At the beginning of each run you specify whether you want a new course, or another run on the previous one. We found a small bug in Lewis's program — on the first run of the day you have to set a new course. Different levels of skill are catered for by offering gates of three widths.

When the course has been



completed the time taken is shown, setting a target for other players to challenge.

The program listed is for the Commodore Pet and we have used the coding conventions outlined on the Pet page in previous issues. It should

be possible to devise versions to run on any microcomputer with a screen display, suitable graphics and an internal clock.

Slalom has apparently proved popular with children and adults who appreciate its rapid movement, competitive

nature, and the opportunity to develop and exercise skill in guiding the skier.

In the listing we have indicated graphics as follows:

```
[CLR] ....clear screen
[HOME] ....cursor home
[R] ....reverse field
[DOWN] ....cursor down
```

```
200 DIM GD(7),GL(7),GR(7)
210 FOR G=1 TO 6:GD(G)=1+5*G:NEXT
300 PRINT"[CLR] S L A L O M[DOWN]"
310 PRINT"DURING PLAY[DOWN]"
320 PRINT"KEY Z TO REVERSE UP/DOWN MOTION"
330 PRINT"KEY M TO REVERSE LEFT/RIGHT MOTION"
340 PRINT"NEW COURSE ? KEY Y (YES) OR N (NO) [DOWN,DOWN]"
350 INPUT RS
360 IF RS="N" THEN 500
370 PRINT "[DOWN]"
371 PRINT"GATE WIDTH ? KEY W (WIDE)"
372 PRINT" M (MEDIUM)"
373 PRINT" N (NARROW)"
375 INPUT RS
380 IF RS="W" THEN GW=4:GOTO 400
381 IF RS="M" THEN GW=3:GOTO 400
382 IF RS="N" THEN GW=2:GOTO 400
383 GOTO 370
400 FOR G=1 TO 6
410 GL(G)=INT(RND(.6)*15+1)
420 GR(G)=GL(G)+GW
430 NEXT
500 PRINT"[CLR] S L A L O M[DOWN]"
510 FOR I=1 TO 38:PRINT"[R]";:NEXT:PRINT
520 FOR I=1 TO 19
525 PRINT" R ";SPC(36);" "
530 NEXT
540 FOR I=1 TO 38:PRINT"[R]";:NEXT
600 FOR G=1 TO 6
605 S=1+5*G
610 PRINT"[HOME,DOWN,DOWN]"
620 FOR I=1 TO 19
630 IF I>GL(G) AND I<GR(G) THEN PRINT:GOTO 650
640 PRINT SPC(S);"[S]"
650 NEXT I,G
700 IO=10:JO=1
710 LR=1:UD=-1
720 G=1
730 T=TI
1000 I1=IO+UD:J1=JO+LR
1010 IF J1=36 THEN 1500
1020 IF I1>GL(G) AND I1<GR(G) AND J1=GD(G)-1 THEN 1300
1050 IF I1=0 OR I1=20 THEN UD=-UD:I1=I1+UD
1060 IF J1=GD(G-1) OR J1=GD(G) THEN LR=-LR:J1=J1+LR
1070 GOSUB 1400
1100 GET CS
1110 IF CS="Z" THEN UD=-UD:GOTO 1000
1120 IF CS="M" THEN LR=-LR:GOTO 1000
1130 GOTO 1000
1300 J1=J1+1:GOSUB 1400
1310 J1=J1+1:GOSUB 1400
1320 FOR I=1 TO GW-1
1330 POKE 32768+40*(GL(G)+2+I)+GD(G),176+G
1340 NEXT
1350 G=G+1
1360 GOTO 1000
1400 POKE 32768+40*(2+IO)+JO,32
1410 POKE 32768+40*(2+I1)+J1,42
1420 IO=I1:JO=J1
1430 RETURN
1500 GOSUB 1400
1510 T=INT((TI-T)/60)
1520 PRINT"[HOME]";SPC(20);"TIME";T;"SECS"
1530 FOR I=1 TO 3000:NEXT
1540 GOTO 300
1550 END
```



# Cassettes for work and play

## Bridge Challenger

*Cassette for Tandy, Apple, Pet. Produced by Personal Software. Available from most dealers. Price, around £10.*

BRIDGE CHALLENGER, according to its brochure, is designed for all players from novices to experts. As a bridge player and avid reader of any publication which prints bridge puzzles, I was delighted to find a piece of software which would generate problem after problem.

I ran the bridge software on our Pet computer. There are two parts to the software. The first gives hands to play; the other is a dealer program which can be used to deal specially-selected hands and save them on cassette.

The first part of the program sets up a hand produced at random using a random number generator in the computer.

For example:

	N	S
S	AQJ2	S 7
H	KJ107	H 9843
D	K5	D AQ987
C	AQ9	C 876

It then asks you what contract you want to play in. I choose 4H. If you don't like the look of the hand you can tell the computer to go to another hand, or you can revoke the hand and play East/West instead of North/South.

Also a good contract is 3NT on this hand, so having made 4H you can get the computer to play you against 3NT.

Once you have decided your contract, the computer makes its lead and you play against it. After making or failing to make the contract, the computer displays the full deal. In this instance, it was:

	N	
S	AQJ2	
H	KJ107	
D	K5	S K84
C	AQ9	H Q65
S 109653		D J102
H A2		C J432
D 643	S	
C K105	H 7	
	H 9843	
	D AQ987	
	C 876	

You are then asked if you wish to play the hand again or move to another. The dealer program on the cassette is a new game. It allows you to deal specially-selected hands and save them on cassette.

With Dealer you can either set up the deal yourself—good for copying from bridge magazines—or cheat. Yes, cheat. You can give the computer a range of high card points (e.g. 20-38) and it will deal hands only within that range of points.

In summary, the computer never tires of giving you hands and it is great for practice and passing hours of your time. My only complaint is that the computer often takes a time to decide what card to play and that can be frustrating.—R.H.

## Eliza Doctor

*Cassette for Commodore Pet. Available from most Pet dealers. Manufactured by Petsoft. Price: £10.*

IN THIS simulation of artificial intelli-

gence, you speak to the psychiatrist, Eliza, and she is supposed to answer you intelligently. She has a set routine of questions and answers which, unfortunately, tend to arise at inappropriate moments.

We did not have much luck with the "intelligent" conversation, an example of which went like this:

Eliza: "Do you have any problems?"

Me: "Yes, I hate my mother".

Eliza: "Do you think you have any psychological problems?"

Me: "What's that if it's not psychological?"

Eliza: "I'll ask the questions"—and so on.

Petsoft says the program is not guaranteed to solve your problems and if you do have any real problems you will probably be more frustrated than soothed by this program.

It was developed originally to run on mainframes and Petsoft claims to have succeeded in putting it on to 8K "without losing anything important". Except, in our opinion, its marbles.—K.F.

## Backgammon

*Cassette for Commodore Pet. Available from most Pet dealers. Manufactured by Petsoft. Price: £8.*

THE excellent graphics definitely place this above other Backgammon programs. Initially, it asks how many players there are, indicating that you can play with the computer, or against a human opponent.

The screen displays an actual simulation of a backgammon board, with the bar in the middle. Unfortunately, there are no instructions with the cassette—at least, we received none—so it is a matter of trial and error to discover the code for getting off the bar and moving to home.

We can reveal that to get a counter off the bar you key-in B, space, and number you are going to, and, to get home, F, space, number you are coming from. The computer rolls the dice for you and you key-in the number to which you want to move.

On the whole, a very enjoyable program to pass the time.—K.F.

## Star Trek III

*Cassette for TRS-80. Written by Lance Micklus. Available from Mad Hatter Software, 219 Washington Ave., Chelsea, Mass 02150.*

TAKING our TRS-80 to a country house session, we played many of the games available on cassette. One which held everyone's unswerving attention was Star Trek III. Attention is what you need, believe me.

The object is to explore as much of the galaxy as possible—a description of the galaxy is given in three-dimensional co-

ordinates—locate the five Class M planets and destroy as many of the 20 Klingon invaders as you can.

You must complete your mission and return to star fleet headquarters before Stardate 2500. You start in a quadrant which has a starbase and docking there concludes the game. Your performance is evaluated—perfect score is 100.

We started casually, thinking this was another rather innocuous game, learned and mastered quickly. No. The first four attempts destroyed our ship, had us drummed out of the corps, demoted us and destroyed our ship again. Our performance score ranged from 2 to 28.

Seeing that we were indeed faced with a more complex game, pencil and paper and two more troopers were requisitioned. Attacking the problem logically, we found the five Class M planets, destroyed 18 Klingon ships, and whizzed back to starbase well within our time limits.

We three were then awarded a 92 performance score and all promoted to Admiralty. Here's the bad news—in a sense; all this took four hours but we were riveted and if you have the time and the inclination to master the game, it seemed like no time at all.

You are provided with screenloads of information in formats which make you believe that you are on the Enterprise.

Calling-up Uhura, Scotty, Spock and the others, getting damage reports, energy reports, weaponry reports, sensors (long-range and short-range) reports, science reports—they're all important and vital to the success of the mission.

The fun was figuring the logical progression you should take to maximise your finds and minimise the damage you sustain in battle.—R.W.

## Financial Analysis

*Cassette for Commodore Pet. Available from most Pet dealers. Manufactured by Petsoft. Price: £9.50.*

THE PROGRAM copes with three types of financial analysis:

- Calculating the present value or future value of an annuity;
- Calculating the present value or future value of a lump sum;
- Calculating the price or yield to maturity of a bond.

Before you continue all terms are defined.

The most interesting part of the program for many people will be the annuity calculation. Using it, you can calculate your pension, new life insurance policy—anything which accrues interest from, say, monthly payments received. You can have a complete listing of each period to payment schedule.—K.F.

## LEENSHIRE LTD

13 CATHEDRAL VIEW,  
WINCHESTER, HANTS.

The VDU and system manufacturers and programmers offer:

Jade, Cromemco, Electrocontrol Technology and WMC Inc. products, together with:

S-100 boards and kits of all types. Shugart floppy disc drives and interface electronics. Malibu 160 characters per second, alphanumeric and graphic printers. Monochrome and colour, mini- and microcomputer systems.

We supplied the formatting equipment for Ceefax; the route-finder equipment at Heathrow; telemetry VDUs, for Abu Dhabi and Forties oil fields; banking, text-editing and machine control systems for industrial and commercial applications.

**CAN WE USE OUR PROFESSIONAL  
EXPERIENCE TO ASSIST YOU WITH YOUR  
PROJECT?**

Telephone: Winchester 3675

● Circle No. 177

# DP-1000

Series Printers

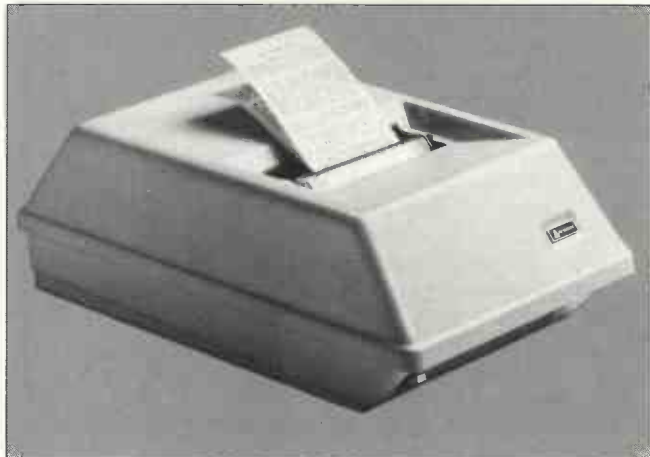

Prints 40 cps in 40 columns.  
Plain paper, multiple copy.  
Data storage – 168 characters.  
Current Loop, RS.232  
Parallel Bit inputs.  
Double width printing selection.



**Anadex Ltd.**

Dorna House, Guildford Road,  
West End, Woking, Surrey  
GU24 9PW

Phone: Chobham (09905) 6333  
Telex: 858762 ANADEX G

OEM quantity price £295

● Circle No. 178

## GODBOUT Computer Products

Altair/Imsai/Cromemco/Polymorphic Etc.  
S-100 Bus Computer Compatible Products

LTT ELECTRONICS has one of the largest stocks of Godbout computer products in the U.K. Only by bulk purchasing and minimising sales overheads can we afford to sell at what amounts to trade prices.

For example:	Kit	Ass.
Econoram III, 2MHz 8K bytes static memory board	£85	£ 99
Econoram IV, 4MHz 16K bytes static memory board	£175	£195
Econoram VII, 4MHz 24K bytes static memory board	£255	£275

All prices include postage and insurance (overseas add £10) – Just add 8% VAT.  
Further 5% Discount for cash with order.  
Also Education/OEM discounts on application.  
Please send S.A.E. for full details.

MAIL ORDER ONLY  
LTT ELECTRONICS  
37 Orlando Road, London S.W.4  
Telephone: 01-828 1785

● Circle No. 179

## FOR NASCOM-1 IN SCOTLAND COME TO STRATHAND

In stock; Nascom-1 buffer boards 8, 16, 32K RAM boards. Super Tiny Basic zeap on tape.



Callers welcome

**STRATHAND**

44 St. Andrew's Square, Glasgow G1 5PL  
**GLASGOW** (041) 552 6731

Telephone order welcome with Access and Barclaycard.

BOOKS AND SOFTWARE  
IDEAL FOR SCHOOLS  
AND COLLEGES NOW  
AVAILABLE.

Please note it is not our policy to advertise Nascom products which are not currently available.

● Circle No. 180



# Stepper motor control using Kim-1

In part one of this Kim project we investigated some of the ways in which small motors could be used. This month the control of small stepping motors is considered.

As the name suggests, the rotation of the stepping motor is in discrete steps. Each step is a pre-determined number of degrees, typically between 3.75 and 90, or between 96 and four steps per revolution. This means that it is not possible to specify an infinite range of positions.

On the other hand, stepping motors show no cumulative error. Remember from part one that if you pulse a DC motor for a set period, any number of factors could prevent the motor rotating the exact amount expected. Extra load, low batteries, or friction in the motor bearings could all affect the extent of the rotation, writes Nick Hampshire.

If the first rotation was 30 degrees plus or minus 2 degrees, and the second was also 30 degrees plus or minus 2 degrees, then the total rotation would be 60 degrees plus or minus four degrees.

## Precise movement

With a stepping motor the first step of 30 degrees might have an error of one degree. The second step would 'flip' it round to the 60-degree position, but this would be 60 degrees plus or minus one degree. When the DC motor has completed one full rotation the total error is plus or minus 24 degrees; for the stepper it is still one degree.

This lack of cumulative error makes the stepping motor useful in a number of

applications where precise movement is required. For example, they are used often to move the read/write head of a floppy-disc unit in and out, the same track being found repeatedly with no effort. A number of matrix printers use stepper motors to scan the dot head across the page, one step for each column in the character matrix.

## Close accuracies

Close accuracies are obtainable when stepping motors are used in numerically-controlled machine tools; this is achieved by making the motor drive turn a threaded shaft, and the movable item is tapped so that it can be pulled or pushed by the shaft rotation. If the pitch of the thread is 0.1in. and a 100-step motor is used, each step represents a movement of only one thou.

This is the idea behind this month's program. If an X-Y plotter is constructed using threaded rod and stepping motors, the code could be used to generate lines given a list of co-ordinates. Figure 1 shows how such a plotter could be made. If the paper is held on a static bed, one of the principal problems of plotter design is the need to move the whole apparatus to pull the second plotting dimension backwards and forwards with the first-dimension motor.

In the design of figure 1 the paper flat-

bed is moved left and right in the X direction on runners by one stepping motor, while the pen is moved up and down in the Y direction across the paper.

Without the facilities of a full engineering workshop and using only DIY materials, a certain amount of play in the design could be expected. One consequence is a reduced requirement for a minute step size. It follows that using threaded rod with a fairly coarse pitch will probably be an advantage. In any case, cheap stepping motors have a limited rotation rate and it would take a long time to draw a picture of any useful size.

## Reducing play

Two things can be done easily to reduce play in the plotter. The first is to ensure that the paper bed and the penholder cover the maximum length of runner. This will reduce the degree of lateral movement they can make.

Secondly, some mechanism should be found to take-up the slack always present between a thread and its nut. To reduce this, some form of tension must be applied to the bed and penholder. A tension spring would be an obvious choice, but they will apply more force as they expand. A second solution would be to attach a cord to the moving parts and hang a weight on the end; well, the design isn't very compact anyway.

## Simplest way

The simplest way to drive a stepping motor is to pass a current through each of the coil windings in the motor in the correct order. Each winding magnetises temporarily one of a number of 'teeth' around the inner surface of the motor cylinder body. The output shaft is connected to a permanent magnet rotor. When the current is connected first, a magnetic flux is set up in the stator teeth and the rotor aligns with the magnetic field produced. The stator is made so that every alternative tooth is magnetised by the same coil.

If the other coil is energised and the first released, the flux will shift to an adjacent tooth and the rotor will be pulled round, to align with that. Rotation is produced by energising the coils alternately. The windings are centre-tapped so

(continued on next page)

Figure 1. Plotter design

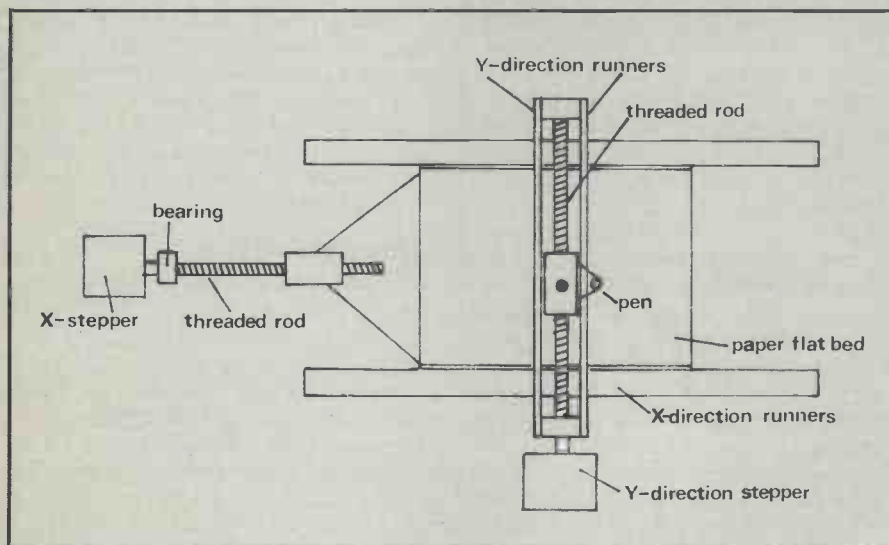

## LOW PRICES —HIGH QUALITY

NIM—up to 250,000 matches £1.49  
 STOCKBROKER—realistic game £2.49  
 BREAKTHRU—reaction game £3.49  
 SURROUND—fast fun for two £3.49  
 NUDGE—sophisticated bandit £3.49  
 LIFE—fastest version ever £3.49  
 All programs are in PET Basic on quality cassettes. Details of many more in our free catalogue including Assembler, Renumber etc.  
 BLANK CASSETTES—C.12 only £3.95 for 10, uncased £3.25.

**SUPERSOFT** 28 Burwood Avenue,  
 Pinner, Middlesex.

● Circle No. 181

## FOUR ON FOUR

in conjunction with

## PETALECT

3-day Pet courses £75,  
 including meals, etc.

Ring Andy Marshall on  
 Woking (04862) 66084.

● Circle No. 182

# Modata

30 St. Johns Road,  
 Tunbridge Wells,  
 (STD 0892) 39591.

Digital Microsystems DSC-2

Low Cost Computer System incorporates

- 1 Megabyte of Floppy Disk storage on two single sided 8" Shugart drives
- 64K bytes of Main Memory Standard 32K or 48K available
- CP/M Disk Operating System Standard TEXT PROCESSING—COBOL—FORTRAN available

EXPANDABLE—Add-on Hard Disk System up to 28 Megabytes per drive

MODATA ARE LOOKING FOR DEALERS AND DISTRIBUTORS

● Circle No. 183

## HUMBERSIDE MICROPROCESSOR SERVICES THE COMPLETE INDEPENDENT SERVICE

Application areas:-

Business, process control, education,

Personal Computing

We can provide for you:-

Consultancy, training, supply, maintenance and software to suit your individual requirements

Including

Commodore P.E.T.

M6800

Compec 202

and full ancillary equipment.

Microprocessor Services,

139 Beverley Road,

Hull

Humberside.

For further details ring (0482) 23146

● Circle No. 184

(continued from previous page)

that they can be magnetised either north or south, producing a four-phase control which will pull the rotor in the desired direction.

It is, therefore, essential to power the coils in the correct order. This data will be supplied with the motor. Even if it is not, it is a simple matter to power each wire in turn until a combination is discovered, so that each step is of the same magnitude and direction. To rotate the motor in the other direction the wires are powered in the reverse order.

As the load is very similar to a solenoid or relay the driver circuits used in part 1 are equally suitable to drive stepper motors (figure 2).

Program listing 2 shows four sub-routines to drive two stepping motors from the same eight-bit parallel port. The

Listing 1 and listing 3 show an algorithm to draw vector lines using a set-up such as the X-Y plotter. Listing 3 is a machine code version of the Basic program. It is loadable directly into the Kim-1 microprocessor. Listing 1 is given instead of a flow-chart of the algorithm, as it is simple enough to be understood easily. In any case the program is written in Pet Basic, and, using the same machine code routines, is fully-functional in its own right. The Basic program was written first and the algorithm debugged using all the facilities of the bigger machine—a process which could easily have taken years using only the Kim. I then pretended to be a Basic compiler and converted the Pet program into assembly-code.

When writing programs in machine code it is important to keep the amount of complex arithmetic to a minimum; it is

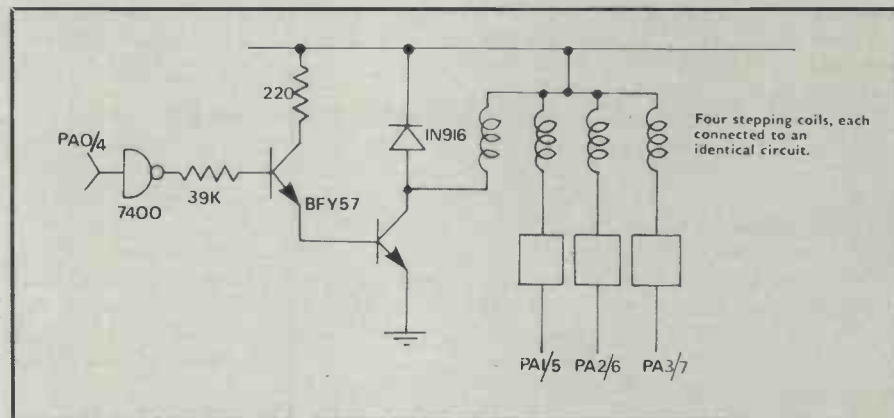

Figure 2.

first four bits PA0-PA3 will drive the X motor. The top four bits PA4-PA7 will drive the Y motor. XPLUS and YPLUS are subroutines which step either the X or Y motor forwards independently one place when called. XMINUS and YMINUS step the X and Y motors in the other direction when called.

## Switching currents

In part one reasons were given for using an active low scheme for switching the coil currents. STEPX is a variable in which only one of the bottom four bits is low, and all the rest are high. When XPLUS is called this location is shifted one place to the right and the carry bit, previously set, is shifted in at the top. If the zero bit is shifted out of the byte it is re-loaded with zero in bit three.

Next the current contents of the output port DA are loaded into the A-register and exclusively ORed with \$0F to set all four bottom bits leaving the Y motor unaffected. Then ANDING with STEPX puts the now-shifted zero bit back into the output port. XMINUS shifts the contents of STEPX left one place before changing the value in DA. When the zero bit enters the fourth bit position STEPX is loaded with its bottom bit set. YPLUS and YMINUS work in the same manner.

hard to code and slow to run. This is true especially of floating point calculations. You will notice that, apart from a single divide by two, the only arithmetic involved is addition and subtraction.

Because of the requirements of real-time computer graphics, a number of techniques for drawing lines with low computational overheads have been developed. The various methods used commonly, such as 'Digital Differential Analyser', 'Symmetric Digital Differential Analyser' and 'Binary Rate Multiplier', are described in chapter 3 of Newman and Sproull's book *Principles of Interactive Computer Graphics*, published by McGraw Hill in its Computer Science Series. Various algorithms for fitting curves to a set of points using only simple calculations also exist.

## Effective variant

The algorithm described here is a particularly effective variant of the Digital Differential Analyser for drawing a line from one pair of co-ordinates (X1 and Y1) to another pair (X2 and Y2). These pairs are read into the Basic program at statement 60, or obtained from a list of co-ordinates in the code program. The last pair of co-ordinates in the code pro-

(continued on next page)





(continued from previous page)

gram are negative—this stops the plotting. In both programs all the co-ordinates are positive, with the origin at (0,0).

At GQ, the start of the code program, the user ports are set up with INIT. Then the start of the co-ordinate table is transferred from START to START1. This

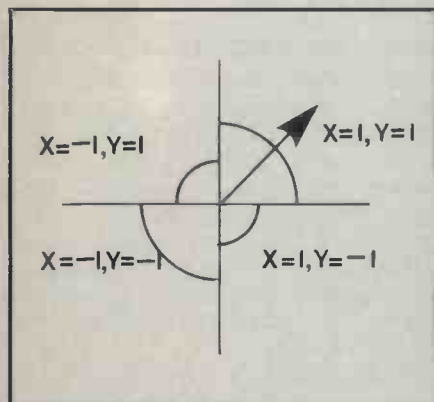

Figure 3.

means that the program can be started many times by running from GO. INIT puts an initial value into DA to lock the motors and also sets PBO low. This will be set high when the plot is over.

The next stage in the algorithm is to determine which is the best approximation to a diagonal, closest to the line (fig. 3). If  $A1=1$  then X will step right, left if  $A1=-1$ . The same is true for Y and AO.

This is determined easily. If the difference between  $X2$  and  $X1$  ( $XD$ ) is positive, then X will step right ( $S110$ ); if negative then left ( $S130$ ). If  $Y2-Y1$  ( $YD$ ) is positive Y will step upwards ( $S120$ ) otherwise downwards ( $S140$ ).

Each chunk of machine code corresponding to a single Basic statement is preceded by a label with the same numeric value as the statement number. All the variables have the same names in the two programs, and the plotting arithmetic is done to 16-bit precision—eight bits would have given a very poor plot resolution; 16-bit addition or subtraction is simply a matter of adding or subtracting the two

Figure 4.

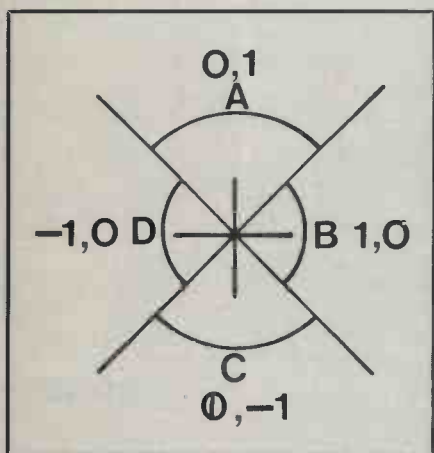

low-order bytes, having first cleared or set the carry bit.

The operation is then repeated with the high-order byte. In keeping with the 6502 convention, the low-order byte is stored first in the pair. The quantity of machine code generated is reduced further by making many of the comparisons either less than zero ( $<0$ ) or greater than or equal to zero ( $\geq 0$ ); this condition may be tested for with a single instruction.

If the top bit of the high order byte is set the number is negative; otherwise it is positive. BPL tests this bit and jumps if it is clear.

### Plot direction

The next stage in the algorithm calculates the nearest horizontal or vertical line to the desired plot direction. The X motor will go left ( $S0=0, S1=-1$ ) or right ( $S0=0, S1=1$ ): or the Y motor will go up ( $S0=1, S1=0$ ) or down ( $S0=-1, S1=0$ ). (figure 4).

If the absolute value of  $XD$  ( $XE$ ) is greater than the absolute value of  $YD$  ( $YE$ ), it is either in quadrant B or D ( $S240-S260$ ). If  $XD$  is also positive then it is quadrant B ( $S260$ )—otherwise D ( $S250$ ). Similarly if Y is greater than X it is either A or C ( $S200-230$ ). If  $YD$  is positive then A ( $S220$ )—otherwise C ( $S200$ ).

At the same time LG (longer) is loaded with the longer of the two plot distances and SH (shorter) with the lesser of the two.

The absolute value of the variables  $XE$  and  $YE$  are computed in machine code by transferring the values if they are positive (if  $XD > 0$  then  $XE=XD$ ). If the number is negative it must be complemented and one added before the result is stored (else  $XE=-XD$ ). Complementing a byte is done by exclusive ORing with  $\$FF$ . One is added normally.

### Axis movements

The algorithm plots the line either by stepping both motors in the direction of the best diagonal, or one motor only in the direction of the best horizontal or vertical line. The ratio of diagonals to axis movements determines the slope of the line. If they are all axis movements then the line was at 0, 90, 180, or 275 degrees to the vertical. If they were all diagonal, then the line was at 45, 135, 225, or 315 degrees to the vertical.

Each iteration around the loop  $S355$  to  $S430$  will step one or both motors in the relevant direction. The total number of iterations (TT) is equal to the number of plotted points in the longest direction (LG). Each time around the loop CT determines whether the current ratio of used-up diagonals to axials exceeds the overall ratio of diagonals to axials ( $S360$ ). When TT reaches zero all the points are plotted and the program returns to  $S60$ .

If more diagonals have been used, an

(continued on next page)

## CALCULATORS

### SCIENTIFIC

- SPECIAL OFFER**  
TEXAS TI59 together with PC100C  
(Complete as manufacturers specifications)  
£285.00
- TEXAS/MP Accessories available
- \*TEXAS TI59 (New Card prog 960 prog steps or 100 mem) £156.50
  - \*TEXAS I58 (New Key prog 480 steps or 60 mem) £60.00
  - \*TEXAS PC100C (New updated Printing Units for TI58/TI59) £140.00
  - \*TEXAS TI57 (Key Prog 8 Mem. 150 Key Strokes/50 Prog Steps) £25.00
  - \*TEXAS TI33 (as TI30 but 3 Mem.) £13.95
  - \*TEXAS TI45 (8 Dig slide Rule with Exp Mem Green Display) £19.95
  - \*TEXAS 42MBA (10 Dig Fin/Stat Prog 12 Mem 32 key strokes) £42.95
  - \*TEXAS TI PROGRAMMER (Hexadecimal Calc) £46.50
  - \*TEXAS TI51/III (New 8 Dig + Exp 10 Mem 32 Prog Steps, Stat/Sci) £26.30
  - \*TEXAS TI25 (LCD Sci/Stat) £18.90
  - \*TEXAS T50 (New LCD Sci/Stat-2 Con. Mem) £23.00

### SPECIAL INTEREST

- TEXAS TI58 or TI59  
with Pre-Programmed Applied  
Statistics Module
- This branch of applied mathematics is useful in many fields: from medicine to political science and quality control to mechanical design. Module includes:
- Random Number Generator
  - Data Entry Programs
  - Means and Moments
  - Histogram Construction
  - Theoretical Histogram
  - Data Transforms
  - Statistic Evaluation
  - Contingency Table Analysis
  - Two-way Analysis of Variance
  - Rank Sum
  - Multiple Linear Regression
  - One Way Analysis of Variance
  - Normal Distribution
  - Binomial Distribution
  - Chi-Square Distribution
  - t & F Distribution Diagnostic
- \*TEXAS TI58 with Applied Statistics £80.00
  - \*TEXAS TI59 with PC100C & Applied Statistics £305.00

### SPRING SALE

- TEXAS TI59 Calculator (complete as manufacturer's spec.) PLUS statistics module & extra set of 40 Blank Prog. Cards with wallet etc. ONLY £180
- \*CBM S61 (Stat + SCI 6 Mem NS Div Chi Sq, Dis, Lin Regr, etc.) £46.00
  - \*CBM 9190R (as 4190R but 9 Mem) £27.50
  - \*CBM Pro 100 (72 Step Prog) £29.50
  - \*HP 19C (Cont. Mem, Key prog, Printer) £129.00
  - \*HP 29C (as 19C but no Printer) £93.00
  - \*HP31E (New Sci replaces HP21) £35.00
  - \*HP32E (Adv Sci with Stat) £50.00
  - \*HP33E (8 Mem Prog, Sci/Stat) £64.00
  - \*HP 67A (Card Prog, 224 Steps 26 Mem) £257.75
  - \*HP 97A (Fully prog, with Printer) £422.00
  - \*CASIO FX201P (Sci, 11 Mem, 127 step Key Prog) Fortran System £44.50
  - CASIO AC 2000 (LCD Cal 3-way Stop Watch/Alarm plus date calendar) £22.00
  - CASIO FX3100 (New version of FX3000-LCD Sci/Std/div, Poles Rec etc) £22.50
  - CASIO FX8000 (as above + Stop Watch/Alarm) £27.75

### THE COMMODORE PET COMPUTER

- with 8K bytes RAM 2001-8  
A complete personal computer that operates anywhere by simply plugging into Mains supply. Allows communications directly from BASIC to IEEE—486 standard devices—Cassette, Video Display Unit & Keyboard built into PET. Fully guaranteed Warranty to CBM complete only £550  
PET 2001/4 £499 PET 2001/16 £675

### NOW IT'S YOU AGAINST 'COMPUTERS'

- Borris is the most advanced chess computer yet. Borris is ideal for learning and improving your chess game from beginner to master. Borris can play against himself has Alpha-Numeric prompting to help improve play and by simple switching you have facility to follow Borris's 'thinking' while he analyses position before making a move. Walnut case wooden chess men board mains adapter etc. £184.00  
Chess Challenger '10' (10 Levels of beginner to master) £180.00

\*FREE—Mains/charger included.\*

GOODS FULLY GUARANTEED. PRICES EXCLUDE VAT (ADD 8%). BUT INC P. & P. CHEQUE WITH ORDER  
Company/hospital and Government orders accepted by phone.  
Barclaycard/Access accepted by phone

**Tel. : 01-455 9823**

EXPORT ORDERS WELCOMED  
Air Freight/Air Post Delivery.  
Quotations on request.

### MOUNTAINDENE

22 Cower St. London EC2

● Circle No. 185



**ANADEX 8000** printer for Pet, Apple and most other micros. 80 columns, 112 cps 84 lines per minute. Heavy-duty cycle 100 M-char print-head life. Universal interface Serial RS232 parallel, current loop. £550 + VAT. **London Computer Store, 43 Grafton Way, W.1.** Telephone: 01-388 5721.

● Circle No. 186

## ■ BARGAIN ■

### SECOND-HAND IBM SELECTRIC TYPEWRITERS

Two years old, formerly part of terminals but now gutted ready for your own interface board. 15cps, golf-ball, letter-quality printing. Good for word processing. Easily modified for use with microcomputers. £175 each to clear. £150 each for 2 or more. Call in at: 17 Bond St, Ealing, London W5 or Telephone: 01-567 2255.

● Circle No. 187

### Dyna-Byte

fully assembled  
burned in S100

16K Dynamic	RAM	£198
16K Static	RAM 250ns	£271
16K Static	RAM 450ns	£266
32K Static	RAM 250ns	£506
32K Static	RAM 450ns	£470

80 x 24 video terminal, just add keyboard and monitor £177.  
Cable set for video terminal £7.20

Post free. Add 8% VAT to all prices.

S.W.C. Electronic distributors, P.O. Box 30, London E.4.

● Circle No. 188

### WANTED URGENTLY!

by Expanding Software House.

If any of you ace PET programmers have good original programs you want to make money out of, look no further.

We buy any type of program, providing they are your copyright, and market them on a generous royalty basis.

Other-type computer programs considered.

Please phone Tony Dawe or Nick Dunn on (04862)-60268.

● Circle No. 189

(continued from previous page)

axial is made next (S370-S380), calling subroutine S1000. Otherwise a diagonal is plotted (S390-S400), calling subroutine S2000. Both S1000 and S2000 transfer the step directions into Z1 and Z0 and call S3000. This in turn calls the code subroutines stored in the Pet memory — XPLUS, XMINUS, YPLUS and YMINUS, with calls of the Basic system function SYS.

A delay is introduced at this point to allow for the mechanical inertia of the motors (S3070 or DELAY at \$0268)—the delay will have to be altered for different makes and sizes of stepping motor.

### Reducing delay

The co-ordinates set in the program draw a duo-decadon as in figure 5. With the delay values used it takes 100 seconds to plot the 2,600 points. The circuits were tested with 15-degree motors manufactured by Eastern Air Devices Inc model LD20ACM-12 motors. They have 20 ohm windings with a maximum working voltage of 28 volts (1.4 amps), giving a maximum output torque (turning ability) of 38 oz. in.

The fastest rotation rate of these motors is about 50 steps per second (125 rpm). If too much load is placed on the shaft the rotor fails to step round but if it does step,

even if at reduced speed, the cumulative accuracy is maintained. If the motors are to be driven from the Pet, the driver circuits can be attached to the user port J2. The processing time of the Basic interpreter means that the steps have a much greater delay; this can be reduced by removing the diagnostic print statements 1010 and 2010.

### Many applications

Statements S5160 to S5540 are decimal values of the bytes in listing 2. Statements S5070 to S5140 are a machine code loaded. The code is transferred from the data statements into the 'unused' #2 tape buffer. Statement S5010 sets the user port to an output by poking \$FF into the control register at 59459, and then initialising the outputs to %01110111 by poking 119 into the data direction register (DA on listing 2) at 59471.

Stepping motors are ideal in numerous applications where accuracy and repeatability are prime considerations. They have been used, therefore, in the design of many forms of small computer peripherals and are most useful for robot and computer-controlled arm and manipulator construction. As they become cheaper and more readily obtainable their use will spread, particularly since they are so readily interfaced to microprocessors.

(continued on next page)

Figure 5.

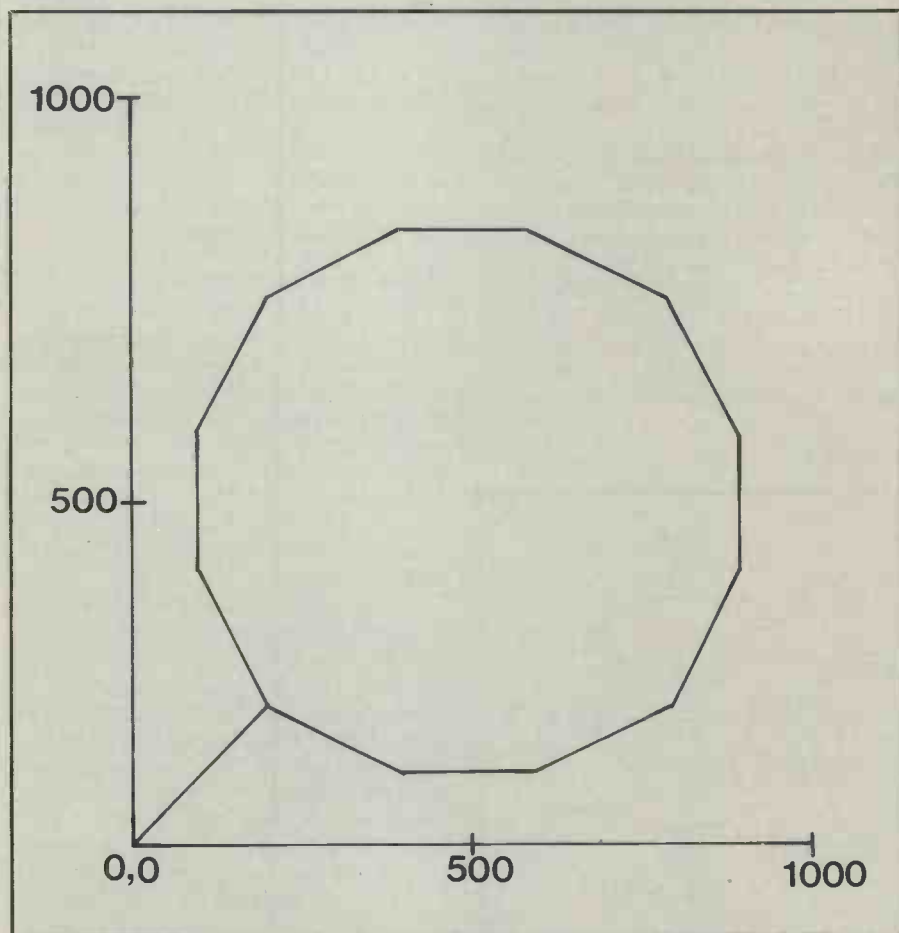



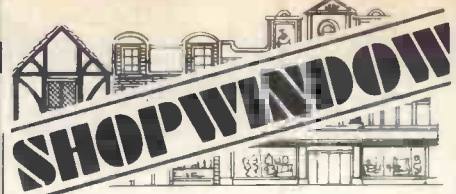

(continued from previous page)

## Listing 1

```

G
10 REM BASIC PROGRAM DEMONSTRATING
20 REM LINE DRAWING PROGRAM FOR
30 REM STEPPING MOTORS ON THE KIM-1
40 REM MICROCOMPUTER.
50 GOSUB 5000
60 INPUT "INPUT (X1,Y1),(X2,Y2)";X1,Y1,X2,Y2
70 REM DISPLACEMENTS IN X AND Y
80 XD=X2-X1
90 YD=Y2-Y1
100 REM CALCULATE NEAREST DIAGONAL
110 A0=1
120 A1=1
130 IFYD<0 THEN A0=-1
140 IFXD<0 THEN A1=-1
150 REM CALCULATE NEAREST HORIZ/VEAT
160 XE=ABS(XD)
170 YE=ABS(YD)
180 D1=XE-YE
190 IF D1>=0 THEN 240
200 S0=-1
210 S1=0
215 LG=XE
216 SH=XE
220 IF YD>=0 THEN S0=1
230 GOTO 270
240 S0=0
250 S1=-1
255 LG=XE
256 SH=XE
260 IF XD>=0 THEN S1=1
270 REM
275 PRINT "XD YD XE YE D1 S1 S0"
276 PRINTXD;YD;XE;YE;D1;S1;S0
280 PRINT "ACROSS=";A1;A0
290 PRINT "UP/DOWN";S1;S0
295 PRINT " X Y"
300 REM SET-UP COUNTERS
310 TT=LG
320 TS=SH
330 UD=LG-SH
340 CT=SH-LG/2
350 REM WHILE MORE POINTS DO
355 IFTT=0GOTO60
360 IFCT>=0 THEN 390
370 CT=CT+TS
375 GOSUB 1010
380 GOTO410
390 GOSUB 2010
400 CT=CT-UD
410 TT=TT-1
430 GOTO 355
1000 REM HANDLE S1 AND S0
1010 PRINT S1;S0
1020 Z1=S1
1030 Z0=S0
1040 GOSUB 3010
1050 RETURN
2000 REM HANDLE A1 AND A0
2010 PRINT A1;A0
2020 Z1=A1
2030 Z0=A0
2040 GOSUB3010
2050 RETURN
3000 REM CALL USER STEP ROUTINES
3010 IFZ1=0THEN3040
3020 IFZ1=>1THEN SYS(826)
3030 IFZ1=-1THEN SYS(849)
3040 IFZ0=0THEN3070
3050 IFZ0=>1THEN SYS(867)
3060 IFZ0=-1THEN SYS(894)
3070 FORDL=1TO10:NEXT
3080 RETURN
5000 REM SET USER PORT TO OUTPUT
5010 POKE 59459,255
5020 REM INITIALISE STEP
5030 POKE 59471,119
5040 REM READ MACHINE CODE PROGRAM
5050 REM INTO TAPE BUFFER #2
5060 REM THE LOADER PROGRAM
5070 READ AD,ND
5080 FOR NN=1TO NO
5090 READ NX
5100 POKE AD,NX
5110 AD=AD+1
5120 NEXT NN
5130 REM THE MACHINE CODE
5140 DATA 626,86
5145 REM XPLUS
5150 DATA56
5160 DATA 110,140,3
5170 DATA 176,5
5180 DATA 169,247
5190 DATA 141,140,3
5200 DATA 173,79,232
5210 DATA 9,15
5220 DATA 45,140,3
5230 DATA 141,79,232
5240 DATA 96
5250 REM XMINUS
5260 DATA 56
5270 DATA 173,140,3
5280 DATA 42,+
5290 DATA 44,142,3
5300 DATA 208,2
5310 DATA 169,254
5320 DATA 141,140,3
5330 DATA 76,69,3
5340 REM YPLUS
5350 DATA 56
5360 DATA 173,141,3
5370 DATA 106
5380 DATA 44,143,3
5390 DATA 208,2
5400 DATA 169,127
5410 DATA 141,141,3
5420 DATA 173,79,232
5430 DATA 9,240
5440 DATA 45,141,3
5445 DATA 141,79,232
5450 DATA 96
5460 REM YMINUS
5470 DATA 56
5480 DATA 46,141,3
5490 DATA 176,5
5500 DATA 169,239
5510 DATA 141,141,3
5520 DATA 76,114,3
5530 REM VARIABLES
5540 DATA 247,127,16,8
5550 RETURN
9999 G=867
10000 PRINTPEEK(Q);;G=Q+1;GOTO10000
READY.
    
```

## MICROTEK COMPUTER SERVICES



Agents for North Star Horizon. Personalised software for small business applications. Stock control, accounting, estate agents package, mailing list programs.

**50, Chislehurst Road,  
Orpington, Kent  
Tel 66-26803  
evenings 0474-872630**

● Circle No. 190

## HAVE YOUR PROGRAMS TO SELL?

Have you written a program, programs or a complete system and would like us to sell it for you? We are particularly interested in APPLE II, MICROPOLIS and CP/M systems.

Send details to:-  
**SWORD Data Systems Ltd.,**  
47 London Road, Redhill, Surrey.

● Circle No. 191

## Listing 2

```

;STEPPING MOTOR DRIVER ROUTINES
;RE-LOCATED FOR THE PET
;USING VECTOR, PLOTTING PROGRAM
DA =59471
PRESIDES IN TAPE BUFFER #2
*=$33A
;
;STEP X MOTOR 1 POLE ON
XPLUS SEC
RUR STEPX
BCS XPI
LDA #SF7
STA STEPX
XP1 LDA DA
DRA #SF0
AND STEPX
STA DA
HTS
;SET X MOTOR 1 POLE BACK
XMINUS SEC
LDA STEPX
ROL A
BIT TESTX
BNE XMI
LDA #SFE
XMI STA STEPX
JMP XPI
;SET Y MOTOR 1 POLE ON
YPLUS SEC
LDA STEPX
RUR A
BIT TESTY
BNE YPI
LDA #SF7
YPI STA STEPX
LDA DA
YP2 DRA #SFO
AND STEPX
STA DA
HTS
;STEP Y MOTOR 1 POLE BACK
YMINUS SEC
ROL STEPX
BCS YMI
    
```

(continued on next page)

## TRS-80 SOFTWARE

All types of Software for the TRS-80. Imported and U.K. written! Business, games and general programs stocked for same day shipment. A few examples:-

Software eradication of key-board bounce 4K-48K **£5.95**

Use Programmable File

Handling **£14.95**

Microchess **£14.00**

Cross Reference **£7.95**

Star Trek **£14.95**

Accounts Receivable **£19.95**

Inventory Management **£19.95**

Space Fighter **£9.95**

Send SAE for full listing and addition to our mailing list.

**A. J. HARDING**  
28 Collington Avenue,  
Bexhill-on-Sea, E. Sussex  
Tel: (0424) 220391

● Circle No. 192

## TOPMARK Computers

dedicated to  
**APPLE II**

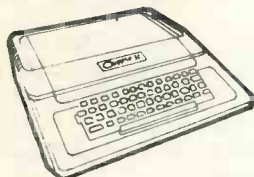

Simply the best!

Full details from Tom Piercy on  
Huntingdon (0480) 212563 or circle  
enquiry card.

● Circle No. 193

NASCOM 1 : Kit £197.50 + VAT  
: fully-built and tested  
£247.50 + VAT

SUPERBOARD II : fully-built and  
tested £284.95 inc VAT  
Ohio Scientific.

8K basic, 4K Static RAM 1K dedicated  
video memory, 53-key keyboard, upper  
and lower-case, graphics and gaming  
characters.  
for details: NIC Models, 27 Sidney  
Road, London N22 4LP Tel. 01-889-9736

● Circle No. 194

### ANDREWS COMPUTING LTD

Programs for minimum-Nascom-1

- Fruit Machine Game @ £4.00  
(rotating drums, hold, etc.)
  - Submarine Chase Game @ £4.00  
(inc. 16 bit multiply & divide)
  - Memory Test Program @ £3.00  
(tests all RAM in one go)
- All supplied fully documented with listings  
on B-Bug, T4 or Nasbug format  
cassette tape.
- C20 cassettes (inc. lib.  
cases) 5 @ £2.40  
10 @ £4.40

Add 35p for P & P, all prices include VAT.  
Send SAE for details.

21 Lime Tree Drive,  
Farndon, Chester.

● Circle No. 195

### WEST COUNTRY DEVON

## Crystal Electronics

FOR THE BEST IN SMALL COMPUTERS

advice and full back up on

**APPLE II NASCOM I ATARI NEW BEAR**  
books (over 150 titles), components, add ons, etc.

SOFTWARE FOR

Apple 2 stock control (disk and printer) for  
10,000 items plus £100+ full update for six months  
exc VAT

Nascom tape containing 6 games etc £6.00 +VAT.  
All products are stocked on advice from our engin-  
eers as to quality value for money and reliability.  
Shop open 0930-1800 except Wed/Sun

**40 MAGDALENE ROAD,  
TORQUAY, DEVON**  
Tel. 0803 22699

● Circle No. 196

(continued from previous page)

## Listing 2—continued

```

0384 A9 EF          LDA #SEF
0386 8D 8D 03      STA STEPY
0389 4C 72 03      JMP YP2
                    ;PROGRAM VARIABLE LOCATIONS
038C F7            STEPX .BYTE $F7
038D 7F            STEPY .BYTE $7F
038E 10            TESTX .BYTE $00010000
038F 08            TESTY .BYTE $00001000
0390
SECOND PASS FINISHED O.K.
SYMBOL TABLE
14
DA E84F XPLUS 033A
XP1 0345 XMINUS 0351 XM1 035D
YPLUS 0363 YP1 036F YP2 0372
YMINUS 037E YM1 0389 STEPX 038C
STEPY 038D TESTX 038E TESTY 038F
END OF ASSEMBLY
00.19.09-
```

## Listing 3

```

;PROGRAM TO DRIVE THE STEPPING
;MOTORS AS AN X-Y PLCIER
;COORDINATES HELD IN TABLE FROM
;START
;
;SYSTEM LOCATIONS
DA = $1700
DDA = $1701
DB = $1702
DDR = $1703
C64D = $1706
SK = $1707
KIMMON = $1C00
;PROGRAM VARIABLES
;INITIAL COORDINATES FROM TABLE
0000 X1 ***+2
0002 Y1 ***+2
0004 X2 ***+2
0006 Y2 ***+2
;COORDINATE DIFFERENCE
0008 XD ***+2
000A YD ***+2
;ABSOLUTE VALUES OF XD & YD
000C XE ***+2
000E YE ***+2
;DIFFERENCE OF XD AND YD
0010 DI ***+2
;STEP DIRECTIONS
0012 S0 ***+1
0013 S1 ***+1
0014 A0 ***+1
0015 A1 ***+1
0016 Z0 ***+1
0017 Z1 ***+1
;MISC - PLUT
0018 LG ***+2
001A SH ***+2
001C TT ***+2
001E UD ***+2
0020 CT ***+2
0022 TS ***+2
;MISC - DRIVE
0024 F7 STEPA .BYTE $F7
0025 7F STEPY .BYTE $7F
0026 10 TESTX .BYTE $00010000
0027 08 TESTY .BYTE $00001000
;START OF LOOKUP TABLE
0028 95 02 START .[WD COORDS
002A ***+2
;SETUP PROGRAM
GC JSR INIT
LDA START
STA STARTI
LDA START+1
STA STARTI+1
;NEXT COORDS FROM TABLE
S60 LDY #0
LUX #0
S60A LDA (STARTI),Y
STA X1,..
INY
INX
CPX #8
BNE S60A
LDA STARTI
CLC
ADC #4
STA STARTI
LDA STARTI+1
ADC #0
STA STARTI+1
LDA X2+1
BPL S80
JMP HALT
;DISPLACEMENT IN X AND Y
S80 LDA X2
SEC
SBC X1
STA XD
LDA X2+1
SBC X1+1
STA XD+1
S90 LDA Y2
SEC
SBC Y1
STA YD
LDA Y2+1
SBC Y1+1
STA YD+1
```

(continued on next page)





(continued from previous page)

## Listing 3—continued

```

;CALCULATE NEAREST DIAGONAL
0073 A9 01 S110 LDA #1
0075 85 14 STA A0
0077 85 15 S120 STA A1
0079 A5 05 S130 LDA YD+1
007B 10 04 BPL S140
007D A9 FF LDA #-1
007F 85 14 STA A0
0081 A5 09 S140 LDA XD+1
0083 10 04 BPL S160
0085 A9 FF LDA #-1
0087 85 15 STA A1

;NEAREST HORIZ/VERT
0089 A5 09 S160 LDA XD+1
008B 10 14 BPL S160A
008D A5 08 LDA XD
008F 49 FF EDH #5FF
0091 18 CLC
0092 69 01 ADC #1
0094 85 0C STA XE
0096 A5 09 LDA XD+1
0098 49 FF EDH #5FF
009A 69 00 ADC #0
009C 85 0D STA XE+1
009E 4C A9 00 JMP S170
00A1 A5 08 S160A LDA XD
00A3 85 0C STA XE
00A5 A5 09 LDA XD+1
00A7 85 0D STA XE+1
00A9 A5 0B S170 LDA YD+1
00AB 10 14 BPL S170A
00AD A5 0A LDA YD
00AF 49 FF EDH #5FF
00B1 18 CLC
00B2 69 01 ADC #1
00B4 85 0E STA YE
00B6 A5 0B LDA YD+1
00B8 49 FF EDH #5FF
00BA 69 00 ADC #0
00BC 85 0F STA YE+1
00BE 4C C9 00 JMP S180
00C1 A5 0A S170A LDA YD
00C3 85 0E STA YE
00C5 A5 0B LDA YD+1
00C7 85 0F STA YE+1
00C9 A5 0C S180 LDA XE
00CB 38 SEC
00CC E5 0E SBC YE
00CE 85 10 STA D1
00D0 A5 0D LDA XE+1
00D2 E5 0F SBC YE+1
00D4 85 11 STA D1+1
00D6 10 46 S190 BPL S240

142N-B. BRANCH FROM PAGE 0 TO PAGE
00DB A9 FF S200 LDA #-1
00DA 85 12 STA S0
00DC A9 00 S210 LDA #0
00DE 85 13 STA S1
00E0 4C 00 01 JMP S215
00E3 **$100
0100 A5 0E S215 LDA YE
0102 85 18 STA LG
0104 A5 0F LDA YE+1
0106 85 19 STA LG+1
0108 A5 0C S216 LDA XE
010A 85 1A STA SH
010C A5 0D LDA XE+1
010E 85 1E STA SH+1
0110 A5 0B S220 LDA YD+1
0112 10 03 BPL S220A
0114 4C 1E 01 JMP S230
0117 A9 01 S220A LDA #1
0119 85 1E STA S0
011E 4C 41 01 S230 JMP S310
011E A9 00 S240 LDA #0
0120 85 12 STA S0
0122 A9 FF S250 LDA #S-1
0124 85 13 STA S1
0126 A5 0C S255 LDA XE
0128 85 18 STA LG
012A A5 0D LDA XE+1
012C 85 19 STA LG+1
012E A5 0E S256 LDA YE
0130 85 1A STA SH
0132 A5 0F LDA YE+1
0134 85 1B STA SH+1
0136 A5 09 S260 LDA XD+1
0138 10 03 BPL S260A
013A 4C 41 01 JMP S310
013D A9 01 S260A LDA #1
013F 85 13 STA S1

;SET UP COUNTERS
0141 A5 18 S310 LDA LG
0143 85 1C STA TT
0145 A5 19 LDA LG+1
0147 85 1D STA TT+1
0149 A5 1A S320 LDA SH
014B 85 22 STA TS
014D A5 1B LDA SH+1
014F 85 23 STA TS+1
0151 A5 18 S330 LDA LG
0153 38 SEC
0154 E5 1A SBC SH
0156 85 1E STA UD
0158 A5 19 LDA LG+1
015A E5 1E SBC SH+1
015C 85 1F STA UD+1
015E 46 19 S340 LSA LG+1 LG=LG/2
0160 66 18 HRA LG
0162 A5 1A LRA SH CT=SH-LG
0164 38 SEC
0165 E5 18 SBC LG
0167 85 20 STA CT
0169 A5 1B LDA SH+1
016B E5 19 SBC LG+1
016D 85 21 STA CT+1
    
```

(continued on next page)

**MICROMEDIA (SYSTEMS)**  
**SYSTEMS BASED ON**  
**PET 2001**  
**NORTH STAR HORIZON**  
**EQUINOX 300**  
**EXTENSIVE RANGE OF**  
**PERIPHERALS AND**  
**APPLICATIONS SOFTWARE.**  
**TRAINING FACILITIES AND**  
**SEMINARS**  
**CALL US TO DISCUSS YOUR**  
**APPLICATIONS ON**  
**0633-841 691/50528 (24 hrs)**

● Circle No. 197

**RADIO SHACK COMPUTER OWNERS**  
**TRS-80 MONTHLY**  
**NEWSLETTER**

- PRACTICAL APPLICATIONS
- BUSINESS
- GAMBLING + GAMES
- EDUCATION
- PERSONAL FINANCE
- BEGINNER'S CORNER
- NEW PRODUCTS
- SOFTWARE EXCHANGE
- MARKET PLACE
- QUESTIONS AND ANSWERS
- PROGRAM PRINTOUTS
- ... AND MORE

ONE YEAR SUBSCRIPTION INC. P&P £16-50  
**G-MAX RESEARCH CO. LTD**  
 8 TATE RD. SUTTON, SURREY  
 TEL. 01-642 8971 (No callers please)

● Circle No. 198

**PET NEWS**  
 Floppy disk system saddle  
 mount twin—£950. Compact  
 free twin—£916.  
**Both units at last**  
 Pet 2001/8 down in price to  
 £550 + VAT  
 for news of the Pet printer, Pet  
 floppy, Super Pet, EDV Pet, key-  
 board, software and dust-covers  
**Why not send for free catalogue**  
**Intex Datalogic Ltd,**  
 Eastcliffe Ind. Est., Eastcliffe  
 Cleveland TB16 0PN  
 Tel 0642-781193

● Circle No. 199

**BRAMBLETYE**  
**COMPUTER SYSTEMS**  
**LTD**  
**(Forest Row, East Sussex)**

Centronics 700, 60cps matrix  
 printer. Twelve months old.  
 £650

**Tel. 034-282-4297**

● Circle No. 200

# SHOP WINDOW

Hybrid systems DAC-371-8, D/A converter, plugs into single IC skt, ttl, dtl compatible 8 bits binary or 2 decades bcd, with data, £2. 2708 (450ns) £6.85p, 2102 (500ns) 98p, 21L02 (250ns) £1.20p, 2513 (Upp case) £5, Micro-speech special synthesiser board, assembled and tested, £320 inclusive (sae with details and type of CPU being used. 2512V (dual 128 bit static shift reg (128 X 2) £1, TMS3128NC (shift reg) £1, N8293A (presettable I/power binary counter) 50p, vero edge connector 2245/2 (22 X 22) key at 7/h 35p, 1702 at £2.95, SN76477 £2.50 p/p 20p.

**LB Electronics**  
43, Westacott,  
Hayes,  
Middx. UB4 8AH  
England

Mail  
Order  
only

● Circle No. 201

## EXIDY SORCERER

32K Micro Computer

£850.00 + VAT

Dealer for

### Bristol and South West

ELECTROPRINT (Mr. Tasker)

5 Kingsdown Parade • Bristol 6 • 292375

● Circle No. 202

## TRS-80 SOFTWARE

We have the largest TRS-80 Program Library in the country. Business, finance, scientific and games. LEV1, LEV11 and DISK. New programs daily. We pay good prices for original programs. S.A.E. for lists to:-

**MICROCOMPUTER APPLICATIONS**  
11 RIVERSIDE COURT,  
CAVERSHAM, READING  
RG4 8AL.

● Circle No. 203

## OHIO SCIENTIFIC C2-0

Adds BASIC to your old TTY

The C2-0 has 8K BASIC in ROM, 4K RAM, 6502 processor, monitor serial port (RS 232 or 20ma) and OSI 48 line BUS connector for further expansion.

**£198.50\* complete board only**

**£278.50\* in case with p.s.**  
Delivery two weeks\* + VAT

Orders to:  
**U-Microcomputers,**  
P.O. Box 24,  
Northwich,  
Cheshire, CW8 1RS.  
Tel: 0606-75627.

● Circle No. 204

(continued from previous page)

## Listing 3—continued

```

016F A5 1C          ;WHILE MORE POINTS DO
S355 LDA TT
0171 D0 07          BNE S360
0173 A5 1D          LDA TT+1
0175 D0 03          BNE S360
0177 4C 37 00      JMP S60
017A A5 21          S360 LDA CT+1
017C 10 1B          BPL S390
017E A5 20          S370 LDA CT
0180 18            CLC
0181 65 22          ADC TS
0183 85 20          STA CT
0185 A5 21          LDA CT+1
0187 65 23          ADC TS+1
0189 85 21          STA CT+1
018B A5 13          S375 LDA S1
018D 85 17          STA Z1
018F A5 12          LDA S0
0191 85 16          STA Z0
0193 20 00 02      JSR S3000
0196 4C B1 01      JMP S410
0199 A5 15          S380 LDA A1
019B 85 17          STA Z1
019D A5 14          LDA A0
019F 85 16          STA Z0
01A1 20 00 02      JSR S3000
01A4 A5 20          S400 LDA CT
01A6 38            SEC
01A7 E5 1E          SBC UD
01A9 85 20          STA CT
01AB A5 21          LDA CT+1
01AD E5 1F          SBC UL+1
01AF 85 21          STA CT+1
01B1 A5 1C          S410 LDA TT
01B3 38            SEC
01B4 E9 01          SBC #1
01B6 85 1C          STA TT
01B8 A5 1D          LDA TT+1
01BA E9 00          SBC #0
01BC 85 1D          STA TT+1
01BE 4C 6F 01      JMP S355
;END OF PLOT PROGRAM
;=#200

O1C1 ;
;SUBROUTINE TO STEP MOTORS
;Z0 FOR Y AND Z1 FOR X
;IF ZX = 0 THEN NO STEP
;ELSF ZX = 1 THEN STEP ON
;ELSF ZX = -1 THEN STEP BACK
S3000 LDA Z1
      BEQ DDY
      BPL FORWX
      JSR XMINUS
      JMP DDY
FORWX JSK XPLUS
      LDA Z0
      BEQ DEL
      BPL FORLY
      JSR YMINUS
      JMP DEL
FORLY JSK YPLUS
      DEL JSK DELAY
      RTS
;STEP X MOTOR 1 POLE ON
XPLUS SEC
      ROR STEPX
      BCS XPI
      LDA #SFT
      STA STEPX
      LDA DA
      AND #SDF
      AND STEPX
      STA DA
      RTS
;SET X MOTOR 1 POLE BACK
XMINUS SEC
      LDA STEPX
      ROL A
      BIT TESTX
      BNE XMI
      LDA #SFE
      STA STEPX
      JSR AFI
;SET Y MOTOR 1 POLE ON
YPLUS SEC
      LDA STEFY
      ROR A
      BIT TESTY
      BNE YFI
      LDA #S7F
      STA STEFY
      YFI STA STEFY
      YF2 LDA DA
      ORA #SFC
      AND STEFY
      STA DA
      RTS
;STEP Y MOTOR 1 POLE BACK
YMINUS SEC
      ROL STEFY
      BCS YMI
      LDA #SEF
      STA STEFY
      YMI JMP YP2
;DELAY SUBROUTINE
DELAY LDY #10
DELAY1 LDA #60
      STA C64D
      RND BIT S#
      BPL AND
      DEY
      CFY #6
      BNE DELAY1
      RTS
;SUBROUTINE TO INITIALISE PORTS
INIT LDA #SFF

```

(continued on next page)





(continued from previous page)

## Listing 3—continued

```

027C 8D 01 17          STA DDA
027F 8D 03 17          STA DDB
0282 A9 EE             LDA #X11101110
0284 8D 00 17          STA DA
0287 A9 00             LDA #0
0289 8D 02 17          STA DB
028C 60                RTS
;HALT CONDITION - TIGHT LOOP
;HAVING FIRST SET PBO HIGH
028D A9 01             LDA #1
028F 8D 02 17          STA DB
0292 4C 92 02          H1
;COORDINATE TABLE
COORDS -WORD 0,0
0295 00 00            -WORD 200,200
0297 00 00
0299 C8 00            -WORD 100,400
029B C8 00
029D 64 00            -WORD 100,600
029F 90 01
02A1 64 00            -WORD 200,600
02A3 58 02
02A5 C8 00            -WORD 400,900
02A7 20 03
02A9 90 01
02AB 84 03            -WORD 600,900
02AD 58 02
02AF 84 03            -WORD 800,800
02B1 20 03
02B3 20 03            -WORD 900,600
02B5 84 03
02B7 58 02            -WORD 900,400
02B9 84 03
02BB 90 01            -WORD 800,200
02BD 20 03
02BF C8 00            -WORD 600,100
02C1 58 02            -WORD 400,100
02C3 64 00
02C5 90 01            -WORD 200,200
02C7 64 00
02C9 C8 00
02CB C8 00            -WORD $FFFF,$FFFF
02CD FF FF
02CF FF FF
02D1
SECOND PASS FINISHED U.K.
SYMBOL TABLE
96
DA 1700 DDA 1701
DB 1702 DDB 1703 C64D 1706
SR 1707 KIMMON 1C00 X1 0000
Y1 0002 X2 0004 Y2 0006
XD 0008 YD 000A XE 000C
YE 000E D1 0010 S0 0012
S1 0013 A0 0014 A1 0015
Z0 0016 Z1 0017 LG 0018
SH 001A TT 001C UD 001E
CT 0020 TS 0022 STEPX 0024
STEPY 0025 TESTX 0026 TESTY 0027
START 0028 START1 002A GU 002C
S60 0037 S60A 003B S80 0059
S90 0066 S110 0073 S120 0077
S130 0079 S140 0081 S160 0089
S160A 00A1 S170 00A9 S170A 00C1
S180 00C9 S190 00D6 S200 00D8
S210 00DC S215 0100 S216 0108
S220 0110 S220A 0117 S230 011B
S240 011E S250 0122 S255 0126
S256 012E S260 0136 SE60A 013D
S310 0141 S320 0149 S330 0151
S340 015E S355 016F S360 017A
S370 017E S375 01BB S380 0196
S390 0199 S400 01AA S410 01B1
S430 01BE S3000 0200 FORLX 020C
DDY 020F FORLY 021B DEL 021E
XPLUS 0222 XPI 022B XMINUS 0236
XM1 0240 YPLUS 0245 YP1 024F
YP2 0251 YMINUS 025C YM1 0265
DELAY 0268 DELAY1 026A RND 026F
INIT 027A HALT 028D H1 0292
COORDS 0295
END OF ASSEMBLY

```

14-02-48-

## Speeding SWT CT64

AN unedited version of this appears in the Cape Computer Club newsletter C3PO. If you have SWTP's economical display terminal, and if you are tired of filling the screen at a maximum of 50 characters per second, you will probably read it with an eye on fast interactive games and graphics. Be warned, however, that these modifications will be beyond the scope of the rank beginner.

### Step 1

THIS involves the CTS board only. Take a wire from IC 9 pin 8 out of the CT64 and connect it to a status input on the serial interface in your computer.

If your computer uses an ACIA, this wire can go to pin 24 of the CTS input. When the signal on this line goes high, the ACIA is inhibited from sending data.

Similarly, if you are using an I8251 serial interface chip in your computer, connect this wire to pin 17—it is functionally equivalent to pin 24 on the ACIA.

If you have neither of these chips, this wire should go to some input where your computer can test its status before sending data to the CT64.

(continued on next page)

MICROMEDIA (SYSTEMS)  
NOW OFFER  
PROFESSIONAL  
CONSULTANCY  
ON ANY COMPUTER-BASED  
SYSTEMS

SOFTWARE SERVICES  
COMPRISING PURPOSE-  
BUILT AND OFF-THE-SHELF  
SOFTWARE  
CONTACT CHRIS HOLBROOK  
ON 0633-841691/50528  
(24 hrs)

● Circle No. 205

## P. I. P. S.

COMPUTER SERVICES

North-East England  
distributors for the  
best selling micro, the

### APPLE II

Full range of accessories  
and software can be  
supplied.

Telephone John or Jane Page  
on (0632) 482359 to  
discuss your requirements.

## NEWCASTLE UPON TYNE

● Circle No. 206

### MAILING SERVICES

Computer held files, Selected  
outputs on labels, letters, enve-  
lopes, Sorted for Mailing  
Rebate, Complete Mailing  
Shots Assembled & Posted,  
Coupon Responses, Order  
Files, Media Analyses etc.  
NLDS, ROTHWELL, LINCOLN  
0472-89346/7

● Circle No. 207

### OHIO SUPERBOARD

Computer on a board. 8K basic  
in ROM keyboard, graphics,  
cassettes interface, 2K monitor,  
British TV interface, expand-  
able.

**4K RAM £275 8K RAM £315**

Please send SAE for details  
**C.T.S., 1 Higher Calderbrook  
Littleborough  
Lancs OL15 9NL  
Tel. Littleborough  
(0706) 79332 anytime**

● Circle No. 208

## GRAFFCOM PROFESSIONAL BUSINESS SYSTEM

We can offer a complete Turnkey installation with everything including evaluation, system design, installation and training.

Our range of systems handles payroll, accounts, inventory, invoicing, financial planning, plus any specialised applications you require.

Why not contact us Today?

**GRAFFCOM**

52 Shaftesbury Av., London W1  
01-734 8862

**GRAFFCOM**

● Circle No. 209

## COMPUSTAT

### Continuous Stationery for the Micro Computer

All sizes of listing paper stocked. Specialists in the preparation of Printed continuous stationery



Design Service available  
Spacing Charts £1.00 C.W.O.

Commercial prices to all.

Phone or write for a  
quotation to Miss Berry.

01-520 6038

63 ORFORD ROAD,  
LONDON, E.17.

● Circle No. 210

## NICOMTECH

Cornish and West Devon distributor for the ITT 2020 and range of accessories.

Amateur radio software available for PET, APPLE, 2020 and TRS-80.

European Distributor for MICROTRONICS MORSE and RTTY software for PET and TRS80.

Blank C10'2 etc. on sale.

Mailing services available.  
Phone Nigel Huntley on (075-55) 2066.  
Address: 212, St. Stephens Road,  
Saltash, Cornwall.

● Circle No. 211

(continued from previous page)

At this stage you can run a quick test by outputting data on your terminal. You will probably notice an immediate increase in speed—particularly on Line 1 of the display.

You can now also run the CT64 at any baud rate you like—up to 1,200 baud from the internal clocks in the CT64, or from external clocks up to 500 KHz, the upper limit of common UARTs. This is possible because of the handshaking you have just added, but though you are now using a higher baud rate, data will still be taken only as and when the CT64 can accept it.

- Cut track from J3 pin 13 to IC31 pin 4; cut this underneath the PCB near J3.
- Cut track between IC17 pins 13 and 12 on PCB upper side.
- Cut track between IC3 pins 14 and 13 on PCB upper side.

Now add the circuitry in Figure 1. Diode 1 should preferably be a germanium type. This wiring can all be executed on the upper side of the PCB.

If you have not socketed your ICs, now is the time to remove ICs 40, 41 and 42 on the main PCB. Do this carefully; you will need them in a later step. Install IC sockets in these positions.

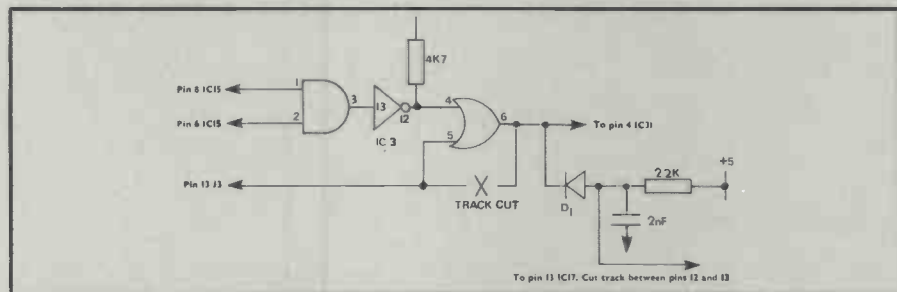

Figure 1

Note also that you will run into trouble when the CT64 has to perform an erase to end of line, or end of frame.

### Step 2

Remove the main PCB from the CT64. You will now have to make three track cuts on the top and bottom of this PCB.

- Cut tracks to IC29 pins 1 and 2, so as to isolate each one—they are on top of the PCB adjacent to the IC and serve only to short these pins to ground. The output pin (3) is not connected.

### Step 3

This is where the hard work begins. You will require some Veroboard. The best mounting position is where the 'screen read' PCB normally resides. If you decide to do this, isolate some of the screen read board pins on the main PCB and connect them to IC45 pin 6 and IC26 pin 3, and make a note of them.

You will then need to make up four cables, preferably with 3M flat cable and DIP header plugs. Three of them will have 16-pin DIP plugs on either end, one with 14-pin plugs.

Figure 2

(continued on next page)

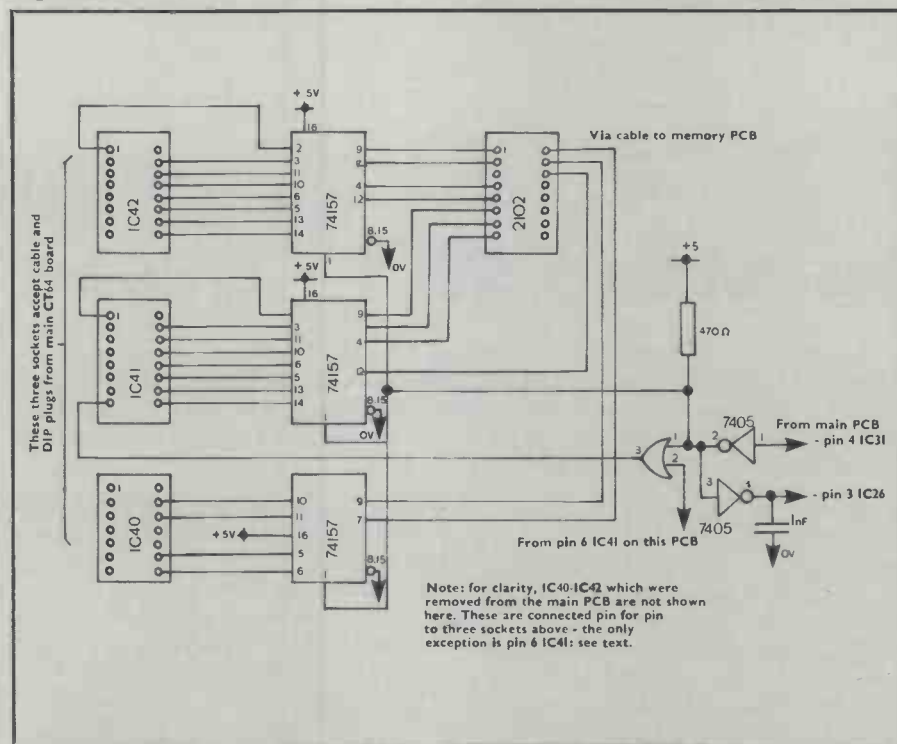



(continued from previous page)

One end of each of these cables will plug into the sockets vacated by ICs 40-42; the fourth goes into one of the sockets on the CT64 memory PCB occupied normally by the second page of memory.

Then take the ICs you removed and mount them on your piece of Veroboard. Wire the pin-for-pin to the 16-pin sockets intended to accept the spare ends of DIP cables and plugs from the main PCB.

In effect, all you have done is to remove

will be possible to enter data at speeds up to the limits of your ACIAs and UARTs. If required, you can upgrade your CT64 UART to an Intersil IM6102 which can accept clock rates up to 4MHz.

The prototype of this modification was run at a clock rate of 450KHz, giving a baud rate of about 2,800. It was possible to load 2,500 characters per second both in page and scrolling mode. This was almost the upper limit of the UART on the CTS board so a higher clock rate was not tried.

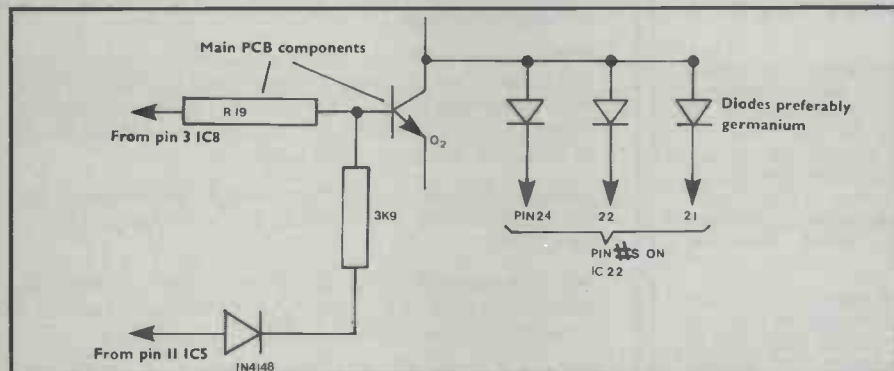

Figure 3

ICs 40-42 from the main PCB and put them on your new PCB. At this stage all functions are unaltered, so then is a good time to plug everything together and test that all is still working correctly.

### Step 4

Isolate all 10 memory address lines to the memory PCB. It can be done by

Note that capacitors C1 and C2 should be disc ceramic types. Although it is bad practice to use caps to slow up TTL, it was considered worthwhile as this reduces chip count and complexity.

Finally, an additional three modifications are included. They do not improve speed but they improve the aesthetic appearance and operation. Figure 3 shows the circuit for changing the cursor

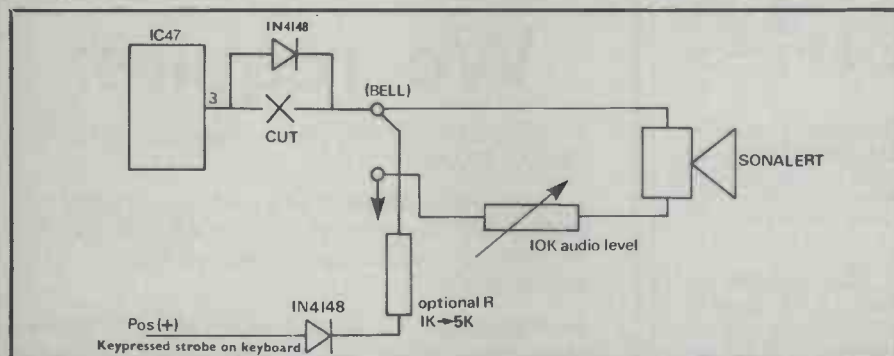

Figure 4

cutting the relevant tracks on the memory board, or preferably by placing heat-shrink tubing over pins 1 to 9 and 13 on J7. Before going further, check with an ohm meter that the lines really are isolated.

Then locate IC41 on your PCB and isolate pin 6. Build the circuit of figure 2 on your Veroboard, noting that pin 6 of IC41 goes to a 7432 IC of figure 2. Then wire the remaining ICs of figure 2. Note that the sockets labelled IC40-42 and 2102 are the ones intended to receive the free ends of the flat cable header plugs.

That completes the modification and all that remains is testing. On powering-up the cursor, erase to end of line/frame functions should all work correctly and it

from a reverse video box to an underscore; the modification requires only four diodes and one resistor.

Figure 4 adds a keypressed monitor. It makes keyboard entry that much easier, as there is no longer a need to look to check that a character has been entered. Only one track cut is required, on the output of the NE555 driving the Sonalert, plus the addition of one diode between pin 3 of the IC and the bell pad. A small pot has also been included to lower the Sonalert Audio Level.

The final modification involves stopping the the bell signal which appears after every 16 lines, since it becomes irritating when loading data at high speeds. For this it is necessary to isolate only pin 1 of IC39.

## INDEPENDENT PROGRAMMERS, DESIGNERS AND TRAINERS

Are you looking for projects on microcomputers?

Digitus MicroSkill is seeking people with experience of minis and micros, especially Z80/8080, 6502, 6800, LSI 11 and MicroNova.

Can you develop systems in Assembler, Fortran, Basic, Cobol, PL/M, PL/Z or teach micros to beginners and computer professionals?

Assignments include systems software, industrial, educational, business applications and running hands-on micro courses.

Establish your place on the MicroSkill Register by sending us a C.V. together with details of two referees who will attest to the quality of your work.

We can provide you with regular, interesting projects for development on your own machine, on our machines in London or on those of our customers in the U.K., U.S.A., Europe and Japan.

**Don't delay—write today to Alan C. Wood, Digitus Ltd., Dumbarton House, 68 Oxford Street, W.1.**

*PS: Four of our London customers are seeking permanent staff to work on advanced mini and micro projects.*

## May

●1

Introduction to computer systems is intended to fulfill the basic requirements of computer knowledge in technical and operational aspects. It is a five-day course and will be running almost constantly from May 1. The courses will be held in the Isle of Wight. The cost of each course is £100, exclusive of accommodation. Contact: ASMAP Environmental Products, Unit 1, Donor Industrial Estate, Newport, Isle of Wight. Tel: Newport (0983) 524393.

●1

The microprocessor industry—the past year and the year to come are two one-day seminars for the experienced microprocessor user and will discuss recent developments and probable trends. The cost is £75.60. Venue: London.

●4

A beginner's seminar on microprocessors is a one-day event designed to give delegates an understanding of what microprocessors are and a perspective of the industry. It will be conducted by Dr Adam Osborne and is sponsored by *Electronic Engineering*. It will cost £64.80, including lunch and refreshments, as well as documentation. The seminar at the Grand Hotel, Manchester. More information from Conference Communications, Monks Hill, Tilford, Farnham, Surrey. Tel: (025 18) 3111.

●4-6

Southern Microcomputer Industry Show. Venue: Expo Hall, Exposition Park, Orlando, Florida. If you have always fancied a trip to sunny Florida, this could be your ideal opportunity to mix business with pleasure. All the latest U.S. technology will be on display. Contact: Bud Felsburg, Felsburg Associates, Inc, PO Box 735, Bowie, MD 20715.

●8-10

Compec Europe Exhibition, Brussels. Similar type of exhibition to Compec but with a European flavour. Contact: Iliffe Promotions Ltd, Dorset House, Stamford Street, London SE1.

●12

Personal Computer World. Venue: West Centre Hotel, 47 Lillie Road, London SW6. Seminar/Mini Exhibition. More information from POW Exhibitions, 62A Westbourne Grove, London W1.

●15-17

Seminex '79. This popular seminar/exhibition is to be repeated for the first time in Scotland this year, at the George Hotel, Edinburgh. A selection of programmes first heard at a London seminar will be given. Seminex Ltd., 79 High Street, Tunbridge Wells, Kent. Tel: (0892) 39664.

●15-17

Micro/Expo 79. Venue: Paris. Promises to be one of the leading microcomputer and personal computing exhibitions in Europe. The themes will be personal computing, new products and industrial applications. Organiser: Sybex Europe, 313 Rue Lecourbe, 75015 Paris, France. Tel: (1) 828 2502.

●21-23

Microcomputers in management—their potential and challenge. Venue: Oxford. This seminar is directed at senior managers and will look at the threats and opportunities presented to companies by the rapid development of microcomputers. Fee for the three days is £250, including residence. Further details from Mrs S Beaven, seminar administrator, Oxford Centre for Management Studies, Kennington Road, Kennington, Oxford. Tel: (0865) 735422.

## June

●4-8

Applications Software for Operational Research. Venue: National Liberal Club, Whitehall Place, London, SW1. Run by Oxford Systems Associates, this course is aimed at those involved in software development. The fee is £300, including course materials and lunches. More information from Judith Wagstrom, Oxford Systems Associates Ltd., BCM OSALTD, London, WC1V 6XX.

●11-15

Trouble-shooting microprocessor-based systems is a five-day course covering all you need to know about micros, from basic concepts and terminology to designing and testing. The cost is £540 plus VAT. Documentation relating to the course will be available at £115. More information from Integrated Computer Systems. Tel: (01) 283 3974.

● If you have an event you would like us to include in our diary columns, write to *Practical Computing*, 2 Duncan Terrace, London N.1.

## QUESTION?

1. Is your hobby home computing or electronics?
2. Do you understand the application of ICs, Transistors, Diodes etc?
3. Have you used or applied analogue or digital techniques?
4. Are you applying TTL Logic to your home computer?
5. Are you programming your home computer using simple software techniques?

If the answer is YES to any of these questions, then why not consider turning your hobby into a career—applying your knowledge to servicing electronic equipment ranging from basic terminals and data processing machines through to advanced micro-processor systems?

We will train you through to advanced technology at the Company training school, fitting the individual in at their own level.

We have vacancies over the whole of the U.K. with the successful applicants working from home, usually in a radius of no more than 60-70 miles.

We supply all tools and test equipment, plus a Company car which is available for private use.

If you are interested, then why not contact Mr. C. Marklew or Mr. D. Simmonds on 0249 813771 to discuss your own career opportunities in confidence, or write to:-

**KODE SERVICES LIMITED**  
Station Road,  
Calne,  
Wiltshire

## We require:

2—PROGRAMMERS with experience in BASIC £3,500—£4,000

1—SYSTEMS ANALYST with experience in BASIC and Commercial Systems £5,500—£6,000. To work on Micro-computers in friendly environment.

1—ENGINEER to service and maintain: Micro-computers, printers and general. £3,500—£4,000

ARE THESE THE  
JOBS FOR YOU?

If so contact:

**Keen Computers Ltd,**

**LIMITED**

**5 THE POULTRY  
NOTTINGHAM NG1 2HW**

**Tel: 0602 583254**



# PROJECT LEADERSHIP PROGRAMMING/ANALYSIS

**London EC4**

**Up to £8,000**

Our client is a well-known international export finance and marketing organisation, part of a major banking group, whose recent growth and diversification have led to the installation of new and more sophisticated hardware, with correspondingly increased demands on the Data Processing team.

If you are an able programmer/analyst who can contribute at project leader level, rather than simply at that of an analyst, you will gain first-class experience which will notably accelerate your personal development. You will be responsible for projects from inception/design through to implementation and will work closely with line management. Training of users in these new on-line systems is an important part of the job.

You should have three to five years' commercial programming experience in more than one language, good analytical skills and must be able to work independently whilst integrating as a member of the total management team.

The Company is located conveniently near Mansion House tube station. A competitive salary will be negotiated and benefits include paid overtime, pension, LVs and other items.

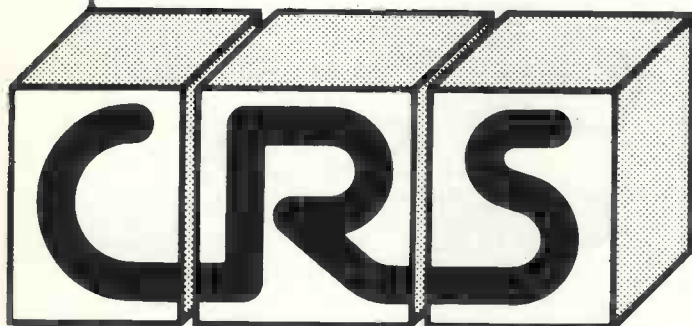

**COMPUTER RECRUITMENT SPECIALISTS**

18 BUCKINGHAM PALACE ROAD, LONDON SW1W 0QP TELEPHONE: 01.828 1384 TELEX: 24891

**For further details and  
confidential discussion  
regarding these opportunities  
please telephone or write  
quoting reference 11/1PC.**

## INTRODUCING THE HAZELTINE 1400 SERIES OF ECONOMY VIDEO TERMINALS TO MICROCOMPUTER USERS

Hazeltine Ltd., the U.K. subsidiary of Hazeltine Corporation, a world leader in Information Electronics for more than half a century, announces the introduction of a low-cost series of interactive video terminals, the 1400 series, aimed specifically at the practical microcomputer market.

The Hazeltine 1400 Terminal, priced at £550 one-off to end-users, contains all the major features required of an interactive video terminal, including all 128 ASCII codes, 64 displayable characters, cursor addressing and sensing, variable transmission rates up to 9,600 baud, EIA standard RS232C interface and remote command facility.

The Hazeltine 1410 Terminal has all the features of the 1400, and in addition has a separate integral numeric pad provided to facilitate efficient numeric data entry. This terminal is believed to offer more of what users want than any other TTY-compatible terminal currently on the market. It is available for around £600 one-off to end-users in the U.K. Hazeltine, has achieved this price/performance by utilising advanced microprocessor design, and produced terminals with an ultra-low component count. The company manufactures all the sub-assemblies including monitor, power supply and controller. Reliability and quality are significantly enhanced since all the electronics are contained on one pcb, eliminating all inter-connections other than input power and monitor connections.

Both terminals are normally available ex-stock from Hazeltine or its distributors throughout the United Kingdom and are supported under one of Hazeltine's Comprehensive Maintenance policies.

**Hazeltine Ltd, Terminal House,  
14 Petersham Rd, Richmond, Surrey TW2 5BR  
Tel: 01-948-3111 Telex: 928572**

### DISTRIBUTORS

Billing Machines Ltd., Unit 22, Galowhill Road, Brackmills Estate, Northampton Tel: Northampton 66416 Telex: 31504  
Fortronic (Fife) Ltd., Donibristle Industrial Estate, Dumfermline, Fife KY11 5JW Tel: Dalgety Bay 823121 Telex 727438  
Rair Terminals, 32 Neal Street, London WC2H 9PS Tel: 01-836 4663 Telex: 298452  
Specialist Office Supplies, 269/271 Barlow Moor Rd., Chorlton-cum-Hardy, Manchester Tel 061-8610757 Telex: 667151  
Technico (Communications) Ltd., Astral House, Adelaide Rd., Dublin 2, Ireland Tel: Dublin 688222 Telex 5129  
Gamma Computer Products Ltd., Gable House, Turnham Green, London W4 Tel: 01-995-3721  
Hamilton Rentals, (centralised enquiries through) 53 Curtain Rd., London EC2 Tel: 01-739-3444 Telex: 263121



● Circle No. 212

## LOOK! New 12" Monitor for your Micro



or CCTV application

**Uncased £60**

**Cased £85**

*The above prices are for 1 off orders (plus VAT)*

Available  
cased or  
uncased  
for OEM's

**6800 Based**  
**Micro Computer**  
**now available – KIT £220**

Power Supply £20 extra (+VAT)

*INCLUDING*  
Tiny Basic and  
on board Prom  
Programmer

(plus VAT)

**CROFTON  
ELECTRONICS LIMITED**

35 GROSVENOR ROAD, TWICKENHAM  
MIDDLESEX - Telephone: 01-891 1923

● Circle No. 213

## THE BEST OF BRITISH...

**Acoustic Coupler  
Compact 1**  
Works either end  
of data link  
- truly reliable  
from £185.00

**Portable  
Terminal  
Compact 2**

The portable hardcopy  
terminal that's built to  
last - thousands of  
satisfied users £1360.00



**Compact 3**  
The VDU that fits most  
micro, mini and mainframe  
systems - lots of built  
in features from £680.00



**The CUB**

An economic answer  
to simple VDU needs,  
64 x 16ch, cursor control  
from £380.00



**The Slave**

Non British but still probably  
the best value 80 col,  
112 cps printer on the  
market from £575.00

## ...FROM COMPUTRADE

OEM discounts available on all of the above products.

Write or call for details:

Computrade Ltd  
Silverwood House, Oxshott Rd  
Leatherhead, Surrey  
Tel: (03723) 79143

or contact your nearest  
distributor:

North 061-477 4960  
Midlands 0533-536077  
South East 01-658 5906



● Circle No. 214

PRACTICAL COMPUTING May 1979



THE BUYERS' GUIDE is a summary of low-cost computers available in this country. It appears each month; we add new computers and amend existing information as required to keep up-to-date. The cut-off point is taken as £5,000. Computer systems costing more than that for a minimum configuration cannot be summarised adequately in a brief table, while probably they fall outside the scope of the magazine.

Systems are listed by manufacturer. We believe this is probably the easiest way to identify particular microcomputers, because the manufacturer's name is likely to be better-known than even that of

a sole U.K. distributor. Some entries, of course, relate to British-made micros available only from the manufacturer, so there will be no difficulty there.

Most of the small computers

available here are from the States, though, and are listed under the States-side name.

Note, however, that for many of them the U.K. distributors provide their own software packages, and in some

cases they also offer their own hardware add-ons.

If you have a small computer which could be included in the Guide, please let us have details.

SUPPLIER	HARDWARE/SOFTWARE & APPLICATIONS/AVAILABILITY	PRICE
<b>ACORN COMPUTERS</b>	<b>Acorn.</b> Single Eurocard-sized microcomputer with 6502 processor, 1KB RAM, 16-way I/O. Max size: a second Eurocard adds hex keypad and CUTS cassette interface. Monitor and machine-code programming now, Basic and disc operating system in the future. "Highly cost-effective basis for a computer or an industrial development system". Sold by post or from Microdigital (051-236 0707).	£70-20 inc VAT and postage for kit. £81 complete for assembled Acorn.
<b>APPLE COMPUTERS</b>	<b>Apple II.</b> Min size: 16K memory; 8K ROM; keyboard; monitors; mini assembler; colour graphics; Pal card; RF modulator; games; paddles and speakers; 4 demo cassettes. Max size: Expandable to 48K memory; floppy discs and printers are now available. Two versions of Basic, PASCAL; Assembler; games; business packages. An American system regarded as suitable for any kind of applications. Maintenance contracts offered. Personal Computers Ltd (01-283 3391) is the sole U.K. agent but has a distributor network of 20 dealers.	Around £1,000
<b>ATTACHE</b>	<b>Attache.</b> Min size: system with 10 slots, S100 bus, 8080 processor and 16KB housed in desk-top case with built-in keyboard. Max size: 64KB, parallel printer interface, two single- or double-density 8in. floppies, video screen. Disc Basic; business applications produced by Moncoland, the sole U.K. agent. Distributors include Keen, GBH, Alba, and Lion.	From £1,737 without video or external storage. Full business system with screen, discs and printer about £5,000
<b>BRUTECH ELECTRONICS</b>	<b>BEM-CPU1:</b> single-board processor with 6502 and no RAM. No applications software. Available from Data Precision Equipment (04862 67420)	From £116
<b>COMART</b>	<b>Microbox.</b> Chassis with three to six PCB sockets for S100 boards, plus fan. Several S100 boards available. Aimed mainly at OEM industrial users and perhaps the serious hobbyist. It will take Cromemco, North Star and other processors. Available from Comart (0480 215005).	£255 for full package plus case.
<b>COMMODORE SYSTEMS DIVISION</b>	<b>Pet.</b> Single unit containing screen, tape cassette and keyboard. Floppy disc, printer and full-size keyboard are options, as are external cassettes. Basic; games; business packages. The British subsidiary of Commodore Systems of the U.S. sells Pet for home, educational and small business applications. About 80 distributors. <b>Kim I,</b> processor (6502 chip); small calculator-type keyboard; LED six-digit display; built-in interfaces for audio-cassette and Teletype; 1K RAM; 2K ROM (can add up to 64K). No software available, but it has three good manuals. An American import which gives Pet-type capabilities with a maximum configuration. For the hobbyist but used mainly as an evaluation board for the 6502 chip. Twelve to 15 dealers.	£460-£795 exc VAT  £99-95
<b>COMPELEC ELECTRONICS</b>	<b>Series I.</b> Z-80 processor 512MB floppy, 32KB, Centronics printer, VDU. Up to 4MB disc and 64KB. CP/M, Basic, Cobol, PASCAL, Fortran IV, Assembler. Business and word processing packages available. From Compelec (01-580 6296), which is also sole supplier of Altair systems.	Less than £5,000 for basic system.
<b>COMPUCOLOR</b>	<b>Compucolor II.</b> Packaged system including 13in. eight-colour display with alphanumeric and graphics, 72-key detachable keyboard, 8KB, and built-in mini-floppy. Max size: 32KB. Extended disc Basic in ROM, graphics programs and games. The system now ranks fourth behind Pet, TRS-80 and Apple in personal computer sales. Abacus (01-580 8841) is sole U.K. agent and is arranging distributors, including the Byte Shop and Transam.	From £1,390
<b>COMPUCORP</b>	<b>610:</b> desk-top unit using Z-80 and incorporating screen, 150KB floppy, 48KB. Up to 60KB memory, four floppies, printers. Basic, Assembler, DOS, text editor, file manager; business packages. Nine dealers.	From £3,890
<b>COMPUTER CENTRE</b>	<b>Mini kit:</b> Z-80 CPU, CTC, USART, serial and parallel I/O. 16 bytes memory, Western Digital disc controller, SA400 5in. drive plus CP/M, cables and connectors. <b>Maxi kit:</b> As above but with DRI 7100 8in. drive instead of 5in. drive. All (33) volumes of CP/M user group library available for cost of media. Library includes utilities, games, Basic compilers/interpreters and Algol compiler. Microsoft Basic, Cobol, Fortran also available. Computer Centre (02514 29607).	Mini kit: £786. Maxi kit: £886.
<b>COMPUTER WORKSHOP</b>	<b>System 1.</b> Typical size: 40K memory; dual 8in. floppy discs, total storage capacity 1.2MB; Ricoh daisywheel printer. <b>System 2.</b> Typical size: 24K memory; dual minifloppy discs of 80K bytes each; Centronics 779 dot matrix printer; VDU. <b>System 3.</b> 12K memory, cassette interface; 40-column dot matrix printer. Editors, Assemblers, Basic, games, information retrieval package. The systems were designed and built in Peterborough and are suitable for educational and small business users and perhaps the more serious hobbyist. Twenty-five dealers.	System 1, £5,000 plus. System 2, around £3,000. System 3, from £1,350.

(continued on page 107)

# DE BOER

## MODULAR MICROCOMPUTER SYSTEM KITS

Our kits are based on the National Semiconductor SC/MP microprocessor. They offer a unique stage-by-stage building and learning system which develops from a simple digital display unit, through a HEX address and display stage, to a complete minicomputer with ASCII keyboard and video display output. Additional facilities are in preparation, including Software. Many of the kits can be used to supplement other systems.

RAM I/O board	£26.75	Basic SC/MP board	£23.25
CPU board	£42.90	Bus board	£3.00
Memory Extension	£38.50	HEX I/O	£62.55
4K RAM	£92.95	Power Supply unit	£19.50
Cassette interface	£16.50	Control EPROMS	£37.00
ASCII Keyboard	£46.50	Video Display Terminal	£69.00

For further information please send SAE  
Please make cheques payable to de Boer Elektronika.  
All prices include VAT; please add 50p for P & P.

ORDER FROM: de Boer Elektronika, 2 Lynn Road  
Grimston, Kings Lynn, Norfolk, PE32 1AD.  
Telephone: 04856-553



● Circle No. 215

## Micro Software Systems

### DESK TOP COMPUTERS

Find it difficult to make a choice?  
Utilise our experience to make the right decision.  
Micro Software Systems Supply:

HORIZON  
RAIR BLACK BOX  
EQUINOX 300  
COMPU CORP 600 SERIES  
COMPACT 400  
MODATA  
COMMA V.03 and other LSI BASED SYSTEMS

A complete range of peripherals complements this selection.

Application Software available: Packaged or Bespoke.

Prices from £350  
Quantity Discounts can be arranged.

Call or write and we will be happy to discuss your problems.

**Micro Software Systems,**  
Stanhope House,  
Stanford-le-Hope,  
Essex  
Tel: Stanford-le-Hope (03756) 41991/2

● Circle No. 217

## The great RAM sale

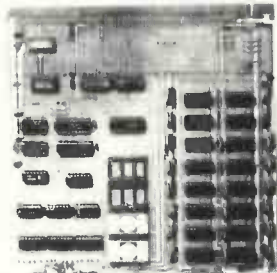

The Nascom system offers major expansion at sale prices. To give you as much choice as possible we offer RAM boards in three configurations to accommodate up to 16 memory ICs of either MK4027 or MK4116, all socketed.

The memory board kit options are:

8K	£85.00
16K	£140.00
32K	£200.00

Boards will also accommodate up to four EPROMS of type 2708 at £10.50 plus VAT each. And if you wish to upgrade 16K to 32K it will only cost you an additional £70.

Memory boards plug straight into a NASBUS and an edge connector is included for this. All boards must be used in conjunction with the buffer board which, like the memory boards, is available in kit form ex-stock from approved Nascom distributors.



Nascom Microcomputers

21 High Street,  
Berkhamsted,  
Herts.  
Tel: (04427) 74343

● Circle No. 216

Which British system can offer the following:

- \* **COLOUR.** Aerial Input, Alphanumerics and Graphics
- \* **CEEFAX.** BBC Television Teletext service
- \* **ORACLE.** IBA Television Teletext service
- \* **BASIC.** ROM-Resident Interpreter
- \* **MONITOR.** Motorola 6800 Machine Code
- \* **VIEWDATA.** Instant Information service

### TECS :

TECHNALOGICS  
EXPANDABLE  
COMPUTER SYSTEM.

Prices start at around  
£360.



Rack-mounting and Tabletop versions (illustrated)—The Logical Development everyone has been waiting for.

Please send large S.A.E. for details to:

**TECHNALOGICS (DEPT. PC)**  
8 Egerton Street, Liverpool L8 7LY

● Circle No. 218



(continued from page 105)

SUPPLIER	HARDWARE/SOFTWARE & APPLICATIONS/AVAILABILITY	PRICE
<b>CROMEMCO</b>	<b>Single-card computer.</b> 4MHz Z-80 CPU, S100 bus, 1KB RAM, sockets for 8K ROM. 20mA/RS232 serial interface and parallel bi-directional interface. Basic in ROM and Z-80 monitor. For OEM and industrial users; used with backplane for "full computer capability". Comart is the sole agent and has 12 distributors.	£247-£281.
	<b>Z-2.</b> Min size: chassis, 30A power supply, motherboard, Z-80 processor, 16KB memory. Max size: 512KB, 21 sockets, three minifloppies or four 8in. floppies. Basic, Fortran, Cobol, assemblers. For serious hobbyists, OEMs, educational applications, and industrial/scientific users.	£372 (in kit form) to more than £4,000.
	<b>System Two.</b> Min size: factory-assembled system with 32KB, dual 90K minifloppies, dual printer interface, serial interface. Max size: two additional floppies, 512KB, up to seven terminals: CP/M-compatible operating system (CDOS), Fortran, Cobol, Basic, assemblers, word processing, database manager. Multi-user system for software development, or scientific/industrial/business users.	£2,294 upwards.
	<b>System Three.</b> Min size: 32KB, dual 256KB floppies, dual printer interface, 20mA/RS232 serial interface, Z-80 processor. Max size: two additional discs, 12KB, seven terminals, multi-channel A/D and D/A interface, PROM programmer. Software as for System Two. Described as appropriate for small to medium business, scientific and industrial users—"rivals minicomputers at more than twice the price".	£3,444 to more than £10,000.
<b>EQUINOX</b>	<b>Equinox 300.</b> Min size: 48K memory; dual floppy discs giving 600K bytes of storage; 16-bit Western Digital m.p.u. Max size: up to 256K memory; up to four 10MB hard discs. Basic, Lisp, PASCAL, Macro Assembler, Text Processor. All software bundled. The system is a multi-user, multi-tasking, time-sharing system for two to 12 users. Application software available for general commercial users. Sole distributor Equinox Computers Ltd (01-253 5181).	£5,000-£40,000 plus.
<b>EXIDY</b>	<b>Sorcerer:</b> based on Z-80. 16K and 32K; cartridge and cassette interfaces; 79-key keyboard; 256-character set (128 graphics symbols); 12 in video monitor; expandable with Micropolis floppy discs. Basic, Assembler and Editor; games, word processor. Other pre-packaged programs plus EPROM pack for your own programs on cartridges. There is no sole importer for U.K.; sold through various importers and dealers.	£760 for 16K, £859 for 32K (excludes video monitor); £1,200 with floppy discs.
<b>IMSAI</b>	<b>VDP 40:</b> 32K or 64K RAM memory 9in. display screen, standard keyboard. Two 5½in. floppy disc drives; serial I/O. No software support, but packages for the larger VDP-80 could be converted for smaller system. This would be from about £700 per package. Computer Mart, Norwich (0603 615089), is the main U.K. supplier but there are other distributors.	£4,507 for 32K model.
<b>ITT</b>	<b>2020.</b> Identical to Apple II. Min size: 4K memory; 8K ROM; keyboard, monitor, colour graphics, mini assembler; Powell card; RF modulator, games, paddles and speaker; Max size: 48K with floppy discs and printers. Basic, Assembler, games, business packages. Generally suited to any type of application. Fifteen wholesalers, including Fairhurst Instruments.	From £965 for 4K and cassette, to £2,014 for 32K plus floppy and printer. £3,003 for 48K version, two floppies and serial printer.
<b>MICRONICS</b>	<b>Micros.</b> Typical size: 1K monitor; 47-key solid state keyboard; interfaces for video, cassette, printer and UHF TV; serial I/O, dual parallel I/O ports; 2K RAM; power supply. 2K Basic; British-designed and manufactured system. Claimed to be the cheapest data terminal—a system with an acoustic coupler and VDU for £1,020. Prospective applications for small businesses, process controllers and hobbyists. Manufacturer is sole distributor (01-892 7044).	From £400, assembled.
<b>MICRO V</b>	<b>Microstar.</b> Single box with twin 8in. floppy discs, 64K RAM, three RS232 serial inputs, STARDOS operating system enables system to have three VDUs, plus a fourth job running simultaneously. Word processing software available. Packages being developed include invoicing system, payroll, accountancy type system. Price includes a reporter generator language. Imported by a Data Efficiency subsidiary, Microsense Computers. Microsolve is London agent; other distributors being arranged.	£4,950 or machine and software.
<b>MIDWEST SCIENTIFIC INSTRUMENTS</b>	<b>MSI 6800.</b> Min size: 16K memory, Act 1 terminal; cassette interface. Max size: three disc systems—minifloppy system with triple drives of 80 bytes each and 32K memory, large floppy system with up to four 312K-byte discs and 56K of memory mounted in a pedestal desk, or hard disc system with 10MB and 56K. Basic interpreter and compiler; editor; assembler; text processor on small disc system. American-designed system being manufactured increasingly in the U.K. Sole U.K. agent is Strumech (SEED) (05433 4321) but a distributor network is being established.	Basic system: £1,100 (£815 as kit); Minidisc: £2,500; Large floppy disc £3,200, plus £1,400 for quad system; hard disc, £8,000-£12,000.
<b>NASCOM MICROCOMPUTERS</b>	<b>Nascom I.</b> Min size: CPU; 2K memory; parallel I/O; serial data interface; 1K monitor in EPROM. Max size: CPU; 64K memory; up to 16 parallel I/O ports. Mostly games, but also a dedicated text editor system written by ICL Dataskil. Nascom is working on large versions of Basic, and 8K Microsoft Basic should be available soon. Eleven distributors in U.K. Nascom is negotiating to increase the number.	£165 exc. VAT.
<b>NEWBEAR</b>	<b>7768.</b> CPU board, 4K memory, cassette and VDU interfaces. Range of Basics and games, British-manufactured system for hobbyists. Expandable to 64K memory, available only in kit form. From Newbear; also from Bearbag dealers, Microdigital, Microbits.	From £45
<b>NORTH STAR</b>	<b>Horizon.</b> Min size: 16K memory; Z-80A processor, single minifloppy disc drive (180KB). Max size: 56K memory, four minifloppy disc drives (180KB), any acceptable S100 peripheral boards. Basic (includes random and sequential access), disc operating system and monitor. Options: Basic Compiler, Fortran, Cobol, Pilot, PASCAL and ISAM. The system is suitable for commercial, education and scientific applications. Application software for general commercial users. Twenty distributors.	£995 to £2,500.

(continued on page 109)

## SDS-100



£3,700

### SDS-100 HIGHLIGHTS

- 32K Bytes of RAM (Expandable to 64K)
- 1 Megabyte Disk Storage On Line (IBM 3740 Compatible)
- Up to 8K PROM
- 12 in. Video Display (24 lines of 80 characters)
- Z80 Central Processing Unit
- Full Upper and Lower Case Keyboard
- Numeric Key Pad and Cursor Controls
- Parallel Input and Output Ports for parallel I/O requirements
- Key Lock On/Off Switch
- Video Display features Blinking, Reverse, Underline and combinations
- RS-232 Serial Interface for on-line applications and serial printers
- Compatible with C-Basic, Disk Fortran, Cobol and CP/M DOS compatible software. (CP/M is a registered trademark of Digital Research of Pacific Grove, California)

### STANDARD FEATURES

- Microprocessor controller
- Serial RS-232C interface
- Parallel TTL level interface
- Full upper and lower case ASCII character set (96 characters)
- Full 8½ in. wide paper
- Line length of 80 columns at 10 characters per inch
- Impact printing
- 7 x 7 dot matrix
- Ordinary paper—roll, fanfold, or sheet
- Serial baud rate to 1,200 bits per second
- Multiple line buffer of 256 characters
- Built-in self test mode
- Instantaneous print rate to 100 characters per second
- Sustained throughput to 50 characters per second
- Multiple copies without adjustment
- Re-inking ribbon mechanism
- Expected ribbon life of 10 million characters
- Front panel operator controls
- Attractive table top console

### OPTIONAL FEATURES

- Line lengths to 132 columns
- Instantaneous print rate to 165 characters per second
- Sustained throughput to 80 characters per second
- Print densities of 8-3, 10, 12 and 16-5 characters per inch
- Options program selectable by control codes
- Full CRT screen size multiline buffer (2,048 characters)
- Special set of graphic symbols
- Graphics dot plotting mode
- Form feed control
- Eight switch selectable form sizes
- Automatic page boundary skip
- Remote printer selection/deselection
- Automatic line feed on carriage return

**IF BOTH UNITS PURCHASED TOGETHER**

£4,149 (125)  
£4,350 (225)

**AIRAMCO LTD**  
30 WITCHES LINN  
ARDROSSAN AYRSHIRE  
TEL: 0294 65530  
TELEX 779808

IP-125/225



£499 (125)  
£695 (225)

● Circle No. 219

## Computer standard

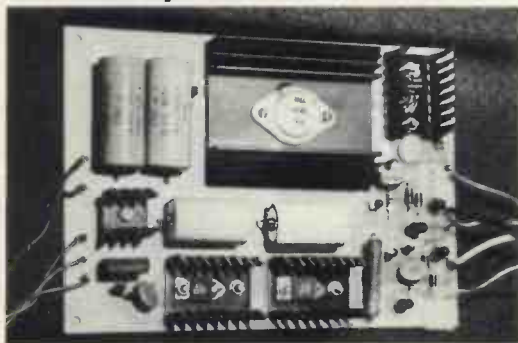

3A PSU

Computers require a reliable and even power supply. The redesigned and uprated Nascom 3A PSU meets these requirements. Its output voltages are +5V 3A; +12V 1A; -12V 1A; -5V 1A. And are sufficient to drive the Nascom-1, buffer board and up to 32K of RAM. It has LED displays on all the outputs and will fit into the Nascom frame to be announced soon. Price of PSU kit—£24.50 plus VAT.

A buffer board kit with edge connectors suitable for the NASBUS and with edge connectors and inter-connectors to attach directly to the Nascom-1 is available at £25.00 plus VAT.

**nm**

Nascom Microcomputers

121 High Street,  
Berkhamsted,  
Herts.  
Tel: (04427) 74343

● Circle No. 220

# EQUINOX 300

A powerful multi-user  
multi-tasking  
multi-language

16-bit microcomputer time-sharing system

supporting

- BASIC
- LISP
- PASCAL
- Floppy discs
- Hard discs

including a powerful Text Formatter,  
Assembly Language Development System  
and disc-based Sort utilities.

Priced from **under £5,000**

Write or phone for further information.

**EQUINOX COMPUTER SYSTEMS LTD**

"Kleeman House" 16 Anning Street,  
New Inn Yard, London EC2A 3HB.  
Tel: 01-739 2387/9 01-729 4460.

● Circle No. 221



(continued from page 107)

SUPPLIER	HARDWARE/SOFTWARE & APPLICATIONS/AVAILABILITY	PRICE
<b>OHIO SCIENTIFIC</b>	<b>Ohio Superboard II:</b> Min size: 6502 processor. 8K Basic in ROM; 2K monitor in ROM; 4K RAM; Cassette I/F; full keyboard; 32 x 32 video I/F. 8K Basic in ROM; Assembler/Editor; American single-board system with in-board keyboard. Aimed at hobbyist/small business. Ohio makes games, personal maths tutors, and business programs. This and other Ohio products have six U.K. distributors.	From £298.
	<b>Challenger C24P:</b> similar to Superboard but with a 32 x 64 character set. Supplied as two separate boards with open slots for expansion. The 'professional portable'; similar to Superboard but packaged and ready to use. Aimed at small business, education, research.	£620 to £1,595.
	<b>Challenger C28P:</b> similar to 4P but expandable to include two 8in. floppies, allowing use of Ohio software. Personal computer for larger business/commercial programs. Aimed at small business, education and research.	£825-£2,670.
	<b>Challenger C3.</b> Min size: 32K RAM, dual 8in. floppies, triple processor architecture (6502A, Z-80, 6800). Max size: 768K RAM, 74MB hard disc, multiple terminals, printers. Can run virtually all 6502, 6800, 8080 and Z-80 code. Runs Basic, Cobol and Fortran under OS CP/M. Full business software packages available, including word processing and database management. Multi-programming available.	£3,425-£13,000.
<b>PERTEC</b>	<b>System 1300.</b> Min size: 32K memory; dual minifloppy discs 71 bytes each, formatted; serial interfaces. Max size: 64K memory; four serial ports. Basic (single and multi-user), Fortran, Cobol. The hardware for Compelec Altair systems is from Pertec but the software is Anglo-Dutch. Sole distributor Compelec (01-580 6296).	£3,000-£5,500.
<b>PROCESSOR TECHNOLOGY</b>	<b>Sol.</b> 808-based S100 microcomputer packaged with cassette and video interfaces (including graphics), keyboard with numeric pad, and 16KB RAM. Basics, assembler, word processors. Floppy disc systems available. Several distributors including Comart (0480 215005), which can offer nationwide maintenance contracts.	From £1,750 (excluding monitor and cassette). Complete floppy disc systems with word processing about £5,000.
<b>RAIR</b>	<b>Black Box.</b> Min size: 32K memory dual minifloppy discs, 80K bytes each; two programmable serial I/O interfaces. Max size: 64K memory; eight serial interfaces; 1MB disc storage (or 10MB hard disc); range of peripherals. Basic, Fortran IV; Cobol. Hardware distributors are being signed and agreements made with software houses to add software. A warranty and U.K.-wide on-site maintenance is given. From manufacturer (01-836 4663) and systems houses.	From £2,300.
<b>RESEARCH MACHINES LTD</b>	<b>380-Z.</b> Min size: 4K memory; 380-Z processor, keyboard. Max size: 56K memory. Options: cassette, single or dual minifloppy discs, dual 8in. double-sided discs (1MB); serial interfaces; parallel interfaces; analogue interface; printer available. Basic Interpreter, Z-80 Assembler; interactive text editor; terminal mode software; data logging routines; CP/M, DOS, text processor, C Basic, Fortran, Algol, Pilot, Cobol, CP/M users' club library. Sold principally to higher and secondary education, and for scientific research, data processing and data logging. Available from Sintel and the manufacturer.	From £830-£3,500.
	<b>280-Z.</b> Board version of 380-Z system. 4K or 32K (identical in performance to the 380-Z). Interfaces, software as for 380-Z.	4KB version at £398; 32KB for £722.
<b>RCA</b>	<b>Elf II:</b> RCA 1802 micro with hex keypad and output to TV screen. Assembler and machine code programming; options include Tiny Basic. Available by mail order from HL Audio (01-739 1582).	From £99-85 in kit form; £164-10 including postage and VAT.
<b>ROCKWELL</b>	<b>Aim-65:</b> Kim-compatible with full keyboard and on-board printer. 1K or 4K RAM. The 4K version is described as a development system rather than a personal computer. Assembler, editor, Basic. Available from Pelco and Microdigital.	1K-£249.50. 4K-£315.
<b>SCIENCE OF CAMBRIDGE</b>	<b>MK14:</b> SC/MP processor, 256 bytes user memory; 512-byte PROM with monitor program; hex keyboard and eight-digit, seven-segment display; interface circuitry; 5V regulator on board. To this can be added: 1/2K RAM (£3-60); 16 I/O chip (£7-80); cassette interface kit (£5-95); cassette interface and replacement monitor (£7-95); PROM programmer (£9-95). No software provided but a 100-page manual includes a number which will fit into 256 bytes covering monitors, maths, electronics systems, music and miscellaneous. Based on American National Semiconductor chips. Science will soon have a VDU interface and large manual on user programming. Mail order from manufacturer (0223 312919) and by selected dealers.	£39-95 basic.
<b>SDS</b>	<b>SDS 100.</b> Single unit containing 32K memory (expandable to 64K); up to 8K PROM; twin double-sided floppy disc drives of 500 bytes each, serial and parallel RS232 interfacing; keyboard; 12in. video display; power supplies; SD monitor program; line printer available. CP/M, 8080 assembler, E Basic, Editor supplied with system; M Basic, Fortran, Cobol available for business use, industrial process monitoring and control (with additional hardware). All CP/M games and business packages. Sole supplier Airamco (0294 65530).	From £3,750 (basic machine) plus £890 (printer); £4,500 combined.
<b>SYNERTEK</b>	<b>Sym 1:</b> 6502 chip and keypad with memory available in 4K blocks to 64K. Any Kim software. American, meant to be the foundation system for very small business and hobbyist users. Available from Newbear (0635 49223).	From £200.
<b>TANDY</b>	<b>TRS-80:</b> Min size: Level 1 4K memory; video monitor; cassette; power supply. Max size: Level 2 16K memory; line printer, floppy disc system. Basic; some business packages. American system from the Tandy consumer electronics chain—the Level 1 is aimed at the hobbyist and education market, Level 2 more at small business applications. Floppy disc and printer available. Tandy has 161 retail shops.	Level 1—£499 Level 2—£807 for basic CPU with no extras.
<b>TRANSAM COMPONENTS</b>	<b>Triton:</b> British-made kit computer. Up to 65KB. Full graphics capability, 64 characters. Power supply: cabinet. Communications interfaces. Tiny Basic or 2K Basic, 1KB monitor plus new option 4K firmware on board. Available from manufacturer. (01-402 8137.)	£286 kit with 5KB.
<b>VECTOR GRAPHIC</b>	<b>48KB RAM, Z-80 micro:</b> 63K bytes, mini-discs are standard, Options: graphics. Monitor, MDOS, Basic: business packages from dealers. Several distributors.	£2,300

# OHIO SCIENTIFIC

Microcomputers from the world's largest  
full-line manufacturer.

Now available from...

## 'Linn Products'

In addition to being Distri-  
butors for the full range of  
Ohio Scientific equipment  
we can offer technical and  
software support.

Why not find out more from Peter MacKinlay at  
LINN PRODUCTS, 235 DRAKEMIRE DRIVE,  
CASTLEMILK, GLASGOW. Tel: 041-634 3860.

● Circle No. 222

## RECREATIONAL COMPUTING

formerly 'Peoples Computers'

**A bi-monthly magazine  
for the micro enthusiast  
who is young or young  
at heart.**

Features: games, fantasy, graphics, music puzzles,  
problems, software, tutorials, interviews + regular  
PET-related articles.

£1.75 single issue  
£8.00 subscription, £8.50 overseas subscription

### HOW TO ORDER:

Payment in sterling drawn against a British bank or  
by credit card to: L.P. ENTERPRISES, Room PC  
313 Kingston Road  
Ilford, Essex IG1 1PJ  
U.K.  
Tel: 01-553 1001

● Circle No. 224

### Written for the Nascom

Among the programs written to run on the Nascom-1  
and available now are:

#### ICL Dataskil Letter Editor

This software provides a comprehensive set of data  
operations. Text can be input, displayed, edited,  
stored on tape, retrieved and further amended.  
Control functions include cursor, character, word, line,  
scrolling, tabbing, tape store and retrieve, text  
printing. All in less than 2K byte plus workspace  
for up to almost two full screens. Price on  
2 x 2708 EPROM £70 plus VAT.

#### TINY BASIC

A 2K BASIC Interpreter in 2x2708 EPROM. Normal  
commands: 1-32767 MSL/single array/arithmetic  
constant/ <>≡≠# /strings valid in PRINT/supplied  
with user manual/additional three level keyboard  
control/compatible with NASBUG and B.Bug Price  
£25 Plus VAT.

An extended version of the above is our SUPER TINY  
BASIC which has all the TINY BASIC functions plus  
full editing features and additional operator  
command. Price in 3x2708 EPROM £35 plus VAT.

#### ZEAP

An editor assembler which runs under NASBUG and  
provides the powerful advantages of writing programs  
in Z80 assembly language instead of directly in machine  
code. Uses less than 3K bytes of memory and is  
supplied on cassette priced £30 plus VAT.

Nascom Microcomputers

121 High Street,  
Berkhamsted,  
Herts.  
Tel: (04427) 74343

● Circle No. 223

### CAMBRIDGE COMPUTER STORE

We can help you select the right system for your applic-  
ation. Here in Cambridge your choice won't be limited —  
we'll demonstrate as comprehensive a range of microcom-  
puters as you'll find anywhere in the U.K.:

**TANDY TRS-80  
COMMODORE PET  
APPLE II  
N-S HORIZON  
CROMEMCO  
SORCERER  
SUPERBOARD II  
NASCOM-1**

Where possible we deliver off-the-shelf. Our stock also  
includes a vast range of **electronic components** as well  
as **computer books and magazines**.

Our store is open 6 days a week from 9-5.30 with demon-  
stration systems always in operation. We offer a professional  
standard of advice and after-sales support and we're ready  
to discuss your application any time.

**CAMBRIDGE COMPUTER STORE  
1 Emmanuel Street, Cambridge  
(0223) 68155**

● Circle No. 225



# A PRACTICAL GLOSSARY

Continuing the terminological gamut from H to I

## Hash

Pre-digested version of dead Argentine cows, much beloved by Boy Scouts. It's also a sign—# the hash mark—which Americans use a good deal as shorthand for 'number' (just as we use No.). That connection means that the hash mark appears frequently on U.S. derived keyboards and internal computer codes; the hash is printable, of course, and the code relating to the hash frequently has an inescapably important internal meaning.

## HDLC

High-Level Data Control. In sophisticated computer networks, many different computers talk to each other and use each other's facilities. A communications protocol is a format to which inter-system messages must conform if all participants in the network are to understand them. HDLC is an example of a protocol. It is utilised by several computer manufacturers as their standard protocol. Its principal competitors are SDLC (from IBM) and DDCMP (from Digital Equipment). This is all a little esoteric, but wait for an entry on PCNET.

## HDX

Abbreviation for *half-duplex*.

## Head crash

Bad news. It's what happens when the read/write head in a disc drive hits the surface of the disc. Disc drive technology is such that a minute particle of dust might cause the head to bump on to the disc; at the very least you are likely to get duff data from the event, and the impact might damage the surface permanently.

## Hertz

Hertz is a measure of frequency and means 'cycles per second'. Electricity supply has frequency. Things which run from the electricity supply have to reflect its frequency, its Hertz rate; and in Europe the supply is at 50 Hertz, while in the States it is 60.

This is important, because it means that something designed to run off a U.S. power supply won't work here. Converting from 60 to 50 Hertz isn't too tricky, but this is the reason why you can't run an unmodified U.S. microcomputer in Britain.

## Heuristic

Means that you rely on trial and error to get your result, learning by experience. It sounds trivial, but it isn't. There is a methodology called heuristic programming

and it is a trifle esoteric. The classic textbook on the subject is Slagle's 1974 opus *Artificial Intelligence—the heuristic programming approach*. Slagle describes "a heuristic" as "a rule of thumb, strategy method, or trick used to improve the efficiency of a system which tries to discover the solutions of complex problems".

## Hewlett-Packard

HP has a running battle with Data General for No. 2 spot in the minicomputer business—Digital Equipment is unassailably top dog, of course. DG ships more minis than HP, but HP minis are worth more, so HP makes more money. In fact, they are in different (albeit related) markets. The bulk of HP mini sales tend to be commercial systems accoutered with terminals, database managers, high-level languages and the like. DG does such systems, but most of its shipments are of cheaper and less fully-specified minis.

DG also sells a 16-bit micro, the microNOVA. HP makes its own micros, using SOS—silicon-on-sapphire—technology rather than the MOS—metal-oxide-silicon—which everyone else has. But HP micros are embedded in HP products, notably a line printer and the HP small business system. You can't buy HP micros like you can the LSI-11 or microNOVA.

There are other important strings to HP's bow, of course. It is one of the leading manufacturers of programmable calculators, and its product lines in this area extend up to the cost and complexity of its minis. HP is also big in instrumentation for hospitals and laboratories.

## Hex

Abbreviation of hexadecimal. Since we shall not repeat it, read on. Hex is a number system to the root 16, just as decimal is to the base 10, binary to the base 2, and octal to the base 8.

Hex uses number 0 to 9 and letters A (for 10) to F (for 15). In this way a byte can be represented as only two digits, one for the first four bits and one for the second four. Hex is thus a neat way of relating numbers to internal computer operations.

A practical example: the decimal number 183 can be represented in binary as 10110111 (which is a precise equivalent to what's going on inside, but it is a bit clumsy). In hex it is B7, B because the first four binary digits represent '13', if you like, and 7 because that's the hex notation for 0111 (which is also 7 in decimal).

## High-level language

Optimistic name for a group of

programming languages which try hard to be independent of any computer. A 'low-level language' is one specific to a particular computer. The lowness of the level refers to how closely the programming language matches the computer's internal machine code; a high-level language needs a good deal of translation and conversion before it can be expressed in machine code. A high-level language tends to use single powerful commands which initiate many machine code operations.

Machine-independence is something of a chimera, of course. Languages like Cobol, Fortran, APL and Basic are largely machine-independent, but the programmer who knows Basic on one computer will have to learn some new wrinkles before writing (or running) a program on another.

## Highway

Alternative name for *bus*.

## HLL

Abbreviation for high-level language.

## Hobby computer

A computer not used for profit, though many companies with conventional computers would be hard put to identify any profit from them. Computing as a hobby implies that you get your buzz from computing itself, rather than from applying the results of computing.

## Hobbyist

One who practices a hobby, of course. It's an ugly word, but try and produce a better alternative. Anyhow, it's one of those words which if you repeat for long enough takes on a life of its own.

## Hollerith

The man who effectively specified the punched *card* as we know and detest it; at the time (1889) it was a great idea, though. Herman H was involved in statistical analysis of the U.S. census and immigrant information and evolved the idea of putting all the information on to cards with holes punched in appropriate places to denote specific information. He then unveiled a machine called a tabulator which detected whether or not a hole or a series of holes occurred in particular positions; if that was the case it added one to a counter.

So if you had a series of columns on a card which denote respectively age groups, sex and marital status, you could detect which of the alternatives in each column a particular card represented, and

you could also sort particular combinations of age, sex and marital status.

Hollerith died rich and the particular code used by him, called the Hollerith code; is still the standard for punched cards.

## Home computer

You're not going to believe this, but a home computer is a computer which can be used in the home. It sounds like a silly name, but there is a distinction between home computers and office computers. An office computer presupposes hard-copy output, for instance, and it tends to be bulkier and more robust than something you can load into the boot of your car or move around from room to room. Home computer isn't exactly a technical definition though.

## Honeywell

One of the big American companies in mainframe computers. Honeywell also has a process control division which, among many other things, makes intelligent thermostats for domestic central heating.

In the early 1970s Honeywell had the chance to become a major force in the mini business but it chose to concentrate instead on its big computers. With the Level 6 mini line launched two years ago, it is once again looking strong at the small end of things.

Honeywell doesn't seem very interested in micros and really small computer systems. It is well into the use of micros for process control, though.

## House-keeping

This is a good analogous term. House-keeping in a computer system covers all those internal activities which don't relate to solving problems or executing user programs but which contribute to the system's general capability for solving problems and executing programs. It's a bit like dusting and sweeping-up at home; these operations don't have much specifically to do with what your house is for but they contribute to the 'operation' of the home.

There probably isn't an exact definition of what constitutes a housekeeping routine, but we would include such activities as checking files for unused space and compacting everything if possible. For instance, you may have a name and address file with space for you to list 50 friends. If you only have two friends at the moment, you might as well cut down the file size and give yourself some more space on the disc

(continued on next page)

(continued from previous page)  
or cassette. You can also forget that football fixtures program you've been writing.

## HPIB

Hewlett-Packard Interface Bus. Essentially a plug-and-socket connection defining one way in which peripherals (typically laboratory instruments, in this case) communicate with a computer.

RS-232 is popular as a standard interface connection but the HPIB was adopted more or less wholesale when the independent American Institution of Electrical and Electronic Engineers produced its own standard interface. That one is known as IEEE-488.

Among other places, it's used by Pet; the standard peripheral connector at the back of Pet is an IEEE-488 interface. Many people were irritated by this, because many standard peripherals (especially printers) have an RS232 interface but not IEEE-488.

## Hybrid

There are three uses of this adjective or noun you might meet and all are rare. A *hybrid computer* combines analogue and digital processing and is used only in esoteric technical application. A *hybrid circuit* is an IC package which incorporates separate chips inside. And a *hybrid disc* is a unit with a fixed disc and a removable cartridge disc. The two are usually the same capacity—2.5 or 5 megabytes seem to be the norm—and the idea that new data or programs can be taken to the computer on the cartridge and loaded into memory and/or the fixed disc. The fast-access fixed disc is then used for most of the processing work and

at the end of the day the cartridge takes a back-up copy for security purposes. This set-up is sometimes called a FEDS (fixed-plus-exchangeable disc store).

Not many people use hybrid computers, not many need to know about hybrid circuits, and not many would recognise the term 'hybrid disc'.

## Hz

Abbreviation for Hertz.

## IBM

International Business Machines Corp is one of the big names. This means it can astound people with the amount of money it makes but it also means that IBM can pay for some of the best R&D in computers and telecomms business.

It dates from 1911, when it was the much less exciting Computing-Tabulating-Recording Corp and its interests lay principally in punched card machines deriving from Hollerith (qv) and his ideas. Big dates in its history include 1914, which was when a brilliant ex-NCR salesman, Thomas J. Watson, became president; 1935, when IBM produced the first commercially-successful electric typewriter; 1958, with the first real IBM computer; 1959, with the arrival of a pioneering smallish business computer, the 1401; 1964, when it launched the stunningly successful 360; and 1970, when the 360 was updated to become the 370.

IBM has elected to stay out of the very small computer business. The unkind view is that the company is geared to making money from service, support and software, and micros do not need

much of that. More likely, IBM is reluctant to lay itself open to still more charges of attempting to monopolise the market.

It makes its own microprocessors by the ton and builds them into the Series/1 minicomputer—a non-LSI device rather like the non-LSI PDP-11s; the 5110 'portable' computer—built-in various 'intelligent' terminals.

IBM is big enough to set *de facto* standards. It was responsible for Fortran, PL/1, and APL among languages: it invented the golf-ball typewriter and many of the basic functions in word processing. One of the standard communications protocols, binary synchronous, is from IBM. In big computers, IBM is king.

## IC

Integrated circuit (qv).

## ICL

The British answer to IBM was something of a shotgun marriage in the late 1960s, welding the most active of the indigenous computer suppliers then, with plenty of Government encouragement. ICL tends to make big computers and sell them in the public sector. The closest it gets to small systems is the 1500, a £10,000-plus computer it inherited when it bought the Singer computer operations two years ago.

## Idle time

The time when a computer is switched-on and ready to go but is not doing anything; typically it is waiting for something else to happen.

## IEE

Institution of Electrical Engineers, which has a micro group among its members, and a home near London's Savoy Hotel.

## IEEE

Institute of Electronic and Electrical Engineers. A U.S. body whose significant activities include the propagation of standards—like IEEE-488, which is the same as HPIB (qv).

## IF

A conditional statement in Basic. You always need a THEN (if some condition is satisfied THEN something) and some versions of the language allow you an ELSE as well.

## IIL

Isoplanar Injection Logic, also wittily referred to by some as I<sup>2</sup>L. It's a way of making expensive high-performance ICs.

## Immediate

An address (qv) mode in which the memory address to be referenced is contained explicitly in the instruction. This is why it is also called explicit addressing.

## Impact printer

A printer with a mechanism which hits something to create a character. Typically a metal-type element bangs against an ink-coated ribbon on to paper. Examples are typewriters, Teletypes, daisy-wheel printers, and most conventional matrix and line printers, though these days some high-speed line printers use non-impact techniques like xerography and lasers.

## Advertisement Index

Acorn Computers	75	Gemsoft	26	Online Conferences Ltd	79
Airamco Ltd	108	Happy Memories	20	Padmede Computer Services	12
A J Harding	20	Hazeltine Ltd	104	Pelco (Electronics) Ltd	8
Almarc Data Systems Ltd	64	HB Computers Ltd	87	Peripheral Hardware Ltd	16
Alpha-meric Keyboards	27	Henry's Radio	64	Personal Computers Ltd	82
American Data and Office Computer	60	H L Audio Ltd	84	Petalect Electronic Services Ltd	6
Anadex Ltd	90	Integrated Circuits Unlimited	15	Petsoft	28
Beys Logic	20	Isherwoods	6	Rair	9, 30
Byte Shop	13	Jade Computer Products	23	Research Machines	4
Boer De, Elektronika	8, 106	Keen Computers Ltd	12, 42	Rockliff Brothers Ltd	20
Cambridge Computer Store	110	Leenshire Ltd	90	Rostronics Computer Centre	18
Camden Electronics	22	Linburg Electronics Ltd	24	Rubide	8
CCS Microhire	10	Linn Products	110	Scicon Consultancy International Ltd	2
Comart Ltd	5	London Computer Store	16	Shelton Instruments Ltd	14
Commodore Systems Division	7	Lotus Sound	32	Sintrom Microshop	21
Comp Computer Components	114, 115	LP Enterprises	25, 110	Small Systems Engineering Ltd	18
Compucorp Ltd	19	LTT Electronics	90	Strathand Security	90
Computech Systems	14	A Marshall (London) Ltd	26	Technalogs	106
Computer Centre	12	Microbits	17	Technical Book Services	58, 59
Computer Guides Ltd	56	Microcentre	62	Terminal Display Systems Ltd	64
Computer Workshop	116	Microcomputer Conference	113	Thomson CSF	80
Computrade	22, 104	Microdigital Ltd	68	TLC World Trading Ltd	26
CPU Peripherals Ltd	63	Microsoft Systems	106	Transam	11
Crofton Electronics	104	Microsolve Computer Services Ltd	64	Trident Exhibitions	22
Digitas Ltd	50	Mine of Information Ltd	10	T & V Johnson (Microcomputers Etc) Ltd	34
Equinox Computer Systems Ltd	8, 54, 108	MWS Consultants Inc	39	Videotime Products	18
Euro-Calc	24	Nascom Microcomputers Ltd	106, 108, 110	Shop Window Careers	92-100 101-103
Factor-One Computers	10				
Games Workshop	24				
Gate Microsystems	16				



# HOW TO BUY AND USE A MICROCOMPUTER

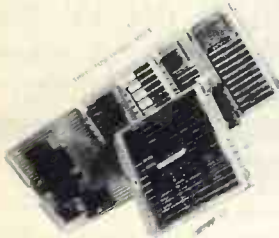

One-day conference for  
managers, accountants,  
entrepreneurs and other  
professional advisers.

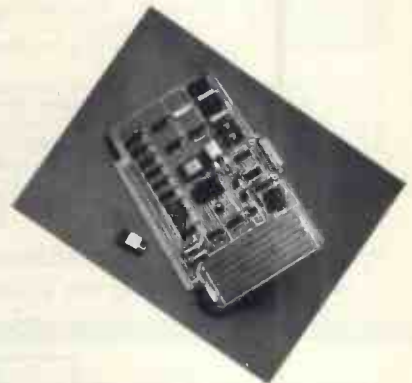

**MOUNT ROYAL HOTEL,  
LONDON, W.1.  
JULY 6, 1979**

Today it is possible to buy a microcomputer and a range of general accounting software for a price which, when converted to a lease payment, is about the cost of one clerk. In addition, the ease of operating a microcomputer is such that a semi-skilled office worker may be trained to operate one of these machines. So for the first time computer power is really available to very small businesses and to divisions or departments within larger firms.

This does not mean that no skills are required in buying or using microcomputers. From the point of view of buying a microcomputer, there are so many machines available with so many differing facilities that the would-be purchaser often has great difficulty in deciding what he requires. This applies both to hardware and soft-

ware, and once the would-be purchaser has decided to acquire a microcomputer, he is faced with the difficult task of knowing which aspects of his business he could computerise and what benefits he should expect to obtain from computerising.

This is a one-day practical conference which will explain to managers, accountants entrepreneurs and other professionals what a microcomputer is and how to decide which type of microcomputer would suit their business needs. The benefits which may be obtained by owning one's own computer will be explained and the pitfalls which a first-time user could encounter will be demonstrated.

The conference will give participants an opportunity to discuss the needs in their business.

**For further information please circle the number below on the  
Reader Enquiry Card.**

## OHIO SUPERBOARD II NEW FIRST IN UK — ON DEMO

For electronic buffs. Fully assembled and tested. Requires +5V at 3 Amps and a video monitor or TV with RF converter to be up and running.



### STANDARD FEATURES

Uses the ultra powerful 6502 microprocessor  
8K Microsoft BASIC-in-ROM  
Full feature BASIC runs faster than currently available personal computers and all 8080-based business computers.  
4K static RAM on board expandable to 8K  
Full 53-keyboard with upper/lower case and user programmability  
Kansas City standard audio cassette interface for high reliability  
Full machine code monitor and I/O utilities in ROM

Direct access video display has 1K of dedicated memory (besides 4K user memory), features upper case, lower case, graphics and gaming characters for an effective screen resolution of up to 256 by 256 points. Normal TV's with overscan display about 24 rows of 24 characters; without overscan up to 30 x 30 characters.

**EX-STOCK — £263**

Please phone to check availability or send £10 to reserve one and pay the balance on delivery

## INTERESTED IN HOME COMPUTING?

Start now and don't get left behind THE NASCOM 1 is here Ex-stock with full technical services

Plus the opportunity to join the fastest moving club of personal computer users enabling you to get the most out of your computer. You can OBTAIN and EXCHANGE programs and other software — many now available.

The Powerful Z80 Microprocessor  
Professional Keyboard  
1 Kbyte Monitor in EPROM  
2 Kbyte RAM (expandable)  
Audio Cassette interface  
Plugs into your domestic TV  
Easy construction from straightforward instructions  
— no drilling or special tools  
— Just neat soldering required.



SAVE £60

Only ~~£197.50~~ + 8% VAT (includes p & p + insurance)

Manuals separately  
Z80 programming Manual 2.95  
Z80 Technical Manual 6.90  
PIO Technical Manual 2.95

**NEW LOW PRICE**  
**£165**

(All prices add 8% VAT) Power supply suitable for NASCOM 19.90

**NASCOM AD ONS** — Nascom improved monitor B Bug (2K) featuring — \*Four times tape speed \*Direct text entry without ASCII \*Extended keyboard facility \*Additional useful subroutines **£23.00**

Nascom Vero Case **£22.50**

Nascom Music Box Kit **£9.90**

(write your own tunes and play them on your Nascom.

Nascom Joy Stick Kit **£14.90**

Complete with full documentation).

**GRAPHICS ADD ON BOARD £9.90**

Complete kit to upgrade your NASCOM for graphics capability includes full documentation and demonstration program.

## MODULATORS UHF Channel 36

Standard 6 meg band width **£2.25**  
High Quality 8 meg band width **£4.90**

## SHORT C12 CASSETTES 10 for £4.00 FOR COMPUTER PROGRAMMES

## KEY BOARD

756 GEORGE RISK

Brand new professional ASCII keyboards (USA)

Full technical details included. RRP £60.00

Only **£49.90**  
+ 8% VAT.

Ready built, tested and guaranteed.



## TRS 80 SOFTWARE NEW £39.00

100 MIXED PROGRAMMES on cassette

Educational Games, Graphics, Finance, etc. on 5 cassettes plus Full Documentation.

## COMP PRO Mixer

Professional audio

mixer that you can build yourself and save over £100.

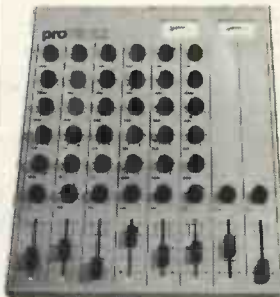

6 into 2 with full equalization and echo, cue and pan controls.

All you need for your own recording studio is a stereo tape or cassette recorder.

This superb mixer kit has slider faders, level meters and additional auxiliary inputs.

Only **£99.90** plus 8% VAT for complete kit Plus **FREE** power supply valued at **£25.00**

Ideal for

**DISCOS STAGE MIXING HOME STUDIOS AND MANY OTHER APPLICATIONS**

## Teleplay presents the PROGRAMAGAME of all time!

TELEPLAY have produced a product of cartridge games, for you and all your family, that will not go out of date. Just ADD each new cartridge, as it becomes available, and your colour video centre will be up to date the Teleplay way. You will Works OK on Black and White TV.

save pounds in the long run  
EX STOCK IMMEDIATE DELIVERY  
REALISTIC SOUND EFFECTS  
We offer all this to you for ONLY **£28.90** + £2.31 VAT (P.V.A. 25%)

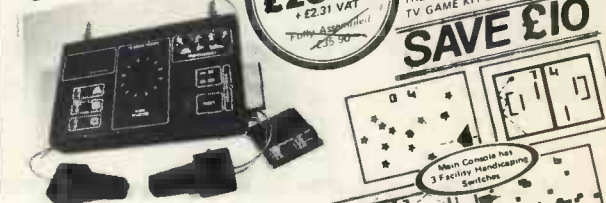

The Teleplay consists of a Professional Finished Joystick Hand Controls Inject moulded Box which consists of 10 games: Football, Tennis, Solo Squash (1 & 2 players), Hockey, Basketball, Mains Adaptor players), Shoot etc. Mains Adaptor TELEPLAY GIVES YOU TWICE THE FUN BUILDING AND PLAYING THE MOST PROFESSIONAL TV GAME KIT EVER OFFERED.

SAVE £10  
Main Console has 3 Facility Handicapping switches

Every 3 months a NEW game will become available to you and those already under production include Submarines, Space War, Wipe Out and many more. The price of these will vary from £12 to £19 (depending upon the complexity of the game).

Additional cartridges NOW available include:  
Stunt Cycle 4 games Cartridges and Hand Controls £14.90  
Tank Battle Cartridge and Hand Controls £18.90  
Road Race 2 games Cartridge Controls already with basic kit £12.90

NEW — WIPE OUT cartridge — 6 games £13.90  
Cartridges come complete with printed case and easy to follow instructions  
All parts fully guaranteed

Orders over £5 post and packing free otherwise add 20p. Please make cheques and postal orders payable to COMP, or phone your order quoting BARCLAYCARD or ACCESS number.

OPEN — 10am to 7pm — Monday to Saturday  
CONTINUOUS DEMONSTRATIONS



SEND FOR OUR SPRING '79 CATALOGUE - 0-60p



SEND FOR OUR SPRING '79 CATALOGUE - 0-60p

## SORCERER™ COMPUTER SPEAKS YOUR LANGUAGE

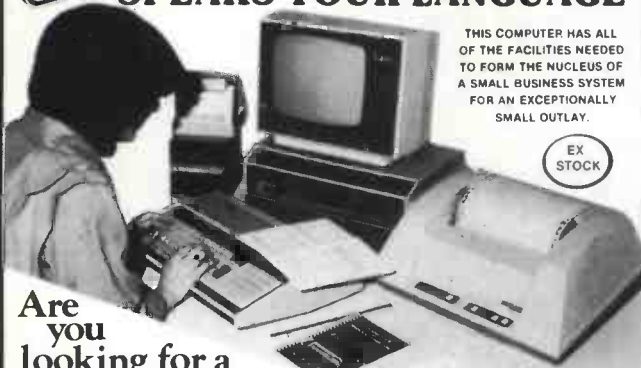

THIS COMPUTER HAS ALL OF THE FACILITIES NEEDED TO FORM THE NUCLEUS OF A SMALL BUSINESS SYSTEM FOR AN EXCEPTIONALLY SMALL OUTLAY.

EX STOCK

Are you looking for a PERSONAL or SMALL BUSINESS Computer? Look at these features for only £850. VAT

- 256 Character Graphics Set includes 128 that you can define.
- 280 Based computer
- Power-on 4K Monitor
- Excellent bit-mapped graphics (512 x 240 point resolution)
- Full 79 key dp keyboard including 16 key numeric pad (Full ASCII)
- Plug-in ROM facility (e.g. 8K BASIC, (supplied), Assembler/editor, word processing etc.) so that you can change your language or utility by simply plugging in the one you want.
- Serial I/O ports for cassette (R232 nic. (300 or 1200 Baud) Parallel I/O port for printer (Centronics Compatible)
- 280 bus available at the rear for connection to the optional 6 slot S100 expansion box (e.g. S100 Floppy disk drives, graphics boards, extra memory etc.)
- EXIDY SORCERER 32K RAM computer £850
- Add E3 for UHF output/16K RAM computer £751
- 12" Video monitor £69
- S100 expansion box (includes 6 Slot Motherboard and power supply) £210

**DISK SYSTEM** as shown  
MICROPOLIS S100 disks — 315 K bytes per drive  
Drive 1 includes S100 controller.  
Micropolis M DOS and BASIC software £649  
Additional 315 K bytes drives up to 4 per controller £349  
Cables and regulators for 2 disk system £41

**PRINTER** as shown  
ANADEX DP8000  
80 columns, 112 char/sec 5 x 7 dot matrix head  
Connects to parallel or serial ports £575

**ADDITIONAL SOFTWARE FOR SORCERER PLUS DISK SYSTEM**  
CP/M operating system £145  
CP/M with C BASIC (Compiler/Interpreter) £235  
FORTRAN 80 £350  
COBOL 80 £490  
MICROPOLIS BASIC PACKAGES FROM COMPUMAX } STOCK CONTROL (INVENTORY) } £99 each  
PAYROLL }  
ACCOUNTS RECEIVABLE }  
LEDGER }  
PERSONNEL }

## BOOK SHELF

- LOW PRICES FAST SERVICE!
- Vol 0 The Beginner's Book ..... £5.40
  - Vol 1 Basic Concepts + ..... £5.90
  - Vol 2 Some Real Products (June 1977) ..... £9.90
  - Microprocessor series, by Rodney Zaks C201 From Chips to Systems ..... £7.50
  - C207 Interfacing Techniques ..... £7.50
  - Microprocessor Systems Design by Edwin Klingman ISBN 0-135-81413-8 (1977) 480 pages hard cover ..... 16.40
  - GMOS Cookbook by Don Lancaster ..... £6.90
  - 6800 Assembly Language Programming ..... £6.50
  - 6800 Software Guide & Cookbook from Scebli ..... £7.90
  - 8080 Software Guide & Cookbook from Scebli ..... £7.90
  - 8080 A/8085 Assembly Language Programming ..... £6.50

- 8080A Bugbook Interfacing & Programming by Rony, Larsen & Titus (1977) 416 pages ..... £6.90
- Z80 Programming for Logic Design by Adam Osborne ..... £5.90
- Z80 Microcomputer Handbook by William Barden ..... £7.20
- Structured Programming & Problem Solving with Pascal ISBN 0-138-54869-2 (1978) 365 pages by Kleburtz "When will your microcomputer speak Pascal" ..... £9.50
- BASIC Computer Games — Microcomputer edition ..... £5.40
- Best of BYTE Vol 1 (1977) 376 pages ..... £8.90
- Best of CREATIVE COMPUTING Vol 1 (1977) 326 pages ..... £6.90
- Vol 2 (1977) 323 pages ..... £6.90
- MOI O'HELLO Game for 2 players on NASCOM 1 cassette ..... £2.00
- MOI MINO PILOT powerful text editor and interpreter in 1/2 KB! ..... £5.00

## THE TRS-80 (SPECIAL SCOOP) Low Priced, Ready to Go!



Use your own cassette

**Level-II with 4K RAM**  
Improved graphics, print formatting, and a faster cassette transfer rate are features of Level-II BASIC.

**£399**

PLUGS INTO YOUR OWN TV

**Level-II with 16K RAM**  
A combination of 16K RAM and the powerful Level-II BASIC produces a system capable of handling most demands.

**£499**

**KEY BOARD ONLY**

**COMPLETE WITH UHF MODULATOR**

**UK POWER SUPPLY — £9.90 + VAT**

## ATTENTION! TRS 80 & APPLE II USERS

**16K UP GRADE KIT** HALF NORMAL PRICE + VAT **£99** LIFETIME GUARANTEE

Simple to fit — only a screwdriver is required.

## ITHACA AUDIO

S-100 bus products from the experts.

Z-80 cpu board. Featuring

- ★ On board 2708 EPROM.
  - ★ Power-on jump. ★ Selectable wait states.
  - ★ 8080 or Z-80 I/O addressing modes.
  - ★ 2.0 MHz or 4MHz. ★ DMA.
  - ★ Power: 8v 1 Amp. + 16v 100mA, -16v 50mA.
- Bare printed circuit board £26.25  
Assembled and tested 2 MHz £130.00  
Assembled and tested 4 MHz £150.00



8K Static RAM board

- Featuring: ★ Memory protect. ★ Power on clear.
  - ★ Selectable wait states. ★ Two independent 4K halves. ★ Fully buffered.
  - ★ Uses 2102L-1. ★ Power requirements: +8volts 1.4 Amps.
- Bare printed circuit board £17.90  
Assembled and tested (450nS) £110.00  
Assembled and tested (250nS) £130.00

## ATARI VIDEO SYSTEM

The Best 200 Games plus REDUCED TO £139

SAVE £30 Selection of Cartridges £13.90 each

## PET COSTS LESS AT COMP and it's a pedigree

The No. 1 Personal Computer in the U.K. **RRP £550**  
**£499** Affordable + VAT **£50**  
SAVE for the first time user and the professional check out the PET, the world's most popular personal computer. **8K**



## NASCOM IMMEDIATE EXPANSION S100 from COMP — strongly recommended

The only available S100 motherboard kit (fully buffered) that plugs directly into your Nascom. Designed for the insertion of S100 boards (e.g. Static RAM, EPROM and discs etc.).

- S100 Motherboard/Buffer (Complete kit + documentation) **£47.50**
  - Suitable 8K Static RAM Memory **£125-£110** (fully assembled tested and guaranteed)
- Motherboard comes complete with 2K Tiny Basic On cassette.

**COMP COMPUTER COMPONENTS**

(PART OF THE COMPSHOP LTD. GROUP)

For technical and sales literature send SAE to:  
COMP COMPUTER COMPONENTS (Exidy UK Sales),  
Freeport, 14 Station Road, New Barnet, Herts.  
Tel: 01-441 2922 (Sales) 01-449 6596 Telex: 298755

TAKE ADVANTAGE OF OUR SHORT DELIVERY TIME.

All prices exclusive of VAT

★ ADD £6.00 FOR SPECIAL DELIVERY ON LARGE ITEMS

# We're getting bigger to give you a better service

**We've opened a Sales and Customer Service Centre in London. And our new factory is fully operational. Southwest Technical Products provide a range of superb computer systems with technical backing second to none.**



#### **Systems**

To suit all types of user – OEM, process control, data handling, small business systems, and all accounting functions.

#### **Software**

Low cost packages for word processing, selective mailing, progress control and invoicing. Our Software Development Unit available to prepare programmes to customer specification.

#### **Training**

Inexpensive courses (at Dover Street): **BASIC** – programming for the businessman; microcomputers in **EDUCATION**; **WORD PROCESSING** made easy; **SOFTWARE DEVELOPMENT** – make your microprocessor work.

#### **Maintenance**

Comprehensive national service by Computer Field Maintenance Ltd.

**Sales Office: 38 Dover Street, London W1.**

**Tel: 01-491 7507 Telex: 268913.**

**Factory: 12 Tresham Road, Orton Southgate, Peterborough.**

**Tel: 0733-234433 Telex: 32600.**

# SWT

**the symbol of reliability**