

LARGEST RADIO CIRCULATION IN THE WORLD

Popular Wireless

Every Thursday
PRICE
3d.

No. 487. Vol. XX.

INCORPORATING "WIRELESS"

October 3rd, 1931.

FULL DETAILS OF —

THE "POP-VOX" FOUR

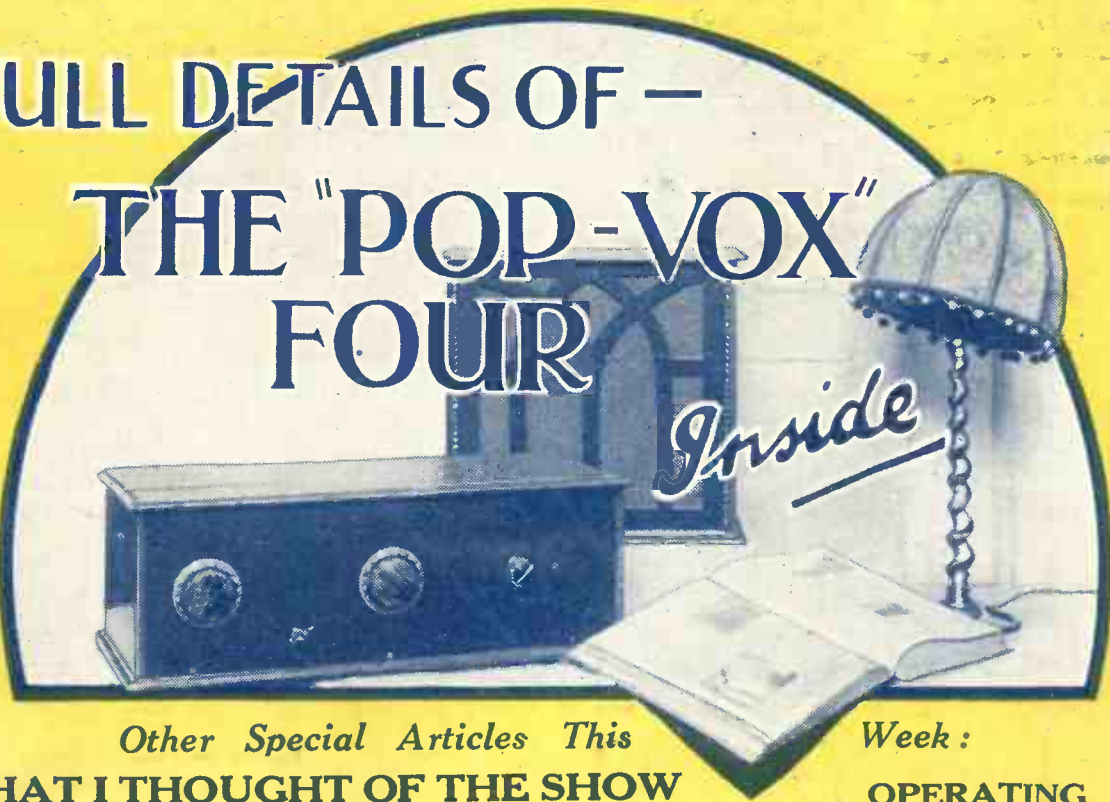

Inside

Other Special Articles This

WHAT I THOUGHT OF THE SHOW

By Capt. P. P. Eckersley, M.I.E.E.

MEASURING YOUR POWER SUPPLY

SMOOTHING SIMPLY EXPLAINED

THE B.B.C. AND ECONOMY

Week:

**OPERATING
OUR "P.V." SETS**

**WHAT I SAW AT
OLYMPIA**

Special long illustrated Show critique.

When building
your set—use a

Ready Radio

**TESTED
KIT**

(See pages 227
and 233
and cover 4)

The **NEW** **LEWCOS** BAND PASS FILTER

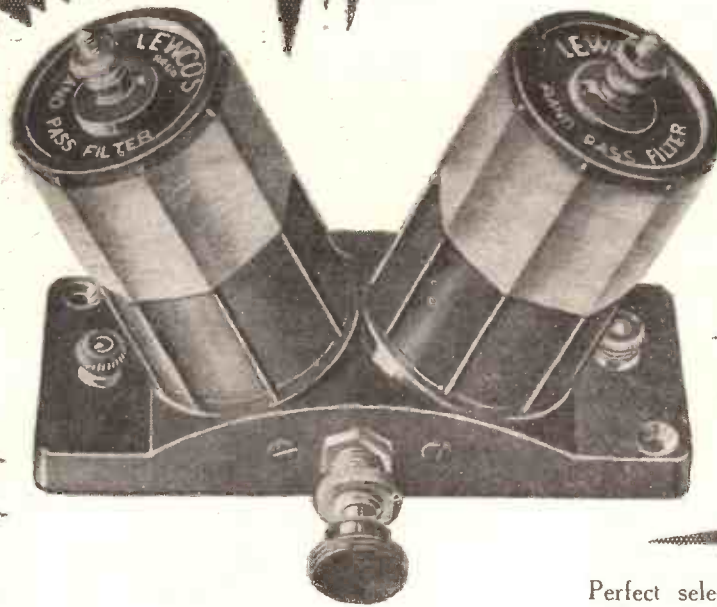

PRICE
12/-
(Screen 2/6
Extra.)



Perfect selectivity—the aim of all radio enthusiasts—can at last be achieved!

The New Lewcos Band Pass Filter, the product of exhaustive experiments in our Laboratories, gives maximum efficiency on both wave-length ranges (235/550 and 1000/2000). This has been obtained by the production of a Filter which is capable of giving a steep-sided and flat-topped response curve—ideal for super-selectivity and quality performance.

Try this new Lewcos component in your set; you will be astounded at the results.

Send for fully descriptive leaflet, Reference R.73.

LEWCOS RADIO PRODUCTS FOR BETTER RECEPTION

THE LONDON ELECTRIC WIRE COMPANY AND SMITHS LIMITED, CHURCH ROAD, LEYTON, LONDON, E.10

2 VOLT MAZDA MASTERPIECES

TYPE	PRICE
H.210 - - -	8/6
HL.210 - - -	8/6
★ HL.2 - - -	8/6
L.210 - - -	8/6
★ L.2 - - -	8/6
P.220 - - -	10/6
P.220A - - -	13/6
P.240 - - -	13/6
PEN.230 - - -	20/0
PEN.220 - - -	20/0
PEN.220A - - -	20/0
S.G.215 - - -	20/0
★ S.G.215A - - -	20/0
★ S.G.215B - - -	20/0

★ METALLISED



LOOK FOR
"EDDY" IN
YOUR DEALER'S
WINDOW

THE AMAZING

MAZDA PEN. 220

Characteristics:

Filament Voltage - - 2.0 volts Anode Current (Max) - 12 mA
 Filament Current - - 0.2 amps. Screen Voltage (Max) - 150 volts
 Anode Voltage (Max) - 150 volts Mutual Conductance - 2.5 mA/V
 At $E_s = 100$; $E_s = 100$; $E_g = 0$.

PRICE 20/=-



Since 2-volt valves were made, never has there been so amazing a range as this — so much evidence of brilliant engineering — so many valves with outstanding characteristics. Instance the Pen. 220; or pentode, which at once presents the solution to the output stage problem in portable sets, for it gives an astonishingly large output for a combined screen and anode current of under 5 mA. It is a valve H.T. dry battery users have longed for. It is typical of all Mazda 2-volt valves. Mazda 2-volt valves, both metallised and clear bulb types, are sold by all good radio dealers.

MAZDA

THE
BRITISH
VALVES

The Edison Swan Electric Co. Ltd.



155 Charing Cross Road, London, W.C.2

V135

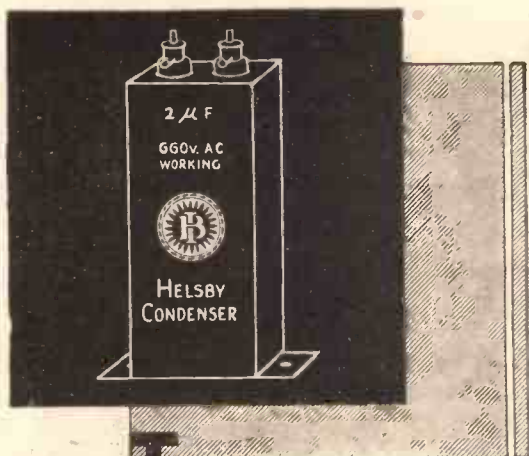

TESTED TO DOUBLE WORKING PRESSURE

Helsing Condensers have been supplied to the G.P.O. and to large manufacturers for thirty years. They are engineer-built, with plates of pure foil, non-hygroscopic, fully tested, and the capacity rating is guaranteed. A boon to the experimenter, for their reliability is unailing.

TWO POPULAR SIZES:

Type 209T. Working voltage, 250 D.C.	
1 mfd. ..	2/7
2 mfd. ..	3/6
Type 212. Working voltage, 400 D.C.	
1 mfd. ..	3/7
2 mfd. ..	4/9

Ask for Helsing Condensers by name—there is a full range to cover every purpose. Types 212 and 212T are particularly suitable for eliminator circuits.

HELSEBY CONDENSERS

BEST FOR THE CONSTRUCTOR

If any difficulty in obtaining from your local dealer, please send us his name and address.

BRITISH INSULATED CABLES LTD
PRESCOT... LANCASHIRE
MAKERS OF B.I. CABLES

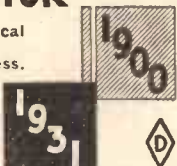

Instantly popular— THE NEW H.T.8

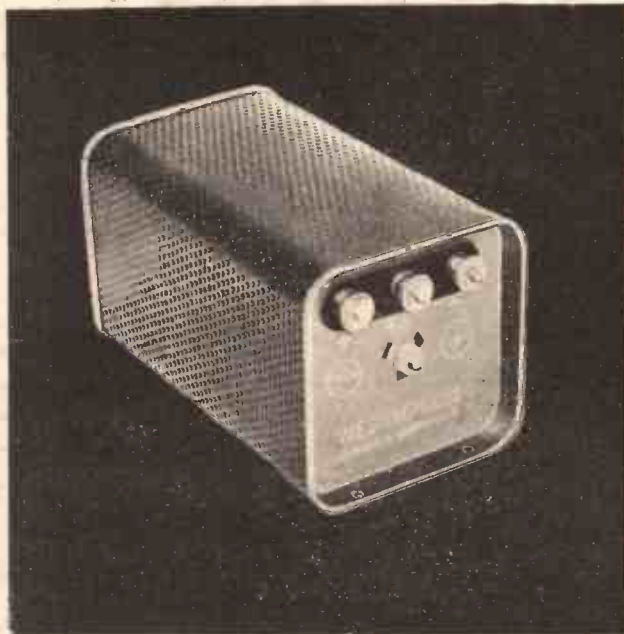

THE H.T.8 Metal Rectifier has become instantly popular for the conversion of three- and four-valve battery-run sets into mains-sets; and for incorporating in amateur-built sets of similar design. It will give an output of 250 volts, 60 milliamps (after smoothing), with an input of 200-210 volts A.C., using the voltage doubler circuit. (*Described in "The All-Metal Way.") The price of the H.T.8 is 21/-. Other metal rectifiers for amateurs' use are the H.T.5—D.C. output 120 v., 20 m.a.—price 12/6; H.T.6—D.C. output 175 v.; 25 m.a.—price 15/-; and H.T.7—D.C. output 200 v., 28 m.a.—price 17/6; and various low tension types.

* The 1932 edition of "The All-Metal Way," which will be sent on receipt of the coupon below with 3d. in stamps, gives all the information required to build an H.T. eliminator or trickle charger, and also full details of running moving coil loud speakers from the A.C. mains. This well-known book has been completely revised, and many questions which were not fully dealt with in our 1931 issue are now discussed in detail. Westinghouse Metal Rectifiers are shown at Stand 76, City Hall, Manchester, Oct. 7-17.

WESTINGHOUSE METAL RECTIFIERS

The Westinghouse Brake & Saxby Signal Co., Ltd.,
York Rd., King's Cross, London, N.1. Phone: North 2415.

COUPON

PUBLICITY MANAGER,

W. B. & S. S. Co., 82 York Rd., King's Cross, London, N.1.
I enclose 3d. in stamps, for which please send me a copy of "The All-Metal Way, 1932."

NAME.....

ADDRESS.....

P.W. 3/10/31

The Name that Guarantees Quality & Precision



The **ORMOND**
Nº 6 LOG CONDENSER

The **ORMOND**
DISC DRIVE

This ORMOND Condenser produced at a remarkable price sets a new standard in Value.

The construction is of aluminium and is very robust, the whole being a precision instrument designed to follow the logarithmic law.

The vanes are perfectly rigid, and are firmly secured to slotted spindles. The special mounting of the fixed vanes support, reduces dielectric losses to a minimum. The moving vanes are connected to the frame, thus eliminating stray capacity effects.

Easy to mount "one hole" fixing.

Terminals and soldering tags for connections.

This Condenser is not supplied with dial.

Cat. No.	Capacity	Price
R/481	.00025	4/-
R/482	.00035	4/-
R/483	.0005	4/-

This NEW ORMOND Dial will prove an instant favourite with those who desire a "back of panel" illuminated dial. The Dial, with support for the variable condenser, is mounted at the back of the panel, the window and knob, with fixing screws and nut, being the only parts at the front.

The lamp bracket is secured to the support, in a convenient position.

An extremely smooth slow-motion movement of ratio approximately 9 to 1 is incorporated.

Easy to mount and may be used on plain type "one hole" fixing condensers.

CAT. NO. R/361 Price 2/6

THE ORMOND ENGINEERING CO., LTD.
Ormond House, Rosebery Avenue, London, E.C.1

Telephone : Clerkenwell 5334-5-6 and 9344-5-6. Telegrams : "Ormondengi, Isling."

You Simply must not miss the

AN
ENLARGED
NUMBER

OCTOBER
**MODERN
WIRELESS**

A
FREE
BLUE PRINT

It contains full constructional details of
A FOUR-VALVE SUPER-HET.

With
**FULL - SIZED
BLUE PRINT**

FREE

Read all about it—The

“M.W.” “SUPER-QUAD”

Other articles in this special number of “M.W.” are:—

Radio and the Moon
Trouble Tracking
Evenings in the Studio
On the Short Waves
Questions Answered

How Much Power?
My Radio Favourites
Using a Frame Aerial
Problems of L.F.
Using Transformers

Recent Record Releases
Using High-Mag. Valves
The Perfect Pick-Up
A Radio Reckoner
A New Use for Short Waves
Round the Turntable

**THE “FOUR-
BAND” THREE**
Long—Medium—and
Short Waves on the
one dial!

**THE WORLD'S
PROGRAMMES**
—Special Supplement
for the long-distance
listener.

**THE “M.W.”
“PENT-ACE”**
—With Screened-Grid
stage and Pentode
detector.

Every phase of radio progress is represented!

October
Double Number

**MODERN
WIRELESS**

Now on
Sale, 1/6

TAKE THE
PERFECT PAIR WAY
TO PERFECT RADIO



Wander plugs in the PERTRIX H.T.? PERTRIX L.T. connected up all right? Then switch on. You never realised radio could be so good, did you? That's the best of getting the Perfect Pair—they work in perfect harmony with each other and with your set, giving you just Perfect Radio. And they last longer, too . . . infinitely longer.

Made by BRITANNIA BATTERIES, Limited
at Redditch who also make:

Batteries for Central Stations • Batteries for Country House Lighting • Emergency and Stand-by Lighting Batteries for Theatres, Cinemas, Hospitals, etc. • Batteries for the Starting and Lighting, and Lighting and Ignition of Motor Cars, Motor Cycles, Buses and Coaches • Batteries for Electric Vehicles, Trucks, Locomotives, Ships and Yachts • The only Nickel-Iron Alkaline Battery on sale in Britain that is entirely made in this country.

PERTRIX
SUPER LIFE
DRY BATTERIES
&
ACCUMULATORS

THE PERFECT PAIR FOR PERFECT RADIO

Advert. of PERTRIX LIMITED, 233, Shaftesbury Avenue, London, W.C.2
Telephone: Temple Bar 7971 (5 lines) Works: Redditch

IMMEDIATE DELIVERY

FOR EVERYTHING NEW IN RADIO

**C.O.D.
CASH
H.P.
as usual**

We are the largest Radio House in the Country and in sending your orders to us there is no risk of delay. Express Service is your guarantee of satisfaction. NEW 116 page Catalogue 6d. Post Free

MANUFACTURERS' KITS

- COSSOR MELODY MAKER TYPE 234.** Screened Grid, Det., and Power. Complete with specified Valves and Cabinet. Cash Price, £6 : 15 : 0. Balance in 11 monthly payments of 12/6. Finished Instrument, Royalties paid, £7 : 10 : 0. Cash only.
- OSRAM NEW MUSIC MAGNET.** Improved version of this famous 4-valve set. 2 Screen-Grid, Det., and Power. With Valves and Cabinet. Cash Price, £10 : 15 : 0. Balance in 11 monthly payments of 19/8. Finished Instrument, Royalties paid, £11 : 15 : 0. Cash only.
- MULLARD 3-1932 RECEIVER.** Screen-Grid, Det., and Pentode. With Valves, less Cabinet. Cash Price, £6 : 10 : 0. Balance in 11 monthly payments of 11/11. Finished Instrument with valves and cabinet. Royalties paid, £7 : 17 : 6. Cash only.
- V.3 RADIO FOR THE MILLION.** Screen-Grid, Det., and Pentode. With Valves, less Cabinet. Cash Price, £5 : 17 : 6. Balance in 11 monthly payments of 10/9. Finished Instrument with Cabinet, Royalties paid, £7 : 8 : 6. Cash only.
- SIX-SIXTY CHASSIKIT (Battery Model).** Complete three-gang band-pass tuning. S.G., Det., and Pentode. Cash Price, with Valves less cabinet, £6 : 17 : 6. Balance in 11 monthly payments of 12/7. Finished instrument with (10/6) Cabinet and valves. Royalties paid, £8 : 3 : 0. Cash only.
- SIX-SIXTY CHASSIKIT (A.C. Model).** Complete as above with A.C. Mains Valves. Cash Price, with Valves less Cabinet, £7 : 6 : 6. Balance in 11 monthly payments of 13/5. Finished instrument, with Cabinet (10/6) Royalties paid, £8 : 12 : 0. Cash only.

- EKCO H.T. UNIT.** Type A.C.25. For multi-valve sets requiring up to 25 m/a. 3 tappings. S.G., detector and 120/150 volts. For A.C. Mains. Cash or C.O.D. Price £3 17s. 6d. Balance in 11 monthly payments of 7/1 only.
- ATLAS A.C. ELIMINATOR TYPE A.C.244.** 3 tappings—S.G., detector, power. Output 120 volts at 20 m.a. Cash Price or C.O.D. £2 19 6. Balance in 11 monthly payments of 5/6 only.
- EKCO K.12 A.C. COMBINED H.T. ELIMINATOR and L.T. TRICKLE CHARGER.** 12 m/a suitable for 1- to 3-valve sets. S.G. 80 v., 120/150 v. Charging rate 1/2 amp. at 2, 4, or 6 v. Cash or C.O.D. £3 19 6. Balance in 11 monthly payments of 7/4 only.
- EXIDE 120-VOLT W.H. TYPE ACCUMULATOR.** in crates. Cash Price, £4 13 0. Balance in 11 monthly payments of 8/6 only.
- AMPLION M.C.6 MOVING-COIL SPEAKER,** permanent magnet, with output transformer. Complete. Cash Price £3 : 7 : 6. Balance in 11 monthly payments of 6/2 only.
- NEW MODEL LAMPLUGH OR FARRAND INDUCTOR SPEAKER** for perfect reproduction. Unit and chassis complete, ready mounted. Cash Price or C.O.D. £3:10:0. Balance in 11 monthly payments of 6/5 only.
- BLUE SPOT PERMANENT MAGNET MOVING-COIL SPEAKER.** Complete with input Transformer. Cash Price, £3:15:0. Balance in 11 monthly payments of 6/11 only.
- CELESTION PERMANENT MAGNET MOVING-COIL SPEAKER.** Type R.P.M.8. 8" Reinforced Diaphragm. In Chassis form without input transformer. C.O.D. or Cash Price, £3:10:0. Balance in 11 monthly payments of 6/5 only.
- EPOCH PERMANENT MAGNET MOVING COIL SPEAKER,** type A.2. Complete with tapped 3-ratio input transformer. Cash price or C.O.D. £3:16:6. Balance in 11 monthly payments of 7/- only.
- REGENTONE W.5 COMBINED H.T. ELIMINATOR AND TRICKLE CHARGER.** One S.G., 1 variable and 1 fixed tapping for H.T. L.T. charging for 2, 4, and 6 volts. For A.C. mains. Cash Price £5 : 17 : 6. Balance in 11 monthly payments of 10/9 only.
- B.T.H. R.K. MINOR PERMANENT MOVING-COIL SPEAKER.** Capable of handling outputs up to 2 watts. Cash Price £2 : 10 : 0. Balance in 8 monthly payments of 6/- only.
- NEW B.T.H. "SENIOR" PICK-UP AND TONE-ARM.** Complete. Cash Price £2:5:0. Balance in 11 monthly payments of 4/2 only.

PILOT PERMANENT MAGNET MOVING-COIL SPEAKER



Matches the requirements of all modern receivers. Includes a Unit designed and built specially for Peto-Scott by Epoch. Handles the smallest to the greatest input, and brings out most minute details of tonal quality with pure, full volume. A multi-ratio input transformer is fitted and provides for matching to all super-power and pentode valves. The handsome hand polished solid oak cabinet is built to give added depth of tone, and is fitted with ebonised base and side wings and silk covered fret. £3 : 15 : 0 or 12 monthly payments of 6/11.

VOXKIT RADIOGRAM CABINET MODEL 1932

Accommodation for largest of Home-built receivers with a full size speaker as well as mains and battery equipment. Complete with motor board. Dimensions overall 39" high X 21" wide X 17" Internal Panel 18" X 7" Baseboard 18" X 14 1/2" Speaker chamber 18" X 14 1/2" X 16". Panel 12 1/2" between moulding. £4 10 0 or 12 monthly payments of 8/3



VOXKIT 1932 CONSOLE (Radio only) Almost identical in appearance with the 1932 Voxkit Radiogram designed for Radio only. Dimensions 37" X 15 1/2" X 22" wide. Panel 18" X 7". Baseboard 18" X 12". L.S. compartment 18" X 14" X 12". Control Panel 12 1/2" wide. OAK Price £3 15 0 or 12 monthly payments of 6/11.

KELSEY SHORT-WAVE ADAPTOR

Adds more stations to your set. Nothing more to buy — no valves or any extras. Plugs direct into your battery or eliminator-operated receiver. Receives short waves from all over the world. Easy to operate. Sent C.O.D. Postage free, or from your usual dealer. Mahogany cabinet, 7 6. C.O.D. Pay the postman. 37/6



SPECIALLY RECOMMENDED

- EPOCH J.1 PERMANENT MAGNET MOVING-COIL SPEAKER.** Chassis model, with multi-ratio transformer. Cash price £2 12s. 6d. Balance in 11 monthly payments of 4/10.
- GARRARD INDUCTION MOTOR, TYPE 202.** With fully automatic start and stop switch, speed regulator, and 12-inch turntable. Cash price £2 18s. 6d. Balance in 11 monthly payments of 5/4.
- HEAYBERD H.T. UNIT—"D" MINOR.** Output 120 v. at 12 m/a.—Tapped at 80 v., 100 v., and 120 v. Westing-house rectification. Cash price £2 17s. 6d. Balance in 11 monthly payments of 5/4.
- MARGONIPHONE GRAMOPHONE PICK-UP.** Complete with Tone Arm. Cash Price £2 5s. 0d. Balance in 8 monthly payments of 5/5.
- MACOM ELECTRIC TURNTABLE.** Complete with Spring Adjustment, Tone Arm, Pick-up, etc. Cash price £4 12s. 6d. Balance in 11 monthly payments of 8/6.
- BLUE SPOT GRAMOPHONE PICK-UP.** Complete with Tone Arm and Volume Control. Cash price £3 3s. 0d. Balance in 11 monthly payments of 5/9.
- COSSOR 4-VALVE ALL-ELECTRIC RECEIVER.** Built-in Moving-Coil Speaker, Pick-up Terminals. For A.C. Mains. Cash price £16 16s. 0d. Balance in 11 monthly payments of 30/- only.

SPECIAL C.O.D. ITEMS

- B.T.H. MINOR GRAMOPHONE PICK-UP AND TONE ARM.** C.O.D. 27/6
- BLUE SPOT INDUCTOR TYPE SPEAKER UNIT AND CHASSIS.** C.O.D. 39/6
- BLUE SPOT MAINS DISTURBANCE UNIT.** C.O.D. 10/6
- WUFA SPEAKER UNIT AND CHASSIS.** NO. 40. C.O.D. 40/-
- TELSEN SPEAKER UNIT AND CHASSIS.** C.O.D. 11/-
- WEARITE "POPULAR TYPE" FRAME AERIAL.** C.O.D. 32/6
- B.T.H. SYNCHRO-BLUE GRAMOPHONE MOTOR.** FOR A.C. MAINS. 39/6

EXPRESS ORDER FORM

To PETO-SCOTT CO., LTD., Please send me C.O.D./CASH/H.P.

for which I enclose Cash/H.P. Deposit £ s. d.

Name.....

Address.....

P.W. 3/10/31

PETO-SCOTT

PETO-SCOTT CO., LTD. Head Office: 77 CITY ROAD, LONDON, E.C.1. Clerkenwell 9406. 62 HIGH HOLBORN, LONDON, W.C.1. Chancery 8266. MANCHESTER: 33 WHITELOW ROAD CHORLTON CUM-HARDY. Phone: Charlton-cum-Hardy 2028. NEWCASTLE, STAFFS., 7 ALBANY RD. Phone: 67190

EXPRESS KIT SERVICE

CONSTRUCTORS!
Build Authors Sets with
100% SUCCESS

Pilot Author's Kits remove all doubt. Containing components "First Specified" in the list of parts and as used by the Author himself in the original Set, you are able to duplicate exactly the set as constructed by the Author. No other Kit of parts offers you this wonderful safeguard against disappointment.

Let the **AUTHOR** be your Surety and the **PILOT** your Guide

PILOT AUTHOR'S KITS
C.O.D CASH H.P. *as usual*

50 P.V. STAR

Check this list of parts with the published specification.

- 1 Panel, 10" X 8", drilled and sanded £ s. d.
- 1 Baseboard and panel supports 4 0
- 2 Cylidon .0005-mfd. drum drive, Extenser-type Ex. 275 2 0
- 1 Ready Radio .0001, .00013 or .00015-mfd. differential reaction condenser 1 17 6
- 1 Ready Radio .0003-mfd. solid dielectric condenser 2 8
- 1 Lewcos and 1 Telsén H.F. choke 3 8
- 1 Graham-Parish 2-meg. grid leak and holder 9 9
- 1 Bulgin 600-ohm Spaghettil resistance 1 6
- 1 Bulgin-25,000-ohm Spaghettil resistance 1 6
- 1 Lotus L.F. transformer 5 6
- 1 Telsén output choke 8 0
- 1 Bulgin filament switch 1 0
- 1 T.C.C. .01-mfd. fixed condenser 3 0
- 1 Dubilier .001-mfd. fixed condenser 2 0
- 1 Goltone .0003-mfd. fixed condenser 1 0
- 1 Formo 1-mfd. fixed condenser 2 2
- 1 Agranic 2-mfd. fixed condenser 6 0
- 1 Bulgin fuse and holder 1 3
- 1 Sovereign P.J.2 coil 1 6
- 1 Sovereign P.J.3 coil 1 2 0
- 1 Peto-Scott coil quitois 1 0
- 1 lb. No. 30 D.S.C. wire 2 5
- 1 Parox screen, 15" X 8" 2 8
- 1 Peto-Scott control discs 3 0
- 1 Goltone crocodile clips 4
- 1 Flex. screws, wire, etc. 2 6
- 1 Pair Peto-Scott swivel-jointed collapsible brackets 3 6

KIT "A" Cash £5.11.11
or **C.O.D.**

Any parts supplied separately: If value over 10/- sent carriage paid or C.O.D.—post charges paid.

52 POP-VOX FOUR

PILOT AUTHOR'S KIT for this Splendid Set keeps strictly to the published specification of the Author in every respect. You are safeguarded against substitutes—a Service offered by no other Firm.

KIT "A" Less Valves and Cabinet £5:18:11

or Deposit 10/11 and balance in 11 monthly payments of 10/11

KIT "B" £8:6:5 **KIT "C" £9:7:5**

With Valves less Cabinet. Complete with Valves and Cabinet. or deposit 15/3 and balance in 11 monthly payments of 15/3. or deposit 17/2 and balance in 11 monthly payments of 17/2. 1 Peto-Scott Cabinet £1:1:0 4 Valves as specified £2:7:6

PILOT AUTHOR'S KITS PRICE CHART

ITEM NO.	SET.	KIT "A," less Valves and Cabinet.	KIT "B," with Valves less Cabinet.	KIT "C," complete with Valves and Cabinet.
50	P.V. STAR	CASH or C.O.D. £5 11 11 or deposit 10/3 11 monthly payments of 10/3	CASH or C.O.D. £7 10 11 or deposit 13/10 11 monthly payments of 13/10	CASH or C.O.D. £8 18 5 or deposit 16/4 11 monthly payments of 16/4
51	P.V. PLUS	CASH or C.O.D. £4 7 8 or deposit 8/- 11 monthly payments of 8/-	CASH or C.O.D. £6 6 8 or deposit 11/7 11 monthly payments of 11/7	CASH or C.O.D. £7 6 8 or deposit 13/5 11 monthly payments of 13/5
53	P.W. SUPER QUAD	CASH or C.O.D. £7 15 6 or deposit 14/3 11 monthly payments of 14/3	CASH or C.O.D. £10 14 6 or deposit 19/8 11 monthly payments of 19/8	CASH or C.O.D. £11 14 6 or deposit 21/8 11 monthly payments of 21/8
54	COMET 3 FOUNDATION CIRCUIT	CASH or C.O.D. £4 0 0 or deposit 7/4 11 monthly payments of 7/4	CASH or C.O.D. £5 7 6 or deposit 9/10 11 monthly payments of 9/10	CASH or C.O.D. £6 7 6 or deposit 11/8 11 monthly payments of 11/8

Any parts supplied separately if value over 10/- Sent carriage paid or C.O.D. All post charges paid.

- Peto-Scott Side Control Swivel, Jointed Brackets Per pair 3/6
- Peto-Scott Side Control Ebonite Discs with Knurled edge Per pair 3/-
- Peto-Scott Ready Wound and Tapped Coil Quitois Per pair 4/3
- Cylidon (.0005-mfd.) Extenser, Type EX275 37/6
- Aluminium Screen to specification, 15" X 8" 2 9
- Peto-Scott P.J. Coil (No. 2) 1 6
- Peto-Scott P.J. Coil (No. 3) 2/-
- Formo (.0005-mfd.) Extensers, The pair 29/-
- 2 Cylidon .0005-mfd. Extenser Condensers Each 15/6
- 2 .0005-mfd. Cylidon (Type EX275) Extenser Condensers Each 16/6

51 P.V. PLUS

Check this list of parts with the published specification.

- 1 Panel, 18" X 7" £ s. d.
- 1 Baseboard, 10" deep 6 0
- 2 Formo .0005-mfd. Extensers 1 6
- 1 Ready Radio filament switch 9 0
- 1 Ready Radio .0001, .00012 or .00015-mfd. differential reaction condenser 10
- 1 T.C.C. 1-mfd. fixed condenser 2 6
- 1 T.C.C. .01-mfd. fixed condenser 2 10
- 1 Telsén .001-mfd. fixed condenser 3 0
- 1 Telsén .0003-mfd. fixed condenser 6
- 1 Ready Radio and 1 Telsén H.F. choke 6 6
- 1 Bulgin 600-ohm Spaghettil resistance 9
- 1 Dubilier 2-meg. grid leak and holder 2 9
- 1 Agranic L.F. transformer 10 6
- 1 P.S. P.J.2 coil 1 6
- 1 Ready Radio P.J.3 coil 2 0
- 1 G.B. battery clip 2 0
- 1 Terminal strip, 18" X 2", ready drilled to specification 2 0
- 1 Lewcos .0001-mfd. compression condenser 2 6
- 10 Indicating terminals 2 6
- 2 Goltone crocodile clips 2 0
- 1 Parox screen, 10" X 6" 2 0
- 2 Belling-Lee G.B. 4 H.T. and 2 L.T. plugs 1 4
- 2 Coil Quitois 1 0
- 1 Flex. screws, wire, etc. 2 6
- 4 oz. No. 30 D.S.C. 2 5

KIT "A," Cash or £4.7.8
C.O.D.

Any parts supplied separately. If value over 10/- sent carriage paid or C.O.D.—post charges paid.

For C.O.D. Parts for this set, see our second advertisement on page 198.

C.O.D. LINES FOR NEW "P.W." SETS

Any of the above items sent C.O.D. Pay the Postman. If value over 10/- we pay post charges.

EXPRESS ORDER FORM

To. **PETO-SCOTT CO. LTD.**
Please send me **C.O.D./CASH/H.P.**

for which I enclose
Cash/H.P. Deposit £ s. d.

Name.....

Address.....

P.W. 3/10/31



PETO-SCOTT CO. LTD. Head Office: 77, CITY ROAD, LONDON, E.C.1. Clerkenwell 9406. 62, HIGH HOLBORN, LONDON, W.C.1. Chancery 8266. MANCHESTER: 33, WHITELOW ROAD, CHORLTON-CUM-HARDY. Phone: Chorlton-Cum-Hardy 2028. NEWCASTLE STAFFS: 7 ALBANY ROAD Phone: 67100.

Increased range -improved selectivity

both follow the fitting of
this—Britain's most popular
Screened Grid Valve



COSSOR

215 S.G.

Cossor 215 S.G. 2 volts,
15 amp. Impedance
300,000. Amplification
Factor 330. Mutual
conductance 1.1 m.a./v.
Normal Working Anode
Volts 120. Positive
Voltage on Screen,
60-80.

Price - **20/=**

COSSOR

220 S.G.

Cossor 220 S.G. 2 volts,
2 amp. Impedance
200,000. Amplification
Factor 320. Mutual
Conductance 1.6 m.a./v.
Normal Working Anode
Volts 120. Positive
Voltage on Screen,
60-80.

Price - **20/=**

YOU can materially improve the performance
of your S.G. Receiver—widen its range
and increase its selectivity—by fitting a
Cossor Screened Grid Valve.

Because of their abnormally low inter-electrode
capacity which is of the order of '001 micro-
microfarads, lower than that of any other S.G.

Valve on the market—and because of im-
portant constructional improvements—Cossor
Screened Grid Valves permit a substantial in-
crease in effective amplification.

As a result, therefore, the use of a Cossor S.G.
Valve in any Screened Grid Receiver will
result in a considerable increase in efficiency.

Cossor Screened Grid Valves are obtain-
able from any Wireless Shop in types to
suit every S.G. Receiver. Full technical
details will be sent post free, ask for
Folder L 31

COSSOR

SCREENED GRID VALVES

Popular Wireless

LARGEST NET SALES



Scientific Adviser:
Sir OLIVER LODGE, F.R.S.
Chief Radio Consultant:
CAPT. P. P. ECKERSLEY, M.I.E.E.
Editor: NORMAN EDWARDS.

Technical Editor: G. V. DOWDING, Associate I.E.E.
Assistant Technical Editors:
K. D. ROGERS, P. R. BIRD,
A. JOHNSON RANDALL.

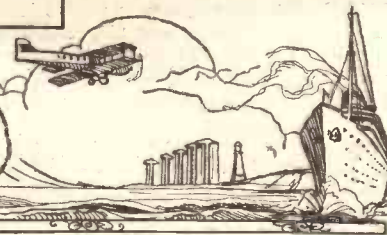

**THE SHOW
ONE TALK LESS
BOXING IN SNOW
KENYA, 7LO**

RADIO NOTES & NEWS

**THE STOP-GAP
THOSE BEES
NOTHING UNDER 70.
AU REVOIR.**

Autumn's Balance Sheet.

BR-R! I don't like the smell of this weather, considering that a fortnight ago I was sloping on and around Dartmoor dressed like a tramp but as warm as the hobs of Hickey and happy as a rabbit with gilt buttons on its waistcoat.

However, lack of direct solar warmth is compensated by an enhanced sense of comfort and cosiness around the fire, and radio seems somehow to have an appeal which it lacks when one is bathed in sunshine and has an unmowed lawn in mind. So, hey! for the long winter evenings with pipe, book and glass, and the Queen's Hall Orchestra or some other notable item "just a-goin' to begin."

The Show.

DID you go? And wasn't it wonderful? When I cast my mind back to the days of 1919 and recalled the meagre equipments available, the high prices and poor "performances," to say nothing of the non-existence of broadcasting, I realised that we have witnessed a "revolution in our time." Also, I was haunted by the feeling that here, under my eyes, was the sign that there is life in the old John Bulldog yet!

The Show by Proxy.

MANY of you, of course, could not possibly go to Olympia, more's the pity! Why not get the October number of "Modern Wireless" and conduct a grand tour round the Radio Show from your armchair? You will miss the human touch—you will, in fact, avoid the rather too many human touches, squeezes, and bumps to which we were subjected there. The "M.W." "Super-Quad" Four, which was the sensation of the "M.W." stand, is fully described, with a full-size free blue print, in this issue; a super-het with Extenser tuning.

One "Talk" Less?

FROM the "Foundry Trades Journal"—ye gods! where do I not delve?—I lift the following story. Mr. O. H. Bessemer, the steel magnate, says that a

few months ago he was approached by a B.B.C. "outside broadcast" official for advice about relaying a commentary on the process of steel manufacture. The magnate applauded the idea, but was forced to tell the official that "you can't make steel without swearing," and that if the furnace manager's language had to be refined as well as the steel, the steel would be ruined. And so that "talk" was lost to a world thirsting for information.

"WHERE'S ALL THAT ROW COMING FROM?"



They are measuring the street noises by means of a sensitive instrument on the tripod in conjunction with the valve amplifier on the tailboard.

Gramophone Note.

THE G.E.C. of America is introducing a radio-gramophone on which special records can be played, giving twenty minutes' continuous music from a 12-incher and twelve and a half minutes from a 10-incher. These records are made at the "talkie" speed of 33½ revolutions per minute and the gramophone can be run at either that speed or that of the standard discs (78). The specification of this instrument includes a home-recording device. As to

the radio side, this is a matter of a 10-valve super-het with two pentodes in the output.

Boxing in Snowstorm.

THE Columbia Television Studios of New York recently broadcast a tele-vision of Benny Leonard and Jimmy Martin boxing each other, and although I mean no disrespect to television, I feel bound to report that the men appeared on the receiver screens to be settling their differences in a snow blizzard, and to be handicapped by beards of considerable length. Well, it might have been worse, for the pugilists might have been represented as wearing straw hats, carpet slippers, calabash pipes and bustles!

Does the "Ether" Exist?

I AM genuinely sorry and surprised to observe that the "Scientific American," a reputable monthly, jokes at Sir Oliver Lodge's persistent efforts to obtain positive proof of the ether's existence. It says that modern science believes there is no ether, by which, I suppose, is meant "modern scientists," in which case I would quote Sir Oliver as a notable and formidable exception. The "Scientific American" refers to Sir James Jean's parallel between the ether and the equator—both imaginary. But there's a big difference.

The equator is not a mathematical necessity; the ether is.

The Kenya Station.

I THINK that the Nairobi station deserves some encouragement. It made a public-spirited attempt to broadcast the lion's roar some time ago, said attempt being rendered abortive only by reason of the fact that the local lion had made other arrangements for that particular evening.

I have heard privately that Mr. Leo had an appointment with a springbok at a water-hole and that the affair went off according to programme—no flowers! Nevertheless, 7LO is very much alive—oh and is from time to time giving some nutty little sketches with local talent.

(Continued on next page.)

"P.W.'s" RUNNING COMMENTARY ON RADIO (Continued)

The Stop-Gap.

THE customary blank time on Saturdays between 2 p.m. and 3 p.m. has been the source of considerable criticism of the B.B.C., particularly amongst radio sales people who had no means of demonstrating sets to prospective clients during that period. However, from to-day the gap is to be filled by light music and other entertaining items, which will be a blessing to many besides tradesmen.

A Fishermen's Friend.

I HEAR they are installing a very hot wireless set on H.M.S. "Challenger," which is now being fitted out at Chatham to make an investigation of the bed of the ocean. She will sail in November, and her rather romantic job will be to investigate the floor of the Atlantic with echo apparatus, looking for the happy hunting ground of the hake, the herring, and other fishy tit-bits of the deep.

It is expected that this modern industrial research of the sea floor will do much for Britain's fishing industry.

Au Revoir to "Proms."

AND so once more we bid au revoir to the Queen's Hall Promenade concerts until next August, I suppose. So far as I am aware, the hall has been filled for every one of the concerts, and I don't wonder at it, though some of my acquaintances have cursed the Queen's Hall broadcasts fluently. On October 14th a new series of symphony concerts begins at Queen's Hall, one weekly until May 4th, 1932. Good! Unless it's a Honegger & Co. repertoire!

"That Heathen Chinese."

THIS radio game that we are all in up to the neck is full of surprises. They tell me that Great Britain is now exporting thousands of radio sets to



China, of all places!

Knowing my Hong Kong and Shanghai fairly well it tickles me to think of radio sets being sold there. I can just picture the scene as the impassive Oriental stand in

a junk shop in the Bubbling Well Road.

Customer: "Dis one a good tuna?"

Dealer: "Dat one vellee good tuna. He catchee plenty station!"

Customer: "Speaka Chinese, or speaka English?"

Dealer: "He speaka anything—allasame parrot!"

"Music Hath Charms."

THERE appears to be a growing body of opinion that music facilitates a greater yield of cow's milk and hens' eggs. I am too much a materialist and biologist

to believe that, though I am also a believer in the effect of mind over body. Unfortunately for the theory, the minds of cows and hens do not appear to bulk very large in the make-up of those creatures or the activity of certain of their bodily functions. Sets specially designed for use in cowsheds and hen-houses were shown at Olympia, and the "Bolton Evening News" is moved to declare that Virgil's Ninth Eclogue advises music as an incentive to full udders. I have looked up the passage, and find that what Virgil really advises is that the cows should

off starboard legs? Or scraping their feet before entering, like good, well-behaved bees?

"Nothing Under 70."

THAT was a cute idea of 3 L O, the Melbourne station, to put out a "Nothing under 70" programme.

The veteran announcer, who fifty years ago was driving a stage-coach over the bumpy roads of early Victoria, handled his microphone team as though they were two-year-olds, and everything on the programme went off with a fine swing.

I hear that Melbourne wants more, and now the 70-year-olds are going about with beards fairly bristling with importance, telling all their pals what a wonderful broadcast it was.



"Figgerin' It Out."

THE U.S.A. Department of Commerce produces very interesting statistics, but whether these are all reliable is another matter. Just how they go about estimating that the total number of receiving sets in use in the whole world is 26,243,000 I cannot imagine. Of this number Europe is said to have some 13 million, we leading with about 3,400,000. To the U.S.A. are credited 10½ million, to Canada 284,000, to S. America 721,800, to Asia 795,523, and Oceania 406,425. Secret and unlicensed sets must amount to a thousands.

Sensational Revelation.

I HAVE to announce the timely discovery of a plot to poison "Ariel." N. E. M. (N.W.5) having observed my request for a good nerve tonic, has sent me a prescription which he guarantees will cure me of any ailment. Oh, Mr. Borgia, your recipe is much too grand for a poor man like me. I see that it includes hydrocyanic acid. Couldn't I take that and leave out all the other nice things? Somehow, I don't think that arsenic and strychnine would suit my temperament.

"Listeners Hear No Good."

DETERMINED to find out what the public really thought of his window display, an ingenious radio dealer is said to have fixed a concealed microphone in front of his shop and connected it with a loudspeaker into his office. Then he sat back and smoked his pipe in comfort while listening to hear what people were saying about the goods in the window!

It must have been rather fun, at times. I should think—especially if his errand boy went outside and told the next door butcher's boy what a mean old hound the boss was!



ARIEL

SHORT WAVES.

The B.B.C. authorities consider that "effects" produce a realistic atmosphere; but it doesn't appear to have occurred to them that a few "moo's" would add greatly to the interest of the fat stock prices.

"Punch."

Senator Marconi plans to light a bonfire 5,000 miles away by wireless. So there is still hope for those with petrol lighters.

"Pictorial Weekly."

OVERHEARD.

The Wireless Chorus recently had a strenuous time while broadcasting Schubert's Song of Miriam, and afterwards, forgetting that the microphone was still in a live condition, somebody remarked: "We're all pleased that that's over, aren't we?" But perhaps he did mean to include the listeners.

We understand that a method of counting bees by wireless is being investigated in London.

Judging by our reception last night, some fairly successful experiments were being carried out.

The young sons of a wireless announcer will broadcast soon.

Then little boys will be heard and not seen.

"Punch."

A LETTER FROM SOUTH AMERICA.

Dear Sirs or Madame.—Here we huge affectionate the without wires, but notwithstanding nevertheless, not to hearken at English station, which God forbid. Have the amiableness telling those Britannical broadcasteurs please to emit by the "beam" for fear that us not overhear its emanations.

be fed with good lucerne—a leguminous plant useful for fodder. Bang goes another beautiful idea!

"The Bees Treading."

WHILE I am on the subject of country life as affected by radio, I may as well pause to mention that from America (naturally) comes an idea of enlisting the microphone to estimate the number of bees entering a hive. The mike is placed so that as the bees enter they scrape their feet on it and set up a current which, being amplified, operates a counting device. That is O.K.—but would the device reject current due to, say, five hundred bees scratching their ears with their

D.R. ?

WHAT I THOUGHT OF THE SHOW

BY CAPT. P. PECKERSLEY M.I.E.E

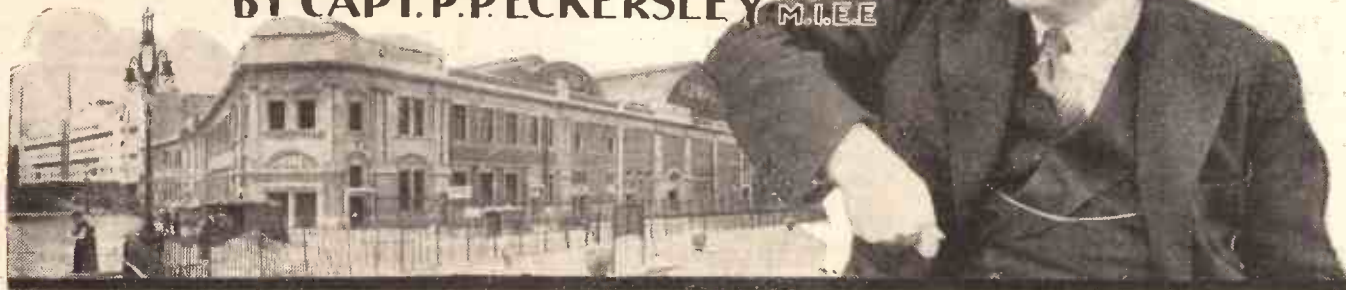

I HAVE been to Radiolympia. I have seen. I am bewildered. I am, however, intrigued. Everybody who is interested in wireless development, in wireless listening, in broadcasting in general, should go to Radiolympia.

But to make a general report is very, very difficult. If a certain thing catches the eye one may humanly miss something else better; if one has certain beliefs others may describe them as prejudices.

The outstanding difficulty, I find, is to criticise the exhibits fairly, since in fact it is impossible to have a demonstration of their true performance. True, some manufacturers have arranged demonstrations, and we must all applaud their enterprise—it shows they have faith. But others who do not demonstrate may have perfectly valid reasons for their abstention, and are certainly not afraid to show off their products.

With this preliminary I now plunge in *medias res*, taking my comments under separate headings, thus:—

Electrical Performance and Circuit Design.

I have already said I do have a little first-hand knowledge of actual performance, but I suppose I may guess at it, to some extent, by my experience with the types of circuit I noticed.

Band-pass and high impedance. That's my general impression. Band-pass high-frequency circuits designed for selectivity and quality; high-impedance valves to increase sensitivity. As a theoretician, I disagree violently with both tendencies; as a business man, looking at a competitive world, I quite see that each forces the other to accept a performance less than might be desirable because the other fellow is bound to steal a march if the one fellow isn't wary.

Band-passing is based upon the erroneous assumption that a ganged condenser maintains strictly accurate matching of elements over the range of adjustments. High-impedance valves certainly give more volts, but are they undistorted volts? I certainly suspect that the pentode detector will give very good quality at big input volumes, but if the input is weak I fear distortion.

There is only one truly original circuit as applied to broadcasting. The Stenode Radiostat may or may not introduce something entirely novel in wireless, certainly it introduces a circuit which in modern conditions of transmission tries to meet the needs of selectivity. Not hearing

"P.W.'s" genial Chief Radio Consultant describes his personal reactions to the National Radio Exhibition in this informative and special contribution.

the actual set on a radio input I am quite unable to judge how far it is successful—certainly the experimental models I heard gave a quality as good as given by many of the sets exhibited.

There were other super-heterodynes. The art of compression is well exemplified on the Marconiphone stand, where the insides of their super-hets were fearlessly exposed to the vulgar gaze. I think we shall see more super-hets next year. If certain snags can be overcome—and for all I know they may have been already—we ought to; it's the best principle, I think, in the long run. That sentence, if quoted, should be quoted *in full!*

"OVER THERE"



A [view of the great Berlin show that has been running more or less concurrently with the British exhibition. On other pages we have included a number of photos taken at Olympia by "P.W.'s" staff photographer

Loudspeaker Design and Performance.

Here one has a better opportunity to correlate both design and performance. I noticed that the moving coil is making a big attack against the moving iron. I notice the moving iron has—with rare exceptions—gone for cheap adequate performance rather than competition in the perfect quality field.

Thus very cheap—moving iron; medium price—moving iron versus moving coil; expensive super-quality—moving coil. There is a remarkable effort to get good quality with relatively low price.

The permanent-magnet moving-coil people show that it isn't really necessary to energise the gap by consuming good current. A more than sufficient volume is obtainable from a permanent-magnet speaker.

On the whole, I feel that there has not been so marked an advance in loudspeaker design generally as I had expected. The manufacturer must study the theory and base his design upon sane conceptions of what it all means. I commend the manufacturer who is bold enough to allow us to see a stroboscopic view of a diaphragm in motion.

Did I not, however, detect an out-of-phase movement between inner and outer edges of the cone? And is not this, in fact, the one thing which must be eliminated? I will not be too sure.

At any rate, it shows that there are some who are designing and not just screwing bits together and hoping for a good salesman.

Record Reproduction.

Incidentally, the gramophone quality seemed exceptionally poor compared with the radio. I cannot reveal, and, indeed, do not know, what pick-up the B.B.C. are using, but it sounded very much like the one we were using when I left the Corporation two years ago.

Very great improvements have been made since then, surely. I also wonder if the B.B.C. give a bass-tapered input which simulates that given by the majority of output valves in the actual sets with which the loudspeakers are normally associated. I thought—but it is very difficult to judge that the quality on radio was a bit bass heavy.

(Continued on page 246.)

THE B.B.C. AND ECONOMY

By THE EDITOR.

Some light on radio's contribution to the needs of the National Exchequer

WELL, and what do readers think of the B.B.C.'s offer to the Treasury? It was certainly a good tactical move on the B.B.C.'s part to make the offer, and no doubt suits Sir John Reith and the other Governors of the B.B.C. much better than putting into practice the recommendations of Sir George May's Economy Report.

If the latter recommendations had been put into effect, the B.B.C. would have had to pay something over £400,000, but, as our Broadcasting Correspondent points out on another page, the B.B.C. really came outside the scope of Sir George May's Economy Report, and consequently Sir John Reith diplomatically opened negotiations with the Postmaster-General and other officials and succeeded in making a much more satisfactory financial arrangement.

Our Colossal Contribution.

At the risk of repeating what readers have probably seen in the newspapers, I will briefly state the position again. The B.B.C. has agreed to forgo £50,000 this year from the licence revenue—that is, in addition to what it already pays to the Treasury and the Post Office—and next year something over £150,000. Mr. Snowden, the Chancellor of the Exchequer, has explained that this year the Exchequer will consequently receive a sum total of £646,166 out of a total gross wireless licence revenue of £2,050,000; while next year it will receive the tidy sum of £775,000 out of an estimated gross wireless licence revenue of £2,250,000.

Add to this the 10 per cent of the total revenue due to the Post Office in order to cover the cost of collecting wireless licence fees, and readers will be interested to know that the Exchequer receives next year at least £1,000,000 from the wireless licence revenue.

"What About the Regional Scheme?"

Immediately these facts were made public a lot of people started to ask: "How on earth will the B.B.C. carry on without radically restricting programme facilities?"

Also, I heard it queried on many sides: "What's going to happen to the Regional Scheme?" "Will it be interfered with?" "What about Empire Short-Wave Broadcasting?" and a dozen other queries which show that the man-in-the-street takes a real interest in the fare offered by the B.B.C. and the progress on the technical side.

Well, the B.B.C. states most emphatically, in answer to inquiries I have made, that the public—that is, the listener—will not suffer. Programmes will not in any way be restricted, nor will the quality of the fare offered be in any way impaired.

Short-Wave Experiments.

Of course, economies will have to be effected, but I understand on excellent authority that these economies will be borne by the B.B.C. staff. Consequently, salaries will be likely to suffer.

The Regional Scheme, however, will go on, although there is still some doubt as to what will happen to the proposed series of experiments in connection with a new and improved short-wave Empire broadcasting service.

There is also a possibility—but readers must regard this as a rumour, because I cannot verify it—that the whole of the B.B.C. service will be placed on a Civil Service basis.

The B.B.C. Orchestra Controversy.

A good deal of publicity has also been given to the B.B.C. recently in connection with its orchestra. It is maintained that this huge orchestra—admittedly the finest in the world to-day—is an expensive luxury, and that the B.B.C. might well make economies in this direction.

It has also been stated in the "Daily Telegraph" that in getting together an orchestra of this size the B.B.C. has "bought off the best players of other organisations."

This has led to a very interesting con-

justified in entering into competition with private interests by means of giving public concerts financed by public money.

"I also agree," wrote Sir Hamilton in the "Daily Telegraph," "that the work accomplished by the B.B.C. Orchestra could be undertaken by other organisations, such as the L.S.O. and the Hallé Orchestra, with at least as good musical results, and with much advantage to the financial well-being of these organisations and others, and possibly a considerable saving in the sums now being expended under the B.B.C.'s present system."

There seems to be a definite case against the B.B.C. in connection with this orchestra, and I have yet to notice any really convincing reply to the criticisms made by Sir Hamilton Harty and other critics in the "Daily Telegraph." If these gentlemen are correct in their facts—and I have absolutely no reason to doubt them—then it seems that the B.B.C. is not really justified in spending so much money—estimated at £100,000—on its huge Symphony Orchestra these days, not only because of economic conditions but because other orchestras are undoubtedly suffering.

How It Affects the Listener.

This is not the first time that criticisms have been made against the B.B.C. for securing at the expense of other orchestras the best players for its own Symphony Orchestra.

"ROLL AWAY, CLOUD"



Many records were broken (and many were cracked!) when a record-rolling race was held in London not long ago during the annual sports of the Columbia Graphophone Co.

trovsky, for the B.B.C.'s official organ, in reply to the "Daily Telegraph," maintains that not more than six musicians in the full Symphony Orchestra strength of 118 players had been obtained from leading orchestras. Nevertheless, the "Daily Telegraph" Music Critic maintained in reply that some forty players had been withdrawn from the Hallé and the various London orchestras.

Sir Hamilton Harty has explained why he has decided to cancel his series of projected London concerts with the Hallé Orchestra. Sir Hamilton says the reason is purely economic, and he states in connection with the B.B.C. that he is fully in agreement with the contention that the B.B.C. is not

Of course, the listener in the end does not suffer, because he gets the finest possible band that can be organised.

On the other hand, is it necessary for the B.B.C. to run an orchestra of this size when there are so many other first-class orchestras in the country, the services of which could probably be obtained for broadcasting purposes?

Investigate the Criticisms.

I think the B.B.C. ought to arrange for a thorough investigation of all the criticisms that have been levelled lately at its policy in connection with orchestras, and to come out in the open and state the facts clearly and concisely once and for all.

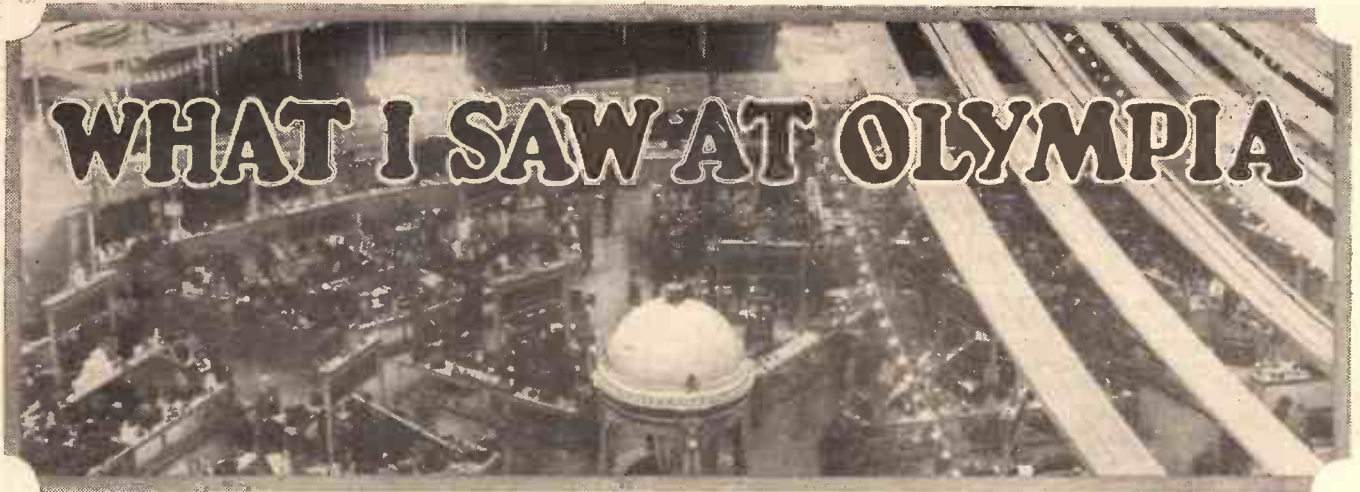

THE local authorities seem determined to make a good job of the main road that runs past Olympia. If my memory serves me well, it had the appearance of a well-shelled battlefield on the occasion of the last Radio Show. But perhaps the Kensington Road is now a permanent "hole" (as per Seamark) and is destined to be handed down from one excavating generation to another.

Anyway, single-file traffic only is possible, and at exhibition time that inevitably means congestion and delay. However, I had plenty of time at my disposal, and I did not find the very slow approach by bus at all irritating.

On the contrary it gave me plenty of time to find my pass and get together pencil and notebook. Also I missed none of the external "atmosphere," and this I might well have done had the bus swung up at speed.

As it was I found the traffic crawl as good as walking, though more restful. I always think that in the usual way one should alight from one's vehicle a good quarter of a mile or so away from an exhibition and complete the journey at a stroll.

Particularly is this the case with Olympia which is always beflagged and gay with banners and streamers. Some of these stretch right across the main road and lend the whole neighbourhood a festive air.

The Outer Circle.

And, again, one should never miss the "outside" shows, the shops and other premises that have been taken by firms not exhibiting at Olympia itself. I generally feel rather sorry for these. They put up such pluckily, gay and attractive

A member of "P.W.'s" staff spent a whole day wandering around the National Radio Exhibition, and he records his impressions in the following very readable article for the benefit of "P.W." readers.

little displays, and yet most people stride purposefully by with their eyes fixed rigidly on the main entrance of Olympia. And when these same people come out they rush for buses and trains quite heedless of the attractions of the "outer circle."

Peaks of the Past.

Nevertheless, I noticed that a number of the "outsiders" (I use the word in its purely literal sense) were collecting very excellent audiences of earnest students of radio. And, in passing, I must mention, too, that at least a few of the firms concerned

were showing outside from choice and not because they were compelled to do so.

This was the tenth National Radio Exhibition, and I have been to them all. And each successive one has outshone in size and general appeal all its predecessors. Has this radio no saturation point?

The first show at the Central Hall, Westminster, was a comparatively tiny affair, but visitors swarmed down on it, and the attendance was out of all proportion with the dimensions of the premises.

The succeeding radio exhibitions did not increase in size gradually, they swelled out at an alarming rate. Three years ago the Main Hall and Gallery at Olympia were filled right up with stands. Last year an overflow swept right over the first floor of the then-new Empire Hall. And now, this year, both the ground floor and the first floor of the Empire Hall were packed with stands in addition to the Main or National Hall.

Will the Radio Show be bigger still next year? I, personally, would not like to say. But I would refuse to believe we have reached the peak, for that peak has been proclaimed as attained at humorously regular intervals in the past!

Too Big Now?

I am, however, of the opinion that the trade would be usefully served if an artificial brake were now to be placed on the expansion of the Exhibition. The show was magnificent as a spectacle, marvellous as an entertainment, but far too huge to serve as a real guide to the buying public.

It is said that there were five thousand different radio sets on view. I can readily accept that statement, and if the

EARLY VISITORS AT "P.W.'s" STAND

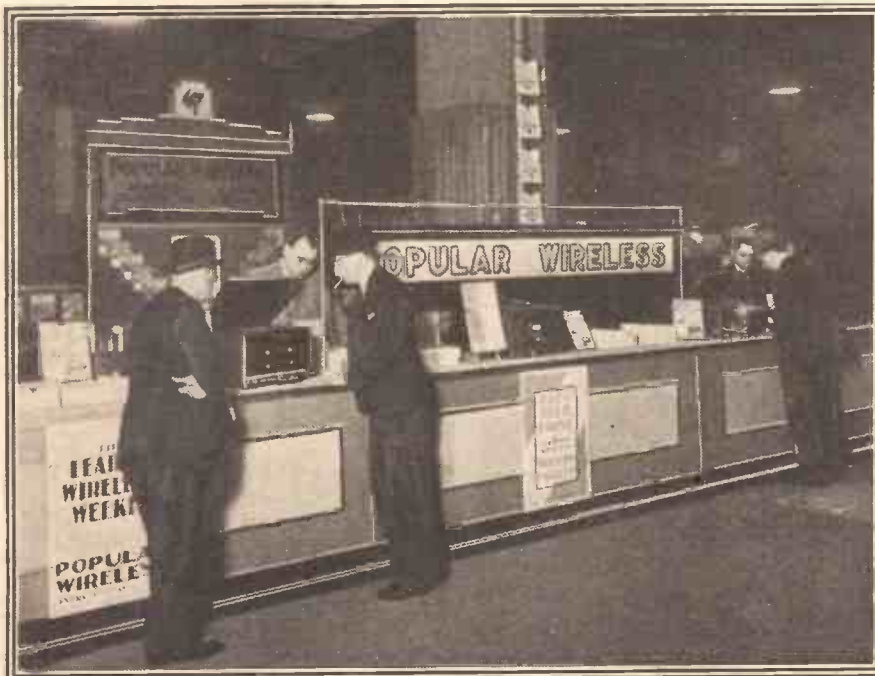

This photograph was taken immediately after the Exhibition opened. Later in the same day it was difficult to approach the stand owing to the crowds around it.

WHAT I SAW AT OLYMPIA

(Continued from previous page.)

industry considers the public are able to choose between the conflicting claims of this mass of gear, then there is nothing more to be said, for, as I have indicated, as an exhibition Olympia was truly grand, and those who were unable to visit it undoubtedly did miss a wonderful experience.

An awe-inspiring sensation of grandeur almost took one's breath away at the entrance of the Main Hall, which was a mass of blue and gold, and twinkling lights reaching from floor to lofty ceiling.

And although I entered early in the afternoon, there were already thousands of people around the stands.

A Good Beginning.

For my part, no exhibition tour could have begun more pleasantly, because the very first display to meet my eye was that of our old friends Ready Radio, and for five minutes or so I craned over the shoulders of the jostling crowd around it.

I craned all the more, for the objects creating the most attention happened to be versions of "P.W." and "M.W." sets built up with glass panels and glass cases. And when an elderly man turned to me with the free and easy camaraderie that always seems part and parcel of "a show" and observed: "Cute, isn't it?" I rejoined: "Is it?" and had my low cunning rewarded by an almost passionate defence of the virtues of the "M.W." "Super-Quad"!

Probably it was my imagination, but it seemed that the large portrait of the cheery old man at the Exide stand bore a distinct likeness to my Ready Radio chance acquaintance, and that his eyes gazed at me with no little reproach!

LOOKING DOWN ON THE NATIONAL HALL

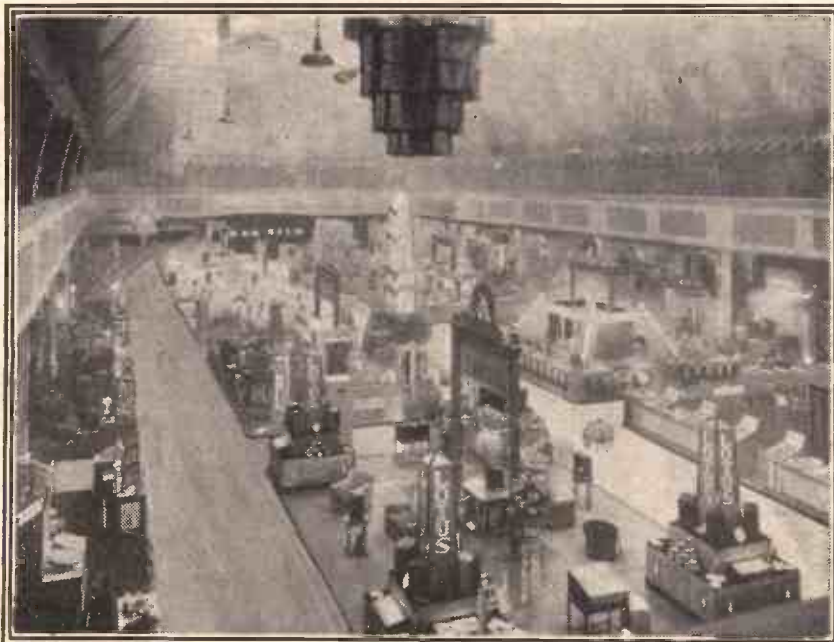

In addition to this Main or National Hall, the whole of the New Empire Hall was packed with stands.

The portrait, by the way, carried the inscription "Long Life," which was an obvious, albeit clever, link with the Exide and Drydex batteries on show. The big picture was flanked at each side by two

visitors would have thought these valves were bright emitters. But, of course, that criticism does not hold good to-day, for the dull emitter is in universal use. Lissen's extremely cheap loudspeaker for home-

A VERY ATTRACTIVE DISPLAY



The pretty personnel of a "home-recorder" display.

large models of one of the Exide accumulator cells.

Light on the Valve Subject.

Lissens were drawing plenty of attention with a particularly ingenious stunt. Groups of their valves were alternately flashing with internal illumination in order to show their internal constructions.

It occurred to me that a few years ago

assembly caused considerable interest. The instrument certainly does look attractive, and at a distance of three or four feet anyone would accept it for a solid wooden cabinet mod' of quite orthodox construction.

I had walked only a few yards when Cossor pleasantly came to my notice. A beautiful "Gretchen" handed me a leaflet. I glanced at her bright eyes, and remarked to myself, "I'll wager enterprising Cossor planned this attack on the susceptible male." And so it was.

Girls of all nations—or, I suppose, girls dressed in the national costumes of all nations—made the Cossor display a "winner." And could there have been a more pleasurable reminder of the space-breaking qualities of the radio gear which bears the brand of "Cossor"?

Science and Showmanship.

I was about to write that "T.C.C. were more scientific," but if their show was, perhaps, slightly more staid, the phrase still cannot hold good; for, after all, Cossor exhibited one hundred per cent science of showmanship!

Anyway, T.C.C. had some colossal fixed condensers of high-voltage types such as are used by high-power transmitters. These "out-size" components are so big that they appear to have little in common with the tiny T.C.C.'s such as you and I use in our radio sets, and yet they are fundamentally similar.

These references to dimensions remind me of the diminutive pageboys that continually dodged between one's feet during the tour of the stands. The little fellows were everywhere, and if they were all engaged upon legitimate business

(Continued on next page.)

WHAT I SAW AT OLYMPIA

(Continued from previous page.)

errands, then the firm employing them must have been conducting simply enormous business!

I hesitate to suggest an alternative—

an interesting psychological point. I wonder what home-constructors' reactions were to one of the G.E.C. features. This comprised (1) a distinctly girlish girl (if you know what I mean) assembling (2) an "Osram" Four.

Deftly her slender fingers flew among the various components and wires, and rapidly but surely the receiver took its attractive final form. Inference: if a girl can do it, so can you! But there is a pretty little riddle buried in the above

which I considered one of the most inviting in the whole of the vast hall. I longed like anything to be able to drop into one of the big red Lotus settees or arm-chairs and experience the sensuous softness of those bright green cushions! But I had neither the time nor the courage, so I spent a few minutes examining the Lotus sets and components, and passed on.

So far, you may have observed, perhaps with irritation, that I have had little or nothing to say about individual apparatus; and if you are waiting for me to go "cataloguey," I fear you are to be disappointed.

My job is to give you "atmosphere" and "impressions"; you have already had full descriptions of individual exhibits in the last two issues of "P.W." However, later I am going to attempt a summary in which I will hearken back and mentally survey the tons of radio apparatus that I examined.

An Electrical "Colorama."

In the meantime, what drew me to Ediswan's stand? Excellent sets? The famous and new inexpensive R.K. speakers? That classic B.T.H. pick-up? Partly, and also an invitation to press buttons and see registered on meters the power output of the AC/PEN.

I don't suppose one-half of one per cent of the button-pushers appreciated the significance of "grid swing" and "anode current" needles swinging. But that apparently didn't worry them a scrap. There were buttons to press and things to happen. So they pressed buttons and—well, they just pressed buttons and everybody was quite happy. I think everyone was greatly struck, too, by this firm's new form of coloured lighting—an enchanting, ever-changing "colorama." Ediswan made many friends in that cheerful atmosphere.

Ferranti, on the other hand, were *grimly* efficient. They operated at the sign of the "flashing hand." Buried in a huge cave-like alcove cornered by those crystal hands grasping forked lightning, earnest young

(Continued on next page.)

EARLY SIGNS OF ENTHUSIASM



One of the earliest visitors making close inquiries regarding the "P.W." "P.V. Plus" receiver.

that these youthful Mercuries were darting about merely to draw attention to the respected name that appeared in artistic letters on their uniform! Anyway, they were all over Olympia all the time I was there, and so were those Mullard bags. A very bright thought, that. As you passed the Mullard stand a charming young woman—one of several such—offered you a stout paper bag which, again being a mere man, one simply had to accept.

And as there were no convenient methods of disposing of same, one had to carry this brightly coloured Mullard bag around, becoming, as it were, a sandwichman, unpaid! And because the thing was strong and had a nice handle—well, one used it to accommodate the sheaves of leaflets and catalogues that were collected. In the end, you and your Mullard bag became inseparable, and Mullards triumphed!

Did You See Her?

There were two horn type loudspeakers on the Igranic stand—but don't gasp! These speakers were huge public address affairs, and were exhibited with their amplifiers.

I thought Lewcos particularly fortunate in that their bright blue wire with which so many of their coils and frame aerials are wound fitted in so well with the standard blue and gold colour scheme of the exhibition.

And mention of colours, by no very devious train of thought, brings me to

few lines, and its subtlety is even greater than that of this present sentence. I leave it for my readers to ponder over at leisure!

I must hasten on to the Lotus stand,

WHAT A RELIEF!

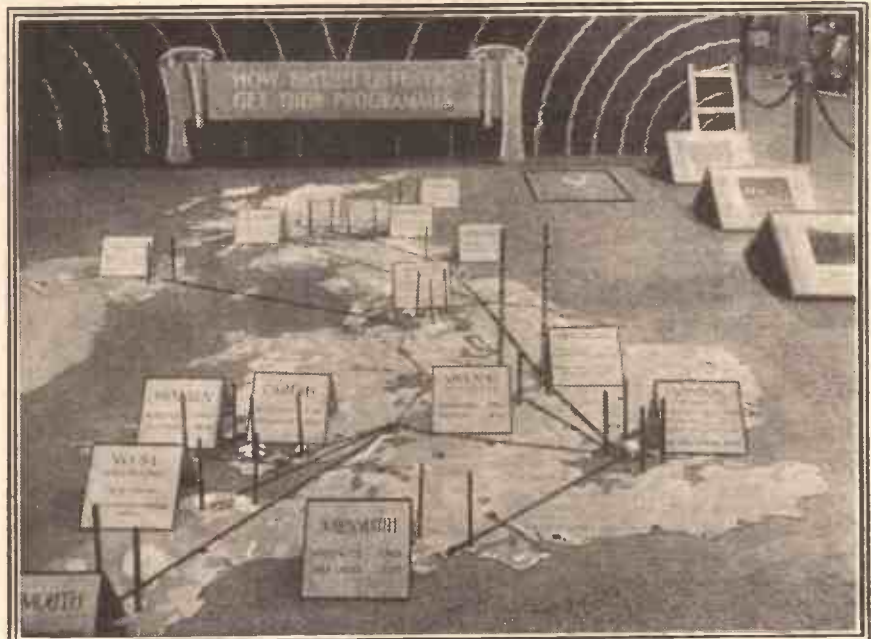

The B.B.C. had a big relief map on view, which illustrated the interlinking of British stations.

WHAT I SAW AT OLYMPIA

(Continued from previous page.)

men tore scepticism away from their visitors and threw them back into the passing stream complete converts to the Hollinwood road to true radio.

And just over the way three long bazaars sheltered the wares of R.I. "Dux," the new L.F. transformer that has created such attention, had a large pictorial back-piece of a magnitude and quality fitting its purpose.

The Candid Demonstrator.

And R.I. Stenode sets graced an appropriate drawing-room setting. Of course, R.I.'s genial managing-director was in evidence, and willing to discuss anything at length with any casual passer-by. What an enthusiast that kindly magnate is.

The whole of the gallery of the Main Hall was devoted to demonstration rooms, and it took me over an hour to dodge in and out of these. I have not the space to recount my adventures there in full, but I must tell you about the Candid Young Demonstrator. (Note the capital letters; their purpose is *not* to mark this incident as a fable!)

I went into a demonstration room rented by a concern who shall be nameless. I listened to a loudspeaker.

"Tell me," said the well-dressed young man, who did not know me as anyone but an ordinary member of the public, "what do you think of it, honestly?"

"You want the truth?" I asked.

AS CLEAR AS CRYSTAL

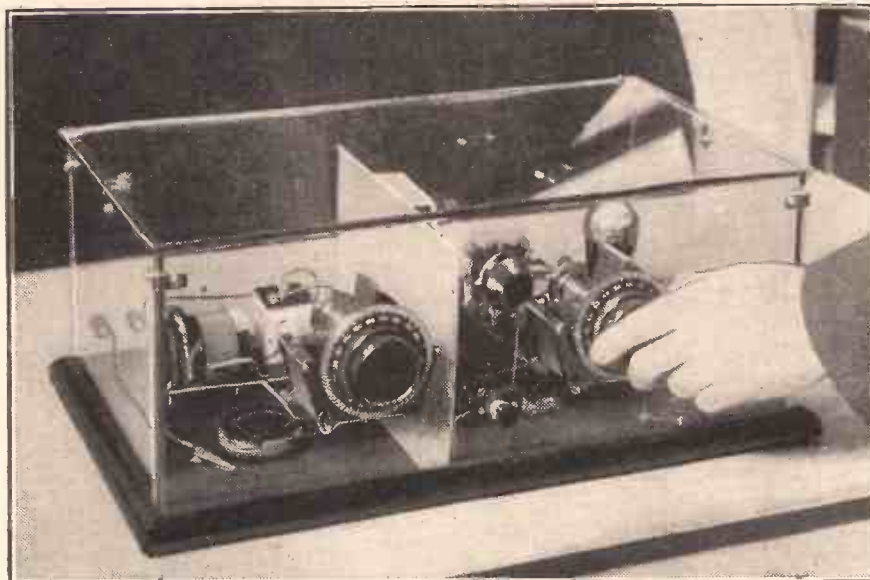

One of the glass-cased Ready-Radio exhibits. It is a "P.W." "P.V. Plus" receiver.

"Yes, I want the truth," he smiled. "You want me to tell you exactly what I think of this loudspeaker?"

"Yes, exactly what you think." "Well, I think it is rather poor as speakers go these days," I replied, and added: "and what do you yourself think?"

The young man sighed deeply. "I don't think it is too good either, sir, but one must live," he observed.

That made me feel rather sad. And I felt even sadder when I wandered round and gazed at the exhibition effort achieved by our B.B.C. Staid and statistical, as usual.

It is true that in my heart of hearts I had expected nothing else. Graphs, curves, literary displays, licence figure maps—all very primly and properly displayed. Ah, well! There was, at least, the dignity expected of a big corporation.

Did You Dance?

I hastened on and paused by the Terpsichorean arena, or, in other words, the dance floor. Now this was bright, cheerful, human. My spirits rose and my feet itched as I watched the graceful dancers wending

(Continued on next page.)

CAPTIVATING COSSOR



Two of Cossor's pretty "internationals." On their sashes appeared the words: "Hear All Europe with Cossor."

STAR-GAZING!



A visitor inspecting the "P.V. Star" at the "Popular Wireless" stand.

WHAT I SAW AT OLYMPIA.

(Continued from previous page.)

their ways in and out of the moving pools of coloured lights thrown by foot-level lamps. Were those so-well-dressed young people who were dancing casual visitors lured on to the floor by the strains of Jack Payne's cheery orchestra as heard through

ANOTHER B.B.C. EXHIBIT



A "set piece" by the B.B.C. which is quite self-explanatory.

the large loud speakers? Were they, on the other hand, pairs of "ten-cents a dancers?" I don't know, but they were good to gaze upon.

I wended my way down the stairs (ignoring the notice which said "Lifts to all floors," because I couldn't see any lifts working) and sank into one of the thoughtfully-provided chairs in the big lighted cavern that separates the National Hall from the Empire Hall.

I chose a chair from which I could see everyone who passed between the two halls. I turned my back to the lady on my left. It was ill-mannered, I know, but, you see, she was sucking an orange with fierce gusto!

What the Onlooker Saw.

I sat in that chair for half an hour, and carefully noted the passers-by. I saw men and women of nearly all nationalities, though there were more "Indians" than most others, except, of course, Englishmen. I presumed that the Round Table must be a very big table!

Most of these visitors were men, and what women there were seemed, for the most part, to be accompanying men-folk. I am afraid I am unable to agree with those journalists who continually described the show as a "woman's show."

The women I saw taking a really keen

interest in the exhibits were mighty few in number. But there were quite a lot who were patently glad to seize chairs and sink into them while their men continued to roam around.

Mind you, these are my personal impressions—they may run contrary to facts.

Instead of proceeding straight into the ground floor of the Empire Hall, I again ascended the stairs and inspected the first floor of the Empire Hall. Frankly, this disappointed me. I don't mean that the exhibits were not interesting; they were, particularly the Wright and Weaire Home Recorder, and other Wearite exhibits, and the Cyldon stand, where an extremely fine array of Extensometers was to be seen, together with "P.W." and "M.W." sets built up, but the general layout and appearance of the floor itself seemed rather dingy and—well, a bit more higgledy-piggledy than its sombre decorations could get away with.

I don't think the exhibitors in that part of the show were well served, and I wish them all better luck in the

However, the "P.W." stand, I can honestly and very gladly say, was undoubtedly the biggest attraction in the Empire Hall. We had a particularly fine show of sets this year, and they were very beautifully arranged. Great assistance was also given by some special lights that were fitted.

Further, the stand was placed rather better than many of the others, and you could see at least one of its glowing signs at the other end of the hall. While I was watching various groups of visitors examining our exhibition sets, I noticed that one of our technical experts was engaged in conversation with a negro—a very friendly, very widely-smiling negro, and I wondered what his query was. Probably it was something most conventional, such as what kind of aerial, etc.

A Snow-white Attraction.

A Snow-white Attraction.

Subsequently to browsing over the intriguing products grouped around a great, big, snowy-white "Polar" bear, I paused awhile to examine the lavish display of valves at the Osram stand.

Note the plural. I said valves, for there were hundreds of them. Large panels studded with valves as profusely as a pearly king is studded with buttons!

Varley indicated their most important exhibit by an array of glowing glass cubes. These looked like big dice (without spots) made of ground glass and internally illuminated. A very clever attraction. And,

(Continued on page 244.)

"A SANDWICHMAN UNPAID!"



The handy Mullard bags were found very useful by visitors for holding leaflets, etc., and certainly widely advertised the name of Mullard.

ballot for stands next year—if it is a ballot that decides the floor and hall.

The ground floor of the Empire Hall was much brighter and gayer, though the fountain, in my opinion, would have been better had it not been there! It was such a small fountain, emitting such thin, weak little streams of water for a big exhibition hall—or so I thought.

Perhaps that was my impression because not so very far away was our own stand! Possibly, I was subconsciously conceiving of a fountain fitting the circulation of "P.W.," a fountain of dimensions worthy of—but I am going "too 'P.W.'" for the purposes of an impartial review!

THE MIRROR OF THE B.B.C.

SIR JOHN'S TRIUMPH

THE FUTURE—SCHNEIDER TROPHY FRACAS—THE BROADCASTING UNION.

HAVING heard the full inside account of the negotiations leading up to the announcement in the House of Commons of the B.B.C. contribution of an extra £200,000 to the Treasury in the next eighteen months, I have no hesitation in describing it as another personal triumph for Sir John Reith.

Returning from his visit to Germany, he found the May Committee's suggested £475,000 extra "cut" regarded as almost a foregone conclusion. But he promptly set to work and in characteristic fashion soon demonstrated that the May Committee had actually exceeded its functions in discussing the B.B.C. at all, and, moreover, in ignoring B.B.C. evidence about broadcasting had invalidated its recommendations, anyway.

Then, having cleared that out of the way to the satisfaction of Major Ormsby-Gore, the new P.M.G., Sir John set about determining how much the B.B.C. could offer as a voluntary contribution.

The ready help of Mrs. Philip Snowden clinched the new "deal." It is no detraction of Sir John's triumph to say that it was shared by the able wife of the Chancellor of the Exchequer.

The Future.

So far as I can discover, the B.B.C. has managed to make the additional sacrifice without endangering any of the really important services. The savings are being found from reduction in the emoluments of the staff and in super-active economy. There is also the determined endeavour to increase profits from publications despite hard times.

While commending the resourcefulness and courage which has saved the B.B.C. from the mutilation contemplated by the May Committee, I cannot refrain from repeating that I think it was taking a barely justifiable risk to refrain from publishing the B.B.C.'s case against the threatened impost.

And I would add this word of warning, that there should be no relaxing of vigilance at Savoy Hill; difficulties may increase, the temptation to raid may strengthen.

Schneider Trophy Fracas.

At the R.A.F. Club the other day, I was amazed to hear from a reliable source that the Schneider Trophy Broadcast on Sunday, September 13th, came within an ace of being cancelled because of a terrific row between an important B.B.C. official and the authorities in control of the Trophy Competition.

At one stage it is alleged that the B.B.C. official was informed that Squadron-Leader Helmore, the Commentator, would have to

lag behind the Press at an interval of at least five minutes.

This produced a series of ultimata, during which at one critical moment the B.B.C. man was threatened with summary eviction from the pier. In the end, however, sweet reasonableness prevailed and the public received its commentary as advertised.

But there is still a good deal of ill-feeling and the relations between the B.B.C. and the Royal Aero Club will be overhauled long before any similar co-operation is contemplated.

The Broadcasting Union.

Since the success of the obstructionists to an emergency meeting of the Post Offices of Europe to re-cast the Prague Plan of wavelengths, serious doubts are entertained as to the wisdom or value of continuing the International Union of Broadcasting.

The position appears to be that the attitude of helpful co-operation and the spirit of give and take which were in evidence at the beginning have now vanished. Naked nationalism is in charge.

Five years ago I said that this country would be well advised to seize those ether channels which it wanted and, by the use of overwhelming power and reprisals, keep these channels clear.

This is the course upon which we may have to fall back perhaps too late. I hope not. A straight-away scramble is ahead and the victory will be to the big battalions, in this case overwhelming power.

NEXT WEEK

"P.W.'s" FIRST GREAT

AUTUMN GIFT ISSUE

ORDER NOW

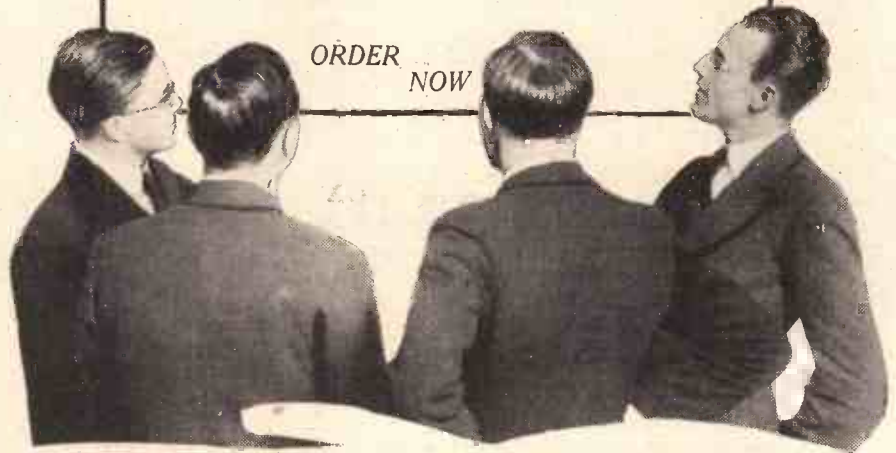

FOR THE LISTENER

By "PHILEMON."

Could the vaudeville programmes be improved? Our contributor says that some favourite artistes take their broadcasting far too easily.

THERE is something unsatisfactory about our vaudeville programmes. I feel rather churlish in making the complaint, for I have a warm corner in the heart for any man who tries to entertain me. Yet the fact has to be faced that this part of our programmes is often the most backward and least efficient of any.

It isn't only the second and the third-raters who are at fault; the stars themselves must bear some blame. Not because they often serve up antiquated stuff, but because much of their new stuff is not up to standard.

I admit that it must be difficult. A music-hall artiste, going the round of the halls in various parts of the country, with practically a different audience every night, can continually pour out his best wine.

He has a soft job compared with the broadcasting comedian, who appears at frequent intervals before the same audience. Nevertheless that's his job, and it's up to him to deliver the goods.

I think the favourites are inclined to take their wireless audiences too easily.

Those Old Gags.

The other night, one of them, a very amusing and competent fellow, tried to get away with the exceedingly ancient wheeze about the sandwiches and the "sand which is there." He may have cracked this mouldy chest-nut with some excellent comic business which took the studio audience by storm; but all we got was a pun which

(Continued on page 252.)

D.R.?

DUX

The RELIABLE LOW PRICED L.F. TRANSFORMER

"DUX" was designed and produced by R.I. to meet the demand of the British Radio Public for a *thoroughly efficient transformer at the lowest possible price.*

"DUX" has been tested and proved by "Popular Wireless" and all the other reputable Radio Press to possess a remarkable performance equal to that of transformers costing many times the price.

That the public has appreciated the remarkable value and performance of "DUX" is amply demonstrated by the enormous demand which has already been experienced for this splendid British component, and the many glowing letters of praise for its performance which we have received.

Use the full technical information given with "Dux" as your medium of comparison. It is your assurance that "Dux" will give you reliable, satisfactory service. You know, before you buy, what "Dux" will do for your set.

Technical Data:

Primary Inductance
30 HENRIES

Radio . . . 1 : 3½ standard, or 1 : 4½ auto-connection.

Weight 11½ ozs.

Approximate Dimensions, 2" x 3¼" x 2½" high.

List No. DY29

Ask your Dealer or write to us for the "Dux" Technical leaflet and our 1931-2 Catalogue.



"DUX"
The Leader

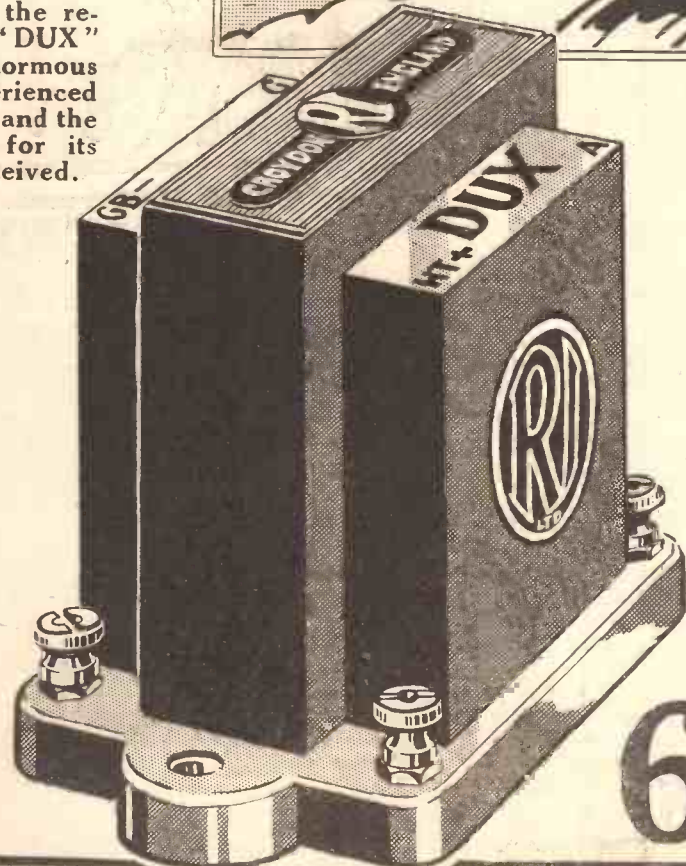

The Lowest Price you can pay for Reliability and satisfactory Service.

6/9



GET FIRST—AND BE SATISFIED

New Ekco Power Units

... never before such amazing performance, such outstanding design



Surpassing all previous achievements... triumphs of efficiency... embodying exclusive features... combining highest efficiency with greatest simplicity.

Immediately adjustable for different output voltages by a method which eliminates all variable resistances and their attendant defects. All the controls compactly arranged, readily accessible, clearly marked. Cleverly recessed, too, so that they do not protrude above the surface of the cabinet. Measuring 9 ins. by 5 ins. by 3 3/8 ins... ideal for portable sets... and for all other receivers. Incorporate Westinghouse Metal

Rectification. Banish all battery worries, renewals and expenses for ever... and give you better radio... permanently... for only a few pence a month.

Worth knowing more about! Post coupon now for full details!



EKCO NEW H.T. UNITS

(For A.C. Mains)

- Model A.C.12 for 1 to 3 valve sets (12 m/a output) £2 15 0
- Model A.C.18 for 1 to 5 valve sets (18 m/a output) £3 7 6
- Model A.C.25 for multi-valve sets (25 m/a output) £3 17 6
- Model D.C.15 25 for D.C. Mains (15 or 25 m/a output) £1 19 6

EKCO NEW COMBINED H.T. AND L.T. CHARGER UNITS

(For A.C. Mains. Supply H.T. and also keep your accumulator constantly charged.)

- Model K.12 for 1 to 3 valve sets (12 m/a output) £3 19 6
- Model K.18 for 1 to 5 valve sets (18 m/a output) £4 12 6
- Model K.25 for multi-valve sets (25 m/a output) £5 7 6

All obtainable on **EASY PAYMENT TERMS** from as little as 3/8 per month!

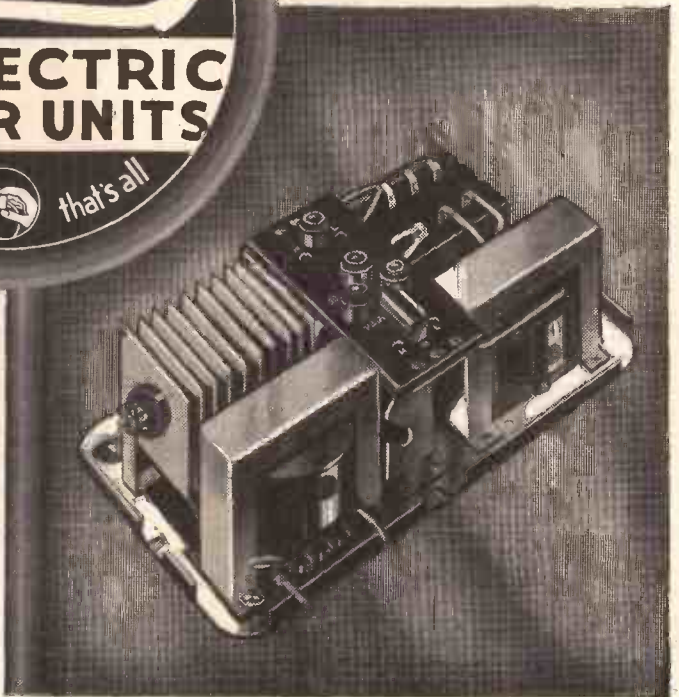

To E. K. Cole, Ltd., Dept. A.14, EKCO Works, Southend-on Sea.
Please send me full descriptions of EKCO Power Units with which I can finish with batteries for ever and obtain permanently perfect radio at a cost of only a few pence a month.

Name.....

Address.....

(If you require details of Easy Payment Terms put a cross here.....)

OPERATING OUR "P.V." SETS



IF we had ever had the slightest doubts as to the interest our "P.V." sets would arouse (which we didn't!) they would have been entirely removed by the sudden swelling of the "P.W." postbags from the day following the publication of the first "P.V." article.

Hundreds of letters have arrived from all over the country, and by the way, no greater proof of the keenness of the home-construction movement could be afforded. It is very evident that this is going to be a great radio season, and that "P.W.'s" "P.V.'s" will be springing up all over the country during the next few weeks!

SAVES THE H.T.



Don't neglect the little one-cell grid-bias battery that serves the S.G. valve, for it reduces the H.T. current consumption. It should be tested every eight or nine weeks.

So far it would seem that the two models are attracting practically equal attention.

That Shorting Tag.

Many correspondents prefer "P.V. Star" because of its handsome appearance and handy side-controls, while others are "all out" for "P.V. Plus," with its progressive possibilities, simplicity and inexpensiveness.

And that reminds me. Quite a few seem to think that "P.V. Star" is—well, an expensive set. I thought I had made it quite clear that, despite its professional, polished appearance and up-to-the-minute side controls and other original features, "P.V. Star" is, in fact a distinctly inexpensive proposition, and though it is admittedly not quite as easy to build as "P.V. Plus" it is still as simple to assemble as many conventional designs.

Its construction is most decidedly a task

The concluding notes regarding the construction and operation of "P.W.'s" two Exhibition receivers. Articles dealing with the "P.V. Plus" refinements and the fitting of a pick-up to "P.V. Star" will appear in early issues.

well within the capacity of a constructor who has had almost negligible experience of home-construction, for there is no soldering to be done and no under-baseboard wiring, etc.

In regard to the building of these notable sets, there is one point that I have not covered in previous articles and which apparently is not quite clear to some readers.

It concerns the .0005-mfd. variable condenser which figures as one of the side controls on "P.V. Star." The words "shorting tag" appear on the wiring diagram against this component.

Automatic Switching Effect.

This can be entirely ignored if you buy one of the special aerial series condensers made by Ferranti Ltd., for this already incorporates a shorting scheme. When the moving vanes are turned right round to the "all out," or minimum capacity position, a switching effect automatically occurs and the moving and fixed vanes are metallically joined together.

This "shorts out" the whole condenser, and it becomes nothing more than a terminal joining two pieces of wire—the two leads which connect to it. For all practical purposes the condenser is then not there at all.

Make Your Own.

There are other makes of condenser which can be used for the aerial selectivity scheme, but which do not include a shorting-out arrangement. If you buy one of these types; it is extremely easy to make it a "self-shorting condenser" yourself with the assistance of a

piece of copper foil (and let me whisper this—you could as a last resource use a bit of tin-plate cut from an old cocoa or milk tin).

Cut a little piece of this material, bore a hole through it and fix it under the fixed vane securing nut, as shown. Bend the foil right over so that when the moving vanes are right out to the minimum capacity position they touch this foil.

Simplicity in Tuning.

Finally, if you do not feel like tackling this job, though I assure you it is quite a simple one, you need not worry much about not having the shorting device, especially if you are obtaining all the long-wave power you need. The idea of the shorting is so that when you are roaming round the long waves you can cut out the series aerial condenser and thus obtain the maximum possible power, for the component is not needed on the long waves at all—in this respect it is exactly opposite to the baseboard variable condenser in "P.V. Plus," which is operative only on long waves and not needed on the short waves, but this one is quite automatically cut out of circuit by the action of the Extensor.

And that quite naturally brings me to
(Continued on next page.)

KEEP IT AWAY FROM THE SCREEN

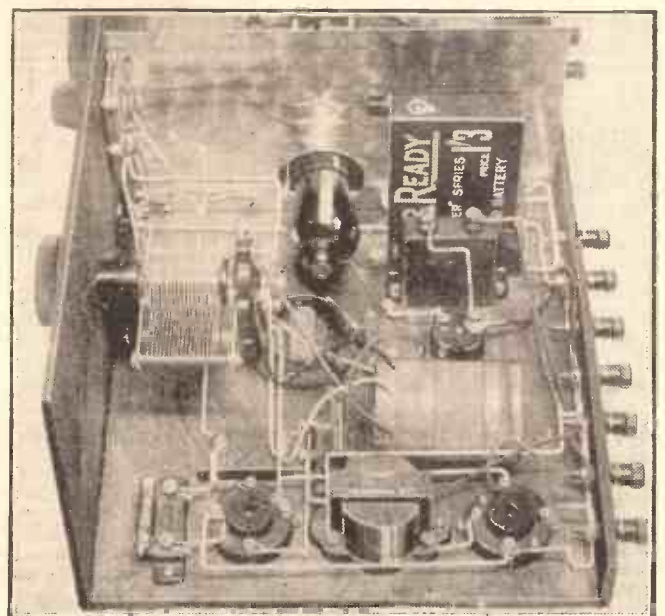

When fitting the S.G. valve in position make certain you connect up its H.T. leads before switching on.

OPERATING OUR "P.V." SETS

(Continued from previous page.)

another point. Those of you who have not yet had any experience of "extended" sets may at first be rather overwhelmed by the sudden merging of two wave-bands into the single-dial rotation.

It must never be forgotten that the Extenser in no way interferes with the regenerative effects of a circuit, and that these always vary considerably at different points in the wave scale.

Handling the Reaction.

You might not notice this so much when using wave-change switches, for the act of pushing in and pulling out such things (which are often very tight) is a crude scheme which imposes awkward physical actions on you. And the considerable readjustment of a reaction condenser is, by comparison, an easy, effortless operation.

THOSE SELECTIVITY ADJUSTMENTS

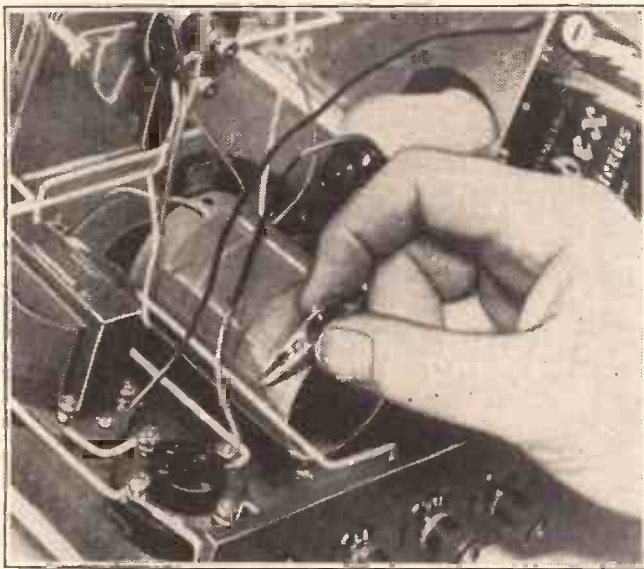

Make sure that you have the various selectivity adjustments properly made before you finally judge the possibilities of your "P.V." set.

But actually, although, because of the above you may not have noticed it, reaction settings tend to vary quite a bit between say, 300 and 1800 metres. We have achieved a pretty high degree of constancy with our "P.W." differential reaction system, and over the medium wave-band and, indeed, over the long wave-band from 900-2000 metres, you will find the reaction effects are fairly even on any "P.W." set.

Big Wave-length Alterations.

But when you slip with effortless speed from 300 metres to 1800 metres with a single flick of an Extenser dial, you can hardly expect reaction automatically to keep pace.

Therefore, a readjustment of the reaction condenser is nearly always needed if you are receiving on the upper limits of the set's sensitivity. (If you are operating the set with little or no reaction, it will not matter a scrap on which wave-band you happen to be.)

So when you leave the set for the "household" to handle (carefully restricting them to the Extenser dial and on-off switch!), see that the reaction is well down, otherwise they may run into some squeaks!

It Was Too Luxurious!

The above reminds me of a motoring friend who remarked to me one day: "Have you noticed how bad the roads are getting—they seem to go from bad to worse." My reply to this was: "No, my boy, the roads are not getting all that worse, it's your mentality that is changing. Your ill-gotten gains are overtaking your powers of adaptability. You have bought three cars to my knowledge during this past year—each one 'posher' than the last. You notice every little bump in the road simply because you expect your magnificent auto to turn all the roads into billiard tables. It can't do that, but I expect it's really making motoring gloriously luxurious—cast your mind back to the days when you bounced around in an old-fashioned 'tinlizzie.'"

And he said: "By Jove, I believe you are right!"

Thus with the Extenser; it is such a step forward in tuning simplification that many can be forgiven for expecting it to carry all kinds of other revolutionary improvements with it.

It certainly has several incidental advantages, as regular "P.W." readers will know, but it cannot possibly rejuvenate H.T. batteries, overcome the disabilities of faulty loudspeakers, and so on!

Don't smile at that, because at least two of our correspondents have asked us whether it can do those very things. They must be extremely new hands at radio home-construction, but I for one refuse to laugh at them for that. As I've often said before, it is extremely probable that such fellows could show me up very badly at something else other than radio!

The Best Beginning.

Anyway, if they make their very first excursion into wireless set assembly with either "P.V. Plus" or "P.V. Star," they will soon be thoroughly convinced that they could not have made a better beginning!

G.V.D

USING A VOLTMETER

Some Practical Hints

THE necessity for using a good-quality voltmeter, with an internal resistance of 200 ohms or so per volt, has often been stressed.

Such a value is especially necessary when measuring the voltages at the H.T. + terminals of a mains unit, where any increase in output current means a drop in output voltage. This is also the reason why you should always measure H.T. volts with the receiver switched on, even if your power supply is from dry batteries. (A mains unit may show 250 volts with the receiver switched off, falling to 150 volts under full load.)

Some mains units have a voltmeter permanently connected across the main output connections, which is always useful.

**USING THE RECOMMENDED
VALVES, THE H.T. CURRENT
CONSUMPTION OF EACH "P.V."
SET IS APPROXIMATELY 12
MILLIAMPS.**

Another good reason for using meters with a mains-operated receiver is that the output voltages are entirely dependent on the amount of current you take from the unit. With dry battery H.T. supply you do know roughly what you are getting, as here voltage is nearly independent of current if the battery is reasonably new.

Measure the Milliamps.

Perhaps the best way of making sure you are getting the right anode voltages from your mains unit is to measure the anode current at the correct grid bias for the voltage you want, adjusting the variable resistance or voltage taps until the milliammeter reads approximately the current that you find from your valve curves corresponds to those values of grid bias and anode voltage.

J.E.

STATION SELECTION

A Reader's Simple Scheme

Dear Sir,—I daresay a number of "P.W." readers would like to learn of a method of station selection which I think is the absolute simplest possible (for det. and L.F. type).

I have tried the arrangement with perfect success with 18 pre-set condensers on the 1930 "Magic" Three, which I must say was, and still is, a wonderful set.

Yours truly,

Wm. S. HUGHES.

Liverpool.

ALL DIFFERENT STATIONS

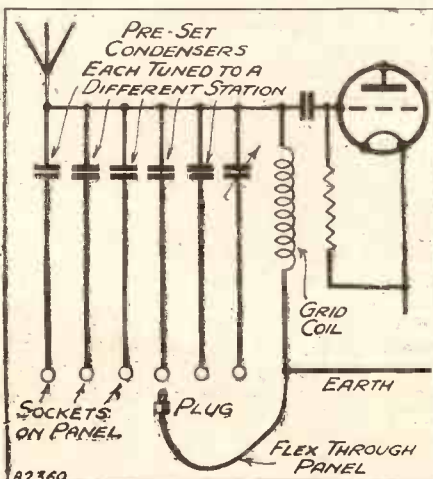

The plug-and-socket tuning system employed by Mr. Hughes

CHALLENGING
INTERESTING
HELPFUL
CRITICAL
SCATHING
TRENCHANT
CONSTRUCTIVE
ENTERTAINING
FORCEFUL
EXPERT
UNIQUE
VIGOROUS
BLUNT
VIRILE
LIVE
OUTSPOKEN
PROVOCATIVE
FRANK
BRIGHT
USEFUL
TOPICAL
INTRIGUING
INSTRUCTIVE

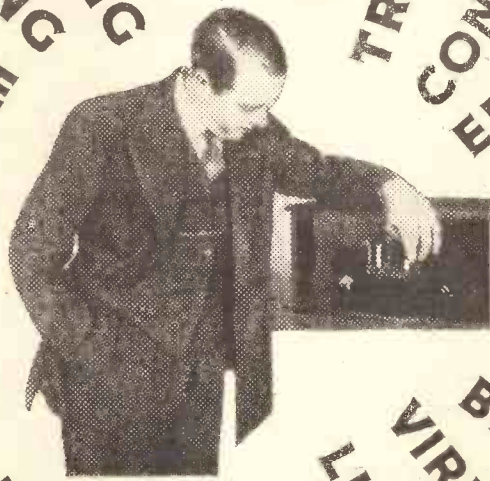

World-famous as one of the pioneers of broadcasting, both with the Marconi Co. and the B.B.C., Captain P. P. Eckersley is now Wireless Editor of *The Daily Mail*.

Read Capt.P.P.
Eckersley's
Radio Feature

every Wednesday in the

DAILY MAIL

NEW
 P.M.3
 CHASSIS
 45/-

PERMANENT MAGNET MOVING COIL SPEAKER

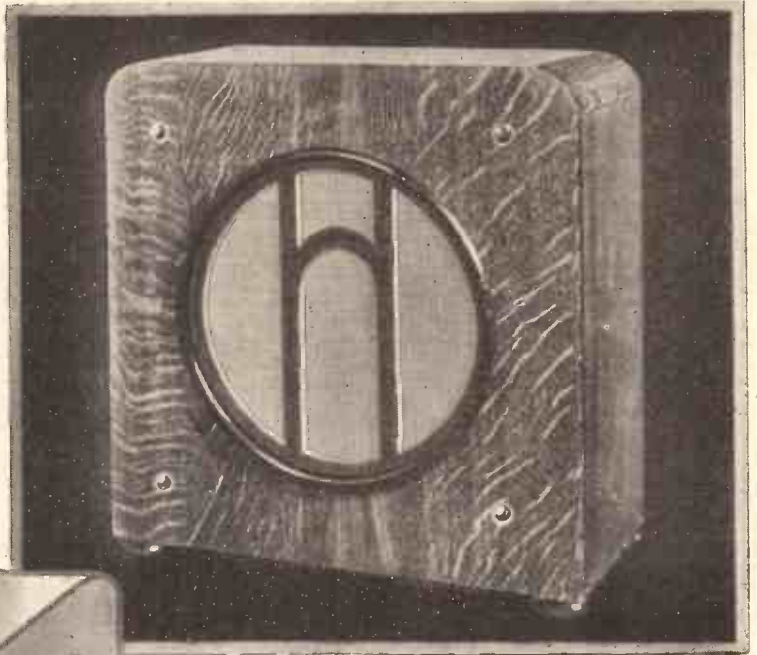

The most astonishing value ever offered. Made by "W.B." —the pioneers in Permanent Magnet Speakers. Very sensitive — large volume. Gives true moving-coil reproduction from any 2 or 3 valve set. A class instrument despite the low price. No mains or batteries needed.

Completely assembled chassis 45/-, or in attractive oak cabinet, as above, 75/- (with transformer, in either case, 7/6 extra). Write to-day for complete illustrated list with new low prices of W.B. Permanent Magnet Moving Coil Speakers and the equally famous W.B. Valveholders and Switches — POST FREE.



Whiteley Electrical Radio Co., Ltd., Radio Works, Nottingham Road, Mansfield, Notts.
 Irish Free State Distributors: Kelly & Shiel, Ltd., 47, Fleet Street, Dublin.

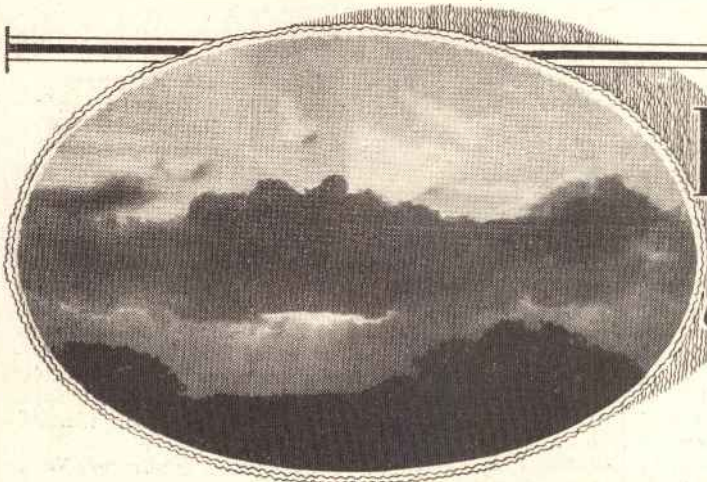

RADIO and the AURORA

Some notes by G. H. Daly on the Northern Lights—that mysterious curtain of the Arctic that seems to be linked up with electro-magnetism and radio reception.

THE aurora borealis has always been of particular interest to the wireless listener owing to the greatly increased ranges which are obtainable when these Northern Lights are in the skies. The report, therefore, that the mystery of the aurora is now solved and that miniature auroral conditions can be obtained in a laboratory is of considerable interest to the wireless world generally.

Of recent years a theory has been put forward to the effect that the layers of electrified gas some hundreds of miles above the earth, which forms the Heaviside Layer, are formed by streams of electrons thrown off by the sun.

The Sun Responsible

This same theory is now put forward to account for the presence of the aurora; namely, that it is caused by streams of electrons from the sun which, on striking the gases of the upper atmosphere, cause the latter to be electrified and, owing to the force of the collision between the high-speed electrons and the atoms of gas, the well-known lights of the aurora are the result.

It is the same electron streams from the sun which are responsible for our wireless echoes from the depth of space.

However, from a wireless point of view, one or two snags must be obvious in this theory. In the first place the Heaviside Layer is a permanency in the heavens, whereas the aurora comes and goes. Why then, if both aurora and Heaviside Layer are caused by electrons from the sun, is the sky not one vivid aurora on every cloudless night?

This theory of the aurora explains that

the reason why the latter is only prevalent towards the poles and not at the equator is because the electron streams which are responsible for its presence are forced towards the poles by the magnetic fields.

Yet in wireless work we know that the Heaviside Layer is just as potent at the equator as anywhere else—this was proved

AN ATTEMPT TO EXPLAIN IT

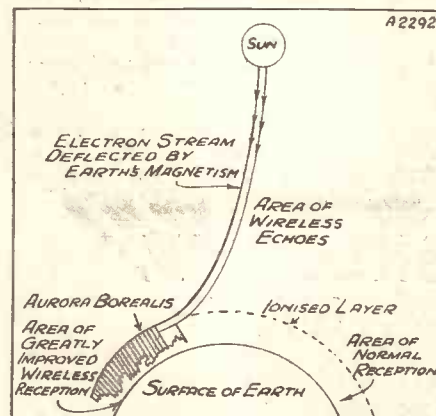

This diagram illustrates one of the theories put forward to explain the Aurora's effects.

conclusively by the Dutch scientist De Groot. But if all the electrons which bombard the atmosphere were pushed away from the equator by the earth's magnetic field then there would be no Heaviside layer at the equator.

Another controversial point is that the appearance of the aurora coincides with disturbances on the sun and also magnetic

disturbances on the earth. The aurora is only seen, in fact, when the surface of the sun is very disturbed, yet our old friend the Heaviside Layer is present whether the sun is disturbed or not.

Although there are many reports to the effect that the aurora has been seen close to or on the ground, the weight of the evidence tends to show that it remains well above the ground at about the same height as the lower fringes of the Heaviside Layer at night.

Magnetic Storms

There are also reports that the aurora can be heard by the unaided ear in the form of whistling atmospherics, yet curiously enough the ether is usually quite quiet when the aurora is in the sky and remarkably long-distance stations are easily heard on the wireless.

The magnetic storms which often accompany the aurora do not as a rule greatly affect radio reception, although at the same time they may be causing great havoc on ordinary land-lines and cable circuits.

Whatever discrepancies lie in this theory of the aurora there is absolutely no doubt that the aurora and the Heaviside Layer are very closely connected, and basing our deductions on wireless research the aurora would seem to be a kind of exaggerated state of the Heaviside Layer.

Owing to the increased activity on the part of the sun the already charged Heaviside Layer is now overcharged with negative electrons and these conditions create the aurora which in turn gives improved wireless reception—in fact the aurora may be the outward and visible sign of the Heaviside Layer.

As semi-variable condensers are not usually intended to withstand high voltages it is not wise to place them between filament and plate, or where the full voltage of the battery will be impressed upon them.

When using a semi-variable condenser in the output circuit, or where it may be called upon to withstand a considerable H.T., it is a good precaution to introduce a large fixed condenser in series with it.

When taking readings with a voltmeter, remember that the instrument will take some current whilst the reading is being made, and only a high resistance voltmeter can give an approximately accurate reading.

One reason why it is dangerous to short

* * * * *

HELPFUL HINTS FOR HOME CONSTRUCTORS

"Semi-Variables"—Screening—Spare Chokes.

* * * * *

an L.T. accumulator is that such a battery has a very low internal resistance and, therefore, delivers an enormous current on short circuit.

A thin piece of metal—much too thin to be self-supporting—is quite satisfactory when secured to a background of stiff cardboard or three-ply wood to act as a screen

Among the rough and ready emergency screens which can be used are cigarette packet foil, or a thin coat of aluminium paint or gold paint.

After cutting three-ply wood it generally has rather splintery edges and the simplest and neatest way to round these off is to lay a fairly large piece of coarse sandpaper flat on the bench and rub the wood along this, so cleaning up the edges.

A good rough and ready test of the insulation of a large condenser is to charge it from a battery and then stand it aside over night, and in the morning see if a spark can be obtained by touching the terminals. If so the condenser is O.K.

THERE are some queer surprises in wireless reception as you, reader, have doubtless discovered by experience. Sometimes you obtain, unexpectedly, loud-speaker reception from a tiny station in a far corner of Europe—and sometimes when you think that you have achieved a feat of this kind you are subsequently brought down to earth with an unpleasant bump by discovering that you were mistaken.

One such thrill followed by a rude awakening occurred to me the other night, when, with a four-valve set yoked to an indoor aerial, I found myself listening to quite excellent volume from Augsburg. "This is something like a set," I said to myself, "Augsburg is a 300-watt relay." And then I looked at a list of stations. Augsburg used to be a little fellow, but now he is using the same power, 1.7 kilowatts, as Munich, his parent station.

Vienna on Long Waves.

Augsburg is shown as working on a common wave-length with Kaiserslautern, (which also relays Munich), and Hamar, a Norwegian station. On this occasion, though, he must have been transmitting alone for there was no interference. Anyhow, the station is worth trying for; you will find him immediately above Budapest.

Have you heard the Vienna experimental station on the long waves? This station is not transmitting regularly, but when he

PROBABLY, by the time this appears in print, I shall have a pile of correspondence reviling me for my remarks on W2XAD last week. I expressed the opinion that he was preparing for his final "fade-out," on account of his very poor strength at my usual listening time—10.30 p.m. and after.

Quite by chance, I listened this week at 9 p.m., and heard him switch on and start up at a strength that can only be described as "100 per cent" again! In view of this, I repeated the performance on the two following nights, finding the same in each case. He is, however, noticeably weaker before 10 p.m., and by 11 p.m. I often find that he has completely gone.

Until the change of schedule is announced, he does not start until 9 p.m., so that we cannot make much use of the good Transatlantic conditions in force before this hour. Seen at the Show.

Some hectic work at the "Show" has been making it difficult for me to keep any regular watch lately, but I hope to resume from now onwards.

Speaking of the Show—as everyone is these days—it strikes me as distinctly disappointing for the short-wave man to find so little notice taken of his requirements. Some of the better-known firms have, of course, a good array of the better-known components that are recognised as suitable for short-wave work.

There is, however, very little "specialised" gear as yet; this, probably, is quite natural, since we are still in the minority as regards quantity, even if we make up for it on quality!

STATIONS WORTH HEARING

Some practical distant-programme notes compiled by a special contributor who nightly searches the ether in order to obtain really up-to-the-minute information for "P.W." readers.

is at work you will find him about half-way between Kalundborg and Motala.

Another Experimenter.

Another experimental station, this time on the medium waves, is Warsaw No. 2, who is right down near the bottom of the band on 214.2 metres. His transmissions come through with surprising strength, and when regular transmissions begin Warsaw No. 2 should be amongst our star stations on the shorter wave-lengths.

If only there were less interference below 250 metres through heterodynes produced by wave-length wandering we should have some wonderful reception from stations down there, for the shorter waves have extraordinary powers of distance-spanning after dark. It is, in fact, not at all unusual to hear quite strongly some of the little 200- to 250-watt Swedish relays.

Quite possibly you have not paid much attention recently to Kalundborg or Oslo on the long waves. The former suffered from a period of weakness some time ago, whilst the latter was very badly heterodyned. Lately I have had fine reception from Kalundborg whenever I have tried for

him, and Oslo has been coming through strongly quite clear of interference.

Madrid Union Radio shows signs of returning to strength. Make a note of him, for he will be a good winter station unless I am much mistaken. Two others that are coming on rapidly are Leipzig and Brno.

The list of star stations—that is, stations that can be relied upon for good loud-speaker reproduction—is now quite a long one. On the long waves we have Huizen, Konigswusterhausen, Radio-Paris, Warsaw, Motala, Kalundborg and Oslo.

On the medium band I find Brussels No. 1, Milan, Langenberg, Rome, Stockholm, Beromunster, Sottens, Katowice, Frankfurt, Toulouse, Hamburg, Strasbourg, Brussels No. 2, Brno, Goteborg, Turin, Heilsberg and Trieste, all worthy of stars, and there are a good many other strong candidates for inclusion in the list.

Heard the U.S.A.?

Amongst these are Budapest, Sundsvall, Berlin Witzleben, Prague, Grenoble and Breslau. This is a very satisfactory state of affairs, for it shows that we shall have a wonderful autumn and winter for wireless reception.

The U.S.A. stations, by the way, are beginning to come in pretty well, and it is worth while to make a search for them if you happen to be up after midnight. Amongst the best just now are WPG on 272.6 metres, WTIC on 282.8 metres, and WGY on 379.5 metres.

SHORT-WAVE NOTES



News and views regarding an exciting and fascinating wave-band.
By W. L. S.

Certainly the intense keenness of the average short-wave fan is becoming almost proverbial. Even the most hardened "broadcatcher" admits it, and the manufacturers with whom I have been in touch all pay tribute to it.

One of them in particular—the maker of a very fine short-wave condenser—told me that there was one fellow who had been pestering him for over a year to make some slight alteration to it, to suit his own particular requirements! He added, sadly: "I suppose I shall have to do it, just to keep the beggar quiet and to reduce the postage bill!"

Was it Leningrad?

H. L., who hails from Ayrshire, is a staunch supporter of mine. In connection with the "mystery station" correspondence, he says that my guess of "Poznan" was correct, and that the reader who said that Leningrad was the station was wrong.

I shouldn't go so far as that, H. L.; if you heard Poznan, he is there, but if the

other man heard Leningrad, he is there, too! Perhaps they are not on together, and that may lead to confusion.

H. L. also mentions logging a strong German station between 19 and 20 metres, announcing himself as "Königswusterhausen." This might be a relay, but can anyone oblige with definite news?

Here is a practical note from W. H. C., of Virginia Water. He forwards me a sample of "Konductite," which may be described either as aluminium-coated paper, or paper-backed aluminium, the proportions appearing to be about half-and-half. For taming hand-capacity-stricken receivers this should be excellent stuff, and very easy to work with.

Mornings Best For Sydney.

After studying it, I have been struck by a rather doubtful brain-wave. Would it not be effective to coat the back of the panel and the underside of the baseboard with aluminium paint?

This paint is too well-known to need description, and I use it in quantities for many purposes not connected with radio. I think two good coats should form a very useful conducting surface, and intend to try it when I have time.

W. H. C. also mentions logging VK 2 ME (Sydney) of late, at 6.15 a.m., improving in strength until 8 a.m. So here is something to help the DX man to get up early! Some of you "nearly-H.A.C." members might like to bag your last continent, so out with the alarm-clocks.

Incidentally, if any of you pick up Australia during the week I shall be glad to have a postcard with details.

EVERYTHING **The G.E.C.** ELECTRICAL
your guarantee

NEW WEMBLEY FILAMENT

**LONGEST 2-VOLT
VALVE FILAMENT
IN THE WORLD**

STRIKING 2 volt VALVE IMPROVEMENT

10% MORE FOR YOUR MONEY

After extensive research and experiment, a new 2-volt filament has been evolved giving:

**10% GREATER ELECTRON EMISSION
THAN ANY OTHER 2-VOLT FILAMENT OBTAINABLE**

This is the latest discovery of the G.E.C. Research Laboratories at Wembley. The "Wembley" filament means, that without loss of amplification, valves of amazing efficiency can be made with adequate electrode clearances, which result in:

- 1 Greater consistency between valve and valve.
- 2 Avoidance of internal contacts and valve troubles.
- 3 Production of non-microphonic valves even under most exacting conditions of use.

THE NEW "WEMBLEY" FILAMENT MEANS MORE RELIABLE WIRELESS, PURER TONE AND MORE FOREIGN STATIONS.

Write for the Osram Wireless Guide (1931 Edition) and also Station Indicator Card. Sent POST FREE on request.

Osram 2 VOLT BATTERY Valves

SOLD BY ALL
WIRELESS
DEALERS.

**BRITISH PRODUCTS DESIGNED
FOR BRITISH RADIO CONDITIONS**

SUPREMACY IN RADIO - G.E.C. Radio

Advt. of The General Electric Co. Ltd., Magnet House, Kingsway, London, W.C.2



EXACTLY what happens to wireless waves when they pass through our atmosphere, especially the upper atmosphere, is still very much of a mystery. The ascent, therefore, of Professor Piccard, accompanied by Herr Kiffer, in an air-tight aluminium sphere into the confines of our upper air, is very interesting from a wireless point of view and is certain to be helpful in the solution of some of our remaining wireless mysteries.

Professor Piccard's Balloon.

Although the height reached by the sphere was greater than ever attained by man before—namely 15½ kilometres or nearly 10 miles, it is, of course, very far short of the height reached by wireless waves generally.

If, for instance, we are to believe the Heaviside Layer theory which postulates the idea of a conducting layer or layers in the heavens at heights varying from 150 to 200 miles, then Professor Piccard's ascent of nearly 10 miles fell a long way behind that of our ordinary wireless waves which strike the Heaviside Layers. Yet despite the smallness of the ascent from a wireless point of view, the results are likely to be of considerable value in radio research.

Practically all our data on the Heaviside Layers is speculative. We know that the wireless waves ascend into the heavens; we know also that the same waves presently return to the earth. Obviously there must be something in the heavens to make them do so.

The most likely thing is a layer of gas capable of reflecting wireless waves in the same way as a material mirror reflects light waves. But we are very uncertain of the whole thing, there are diehards who still maintain that the layers do not exist; so that the only way of becoming absolutely certain that such layers do exist is to visit them and see for ourselves.

Studying It "On the Spot."

For, as Professor Piccard has said in connection with his particular objective: "The stratosphere could only be studied on the spot, and I had to go 10 miles up into the air to study it," and this statement applies also to our wireless Heaviside Layers.

It is true that meteorologists have sent up small balloons fitted with self-recording instruments in an endeavour to find out something about the upper atmosphere;

By G. H. DALY.

The recent successful attempt to beat mankind's record height reached in a balloon starts our contributor off on some very fascinating speculations.

but while these balloons have reached enormous altitudes, higher even than those attained by Professor Piccard, the results are very unsatisfactory compared with those attained in the man-carrying balloon. Which points to the fact that, as in other cases, a personal visit is more desirable.

Some Useful Information.

It was Professor Piccard's intention to obtain data concerning a number of points, the principal of which are: 1. the mysterious cosmic rays; 2. the presence of carbonic acid gas, ozone and the composition of the upper air generally; 3. the electrical condition of the latter; and 4. the absorption of different wave-lengths of the upper atmosphere.

Now all these points concern the propagation of wireless waves intimately. In the first place the mysterious cosmic ray, coming from we know not where and full of unknown possibilities, are ether waves differing from wireless waves only by their infinitely high frequency—that much we do know about them.

SCREENING THE WHOLE WORLD!

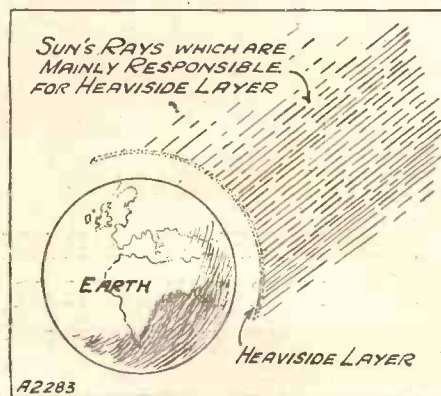

The Heaviside Layer acts rather like a mirror, and is capable of reflecting radio waves back to earth again.

With regard to the composition of the upper atmosphere, i.e. the proportion of gases such as ozone, carbonic acid gas, oxygen, helium and other gases, is also very important where wireless waves are concerned, for upon the amount of these gases present will depend the reflection, absorption and general behaviour of our wireless waves.

The Heaviside Layer is, in fact, created by the effect of the sun's rays on these individual gases, and each gas is differently affected by these rays.

Finding Out the Facts.

Without the combination of the sun's rays and the gases of our upper atmosphere there could be no Heaviside Layer and long-distance wireless would be impossible, as the waves would shoot off the world into space and be lost. It will be seen, therefore, that the information which Professor Piccard has obtained concerning the upper air, even although he has only touched the fringe of things from a wireless point of view, has a very great value to us by enabling scientists to discover something more definite about the behaviour of our wireless waves when they pass through the upper air.

Another important point is that his achievement opens up possibilities of further ascents to still greater heights. While Professor Piccard has denied the rumour that he intends to make another ascent of 20 miles, saying that such a height would necessitate the use of a balloon having a diameter of 360 ft., he adds that his own ascent was by no means particularly uncomfortable, and he sees no reason why other scientists should not follow in his footsteps.

Higher Ascents Possible.

Altogether, therefore, we may expect that given more efficient and scientifically fitted aircraft, man will ascend higher and higher, until eventually he penetrates to the outermost fringes of the atmosphere and is able to solve the mystery of the Heaviside Layer once and for all.

Although at the time of writing Professor Piccard has denied that he intends making another ascent, in many quarters it is not thought impossible. However, time will tell and we can only wait developments.

TELSEN H.F. CHOKES

TELSEN BINOCULAR H.F. CHOKE

Hailed unanimously by the leading experts as the perfect H.F. Choke. The Telsen Binocular Choke is called for wherever highest efficiency is desired. Especially in H.F. amplification is the performance of the Choke of supreme importance.

Its highest inductance (180,000 micro-henrys) and exceptionally low self-capacity (.000002 microfarad) ensure a very high impedance at all wavelengths, and its excellent efficiency curve is free from parasitic resonances. These qualities, together with the restricted field due to the binocular formation, make it the ideal choke for a high-class circuit.

Telsen Binocular H.F. Choke Price **5/-**

TELSEN STANDARD H.F. CHOKE

The Telsen Standard H.F. Choke utilises the minimum base-board space. It is designed to cover the whole broadcast band and has an extremely low self-capacity. The inductance is 150,000 microhenrys and the resistance 400 ohms.

It has proved very popular and has been incorporated by set designers in many of the leading circuits.

Telsen Standard H.F. Choke Price **2/-**

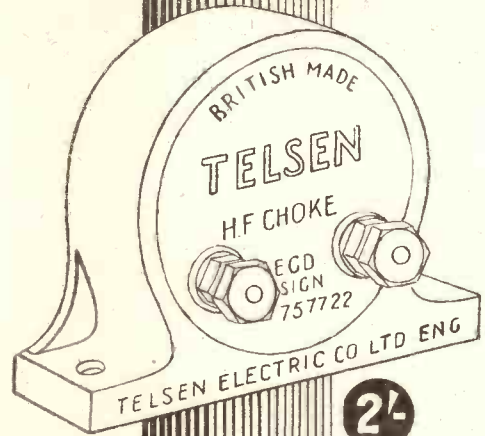

TELSEN

THE SECRET OF PERFECT
RADIO RECEPTION

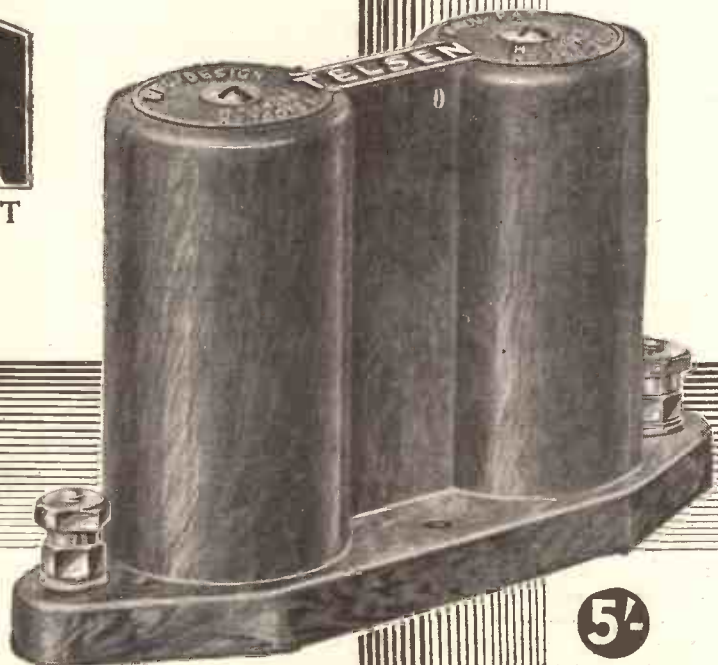

Send for the "Telsen Radio Catalogue" and book of "All-Telsen Circuits" to The Telsen Electric Co., Ltd., Aston, Birmingham.

FROM THE TECHNICAL EDITOR'S NOTE BOOK.

Tested and Found-?



FORMO "P.V." AND "P.J." COILS.

AS "P.W." readers will already know, Formo are making POPULAR WIRELESS P.V. and P.J. coils. On the P.V.1 coil Messrs. Formo exhibit some remarkable pile winding; the reaction turns are neatly arranged in three piles, and constitute one of the best examples of this kind of work I have seen.

The Formo P.J. coils are provided with neat wooden fittings, enabling them easily to be mounted horizontally or vertically on baseboards.

Needless to say, the Formo P.V. and P.J. coils are exactly in accordance with our original specifications, and readers can incorporate them in their designs with the utmost confidence.

FOR MAINS GRID BIAS.

S. G. Heayberd & Co., Ltd., who will be well known to "P.W." readers as suppliers of reliable and inexpensive mains components and units, are now in production with a new line in the form of a tapped resistance, specially designed for grid-bias arrangements in mains units and sets.

It costs 6s., and is quite a bit smaller

EASY TO FIX



Formo provide neat wooden mounting brackets with their P.J. coils.

than a single-cell grid-bias battery. It has a total resistance of 1,200 ohms, and there are five tappings at intermediate resistances.

A leaflet is included in the carton which shows exactly how the device should be connected up to provide correct grid bias in varying circumstances. It is a well-made component.

PRICE REDUCTIONS.

The G.E.C., Ltd., has decided to reduce the prices of the whole range of their Magnet wireless dry batteries, notwith-

standing the fact that the quality and capacities of all their batteries have been considerably improved.

EXIDE PRICE REDUCTIONS.

Many of the price reductions in connection with Exide batteries are considerable, and amount, in cases, to as much as three and four shillings. By the way, "P.W." readers will probably remember that only quite recently the popular Exide "D" type L.T. batteries were considerably improved, so that they now constitute one of the most attractively priced batteries going, and are even better value for money than before.

TWO WATES' COMPONENTS.

The Standard Battery Company makes excellent batteries, but I trust it is equally well known that they also make some very

HANDY ADJUSTMENTS



The Wates' Potential Divider has adjustable tappings.

fine mains components and accessories as well. For example, I have a Wates' potential divider before me as I write.

It is compactly constructed and eminently practical in design. It embodies a unique method of contact for the intermediate terminals. There are sliding clips which can be screwed rigidly into position in an instant, thus enabling close but, if necessary, permanent adjustments quickly to be made. Therefore, those of you who may be contemplating the construction of a mains set should bear the Standard Battery Co.'s name well in mind.

Another Standard Battery item of interest is a mains-driven gramophone motor, a most fascinating device. It is designed to work only from A.C., and the frequency, 50 cycles, has an important bearing on its operation.

The design is such that the spindle rotates at the exact figure of 78 revolutions per minute under all conditions, and there is no gearing, governors, driving belts or other complications.

Further, it consumes only about 9 watts, so that it costs very little to run.

On the other hand, it is powerful and, naturally, its speed is absolutely constant. Radiogram amateurs will be interested to learn that the winding is completely enclosed in iron which can be earthed, and that when this is done hum is eliminated.

The motor runs with complete freedom from mechanical noises; it is, in fact, dead silent, and even after it has been in operation for a lengthy period there is practically no heating.

Indeed, its simplicity and general effectiveness, together with its low price of three-

PLEASE NOTE

Manufacturers and traders are invited to submit radio apparatus of any kind for review purposes. All examinations and tests are carried out in the "P.W." Technical Department, with the strictest of impartiality, under the personal supervision of the Technical Editor.

We should like to point out that we prefer to receive production samples picked from stock, and that we cannot in any circumstances undertake to return them, as it is our practice thoroughly to dissect much of the gear in the course of our investigations!

And readers should note that the subsequent reports appearing on this page are intended as guides to buyers, and are, therefore, framed up in a readily readable manner free from technicalities unnecessary for that immediate purpose.

guineas with a guarantee of two years, should make it one of the new season's best-sellers.

"ACHIEVEMENT."

I have had an opportunity of examining a copy of "Achievement," a brochure prepared for limited circulation by Pertrix Ltd. It is a lavishly illustrated book, and shows that Pertrix batteries originate in an immensely large and very well-equipped factory.

"THE TRUE ROAD TO RADIO."

This is the title of a book published at 5/- by Ferranti, Ltd. It consists of about 250 pages and is lavishly illustrated with photos and designs. All aspects of radio reception are thoroughly covered in an authoritative but entirely readable manner. It is a book which should prove very popular among all classes of radio enthusiasts.

AN INTERESTING COMPARISON



The penny is included in this photo to give you an indication of the dimensions of the Wates' electric motor for turntables.

TELSEN SWITCHES AND DIALS

TELSEN PUSH-PULL SWITCHES

(Prov. Pat. No. 14125/31) From **1/-**

The Telsen Push-Pull Switches employ a proper electrical knife switch contact and are soundly constructed on engineering principles. The centre plunger is wedge-shaped, so that as it is pulled out it forces the inner fixed contacts outwards, tightly gripping the moving contacts. There is no fear of cracking with Telsen Push-Pull Switches. Their low self-capacity makes them suitable for use in H.F. circuits.

Telsen Push-Pull Switches—

- Two-point Price 1/-
- Three-point Price 1/3
- Four-point (2 pole) Price 1/6

TELSEN SLOW-MOTION DIAL

The Telsen Slow-motion Dial has an exceptionally smooth action with an approximate ratio of 8-1. There is no toothed gearing, so that it is impossible to strip the dial. The figures are clear and arranged to provide for right and left-hand condensers.

Telsen Slow-motion Dial Price **2/6**

Supplied in Black or Brown Bakelite.

TELSEN

ALL-BRITISH
RADIO COMPONENTS

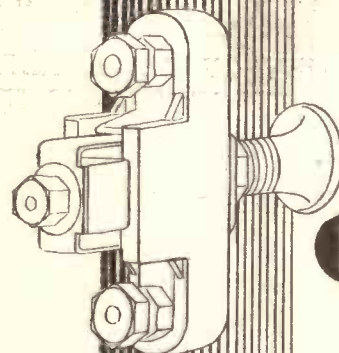

1/-

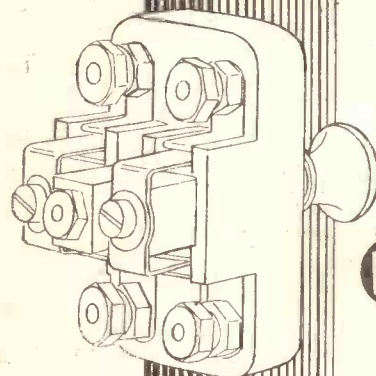

1/6

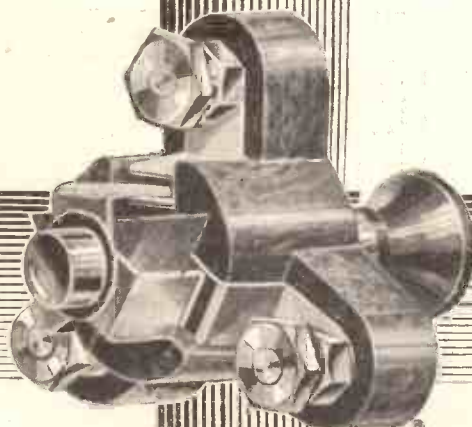

1/3

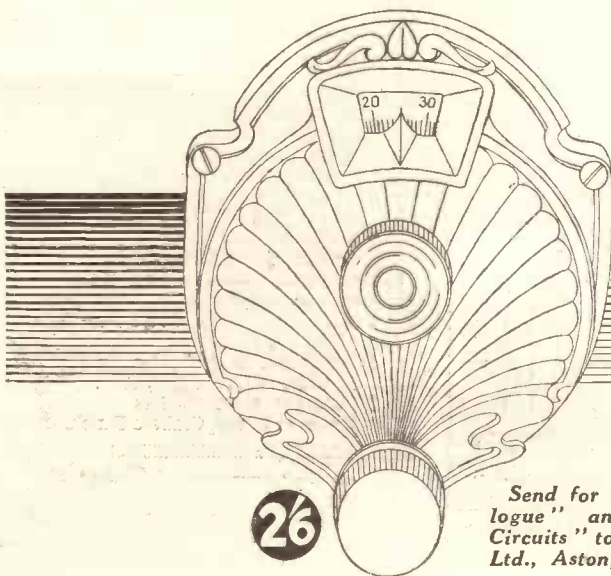

2/6

Send for the "Telsen Radio Catalogue" and book of "All-Telsen Circuits" to The Telsen Electric Co. Ltd., Aston, Birmingham

THIS is the first four-valver of the now famous "P.W." "P.V." series of sets of which the "P.V." Junior forms the junior section. And the popularity of the "Pop-Vox" Four is apparently already assured, for its present introduction to "P.W." readers follows upon a large number of requests for such an outfit!

But I fear we cannot give the credit of the evolution of the set to these pleading correspondents, for it was "laid down" in the Research Dept. before the descriptions of the first "P.V.'s" appeared in print!

It was only because of the even greater number of requests for S.G., det., L.F., "P.V.'s" that the "Four's" introduction to readers was somewhat delayed.

example. Note these points carefully, for you will not find a similar combination of features in any design hitherto described. And, I must add, these features are not variations on an old theme provided only to justify a claim for novelty, but worth-while contributions to better radio.

Extenser Tuning Throughout.

Here, in brief, are the items in question for you to form your own opinion.

Our new "P.J." Coils and "P.W." Coil Quits for better and cheaper results on both wave-bands are used. There are two Extensers which eliminate wave-change switches, simplify wiring and tuning, increase the ease of assembly, and add efficiency to the set and give real meaning to dial readings. Additionally, one Extenser automatically cuts a long-wave selectivity condenser in and out as you go round the dial.

There is a control switch that turns the receiver on to either radio reception or pick-up. "P.W." differential reaction provides wonderfully smooth but virile reaction on both wave-bands without seriously affecting tuning adjustments, as do ordinary methods of regeneration.

Complete stability, despite the great amplification, is assured by the inclusion of adequate decoupling plus a filter output. There is a

resistance-capacity coupled L.F. stage right at the "end" of the outfit to give quality plus additional stability—if such were necessary. The layout is so arranged that only a simple single home-made screen is required for the H.F. stage.

Notwithstanding all these points it is pre-eminently a set for the beginner. That is to say, its design is such that even those who have hitherto done hardly any set assembly at all, worth mentioning can tackle it with complete confidence and, providing they carry out our few instructions, be

INDEPENDENT OF ALL CONDITIONS

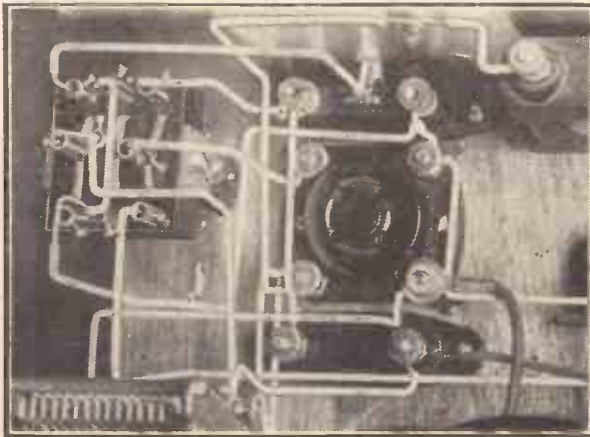

By means of the control switch you can immediately switch over to the pick-up should there be nothing that attracts you in the ether.

But, it must not be thought that the "Pop-Vox" Four is merely a "P.V." Three with an extra L.F. added. It has points of its own, especially in layout, that give it an attractive individuality.

A Combination of Fine Features.

It has been said, and more than once, too, that modern sets are nothing but old circuits in new clothes, as it were. That may be true of some present-day designs, but it certainly is not the case with current "P.W." sets.

Take this "Pop-Vox" Four as an

EACH VALVE PULLS ITS FULL WEIGHT

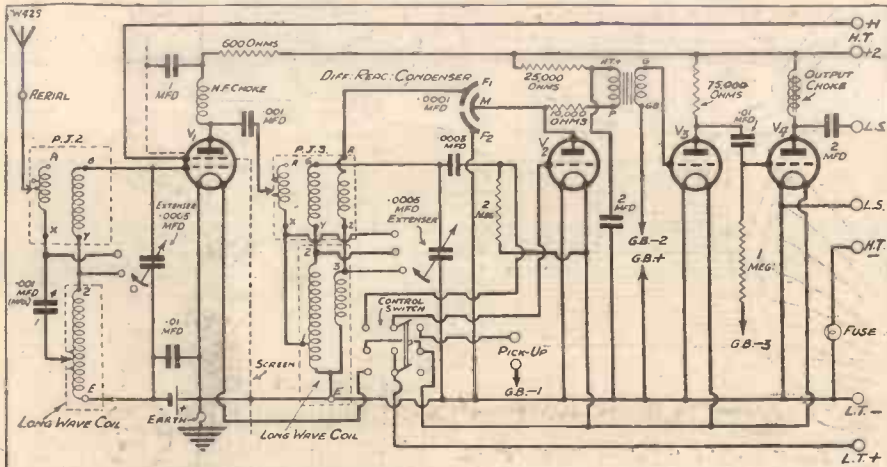

There is an S.G. valve coupled to a grid-leak detector by a parallel-tuned grid circuit, and one transformer-coupled L.F. valve followed by an R.C.C. stage.

THE "POP VOX" FOUR

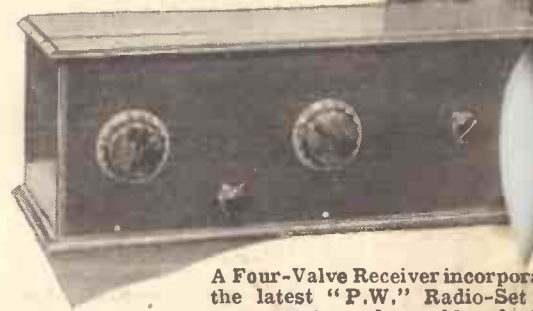

A Four-Valve Receiver incorporating the latest "P.W." Radio-Set improvements and capable of giving magnificent loudspeaker results.

certain to get just as good results as the skilled engineer, probably better results if his set happens to be one arranged on conventional lines!

COMPONENTS AND ACCESSORIES

- 1 Panel, 21 in. x 7 in. (Permeol, or Goltone, Lissen, Peto-Scott).
- 1 Cabinet for above with base-board 10 in. deep (Cameo or Osborn, Pickett, Gilbert.)
- 2 .0005-mfd. Extensers (Wave-master or Cydon, Formo.)
- 1 .0001-, .00012- or .00015-mfd. differential reaction condenser (Igranic, or Lotus, Ready Radio, J.B., Lissen, Formo, Wave-master, Telsen, Cydon).
- 1 Triple pole change over switch (Wearite, etc.).
- 2 2-mfd. condensers (Helsby and T.C.C., or Dubilier, Igranic, Ferranti, Mullard, Lissen, Telsen.)
- 1 1-mfd. fixed condenser (Lissen etc.).
- 1 .001-mfd. maximum compression condenser (Formo, or Leweos, R.I., Sovereign, Telsen).
- 2 .01-mfd. fixed condensers (Lissen and T.C.C., or Mullard, Dubilier, Ediswan, Ferranti, Igranic, Graham Farish).
- 1 .001-mfd. fixed condenser (Telsen, etc.).
- 1 .0003-mfd. fixed condenser (Ferranti, etc.).
- 1 Horizontal valve holder (Junit, or W.B. Bulgin, Parex, etc.).
- 3 Ordinary valve holders (Benjamin, or Telsen, Graham Farish, Igranic, Lotus, Bulgin, Formo, etc.).
- 1 2-meg. grid leak condenser (Ferranti, Telsen, Ready Radio, Farish, Watmel).
- 1 1-meg. ditto (Ferranti, etc.).
- 1 L.F. transformer (Igranic, Lissen, Ferranti, Lotus, etc.).
- 1 Output choke (R.I., etc.).
- 1 75,000-ohm spacer (Leweos, Ready Radio, Graham Farish, etc.).
- 1 25,000-ohm spacer (Bulgin, etc.).
- 1 600-ohm spacer (Tunewell, etc.).
- 1 10,000-ohm spacer (Varley, etc.).
- 1 H.F. choke (Leweos, Telsen, Radio, Parex, etc.).
- 1 Fuse and holder (Radio).
- 1 P.J.2 coil (Ready Radio, Wearite, Goltone, etc.).

NO WAVE-CHANGE SWITCH

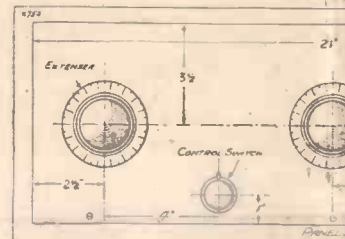

RADIO OR RECORDS AT

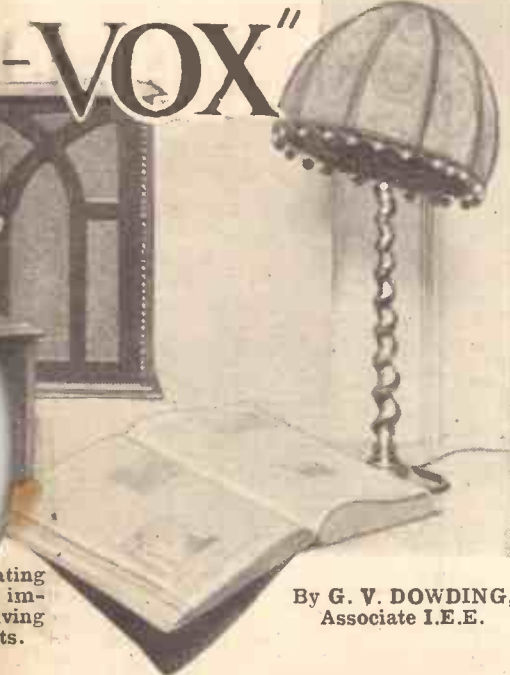

By G. V. DOWDING, Associate I.E.E.

Moreover, the "Pop-Vox" Four is the ideal receiver for experimenter and household alike. Its controls are few and simple in nature, so that no experience at all is

CATEGORIES WE RECOMMEND

- Lissen, Clix, Wearite, Dario).
 - and holder
 - Ediswan, Igranic, Graham
 - Ferranti, etc.).
 - Telsen, or Varley, R.I., Lewcos.
 - (I. or as above).
 - ghetti resistance
- Parex, Peto-Scott, Formo, Ferranti, Lewcos).
 - 1 P.J.3 coil (Peto-Scott, etc.).
 - 2 Coil quitois (Wearite, or Peto-Scott, Melbourne, Parex, Ready Radio, A.E.D.).
 - 4 oz. of No. 30 D.S.C. wire.
 - 1 Terminal strip 14 in. x 2 in.
 - 1 Terminal strip, 4 in. x 2 in.
 - 11 Terminals (Igranic, Belling & Lee, Elelex, Clix).
 - 3 Crocodile clips, wire, flex, screws, G.B. battery clip, copper foil, etc.

WIRE WORRIES!

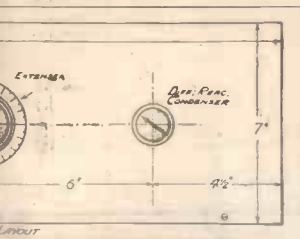

- Radio, Bulgin, Varley, Telsen).
 - ghetti resistance
 - ti resistance
 - ghetti resistance
 - Peto-Scott, or R.I., Ready (ofus, Wearite, (Bulgin, Ready
 - Radio, or R.I., he, Melbourne,
- Osram, Cossor, Fotos, Lissen.)
 - BATTERIES.**—120- to 150-volt. super-capacity H.T. Grid (bias for H.F. valve, .9 or 1.5-volt. Grid bias for L.F. valves to suit types used (Drydex, Pertrix, Ever Ready, G.E.C., Lissen).
 - ACCUMULATOR.**—2-, 4- or 6-volt. to suit valves. (Exide, Ediswan, Lissen, Pertrix).
 - MAINS UNIT.**—State type of mains, voltage, and details of set, when ordering (Regentone, Ekco, Tannoy, Atlas, R.I., Heayberd, Lotus).

needed for its handling, yet it is as lively as the most ardent "DX" fan could wish a set to be and, by carefully using the reaction, dozens of different stations can be tuned-in direct on the loudspeaker.

Of course, the reaction control need not be touched in the case of the more powerful stations, and an uninitiated child would find no difficulty in hitting on several alternative programmes; he couldn't help doing so if he merely twisted the Extenser dials at random!

Will Work Any Speaker.

Providing the correct valves and H.T. voltages are used, there is sufficient volume to work a moving-coil loud-speaker at fine volume, though a small loudspeaker of any sort can be driven.

The "Pop-Vox" Four is not quite as powerful as our "Super-Quad," it could not be expected to be. But, if anything, it is easier to handle and is much quieter during tuning operations. Also, it has a particularly quiet background while in action. It is, in fact, a set which will give satisfaction all round and we feel sure that whoever builds it will thoroughly appreciate its merits as a sound, honest proposition free from all the usual little snags.

The components needed are carefully listed together with various makes which we can recommend, so that there will be little need to deal with them in detail. But for the benefit of new readers who are attracted to this design, I must extend the usual warning about cheap and nasty substitutions.

It really does not pay to accept unknown brands of components, however alluring

the prices and claims. Such a course is an extremely bad policy and a decidedly false economy. Many, many times during every month we hear of perfectly good sets completely ruined by the inclusion of one or two bad components. And, remember, it is almost impossible for you to trace a fault due to such a cause unless you possess testing gear and know how to use it.

Also, whatever you may be told to the contrary, none but components of exactly the specified values will serve. If a .001-mfd. fixed condenser is included at a certain point in the circuit, for instance, then that value, .001 mfd., was chosen for a definite purpose, and it is on the cards

THEY ARE A PERFECT PAIR

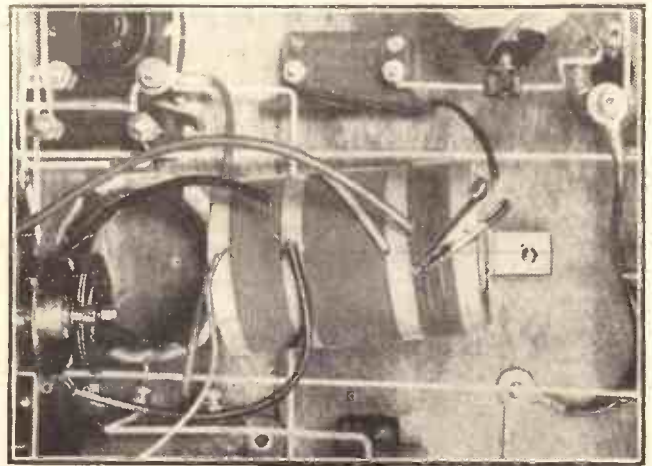

The P.J.3 coil and a Coil Quoit make up the intermediate two-band tuner, and although they cost only a shilling or two they give perfect results.

that a different value will tend to upset the processes concerned.

A Point To Remember.

It is vital that a good H.F. choke should be used. It sometimes happens in a set that the H.F. choke can be of inferior quality without detracting much from the results given by the receiver; but such is not the case with the "Pop-Vox" Four. You will lose amplification if the H.F. (Continued on next page.)

YOU MAKE YOUR OWN SCREEN

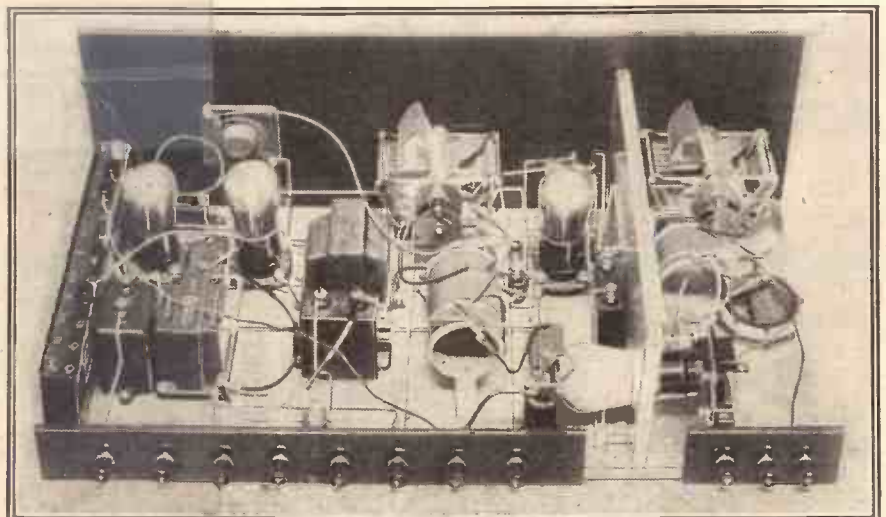

The effective screen consists merely of a rectangular piece of wood covered with metal foil.

FIRST-RATE QUALITY

THE "POP-VOX" FOUR

(Continued from previous page.)

choke is not right up to scratch. You will be quite safe if you purchase one of the brands listed.

The differential condenser is another somewhat vital item. An ordinary re-

action condenser that happens to have three terminals is no substitute at all. But a differential that chances to have four terminals (F_1 or F_2 being duplicated) will be quite O.K. There is at least one of these on the market, and all that can be said against it is that it tends to cause some little confusion and doubt in the minds of constructors who buy it and do not realise that there is merely a harmless repetition of one of the terminals, and that either or

both of these two terminals can be employed in wiring up.

I am afraid there is no more space for further constructional tips this week; but with the wiring diagram and photographs before you there should be little to impede your progress in the assembly of the set. But if there happens to be any points that puzzle you, I expect you will find that I have covered them in my second article, and this will appear next week.

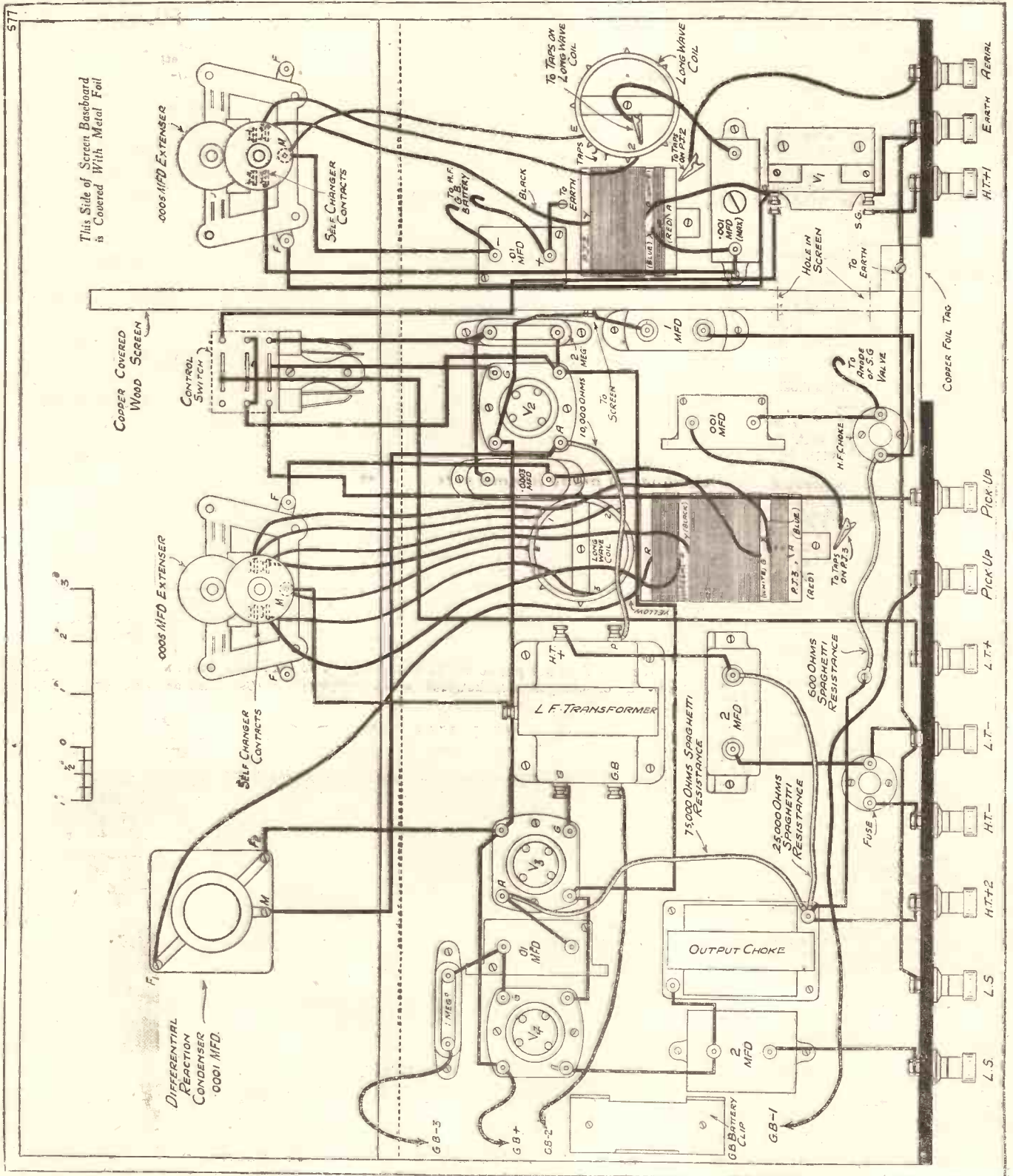

READY RADIO TESTED KITS

Every Ready Radio Kit is composed of chosen components which have been tested and passed before despatch under the supervision of Mr. G. P. Kendall. ★ By building your receiver with a Ready Radio Tested Kit you are consequently assured of the finest possible results obtainable from the circuit of your choice.

★ *Mr. G. P. Kendall, B.Sc., has joined the staff of Ready Radio as Chief Engineer. He was for many years the well-known Chief of Research for "Popular Wireless" and "Modern Wireless" and is the designer of many famous sets.*

TO INLAND CUSTOMERS—Your goods are despatched Post Free or Carriage Paid.

TO OVERSEAS CUSTOMERS—Everything Radio can be supplied against cash. In case of doubt regarding the value of your order, a deposit of one-third of the approximate value will be accepted and the balance collected by our Agent upon the delivery of the goods. All goods are carefully packed for export and insured. All charges forward.

THE "P.V. PLUS"

KIT "A" (Less valves and cabinet) £4. 5.6
or 12 monthly instalments of 8/-

KIT "B" (With valves less cabinet) £6. 4.6
or 12 monthly instalments of 11/6

KIT "C" (With valves and cabinet) £7. 9.6
or 12 monthly instalments of 13/9

Completely assembled Receiver, Aerial tested, Royalties paid - £8.19.6
or 12 equal monthly instalments of 16/6

THE "P.V. STAR"

KIT "A" (Less valves and cabinet) £5.18.6
or 12 monthly instalments of 11/-

KIT "B" (With valves less cabinet) £7.17.6
or 12 monthly instalments of 14/6

KIT "C" (With valves and cabinet) £9. 5.0
or 12 monthly instalments of 17/-

Completely assembled Receiver, Aerial tested, Royalties paid - £10.15.0
or 12 equal monthly instalments of 19/9

If you do not need the complete kit you can buy any of the parts you require separately.

All Ready Radio cabinets have the special Landor finish. The beautifully subdued effect of the Landor process will give your set the same handsome appearance as that of the most expensive and exclusive receiver on the market.

Ready Radio

ORDER FORM

To
READY RADIO LTD.
159, Borough High St.
LONDON BRIDGE
S.E. 1.

Phone: Lee Green 5678

CASH ORDER. Please despatch to me at once the goods specified for which I enclose payment in full of £.....

C.O.D. ORDER. Please despatch to me at once goods specified for which I will pay in full the sum of £.....

EASY PAYMENT ORDER. Please despatch my Easy Payment Order for the goods specified for which I enclose first deposit of £.....

Name.....

Address.....

Kit Required.....

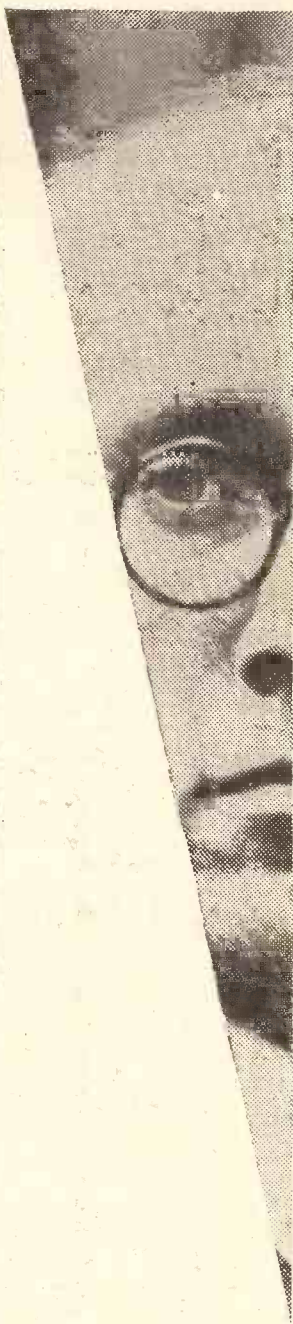

CAPT. ECKERSLEY'S QUERY CORNER



EARTH CONNECTIONS WITH A.C. AND D.C.—WHAT IS BAND-PASSING ?

Under the above title, week by week, our Chief Radio Consultant comments upon radio queries submitted by "P.W." readers. Don't address your questions to Capt. Eckersley, however—a selection of those received by the Query Department in the ordinary way will be answered by him.

Earth Connections with A.C. and D.C.

N. J. M. (Cricklewood).—"Why is it that with my D.C. mains H.T. unit in use the earth terminal of the receiver must not be joined direct to earth, but via a fixed condenser, and yet with A.C. mains it is quite in order to wire directly to earth?"

I would refer you to my diagrams, where you will see I have drawn the schematic diagram of a D.C. mains set. You will at once see that as the positive of the mains is earthed, then, considering the negative of the mains has got to be connected to the filament of the valve, you cannot earth the filament of the valve directly, you must earth it through a condenser, otherwise the mains will be shorted.

The condenser acts, however, to earth the filament with regard to alternating currents of both high and low frequencies, and so with regard to wireless the negative is earthed, or, at any rate, very "earthy." The supply company mains are not short-circuited, and that pleases them, I suppose, but probably pleases you more.

The positive of the mains is, in fact, frequently earthed, particularly with three-wire systems of electric power distribution, and this then earths your H.T. positive also.

With A.C. no such effects take place, both H.T. — and H.T. + being protected from any external earthing by the transformer used.

What is Band-Passing ?

M. D. R. (Ealing).—"I have recently heard quite a lot about band-pass tuning. What exactly is this particular system of tuning, and what advantages does it confer?"

"FLAT-TOP" TUNING

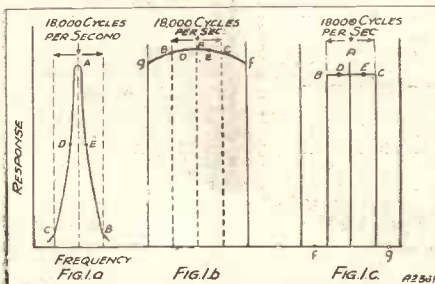

The band-pass principle is explained by these different response curves.

When a broadcasting station transmits a programme it can be shown that it emits waves of several different frequencies. Thus, for example, when a station is modulated from the output of the microphone into which a man is talking or an orchestra playing, the station sends out a wave of frequency, say, 1,000,000 a second, and a host of other waves, grouped around this central frequency, having frequencies up to 1,000,000 plus 10,000 and down to 1,000,000 minus 10,000.

ONLY IN "P.W."

can you read Captain Eckersley's replies to listeners' own problems.

**AND REMEMBER—
Captain Eckersley's technical articles appear only in the "Big Three."**

**"POPULAR WIRELESS,"
"MODERN WIRELESS," AND
"WIRELESS CONSTRUCTOR."**

These added and subtracted waves are called "side-bands." The object of a receiver is not then to tune-in only to one frequency, but to a band of frequencies about 20,000 cycles wide (owing to the fact that the carrier-waves of stations are separated by only 9,000 cycles this band is actually in practice about 18,000 cycles wide: 20,000 would give better reproduction).

The method by which receivers work generally is that they include in their design resonant tuned circuits which respond much more to one frequency than to another. If a high-frequency circuit is said to be very selective it has a shape something as shown in Fig. 1a.

You will immediately realise that this circuit gives full response to the waves at one point, A, but nothing like a full response at points B or C, or even D and E.

This means that the upper side-bands will not be picked up at full strength, so reproduction will suffer. (Who doesn't know that if you apply intensive reaction and make the resonance curve very sharp that

the speech or music becomes very "heavy"?)

If you were to make a response as in Fig. 1b you would reproduce all the side-bands all right, and the response at A, B, C, D, or E would be about equal.

Unfortunately, however, if there was another band of frequencies next door to the station you wish to receive, the response at f and g would be so great that there would be interference between one station and another, and your receiver would not be sufficiently selective. Obviously, therefore, the ideal response curve is as shown in Fig. 1c, the response at f and g being practically nothing, but the response at B and C being full.

Some Final Remarks.

As I said before, an ordinary resonant circuit does not produce this type of response. It is the object of a band-pass filter to give a response as shown in Fig. 1c.

The principle of the band-pass filter is to use two highly resonant circuits and couple them close together, when response approximates to that shape as indicated in Fig. 1c. I have not got space here to explain the many ways in which this can be done, but there are a great many articles in current wireless literature upon the subject, and I must refer you to these if you wish to experiment on the subject.

In principle, however, remember that you should have two tuned circuits and couple them closely to produce the effect.

DON'T DO IT!

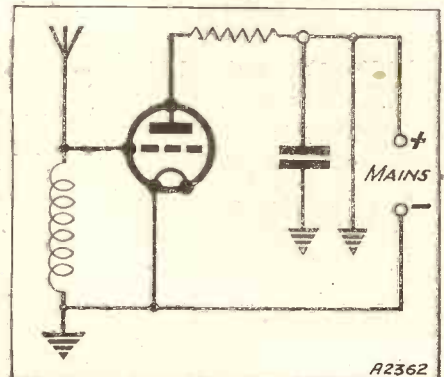

These are the wrong connections referred to in the reply to N. J. M. on this page.

TELSEN CONDENSERS

TELSEN MANSBRIDGE TYPE CONDENSERS

Telsen have installed the most advanced plant in the world for the manufacture of Mansbridge Type Condensers. Only genuine Mansbridge foil paper and the finest linen tissue are employed in the exclusive method of manufacture. Every Telsen Mansbridge Type Condenser is hermetically sealed from the atmosphere and Post Office standards of insulation are adopted throughout. The preliminary research, the most modern plant in the world, the finest raw materials, the latest methods of manufacture and the final test, all combine to give Telsen Mansbridge Type Condensers a high insulation through years of service with freedom from breakdown. The type of construction employed makes them genuinely non-inductive.

The following values are guaranteed within 5 per cent:—

Cap. mfd.	500 Volt Test Price	1,000 Volt Test Price
.01	1/6	2/6
.04	1/9	2/9
.1	1/9	2/9
.25	2/-	3/-
.5	2/3	3/3
1.0	2/3	3/6
2.0	3/-	5/-

TELSEN FIXED MICA CONDENSERS

(Prov. Pat. No. 20287/30)

Telsen Fixed Mica Condensers are made in capacities from .0001-microfarad to .002-microfarad. They can be mounted upright or flat and the .0003-microfarad Telsen fixed mica condenser is supplied complete with patent grid-leak clips to facilitate series or parallel connections. All Telsen fixed mica condensers are tested at 500 volts.

Telsen Fixed Mica Condensers Price **6d.**

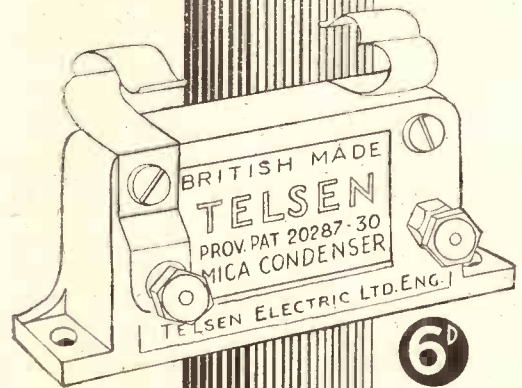

TELSEN

THE SECRET OF PERFECT RADIO RECEPTION

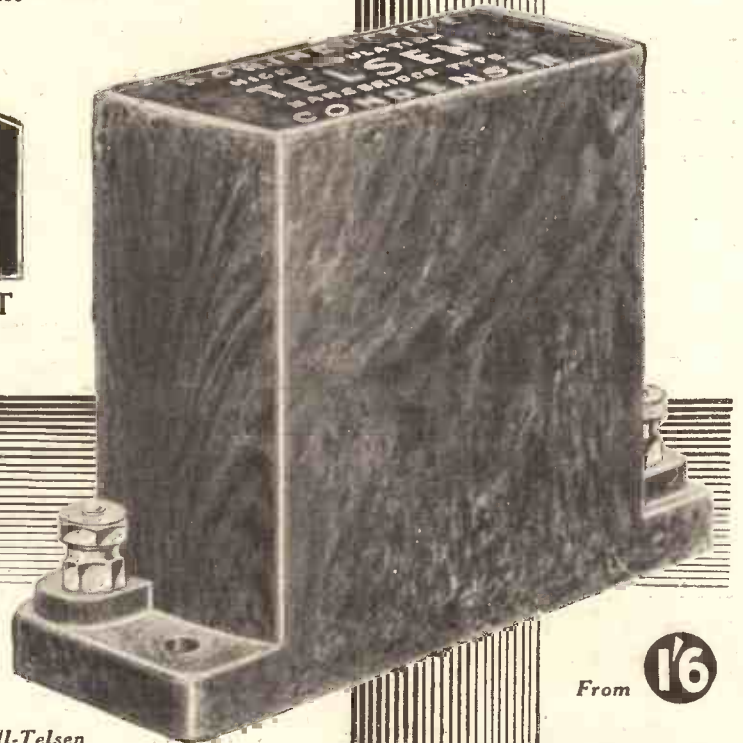

From **1/6**

Send for the "Telsen Radio Catalogue" and book of "All-Telsen Circuits" to The Telsen Electric Co., Ltd., Aston, Birmingham.

SMOOTHING SIMPLY EXPLAINED

By HANDEL REES

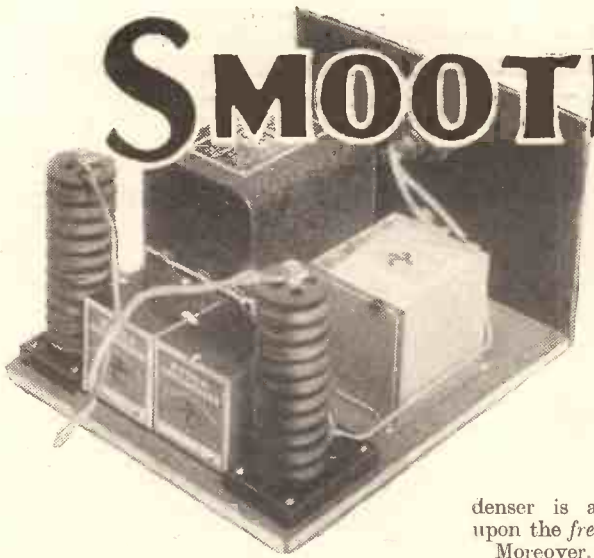

In every set that derives a supply of current from the electric-light mains, there is a smoothing circuit of one sort or another. In this article our contributor tells you all about the inner workings of the apparatus involved.

ALL mains-units contain some sort of smoothing arrangements, and Fig. 1 (a) shows a simple circuit of the type used in an average eliminator.

For the purpose of explanation, it may be better represented in the form shown in (b), where it will be seen that the choke and condenser are really in series across the input from the mains, while the output is drawn from the condenser.

Fundamental Facts.

Before discussing the action of the arrangement, consider the following elementary fact. If two resistances, R_1 and R_2 , are connected together in series across a voltage V as indicated in Fig. 1 (c), the voltage will divide across them in direct proportion to their respective resistances; in other words, voltage = current \times resistance.

Thus, if $R_1 = 99$ ohms, $R_2 = 1$ ohm and the mains voltage $V = 100$, one ampere will flow through both resistances. Then the voltage across $R_1 = 1 \times 99 = 99$ volts, and across $R_2 = 1 \times 1 = 1$ volt.

THE CIRCUIT ARRANGEMENT

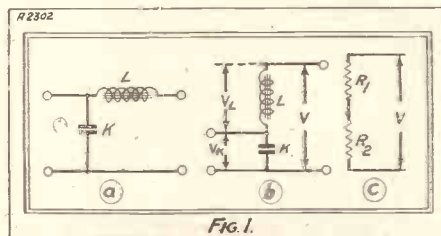

These sketches illustrate the principle used in all mains-units, as well as in the H.T. circuits of A.C. and D.C. all-mains receivers.

Now the circuit of Fig. 1 (b) is similar to the above, only that, instead of resistances, we have a large inductance L and large capacity K which offer a certain impedance to alternating or pulsating currents.

Comparative Impedances.

"Impedance" is somewhat analogous to "resistance" in the sense that it is an opposition to the flow of current; but whereas resistance is a property of the wires, and other materials used to carry electric currents, the impedance of a coil or con-

denser is a property depending partly upon the frequency of the current.

Moreover, while the impedance of a choke varies practically in direct proportion to the frequency, that of a condenser varies in the inverse order, i.e. the higher the frequency the lower the impedance.

CHARGING THE CONDENSER

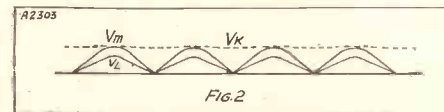

The dotted line represents the practically steady potential of the smoothing condenser, pulsations being absorbed in the choke.

If, then, we have a large inductance or choke connected in series with a large-capacity condenser, the impedance of the choke would be enormously higher than that of the condenser for a given frequency.

Suppressing the Ripple.

From what was said about the resistances in (c), therefore, it is evident that a fluctuating voltage would divide across the combination in (b) in direct ratio to the impedances. That is to say, it would be practically all absorbed in overcoming the high impedance of the choke, only a very small fraction remaining across the condenser.

Bearing these facts in mind, consider now what occurs when this smoothing circuit is used with an A.C. rectifier. The voltage or current input will be of the form shown in Fig. 2, the frequency depending upon whether half- or full-wave rectification is used.

If we denote the peak value of the voltage by V_m , it will be evident that the condenser will be charged to this voltage, if we neglect the small voltage drop due to the ohmic resistance of the choke.

Now this charge will be maintained practically

constant because, as just shown, the succeeding voltage variations will have little effect on the condenser; they are confined chiefly to the choke, owing to its relatively high impedance. Thus we might represent the voltage variations across the condenser by the dotted line V_K in Fig. 2.

The Condenser's Output.

The line V_K shows the condenser voltage to be almost of straight-line form, the "ripple" having been smoothed out into pulsations of negligible amplitude. In other words, the condenser provides a practically steady D.C. output such as would be required for the anode supply to a receiver.

The higher the values of the inductance and capacity, the greater the proportion of the ripple thrown across the choke, and the less is that which remains across the condenser.

In fact, it can be shown mathematically that the degree of smoothing obtained is, roughly, proportional to the product

(Continued on page 232.)

FOR FLATTENING OUT "HUMPS"

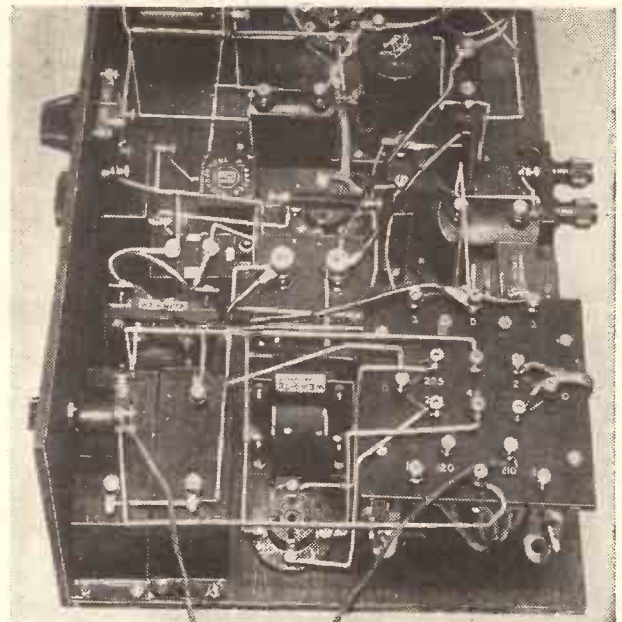

This is the "Power-pack" end of a "P.W." all-electric receiver. The rectifier valve holder can be seen in the foreground with the mains transformer to the right. Note the large fixed condensers on the left for smoothing out all the "humps" in the supply.

TELSEN LOUD-SPEAKERS

TELSEN LOUD-SPEAKER UNIT

The Telsen Loud-speaker Unit is pleasing to the most sensitive ear. The deep notes of the bass, the brilliance of the soprano, and the crispness of diction are clearly reproduced without any distortion. It employs cobalt steel magnets, and the detachable rod which carries the cone is fitted with cone washers and clutch. The entire unit is enclosed in a beautifully moulded bakelite dust cover.

Telsen Loud-speaker Unit Price **5/6**

TELSEN LOUD-SPEAKER CHASSIS

The fully floating cone mounted on a flexible felt surround renders the Telsen Loud-speaker Chassis very sensitive, giving perfect balance of tone. It is unaffected by damp conditions because the cone material is practically non-hygroscopic. The Telsen Loud-speaker Chassis is substantially made and it is light in weight. Holes are provided for easy attachment to most of the popular makes of loud-speaker units. The Chassis may be readily fixed to a baffle board or cabinet by three or more wood screws.

Telsen Loud-speaker Chassis .. Price **5/6**

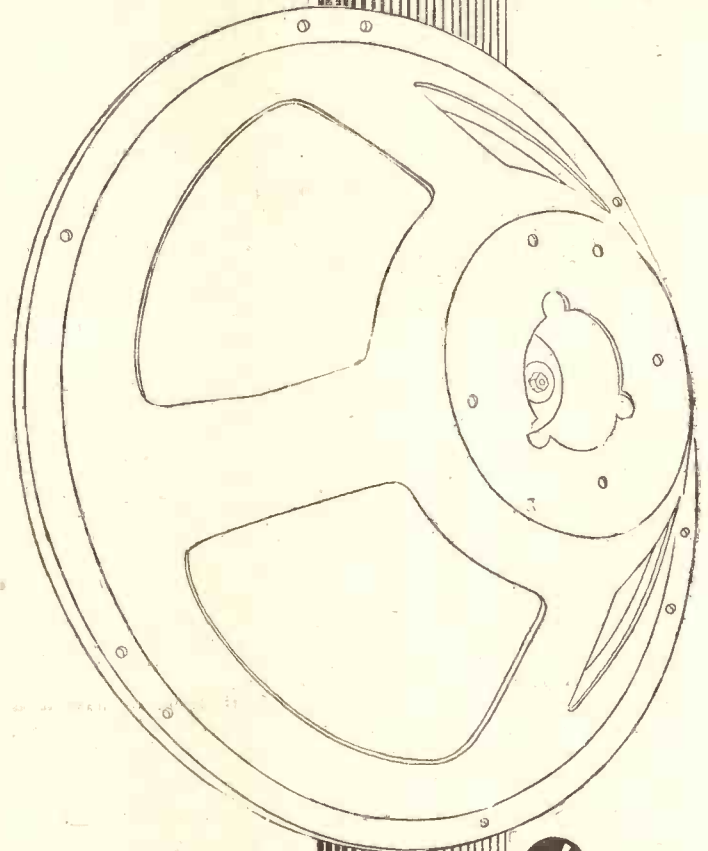

5/6

TELSEN

ALL-BRITISH
RADIO COMPONENTS



5/6

Send for the "Telsen Radio Catalogue" and book of "All-Telsen Circuits" to The Telsen Electric Co., Ltd., Aston, Birmingham.

SMOOTHING SIMPLY EXPLAINED

(Continued from page 230.)

LK, where L is the inductance and K the capacity.

For instance, it is useful to remember that we get approximately the same degree of smoothing with a 50-henry choke and 2-mfd. condenser as with a 25-henry choke and 4-mfd. condenser, for in each case the LK product is 100.

While the simple arrangement of Fig. 1 (a) is satisfactory for general purposes, it is sometimes a decided advantage to have separate smoothing circuits for the various stages of a receiver.

In Series or Separate.

Thus, in a simple det., 2. L.F. receiver, more smoothing is usually necessary for the detector than for the succeeding stages, owing to the tendency for any slight ripple present to be greatly amplified by the set.

We might, of course, make the value of L and K in Fig. 1 (a) sufficiently high to eliminate even this "slight ripple," but the problem of removing the last traces of hum in this way is apt to prove difficult and expensive in certain cases, and it is generally far better to use separate circuits as indicated in Fig. 3 (a) and (b).

This method has also the advantage of cutting down the current in the detector choke to a comparatively small value, so that the danger of a decrease in inductance where it is most required is largely eliminated.

In the Fig. 3 (a) circuit the chokes are entirely separate, whilst in (b) the choke L_1 is common to both the output circuits, and consequently it must be designed to carry the total plate current.

SEPARATE OUTPUTS

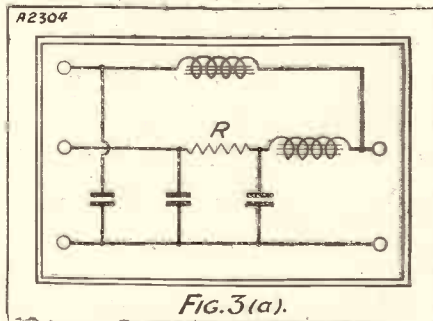

When two outputs having different voltages are required it is nearly always better, both from an economical and satisfactory working point of view, to use two separate filter circuits.

It will be observed that in (b) the choke values are additive, i.e. the total inductance for the detector stage is the sum of L_1 and L_2 , so that L_2 need only be of sufficient magnitude to give the necessary extra smoothing. In (a), however, the separate inductance values must be high enough to give the required smoothing for each stage.

Detector Decoupling.

The complete smoothing circuit should also include a dc-coupling resistance and condenser, usually connected in the detector stage in the circuit we are considering, and it has to be realised that a high resistance with condenser, although not

so desirable, is as much a smoothing device as a choke and condenser.

These, therefore, add considerably to the smoothing, and are taken into account when deciding on the choke values.

ANOTHER SYSTEM

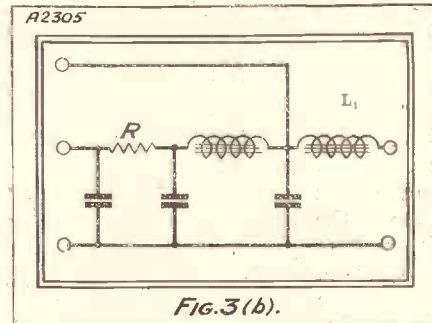

Here we still have separate filter circuits for the different outputs, but the first choke has to carry the load of both tapplings. It should, therefore, be capable of carrying both currents.

WHAT COUNTRY WAS THAT?

By W. L. S.

A useful list of International Prefixes used by the World's Amateur Stations.

JUDGING from my correspondence each week there are many readers of "P.W." that still have not found a back number with the International Prefixes contained therein. In any case, the prefixes suffer so many changes, and are given correctly in so very few lists or books, that I am giving a really up-to-date list of those in use.

Many of these are "unofficial," and many of them are different from those that should be used by stations in their particular country, but in every case the letters given are those that are used—by amateurs, at all events.

World-Wide Calls.

With the colossal number of amateur stations now operating on the short waves, and covering the whole world with their signals, it is naturally important that their registration should be internationally agreed—as it is in the case, for instance, of aeroplanes.

Very much the same grouping of letters has been adopted in the two cases, and we have now reached the happy state when we have not the slightest doubt where a station is located after once having heard his call-sign.

Although I call these letters "prefixes," this is really incorrect, since they form part of the call-sign, and must be sent every time the call-sign is sent. Thus French F 8 B J calling American W 1 M K would have to send "W 1 M K W 1 M K W 1 M K de (from) F 8 B J, F 8 B J, F 8 B J," etc.

These combinations given are merely

those assigned to the amateurs in each country; in most cases, however, the commercials have combinations that are either identical or "next-door neighbours," and high-power commercial stations may thus be distinguished. Melbourne, for instance, when not using the experimental call-sign V K 3 M E, calls himself "V L—" and a letter.

What the Letters Stand For.

AC	China	PY	Brazil
AU	Siberia	RX	Panama
CE	Chile	RY	Lithuania
CM	Cuba	SM	Sweden
CN	French Morocco	SP	Poland
CR	Portuguese Colonies	ST	Sudan
CT1	Portugal	SU	Egypt
CT2	Azores	TF	Iceland
CT3	Madeira	TI	Costa Rica
CV	Roumania	TS	Saar
CX	Uruguay	UL	Luxembourg
D	Germany	UN	Jugo-Slavia
EAR	Spain	UO	Austria
EI	Irish Free State	V1	Barbados
ES	Estonia	VE	Canada
F	France & Colonies	VK	Australia
FM	Algeria	VO	Newfoundland
FR	Canary Islands	VP	British Colonies
G	Great Britain	VQ2	Northern Rhodesia
GI	Northern Ireland	VQ3	Tanganyika
HAF	Hungary	VQ4	Kenya
HB	Switzerland	VQ5	Uganda
HC	Ecuador	VS1	Straits Settlements
HH	Hayti	VS2	Federated Malay States
HS	Siam	VS3	Unfederated Malay States
I	Italy and Colonies	VS6	Hong Kong
J	Japan	VS7	Ceylon
K4	Porto Rico	VT	and VU India
K6	Hawaii	W	United States
K7	Alaska	X	Mexico
KA	Philippines	YI	Iraq
LA	Norway	YL	Latvia
LU	Argentina	YM	Danzig
NN	Nicaragua	YS	Salvador
OA	Peru	YV	Venezuela
OH	Finland	ZC	Trans-Jordania
OK	Czecho-Slovakia	ZE1	Southern Rhodesia
OM	Guam	ZL	New Zealand
ON	Belgium and Colonies	ZP	Paraguay
OZ	Denmark	ZS—ZU	Union of South Africa
PA	Netherlands		
PK	Dutch East Indies		

The full list of the assignments to every country in the world is to be found in the Radio Amateur Call Book.

SOME RADIO SHORTS

On-Off Switches — Loudspeaker Efficiency — Indirectly-heated Valves, etc.

When making up a mains set, or mains unit, never attempt to economise on the mains switch by using an ordinary on-off switch, as to do so would definitely be unsafe.

The loudspeaker is one of the most inefficient accessories associated with radio, and even good ones can hand out only about 10 per cent of the energy that is delivered to them by the radio set!

In the U.S.A. mains-driven valves are so popular that the battery-heated valves are mostly to be found in out-of-the-way districts, where there is no electric supply.

The indirectly-heated valve is so called because the mains current, after being stepped down to a suitable voltage, is applied to a special heater element which warms the electron-emitting cathode although it is electrically insulated from it.

In the battery-heated valve there is always a voltage drop across the filament, but the cathode of an A.C. valve is at equal potential all over.

Owing to its equal potential cathode, the curve of an A.C. valve is more clear cut and definite than that of a battery-driven valve.

MODERN WIRELESS

is
Britain's Leading Radio Magazine.

Kendall wrote this book for you!

10 HOWS

FOR MODERN RADIO
CONSTRUCTORS BY
G. P. KENDALL, B.Sc.

A new and wonderfully useful book which should be read by every constructor. Full of useful information and copiously illustrated.

Do you know

- HOW to use a Blue Print?
- HOW to get real quality?
- HOW to Increase your Selectivity?
- HOW to Convert your Set for Mains Working?
- HOW to add a Gramophone Pick-Up?

Over 15,000 copies were sold at the Radio Exhibition. Get your copy at once and save disappointment.

Price 6d. post free.



COUPON

READY RADIO LTD.
EASTNOR HOUSE,
BLACKHEATH, S.E.3

I enclose four 1½d. stamps; please send me a copy of "10 Hows for Modern Radio Constructors" by return.

Name.....

Address.....

THE "POP-VOX" FOUR

	£	s.	d.
1 Ebonite panel 21" x 7" x ½" drilled to specification	6	6	
1 Polished Oak Cabinet to specification with 10" baseboard	1	8	0
2 Wavemaster '0005-mfd. Extensers with Slow Motion Drive	1	11	0
1 ReadiRad '00015-mfd. Differential reaction condenser	2	6	
1 Wearite rotary switch with terminals	4	6	
2 T.C.C. 2-mfd. condensers type 50 (non-inductive)	7	8	
1 T.C.C. 1-mfd. fixed condenser type 50 (non-inductive)	2	10	
1 Sovereign compression condenser type G	1	6	
2 T.C.C. '001-mfd. fixed condensers type S	5	0	
1 T.C.C. '001-mfd. fixed condenser type S	1	6	
1 '003-mfd. fixed condenser type 34	1	6	
1 Junit H.V. Valve holder	1	1	9
3 Junit "Lolos" 4-pin valve holders	2	0	
1 ReadiRad 2-meg. grid leak and holder	1	1	4
1 ReadiRad 1-meg. grid leak and holder	1	4	
1 Lotus L.F. transformer, ratio 3-1, type AT23	7	6	
1 Lewcos 75,000-ohm spaghetti resistance	1	6	
1 Lewcos 25,000-ohm spaghetti resistance	1	6	
1 Lewcos 600-ohm spaghetti resistance	1	9	
1 Lewcos 10,000-ohm spaghetti resistance	1	6	
1 ReadiRad H.F. Choke	4	6	
1 R.I. Output G.P. Choke	12	6	
1 ReadiRad fuse and holder	1	3	0
1 P.12. Coil Unit	2	0	
1 P.13. Coil Unit	2	6	
2 Coil Quits, ready wound	5	0	
1 Terminal strip 21" x 2" drilled to specification	1	9	
1 Belling-Lee terminals type "R"	2	9	
1 Packet "Jifilinx" for wiring	2	6	
1 Siemens S.G. cell	1	0	8
1 Aluminium screen with S.G. hole	2		
4 Belling-Lee G.B. wander plugs			
4 Mullard valves to specification PM12, PM1LF, PM1HL	2	7	6
PM2			
3 Crocodile clips, flex, fixing screws and battery clip			11

TOTAL (including Valves and Cabinet) **£9.18.6**

Kit "A" (less Valves and Cabinet) **£6. 3. 0**

or 12 monthly instalments of 11/3

Kit "B" (with Valves less Cabinet) **£8.10.6**

or 12 monthly instalments of 15/9

Kit "C" (with Valves and Cabinet) **£9.18.6**

or 12 monthly instalments of 18/3

COMPLETELY ASSEMBLED RECEIVER.

Aerial Tested and including Royalties. **£11.18.6**

or 12 monthly payments of 22/-

Mr. Kendall's wide experience is at the service of every purchaser of a Ready Radio Kit. Should you be in difficulties with your set or fail to obtain the results you anticipate write to Mr. Kendall about it and he will give your enquiry his personal attention. By building your receiver with a Ready Radio Kit you are consequently assured of the best possible results of which the circuit is capable.

Ready Radio



SWITCHING BACK

I HAVE always wondered in what lay the particular charm Nell Gwynn undoubtedly possessed—a London gamine who sold oranges outside Drury Lane

"OUR MABEL"



She would like to bring back "Sweet Nell" of Old Drury.

and rose to be a famous actress and so much a favourite of King Charles II that his last thoughts were for her as he lay dying.

I wonder how "Pretty Witty Nelly's" charm would have come through the microphone?

I wish we could recapture bygone waves

of sound so that I could hear her—she must have been a darling.

PHILIP RIDGEWAY.—Much as I admire many of the great ones who are gone, I cannot think of one sufficiently convincing reason for bringing them back from the past even if this were possible. I cannot help thinking, in spite of their indubitable artistic qualities, that they would not be tolerated to-day.

Times have changed. The standard of entertainment expected and enjoyed to-day by the public is so high. For this reason I do not imagine that there were many among the artistes of the past who could compete to-day with any great hopes of success.

They—in their old setting—were different. They were satisfactory then, but the world moved so differently. Now the whole pace of life is completely changed.

Plays that are revived are nearly always failures. I am not referring to musical plays. Composers might stage a successful come-back, but the actors of old would not stand an earthly chance.

No, the past is the past. Please let its ghosts remain as glorious memories.

WHOM WOULD YOU CHOOSE?

If it were possible to summon an artiste from the past to broadcast for half an hour, whom would you choose? Here, some favourite radio personalities give their views on this fascinating topic.

DE GROOT.—My choice would be the two exponents of violin and pianoforte who were, to my mind, the greatest among the past generation—Henri Wieniawsky and Anton Rubenstein.

Both were famed not only as executants, but also as composers, and their names still live through the works they handed down to posterity. Only the greatest violin virtuoso can play the works of Wieniawsky impeccably; technically, they are among

the most difficult ever written. To hear even just a few bars played by the composer himself would be a revelation such as every violinist must surely dream about!

If two short recitals by Wieniawsky and Rubenstein could be broadcast in one crowded but glorious half-hour from Savoy Hill, I would willingly pay the cost of my wireless licence a hundredfold. Such a musical feast would be well worth it. At any rate, that is my opinion, but of course, everyone might not agree.

DE GROOT



He would choose two great Musicians of the past whose works he specially admires.

PHILIP RIDGEWAY



He says we would be disappointed in the old-timers and prefers to leave them as glorious memories.

VIOLET LORAINÉ.—The difficulty about making such a choice as this is that there are so many artistes from whom to choose—from Mrs. Siddons onwards.

In the matter of knowing just what past favourites were really like, future generations will be more happily placed than we are, for hardly an artiste of the present day escapes some sort of a permanent record at the hand of the gramophone companies.

It is a moot point whether so elusive a thing as the personality of genius can be captured with any degree of reality on these small discs for the enjoyment of posterity, but posterity will at least be able to glean some notion, however inadequate, of the quality of the giants of our day.

However, if I must be pinned down to naming whom I would like to bring before the microphone for one short half-hour, I think that at any rate I would have two artistes for the sake of contrast.

They would have to be supreme and unchallengeable in their own spheres, and

(Continued on page 236.)

"Ever since I bought this Regentone Mains Unit I get twice as much pleasure out of my radio."

"In what way?"

"Well, it's so convenient—no batteries to think about, no hiking to the charging station with my accumulator, and on top of it, results are ever so much better."

"Yes, but look at the expense."

"Well, this one cost me just over three pounds and I have nearly saved that already on H.T. Batteries and charging fees."

"This is obviously worth looking into. I must get a Regentone catalogue somehow."

"That's easy. Call on any of the wireless shops in the town, or if that is too much of an effort for you, drop a card to Regentone."

Write for Free Art Booklet to:—REGENTONE, LIMITED, Regentone House, 21 Bartlett's Buildings, E.C.4. Tel. Central 8745 (5 lines) E.W.G.

Irish Free State Distributors: Kelly & Shiel, Ltd., 47 Fleet Street, Dublin.

NOTES ON RECEPTION

Short Waves — Threshold Howl, Hand-Capacity, etc.

For receiving short-wave Morse, as distinct from broadcasting, it is advisable to use a high-ratio L.F. transformer, owing to the greater sensitivity of this arrangement.

In practice it has proved so much better to use a grid-leak return to a potentiometer instead of to the filament that this is now standard S.W. practice.

A 10,000- or 20,000-ohm Spaghetti resistance in the plate circuit of a short-wave detector instead of an H.F. choke often decreases the tendency to howling.

Threshold howl can often be stopped by placing a .5-megohm or less resistance across the secondary of the L.F. transformer, though this may make a noticeable reduction in the amplification of the stage.

The output filter on a short-wave set tends not only to eliminate hand-capacity effects, but also to decrease the liability to threshold howl.

An easily-made improvement to many a short-wave set is to place an H.F. choke (or chokes) in one (or both) of the 'phone leads:

AN ANTI-HUMMING TIP.

If you are bothered with mains hum on short-wave work try standing all the batteries on an earthed metal plate.

Do not hang up telephones when not in use against an outer wall, as this intensifies their tendency to rust.

The little cord near the telephone tags is intended to be fastened down to some immovable part of the set, so that a pull on the cord will not weaken the connections inside it.

When an output or L.F. valve is not being worked on its maximum H.T., it is sometimes possible to remove overloading distortion by applying all the extra voltage possible and readjusting grid bias to correspond.

The loud hum often heard when attempting to work a pick-up is frequently caused by the pick-up leads in the grid circuit being too long.

The use of "armoured" twin flex for pick-up leads (in which the covering can be earthed) is frequently effective in removing hum.

Where pick-up leads must necessarily be long it is a good plan to incorporate an L.F. transformer with short wiring from its primary to the grid circuit so that the long leads to the secondary are decoupled from the valve.

When a milliammeter connected in the plate circuit of the last valve kicks to a lower value on loud passage, it generally means that the grid-bias value is too low.

LEARNING THE MORSE CODE

By S. GASSMAN.

I HAVE never regretted the period I spent in learning the Morse code, for I can now obtain much enjoyment from "reading" ships at sea and amateur transmitters.

Like most people, at first I experienced difficulty in receiving it, although I could send it with comparative ease. I knew

without any conscious effort that the alphabetical letter A was . —, but when confronted with the symbol . — had to "stop and think."

I attempted to obtain practice by listening to amateur transmitters on short waves, and constructed a special receiver for this purpose. Unfortunately, I made little headway, for to my inexperienced ears they transmitted at such a tremendous rate.

I then bethought me of the little gadget described here which I think is the next best to having the help of a friend who knows Morse. I made good use of this little gadget and found it a marked improvement over the other method of listening to transmitters.

A Couple of Discs.

It consists of two cardboard discs placed one above the other with a pin or nut and bolt passing through their centres, and enabling them to be rotated freely. The top disc has a small "window" cut in it so that as the bottom disc is revolved the dots and dashes of the Morse code appear beneath the window.

Out of sight, and nearer the centre are the letters represented, and when necessary they can be seen by slightly lifting the edge of the upper disc. A little practice with this gadget soon makes one familiar with the code and enables one to decipher the staccato series of dots and dashes with comparative ease.

HERE'S A GOOD TIP FOR LEARNING THE LETTERS

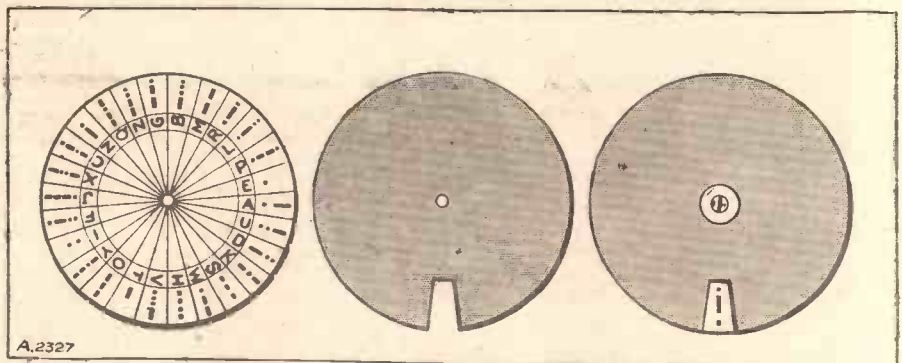

Even if you haven't a friend to practise with, you can soon learn Morse by this method.

VIOLET LORAINE



For the sake of a great contrast she would select to hear Caruso and George Chirgwin.

sufficiently near in time to be acceptable and understood by the great body of listeners.

Taking everything into consideration, therefore, here are my two names — Caruso; and George Chirgwin!

A great contrast, but a magnificent half-hour!

SWITCHING BACK

(Continued from page 234.)

BRANSBY WILLIAMS.—If I could summon some one from the past to broadcast from Savoy Hill, my choice would be a personal one — Captain Bransby Williams, M.C., R.F.C.

He was my son. He was reported missing in May, 1917. The four who were the last to be with him never explained, but said simply, "Last seen flying high." When my wife and I arrived in New Zealand, we discovered that one of them was in the hotel, but he disappeared within the hour.

If my son came to the microphone I could learn so many of the things that I want badly to know—all about those last flights of his. He left a wonderful diary, but, unhappily, it is so very incom-

plete. He was known as "Side-Slip Willy."

No trace of him or of his machine was ever found.

If, by some miracle, he could be brought before the microphone, his words would be interesting to a large circle of listeners, for he was so much admired by his fellow airmen.

BRANSBY WILLIAMS



His wish is a personal one that many will echo—he would summon back his son, Bransby Williams, reported "missing" in May, 1917.

The
LISSEN
ECONOMY
POWER
PENTODE



How to get MORE VOLUME and better quality reproduction without paying more for it!

If you would like your radio louder—if you would like to get the Continental stations at fuller loudspeaker strength—if you have a two-valve set and would like to have it perform like a three—if you have a three-valve set and would like it to perform as a four—*replace the last power valve with a Lissen Power Pentode.* Immediately you will notice a tremendous step-up in volume on all stations.

The valve to get is the Lissen P.T.225—the Economy Power Pentode—so called because, although its magnification factor is over 90, its power consumption is only 7 m. A. That means you can work it off the same batteries as the power valve it replaces and get **IMMENSELY INCREASED VOLUME** without adding to running costs.

P.T.225 PRICE

12'6

USE ALSO THE LIVELY LISSEN

OTHER TYPES	
H.210	5'6
L.210	5'6
P.220	7'3
P.X.240	8'/-
S.G.215	12'6

4-volt and 6-volt types also available.

DETECTOR VALVE
 TYPE H.L.210
 PRICE **5'6**

Lissen Valves are British and Best

LISSEN LIMITED, WORPLE ROAD, ISLEWORTH, MIDDLESEX.

EVERYTHING **G.E.C.** ELECTRICAL
your guarantee

**A HIGHLY
 SPECIALISED
 FACTORY
 KIT**

**DESIGNED AND MANUFACTURED TO BE AND TO LOOK LIKE
 A HIGH CLASS RADIO SET AND NOT LIKE A HOME MADE JOB**
**THE NEW CONSTRUCTOR'S CIRCUIT
 DEVELOPMENT**
note the choice Walnut cabinet work

The OSRAM
 "FOUR" Constructor's
 Instruction Chart, sent POST
 FREE for coupon, gives you the
 fullest advice and
 information.

**MADE IN
 ENGLAND**

*Sold by all Wireless
 Dealers.*



**OSRAM
 "FOUR"**

NEW MUSIC MAGNET

**The
 OSRAM "FOUR"
 NEW MUSIC MAGNET
 is the
 best circuit with the
 best valves and the
 best components
 —made entirely in England**

Previous models of the OSRAM
 MUSIC MAGNET kit sets have
 earned a world-wide reputation
 for outstanding radio perform-
 ance, range, selectivity and
 quality of reproduction. This
 new model surpasses its pre-
 decessors in performance while
 exterior appearance has been
 completely changed by the pro-
 vision of a magnificent walnut
 cabinet of modern design.

**A BRITISH PRODUCT
 DESIGNED FOR BRITISH
 RADIO CONDITIONS**

The OSRAM "FOUR" introduces an entirely new and improved conception of home-assembled circuits. In appearance, in performance, it represents high-class, super-efficient radio. At the remarkably low price of £10-15-0 it introduces, as well, a standard of radio value never before attained.

It embodies all essential features required for modern broadcasting conditions, and which are incorporated in the highest-class manufactured sets. Results—GREAT SELECTIVITY which enables you to get any station you want, GREAT POWER when the full output of the set is required, GREAT PURITY at any strength. These are the results you want. This is real, satisfying radio enjoyment, obtainable only from a powerful set such as the OSRAM "FOUR."

Many more stations, much more selectivity, much more volume, much more purity are qualities that particularly commend the OSRAM "FOUR." It is the world's best circuit and assembly kit, with the best valves (OSRAM), the best components (GECOPHONE), and gives the best rendering of all that is broadcast. It is MADE IN ENGLAND at the Coventry works of The General Electric Co., Ltd.—your guarantee of reliability and satisfaction.

SUPREMACY IN RADIO

Admt. of the General Electric Co., Ltd. Head Office and Public Showrooms ; Magnet House, Kingsway, London, W.C.2

**The position of every component is fixed
— all you have to do is to wire up**

**Easy to assemble
Easy to operate
Easy to get the
world's best stations**

You will find absolutely no difficulty in assembling the various parts of the OSRAM "FOUR" together. The position of every component is fixed—all you have to do is to wire up, directed step by step by the full size Constructor's Instruction Chart. Wherever you live you can be sure of the utmost of radio enjoyment with this latest radio marvel.

WRITE for the OSRAM "FOUR" Constructor's Instruction Chart, and learn all about this radio sensation. **FILL IN THE COUPON BELOW.** The clear directions given in these instructions will enable you to assemble the OSRAM "FOUR" without the possibility of mistake. It is crammed full of useful hints and tips, and contains a rapid guide for getting practically all Home and Continental stations. **SEND FOR A COPY TO-DAY.**

SPECIAL FEATURES OF THE OSRAM "FOUR"

- 1** The two Screen Grid high frequency stages give extreme selectivity and sensitivity with an unrivalled range.
- 2** Enormous amplification with perfect stability is given by the complete shielding of H. F. circuits.
- 3** Equal efficiency guaranteed on both wavelength bands.
- 4** Change of wavelength is effected by an external switch and the set need not therefore be opened.
- 5** Maximum ease in tuning with single knob controlling triple gang condenser.
- 6** Assembly is the essence of simplicity.
- 7** Volume control is provided not only to act as such, but to secure extreme selectivity.
- 8** Two terminals provided for connection to Gramophone Pickup.
- 9** Attractive Walnut Constructor's Cabinet of modern design with front panel to match.

HIRE PURCHASE You can either buy your OSRAM "FOUR" for cash or on these attractive **HIRE PURCHASE** terms—Deposit 25/- and 12 monthly payments of 17/-.
Your dealer will give you full particulars.

**NOTE
THE LOW
PRICE
ONLY**
£10.15.0
Including OSRAM VALVES
GECOPHONE COMPONENTS
& POLISHED HEAVY WALNUT
CONSTRUCTORS CABINET

**A. C. MAINS
OPERATION**

The OSRAM "FOUR" can be built for A.C. All-mains operation by means of the new GECOPHONE A.C. All-Power Unit and Conversion parts. This Unit can also be used to convert last season's "Osram Music Magnet 4."



POST FREE
Instruction Chart

POST COUPON TO-DAY!
Please send me particulars of the OSRAM
"FOUR" NEW MUSIC MAGNET.

Name _____
Address _____

The General Electric Co. Ltd.,
Magnet House, Kingsway,
London W.C.2
P.W.

Cut out and paste on postcard, or enclose in unsealed envelope.
Halfpenny postage in other case.

S.E.C. RADIO

Branches and Public Showrooms throughout Great Britain.

MEASURING YOUR POWER SUPPLY



The man with a meter does not always get all the help from it that he might. Here is an article full of useful measuring hints.

By J. ENGLISH.

IN spite of its title, this article has nothing to do with the readings of your electricity meter, but measurements of electrical power on a very much smaller scale—the anode current and H.T. voltages supplied to your receiver.

Don't Work in the Dark.

Perhaps, however, you never measure your power supply, and there must be a large number of people who don't. No doubt you have asked yourself whether a voltmeter or a milliammeter is a necessary adjunct to an up-to-date receiver, knowing that you get satisfactory results without, by experimenting with anode and grid-bias voltages.

This may be true enough, but it is not quite all the truth. Without a meter of some sort you are working in the dark, and if you buy new valves or experiment at all, you never quite know where you are as regards volts and milliamperes.

As for mains operation, the position is far worse, because the more current you take from the unit the lower the voltage available at its terminals. This fluctuation of voltage according to the current load is more pronounced in smaller and cheaper eliminators—poor voltage regulation we call it.

It is my experience, and probably that of many readers, too, that the man with the meter definitely gets better results and better value for his money, especially with a three- or four-valver. In fact, attempting to get full efficiency and high quality without measuring your volts and milliamperes is as wasteful of time and energy as hiking across unknown country without a map.

A Combined Meter.

To cover all the measurements you are likely to make you really require a combined meter with at least two milliamp ranges, say 0—5 and 0—25 milliamperes, and one or two voltage ranges, say 0—10 and 0—200 volts. This is the type of meter which I find extremely useful with my own installation, and quite indispensable for adjusting output stages, power amplifiers, etc.

For general use, however, a single range milliammeter and a high-range voltmeter will cover most of your measurements, while such instruments are now relatively inexpensive, especially in view of what they can save you.

While on the subject of meters, I should like to emphasise the danger of purchasing cheap high-range voltmeters. These invariably draw a large current, sometimes 40 milliamperes or more, for full-scale deflection which makes their voltage readings quite worthless.

The ideal voltmeter, of course, draws no current from the power supply. However, you do get reliable readings with the better makes of voltmeters, and then you can find out what is happening in each valve stage, besides checking your H.T. voltages and grid bias.

Checking the Current.

Now for the majority of power supply adjustments a milliammeter is rather more useful than a voltmeter, as it gives you a visual indication as to whether your valves

be used if you are measuring up a super-power valve.

Having provided adequate H.T., the next step is to adjust grid bias until the meter needle is reasonably steady when volume is turned full on. You will, of course, switch off before moving the G.B. plug.

If the meter needle kicks up and down on loud signals, you know at once that the last stage is being overloaded—remedy, a post-detector volume control, more H.T., or a bigger output valve. If the needle kicks upward, insufficient grid bias is indicated, while downward deflections indicate the reverse.

An Aid To Good Reproduction.

Adjusting the output, or, for that matter, any L.F. stage by watching the behaviour of the milliammeter, is a much easier and quicker method than relying upon the ear alone. In addition, you can see at a glance whether any valve is passing the anode current normally to be expected for the values of anode volts and grid bias applied.

When measuring anode currents it is well worth while making a permanent record of the current taken by each valve for known values of anode voltage and grid bias. These readings should compare within 10 per cent or so with these shown by the manufacturers' curves.

If at any future time you duplicate these measurements under the same conditions, you can tell whether that set of valves is up to scratch.

Faulty Valves.

Any drop in anode current will indicate a falling-off in filament emission, due in most cases to excessive anode voltage or insufficient grid bias, for which there is no excuse if you use a meter!

Other occasional uses for your milliammeter are testing for leakage in the H.T. circuit, by inserting the meter in the H.T. negative lead, with the receiver switched off, and, when switched on, measuring up the total anode current to enable you to form an idea as to the best size of the next H.T. dry battery you purchase

LOOKING FOR THOSE TINY FLAWS

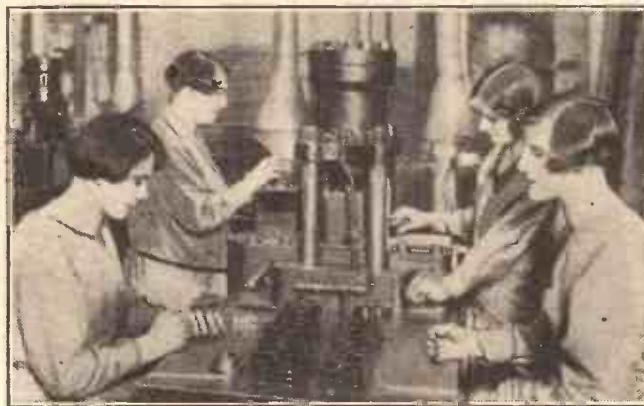

Modern methods of radio manufacture include extensive checks at every process. This is a typical testing room at Ferranti's Hollinwood factory.

are amplifying properly. Take the output stage of your receiver.

Here you connect a milliammeter so that it measures only the anode current of the last valve, remembering that the + terminal of the meter goes to H.T. +, and that a range of 0—20 m.a. or so should

H.T. from L.T. accumulator!

Sensation at Radio Show. Crowds flock to see S.G. Brown

“BATTERY SUPERSEDER”

Visitors to Olympia last week saw that Mr. S. G. Brown had done it again! The maker of the first loudspeaker and inventor of the Microbox and a host of other devices had added yet another to his long list of triumphs. His BATTERY SUPERSEDER does away once and for all with the bother and expense of using H.T. batteries. By connecting the SUPERSEDER to your present accumulator you can obtain both H.T. and L.T. from it and you will be consuming very little more current! In short, this is how the SUPERSEDER works; it takes the 2 or 4 volts of your accumulator, converts it into A.C., steps up the voltage with a transformer, and then rectifies and smooths the current with chokes and T.C.C. condensers. The SUPERSEDER was tested and retested and run continuously for weeks on end before we announced it, and every model carries our twelve months' guarantee. The BATTERY SUPERSEDER shown here is designed for home cabinet sets. When connected to your existing 2-volt accumulator it consumes half an amp. and gives an output of 85 volts at 6 milliamps, which is ample for most ordinary 2 or 3 valve sets. If greater output is desired the BATTERY SUPERSEDER can be connected to a 4-volt accumulator and will then give 112 volts at 10 milliamps. It should be emphasised that the above readings are constant, whereas the finest dry batteries very quickly drop below their nominal voltage. Complete, this model costs £3 15s. 0d. (or it can be purchased by 9 easy monthly payments of 10/- from any S. G. Brown dealer). Other models for use with portables and others giving higher output are in course of construction and will be announced later. The SUPERSEDER will shortly be shown in all good radio shops. If you care to send your name and address to S. G. Brown, Ltd., 19, Mortimer Street, London, W.1, we will gladly send full particulars of this and all the other new Brown models.

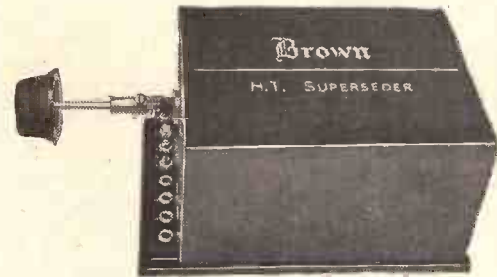

This photograph shows the neat exterior of the S. G. Brown BATTERY SUPERSEDER. One switch controls both set and SUPERSEDER.

Other S. G. Brown Models.

KIT CABINET AND SPEAKER IN ONE!

Thinking of buying a kit set? An excellent idea! But not quite perfect until you've got a speaker worthy of your set, and a hiding place for your batteries. Well, you can get both in an S. G. Brown KIT-CABINET SPEAKER.

MODEL 1. For Mullard 1932 3 valve Kit or Radio for the Million V.3 Kit (incorporates S. G. Brown SOLO speaker). Price 47/6 (or 6 monthly payments of 10/-.)

MODEL 2. Stand-on kit-cab. for 1932 Melody Maker, Osram 1932 Music Magnet, etc. Price (with Brown SOLO SPEAKER), 39/6 (or 6 monthly payments of 8/-.)

MOVING COIL SPEAKERS MAKE ALL THE DIFFERENCE.

Are you strangling your set with an out-of-date speaker? A speaker that was the last word two years ago, to-day is definitely old-fashioned, such have been the developments in speaker design. Take the new S. G. Brown permanent magnet, moving-coil speaker, for instance. It costs only £4 19s. 6d. (or 9 monthly payments of 13/6), and yet it will get the very best from any set. Ask your dealer for a demonstration.

ANOTHER FAITHFUL PRODUCT MADE BY

Yours faithfully

S. G. Brown

FAITHFUL RADIO

GOOD NEWS!

*Next Week's "P.W."
is a great*

**BETTER
RECEPTION**

**ECONOMICAL
RUNNING**

AUTUMN GIFT ISSUE

Every copy of "P.W." next week will contain
a specially-compiled gift-book entitled:

The "P.W."

GUIDE TO BETTER RADIO

Don't fail to get your copy of this valuable
work of reference. Whether you are buying
a battery, building a portable, using your
mains, selecting an accumulator—in fact,
whatever your radio problem—you need
this wonderful

**FREE
TO
EVERY
"P.W."
READER**

**TO AID
YOU IN
CHOOSING
& USING
YOUR SET**

FREE BOOK

with "P.W."

NEXT WEEK

**CHOOSING THE
RIGHT CIRCUIT**

**OUT ON
THURSDAY**

**ORDER
NOW**

**USUAL
PRICE**

**SELECTING
YOUR ACCESSORIES**

100% BRITISH MADE



1931/2 Models.
Senior A.C. Model
New Reduced
Price £7.15.0.
1931/2 Senior
Permanent
Magnet
Senior D.C. Model
New Re-
duced Price
£5.12.6.

Minor Permanent
Magnet Model
Price £2.10.0.

Minor D.C. Model
Price £1.11.6.

**-and it
costs
less**

If you must have the best possible reproduction it means a B.T.H. R.K. There are many new models available now. In the R.K. range, from the "Minors" at 31/6 (field excited model) and 50/- (permanent magnet) to the Senior A.C. R.K. at £7:15:0, there is a model specially suited to your requirements.

Ask your dealer for a demonstration and full particulars.

**GREENWICH
TIME FROM THE
MAINS**



Have you seen the Ediswan A.C. Mains Electric Clock? Ask your radio dealer. Prices from 45/-.

B.T.H.



**MOVING COIL
REPRODUCER**

EDISWAN RADIO



THE EDISON SWAN ELECTRIC CO. LTD.
Radio Division: 155 Charing Cross Road, London, W.C.2

W.177

COMPARE the power of these ATLAS MAINS UNITS

The Highest Output at the
Minimum Price

For 1, 2 and 3
VALVE SETS

Incorporating Westinghouse Rectifier, 1 Tapping 60/80v., 1 Tapping 90/100 v., 1 Tapping 120/150 v., Output 12 m/A. Trickle Charger for 2 v., L.T. Accumulators at 3 Amps.

77/6, or 10/- down
and 9 monthly payments of
8/6 each.



Model A.K.22

For sets up to
4 VALVES

Incorporating Westinghouse Rectifier, 1 Tapping 60/80 v. (Max. and Min.), 1 Tapping 50/90 v. (Max., Med., and Min.), 1 Tapping 120/150 v. Output 20 m/A. at 120 v. Trickle Charger for 2, 4, and 6 v. L.T. Accumulators at 3 amps.

90/-, or 10/- down
and 9 monthly payments of
10/- each.



Model A.K.260

For sets up to
5 VALVES

This amazingly successful unit was voted the finest Mains Unit at Olympia, 1930. Incorporating Westinghouse Rectifier, 2 Variable Tappings 0/100 and 0/120 v., 1 Fixed 150 v. Output 25 m/A. at 150 v. Trickle Charger for 2, 4 and 6 v. L.T. Accumulators at 5 amps.

£6, or 10/- down
and 7 monthly payments of
15/6 each, and one of 14/6.



Model A.C.188

All the above for A.C.

You will find that the claims made for "ATLAS" MAINS UNITS are fulfilled *absolutely* in use. If you require 25 m/A at 150 Volts, and the "ATLAS" specification gives this output, then you can be sure you will get it.

An "ATLAS" Mains Unit has been designed for conversion of every type of Battery Set. Send for a price list of the full range to the address below.

All Units are guaranteed for 12 months.

"CLARKE'S" ATLAS MAINS UNITS

H. CLARKE & CO. (M/CR) LTD., Old Trafford, MANCHESTER
LONDON OFFICE: Bush House, W.C.2

WHAT I SAW AT OLYMPIA

(Continued from page 206.)

in passing, I must mention that dozens of enthusiasts were examining the Varley "Square Peak" coil and "Square Peak" sets with every evidence of keen appreciation.

At no great distance Heayberds had an ingenious robot in action.

I had now been right round the exhibition, and I spent the remaining time at my disposal re-visiting some of the outstanding displays. Thus I made a point of again inspecting the fine Telsen range of components on show. These are, of course, sufficiently important in themselves to provide a worthy base for an exhibition display, but I felt that the large Telsen stand, with its excellent position, rather lacked novelty in setting.

The Blue and Gold Standard.

But, then, the same applied equally to many of the other stands, and no doubt that was due in large measure to the enforced standardisation of decorations. I consider that a vast mistake. If I were the deciding authority I'd give every exhibitor a fairly free hand, as is done at the Manchester show.

That policy makes for a much brighter general display.

One of the newest ideas in radio seen at the show is the Six-Sixty "Chassikit," and this idea appears to me to combine the

advantages of the commercial set with those of the ordinary kit without any of their individual disadvantages.

There is absolutely no wiring or soldering in the whole receiver, which employs a screened-grid, detector and Pentode with pre-selector and band-pass tuning. The complete set can be put together in two minutes and has only one-knob control.

I also notice that a large variety of modern attractive cabinets is available for the "Chassikit" at very moderate prices.

Another stand I revisited was that of Messrs. Peto-Scott, for I wanted to have a further opportunity of calculating how visitors were reacting to our set designs—and, of course, Peto-Scott were showing kits of our sets. I noted that quite a keen interest was being evinced in the Peto-Scott version of our Coil Quoit.

I repassed the Bulgin stand and saw that the many new Bulgin lines were deservedly arousing considerable attention, and I had another few minutes with the "Ekco" sets and units.

Space is getting short, but I must at least record the fact that Regentone, Benjamin, Utility, Dubilier, Ever Ready, Atlas, Graham Farish, Amplion, and last, but by no means least, Blue Spot, all managed to make me linger much longer than I really ought to have done.

Could I have given more detailed appreciations of these and various other fine exhibits I would most certainly have done so, and I sincerely trust no reader or exhibitor will regard the number of words I have devoted to each of the firms mentioned as in any way an indication of merit

or importance. And that applies equally to their order of mention.

This is presumed to be, as I have said before, just a personal account of a ramble round the stands, not an official analysis.

As a matter of fact, one of the things that I remember most clearly took place at a stand the number and owner of which I've entirely forgotten! I hasten to say that I did take a note of the incident, but that this note, with several others, was subsequently lost.

However, this is the incident in question. There was a tiny boy wearing a very large Eton collar perched right on the top of a mound of radio gear. He was assembling a radio receiver. He appeared to be very young—ten years old, I would have said.

There were two ladies dressed in nurses' uniform standing solemnly watching him. I edged nearer, anticipating a sweep on the part of the Royal Society for the Prevention of Cruelty to Children, or some such body, on account of the youth of this juvenile worker. I presumed the elderly nurses were officials of an institution of this kind.

The Little Cherub.

To my eyes the little boy seemed just a wee bit self-conscious. A stray lock of hair drooped over his forehead, his rosy cheeks were just a trifle more rosy than was natural. He was obviously a little "hot under the collar." But he plied his diminutive fingers in a quite businesslike fashion.

"He's all there!" explained one of the nurses, turning to the other with a smile

(Continued on page 246.)

The Outstanding feature of the show



BRITISH GENERAL

BAND PASS 10K.C. TUNING UNIT

At last—a Tuning Unit which gives the separation of 10. Kilocycles as laid down by the International Radio Convention, and yet gives full strength throughout the entire wave-band between 230 and 550 and from 800 to 2,000 metres.

PRICE
14/6
INCLUDING
COUPLING
CONDENSER

Of all dealers of repute or direct from the manufacturers:

**BRITISH GENERAL
MANUFACTURING Co. Ltd.,
BROCKLEY WORKS, LONDON, S.E. 4.**

At last! A panel guaranteed **NEVER TO DISCOLOUR**

PERMCOL
The Perfect Ebonite Panel

Specified by the leading technical journals and recognised as the only Ebonite Panel that will never discolour. Neither chips nor splinters. Easy to cut and drill. Splendid insulation. Low in price.

Such is PERMCOL, the Panel with the mirror-like surface. Black or Mahogany. Ask your Dealer, or direct, cash or C.O.D. **BRITISH MADE.**

PERMCOL MIRROR-POLISH 3/16th" PANELS.

Size	Black-Polished	Mahogany Finish
7" x 14"	3/6	4/3
7" x 18"	4/6	5/6
7" x 21"	5/3	6/4
8" x 16"	4/7	5/6

**BRITISH HARD RUBBER CO. LTD. (Dept. B.),
PONDERS END, MIDDLESEX**

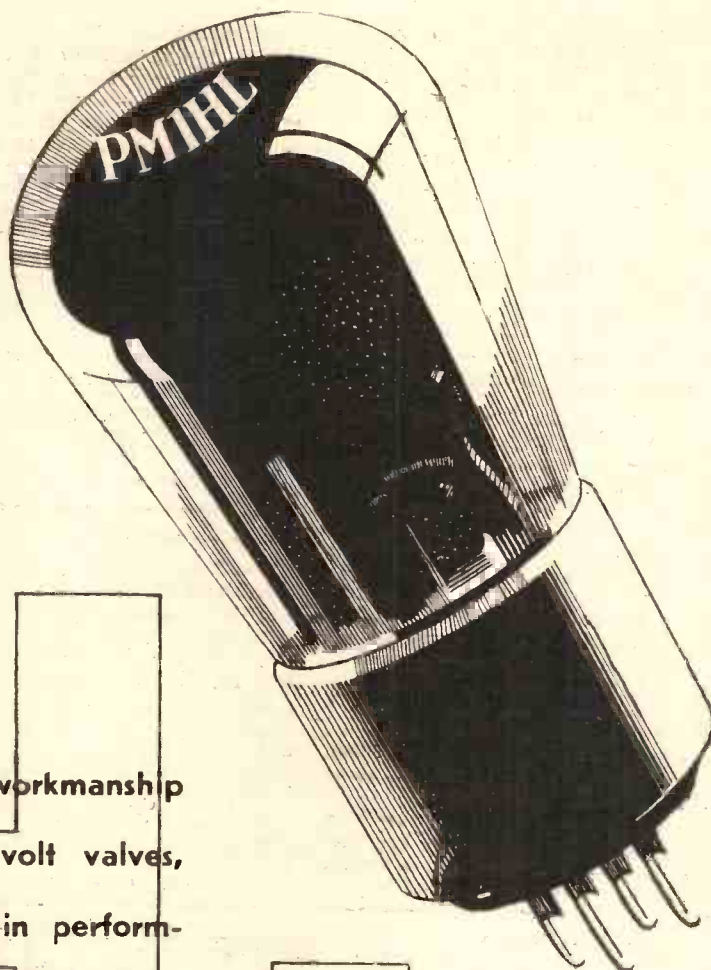

Mullard research, and Mullard workmanship have produced a range of 2 volt valves, flawless in construction, supreme in performance. The P.M.1 HL is a general purpose valve from the 2-volt range. It is primarily designed for use as a high frequency amplifier in sets not employing a screened grid valve, but it will also give excellent results as a detector or low frequency amplifier. Buy one today from your dealer.

Price 8/6

Mullard

THE · MASTER · VALVE

WHAT I SAW AT OLYMPIA

(Continued from page 244.)

And then the little boy dropped a wire and said something. I couldn't catch the words, and it may have been quite a coincidence that the nurse should have chosen that moment to turn sharply away. But they were not then smiling—of that I am quite sure, because I saw their faces clearly.

I wonder *what* that little boy said and—but there, I always did have a superabundance of inquisitiveness in my make-up.

The Judge Sums Up.

And now to sum up. My general impressions were that the radio has reached and is determined to remain on a high plane. The sets, components, and accessories on show at Olympia were, on the whole, of definitely good standard.

There is apparently a quality competition in progress rather than a competition to sell goods as cheaply as possible, though prices are definitely low. Indeed, there is no doubt at all but that for the most part the radio trade is offering the public good-class gear at real value-for-money prices.

Here and there I am bound to say I caught glimpses of shoddiness and heard loudspeakers that were none too good. But that was inevitable, for, remember, about two hundred firms were showing.

After the fulsome flattery that has been poured out in other quarters, I am sure that "P.W." readers will appreciate a candid commentary.

I felt a little sorry for the general public. There was such a vast collection of apparatus all priced within certain fairly well-defined limits. At a motor show one discovers that there are mighty few of the hundreds of cars shown that fall within the boundaries of one's own price requirements. But at Olympia there seemed to be thousands of sets listing at more or less the same figures.

No one can say that there was no choice! There were many more components shown this year, and it is obvious that the trade now realises that home-construction is Big Business. And the technical standard of components seems to have risen as much as prices have fallen.

WHAT I THOUGHT OF THE SHOW

(Continued from page 203.)

Appearance and Controls.

I said last year that I felt more could be done about appearance. Certainly this year certain manufacturers are to be congratulated on their enterprise in giving us something that has individuality and form. In fact, I have seen for the first time in my life a wireless set which can really be described as handsome—whatever you may think about your taste.

There are still far too many little wooden knobs which move scales deep down a long tunnel. I do think something might be done to improve controls, and again I recommend you to see particular examples of switching on the Marconiphone stand.

By the way, a friend I took round, who is a very good wireless engineer, was very struck with the Extenser on the POPULAR WIRELESS stand. This ought to be taken up more.

Presentation.

I still could wish for better presentation of the exhibition as a whole. But, alas! the crowded state is due to lack of accommodation, which is no fault of the organisers.

Stunts.

The B.B.C. exhibit is conscientiously done. It does not, however, exactly sparkle. And why—oh, why—put a small amplifier in so huge a room, and then leave straggling bits of wire about? The accumulators are dull things; they should be hidden. Is it necessary to have a voltmeter (?) with pendulous connections standing on a flap hanging down from the side of the amplifier. The B.B.C. should be slick, smart, tidy, and clean.

General.

And, in conclusion, many thanks to the organisers and the trade. I have criticised—I hope in no carping way—because I am interested. There is a great improvement on last year. One thing is wanted at the next exhibition—

Demonstration.

I think it might be done, given a little courage and initiative. Buy now, buy British, for no other reason than that, with a wide experience of other countries' products, I can definitely say, in spite of the criticism, that I think that British sets are better than any other.

High-Grade RADIO GRAMOPHONE CABINET

of exclusive modern design, hand-made and polished on Queen Anne legs.

Figured Oak - - - - - £5 : 5 : 0
Figured Walnut or Mahogany £5 : 19 : 6
Carriage Paid.

THE ACME OF CRAFTSMANSHIP

Radio-Gram Cabinets from £3 : 19 : 6 to £21
Wireless Cabinets - - - - - from £2
Photographs and 30-page illustrated Catalogue free.

Cabinets made to order a speciality. Furniture at Maker's prices.

GILBERT, CABINET MAKER, SWINDON.

Estimates free. Estd. 1866

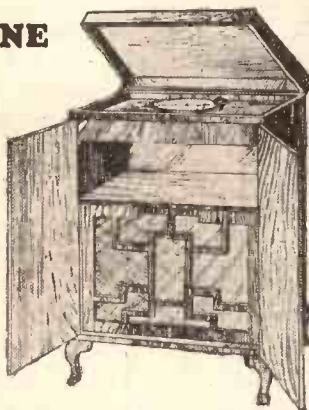

"DAPTACON"

The Pick-Up for use with any Set



Remarkable results obtainable even when used on a ONE Valve circuit!

The British Ideal "DAPTACON" Pick-Up is supplied with three separate leads, giving low, medium and high-output for use with different power sets. It is beautifully finished in Florentine Bronze, absolutely complete in box, with full instructions and ready for use.

PRICE **32/6** COMPLETE

MAKE YOUR OWN

"DAPTACON" ELECTRIC GRAMOPHONE MOTOR



55/-

This Motor is universal for both A.C. or D.C., and covers voltages 100 to 200, and 200 to 250 A.C. or D.C. Therefore can be used anywhere by simply plugging into any electric light socket. Built of finest materials and supplied complete with 42 in. plush-covered Turntable and geared speed indicator. When used in a Radio-gramophone electrical-interference is eliminated by the use of a small condenser, supplied without extra cost.

RADIO-GRAM

The "DAPTACON" Pick-Up is supplied on a straight arm of conventional type or with a patent CARRIER-ARM as illustrated above. This Carrier-Arm ensures that the Pick-Up travels across the record in a dead straight line, thus minimising wear on the record grooves. Either type at same price, 32/6. On sale at leading dealers everywhere. Trade enquiries to **BRITISH IDEAL PATENTS, LTD.**, Green St., Brimsdown, Middlesex. Tel.: Enfield 1741-1808. Or to the usual Factors.

REDUCED PRICES! QUALITY MAINTAINED

BECOL LOW LOSS FORMERS

26 Types. Tested before despatch.

LOOK FOR TRADE MARK

PANELS CUT TO ANY SIZE

THE BRITISH EBONITE Co. Ltd., Hanwell, W.7



AN ENTIRELY NEW RANGE

MULTI-GRID VALVES

An entirely new range of Tungram Multi-grid Valves—the first of the new Tungram series. Of unique construction, they supersede entirely the pentodes at present on the market; they are so arranged internally that the electron stream is *twice* controlled by the grid.

These new valves can be used in any existing pentode receiver without any circuit alteration whatsoever; in ordinary receivers only one extra connection is necessary. Three types of Multi-grid Valves have been introduced: PP230 (2 volt), PP415, and PP430 (4 volt). PP230 will very materially increase the output of the small receiver, although the anode current consumption will in most cases be below that of the ordinary power valve. PP415 and PP430 will be found extremely efficient for the output stage of A.C. Receivers. All Tungram Multi-grid Valves can be supplied with a 5-pin base, or 4-pin base with side terminal.

For characteristic curves and other technical information write to Dept. ST3.
 Prices: Multi-grid Valves Type PP230, 16/-; PP415, 16/-; PP430, 19/-. Other types from 5/6 to 19/-. Tungram Barium Valves are manufactured under one or more of the following Patent Nos.: 289,762, 289,763, 311,705, and 313,151.

TUNGSRAM ELECTRIC LAMP WORKS (GT. BRITAIN), LTD.
 Radio Department, Commerce House, 72 Oxford Street, London, W.1.
 Makers of the famous Tungram Electric Lamps.

Branches in Birmingham, Bristol, Cardiff, Glasgow, Leeds, Manchester, Newcastle, Nottingham, Southampton
 Lamp, Valve and Glass Factories: Austria, Czecho-Slovakia, Hungary, Italy and Poland.
 I.F.S. Organisation, Tungram Lamps & Radio, Ltd., 11 Burgh Quay, Dublin.
 Tungram photo-electric cells: Nava "E" (for scientific measurement), £2 17s. 6d.;
 Nava "R" Red sensitive cell (for colour matching devices), £3 3s.; Nava "EII" (for talkie work), £3 13s. 6d.

3125

TUNGSRAM



All Editorial communications should be addressed to the Editor, POPULAR WIRELESS, Tallis House, Tallis Street, London, E.C.4.

The Editor will be pleased to consider articles and photographs dealing with all subjects appertaining to wireless work. The Editor cannot accept responsibility for manuscripts or photos. Every care will be taken to return MSS. not accepted for publication. A stamped and addressed envelope must be sent with every article. All inquiries concerning advertising rates, etc., to be addressed to the Sole Agents, Messrs. John H. Lile, Ltd., 4, Ludgate Circus, London, E.C.4.

The constructional articles which appear from time to time in this journal are the outcome of research and experimental work carried out with a view to improving the technique of wireless reception. As much of the information given in the columns of this paper concerns the most recent developments in the radio world, some of the arrangements and specialities described may be the subject of Letters Patent, and the amateur and the trader would be well advised to obtain permission of the patentees to use the patents before doing so.

QUESTIONS AND ANSWERS

TESTING THE TELEPHONES.

C. H. (Eastbourne).—"I have been waiting for a long time to see if you would give in 'P.W.' the method of testing telephones. I know the ordinary method of using a battery and listening for the clicks, but this is supposed not to be good for the 'phones.

"What is the correct method?"

It would certainly not be good for the 'phones to use a high-voltage battery, but little if any damage would be done with low voltages. It is not, however, for this reason that the battery method is not recommended, but because it is not so sensitive as the correct way.

Unless a pair of 'phones has absolutely konked out with a complete break or something of the kind, you will generally receive a distinct click when a battery is in the test circuit, and consequently may be misled into thinking the 'phones are in perfect order. It is better to dispense with the battery altogether.

Place the telephones over the ears as for listening in the ordinary way, and then put one of the tags at the end of the cord into your mouth, holding it firmly between the lips. Now, in one hand take the second tag of the telephones, and in the other hand a key or a nail or a similar piece of metal, and rub

this gently on the second tag. If the telephones are in good order you will hear noises corresponding with this rubbing in the earpieces.

They will not be very loud, for in the absence of an external battery you are working the telephones by a kind of human electricity from your own body. But so sensitive is a good pair of 'phones that if they are in decent working condition the noises will be quite distinct and unmistakable.

You can test each earpiece separately by removing one of the earpieces from the ear and listening only with the other. Or alternatively you can place a pad between the ear and adjacent earpiece so as to cut off the sound from it.

In this manner you can compare the loudness of the two earpieces. But do not forget that most people hear much better with one ear than with the other, so before definitely pronouncing one earpiece less sensitive than its fellow, turn the telephones round and try both earpieces in turn on one ear.

This method of testing 'phones has the advantage not only of extra sensitivity, but of being extremely easy, as it requires no external battery at all and almost any piece of metal will do for getting the rubbing contact.

A MATTER OF CALIBRATION.

P. C. F. (Faversham, Reading).—"What is the difference between a wave-meter and a frequency-meter?"

Essentially there is no difference; both the instruments named are used to measure the wavelengths or frequencies of transmissions or circuits.

The practical difference is that whereas the wave-meter is calibrated in so many metres, the frequency meter is calibrated in kilocycles or cycles.

(Continued on next page.)

YOUR BIT TOWARDS ECONOMY

Have you ever thought how difficult it is for a newsagent to order just the right number of copies of any particular paper each week? You can make his task much easier if you place a regular order with him. You will not only help him to order correctly and avoid waste but will make sure of getting your copy regularly each week.

All About

The Romance of the Skies!



A Queer 'Plane.

A queer 'plane, this Northrop "Flying Wing," but no queerer than some of the other aircraft pictured and described in the MODERN BOY'S BOOK OF AIRCRAFT. This magnificent new volume is written by flying men and tells of the romance of Man's Mastery of the Air. It gives the story of Aviation from the earliest days and contains four full-page Coloured Plates, fifteen full-page pictures, and hundreds of photographs and drawings. It is an ideal gift for boys, old and young, and for Fathers, too!

The Modern Boy's BOOK of AIRCRAFT

At all Newsagents and Booksellers

7/6 net.

RADIOTORIAL QUESTIONS AND ANSWERS

(Continued from previous page.)

FITTING A VOLUME CONTROL.

W. G. (Kingston-on-Thames).—"I want to put a volume control of the potentiometer type in my low-frequency amplifier, which has two low-frequency transformers. Could you tell me whereabouts to fit it, as I do not know whether it would be best on the first or second transformer for maximum control?"

We should make the alteration on the first low-frequency transformer. All you have to do is to disconnect the secondary from the grid of the first valve in the amplifier, and wire this latter point to the slider of the potentiometer instead.

Then join the ends of the potentiometer across the two secondary terminals of the transformer, leaving the "G.B." to grid-bias wiring, etc., as before. Variation of the potentiometer slider will now give you the required control.

A TWO-CONDENSER FILTER OUTPUT.

M. S. W. (Pendleton, near Manchester).—"To put the final touches on the 'Clear-Cut' cone I want to divert the last valve's plate current by a filter circuit. I think I understand how it is to be done, and wish to use two 2-mfd. condensers and a choke (inductance 20 henries).

"Would you give me the necessary connections in words, as I understand this better than a diagram?"

The alterations are quite easy. First of all mount your two 2-mfd. condensers and the low-frequency choke close to the present loudspeaker terminals and output valve.

Be careful not to place this choke near one of the low-frequency transformers, and try and stand it with its core at right angles to that of the nearest L.F. transformer.

"HULLO! WHAT'S WRONG WITH THE SET?"

Perhaps the switching doesn't work properly? Or some mysterious noise has appeared and is spoiling your radio reception? —or one of the batteries seems to run down much faster than formerly?

Whatever your radio problem may be, remember that the Technical Query Department is thoroughly equipped to assist our readers, and offers an unrivalled service.

Full details, including scale of charges, can be obtained direct from the Technical Query Dept., POPULAR WIRELESS, The Fleetway House, Farringdon Street, London, E.C.4.

A postcard will do. On receipt of this an Application Form will be sent to you post free immediately. This application will place you under no obligation whatever, but, having the form, you will know exactly what information we require to have before us in order to solve your problems.

LONDON READERS, PLEASE NOTE: Inquiries should NOT be made by phone or in person at Fleetway House or Tallis House.

In your present arrangement the plate of the last valve goes to one of the loudspeaker terminals. It should instead be taken to one end of the new low-frequency choke, this point also being joined to one of the two condensers.

The other side of the low-frequency choke carries the wiring that previously went to the other loudspeaker terminal, i.e. the H.T. + lead, and possibly other plate connections.

You now have to wire the loudspeaker terminals. One of them is joined to the remaining side of the new condenser already dealt with, and the other loudspeaker terminal goes to the second large condenser. Finally, the remaining side of this second condenser is taken to "earth"—i.e. to the earth terminal itself, or to the nearest point directly connected to it, such as L.T. — lead, or negative side of the filament wiring. This completes the alterations.

SIMPLIFIED TUNING FOR THE "COMET."

W. A. W. (Reading), D. A. (Bournemouth), S. S. G. (Stalybridge), "NORTHERN" (Dewsbury), and others.—A great many readers have enquired if the Extenser system of

(Continued on next page.)

New Times Sales Co

We can supply any accessory advertised in "Popular Wireless" on EASY TERMS. Send US your next order. We guarantee you every satisfaction.

NEW TIMES SALES PERMANENT MAGNET MOVING-COIL SPEAKER. With 6/11 order
In handsome oak french polished cabinet, with specially designed Epoch chassis, giving glorious tone and volume. With multi-ratio transformer. Cash Price £3 15s. 0d. Balance in 11 monthly payments of 6/11.

AMPLION MOVING-COIL SPEAKER, TYPE M.C.6. With 6/2 order
Permanent magnet, with output transformer. Complete. Cash price £3 7s. 6d. Balance in 11 monthly payments of 6/2.

B.T.H. RK. MINOR PERMANENT MOVING-COIL SPEAKER. With 6/- order
Handles output up to 2 watts. Cash price £2 10s. 0d. Balance in 8 monthly payments of 6/-.

EPOCH PERMANENT MAGNET MOVING-COIL SPEAKER. With 5/9 order
Type A.1. Cash price £3 3s. 0d. Balance in 11 monthly payments of 5/9.

R & A "100" MOVING-COIL REPRODUCER. With 5/4 order
With tapped Input Transformer. Cash price £2 17s. 6d. Balance in 11 monthly payments of 5/4.

ORMOND PERMANENT MAGNET MOVING-COIL CHASSIS (No. 464). With 6/- order
With tapped input transformer. Cash price £3 5s. 0d. Balance in 11 monthly payments of 6/-.

CELESTION PERMANENT MAGNET MOVING-COIL SPEAKER. With 6/5 order
Type RPM8. 8 in. Reinforced Diaphragm, excluding input transformer. Cash price £3 10s. 0d. Balance in 11 monthly payments of 6/5.

LAMPLUGH, FARRAND, FERRANTI or GECOPHONE DYNAMIC INDUCTION SPEAKER With 6/5 order
For perfect reproduction. Unit and chassis complete, ready mounted. Cash price £3 10s. 0d. Balance in 11 monthly payments of 6/5.

N & K INDUCTION DYNAMIC SPEAKER. With 6/5 order
Unit and Chassis Complete. Cash price £3 10s. 0d. Balance in 11 monthly payments of 6/5.

EPOCH J. I. PERMANENT MAGNET MOVING-COIL SPEAKER. With 4/10 order
In chassis form with multi-ratio input transformer. Cash Price £2 12s. 6d. Balance in 11 monthly payments of 4/10.

GARRARD INDUCTION GRAMOPHONE MOTOR. With 5/4 order
Model 202. Mounted on 12-inch Nickel Motor Plate with fully automatic electric starting and stopping switch. Cash Price £2 18s. 6d. Balance in 11 monthly payments of 5/4.

B.T.H. PICK-UP and TONE-ARM. With 4/2 order
Cash price £2 5s. 0d. Balance in 11 monthly payments of 4/2. With order

DELIVERIES OF RADIO FROM STOCK ON REALLY EASY TERMS

ELIMINATORS

EKCO K.18 COMBINED H.T. ELIMINATOR AND L.T. TRICKLE CHARGER. With 8/6 order
Delivers 18 m/a. and suitable for 1- to 5-valve sets. S.G., 50/80v., 120/150. Charges at 25 amp. at 2, 4 or 6 volts. Cash price £4 12s. 6d. Balance in 11 monthly payments of 8/6.

ATLAS A.C. ELIMINATOR TYPE A.C.244. With 5/6 order
3 Tappings, S.G., Detector and Power. Output 120 volts at 20 m/a. Cash price £2 19s. 6d. Balance in 11 monthly payments of 5/6.

EKCO A.C.25 H.T. ELIMINATOR. Send 7/1 only
S.G. 50/80 volts, 100/150 volts at 25 m/a. Cash £3 17s. 6d. Balance in 11 monthly payments of 7/1.

EXIDE 120-volt. TYPE W.H., H.T. ACCUMULATOR, in crates. With 8/6 order
Cash price £4 13s. 0d. Balance in 11 monthly payments of 8/6.

HEAYBERD H.T. UNIT "D" MINOR. With 5/4 order
Output 120v. at 20 m/a. Tapped at 80v., 100v. and 120v. Cash price £2 17s. 6d. Balance in 11 monthly payments of 5/4.

SIX-SIXTY CHASSIS KIT. With 12/7 order
Battery Model. Complete three gang band-pass tuning. S.G., Detector and Pentode. Cash Price with valves less cabinet £6 17s. 6d. Balance in 11 monthly payments of 12/7.

SIX-SIXTY CHASSIS KIT. With 13/5 order
(A.C. Model). Complete as above with A.C. Mains Valves. Cash Price with valves less cabinet £7 6s. 6d. Balance in 11 monthly payments of 13/5.

MANUFACTURERS' 1932 KITS

COSSOR 234 EMPIRE MELODY MAKER
Screened-Grid, Detector and Power. With valves and cabinet 10/-

CASH PRICE £6 15s. 0d. WITH ORDER
Balance in 11 monthly payments of 12/6. Finished Instrument. Royalties Paid, £7 10s. 0d. Cash or £2 deposit and 11 monthly payments of 11/-.

MULLARD 3 1932 TYPE

Screened-Grid, Detector and Pentode. With valves less cabinet 11/11
CASH PRICE £6 10s. 0d. WITH ORDER
Balance in 11 monthly payments of 11/11. Finished Instrument, with Valves and Cabinet. Royalties Paid, £7 17s. 6d. Cash, or £2 deposit and 11 monthly payments of 11/9.

OSRAM NEW MUSIC MAGNET 4

2 Screened-Grid, Detector and Power. With valves and cabinet 19/8
CASH PRICE £10 15s. 0d. WITH ORDER
Balance in 11 monthly payments of 19/8. Finished Instrument. Royalties paid, £11 15s. 0d. Cash or £2 deposit and 11 monthly payments of 19/6.

V.3 RADIO FOR THE MILLION

Screened-Grid, Detector and Power, with valves less cabinet 10/0

CASH PRICE £5 17s. 6d. WITH ORDER
Balance in 11 monthly payments of 10/9. Finished Instrument, with valves and cabinet. Royalties Paid, £7 8s. 6d. Cash, or £2 deposit and 11 monthly payments of 10/10.

ESTABLISHED IN 1924—FIRST WITH EASY TERMS

NEW TIMES SALES CO. 56, LUDGATE HILL, LONDON, E.C.4. Phone: Central 2716

(a) Please send me further particulars of

(b) I enclose s. d. as first payment for

NAME

ADDRESS

P.W. 3/10/31.

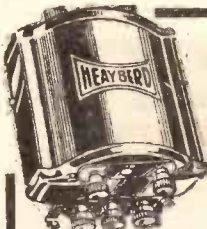

THE 5-Way TRANSFORMERS

Designed primarily for five important usages, the new range of Heayberd Duplex Transformers are ideal for supplying A.C. & Power Valves, charging Accumulators, running L.T. Eliminators, Energising M.C. Speaker Fields, Operating Model Motors, etc.

No.	Secondary Outputs	Price
930	{ 4 volts 4 amps. 6 volts 2 amps.	19/-
931	{ 4 volts 3 amps. 6 volts 1 amp.	16/-
932	{ 4 volts 2 amps. 4 volts 1 amp.	12/6

..... Post This To-day

I enclose 3d. stamps for List 957 describing fully, with circuit diagrams, the uses of the new Heayberd L.T. Duplex Transformer.

Name.....
Address.....

HEAYBERD

10, Finsbury Street, LONDON, E.C.2.

RADIOTORIAL QUESTIONS AND ANSWERS

(Continued from previous page.)

simplified tuning without wave-change switching can be applied to existing sets, and in particular to the famous "Comet" Three?

Thousands of readers will be interested in such an improvement and, as the "Comet" Three is typical of many older sets, we give below the full details for fitting an Extenser to this famous receiver in place of the ordinary tuning condenser and wave-change switch.

The blue print of the "Comet" Three shows an ordinary '0005-mfd. tuning condenser to it, mounted on the panel. Near it on the panel is a wave-change switch which has three leads to it.

With that arrangement the tuning condenser covers ordinary waves when the wave-change switch is out, and long waves when this switch is in; but dial readings are "doubled"—that is to say, you may get Midland Regional on 70 degrees with the switch in one position, and a different station altogether with the same dial reading when the switch is in the other position.

ITS SIMPLICITY

With an Extenser all this is altered. There is no wave-change switch at all, and no wave-changing to do. You simply turn the Extenser dial.

Long-wave stations are those with dial readings above one hundred; all ordinary wave stations are below one hundred. Could anything be simpler?

To change over is a very simple matter. Simply take out the old tuning condenser, noticing which wire is which, and put the Extenser in its place, re-connecting to the fixed and moving vanes as before.

Remove also the wave-change switch and join its three wires to the Extenser self-changer contacts instead. That's all.

Do not forget to set the Extenser dial in position so that it will read below one hundred when the three self-changer contacts are all "on" connected together.

Its other half revolution (when the dial readings are all over one hundred) will then be made with the three contacts on the

The resistance-condenser method relieves the primary of the "steady" plate current, and it is called on to pass only the fluctuations due to modulation. (They are often relatively quite small.)

As the amount of current through the primary has an important effect on quality—which it spoils when current is excessive—this removal of unwanted plate current enables the quality and power-handling properties of the transformer to be at a maximum.

THE BUZZ FROM THE RECTIFIER.

"NERVINESS" (Waltham Abbey).—"Having fitted up a valve rectifier for charging my 6-volt accumulator, I was rather alarmed to notice after it had been running several hours that it was accompanied by a distinct buzz.

"Probably this was there all the time, but it was not noticed till the house was quiet, in the evening. It stops immediately I switch off, but comes on all the time the

MISSING LINKS, No. 18 AN EASILY-TUNED ONE VALVER.

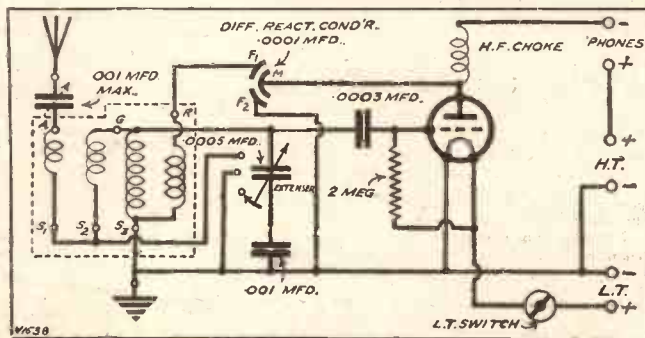

In the circuit shown last week three symbols were missing. The first of these was the earth connection, the second the 2-megohm grid leak attached to the grid of the detector valve, and the third the L.T. switch, all of which are now shown in place.

charger is put on. Is that a sign of something wrong, and ought I to use it?"

Nearly all such arrangements give rise to a slight but distinct humming sound when in operation, due to vibration. It is nothing to bother about, unless it gets worse.

REACTANCE OF INDUCTANCE.

T. C. (Prittlewell, Essex).—"What is the method of finding the reactance of a tuning coil having an inductance of 200 microhenries? I understand this reactance varies with frequency, so please give examples at (a) 300 metres and (b) 600 metres."

The reactance in ohms is given by the formula

$$\text{Reactance} = \frac{1884 \times \text{microhenries}}{\text{metre.}}$$
 Thus (a) becomes

$$\frac{1884 \times 200}{300} = 1,256 \text{ ohms.}$$
 Similarly for 600 metres (b)

$$\frac{1884 \times 200}{600} = 623 \text{ ohms.}$$

TONAX CONE ADAPTOR

Improved model

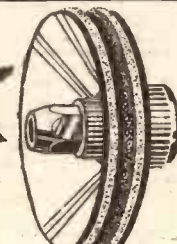

gives the greatest value to every cone user.

Tonax is quickly and perfectly fitted to any Single or Double Cone Speaker, using any unit. All rattles, and distortion caused by badly fitting parts is cut out leaving reproduction pure and clean-cut.

Every Tonax carton contains two extra washers, two felt washers, two deep metal washers, and full instructions.

Single Cone Type 1/-
Double Cone Type 1/6

From all dealers or direct. Send P.O. to Dept. P.
GARRATT STORES.
 133, Garratt Lane, Wandsworth, London, S.W.18.

It pays you to ask your Retailer for genuine guaranteed

WAVEMASTER

Variable Condensers and Extensers for all the latest Circuits

WEBB CONDENSER CO. LTD.
 42, Hatton Garden, London, E.C.1.

FOR YOUR RADIO COMPONENTS

A. T. HARRISON & CO.

Copper and Aluminium Screens by return of post.
 Bakelite Moulds, Bakelite Mouldings,
 Trade inquiries invited.

KINTORE WORKS, BERMONDSEY, LONDON, S.E.1.

No. 39. THE GRID-BIAS BATTERY.

The G.B. battery is one of the most important radio accessories.

Properly used, it reduces the drain on the H.T. battery and also makes for distortionless reception.

If G.B. is neglected, quality will certainly suffer, the H.T. battery current will be excessive, and crackling noises and other spurious effects may be caused.

Usually a good grid-bias battery lasts for about six months.

Extenser "open"—you will then be tuning on long waves. Incidentally either a drum-driven or ordinary Extenser can be used.

SHUNT-FED L.F. TRANSFORMERS.

"CAPTAIN D." (Baston).—"What is supposed to be the advantage of feeding an L.F. transformer by the use of resistance and condenser, instead of inserting the primary in the plate circuit?"

A TUNING PUZZLE.

N. W. (Aldershot).—"Really, I suppose I did not need the Selector coil here for the sake of its sharper tuning, but I thought I should like to try it, and I was very glad I did. It seemed to clean up the dial and give extra strength on all foreign stations. It was no trouble to adjust, and I thought it was a permanency, but now I don't know what to make of it.

(Continued on next page.)

RADIOTORIAL QUESTIONS AND ANSWERS

Continued from previous page.)

"Nothing has been touched on the set (H.F. Det. and L.F.), but the Selector has developed a kind of dead spot at one end of its dial.

"I ought to explain that when first put in all long-wave stations were good when the Selector was hard over to the right. And just before reaching that position the Vienna, Budapest, and other top-of-the-dial medium-wave stations were strong when the Selector was adjusted right.

"Lately this has altered. I get London Regional strong on one stud as I turn the Selector knob round, but on the next stud it drops to practically nothing (suddenly) and none of the longer wavers come in well past this point. I can still get Vienna and Budapest, but only by leaving the Selector set on the London Regional stud.

"Past this the Selector tuning is dead. It only affects the longer wavers, none of which are good. Below London Regional and right down to Cork, I get sharp tuning on Selector, fine loud results and all as formerly.

"What would be a likely cause of a sudden dead spot like this at the top of a Selector coil?"

Everything points to a break in the Selector coil. This is evidently located just past the London Regional setting, and we suspect that examination would prove a complete break exists, probably at one of the tapping points.

When you adjust the knob past the point your aerial is virtually cut off, and consequently all the longer-wavers are untunable: or can be received below their full strength by adjusting the Selector to the London Regional setting, at which point the aerial circuit is still complete, though out of tune.

We should have that Selector coil out and examine it for the break, if possible, as a spot of solder may put it right. But if it seems difficult or impossible to get inside you will have to drop the makers a line explaining the trouble, or get your dealer on the job.

CUTTING THE LOCAL STATION RIGHT OUT.

T. L. (Huddersfield).—"Even after shortening the aerial, I found the wipe-out of my set was so bad that I complained about it to nearly everybody I met who was interested in wireless. And one chap laughed at me, and said I ought to get a 'P.W.' rejector.

"As I did not believe all he claimed for it, I went round to his house and, sure enough, it absolutely wiped the local station right off the map. He could not find the number of POPULAR WIRELESS that he built it from, so could you give me details of the home-made coil and wiring in words?"

"It looked so simple that I am sure I could make a good job of it after only seeing it once, if I had the full particulars. It was for both long and ordinary waves using an Extenser."

The instrument you saw was evidently a "P.W." Extenser Rejector, and all you need to build it, besides the panel and baseboard are two terminals labelled respectively "A1" and "A2," a .001 maximum compression type condenser, a .0005-mfd. Extenser, and the two home-made coils.

One of these is wound on a coil quoit, and the other on an ordinary coil former, 2 in. diameter, by 1 1/2 in. length. Three ounces of No. 30-gauge D.S.C. wire for the coils will be enough.

The long-wave coil which is wound on the coil quoit is a plain winding of 170 turns of the No. 30 D.S.C., and it is fixed to the baseboard by a strip of wood screwed across it or by any other convenient method. The medium-wave coil also is a plain winding on the tube, 70 turns of the No. 30 D.S.C. being wound on side by side, and the coil being mounted at right angles to the other.

The terminal A1 is joined to one side of the .001 compression condenser and to the fixed vanes of the Extenser. The moving vanes of the Extenser are joined to one end of the long-wave coil.

The other end of the long-wave coil and one end of the medium-wave coil are joined to one of the self-changer contacts on the Extenser. The remaining end of the medium-wave coil is joined to the remaining side of the .001-mfd. semi-fixed condenser, and also to the A2 terminal.

This completes the wiring. The rejector is joined in circuit by removing the aerial lead from the set, and joining this instead to the A1 terminal, the A2 terminal on the Extenser rejector being taken to the aerial terminal of the set.

STOP THE DOLE!

BY BUYING A

BRITISH H.T. BATTERY

There's more sense in that remark than in hours of argument about politics. Here in Watford hundreds of British people are making what we truly believe to be the finest H.T. Battery in the world.

So many wild claims are made for H.T. batteries that we won't compete. We'll make one true statement, however.

●●● To the best of our belief no battery gives as consistently good results or has as consistently long a life as a Grosvenor.

Hundreds more would be busy in our works within a week or so if you bought a Grosvenor Battery.

Tens of thousands of foreign batteries are being sold in this country. Some all-foreign, some part-foreign. Refuse them all. They are keeping British people on the dole.

It will be a great encouragement to us in this campaign to increase British trade, if you will write to us assuring us of your support.

PRICES:

RED LINE.

	s.	d.
60 V. ..	5	6
66 V. ..	6	0
99 V. ..	9	0
108 V. ..	10	0
120 V. ..	11	0

TRIPLE RED LINE.

60 V. ..	12	0
64 V. ..	13	0
99 V. ..	20	0
105 V. ..	21	0
120 V. ..	24	0

BROWN LINE.

36 V. ..	6	0
66 V. ..	8	6
99 V. ..	13	0
108 V. ..	14	0
120 V. ..	15	6

Go out and buy a
GROSVENOR
MERCURY • BATTERY
IT'S BRITISH

A FINE KIT SET

By F. BRIGGS.

One of "P.W.'s" technicians builds up the new Mullard Kit Set and describes his experiences in this article.

THE Mullard "3" Receiver, Type 1932, is an S.G., Det., L.F. set using a Pentode in the last stage. The receiver is sold as a complete kit, including Mullard

COMPLETE CONTROL



The Mullard set is a most "flexible" instrument, and its various controls are very effective in operation,

valves. In fact, everything is supplied except batteries and loudspeaker.

Easy to Assemble.

Recently the Mullard people sent "P.W." one of these kits for test and a report, and the evening following its arrival it was handed to me and I packed it up and took it home to build and test under domestic conditions.

The kit is contained in a stout cardboard box, and includes everything from the smallest screw to the cabinet. The latter is supplied ready to assemble. Very complete instructions are given, and I can assure you that the merest novice would not have the slightest difficulty in constructing the receiver. When I built the set I was agreeably surprised at the simplicity of the whole thing. Evidently the designers spent a great deal of time planning the layout, for if the instructions are followed step by step it is simply a matter of straight forward assembling.

No Snags Whatever.

There are no snags whatever, and from start to finish the job only took me just under three hours. The only tools required are a small screwdriver and a small pair of pliers incorporating a wire cutter.

There is nothing abnormal about the circuit. It is just a straight three-valver using a screened-grid valve in the H.F. stage and a Pentode as the loudspeaker output valve. The aerial is loosely coupled to the grid coil, the whole being tuned by a 0005-mfd. variable condenser. This is

ganged to another and similar condenser which tunes the grid circuit of the detector valve.

The only part of the work which needs particular care is the matching up of these two condensers so that they are accurately ganged over the whole of both wave-bands. Provided the instructions are followed carefully, however, this is no difficult task. Once the job has been done it is unnecessary to touch the adjustments again. Unless, of course, the aerial is changed in any way.

The appearance of the finished receiver is very attractive indeed. The panel is made of metal, and you will be able to see the arrangement of the controls from the accompanying photograph. On the extreme left there is the volume control, further to the right and a little below is the wave-change switch. The fairly large knob in the centre of the panel is the main tuning adjustment for the ganged condensers. The remaining two knobs are for the reaction and "on-off." The former is to the right, and the latter to the left and a little lower down.

Excellent Quality.

If you decide to buy one of these kits I feel sure you will be completely satisfied, for the receiver gives very good results indeed. The quality is excellent, and thanks to the big output of the Pentode valve, the set is capable of putting out all the volume required.

The selectivity is such that twelve miles from the Brookmans Park stations it was an easy matter to separate the two pro-

A WIDE WAVE RANGE

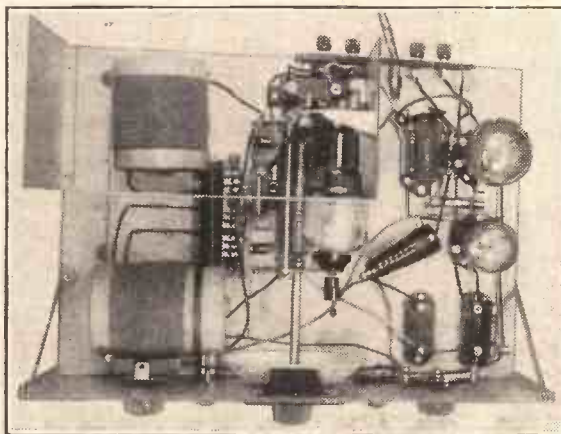

The Mullard Kit Set is a dual-range receiver and adequately covers long and ordinary waves.

grammes, and get several foreign stations in between, without any trace of interference. All the high-power Continentals came in strongly, and quite a number of the smaller fry as well.

On the long waves results were also very good. The tuning range here extends from shipping on 600 metres, to close on 2,000 metres. And on this range, provided conditions are reasonably good, it should be possible to tune-in almost anything that is going.

So taking it all round the Mullard "3" Receiver (Type 1932) is a very interesting proposition. For the man who wants to build his own with a minimum of trouble it will take some beating.

FOR THE LISTENER

(Continued from page 210.)

was in its dotage centuries before Queen Anne! This, of course, won't do.

There is something to be said for the old days when a comedian who tried to palm off this sort of thing would be greeted with rotten eggs from the gods. That would help him to keep up to the mark.

What the wireless substitute for rotten eggs may be, I don't know. Sometimes I wish I did know!

I suppose, as a matter of fact, that an armchair audience—which is what a wireless audience is—is rather more easy going than one which has taken some trouble to get to the theatre or the music hall; but I don't like this idea that "anything is good enough" for an audience which can't see you and can't "boo" you off the stage.

Why They Cheer!

The studio audience, of course, always cheers. It hasn't paid for its seats, and has the corresponding manners.

I like a comedian who takes himself and his work seriously. He ought to take it as seriously as a parson who has to turn out a couple of sermons per week. If he can't turn out as much good, new stuff as the microphone demands—and small blame to him, for it must be a dickens of a job!—let him take a rest.

I am as fond of the favourites as anybody; I like them to be at their best (when they aren't at their best they sound worse than inferior craftsmen); so, for their own sakes as well as my own, I would rest them. Rest the favourites.

A wise man will even rest his favourite pipe. There are some names which appear in the vaudeville programmes more frequently than is for their good. It is a hard saying, and I hate saying it, but I believe it is true.

While I am on this question of the lighter side of our entertainment, I have a bone to pick with "The Roosters." They are excellent fellows all. They have hold of a very good thing. We listen to their performances through the sympathetic ear of memory.

"The Roosters" Route March.

They do not come too often to the microphone; and I hope they will make many more appearances there. So that they will not mind my saying that I thought one of their items has not been properly thought out from the point of view of broadcasting.

You know the one—a route march. There was the tramp of feet; a band playing; officers shouting orders; men singing songs on the march; and men back-chatting each other as they went along.

It was exceedingly and unremittently noisy. I got it as a continuous din, out of which I could distinguish little except the songs and the tramp of feet.

You may say that a route march, in the livelier quarters of the column, can be a very noisy affair. I agree. But it is in the open air, not in the ear of the microphone.

For the art of the theatre, and for these purposes the art of the studio, too, is not to reproduce a piece of real life as the photograph reproduces a scene with every detail, but to represent it as a painter represents a landscape by choosing only such details as are able to make the scene live.

TECHNICAL NOTES

Some diverse and informative jottings about interesting aspects of radio reception.

By Dr. J. H. T. ROBERTS, F. Inst.P.

OWING to the fact that power-grid detection is now so popular, there is a tendency for many people to get the impression that by merely changing over to power-grid they are bound to improve results.

Like so many other things, however, power-grid detection has to be used with discrimination. It is only applicable in certain definite conditions, and if used in the wrong circumstances may well have the very opposite effect to that intended.

Power-Grid Detection.

In the first place, perhaps I should explain, for the benefit of any of my readers who may not be familiar with the power-grid principle, that it does not differ essentially from the ordinary leaky-grid arrangement, except as regards the values of the grid leak and condenser and—perhaps I should add—the value of the H.T. voltage applied to the detector anode.

A common value for grid leak is, say, 2 megohms, and, for condenser, .0003 mfd. If you wish to go over to power-grid detection, however, these values will become more like .0001 mfd. for the condenser, and .25 megohm, or even .15 megohm, for the grid leak.

To change over to these values is a comparatively simple matter, but you want to bear in mind that a mere change in the values of these components does not mean satisfactory power-grid operation. There are several other equally important points to be attended to. The detector should be of medium impedance and should be given its maximum anode voltage.

A Question of Input.

Now the purpose of power-grid rectification is to give distortionless detection when the input is very much greater than the average. In consequence of this, people often think that the power-grid arrangement will work similarly well with small inputs, because it is capable of handling a large amount of power.

This is particularly the point where caution has to be exercised in dealing with this method. The operating curve of the valve under these conditions is such that, if the signal input is too small, what is known as amplitude distortion will set in. In these circumstances it is clearly better to use the ordinary values for grid leak and condenser.

Power-grid detection, in fact, is particularly intended for receivers where a fair or large amount of H.F. amplification is used, and where consequently the signal is heavily amplified before detection. It is only in these circumstances that it should be used.

Low Stage Gain.

Now as regards the L.F. stages to follow the power-grid detector, remember that if
(Continued on next page.)



NEW DARIO RADIO VALVES

with

The Very Steep Slope

TRANSFORMERS

Dario Transformers are made under a special process of wiring and insulating the different circuits. Notwithstanding their very low price they give marvellous results.

Ratios 1-3 and 1-5.
Constructor - - - 4/6
Normal - - - - 5/-
Super - - - - 6/-

Also available, extensive range of mains transformers and Filter Chokes.

DARIO SILVER OXIDE CHARGER

the best in the world. Enables you to charge your accumulators in your own home. 17/6

DARIO SETS

The Dario S.G. 3 Battery Type Receiver now reduced to £5-17-8, complete with Dario Valves. Represents amazing value. Highly sensitive, gives wonderful volume. Renowned for its purity of reception.

The Dario Regional Straight 3 Transportable housed in an attractive oak modern cabinet complete with Dario valves and matched speaker - - - £4-17-8

Inside frame aerial 10/- extra.

Made in one of the most modern factories in the world under a special secret process, Dario valves incorporate the new Radio Micro Dull Emitter Filament which ensures great sensitivity, unequalled performance and utmost current economy.

DARIO UNIVERSAL BIVOLT - 5/6
DARIO SUPER H.F. BIVOLT - 5/6
DARIO SUPER POWER BIVOLT 7/6

etc., etc.

Also 4 volts and A.C. Mains types.

Write for illustrated folder giving full particulars.



MAKE SURE
that your
EXTENSER
has this patent
SILVER-GOLD
AUTOMATIC
WAVE SWITCH

14/6

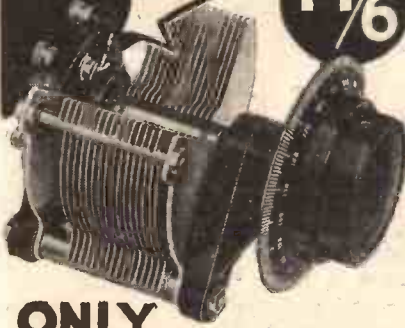

ONLY



MAKE IT

The Formo design and construction of the Extenser Condenser incorporates features of special importance for the experienced constructor, who desires to choose the best components available. The slow- and fast-motion dials give a silky smoothness essential for the tuning of close stations, whilst the special type of wave-switch is fitted with silver-gold contacts ensuring perfect electrical continuity. Tested to 200 volts before despatch and guaranteed exactly to "P.W." specification.

0-100 covers 230-530 metres.
0-200 covers 1000-2000 metres.

DUAL RANGE COIL
PRICE 12/6



Superior finish, wound on a well-designed moulding with accessible terminals.

ARTHUR PREEN & Co., Ltd.
Golden Sq., Piccadilly Circus, London, W.1.
Crown Works, Southampton.

TECHNICAL NOTES

(Continued from previous page.)

two stages are used the first should be of only low-stage gain, and even then a good power or super-power valve should complete the L.F. amplifier.

Of course, inasmuch as the change to power-grid rectification involves a considerable change in the value of the detector components, it is obvious that for what we may call intermediate cases—cases where the H.F. amplification and consequent power input into the detector are larger than normal, but not particularly large—you may resort to an intermediate or medium amount of power-grid detection; this is done by changing the values of grid leak and condenser to, say, 1 megohm and .0002 mfd. respectively.

Sometimes desired results can be obtained by slightly changing the value of only one of these two components, whilst sometimes it is better to change both. I should add that the change may quite possibly result in some

TECHNICAL TWISTERS

No. 81. THE S.G. VALVE

CAN YOU FILL IN THE MISSING LETTERS?

The S.G. valve has electrodes—one filament, one plate, and

Placed next to the filament is the grid, which is connected to the preceding tuned circuit.

The grid—that placed next to the plate acts as a and prevents unwanted feed-back.

Last week's missing words (in order) were: Series. Impedance. Parallel. Filter.

slight loss of sensitivity, but this should be more than compensated for by the improvement in quality.

Increasing the Load.

Before leaving this subject, I should like to mention also that unless there is any real need for you to go over to power-grid detection, even partially, you will be wiser not to do so, as you will be throwing a considerably greater load upon your H.T. battery (or other H.T. source) owing to the much higher value of anode voltage on the detector.

This, again, throws a correspondingly greater load upon the transformer primary, and may seriously affect inductance and consequently quality. In such a case, however, a special low-frequency choke may be used in series with the H.F. supply to the detector anode.

Home Records.

Several readers have asked me lately for my views on the making of home records. Well, it is not very easy to give them concisely, as so much depends upon individual taste and also upon the apparatus used.

(Continued on next page.)

WITHOUT RESERVE

CLEARANCE LINES re CONTROLS LTD. and Liquidation Stock of other Firms.

At 70, Seymour Place, Bryanston Square, W.1
A few minutes walk from Marble Arch, Edgware Road and Baker Street Stations.

GODDARD & SMITH

are instructed to sell by Auction, at their rooms as above on THURSDAY, OCTOBER 1st, at 11 o'clock, in lots to suit all purchasers,

RADIOGRAM CABINETS ALL-MAIN SETS, Etc., including 3-, 4-, 5-valve Radiograms in handsome oak and mahogany cabinets.

Turvox and other 3 and 5-valve All-main sets 3-valve Transportable sets in mahogany cases. 2 and 5-valve attache-case sets, Screen-grid Transportables.

Portable Radiogram sets with Garrard and other motors.

3-valve E.R.P. screen-grid All-main A.C. Cabinets, in oak, mahogany and walnut.

60 complete 3 and 5-valve Portable sets in oak and mahogany, A.C. and D.C. moving-coil loud-speakers.

Permanent magnet moving-coil loudspeakers by Rolla, Brown, etc.

300 Gramophone cases in oak, mahogany and rexine.

50 Portable cases in leather.

500 oak (light and dark) 5-valve cases.

400 Rexine-covered cases, 400 speaker units, power and other transformers, case fittings, 1,000 various dials, 30 variable condensers, cable and sleeving.

Turvox pick-ups and arms, Axuel time control clocks and numerous other goods too numerous to mention.

On view Wednesday, September 30th. Catalogues of Goddard & Smith, 70, Seymour Place, W.1. Paddington 0277-8 and 5805.

CONSTRUCTORS

JUST THINK!

The Most Selective and Greatest Long-Distance Getter in Europe.

"SENSITITE" All Electric 3 Kit £8 : 5 : 0

All Electric 2 Kit £4 : 12 : 0

Sold under guarantee. Lists & Wiring Diagrams Free. THE WHOLESALE WIRELESS CO., 103, FARRINGTON ROAD, LONDON, E.C.1. Telephone: Clerkenwell 5312.

EASY PAYMENTS

The first firm to supply Wireless parts on easy payments. Seven years advertiser in "Popular Wireless." Thousands of satisfied customers.

COSSOR 1932 Kit. Cash £6 15s. 0d., or 10/- with order, 11 monthly payments of 12/6d.

EXIDE 120v. H.T. Accumulator. Cash £3, or 6/- with order, 9 monthly payments of 6/8d.

AMPLION Permanent Moving Coil Speaker, with step-down transformer. Cash 67/6d., or 7/5d. with order, 9 monthly payments of 7/5d.

BLUE SPOT 66R. Unit, with Cone and Chassis. Cash price 42/6d., or 5/6d. with order, 9 monthly payments of 4/6d.

New Goods Obtained for Every Order.

Send us a list of the parts you require, and the payments that will suit your convenience, and we will send you a definite quotation. Anything wireless.

H. W. HOLMES, 29, FOLEY STREET, Phone: Museum 1414. Gt. Portland St., W.1.

EXACT TUNERS

250 to 2,000 metres. Thousands of these tuners are in use, and we can strongly recommend them. No further coils are required. Send P.O. for particulars and circuits—FREE.

THE EXACT MANUFACTURING CO., Croft Works, Priory Street, Coventry.

WET H.T. BATTERIES

Solve all H.T. Troubles.

SELF-CHARGING, SILENT, ECONOMICAL.
JARS (waxed), 2 1/2" x 1 1/2" sq. 1/3 doz.
ZINCS, new type 10d. doz. Sacs 1/2 doz.
Sample doz. (18 volts), complete with bands and electrolyte, 4/1. post 9d.
Sample unit, 6d. illus. booklet free.

Bargain list free.

AMPLIFIERS, 30/-. 3-valve set, £5.
P. TAYLOR, 57, Studley Road, STOCKWELL, LONDON



TECHNICAL NOTES

(Continued from previous page.)

Speaking generally about home recording—of course, you know that home-recording outfits have made their appearance upon the market for a great many years past—I think that most people very soon grow tired of hearing their own voice reproduced, although they still gain pleasure from hearing the recording and reproduction of the voices of their friends.

There are comparatively few people who can sing or speak sufficiently well to be worth permanently recording, and, therefore, once the novelty has worn off it comes down to a question of making a few good records at first hand and permanent records of broadcast items, or duplicates of commercial records.

For example, a friend of mine played over for me the other day a record which he had obtained of the Prince of Wales' speech in South America. This was exceedingly good, and the waves and gusts of "fading" (which those of you who heard the broadcast of the speech will remember) rendered it most realistic.

Recording Blanks.

I think there is a good deal of room for improvement in the blanks upon which the home records are made, and it is obvious that electrical recording is vastly better for home purposes than direct recording.

But, to my mind, the greatest inherent difficulty in the home-recording idea is to get the ordinary gramophone to drive the record when cutting. I have tried a good many gramophones of all kinds, but have always found this to be a difficulty—sometimes an insuperable one.

Of course, it is always possible to sell a special motor for the purpose, but this adds greatly to the cost, and it seems to me that to be really popular the home-recording outfit must be cheap. I should be glad to hear from any of you who have experimented with home recording as to the results you have obtained.

Valve Specifications.

For some purposes you want to be sure that your valves comply fairly accurately to makers' specifications, or, at any rate, that you can rely upon two valves of the same type to be pretty well matched; this is the case, for instance, when you want to use matched valves in the H.F. stages, or for push-pull amplification.

For general purposes, on the other hand, it is not usually a matter of great importance whether the valves which are supposed to be the same are, in fact, quite the same or not, so long as they are reasonably near to specification.

In some tests recently carried out upon batches of valves of the same specification it was found that quite considerable variations occurred; much larger than you might have expected.

For instance, in the case of a type of power valve where the magnification was specified as 12.5, it varied between 11.0 and 13.5, variations of 12 per cent below to 8 per cent above.

Impedance Variations.

The specified impedance of 3,500 ohms varied between about 3,000 ohms and
(Continued on next page.)

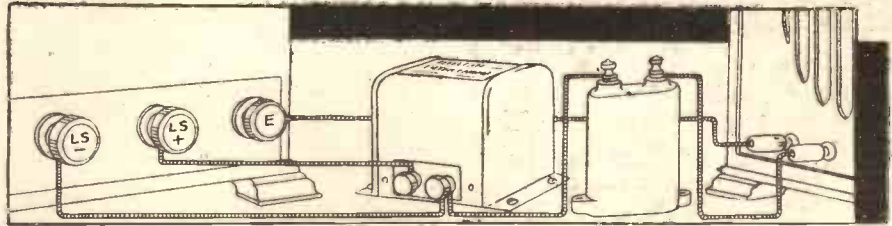

**20 HENRY
FILTER CHOKE**
for use with
valves below
3,000 ohms
impedance.

**32 HENRY
FILTER OUTPUT
CHOKE**
for valves above
3,000 ohms.



12/6

Simplicity Itself to fit a Filter Choke

Connect Choke across Set Output Terminals. From Minus Output take a lead also to Large Fixed Condenser. To other side of Condenser take one Loudspeaker Lead. Return Lead from Loudspeaker goes to any convenient Earthed Point. The Choke Filter forms an essential part of the decoupling and anode-feed system, and is a necessary adjunct to even the simplest loudspeaker set.

Bulgin L.F. Chokes will maintain their rated inductance while carrying a far heavier current than the average amateur is likely to use.

Send 2d. postage for the new 75 pp. Bulgin illustrated Catalogue and Manual, which also describes the Bulgin Technical Service.



A. F. BULGIN & CO. LTD.,
Abbey Road, Barking, Essex.

Telephone: GRANGEWOOD 3266 & 3267.
London Showrooms: 9, 10 & 11, Cursitor Street, Chancery Lane, E.C.4
Telephone: HOLBORN 2072.



**AMAZING
OFFER!**

"CLIMAX"

"All-Mains Two"

Original Price	OUR PRICE
£9 : 9 : 0	£5 : 15 : 0

Including Mullard Valves & Royalties

"CLIMAX"

"All-Mains Three"

Original Price	OUR PRICE
£16 : 16 : 0	£8 : 10 : 0

Including Mullard Valves & Royalties

Here's all-electric Radio at a price everyone can afford. For a short time only we are offering a limited number of "All-Mains Two" and "All-Mains Three" sets, manufactured by Climax Radio Electric Ltd. All guaranteed in first class working order and perfect condition. Delivered packed and sealed in original cartons. The two-valve receiver is designed to give local reception within radius of 50 miles, or 100 miles of a Regional, and several Continental stations under favourable conditions. The three-valve set gives exceptionally good reception over far greater distance, bringing in Continental Stations powerfully under normal conditions.

Both sets are highly selective, pure and mellow in tone, with no Mains hum. Patent tone control and fitted with sockets for Gramophone pick-up. Cabinets are finished to modern design in figured walnut. Remember, this is a "limited" offer only. It is advisable to order at once.

Terms—Cash with Order or C.O.D

J. E. SEXTON,

Rugby Chambers, Great James Street, W.C.1.

Phone:
Holborn 1862.



EASY TERMS

WE supply all good quality Radio Receivers, Components and Accessories on deferred terms. We carry adequate stocks and can give PROMPT DELIVERY.

NEW COSSOR 1932 EMPIRE KIT No. 234.
A remarkable advance on last season's model.
Cash Price £6 15 0
Or 10/- with order and 11 monthly payments of 12/4.

NEW HEYBERD A.C. ELIMINATOR KIT C.150. Complete kit of parts for building an H.T. Eliminator, including steel case. Output 25 m/a., 150 volts. 3 H.T. tappings, one variable.
Cash Price £3 16 0
Or 7/6 with order and 11 monthly payments of 7/-.

12 EKIDE W.H. HIGH-TENSION ACCUMULATORS (120 volts, 5,000 m/a.). Higher voltages if desired.
Cash Price £3 15 0
Or 7/6 with order and 11 monthly payments of 7/-.
Carriage charged on all orders from Scotland.

N.K. FARRAND INDUCTOR LOUD-SPEAKER UNIT.—Quality of reproduction almost equal to a moving-coil speaker
Cash price £3 10 0
Or 5/6 with order and 11 monthly payments of 6/6.

SET OF 3 VALVES, S.G., Det. and Power, Mullard or Cossor.
Cash Price £1 19 0
Or 6/- with order and 7 monthly payments of 5/4.

NEW BLUE SPOT 66R UNIT. The finest balanced armature movement on the market, complete with large Cone and Chassis
Cash Price £2 10 0
Or 5/- with order and 10 monthly payments of 5/-.

NEW CELESTION MOVING-COIL L.S. UNIT (PERM. MAGNET), with Transformer.
Cash Price £4 5 0
Or 13/6 with order and 10 monthly payments of 8/-.

Any radio goods sent C.O.D.
We pay carriage and all C.O.D. charges.
Send list of requirements, and quotations will be sent by return.

LONDON RADIO SUPPLY CO.
11, OAT LANE
NOBLE STREET, LONDON, E.C.2

TELEPHONE: National 1977.

ENGINEERS!—Are you earning less than £10 per week? If so, you cannot afford to carry on without reading "Engineering Opportunities." This 200-page book is filled with matters of vital importance to you. Among other things, it explains the methods of our unique Appointments Department, gives details of all leading Eng. Exams. (A.M.I.Mech.E., A.M.I.E.E., B.Sc., G.P.O., etc.) and outlines modern Courses in Civil, Mech., Elec., Motor, Aero, Radio, Talkie, and all other branches of Engineering. This book will alter your entire outlook and earning power. It is quite FREE. Send a P.C. for your copy—NOW.

BRITISH INSTITUTE OF ENGINEERING TECHNOLOGY,
401, Shakespeare House, 29/31, Oxford St., London.

LOUD SPEAKERS REPAIRED, 4/-

(Blue Spot a Speciality, 5/-)

Transformers 4/-. Headphones 4/-. all repairs magnetised free. Tested, guaranteed, and ready for delivery in 24 hours.

Discount for Trade. Clerkenwell 9069.
E. MASON, 44, EAST ROAD, N.1.

YOUR NEW CIRCUIT

Reg. Design 766870



Standard Type (Reduced View).

STRAIGHT or SUPER requires the "KINVA" SCREENED H.F. CHOKE FOR BEST RESULTS. A high Inductance, Fieldless Choke at low price. Free List explains why. 2/9. If your dealer is not stocking, write POSTLETHWAITE BROS. KINVER, STOURBRIDGE.

MELODISCS are a perfected type of non-metal, non-brittle centre washers designed to fit all SINGLE or DOUBLE CONE Speakers. Metallic or other noises associated with old type metal washers are entirely absent and PERFECT REPRODUCTION attained. The discs are reversible, adjustable and complete with SELF-CENTERING CHUCK, instantly fitting and gripping all unit driving rods. Finished, as a violin, FOR TONE. Fitted in a few minutes to your Speaker. Send now to "MELODISCS," 2, New Ed., Willenhall, Staffs.

TECHNICAL NOTES

(Continued from previous page.)

4,200 ohms. The other characteristics, such as anode current, under specified conditions, and mutual conductance, also showed considerable departures from specification.

For reasons such as these it is a good plan to examine your valves very carefully if you are intending to use them in parts where matching is important, and also to ascertain whether a valve is reasonably near to specified characteristics.

Bear in mind, however, that the modern receiving valve is really a wonderfully uniform product considering the many scientific processes involved in its manufacture, and you can't expect valves to come out all as like as peas.

Valve Life.

I wonder how many people stop to consider the fact that their valves only have a limited life and that, when the efficiency of the set begins to fall off, it is quite possible that the falling emission of one or other of the valves is responsible. The valve (like the grid-bias battery), is apt to be regarded as a permanent fixture which never requires attention or renewal.

In point of fact some valves lose their efficiency after quite a short life, while in other cases a valve may last for years. The makers use every endeavour not only to give their valves a long working life, but also to turn out valves as nearly as possible to a standard.

It is easy to realise, however, that in a highly technical product like a radio valve, absolute uniformity is very difficult to obtain, and furthermore the usage to which the valves are subject varies so very greatly that it is impossible to say beforehand what the life of any particular valve may be.

A life of about a thousand hours under actual working conditions has generally been regarded as a reasonable standard, but in point of fact some valves will work for very much longer than this.

An Old Stager.

Amongst my own receivers I have one—a four-valve battery-operated set—which has been working for over four years without the valves being changed in any way, and although, of course, it is not to be compared for efficiency with some mains-driven receivers which I also use, nevertheless its efficiency has scarcely depreciated during that time.

On the other hand, I had a case only a few weeks ago where a set with two screened-grid high-frequency amplifiers "went off" very rapidly in sensitivity and in performance generally, although all the valves were comparatively new.

NEW "PURATONE" PROCESS

2 VOLT DARK EMITTER

H.F., L.F., VALVES 3/9
DET., R.G.

Power 5/3

Super-Power 6/3 Screen-Grid 7/6

BRITISH MADE. FULLY GUARANTEED.

Actual Makers **RUBON LTD.,**
189, New King's Rd., London, S.W.6

ELECTRADIX RADIOS

MICROPHONES, all types, W.E. buttons, 1/-; No. 11, Hand Mike, 4/6; Pedestal, 12/- to 18/6. Write for special list.

MORSE KEYS, 1,000 in stock. Lucas, 2/6; R.A.F. No. 1, 6/-; S. G. Brown Treble Contact Key, 7/6. Practice Buzzer Set, Key and Buzzer on Mahogany base, 7/6; heavy type, 10/-.

INSTRUMENTS. Hot Wire Ammeters, 5 amp., 5/-; 2½ in. Electrostatic Voltmeters, 500/2,500 volts, for H.T., consume no current, 40/- Weston & Turner M.C. Meters, 100 m.a. or 500 m.a., 25/- Voltmeters, 30 v. and 300 v., 35/- G.P.O. Galvos., 7/6.

THERMO METERS, for A.C. moving-coil, 1½ amps., 25/-.

SUNDRIES. Polarity Indicators, 3/6. Auto Cutouts, 12/100 volts, 10 amps., 7/6. Helio Mirrors, 5½ in., 1/6. Wavemeters from 25/- Telephones, Single, 11d. Sullivan L.R., 3/6. 8,000, 4/3. Brown, 120 ohms, 7/6. H.R., 12/6.

Send for Catalogue.

218, Upper Thames Street, E.C.4.

REPAIRS IN 48 HOURS

single ratio L.F. Transformers, Headphones, Loudspeakers (except Blue Spot). ONE YEAR'S GUARANTEE. Post Free 3/9

TRANSFORMER REPAIR CO., 953R, GARRATT LANE, LONDON, S.W.17 Terms to Trade

PERSONS REQUIRED immediately to make Leather Matting; regular work supplied, cash paid weekly. Write: E. 14 "Everlast" Leather Matting Co., Wellingborough.

PAREX

Products PAR-EXcellence are used and recommended for the

"POP-VOX" FOUR

P.J.2 and P.J.3 COILS, each 2/6
EBONITE PANEL, 21" x 7", polished and drilled, 9/6

·00015 DIFF. REACTION COND. - 4/6

H.F. CHOKE - - - - - 3/6

S.G. VALVE HOLDER - - - - - 1/6

COIL QUILTS, wound to specification, each 2/6

SPAGHETTI RESISTANCES, ALL SIZES

FIT PAREX AND AVOID TROUBLE
Unconditional Guarantee of Satisfaction.

From your dealer, or direct from

E. PAROUSSI,
10, FEATHERSTONE BUILDINGS,
HIGH HOLBORN, LONDON, W.C.1.

Phone: Chancery 7010

B.A.U. BUY your Moving Coil Speaker WRITE NOW FOR

42 pages of valuable information on how to secure REALISTIC REPRODUCTION.

BAKER'S
Selhurst
RADIO
CROYDON - SURREY.
PHONE CROYDON 161

At last!

**THE PERFECT
ALL MAINS SET
with the
perfect Speaker**

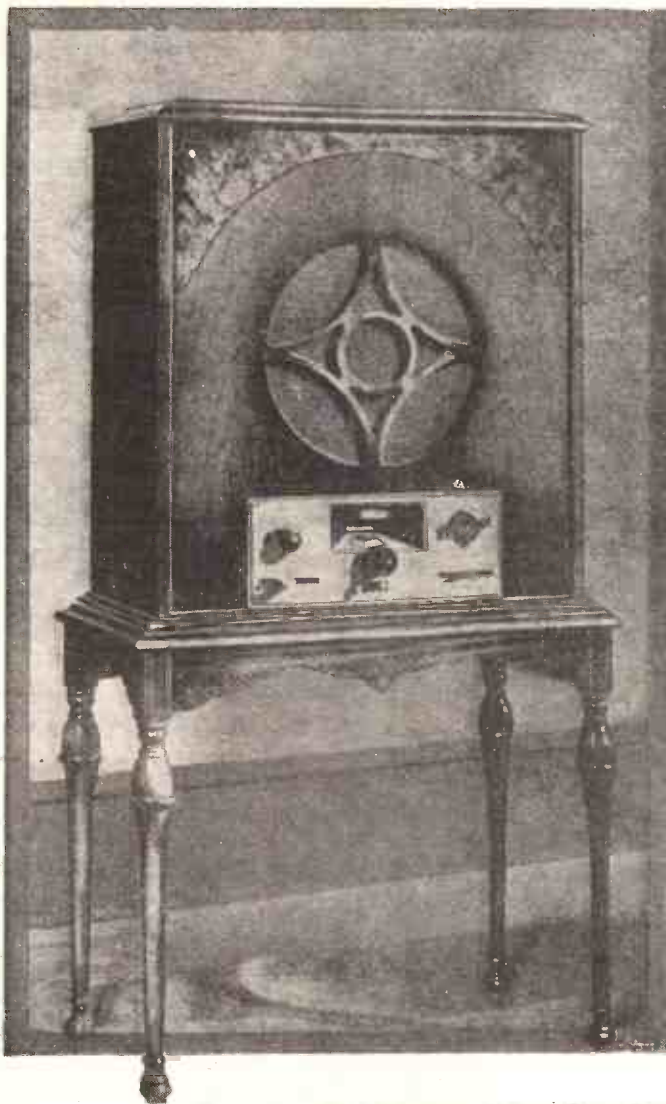

The receiver shown above is The BLUE SPOT "UPRIGHT GRAND," in a handsome cabinet of Walnut, Complete with stand **Price 27 Gns.**



Alternative design of stand for BLUE SPOT "Upright Grand Receiver."

THE BRITISH BLUE SPOT COMPANY LTD.
 BLUE SPOT HOUSE, 94/96 ROSOMAN ST. ROSEBERY AV., LONDON, E. C. 1
 Telephone: Clerkenwell 3570. Telegrams: "Bluospot, Isling, London."
 Distributors for Northern England, Scotland and North Wales: H. C. RAWSON (Sheffield and London) Ltd., 100, London Road, Sheffield; 22, St. Mary's Parsonage, Manchester; 183, George Street, Glasgow.

FOR years BLUE SPOT Loudspeakers have been famous as the best in the world.

Now come the BLUE SPOT Receivers which, with BLUE SPOT Speakers, make the most perfect wireless combination that brains can devise or money can buy.

BLUE SPOT Receivers bring in the best of the home and foreign programmes—simply by turning the tuning dial. Every word is crisp and clear, every musical note a delight to hear. BLUE SPOT Receivers never miss a sound, never distort, never blur. They bring you speech, song and music *exactly* as the original.

In appearance these receivers are beautiful. Their convenience is great, for you can plug them in to any near-by light socket or wall plug and connect to any convenient earthing point. Their upkeep is small—no more than your reading lamp. Last, but not least, prices are moderate for the high quality of design and workmanship. Ask your dealer for a demonstration or send for illustrated catalogue P.W.10.



TRADE MARK
 Regd. Nos. 515639 & 516180

SUPER RECEIVERS

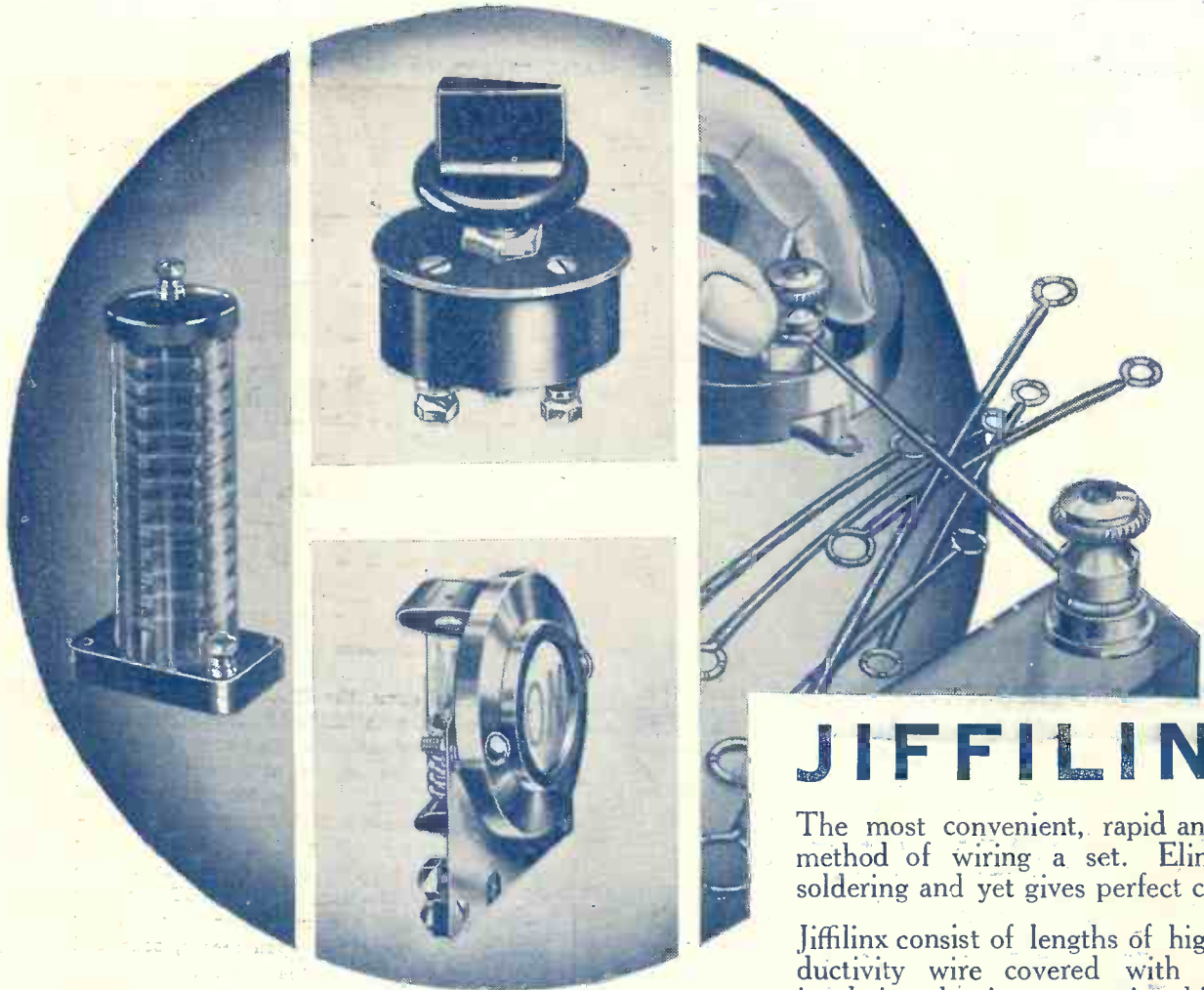

READIRAD SUPER-HET. CHOKE

Specially designed for use in the modern type of Super-Het circuits for excluding the intermediate frequency currents from the low frequency circuits. Should also be used wherever a Choke of extra high inductance is advisable. Price **5/6**

READIRAD STANDARD H.F. CHOKE
Price **4/6**

READIRAD SNAP SWITCH

Almost instant action, the elimination of all noises and the instant suppression of arcing with exceptional positive and direct contact. Made in two types—"Radio-Gram" (single-pole change-over) and "On-Off." Price **2/9**

READIRAD PANEL LIGHT

Shows the word "ON" in glowing red when the set is switched on. Adds a distinctive touch to the set and prevents battery wastage.

Two models; Battery Set, Mains Set **2/3** each.

JIFFILINX

The most convenient, rapid and neat method of wiring a set. Eliminates soldering and yet gives perfect contact.

Jiffilinx consist of lengths of high-conductivity wire covered with special insulating sleeving possessing high insulation properties which ensure absolute freedom from "short circuit." Both ends are terminated with shake-proof connectors designed to fit the terminals of all components. They can be bent easily with the fingers to any desired angle.

Each packet contains 40 Jiffilinx in many various lengths, ample to wire a large set. Jiffilinx are indispensable to the experimenter, as they can be used over and over again. Changes in connections can be made instantly, and errors in wiring easily rectified without wastage.

Try Jiffilinx for your next set, or re-wire your present set and make sure of perfect electrical contact everywhere. Once you have used them you will never use any other form of wiring. Send for a packet to-day.

2/6 PER PACKET

Ready Radio

**159 BOROUGH HIGH STREET
LONDON BRIDGE S.E.1**

HEAD OFFICE AND WORKS
EASTNOR HOUSE · BLACKHEATH
PHONE: LEE GREEN 5678
SHOWROOMS, PHONE HOP 3000 GRAMS: READIRAD, SEDIST

Advt. of Ready Radio, Ltd.

SIXPENNY RADIO BOOK FREE THIS WEEK

Popular Wireless

Every Thursday
PRICE
3d.

No. 488. Vol. XX.

INCORPORATING "WIRELESS"

October 10th, 1931.

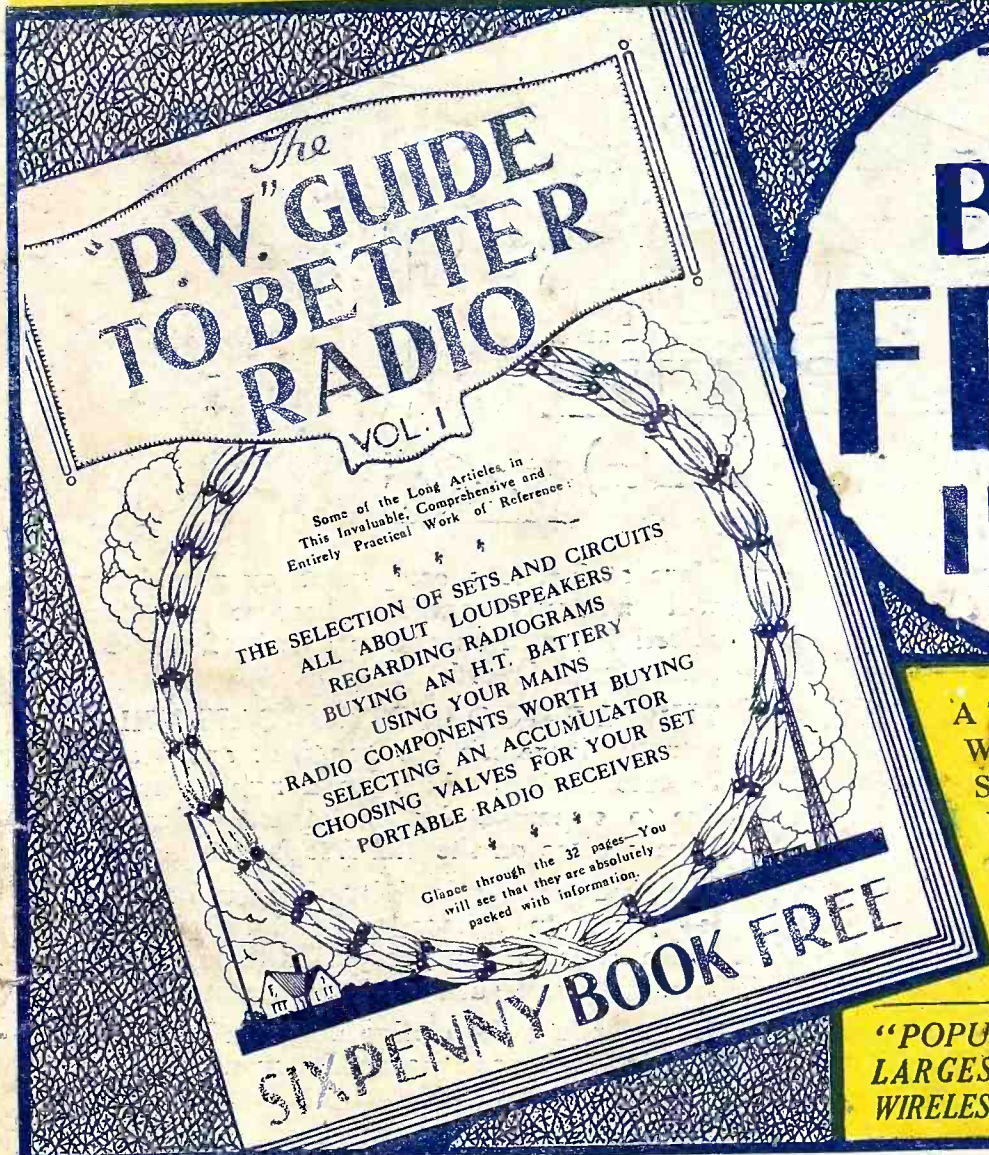

THIS BOOK FREE! INSIDE

A THIRTY-TWO PAGE BOOK WHICH EVERY LISTENER SHOULD POSSESS. IT IS WRITTEN THROUGHOUT IN NON-TECHNICAL LANGUAGE, AND WILL SAVE YOU TIME, TROUBLE AND MONEY

"POPULAR WIRELESS" HAS THE LARGEST CIRCULATION OF ANY WIRELESS JOURNAL, IN THE WORLD

Build your B.P.3 with a

Ready Radio

TESTED KIT

See pages 293, 299, 300, 303, 305.

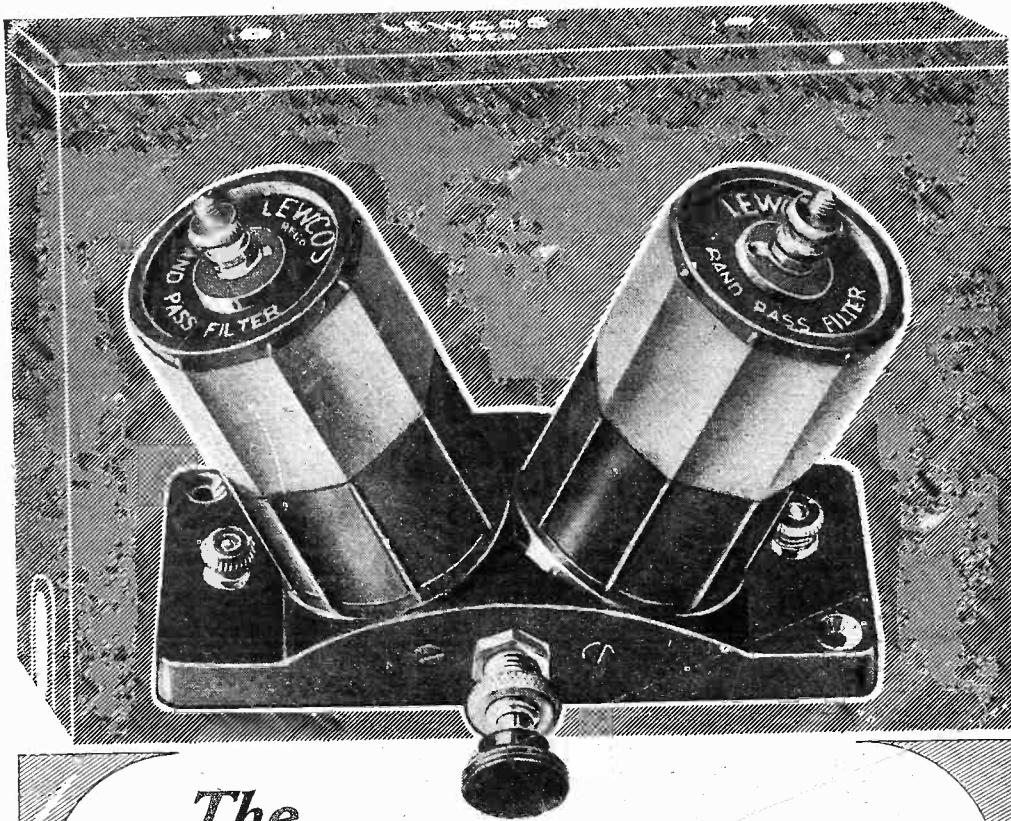

The Selectivity Problem

SOLVED BY LEWCOS

The LEWCOS BAND PASS FILTER

Price 12/- (Screen 2/6 extra)

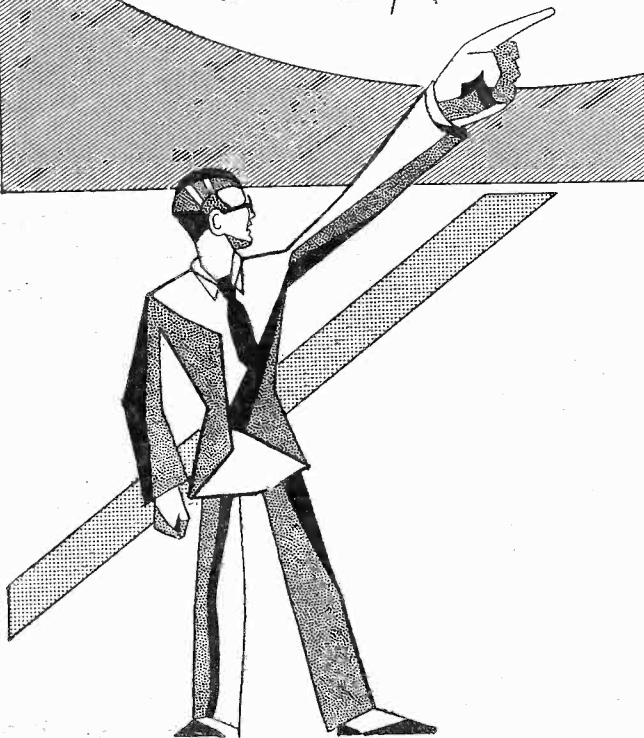

Here at last is a component over which you will naturally enthuse because it ensures selectivity such as you've heard of, but never before experienced.

THE LEWCOS BAND PASS FILTER actually increases the range of any Receiver because stations which are normally inaudible, due to swamping by local transmissions, now have a place on the dial free from interference.

The phenomenal selectivity of this unique device is apparent on both long and medium wave bands; hence it is infinitely superior to any existing selectivity unit, such as wave traps, etc.

Write for fully descriptive leaflet, Reference R.73, showing flat-topped response curves.

THE LEWCOS BAND PASS FILTER
IS SPECIFIED FOR THE NEW
"B.P." THREE described in this issue.

LEWCOS RADIO PRODUCTS FOR BETTER RECEPTION

THE LONDON ELECTRIC WIRE COMPANY AND SMITHS LIMITED, CHURCH ROAD, LEYTON, LONDON, E.10

REASONS WHY YOU SHOULD USE MAZDA INDIRECTLY HEATED RECTIFIERS

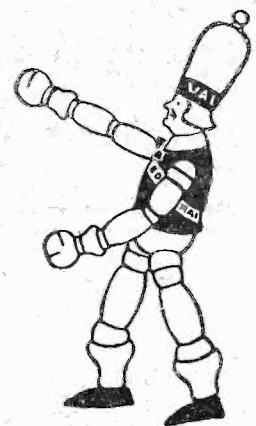

MAZDA INDIRECTLY HEATED RECTIFIERS

TYPE	PRICE
Full wave	
UU.30/250 - - -	12/6
UU.2 - - -	15/-
UU.60/250 - - -	15/-

If you are using rectifying valves in your A.C. mains receiver there is a definite advantage to be gained by using **Mazda indirectly heated Rectifying Valves**. You are safeguarding the condensers, chokes and valves of your receiver. When you switch on an ordinary rectifying valve, operating temperature is reached considerably before that of the receiving valves. A surge is caused and damage is frequently done.

Mazda indirectly heated Rectifiers heat up with the receiving valves, and so afford you absolute protection.

THE AMAZING
MAZDA
 THE
 BRITISH
VALVES

THE EDISON SWAN ELECTRIC CO. LTD.
 RADIO DIVISION:
 155 CHARING CROSS ROAD, LONDON, W.C.2



EDISWAN RADIO

THE BEST SETS ARE WELL CONNECTED

Set manufacturers, Government Departments, technical experts, the leading wireless journals, ALL use and specify Belling-Lee Radio Connections. Make them *your* choice.

BELLING-LEE BATTERY CORDS as illustrated, complete with engraved Wander Plugs, spring grip Spade Terminals, and 5/4" cords in 5, 6, 7, 8, 9 and 10 way, from 4/- to 6/6, and 30" cords from 2/6 to 5/-. With fuse 1/- extra.

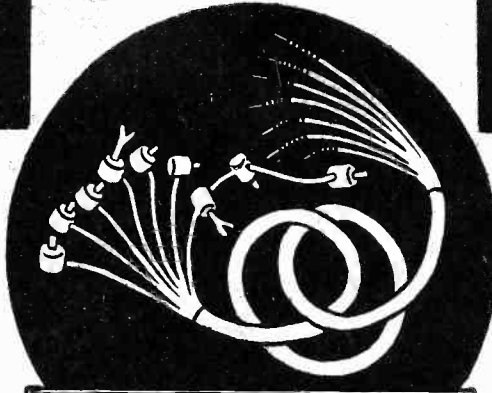
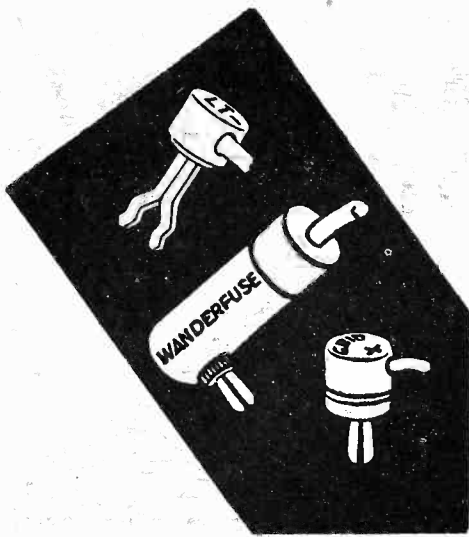

BELLING-LEE
FOR EVERY RADIO CONNECTION

THE WHOLE FLEX GRIPPED—

copper, rubber and fray. A feature of all Belling-Lee Plugs. No loose straggling ends to cause short circuits. And for absolute safety you should put a Wanderfuse in the H.T. lead instead of the ordinary Wander Plug. It is a Wander Plug and Fuse combined, and takes no extra head-room.

Belling-Lee Wander-fuse, with 60 m'a fuse 1 6
Engraved Wander Plug 2d.
Spade Terminal 2d.

Advertisement of Belling & Lee Ltd., Queensway Works, Ponders End, Middlesex.

FOR THE OTHER END of the CORD!

The Belling-Lee Battery Cord is the neatest method of connecting set to battery, for all leads are enclosed inside *one* outer silk covering. To make a sound job at the set end also, fit your receiver with either Belling-Lee Terminals or Plugs and sockets. Then you *can't* go wrong.

Belling-Lee Terminals Type "R"	3d.
Type "M"	4 1/2d.
Type "B"	6d.
" " Plug and Socket	6d.
" " S.G. Safety Anode Connector	6d.

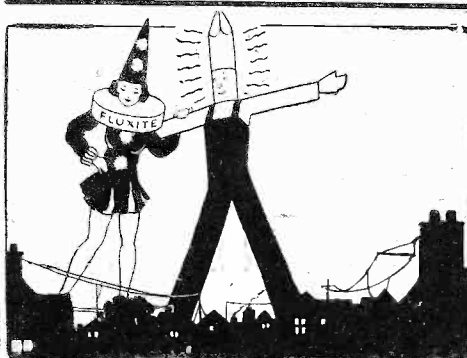

"We're Fluxite and Solder, the reliable pair, Famous for Soldering—known everywhere! We've soldered all connections, and here's the reward—Good Programmes come clearly From Home and Abroad!"

See that Fluxite and Solder are always by you—in the house, garage, workshop—anywhere where simple, speedy, soldering is needed. They cost so little, but will make scores of everyday articles last years longer! For Pots, Pans, Silver, and Brassware; RADIO; odd jobs in the garage—there's always something useful for Fluxite and Solder to do.

All Hardware and Ironmongery Stores sell Fluxite in tins, 8d., 1/4 and 2/8.

ANOTHER USE FOR FLUXITE
Hardening Tools and Case Hardening. Ask for Leaflet on improved method.

NEW "JUNIOR" SIZE, 4d. per tin.

FLUXITE SOLDERING SET

Simple to use and lasts for years in constant use. Contains special "small-space" soldering iron with non-heating metal handle; pocket blow-lamp, Fluxite, Solder, etc., and full instructions. COMPLETE, 7/6, or LAMP only, 2/6

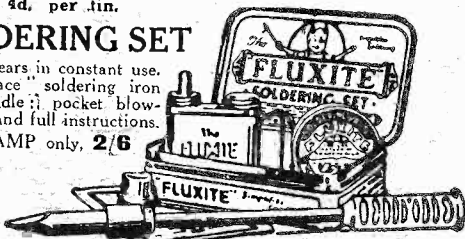

FLUXITE LTD.
(Dept. 324),
ROTHERHITHE, S.E.16

ALL MECHANICS WILL HAVE

FLUXITE

IT SIMPLIFIES ALL SOLDERING

(INDOOR)



(LOW-LOSS)

7 in 1 AERIAL

has eliminated unsightly, inefficient and costly outdoor aerials.

LABORATORY TESTS PROVE 25% INCREASE IN SIGNAL STRENGTH.

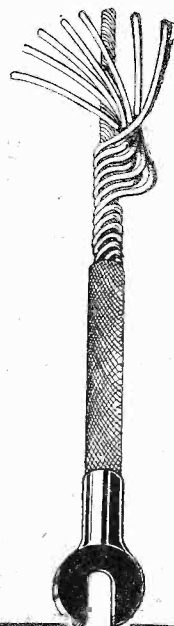

Have you ever considered the fact that aerials are the only remaining part of modern wireless reception that have lagged behind in the swift development of wireless?

Do not waste any more money on repairing your outdoor aerial. Simply place the FORMO Low-Loss Aerial around the picture-rail or other convenient place, and enjoy improved and trouble-free reception of stations you may never have heard before.



Price—15 ft., 3/9

20 ft., 4/6

Packed in Strong Carton ready for use. Obtainable from all Radio Dealers. Catalogue from:

ARTHUR PREEN & CO., LTD., Golden Square, Piccadilly Circus, London, W.1. Crown Works, Southampton.

20 MILLIAMPERE A.C. ELIMINATOR 60/-

20 Milliampere Output at 120 volts.

Fitted with two variable wire wound resistances, 0/120, and 1 fixed, 120 volts. Incorporating Westinghouse Metal Rectifiers

60/- Cash, or on Easy Terms.

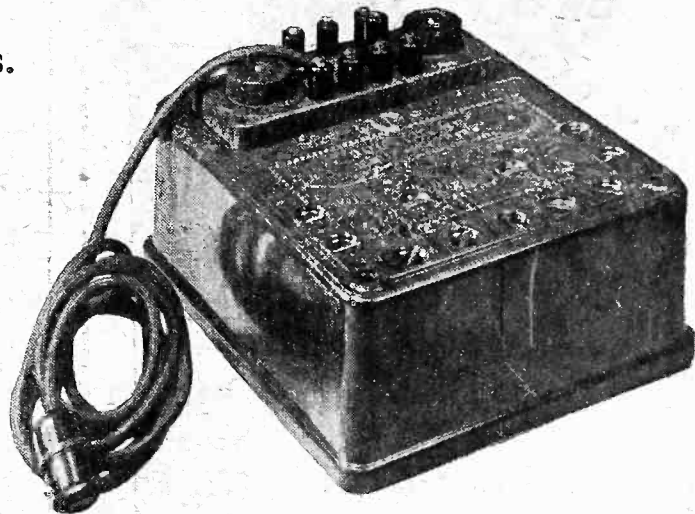

D.C. MODEL 1. ELIMINATOR

30 milliampere output at 120 volts.

27/6

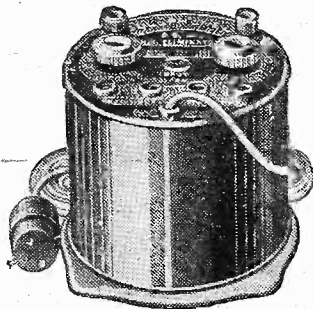

D.C. Model 2. With two variable wire wound resistances, 30 milliampere output at 120 volts.

42/-

Or on Easy Terms.

All Bullphone Eliminators are Shrouded in all Bakelite Shockproof Cases and are guaranteed for two years.

BULLPHONE A.F. COIL

(Aerial or H.F. Transformer)

This Coil is suitable as a dual range aerial unit with fixed aperiodic aerial and reaction windings and may also be used as a tuned anode, tuned grid or high-frequency transformer.

5/6

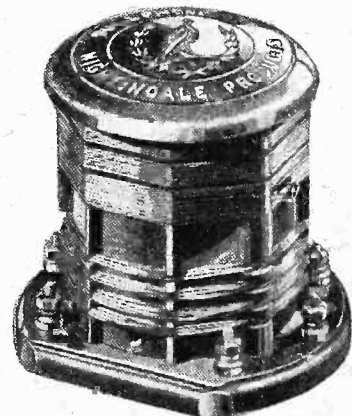

BULLPHONE LTD. BARKINGSIDE, ESSEX
Telephone Chigwell 162.

Do You Know?

Historical Signs—No. 1



The Sign of St. Crispin

CRISPIN, a Christian martyr and shoemaker of Soissons, because of his goodness to the poor in making their shoes without payment, was, after his martyrdom in 286 made the patron saint of the shoemakers. In the middle-ages and onwards the sign of St. Crispin was used by all true craftsmen among leatherworkers.

To-day, in the same way, "the green case" is a recognised sign of condenser efficiency—indicating as it does the product of experience and skill. For every T.C.C. Condenser is the result of a quarter of a century's specialised experience—that of designing and making condensers—and condensers alone. Be sure your next condenser has this backing—be sure its T.C.C.

Look for the initials T.C.C. on the condenser in the green case

T.C.C.

CONDENSERS

The Telegraph Condenser Co. Ltd., Wales Farm Road, N. Acton, W.3

9113

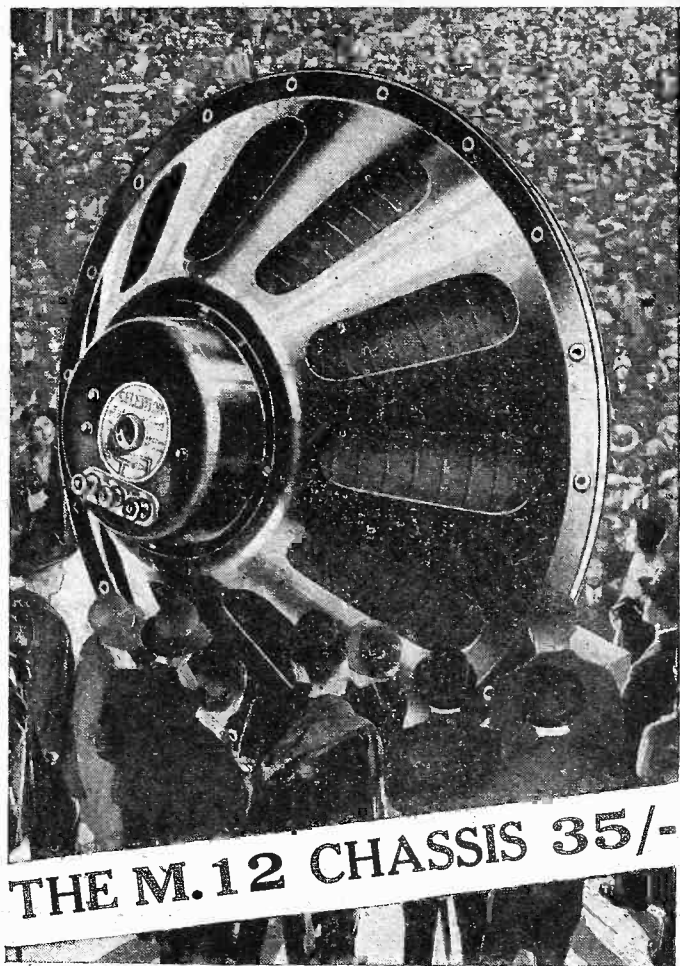

The Most Amazing Speaker Ever Made

Outstanding in its wonderfully realistic tone, and its ability to handle great volume. That *essential* to absolutely true reproduction—The **RE-INFORCED DIAPHRAGM**—is found **ONLY IN CELESTION SPEAKERS**. That is why the Celestion M.12 gives such outstanding results, and why it covers a tonal range never before attained in a cone speaker.

Three terminals allow any output valves to be accurately matched. At **35/-** the M.12 represents *the finest value ever offered*. Truly a speaker of outstanding merit.

A demonstration will instantly convince you. Insist on your dealer demonstrating CELESTION or write for literature to:

CELESTION LTD.,
London Rd., KINGSTON-ON-THAMES
London Showrooms:
106 Victoria Street, S.W.1

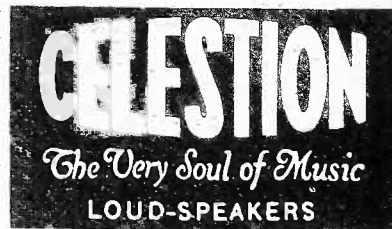

FOREMOST NAME IN SOUND REPRODUCTION

The Mullard 2-volt range offers a choice of valve types fitted both by construction and performance, to take their place as the vital components of your receiver. Among them is the P.M.2D.X, the Mullard 2-volt super detector, which can also be used as an L.F. Amplifier immediately prior to the output stage. Buy one to-day from your dealer,

Price 8/6.

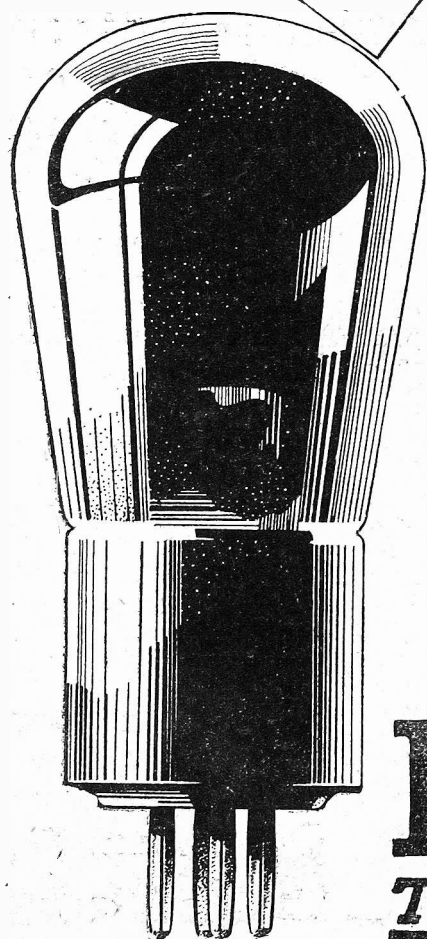

Mullard

THE · MASTER · VALVE

NEXT WEEK!

Every copy of next week's "P.W." will contain

Another GREAT GIFT BOOK

AN AID
to
Better
Reception

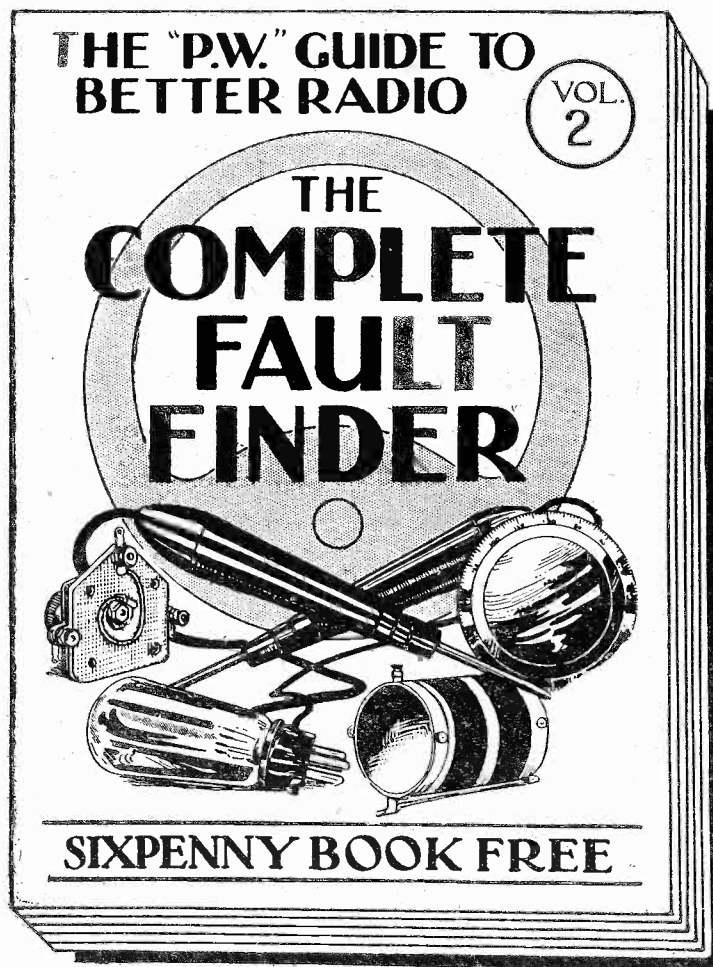

Practical
Help for
Every
Listener

Specially compiled by the Technical Staff of "P.W.," this valuable and unique book helps you to

GET THE BEST OUT OF YOUR SET!

There is sure to be an enormous demand

SO

Out Next
Thursday

ORDER NOW
POPULAR WIRELESS

Usual Price—
3d.

EXPRESS KIT SERVICE

THE NEW B.P. THREE READY FOR IMMEDIATE DELIVERY

Send 6d. in Stamps for NEW 116-page "Radio Buyers' Guide of 1932 Radio."

Pilot Author's Kits remove all doubt. Containing components "First Specified" in the list of parts and as used by the author himself in the original Set, you are able to duplicate the set as originally constructed by the Author. No other Kit of Parts offers you this wonderful safeguard against disappointment.

C.O.D. CASH H.P. as usual

PILOT AUTHOR'S KITS

DETAILED PART LIST FOR NEW B.P. THREE

CHECK this list of parts with the Author's specifications, photographs and diagrams on pages 290-1-2.

	£	s.	d.
1 Baseboard, 10" deep	1	6	
1 Panel, 18" x 7" (drilled to specification)	12	0	
1 Lewcos band-pass coil	6	0	
1 Utility -0005 mfd. double gang variable condenser	1	2	6
1 Igranic Vernier dial for same	5	0	
1 A.E.D. volume control, 500,000 ohms	8	6	
1 Ready Radio "on-off" switch	10		
1 R.I. L.F. transformer, G.P. type, 7-1	10	6	
1 Ready Radio H.F. choke	4	6	
1 Ferranti output choke	7	0	
1 T.C.C. -0003-mfd. fixed condenser	1	6	
1 Dubilier -02-mfd. condenser (non-inductive)	2	0	
1 T.C.C. -01-mfd. condenser	3	0	
2 T.C.C. -2-mfd. condensers	7	8	
1 Graham-Farish 2-meg. grid leak and holder	1	4	
1 Varley 100,000-ohm spaghetti resistance	1	6	
1 Ready Radio 25,000-ohm spaghetti resistance	1	6	
1 Telsen -0005-mfd. reaction condenser	2	6	
1 Bulgin fuse holder, with fuses	2	6	
1 Bulgin two-way switch, Type S.86	2	0	
1 Terminal strip, 18" x 2"	2	0	
11 Belling-Lee Indicating terminals, Type R	2	9	
4 G.B. 3 H.T. and 2 L.T. plugs, and 2 spade terminals	1	6	
Author's Kit "A," Cash or C.O.D.	£5	13	1
3 Ostron valves (as specified): H.L.210, L.210, P.215	£1	7	6
1 Mahogany cabinet, with lift-up lid	17	6	
Any parts supplied separately. If value over 10/- sent carriage paid or C.O.D. All post charges paid. State your requirements in the coupon. Immediate dispatch C.O.D. You pay the postman. We pay all post charges.			
SPECIAL C.O.D. LINES FOR NEW B.P. THREE			
1 Lewcos Band-pass Coil	12/-		
1 Utility -0005 mfd. Double Gang Variable Condenser	22/6		
1 Igranic Slow Motion Dial	5/-		

55 NEW B.P. THREE

KIT "A" Author's Kit "A" less Valves and Cabinet £5:13:1
or 10/5 down and 11 monthly payments of 10/5

KIT "B" Author's Kit "A" with Valves less Cabinet £7: 0:7
or 12/11 down and 11 monthly payments of 12/11

KIT "C" Author's Kit "A" with Valves and Cabinet £7:18:1
or 14/6 down and 11 monthly payments of 14/6

PILOT RADIO KIT PRICE CHART FOR OTHER FAVOURITE P.W. SETS

ITEM NO.	SET.	KIT "A," less Valves and Cabinet:	KIT "B," with Valves less Cabinet.	Kit "C," complete with Valves and Cabinet.
52	POP-VOX FOUR (Author's Kit)	CASH or C.O.D. £5 18 11 or 10/11 down and 11 monthly payments of 10/11.	CASH or C.O.D. £8 6 5 or 15/3 down and 11 monthly payments of 15/3.	CASH or C.O.D. £9 7 5 or 17/2 down and 11 monthly payments of 17/2.
50	P.V. STAR (Author's Kit)	CASH or C.O.D. £5 11 11 or 10/3 down and 11 monthly payments of 10/3.	CASH or C.O.D. £7 10 11 or 13/10 down and 11 monthly payments of 13/10.	CASH or C.O.D. £8 18 5 or 16/4 down and 11 monthly payments of 16/4.
51	P.V. PLUS (Author's Kit)	CASH or C.O.D. £4 7 8 or 8/- down and 11 monthly payments of 8/-.	CASH or C.O.D. £6 6 8 or 11/7 down and 11 monthly payments of 11/7.	CASH or C.O.D. £7 6 8 or 13/5 down and 11 monthly payments of 13/5.
53	P.W. SUPER QUAD	CASH or C.O.D. £7 15 6 or 14/3 down and 11 monthly payments of 14/3.	CASH or C.O.D. £10 14 6 or 19/8 down and 11 monthly payments of 19/8.	CASH or C.O.D. £11 14 6 or 21/6 down and 11 monthly payments of 21/6.
54	COMET 3 FOUNDATION CIRCUIT	CASH or C.O.D. £4 0 0 or 7/4 down and 11 monthly payments of 7/4.	CASH or C.O.D. £5 7 6 or 9/10 down and 11 monthly payments of 9/10.	CASH or C.O.D. £6 7 6 or 11/8 down and 11 monthly payments of 11/8.

★ Any parts supplied separately if value over 10/- . Sent carriage paid or C.O.D. All post charges paid.

SPECIAL C.O.D. LINES FOR "P.W." SETS.

Fill in the Coupon. Pay the postman, we pay all post charges.

Peto-Scott Side Control Swivel Jointed Brackets	Per pair	3/6
Peto-Scott Side Control Ebonite Discs with Knurled edge	Per pair	3/-
Cydon (-0005-mfd.) Extensers, Type Ex215	The pair	37/6
Aluminium Screen to specification, 13" x 8"	Each	2/9
Peto-Scott P.J. Coil (No. 2)		1/6
Peto-Scott P.J. Coil (No. 3)		2/-
Formo (-0005-mfd.) Extensers		29/-
2 -0005-mfd. Cydon (-Type Ex5) Extensers	Each	16/6
2 Peto-Scott Ready Wound Coil Quits, tapped to specification	The Pair	4/3
POPULAR ACCESSORIES ON OUR C.O.D. LIST.		
B.T.H. Minor Gramophone Pick-Up and Tone Arm	C.O.D.	27/6
Blue Spot Inductor Type Speaker Unit and Chassis	C.O.D.	39/6
Blue Spot Mains Disturbance Unit	C.O.D.	10/6
W.F.F.A. Speaker Unit and Chassis, No. 40	C.O.D.	40/-
Telsen Speaker Unit and Chassis	C.O.D.	11/-
Wearite "Popular Type" Frame Aerial	C.O.D.	32/6
B.T.H. Synchron-Blue Gramophone Motor, For A.C. Mains		39/6

SEE OUR FULL PAGE ANNOUNCEMENT IN LAST WEEK'S ISSUE OF "POPULAR WIRELESS" PAGE 198.

EXPRESS ORDER FORM

To PETO-SCOTT CO. LTD. Please send me C.O.D./CASH/H.P.

.....

.....

.....

for which I enclose Cash/H.P. Deposit £ s. d.

Name.....

Address.....

.....

P.W. 10/10/31

PETO-SCOTT

PETO-SCOTT CO. LTD. Head Office: 77, CITY ROAD, LONDON, E.C.1. Clerkenwell 9406. 62, HIGH HOLBORN, LONDON, W.C.1. Chancery 8266. MANCHESTER: 33, WHITELOW ROAD, CHORLTON-CUM-HARDY. Phone: Chorlton-Cum-Hardy 2028. NEWCASTLE, STAFFS: 7, ALBANY ROAD Phone: 67190.

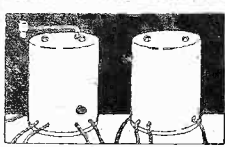
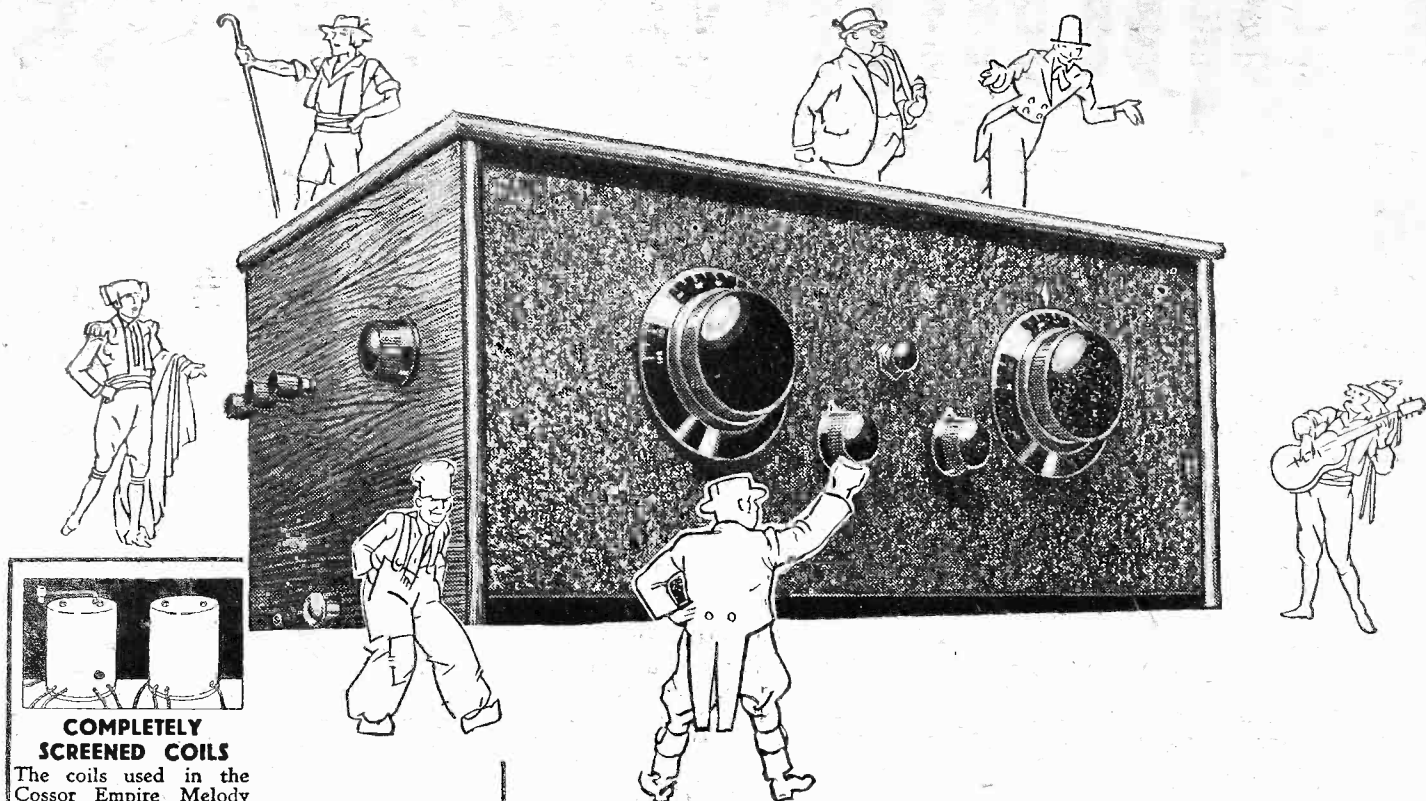

COMPLETELY SCREENED COILS

The coils used in the Cossor Empire Melody Maker are completely screened in metal "pots" entirely eliminating direct pick-up, thus further improving selectivity.

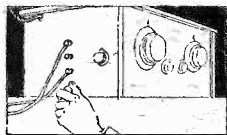

EXTERNAL WAVE-CHANGE SWITCH

Wave Change Switching is effected by operating the switch at the end of the cabinet—"in" for long—"out" for short.

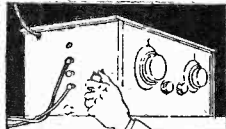

SERIES AERIAL CONDENSER

The variable Series Aerial Condenser permits adjustment of selectivity to give the fine tuning necessary to cut out powerful local stations.



COSSOR METALLISED SCREENED GRID VALVE

Even better performance is ensured by the use of a Cossor Metallised Screened Grid Valve with its record low inter-electrode capacity and its ability to eliminate stray coupling effect between anode and nearby components.



ALL-METAL BASEPLATE
Construction is simpler than ever, due to the Metal Baseplate, which is supplied with every hole drilled, thus automatically positioning every component.

Britain's Greatest Radio Value

Never before has such a powerful 3-valve Screened Grid Receiver been obtainable for so modest an outlay. The Cossor Empire Melody Maker is the greatest value-for-money ever offered in Wireless Receivers.

It has "All-Europe" range. Its selectivity is remarkable. It will cut out the powerful transmissions of nearby stations and bring you the programme you want to hear.

Yet in spite of its efficiency the Cossor Empire Melody Maker is so simple that you can easily assemble it yourself—no Wireless knowledge is necessary.

The Cossor Empire Melody Maker Model 234 for battery operation is obtainable from your usual Radio Retailer. Get full details—use the coupon.

Sold as a complete Set of parts including Valves and Cabinet

Cossor EMPIRE Melody Maker Model 234

Complete Kit including handsome oak Cabinet, three of the latest type Cossor Valves, all the parts necessary for assembling the Receiver as Illustrated and full-size "easy-to-follow" Constructional Chart. Price **£6.15**

or 15/- down and nine monthly payments of 15/-

A. C. COSSOR LTD., Highbury Grove, London, N. 5. Depots at Birmingham, Bristol, Glasgow, Leeds, Liverpool, Manchester, Newcastle, Sheffield and Dublin.

9086.

To Messrs. A. C. Cossor, Ltd., Highbury Grove, London, N. 5.
Please send me free of charge one of your Constructional Charts No. C. 12 which tells me how to build the Cossor Empire Melody Maker.

Name

Address

P.W. 10/10/31.

Popular Wireless

LARGEST NET SALES

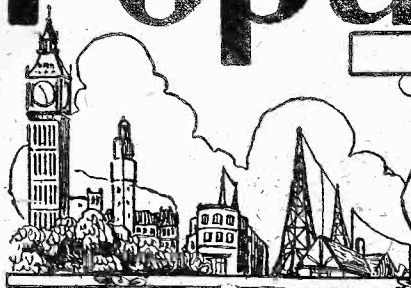

Scientific Adviser:
 Sir OLIVER LODGE, F.R.S.
 Chief Radio Consultant:
 CAPT. P. P. ECKERSLEY, M.I.E.E.
 Editor: NORMAN EDWARDS.
 Technical Editor: G. V. DOWDING, Associate I.E.E.
 Assistant Technical Editors:
 K. D. ROGERS, P. R. BIRD,
 A. JOHNSON RANDALL.

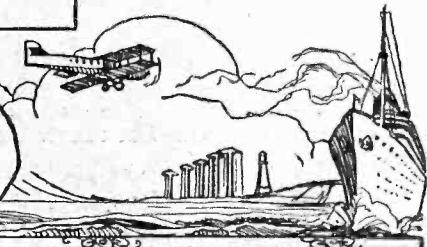

**WAR ON INFRINGERS
 LINDBERGH'S RADIO
 BATTERY NEWS
 A ROMANTIC CAREER**

RADIO NOTES & NEWS

**SET-BUILDING NOTE
 THE SMACK WENT BACK
 A PALPABLE HIT!
 FRENCH NEST EGG**

War on Infringers.

CERTAINLY the radio trade has no great reason to complain of the support it receives at home, with the results of the show at Olympia available. And a further cause of joy to the manufacturers and all radio workers is to be found in the decision of the big licensing Pool, consisting of Marconi's, the Gramophone Co., and Standard Telephones and Cables, to refuse licences to sellers of imported foreign-made receivers.

The Big Three announce that they are "going all out" after infringers of their patents, which includes the sale of imported broadcasting receivers.

Marconi's at the Faraday Exhibition.

IT is safe to say that the Marconi Company's contribution to the Faraday Exhibition was one of the most, if not the most, striking collection of historical radio gear ever brought together in one place. Besides replicas of Marconi's earliest apparatus used in 1895 at Boulogne, the exhibit included a complete collection of valves ranging from two experimental two-electrode valves made by Dr. Fleming from 1904 to 1908, to a great 100-kw. valve as used to-day.

One of the kites used by Marconi in his first transatlantic experiments was shown also.

Radio Society Note.

"WHEN the clubs are opened, the secretaries sing"—to parody a well-known rhyme. The first carol of the season comes from Raynes Park, S.W.1, 9, Westway, the official domicile of Mr. A. L. Odell, hon. sec. of the Bec Radio Society, which resumed its meetings on Sept. 29th, at Bec School, Beecheroff Road, Balham, S.W.17.

Two meetings weekly are held, on Tuesdays and Thursdays, at 7.30 p.m., the Tuesday meeting being for advanced members and the other for beginners. Prospective members please apply to the hon. sec.

for particulars of enrolment and copies of the syllabus.

Have You Heard Lindbergh?

THOSE short-wave hunters who can read Morse—and all should have that ability—will probably be interested to know that the call-signal of Col. Charles

LEILA LIKES LISTENING!



This is Leila Hyams, one of the Metro-Goldwyn-Mayer's stars—and she appears to forget all about her boy friend's set when her favourite tune comes through.

Lindbergh's short-wave transmitter on his aeroplane is K H C A L, and that it operates on 53.41, 37.42, 35.5, and 22.66 metres.

The gallant colonel is not a "demon" operator, and therefore if any of you amateur Morse readers happen to pick up his signals the speed of transmission will not be too high to baffle you!

Youth at the Helm.

A NOTE of praise for G. L. B. (Shepherd's Bush), aged sixteen and never queued up for his grub during the war. He has rebuilt his hook-up a la "Titan" Two, using the Extenser and incorporating interwave coupling and flexi-coupling, which gives the set great sensitivity and selectivity. His diagram is a credit to him—and us! Other readers have worked along similar lines, and we suggest that he and they would do well to take a look at big brother "Modern Wireless" for September, where they will find something to their advantage.

The "Clear-Cut" Cone.

AN ingenious correspondent—N. A. P., of Chatham—rightly says it will interest me to know to what practical use suggestions made in "P.W." can be put. Being mightily smitten by the look of the "Clear-Cut Cone" ("P.W." 447), and the "Sound Deflector" ("P.W." 468), he combined these two into an open-backed cabinet, and drove a Blue Spot unit from a Detector and Pentode combination.

What kind of results did that produce, ses you? Well, N. A. P. affirms, "Using the 'Clear-Cut Cone' results are almost, if not quite, equal to moving-coil work, both for volume and quality."

Looks as though some of you other fellows ought to "go NAP" on that idea, too!

"Omba Pende."

THANKS to A. J. F. F., of Singapore, I have before me "Omba Pende," which seems to mean "Short Waves," and is the organ of the Amateur Wireless Society of Malaya (Singapore), Vol. 1, No. 1, and good luck to our wee sister. Anything "P.W." can do—delighted.

There are just a few minor printing blemishes, and a slight "rawness" in the "make-up" of some of the pages, but for (Continued on next page.)

"ARIEL'S" REVIEW OF RADIO TOPICS (Continued)

a first number it is quite a notable achievement, and quite honestly I think it a bright magazine worthy of encouragement. Copies would be received by me with pleasure—especially as I took the hall-porter of "Raffles Hotel" for an enforced ride in a rickshaw in 1911. But rubber ain't what it was then, alas!

Lions Roar on Radio.

QUITE recently I was referring to 7 L.O.'s gallant attempt to relay a real lion's roar. And now comes the rumour that the Johannesburg short-waver (on 49.4 metres) has leanings towards a broadcast of that kind.



It should be an interesting item on the programme, but I should hate to be the engineer that has to go out and tell the lion that he is wanted on the "mike"!

Battery News.

AS you have probably discovered, there is a deal more to learn about accumulators than the glass bead and distilled water racket. They could well be a lifetime's study.

Nothing has so powerfully demonstrated to me how elementary is my understanding of this type of cell as the articles by the Chief Engineer of the Chloride Electrical Storage Co., published in that firm's "Chloride Chronicle and Exide News," price twopence. The summer number contains article No. 30, and I hope that Exides will reprint the lot and sell them at a nominal price, though they would be worth half a guinea.

A Romantic Career.

YOUNG David Sarnoff, the President of the Radio Corporation of America, who was recently in London, got his first big chance in life because he didn't mind the temperature being at zero or below it! When they wanted a wireless operator on a seal-fishing expedition to the Arctic he volunteered for it, and on his return to civilisation they compensated him with a "cushy job" on the radio station at the top of the Wanamaker Building in New York.

Here, one night, he picked up distress signals from the sinking "Titanic," and he stuck on duty for 72 hours until the full list of survivors' names was safely received. From that day David Sarnoff was a marked man, and now he's right at the top of one of America's biggest combines.

Note on Set-Building.

MR. ALF. MANN has made a new short-wave set which he considers to be unbeatable and a short history of the job may provide a few tips. First

D.R.!

he read all "P.W." short-wave articles for the past three years, and then taking Mr. P. W. Harris's "Short-Wave" Three circuit as a basis laid out a set to suit his discriminating views.

Three layouts were scrapped before he satisfied himself, and now he has a wonderful receiver.

Note on Set-Building (Continued).

HE put a copper screen (earthed) between the detector and amplifier stages, and got increased strength and stability; then he did the same for the first and second amplifiers, with further improvement but slight feed-back; then he decoupled the H.T. positive, fitted an aluminium panel behind the wooden panel, and earthed the moving vanes of the variable condensers to it, thereby getting 50 per cent more volume and no hand capacity.

SHORT WAVES.

"I am told there is a prospect of a colossal boom in wireless this winter," says Mr. G. Murdoch.

There have already been some colossal booms in my wireless for the last twelve months. "Pictorial Weekly."

FINE—FOR OTHERS.

I am looking forward to the time when I shall awake at 7 a.m., turn on the wireless and remain in bed! Then, listening to the broadcast exercises, I shall think luxuriously of the thousands of poor wretches all over the country who are at that moment strenuously knees-bending in the cold bedrooms. And that will be closely approximate to my idea of perfect content.

"Sunday Pictorial."

Grannie (discussing the loudspeaker): "It makes me so nervous when I think of all the different things struggling to get out."

"Punch."

Mrs. Binks: "Very few people wear headphones nowadays."

Mrs. Jinks: "Yes, and I think it's a shame. John's ears were just starting to look natural, and now he's looking as much like a donkey as ever."

Artists say the B.B.C. gives them ridiculous fees for their broadcasts. Wireless fiends say the B.B.C. gives them ridiculous broadcasts for their fees.

He put the screens in one at a time so that if he found anything wrong he would know at once which screen was responsible and would not scrap all screening.

The Smack Went Back.

IN case other readers may suffer from the habit of shooting first and making inquiries afterwards, I draw attention to a letter from C. H. L. (Clevedon), who says that the Editor deserves a smack on the hand for publishing a picture of a microphone being put into a hen-coop for the broadcasting of the nightingales' utterances.

What does C. H. L. want the "mike" put in? A steak pudding? The coop had been kept around long enough for the birds to get accustomed to it; had the "mike" been planked down without concealment the birds would have been suspicious, and might not have obliged with their performance. The caption makes this clear, surely.

A Palpable Hit!

THEY say that if your poor old head is unlucky enough to get in the way of a nasty crack from a descending crowbar, your sensations, when returning to consciousness, are very mixed.

It's true, and I know it, for a shrewd blow has just descended upon my pate, and I'm feeling very, very "mixed" indeed, as I look at a letter from Hemel Hempstead.

"Regular Reader," I thank you. 'Twas a hit—a palpable hit, and fortunately nobody besides you noticed that little slip.



The "Super-Coil" Three.

FROM a rectory near Sleaford in Lincolnshire, comes an interesting letter about the "P.W." Super Coil Three—a letter which I dare not show to the Technical Hounds. If I let them read all the complimentary things said of that design they would never get their hats on again.

Apparently this enthusiastic constructor added the Star Turn selector coil and an output filter, with the result, "it would be impossible to better it."

But what is this? Three or four pages further on in the letter I find that he is going to make it a radiogram as soon as the pick-up arrives! And I am open to bet that before the season is out even that super "Super Coil" will have a rival in his affection!

That's the worst of this radio game—as soon as a man gets absolutely satisfied, another circuit comes long and out come the pliers and the screwdriver again!

The French Nest Egg.

ISN'T it queer that the French don't seem to be able to evolve a really good national broadcasting service? The other day their Minister of Posts and Telegraphs referred to a scheme for eleven big new stations, but it was all very vague and indefinite.

Our cross-Channel friends can't seem to find the right man for radio—they are still looking in vain for a Monsieur Eckersley or a Vicomte Reith. It certainly isn't the boodle that holds them back, for the French P.O. is sitting on a £600,000 nest-egg specially laid aside for radio.



ARIEL.

ARE RADIO SETS TOO SMALL?

BY CAPT. P. P. ECKERSLEY M.I.E.E.



I HAVE just moved into a new flat. I must have some means of listening to the programmes. In these days rents are high and flats are small. My wireless set is about as easy to accommodate as a grand piano: not because my set is as bulky but because it fails hopelessly to harmonise in appearance with anything else.

The essential loudspeaker is an unlovely thing, and no one would exactly rave about the lines of a wireless set. But, as a minimum, we have got to have a loudspeaker. Here again, quality of reproduction fights against æsthetic value. No one can deny that, firstly, a loudspeaker must be large, either as a whole diaphragm or as a movement plus baffle, and secondly, it should be at head level and thirdly, it must stand away from the wall because it radiates backwards as much as frontwards.

Ludicrous Acoustics!

For some time we thought we might have a corner cupboard, and thus accommodate the set on one of the shelves and put the loudspeaker above it. But the acoustics of the corner are ludicrous, and one could never get real pleasure listening to a loudspeaker speaking frontways at one and backways into a corner, and thence out again.

Let us tackle this problem a little more fundamentally. Take first the question of the radio-gram. This, I think, must be a piece of furniture. What piece of furniture? Oak, mahogany, white wood, with or without scroll work?

It is impossible to decide, because different tastes and different rooms demand different finishes. Obviously, for certain markets the manufacturer could build chassis and give his customer a choice of body work.

The Tendency to Compress.

This is a possible solution to the problem of building a radio-gram. If you must have a big thing, make the best of it, and if it's big make it, with the fewest adaptations, able to fit the design of anyone's room.

There is still the question of the loudspeaker. If you build this in between the legs of the radio-gram you have to face two problems, box resonance behind the speaker and the source of sound being low down near the floor. I don't think there is one solution to this problem.

One of the advantages of a keenly analytical mind is that it can always see new aspects of old problems, and invest even the familiar things with new interest. Read this article and you will certainly enjoy Capt. Eckersley's analysis of radio under home conditions.

One might have a loudspeaker which pulls out of the whole set and stands where the user wills, or remains in the set, if it's too much of a bother to move it, but then gives slightly poorer quality.

There are other ideas which might be worked out, but basically I feel a radio-gram must be a piece of furniture, and must therefore make a virtue of necessity.

But the tendency with the ordinary wireless set is to compress. Manufacturers are making their tuning-circuits, mains

A "RADIO APPOINTMENT"



This is Mr. P. J. Pybus, the new Minister of Transport, who received a radio message notifying him of his new appointment when on the "Mauretania" in Mid-Atlantic.

units, loudspeakers, etc., smaller and smaller. It is interesting to discuss whether they are right in so doing.

From an electrical performance point of view they are wrong; æsthetically they

have justification. If you can't make a wireless set harmonise with other furniture, why, then, make it as small as possible.

But from an electrical point of view, you are intensifying circuit component design enormously. The effectiveness of a tuning coil, to assume a proper measure of selectivity, is in proportion to its bulk.

True a lot of small coils in cascade are as good, or even better than, one big coil, if you are talking of sheer selectivity, but each coil must be screened, there must be both a long- and short-wave coil in each compartment and so on.

Why Not Separate Them?

Then cutting down the power supply bulk means transformers which are on the verge of a factor of safety, means starving the valves of the power they deserve, means more mains hum than would otherwise be necessary. Every time a little more trouble is taken to assure good performance, it seems as if more space is required.

I wonder if it would not be a good idea always to separate mains unit and set? Thus the mains unit could be designed, surely, to go in a cupboard, under the stairs, in the cellar, anywhere out of sight.

Even if one used batteries, the same idea applies. Then you wire to a plug into which you plug the (smaller) set or the same-sized set with better performance.

But still this loudspeaker problem haunts us. If you take a little 10-in. cone moving-iron loudspeaker without a baffle, you are surely bound to lose bass? Typical loudspeakers are mounted in boxes, and doesn't one know it! But what else can one do?

A Big Problem.

I once saw a loudspeaker which was really of the horn type, but the horn was covered up in an ingenious way and the whole instrument was effectively flat. I feel such a type would stand unobtrusively against a wall when out of use, and could be simply swivelled round in use.

Unquestionably it's a big problem, and one that must have a determining effect on circuit design.

There is, of course, finally the idea of a remotely controlled set when one dials for programmes. When, and if such an idea is worked out commercially, it will largely help to solve the problem, but we still shall require a loudspeaker.

THE MIRROR OF THE B.B.C.

PROSPECTS FOR ROME.

B.B.C. SPORTS—MORE MONEY FROM RADIO?—B.B.C. IN THE EMERGENCY—PROGRAMME "HIGH LIGHTS."

THE meeting in Rome next week of the International Broadcasting Union will receive the report of the Technical Committee which deliberated at Brussels last month. It will be recalled that at the latter place Mr. Noel Ashbridge, Chief Engineer of the B.B.C., put up a stout fight for agreement on the necessity of immediate changes in distribution of channels.

But he was outvoted. Another blow to British aspirations was the unprecedented conjuncture of Germans and French to defeat the proposal for a meeting of "Administrations," that is, Post Offices, this autumn.

So now the only hope lies in the possibility of some "gentlemen's agreement" emerging at Rome. And I believe this is slender. If the British case is again blocked it may mean the end of the Union, because the patience of the B.B.C. is taxed to about the limit, and its withdrawal would, of course, end the Union.

Then there would be straight international competition, with the best channels to the strongest in the sense of power at the

"P.W." ALWAYS LEADS!

Our claim to the largest circulation of any wireless paper is once again justified by the net sales certificate which we have received from Messrs. Price, Waterhouse & Co.

It shows that even over the six months ending in mid-summer "P.W.'s" AVERAGE NET SALE WAS

129,806

copies per issue!

POPULAR WIRELESS
is the paper that made
WIRELESS POPULAR

aerials. This is what I have been expecting for years. We should have a proper struggle for the air channels; and then see where the present obstructionists get off.

B.B.C. Sports.

I hear the economy campaign is threatening the B.B.C. staff sports. Some time ago a commodious sports ground was bought somewhere down Surbiton way. It was fully equipped, but has been only partially used because of the difficulty of the staff in

finding time. Now all this will be curtailed, if the ground is not actually disposed of.

More Money from Radio?

Still smarting from the defeat of their attempt to get the extra half-million instead of the £200,000 a year agreed from the B.B.C., the Whitehall pundits are planning another attack next year, this time basing their demands on the possibility of the sale of time on the air.

There is also the suggestion that the B.B.C. does not take the full advantage of its publishing rights. From these two sources the Treasury believe that the B.B.C. should be able ultimately to pay for an attenuated but adequate broadcasting service and at the same time provide at least two and a half million pounds a year to public funds.

I gather Savoy Hill is alive to the danger and is taking the necessary counter-action.

B.B.C. in the Emergency.

I do not think the B.B.C. is doing itself justice in the present emergency. There is a lot of economics and a good deal of admonition to rigid economy. Also there is the new religious mid-week service. So far so good.

But why not let us have every day a simple and comprehensive explanation of exactly what is happening? The community at large (that is, the listening public) is in a state of bewilderment at the reasons for rapidly changing situations.

There is real need for simple non-technical and non-tendencious explanations. Why not have ten minutes nightly after the second general news bulletin?

Programme "High Lights."

Some weeks ago I gave the first intimation that Mr. Edgar Wallace, who you will remember was then very much in the news through one of those "million dollar a

minute" kind of offers to write film scenarios for Hollywood, would give a series of broadcasts called "Stories for Broadcasting."

The name of the series has now been changed to "The World of Crime," Mr. Wallace having decided to substitute personal recollections for sensational fiction—which is a much more attractive title, and will convey a better idea of what our world-famous writer is going to talk about when he gives the first talk during the National programme on Saturday, October 10th.

Continued on page 317.

THEIR LEADER LISTENS!



Anton and his orchestra, at a Streatham cinema, recently gave selections from operas aided by a big amplifier. He is shown here wearing the headphones to synchronise the orchestra with the record being played.

FOR THE LISTENER

This week our popular contributor tells of an odd experience that befell him when returning from his holiday abroad.

THIS must be the oddest experience I have ever had in all my life. I am writing this somewhere in France. Exactly where, I don't know.

Among the Jura Mountains, I think; but geography was always a weak point with me. We crossed the Swiss frontier about a couple of hours distant from the spot where we now are—where we have been all the night! I am on the road home; but the amusing thing is that I am stuck on the road!

We were behind our schedule time at the frontier; and instead of stopping at dusk according to our rule, we decided to press on. We may have missed our way in the dark. We got into some wild country.

And about nine o'clock last night, in an apparently uninhabited world, something ceased to function in the bowels of the car, and it came to rest. It is still resting.

I am not much good at mending a car

even in daylight. In the dark I am no good at all. Who is? I examined what I could see with a torchlight; but I knew it was hopeless from the first. We were in for a night of it.

We had passed through a village about ten miles back; but it was no use walking back; everybody would be in bed by that time; and the place probably hadn't a mechanic in it, anyhow. We were destined to spend a night on the roadside. It was cheap lodging.

The Break-Down.

We had our wireless, and we had something to eat. We had bought a German sausage in Switzerland; a thing about a foot long and as thick as your wrist. We reckoned we could lunch off that until we got to Calais!

And we had one of those long twists of
(Continued on page 320.)



IT was eight years ago that the first Manchester Radio Exhibition was organised by the Manchester Evening Chronicle. And, although it proved a great success, it can hardly be said that, compared with current shows at Olympia, it was then much more than merely a provincial display.

But, guided by the able hands of its original enthusiastic sponsors, it has increased in size and importance year by year until now at last it has deservedly earned the description of "National."

Henceforth the "Manchester Show" is to be known as the Northern National Radio Exhibition, and is to have the full backing of the Radio Manufacturers' Association. And it is particularly fitting that this should be so, in view of the fact that the Manchester broadcasting station has also this year emerged from the local status and become the North National.

Figures and Facts.

This has given radio in the North an immense fillip, and both the radio trade and the licence figures for this area have expanded very considerably. Quite often it has happened during the past months that the sales of various makes of sets and components have actually been greater in the North than in the South of England (in which the London district is included).

A case in point concerns one of our "P.W." coil designs. One of the most successful suppliers of these records that his total sale throughout the whole of the country is somewhere in the neighbourhood of fifty thousand. And yet a Manchester concern whose goods circulate almost exclusively in the North states that they have exceeded that figure!

Bigger Than Ever.

From such evidence as this and many other facts known to us, it seems quite a foregone conclusion that the Northern National Radio Exhibition will prove a tremendous success.

It is considerably larger than last year's show, but whatever space is available we are sure it will be taxed to the utmost by the number of visitors descending upon it from all parts.

The exhibition opened at three o'clock on

This year the Manchester Show becomes, for the first time, the Northern National Radio Exhibition and has the full backing of the R.M.A. It opened on Oct. 7th and will remain open during next week.

Wednesday the 7th of October. The proceedings in connection with the opening were arranged to form the subject of a broadcast from the North Regional station.

At the City Hall.

We have made very special arrangements to include a critique of the exhibits in our

A FINE SHOW PIECE

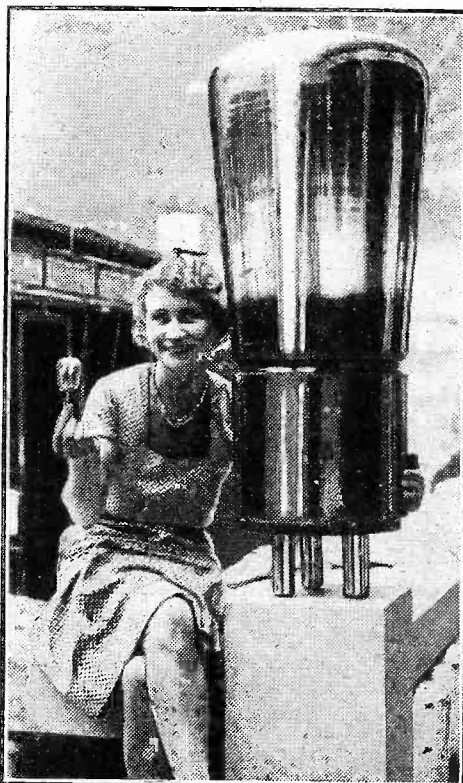

An "outside" in valves compared with one of ordinary dimensions. Giant components and accessories always make attractive exhibits at Radio Shows.

next issue, and a member of our technical staff is visiting Manchester for this purpose.

As before, the show is being held at the City Hall in Deansgate. This is not a particularly cheerful part of the City, but is within easy reach of the stations. Indeed, there is an excellent service of trams which enables you to get there with a minimum of trouble.

And whatever the external conditions, the interior of the hall will be one of the most brilliant places in the country. Both the organisers and the firms exhibiting are making a strenuous effort to render the show the brightest and best yet.

It isn't Olympia in miniature—it is Olympia itself transported and perhaps, in various respects, even improved. And another big section of the population is having the opportunity to see for itself how the British Radio Trade has grown in dimensions and advanced in technique.

You Ought to Go.

The Manchester show always has had a vitality and an underlying enthusiasm that is so often sadly lacking in exhibitions. You obtain a keen sense of the people behind the things arrayed. Exhibitions are frequently mere displays of goods, and as such tend to become unutterably boring.

Radio exhibitions in general are in the nature of exceptions to this, and we are certain visitors to the Northern National will thoroughly enjoy their experience and find that they can go and go again without losing interest.

The exhibition will remain open daily from 11 a.m. to 10 p.m. until October 17th, and the price of admission is 1s. 6d. including tax. Arrangements have been made with the railway companies for reducing railway fares.

Intending visitors are invited to write to Provincial Exhibitions, Ltd., The City Hall, Deansgate, Manchester, enclosing stamped, addressed envelopes, for railway vouchers.

These vouchers entitle their holders to travel the return journey up to 60 miles from Manchester for the cost of a single fare.

A number of competitions have been arranged in connection with the Northern National Radio Exhibition, and the exhibits concerned are being prominently displayed. These will prove a popular feature.

ARE PORTABLES STILL POPULAR?

A correspondent who lives in the country went to the Radio Show as a prospective purchaser of a portable set, and in this informative article tells you of the impressions he gained concerning the models exhibited.

"EXHIBITOR, what of the portable?" Thus my mental frame of mind as the express bore me at over 60 miles an hour towards that Mecca of all good enthusiasts—the "Show."

A Long Journey.

I was travelling the hundred-odd miles or so from my country home to see the goods in person before buying a portable receiver. And when I say "portable" I mean portable! Namely, one of passable weight and housed in neat suit-case style so that when I hiked down the street with it everyone's eyes would not goggle at my "luggage."

I was prepared really to enjoy myself; metaphorically to wallow for a space in portables. True, there had not been much about such apparatus in the papers, in the adverts, or even in the technical journals; but, after last year—well, surely there must be a plentiful crop!

But I was mistaken. Indeed, I will go further—I was disappointed. Out of the 250 or so exhibitors there were only around about 50 makes of portables to be found!

There was stacks and stacks of all-mains sets and apparatus on show, but, as a prospective purchaser, these had no interest for me, for the metal masts for mains are still years from our out-of-the-way dwelling. But yet I was very interested in all this all-mains fare.

From it I learned the truth—I learnt why my pet item was so lacking. It had nothing to do with the increased popularity of hiking, nor yet with the high cost of running a motor-car. No, not at all; but let me tell you what conclusion I came to.

Portables have never been used very extensively for the purpose for which they were originally introduced, namely, to provide entertainment on picnics and other outings in the open. Rather, their popularity has been due mostly to their convenience as receivers that can be taken from room to room quite easily, and which can be put out of the way when not in use.

For Indoor Use.

It was through this particular advantage that transportables came along. A transportable was at first simply a more elaborate sort of portable but finished in a more elegant manner.

With the advent of all-mains design the transportable jumped into prominence. And since the majority of all-mains receivers can be moved about as easily as portables, they have more or less ousted the latter as indoor receivers.

Another thing that has contributed to the popularity of the portable, but in a lesser degree, is that they enable radio to be taken to a house where a set is non-existent. But this aspect of their usefulness is fast dying out as radio becomes more and more universal, for before so very long there will be but few houses without a radio of some sort.

With this reasoning I decided that it was only natural to find fewer portables at the show this year, and set myself to see whether portable sets had progressed in quality if not in quantity. I found that they had without a doubt, and here are a few of the items that were of particular interest.

First of all, like the remainder of the sets, the prices were down quite considerably. But the size in most cases did not seem to be cut down at all, although this is largely made up for by the improvement in quality

that only one tuning condenser has to be used.

But the modern portables are just as easy to operate, for only in one or two are there more than one tuning control. This effect is, of course, largely obtained by ganging.

One set has the controls so arranged that the two circuits in it can be either tuned separately, or at the same time with one knob. Another interesting item is the provision of direct calibration of the tuning of a receiver in wave-lengths with the more important stations mentioned by name.

Super-Het. Sets.

In the super-het. circuits the new double-grid combined oscillator and first detector valves are naturally largely used. Another item which shows that portables are well up to date is the absence of a G.B. battery in one of them, grid-bias being obtained automatically.

So far as the general design is concerned, the sets follow more or less recognised lines. The loudspeaker is in the lid, and the

THESE "GUARDS" AREN'T ON PARADE!



An "unofficial demonstration" of the wireless van used by the Guards during recent manoeuvres.

that has taken place over the older type of portable.

There was one portable that struck me as a good effort, however, in keeping down the size. It was 12½ in. × 11 in. × 8 in., and employed a super-heterodyne circuit.

As a matter of fact, super-het. circuits are very much to the fore in portables this year. One firm is showing a six-valve super-het.

The majority of the sets that are not supers. employ a four-valve arrangement, which consists of an S.G. H.F. valve followed by a detector and then two L.F. stages. In only a few cases are pentode valves utilised, and this may be the reason that current consumptions are kept within quite reasonable limits.

An Old Pattern.

The old type of five-valve circuit with two aperiodic, three-electrode H.F. valves is not very much in prominence, although there are still a few makes employing this arrangement. Its chief advantage lies in the fact

remainder of the case is roughly separated into three divisions, one for the set proper with the controls, one for the valves, and the third for the batteries.

Items of Interest.

Also, both long and medium waves are available. The usual arrangement is to have a three-position switch, the centre position being off.

Two items of particular interest are the presence of a moving-coil speaker in at least one of the portables, and a specially hinged lid in another. In the latter case the hinge is so arranged that when open the lid of the case can be rotated independently of the rest of the case, so that orientation of the frame is possible without a turntable or without swinging the set round.

Yes, I think, on the whole, the user of a portable has not been forgotten. My visit was not in vain, and the only difficulty I met was on the way home in the train, trying to make up my mind which set I liked best.

WHAT IS SHOCK EXCITATION?



by
Dr. J.H.T. Roberts.
— F. Inst. P. —

WHEN reading the account of the operation of a particular type of receiving circuit, you sometimes come across the term "shock excitation," and perhaps you may not be quite clear what it means. It sounds rather a mysterious term, but as a matter of fact it is really very simple and can be explained quite easily.

Atmospherics and Noise.

Perhaps I should say first of all that generally when we come across this term "shock excitation" with reference to a radio circuit it is in connection with the effect of *atmospherics* upon the circuit.

Most *atmospherics* are due to lightning flashes or similar electric discharges which radiate out into the ether a torrent of irregular ether waves. I call them "irregular" to distinguish them from the "regular" waves which are sent out by an ordinary oscillating valve circuit.

Perhaps this distinction can be made clearer by comparing radio waves and sound waves. If we look at the matter in this way, the *atmospherics* may be compared to *noise* and the regular radio waves may be compared to *musical sounds*.

If you strike a non-resonant object, such as a battered tin canister, you produce simply a *noise*, whereas when you strike a resonant object, such as one of the strings of a pianoforte, you produce *musical sound*.

Unrelated Waves.

Whilst making this distinction between noise and musical sound, I should perhaps add that the distinction is one of degree rather than of kind. The noise produced by striking the tin canister consists of definite wave-lengths, but there are so many different wave-lengths, and each one persists for so short a time, that you get in the result a conglomeration of unrelated sound-wave and this is what we call "noise."

A definite musical sound, on the other hand, comprises one wave-length (the fundamental) with or without a number of other wave-lengths (the harmonics), and

Here is a concise and eminently readable explanation of a phenomenon that is often referred to but is seldom clearly defined.

the point here is that these different wave-lengths bear a definite relationship to one another instead of being entirely unrelated as in the case of a noise.

When you strike a key of the pianoforte the hammer hits the string and "shock excites" it; the string, however, being left in a state of vibration in its own natural frequency. The string may be set into vibration, as you know, in another entirely different way, that is, by resonance with another vibrating body having the same frequency.

Vibration Due to Resonance.

For example, if you depress the loud or sustaining pedal of a piano (so as to remove

natural frequency as the tuning fork, and it is set into vibration by the continued and synchronous atmospheric impulses from the tuning fork, the effect being known as "resonance."

If the string is struck and the duration of the impulse is short compared to the time of a complete vibration of the string, then the striking object will have retired or receded before the string returns to the mean position from which it has been displaced, and consequently the string will be left vibrating instead of being damped by the striking object.

All Manner of Wave-lengths.

Now to return to the question of shock excitation of a radio circuit. A lightning flash or other source of *atmospherics* sends out radio waves on all manner of wave-lengths.

When these wave-lengths strike a receiving aerial, one or other of them may set the receiving circuit into vibration by a kind of resonance, whilst those which are of higher frequency than the natural frequency of the circuit in question act in the same way as the striker on the pianoforte string, and so "shock excite" the circuit.

You will see from the foregoing that in the case of a circuit which has a low natural frequency (e.g. one tuned for long wave-lengths) since its natural period of vibration is longer it will be more likely to be shock excited than one where the natural period of frequency is extremely short.

Record Surface-Noise.

It may be of interest to mention that there are reasons for believing that the surface noise from a gramophone record consists of small shock-excitations, and on this basis methods have been devised (using electrical reproduction) whereby the noise can be separated out from the regular acoustic frequencies, the noise of shock excitations being then suppressed by suitable filter circuits, whilst the regular desired frequencies are retained.

It is due to the large variety of wave-lengths in *atmospherics* that make it impossible to avoid them no matter to what wave-length the set is tuned.

SOME LONG SETS FOR THE SHORT WAVES

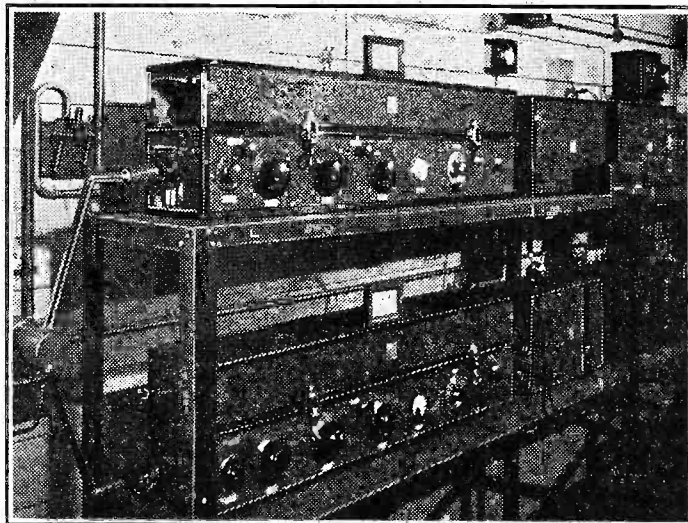

This is a view of one corner of the short-wave reception room at Geltow, which is Germany's wonderful radio receiving station.

the dampers from the strings) and then sound a tuning fork close by the instrument, you will find that at least one string of the piano will pick up the note of the tuning fork.

This string of the piano must be one which has the same or practically the same

FROM THE TECHNICAL EDITOR'S NOTE BOOK.

Tested and Found—?



SOME GOLTONE ITEMS.

In a range of Goltone components that recently reached us were three Midget fixed condensers, three Midget type condensers, and several two-point and three-point switches.

The three-point switch seems to me to be a very sound design. Its action is brisk, by which I mean it goes on and off with a nice click, leaving no doubt whatever as to its position, there being no "half-way" position possible.

It is provided with a panel disc carrying the words "Push for Long Waves, Pull for Short," a feature which constructors will no doubt appreciate.

The Goltone compression type condenser is skilfully arranged either for baseboard or panel mounting, and is a good piece of work. The "Goltone" Midget condenser also exhibits sound commonsense in its design, in that it has its value very plainly marked at the top.

EXCELLENT COMPONENTS

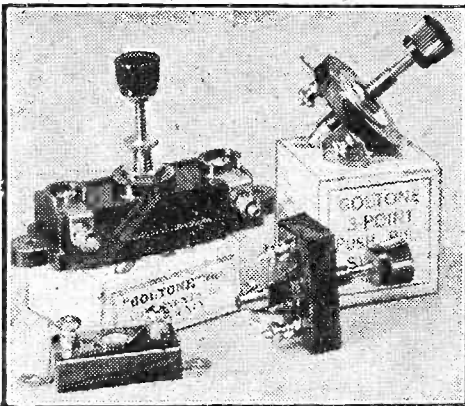

We can recommend the use of these "Goltone" components in "P.W." sets.

NEW "LOTUS" COMPONENT.

I have remarked before that I tend to find the best examples of modern radio engineering in variable condenser construction and that this branch of the radio industry seems to be largely the preserves of the best craftsmen of the day.

Well, I have no need yet to modify these views of mine; indeed, there is growing evidence in their favour.

Take, for example, the new "Lotus" variable condensers, these surely prove my point admirably.

Lotus Radio, Ltd., always did produce beautiful gear of this nature, but their latest

efforts are even better than before.

I have in front of me as I write a "Lotus" Two-Gang, and, honestly, there is not a point in it that I could criticise if I were in my most carping mood.

Its construction is first-class in every respect and it is undoubtedly one of the best components of any kind that has come my way.

A "LOTUS" GANG

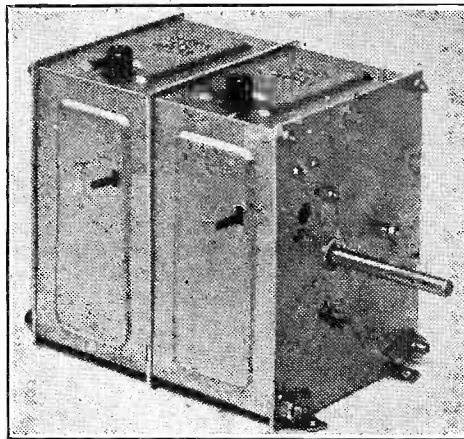

An extremely useful device particularly for band-pass-sets.

It comprises two totally screened .0005-mfd. sections, matched with almost unnatural precision.

I particularly like the accessibly placed trimming adjustments. These, which are liberal and completely dependable in their actions, have their slotted knobs protruding through the top of the metal casing, so that it is the easiest possible task to adjust them when the component is built into a set.

The price of the Lotus Two-Gang is 20/-, and for 5/- extra it is supplied with a fine disc drive. A drum drive is also available at an additional cost of 7/6.

These prices reveal the good value for money that is obtainable in radio these days.

The "Lotus" Two-Gang has several important uses in present-day radio receivers, as is being revealed in "P.W.'s" set designs.

READY RADIO "INSTAMAT" MAJOR.

This is an output transformer for accurately matching moving-coil loudspeakers to set outputs of unknown quantities—and qualities. As many readers will know, it is vital that the last valve of a set should be matched with the loud speaker. There is only one ratio of impedances that gives optimum volume plus greatest fidelity.

In the majority of cases the amateur is unable to determine the values in question with any degree of accuracy even with the

aid of the published characteristics of valves and speaker.

But a perfect result is assured if means are provided for an immediate adaptation of the conditions. This is possible with the new Ready Radio component, for switches are fitted to it so that you can change from

PLEASE NOTE

Manufacturers and traders are invited to submit radio apparatus of any kind for review purposes. All examinations and tests are carried out in the "P.W." Technical Department, with the strictest of impartiality, under the personal supervision of the Technical Editor.

We should like to point out that we prefer to receive production samples picked from stock, and that we cannot in any circumstances undertake to return them, as it is our practice thoroughly to dissect much of the gear in the course of our investigations!

And readers should note that the subsequent reports appearing on this page are intended as guides to buyers, and are, therefore, framed up in a readily readable manner free from technicalities unnecessary for that immediate purpose.

one ratio to another, noting the aural effects as you do so, with only the lapse of fractions of seconds between.

"Instamat" Major is an excellent production and it has few practical limitations in use. It is able to handle up to 150 milliamperes of D.C. current through its primary without serious saturation trouble—a far greater current than is met with even in the most ambitious of ordinary receiving sets. Further, it has an extremely low primary resistance—so low, in fact, that there is negligible voltage drop even when paralleled power-valves are employed.

As far as I know, there is no other component like it on the market, and its production is a very creditable feat on the part of Messrs. Ready Radio, and one for which they will undoubtedly earn the thanks of many moving-coil enthusiasts.

The price of this four pounds of scientific radio engineering is 35s.

IMPROVING MOVING COILS

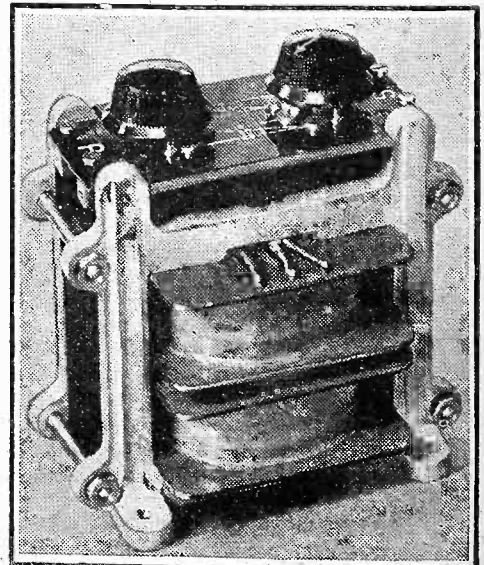

You can exactly and quickly match your moving-coil speaker with any set output by means of this new Ready Radio product.

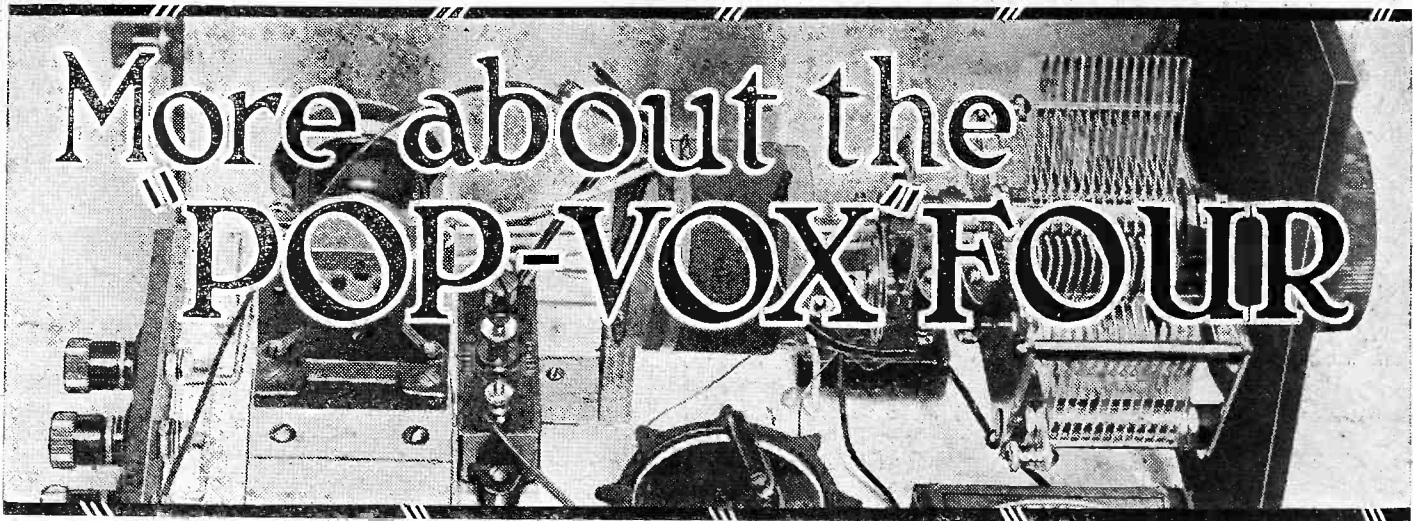

THE screen is a very simple affair in this "Pop-Vox" Four set. It consists of a piece of ordinary wood, any kind will do, covered with either thin copper sheeting or with tin foil. But the covering must be complete and on both sides. If a number of separate sheets are used, then these must overlap quite a bit and come into clean, close contact. No glue or other such adhesive should be used between overlapping sheets. The necessary contact to the screening material can be made by soldering if desired, but if not a wire should be screwed down over a tag of the foil, as shown in the wiring diagram.

The hole through which the S.G. valve passes must not be any larger than is required for the valve easily to pass through it. The valve holder is fixed on to a piece of wood in order to raise it and make the component more accessible.

About the Coils.

The full specifications of the coils employed are given on the next page so that you can make them yourself if you so desire. By the way, even if you don't wind the P.J.'s we certainly recommend you to wind your own Coil Quoits. This is an extremely simple task, and you will get just as good results with your own home-made versions as could be obtained with any factory construction.

The mounting of the components should present no difficulties. The screen can be fixed by screws passing up from under the baseboard and this article, the screen I mean, acts as a fine panel bracket if a couple of screws are driven into it from the front of the panel. Some makes of Coil Quoits have mounting feet moulded on to them, although there are others that are supplied with separate fixing pieces, but in either instance the fixing of these little articles is quite straightforward. There is no technical objection to the wiring-up of the Coil Quoits before they are finally screwed into place.

Mounting the P.J.'s.

Those P.J. coils not equipped with mounting brackets may be screwed to the baseboard by small screws passing through the ends of the formers.

 By **G.V. DOWDING**,
 Associate I.E.E.
 Further constructional notes and
 the operating details are given
 this week.

It pays to make the wiring neat and orderly, for tidy wiring is easy to check up and generally means greater efficiency.

In the H.F. Section.

As was indicated on the wiring diagram, a part of the baseboard has to be covered with metal foil. We ought to have men-

tioned this before, because it is obviously necessary to do that part of the job prior to the screwing down of the components. You should use copper or tin foil and ensure that, (1), this baseboard foil makes good contact with the foil on the vertical screen and, (2), that none of the leads or component terminals accidentally short-circuit through it.

Pay particular attention to the connections of the coils—a slip in these is not hard to make! Commercial P.J.'s have coloured leads to denote their various winding ends, as described on the next page, and it is a good plan, if you wind your own P.J.'s, to cut little labels from stiff paper, write the appropriate colours on these and fix them to the coil leads.

PLACING THE G.B.

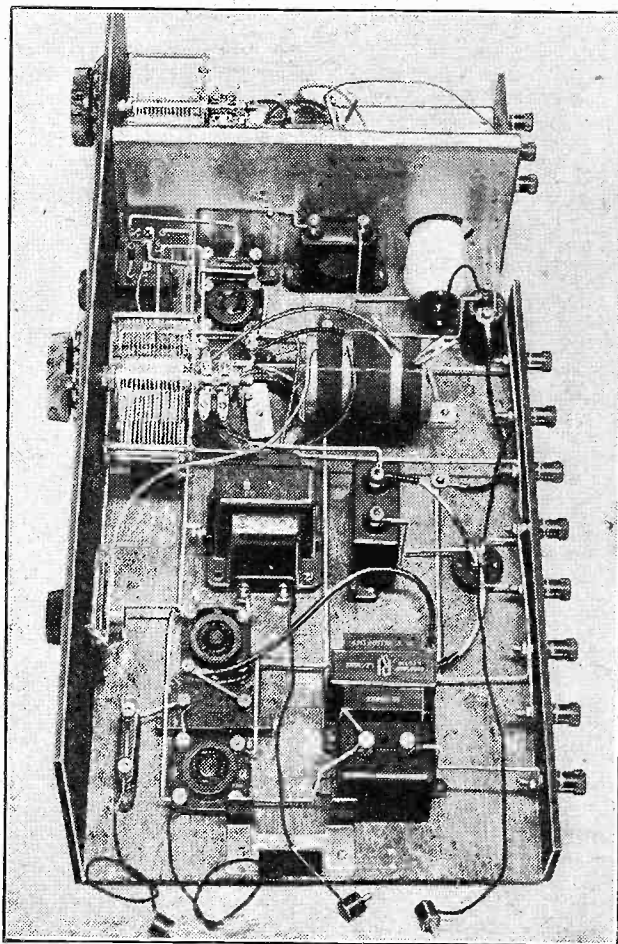

The grid-bias battery stands in the clip that can be seen right in the foreground of this photograph.

Spaghetti Resistances.

During the wiring you will appreciate the advantages of the Spaghetti resistances, for those act as their own connecting leads! But don't pull on these "Spags," for in a few makes the metal end pieces are not very robustly fixed.

There is sufficient space at the one end of the baseboard for the large grid-bias battery, and this can be kept in position by a grid-bias battery clip for baseboards. Such an item costs only a few pence.

Place the battery in position before you cut and fix the grid-bias leads. These leads should be of flexible wire—single strand stuff is apt to break with apparently little provocation!

Grid Bias for the S.G.

The H.T. current to the S.G. valve is somewhat reduced by the provision of a one-cell grid-bias battery. Don't try to do without this little battery. That would be a very false economy indeed, for it will save its few pence of initial cost time and time again. The Siemens make has a small flap enabling it quickly to be screwed securely to the baseboard.

But you must not regard this little battery as a component having an indefinite life. It might last a whole year, but at length it is bound to run down. A periodic test, say once every two or three months, is

(Continued on next page.)

MORE ABOUT THE "POP-VOX" FOUR

(Continued from previous page.)

advisable. Remember it acts like a tap and regulates your H.T. to some moderate extent.

Mains Unit Can Be Used.

The "Pop-Vox" Four, like all other "P.W." sets, has been so designed that it will work perfectly with any good make

COIL DETAILS.

P.J.2.—Former 2 in. diam., 2 in. long. Medium-wave aerial unit.

Wire 30 D.S.C.

AERIAL WINDING, 9 turns, tapped at 4 and 6. Beginning "A" (red flex); end "X" (blue flex). Space $\frac{3}{8}$ in. between aerial and grid.

GRID WINDING, 64 turns. Beginning marked "G" (white flex); end marked "Y" (black flex).

P.J.3.—Former 2 in. diam., 3 in. long. Intervalve medium-wave unit.

Wire 30 D.S.C.

PRIMARY, 30 turns, tapped at 10 and 20 from beginning marked "A" (red flex); end marked "X" (blue flex). Space between pri. and grid windings $\frac{3}{8}$ in.

GRID, 64 turns. Beginning marked "G" (white flex); end marked "Y" (black flex). Space between grid and reac. windings $\frac{1}{4}$ in.

REACTION, 34 turns. Beginning marked "Z" (green flex); end marked "R" (yellow flex).

1st LONG-WAVE UNIT.—Coil Quoit, 30 D.S.C. Wire, 150 turns tapped at 30 and 60 turns away from the "E" end.

2nd LONG-WAVE UNIT.—Coil Quoit, 30 D.S.C. Wire.

REACTION.—60 turns. End joined to "E" of Grid Winding.

GRID WINDING.—150 turns tapped at 60 from "E."

Winding of ALL coils in SAME direction.

of H.T. mains unit. But if you can and do intend employing one of these attractive accessories, make sure you purchase a model capable of supplying enough current, and a bit to spare, for the particular valves you buy.

Don't be tempted to purchase cheap foreign valves of doubtful origin and merit. Truly, to buy British is the soundest common sense in this regard, although I must hastily add there are one or two foreign brands carrying well-known names which are quite satisfactory from every point of view. You will be completely safeguarded if you refer to the makes given in our accessory list, for all these have been fully tested in our Research Dept.

Also, take note of the types recommended.

Final Adjustments.

An H.T. battery of higher capacity type than the ordinary "normal" is advised.

When the set is hooked up for its first aerial test it will be necessary to adjust the compression condenser that is fixed on the baseboard. But once set this component need never be touched again. It functions only on the long waves, and you should slowly turn its little knob first the one way and then the other until you have just the selectivity you desire.

Also, you will need initially to find the best tapping points on the coils.

And the tappings on the aerial or first

long-wave Coil Quoit constitute the second long-wave selectivity adjustment.

The P.J. Coil Tappings.

The P.J. coil tappings have little or no effect on the long waves, for it is one of the advantages of this receiver design that the two sets of inductances in each case operate more or less independently in this respect.

The Tappings on the P.J. coils need to

ADJUSTING FOR BEST SELECTIVITY

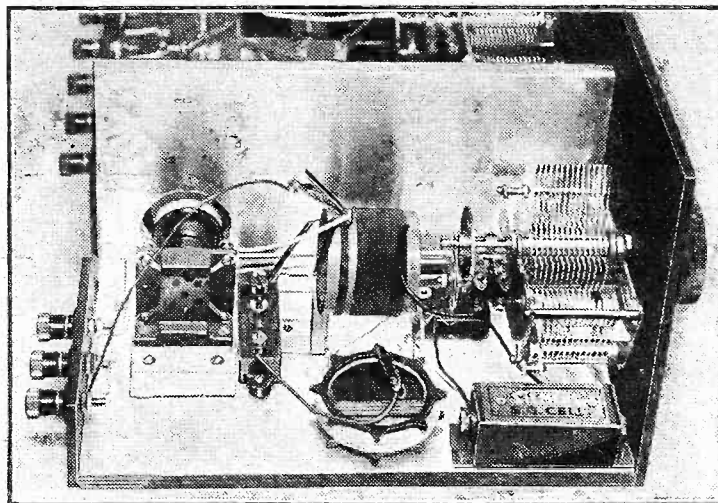

You vary the clips between the tapping points until you have just the degree of selectivity necessary for your local conditions.

be adjusted while you are tuned to an ordinary wave station.

Once these adjustments are made you can leave them permanently "set."

PERFECTLY ADEQUATE SCREENING

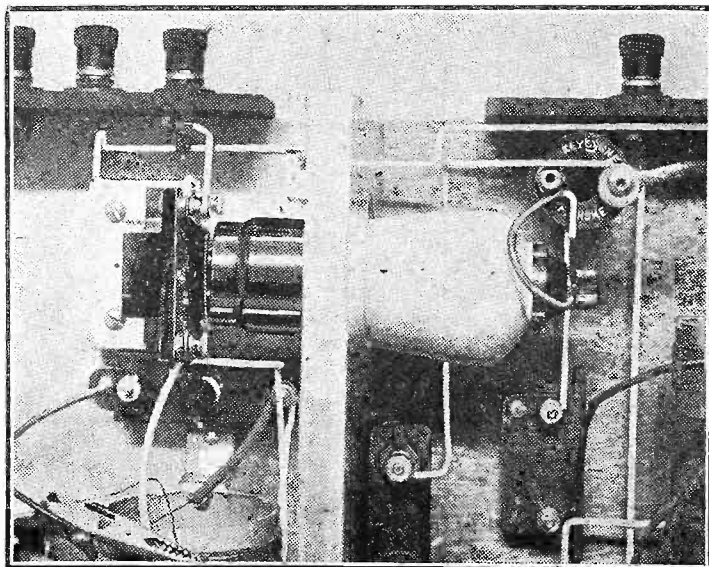

Note how the S.G. valve fits through the screen and how the connection is made to its anode terminal by a short flexible lead.

THE COMPONENTS AND ACCESSORIES WE RECOMMEND

- | | |
|--|--|
| 1 Panel, 21 in. x 7 in. (Permeol, Goltone, Lissen, Peto-Scott). | 1 25,000-ohm Spaghetti resistance (Bulgin, etc.). |
| 1 Cabinet for above with baseboard 10 in. deep (Camco, Osborn, Pickett, Gilbert). | 1 600-ohm Spaghetti resistance (Tanewell, etc.). |
| 2 .0005-mfd. Extensers (Wavemaster Cydon, Formo). | 1 10,000-ohm Spaghetti resistance (Varley, etc.). |
| 1 .0001, .00012 or .00015-mfd. differential reaction condenser (Igranic, Lotus, Ready Radio, J.B., Lissen, Formo, Wavemaster, Graham-Farish, Telsen, Cydon). | 1 H.F. choke (Peto-Scott, Lewcos, Telsen, R.I., Ready Radio, Parex, Lotus, Graham-Farish, Wearite.) |
| 1 Triple-pole change-over switch (Wearite). | 1 Fuse and holder (Bulgin, Ready-Radio). |
| 2 2-mfd. condensers (Helsby, T.C.C., Dubilier, Igranic, Ferranti, Mullard, Lissen, Telsen). | 1 P.J.2 coil (Ready Radio, R.I., Wearite, Goltone, Melbourne, Parex, Peto-Scott, Formo, Ferranti, Lewcos). |
| 1 1-mfd. fixed condenser (Lissen, etc.). | 1 P.J.3 coil (Peto-Scott, etc.). |
| 1 .001-mfd. maximum compression condenser (Formo, Lewcos, R.I., Sovereign, Telsen, Graham-Farish). | 2 Coil quoits (Wearite, Peto-Scott, Melbourne, Parex, Ready Radio, A.E.D.). |
| 2 .01-mfd. fixed condensers (Lissen, T.C.C., Mullard, Dubilier, Ediswan, Ferranti, Igranic, Graham-Farish). | 4 oz. of No. 30 D.S.C. wire. |
| 1 .001-mfd. fixed condenser (Telsen, etc.). | 1 Terminal strip, 14 in. x 2 in. |
| 1 .0003-mfd. fixed condenser (Ferranti, etc.). | 1 Terminal strip, 4 in. x 2 in. |
| 1 Horizontal valve holder (Junit W.B., Bulgin, Parex). | 11 Terminals (Igranic, Belling & Lee, Elex, Clix). |
| 3 Ordinary valve holders (Benjamin, Telsen, Igranic, Lotus, Lissen, Clix, Bulgin, Formo, Wearite, Graham-Farish, Dario). | 3 Crocodile clips, wire, flex, screws, G.B. battery clip, copper foil, etc. |
| 1 2-meg. grid leak and holder (Ferranti, Telsen, Ediswan, Ready Radio, Igranic, Graham-Farish, Watmel). | LOUD SPEAKER.—Amplion, Celestion, B.T.-H., Blue Spot, Undy, W.B., Graham-Farish. |
| 1 1-meg. grid leak and holder (Ferranti, etc.). | VALVES.—2, 4, or 6-volt. 1 S.G., 1 H.L., 1 L.F., 1 power or super power (Six-Sixty, Mazda, Eta, Osram, Cossor, Fotos, Lissen, Tungsram, Dario). |
| 1 L.F. transformer (Telsen, Igranic, Lissen, Varley, R.I., Ferranti, Lotus, Lewcos). | BATTERIES.—120 to 150-v. It super-capacity H.T. Grid bias for H.F. valve, .9 or 1.5-volt. Grid bias for L.F. valves to suit types used. (Drydex, Pertrix, Ever Ready, G.E.C., Lissen). |
| 1 Output choke (R.I., Graham-Farish or as above). | ACCUMULATOR.—2, 4 or 6-volt to suit valves. (Exide, Ediswan, Lissen, Pertrix). |
| 1 75,000-ohm Spaghetti resistance (Lewcos, Ready Radio, Bulgin, Graham-Farish, Varley, Telsen). | MAINS UNITS.—State type of mains, voltage and details of set when ordering. (Regentone, Ekco, Tannoy, Atlas, R.I., Heayberd, Lotus). |

REMARKABLE WIRELESS EXPERIENCE IN MANCHESTER

Local experts perplexed

Mr. T. A. Kennedy's own story of Battery Record

Everybody who owns a wireless set will be interested in the following letter received from Mr. T. A. Kennedy, of Willington, Manchester, whose experience surprised and puzzled even local experts.

"Dear Sirs :

As I write I am listening to the Wireless on a McMichael Screened 3-valve Pentode employing two EVER READY super-capacity batteries, which yesterday completed their 56th week (14 months) continuous use, Surely this is a very exceptional length of time for any battery to last ?

I wrote you on their completion of 8-9 months never expecting a further 5 months' use. Local dealers here are perplexed and say I am mistaken but I know positively that the batteries were put into commission on June 5th, 1930."

(This letter may be inspected at the office of the Company.)

When a set is adequately powered, and only then, it is economically powered! That is the secret of Mr. Kennedy's success. There is an EVER READY Battery made to fit every type of set, portables included; and Mr. Kennedy chose the EVER READY battery made for his. Result: 14 months of trouble-free wireless for two guineas! Why not fit *your* set with the battery made by an exclusive process and guaranteed to give satisfaction by the firm that has been making reliable batteries for over 29 years? Write to the address below for a free list of popular wireless sets and the EVER READY Battery specially recommended for each of them.



**THE BATTERY
THAT LASTS A
LONG TIME**

THE EVER READY
CO. (GT. BRITAIN)
LTD., HERCULES PLACE,
HOLLOWAY, LONDON, N-7.

SQUARE

PEAK

(REGD TRADE MARK)

NEW EXTENSER MODELS

of the famous "Square Peak" Coil. Approved by "P.W." Set Designers. Already specified and used in the "Modern Wireless" and "Wireless Constructor" Exhibition Sets—the "Super Quad" and the "Exhibition Four."

This new Model BP7 is fitted with terminals in place of wave-change switch, enabling the coil to be used with Extensers or any type of remote switch control. Identical in all other respects with the original model BP5, of which users write:—

"I have fitted one in my receiver and the results are amazing. *The sharpness of tuning is uncanny.*"
(Midlands)

"For selectivity I have seen or heard nothing to equal the 'Square Peak' Coil, and although I have built dozens of receivers I have never obtained such wonderful tone."
(F.A.G.)

READY NOW

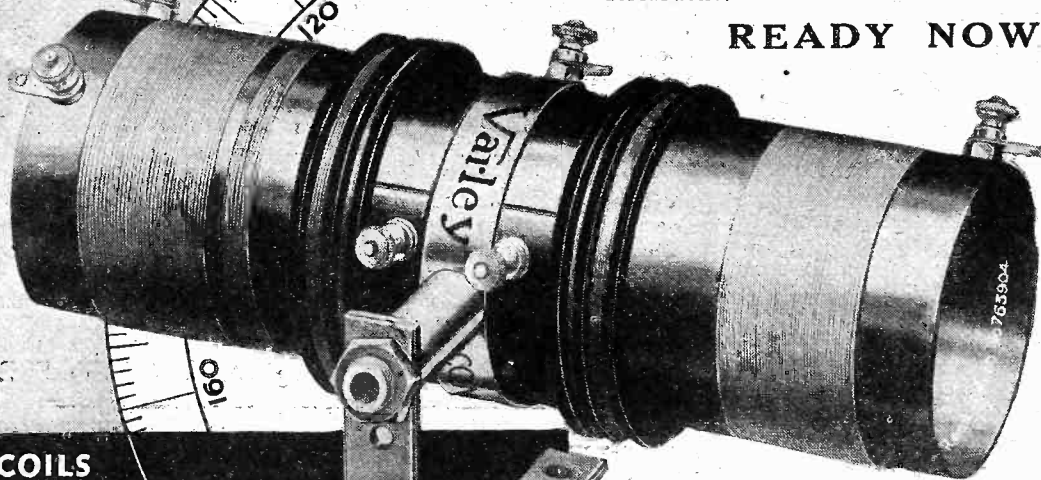

**MATCHED COILS
ENSURE PERFECT
GANGING**



NEW H.F. INTERVALVE COIL.
(Dual range.) Without switch, for use with the "Square Peak" Coil type BP7. Completely screened. Its inductance inside the screen is exactly matched to that of the "Square Peak" Coil to ensure perfect ganging.

List No. BP8. Price **8/6**

(Also supplied with wave-change switch. Model No. BP6. Same price.)

Reg. Design.
Pat. Pending.

**15/-
THE
"SQUARE PEAK" COIL**

The Varley "Square Peak" band-pass aerial Coil (dual-range) Model BP7 gives a constant square-topped peak and separation of substantially 9 kilocycles over the whole of both wave-bands. (Model BP5 complete with wave-change switch, same price.)

Varley

STANDS 82/83, MANCHESTER

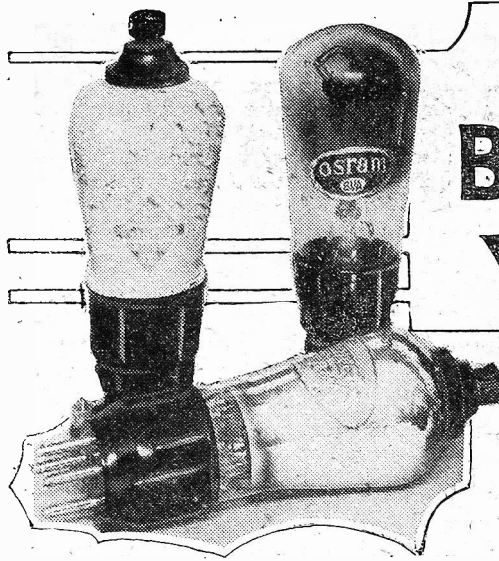

NEW BATTERY VALVES

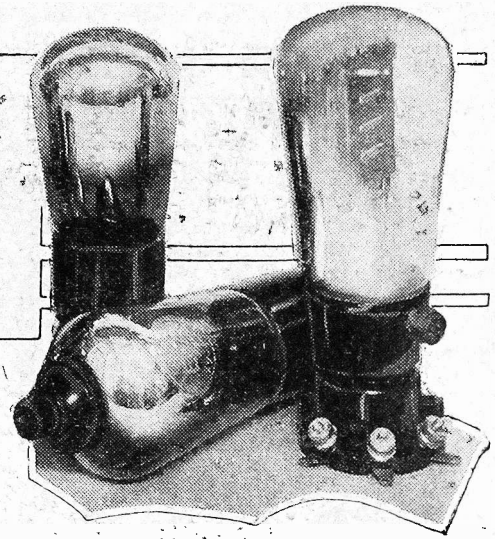

A brief outline of the many new battery valves that have made their appearance on the market during the past few months.

By K. D. ROGERS.

THOUGH the recent National Radio Exhibition at Olympia provided no surprises in the way of revolutionary set designs, it gave a very clear indication of the vigour of the radio trade, and the valve manufacturers in particular.

There were numerous new designs of both battery and mains valves which attracted widespread attention from visitors, and though nothing startling appeared, nevertheless there were many very valuable additions to the valve ranges.

An example of these is the new Mazda Pen 220, which has been brought out specially for use in small battery-operated sets, where anode consumption is a vital factor.

Ideal for Portable Sets.

Probably the biggest problem which confronts the designer of the portable battery receiver is that of anode current consumption. Realising this, the Mazda engineers set out to produce a power valve which gave an unusually large power output with only 100 volts H.T., and with a very low anode current consumption. The result is the Mazda Pen 220, which incorporates new methods of construction and new features of design which have never before been employed in the pentode valve.

The results are remarkable; for the same anode consumption as with an ordinary power valve, the output is two and a half to three times as great. Thus one can get with an anode consumption of five milliamps, and 120 volts H.T., a power output sufficient to work a moving-coil speaker in an ordinary room. As a matter of fact, a signal voltage of only three volts is required to provide the maximum power output with this remarkable little valve.

More New S.G. Valves.

Another new two-volter in the same range is the Pen. 220A, which has a consumption of ten to twelve milliamps at 100 to 120 volts and with a corresponding larger output.

A new metallised detector valve has also been brought out by the same firm specially designed for use with the pentode, and known as the H.L.2. There are also two new two-volt screened-grid valves, the S.215A and S.215B, which, with the old valves with which we are so familiar, provide an impedance range from some 350,000 to 800,000 ohms. But good as these valves are, it is undoubtedly the pentode which will create the most interest during the coming season.

Mullards also have prepared an intensive campaign, and their new range of valves has a very wide scope. Among the battery-heated type newcomers, the two-volt range shows a steady increase in efficiency and in many cases a decrease in battery consumption.

A Special Detector.

The two-volt S.G. valve, for instance (the P.M.12), has been improved; the impedance having been put down to 180,000 ohms with a mutual conductance now of 1:1, as against .9 before. The P.M.1 H.L. is a general-purpose valve which was introduced a month or so ago and has an impedance of 18,500 ohms and an amplification factor of .28, while a newly-designed detector, P.M.2-DX, has been placed on the market with improved characteristics and a filament consumption of 1 of an amp.

Two-volt power valves which "P.W." readers will find very useful are the Mullard

and will make a tremendous difference to two-volt valve set owners.

Now let us come to the Osram releases; here we find quite a number of two-volt valves which have been introduced during the last year or which made their first appearance at the Exhibition. First amongst these is the S.22, which readers of "P.W." will notice has often been used in our recently-designed sets, and with extremely good results.

With or Without Grid Bias.

It is a two-volt S.G. valve having an unusually steep slope, the actual figure being 1.75 milliamp per volt. The impedance is 200,000 ohms and the amplification factor 350, and the valve is designed to operate, if desired, with no negative grid bias, though it usually is better to apply 1.5 volts.

The average anode current at 120 to 150 volts with a bias of 1.5, which is the usual

DO YOU USE ANY OF THESE ?

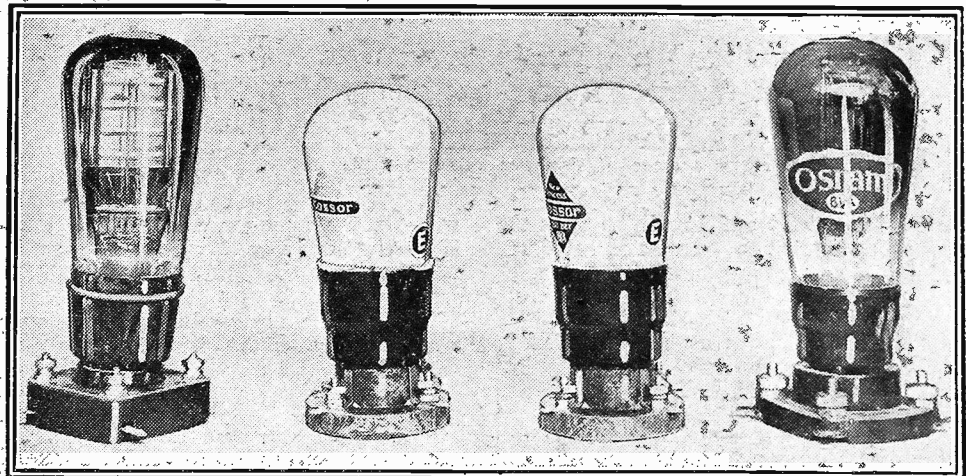

A group of two-volters that are earning widespread popularity. They are from the Lissen, Cossor, and Osram factories.

P.M.2A, which has an impedance of 3,600 ohms and an amplification factor of 12.5, and the P.M.202, which has an impedance of only 2,000 ohms and an amplification factor of 7, bringing the slope to 3.5 milliamps per volt.

The P.M.252, an old favourite, has been redesigned, and now appears with an impedance of 1,900 ohms and an amplification factor of 7, giving a mutual conductance of 3.7; these are remarkable figures

figure to employ for this valve for best results, is 1.5, while the screening current is about 1.6. With no bias at all the makers' figures show the anode current increases to 4 milliamps; so it is obviously a great economy to use bias with this valve.

Another new screened-grid valve is the S.21, having a mutual conductance of 1.1, with the same impedance as the S.22. It has been placed on the market specially for

(Continued on next page.)

NEW BATTERY VALVES.

(Continued from previous page.)

use where two or more S.G. stages are employed, and it is claimed that with the use of this valve cross modulation can be very largely avoided.

The H.2, a high magnification detector that made its appearance not very long ago, and has an impedance of 35,000 ohms and an amplification factor of 35, is a useful valve; while the H.L.2, with its impedance of 18,000 ohms and its amplification factor of 27, is an even more useful detector than the H.2.

Two Economical Power Valves.

Going on towards the power and super-power types, we come to the L.P.2, which has been out for some time but is nevertheless worthy of mention here. It has an impedance of 3,900 ohms and a mutual conductance of 3.85, while the P.2—its larger brother, so to speak—has a mutual conductance of 3.5 and an impedance of 2,150 ohms. This latter is an extremely useful loudspeaker valve, and at 125 volts anode potential the average anode current

SENSITIVE AND SURE AMPLIFIERS

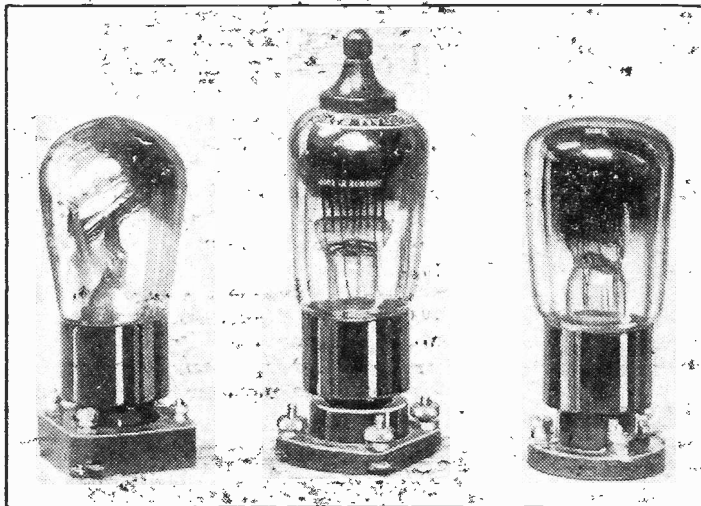

This photograph shows a group of Tungsram valves, including the new Tungsram S.G. amplifier.

varies between 10 and 14 milliamps as the grid bias is varied between 9 and 10½ volts, the limits advised by the makers.

Another Useful Pentode.

Then, again, I must not forget the P.T.2, a pentode valve having a particularly low anode current, the latter being only 7 milliamps at 120 volts. This valve has been designed for sets employing only one stage of L.F. amplification, for it is extremely sensitive to weak signals and has, of course, a rather restricted grid swing.

The D.G.2 (double-grid valve) really ought to be placed in a class by itself, for it has been designed and brought out by many manufacturers, including Osram, Marconi, Mullard, Cossors, Six-Sixty, Tungsram, etc., especially to act as the frequency changer in super-heterodyne circuits. Readers will remember the famous "P.W." "Super Quad" uses a double-grid valve as a mixer valve, with particularly fine results.

It can be used as an amplifier, however,

though as such it is rather heavy on anode current. For instance, with anode volts of 15 to 25 and the inner grid volts at 20, and the recommended bias of -3 or -4½ volts, the inner grid current comes to something like 11 milliamps, while the average anode current is only 1.2 to 2 milliamps.

Among the Cossor battery valves which have made their appearance during the last few weeks, the metallised detectors are particularly interesting, and these in conjunction with the already popular metallised S.G.'s, are very useful.

The New "Double-Gridder."

The large range of Six-Sixty valves has been made still larger by the addition of several interesting newcomers, among which some fine output valves will be of special interest to POPULAR WIRELESS readers.

The double-grid valve, of course, figures in the S.S. list, as does a new special detector with improved characteristics.

I have recently had in for test a batch of Tungsram valves, whose barium filaments are famous throughout the Continent and are rapidly gaining favour in this country. Among these there is the new screened grid valve, which has particularly interesting characteristics, the impedance being 430,000 ohms, while the magnification factor is 300. Most of the new valves in this make have been introduced in the mains section, and there is nothing very much to any about the two-volters, though perhaps a few details of the main two-volt valves will be of interest as, though low in price, these valves are very efficient.

For Detection.

The best detector is undoubtedly the P.D.220 in the two-volt class. This is followed very closely by the L.210. This latter valve also makes an excellent two-volt L.F. valve, while in the four-volt L.F. series the recommended type is the G.409. Of the power valves the P.215 and the P.220 are available,

while in the super-power class the S.P.230 is a remarkably good valve for two volts working, and the P.414 in the four is to be recommended.

There is also a new valve (P.460) on a par with the famous P.X.4, giving an undistorted output of over two watts. It takes 6 amp., and while it can be used with a four-volt accumulator it is more especially designed for use as a directly-heated A.C. valve. There are several interesting specimens in the six-volt range of the Tungsram type, though there are no H.F. types in this class.

Additions to Other Ranges.

Dario valves are also going ahead, and several new ones have made their appearance, notably some very steep-slope valves that give excellent results.

Three more Eta battery valves have been added to the well-known range, two being of the H.L. detector type and the other a super-power.

The first two are the B.Y.1210 and

B.Y.2020, with amplification factors of 12 and 20 respectively, and impedances of 10,000 ohms and 20,000 ohms.

The third valve is the B.X.604, having an amplification factor of 6 and an impedance of 4,000 ohms. Sold at 8/-. It makes a very attractive super-power, especially as it takes quite a reasonable anode current.

CAPT. ECKERSLEY EXPLAINS

Some further light on an answer given in his Query Corner.

To the Editor "POPULAR WIRELESS."

Dear Sir,—I have been guilty of misleading B.R. of Chelmsford on the question of the connection to be adopted when using D.C. mains for high-tension supply of wireless sets.

B.R. asked me was it safe to connect his filaments to earth if the negative of supply was earthed? I replied: "Yes, it was safe provided the negative remained earthed."

So far I was perfectly right and I was at pains to point out that if the supply company started to unearth the negative and earth either of the other conductors, leaving the neutral in the air, then short circuits would occur. Where I misled your correspondent was in making him think that the supply companies having once earthed the negative would never earth the others.

Possibility of Alterations.

Apparently, however, it is the custom of supply companies to do just this thing, and of course in doing this anyone with a wireless set and without a condenser in the earth lead is liable to short-circuit the mains.

Secondly, the I.E.E. lays down regulations to say that whatever conductor is earthed there must be a condenser in the earth lead. I answered a specific question, however, of B.R. of Chelmsford, and answered it really accurately, but I am afraid so accurately that in the upshot it was misleading.

It would, I think, be advisable, in the general interest, to give this letter prominence, in order that all those who are intending to use D.C. mains should be aware that it is against the law to use the mains for high-tension unless the filaments of the set are connected to earth through a condenser which, of course, must be built to withstand the maximum pressure between any one conductor and earth. 250 volts would surely be sufficient.

"Thanks"—To Two Readers.

I must apologise to B.R. of Chelmsford, and to others who may have been misled, although I must point out that my answer was substantially accurate.

May I also take this opportunity of thanking two gentlemen who have written to me pointing out the misconceptions that might arise by a too literal interpretation of my answer, namely Mr. H. J. Henwood of Ilford and Mr. E. H. Skinner of Beckenham.

Yours faithfully,
P. P. Eckersley.

A Valveless Amplifier!

—well-known inventor's brilliant achievement

The "Microbox" is one of the latest inventions of Mr. S. G. Brown, F.R.S., inventor of the very first loudspeaker, and a host of other devices, including the already famous Battery Superseder, which he introduced at this year's Radio Show. The "Microbox" is no bigger than the ordinary pick-up, yet it is a self-contained amplifier producing all the volume and rich tone of an expensive multi-valve reproducer. All you have to do is to change your present gramophone tone-arm and sound-box for the "Microbox" and connect it up to your loudspeaker. The little power required (10 volts at $\frac{1}{2}$ amp.) can easily be supplied by a small accumulator. The only other component required—a transformer—is supplied with the "Microbox." The price of the two complete is 3 gns.



The MICROBOX combines pick-up and amplifier on the microphone principle. Price (with transformer) 3 Gns. (or 9 payments of 8/6). Mains unit. A.C. £3/15/0. D.C. £3/3/0.

Is yours a popular 'kit'?

—if so, here's something to interest you!

Excellent idea—the Kit. But not quite perfect unless you get a speaker worthy of the set, and a hiding place for your batteries. Well, you can get both in an S. G. Brown Kit-Cabinet Speaker. These S. G. Brown KIT-CABINET SPEAKERS are definitely built to save you time and trouble—and money. Scarcely worth while to make your own when you can walk away with one of ours having spent so little. They are priced from only 39/6. (See photograph and full description on right.)

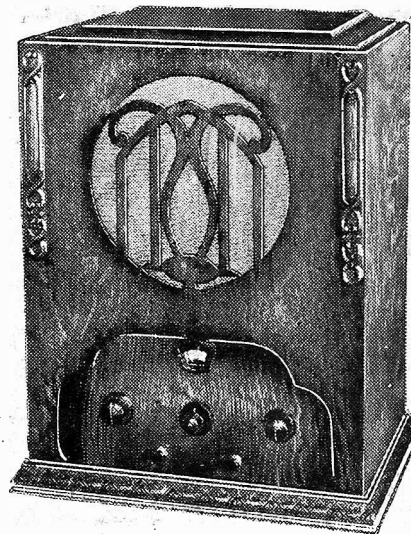

KIT-CABINETS.

MODEL 1. For Mullard 1932 3-valve Kit or Radio for the Million V.3 Kit (incorporates S. G. Brown SOLO Speaker). Price 47/6 (or 6 monthly payments of 10/3).

MODEL 2. Stand-on KIT-CAB. for 1932 Melody Maker, Osram 1932 Music Magnet, etc. Price (with Brown SOLO Speaker), 39/6 (or 6 monthly payments of 8/.)

Is your set 'muffled' by your loudspeaker?

—ten to one you'll answer 'No'—but are you sure?

Improvements in loudspeaker design have recently been so rapid that speakers which were the last word three years ago sound amazingly inefficient when heard beside such speakers as the new S. G. Brown permanent magnet moving coil (which costs only £4/7/6). Nine people out of every ten "muffle" perfectly good sets with old-fashioned speakers—and don't realise it. Are you quite sure you are not one of them? Go to your dealer and hear the new S. G. Brown Speakers for yourself. You'll know then whether you are doing your set justice, or not.

Send to 19 Mortimer Street, W.1, for free leaflet describing the FAITHFUL MODELS MADE BY

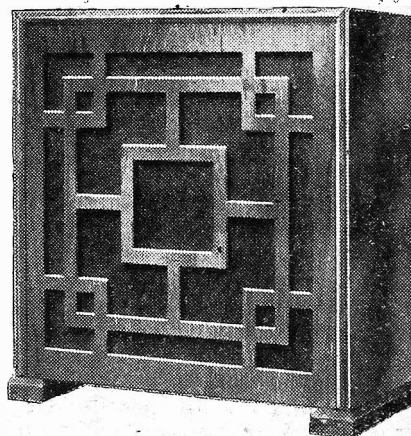

S. G. BROWN PERMANENT MAGNET MOVING COIL UNIT costs £4/7/6. Complete with handsome cabinet shown it costs £4/19/6 (or 8 monthly payments of 13/6).

Yours faithfully

FAITHFUL RADIO **S. G. Brown**

SATISFACTION GUARANTEED!

Satisfaction is guaranteed if you fit "Wearite" components. They are scientifically constructed with the finest workmanship and materials. You cannot do better.

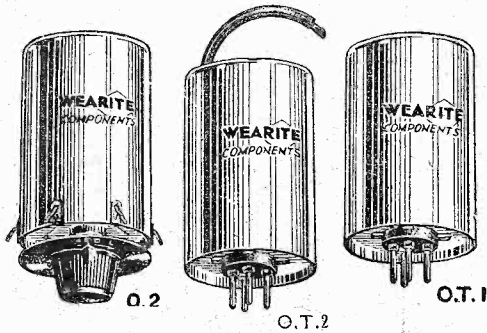

"WEARITE" SUPER-HET. COILS

Three of the original "Wearite" Super-Het. Coils (British Patent No. 349403) are used in the "Super-Quad." One Oscillation Unit, type O.2. One Band Filter Unit with pigtail, type O.T.2 and one Band Filter Unit, type O.T.1. The original coils are made in London and supplied only by Wright & Weaire, Ltd. Price, per set of three **37/6**

"WEARITE" H.F. CHOKE

A first-class component with a very fine performance. It covers efficiently the remarkable range from 10 to 2,000 metres without any marked resonances. Self-capacity very low.

Type H.F.O. **6/6**

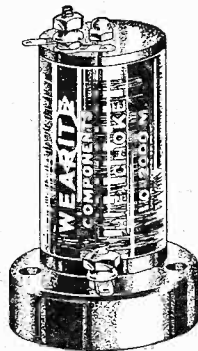

HFO

Write for FREE list.

WEARITE COMPONENTS

WRIGHT & WEAIRE, LTD., 740, High Road, Tottenham, N17. Phone: Tottenham 3847/8/9.

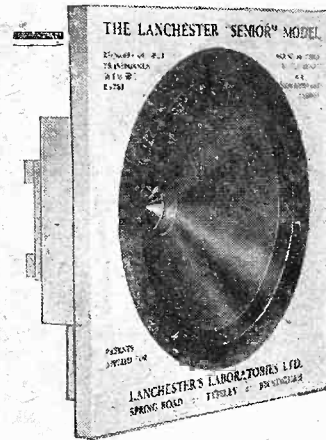

The Lancheater

PERMANENT MAGNET MOVING-COIL SPEAKERS

You cannot afford to be without our new 1932 CATALOGUE, beautifully illustrated and containing full particulars and prices of our Season's products now available.

It contains in addition a mine of useful information, and is

FREE & POST FREE

Lancheater speakers are sold direct to public only on 14 DAYS' FREE TRIAL against cash with order or C.O.D. Their compact dimensions readily permit their incorporation in Portable Receivers, and the fascia board simplifies attachment.

PRICES:

SPEAKERS from £1-10-0 to £3-3-0
Complete in CABINET from £2-10-0 to £4-15-0
 Output Transformer required: extra. See Catalogue.

NEW 1932 MODELS.
 HIGHER SENSITIVITY.
 SPEED PERFECT.
 FULL MUSICAL RESPONSE.

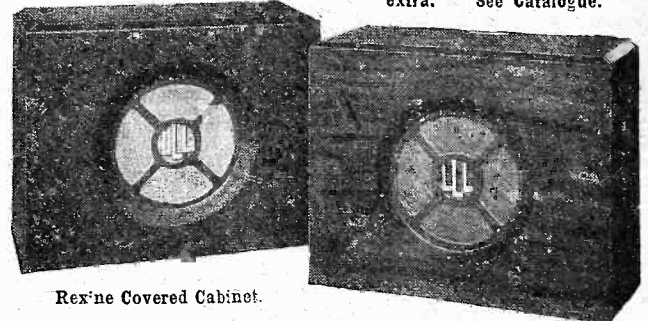

Rexine Covered Cabinet.

Solid Mahogany Cabinet.

LANCHESTER'S LABORATORIES
 TYSELEY LIMITED BIRMINGHAM

ALL applications for Advertising Space in

"POPULAR WIRELESS"
 "MODERN WIRELESS"
 and
 "WIRELESS CONSTRUCTOR"
 must be made to the Sole Advertising Agents,

JOHN H. LILE, Ltd., 4, Ludgate Circus, London, E.C.4.

Phone: City 7261.

SPECIALLY CONSTRUCTED RADIO-GRAMOPHONE CABINET

for the **OSRAM "FOUR"**

(New Music Magnet)

and any set which has side controls.

THE "OSBORN MAGNET"

Specially constructed Radio Gramophone Cabinet for the Osram Four (New Music Magnet) and any set which has side controls. 3' 6" high, 1' 10 1/2" wide, 1' 8 3/4" deep. The baffle behind the speaker 20" x 17". There is storage for 100 records and a door on either side of cabinet as illustrated, offering easy access to controls, also door at back.

PRICES.

Assembled Ready to Polish. Oak, £4 0 0.
 Assembled and Polished. Oak, £5 0 0.
 Assembled Ready to Polish. Mahogany, £5 0 0.
 Assembled and Polished. Mahogany, £6 0 0.
 Assembled Ready to Polish. Walnut, £6 0 0.
 Assembled and Polished. Walnut, £7 0 0.
 All Models Carriage Paid.

Send 3d. in stamps for 56-page illustrated catalogue

CHAS. A. OSBORN
 Dept. P.W.

The Regent Works, Arlington St., London, N.1. Telephone: Clerkenwell 5095. And at 21, Essex Rd., Islington, N.W.1. (1 min. from the Agricultural Hall). Telephone: Clerkenwall 5634.

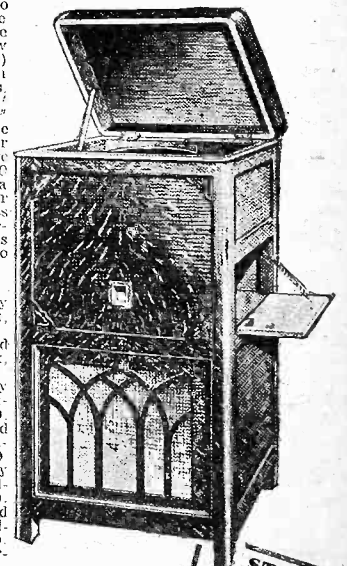

STAND No. 51. NEW HALL Northern National Radio Exhibition, City Hall, Manchester, Oct. 7-17.

THE NEW B.P.

THREE

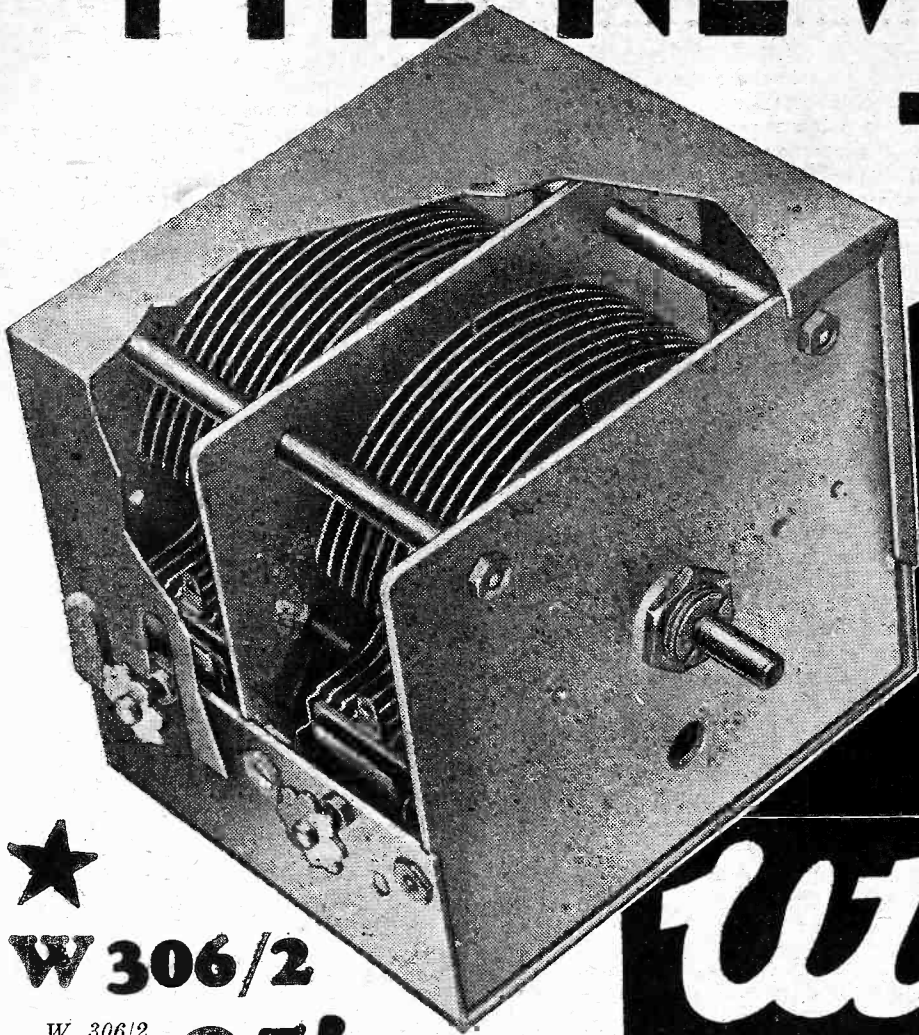

★
W 306/2
W 306/2
two gang
complete
with dial. **25'.**

Utility

TUNED

Again "Popular Wireless" designers have specified 'Utility' Condensers, this time for the B.P. Three. For this fine 3-valve set the choice is Utility W 306/2, our very latest fully-screened condenser complete with trimmers.

This new condenser is so accurately made and adjusted that it is balanced within one half of one per cent. Never before has a British-made condenser with such a high efficiency ratio been available to the amateur, and he is now assured of the accurate hair-splitting tuning which is imperative if he wishes to get the utmost from his circuit.

Remember then to insist on the new Utility complete with Disc Dial, the dial specially made for it.

★ Send a post-card for the new "Utility" Catalogue.

WILKINS & WRIGHT LTD.

UTILITY WORKS, HOLYHEAD RD., BIRMINGHAM

AGENTS—London: E. R. Morton, Ltd., 22, Bartlett's Buildings, Holborn Circus, E.C.1;
 Scottish: E. B. Hammond, 113, Vincent Street, Glasgow; Lancashire and Cheshire:
 J. R. Lister, 93, Old Road, Blackley, Manchester; Westmorland, Cumberland, Durham,
 Northumberland, Yorkshire and Derbyshire: H. C. Rawson, Ltd., 100, London Road,
 Sheffield; South Western: Mr. Lawrence Fraser, Chelsea House, Lansdown Road, Bath.

The following represents the complete range of these wonderful condensers.

SEMI-SCREENED

W 305/2, 2 gang	17'6
W 305/3, 3 gang	22'6
W 305/4, 4 gang	40'.
Disc Dial 2/6 extra			

TOTALLY SCREENED

W 306/2, as illustrated	22'6
W 306/3, 3 gang	27'6
W 306/4, 4 gang	42'6
Disc Dial 2/6 extra			

Always insist on Utility Condensers and Switches the finest in the World. Write for the new Catalogue showing the complete range.

RECORD BUSINESS AT OLYMPIA

Huge orders for Sets and Components were placed at the National Radio Exhibition, all previous records being broken.

BUSINESS at the Radio Exhibition at Olympia this year broke all records.

If only other industries could do as well as the radio industry! Let's hope they will! Radio manufacturers have certainly every reason to be well pleased with themselves, for it is estimated that there will be an increase of at least ten million pounds in business done over last year.

One Million Sets!

Orders have been placed for one million wireless sets valued at £10,000,000, as against 649,100 sets last year, when the value was £7,000,000.

Huge orders for valves have also been taken. The figure this year is 8,000,000, to a value of £3,500,000, compared with 5,321,800 valves valued at £2,600,000 last year.

Batteries also have been in very heavy demand. Orders for ten million, representing £4,000,000, have been taken, an increase of one and a half million batteries, and £600,000 over last year's figures.

It is estimated that at least £10,000,000 has been spent on components, and an extra £1,000,000 on additional apparatus, such as Home talks.

"The results of our Show at Olympia are very encouraging," declared one prominent manufacturer to me after the Exhibition had closed. "It means that thousands of workers throughout the country are going to reap a rich harvest during the coming year.

Passed All Expectations.

"This Exhibition has certainly done the whole trade an enormous amount of good."

"It has been the most successful radio show ever held in this country," Mr. R. M. Ellis, chairman of the Radio Manufacturers' Association, told me.

"At my own stand we took record orders, one being for 3,000 all-electric 4-valve and 3-valve sets and another for 2,500.

The number of sets and accessories sold has exceeded all expectations."

Here are a few reports I gathered from some of the leading exhibitors.

Columbia: Thirty per cent up on last year; 200 sets sold in a day.

Igranic: Fifty per cent better.

Marconiphone: If sales continue at the same rate until the end of the show we shall have done three times as much business as we did last year.

Exide: We are looking forward to the season with unquenchable optimism.

Cossor: Sales are far ahead of last year.

A fleet of 300 motor-lorries left Olympia at midnight on the closing night of the Exhibition conveying the Exhibition in its entirety to the City Hall, Manchester.

A "Boom" Year.

Every record has been broken at Olympia this year. The attendance has been 50,000 in advance of last year, and the average increase of business done is 50 per cent more than last year.

It would certainly seem that this will be a boom year for radio. The interesting thing is that year by year the demand for radio sets increases, and year by year technical progress is made.

Competition comes chiefly from the United States. The British public has been attracted by offers of 7- and 9-valve sets at prices which apply to smaller sets made in this country, and inexperienced people who like a lot for their money have not troubled to enquire into the efficiency of the apparatus, which is the only test worth applying. It is stated in the trade that illegitimate competition from outside has been pursued also by pirating British patents. Patents are held by leading British firms covering practically the whole range of components. These patents have been pooled, and an important step has lately been taken for defending them against foreign exploitation, licences being limited to the British trade.

THE VALVES THEY USE IN GERMANY

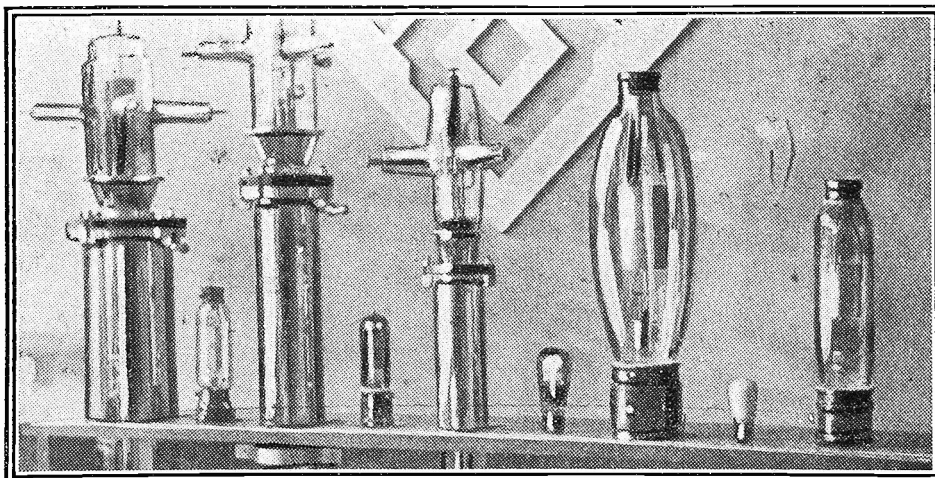

The five bigger valves are the types used in the German broadcasting stations, while the four smaller ones are representative of those used in German receiving sets.

In connection with the new broadcast symposium, "The Changing World," which is scheduled for the winter and spring sessions, the B.B.C. has sent me five pamphlets, each dealing with one of the phases of life to be discussed.

B.B.C. Pamphlets.

The first of these, "Industry and Trade," is by Professor Henry Clay, formerly Professor of Social Economics at Manchester University, and is introductory to and explanatory of twenty-four talks on the subjects "How Wealth has Increased," "Why does Poverty Continue?" "How has Private Enterprise Adapted Itself?" and "How has the State met the Change?"

The pamphlet is comprehensive in scope, and is well illustrated by pictures of industry, and by graphs and statistical tables.

OUR NEW P.M.G.

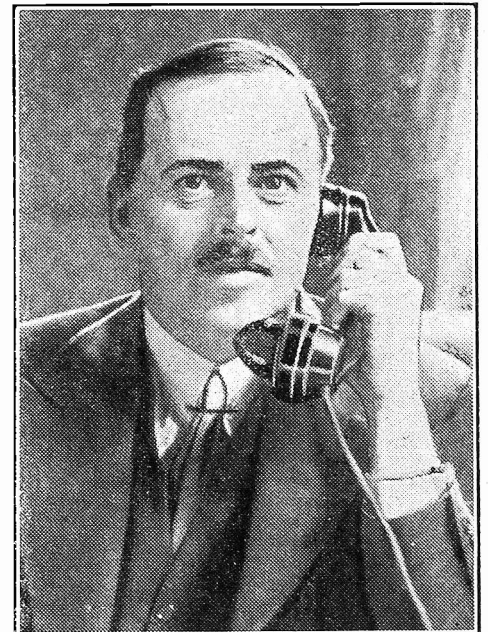

Major Ormsby Gore, the new Postmaster-General.

As an introduction to the twelve talks he is to deliver on "The New Spirit in Literature," Mr. Harold Nicolson has written an essay which is well worth the attention of the listener.

Professor H. Levy has written an essay, "Science in Perspective," which introduces twenty-four talks on this subject by Professor Julian Huxley, Dr. John Baker, Mr. Hilaire Belloc, Professor J. B. S. Haldane, Sir Oliver Lodge, and several other scientists. The pamphlets cover a good deal of ground, and the problems to be discussed are very clearly set out.

On Political Problems.

Another pamphlet is devoted to the political problems to be discussed by various speakers under the heading of "The Modern State." The explanatory pamphlet is by Mr. John A. Hobson.

Professor John Macmurray has written an essay on "Education and Leisure," as introductory to the twenty-four talks by Professor Macmurray, Professor J. Dover Wilson, Sir Percy Nunn, and Professor P. Delisle Burns.

All told, these pamphlets are well worth acquiring, and I advise readers to lose no time in writing to Savoy Hill for the complete series.

DX: 43

RADIO TIMES

DAVENTRY

103 kcfs (1,554.4 m.)

PROGRAMME

THE REVUE CHORUS and ORCHESTRA
Conducted by
STAFF

Every item's a better item
if you've a **Drydex**

15 a.m.
30 TIME
cast
1.45-11.0
2.0
12.45

By (Organist to the Society)
Relayed from ALL SAINTS, MARGARET STREET
Introduction and Passacaglia Reger
(Note on page 12)
Adagio Lemare
Grand Choeur (7th) Guilmant
Intermezzo Sonata
Finale
Nocturne Bonnet
Minuet Scherzo Jongen
Fantasy—Toccata Leslie Woodgate



Some
Written, composed
produced by
ERNEST

iony
cert
IE (Soprano)
ORCHESTRA
ucted by
N CLIFFORD

Time Signal, Greenwich, at 1.0
1.30-2.30 Light Music
FRASCATI'S ORCHESTRA
Directed by GEORGES H.
From THE REPERTOIRE
9.30 Symph
Relayed from
Bo
THE BOURN
Conductor,
EDA K
Porsian Dan
Violin Conce

No. 1 in C B.
Allegro: A
Allegro
e and Orche
r (Tell me
ly (Octet) f
truments
Allegro moderato;
with Variations; 2
two Trios; Finale;



NOEL EADIE
Songs

★
Makers of the world
famous Exide offer
greatest dry battery
value

Obtainable everywhere from all good dealers in
sizes and types to suit every wireless set. Also
for torches, pocket lamps, cycle lamps and bells.

4.45 REGINALD NEW
At THE ORGAN OF THE BEAUFORT CINEMA
Relayed from WASHWOOD HEATH, BIRMINGHAM
Coronation March, The Prophet Meyerbeer
Selection, The Desert Song Ronberg
Sanctuary of the Heart Ketelbey
Introduction, Act III, Lohengrin Wagner
5.15 The Children's Hour
by ETHEL MALDEN

7.30 A RECITAL OF GRAMOPHON
By CHRISTOPHER STOR
ECHOES OF OPERETTA
8.0 A Second Helping
of
Gramophin P

Exide Batteries, Clifton Junction, near Manchester. Branches at London, Manchester, Birmingham, Bristol, Glasgow, Dublin and Belfast.

J.B. DREADNOUGHT
(.0005)
2-gang, 20/-; 3-gang, 29/6.

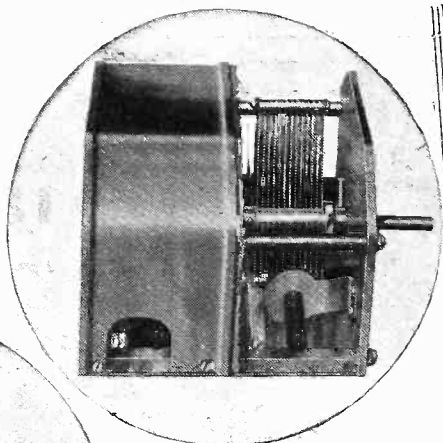

BASEBOARD DRUM DIAL,
4" Drum. Ratio 16-1. 7/6.

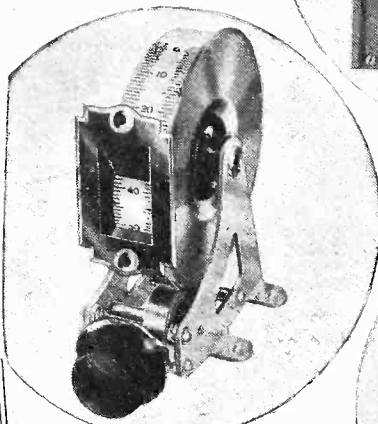

TYPE RM SCREENED 2-GANG
(.0005) for V3 Kit Set, complete as illustrated, 22/-.

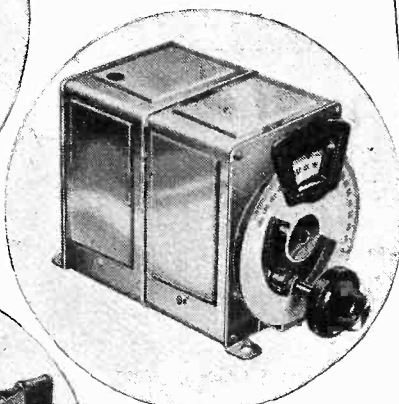

TYPE U.20 for "Square Peak"
Coils, 24/-.
TYPE U.30 (3-gang), 34/6.

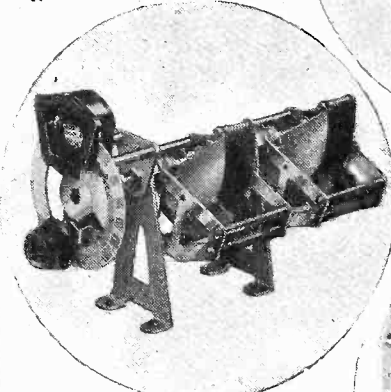

J.B. CHASSIMOUNT, 2, 3, 4, 5
or 6 stage. Prices from 15/-.

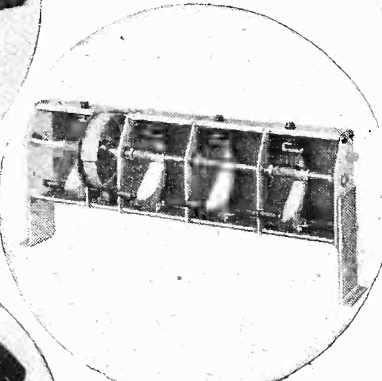

POPULAR. Slow Motion (35-1)
as illustrated, 8/6.
Plain type, 6/- 4" dial, 1/6
extra.

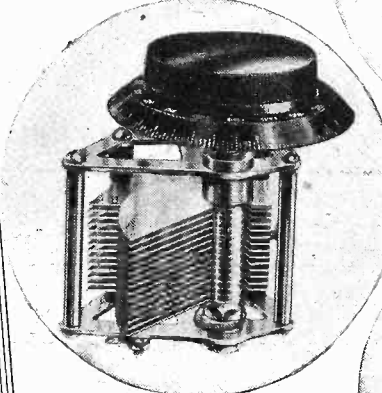

**BASEBOARD TRIMMING
CONDENSER.** Ebonite Base.
Mica insulation. .00005 and
.0001, 1/- each.

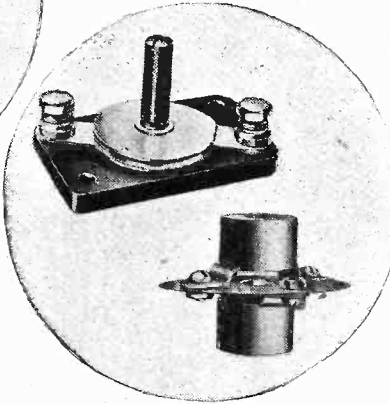

GANG COUPLING DEVICE.
Gangs two condensers while
insulating rotors, 9d.

NEW J.B. PRECISION INSTRUMENTS

J.B. leave nothing to chance. Laboratory research is followed by exhaustive testing. The J.B. standard of achievement is high, and no J.B. Condenser or Dial is ever introduced until it satisfies this exacting standard. Add excellence of materials and workmanship, and you will see why, since the earliest days of broadcasting, home constructors and manufacturers have used J.B. consistently and in increasing numbers.

See these J.B. Precision Instruments at your dealers, or write for the new J.B. catalogue, which gives full particulars.



PRECISION INSTRUMENTS

The Future of Broadcasting in Britain

BY— LT. COMMANDER THE HON. J. M. KENWORTHY *R.N., M.P.*



The problem facing the B.B.C. is very much the same problem that faces the householder—how best to make both ends meet! And here are some very practical if somewhat surprising suggestions by a recognised authority.

IT would have been strange if, in the new financial situation, the B.B.C. had remained unaffected. After balancing the Budget the present Government was at its wits' end for money, and here was a nest-egg in the listeners' licences that even the present Chancellor of the Exchequer could not overlook.

Mr. Snowden made a hard fight to retain the £17,000 a year for Grand Opera subsidy, and succeeded; but he has had to raid the listening public for general revenue.

The May Committee on Economy, going right outside its terms of reference, made some suggestions for raising money in this way. Their crude proposal was that the B.B.C. should hand over £400,000 of capital at once.

The Post-Office "Rake Off."

This was rather too "steep," however, and I am glad it was successfully resisted by the Corporation. The financial bargain struck is that the B.B.C. hands over an additional £50,000 of its revenue this year, and will be mulcted of another £150,000 next year.

It must be remembered that this is on top of the very heavy tribute already paid to the Exchequer for a number of years. This year the amount received by the Exchequer from broadcasting will be £646,166 out of a total licence revenue of £2,050,000.

Next year the Treasury will net £775,000 out of an estimated revenue from listeners of £2,250,000. But this is only an estimate, and if the extra impost means a falling off in the programmes, to which possibility I shall return presently, some listeners may give up paying their licences and the anticipated amount may not be realised. In addition, the Post Office takes the ridiculously large commission of ten per cent for the cost of collection.

Cuts in Staff Salaries.

In any case the Treasury will take £1,000,000 from the B.B.C. next year. In his statement in the House of Commons the Chancellor of the Exchequer said it was hoped there would be no falling off in the quality of the programmes, but that sacrifices were to be made by the staff of the B.B.C. There are apparently to be dismissals, cutting down salaries and so on.

Everyone will sympathise with the unfortunate members of the staff, especially

as there is bound to be a slight rise in the cost of living owing to the country coming off the gold standard; and no doubt many of the persons concerned will be hard hit.

One of the economies that might well be made would be to drop the special B.B.C. orchestra. Sir Hamilton Harty and other prominent musicians have criticised the maintenance of a permanent orchestra and consider that the money would be better spent by engaging first-rate artists, bands, etc., and paying them adequate fees.

Now the B.B.C. has undoubtedly shown a patriotic attitude in making a voluntary offer to the Treasury, and this has been accepted. But the new situation raises the whole question of the future of broadcasting in Great Britain.

This rapidly developing service needs considerable and continuing capital expenditure if it is to keep up to date and take advantage of modern inventions and discoveries. We cannot afford to lag behind other countries in technical efficiency here;

THE AUTHOR



Lt.-Comdr. The Hon. J. M. Kenworthy, M.P., has always been specially interested in radio, and the wider policies that govern its development.

and neither would this be fair to the listening public.

We should, therefore, seriously consider whether there should not be some modification of the original policy of treating the B.B.C. as a purely public Corporation and of denying them all sources of revenue except the proceeds of wireless licences.

The American System.

In other words, cannot we strike a happy mean between the present system, which will be shaken by the new financial conditions imposed, and the American system where there is no revenue from licences but a very handsome income made by the broadcasting companies in the United States by entirely different methods? In other words, why not "sell the air," or a part of it, and combine the two systems.

Now a word as to the American system. Broadcasting in the U.S.A. relies on three sources of revenue. The ether is leased to advertisers. As few people will listen to straight advertising by itself on the wireless, the great firms using this medium must provide first-class entertainment to which people will listen, and a short talk is interposed.

This talk is straight advertising publicity.

Then the advertisers must use the Radio Corporations as their agents for engaging artists, bands, etc., and they pay a commission for their service; and, thirdly, the artists themselves pay a commission on their fees to the Radio Corporations.

We must, of course, make allowances for different national outlooks. The Americans will stand more straightforward advertising than the British people. But it is easy to exaggerate this difference.

Artistic Advertising.

No one in this country objects to advertising that is artistic and pleasing, indeed rather the other way about. For example, really beautiful posters have been appearing on our hoardings lately.

Many people realise that they brighten the drab streets of our industrial cities. I would draw attention also to the advertisements and posters of the Empire Marketing Board.

These are straight advertising of Empire goods; but many of them are beautiful, others are instructive, and I have never heard any objection taken to them by anyone.

Again, advertising in some of our high-class weekly illustrated papers has reached a very high plane of artistic merit.

In the United States the most famous of
(Continued on next page.)

THE FUTURE OF BROADCASTING IN ENGLAND.

(Continued from previous page.)

the radio orchestras is the "Lucky Strike" Band. This is to advertise an immensely popular brand of cigarettes, and the manufacturers have engaged what is undoubtedly the finest dance band in the world.

Source of Great Revenue.

The B.B.C. could not possibly pay for such a band without additional aid. The American public, and indeed anyone else within radio distance of it, cannot help listening; and then there is a few minutes talk about the cigarettes.

Now why in this country should not a very great source of revenue be tapped by letting out the ether for a part of the time to great commercial houses on the American system? In their own interests the advertisers would not annoy the listening public by too much advertising boost, and they would be bound, also in their own interests, to keep the quality of the programmes very high indeed.

The Midland Regional station might well be used for this purpose. And it is not only a question of the provision of really first-class orchestras and dance bands; but also of the obtaining of the services of great artists who, as things are, would demand fees, and quite naturally so, outside the capabilities of the B.B.C., under the new financial conditions, to pay.

The great singers, Galli-Curci and Chaliapine; the violinists of the rank of Kubelik and Heifetz; Moiseivitch, the pianist, come to my mind.

Why Not Try It?

There is no reason why they should not perform for some great British firm, taking a fee for so doing, as in the Albert Hall or Covent Garden Opera House. The only difference would be that their art would be available for the whole population of these islands. In any case the B.B.C. now is not giving a full alternative programme, owing, no doubt, to the heavy drain on their fees made by successive Chancellors of the Exchequer.

The very idea of letting out the ether in this way for advertising purposes will shock the super-sensitive; but we are living in abnormal times. And there is this to be remembered also. English is very

rapidly becoming the universal language, especially on the continent of Europe.

Super-excellent British programmes are listened to from Bergen in Norway to Seville in Spain; and from Calais on the West to Warsaw in the East. A great many of the listeners would understand the short reference to the goods in the English language, the excellence and sale of which had enabled the programmes to be paid for.

The more we can advertise British manufactured goods the more we shall help the export trade. While if some of our great stores and multiple shops advertised in this way we might attract additional visitors and buyers to this country and help the tourist and hotel industry.

In any case, why should not this experiment be tried? If it were a failure, no one would be any the worse; though I don't think for a moment it would be a failure. It would mean some alteration in

CAN WE BLEND BUSINESS WITH BROADCASTING?

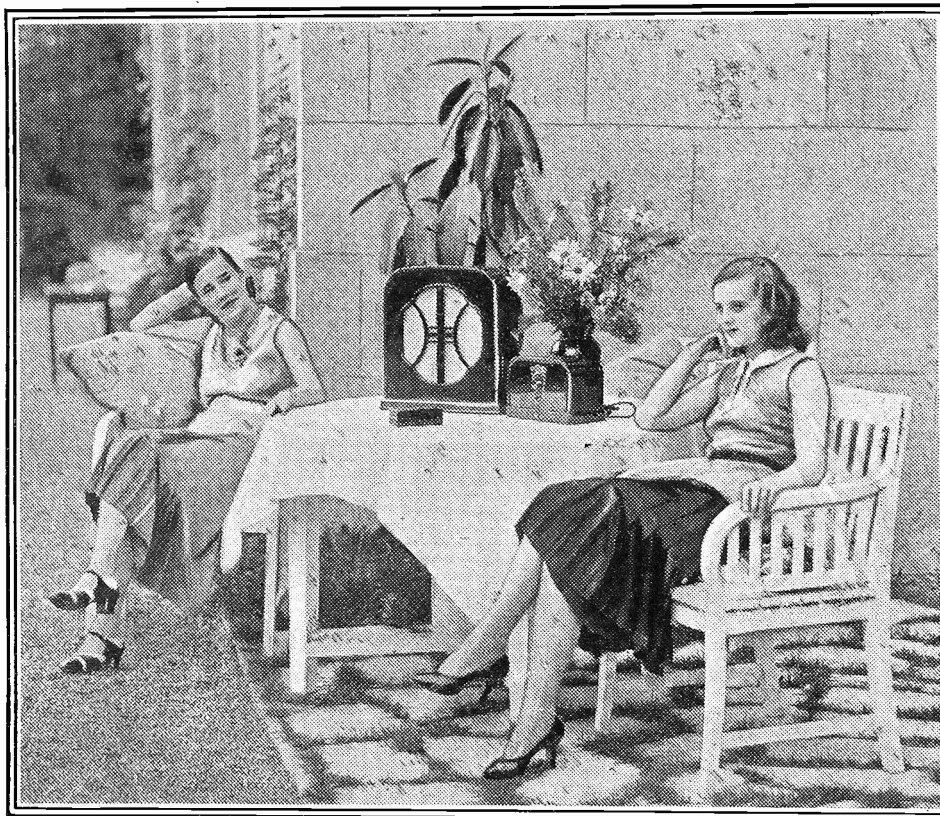

Up to now we have relied on radio to be an entertainer, but Lt.-Comdr. Kenworthy suggests that it might do a little salesmanship as well. Would the ladies like to hear, by wireless, of the latest bargains?

the B.B.C.'s charter; but I do not believe Parliament would object, under all the circumstances, if the situation were properly explained.

What I suggest is that we should avoid complete commercialisation, as in the United States; and, while keeping the B.B.C. a public Corporation, with the services of the public as its first and chief object, we should, at the same time, be able to draw a substantial revenue, which I know is only waiting the opportunity to be spent in the way I have suggested and described.

**YOU WILL MEET
"D.R." NEXT WEEK**

TIPS FOR CONSTRUCTORS

A tip which sometimes helps in getting rid of H.F. from the L.F. stages is to connect the moving vanes of a differential reaction condenser to filament, and each set of the fixed vanes to different ends of the high-frequency choke, adjusting the position of the moving vanes to give the required result when setting for the first time.

Do not run a long lead to an H.F. grid-bias battery, but use one of the special small cells which can be placed in close proximity to the S.G. valve.

A discarded three-point wave-change switch can easily be fitted up in place of the ordinary

on-off switch, with the additional advantage that its third contact can be arranged to break the H.T. circuit as well.

If you have a spare H.F. choke in the junk box remember it often happens that when connected in series with the primary of an L.F. transformer both quality and reaction effects are improved.

Use a hacksaw for cutting ebonite, and remember that the finer its teeth the less the smoothing up that you will have to do after.

**"LINEN"
LOUDSPEAKER
DIAPHRAGMS**

The Editor,
POPULAR WIRELESS.

Dear Sir,—As a considerable amount of publicity is given from time to time in wireless papers regarding the making of linen diaphragm loud-

speaker units, I hasten to advise you of a matter which has a very important bearing on this subject.

A few weeks ago there was brought to my notice a sample of material which was being sold as "doped" linen, for use in the construction of a linen diaphragm speaker, and as I was not satisfied with the texture of the sample, I had a test made and discovered that it was an all-cotton fabric. I immediately took the matter up with the firm selling the material, and received, in reply, an unconditional apology and a promise, to discontinue advertising the fabric as "linen."

The firm in question intimated that they were innocent of any intent to misrepresent their wares, and that they merely referred to the material "in a wireless term," but I should point out that to sell an all-cotton fabric or material other than a flax product as linen in any circumstances would constitute misrepresentation within the meaning of the Merchandise Marks Act, and my Association is prepared to institute proceedings against any person or persons guilty of this offence.

I would appreciate your assistance in the matter of giving this letter publicity in POPULAR WIRELESS and allied publications.

Yours faithfully,
G. A. E. ROBERTS,
Secretary and Inspector.

7, Donegall Square West, Belfast.

TELSEN VARIABLE CONDENSERS

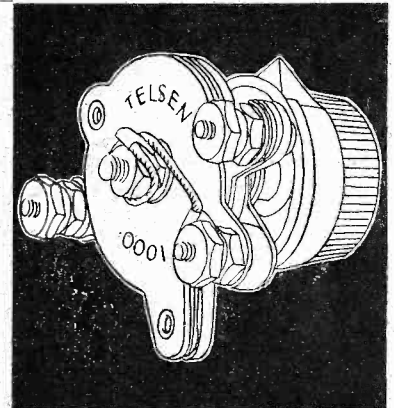
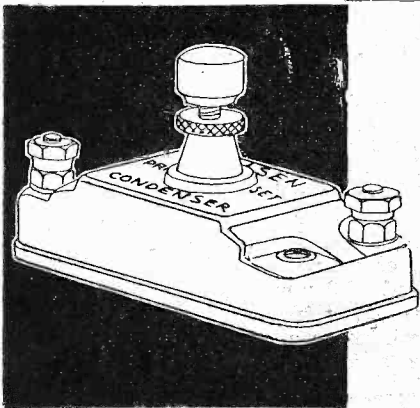
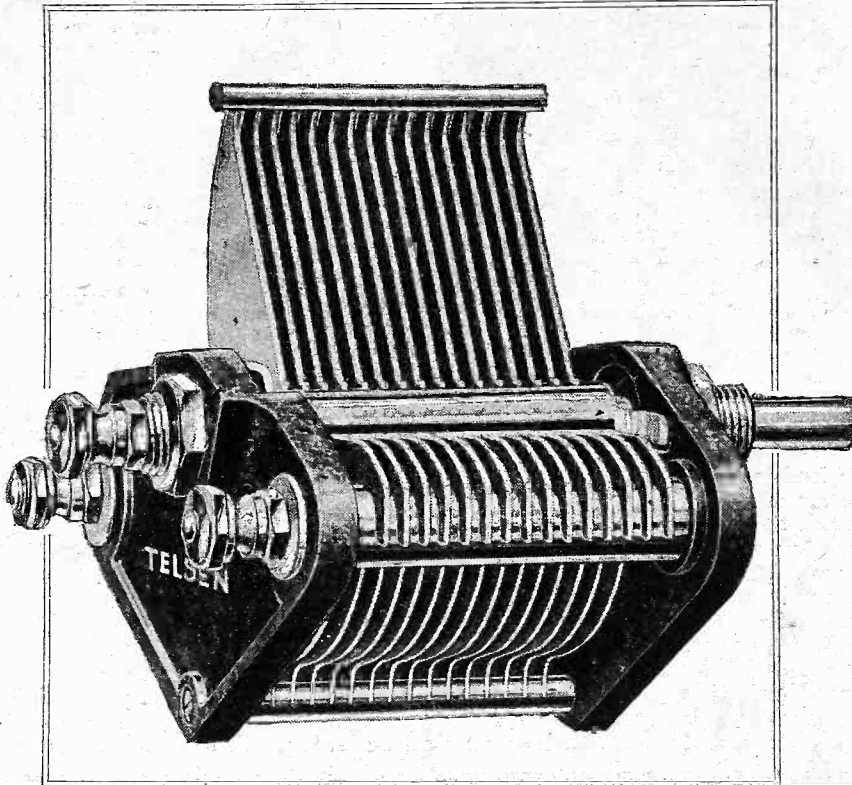

TELSEN LOGARITHMIC VARIABLE CONDENSERS

The Telsens Logarithmic Variable Condenser is of robust construction and high insulation. The H.F. losses are very low and the frame is braced at three points, so that the possibility of distortion and short-circuiting is negligible. Substantial terminals are provided with alternative connection to the stator.

Telsens Logarithmic Variable Condenser—
Made in capacities of .0005, .00035, .00025 Price 4/6

TELSEN PRE-SET CONDENSERS

These Condensers have been carefully designed to give proper separation of vanes when the adjustment is unscrewed, which results in a very low minimum capacity, giving a wide range of selectivity adjustment when used in the aerial circuit.

Telsens Pre-Set Condenser—
Made in capacities of :

Maximum capacity	Minimum capacity	Price
.002	.00025	1/6
.001	.00004	1/6
.0003	.000005	1/6
.0001	.000001	1/6



THE SECRET OF PERFECT RADIO RECEPTION

Send for the "Telsens Radio Catalogue" and book of "All-Telsens Circuits" to—The Telsens Electric Co., Ltd., Aston, Birmingham.

TELSEN BAKELITE DIELECTRIC CONDENSERS

These Condensers are of a new and improved type, and of compact dimensions. The moving vanes are keyed on to the spindles so that they cannot be pushed out of line, and there is a definite stop at each end of the travel. The connection to rotor is made by means of a phosphor-bronze pigtail, so that there is no crackling due to rubbing contacts. The connection to the stator vanes is absolutely positive—a very important point.

Telsens Bakelite Dielectric Differential Condenser—
Made in capacities of .0003, .00015, .0001 Price 2/-
Telsens Bakelite Dielectric Reaction Condenser
Made in capacities of .0003, .00015, .0001 Price 2/-
Made in capacities of .00075, .0005 Price 2/6
Telsens Bakelite Dielectric Tuning Condenser—
Made in capacities of .0005, .0003 Price 2/-

THE coming of those splendid autumn conditions for which all true wireless men long has been somewhat delayed this year. Or rather, perhaps, I should say that the progress towards first-rate conditions which began so promisingly suffered from setbacks of unusual severity and duration. At the end of September, for instance, we had a rather dreadful ten days during which atmospherics abounded and the receiving set seemed to have lost all its own life.

Not Up To Standard.

This was fortunately followed by a big improvement, but we are still rather behind the position in normal years. Genuine autumn conditions will probably come with a rush. One night we shall find stations pouring in at every division of the condenser dials.

A good many of our old friends are distinctly disappointing at the moment. On good nights they are very much there, but on bad nights it is often difficult to hear anything of them at all. I am referring to such stations as Vienna, Milan, Katowice, Lwow, Barcelona, Bordeaux, and Hamburg. All these should now be reliable, but for some reason or other they are not.

It is just this kind of thing, though, that makes wireless so interesting. There is far more pleasure in hunting down and



Some practical distant-programme notes compiled by a special contributor who nightly searches the ether in order to obtain really up-to-the-minute information for "P.W." readers.

working up to good loudspeaker volume a station that is on the weak side than there is in using the volume control to tone down a terrific transmission that simply finds itself.

One very promising sign is that apart from atmospherics there is a good deal less interference than there was on the medium wave-band. We are not nearly so much bothered as we used to be by spark signals, and I do not seem to notice the same amount of mush from big commercial stations. In the absence of background interference big amplification can be used successfully on weak signals, and you can give a sensitive set a real chance of showing what it can do.

Some Good "Goers."

Among the best medium-wave stations just now are Trieste, Horby, Gleiwitz, Heilsberg, Turin, Gothenburg, Brno, Lwow, Brussels No. 2, Toulouse, Frankfurt, Sottens, Beromunster, Rome, and Langenberg.

There are many others, too, which are

La Doua, Vienna, Prague, Sundsvall and Munich.

"Letting Loose" at Toulouse!

We shall soon be hearing a good deal more even than we do at present from our old friend, Radio Toulouse. He has just sent me particulars of the new station which is now nearing completion. Here is a problem for you to think over: If Toulouse, using 8 kilowatts, was one of the strongest European stations, what will he be like when he is putting 85 kilowatts into the aerial?

That is what he is going to do presently. The new station is at St. Agnan, about twenty miles from Toulouse itself. The two aerial masts are 120 metres in height and 200 metres apart.

A new system of modulation is to be used, which is described as being "of purity hitherto unknown." As the present Toulouse has frequently been heard on crystal sets in Northern Africa great things are expected of the new station, and regular reception in America is prophesied.

AS a result of an accumulation of requests, from places as far apart as Bow and Burma, I am making for "P.W." a short-wave receiver of a type that has not, I believe, been too prominent in the past. I refer to a set intended essentially for short-wave broadcasting, and capable of operating a speaker at real "hefty" volume.

"Amateur-band" work will be neglected entirely, and the aim will be to cover the whole range of short waves with about three changes of tuning coils. The set will be an S.G.4, and, rather than talk now, I will go ahead with the work.

Well Done, "Plymouth."

My little log on W 2 X A D has prompted quite a number of readers to send in their own, which I much appreciate. Strangely enough—for I had not expected it—most of them tally quite closely with my own. Even in the wilds of Scotland W 2 X A D appears to be subject to the same changes that I log in the south.

The "prize" this week, however, must be awarded to W. H. R., of Plymouth, who writes a *nineteen-page letter* and includes a very fine log of W 2 X A D and W 2 X A F. I am keeping this for reference, since I myself did not log W 2 X A F to any great extent. On W 2 X A D, however, we agree quite well.

It is specially interesting to note that W. H. R.'s log, written up before my own

SHORT-WAVE NOTES



News and views regarding an exciting and fascinating wave-band.

By W. L. S.

appeared in print, also has a footnote to the effect that September 1st was the best day ever recorded for long-distance reception.

You may remember that I had to scrap my previous idea of 100 per cent on that night and call "X A D" 100 per cent *plus*. On that same night W. H. R. found W 8 X K coming in as early as 8.15 p.m., although he is usually absent until 9.30, or even later.

Last Sunday's "Thriller!"

The same gentleman was responsible for getting me out of bed very early last Sunday morning to hear V K 2 M E, and I did not regret it, cold and draughty though it was. From 6.30 a.m. till 8 o'clock I listened to him at a strength that surprised even a hardened case like myself.

Will Australia on telephony ever cease to thrill us, I wonder; or shall we, in the days of inter-planetary working, looking back with scorn at the times when "Hearing Mars was thought to be wonderful?"

When you read this we shall be back on G.M.T. once more, and our ideas of times will have to be revised. I do not know whether W 2 X A D's schedule will have changed, but if it stands as at present he will, of course, be starting up at 8 p.m. instead of 9 p.m. Likewise we shall hear more of the 25-metre and 32-metre Americans on account of their starting an hour earlier by our time.

Don't Forget the "Hams."

I seem to have been neglecting the "hams" of late in these notes. Do not think from this that I have forgotten them, or that they are inactive. Far from it.

It is natural, however, that a certain lack of interest during the summer (*has there been one?*) should occur. Perhaps it is all to the good, for they all come back refreshed in the month of October, brush the cobwebs off the transmitters, and, in some cases, build brighter and better ones.

The current opinion among them is that 80 metres will be very useful this winter. There are, once more, long odds on a very bad period for 20 metres, and 40 is always overcrowded. The tendency is to revert to the higher bands, so that "80" and "160" may take on a new lease of life.

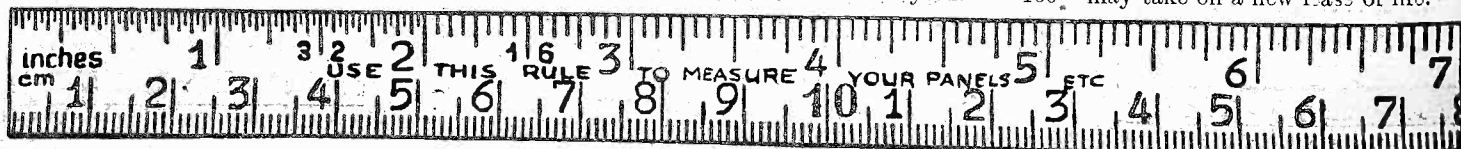

TELSEN TRANSFORMERS & CHOKES

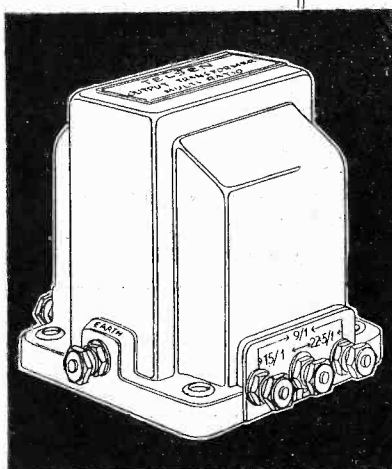
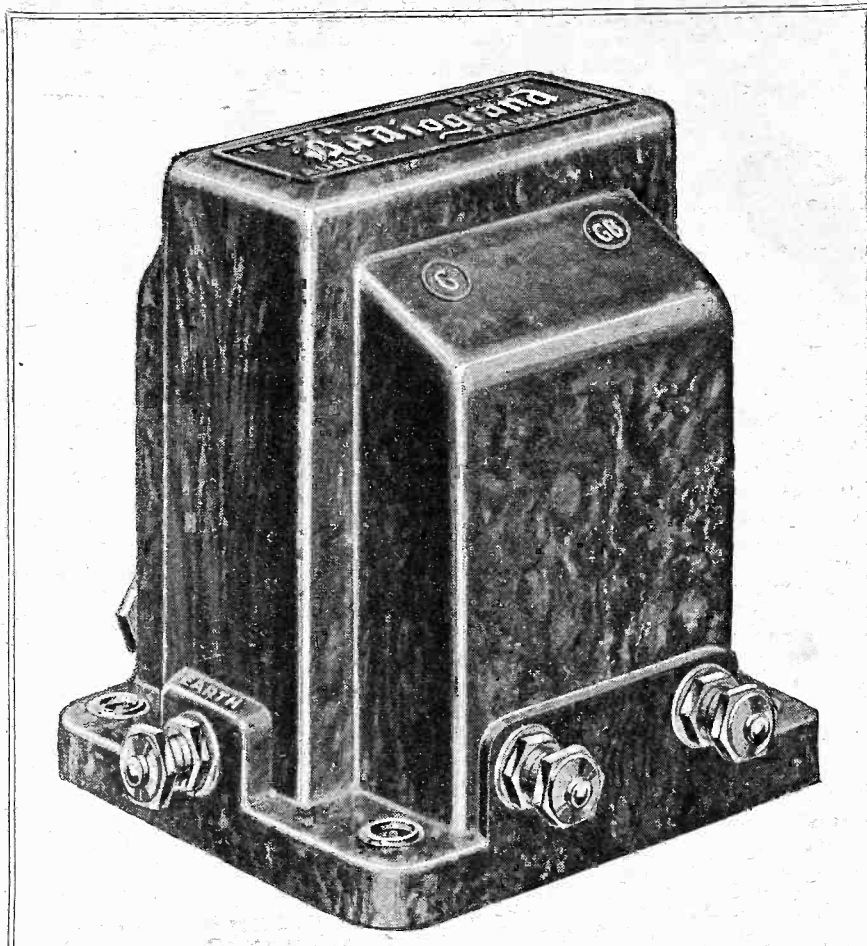

TELSEN OUTPUT TRANSFORMERS

- Telsen Multi - Ratio Output Transformer, giving three ratios of 9-1, 15-1, 22.5-1 . . . Price 12/6
- Telsen Output Transformer, Ratio 1-1 . . . Price 12/6
- Telsen Pentode Output Transformer Price 12/6

TELSEN L.F. & OUTPUT TRANSFORMERS

Telsen transformers have achieved fame in the radio world on account of the high standard of their quality and performance. Designed and built on the soundest engineering principles, these robust, full-size transformers will give not only efficient but enduring service.

TELSEN L.F. TRANSFORMERS

- Telsen "Ace" Transformer, Ratios 3-1, 5-1 Price 5/6
- Telsen "Radiogrand" Transformer, Ratios 3-1, 5-1 Price 8/6
- Telsen "Radiogrand" 7-1 Super Ratio Transformer Price 12/6
- Telsen Intervalve Transformer, Ratio 1.75-1 Price 12/6

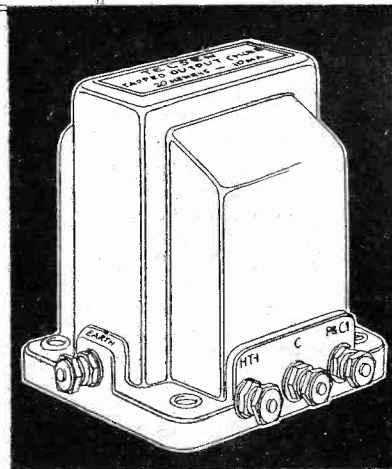

TELSEN L.F. CHOKES

- Telsen L.F. Intervalve Coupling Choke, 40, 100, and 125 henrys Price 5/-
- TELSEN OUTPUT CHOKES**
- Telsen Output Choke (Plain), 20 henrys Price 8/-
- Telsen Output Choke (Tapped), 20 henrys Price 8/6
- Telsen Heavy Duty Power Grid L.F. Choke, 40 henrys Price 8/-

TELSEN

ALL-BRITISH RADIO COMPONENTS

Send for the "Telsen Radio Catalogue" and book of "All Telsen Circuits" to—The Telsen Electric Co., Ltd., Aston, Birmingham.

NO one need cherish any doubts as to the merits of band-passing. It is a very sound scheme, both theoretically and in practice. Various methods of applying it have appeared in several of "P.W.'s" most successful sets.

An Ideal Combination.

The object of band-passing is to obtain selectivity without sacrificing quality. The term is really quite self-explanatory, and means just what it says, i.e. the passing of a band of wave-lengths.

An ordinary tuned circuit of high efficiency and comprising a coil tuned by a variable condenser will select any one individual wave-length and enable this to develop a certain amount of energy.

The immediately adjacent wave-lengths are handled much less effectively, and the energy from these tends to fall away quickly. Thus you get a condition that can be represented graphically by a kind of sharp-pointed mountain, the peak indicating the energy developed from the selected energy, and the steep sides the sharply decreasing energy due to the adjacent waves.

But selectivity of this type is not what we want, for no broadcast programme is carried on the wings of one wave-length only. There are "side-bands" of wave-lengths slightly shorter and slightly longer that also need to be tuned in, if fidelity is to be achieved in the reproduction.

Saving the Side-bands.

Band-passing aims at including these side-bands, but rigidly excluding any more wave-lengths either longer or shorter. And for this you can picture a square column,

the flat top covering the desired wave-length plus its "side-bands" and the vertical sides showing that no other waves are allowed to develop energy in the receiving system.

That is the ideal, and as with most ideals is unattainable in practice. But you can approach it by having two tuned circuits instead of the usual one and coupling them together in a certain manner.

In the New "B.P." Three the coupling is carried out by a fixed condenser. Needless to say, the sizes of the coils and the capacity of the coupling condenser have to be very carefully chosen.

Two-Band Tuning.

The New "B.P." Three really is new, for it is one of the first sets to give practical expression to the work that has been undertaken during the past months by our leading component manufacturers.

The interesting result of this useful activity is that complete double-band band-pass arrangements are now available in single compact units.

For instance, the Lewcos Band-Pass unit which figures in the original model of the New "B.P." is hardly larger than a normal dual-wave coil, and yet it embodies all the inductances needed for covering both ordinary and long wave-lengths.

The form it

THE NEW



A powerful receiver in the very last "simple"

adopts is intriguingly reminiscent of a "V" twin-cylinder motor-cycle engine, and it is wonderfully small.

And it will be observed that there are only four terminals on it, so that it brings with it no little simplification.

The New "B.P." also introduces you to a second important component development—the mass-production, highly effective and inexpensive two-gang condenser.

SEEN THE "BAND-PASS"?

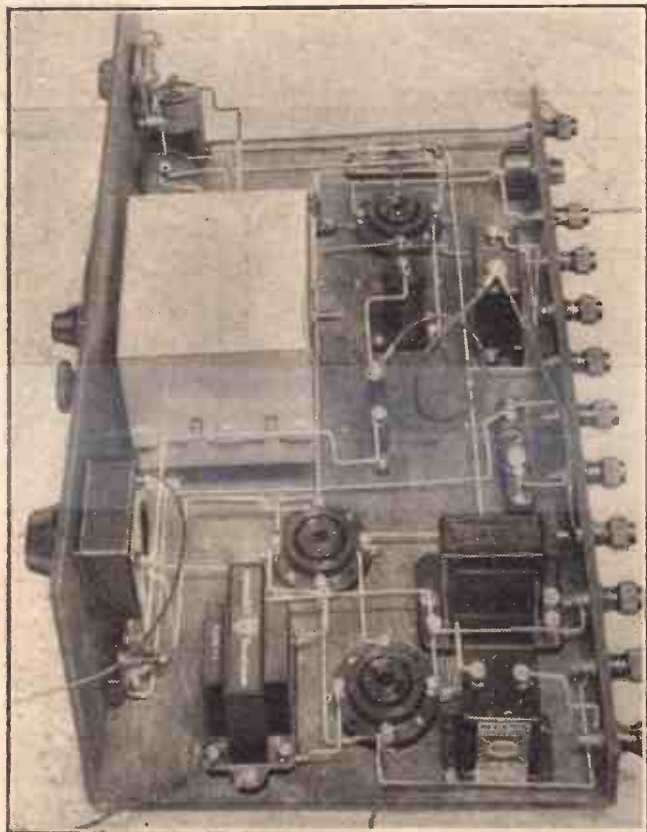

The extremely neat band-pass coils are almost hidden behind the screened dual-condenser.

CHOOSE YOUR COMPONENTS

- 1 Panel 18 in. x 7 in. (Permcot, Peto-Scott, Becol, Wearite, Goltone).
- 1 Cabinet to fit, with 10-in. baseboard (Pickett, Peto-Scott, Camco, Gilbert, Osborn, Ready Radio).
- 1 Band-Pass coil (Lewcos, Varley, R.I.).
- 1 .0005-mfd. double gang variable condenser (Utility, Cyldon, J.B., Polar, Wavemaster, Lotus).
- 1 .0005-.00075 reaction condenser (Telsen, Ready Radio, Polar, Cyldon, J.B., Lotus, Graham Farish).
- 1 Vernier dial for same (Igranic Indigraph, or disc drive supplied by makers of condenser).
- 1 Volume control, 500,000 ohms (A.E.D., Wearite, R.I., Varley, Magnum, Sovereign, Igranic, Graham Farish).
- 1 On-off switch (Ready Radio, Telsen, Bulgin, Goltone, Lissen, Graham Farish, Igranic, Lotus, Peto-Scott, Wearite).
- 3 Valve holders (Lotus, W.B., Burton, Wearite, Telsen, Igranic, Graham Farish, Clix).
- 1 L.F. transformer (R.I. type 1:7, Telsen, Ferranti, or Varley, Igranic, Lotus, Lewcos, Graham Farish, of ordinary ratio).
- 1 H.F. choke (Ready Radio, Telsen, Lewcos, Lissen, R.I., Varley, Sovereign, Watmel, Peto-Scott, Atlas, Graham Farish, Dubilier).
- 1 Output choke (Ferranti, Telsen, Graham Farish, Lotus, R.I., Igranic, Varley, Lissen, Bulgin).
- 1 .0003-mfd. fixed condenser (T.C.C., Telsen, Lissen, Dubilier, Mullard, Ferranti,
- Ediswan, Igranic, Graham Farish, Goltone).
- 2 .01-mfd. condensers (T.C.C., etc.).
- 2 2-mfd. condensers (T.C.C., Form Dubilier, Mullard, Igranic, Lissen, Telsen, Helsby, Ferranti).
- 1 2-meg. grid/leak and holder (Graham Farish, Lissen, Telsen, Dub

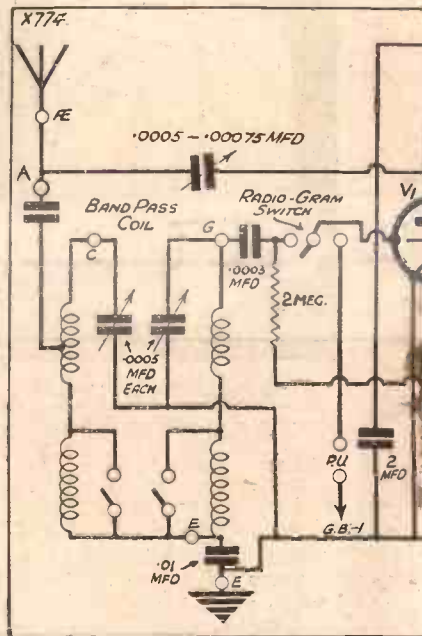

The detector is followed by one resistance-

"B.P." THREE



...three-valve employing one of the best systems of selectivity."

This is in essence two variable condensers welded into one and driven by a single tuning dial. So you see your two circuits that are necessary for band-passing are not present as two sets of components.

Concentrated Compactness.

The band-pass coil is no larger than any normal tuning unit, while the two-gang condenser is compact and has merely three

terminals. Here you have band-passing without the complicating drawback of a multiplicity of parts.

The system is particularly applicable to the popular det.-2 L.F. type of circuit, for such a hook-up provides plenty of amplification and is yet remarkably straightforward.

No Screening Whatever.

There are none of those screens that are so frequently needed in S.G. circuits, and at every point there is an adequate margin safeguarding the interests of the less expert constructor.

Indeed, the New "B.P." is one of the stoutest propositions we have been able to bring to your notice. But we must make it quite clear that we lay no claims to the inception of the "motif," as it were, of this particular set.

The circuit includes nothing originating in our own Research Dept. Our contribution lies in the creation of a "layout" for the components employed, and we cannot honestly say that this was a particularly tricky task. The components almost laid themselves out on panel and baseboard. It follows then that the results your own New "B.P.'s" give must very closely approximate to those worked to by the component makers themselves.

This automatic

standardisation, which must inevitably follow if you all build your sets with the recommended parts and adhere to our layout, is a particularly attractive feature of the design both from your point of view and ours.

It represents exactly the opposite extreme to that which I indicated in an article describing a previous set with none of this one's limitations. Your individual freedom of choice is still present in that you are free to build this set or not, your decision depending upon your reactions to its design and performance. And we know that many of you will welcome it with open arms as it fulfils so many obvious needs.

Its utter simplicity of assembly, and its comparative inexpensiveness are bound to constitute very powerful attractions. And as it is remarkably easy to operate and gives powerful loudspeaker results it certainly "catalogues" with great advantage.

Provision for a Pick-up.

It will be noted on reference to the theoretical diagram that we have included provision for a gramophone pick-up. But you will observe that this is accomplished in a most economical manner, though I must say that there is none which is more effective.

Even if you do not immediately contemplate using a pick-up the extra parts and work involved in incorporating this section of the circuit in the finished receiver are such that it is an almost negligible addition. And yet your set is immediately ready for pick-up work should you at any

(Continued on next page.)

WHAT MAKES FROM THIS LIST

- 1 100,000-ohm Spaghetti resistance (Varley, Ready Radio, Telsen, Lewcos, Igranic, Bulgin, Graham Farish).
- 1 25,000-ohm Spaghetti (Ready Radio, or as above).
- 1 Fuse holder (Bulgin, Ready Radio).
- 1 Two-way switch (Bulgin, Ready Radio, Wearite, Melbourne, Red Diamond, Ormond).
- 1 Terminal strip, 18 in. x 2 in.
- 11 Indicating terminals (Belling & Lee, Igranic, Eelex, Clix, Goltone). Glazite, Lacoline, Quickwire.
- G.B., H.T., and L.T. plugs, or spade terminals (Igranic, Belling & Lee, Eelex, Clix).

ACCESSORIES.

LOUDSPEAKERS.—Amplion, Blue Spot, B.T.-H., Graham Farish, Celestion, Mullard, Undy, W.B.

VALVES.—1 H.L. or H2 type, 1 L type, 1 power or super-power. (Osram, Mazda, Mullard, Six-Sixty, Cossor, Eta, Fotos, Lissen, Tungram, Dario.) (H.T. current consumption at 120 volts 15 milliamps, using P2 type of valve.)

BATTERIES.—H.T., 120-volt max., Super-capacity (Ever Ready, Magnet, Ediswan, Pertrix, Drydex, Lissen, Columbia).

G.B., 9-18 volts, to suit output valve, as above.

ACCUMULATORS.—Voltage to suit valves. (Exide, Lissen, Pertrix, G.E.C., Ediswan.)

MAINS UNIT.—Heayberd, Regentone, Atlas, Lotus, Tannoy, R.I., Ekco.

(State type of set and milli-amp consumption, also details of mains when ordering.)

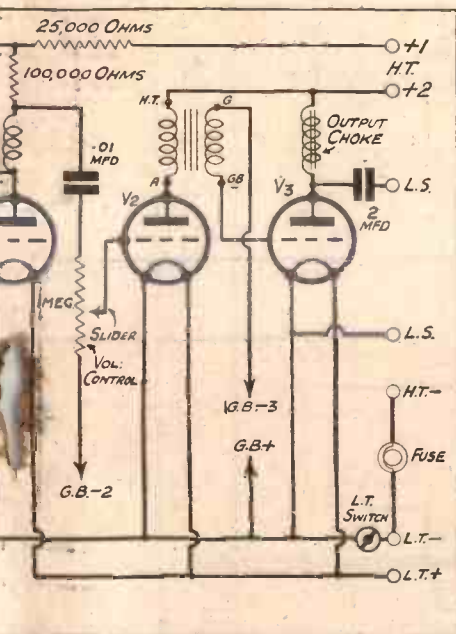

...one transformer-coupled stage of L.F. amplification.

LOOK AT THIS LAYOUT

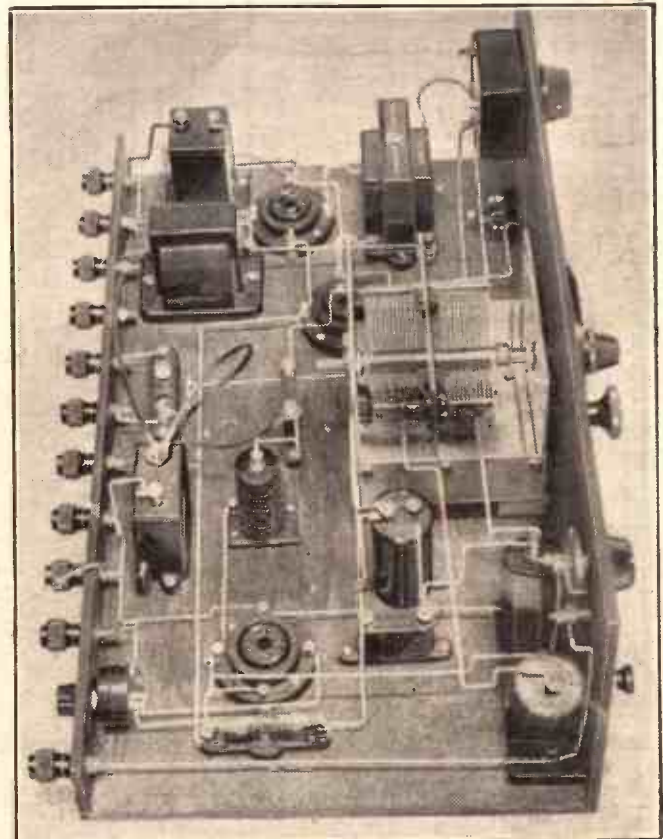

Even the not-very-experienced will appreciate the clean lines and good spacing of the New "B.P." Three layout.

THE NEW "B.P." THREE

(Continued from previous page.)

time in the future wish to so use it. The only point to watch in such an event is that you feed the G.B.—1 lead with about 1½ volts grid bias. This can, of course, be taken from the same battery that serves the other G.B.'s.

Well, that completes our survey of the New "B.P." Three, and there remain now only the constructional details, and these we propose to give you next week. Many of you, however, will not need to wait for these, in view of the set's straightforwardness.

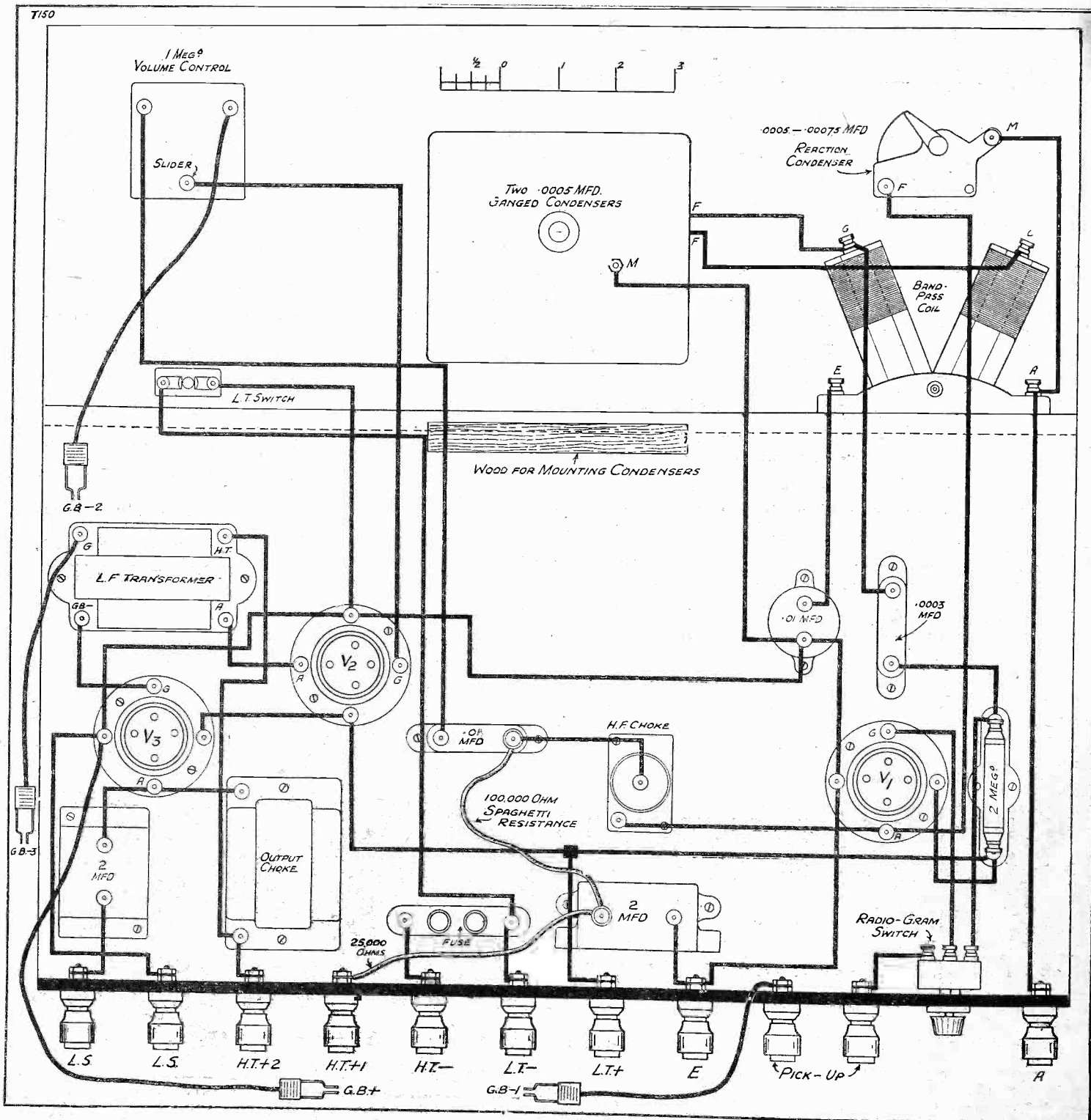
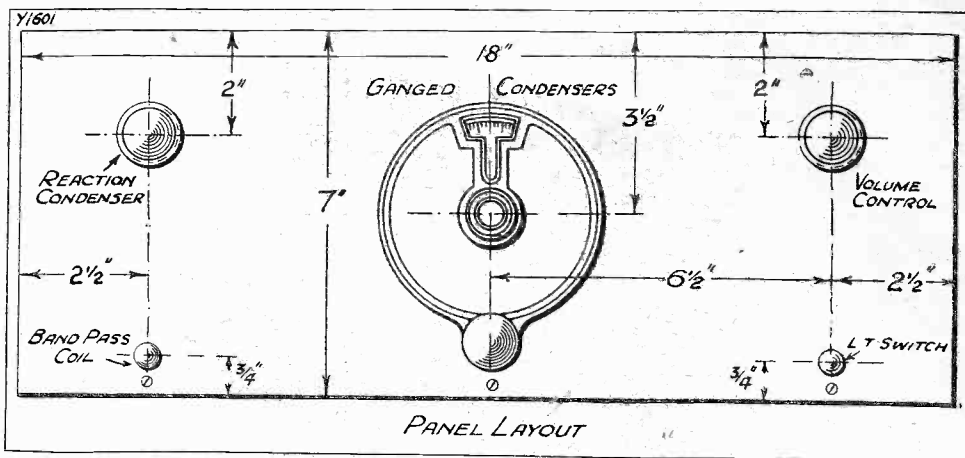

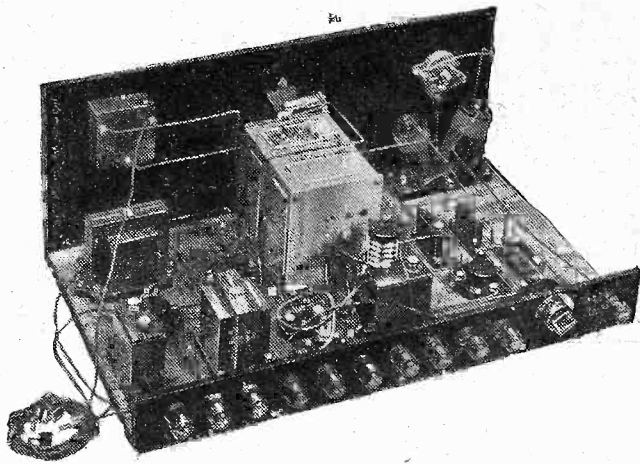

KENDALL'S TEST REPORT

"I have carried out comprehensive tests under varied conditions upon a model of the 'B.P.' Three, and have formed a high opinion of the capabilities of this receiver.

"The model used for the tests was assembled with the makes and types of components which I have chosen specially for the Ready Radio Kit, and I am satisfied that it gave the full results possible from this remarkably efficient circuit.

"I was impressed by the extreme ease of handling of the receiver, and noted particularly the excellent quality of reproduction. Selectivity and sensitivity were both most definitely above the normal level expected from even the best receivers of this type, and the instrument was extremely stable. For the connoisseur I recommend the use of an 'Instamat' Output Transformer instead of the choke condenser output."

Mr. G. P. Kendall, B.Sc., now Chief Engineer of Ready Radio Ltd., was for many years Chief of Research for "Popular Wireless" and "Modern Wireless."

FULL LISTS OF KITS
AND COMPONENTS
AND FURTHER
DETAILS ON PAGES
299, 300, 303, 305

G.P. Kendall

Ready Radio



EASTNOR HOUSE, BLACKHEATH, S.E.3

Telephone: Lee Green 5678.

Telegrams: Readirad, Sedist.

Showrooms: 159 Borough High Street, London Bridge, S.E.1

Telephone: Hop-3000.

DO WE NEED H.F.?



A provocative article by W. L. S., in which he asks a time-honoured question, and deals with it in the light of modern developments.

PLEASE believe me at the outset when I state that I am not writing this in the hope of starting an argument. I am asking the question in all good faith, as one who has an open mind and would like to be convinced in one direction or the other.

Two Schools of Thought.

I am in the unhappy position of sympathising to an equal degree with two different schools of thought. On the one hand, we have those who say that H.F. amplification is an indispensable part of the modern receiver; on the other, those who think it is complicated, difficult and unnecessary.

Probably the first school is in the vast majority. Hear me out, though, while I plead the cause of the other, heard less often, but nevertheless worth a hearing.

Admitting, in the first place, that a modern high-frequency amplifier does give enormous amplification of the signals coming in from the aerial, before they reach the detector, is there very much point in doing so? Our modern valves are so efficient that a detector *will* detect any signal that is strong enough to make itself heard above the inevitable "strays" of all description.

The Noise-Level.

How, then, does one benefit from a general amplification of the whole range of noises, wanted and unwanted, before they reach the detector? Just imagine that a comparative novice in radio matters had asked you this question. What could you reply?

It is my personal opinion that he is right about the "signal-noise" ratio. Our general background of noise has so high a level nowadays that any signal loud enough to cut through it will be loud enough to detect without previous amplification.

Why, then, do we not concentrate upon an efficient detector, and follow it up with L.F. amplification *ad lib*, instead of worrying about carefully screened H.F. stages, ganged controls, and so forth?

To put the matter in another way, we can say this. Once a signal has been detected, it matters not in the least how weak it is. Our problem is to receive a *clear* signal

free from noises, even if its strength, when we have finished with it, be infinitesimal.

Once the signal is there, in the anode circuit of the detector, as a signal free from interference, we can amplify it to any extent we like, and it will *still* be clear of interference! There you have the "anti-H.F." man's case in a nutshell.

Now, to anticipate the replies from the opposition, I will quote one that will certainly be forthcoming. "Yes," say they, "we grant you this; but the H.F. side of the set serves the double purpose of giving amplification *and* selectivity. The latter can only be obtained by means of a multitude of tuned circuits, which are provided in this way."

RADIO "ON LOCATION"

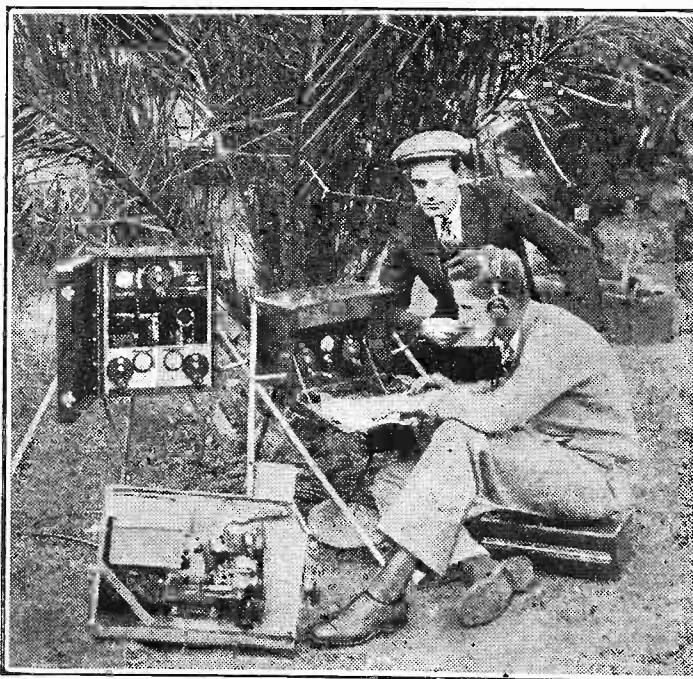

W. S. Van Dyke, the director of an important Metro-Goldwyn-Mayer talkie, inspecting the radio apparatus he used in order to keep in touch with civilisation while taking scenes in Central Africa.

This, at first sight, is rather a poser to answer. Why, however, can we not use an equivalent number of tuned circuits without the H.F. stages? Why not use efficient band-pass coupling to a detector only, and follow that up by as much straight-line L.F. amplification as we like?

Some Further Points.

And why, indeed? Writing still as an impartial chairman to this imaginary debate, I find it very hard to see why the "anti-H.F." man has not scored up to the present.

Further points that he has in his favour are these: That L.F. is easier to arrange for than H.F. amplification; that the set will probably have fewer controls; and that it will *certainly* need less screening.

Representative Receivers.

The only point against his case is that the amplification that one can obtain from a good L.F. stage does not approach that obtainable with screen-grid valves *in front* of the detector.

So, before we close, let us imagine and compare the set that would be favoured by each party. "A," the multi-stage H.F. exponent, would probably use two screen-grid stages, extensively screened, and perhaps stabilised, in addition, in some way that materially reduces their efficiency.

These would be followed by a detector, which would have to be specially looked after to prevent overloading from the tremendous input it *could* receive from the foregoing valves. After this there would probably be two good note-magnifiers.

In all there would be three controls, or, perhaps, one ganged control and two trimmers.

Force of Habit.

"B," the man that likes to make his detector do all the work, would use something of this sort: There would be a very loosely-coupled aerial circuit, perhaps a band-pass coil of one of the commercial varieties, a detector of the high-amplification factor class; and after this there would be not more than three "note-mags." Thus he would have four valves against the other man's five, and, at the most, two controls instead of three.

Further, from my personal experience, he would receive everything that "A" received, and probably with less interference.

This being true, why is it that nearly everyone that wants distant reception, myself included, uses a set of the "A" class? I think the answer is that, even in radio matters, one does not like to be thought a heretic. Convention is a wonderful thing!

W.L.S. writes regularly for
MODERN WIRELESS,
Britain's Leading Radio Magazine

TELSEN DUAL-RANGE COILS

TELSEN DUAL-RANGE AERIAL COIL

The Telsen Aerial Coil is the very latest development in dual-range aerial coil design. It incorporates a variable series condenser which can be set to give any desired degree of selectivity, making the coil suitable for all districts, whatever reception conditions may be. It has been tested in various parts of the country, and down to distances of five miles from Regional stations a single tuned circuit will definitely separate the Regional programmes. This adjustment also acts as an excellent volume control and is equally effective on long and short waves. The waveband change is effected by means of a three-point switch. A reaction winding is provided and the primary and secondary windings are separated so that the aerial circuit can be isolated in mains-driven or screened-grid receivers.

Telsen Aerial Coil with Variable series Condenser incorporated. Price **7/6**

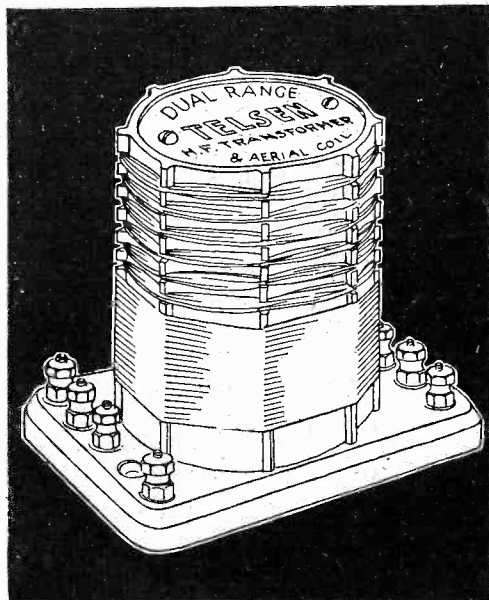
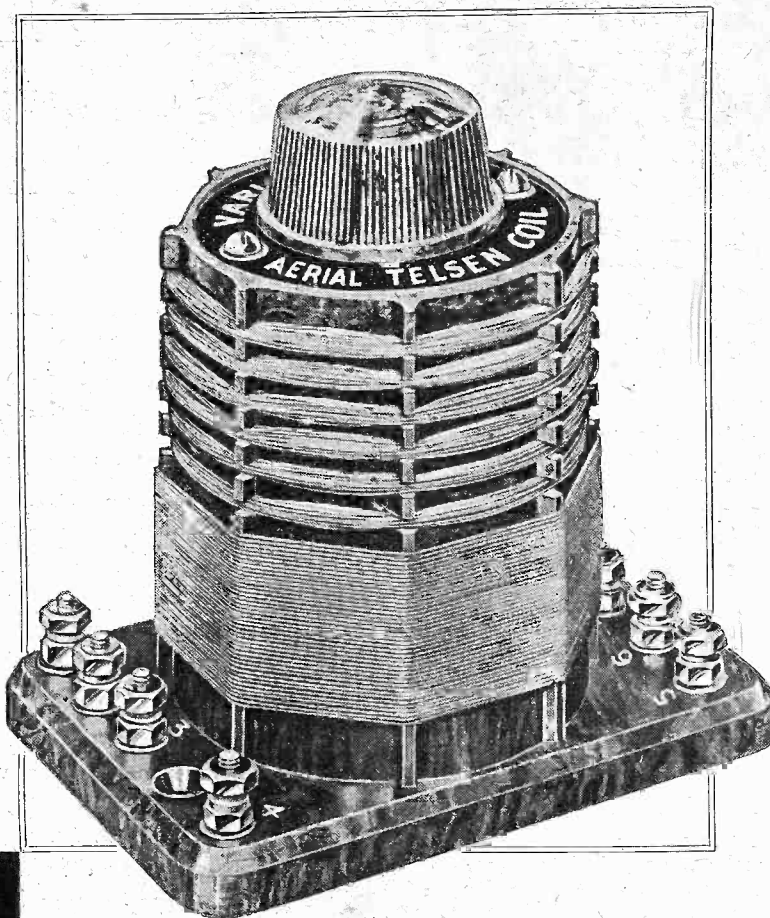

Send for the "Telsen Radio Catalogue" and book of "All-Telsen Circuits" to the Telsen Electric Co., Ltd., Aston, Birmingham.

TELSEN H.F. TRANSFORMER AND AERIAL COIL

This Coil is primarily designed for H.F. amplification in conjunction with screened-grid valves. It is arranged so that it can be connected as a tuned-grid or tuned-anode coil, or alternatively as an H.F. Transformer.

It also makes a highly efficient aerial coil where the adjustable selectivity feature is not required. A reaction winding is incorporated. When used as an H.F. Transformer the wave-change is effected by means of a two-pole (four-point) switch. When connected otherwise a three-point switch should be used.

Telsen H.F. Transformer and Aerial Coil .. Price **5/6**

TELSEN

THE SECRET OF PERFECT RADIO RECEPTION

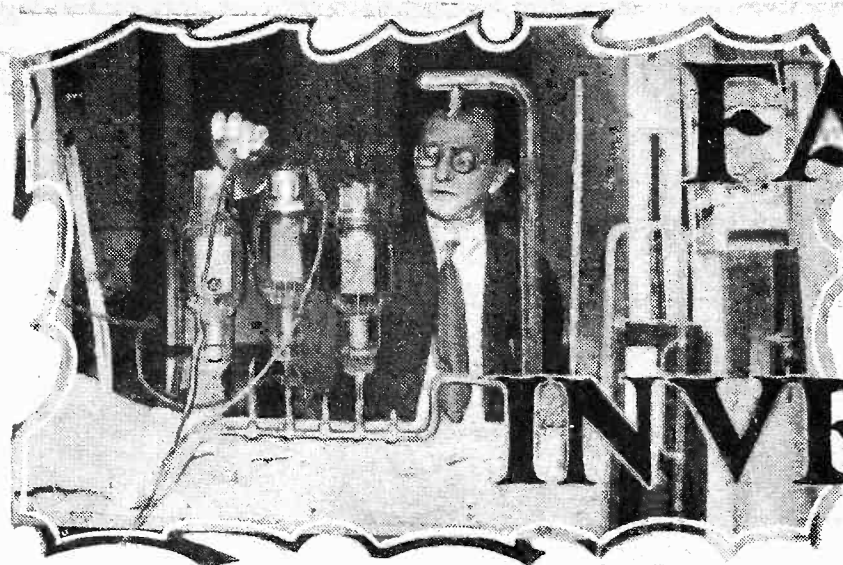

FAMOUS RADIO INVENTIONS

A SURPRISING ARTICLE

By

CARDEN SHIELS.

THE biggest of the so-called "master" patents in the wireless industry—the one which covered "reaction"—died a natural death last year, after enjoying a lucrative life of sixteen years. The famous "grid-leak" patent shared a similar fate about the same time, and others are due to make their exit in the near future.

Meanwhile, of course, their place is being filled with more up-to-date improvements, because though patents may come and patents may go, the inventor works on for ever. No sooner is one invention out of the way than another looms up to take its toll out of the public. And this is only as it should be.

For Services Rendered.

People are very often inclined to regard the payment of patent royalties as an imposition, forgetting, perhaps, that if it were not for the professional inventor we should not make the rapid progress we do. If Fleming had not invented the valve we should, presumably, be anchored to the crystal and a pair of headphones.

It is possible, of course, that if Fleming had not discovered the valve, someone else would have done so, and we should still be where we are. That may be so, but one may be quite sure that whoever "did the trick" would have secured patent rights and extracted royalties just the same.

The fact of the matter is that an industry like radio rides on the back of the research men, and it is only fair that we should be prepared to pay a reasonable return for the work they do.

One important patent in the radio industry has recently received an unexpected new lease of life. This is the well-known "push-pull" circuit which was owned by the Western Electric Co.—now the Standard Telephones & Cables, Ltd. The patent was first filed in January of 1915, so that in the ordinary course of events it was due to expire in January of the present year.

An Interesting Patent.

The patentees, however, applied to the High Court for an extension of time on the ground that they were prevented from fully exploiting the invention during the period of the War, because as a "controlled establishment" they were then chiefly occupied in the manufacture of munitions and on other important war work. This argument was accepted, and the Court

★ Did you know that poor old Reaction was dead? This is one of the astonishing facts disclosed by our contributor in this clever survey of radio ideas! ★

added a further term of four years to the patent, which will accordingly continue to draw royalties until January, 1933.

Another outstanding invention is that covered by the so-called "eliminator" patent, which in the ordinary course of events will expire at the end of this year. The "eliminator" circuit covers any means for rectifying and filtering or smoothing current drawn from the electric-supply mains in such a way as to make it suitable for use as the high-tension supply to a wireless receiver.

All sorts of different rectifiers for converting alternating current into direct current were known before the date of this patent, but no one had previously thought of smoothing-out the rectified current so

thoroughly as to allow it to be utilised to feed the plate current of an amplifying valve.

The "pulses" of direct current delivered by a rectifier depend, of course, upon the periodicity of the A.C. supply. In the case of D.C. mains units there are various kinds of irregularities in the "raw" mains supply, due principally to the commutator brushes which connect the dynamo at the generating station to the distributing lines.

Keeping It "Alive."

All such fluctuations must be smoothed out before they reach the plate of the valves, otherwise they will get through to the loud speaker. The "eliminator" patent covers the ordinary smoothing arrangement of chokes and condensers used for this purpose.

It sometimes happens that an inventor fails to pay the annual renewal fees required to keep a patent alive for the full term of sixteen years. In this connection it should perhaps be explained that when a patent is originally filed the fees then paid cover the first four years of its life. After that it is necessary to pay a further £5 for the fifth year, £6 for the sixth, and so on up to the sixteenth year.

It often takes several years to get an invention on to the market. If at the end of the four "free" years the patentee has made no profit, he may well be tempted to let the whole thing drop, in order to save the £5 renewal fee which then falls due.

A Fortune Thrown Away.

This is what happened to the famous de Forest patent covering the first three-electrode valve. De Forest, it will be remembered, improved the original two-electrode Fleming valve by inserting a third electrode or grid between the plate and filament. Later on this proved to be a vitally important step in the development of the valve, but in 1910, when the first £5 renewal fee fell due, no one was using it, and so de Forest let his patent lapse.

Had he kept it alive it would have been one of the master patents in the wireless industry, drawing a royalty from every three-electrode valve made and sold to the public. It has been estimated that de Forest threw away over a million pounds when he failed to pay that modest fee.

(Continued on page 298.)

WHAT'S ALL THIS?

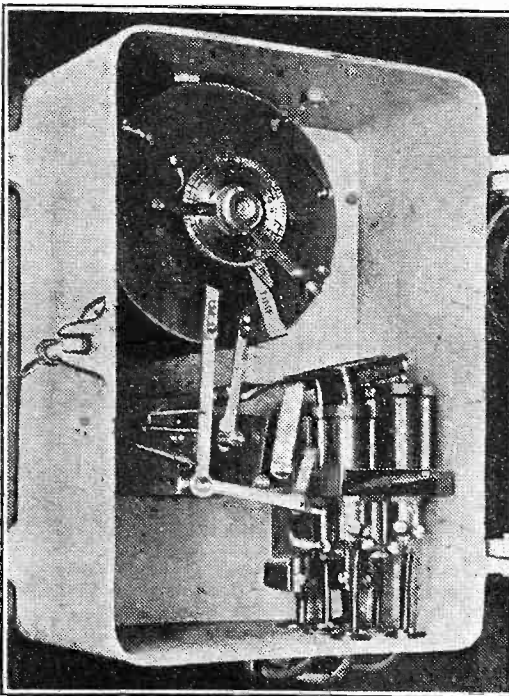

An ingenious clock which automatically switches on the required programme according to time.

TYPICAL OF TELSEN VALUE

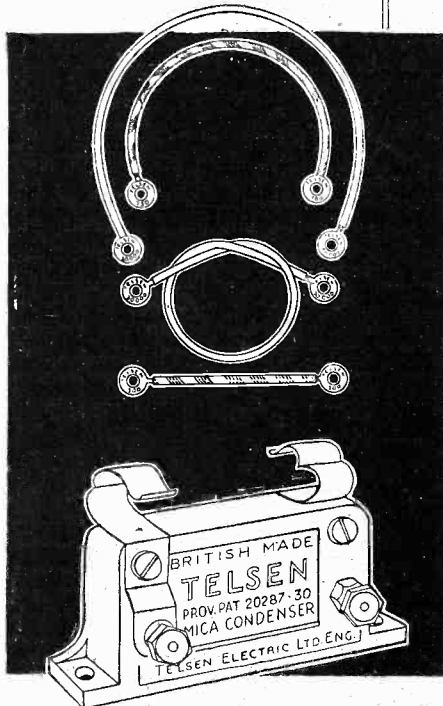
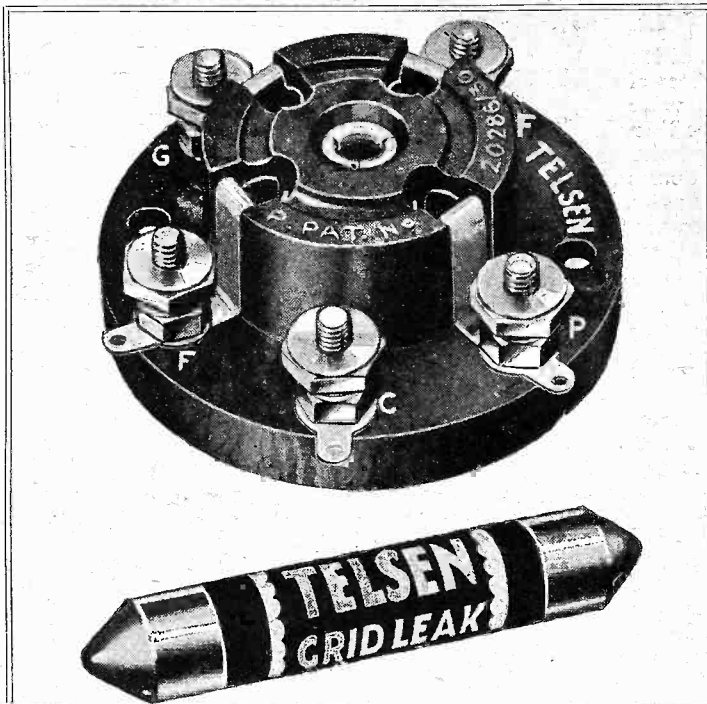

TELSEN SPAGHETTI FLEXIBLE RESISTANCES

These are made in a range of values from 300-200,000 ohms with a maximum current varying from 42 m/a. to 1 1/2 m/a. The terminal tags are firmly fixed to the wire and clearly marked with their respective resistance values; they are impregnated with special insulating compound which renders them proof against corrosion.

Telsen Spaghetti Flexible Resistances, from 6d.

TELSEN FIXED MICA CONDENSERS
(Prov. Pat. No. 20287/30)

Telsen Fixed Mica Condensers are made in capacities from .0001 microfarad to .002 microfarad. They can be mounted upright or flat, and the .0005-microfarad Telsen fixed mica condenser is supplied complete with patent grid leak clips to facilitate series or parallel connections. All Telsen fixed mica condensers are tested at 500 volts.

Telsen Fixed Mica Condensers, Price 6d.

TELSEN VALVE HOLDERS

(Prov. Pat. No. 20286/30)

The Telsen four and five-pin valve holders embody patent metal spring contacts, which are designed to provide the most efficient contact with split and non-split valve legs, and are extended in one piece to form soldering tags. Low capacity and self-locating.

Telsen 4-pin Valve Holder Price 6d.

Telsen 5-pin Valve Holder Price 8d.

TELSEN GRID-LEAKS

Telsen Grid-leaks are absolutely silent and non-microphonic, and practically unbreakable. They cannot be burnt out, and are unaffected by atmospheric changes. Telsen Grid-leaks are not wire wound and therefore there are no capacity effects. Their value is not affected by variation in the applied voltage. Made in capacities ranging from 1/4-5 megohms.

Telsen Grid-leak Price 9d.

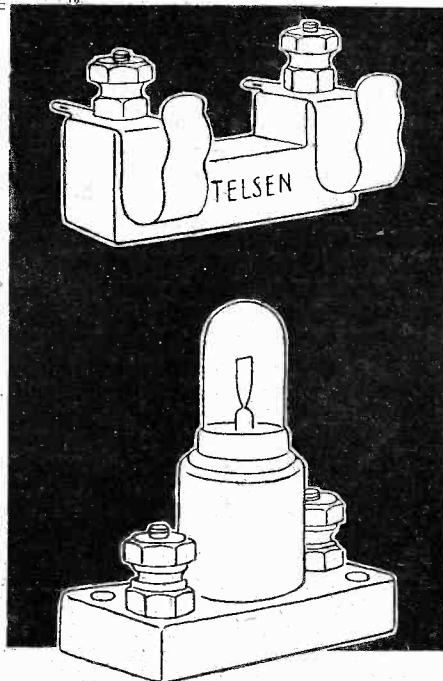

TELSEN GRID-LEAK HOLDER

The Telsen Grid-leak Holder will hold firmly any standard size or type of grid leak. Ample clearance is provided between the terminal screw leads and the baseboard (underneath), preventing any surface leakage upsetting the value of the grid-leak. The terminals and fixing holes are accessible without removing the grid-leak.

Telsen Grid-leak Holder, Price 6d.

TELSEN FUSE HOLDER

This is a neat and inexpensive device which should be incorporated in every set as a precaution against burnt-out valves.

The Telsen Fuse Holder firmly grips the standard radio fuse, giving a perfect contact.

Telsen Radio Fuse Holder, Price 6d.

TELSEN SCREENS

Price 2/- and 2/6

TELSEN

ALL-BRITISH RADIO COMPONENTS

Send for the "Telsen Radio Catalogue" and book of "All-Telsen Circuits" to The Telsen Electric Co., Ltd., Aston, Birmingham.

FAMOUS RADIO INVENTIONS

(Continued from page 296.)

As a matter of fact, the story of the long rivalry between Fleming and de Forest over the discovery and development of the thermionic valve is one of the romances of patent law. Fleming filed his first valve patent in America, a few weeks later than de Forest, but when the question of priority came to be fought out, the American Courts decided that the de Forest valve was not a true thermionic valve, as we now know it, but depended for its action upon heat applied to the gas contained inside the bulb, whereas the Fleming valve utilised the electron stream emitted from a heated filament.

This interpretation was, of course, a victory for Professor Fleming (as he then was), and made his patent "master" over all subsequent valve improvements, whether made by de Forest or others.

A Generous Action.

Occasionally an inventor, instead of patenting a discovery, will give the benefit of it freely to the public without fee or royalty. Professor D. P. Hughes' lecture on the first microphone, before the Royal Society in 1878, is a case in point. By describing the microphone openly in this fashion, he sacrificed all patent rights on what would undoubtedly have proved a most valuable invention.

Among the older and now defunct "pioneer" wireless patents one may mention the well-known "four-sevens" patent of 1900, which covered the use of

loose-coupling between the aerial and the input circuit. This improvement might be described as the first step in the long search for selectivity.

There were also a series of early valve patents owned by the Marconi Company which were upset a few years ago as the

result of prolonged and costly litigation by the Mullard Valve Co. This famous valve action was fought out first in the High Court, then in the Court of Appeal, and lastly in the House of Lords, before the question of infringement or not could be finally settled.

SOME OF THE MANY INVENTIONS IN RADIO

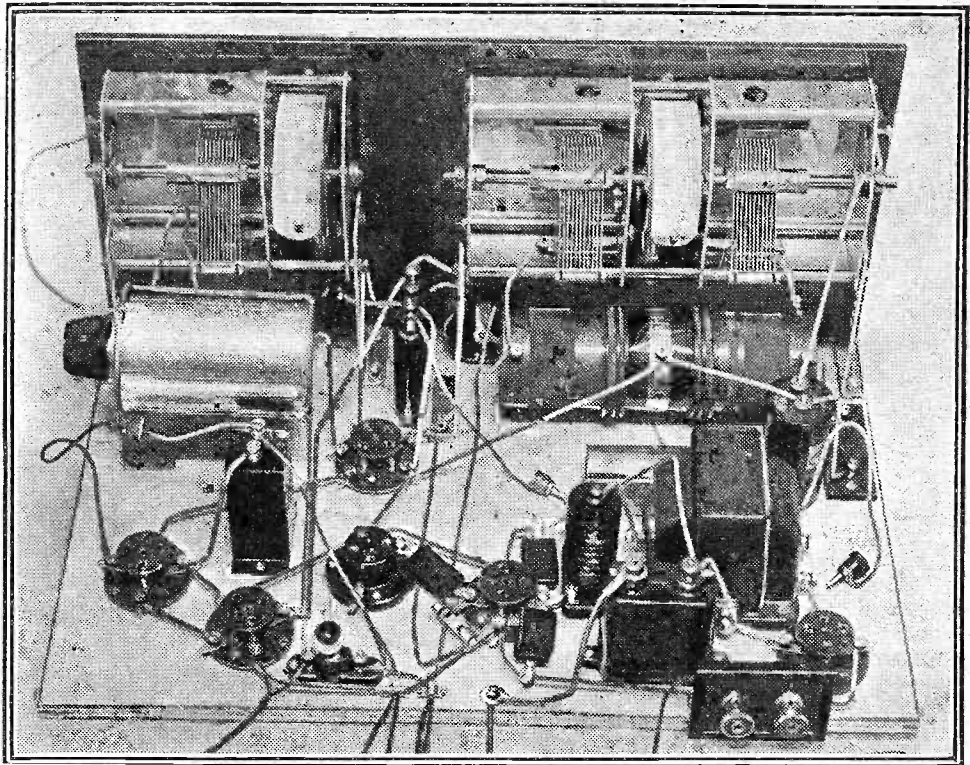

This is the famous "P.W." "Super-Quad," and, like other modern sets, it simply bristles with brainy ideas that have been applied to radio reception.

WIRING YOUR SET

The whole business simply explained.

TO obtain neatness, wiring-up a set is always well worth a little trouble. It can be made quite a pleasure if you follow the right methods. Some prefer to start by cutting the wire up into short lengths, but this is not necessary and wastes a lot of good wire.

Take your coil of wire and open it out to about 12 in. Place the extreme end in the vice and stretch the length out with the pliers. Decide on your first connection, and, having put a neat turn on the end of your wire, as shown at "A" in sketch, slip this over the terminal and shape the wire up to the next connection, finishing up by cutting off the coil and putting on the turn.

If you have need for a junction, and do not want to solder up the wires until you have given the set a trial, a good method of joining the wire is shown at "B." Grip the wires as shown and turn one round the other—the finished joint is shown at "C"—as if the work has been carried out correctly it will give a firm joint which can be soldered later if desired.

Sometimes it is necessary to run one wire so as to link up several points, such as the valves. A good way of doing this is illustrated at "D," where a small former is used to shape up the wire. In "E" we see the

result—one loop goes over one terminal and the other goes to the next, and so on.

In every case always start by making a loop on the end of the wire, then running it to the next point, putting in the bends neatly as you proceed.

HOW TO PLY YOUR PLIERS

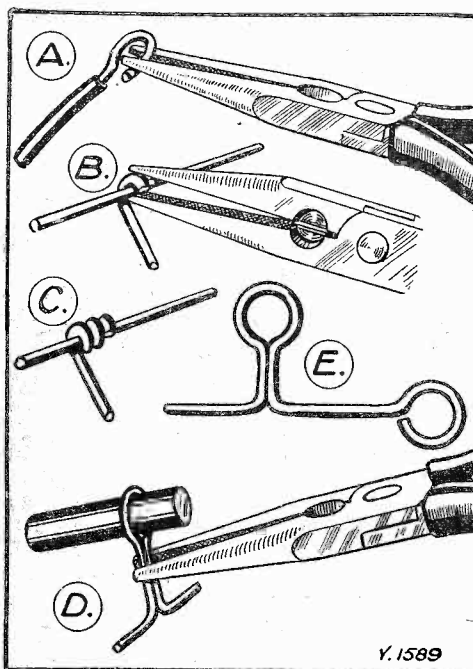

Neat joints and wiring are SO easy if you go about them in the right way. It is explained on this page.

SOME RADIO WRINKLES

Filing, Charging, etc.

Do not file ebonite with a fine file unless it has been dusted first with French chalk.

If you charge your L.T. battery whilst it is inside the cabinet the effect of spraying on the leads may be overcome by using long lead connectors smeared lightly with vaseline to hold the connecting wires well away from the accumulator itself.

A common cause of "hum" is the earth lead becoming broken underground.

If you derive your high tension from D.C. mains, and you feel a tingle when you touch your loud speaker there is a defect in the installation, and you should switch off until it is put right.

It is not necessary to have a separate short-wave set for short-wave reception, but a special short-wave adaptor can be plugged into the ordinary set. (This idea, which is now extremely popular in America, and, indeed, all over the world, was first tried out in the "P.W." laboratory.)

For short-wave reception special coils are used, which generally have from two to ten turns.

Ready Radio

TESTED KITS

B.P. 3

THE NEW "B.P." THREE

	£	s.	d.
1 Ebonite Panel 18 in. x 7 in., drilled to specification	5	6	
1 "LANDOR" Cabinet to specification with 10-in. baseboard	1	5	0
1 Lewcos Band Pass Coil	12	0	
1 Lotus .0005 Double Gating Condenser with Disc Drive	1	5	0
1 ReadiRad .00075 Brookmans condenser	3	6	
1 A.E.D. volume control 500,000 ohms	8	6	
1 ReadiRad on-off switch	0	10	
3 Junit valve holders	2	0	
1 R.I. General Purpose L.F. transformer, ratio 7-1	10	6	
1 ReadiRad Standard H.F. choke	4	6	
1 R.I. General Purpose L.F. choke	12	6	
1 T.C.C. .0003 fixed condenser, type 34	1	6	
2 T.C.C. .001 fixed condensers flat, "S" type (non-inductive)	5	0	
2 T.C.C. 2-mfd. fixed condensers, type 30	7	8	
1 ReadiRad 2-meg. grid leak and holder	1	4	
1 Lewcos 100,000-ohm spaghetti resistance	1	6	
1 25,000-ohm spaghetti resistance	1	6	
1 ReadiRad H.T. fuse and holder	1	3	
1 ReadiRad radio gram. snap switch	2	9	
1 Terminal strip, 18 in. x 2 in., drilled to specification	1	6	
11 Belling-Lee indicating terminals, type "B"	5	6	
1 Packet Jiffilix for wiring	2	6	
7 Belling-Lee wander plugs	1	2	
2 Belling-Lee spade terminals	0	4	
3 Mullard valves to specification, PM2DX, PM1LF, PM2	1	7	6
Screws, Flex, etc.	0	8	
TOTAL (Including Valves and Cabinet)	£8	11	6

If you do not need the complete kit of parts, you can purchase any component you require separately.

KIT "A" - £5:19:0

(Less Valves and Cabinet)
or 12 equal monthly instalments of 11/-

KIT "B" - £7: 6:6

(With Valves Less Cabinet)
or 12 equal monthly instalments of 13/6

KIT "C" - £8:11:6

(With Valves and Cabinet)
or 12 equal monthly instalments of 15/9
COMPLETELY ASSEMBLED RECEIVER Aerial
Tested, Royalties paid £10.1.6
or 12 monthly instalments of 18/6.

INSTAMATIC OUTPUT

If you require an INSTAMAT instead of the choke-condenser output circuit add 11/2 to the cash price of Kits A, B or C or 1/- to the Hire Purchase Terms. If you require an INSTAMAT MAJOR add £1:1:2 to the cash price of Kits A, B or C or 2/- to the Hire Purchase Terms.

See page 300

Cash or Easy Payments

Hear the B.P.3 demonstrated at our showrooms, 159, Borough High Street, S.E.1.

Immediate Dispatch

See also pages 293, 300, 303, 305.

ORDER FORM To READY RADIO, LTD., Eastnor House, Blackheath, S.E.3.

CASH ORDER. Please despatch to me at once the goods specified for which I enclose payment in full of £

C.O.D. ORDER. Please despatch to me at once goods specified for which I will pay in full the sum of £

EASY PAYMENT ORDER. Please despatch my Easy Payment Order for the goods specified for which I enclose first deposit of £

Name.....

Address.....

Kit. Required.....



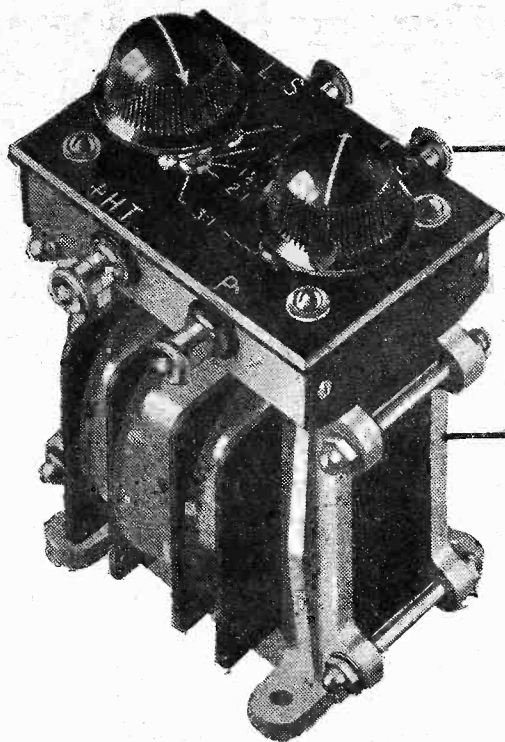

**MAKE SURE
OF
QUALITY**



INSTAMAT OUTPUT TRANSFORMER

(guaranteed for 5 years)

For all types except moving-coil loud-speakers. Five different ratios all clearly marked, 1:2, 1:1, 1½:1, 2:1, 3:1.

PRICE 27/6

INSTAMAT MAJOR

For low resistance moving-coil speakers. Six ratios: 10:1 up to 25:1.

PRICE 37/6

The B.P.3 is capable of giving exceptionally good quality, and you will probably use a good loud-speaker with it. *But do they match?* Accurate matching between output valve and loud-speaker is essential for good quality reproduction. The easiest, quickest and most certain way of obtaining accurate matching is to use an INSTAMAT with which you can switch instantly from one ratio to another until you obtain the one which matches your valve with loud-speaker perfectly.

The INSTAMAT is an Output Transformer of the very highest grade. It is exceptionally robust in construction and will carry heavy current without over-loading. It is connected between output valve and loud-speaker and different ratios are obtained simply by turning the switches.

For the B.P.3

Output Circuit

Instead of the choke-condenser output circuit incorporated in the B.P.3, you are recommended to use an INSTAMAT Output Transformer. In addition to obtaining all the benefits of a correctly designed output stage you will also be able to match your output valve and speaker instantly and perfectly.

If you require an INSTAMAT Output Transformer instead of the choke-condenser output circuit, see page 299.

For full lists of parts and order form see page 299.

Ready Radio



EASTNOR HOUSE, BLACKHEATH, S.E.3

Telephone : Lee Green 5678.

Telegrams : Readirad, Sedisi.

Showrooms : 159 Borough High Street, London Bridge, S.E.1. Telephone : Hop 3000.

CAPT. ECKERSLEY'S QUERY CORNER



Under the above title, week by week our Chief Radio Consultant comments upon radio queries submitted by "P.W." readers.

Don't address your questions direct to Capt. Eckersley, a selection of those received by the Query Department in the ordinary way will be answered by him.

A Question of Stability.

N. V. (Brixton).—"My receiver, which incorporates a stage of screened-grid H.F. amplification, was originally designed to use the tuned-anode coupling between the detector and H.F. stages.

"Slight H.F. instability was experienced, and I tried the effect of using the tuned-grid coupling, feeding the H.T. to the S.G. valve anode through an H.F. choke and placing a .001 fixed condenser between the latter point and the grid end of the detector-stage coil.

WAS IT DAMPING?

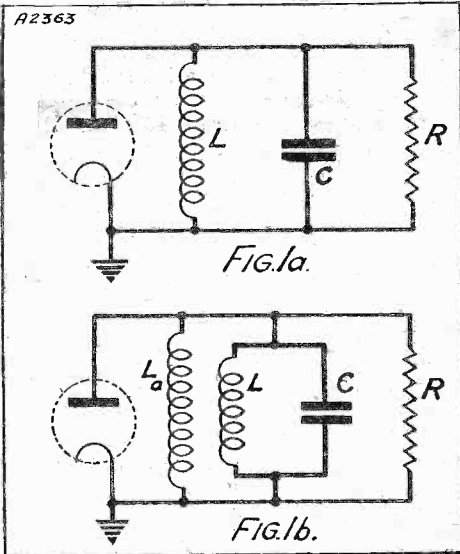

The 1b circuit proved to be much more satisfactory than 1a, and Capt. Eckersley suggests that the shunted choke was responsible.

"The receiver is now quite stable and the amplification does not appear to have suffered. Can you tell me why this should be the case?"

It is a little difficult to answer your question categorically. When one finds greater stability in one circuit than another one usually suspects that the more stable circuit has a greater damping introduced somewhere.

If you draw a "schematic," as I have done, of your two circuits, you will find that Fig. 1a represents the first arrangement (leaving out the H.T., blocking condensers, etc., and considering the whole thing from the point of view of high frequency), while Fig. 1b represents the second arrangement.

You will see that in Fig. 1a the circuit L.C. is in parallel, in effect, with the resistance R, and with the valve.

In the case of Fig. 1b, the circuit L.C. is in parallel with a resistance and a choke.

It is probable that because you have shunted the circuit L.C. in Fig. 1b by the impedance of the choke additional to the resistance you had in Fig. 1a, this has introduced an extra damping and so the circuit is more stable. This would not greatly effect the amplification because the introduction of the choke would only slightly diminish sensitivity, but nevertheless enough to prevent instability.

How Alternating Currents Flow.

W. J. R. (Bexhill).—"Having seen in a text-book that alternating currents flow first in one direction and then in the reverse direction, I find it difficult to understand the exact manner in which the current flows. Does the current flow straight along the wire, as the normal illustration shows, or from one side of the wire to the other as the polarity changes?"

I don't quite understand your question, but surely the matter is very simple. Please see my diagram.

In Fig. 1a, let us say for the sake of convenience, that a current flows through the resistance R from plus to minus. Now if I reverse the battery, as shown in Fig. 1b, the current flows in the other direction through the resistance, as indicated by the arrow.

If I were to arrange, as shown in Fig. 1c, a double-pole change-over switch, cross connected as shown, then the current could be made to flow first in one direction through the resistance and then, by throwing over the double-pole switch, in the other direction, and you would have a sort of alternating current (with a rather bad wave form!).

I have drawn below Fig. 1c the direction and intensity of the current if the switch

is thrown over. An alternator does not reverse the current abruptly but gradually, and in Fig. 1(d) you will see, below the drawing of the alternator and the resistance, the shape and direction of the current-time curve, called a sine curve. I hope the matter is now perfectly clear to you.

WHAT IS A.C.?

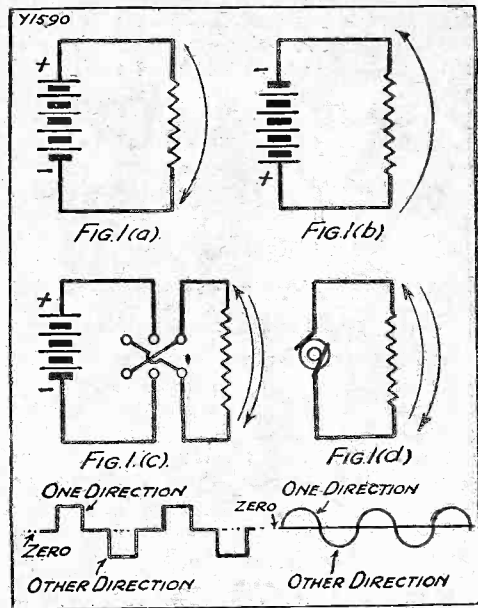

Read the easy-to-follow explanation of alternating current given to a Bexhill reader.

Shifting the Mains Unit.

B. R. (Tooting).—"I used to be troubled with a loud hum when using my S.G. detector and pentode receiver with an A.C. eliminator. The eliminator was normally kept close to the L.F. stage, but on moving the unit to the opposite (H.F.) end of the receiver, the hum ceased and programmes were received with a background of absolute silence. "Why did the position of the H.T. unit show such a marked difference in results?"

Probably merely because the H.T. transformer's magnetic field leakage coupled with the iron-cored choke (or transformer) in the pentode anode (or any other transformer and choke in the L.F. circuits). It was a pure induction effect of 50-cycle circuits in the receiver L.F. circuits, and when you moved the H.T. unit away from the L.F. circuits the inductive effect was eliminated.

Naturally you can't induce 50-cycle effects into high-frequency circuits designed to respond to million-cycle effects, and so putting your eliminator near the H.F. end gave you that "background of absolute silence."

ONLY IN "P.W."

can you read Captain Eckersley's replies to listeners' own problems.

AND REMEMBER—

Captain Eckersley's technical articles appear only in the "Big Three,"

"POPULAR WIRELESS,"
"MODERN WIRELESS," AND
"WIRELESS CONSTRUCTOR."

POZNAN — A LITTLE STATION WITH A BIG RANGE



I HAVE met Mr. Okoniewski! a very important personage in Poland, for he is the Director of the Poznan broadcasting and short-wave stations; and as little Poland is very proud of these links with the outside world, it is also very proud of Mr. Okoniewski!

Through a liaison with a Dutch broadcasting concern, arrangements were made for me to meet this Poznan official, and I spent an interesting afternoon at the short-wave station.

Poznan also boasts of a medium-wave broadcasting station working on about 350 metres, and no doubt some of you have this down on your logs, but as its power is only of the order of less than two kilowatts, and as it is rather a poor spot in the medium waves for British listeners, it is not generally heard well.

The short-wave Poznan is quite a different proposition, of course, and its short-wave transmissions have been heard over practically the whole of Europe, in many parts of America, and further afield.

Mr. Okoniewski told me this with pride, and then put me in the care of one of the station staff, who explained the working to me.

"The station has been going for two years," he said.

"There were twenty-four months of constant experiment before the present good results were obtained, and until we could guarantee a regular transmission schedule.

When to Tune.

"As readers may not know the exact regular working times of the station you had better make a note of these, which are reduced to British summer time. On Tuesdays we work for three hours, from a quarter to eight till a quarter to eleven at night, and on Thurs-

* * * * *

Our Special Correspondent here describes a visit to Poznan, the short-wave transmitter of Poland, which has been heard all over the world, and he tells of an interesting conversation with the station director.

* * * * *

days from 7.30 in the evening till 2 o'clock in the morning.

A Home-Made Transmitter.

"During the early days of the station we were not so fortunate in having facilities to give a regular weekly schedule like this. At the beginning of 1928 we started plans for the formation of a short-wave transmitter to link up Poland with the rest of the world, but owing to the difficulty of raising funds it was not until January, 1929, that we first managed to get tests put out on two wave-lengths, one just below 30 metres and the other just above.

"The power was very low because we had not then sufficient apparatus. During the

following three months a new generator was obtained and shortly we were transmitting with a power of about half a kilowatt.

It does not sound very much, but then, as you probably know, low-power short-wave transmissions are often the most efficient. Well, in 1930 the new building was taken over and new gear was installed. Since then we have worked regularly according to the schedule I have just given."

I found that the short-wave gear is in the main broadcasting station building, and has been built entirely by the engineers at the station. All credit to them for the highly successful results!

The engineers in the station shops have made a good job of the constructional work, and the transmitter itself is a fine piece of woodwork and copper shielding. A wooden cabinet is used—some 5 ft. to 6 ft. high—to prevent stray currents being set up, as might be the case were a metal frame used.

As shielding is of vital importance in a short-wave transmitter, just as it is in your short-wave receiver, copper screens have been placed at critical points and these are earthed.

The transmitter is crystal controlled, which accounts for the fact that Poznan is always exactly on its wave-length. I was rather interested in the special way in which the crystal is used for controlling the first stage.

Quartz Control.

It appears that an ordinary push-pull circuit is used with large power valves in the first stage of the transmitter, and the quartz crystal is simply placed in the common grid circuit of the two valves.

Following this push-pull stage is the first frequency doubler, and here, again, two valves are used. This idea of

(Continued on page 304.)

"PEEPING IN" TO POLISH PROGRAMMES

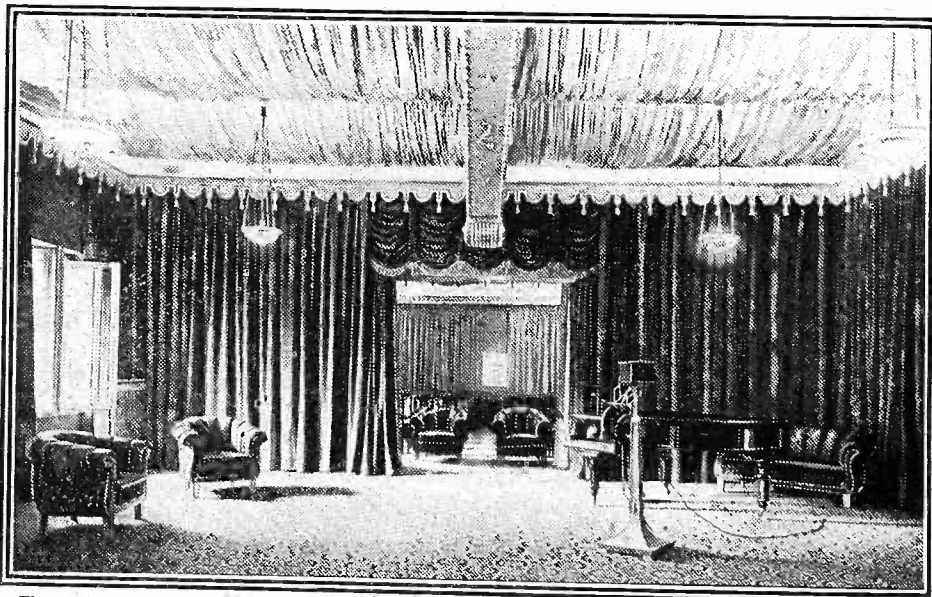

The main studio at Poznan is so arranged that an audience can watch the artistes broadcasting although the audience is not actually in the studio itself. Between "turns" the curtain can be drawn if desired, as at a theatre.

ALL Ready Radio kits are tested & passed before despatch



Every receiver described in "Popular Wireless" is assembled by Ready Radio Experts with chosen components and is tested and passed before despatch under the supervision of Mr. G. P. Kendall. Every purchaser of a Ready Radio Kit is consequently able to build a receiver identical in performance and appearance with the original model.

Below are listed some of the Kits of receivers which have proved particularly popular.

Immediate Dispatch

Ready Radio hold colossal stocks of all makes of Components, Receivers, Loud-Speakers, Mains Units and other radio accessories. Everything for radio can be obtained from Ready Radio.

Order form on page 299.

"POP-VOX" FOUR
KIT "A" - - £6. 3.0
or 12 monthly instalments of 11/3
KIT "B" - - £8.10.6
or 12 monthly instalments of 15/9
KIT "C" - - £9.18.6
or 12 monthly instalments of 18/3

"COMET" THREE
KIT "A" - - £4. 5.0
or 12 monthly instalments of 7/9
KIT "B" - - £5.12.6
or 12 monthly instalments of 10/4
KIT "C" - - £7. 2.6
or 12 monthly instalments of 13/-

"P.V." PLUS
KIT "A" - - £4. 5.6
or 12 monthly instalments of 8/-
KIT "B" - - £6. 4.6
or 12 monthly instalments of 11/6
KIT "C" - - £7. 9.6
or 12 monthly instalments of 13/9

"P.V." STAR
KIT "A" - - £5.18.6
or 12 monthly instalments of 11/-
KIT "B" - - £7.17.6
or 12 monthly instalments of 14/6
KIT "C" - - £9. 5.0
or 12 monthly instalments of 17/-

*KIT A—Full set of components except valves and cabinet.
KIT B—Full set of components with valves less cabinet.
KIT C—Full set of components with valves and cabinet.*

Ready Radio

G.P. Kendall

For full details of the "B.P.3" see pages 290,
293, 299.

POZNAN—A LITTLE STATION WITH A BIG RANGE.

(Continued from page 302.)

having push-pull stages in transmitters seems to be catching on. I have seen it at one or two other stations not built by British engineers, who, for some reason, prefer single stages.

The second frequency doubler at Poznan is a single stage, and the final valve which links up with the aerial and the tuning arrangement is a $1\frac{1}{2}$ kw. "tube."

I admit that a power of only $1\frac{1}{2}$ kw.—about one-fiftieth of that put out by Brookmans Park—does not sound very impressive, but if you could see the reception log of Poznan you would realise how wonderfully these short waves of about 30 metres—Poznan works on 31.35 metres—reach out, although the power is modest.

250 Volts Grid Bias.

The side tone reception I heard indicated that the quality is good, although, frankly, this is hardly what one would expect from the type of modulation circuit used. It is what is known as grid modulation, and is the system used by many British amateurs.

It is generally reckoned to give good percentage modulation; although the quality is not excellent, but there was certainly no fault to find with the Poznan transmissions, as many short-wave enthusiasts in England can testify.

I asked how it was that the power output had been doubled, for although it is now just over a kilowatt, it was, until last year, only just over half that.

I was taken into the control-room of the main broadcasting station and shown the generators for the short-wave plant. There are two 2,000-volt H.T. generators which are now connected in series, giving 4,000 volts, and which have enabled the power thus to be put up. There is a separate little generator which, they told me, gives the grid bias at 250 volts.

CRYSTAL CONTROLLED

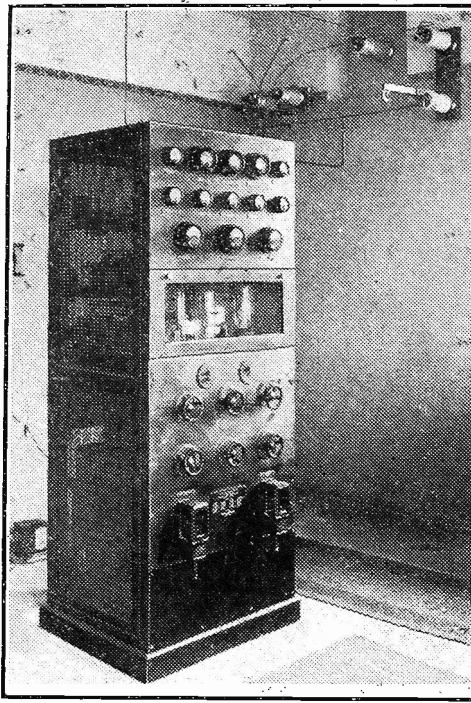

The Poznan Short-Wave transmitter is crystal-controlled and specially screened. It doesn't look a very big instrument with which to cover the world, does it? But an effective short-waver can achieve astonishing ranges with comparatively low power.

The control gear for the short-waver is also in the control-room of the medium-wave station. There is rather a long landline from the studio to the control, so on the desk is a little 10-watt speech amplifier—a single L.F. valve job—which boosts up the speech input.

Up-to-date Aerials.

As at most short-wave stations, the aerial has been somewhat of a trouble because short-wave aerial theory is constantly varying and the Poznan engineers have tried to keep always up to date.

Out in the grounds I found that there was a short aerial known as the half-wave type. Now that arrangements have been

made to use the broadcasting station masts for the short-wave aerial, the engineers are copying one of the Koenigswusterhausen short-wave aerials and are hoping to get still better results.

A HANDY RESISTANCE.

A MOST useful resistance for many purposes can be made out of an ordinary lead pencil, which should preferably be of the 2H grade.

Sharpen the pencil at both ends, and then at each end make an electrical connection by wrapping the lead points with several turns of fine bare wire. Afterwards, a layer of silver paper may be placed over the turns of bare wire, and then, over the tinfoil layer, a few turns of heavier wire may be wound on and retained permanently and securely in position by means of a spot or two of liquid glue.

A pencil got up in this manner has a resistance of something like 300 ohms—the harder the pencil, of course, the higher being the resistance.

USEFUL FOR TESTING

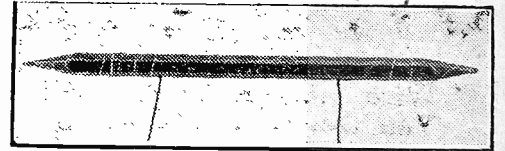

You can use it as a safeguarding resistance, as explained in the article.

In testing out delicate instruments, voltmeters, ammeters, and so on, it is a very handy little device.

Attached to an H.T. battery unit, also, it will act as a safeguarding resistance, enabling the current for the valves to flow freely, but absorbing the heavy flow of current which would take place in the event of any accidental short-circuiting of the H.T. system. For this purpose, the pencil-resistance could be permanently secured in place within the H.T. battery box.

PLUGGING-IN TO THE DIFFERENT STUDIOS

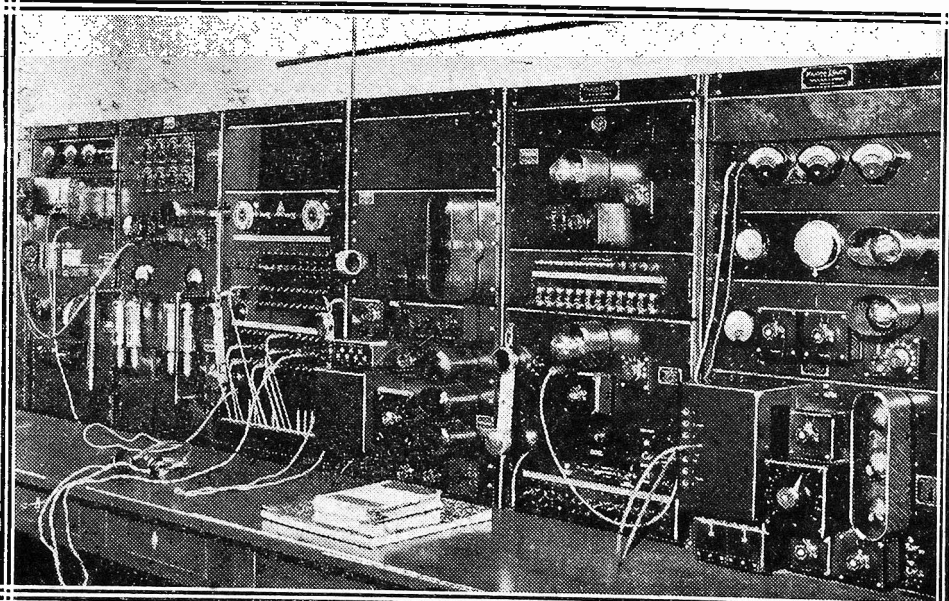

Towards the left of these control panels you will see a kind of telephone switchboard, and it is with this that the engineer connects the Poznan transmitter to any one of a number of studios and landlines.

AN UNUSUAL FAULT—

which would have interested Miss Muffit!

A FEW evenings ago the signals from my fairly powerful mains set began slowly but very surely to fade away, until after about five minutes only a whisper remained.

As the outfit was a radio-gram, whose "innards" were not readily accessible, I determined, after assuring myself that it was not a station "fade," to examine externals first.

Result—a double-pole, double-throw porcelain switch, used for earthing the aerial, had attracted the attention of a large spider, which, when I appeared on the scene, was busy spinning its web across two of the springs, thus forming a reasonably effective "short."

The spider was despatched, the web removed, and all was well again. A.B.

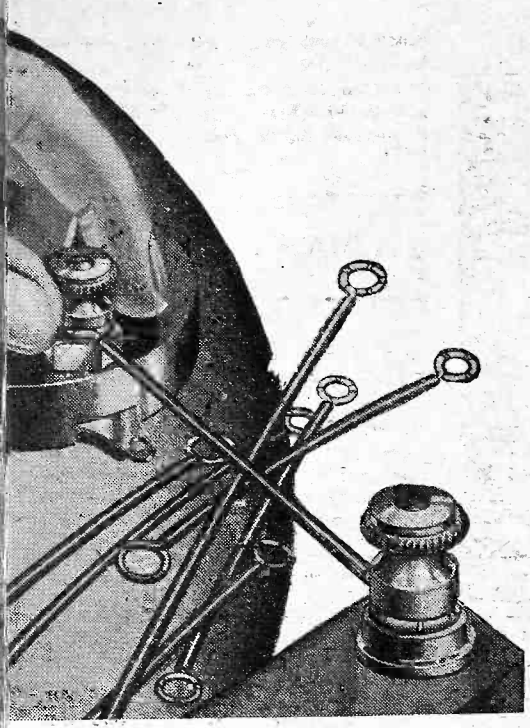

JIFFILINX

Wire your set with Jiffilinx. You will be delighted with the ease and rapidity as well as the neat appearance of the finished job. What is more you will be sure of perfect contact throughout.

Jiffilinx consists of lengths of high conductivity wire covered with special insulating sleeving which obviates all risk of short circuits. Both ends of the Jiffilinx are terminated with shake-proof connectors designed to fit the terminals of all components. They grip fast and give perfect contact without soldering.

Each packet contains 40 Jiffilinx in various lengths—ample to wire a large set. Jiffilinx can be used over and over again. Changes in wiring can be made instantly and errors corrected without wastage.

Get a packet now. Once you have used Jiffilinx you will never use any other form of wiring.

2/6 Per Packet, Post Free.

10 HOWS FOR THE MODERN RADIO CONSTRUCTOR

Would you pay 6d. for real quality?

“How to get real quality” is only one of the many interesting subjects dealt with in the new Kendall book. It contains hundreds of useful suggestions which will help you to get better radio.

Nearly 20,000 words, free from advertising. Equally useful to the non-technical as well as to the technical reader. Many illustrations.

The finest six-penny-worth ever offered.

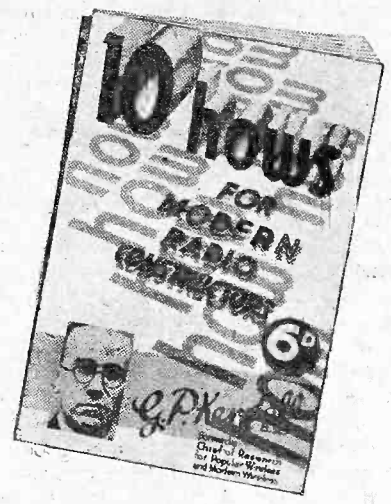

PRICE 6^D POST FREE

Over 15,000 copies sold at Olympia.

POST COUPON TO-DAY FOR YOUR COPY.



To: **READY RADIO, Ltd., Eastnor House, Blackheath, S.E.3**

Please send me (a) a copy of Kendall's Book for which I enclose four 1/2d. stamps. (b) One packet of Jiffilinx, for which I enclose 2/6. (Cross out items not required.)

Name.....

Address.....

BROADCASTING IN IRELAND

1. AN 80-KW. STATION FOR THE IRISH FREE STATE.

Following his recent tour of B.B.C. stations in the North for "Popular Wireless," Mr. Leslie W. A. Baily visited Ireland, and he has written three extremely interesting articles on broadcasting in the Free State and in Ulster. The first appears below.

ON the site of the old Dublin General Post Office, which was sacked in the 1916 rebellion, a mammoth new building is rising. Here all the administrative activities of the Department of Posts and Telegraphs (which is the Irish Free State's equivalent to our Post Office) are being centralised, and in the part which is now finished I found the studios and offices of the Dublin broadcasting station.

The fact that (except for the transmitter) the broadcasting station has its being under the roof of the General Post Office was the first indication of the Civil Service status of broadcasting in the Irish Free State. Others soon followed.

FRIENDLY LINKS

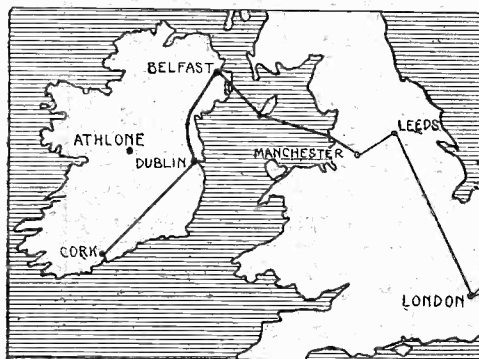

This map shows the proposed location of the Irish high-power station at Athlone. It also indicates the land-line route used when Irish stations relay a B.B.C. programme.

The officials, who are all Post Office servants, were eager to show me round the station, but when I asked questions about Policy they referred me to Dublin Castle.

A Question of Policy.

This is perhaps the most striking of all the differences between the Free State's system of broadcasting and that of Great Britain. The B.B.C. has complete responsibility for broadcasting; but in the Irish Free State the job of broadcasting officials is simply to organise the daily programmes. Questions of policy are not their business.

And so it was to Dublin Castle, the seat of Government, that I went to find out on what general lines the Free State is running its broadcasting. I interviewed the Assistant Secretary to the Department of Posts and Telegraphs, Mr. B. de Brit.

"State control is proving satisfactory,

and is not likely to be changed," said Mr. de Brit. "Our system is that a sum of money is voted by the Dail, our Parliament, for the broadcasting service.

Paying for the Programmes.

"The vote for 1931-32 was £78,784, which included certain estimated expenditure on the proposed high-power station.

"Revenue for broadcasting is obtained from three sources. First, receiving licences. Over 26,500 have now been issued. Each costs ten shillings, and the entire revenue from this source goes to broadcasting, less a charge taken by the Post Office to cover the cost of collection.

"The second source is a tax on wireless apparatus imported into the Free State. In 1930-31 this brought in £35,000. The third source is the revenue from sponsored programmes.

"I would emphasise," added Mr. de Brit, "that our sponsored programmes are still experimental. We ran them occasionally between last October and March, when they produced a revenue of £510, plus the saving to us in having these programmes paid for by outside advertisers.

Revenue from Advertisements.

"We started them again on September 1st, and we shall run them through the winter. Their future will depend upon developments with the high-power station."

While he was unwilling to express an opinion on them, Mr. de Brit said emphatically that sponsored programmes have not been a failure. There have been no complaints from the public about them.

"And what about the high-powered station?" I asked.

"Everything is ready," replied Mr. de Brit. "The Marconi Company is well advanced with the construction of the 80-kw. transmitter, at its Chelmsford works. The building plans are completed.

"A site at Athlone is considered suitable

from a technical point of view, but there has been some delay in its acquisition. A final decision will be taken very shortly. Building operations will then commence immediately."

"How long," I enquired, "will it be after that before the station is in service?"

"Including time taken for tests, at least eight to ten months, and possibly twelve," was the reply.

The New Station.

The studios will remain in Dublin when this giant station is opened in the centre of Ireland. The Free State's present transmitters at Dublin and Cork have a power of only 1.5 kw. each, and their range is accordingly limited.

Large areas of the Free State are beyond the range of Free State programmes. It is the aim of the high-power station to cover the whole of the Free State.

Its transmissions will undoubtedly be heard in England at great strength. I was told by many people in Ireland that the B.B.C.'s North Regional station (which has a power of slightly less than that to be used at Athlone) is a very strong signal over there. North Regional and Daventry National are popular programmes with Irish listeners.

Mr. de Brit informed me that the future of the Dublin and Cork transmitters cannot be foreseen, but I gather that it is probable

(Continued on page 318.)

THE DUBLIN TRANSMITTER

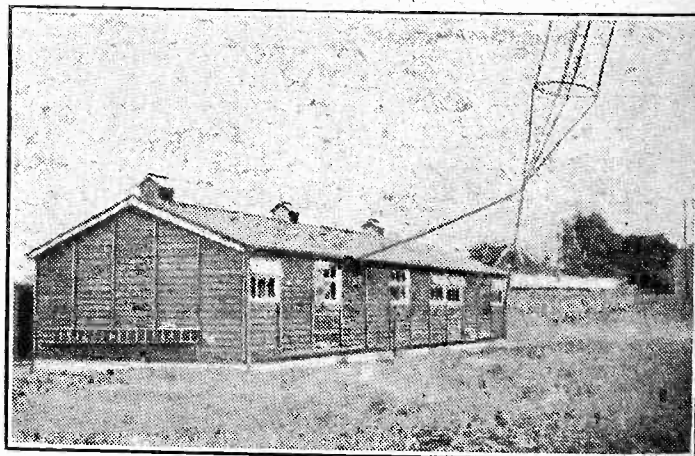

The building which houses the 1.5-kw. transmitter used by the Dublin station, which, by the way, broadcasts on a wave-length of 413 metres.

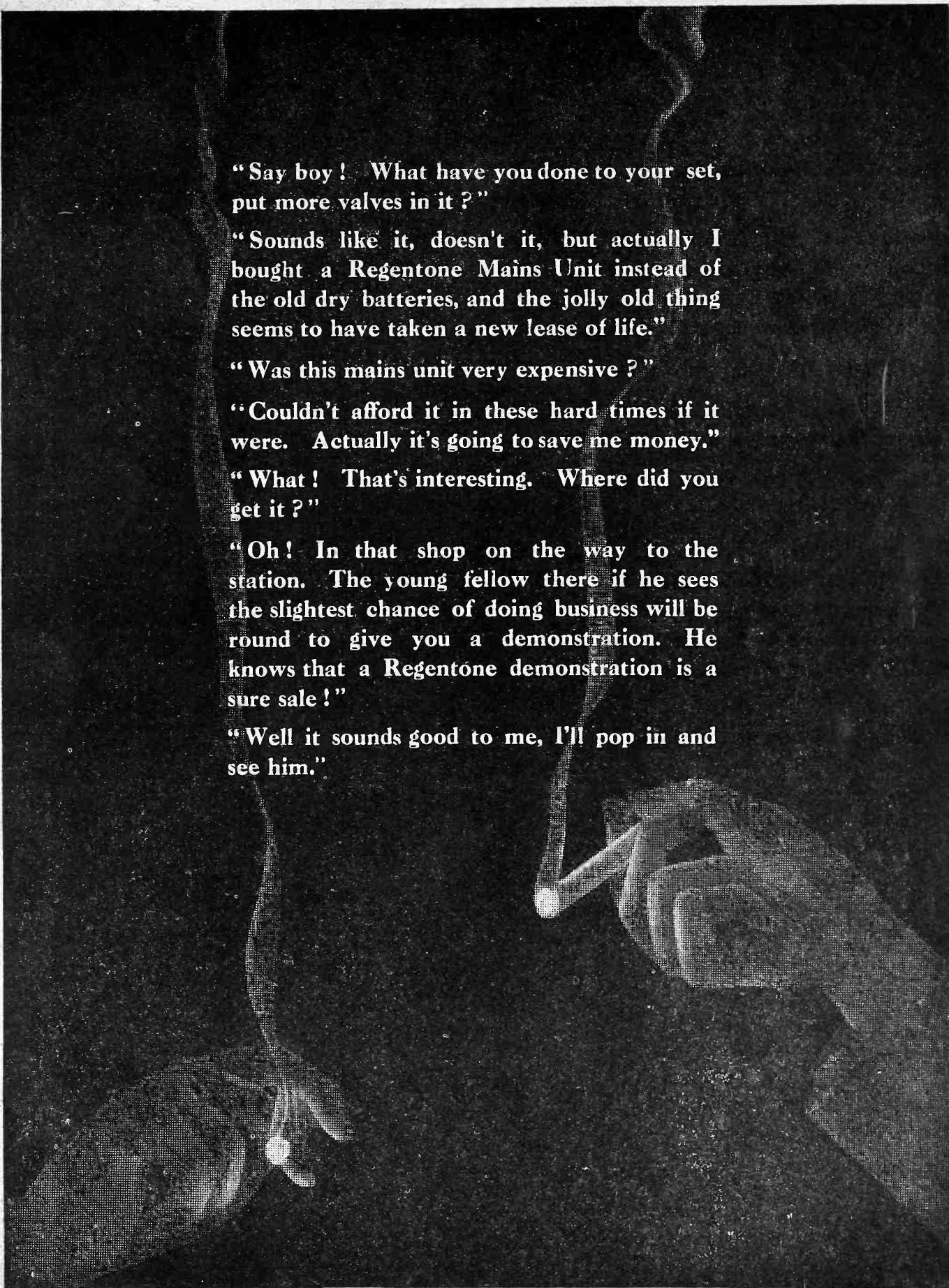

"Say boy! What have you done to your set, put more valves in it?"

"Sounds like it, doesn't it, but actually I bought a Regentone Mains Unit instead of the old dry batteries, and the jolly old thing seems to have taken a new lease of life."

"Was this mains unit very expensive?"

"Couldn't afford it in these hard times if it were. Actually it's going to save me money."

"What! That's interesting. Where did you get it?"

"Oh! In that shop on the way to the station. The young fellow there if he sees the slightest chance of doing business will be round to give you a demonstration. He knows that a Regentone demonstration is a sure sale!"

"Well it sounds good to me, I'll pop in and see him."

NEW PERMANENT MAGNET MOVING COIL SPEAKERS

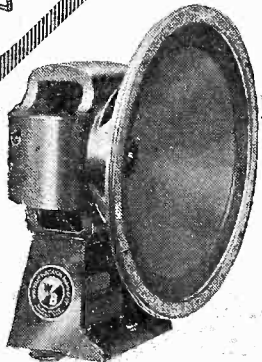

P.M.1. The original, but with new chassis. Extremely sensitive. No hum, boom or resonance. Massive Darwin Cobalt Steel Magnet weighs 11½ lbs. Chassis only £5.5.0. Three-ratio output Transformer extra 15/-

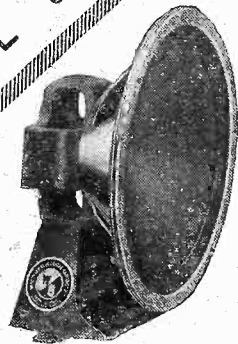

P.M.2. Identical with P.M.1 except that weight of Sheffield-made Cobalt Steel Magnet is 6 lbs. Has sold in thousands this summer. Chassis only. £3.10.0. Three-ratio output Transformer extra 15/-

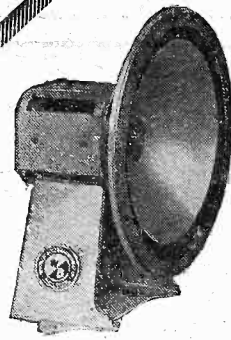

P.M.3. Entirely new model at astonishing price. Gives true moving coil reproduction from any receiver capable of working an ordinary cone speaker. Weight of Cobalt Steel Magnet 5 lbs. **45/-** Chassis only Three-ratio output Transformer extra 7/6.

Give your set the speaker it deserves—a modern moving coil speaker. Give it the most practical form of moving coil reproduction—PERMANENT MAGNET. Give it "W.B." "W.B." are pioneers in this field. These three new models are the most reliable and efficient PERMANENT MAGNET Moving Coil Speakers that radio has known. Write for Art Booklet "Speaking of Speakers"—FREE.

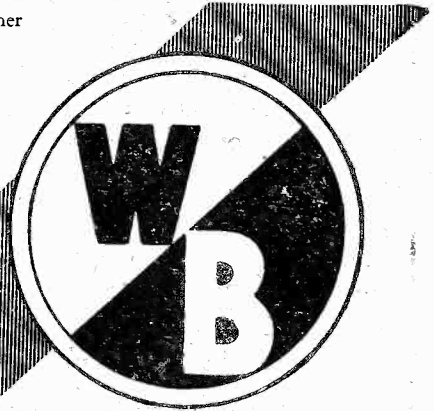

Made by the makers of the famous W.B. Valveholders and Switches.

Hear them at your Radio dealer's. **WHITELEY ELECTRICAL RADIO CO., LTD., NOTTINGHAM RD., MANSFIELD, NOTTS**
Irish Free State Distributors: Kelly & Shiel, Ltd., 47 Fleet Street, Dublin.

3 Superb ART Portrait ALBUMS of Famous Film Stars GIVEN FREE!



Photos of Over 140 FILM FAVOURITES

These wonderful Albums are FREE with ANSWERS—the first in TO-DAY'S issue, the others the next two weeks. They will help you to solve the new "Name the Stars" Contest which offers the stupendous first prize of

£10 A WEEK for LIFE or £3,000 CASH

which **MUST BE WON!** Make sure of your copy of

ANSWERS

Britain's National Weekly. Buy Your Copy Now **2d.**

**THE LEADING SUPPLIERS
FOR ALL COMPONENTS**

used in

THE NEW "B.P." THREE

A powerful three-valve receiver employing one of the very latest systems of "Single selectivity."

This is one of the most interesting sets of the season—to get the very best results from it you must use the best components, you can get them all from Will Day Ltd.

We have complete stocks of all the latest sets, radio gramophones, eliminators, speakers and components. Send for our new 1932 catalogue free to callers—by post 6d. refunded on first order.

WILL DAY LTD.

19, Lisle Street, Leicester Square,
LONDON, W.C.2.

'Phone : Gerrard 4476.

**POLAR
GIVES
YOU
FINER
REACTION**

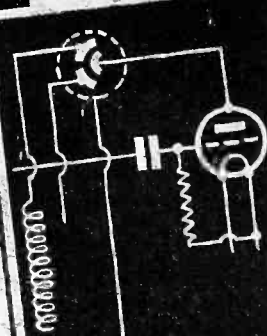

Polar Differential.

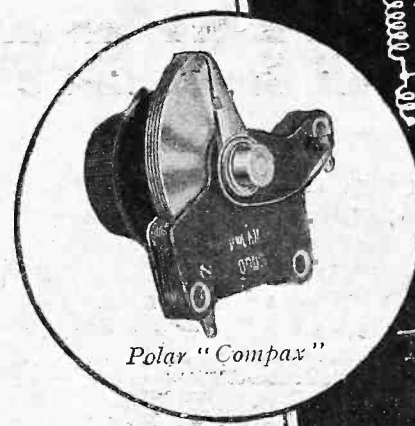

Polar "Compax"

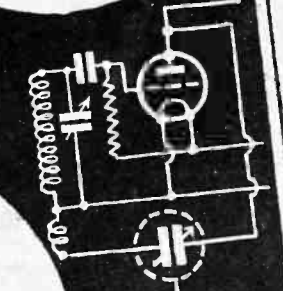

PRICE
12/6

READINGS :
0-150 VOLTS.
0-6 VOLTS.
0-30 MILLIAMPS.
3-3000 OHMS.

WATER'S UNIVERSAL TEST METER

Perfect control of your radio set is ensured with this handy test meter. It is fitted with a small battery and special leads with contacts for testing valve filaments. Supplied in neat polished black case with full instructions.

From all radio dealers. Literature direct from :—

THE STANDARD BATTERY CO., 184-B, SHAFTESBURY AVE, LONDON, W.C.2

"GOMPAX" CONDENSER

A solid dielectric specially designed for use as Reaction or Tuning condenser. Perfection of action. Bonded rotor vanes. Finely built. Price includes knob.

- 0003, ·00015, ·0001, 2/6
- 00005 2/9
- 0005 3/9
- REACTION No. 4 CONDENSER, ·0001, ·00015, ·00025 3/9

DIFFERENTIAL CONDENSER

Direct Drive. Constructed of highest quality materials. Smooth action gives very accurate control. Insulated spindle. Supplied with knob.

- 0001, ·00015, ·0003, 3/-

Slow Motion Type in same capacities as above... 6/6

Fully Illustrated Catalogue—Free.

WINGROVE & ROGERS, LTD.

188-189, STRAND, LONDON, W.C.2.
Polar Works, Old Swan, LIVERPOOL.





All Editorial communications should be addressed to the Editor, POPULAR WIRELESS, Tallis House, Tallis Street, London, E.C.4.

The Editor will be pleased to consider articles and photographs dealing with all subjects appertaining to wireless work. The Editor cannot accept responsibility for manuscripts or photos. Every care will be taken to return MSS. not accepted for publication. A stamped and addressed envelope must be sent with every article. All inquiries concerning advertising rates, etc., to be addressed to the Sole Agents, Messrs. John H. Lile, Ltd., 4, Ludgate Circus, London, E.C.4.

The constructional articles which appear from time to time in this journal are the outcome of research and experimental work carried out with a view to improving the technique of wireless reception. As much of the information given in the columns of this paper concerns the most recent developments in the radio world, some of the arrangements and specialities described may be the subject of Letters Patent, and the amateur and the trader would be well advised to obtain permission of the patentees to use the patents before doing so.

QUESTIONS AND ANSWERS

MAXIMUM STRENGTH OF A SHORT-WAVER.

Q. S. T. (Coventry).—"I propose to make a short-wave set solely and simply for the kick of the long-distance reception. Being able to read the Morse code at twenty-five words a minute, I am out particularly for American amateurs.

"Would it be an advantage to use a 7 to 1 ratio L.F. transformer as giving a greater step-up instead of the usual 3½ to 1, in order to get greater amplification?"

Certainly it would be advantageous, and even for the reception of American broadcasting you probably would not find that the transformer introduced noticeable extra distortion, even if the set was not designed for a high-ratio instrument.

BACK NUMBERS OF "P.W."

Back numbers of "P.W." are obtainable from the Amalgamated Press, Ltd., Back No. Dept., Bear Alley, Farringdon Street, London, E.C.4, price 4d. per copy post free.

DROPPING THE VOLTS BY A RESISTANCE.

R. D. (Sussex).—"I have 200 volts available, but wish to drop it down to about 150 volts. What is the resistance required for this?"

For the reason to be given further on you will have to calculate this out for yourself. It is very easy to do by means of Ohm's Law.

One way of stating Ohm's Law is to say that $R = \frac{V}{I}$. We can call the resistance R, the volts to be absorbed by that resistance V, and the current (to be passed by the resistance) I.

You will now see that in order to solve the equation in your case it is imperative to know the current to be passed. This you do not mention.

This current, of course, is the anode current which must flow through the "dropping" resistance, and is

YOUR BIT TOWARDS ECONOMY

Have you ever thought how difficult it is for a newsagent to order just the right number of copies of any particular paper each week? You can make his task much easier if you place a regular order with him. You will not only help him to order correctly and avoid waste but will make sure of getting your copy regularly each week.

easily ascertained either by measurement, or by calculation from the manufacturer's literature on the subject.

Suppose, for instance, that you find the resistance (R) must pass a current (I) of 1 milliamp, then the equation is easily solved because the required resistance (R) will be equal to 50

001 amps.

The 50 volts are, of course, those to be absorbed by the resistance and the 001 is the 1 milliamp expressed in amperes. It will be seen that the answer to this is 50,000, and this is approximately the number of ohms required in this instance.

Other values may be worked out in exactly the same way.

(Continued on page 312.)

A Set can never be any better than its Transformer

No matter how carefully the receiver may be planned; no matter how expensive the components; it is not possible to obtain better reproduction than that permitted by the audio frequency transformer.

This is one of several reasons why the expert, when designing a set for quality reproduction, specifies Ferranti as a matter of course.

There is no better Transformer than Ferranti

AF3. Ratio 1 to 3½ 25/-
AF5. Ratio 1 to 3½ 30/-
AF7. Ratio 1 to 1½ 30/-

AF4. Ratio 1 to 3½ 17/6
AF6. Ratio 1 to 7 30/-
AF8. Ratio 1 to 3½ 11/6



FERRANTI



FERRANTI Ltd. Head-Office and Works: HOLLINWOOD, LANCASHIRE.

LONDON: BUSH HOUSE, ALDWYCH, W.C.2.

THE FULLER LIFE PRESERVER does lengthen battery life

Immediately you discharge a battery below a certain point you shorten its life. How are you to tell when this point is reached? It is simple with the Fuller Life Preserver. When the red ball sinks you should charge your battery. Fuller Batteries have more points of superiority than any other. They are dry charged, and have Fuller micro-porous plates to ensure long life, patent double grease-cup terminals to guard against acid corrosion, red and blue collars and embossed polarity signs on the nuts to prevent incorrect connection. Patented free carrier. Prices lower than ever. Standard plate types available in glass (S.W.G.H.), in celluloid (S.W.X.H.), or in ebonite (S.W.E.H.) containers.



Enlarged view of LIFE PRESERVER

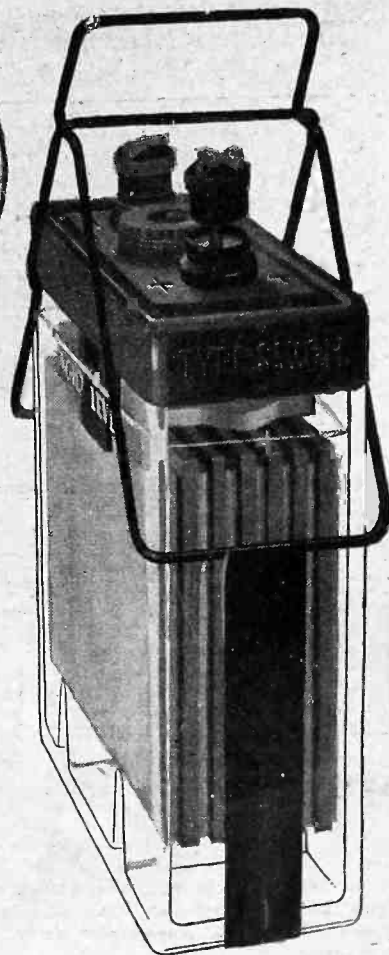

Visit us at the Manchester and Edinburgh Radio Exhibitions: The Motor Show, Stand 316 National Hall Gallery.

FULLER SUPER BATTERIES

Full list of H.T. Dry Batteries and L.T. and H.T. Accumulators on request.

FULLER ACCUMULATOR CO. (1926) LTD., CHADWELL HEATH, ESSEX

Phone: Seven Kings 1200. Grams: "Fuller, Chadwell Heath." Contractors to British and Overseas Government Departments, Railways, etc.

2 VOLT		
STANDARD PLATE		
TYPES SWGH—SWXH		
—or SWEH		
†Amp.	Hours	Price
20	...	8/3
30	...	10/3
40	...	12/3
50	...	14/3
60	...	16/3

†Actual at 20 hour rate.



Given an undistorted input the reproduction of speech and music is as near the original performance as has yet been attained by any type of speaker. Sensitive enough to operate from a two valve receiver; powerful enough to handle the output from large power amplifiers.

PRICE
45/-

Multi-ratio
Output Transformer
to suit all Power
Valves
12/6



The Supreme Achievement

in Permanent Magnet
Moving Coil Speaker Design & Performance

Compare the R. & A. 100 with any other P.M. Moving Coil Speaker at any price, and you will realise there is none to equal it for sheer value. Ask your dealer to demonstrate and do not be put off with costly or inferior substitutes. If any difficulty write us. Descriptive leaflet sent free on request.

REPRODUCERS & AMPLIFIERS LTD., Frederick St., WOLVERHAMPTON.

A FIRST-CLASS RADIO-GRAM CABINET

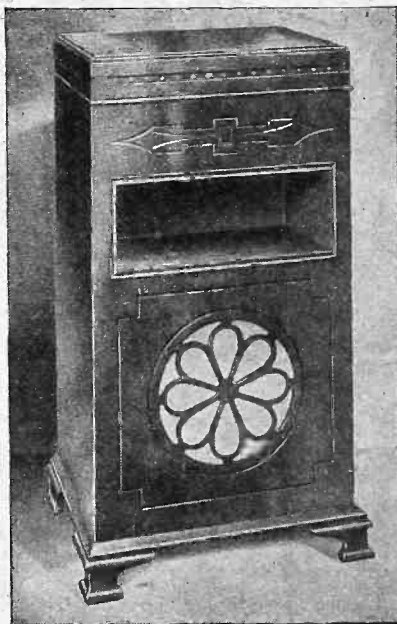

The Camco "Waverley" Radio-Gram Cabinet is appealing tremendously to the Public. A beautifully-finished and handsome piece of furniture, it is an astonishing value at only £5:10:0. There are two models, Junior and Senior, and in each ample space is provided for batteries, etc., and clearance allowed for gramophone motor. Write now for the 24-page Camco Radio Cabinet Catalogue giving full details of Camco's fine range.



AT A
SURPRISINGLY LOW PRICE!

Name.....
Address.....

P.W. 15.

**CARRINGTON
MFG. CO., LTD.,
24, Hatton Garden,
London, E.C.1.**

Phone: HOL. 8202.
Works: S. Croydon.

RADIOTORIAL QUESTIONS AND ANSWERS

(Continued from page 310.)

CONTRADYNE COILS.

T. G. S. (Bristol).—24 D.S.C. (60 turns) should be used for all Contradyne coils unless some other gauge of wire is specially stated.

THE "POP-VOX" FOUR.

E. P. H.—"I see that the above set was described in 'P.W.' last week. I have been waiting for it for some time, but find that in accordance with recent practice it has 'Extenser' tuning.

"At present I do not wish to go to the expense of buying Extensers, but should like to incorporate them afterwards, and I hope, therefore, that at some time you will give in-

It is not at all difficult to use ordinary tuning condensers and wave-change switches for this circuit. But some little care is necessary in the arranging and spacing of the leads to the switches, or otherwise in stability or reduced strength may be the result.

One great advantage of the use of Extensers is that wave-change wiring is automatically shortened and simplified, the actual change-over being made in the tuning circuit by the self-change contacts on the Extenser itself.

If wave-change switches are to be used instead, mount them under the respective tuning condensers and try to keep the wiring well spaced and yet direct.

The switch under the first Extenser may be an ordinary 3-point wave-change switch. The other switch (to be mounted under the Extenser in the centre of the panel) must be of the four-contact wave-change type, or else must have a metal plunger to which a flex lead can be taken, to provide a fourth contact, in the manner so often described in "P.W."

The fitting and wiring is really quite straightforward, and in the case of the first switch (under the aerial condenser) can be described in just a few words.

As far as the condenser is concerned, the fixed and moving vanes can be fixed exactly as at present. In addition, the lead joining X on the P.J.2 unit to the .001 compression condenser must be joined to one contact on the wave-change switch.

A second contact on that switch must be joined to the wire that joins Y on the P.J.2 to 2 on the long-wave coil.

Finally a third contact on that switch would be connected to the moving vanes of the Extenser. And that is all.

When the switch is "on" all the contacts will be joined together and the tuning will be on ordinary wave-lengths. When the switch is "off" the condenser will tune over long waves.

In the case of the second stage there are four contacts to be joined—three switch points as before, and a fourth which may be either a flex lead to the metal plunger, or the fourth contact on a four-contact switch.

One contact goes to the junction between X on P.J.3 and the tapping on the long-wave coil.

Another contact goes to the junction of Y and 2. A third contact goes to the junction of Z and 3. And finally a fourth contact (for the flex if used) goes to the moving vanes of the second tuning condenser.

That completes the alterations.

THE "SUPER-QUAD" WITH EXTENSER.

R. W. B. (Teddington).—"I would like to make the 'Super-Quad,' but am disappointed to see there is no Extenser in it. Could this be

arranged instead of ordinary tuning and switching?"

The advantages of the Extenser can be incorporated in a "Super-Quad" circuit, and indeed a full description of such a set—very similar otherwise to the "Super-Quad" in "P.W." dated August 22nd—appears in the October enlarged number of "Modern Wireless." It is called "The 'M.W.' Super-Quad," and a full-sized blue-print is given away with every copy of the October "M.W."

FINDING A FAULT.

P. H. H. (London, S.W.5).—"I never believe in looking for trouble, but I realise how much my set means to me, and I should hate to be without wireless now. Although my 'Pop-Vox' is going good (touch wood!), if anything

(Continued on page 314.)

"HULLO! WHAT'S WRONG WITH THE SET?"

Perhaps the switching doesn't work properly? Or some mysterious noise has appeared and is spoiling your radio reception? —or one of the batteries seems to run down much faster than formerly?

Whatever your radio problem may be, remember that the Technical Query Department is thoroughly equipped to assist our readers, and offers an unrivalled service.

Full details, including scale of charges, can be obtained direct from the Technical Query Dept., POPULAR WIRELESS, The Fleetway House, Farringdon Street, London, E.C.4.

A postcard will do. On receipt of this an Application Form will be sent to you post free immediately. This application will place you under no obligation whatever, but, having the form, you will know exactly what information we require to have before us in order to solve your problems.

LONDON READERS, PLEASE NOTE: Inquiries should NOT be made by phone or in person at Fleetway House or Tallis House.

MISSING LINKS, No. 19 AN H.T. UNIT FOR A.C. MAINS

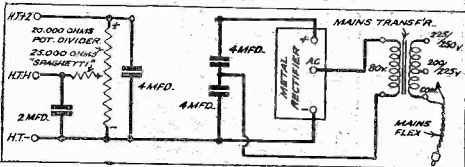

This diagram shows the connections for obtaining H.T. from A.C. mains, using a metal rectifier. But one of the "components" has purposely been omitted. Can you fill it in correctly? (Look out for the answering diagram next week.)

structions for wiring it with ordinary condensers and wave-change switches, for those who would like to construct the set on those lines."

SO GENTLE SO POWERFUL

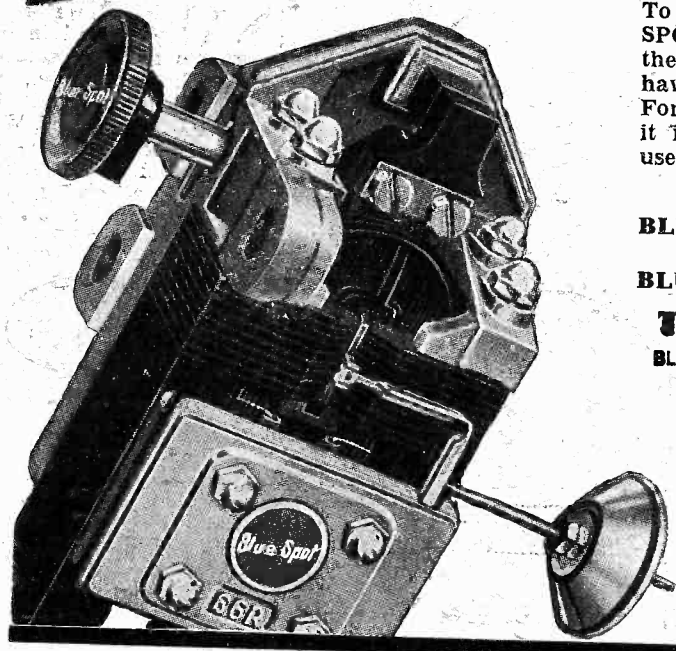

The last whisper of a muted violin, the swelling crescendo of a mighty organ are reproduced with equal exactitude. To achieve such perfection requires tremendous flexibility. BLUE SPOT 66R is flexible to the nth degree. There is no vibration in the musical range that it cannot handle with ease. Even with sets having an enormous output distortion and rattle are entirely absent. For genuinely magnificent performance and superb reproduction it is impossible to better BLUE SPOT 66R, especially if it is used, as it ought to be, in conjunction with a BLUE SPOT Chassis.

Your dealer will demonstrate BLUE SPOT with pleasure.

BLUE SPOT UNITS: 66K..25/-; 66P..27/6; 66R..35/-; 100U (with chassis)..39/6.

BLUE SPOT CHASSIS: MAJOR..15/-; SPECIAL..7/6.

THE BRITISH BLUE SPOT COMPANY LTD

BLUE SPOT HOUSE, 94/96 ROSOMAN ST., ROSEBERY AV., LONDON, E.C.1

Write for Catalogue P.W. 11 which gives full details of Blue Spot Units.



Registered Trade Mark

How to get **MORE VOLUME** and better quality reproduction **WITHOUT PAYING MORE FOR IT!**

WHEN you replace your power or super-power valve with a Lissen Power Pentode you increase the amplification of the last stage of your receiver to an enormous degree. For instance, the amplification factor of an ordinary power valve is seldom more than 10—while that of the Lissen Power Pentode is never less than 90! Think of the difference that makes to your set—how it converts a whispering foreign station to fine, full loudspeaker strength, and makes the “local” give you a torrent of pure sound.

GETTING PENTODE OUTPUT FROM BATTERY SETS

No need to alter your receiver at all. Simply replace your power valve with a Lissen Power Pentode. *The same battery drives this powerful valve*—no increase in current consumption takes place at all. That is why this valve is called the **LISSEN ECONOMY POWER PENTODE**—it gives you more volume for the same money!

The valve to ask for is the Lissen P.T.225—the

LISSEN ECONOMY POWER PENTODE



OTHER TYPES AND PRICES:

H.L.210-5/6 H.210-5/6 L.210-5/6 P.220-7/3 P.X.240-8/-
S.G.215-12/6. 4-volt and 6-volt types also available.



LISSEN LIMITED, WORPLE ROAD, ISLEWORTH, MIDDLESEX.

RADIOTORIAL QUESTIONS AND ANSWERS

(Continued from page 312.)

went wrong with it I should not know in the least how to find where a fault lay.

"I suppose there is a proper method? If results suddenly got weak, for instance, what would be the correct process for rapidly discovering the source of the failing?"

Even the most complex set will quickly yield up its secret if it is tested stage by stage.

Whatever complications may be involved in a valve circuit, it always consists of an output from a tuning coil and condenser, which is applied across the grid and filament of the first valve. The plate circuit of this valve has an output which is handed to the next valve's input (i.e. between its grid and filament), and this valve, in turn, has a plate output.

This output, also, is applied to the next valve in the chain of amplification, and finally the loudspeaker results appear either directly in the plate of the last valve or in the output filter circuit associated with this. Once these points of input and output are recognised, it is quite a simple matter to check the performance of the various valves, etc., by listening in turn to the various stages.

As an instance, suppose your "Pop-Vox" started to give weak results, the first thing you could try would be to test the loudspeaker itself by the substitution of another one; or, at a pinch, by listening for a moment with 'phones.

ONE SECTION THUS PROVED O.K.

Having thus assured yourself that the poor results were in the set, and not caused by the loudspeaker, you could use this latter, or the 'phones, as a testing instrument to determine where the fault lay. If, for instance, there is some fault in the output circuit itself, it would immediately be shown up by connecting the loudspeaker terminals in place of the filter circuit's output choke.

Normally, the output choke hands over the programme to the loudspeaker circuit, so if you found, on connecting the loudspeaker in place of the output choke, that results were normal, you would know that it was somewhere *after* that point that the fault lay—namely, in the loudspeaker filter circuit itself.

But if results were found to be just as poor at the output choke as before, you can exonerate the loudspeaker connections, the filter condenser, etc.

To test the preceding stage, replace the output choke connections, but undo the primary of the low-frequency transformer (the terminals marked H.T. + and A).

Connect the loudspeaker leads in the place of the primary itself, switch on again, and note results. If there is a sudden improvement in comparison with the last test, you may be sure either that your low-frequency transformer itself is wrong or some of its associated apparatus, such as the grid-bias tapping (G.R. - 2), or that the last valve itself is not working properly.

A STAGE AT A TIME.

Do not forget, however, that in "checking back" in the circuit in this way results progressively get weaker as you cut out the various stages of amplification. For you naturally could not expect that the loudspeaker in place of the low-frequency primary would give results as loud as you are accustomed to.

Nevertheless, a bad fault would be shown up clearly, because if the last valve or transformer were wrong the results obtained by the loudspeaker connected as described would be normal in quality,

The set should then behave exactly as an ordinary one-valver. Reaction and all the effects normally associated with the detector should be good, and it should be possible to tune in a dozen or more foreign stations quite easily and at good volume if the set is O.K. up to this point.

If, however, it is still faulty, the process of elimination, stage by stage, can be carried still a step further. You could cut out the selector coil, for instance, by connecting the aerial direct to the A terminal on the medium-wave coil.

Should it happen that this immediately improved matters, the probability is that you have found the fault, and that the selector coil itself is faulty. Note, also, whether switching over to the long waves improves matters, in which case the fault, of course will lie in one of the short-wave coils.

The first valve itself may be substituted by the second L.F. valve, just to determine whether it is working properly, and if the latter gives much better results you would at once have proved that the fault lay in the detector valve itself.

By tackling the job systematically in this way, it is possible easily to trace and locate the circuit in

"P.W." PANELS.—No. 40—WAVE-BANDS.

Groups of adjacent wave lengths allotted to any purpose (such as broadcasting) are known as wave-bands.

Europe has two main wave-bands for broadcasting.

The long-wave broadcasting band includes all wave lengths from 2,000 to just below 1,000 metres.

The "medium," or ordinary wave-band (sometimes wrongly called the "short" wave-band to distinguish it from the long wave-band), extends from just below 200 metres to about 600 metres, where it more or less begins to merge with the long waves.

and much better than when it was in its usual position, but with a faulty component or valve in front of it.

If, however, very poor and faulty results were still to be heard when the low-frequency transformer and last valve had been cut out of circuit, you could carry the test a step further and discover what is happening in the detector.

For this purpose you really need the pair of 'phones, rather than a loudspeaker, because the latter is not sensitive enough to give a satisfactory test, though it could be used as a last resort. With telephones, however, you have the exact equivalent of a one-valve set when the telephones are connected in place of the 100,000-ohm resistance in the plate circuit.

which the fault lies, and then, by substitution of the components as far as possible, to discover which is the offender.

Just at first, when you are not familiar with the various circuits, and of what they comprise, it may sound confusing, but it is on this principle of stage-by-stage investigation that the expert is able to simplify the search for a fault in even the most complex receiver.

"FREE G.B."

"TOMMY" (Battersea, S.W.)—"Please give the number and date of the 'P.W.'"

(Continued on page 316.)

QUALITY AND QUANTITY

MAKE

Player's Please



THE FULL VALUE CIGARETTE

HAVE YOU GOT YOUR DAILY MAIL RADIO CHART?

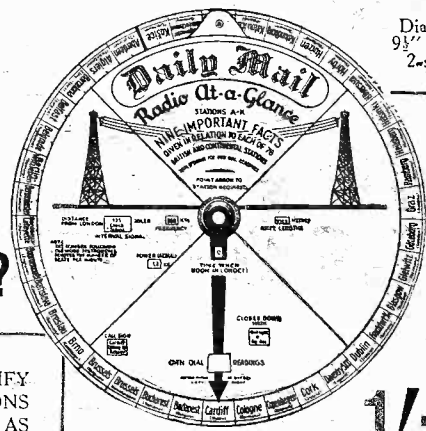

Diameter 9 1/2 inches. 2-sided.

- HOW TO IDENTIFY FOREIGN STATIONS
- AND GET THEM AS YOU WANT THEM.

ANSWERS NINE OF THE MOST FREQUENTLY ASKED QUESTIONS CONCERNING EACH OF THE 76 BRITISH & CONTINENTAL STATIONS.

A BLANK WINDOW IS PROVIDED FOR MAKING A PERMANENT RECORD OF ALL YOUR OWN DIAL READINGS.

EVERYBODY'S USING IT! GET YOURS TO-DAY.

"The cleverest thing of its kind ever devised."

AT ALL RADIO STORES, STATIONERS, BOOKSELLERS, ETC., OR WRITE DIRECT TO FRANK PITCHFORD & CO. LTD., WELL ST., LONDON, E.C.1

HELPFUL
CRITICAL
OUTSPOKEN
ENTERTAINING
FORCEFUL
UNIQUE
LIVE
FRANK
BRIGHT
CONSTRUCTIVE
TOPICAL
USEFUL
EXPERT



Capt. P.P.

Eckersley

—world-famous as one of the pioneers of broadcasting with the Marconi Co. and the B.B.C.—is now Wireless Editor of *The Daily Mail*. His brilliant and outspoken article every Wednesday is one outstanding feature of the day-to-day service for the listener provided by The

DAILY MAIL

Tests Everything!
VALVES
FILAMENT
ANODE & GRID
COMPONENTS
AND CIRCUITS
H.T. AND L.T.
MILLIAMPS

AS
INDISPENSABLE
AS A CLOCK

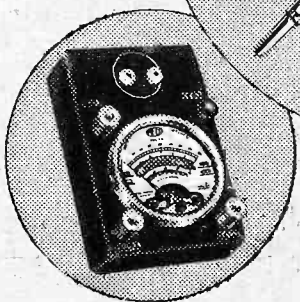
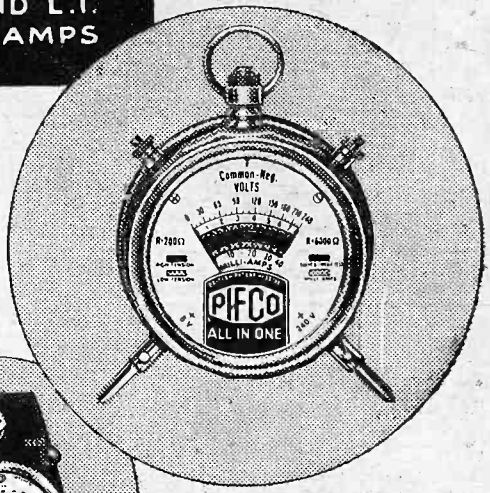

*Standard Model—
 for Battery Receivers. Hand-
 somely finished in
 octagonal bakelite
 case, complete with
 leads. Price* **12/6**

*De Luxe Model,
 125,000 ohms Re-
 sistance, for Elec-
 tric Receivers,
 Mains Units, and
 Battery-operated
 Sets. In maroon,
 Bakelite case, com-
 plete with cables.
 Price*

£2:2:0

The innermost problems of your radio can be easily diagnosed—with an "All-in-One" Radiometer. This wonderful little instrument enables you to keep a constant check on the conditions of every part of the set.

Electric Current, Valves, Batteries, Circuits, Components—everything can be kept under perfect supervision, and the slightest variation in performance instantly traced to its source.



*The
 Sherlock Holmes
 of Radio.*

The "All-in-One" Radiometer will save its first cost over and over again by safeguarding your set and making you independent of expensive expert assistance.

Obtainable at all Stores and good class Radio Dealers. Booklet free from Patentees: PIFCO LTD., HIGH ST., MANCHESTER.

PIFCO
ALL IN ONE
RADIOMETER

GIVE YOUR OLD BATTERY SET

a New Lease of Life!

By fitting—

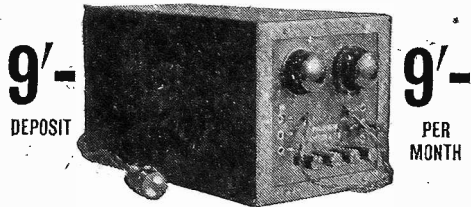

The Philipson SAFETY ALL-POWER UNIT

(Patent No. 353,357 Under Licence.)

WESTINGHOUSE RECTIFIERS.

H.T.—3 tappings — 60/75y; 0/120v., 130v., at 20 m.a. Price:

L.T.—2v., 4v. and 6v.

G.B.—1½v., 4½v. and 10v. **£4.17.6**

The set itself may be quite good, but it can never give first-class results while subject to a voltage that is never constant and is always decreasing! And then look at all the trouble and expense of new batteries every so often!

Write for details or see us at *STAND 132, Manchester.*

Made by the makers of "The Safety All Electric Band-Pass 3."

PHILIPSON & CO., LTD. Est. over 50 years.
ASTLEY BRIDGE, BOLTON.
 Phone: 2038. Grams: Safety, Bolton.

RADIOTORIAL QUESTIONS AND ANSWERS

(Continued from page 314.)

which had an article on 'Free G.B.' with small diagram showing connections and decoupling values."

The article was entitled "The f. s. d. of Free G.B." and it appeared in "P.W." No. 484, September 12th, 1931. (Back numbers of "P.W." which are still in print, but unobtainable locally, can be purchased from The Amalgamated Press, Ltd., Back Number Dept., Bear Alley, Farringdon Street, London, E.C.4, price 4d. per copy, post free.

CONVERTING THE "COMET" TO P.J. COILS.

S. W. E. (Brighton).—"In all, I got over seventy stations on the 'Comet,' most of these being obtained while I lived in Hounslow. Last March I moved to Brighton, and with a rather poor aerial (the best I can do) results were not so good.

"There was interference from ships with the weaker foreigners at top and bottom of the dial, and for this reason I paid more attention to long waves than formerly.

"Reception on long waves had never seemed so good as the medium waves (200-600 metres), and Radio Paris and Daventry were the only strong stations on long waves. Your department's suggestions re aerial were, unfortunately, impossible to carry out, but I found some improvement from the 'Inter-wave' wiring, with resistance across the .002.

"I am still not satisfied, however, and should like to try the new P.V. coils instead of the 'P.W.' dual-range coil, if this can be done easily.

"What are the connections necessary to put in the later type of coil?"

It would be quite easy to make the change over, and we suggest that you use a P.J.1 coil for medium waves, and a coil quoit for the long waves.

(Details of windings for the P.J.1 were given in "P.W." No. 475, and a suitable long-wave coil quoit, with reaction, in Radiatorial, "P.W." No. 485, page 88.)

The original dual-wave coil and also the .002 coupling condenser (with its resistance, if used) must be removed from the set.

The P.J.1 must be mounted in place of the original coil and the coil quoit must be placed on the base-board near where the .002 was formerly located.

The new connections will then be as follows: Leaving the aerial terminal connected to one side of the .001, the other side of this will go to A on P.J.1. The X terminal on P.J.1 will go to one contact on the switch and to one tapping on the long-wave coil quoit: i.e. 30th or 60th turn from the "earth" connection.

"Earth" on the long-wave coil quoit will go to the moving vanes of the .0005-mfd. tuning condenser, to another contact on the wave-change switch, to the "F₂" side of the differential reaction condenser, and to the set's earth terminal (which is joined to the 2-mfd. condenser, G.B.+, filaments, etc.).

Now "G" on the P.J.1 goes to the fixed vanes of the .0005-mfd. condenser and the vacant side of the grid condenser (.0003, which was formerly joined to G on the old coil).

Y on the P.J.1 goes to "2" on the long-wave coil quoit and to the third contact on the switch.

The remaining connections concern reaction. First, R on the P.J.1 will go to the other fixed vanes of the differential: that is, to F₁. Finally, Z on the P.J.1 is connected to 3 on the long-wave coil quoit.

How the Switching Works.

The great point to remember is that when the switch is in one position, for the medium waves, all three spring contacts and metal plunger are joined together.

In the switch's other position (long waves) all the springs are disconnected from each other and from the metal plunger.

That completes the change-over, but two other points are worthy of mention. Firstly, the whole of the switch connections can be saved by using an Extenser, instead of an ordinary tuning condenser. In this case the three connections now going to the wave-change switch would go instead to the self-changer contacts on the Extenser.

Secondly, if the set is ever used near a powerful local station it would be advisable to do away with the .001 selectivity condenser (connected to the aerial terminal) and to use a Selector coil instead. (Its A terminal would go to the set's A terminal and its B and C terminals should be joined together and taken to the "A" of the P.J.1.) This would give additional strength as well as greater selectivity!

RADIO-GRAM ENTHUSIASTS!

Here's the way to the best possible reproduction

A well designed amplifier, a good moving coil speaker and—a B.T.H. Pick-up and Tone Arm. These are the ingredients for the finest reproduction of records. The recipe is recognised by leading Radiogram experts.

And there's no need now to forego your B.T.H. Pick-up on the score of cost. The new B.T.H. "Minor" is a product of the same engineering principles that have made the "Senior" Model the standard of excellence where Pick-ups are concerned. **Ask your dealer for a demonstration.**

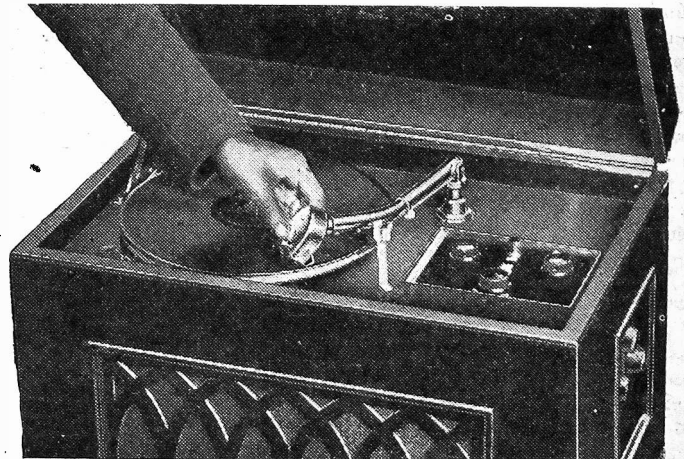

PICK-UP and Tone Arms



THE EDISON SWAN ELECTRIC CO. LTD.
 155 Charing Cross Road, London, W.C.2



"Minor" B.T.H. Pick-up and Tone Arm. Price complete 27/6

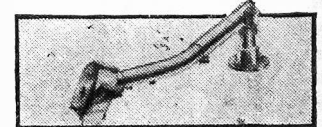

"Senior" B.T.H. Pick-up and Tone Arm. Price 45/-

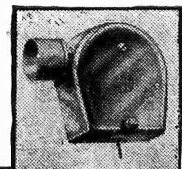

"Senior" B.T.H. Pick-up only with adaptors. Price 27/6

MIRROR OF THE B.B.C.

(Continued from page 268.)

There is perhaps quite a number of other people who know life in the underworld on both sides of the Atlantic as well as does Mr. Wallace, but there is certainly no one who can describe it more vividly and more entertainingly than this man whose own strangely exciting career would in itself make such a story that simply could not help being a "best seller."

Perhaps one day we shall be told more of his life from the time he began to earn his living selling newspapers in the streets, and soldiered as a private in the R.A.M.C. before he became a war correspondent in South Africa and brought off "scoops," including the first news of peace.

Vaudeville Features.

Since then he has successively been novelist, dramatist, film producer, racing expert and criminologist, and everybody is taking it for granted that, should he choose, he will become quite as outstanding among those who face the microphone as he is in everything else he tackles.

Repetition of names of vaudeville artistes is apt to get monotonous, so I will not mention those of famous radio stars who are taking part in the programmes for National and Regional listeners on Wednesday and Saturday, October 14th and 17th, respectively.

National listeners also get some vaudeville on Monday, October 12th. Another light programme is down for Tuesday, October 13th (National), and October 15th (Regional), when Gordon McConnel will produce a revised version of the late Clifford Seyler's revue, "Peep-bo-hemia," which has been prepared by Leonard Henry and John Derwent.

Another forthcoming production is an operetta by Holt Marvell and George Posford called "Good Night Vienna," which, incidentally, is one of the first specially written radio shows to be filmed. I understand that Mr. Holt Marvell will shortly assist Herbert Wilcox in the filming of it at the Elstree studios.

Sporting Broadcasts.

Now that running commentaries on Association football matches have been banned by the powers that be, listeners are beginning to notice the absence of broadcast descriptions on outdoor sporting events.

Quite likely we shall hear one or two commentaries on speedway meetings before Christmas, while another sport, which so far has received no attention from the microphone, gets a look in on Saturday, October 17th, when Mr. W. J. Howeroft will describe the Water Polo International match between England and France which takes place at the Marshall Street Baths, London. The broadcast will also include a commentary on the English 220 yards swimming championship.

An England and France sporting event also comes into the programmes on the previous Saturday, when Miss Eleanor E. Helme, the well-known golfer, gives an eye-witness account of the match between ladies representing their respective countries.

Real novelty and originality is displayed in the idea of broadcasting a Somerset "Harvest Home" to West Regional listeners on Friday, October 23rd.

New Times Sales Co

We can supply any accessory advertised in "Popular Wireless" on EASY TERMS. Send US your next order. We guarantee you every satisfaction.

SECURE THE NEWEST RADIO TO-DAY ON REALLY EASY TERMS

MANUFACTURERS' 1932 KITS

GOSSOR 234 EMPIRE MELODY MAKER

Screened-Grid, Detector and Power.

With valves and cabinet 10/-

CASH PRICE £6 15s. 0d. WITH ORDER

Balance in 11 monthly payments of 12/6. Finished Instrument. Royalties Paid, £7 10s. 0d. Cash, or £2 deposit and 11 monthly payments of 11/-.

MULLARD 3, 1932 TYPE

Screened-Grid, Detector and Pentode.

With valves less cabinet 11/11

CASH PRICE £6 10s. 0d. WITH ORDER

Balance in 11 monthly payments of 11/11. Finished Instrument, with Valves and Cabinet. Royalties Paid, £7 17s. 6d. Cash, or £2 deposit and 11 monthly payments of 11/9.

OSRAM NEW MUSIC MAGNET 4

2 Screened-Grid, Detector and Power.

With valves and cabinet 19/8

CASH PRICE £10 15s. 0d. WITH ORDER

Balance in 11 monthly payments of 19/8. Finished Instrument. Royalties paid, £11 15s. 0d. Cash or £2 deposit and 11 monthly payments of 19/6.

V.3 RADIO FOR THE MILLION

Screened-Grid, Detector and Power, with valves less cabinet

CASH PRICE £5 17s. 6d. WITH ORDER

Balance in 11 monthly payments of 10/9. Finished Instrument, with valves and cabinet. Royalties Paid, £7 8s. 6d. Cash, or £2 deposit and 11 monthly payments of 10/10.

NEW TIMES SALES PERMANENT MAGNET MOVING-COIL SPEAKER

In handsome oak french polished cabinet, with specially designed Epoch chassis, giving glorious tone and volume. With multi-ratio transformer. Cash Price £3 15s. 0d.

Balance in 11 monthly payments of 6/11

AMPLION MOVING-COIL SPEAKER, TYPE M.C.6.

Permanent magnet, with output transformer. Complete. Cash price £3 7s. 6d.

Balance in 11 monthly payments of 6/2

B.T.H. RK. MINOR PERMANENT MOVING-COIL SPEAKER.

Handles output up to 2 watts. Cash price £2 10s. 0d.

Balance in 8 monthly payments of 6/-

EPOCH PERMANENT MAGNET MOVING-COIL SPEAKER.

Type A.2. Cash price £3 17s. 6d.

Balance in 11 monthly payments of 7/1

R & A "100" MOVING-COIL REPRODUCER.

With tapped Input Transformer. Cash price £2 17s. 6d.

Balance in 11 monthly payments of 5/4

ORMOND PERMANENT MAGNET MOVING-COIL CHASSIS (No. 464).

With tapped input transformer. Cash price £3 5s. 0d.

Balance in 11 monthly payments of 6/-

SIX-SIXTY CHASSIKIT. Battery Model.

Complete three gang band-pass tuning. S.G., Detector and Pentode. Cash Price £6 17s. 6d.

Balance in 11 monthly payments of 12/7

SIX-SIXTY CHASSIKIT. (A.C. Model)

Complete as above with A.C. Mains Valves. Cash Price with valves less cabinet £7 6s. 6d.

Balance in 11 monthly payments of 13/5

ELIMINATORS

EKCO K.18 COMBINED H.T. ELIMINATOR AND L.T. TRICKLE CHARGER. Delivers 18 m/a. and suitable for 1- to 5-valve sets. S.G., 50/80v., 120/150. Charges at 2.5 amp. at 2, 4 or 6 volts.

Cash price £4 12s. 6d.

Balance in 11 monthly payments of 8/6

ATLAS A.C. ELIMINATOR TYPE A.C.244.

3 Tappings, S.G., Detector and Power. Output 120 volts at 20 m/a. Cash price £2 19s. 6d.

Balance in 11 monthly payments of 5/6

EKCO A.C.25 H.T. ELIMINATOR.

Send Tappings—S.G. 50/80 volts, 100/150 volts at 2.5 m/a. Cash £3 17s. 6d.

Balance in 11 monthly payments of 7/1

HEYBERD H.T. UNIT "D" MINOR.

Output 120v. at 20 m/a. Tapped at 80v., 100v. and 120v. Cash price £2 17s. 6d.

Balance in 11 monthly payments of 5/4

EXIDE 120-volt. TYPE W.H., H.T. ACCUMULATOR, in crates.

Cash price £4 13s. 0d.

Balance in 11 monthly payments of 8/6

CELESTION PERMANENT MAGNET MOVING-COIL SPEAKER.

Type RPM8. 8 in. Reinforced Diaphragm, excluding input transformer. Cash price £3 10s. 0d.

Balance in 11 monthly payments of 6/5

LAMPLUGH, FARRAND, FERRANTI or GECOPHONE DYNAMIC INDUCTION SPEAKER

Unit and chassis complete, ready mounted. Cash price £3 10s. 0d.

Balance in 11 monthly payments of 6/5

N & K INDUCTION DYNAMIC SPEAKER.

Unit and Chassis Complete. Cash price £3 10s. 0d.

Balance in 11 monthly payments of 6/5

EPOCH J. I. PERMANENT MAGNET MOVING-COIL SPEAKER.

In chassis form with multi-ratio input transformer. Cash Price £2 12s. 6d.

Balance in 11 monthly payments of 4/10

GARRARD INDUCTION GRAMOPHONE MOTOR.

Model 202. Mounted on 12-inch Nickel Motor Plate with fully automatic electric starting and stopping switch. Cash Price £2 18s. 6d.

Balance in 11 monthly payments of 5/4

B.T.H. PICK-UP and TONE-ARM.

Cash price £2 5s. 0d.

Balance in 11 monthly payments of 4/2

Communicate your Radio needs to us, we are certain to satisfy.

ESTABLISHED IN 1924—FIRST WITH EASY TERMS

NEW TIMES SALES CO. 56, LUDGATE HILL, LONDON, E.C.4.

Phone: Central 2716

(a) Please send me further particulars of

(b) I enclose s. d. as first payment for

NAME

ADDRESS

P.W. 10/10/31.

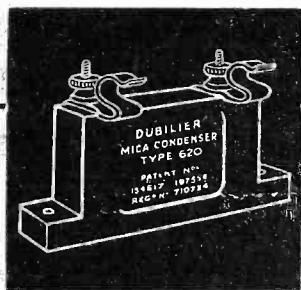

You can
rely on
DUBILIER

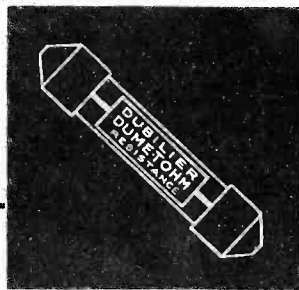

Dubilier is the first choice of the leading set designers. High-class materials, faultless workmanship, meticulous methods of manufacture and rigorous factory tests are a guarantee of Dubilier reliability.

You cannot buy better than Dubilier. Whether you require Fixed or Variable Condensers, Resistances, R.C. Coupling Units, Wave Traps, or H.F. Chokes, always ask for Dubilier.

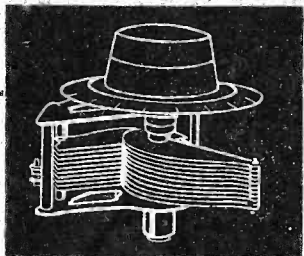

Use

DUBILIER
COMPONENTS

in YOUR set!

**NORTHERN NATIONAL
RADIO EXHIBITION**

October 7-17th.

STANDS 64 & 78

DUBILIER CONDENSER CO. (1925) LTD.,
Ducon Works, Victoria Road, N. Acton, London, W.3

BROADCASTING IN IRELAND.

(Continued from page 306.)

that they will close down when the high-power station is in service. In that event the new transmitter would take over the Dublin wave-length, 413 metres.

The estimated cost of the new station is over £70,000. It is expected that there will be a large increase in licence holders after the station has opened.

One Programme Only.

This will not be a dual-programme station, like the B.B.C. high-power stations. The Free State is content to give its listeners one programme only, the Cork transmitter acting as a relay of the Dublin programme, and the hours of transmission are short compared with those of the B.B.C. The Free State service has not nearly so much income as the B.B.C., and one must cut one's coat according to the cloth.

Mr. de Brit showed me the details of the broadcasting estimates for the present year, and I noticed that the cost of programmes is estimated at just over £15,000.

NEXT WEEK

**ANOTHER
SIXPENNY BOOK
FREE!**

ORDER YOUR COPY OF
NEXT WEEK'S 'P.W.' NOW!

Compare with this the half million or so that the B.B.C. spends annually on programmes alone!

Dublin and Cork sometimes relay B.B.C. programmes by landline connection with Belfast. I found that there are particularly happy relationships between the authorities in Dublin and the B.B.C. officials at Belfast.

Relayed by Belfast.

The Belfast station, in return, takes occasional relays from Dublin. Sports commentaries are often relayed, and a popular item is the crack Number One Band of the Free State Army, under its German conductor, Colonel Fritz Brase, who is Director of the Army School of Music.

Artists from Southern Ireland have visited the Belfast studio by arrangement with the Dublin station, but the most notable example of the collaboration between the two stations is the relay of "Cathleen in Houlihan," from the stage of the Abbey Theatre, Dublin, on St. Patrick's Day, 1930, - broadcast Nationally. The Abbey Players now pay regular visits to the Belfast station.

Next week I shall describe the interesting equipment of the Dublin studios, transmitter, and control-room, which differs in many respects from B.B.C. practice.

In Messrs. Belling and Lee's advert. in our Sept. 12th issue, the price of their type "R" terminal is given as 6d. This should, of course, have been 3d. Actually it is the price of the type "B" terminal.

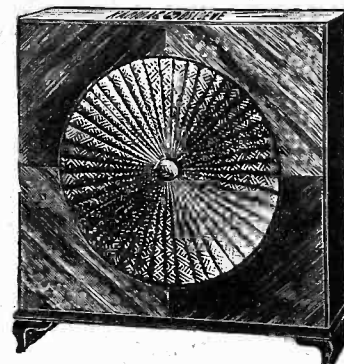

**GREATEST
IN CONE
SPEAKERS!**

Never before has there been such a wonderful Speaker. Never before have you heard such amazing Tonal Purity and volume.

42/-

Retail price complete

Unit only, 12/- Unit and chassis, 16/6

Full details from:-

THE LOEWE RADIO CO., LTD.,
4 Fountayne Road, Tottenham, N.15.

Phone: Tottenham 3911/2.

LOEWE RADIO

MAKE OR BUY A GRAMOPHONE

at a quarter shop prices, or buy Cabinets for Wireless. British double spring motor, 12" velvet turntable, swan arm, metal sound-box, amplifier, needle cups, for £1/16/0 p.p., and build your own Cabinet. Portable Gramophones from 15/6, postage 1/6. Motors from 7/6. Lists free, 64 pp. 1931 Catalogue No. 220, with Reduced Prices. Drawing and How to Make Gramos., 3d.

REGENT FITTINGS CO. (P.W.), 120, Old Street, London, E.C.1

WIRELESS CABINETS

We can supply any type of cabinet ready to receive your radio set direct from our works at lowest costs.

Real Photographs, with sizes and prices of our latest models, also Woodworker's Pocket Guide of ready to assemble cabinets, will be sent on receipt of 3d. in stamps.

REDRUP & SON, Radio Cabinet Makers,
178, Albert Road, Southsea.

REPAIRS

single ratio L.F. Transformers. Headphones, Loudspeakers (except Blue Spot). ONE YEAR'S GUARANTEE.

IN 48 HOURS
TRANSFORMER REPAIR CO., Post Free 3/9
63R, GARRATT LANE, LONDON, S.W.17 Terms to Trade

Cut out that Interference by fitting the

"SPIRANIC"

SELECTIVE INDOOR AERIAL INTERFERENCE
"60 Feet in 16 inches"
Just fills that available space!
From all Cash Price Send for Descriptive Leaflet
Dealers or Post Free 2/- Leaflet
Makers: "SANA-RAY" ELECTRICAL CO., 185, DERITEND, BIRMINGHAM.

ADVERTISERS PLEASE NOTE!

The Rate for a one-inch single Column Advertisement is 30/-

Minimum Space Accepted:
Half-an-inch .. 15/-

Send Remittance with instructions to

JOHN H. LILE, LTD.,
4, LUDGATE CIRCUS, LONDON, E.C.4.

Telephone - City 7261.

AMATEUR TRANSMITTERS IN CONFERENCE

By W. L. S.

I WRITE these few notes after having spent one of the most pleasant weekends I can remember. I refer to the Sixth Annual Convention of the R.S.G.B., at which more amateur transmitters meet together than at any other time throughout the year.

The convention, immediately after the show, is now an established tradition, and the usual attendance at the closing dinner is about 130. Here, and here only, can one meet in the flesh all the provincial station-owners with whom one has talked over the air for years.

Still a "Ham" at Heart.

An honoured guest at the dinner was Capt. P. P. Eckersley, who is, perhaps, the most famous "ham" in the British Isles. Perhaps I should say "was" (for the days of Writtle seem far off now), but in his speech he made it plain that he was still an amateur at heart, and would always view the amateur movement with the friendliest feelings.

The reception with which his remarks met left no doubt about the feelings of the old-stagers who started in the Writtle days, or the youngsters who had never had the privilege of hearing the famous station.

"For whom," Capt. Eckersley characteristically added, "I feel very, very sorry. I really was very good!"

The keynote of the whole affair, appropriately, was friendship, and it is this friendship, applied on an international basis, which is the best argument in the world for amateur transmission.

The Prime Minister remarked, during a recent speech, that "if the Nations of the world could see each other and talk to each other, war would be out of the question." Is there any more complete means of allowing the nations to talk to each other than that afforded by radio? And particularly, I might say, by amateur short-wave transmission.

Linking up the Empire.

Here is the surest argument that can be put forward when the time comes, at Madrid next year, for the amateurs to justify their existence.

The world is linked up by means of an organised chain of short-wave stations, and messages from almost any part of the Empire may be shot to London through recognised "Link Stations."

These and many other points may not be known to the "layman," but their development has, of course, been going on for some years. There are now upwards of 30,000 amateur transmitters in the world, grouped into societies in most countries, and such is the fellowship among them, that any amateur going abroad would automatically have free entry to the homes of all his friends, though he might be meeting them for the first time!

Perhaps we may hope for an International Convention—a kind of Jamboree—at which all countries may meet and show their strength.

BEWARE THE POWER THIEF!

—Is electrical leakage robbing you of money—and the Power your set needs?

ELECTRICAL cell to cell leakage has been definitely eliminated. Smooth top H.T. Accumulators with their 10-volt single glass cell provide direct electrical connection between terminals. Thus power leaks away, causing serious waste.

In the Lively 'O' H.T. Accumulator this cannot happen. Each 2-volt cell is separated from its neighbour by an air gap. All the power you have paid for is stored up, being released *only* when

working your Set—there can be no "falling off" in voltage—your set gets *all* the power it needs. Write for free booklet—it tells you all about it.



LIVELY 'O' H.T. ACCUMULATORS

Two Types

Standard 10 volt unit (2,750 Milliamps)

5/6

Extra large capacity (5,500 Milliamps) per 10 volt unit

6/9

Send at once—

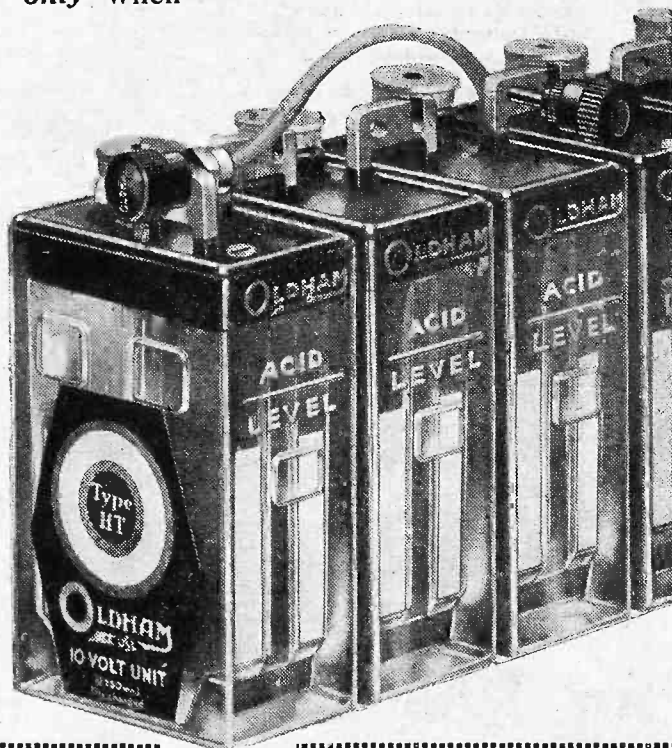

To Oldham & Son, Ltd., Denton, Manchester.

Please send me free of charge, a copy of your book "How to save money on your H.T."

Name

Address

P.W. 10/10/31

IN GREAT DEMAND

WATMEL'S LATEST

A SQUARE-LAW TAPERED WIRE-WOUND RESISTANCE.

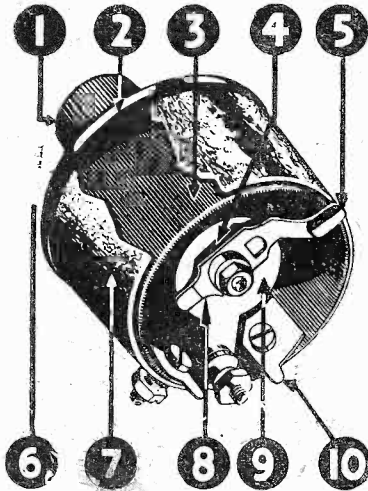

OUR latest product—the Watmel 50,000 ohms wire-wound potentiometer was very favourably commented upon at the Exhibition. This resistance is specially wound on a tapered former which gives a perfect square-law reading. This is the first resistance of its kind.

NOTE THE POINTS:—

- 1—Polished pointer-knob.
- 2—Engraved Bakelite front plate.
- 3—Wire Wound Former.
N.B.—The resistance is WIRE, NOT compound with wire contacts. It is specially wound on a tapered former.
- 4—Insulating bush to insulate spindle from panel.
- 5—Contact finger. Phosphor Bronzo.
- 6—One-hole fixing—Brass bearing bush resulting in perfect bearing.
- 7—Bakelite case—protects winding.
- 8—Back self-cleaning contacts.
- 9—Large contact plate.
- 10—Stops at end of winding.

Every part is made from the finest materials

ANY RESISTANCE UP TO 50,000 OHMS—

STANDARD WINDING **5/6**

SQUARE LAW **6/6**

BUY BRITISH.

Ask your dealer for full particulars or write direct to us. Try Watmel components in your new sets this season.

WRITE for CATALOGUE. Trade inquiries invited.



Watmel

"GETS THE BEST OUT OF ANY SET"

WATMEL WIRELESS CO. LTD.,

Imperial Works, High Street, Edgware.

Telephone: Edgware 0323 (M.C.42)

FOR THE LISTENER

(Continued from page 268.)

bread which you see everywhere abroad; almost long enough for a walking-stick—the staff of life! So that was all right. We munched the sausage, mumbled the bread, and turned on the wireless.

What a comfort the wireless is! I thought of patients in hospitals, of blind folk, of lonely and stranded people. Nobody need be lonely any more. A modern Robinson Crusoe would have his portable set with him on his desert island—the one thing, after his own skin, which he would save from the wreck!

It was a boon to us last night. I shouldn't have minded if we had run into an hour of Chamber Music! As it was, we found ourselves listening to a very pleasant concert, with a small orchestra playing things like the "1812" Overture, and somebody singing Schubert's songs.

A Gay Night!

It may have been from Toulouse, or one of the Swiss stations, or even our old friend Mühlacker. I reflected on the blessings of music. It is good to "count your blessings" when you are stranded on the roadside and due to spend a night in the open! Particularly, what a blessing it is that music speaks no language, and therefore can be understood in all languages.

The Ninth Symphony may come from Berlin, or Vienna, or London, or Timbuctoo, and it is still the Ninth Symphony. If Polish music were rendered in Polish, or even if Scotch music (if any!) were rendered in Scotch—good lord!

Then we searched the air for some dance music. We hadn't to search far. The whole of Europe seemed to be having a gay night.

It was really rather extraordinary. Every turn of the dial brought us new signals; some weak, some strong. Now somebody was chattering in a voice like a pair of scissors; now some robust tenor was lifting the roof off; now a military band was marching to Georgia; now a burst of thunderous applause; now a soprano was dropping her notes like pearls.

My Radio Dream.

The whole of the continent seemed to be under a cloud from which music, instead of August rain, was falling; and people everywhere were catching it in their loud-speakers, like buckets!

Then the world "closed down." We wrapped ourselves up in rugs. We nodded. We slept.

As at all such times, my sins come home to roost in dreams. I had nightmares. I have criticised the programmes now for some years, and now it was their turn!

I dreamt that Sir John Reith came furiously upon me with a big stick. Then I was alone in a little boat, and Broadcasting House, like a huge ocean liner, bore down on me and cut me in half.

It was a thick night for me. At length the dawn broke. And our luck was still in.

About half-past six this morning, a tradesman with a small van came along the road. There is a decent-sized town about three miles ahead of us. The man took my companion with him to find a mechanic there and bring him to the rescue. The car is roaring. Forward, for England!

ELECTRADIX BARGAINS

HEADPHONES. 8,000 ohm. Double Sullivan, 4/3 pair. 120 ohm Sullivan, 3/6 pair. Brown's do., 10/-. 2,000 Singles, field D.111, 1/-. Phone Bobbins, wound, 6d. pair. Speaker do., 6d. pair. House Phones, 10/- pair of Stations. Twin cable, 4/26, 25 ft. for 1/-, 4-way, 22g, 100 ft., 1/3.

RECEIVERS. 7-v. Superhets W.E. with valves, £7. Superhet R.L. 6-v. with valves, £5 15s. Long range guaranteed. Batts. extra. Fellows' 3-v. L.G. with valves, 35/-. Fellows' 4-v. L.G. with valves, 45/-. All in fine cabinets. W.D. Mark III Tuners, 19/6. 2-v. Edison, Marconi and T.M.C. with valves, 35/-. 3-v. G.E.C., Victor, £3 5s. with valves. R.A.F. 3-v. Aero, 30/-. 3-v. Naval T.F., 30/-. valves 3/6 each.

METERS. A.C. Hot Wire to 1/2 amp, 5/-; to 1 1/2 amps., 5/-. Thermojunction M.C., 2 1/2 in. panel Turner, 1 1/2 amps. or 6 amps. or 12 amps, 30/- each. B.T.H., 50 m.A. M.I. 2 in. dia., 8/6. Fine Electrostatic 500-v. to 2,000-v. 2 1/2 in. panel, 40/-. Switchboard 6 1/2 in. dial Volt and Ammeters: M.I., 12/6 to 27/6. Bridges and Galvo, 45/-. D.C. Weston, Tur. and E.E. 20.0-20 amps., 2 1/2 in. panel, 25/-; 0-100 m.A. do., 25/-; Record Circscales, 3-0-3-v., 25/-; Evershed do., 25/-; G.P.O. Volt-Milliammeters, 45/-; Elliott Multi E.108, 37/6. Silvertown Galvos, 5/-. Magnetometers for Gauss Law, 12/6. Compass for Frame Aerial, 2/-; Wavemeters, 25/-; Meggers, £8 10s. Pole Indicators, 3/6. Naval Telescopes fitted Mov. Coil Range Needle, 25/-. Pocket Parabolic 10 in. Mirrors, 15/-.

VALVES. 250 watt. M.O. Transmitters, 30/-; 40 watt M.O. Trans. or Power, 4/6; Cossor H.T. Rectifiers, M.O., 2/6; V.24, 10/-; Vicco Receiving Valves, 4-v., 2/6. Siemens Bi-Grid 5-pin Valves, 2/-. Weeco Bayonet and 4-pin valves, 4/6; Western Electric 6-v. power amplifier valves, 5/-.

SPECIAL BARGAINS. 9-lb. Parcel of Radio Experimenters' useful Sundries, terminals, panels and fittings, holders, chokes, magnets, switches, wire, etc., etc. 9-lb. parcel for 5/-, postage 1/-. 2/6 for 5 bobbins of 36g enam. copper wire, 300 ft. each, total 1,500 ft. 250 ohms for 2/6, post 6d. Big Parmeko Heavy Duty 1/2 amp. Chokes, 15/-. T.V.T. Generator for H.T. from 6-v., 12/6, or with Rectifier, 25/-.

October Sale List Post Free.

ELECTRADIX RADIOS,

218, Upper Thames St., E.C.4

It pays you to ask your Retailer for genuine guaranteed

WAVEMASTER

Variable Condensers and Extensers for all the latest Circuits

WEBB CONDENSER CO., LTD.,
42, Hatton Garden, London, E.C.1.

THIS EARTH TUBE WILL NEVER CORRODE

Gives Perfect Earthing.

The tube, giving 180sq. ins. of earthing surface is of heavy gauge steel heavily coated inside and out with lead. Earth wire sinks into lead coating on tightening thumb-screw, giving perfect electrical connection without soldering. From your radio dealer individually boxed 3/6 or direct (Postage 6d.).

"GODWINEX"

Earth Tube is definitely non-corroding. It will give perfect results for years.



LOUD SPEAKERS REPAIRED, 4/-

(Blue Spot a Speciality, 5/-)

Transformers 4/-, Headphones 4/-, all repairs magnetised free. Tested, guaranteed, and ready for delivery in 24 hours.

Discount for Trade. Clerkenwell 9069.
E. MASON, 44, EAST ROAD, N.1.

Make
The DAILY SKETCH
YOUR Picture Paper

TECHNICAL NOTES

Some diverse and informative jottings about interesting aspects of radio reception.

By Dr. J. H. T. ROBERTS, F. Inst.P.

SOME time ago I mentioned the Ferranti double condenser arrangement for preventing tuneable hum and, as this is a matter which is of interest to a large number of constructors, I would like to pass on some further information which has come to hand.

Preventing Tuneable Hum.

The Ferranti patent covering the use of a double condenser, or two single condensers, for the prevention of tuneable hum usually relates to condensers having a capacity, say, 1 microfarad on each side; if a much larger condenser, say 1 microfarad, is used on each side, there is an appreciable load on the transformer, which may thereby become overloaded, and current through the condenser may be excessive.

This is a very important point with regard to condensers connected with the supply current, and it is one which is not always recognised; for example, I have actually known cases where smoothing condensers have been connected across mains transformers in such a way that the transformer has been carrying as much as 50 per cent overload.

Combination of Capacities.

The principal object of the condenser in question is that it provides in a convenient and compact form a combination of capacities from .5 microfarad to 2 microfarads, and it may, therefore, be used in places where 1 microfarad is adequate for smoothing purposes.

It may also be used in connection with a resistance condenser feed to transformers, as this gives the various effects of using .5 microfarad, 1 microfarad, and 2 microfarads may be found; the smaller the capacity the greater, as a rule, the increase in amplification in the lower registers.

Vexed Question.

A good deal of argument has been spent from time to time on the question of full-wave and half-wave rectification, whether a half-wave rectification is less efficient or more wasteful than the other.

This point was much debated in the early days of crystal receivers, but nowadays the controversy centres almost entirely on the question of rectification for mains units and ch-like purposes.

At first sight you might think that a half-wave rectifier, inasmuch as it rectifies only one-half of each wave, must necessarily waste the other half. Another prevalent idea is that a full-wave rectifier must give twice the output of a single-wave rectifier. These ideas are almost entirely erroneous.

It is true that the current from a half-wave rectifier is, so to speak, more intermittent and therefore more difficult to

(Continued on next page.)

It's So Easy

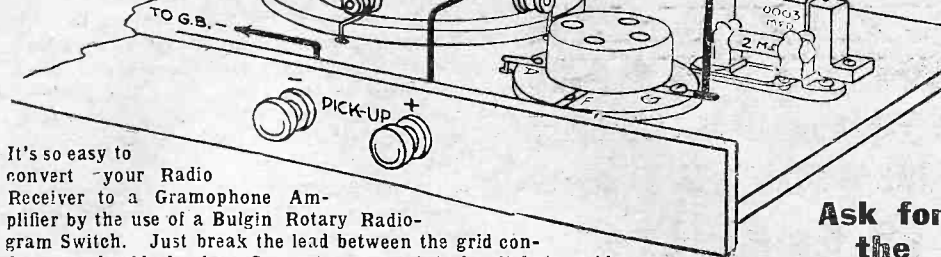

It's so easy to convert your Radio Receiver to a Gramophone Amplifier by the use of a Bulgin Rotary Radiogram Switch. Just break the lead between the grid condenser and grid of valve. Connect centre point of switch to grid connection of valve holder. Then connect one outer switch terminal to grid condenser and the other to the pick-up terminal. The pick-up terminal goes to $-1\frac{1}{2}$ volts on the G.B. Battery.

Ask for the

BULGIN ROTARY RADIOGRAM SWITCH

Fully insulated snap action. Wiping contact. Totally enclosed in Bakelite Moulding. Permits pick-up to be permanently connected. Complete with engraved indicating frame.



Send now for the new Edition of 75 pp. Catalogue and Manual which also describes the new Bulgin Technical Service. Enclose 2d. postage.

List No. S.86.

PRICE

2/-

finished in Black, Walnut, or Mahogany.

AS SPECIFIED IN THIS WEEK'S "POPULAR WIRELESS."

A. F. BULGIN & CO., LTD., ABBEY ROAD, BARKING, ESSEX.
 London Showrooms: 9, 10, 11, Cursitor Street, Chancery Lane, E.C.4. Telephone: Holborn 2072.

CABINETS "DE - LUXE" PICKETTS

Remarkable Offer.

Usual Price	Makers' Price
£8 15 0	£6 18 0
£7 7 0	£5 10 0
£3 3 0	£2 7 0

SAVES YOU MONEY
 The Superior QUALITY delights! A fine charm of style that people desire. Advantages also of PIANO-TONE Baffle and sound chamber (no distortion, no drumming). Quite new—as supplied to leading experts, B.B.C. and Radio Press. You may have ON APPROVAL and return at OUR expense if you wish to part with it! Deferred Terms 10/- or 1/1 monthly. Photographs and full details FREE!

PICKETTS, Radio Furniture Works (P.W.), Albion Road, Bexleyheath, Kent.

YOU CAN USE YOUR SPARE TIME TO START A MAIL ORDER BUSINESS

that quickly brings you a full-time income. Few pounds capital only needed; no samples or outfits to buy. No rent, rates or canvassing. New method makes success certain. Send to-day for booklet.

BUSINESS SERVICE INSTITUTE, Dept. 320, 6, Carmelite Street, E.C.4.

PERSONS REQUIRED immediately to make Leather Matting; regular work supplied, cash paid weekly. Write: E. 14 "Everlast" Leather Matting Co., Wellingborough.

FOR YOUR RADIO COMPONENTS
A. T. HARRISON & CO.
 Copper and Aluminium Screens by return of post. Bakelite Moulds, Bakelite Mouldings. Trade inquiries invited.
KINTORE WORKS, BERMONDSEY, LONDON, S.E.1.

EASY PAYMENTS

The first firm to supply Wireless parts on easy payments. Seven years advertiser in "Popular Wireless." Thousands of satisfied customers.

COSSOR 1932 Kit. Cash £6 15s. 0d., or 10/- with order, 11 monthly payments of 12/6d.

EXIDE 120v. H.T. Accumulator. Cash £3, or 6/- with order, 9 monthly payments of 6/8d.

AMPLION Permanent Moving Coil Speaker, with step-down transformer. Cash 67/6d., or 7/5d. with order, 9 monthly payments of 7/5d.

BLUE SPOT 66R. Unit, with Cone and Chassis. Cash price 42/6d., or 5/6d. with order, 9 monthly payments of 4/6d.

New Goods Obtained for Every Order.

Send us a list of the parts you require, and the payments that will suit your convenience, and we will send you a definite quotation. Anything wireless.

H: W. HOLMES, 29, FOLEY STREET, Phone: Museum 1414. Gt. Portland St., W.1.

WET H.T. BATTERIES

Solve all H.T. Troubles. SELF-CHARGING, SILENT, ECONOMICAL

JARS (waxed), 2 1/2" x 1 1/2" sq. 1/3 doz.
ZINCS, new type 10d. doz. Sacs 1/2 doz.
 Sample doz. (18 volts), complete with bands and electrolyte, 4/1. post 9d.
 Sample unit, 6d. Illus. booklet free.
 Bargain list free.

AMPLIFIERS, 30/-. 3-valve set, £5.
P. TAYLOR, 57, Studley Road, STOCKWELL, LONDON

BUY your Moving Coil Speaker
WRITE NOW FOR

42 pages of valuable information on how to secure REALISTIC REPRODUCTION.

BAKER'S Selhurst RADIO CROYDON SURREY.
 PHONE CROYDON 1619.

★ PLEASE be sure to mention "Popular Wireless" when communicating with Advertisers. Thanks! ★

THE SHADOW ON THE DIAL

clearly shows the
position of the stators

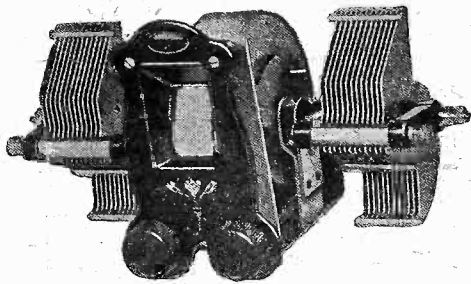

DUAL GANG

It has been so arranged that the two Condensers are completely insulated one from the other. If the frame of the Drum Dial is connected to earth, it makes a perfect metallic screen between the two Condensers. The position of the stators can easily be seen as there is a hidden pointer behind the celluloid drum which throws a shadow on to the drum. Price **18/6**

TRIPLE GANG (Completely Screened)

The left-hand knob controls the stators of the two left-hand Condensers and the position of the stators is indicated on the celluloid drum by a shadow thrown from a hidden pointer. The two left-hand Condensers are provided with small balancing condensers for balancing the stray capacities in the circuit of the Band-Pass. Price **30/-**

If with rotor and stator of right-hand condenser insulated from the wiring. Price **3/6**

"P.W." COILS

and the full range of
FORMO CONDENSERS
can be seen on Stand 81
MANCHESTER SHOW

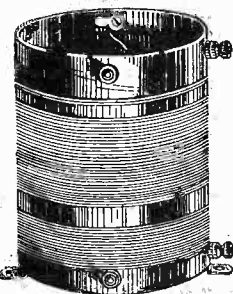

"POP-VOX"
These Coils are accurately made to the specification of "Popular Wireless." The windings are carefully and accurately made on a strong, reliable former. Use FORMO coils and be certain of best results.

Price **3/9** each

DUAL RANGE - 12/6
P.J. COILS - 2/- & 2/9

Obtainable from all Radio Dealers.
Complete Catalogue from:

ARTHUR PREEN & CO. LTD.,
GOLDEN SQUARE, PICCADILLY CIRCUS, LONDON, W.1.
Crown Works, Southampton.
SEE ALSO PAGE 258

TECHNICAL NOTES

(Continued from previous page.)

smooth-out than the current rectified by a full-wave rectifier. It is also true that to a very slight extent a half-wave rectifier is more wasteful than a full-wave one.

Little to Choose.

But on the general question as to a choice between these two types of rectification—apart from what I have just mentioned—there is really very little in it. It is perhaps convenient to compare the rectifying system to the engine of a motor-car.

You might say that an engine with four cylinders (or one cylinder for that matter) would give less power than an engine with six or eight cylinders, but actually the power delivered has little or nothing to do with the number of cylinders, and depends upon other considerations entirely.

In the same way, a full-wave rectifier can be designed to give any desired power output and a half-wave rectifier can be designed to give any desired output.

If a full-wave rectifier is converted into a half-wave rectifier by the suppression of half of each wave, then, of course, you would definitely reduce the power output to approximately half. But that is not the way to look at the matter.

A Question of Design.

Anyway, without going into further details, you needn't worry a bit if the mains unit, or any other device which you may use, employs half-wave rectification. You may be sure that the design of the instrument has been worked out to give the desired power upon the half-wave principle and that the smoothing arrangements are also to correspond. It does not matter to you in the least whether the rectification is single-wave or double-wave, so long as the other factors are made to correspond.

Adaptable Frames.

A frame aerial is apparently such a simple thing to make that a good many people overlook the fact that, by attention to a few little details, the efficiency of the frame aerial may be greatly increased.

For instance, where the frame is arranged for medium wave-lengths and also for long waves, as it generally is, it may be that when the long-wave part is cut out by means of a switch, it will have an adverse effect upon the tuning of the medium-wave winding, because the wave-length of the long-wave part may happen to be within the medium-wave range.

The effect of this will undoubtedly be to weaken the signals at this point and to render the tuning very poor. Furthermore, if reaction is used in connection with the frame you will find that at about this particular point you cannot make it oscillate.

Alternatively, if the long-wave winding and the medium-wave winding are placed in parallel with one another, it is quite possible that the results obtained will not be anything like as good as those when the long-wave part of the frame is cut out.

These are points which require careful attention if you want to get a frame which is really efficient for picking up signal energy; bear in mind that you want to gain everything you possibly can at the pick-up stage, because this makes a direct difference to the

(Continued on next page.)

ELEX

ENSURE THE
BEST
RECEPTION

FRAME AERIAL

A first-class frame aerial which can be used with any circuit, with or without centre tap, for only 20/- . The milliwatt output is higher than any other aerial, definite minimum silent point.

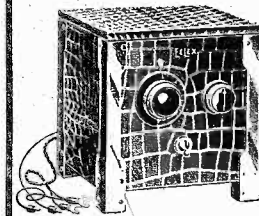

SHORT WAVE CONVERTER

If you fit the new Elex Converter your present set can be used for reception on the ultra short waves. It is an indispensable addition, it will add 50 stations to your log

BYLDURONE CABINET

The ideal system for the home cabinet maker. You can safely use "Byldurone" because no experience is needed to build a cabinet the "Byldurone" way. Ask your dealer about "Byldurone".

WRITE FOR LIST A3.

J. J. EASTICK & SONS
EELIX HOUSE, 118, BUNHILL ROW,
LONDON, E.C.1.

Phone: Metropolitan 0314/5/6.

EXACT TUNERS

250 to 2,000 metres.
Thousands of these tuners are in use, and we can strongly recommend them. No further coils are required. Send P.O. for particulars and circuits—FREE.

THE EXACT MANUFACTURING CO.,
Croft Works, Priory Street, Coventry.



PAULETTE ALL WAVE TUNER

250-2,000 metres. No coils to change. Greatly improved selectivity and range. PRICE, with Switch, 7/- post paid. Send stamp for FREE WIRING DIAGRAMS OF PAULETTE 3-VALVE SET. Easy to construct. Parts cost £2. 12. 6.

PAULL'S WIRELESS STORES,
43, Caroline Street, Cardiff.

MAKE YOUR OWN HIGH TENSION ELIMINATOR AND ALL-POWER UNIT

"SENSITITE"

Eliminator Kits employing famous
"Radcroix" Transformers.

KITS FOR PARTS FOR:

H.T., A.C. Units
20 mA., 120 v., S.G. 60, Det. 80, Max. 120, £2 0 0
35 mA., 200 v., S.G. 65, Det. 75, Int. 150,
Power 200 volts £2 15 0

H.T. and L.T.
12 Variable Voltages, 20 mA., 190 v., S.G.
var., Det. var., Power 190 volts £3 5 0
Wiring Diagrams free. State A.C. or D.C.

THE WHOLESALE WIRELESS COMPANY
103 Farringdon Road, London, E.C.1.
Telephone: CLERKENWELL 5312.

THE PICTURE PAPER WITH THE
MOST NEWS

SUNDAY GRAPHIC

TECHNICAL NOTES

(Continued from previous page.)

amount of amplification required and to the volume ultimately produced.

Comparing Frame Aerials.

If you are going to use the frame for only one particular purpose, say for medium waves only, it is much better to design and make it specifically for that purpose and not to introduce alternative wave-length ranges which will only have the effect of diminishing its efficiency.

Personally, I always think it better to make two or three different frames and to test these out in actual practice. They are very easily rigged up in a temporary fashion, and then you can tell which is going to give you the best results far better than by a lot of doubtful calculations.

"Peak" Tests.

You hear a good deal of talk about "peak-frequencies" or resonances in loudspeakers, but you never really understand what these mean until you make a series of accurate tests by means of some form of oscillator which will give you a complete range of oscillations and of adjustable amplitude.

I was making some tests of this kind recently on a number of loudspeakers, and was surprised to find what a large number of resonance points could be detected. These, of course, varied in sharpness, and some were much more pronounced than others.

They arise from a variety of causes, some mechanical, some electrical, but they are there nevertheless, and if you had been able to hear the results of these tests you would have realised at once why so much research has been devoted, and is still being devoted, to the quest of the perfect loudspeaker.

In some cases an instrument will respond particularly to the higher frequencies—this is altogether apart from the occurrence of isolated peak frequencies—whilst in other cases the low notes come in for greater amplification.

Matching Set and Speaker.

For reasons of this kind it is a very good plan to find out which part of the register is most amplified by your receiver and also which part is most generously reproduced by the loudspeaker.

Obviously, if you have a receiver which is favouring the higher frequencies and a loudspeaker which is doing the same, you are going to get pronounced distortion in the reproduction.

Much good can often be done by setting off the deficiencies of the loudspeaker against those of the set using, for example, a speaker which favours the higher ones.

But obviously all this is impossible unless you know something definite about the characteristics both of the speaker and of the receiver. A good many listeners use one loudspeaker for, say, dance music, and another for vocal selections. This is a perfectly good plan, and the same principle may with advantage be extended still further, as I have indicated above.

Position of Choke.

By the way, reverting to the question of smoothing high-tension supply, which I mentioned earlier in these Notes there is

(Continued on next page)

CLIX



CONSTRUCTOR'S KIT
Saves you Time and Money.
Contains an assortment of nineteen Clix fittings specially selected for the set builder.
Buy a Clix Kit for your next set and save fivepence.

Contents:—2 Spade Terminals engraved L.T.; 2 Plugs and Sockets (A and E); 7 Terminals, H.T., L.T., L.S.; 6 Wander Plugs, H.T. and G.B.
Value 3/5. Price **3/-**
Obtainable from most dealers or direct.



INDOOR AERIAL INSULATOR 2d.



"VICEGRIP" WANDER PLUG 1½d.



PANEL TERMINAL 3d.



ANODE CONNECTOR 3d.
Horizontal or Vertical.



ACCUMULATOR CONNECTOR 3d.

Lead-Coated Pin Permanently Fixed To Accumulator
Insulated Resilient Socket

Cheapest PERFECT Contact

Folder "P." on Request.

Lectro Linx Ltd., 254 Vauxhall Bridge Road, S.W.1.

CIRCUITS.

SOMETHING NEW!

Benjamin All-Mains Three, a reasonably high-powered set capable of a selection of at least 12 stations at loudspeaker strength.

The Benjamin Super Four—a super selective set and the Local Station Two. Full details and diagrams of these original circuits given in our 1932 Catalogue. Write for your free copy to-day.

The Benjamin Electric Ltd.,
Tarriff Road, Tottenham, N.17.

BENJAMIN

THE PICTURE PAPER WITH THE MOST NEWS—

SUNDAY GRAPHIC

and Sunday News.

You cannot imagine what real Radio reception is until you have tried...



THE MINOR
£4.15.0

See and hear it at your Dealers or write to-day for full details...

The new & improved Silver Ghost Lamplugh
Inductor-Dynamic-Speaker

The "Silver Ghost" Inductor Dynamic Speaker was designed to overcome that hollow boom type of sound reproduction associated with the moving-coil speaker without sacrificing volume. The perfectly natural tone of sound reproduced by the Inductor gives an entirely revolutionary meaning to what has previously been regarded as Speaker perfection. Moving-coil Speakers (P.M. type) with small magnets are low in efficiency and bear no comparison, to give efficiency approaching that of the Inductor. They require very large magnets making the price nearly double that of the "Silver Ghost" Inductor Dynamic.

Listen to the World's Radio under the truly delightful conditions which only the INDUCTOR DYNAMIC SPEAKER can make possible.

Licensed under Farrand Patents and patent applications. Send for fully descriptive pamphlet and other interesting literature. Chassis only £3 10s. Ask also for details of the all-electric Inductaset at £17 17s. 0d.

S. A. LAMPLUGH LTD., Little Park St., Coventry

"Popular Wireless" Recommend HEAYBERD

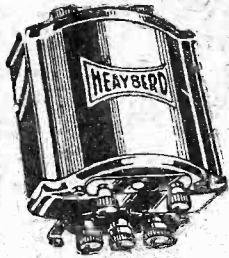

This national Radio weekly specifies Heayberd Units for use with its many Mains Sets. When Transformers of quality are required Heayberd is the choice. Here is our latest:

Model W.30.
200 v. @ 60 ma. using tapping 175
250 v. @ 60 ma. using tapping 200 v.
Price - 22/6

Remember all Heayberd Mains Units are Guaranteed Three Years against breakdown. This is the Kit that was Olympia's "best seller."

MODEL C.250—Output 250 v. @ 50 ma.
Four tappings: 60/80 Variable, 0/150 Variable, 100/200 Variable, 250 Fixed. West-house rectification. Assembled in Case. Requires wiring up only.

Price - 137/6

Send 3d. stamps for full lists showing how to make your own Mains Unit and circuit diagrams and valuable hints on new Transformers.



MASTERS OF THE MAINS

10, Finsbury St., LONDON, E.C.1.

For Sharpest Tuning and Minimum Disturbance fit the

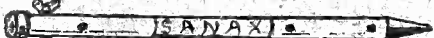

"SANAX" High Conductivity Copper Earth Tube
2/3 Post free. Illus. List Free. Trade Supplied.
Makers: "SanaRay" Electrical Co.,
185, Deritend, Birmingham.

JACOBAN POLISHED OAK RADIO-GRAMOPHONE CABINET

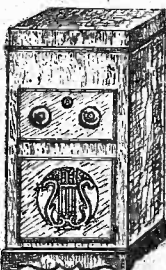

Cabinet with 4" clearance for the pick-up, Dome Lid, set compartment takes any panel up to 18 x 8", and 15 1/2" baseboard. Speaker compartment 19" high, 18" wide, and 15 1/2" deep. 3" Baffle fitted. Removable back to cabinet.

Machined ready to assemble, 17/-
Assembled ready to polish, 25/-

POLISHED JACOBAN, 30/-
Packed free, carriage forward.
Money returned if not satisfied.

FRANKS CABINETS 13, Martha Court, Cambridge Rd., London, E.2

PAREX

Products PAR-EXcellence are used and recommended for the

"POP-VOX" FOUR

P.J.2 and P.J.3 COILS, each 2/6
EBONITE PANEL, 21" x 7", polished and drilled 9/6

- .00015 DIFF. REACTION COND. 4/6
- H.F. CHOKE 3/6
- S.G. VALVE HOLDER 1/6
- 10" x 6" SCREEN with hole 2/6
- QUOIT COILS, per pair 4/-

SPAGHETTI RESISTANCES, ALL SIZES. SCREENS AND COILS OUR SPECIALITY.

E. PAROUSSI 10, Featherstone Buildings, High Holborn, London, W.C.1
Phone: Chancery 7010

TECHNICAL NOTES

(Continued from previous page.)

a point which often crops up which is sometimes very useful to know—and that is that if you are making up your own unit, and you are limited as to cost and can only go in for one smoothing choke, you will find that this is more effective in one position than in another.

It is not always possible to say in which of the two supply leads the choke should be inserted, but in many cases there is a very definite difference on transferring the choke from the one lead to the other.

Therefore, before deciding where to fix the choke permanently you should try it first in one lead and then in the other. Of course, there are some cases in which you really want a choke in each lead; in quite a number of cases, however, I have found

TECHNICAL TWISTERS

No. 82

FREQUENCY AND WAVELENGTH CAN YOU FILL IN THE MISSING LETTERS?

The speed of all electro-magnetic waves is approximately miles per second.

This is equivalent to about metres per second.

If, therefore, one million waves are leaving a transmitting aerial in one second, each wave would be . . . metres in length.

When the wave-length of a station is known, the frequency of its carrier-wave can always be ascertained by dividing the wave-length into

Last week's missing words (in order) were: Four, Two Grids, Control, Outer, Screen.

that you get all you want by a single choke in one lead. But, as I say, it is important to find out which lead gives the best results.

A Needle Hint.

I wonder how many of you have experienced a little trouble I had the other day, when putting a needle into the holder of a gramophone soundbox. When screwed up, the needle persisted in wobbling, and it turned out that it was only being gripped by two opposite points—the point where the screw touched it and the point directly opposite.

I suppose, theoretically, all gramophone needles are held the same way, and it is only due to deformation or some accidental circumstance that they are held securely at all. Wouldn't it be much better if the side of the needle-holder opposite to the screw were cut away, so that the needle would be resting against two points, separated by a distance of a few millimetres, at one side, the screw bearing on the needle at the other side at a point intermediate between the other two points?

In this way a very secure grip would be obtained, and the arrangement would conform to the elementary principles of the "geometrical clamp."

EASY TERMS

WE supply all good quality Radio Receivers, Components and Accessories on deferred terms. We carry adequate stocks and can give PROMPT DELIVERY.

NEW COSSOR 1932 EMPIRE KIT No. 234.
A remarkable advance on last season's model.
Cash Price £6 15 0
Or 10/- with order and 11 monthly payments of 12/4.

NEW HEAYBERD A.C. ELIMINATOR KIT C.150. Complete kit of parts for building an H.T. Eliminator, including steel case. Output 25 ma., 150 volts. 3 H.T. tappings, one variable.
Cash Price £3 16 0
Or 7/6 with order and 11 monthly payments of 7/-.

12 EXIDE W.H. HIGH-TENSION ACCUMULATORS (120 volts, 5,000 ma.). Higher voltages if desired.
Cash Price £3 15 0
Or 7/6 with order and 11 monthly payments of 7/-.
Carriage charged on all orders from Scotland.

N.K. FARRAND INDUCTOR LOUD-SPEAKER UNIT.—Quality of reproduction almost equal to a moving-coil speaker
Cash price £3 10 0
Or 5/6 with order and 11 monthly payments of 6/6.

SET OF 3 VALVES, S.G., Det. and Power, Mullard or Cossor.
Cash Price £1 19 0
Or 6/- with order and 7 monthly payments of 5/4.

NEW BLUE SPOT 66R UNIT. The finest balanced armature movement on the market, complete with large Cone and Chassis
Cash Price £2 10 0
Or 5/- with order and 10 monthly payments of 5/-.

NEW CELESTION MOVING-COIL L.S. UNIT (PERM MAGNET), with Transformer.
Cash Price £4 5 0
Or 13/6 with order and 10 monthly payments of 8/-.

Any radio goods sent C.O.D.
We pay carriage and all C.O.D. charges.
Send list of requirements, and quotations will be sent by return.

LONDON RADIO SUPPLY CO.,
11, OAT LANE,
NOBLE STREET, LONDON, E.C.2

TELEPHONE: National 1977.

MELODISCS MELODISCS

are a perfected type of non-metal, non-brittle centre washer designed to fit all SINGLE or DOUBLE CONE Speakers. Metallic or other noises associated with old type metal washers are entirely absent and PERFECT REPRODUCTION attained. The discs are reversible, adjustable and complete with SELF-CENTRING CHUCK, instantly fitting and gripping all unit driving rods. Finished, as a violin, FOR TONE. Fitted in a few minutes to your Speaker. Send now to "MELODISCS," 2, New Rd., Willenhall, Staffs.

FOR YOUR LINEN CONE SPEAKER 2/6 only PER SET POST FREE

Patents, Trade Marks "Advice Handbook" and Consultations FREE.—B. T. KING, C.I.M.E., Regd. Patent Agent (G.B., U.S. and Canada), 146a, Queen Victoria Street, London, E.C.4. 45 years' references. Phone: Cent. 1682

ENGINEERS. Seriously, if you are earning less than £10 per week you cannot afford to carry on without reading "Engineering Opportunities." Whether you are an old hand or a budding apprentice, this 200-page volume will point to a worth-while future. Among other things the book explains the methods of our unique Appointments Department, gives details of all leading Eng. Exams. (A.M.I.Mech.E., A.M.I.E.E., B.Sc., G.P.O., etc.) and outlines Modern Home Study Courses in Civil, Mech., Elec., Motor, Aero, Radio, "Talkie," and all other branches of Engineering. This book will alter your entire outlook, and earning power. It is quite FREE. Send for your copy now.

BRITISH INSTITUTE OF ENGINEERING TECHNOLOGY,

401, Shakespeare House, 29/31, Oxford St., London.

AMPLIFY!

Let your Cone (or Horn) Speaker give that Moving Coil Quality and ample distortionless volume without extra valves by adding the "Magna" Amplifier (Pat.) Something new in amplifiers for it is worked by L.T. supply only. Needs no valves, alterations to set, wiring, or expensive parts, and is very compact. Actually GUARANTEED to amplify reception three times. Special Electrode material, Reed, and Rubber Blocks, 2/6, together with full-size, clear, constructional blue-prints and diagrams. Simple to construct.—Agent, L. Cook, 182, Cranston Rd., S.E.25.

PLEASE be sure to mention "POPULAR WIRELESS" when communicating with Advertisers. THANKS!

EVERYTHING **The G.E.C.** ELECTRICAL
your guarantee

**THE WORLD ASKED FOR A
BETTER LOUD SPEAKER
AT A LOW
PRICE!**



The GECOPHONE

**INDUCTOR DYNAMIC
LOUD SPEAKER**
now fills the demand

(Farrand Inductor Patent)

A BRITISH PRODUCT
DESIGNED FOR BRITISH
RADIO CONDITIONS

Sold by all
Wireless Dealers

Only the finest loud speaker movement is good enough to reproduce the natural tones of instruments and voices in a manner to suit modern standards of quality. The GECOPHONE Inductor Dynamic Loud Speaker raises the quality of home entertainment to a higher level than ever before obtained. Its low price only adds to the marvels of this brilliant loud speaker.

WRITE for folder BC5958 which fully describes and illustrates in colours the complete range of GECOPHONE Radio Receivers and Loud Speakers. SENT POST FREE.

Cat. No. BC1850
Chassis only. Price
£3.10.0

Cat. No. BC1855
complete in wal-
nut cabinet. Price
£5.10.0

HIRE PURCHASE:
(BC1855) Deposit £1
and 12 monthly pay-
ments of 8/-

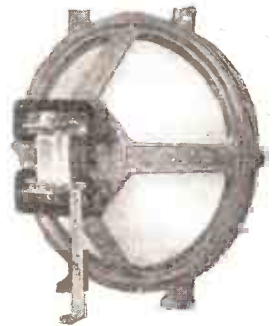

SUPREMACY IN RADIO — G.E.C. Radio

The Two Principles of Amplification!

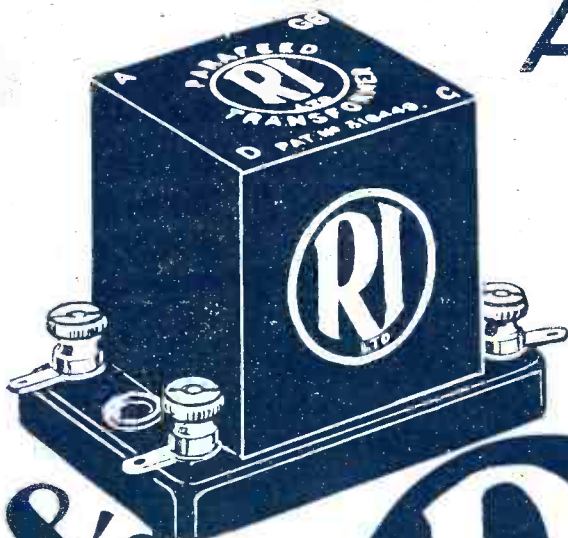

8'6

The Parallel Feed System With PARAFEED

The exponents of the system of Parallel Feed Amplification declare that it yields the positively best reception in suitable circuits.

R.I., by a masterly piece of brilliant research, have produced the "Parafeed," now universally acknowledged to be the Best Transformer for this form of coupling—the five N.P.L. Curves definitely prove this by High and Uniform Amplification of

25 to 8,000 Cycles

as also does its amazing inductance of 100 henries



The "PARAFEED" operates with a condenser and resistance and gives reception of unsurpassed brilliance over all frequencies.
List No. DY 28 Pat. No. 316449 Size 2½ x 2½ x 1½ ins. Weight 3½ ozs.

And for the standard principle

DUX

The Reliable Low Priced Transformer for Standard Coupling

A Transformer with an inductance of **30 HENRIES**

and a performance, to quote the Technical Press, equal to many transformers at four times the price. You know before you buy "DUX" that the performance will be right by the published technical facts given in the "DUX" leaflet, which also contains suitable diagrams, and is obtainable free from your dealer, or us, at request.

Ratio: 1-3½ (standard) or 1-4½ (auto-connection).
Weight: 11½ ozs. Size: 3½ x 2 x 2½ ins. high. List No. DY 29.

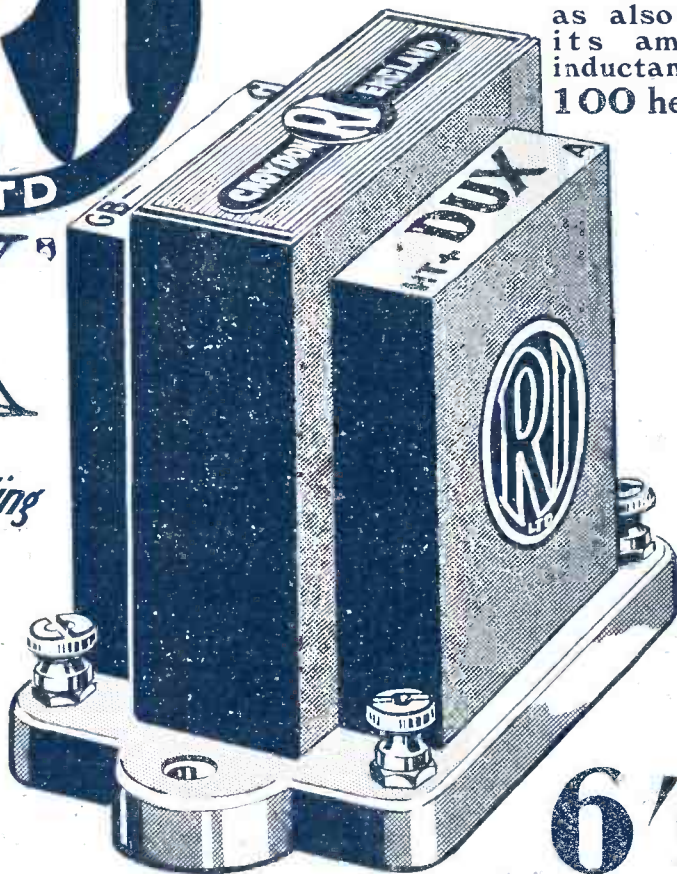

6'9

The lowest price you can pay for Reliability

ASK YOUR DEALER OR US FOR BOOKLET "THE PARAFEED WAY TO BETTER AMPLIFICATION" AND ALSO FOR DUX LEAFLET

R.I. Ltd., Purley Way, Croydon, England. Telephone: Thornton Heath 3211.

INTRODUCING THE "DUAL RANGER" (See page 361)

Popular Wireless

Every Thursday
PRICE
3d.

No. 489. Vol. XX.

INCORPORATING "WIRELESS"

October 17th, 1931.

THE "P.W." GUIDE TO
BETTER RADIO

VOL. 2

THE
COMPLETE
FAULT
FINDER

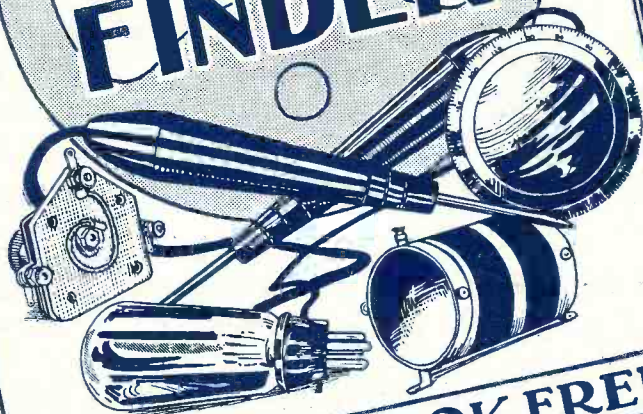

SIXPENNY BOOK FREE

Our Second
Free Gift!

INSIDE

ALSO THIS WEEK

101 HINTS
AND TIPS

JACK PAYNE'S POSTBAG

SPECIAL MANCHESTER
EXHIBITION CRITIQUE

THE NEW MAINS VALVES

LARGEST RADIO
DISTRIBUTORS
IN THE WORLD

Ready Radio

EASTNOR HOUSE

BLACKHEATH

LONDON

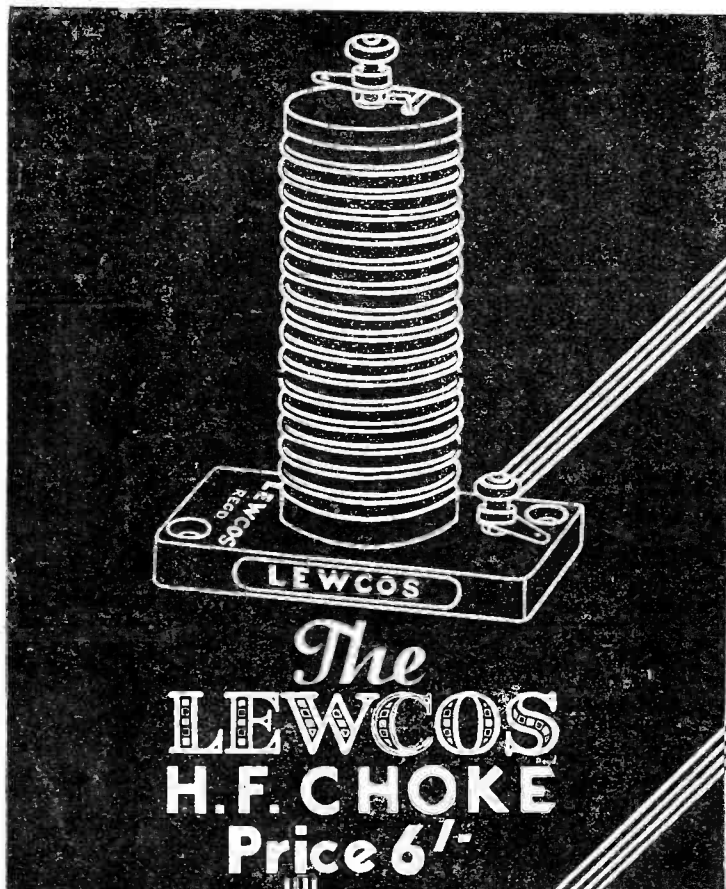

MADE BY
MASTER-
CRAFTSMEN

The
LEWCOS
H.F. CHOKE
Price 6/-

THE Lewcos Super H.F. Choke is specially constructed to eliminate self-oscillation. Scientific research by highly skilled engineers shows that this choke can be used with complete confidence in its efficient performance on all wavelengths from 20 to 2,000 metres.

The following are extracts taken from an appreciation by Industrial Progress (International) Limited, Bristol. ". . . the Lewcos H.F. Choke is, in our opinion, *the most efficient choke we have tested . . . and its design places it in the front rank of high-class components.*"

In short, the Lewcos Super H.F. Choke fulfils its purpose because it is constructed on a scientific basis with the best materials by master craftsmen.

Write to-day for a fully descriptive leaflet Ref. R. 33, which shows the choke curves and gives tested values.

THE LEWCOS SUPER H.F. CHOKE IS SPECIFIED FOR THE "DUAL-RANGER" RECEIVER DESCRIBED IN THIS ISSUE.



LEWCOS RADIO PRODUCTS FOR BETTER RECEPTION
THE LONDON ELECTRIC WIRE COMPANY AND SMITHS LIMITED, CHURCH ROAD, LEYTON, LONDON, E.10

2 VOLT MAZDA MASTERPIECES

TYPE	PRICE
H.210 - - -	8/6
HL.210 - - -	8/6
★ HL.2 - - -	8/6
L.210 - - -	8/6
★ L.2 - - -	8/6
P.220 - - -	10/6
P.220A - - -	13/6
P.240 - - -	13/6
PEN.230 - - -	20/0
PEN.220 - - -	20/0
PEN.220A - - -	20/0
S.G.215 - - -	20/0
★ S.G.215A - - -	20/0
★ S.G.215B - - -	20/0

★ METALLISED

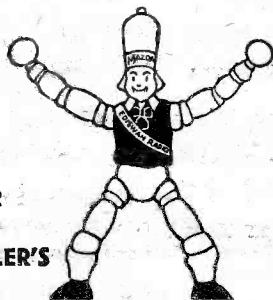

LOOK FOR
"EDDY" IN
YOUR DEALER'S
WINDOW

THE AMAZING

MAZDA PEN. 220

Characteristics:

Filament Voltage - 2.0 volts Anode Current (Max) - 12 mA
 Filament Current - 0.2 amps Screen Voltage (Max) - 150 volts
 Anode Voltage (Max) - 150 volts Mutual Conductance - 2.5 mA/V
 At $E_a - 100$; $E_s - 100$; $E_g - 0$.

PRICE 20/6

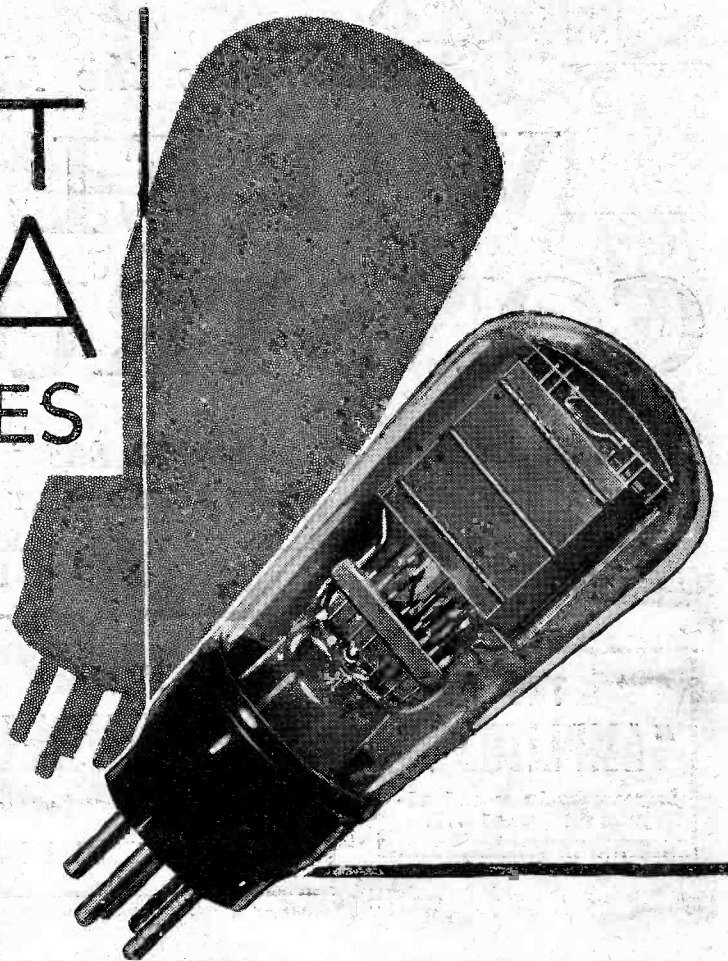

Since 2-volt valves were made, never has there been so amazing a range as this — so much evidence of brilliant engineering — so many valves with outstanding characteristics. Instance the Pen. 220; or pentode, which at once presents the solution to the output stage problem in portable sets, for it gives an astonishingly large output for a combined screen and anode current of under 5 mA. It is a valve H.T. dry battery users have longed for. It is typical of all Mazda 2-volt valves. Mazda 2-volt valves, both metallised and clear bulb types, are sold by all good radio dealers.

MAZDA

THE
BRITISH
VALVES

The Edison Swan Electric Co. Ltd.



155 Charing Cross Road, London, W.C.2

V135

Don't miss the November

WIRELESS CONSTRUCTOR

This new issue is an unusually fine number for listener and experimenter alike. Some absolutely new features are presented in the November designs for constructors, which include:—

THE "AMPLITONE"

Increases volume and adjusts the tone as well.

THE "I.E. THREE"

Ordinary & short waves
ON THE ONE DIAL!

THE D.C. "ACE"

An all-electric economy
loudspeaker set.

Among the other contents of this fine issue are:—

Power from Low-Voltage-Mains
Queer Queries
Seen at the Show
An "Inter-Spag" Unit
As We Find Them
Making a Radio Cabinet
With Pick-up and Speaker
Round the Dials
Points for Purchasers
From Metres to Inches
Pick-up Hints and Tips
A Practical Man's Corner

In Lighter Vein
Savoy Hill News
The Month on Short Waves
"On the Grid"
Is Home Construction Worth While?
Efficient Indoor Aerials
"A Pat on the Back"
Wiring Wrinkles
Easy Connections
Do Your Records Run True?
The Radio Doctor
The Origin of the Morse Code

MAKE SURE OF YOUR COPY TO-DAY!

**NOW ON
SALE**

THE NOVEMBER
WIRELESS CONSTRUCTOR

**ONLY
SIXPENCE**

Amazing fineness of adjustment Unprecedented perfection of reproduction

100%
improvement
in tone & volume
on any unit
previously
marketed

Gone can be the artificiality—the “sound thinness” which has hitherto characterised ALL speakers—the new Undy “8” and “4” pole Units ensure a “human” rendition of voice and music. It is indeed a marvellous revelation of tone, quality and truth. Here’s an amazing test that must interest you. Impartial experts, assembled in a large Hall, could not distinguish natural sounds from the sounds reproduced by the Undy Units. You, too, can enjoy the same perfect reproduction. The new “Undy” 8 is fitted with tapings to suit valves of low or high impedance as desired.

Go to your dealer and hear it for yourself.

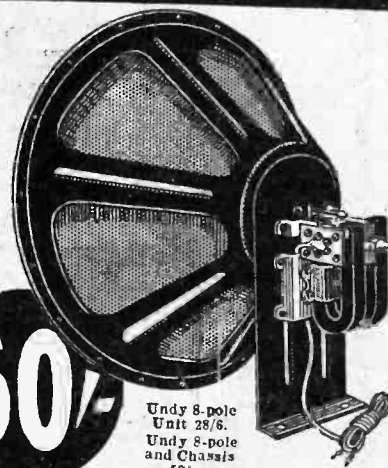

Undy 8-pole Unit 28/6.
Undy 8-pole and Chassis 50/-

Undy 4-pole Unit and Chassis 28/6.
Undy 4-pole Unit 15/-
Also a very fine selection of cabinets.

The New *Dynamic* 8 pole **UNDY**

50/-

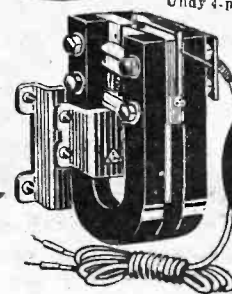

28/6

Brit. Pat. 332930.

obtainable from all wireless stores

Sole Wholesale Representative for Gt. Britain and Ireland: J. Hemelik, 8, Cullingworth Road, London, N.W.10 Telephone: Glad. 3033.

The Outstanding feature of the show

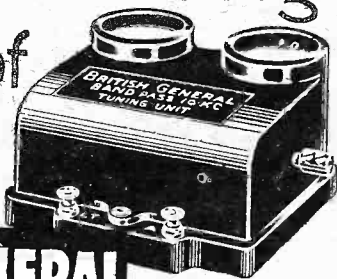

BRITISH GENERAL

BAND PASS 10K.C. TUNING UNIT

At last—a Tuning Unit which gives the separation of 10 Kilocycles as laid down by the International Radio Convention, and yet gives full strength throughout the entire wave-band between 230 and 550 and from 800 to 2,000 metres.

Of all dealers of repute or direct from the manufacturers:

BRITISH GENERAL

PRICE 14/6

SOVEREIGN P.W. TUNING UNITS



Coil Quits, P.J. Coils and P.V. Coils designed by “Popular Wireless” are now available by Sovereign to exact specifications by Sovereign. You can rely on these components doing everything “Popular Wireless” claims. You can rely on their quality. They’re right because they’re Sovereign—the Components that improve any circuit.

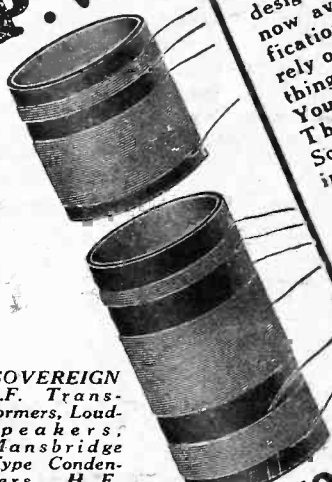

COIL QUITTS 6D
of moulded bakelite with lugs for mounting, 4 drilled holes and slotted shoulders to facilitate winding. Each

SOVEREIGN L.F. Transformers, Load-speakers, Mansbridge Type Condensers, H.F. Chokes, Volume Controls, Spaghetti Resistances, Mains Components SEND

P.J. COILS
No. 1. 2/- No. 2. 1/6
No. 3. 2/-

P.V. COILS
- 6/6

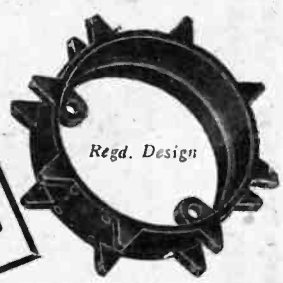

Regd. Design

Longer Life

for LESS MONEY

The

GUARANTEE OF LONGER BATTERY LIFE

LONGER lasting power has been put into the Improved Lissen H.T. Battery—and a LIFE GUARANTEE is printed on the side of every Improved Lissen Battery you buy.

Prices, too, have been greatly reduced so that to-day when you buy a Lissen H.T. Battery you get much longer lasting battery for much less money than before.

Look for the Lissen Longer Life Guarantee—buy only at the reduced prices. Ask for “the Improved Lissen H.T. Battery”—stocked by all good radio dealers.

- | | |
|--|--|
| 60v. Standard Reduced from 7/11 to 5/6 | 36v. Grid Bias Reduced from 4/6 to 4/- |
| 100v. Standard Reduced from 12/11 to 9/3 | 99v. Portable Reduced from 12/6 to 9/- |
| 120v. Standard Reduced from 15/10 to 11/- | 60v. Portable Reduced from 7/11 to 5/6 |
| 9v. Grid Bias Reduced from 1/6 to 1/- | 60v. Super Power Reduced from 13/6 to 12/- |
| 16v. Grid Bias Reduced from 2/9 to 1/9 | 100v. Super Power Reduced from 22/- to 20/6 |

IMPROVEMENTS INCORPORATED IN THE LISSEN BATTERY ENABLE US TO GIVE THE FOLLOWING

Guarantee

This Lissen battery is definitely guaranteed to have a much longer life than a 100 volt Lissen battery bought prior to August 1st, 1931.



← **LOOK FOR THIS WHEN YOU BUY**



60 VOLT
5/6
100 VOLT
9/3

**An
instantaneous
Success**

**for
high Quality
& Brilliant
Performance**

**The ORMOND
MOVING COIL
LOUDSPEAKER**

Here, again, Ormond offer the home constructor the opportunity to make for himself a 'speaker,' equal to the most expensive products on the market, at a price well within reach of the slender purse. Gloriously natural tone is ensured by the perfectly balanced frequency response.

The construction is extremely robust, the whole being mounted as a complete chassis. The cone, speech coil and suspension are arranged to give a truly parallel action, to handle a heavy input without distress.

A speech transformer is incorporated, terminals being provided with alternative ratios for matching with the valve used in the output stage.

£3:5:0

Cat. No. R/464.

Also available complete in handsome figured oak cabinet. Height 16½ in. Width 16½ in. Depth 10½ in. Cat. No. R/466. Price £4 19s. 6d.

THE ORMOND ENGINEERING Co. Ltd.
Ormond House, Rosebery Avenue, London, E.C.1

Telephone: Clerkenwell 5334-5-6 and 9344-5-6.
Telegrams: "Ormondengi, Isling."

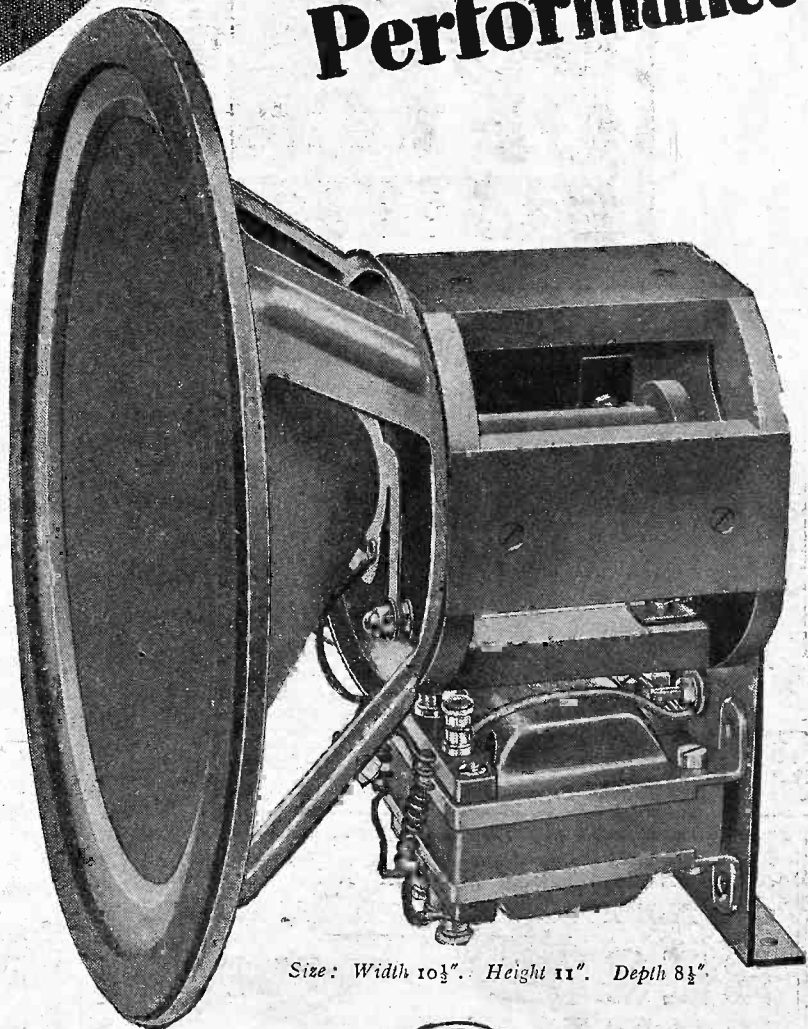

Size: Width 10½". Height 11". Depth 8½".

We are exhibiting at Stand 27 at the Manchester Wireless Exhibition



FERRANTI SPEAKERS

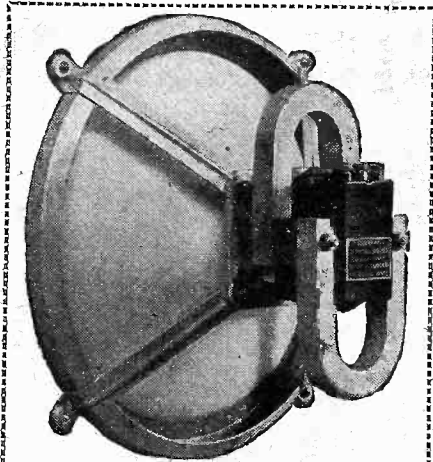

**THE NEW
FERRANTI INDUCTOR SPEAKER**
and the Moving Coils now available provide a range which will enable every listener to secure the best reproduction of which his Set is capable. It's well worth while to use a better speaker.

	PRICES:	Chassis only.	
Moving Coil, M.1	-	-	£9.10.0
Moving Coil, M.2	-	-	£5.10.0
Moving Coil, M.3	-	-	£3.15.0
Inductor	-	-	£3.10.0

Cabinets from £2 extra.



Small dealers, or direct

Visitors to Olympia were captivated by the life-like reproduction afforded by Ferranti Speakers—a quality which is attained only by intense research, careful selection of the materials used, and unrivalled experience in true reproduction.

The Ferranti Standard Moving Coil Speakers are established as the finest reproducers of radio music and speech that science has yet devised, and they maintain that position by consistent excellence of workmanship.

FERRANTI LTD. Head Office & Works:
HOLLINWOOD, LANCASHIRE.
London: Bush House, Aldwych, W.C.2.

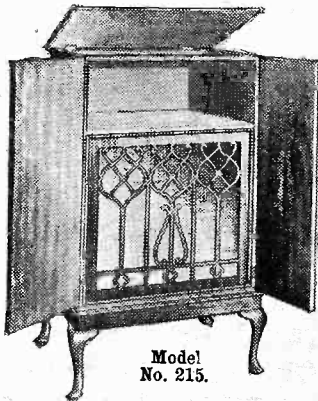

Model
No. 215.

OSBORN

Ready-to-Assemble **RADIO CABINETS**
There is an Osborn Cabinet for every set on the market.

Model No. 215 specified for the "Popular Wireless" Comet 2, Comet 3 and Comet 4. 4ft. high, 2ft. 2ins. wide, 1ft. 6ins. deep. Size of baffle board behind fret is 24ins. by 24ins. Metallic Fabric for the fret front is included. Opening at top and back. Cabinet takes panel 2ft. by 9ins. (or smaller).

PRICES:
Machined, Ready to Assemble: Oak, 60/-; Mahogany, 65/-; Walnut, 75/-; Assembled, ready to polish, Oak, 80/-; Mahogany, 85/-; Walnut, 95/-; Assembled and Polished, Oak, 100/-; Mahogany, 115/-; Walnut, 130/-. All Models carriage paid.

For 5/- extra cabinet made four inches higher and converted into a Radio Gramophone Cabinet, complete with Motor Board.

Send 3d. in stamps for 56-page illustrated catalogue.

CHAS. A. OSBORN, Dept. P.W.

The Regent Works, Arlington Street,
London, N.1. Telephone: Clerkenwell 5095.
And at 21, ESSEX RD., ISLINGTON, LONDON,
N.1 (1 min. from the Agricultural Hall).
Telephone: Clerkenwell 5634.

STAND No. 51. New Hall,
NORTHERN NATIONAL
RADIO EXHIBITION
City Hall, Manchester. Oct. 7-17.

**REDUCED PRICES!
QUALITY MAINTAINED**

**BECOL LOW LOSS
FORMERS**

26 Types. Tested before despatch.

LOOK FOR TRADE MARK

PANELS CUT TO ANY SIZE

THE BRITISH EBONITE Co. Ltd.,

How to Make a Sailplane

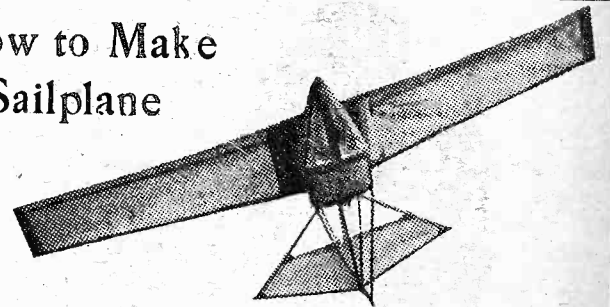

This ripping Model Sailplane —an engineless model aircraft —can be made in a spare hour for only a few pence. It will rival the performance of almost any self-powered model plane. You will find full details of how to construct this super-glider in the 1932 HOBBY ANNUAL, the finest book for the boy who is keen on making things and finding out how things work. This topping gift book is profusely illustrated with photographs and drawings that show "how" in the simplest way. There are also two large folding photogravure plates.

*The Book for
the Boy with
a Hobby*

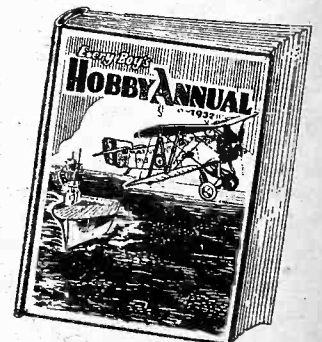

HOBBY ANNUAL

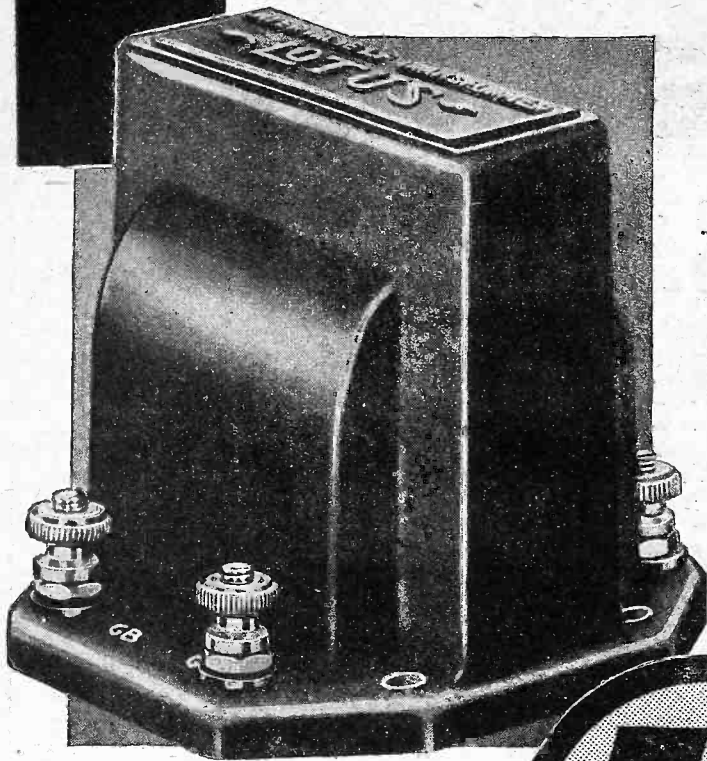

not a cheap transformer but a sound instrument

at a very



low price

All the leading set designers specify LOTUS. They know that for reliability and efficiency they are absolutely dependable.

Follow the experts' lead; insist on LOTUS Components.

This new LOTUS Audio Transformer No. 1 is a particular triumph of value, and its performance is equal to many at twice the price. It is designed specially for the use of the home constructor. While small in size, specially designed windings and core give high efficiency, good reproduction and an exceptional straight-line amplification curve.

It is enclosed in a neat brown bakelite moulding, and the core is earthed through one of the fixing eyelets. Ratios 3-1 and 5-1. Type AT/1, Price 5/6.

Every home-constructor should have the new LOTUS Component Catalogue. Ask your dealer or write for your copy to-day.

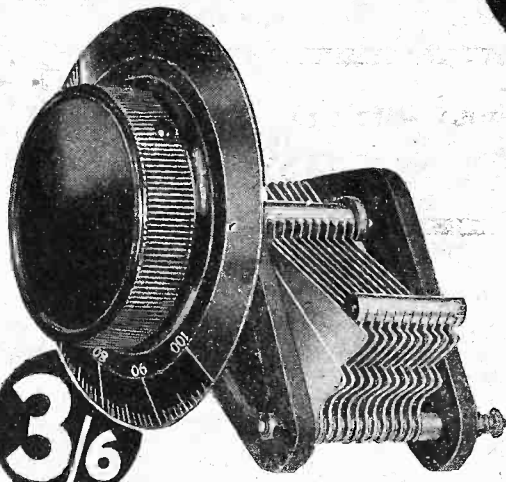

THE LOTUS RIGID DRIVE LOG CONDENSER.

An inexpensive, small, but highly efficient condenser with heavy gauge aluminium vanes. The endplates are high-grade bakelite mouldings, and the special method of assembly ensures accurate spacing. One-hole fixing is employed and the highly finished Knob-Dial, engraved 0-100, is supplied in either Black or Mottled Brown finish.

Capacities .0003, Type KC/3
and .0005, Type KC/5 **3/6** EACH

EXCLUSIVELY USED IN THE "DUAL RANGER"

described in this number.

One LOTUS Audio Transformer Type AT/1 featured on this page.

Two LOTUS Vernier Condenser Drives.



ANOTHER GIFT FOR READERS!

To assist in the construction of the fine set we have introduced to readers of POPULAR WIRELESS in this number, we are presenting a free blue print to every reader.

NEXT WEEK

FREE!

FREE!

A BLUE PRINT of THE

“DUAL-RANGER”

FREE!

FREE!

Make
Sure of

“ P.W. ”

Order it
NOW

USUAL PRICE

NEXT THURSDAY

THREEPENCE

EXPRESS KIT SERVICE

DUAL RANGER "B.P." THREE

READY FOR IMMEDIATE DELIVERY

The components contained in Pilot Author Kits are as chosen, tested and specified by the Technical Department of "Popular Wireless" and approved, therefore, by an established technical authority that you can trust implicitly.

**C.O.D.
CASH
H.P.**
as usual

PILOT AUTHOR'S KITS

Send 6d. in Stamps for NEW 116-page "Radio Buyers' Guide of 1932 Radio."

DUAL RANGER

CHECK this list of parts with the Author's specification, photographs and diagrams on pages 361-362 of this issue.

- | | |
|--|--------|
| 1 Panel, 16" x 8" | s. d. |
| 1 Baseboard, 10" deep | 6 9 |
| 2 Telsens .0005-mfd. condensers with slow-motion dials | 1 6 |
| 1 Ready Radio .0005-mfd. solid dielectric condenser | 14 0 |
| 2 Ready Radio 3-point wave-change switches | 3 0 |
| 1 Lissen on-off switch | 1 0 |
| 1 Telsens .0001-mfd. differential reaction condenser | 2 0 |
| 1 "P.W." and "M.W." dual range coil | 12 6 |
| 1 Goltone .002-mfd. max. compression condenser | 1 3 |
| 1 Igranic 1-mfd. fixed condenser | 1 6 |
| 1 Ferranti .0003-mfd. fixed condenser | 1 6 |
| 1 T.C.C. .001-mfd. fixed condenser | 1 10 |
| 1 T.C.C. 1-mfd. fixed condenser | 2 10 |
| 1 R.I. P.J.3 coil | 2 6 |
| 1 Peto-Scott ready wound coil quoit | 2 0 |
| 1 Screen, 10" x 7", with hole for S.G. valve | 2 9 |
| 1 Graham-Farish 2-veg. leak and holder | 1 4 |
| 2 Lewcos and Varley H.F. chokes | 9 6 |
| 1 Lotus L.F. transformer, ordinary ratio | 5 6 |
| 1 Bulgin 50,000 ohms Spaghetti resistance | 1 9 |
| 1 Terminal strip, 16" x 1 1/2" | 2 0 |
| 1 Bulgin 25,000-ohm Spaghetti resistance | 1 6 |
| 9 Belling-Lee Type R indicating terminals | 2 3 |
| 1 Glazite, flex, screws, etc. | 3 0 |
| 1 Bulgin crocodile clip | 2 9 |
| 1 1-5 G.B. battery for S.G. valve | 9 |
| Author's Kit "A" Cash or C.O.D. | £4 8 2 |

KIT "A" Author's Kit "A" less Valves and Cabinet or 8/1 down and 11 monthly payments of 8/1 **£4 8 2**

KIT "B" Author's Kit "A" with Valves less Cabinet or 11/8 down and 11 monthly payments of 11/8 **£6 7 2**

KIT "C" Author's Kit "A" complete with Valves & Cabinet or 13/7 down and 11 monthly payments of 13/7 **£7 8 2**

- SPECIAL C.O.D. ITEMS FOR NEW "POPULAR WIRELESS" SETS**
- DUAL RANGER**
- 2 Telsens .0005 mfd. condensers with slow motion dials ... 14 0
 - 1 Coil Equipment comprising "P.W." and "M.W." Dual Range Coil, Peto-Scott Ready Wound Coil Quoit, and 1 R.I. P.J. 3 Coil ... 17 0
 - 3 Valves as specified: Metallised S.G., Osram H.L.2, and Mazda P.220 ... £1 19 0
 - 1 Cabinet as specified

"B.P." THREE

KIT "A" Author's Kit "A" less Valves and Cabinet or 10/5 down and 11 monthly payments of 10/5 **£5 13 1**

KIT "B" Author's Kit "A" with Valves less Cabinet or 12/11 down and 11 monthly payments of 12/11 **£7 0 7**

KIT "C" Author's Kit "A" with Valves and Cabinet or 14/8 down and 11 monthly payments of 14/8 **£7 18 1**

- B. P. THREE**
- 1 Lewcos Band-pass Coil ... 12 0
 - 1 Utility .0005 - mfd. Double Gang Variable Condenser ... £1 2 6
 - 1 Igranic Slow-Motion Dial ... 5 0
 - 3 Osram valves (as specified): H.L.210, L.210, P.215 ... £1 7 8
 - 1 Mahogany cabinet, with lift-up lid ... 17 6
 - 1 Cabinet as specified ... £1 1 0

CHECK this list of parts with the Author's specifications, photographs and diagrams on pages 290-1-2 of last week's issue.

- | | |
|--|---------|
| 1 Baseboard, 10" deep | s. d. |
| 1 Panel, 15" x 7" (drilled to specification) | 6 0 |
| 1 Lewcos band-pass coil | 12 0 |
| 1 Utility .0005 - mfd. double gang variable condenser | 1 2 6 |
| 1 Igranic Vernier dial for same | 5 0 |
| 1 A.E.D. volume control, 500,000 ohms | 8 6 |
| 1 Ready Radio "on-off" switch | 10 |
| 1 R.I. L.F. transformer, 7-1 | 10 6 |
| 1 Ready Radio H.F. choke | 4 6 |
| 1 Ferranti output choke | 7 0 |
| 1 T.C.C. .0003-mfd. fixed condenser | 1 6 |
| 1 Dubilier .02-mfd. condenser (non-inductive) | 2 0 |
| 1 T.C.C. .01-mfd. condenser | 3 0 |
| 2 T.C.C. .2-mfd. condensers | 7 8 |
| 1 Graham-Farish 2-veg. grid leak and holder | 1 4 |
| 1 Varley 100,000-ohm spaghetti resistance | 1 6 |
| 1 Ready Radio 25,000-ohm spaghetti resistance | 1 6 |
| 1 Telsens .0005-mfd. reaction condenser | 2 6 |
| 1 Bulgin fuse holder, with fuses | 2 6 |
| 1 Bulgin two-way switch, Type S.86 | 2 0 |
| 1 Terminal strip, 18" x 2" | 2 0 |
| 11 Belling-Lee Indicating terminals, Type R | 2 9 |
| 1 Glazite, wire, screws, etc. | 3 0 |
| 4 G.B., 3 H.T. and 2 L.T. plugs, and 2 spade terminals | 1 6 |
| Author's Kit "A" Cash or C.O.D. | £5 13 1 |

PILOT RADIO KIT PRICE CHART FOR OTHER FAVOURITE P.W. SETS

ITEM NO.	SET.	KIT "A," less Valves and Cabinet.	KIT "B," with Valves less Cabinet.	Kit "C," complete with Valves and Cabinet.
50	P. V. STAR (Author's Kit)	CASH or C.O.D. £5 11 11 or 10/3 down and 11 monthly payments of 10/3	CASH or C.O.D. £7 10 11 or 13/10 down and 11 monthly payments of 13/10	CASH or C.O.D. £8 18 5 or 16/4 down and 11 monthly payments of 16/4
51	P.V. PLUS (Author's Kit)	CASH or C.O.D. £4 7 8 or 8/- down and 11 monthly payments of 8/-	CASH or C.O.D. £6 6 8 or 11/7 down and 11 monthly payments of 11/7	CASH or C.O.D. £7 6 8 or 13/5 down and 11 monthly payments of 13/5

★ Any parts supplied separately if value over 10/- . Sent carriage paid or C.O.D. All post charges paid.

EXPRESS ORDER FORM
To PETO-SCOTT CO. LTD.
Please send me C.O.D.,/CASH/H.P.

for which I enclose Cash/H.P. Deposit £ s. d.
Name



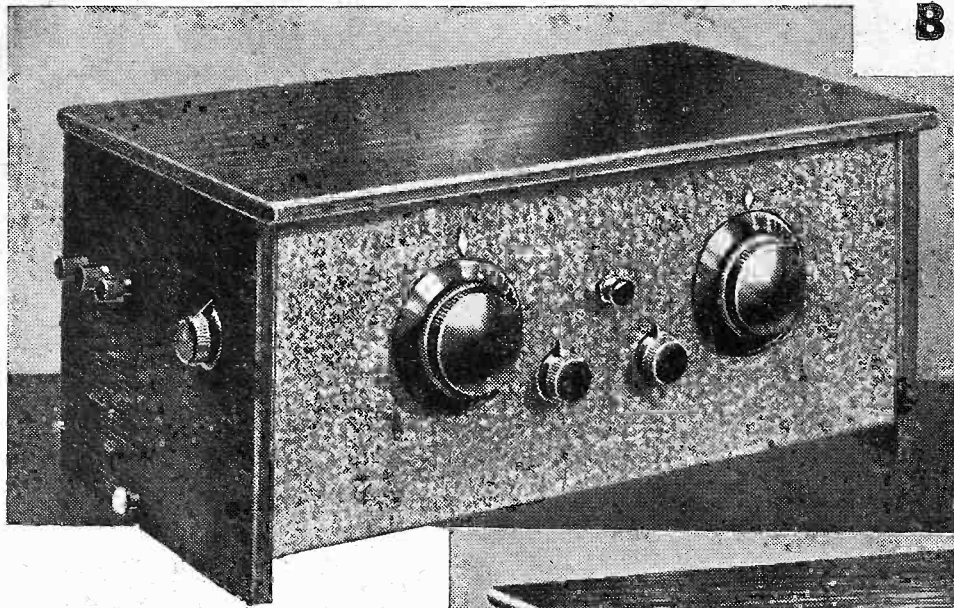

BATTERY MODEL

£6.15

Price includes latest types of Cossor Metal-lised Screened Grid, Cossor Detector and Power Valve, handsome oak cabinet and all parts necessary for home assembly of the complete Receiver (as illustrated at left) which is so simple that it can be easily built by anyone—even if they know nothing about Wireless.

Hire Purchase terms
15/- deposit and 9 month-
ly payments of 15/-

All-British

—latest

Screened Grid circuit

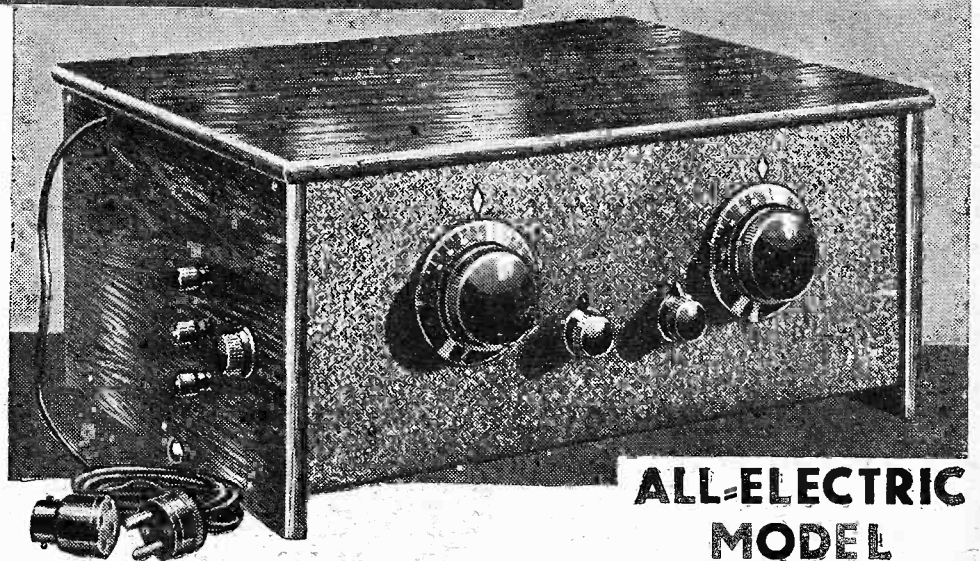

ALL-ELECTRIC MODEL

£9.19.6

Price includes handsome oak cabinet, latest type Cossor Metallised Screened Grid Mains Valve, Cossor Metallised Mains Detector, Cossor Mains Power Valve and Cossor Rectifier, Cossor Heavy-duty Mains Transformer, all the parts necessary for assembling the complete Receiver (as illustrated above) and full size Constructional Chart.

Hire Purchase terms:
20/- deposit and 10
monthly payments of 20/-

NO matter how much you pay you cannot buy a more powerful 3-valve Receiver than the Cossor Empire Melody Maker.

This remarkable Set incorporates all the most up-to-date features of design—latest screened grid circuit—completely screened coils—series aerial condenser—external wave-change switch and all-metal baseplate. Its range is enormous. Its selectivity

is remarkable. It will bring in all the main European programmes even while your local station is working.

The Cossor Empire Melody Maker is available in two types—Model 234 for use with batteries and accumulator and Model 235 which works from the electric light mains. Send at once for full particulars of the model that interests you—use the coupon below.

Use this coupon

To Messrs. A. C. Cossor, Ltd., Highbury Grove, London, N.5.
Please send me free of charge a Constructional Chart which tells
how to assemble the Cossor Melody Maker
(Fill in type required, viz. Battery operated or All-Electric)

Name.....
Address.....

Cossor

EMPIRE

Melody Maker

MODELS 234 & 235

A. C. COSSOR LTD.,
Highbury Grove, London, N.5.
Depots at Birmingham, Bristol,
Glasgow, Leeds, Liverpool,
Manchester, Newcastle
Sheffield and Dublin.

Popular Wireless

LARGEST NET SALES

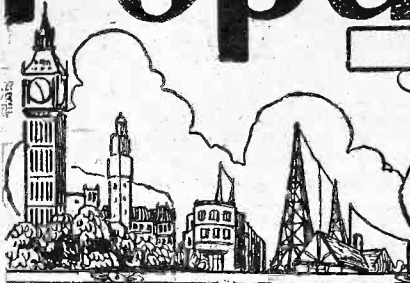

Scientific Adviser:
 Sir OLIVER LODGE, F.R.S.
 Chief Radio Consultant:
 CAPT. P. P. ECKERSLEY, M.I.E.E.
 Editor: NORMAN EDWARDS.
 Technical Editor: G. V. DOWDING, Associate I.E.E.
 Assistant Technical Editors:
 K. D. ROGERS, P. R. BIRD,
 A. JOHNSON RANDALL.

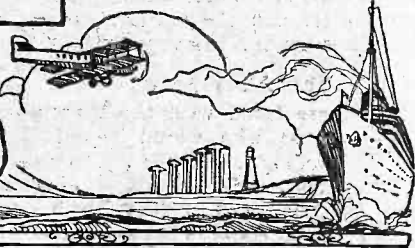

RADIO NOTES AND NEWS

Authentic Anecdote.

I HAVE had the joy of beholding the most eloquent amateur I know silenced—almost dumbfounded—by one sentence. At an evening gathering of the clans he was demonstrating his new set and took a lot of pains to explain the principles of reception to a charming old lady relation whose understanding of science began and ended with magic lanterns. After tuning in various English stations he said that he would get some foreigners. He then changed the L.T. accumulator for a freshly-charged one and got Oslo, a fact which he proudly announced. Then dear old Mrs. “—” said: “But how does the *bottle* know what place you want?” I doubt if he’ll ever live it down!

Night-Time—and Winter-Time.

WHICH reminds me of a moment I experienced at home the other evening not long after the transmogrification of Summer-time to that dark

CAPT. P. P. ECKERSLEY—

Builder of British Broadcasting Technique, Originator of the Regional Scheme, and Father of all “Twin” Stations!



frightfully sterling permitting (or nor permitting), at the Criterion Restaurant, Piccadilly Circus, on Saturday, October 24th, at 7 p.m. (G.M.T., Winter-time). Tickets, passwords and all other pertinent details can be obtained (or procured) from Mr. J. F. Herd, Ditton Corner, Datchet, Windsor.

How We Travel.

I AM deeply beholden to T. J. S. (Ontario, Canada) for pointing out that the “New York Sun” has published my challenge to Mr. John R. Carey to reproduce artificially the noise of an honest-to-goodness cat-fight. Be gum! we are getting there—and no error! I shall soon be challenging the President to make a noise like a dollar falling off the Gold Standard!

More Business.

BEFORE I pass to my weekly survey of radio “from China to Peru,” allow me to say that the Harrow and District Radio Society, a newcomer to radio club

—“P.W.’s” Chief Radio Consultant

Answers readers’ questions in our columns every week. And his technical articles appear only in “The Big Three” — “P.W.,” “M.W.” and “The Wireless Constructor.”

stuff which I suppose we ought to call Winter-time. The stage was set for my aunt from Harrogate to listen to a Queen’s Hall “Prom.” concert, and I was anxious to make a good impression because her circle at Harrogate seems to regard “listening-in” as something like putting a penny in an electric piano in a “pub”! But the “background” was frequently occupied rather noticeably by our familiar Teutonic friend, and after a painful lapse of time Auntie took off her *pince-nez* and remarked: “How provoking! *There’s a dog barking somewhere. How can dear Sir Henry abide it!*”

Strictly Business.

AVAST frivolling! Smother those guffaws in the rear rank and note that

history, is anxious to secure more members. To that end they have prepared an attractive syllabus, including cinema film displays, of undoubted interest and utility to amateurs. For details interested readers should write to the Hon. Sec., Mr. Ivor Davies, 47, Locket Road, Wealdstone, Harrow. I hope the whole school will join!

Can This be True?

I UNDERSTAND that the Russian violinist, Edward Soermus, is not allowed to broadcast in England because of the political opinions which he harbours. Let us be clear about this. If E. Soermus would be permitted by the Government to land here I do not see why he should not fiddle for the B.B.C.—if he is good enough and there are no British violinists out of a job. But

"ARIEL'S" RUNNING COMMENTARY ON RADIO (Continued)

pro-Bolshevik (or anti-British) work, then the question of his broadcasting is a secondary matter and the exclusion of an undesirable alien is a primary one.

They Always Switch Off!

"WE are faced with the opposition of those who would regard broadcasting merely as a means of entertainment, who resent having any good material put before them, even though they could always switch off.



Their mind is a wilderness through want of care, the plough of wisdom never entering there. The italics are mine; the words Sir John Reith's.

Surely "entertainment" and "good material" can be synonymous? Why, the B.B.C. programmes themselves prove that. However, now some of us know what the head broadcaster believes about our minds!

Voice in the Night.

YEARS ago, so I heard, the proprietors of Madame Tussaud's used to offer money to anyone who would remain in the Chamber of Horrors for one night. I never heard of any takers. But it has fallen to the night-watchman of "His Master's Voice." Modern Hall of Music, opposite Olympia, to get a jolt which I wager he will not quickly forget. That worthy had just settled down, on the night of Saturday-Sunday, September 19-20, to his job. Probably he was reading a murder mystery—when suddenly—

A Ghostly "Oh, Yeah."

SUDDENLY he heard a voice making a speech in American—and you know how frightful that is! Every hair erect, he crept off to investigate. Was it Al Capone exploding into the Radio Business, or Jack Diamond trying to land in England for a second time? Oh no! the row was coming from the new H.M.V. Model 531 Super-hot Radio-gramophone, which some ass had left active, this remarkably sensitive receiver picking up the voice of an announcer thousands of miles away and pushing it out into the stilly night.

Borrowing and Lending.

THOSE famous words of William Shakespeare, "Neither a borrower nor a lender be" don't cut any ice in Helsingfors, it seems—for the Helsingfors station has just borrowed a wave-length from Spain!



It appears that Spain wasn't using her 368-metre wave-length, which is allotted to Seville. So Finland dropped Spain a polite note explaining that the listeners to Helsingfors programmes were

wave-length, and it was a pity to let it go rusty, and er—well, in short—what about lending it?

Spain, gallant as ever, said, "Sure thing, old top," or words to that effect, and so, for the time being, Helsingfors (or Helsinki if you like to spell it that way) is working on 368 metres.

The Scottish "Ideal Home."

I WISH that I had the time to go to the Kelvin Hall, Glasgow, to look over the Scottish Ideal Home Exhibition which has been organised by the "Daily Mail." Being a student of history I am thrilled at the list of historical exhibits which are on view there; some of which have never

SHORT WAVES.

After endeavouring to sleep for three nights with my windows open, I would like to meet the chap who said wireless would make for peace.—"Pictorial Weekly."

THE FINANCIAL CRISIS.

Patriotic Father: "I'm afraid you can only have threepence a week now, dear."

Bright Child: "But, daddy, Ramsay MacDonald said on the wireless that there must be no reduction in children's allowances."—"Punch."

FOR HUSBANDS.

"Check all connections. Permit no WIFE to make contact with metal of unit," we read in a contemporary.

We quite agree; radio is not women's strong point.

A bull recently rushed into a house and damaged a gramophone and many records. A reader wants to borrow it for his neighbour's loudspeaker.

COMPOSED ON A PACIFIC CRUISE?

The first new work will be Gustav Holst's "The Coral Fantasia."

Anyway, it is better than a Chloral Symphony.—"Punch."

Daylight fading was a radio phenomenon not unknown to Shakespeare, apparently, for he remarks:

"Methinks it sounds much sweeter than by day."—(Merchant of Venice II. i.)

before been publicly shown in Scotland. I suggest that the Scottish ideal wireless outfit is a crystal set comprising a bit of native crystal, the gudewife's hairpin; the trophy of a raid on a telephone booth—and a forged licence. Na, na! Dinna twine wi' me, for I love ye like' brithers, but I maun hae a wee joke.

Query Answered.

MY "good young beans," J. G. and B. W. (Nottingham) enquire about certain stations. Here goes! GLSQ is s.s. Olympic; G 2 B A is an experimental station whose name I don't know; G B S and G B W are Rugby. I am sorry to learn from these two young radio rips that Nottingham is about as dead as cold mutton-fat where radio is concerned. Better take up chemistry, eh? But what boots it, so long as you have "P.W." and plenty of signals?

Watching the Wood.

THE Provincial Forestry Department is to build a system of look-out towers

tion with each other, with aeroplanes and base stations, the whole system being intended as an aid to the control of forest fires. I love reading Robert Louis Stevenson's account of how he deliberately set fire to a Californian forest. Strange aberration on the part of one who was generally so mindful of others.

Queer Radio Happenings.

YOU all know that I really do appreciate hearing from any of you on matters of general radio interest, radio jokes or queer radio happenings. But I would beg leave to remark that there is a growing tendency to address to me purely technical queries, sometimes in order to "try me out" and at other times, apparently, to get a reply in a hurry. Occasionally a certain query may attract me as being one which, in answering it, I can instruct or amuse the majority of Arielites, but as a rule all I can do is to pass the letter over to out technical people. So that's that. Have you noticed the posters on the buses, all about "Ariel" of a certain daily paper. Nobody spends all that money on your faithful Notist and News reporter! (He doesn't need it. Ed. "P.W.") Oh—quate!



In the Matter of Correspondence.

AND while on the subject of letters I might as well confess that what with these holidays and exhibitions and what-not, I have fallen behind with my letters; my pile of un-dealt-with correspondence now measures two feet, three bottles and a clothes-brush, from desk to yesterday's mail. Have a heart! All—or most—will be attended to as space, weather and opportunity permit, and I beg of you that you will not deem yourselves neglected if Ariel does not mention you. I am the Human Small tooth Comb. Gad! I've got one letter dated Feb., 1929, which I am determine to master so soon as I have learned Gaelic and Sankskrit.

Message to Traders.

I RECEIVE letter after letter from readers of "P.W." advertisements who complain, and with reason, either of delays in replies to their inquiries, or that no relies whatever are vouchsafed. Here's a typical instance. W. I. B. (Morden) during the six weeks preceding September 16th, wrote for lists to six British firms, three American firms, and one Austrian firm, all in Great Britain. All the foreign firms replied by return of post. One British firm did the same, two took a week, one a fortnight, and two took several days. Now, I ask "the trade," what is the good of employing the



JACK PAYNE'S POST BAG

In this exclusive interview with a special representative Jack Payne tells you about the letters which reach him from "flappers," and would-be composers who send him their songs and lyrics.



IF the ability to attract correspondence from every quarter of the globe is any test of popularity, then Jack Payne of the B.B.C. is one of the most popular men in the world. Last year he personally received no fewer than forty thousand communications, most of them in the form of letters, but including a large and varied assortment of postcards, telegrams, radiograms, and cables.

Most people are inherently lazy in answering their correspondence. Film

part broadcasting now plays in national life to realise there must be many other wireless personalities in the same position as myself.

"Actually, the position is rather an anxious one. It is my business to fulfil public demand, and my only gauge of that demand is my letter bag. And in spite of the enormous number of letters I receive; I can never be absolutely certain they are fully representative of listeners' opinions. It is for this reason I welcome more and more correspondents, for the more letters I receive the more certain can I be of the accuracy of my gauge."

I asked him to detail the various sections of his mail and the work entailed in it.

"Before I arrive here in the morning," he said, "all my letters are opened for me by my office staff. They are arranged under various head-

ings—listeners' letters, personal letters, music manuscripts, business communications, and so on.

"They total, I suppose, something like a hundred a day, but the number fluctuates according to the period of the year. During the summer, for instance, when so many people are away on holiday, the average is slightly less.

"I suppose Christmas is the busiest time for us. Then we may receive anything up to two hundred letters by the morning post.

"Sergeant Flagg"—Ses You!

"Again, very often a new or unexpected item in one of our programmes will bring in a rush of letters. Quite recently, for instance, we broadcast one of our oldest comedy numbers, 'Sergeant Flagg,' just in the nature of an experiment. The result was astounding. Letters poured in from all over England, asking us to repeat it.

"Quite ninety per cent of my letters are from wireless listeners, and I am glad to say they are nearly all letters of appreciation. Occasionally the other sort come in from the anti-dance faddists. I scan their letters as eagerly as any, because if there is genuine criticism to be offered I am glad of it.

(Continued on next page.)

GIVING THE PATIENTS A MUSICAL TONIC!

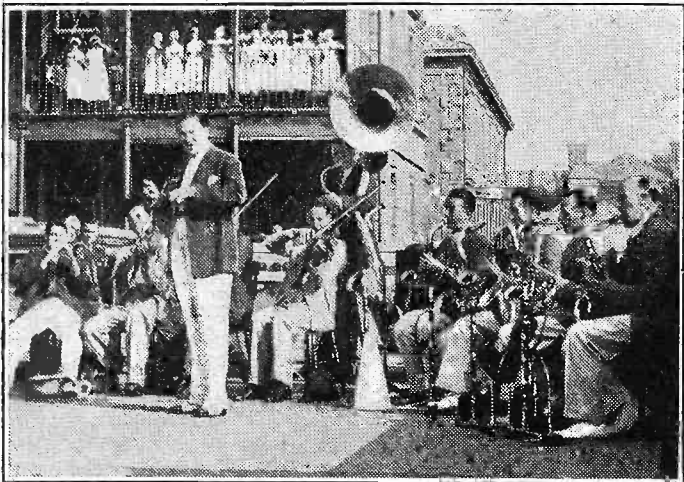

During a recent visit to a south coast resort Jack Payne and his Merry Men entertained the patients and nurses of the local hospital with some of the latest tunes.

stars, for instance, rarely see their "fan mail," as it is called. They employ secretaries solely to answer the queries of their admirers, to send out photographs, and to carry out the thousand and one favours demanded of them through the post.

His Link with Listeners

That is a method which does not appeal to Jack Payne, and his personal letter bag is the largest in the world, far greater than any film star's. He believes in applying the personal touch, not to flatter the vanity of his correspondents, but to ensure that at all times he is fully conversant with the fluctuating opinions of his public.

He explained it to me in this manner:

"Wireless broadcasting is unique in that it creates public figures who are almost

A MERRY BAND OF MUSICIANS



JACK PAYNE'S POST BAG

(Continued from previous page.)

"My correspondents cover every class of society. I receive elaborately typed fool-cap pages and hastily scribbled scraps of paper. Some thirty or forty people write each day for my photograph, or a photograph of my dance orchestra.

Letters from Everywhere.

"And only yesterday I received a lengthy cable from America saying how well we had been received in one of the Southern States. I have, too, received cables and radio messages from Australia, New Zealand, Turkey, and India. If there is anyone who still doubts the world-wide success of British broadcasting methods, I would like them to spend a week dipping into my mail bag.

"Of course, there are plenty of 'query' letters—about a dozen a day on the average—'Who sang the chorus of such-and-such a song three weeks ago last Thursday?' 'Who are the publishers of this foxtrot or that tango?' 'Is the song copyright?' and so on."

For "Mrs. Jaek" Too!

Jack Payne went on to explain that the letters that "got home" with him—and with his "boys"—were those he received from hospital patients. "Such letters," he said, "impress on us the importance of our position, and make us feel we are doing really worth-while work."

Practically every day brings a present of some sort to Jack Payne's office. And the surprising thing is this, the majority of them are not for Jack, but for his wife! Three or four times a week a bunch of flowers arrives; sometimes an ornament or a piece of embroidery.

"It is quite impossible to tell you how much Mrs. Payne and myself appreciate such tributes," said Jack—and he meant it.

There is only one type of letter which annoys him. It is that which he receives from "foolish flappers" and "sentimental spinsters"—the phrases are his own. They are an annoyance and hindrance in his work. So much so that quite recently he gave his manager orders to consign them all to the waste-paper basket without submitting them to himself.

Picture Puzzle Posers.

"I wish you would let the world know that I am happily married," he said, "and that I am too busy to be bothered with communications which have no bearing whatever on my radio work."

Quite abruptly he tossed a sheet of paper across the desk.

"Here is another type," he said. "Read it."

which I have found too difficult to solve. I feel sure you would like to solve them for me. Please send them back as soon as you have done them."

About a Hundred a Day!

Nearly a hundred manuscripts from would-be composers and lyric writers are sent to Jack Payne each week. Some of them are pathetic in the extreme; many are absurd and savour of a "leg-pull." One "lyric" I examined was written in pencil on a sheet of paper torn from an exercise book. There were not two rhyming words on the whole sheet.

Sometimes, however, "discoveries" are made. It is a fact that when Jack Payne's band broadcasts a new composition, even if the composer is quite unknown, he at once takes his place among the leading composers of the country.

Such is the value of Jack Payne to a song writer.

A TRULY TITANIC TRANSFORMER

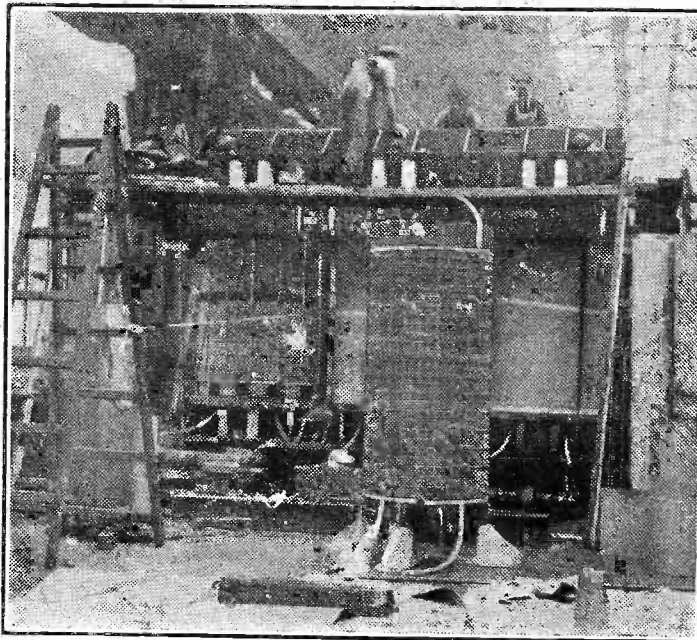

In preparation for the "Grid" scheme the engineers at Messrs. Ferranti's works recently assembled this High-Tension Transformer which is to be used in conjunction with the new power distribution lines throughout the country.

AN INTERNATIONAL RADIO CODE

HOW STATIONS OF VARIOUS NATIONALITIES CONVERSE.

HAVE you ever wondered how it is that Radio Telegraph Stations situated in various countries of the world, and whose operators speak only their own particular language, manage to converse with one another? That it is done is a fact, and the old saying, "Necessity is the Mother of Invention," just about explains it.

A good example of this sort of thing is the case of a ship station, for in the space of a

so different nationalities. Even though they know only their own tongue, they experience not the slightest difficulty in making themselves understood.

The secret of their success is a form of "international code," which was originally brought out by the International Radiotelegraphic Convention in 1912. Since that day it has been considerably enlarged and now consists of about 150 abbreviations.

All wireless stations are given a call sign, which really corresponds to a telephone number. What is more, they are all divided up into different classes and nationalities, so that an experienced person can tell at a glance the nationality of that particular station, whether it is on land or a ship at sea, or an experimental station.

Overcoming Language Limitations.

The call signs of all land stations are comprised of three letters, those of ships have four letters and experimental transmitters have a figure inserted after the first letter. The first letter, by the way, denotes the nationality of the station in each case.

A ship coming up the English Channel often finds it necessary to call a French station, to report its position, etc. After the preliminary exchange of call signs for identification purposes, the operator on board the ship is now faced with the problem of telling the Frenchman at the other end how far he is away.

What does he do? He resorts to the famous International Q code, as it is called, and sends the three letters Q R B, followed by the number of miles he is away from the Frenchman. If he sends Q R B 120, every operator, no matter what his nationality, understands that he is saying, "The approximate distance between our stations is 120 nautical miles."

Similarly, the French operator may want further information, and send Q R D, or in other words, "Where are you bound?" The ship would then probably reply "Q R D London," which means "I am bound for London." So you see it is really a fairly easy matter for radio stations of different nationalities to understand one another.

The Chatter of the Ships.

The two abbreviations I have given above are only two of a whole long list by means of which it is possible to ask any normal question, or give the correct answer to one. Another great advantage of this code is that it saves an enormous amount of time. If you have ever heard the "babble" that goes on, almost continuously, on the shipping wave of 600 metres, you'll realise what this means!

It is, of course, impossible to give a complete list of the abbreviations here, owing to the space it would take up. But if any of you would like to have it, it is published in The Handbook for Wireless

THE NEW "B.P." THREE

Full Constructional Details.

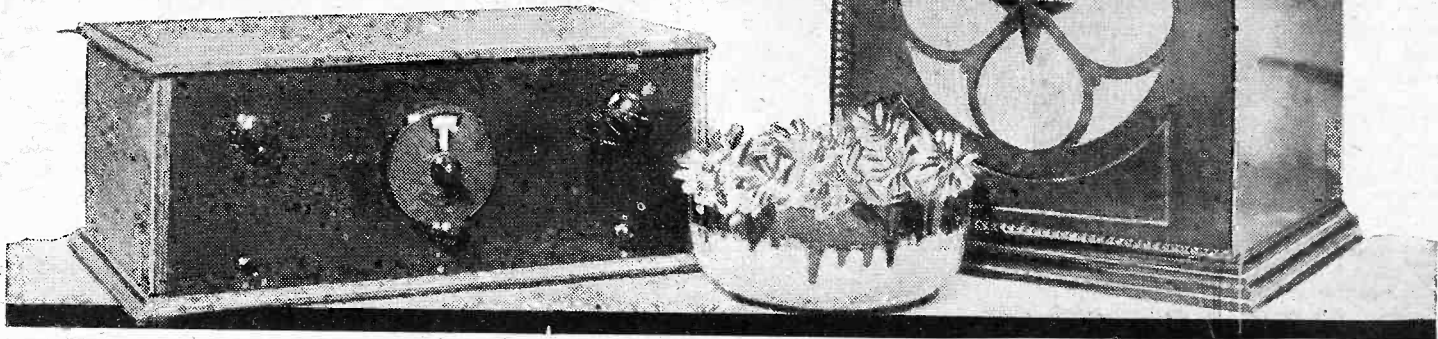

BUILDING a radio set is one of the easiest things in the world. Glance at the photographs of the new "B.P." Three. Looks a simple, straightforward job, doesn't it? And it is, too! Suppose we build it together, step by step?

First of all we have got to get our parts together. In order to simplify our task, the components required are given in a tabulated list on the next page.

We obtain various parts, not forgetting a few assorted wood screws, a small quantity of rubber-covered flex, four wander plugs for the grid-bias connections, and some insulated tinned copper wire or bare wire and Systoflex covering.

Then we are ready to commence the constructional work.

Drilling the Panel.

Let us make a start by drilling the panel ready for mounting the components.

The panel is placed with its face upon a flat surface, and so that its highly polished finish is not scratched it is advisable to interpose a piece of paper between the panel and the flat surface. The next procedure is to mark off the drilling centres.

You will need a straight-edge (preferably a steel rule), a scriber, or a sharpened nail, and a centre punch.

Starting from the left of the panel (looking at the back) the first two components are the volume control and L.T. switch.

Place the straight-edge on the panel and scribe two lines—one vertical and two horizontal—to the dimensions given on the "panel-drilling diagram." The vertical line in this case serves for both the volume control and the L.T. switch, so one measurement from the left-hand edge of the panel (back) suffices here.

Carry on in the same way for the tuning condenser (this is in the centre of the panel), the reaction condenser, and the band-pass coil switch.

Use a Centre-Punch.

Here are the how-to-make instructions for building the fine three-valve band-pass receiver for long-distance loudspeaker reception, which we introduced in last week's "P.W."

punch a sharp tap with a hammer.

Before commencing to drill the holes it is just as well to give the various dimensions the "once-over" with the rule to make sure that no mistake has been made.

Now take your brace (a carpenter's brace preferably) and a large drill and carefully drill the five holes whose centres you have already marked.

It usually facilitates matters if you first of all run a small "pilot" drill (about $\frac{3}{16}$ in.) through, because this helps to keep the large drill from wandering out of centre.

I only mention this in case you wish to be absolutely accurate; for of course, the "pilot" holes are not essential.

Don't press too hard on the drill, since you may make ragged edges to the holes instead of getting them clean cut.

When you have finished these five holes, drill three more smaller ones along the bottom edge of the panel for securing it to the baseboard.

You can easily countersink these holes by replacing the $\frac{3}{16}$ in. drill in the brace and rotating it a few times.

Having completed the panel the next job is the terminal strip. This is a 2-in. wide strip of ebonite running the full length of the baseboard and it contains eleven terminals and the radiogram switch.

The Terminal Strip.

These twelve holes are each $1\frac{1}{2}$ in. apart, the first hole being $\frac{3}{4}$ in. from the end and upon the centre line of the ebonite strip. In addition there are three holes along the bottom edge for fixing the strip to the baseboard.

Drill these holes in exactly the same manner as you did those for the panel.

Now we can secure the panel and terminal strip to the baseboard. Do this carefully, so that the baseboard does not project below the bottom edge of the panel. This would look rather unsightly and might make it difficult to fit the set into the cabinet. It is a good plan to enlist the services of a member of the household to assist by holding the baseboard and panel in position while the wood screws are being inserted.

Components Next.

When this job is completed we can start mounting the components on the panel and the terminals and radio-gram switch in their positions on the strip.

At this juncture I would like to say a word or two about the twin-gang condenser. The particular unit used in the original set was not supplied with supporting brackets to take the overhanging weight, and in consequence a block of wood was

A FINAL TRIM FOR THE TUNING

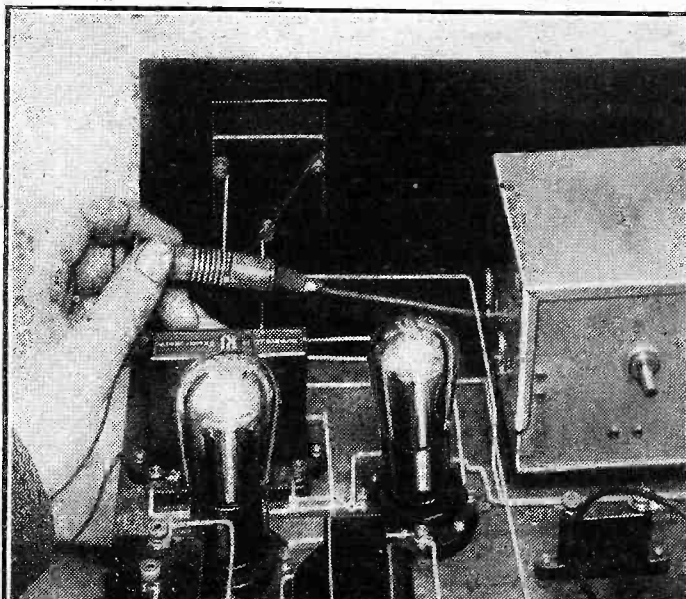

THE NEW "B.P." THREE

(Continued from previous page.)

weight should not be borne by the condenser spindle.

However, special supporting brackets are now supplied with the condenser, so the wood block will not be necessary.

Adhere To Our Layout.

So far we have fixed the panel and terminal strip to the baseboard and secured the components and terminals in position.

The next step is to screw down the remaining components to the baseboard itself, and we carry out this work by adhering as closely as we can to the back of panel diagram, assisted by the photographs of the original set.

Incidentally, we must remember to leave a small space between certain of the components and the ends of the baseboard sufficient to clear the fillets on the sides of the cabinet. Otherwise we shall find ourselves with a completed set which will not go into the cabinet until we have cut away a portion of the fillets.

The 2-mfd. output condenser is a case in point.

The final step in the construction is wiring up. It is not advisable to rush this part of the work, which should be carried out neatly and systematically.

Wiring Up.

You can start wherever you prefer, but I suggest commencing with the lead which goes from the L.T.—terminal on the terminal strip to the L.T. switch on the panel. This particular lead is the one nearest the baseboard.

You will be able to get at the L.T. switch more easily if you temporarily remove the L.F. transformer. Next, proceed to wire up the filament terminals on the valve holders, completing the L.T. — wiring at the earth terminal on the strip.

Proceed in this way with the L.F. + lead and all the short wiring nearest the baseboard, leaving the wires from the reaction condenser, band-pass coil, volume

control, and tuning condenser until later. The reason is because these last-named leads are above the remainder of the leads, and should therefore be tackled after the wiring nearer the baseboard is completed.

Improved Appearance.

Now for some hints concerning the arranging of the various wires and the method of connecting them. If you examine the photographs you will see that right-angle bends are employed throughout.

Naturally, when the leads are arranged in this way the set's appearance is vastly improved, but I can assure you that there is no need to go to all this trouble on the score of efficiency.

By all means space out the wiring, but

THE TWO TUNING COMPONENTS

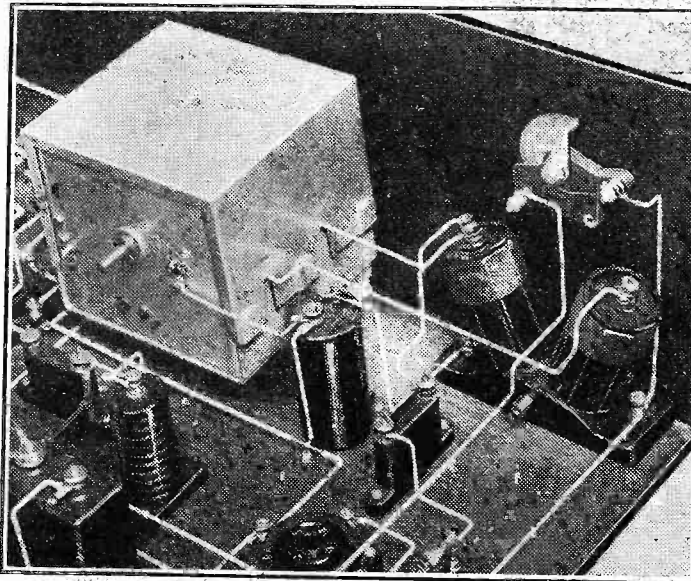

On the right and close to the panel can be seen the band-pass coil, while to the left of it is its two-gang tuning condenser.

don't spend hours in endeavouring to arrange each lead exactly at right angles to or parallel with its neighbour. It won't improve the working of receiver. Be as neat as you like, but don't let it worry you unduly. Don't go to the other extreme and bunch your wiring or run long straggly leads all over the place. This will produce inefficiency. Reasonably short direct wiring and adequate spacing is the road to efficiency. Practically every wire can be taken to a terminal, perhaps with the exception of two leads.

These are the wires which go to the fixed vanes of the twin condenser, and with some condensers terminals may not be provided. This should not deter you, however, since you can purchase special tags which do away with the necessity for soldering. Your dealer will be able to supply you with these.

A Few Hints.

The lead from the band-pass coupling condenser (0.01 mfd.) to the moving vanes of the tuning control can be taken to any convenient nut or terminal on the casing of the condenser assembly, because this casing is electrically connected throughout and joined to the moving vanes.

The L.T. + lead from the L.T. terminal on the strip can go direct to the positive filament terminal on the second valve holder, thus eliminating any soldering at this point.

There are four flexible leads terminating in wander plugs. These are G.B. +, G.B. - 1, G.B. - 2, and G.B. - 3. G.B. + is joined to the L.T. - terminal on the third valve holder, G.B. - 1 to the second pick-up terminal, G.B. - 2 to one side of the volume control (not the slider), and G.B. - 3 to "G" on the L.F. transformer.

The Bias Battery.

The grid-bias battery can be clipped on to the inside of the cabinet, and special grid battery clips are readily obtainable from most radio stores. Siemens make a grid-bias battery with a flap so that it can be screwed to any convenient part of the cabinet.

In connecting up the radio-gam switch, remember that the common terminal, that is, the spindle or arm of the switch goes to the grid terminal on the first valve holder.

When you have completed the wiring, check over each lead against the wiring diagram and satisfy yourself that every wire is joined to its appropriate terminal.

Check All Connections.

Don't try the set with the batteries connected until you have proved to your own satisfaction that the wiring is identical with the diagram.

(Continued on next page.)

CHOOSE YOUR COMPONENT MAKES FROM THIS LIST

1 Panel, 18 in. × 7 in. (Permcot, Peto-Scott, Beecol, Wearite, Goltone).

1 Cabinet to fit, with 10 in. baseboard (Pickett, Peto-Scott, Cameo, Gilbert, Osborn, Ready Radio).

1 Band-pass coil (Lewcos, Varley, R.I.).

1 0005-mfd. double gang variable condenser (Utility, Cyldon, J.B., Polar, Wavemaster, Lotus).

1 0005-00075 reaction condenser (Telsen, Ready Radio, Polar, Cyldon, J.B., Lotus, Graham Farish).

1 Vernier dial for same (Igranie Indigraph, or disc drive supplied by makers of condenser).

1 Volume control, 500,000 ohms (A.E.D., Wearite, R.I., Varley, Magnum, Sovereign, Igranie, Graham-Farish).

1 On-off switch (Ready Radio, Telsen, Bulgin,

Goltone, Lissen, Graham Farish, Igranie, Lotus, Peto-Scott, Wearite).

3 Valve holders (Lotus, W.B., Burton, Wearite, Telsen, Igranie, Graham Farish, Clix).

1 L.F. transformer (R.I. type 1-7, Telsen, Ferranti, or medium ratio Varley, Igranie, Graham Farish, Lotus, Lewcos).

1 H.F. choke (Ready Radio, Telsen, Lewcos, Lissen, R.I., Varley, Sovereign, Watmel, Peto-Scott, Atlas, Graham Farish, Dubilier).

1 Output choke (Ferranti, Telsen, Graham Farish, Lotus, R.I., Igranie, Varley, Lissen, Bulgin).

1 0003-mfd. fixed condenser (T.C.C., Telsen, Lissen, Dubilier, Mullard, Ferranti, Ediswan, Igranie, Graham Farish, Goltone).

2 01-mfd. condensers (T.C.C., etc.).

Mullard, Igranie, Lissen, Telsen, Helsby Ferranti).

1 2-meg. grid leak and holder (Graham Farish, Lissen, Telsen, Dubilier, Mullard, Ferranti, Igranie).

1 100,000-ohm Spaghetti resistance (Varley, Ready Radio, Telsen, Lewcos, Igranie, Bulgin, Graham Farish).

1 25,000-ohm Spaghetti resistance (Ready Radio, or as above).

1 Fuse holder (Bulgin, Ready Radio).

1 Two-way switch (Bulgin, Ready Radio, Wearite, Melbourne, Red Diamond, Ormond).

1 Terminal strip, 18 in. × 2 in.

11 Indicating terminals (Belling & Lee, Igranie, Eelex, Clix, Goltone).

Glazite, Lacolone, Quickwire, Jiffy

THE NEW "B.P." THREE

(Continued from previous page.)

Now, what about the H.T. and G.B. voltages? H.T. + 1 should be 60-80 volts, and H.T. + 2 120-150 volts. The G.B. voltages I suggest are as follows: G.B. - 1, 1½ volts; G.B. - 2, 3-4½ volts; G.B. - 3, 7-9 volts for an ordinary small

AT THE INPUT END

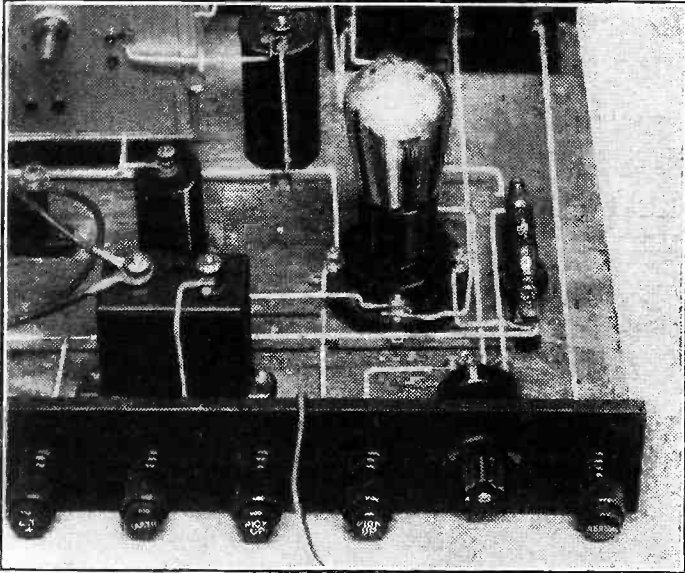

On the right is the aerial terminal, and next to it the radio-gram switch and the two terminals for the leads to a pick-up, if used.

power valve, and 16-21 volts for a super-power valve.

These values are approximate, and you should adhere to the valve-maker's instructions on this point.

If you are thinking about using a moving-coil loudspeaker, there are two alternatives open to you. You can either leave the output-filter choke and 2-mfd. condenser where they are and connect the primary terminals of the loudspeaker output transformer to the two L.S. terminals on the set, or insert an output transformer in the set in place of the filter-output choke and condenser.

It is impossible to have a hard and fast rule on this point, because a number of the loudspeakers at present on the market have the output transformer incorporated in the base, so that all you have to do is to join the two leads from the L.S. terminals direct to the terminals on the base of the speaker and the output transformer is automatically connected in circuit.

Output Transformers.

Sometimes the output transformer has to be purchased as a separate article, in which case there is no reason why it should not be wired directly into the set.

An alteration in the wiring to the last valve will be necessary, and this is as follows.

The existing output choke and 2-mfd. condenser must be removed. This will necessitate the removal of all the leads to the choke and condenser. Also remove the wire which is joined from one filament terminal of the valve holder V_8 to one of the L.S. terminals.

will see that the H.T. + 2 lead is attached to one side of the output choke. It will, of course, no longer make connection at this point, since the choke has been removed, but it will simply go straight from the H.T. + 2 terminal to the H.T. terminal on the transformer.

Now in the space available place the output transformer, joining one primary terminal to A on the valve holder V_8 and the other primary terminal to H.T. + 2. Join the two secondary terminals to the two L.S. terminals on the strip.

In connection with this question of the output transformer, it is essential to obtain an instrument having a suitable ratio for the moving coil, or you can purchase a transformer having tapped windings and match up your output circuit by experiment.

A Simple Scheme.

Now about the radio-gram side. I have already told you that the two pick-up leads are connected directly to the two pick-up terminals on the strip, but I said nothing about the use of a volume control across the pick-up itself. There is, of course, one already in the set, and in most cases this will do all that is required.

These days, however, pick-ups are very sensitive, and there is some danger of the valve V_1 becoming overloaded on loud record passages, in which case the volume control which is already in the set will be of little use in preventing distortion through overloading of this type.

ACCESSORIES

LOUDSPEAKERS.—Amplion, Blue Spot, B.T.-H., Graham Farish, Celestion, Mullard, Undy, W.B.

VALVES.—1 Detector type, 1 L.F. type, 1 power or super-power (Osram, Mazda, Mullard, Six-Sixty, Cossor, Eta, Fotos, Lissen, Tungram, Dario). H.T. current consumption at 120 volts 15 milliamps, using P.2 type of output valve.

BATTERIES.—H.T. 120-volt max. super-capacity (Ever Ready, Magnet, Ediswan, Pertrix, Drydex, Lissen, Columbia).

G.B. 9-18 volts to suit output valve, as above.

ACCUMULATORS.—Voltage to suit valves (Exide, Lissen, Pertrix, G.E.C., Ediswan).

MAINS UNIT.—(Heayberd, Regentone, Atlas, Lotus, Tannoy, R.I., Ekco). (State type of set and milliamp consumption, also details of mains when ordering.)

A very simple scheme, and one usually employed by radio-gram enthusiasts, is to mount a high-resistance potentiometer on the motor turntable cabinet, connecting the two leads from the pick-up to the two outside terminals on the potentiometer.

Slider Connection.

These two terminals are joined internally to the two ends of the potentiometer resistance element, and generally the slider is joined to the centre terminal. The slider is joined to the pick-up terminal on the terminal strip which goes to one side of the radio-gram switch. One of the remaining potentiometer terminals is connected to the terminal on the strip which goes to G.B. - 1.

By using this method you get a splendid control of volume and absolutely no distortion through the first valve being overloaded. Moreover, it is unnecessary to go backwards and forwards to the set in order to adjust the volume control on the panel when the gramophone is in use.

A POWERFUL SET, BUT EASY TO CONSTRUCT

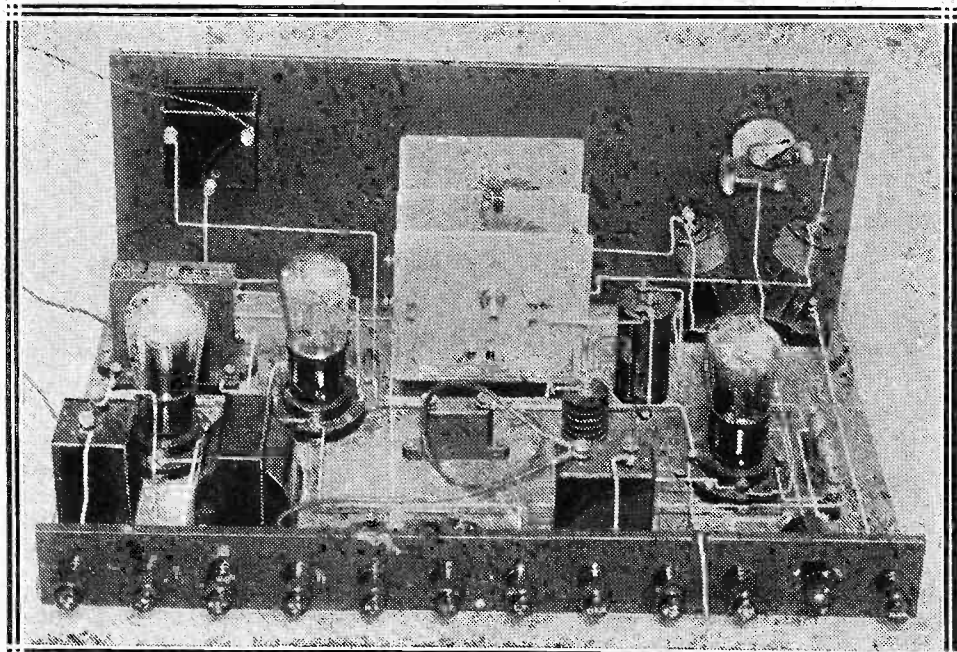

SHOULD BRITAIN RESIGN?

By THE EDITOR.

For years a measure of mutual co-operation has been the only means of maintaining moderate peace in the ether, and preventing the grabbing of wave lengths by the different countries. Is this situation becoming impossible? Should we resign and let every country struggle for its own share of wave lengths?

BY the time this issue of POPULAR WIRELESS is on sale leading members of the Union Internationale de Radio-diffusion will have met in Rome, there to receive the report of the Technical Committee which met recently in Brussels.

As my readers will remember, the chief engineer of the B.B.C.—Mr. Noel Ashbridge—attended this meeting in Brussels armed with the authority of the B.B.C. to make certain offers which, if accepted, together with a specific scheme, would have resulted in a temporary revision of the Prague wave-length plan and, incidentally but most importantly, the removal of some of the chief fears in connection with ether chaos this winter.

An Insufficient Separation.

Anybody who knows anything about broadcasting to-day realises that the number of available broadcasting wave lengths is far too small, and that the present 9 kilocycle separation between these wave lengths is insufficient. Experience has shown, and many readers of POPULAR WIRELESS will bear this out, that even with the great strides made in selectivity devices to-day there is still considerable interference experienced by readers even with first-class receivers and, unless one uses some extraordinarily selective device—such as the Stenode Radiostat—a certain amount of interference is more or less inevitable.

Bad as it is at the moment, there is every chance that it will be considerably worse—in fact, desperately worse—as the winter nights draw in this year. A tremendous amount of research work and inventive genius has been expended on improving the selective side of receivers, but we think that at the present moment it is not so much a question of further improvement in selective devices as a more practical arrangement of broadcasting wave lengths.

Giving Up Wave Lengths.

Mr. Noel Ashbridge, the chief engineer of the B.B.C., fully realises this. Consequently, when he went to Brussels to meet the Technical Committee, he went with the proposal that there should be a conference of Administrations. That is to say, that various Continental Post Office authorities should get together in conjunction with the members of the Union, with the idea of revising the Prague Plan.

Roughly, the idea was that the B.B.C. would give up two wave lengths if other members of the Committee would, in conjunction with their various broadcasting concerns, also make concessions. France and Germany opposed this suggestion.

Certain countries, however, were quite ready to have Great Britain give up two wave lengths, because some of the smaller countries maintained that we have more than our fair share as it is; and if we had

pool it looks as though certain smaller countries would have squabbled among themselves for the use of these wave lengths. Consequently, the position would have been just as bad!

A "Gentleman's Agreement."

The idea is that if every country gave up something in the way of wave lengths it would be possible to revise the Prague Plan

GENERAL INSPECTS WORLD'S BIGGEST VALVE

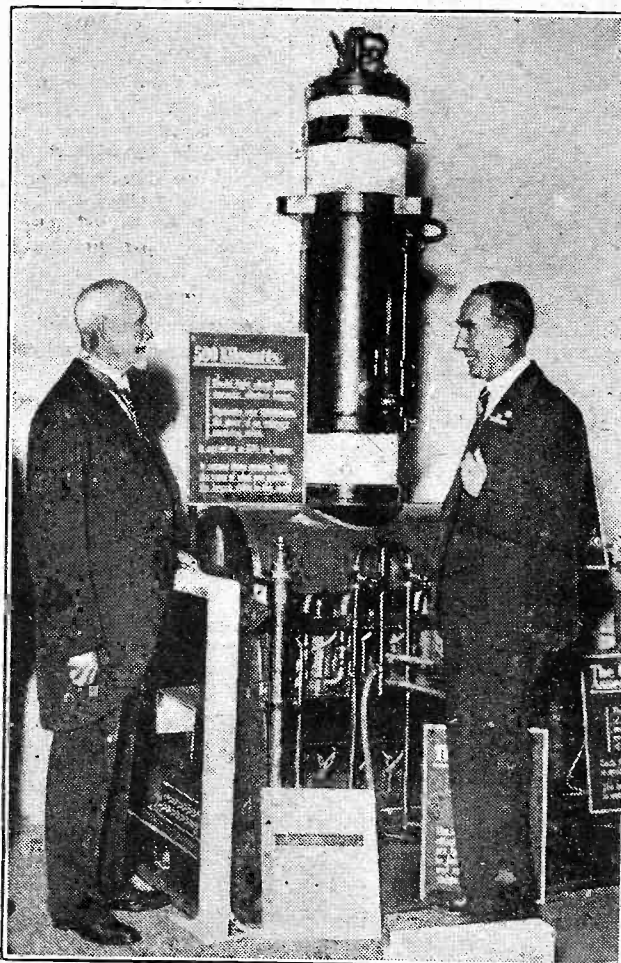

On the left is General Smuts—valiant foe, trusted friend, soldier and scientist—examining the new Metro-Vick. valve, which is far and away the most powerful in the world.

and to increase the kilocycle separation between broadcasting wave lengths.

Well, the idea fell through, as I have said, but now the Technical Committee has met in Rome it is just possible that by the time this issue is on sale some sort of a gentleman's agreement will have been brought about, as was suggested in a recent issue of POPULAR WIRELESS by our correspondent O. H. M., who writes "The Mirror of the B.B.C."

Frankly, we have little hope that this

something quickly in order to prevent interference getting worse this winter. Otherwise it looks as though nothing will be done until the Madrid Conference in 1932.

Interference Becoming Worse.

We don't want an experience this winter similar to that we had last year, when Mühlacker was practically on top of the London Regional; but it is only fair to warn readers that conditions look like being similar and, in fact, worse. Even to-day, Mühlacker and London Regional are situated as near to each other as the Prague Plan allows, i.e. 9 kilocycles. When the Union first began, the separation was fixed at 10 kilocycles a second, but in 1929 a revision reduced it to 9 so that more stations could come "on the air."

Interference in the early days, of course, was more or less confined to a heterodyne note of a very high pitch, but now that receivers are capable of reproducing frequencies so high, and with the growth of

high-power stations, a new type of interference (side-band jamming) has been growing more and more menacing. Consequently, the B.B.C. and other authorities who really keep an open mind on the question are convinced that, to say the least of it, we should all return to a separation of 10 kilocycles per second or, to be really safe, go to 11 kilocycles separation.

Receiving Technique.

The only way to space stations further apart in frequency is to effect a reduction in the wave-lengths used within the broadcasting band. It is no good listeners blaming set designers; they have done everything which modern receiver technique makes it possible for them to do in providing circuits of ultra-selectivity—within, of course, economic means.

As readers naturally realise, everyone cannot afford a Stenode Radiostat, nor can everyone afford a really first-class super-selective super-heterodyne receiver.

Considering Everyone.

The B.B.C. realises this. It realises that it has got to put across a broadcasting service which will be practical from the lowest common denominator, which in this case is represented by the listener with an ordinary straightforward receiver.

The Continental listener doesn't seem to worry so much about interference. More's the pity. And if France and Germany continue to prove recalcitrant, and to refuse a plan which, after all, is for the common good, then there is only one thing the B.B.C. can do, and that is to resign from the Union.

And if Great Britain resigns from the Union, the Union would fall to pieces automatically. There would then be a first-

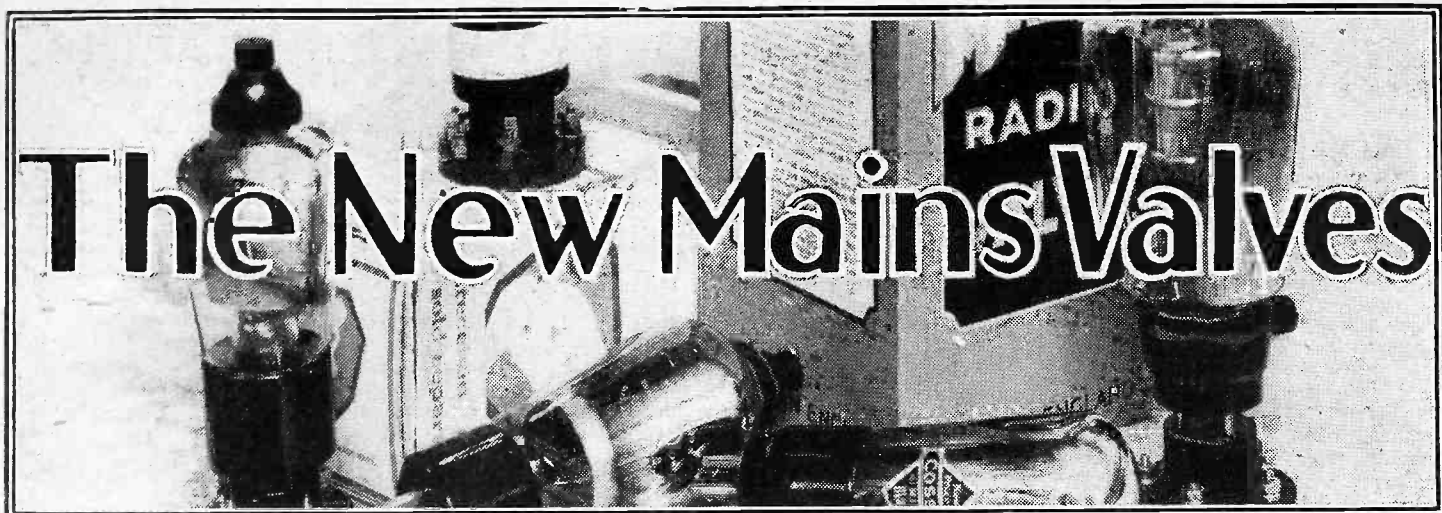

THE mains valve that has created the most interest during the last few weeks is undoubtedly the variable-mu type of screened-grid valve. Marconi and Osram members of this type are known as VMS4, while the Mullard variable-mu valve is called the MM4V, and has a slope of 3.5.

The variable-mu valve needs some explaining, perhaps, but this can be done quite simply. The ordinary S.G. valve has not got a quite straight characteristic when operating under normal bias conditions.

FOR D.C. USERS

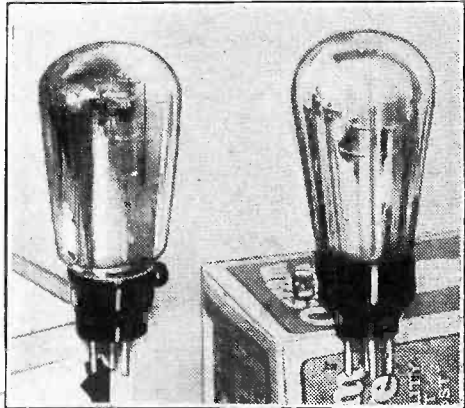

The D.P.T. and the D.H., two of the Osram indirectly-heated D.C. valves.

Also, if bias is increased the curvature becomes more curved, and so it is useless to try and get the valve to deal with more input by biasing it down to prevent overloading, as linear amplification will not be obtained.

Cross-Modulation Avoided.

This gives rise to cross modulation and other faults, and it is in an attempt to remedy this that the variable-mu valves have been designed, which will automatically reduce or increase their amplifying powers in accordance with the grid bias, and so the valves can be set to have either high or low mutual conductances.

Another valve that is worth note is the H.F. Pentode. This has been introduced by Cossors, and is a screened pentode capable of handling comparatively large H.F. inputs before rectification, or partial rectification due to overloading, commences. It also makes

Many notable advances have been made in the design of mains valves, and they are described in this article by K. D. Rogers.

Mazdas have evolved a still more sensitive valve than their famous AC/S.G. in the AC/S2. This is a real star turn, for it has a slope of 5, an impedance of 600,000 ohms, and the wonderful amplification factor of 3,000.

Nothing like this in stage gain can be obtained, of course, but with efficient coils and good screening a very much higher amplification per stage should be available with this valve than with the older type.

The Mazda PP5/400 is a more or less old friend, having been introduced some nine months ago, but it has been improved since then and has met with wide popularity among large-output mains users.

Undistorted Output of 5 watts.

As our readers may remember, it is a 400-volt anode, steep slope, directly-heated A.C. valve capable of providing an undistorted output of 5 watts.

Indirectly-heated mains rectifiers are also included in the Mazda programme, and the UU60/250 and the UU2 will be of particular interest owing to this fact.

The 5-amp. D.C. mains indirectly-heated Mazda valves are giving place to 1-amp. valves of the same types. These are not yet generally released, but they will make for very much more economical running. At 1 amp. and with 200-volt mains only 20 watts will be consumed, a distinct saving on the 100 watts required by the earlier 5 amp. type.

Marconi and

D.C. indirectly-heated valves, but these differ from the others in that they require .25 amp. (50 watts at 200 volts). It seems rather unnecessary that the D.C. valves have not been standardised in their heater current in the same way as have the A.C. types. Perhaps that will come.

But the fact remains that the D.C. mains user can now compete on more or less even terms with the A.C. man. It is a big step forward and should have a rapid effect upon D.C. receivers, both commercial and home-constructed.

Some of the New Pentodes.

Regarding the subject of output valves, I must mention the new Mullard PM24 pentodes — the PM24C and PM24D. These are both "larger" than the popular 24A and 24B, and have outputs of 3.5 and 8 watts respectively.

An indirectly-heated pentode (the foregoing are directly-heated, of course) has also been placed on the market by the same firm. This is the Pen/4V which has a slope of 3.

Six-Sixty have several new or improved mains valves, including pentodes and an excellent mains detector, while Tungsum and Eta have devoted a lot of careful experiment to the subject of indirectly- and directly-heated valves. Of the latter type the P460 is worth noting.

SOME NEW A.C. TYPES

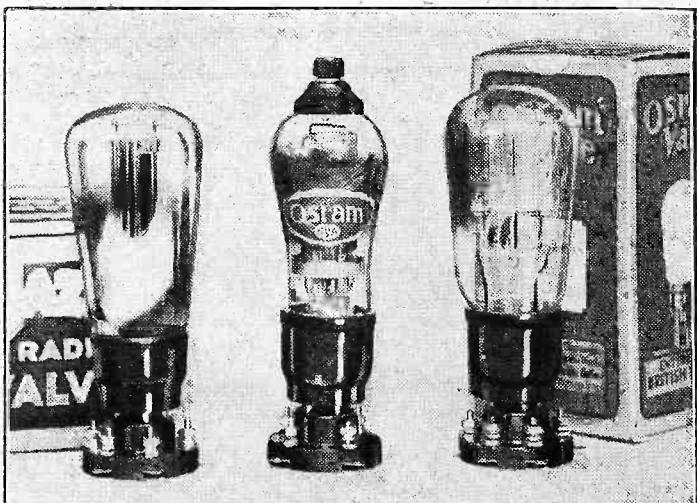

THE MIRROR OF THE B.B.C.

By O.H.M.

GOOD LUCK AT ROME!**B.B.C. RECEPTION STANDARDS—PACKING PARCELS AT BROADCASTING HOUSE—WHAT ABOUT EMPIRE BROADCASTING? Etc.**

MR. ASHBRIDGE and his colleagues will carry with them the heartiest good wishes of all British listeners for the success of their mission to Rome next week. True, the dice are loaded against them. The "alliance" between the Germans and the French may satisfy their immediate purpose: if it persists at Rome to defeat the legitimate requirements of Great Britain, they will both live to regret their success.

We are long suffering, but when our patience is exhausted we know how to act, quite as thoroughly and as extremely as in normal conditions we practise the virtues of patience. It will be a healthy lesson to the whole Continent to realise that in a struggle for the "air" they will have to take what is left over.

B.B.C. Reception Standards.

After eight years of studied reserve in the practice of reception the B.B.C. broke out at the National Radio Exhibition, making themselves responsible for the loudspeaker work in Olympia. And, strange to relate, it just didn't come off. A lot of things went wrong, and there is an enquiry in progress now at B.B.C. headquarters to find out exactly why.

Packing Parcels at Broadcasting House.

I heard a curious tale the other day of how the B.B.C. deals with its publication mail order department, now removed to Broadcasting House. What I was told was that the publications for despatch arrive in bulk, are solemnly conveyed two floors up, then made into packages and addressed, and then as solemnly carried back down stairs.

Also, the packers work in one of the inside tower rooms in permanent artificial light, thus bearing out what I said some time ago, much to the chagrin of Savoy Hill, when a denial was issued so angrily as to discount its sincerity.

I think the B.B.C. will have to look to this anomaly of Broadcasting House. It was never intended that any offices should be in the inside tower, or in any rooms having no access to open air.

What About Empire Broadcasting?

The national economy urge seems to have affected the proposal to turn G 5 S W into a permanent properly organised Empire transmitter putting out a twenty-four hour programme for all parts of the Overseas Dominions and Colonies, and incidentally, of course, for the world at large.

I know that before the financial crisis the Chancellor of the Exchequer had been convinced that this Empire service should be developed out of the Treasury balance of licence revenue. What the situation is now is obscure, but I was told in Whitehall that there is no chance of the measure going through.

Here, if you like, is false economy with a vengeance. When all other world powers are pouring out money to get their short-wave programmes to every corner of the world, Great Britain sits tight. To go on

with G 5 S W is a national and Imperial interest of the first magnitude, rendered by the crisis itself all the more important both politically and industrially.

Radio in Birmingham.

Birmingham and Broadcasting are not very happy together at the moment, and the time is fast approaching when something will have to be done about it.

The crux of the trouble is that somebody with a fair amount of authority at Savoy Hill feels that there is no real necessity for Birmingham to have a broadcasting

THEY'VE MADE THOUSANDS OF SETS

Photo by the courtesy of Ferranti, Ltd
Your best constructional feats would be considered "less than the dust" by these young ladies, who have made thousands of sets this year! But it was all done in the day's work, for they are employed from morn till night on set-assembly.

As I say, there is a strong tendency at Savoy Hill practically to wash out Birmingham as an originating centre and to put the Midland Regional transmitter as permanently on to the London studios as its neighbour 5 X X at Daventry is unalterably hooked up with other transmitters that send out what is known as the National programme.

It is with considerable surprise, therefore, that I learn that Eugene O'Neil's play "The Emperor Jones," in which, as I announced some time ago, Paul Robeson was to have taken part on October 23rd, will not now be broadcast.

(Continued on page 392.)

FOR THE LISTENER

Radio Drama is the theme of our popular contributor this week—and he hits out at it with vigour.

I LISTENED-IN not long ago to "The Lost Cause," a pageant play for which Mr. Compton Mackenzie was responsible. I am perfectly sure that there is no future for this kind of play in Radio Drama.

The play lasted for 100 minutes, more or less; there were thirty-two scenes, connected together by some sort of reading. You had a scene of about a couple of minutes, then a connecting link of reading, then another couple of minutes of play-acting.

Personally, I found it almost intolerable. The dialogue was poor, the characterisation was poor.

Bonnie Prince Charlie and Flora MacDonald are characters known and loved the world over; and Mr. Mackenzie couldn't, therefore, very well go wrong with them. But the other characters, with their two-minute appearances, were so shadowy and

perfunctory that I wasn't the slightest bit interested in them, and didn't care twopence what they did or what happened to them.

I question whether an accomplished dramatist could have made this "pageant-play" live on the air. These snippets of action, inter-linked with really rather dull reading, are too irritating.

Laying Down a Law.

We have had a good deal of experimenting now for several years in the matter of Radio Plays. It ought to be possible by this time to get firmly hold of at least one end of the stick. I will lay down the law. A good Radio Play must first of all be a good play in itself.

Many Radio Plays have failed; one expects this in a period of experimenting. Some have failed because they did not lend

Specified for the P.W. "DUAL RANGER"



RI have produced the amazingly improved Dual Range Coil. It ensures a degree of efficiency in the "P.W." "Dual Ranger" and other "P.W." circuits, unobtainable with any coil of less critical production and finish.

LABORATORY TEST Your Safeguard
The laboratory tests on the wavemeter, inductance bridge and special "Dual Ranger" circuit apparatus, absolutely determine that the performance will be right and the following advantages are ensured by the marvellous accuracy of the

new **RI** constructional design.

- 1 Perfect electrical uniformity because of the self centring arrangement of the inner and outer coils.
- 2 Immunity of the windings from varying temperature effects.
- 3 Simplification of the fixing, accessibility of the terminals and clearly engraved identification marks.
- 4 Special guarantee by test on the Wavemeter and Inductance Bridge.
- 5 **ABSOLUTE WAVELENGTH CERTAINTY—NO MORE TROUBLE**

The **RI** IMPROVED DUAL RANGE COIL P.W. & M.W. HIGH EFFICIENCY

Ask your dealer or write to us for a copy of the R.I. 1931-32 Catalogue. It is the best component reference obtainable.

Now made with all Bakelite Former ensuring absolutely Best Circuit Performances—

12'6
NO INCREASE IN PRICE.

SELECT **RI FOR VALUE AND SATISFACTION**

FORMO

ARTHUR PREEN & CO. LTD.

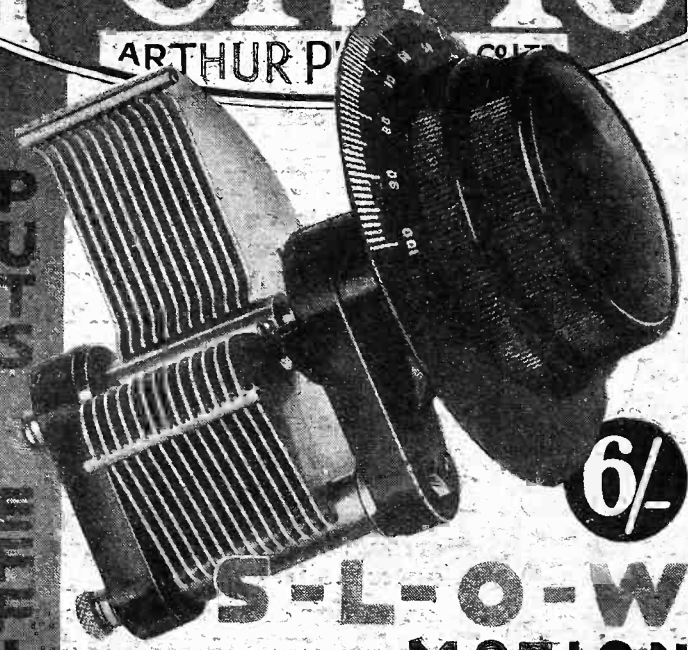

6/-

S-L-O-W
MOTION
THAT MEANS

QUICK
STATION
FINDING

The Formo Company with their great experience in construction of variable Condensers introduce this new model Fast and Slow-Motion Condenser, confident that this is the highest quality instrument available. The slow-motion drive is silky and permits the tuning of close stations to a degree of accuracy that vastly improves the reception of your set. Other features are the Internal Pigtail and its small size and light weight.



DIFFERENTIAL CONDENSER

For reaction, the Formo differential condenser achieves the smoothest possible control. Complete with moulded knob.

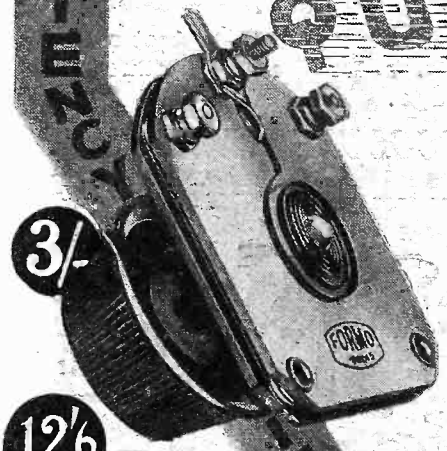

3/-



12/6

DUAL RANGE COIL as specified for the Dual-Range.
The Formo Dual Range Coil is scientifically tested and absolutely reliable. Universally acknowledged the best type for radio construction. It is of superior finish, being wound on a well-designed moulding with accessible terminals. For best results and easy assembly make sure that you get a "FORMO."

Complete Catalogue from :-

ARTHUR PREEN & CO. LTD.
GOLDEN SQUARE PICCADILLY CIRCUS W.1
CROWN WORKS, REGENTS PARK, SOUTHAMPTON

When the very best reproduction is required



Minor D.C. Model
Price £1.11.6.

Minor Permanent Magnet Model
Price £2.10.0.

1931/2 Senior Permanent Magnet
New Reduced Price £5.12.6.

1931/2 Models. Senior A.C. Model
New Reduced Price £7.15.0.

Senior D.C. Model
New Reduced Price £5.5.0.

... the expert chooses a B.T.H.

First among moving coil speakers was the R.K. and still it retains its supremacy. When really first-class reproduction is required—the expert chooses an R.K. When leading radiogram designers consider the question of speakers—they specify an R.K. The very best of the moving coil speakers, and at a price within the reach of all.



MOVING COIL REPRODUCER

(100% BRITISH MADE)

GREENWICH TIME FROM THE MAINS



Have you seen the Ediswan A.C. Mains Electric Clock? Ask your radio dealer. Prices from 45/-

EDISWAN RADIO



THE EDISON SWAN ELECTRIC CO. LTD.
Radio Division: 155 Charing Cross Road, London, W.C.2

"I've got to study economy now old chap and stay at home in the evenings."

"Oh! well you've got your radio, although you are always grumbling about it."

"Not now! I've made my set all-electric with a Regentone Mains Unit and you wouldn't believe the difference it's made."

"In what way?"

"I never have to bother with batteries or accumulators—I just plug in to the electric light and I get tip-top reception every time I switch on. My set is far more powerful now and I've finished with all this battery expense and trouble."

"Would it be difficult to make my set All-Electric?"

"Not with Regentone—these people specialise in this Mains business and you can take it from me their units take some beating. Why don't you ask your Wireless Dealer about it, or write to Regentone for their latest catalogue."

THANK goodness the improvement that I foreshadowed last week has duly occurred, though it is not perhaps quite so marked as might have been expected. Still, there is an improvement and that is the great thing.

With the decrease in atmospheric interference, in which we are rejoicing just now, reception of the long-wave stations once more becomes enjoyable, though it is out of the question when there is a constant accompaniment of crackles and fizzes and tearing noises, for the longer the wavelength of the station that you are after the worse is the interference experienced.

There is no end to the queer things that happen in long-distance reception. Why, for instance, should Huizen have continued as a strong and reliable transmission all through the period when other stations were coming in rather badly, and then have "gone off" just when they were showing signs of improvement all round? That, though, is just what happened.

Huizen Confusion

Here, for instance, is Huizen's record on seven recent consecutive days in my log: V.G., V.G., V.G., G., F., F., F. And turn-

STATIONS WORTH HEARING

Some practical distant-programme notes compiled by a special contributor who nightly searches the ether in order to obtain really up-to-the-minute information for "P.W." readers.

ing back its pages for many weeks previously I find that he has been V.G. all the time.

On Long Waves

Of the other long-wave stations Zeesem is coming in splendidly, as is Radio-Paris at most times; though this station seems to be working rather shorter hours than he was. The Eiffel Tower has been rather badly heterodyned once or twice lately by Moscow.

These Russian stations really are a nuisance, for they seem deliberately to select channels only 4 or 5 kilocycles away from those of other stations on both wavebands, and the heterodyne interference that they cause is becoming very serious. Motala is pretty good and Warsaw shows splendid strength. Kalundborg is quite back to his old form, and I can recommend Oslo as a reliable station.

this without spoiling the quality.

Vienna is still on the weak side, though I think that we shall hear him well very soon. Brussels No. 1 is by no means up to form; good nights and weak nights seem to alternate. Prague has suffered from some spark interference, but when this is absent good reception is obtainable.

Milan is generally a useful station. Langenberg remains a good standby, and both Rome and Stockholm are coming in well. Beromunster and Sottens are stations that you should never miss when you are trying round.

Berlin and Belgrade

Berlin Witzleben is surprisingly good on some nights, but on others you will have your work cut out to find him at all. Belgrade is always worth trying for, though one cannot guarantee that great volume will be obtainable.

I HAVE, of late, had rather more spare time than is my wont, and I have filled in a good deal of it by visiting friends, be they "hams" or merely receiving enthusiasts, to see what I could learn.

The net result is that the astonishing evidence of bright ideas on all sides makes me feel quite ashamed of myself. First I see a beautiful job in the way of a completely screened and portable two-valve short-waver. Then along comes about the most sensitive set I have ever heard in my life, although the wildest stretch of imagination would not describe *that* as portable.

W 2 X A D Again

Other brain waves include the use of "doublet" aerials for cutting down interference; peaked output stages for C.W. reception; "noise filters" which really work in the output circuit; and a combined monitor and portable receiver.

Most of the really brainy parts of the above-mentioned were, it is true, in matters of detail, but they certainly were there.

I am not going to detail them here, but I solemnly promise that, as I do mention them one by one, I will acknowledge them to be borrowed, and not claim the credit myself!

Regarding the week's note on W 2 X A D, the less said the better. I have not been able to listen until 10.30 p.m. most days, and by then he has usually disappeared completely. No doubt he is still good as he starts up—perhaps someone will be good enough to inform me—but he certainly does not last long. By next month

SHORT-WAVE NOTES



News and views regarding an exciting and fascinating wave-band.

By W. L. S.

he will not be worth listening to at any time, unless he is on the air by 6 p.m. Greenwich Time.

An unusual feature of conditions during the past fortnight has been the strength of amateur signals from South Africa and Asia. Two South Africans in particular, ZS 6 Y and ZS 4 M, have been uniformly good during the afternoon and early evening. The "Japs" have had two or three good evenings; two Indians have been logged more than once, and such places as Malay appear to be coming over quite well, providing that somebody at the other end is really on the air!

El Prado Calling

An interesting newcomer to the broadcasting stations is El Prado, Ecuador. He works on 39.5 metres, and I am not certain of his times except that he is on every Sunday morning from 4 a.m. to 6 a.m. G.M.T.

The announcer is the operator of the famous Ecuador station H C I F G.

In a mild moan from Chesterfield, "D. P." expresses disagreement with my loggings on W 2 X A D. He says, "Conditions always seem to be the reverse to yours. Somehow I can hardly believe it is true when you keep saying W 2 X A D is a reliable signal." Well, "D. P.," remember that these notes have to be written some little time before you read them. Allow for the "time lag." But I know very well how conditions vary over different parts of the country.

Trades Union Results

"D. P." finds the Trades Union station one of the best, whereas here he is nothing outstanding. Curiously enough, in the same batch of letters is one from fairly near my own quarter of the globe expressing perfect agreement with my records.

Talking of records, I have been thinking of a possible use for another kind. Home recording is great fun, especially when one records funny incidents heard "on the air" and puts them out again at a later date! Amateur transmitters will have the shock of their lives when they hear some of the unimpeachable records I have made of their doings.

And I wonder whether "Croydon" would like to know that I have some bad language of his "bottled up" somewhere? When we get some real broadcasting from the States again (apart from the small hours, which have a dire effect on me) I am going to get busy.

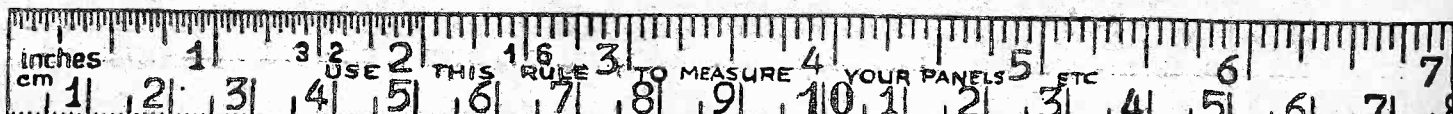

THE long-life BATTERY



The Exide "C" Battery for low tension is the battery for big sets and greedy valves. This battery is famous for its strong construction—robust Exide long life plates—patented separators to prevent shorting—strong leak-proof containers of celluloid or glass. It is a very *convenient* battery—fitted with the new Exide identification slip to

prevent mistakes during recharging—terminals of different colour and shape distinguishable even in the dark. Thus the way of the listener-in is made smoother still by Exide. If your set makes such a demand on L.T. current that recharging must be frequent, you cannot do better than fit an Exide "C" Type Battery.



Reduced prices per 2-volt cell: CZ2-20 amp. hrs. 9/-. CZ4-40 amp. hrs. 13/- CZ6-60 amp. hrs. 17/-. Other sizes up to 120 amp. hrs.

From Exide Service Stations or any reputable dealer.

Exide Service Stations give service on every make of battery

Exide Batteries, Clifton Junction, near Manchester. Branches at London, Manchester, Birmingham, Bristol, Glasgow, Dublin and Belfast

Have **YOU** joined the new Radio Cult?

Sound Magic

Converts your old
Battery Set into a
LIVE UP-TO-DATE

**ALL-MAINS
RECEIVER**

at the Fractional cost of
ONLY 1d. PER WEEK

OBTAINABLE FROM ALL RADIO DEALERS.

This model illustrated
is the

"MULTIVO."

All Formo Eliminators
incorporate

WESTINGHOUSE

**METAL
RECTIFIERS**

and are, therefore,
absolutely trouble-free
and super-efficient.



**BATTERY
ELIMINATORS**

"MINIVO" MODEL

Suitable for 1-, 2-, and 3-valve sets. H.T. only.
H.T. OUTPUT: 120 volts at 20 milliamperes.
1 tapping 50/90 volts.
1 tapping 90/100 "
1 tapping 120/150 "

Housed in attractive metal box, with coloured jacks.
Size, 9 in. by 5 in. by 3½ in. Fits any portable set.
PRICE £3 3 0, or 10/- down and balance in
6 easy monthly payments.

"MULTIVO" MODEL

Suitable for multiple valve sets, employing super-
power or pentode valves. Combined H.T. and L.T.
trickle charger.

H.T. OUTPUT: 25 milliamperes.
1 variable tapping .. 0/100 volts
1 tapping 50/90 "
1 tapping 150 "

Trickle charger for 2-, 4, and 6-volt accumulator at
5 amps. Housed in attractive metal box, with
coloured jacks and ample control knob. Size, 10 in.
by 5 in. by 3½ in. Easily fitted into transportable sets.

PRICE £5 5 0, or 10/- down and balance in
11 easy monthly payments.

SEE ALSO PAGE 346.

"VOLTEX" MODEL

Suitable for multiple valve sets. Combined H.T. and
L.T. (raw A.C.), for indirectly heated valves.

H.T. OUTPUT: 25 milliamperes.
1 variable tapping .. 0/100 volts.
1 tapping 50/90 "
1 tapping 150 "

L.T. OUTPUT: 4 volts 4 amps (raw A.C.) for in-
directly heated valves.

Housed in attractive metal box, with coloured jacks
and ample control knob. Size, 10 in. by 5 in. by
3½ in. Easily fitted into transportable sets.

PRICE £5 5 0, or 10/- down and balance in
11 easy monthly payments.

ARTHUR PREEN & CO., LTD., GOLDEN SQUARE, PICCADILLY CIRCUS, W.1. Crown Works, SOUTHAMPTON.

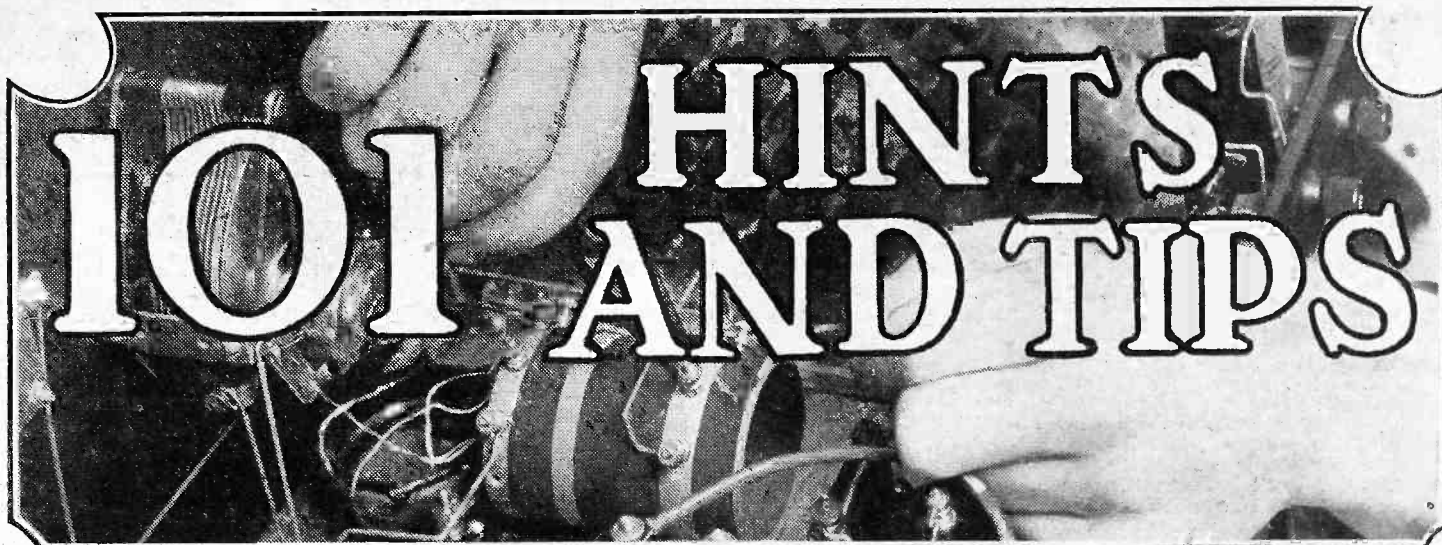

A good method of obtaining selectivity with an old-fashioned aerial coil is to wind 20 or so turns of No. 24 D.C.C. around it, connecting the aerial and earth wire to these, the other connections to the main coil being as formerly.

When experimenting with circuits in which centre-tapped coils are used, do not forget that the centre terminals of such coils may easily touch one another, with disastrous results if one of them is at high potential.

When condensers are placed in series with one another, remember that the total capacity of any number will always be less than that of the smallest single capacity.

When laying aside a spare variable condenser don't forget that to wrap it in clean paper will save endless trouble in removing dust from the vanes.

Improving Old Condensers.

Variable condensers of old construction which appear to have deteriorated with use, can often be greatly improved by providing a pigtail contact between the moving vanes and their connecting terminal, in place of a rubbing contact.

An unnecessarily long earth wire not only gives rise to flat tuning, but is often the cause of considerable hand-capacity effect.

If a fairly large nail is driven up through an old baseboard a reel of wire may be placed over this when coil-winding is carried out. And if three or four other small nails or staples are "staggered" over the baseboard and the wire threaded between these, the desired tension when winding may be obtained.

When using a crystal set it is essential to get as much energy as possible in the aerial, and for this purpose an outdoor aerial is generally very much to be preferred to an indoor one.

If you use an earth connection to a water-pipe make sure that the pipe is not painted or dirty, as such connections depend for their efficiency upon being affixed to a thoroughly clean surface.

When unwinding earth wire from a coil, remember that kinks should be avoided, for even though carefully straightened, they afterwards represent weak places in the wire.

A Good Earth.

If you are putting in a new earth wire, do not forget that an old gas pipe or similar metal tube leading from the buried earth to the surface is not only helpful for the wire to pass through, but acts as a channel through which water may be poured in dry weather.

A piece of corrugated iron such as is used for roofing sheds, etc., makes a good earth plate.

When baring flex, take care to nick the rubber only, as if the wire is cut, it will eventually break.

use for this length of time they require an overhaul if you are to be free from "crackling," etc.

Correct grid bias is particularly important for the last valve in a set, and too little grid bias will inevitably shorten the valve's life and introduce distortion.

Although no current is actually taken from the grid-bias battery, its paste electrolyte tends to dry up after six months or so, so that the battery should be replaced when distortion appears or its voltage drops.

With valves of the indirectly-heated variety, it is usual to obtain grid bias by means of a resistance connected in the cathode lead. Bias obtained by this method is often termed "automatic bias."

One of the advantages of an anti-motor-boating device is that it can be fitted externally, if the set is of a type in which it is difficult to interfere with the internal wiring.

A possible but often unsuspected source of distortion is the allowing of grid-bias flexible leads to run close to other leads in the set.

Be extremely careful never to connect up a grid-bias battery the wrong way round. Even the momentary application of positive bias may do considerable harm to a valve.

* * * * *

Here are some selected reminders to aid you in getting the best possible results from your radio. Terse, tested and practical, they will be a boon particularly to new readers.

* * * * *

Programmes can sometimes be prevented from clashing by connecting a .0001-mfd. or similar small fixed condenser, between the aerial terminal and the aerial lead in.

If you are using a permanent magnet moving-coil loudspeaker, be careful not to put a delicate watch near it, for you may magnetise the movement and spoil its accuracy.

When one of the loudspeaker leads is connected to earth or filament and the other to a condenser forming part of a choke output unit, this condenser will have practically the full H.T. voltage across it, and therefore it should be of good quality, able to withstand such a strain.

Do not run long leads from your set to distant loudspeakers unless you employ an output filter circuit to prevent H.T. wastage.

If two condensers are used in an ordinary choke-output circuit, remember that they are in series with one another, and that this will greatly reduce the total capacity of the arrangement.

Interference which would not otherwise be

A deciding factor in baseboard design is the circuit arrangement and on no account should positions be varied just to make the baseboard look symmetrical.

If you have not done much set building remember when making a set that you should occasionally insert the valves and the coils into their respective places, so as to make sure that none of the wires will foul them.

There is little or no advantage in using two or more wires for your aerial, unless it is a particularly short one.

Overhauling the Aerial.

When overhauling the aerial remember that the lead-in tube should also be inspected to make sure it is in first-class working order. (Only perfectly clean contacts should be tolerated.)

If you use an outdoor aerial it should be fitted with an earthing switch so that the aerial can be connected direct to earth outside the house when not in use.

On no account should an aerial with a condenser wired in series with it be left for long periods "unearthed" when the set is out of use, as even in winter an insulated wire exposed out of doors is liable to gather an electric charge (from snowflakes, rain, etc.).

If you have a compression condenser on hand and not in use, remember that inserted in series with the aerial lead it is often a great aid in improving selectivity.

One disadvantage of using an aerial behind a picture-rail is that it is too close to the wall, the ideal arrangement being an aerial well spaced away by stand-off insulators.

An excellent means of reducing the damping of an aerial for short-wave work is to connect an ordinary neutralising condenser in series with it.

By arranging that the down lead from the aerial either dips below the lead-in point, a good deal of leakage due to a wet lead-in, etc., can be overcome.

Covering an Arrester.

A little time and trouble taken in making a box or other covering for an earth arrester and switch which are placed out of doors, is well repaid by the better results due to improved contact at this point.

Enthusiastic gardeners should remember that wire stays from the aerial mast should not be run through the foliage of valuable fruit trees, as charges due to nearby lighting might easily damage the trees.

Never under any circumstances attempt to erect an aerial under, over or near to a power line carrying high voltage current.

101 HINTS AND TIPS

(Continued from previous page.)

Distortion due to H.F. leakage into L.F. circuits can often be prevented by inserting a H.F. choke between the grid of the amplifying valve and the lead which is connected to it.

The proper way to test the voltage of a high-tension battery is to join a high-resistance voltmeter across the battery when it has been in action for about an hour.

Any leakage, however small, across the insulation of an H.T. accumulator constitutes a continuous discharge, so that great attention should be paid to maintaining the insulation as nearly perfect as possible.

Concerning H.T. and L.T. Batteries.

Never join an old H.T. battery up in series with a new one, as the latter is definitely unsuitable for use in such circumstances.

If you find that your set distorts only after the receiver has been in use for an hour or two, you can be pretty sure that either the high- or low-tension supply is inadequate for the needs of the receiver.

The dry cells used for flashlamps are quite satisfactory as H.T. batteries for a two-valve set, but when a large power valve is employed these small cells are incapable of supplying the amount of current required.

It is unwise to hold a naked light, such as a match or cigarette, near to an accumulator, particularly when this is being charged.

If you keep your L.T. battery inside the set's cabinet, see that flex leads do not touch it, as its acid will play havoc with the insulation.

Anti-sulphuric paint, which is obtainable quite cheaply, is an excellent preservative of a wooden accumulator carrying case, and is very useful for treating wooden floors, etc., where the accumulator stands.

The action of a vent plug in an accumulator is four-fold, it prevents the loss of electrolyte from spraying, it allows the gases formed in the cell to find a way out, it prevents the electrolyte from spilling, and it also keeps dirt out of the cell.

If one of the plugs from an accumulator is lost do not block up the hole with a plain cork or wooden stopper, but drill a small hole in this, or otherwise the gases formed inside the cell will have no opportunity to escape.

Unsatisfactory service from an accumulator service station often results in the return of accumulators with dirty terminals. And although it should not be necessary, the listener can, with a penknife, scrape the contacts and eradicate this trouble himself.

The greatest enemy of the accumulator is sulphation, and the best way of preventing this is to have the battery charged regularly, and never allow it to stand discharged longer than necessary.

If you are often fiddling with a terminal in a rather inaccessible place, do not forget that it may be an advantage to cut a slot across the top of it with a hack-saw, afterwards using a screwdriver to tighten the terminal.

An ordinary on-off switch fitted across the terminals of one loudspeaker wired in series with another will enable it to be switched out of

Faulty switches in the house lighting circuit will give rise to clicks and noises in the loudspeaker, owing to sparking occurring across the defective points.

As it is difficult to make perfectly clean cuts through brass rod without spoiling the thread, a useful method is to affix one or two nuts to the rod before cutting it, so that when these are unscrewed the thread displacement is restored.

A carpenter's brace can often be adapted to take a small wireless drill, if necessary, by winding a fairly stout wire around the drill in the form of a spiral to enlarge its diameter.

Do not throw away old hack-saw blades, as one of these, ground down and put on a handle of suitable size, will make a good keyhole saw for cutting small holes in ebonite.

Hand-capacity can often be reduced by changing over the leads to the variable condenser concerned.

When using a screened-grid valve for the first time, remember that the pin on its base opposite the grid one does not carry the output from the valve. The "P" or "A"

SPACING THE COILS

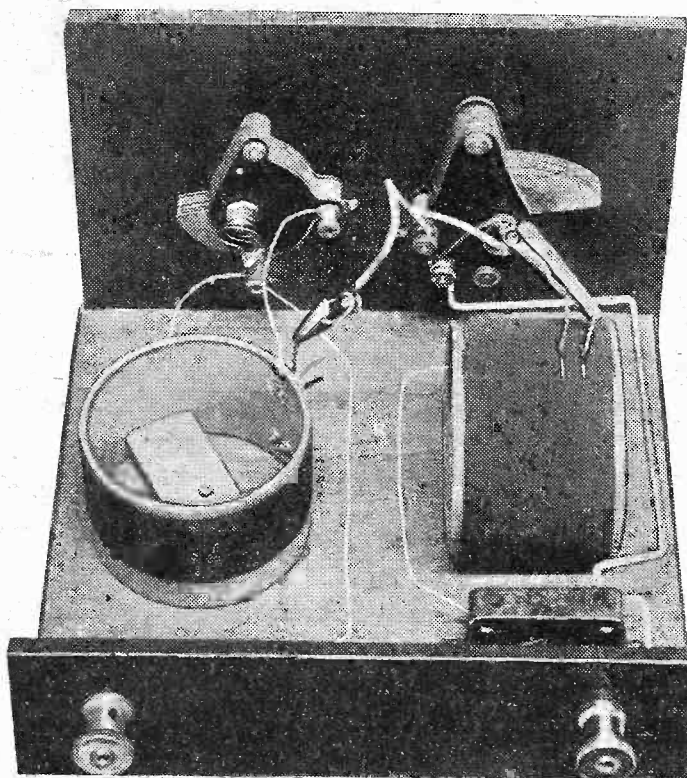

If one coil is placed horizontally and the other vertically they do not tend to "couple" and give unwanted interaction, as they would if mounted "in line."

socket on the valve holder will be connected to the screening electrode.

When calibrating a two-dial set, it is better to pay particular attention to readings of the high-frequency or anode dial, rather than to the aerial dial, as variations are more likely to affect the latter than the former.

Reducing Tuning Ranges.

When a fixed condenser is connected in series with a variable condenser used for tuning, to reduce the tuning range, the law of the tuning scale will be altered and a "straight-line" condenser will be thrown out of the straight-line condition by such a connection.

"Overloading" is not peculiar to the last stage; it often takes place on the first L.F. valve, or even on the detector.

In order to get the best possible results from a screened-grid valve, it is important to take every care that the correct voltages are used

Although the ordinary H.F. valve only takes up to about 1 milliamp. H.T. current, this is not true of the screened-grid H.F. valve, which may take up to six times as much.

In an average modern set the H.T. consumption in rough and ready figures is: H.F. valve (S.G.), 4 milliamps; detector, 1 milliamp; L.F. valve, 2 milliamps; and power valve, 6 milliamps. (Super-power valve, at least 12 milliamps, probably 15 or more.)

When a certain valve is recommended for use with a particular L.F. transformer, the valve referred to is the one preceding the transformer, and not the one to which its secondary is joined.

Decoupling for Pentodes.

Failing separate tappings for all the valves in a powerful set employing a pentode, the tendency to motor-boating may be overcome by the use of a decoupling device in the circuit of one of the valves run from the common tap.

Generally speaking, an increase in the high-tension on the detector valve will mean increased strength of reaction.

Never attempt to make any adjustments inside a set with a metal screwdriver unless the H.T. negative plug is removed from the H.T. battery.

Inside a pentode valve the next-the-plate "grid" is joined permanently to the filament of the valve.

Gradual weakness of reception in a valve set is very often caused by the emission of a valve failing.

When adjusting the high-tension positive taps to various valves, do not forget that the voltage on the plate will be less than the voltage at the plug, on account of the voltage drop through the resistance in the circuit between these two.

Generally speaking, a high-magnification valve makes a good detector for short-wave work.

Although, with modern valves, rheostats are not generally necessary, it is as well to remember that a filament adjustment of the detector valve on a short-wave set is often an invaluable aid to smooth reaction.

Among the commonest causes of crackling noises are bad connections at the accumulator terminals and imperfect joints in the wiring.

When wiring up a multi-valve set, it is a good plan to check valve holders, etc., for continuity before mounting them in place, as the little time lost is more than justified when it is remembered how long such a small fault may take to remedy in a completely-built set.

It is illegal to run a wire from your loudspeaker to your neighbour so that he can listen free to your set. (In such cases a separate licence should be procured by each householder.)

An excellent test for sensitivity is to place the telephones over the ears in the ordinary way, put one of the tags between the lips and rub the other tag with a key, nail, or other piece of metal. If a rubbing noise is heard corresponding with the movement of the key, you can be sure the 'phones are sensitive.

If, for any reason, it is necessary to remove the diaphragm from the telephone earpiece, it should be slid off sideways, and not pulled up from the magnets.

Do not point your loudspeaker towards your set or place it too close to the receiver, as it is very easy to build up a howl in this way.

To Be Completed In About 32 Weekly Parts

**A NEW
WORK WRITTEN
BY EXPERTS**

NEWNES PRACTICAL ELECTRICAL ENGINEERING

Here is a splendid work which, when completed, will be worth pounds to every reader of "Popular Wireless." It is packed full of practical information on every branch of modern wireless practice, and on the wider subject of electricity as applied to everyday life. It shows the approved methods of wiring a house for lighting, heating and power, how to instal a private generating plant, how to re-wind a motor, how to instal and keep in good repair all kinds of electrical accessories.

AN OUTLINE OF THE WORK

WIRELESS FOR THE PRACTICAL MAN

Trouble Shooting in Wireless Sets.
Some Standard Wireless Circuits.
Practical Notes on—
Battery Charging.
Loudspeakers.
Low Frequency Transformers.
High Frequency Transformers.
Variable Condensers.
Fixed Condensers.
Coils and Inductances.

Trickle Chargers.
Remote Control.
H.T. Units.
Types of Valves and Their Uses.
Cases and Cabinets.
Erection of Aerials.
Wiring a House for Wireless.
Testing of Wireless Components.
Radio Gramophones.

PRACTICAL NOTES ON

Accumulator Charging.
Accumulator Repair.
Primary Batteries.
Bells and Indicators.
Burglar Alarms.
House Telephones.
Sound Film Apparatus.
Dynamos.

Motors.
Switchgear
Instruments and Meters.
Transformers.
Electric Lifts.
Electric Cranes.
Electromagnets.

INSTALLATION WORK

Electric Wiring Systems—Conduit,
Lead-Sheathed Surface System,
Other Surface Systems.
Planning a Wiring Circuit.
Installation Accessories.
Domestic Power Apparatus and
Control.
Inspecting and Testing an Instal-
lation.
Office Lighting and Wiring.

Maintenance Notes for the Instal-
lation Engineer.
Shop Lighting and Wiring.
Theatre Lighting and Wiring.
Restaurant and Hotel Lighting
and Wiring.
Factory Wiring for A.C. Motors.
Factory Wiring for D.C. Motors.
Private Generating Plant.

UPKEEP, FAULTS AND REPAIRS FOR

Electric Signs.
Electric Radiators.
Electric Suction Cleaners.
Electric Hairdressing Appliances.
Electric Fans.
Electric Tools.

Electric Washing Machines.
Electric Water Heaters.
Electric Clocks.
Electric Cooking Accessories.
Electric Dimmers.
Electric Time Switches.

ELECTRICITY IN INDUSTRY

Electro Medical Apparatus.
Electroplating.
X-Ray Apparatus.

Electric Welding.
Electric Furnaces.
Electric Traction. Etc.

A FEW OF THE CONTRIBUTORS

Sir John Ambrose Fleming, M.A., D.Sc., F.R.S. W. M. Thornton, O.B.E., D.Sc., D.Eng., M.I.E.E.
Col. R. E. Crompton, C.B., M.I.E.E., R.E., M.Inst.C.E. Miles Walker D.Sc., M.I.E.E.
Sir Richard Tetley Glazebrook, K.C.B. Lt.-Col. Kenelm Edgcombe, M.I.E.E.
Col. Sir Thomas E. Purves, M.I.E.E. A. T. Dover, M.I.E.E.
Dr. S. Parker Smith A. E. Watkins, M.I.Rad.E.

**EASY TO
UNDERSTAND**

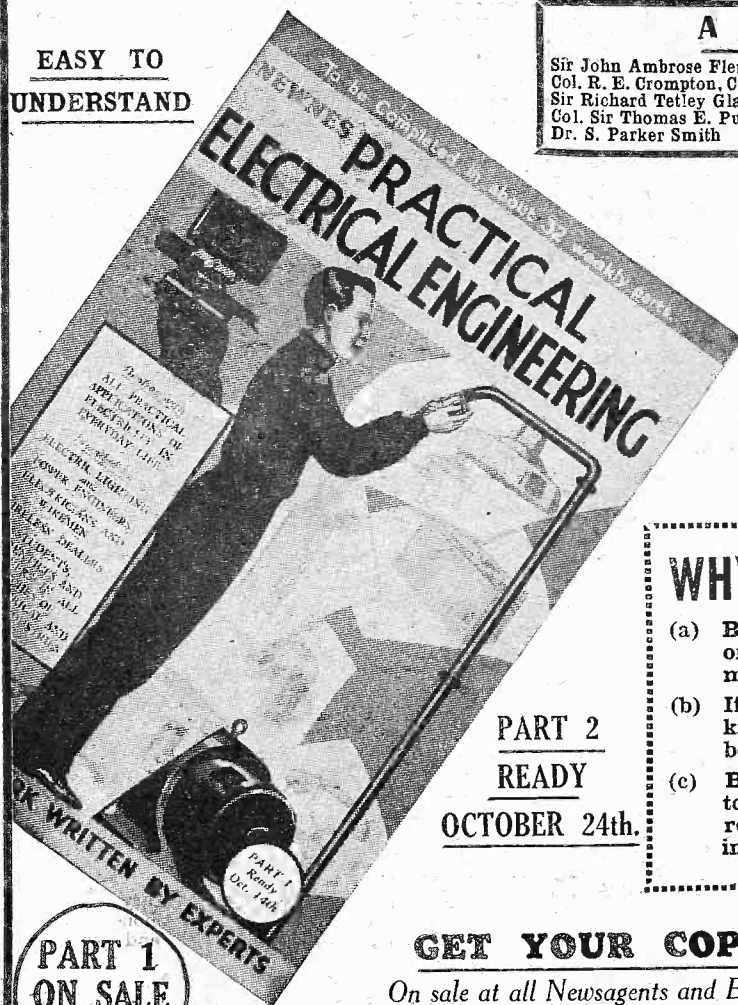

FREE with Part 1

14 TYPICAL WIRING DIAGRAMS
FOR BELLS, TELEPHONES, MOTORS,
HOUSEWIRING, BURGLAR ALARMS.
PRINTED IN 2 COLOURS.

WHY YOU SHOULD BUY THIS WORK

- (a) Because you will find in it many practical hints and tips on the installing, construction and repair of wireless. Many money-making ideas!
- (b) If you are an expert on wireless matters you will find that a knowledge of the other branches of electrical engineering is both useful and valuable in your work.
- (c) Because when this work is completed you will find it is worth to you many times what it has cost, as it will provide an ever-ready source of reference on any practical point which may arise in connection with electrical engineering and wireless practice.

PART 2

READY

OCTOBER 24th.

GET YOUR COPY OF PART 1 TO-DAY

On sale at all Newsagents and Bookstalls, or 1s. 2d. post free from

**PART 1
ON SALE
TO-DAY**

GEORGE NEWNES Ltd 8/11 Southampton St Strand London W.C. 2

**ONE
SHILLING
WEEKLY**

£6.6.0!

**An astounding
Olympia Success—**

ZONOPHONE Home Constructors KIT SET



FAMED ALIKE FOR RADIO AND RECORDS

Seven Points of vital importance

- 1** Self-contained Loud-Speaker.
- 2** Band-Pass Tuning and Pentode Output giving astonishing selectivity and power.
- 3** Economical Battery consumption.
- 4** Full Broadcast range and easy operation.
- 5** Entirely new and simple colour-coded assembly without soldering.
- 6** Fixed Pick-up Sockets.
- 7** Compact Walnut Cabinet.

● And ZONOPHONE BATTERIES

HIGHEST EFFICIENCY

GREATEST ECONOMY

THE ZONOPHONE PICK-UP

The finest Pick-up value in the world



Output 1½ Volts
Weight 130 grs.

15/-

- | | |
|-------------------------------------|------|
| High Tension | 14/- |
| (108 v. Standard Capacity) | |
| Grid Bias (9 v. Standard Capacity) | 1/6 |
| Low Tension | |
| GLASS Accumulators, Mass Plate Type | |
| Size 1 . . . 20 amp. hour | 4/6 |
| Size 2 . . . 45 " " " | 8/6 |

These Prices do not apply in the Irish Free-State

By A. S. CLARK

AN INEXPENSIVE LOUDSPEAKER

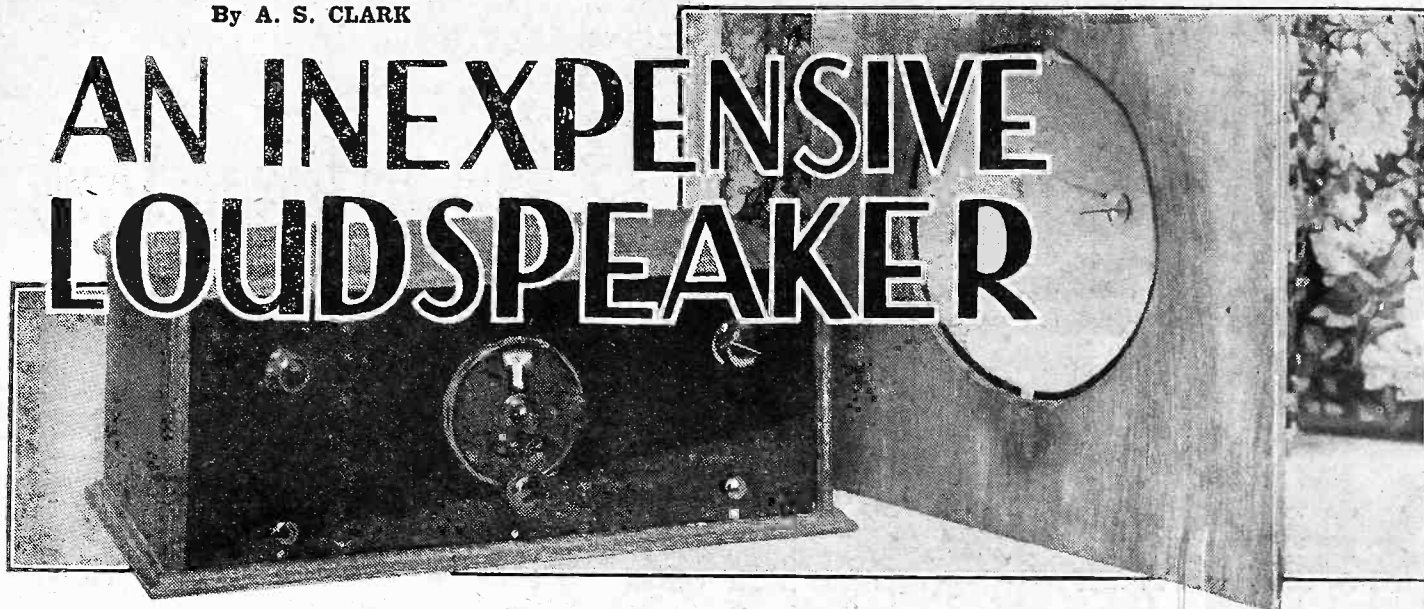

LIKE most other radio apparatus, the loudspeaker has experienced a drop in its cost of late. In spite of this, it is still an item that carries considerable weight in the question of whether one shall go in for a loudspeaker set or not.

But if you decide to make a speaker yourself—just as you, no doubt, would build your own set—there is no reason why it should not become one of the minor items of the total expenditure. For a surprisingly small sum you can make up a cone speaker of fine tonal quality, which is also very sensitive.

The speaker illustrated on this and the next page uses a Telsen unit which costs only 5s.6d., while the necessary pieces of wood and the cone paper need not come to more than a couple of shillings. At such a price it is an attractive proposition even if you already have a loudspeaker, for I expect you can think of many ways in which you could make use of an extra one.

Easy to Make.

Quite apart from its inexpensiveness, the speaker makes high claim to popularity on its sheer simplicity. As a matter of fact, I very much doubt whether the cleverest designer could devise a simpler way of assembling the necessary parts and yet retain the same inherent efficiency!

There are four pieces of wood to be fitted together to make the chassis, four drawing-pins to be pushed in place to secure the cone, and two screws to mount the unit in place. You will agree that anyone can tackle that without misgivings as to the success of the venture.

Cutting The Cone.

So far as the cone itself is concerned, a glance at the one and only diagram on the next page will show that it is as plain as can be. There is only one

Four pieces of wood, one paper cone, and a speaker unit—that's all. Just assemble these in the simple manner clearly explained in this article, and you have a "pukka" cone loudspeaker that will have cost remarkably little.

and there are no twiddle bits to fiddle with, four projecting paper lugs providing all the necessary mounting material.

The unit itself is screwed to a simple bridge piece attached to the baffle-board and which also serves for a "leg" for the speaker when it is used without a cabinet, as it will be in most cases. A hole in the centre of the back piece of the bridge gives access to the adjusting screw of the unit.

Now for a few practical details. First of all as regards the baffle, which is 18 in. by 18 in. Any plywood a $\frac{1}{4}$ in. thick or thicker will do. Plywood is not, of course, absolutely necessary but is certainly desirable because plain wood might become badly warped.

EMPLOYING A SIMPLE WOODEN CHASSIS

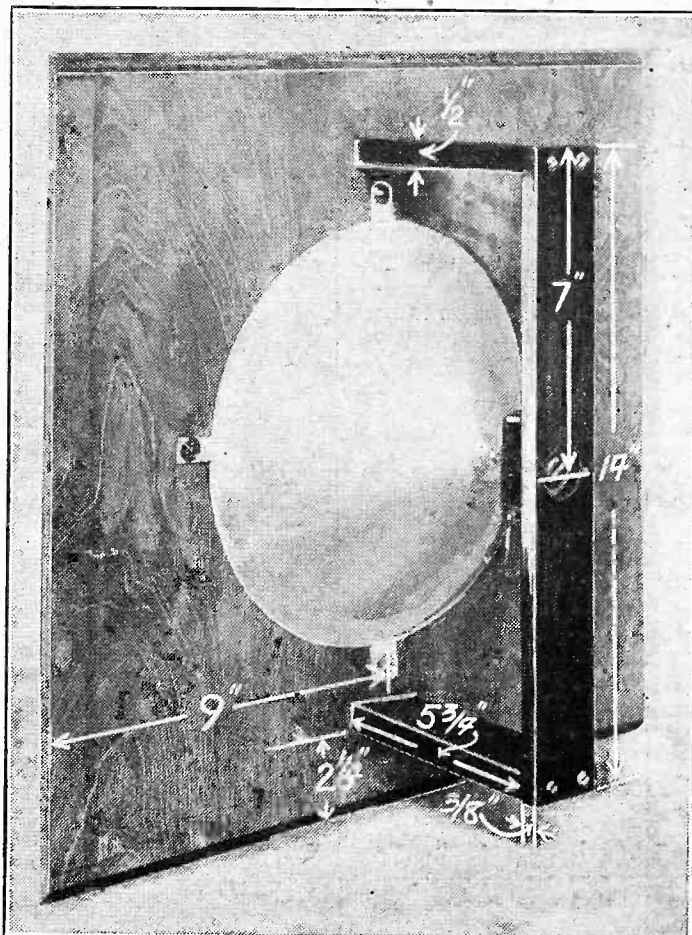

The important dimensions of the three pieces of wood which support the speaker

Aperture Size.

The aperture for the cone is in the centre of this piece of wood and is $9\frac{1}{2}$ in. in diameter. You can easily cut this out with a hack-saw, or you could get it done at the wood shop where the baffle is purchased by paying a few extra pence.

Those who desire can cut out a fret to cover the hole, and can finish the baffle with varnish stain, or enamel. That, however, is all a matter of taste and personal inclination and has no bearing on the construction of the speaker, which is what we are concerned with here.

The Framework.

Having got your baffle, you next require three pieces of wood to the dimensions shown in the first photograph. These are two pieces $\frac{1}{2}$ in. thick and $5\frac{3}{4}$ in. long, and one piece $\frac{3}{8}$ in. thick and 14 in. long.

The width of these pieces is immaterial, but can be about 2 in. In the centre and half-way along the 14-in. piece, drill a hole large enough for the adjusting screw of the unit to fit in easily, and then secure the

AN INEXPENSIVE LOUD-SPEAKER

(Continued from previous page.)

three pieces together as in the photographs.

Next screw the unit to the back piece of wood with its adjusting knob sinking into the hole cut for it. Remember that the operating rod of the unit must project on the same side as the two smaller pieces of wood.

Fixing the Unit.

When you have done that, measure out carefully the positions for the four fixing screws that pass through the baffle from its front into the two smaller pieces of wood to hold the bridge piece in place against the baffle. If you don't get the holes for these just right the cone will not set centrally in the hole in the baffle.

With that completed we come to the cone.

A "STARBOARD" VIEW

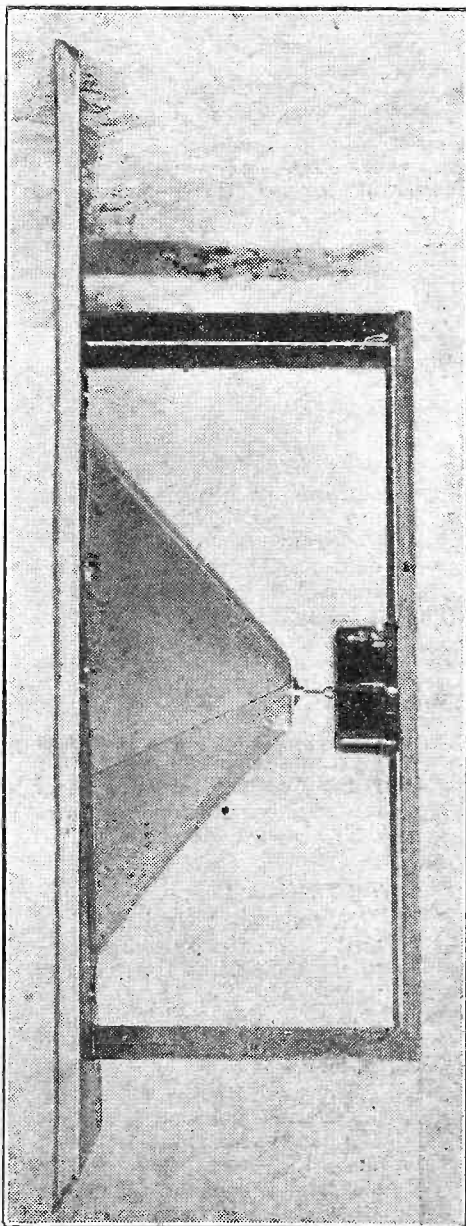

This is what the speaker looks like from the

This is cut out of stiff brown paper, known as Kraft paper of 120 lb. to the ream and of standard size; that is the size most commonly used.

Mark out a circle on it with a radius of 6 in. Then measure out a chord 8 in. long, and after that—but there, you have it all in the diagram and anyone can draw out an exact copy of that, without A B C instructions!

The four spaces between the four tabs, which are all the same size as the dimensioned one, are all equal. Don't omit to cut out the little V piece near the centre of the cone, from the $\frac{1}{2}$ "-wide strip that is stuck down.

Check Your Measurements.

Make sure you have marked things out right, and then cut out. Put some gum, or rather glue, for a strong joint is necessary, on the little $\frac{1}{2}$ -in. wide flap and stick this down along the other radial edge so that the cone takes shape. Press the paper well together and also give it plenty of time to dry properly.

When the cone is dry, fit the little conical metal washer to its apex, tightening up the fixing screw really tight. Also tighten up well the little clutch nut that holds the operating spindle to the unit.

Final Touches.

Slide the cone on to the unit's spindle by passing the former through the hole in the baffle. Before tightening up the second little clutch nut, centralise the cone by fixing the four paper tabs to the baffle with four drawing-pins.

Let the cone find its own position along the unit spindle and then tighten it up finally in place, and the speaker will be com-

is to use it, but you certainly won't need any instructions on how to do that!

It occasionally happens that home-made cone loudspeakers develop a peculiar "buzz" when dealing with fairly loud pas-

sages of music or speech. This is sometimes due to the cone not fitting snugly on the unit spindle, or the nuts which grip the latter not doing their job properly.

If you experience any trouble of this nature it is a good idea to put a little shellac varnish around the spindle and securing nuts on both sides of the cone. This has the effect of welding all the small parts, which are liable to rattle, into one rigid and solid mass.

In fact, this is a little dodge that can be very usefully applied to other parts of your set. Particularly in the case of portables where nuts are liable to shake loose.

CONE AND MOUNTING IN ONE

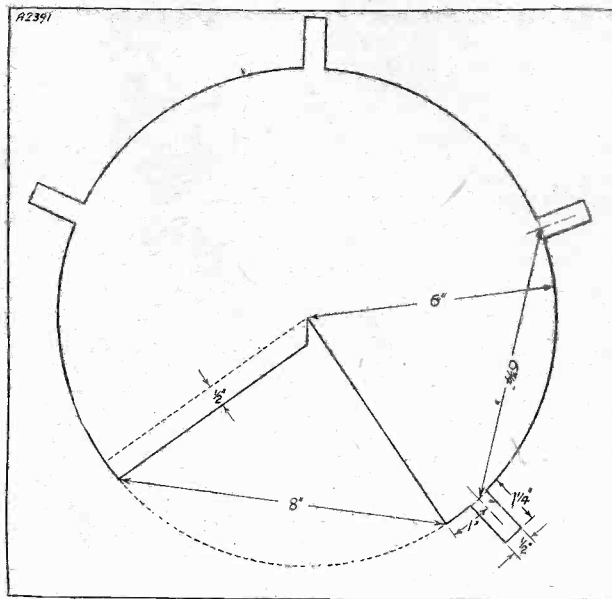

The little tabs cut as part of the cone form the mounting strips for the former, thus greatly simplifying the fixing of the cone to the baffle.

IT BAFFLES—BUT NOT YOU!

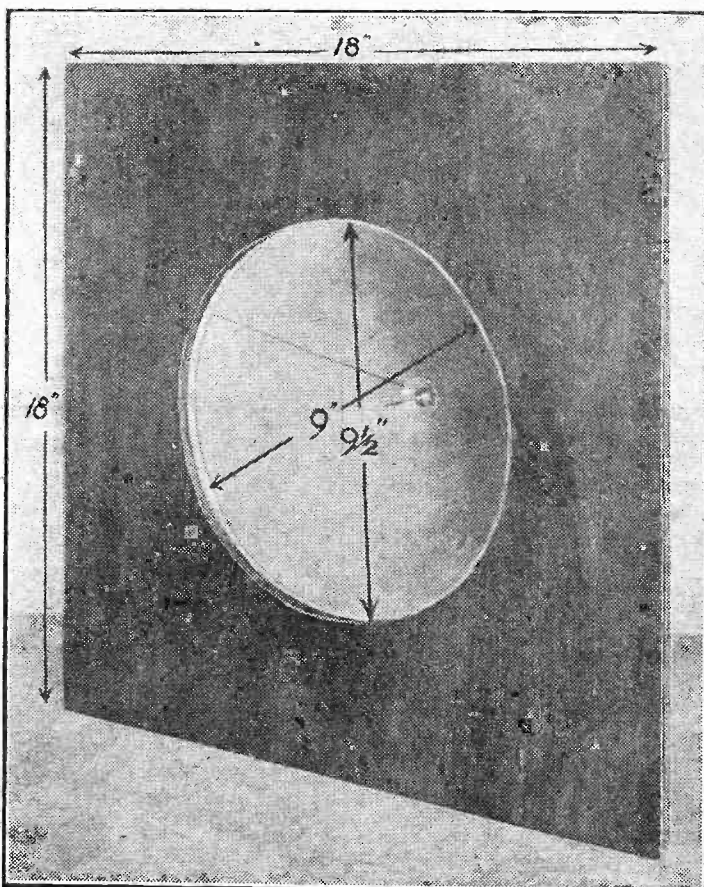

You won't find anything difficult in cutting the baffle to size. Note that the

TELSEN H.F. CHOKES

TELSEN BINOCULAR H.F. CHOKE

Hailed unanimously by the leading experts as the perfect H.F. Choke. The Telsen Binocular Choke is called for wherever highest efficiency is desired. Especially in H.F. amplification is the performance of the Choke of supreme importance.

Its highest inductance (180,000 micro-henrys) and exceptionally low self-capacity (.000002 microfarad) ensure a very high impedance at all wavelengths, and its excellent efficiency curve is free from parasitic resonances. These qualities, together with the restricted field due to the binocular formation, make it the ideal choke for a high-class circuit.

Telsen Binocular H.F. Choke Price 5/-

TELSEN STANDARD H.F. CHOKE

The Telsen Standard H.F. Choke utilises the minimum base-board space. It is designed to cover the whole broadcast band and has an extremely low self-capacity. The inductance is 150,000 microhenrys and the resistance 400 ohms.

It has proved very popular and has been incorporated by set designers in many of the leading circuits.

Telsen Standard H.F. Choke Price 2/-

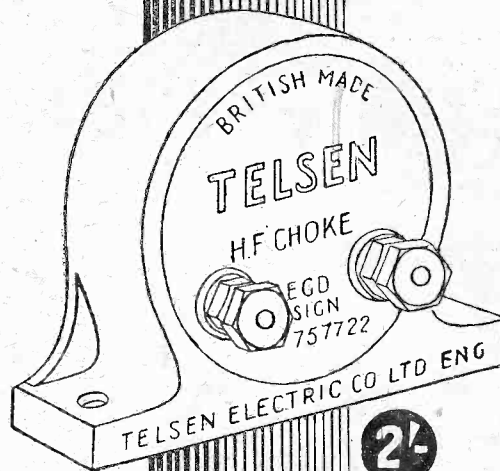

TELSEN

THE SECRET OF PERFECT
RADIO RECEPTION

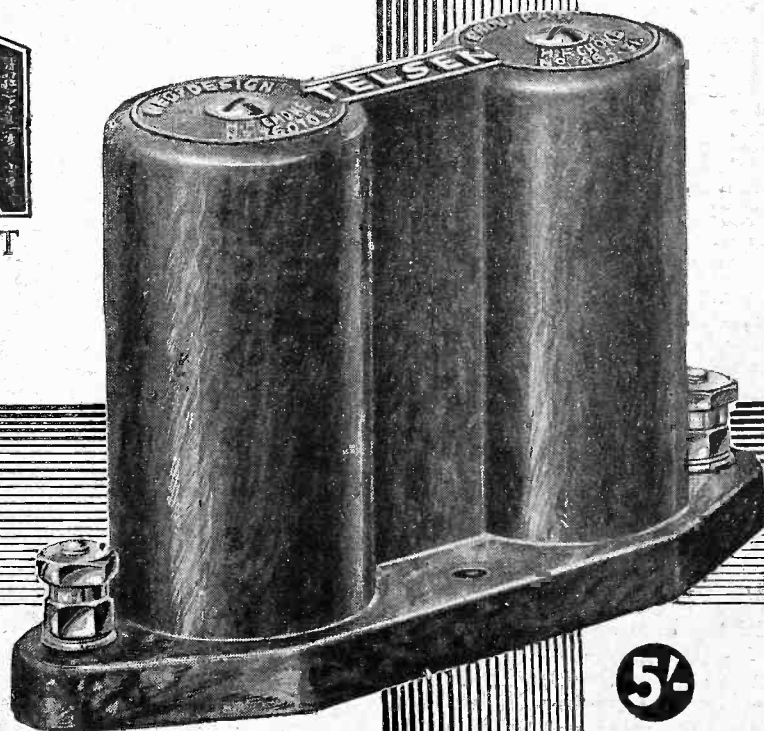

CAPT. ECKERSLEY'S QUERY CORNER



Under the above title, week by week, our Chief Radio Consultant comments upon radio queries submitted by "P.W." readers.

Don't address your questions direct to Capt. Eckersley, a selection of those received by the Query Department in the ordinary way will be answered by him.

Coupling the Aerial.

M. K. (Leicester).—"I have had a certain amount of difficulty in deciding upon the best method of aerial coupling to use in a ganged-tuning receiver:-

"I have found previously that when the aerial is coupled by a small coil to the first H.F. grid coil the load transference to this tuned circuit varies at various wavelengths. As the gang condenser incorporates small trimming condensers to equalise the various stray capacities and the inductances are identical, this prevents full efficiency being obtained.

"If the aerial is coupled by a small capacity to the grid end of the first tuned circuit the matching remains much more constant but the sensitivity is somewhat reduced. I should be glad if you can inform me as to the cause (and cure, if any) of the troubles experienced when the first method of aerial coupling is adopted, and why the latter system reduces the sensitivity."

D.C. HEATING

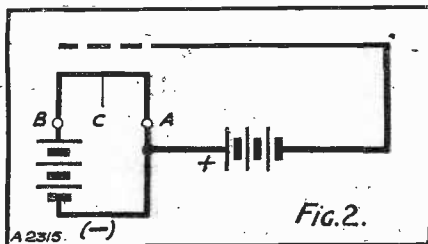

The mid-point C is not neutral in this case.

You are asking a big question. The answer—that is to say, how to keep a stable performance of coupled circuits throughout the range—is not yet available.

I shall be writing a good deal on this subject shortly, and so ask you not to spoil a series of articles by half statements at this stage. The reason, by the way, that you lose sensitivity by (very small) condenser coupling is that the condenser being very small the coupling is very loose, and if the coupling is very loose we always lose signals.

Selectivity and Sensitivity.

B. R. (Newcastle).—"Recently when comparing the selectivity of a receiver incorporating Litz wire coils and a neutralised triode valve with another using a screened-grid valve in the H.F. stage, it appeared that, although the latter was generally more selective than the former, greater difficulty was experienced in

eliminating the local station with this receiver. What is the cause of this apparent contradiction?"

Is it not rather a contradiction to say that

CENTRE-TAPPED SECONDARY

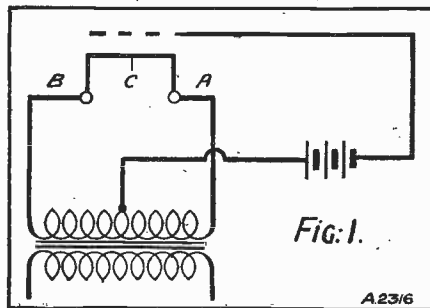

The usual method of G.B. connections, but omitting the secondary or other form of coupling.

the one H.F. arrangement was more selective, but more difficulty was experienced in eliminating the local station? Would it not be fairer to say that the H.F. screened grid was more sensitive and showed an apparent sharpness of tuning on lots of distant stations which the ordinary valve did not pick up?

As a matter of fact, sensitivity and selectivity are bound up together. Thus, imagine a sensitive set, with many tuned circuits even, taken into the field at Brookmans Park and connected to a big aerial. You probably couldn't tune out Brookmans Park. A crystal set, without aerial however, could, with only one tuned circuit, tune out one station and tune in the other. And yet the crystal set has only one tuned circuit, the valve set had two or three.

The only difference was that the valve set was ever so much too sensitive. So sensitivity and selectivity are dependent.

ONLY IN "P.W."

can you read Captain Eckersley's replies to listeners' own problems.

AND REMEMBER—
Captain Eckersley's technical articles appear only in the "Big Three,"

"POPULAR WIRELESS,"
"MODERN WIRELESS," AND
"WIRELESS CONSTRUCTOR."

If your ears were made very, very sensitive you might hear all the roar of London and all the people in London talking and yet not be able to pick out the nearby noise, it being so interfered with by the other noises.

We only select what we want to hear by rejecting what we don't. A more sensitive set is, simply, in being more sensitive, less selective.

Less Bias for A.C. than for D.C. Heating.

L. K. (Plymouth).—"While reading the maker's specification of a large super-power valve, I noticed that it was stated that, when the filament of the valve was fed by A.C. from a transformer, the bias should be 2 volts less negative than when an L.T. accumulator was employed.

"The valve in question was of the ordinary directly-heated type, and I am unable to understand why a difference in the nature of the L.T. supply should affect

USING A POTENTIOMETER

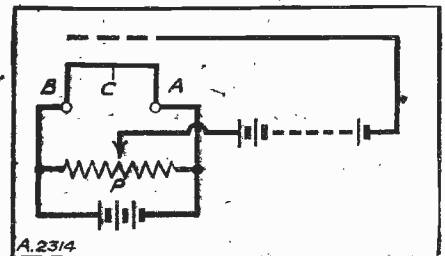

Varying the slider alters the value of grid-bias.

the extent of the bias required on the grid."

It is usual to connect the grid to the filament with an A.C. directly-heated valve, as in Fig. 1.

The difference of potential between A and grid due to the A.C. heating voltage is

$$+\frac{1}{2}V \text{ (where } V \text{ is the heating voltage)}$$

and between B and grid $+\frac{1}{2}V$. C, the mid-point, remains always at 0 difference of potential as regards filament-heating voltage.

Now if you heat by D.C. (Fig. 2), B is $+V$ different due to heating voltage A is 0 and $C = \frac{1}{2}V$. This is a charged condition, and the average is $+\frac{1}{2}V$, volts less negative.

Thus you want more negative volts in the D.C. heating.

If you like to heat with D.C., like Fig. 3, by adjusting P, you can do what you like about it all.

TELSEN SWITCHES AND DIALS

TELSEN PUSH-PULL SWITCHES

—(Prov. Pat. No. 14125/31) From 1/-

The Telsen Push-Pull Switches employ a proper electrical knife switch contact and are soundly constructed on engineering principles. The centre plunger is wedge-shaped, so that as it is pulled out it forces the inner fixed contacts outwards, tightly gripping the moving contacts. There is no fear of crackling with Telsen Push-Pull Switches. Their low self-capacity makes them suitable for use in H.F. circuits.

Telsen Push-Pull Switches—

Two-point	Price 1/-
Three-point	Price 1/3
Four-point (2 pole)	Price 1/6

TELSEN SLOW-MOTION DIAL

The Telsen Slow-motion Dial has an exceptionally smooth action with an approximate ratio of 8-1. There is no toothed gearing, so that it is impossible to strip the dial. The figures are clear and arranged to provide for right and left-hand condensers.

Telsen Slow-motion Dial Price 2/6

Supplied in Black or Brown Bakelite.

TELSEN

ALL-BRITISH
RADIO COMPONENTS

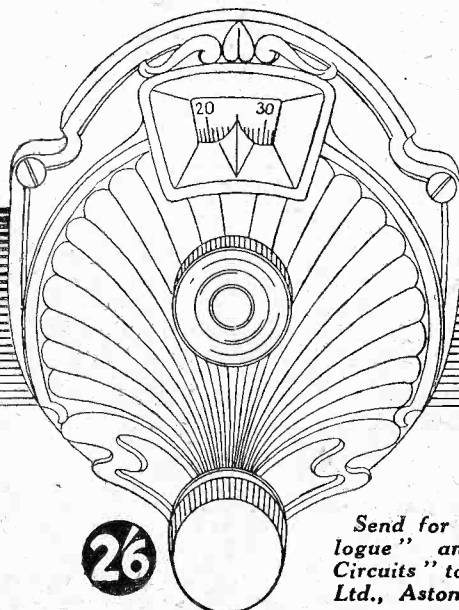

26

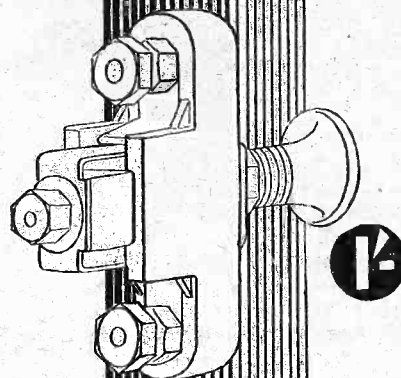

1/-

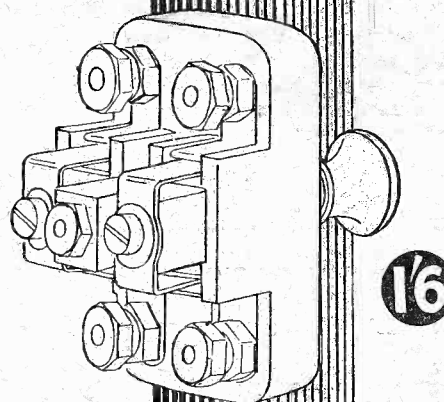

1/6

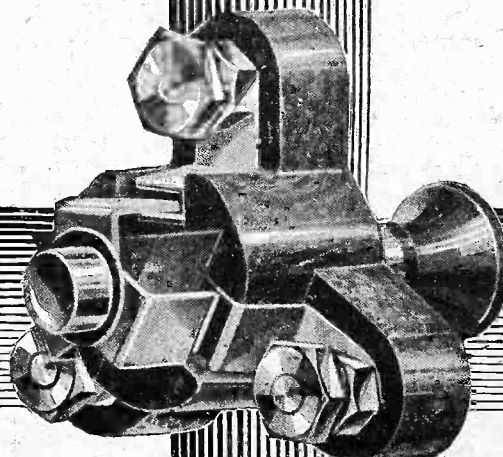

1/3

Send for the "Telsen Radio Catalogue" and book of "All-Telsen Circuits" to The Telsen Electric Co., Ltd., Aston, Birmingham.

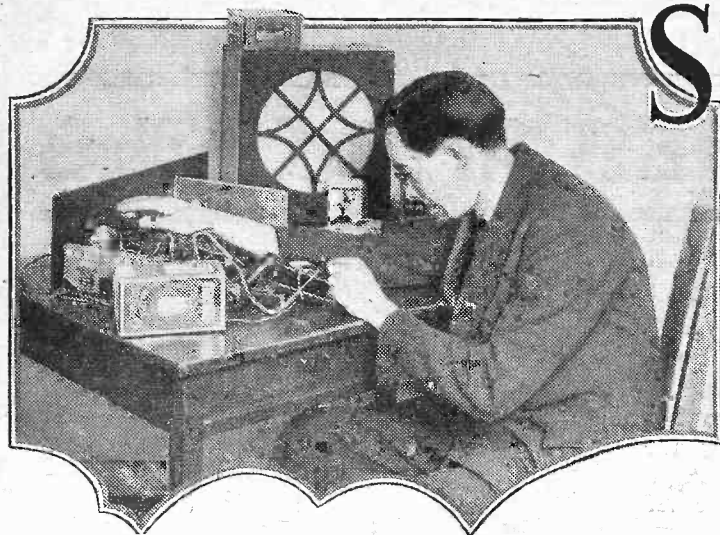

SHOCK-PROOF SETS

by
A.V.D.HORT

How to fit a safety device to your mains set and provide protection against accidental shocks.

sketches will make the details clear. The two spring plungers of the switch itself are a pair of the ever-useful contacts from the standard electric lamp holder, mounted on strips of brass, with bolts and soldering tags for the connections. Since the current taken from the mains is very small, no appreciable sparking is to be anticipated at the switch contacts, and, in fact, no noticeable burning of the contacts has taken place in spite of considerable use of the switch in the early days of the receiver, when the first adjustments were being made.

Insulated With Ebonite.

It will be observed that there is an ebonite guide piece between the two spring contacts. This serves a double purpose, to guard against accidental contact between the two poles of the switch, and to ensure that the moving portion of the switch keeps in alignment with the lower contacts. The ebonite blocks carrying the upper contacts are bolted to the operating rod, as shown.

The top of the operating rod is fitted with a brass-headed nail of the type used by upholsterers, and a brass plate is fixed underneath the lid to correspond with it. This is merely to prevent the abrasion of the wood which would otherwise occur, since the part of the lid in contact with the rod moves through the arc of a circle, while the rod itself moves up and down.

The rod moves in wooden guide blocks, and a spiral wire spring, in tension when the lid is down, raises the rod when the lid is lifted, and so opens the switch.

ALTHOUGH a certain degree of skill in the tuning of receivers is possessed by every member of the modern household, there is usually one expert who is responsible for the maintenance of the set, and for doing any repairs that may be necessary.

It may thus happen (such indeed has been the writer's experience) that when the expert is away from home, and the receiver chooses to misbehave, well-meaning efforts are made to rectify the fault, with disastrous effect on the apparatus.

A Worth While Addition.

When the receiver is run from the supply mains, inquisitive and unwary fingers are more than likely to take nasty shocks from live parts of the set, apart from any damage which may be done to expensive valves or other components. With gloomy forebodings of such occurrences in his own household, the writer of this article, in designing and constructing a mains-driven cabinet receiver, set himself the task of making the apparatus, as far as possible, fool-proof. The results have so far justified the attempt that some notes on the method of achieving this end may be of interest to those similarly situated.

The circuit of the receiver is of the simplest kind. It consists of a detector followed by one stage of L.F. amplification. The supply mains being 240 volts A.C., current is drawn from this source for heating the A.C. valves and for supplying the H.T., through a half-wave Westinghouse rectifier.

The cabinet is divided into three sections. The top compartment houses the receiver, the bottom compartment the mains unit, the loudspeaker occupying the space between the two. The loudspeaker compartment does not extend to the back of the cabinet; it has a false back, and the space between this and the back of the cabinet is left clear for the leads from mains unit to receiver.

The Safety Switch.

The top and bottom compartments have drop-down doors, the top one giving access to the controls, but not to the receiver itself. To reach the receiver the top lid must be lifted. This is normally kept locked, but in case some unauthorised person should open it, a switch is provided in such a position that as soon as the lid has been raised half an inch the mains circuit is interrupted at the points where the leads

is "dead" from an electrical point of view.

Furthermore, the bottom door, leading to the mains unit, cannot be opened from the outside. The lock is inside the top lid, which must be opened, and the circuit consequently broken, before the mains unit can be touched. The back of the cabinet, which is removable, is also fastened from the inside.

For The Expert.

An obvious objection suggests itself—namely, that you yourself, the expert, cannot attend to the needs of the receiver while it is working. This is certainly a practice to be avoided with mains-driven receivers, but there are occasions when it is essential; provided that due respect for live parts is observed, no harm need result. This is allowed for by means of a catch on the automatic switch, so that the switch can be locked in the "on" position while the lid is open.

The actual method of making the switch is simplicity itself, and the accompanying

OPENING THE LID SWITCHES OFF THE MAINS

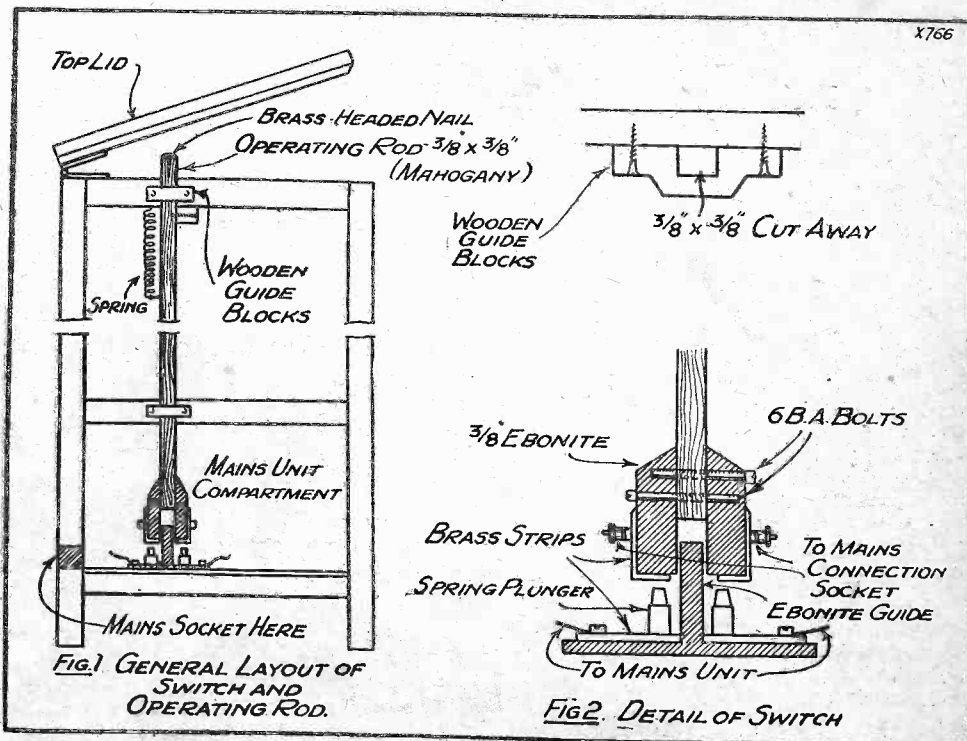

There is a special plunger type of switch which is actuated by the lid of the set, and which is

THE "P.W." DUAL-RANGER

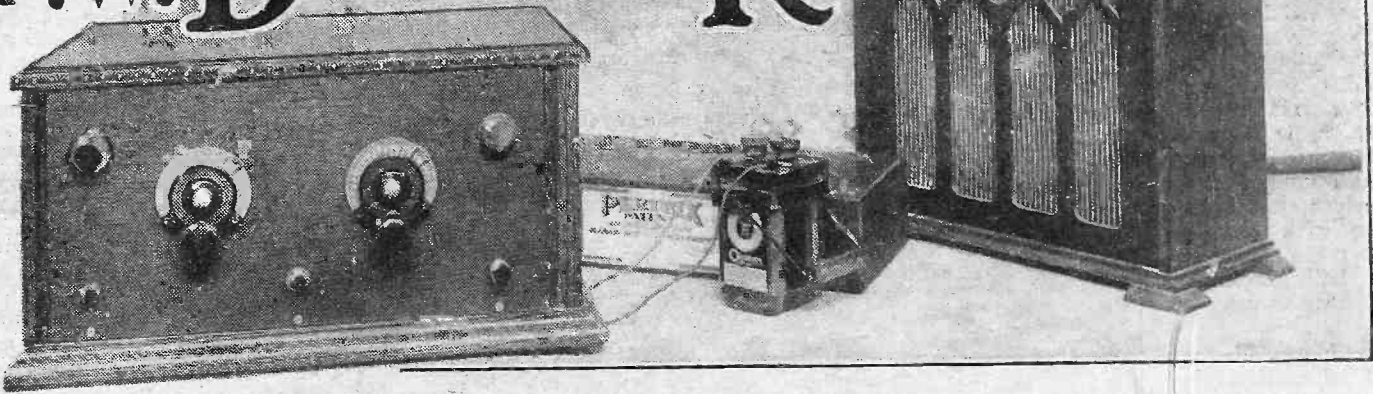

JUDGING by our correspondence, it is quite evident that there are at least a few readers who hold the opinion that the job of the "P.W." Research and Construction Dept. is to display as much ingenuity as possible in providing new variations on old themes.

And I can imagine such sceptics cynically saying to themselves, "The 'P.W.' 'Dual-Ranger!' Huh! Another slice off the same joint served up with different gravy!"

Peaks of Progress.

But they would be quite wrong. We don't go round in circles; we are moving steadily forward all the time. There may be periods during which progress is slow; and there are, likewise, times when the peaks in the calendar representing the introduction of "P.W." "star" designs tend to crowd together.

We are in the middle of an era of the latter variety at the present moment.

What of those many tens of thousands of "P.W." readers who have just built "P.W." sets of somewhat similar calibre to the "P.W." "Dual-Ranger"? Well, they have the full satisfaction of knowing that they possess "threes" which we honestly believe can hold their own against, if not beat, anything else of like nature in existence. They can hardly ask for much more than that, can they?

"Shall I Change?"

Our opinion, confirmed by exhaustive laboratory tests, is that the "Dual-Ranger" is still just a bit better, but you would have to go back eight or nine months in "P.W." set designs before the superiority of the "Dual-Ranger" became so insistently marked that you

By G. V. DOWDING,
Associate I.E.E.

Some introductory notes regarding an outstanding "P.W." set design. As you will see when you have read the following article this new set constitutes one of the most important receiver developments of the year.

Further details of it will be found in next week's "P.W." and we are giving a free blue-print of the "Dual-Ranger" with every copy of that issue.

ing S.G. "Three" set for this one. That is, you must agree, a straightforward statement of the position.

How It all Started.

On the other hand, you face certain satisfaction if you scrap a year-old receiver in favour of the "Dual-Ranger," and cannot be disappointed if you modify any three to this design.

The "Dual-Ranger" started as a brain-wave, and one for which no apologies are necessary. Perhaps you will find it of interest if I explain this in detail.

The outstanding success of the last radio season was the Kendall dual-range coil. (Two of the several firms selling commercial versions sold no less than 110,000 between them!)

This dual-range coil undoubtedly constituted the best two-band inductance system of its time, and it had an abnormally long run. But in due course, as was quite inevitable, a superior method was originated and for this our "P.V." and "P.J." coils were devised.

Using the Dual-Range Coil.

Recently it occurred to me that if the "P.V.—P.J." and Dual-Range schemes could be combined in one set, a very striking result ought to be obtained, for the qualities in the dual-range coil which have been overshadowed would be very largely augmented by the "P.V.—P.J." contribution to the whole; while those dual-range advantages which, by the way, are still entirely outstanding, would receive a further stimulus.

And in an S.G. Three where, in any case, two sets of inductances are required, the demand for economy is still adequately met. Further, the compactness and utter simplicity of the dual-range coil can be made to express themselves to the fullest possible extent.

The Test Model.

Quickly the thought was followed by the deed and a model of the proposed instrument built up. The results given were absolutely in accordance with our expectations.

THIS IS "P.W.'s" STRONGEST COMBINATION

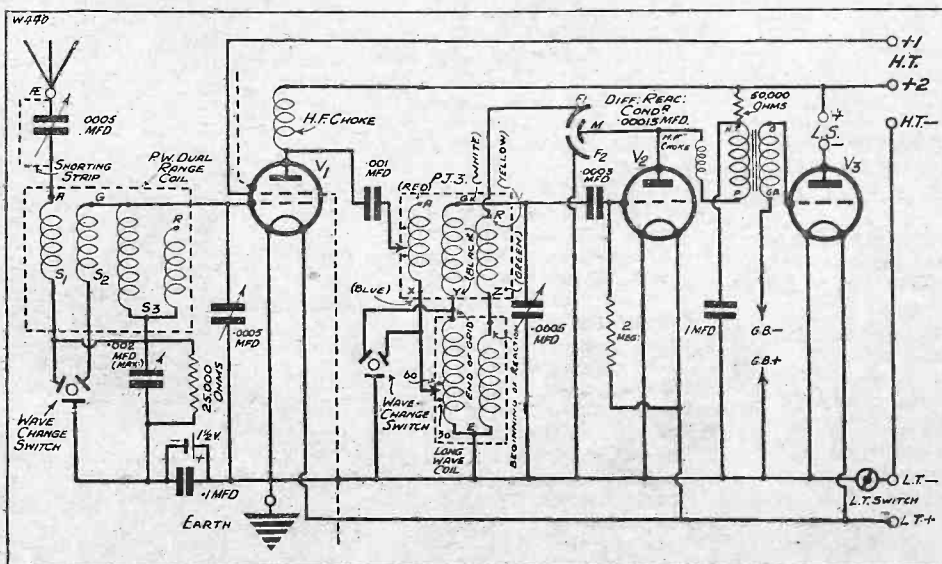

THE "P.W." "DUAL RANGER"

(Continued from previous page.)

After a slight modification here and there of the original plan, a most excellent performance was obtained.

It was found that practically perfectly bi-band balance had been achieved. But I forget, you may not guess what "bi-band balance" is intended to convey. As a matter of fact, it is a quite home-made term, and I apply it to a receiver that operates with exactly the same efficiency on both ordinary and long waves.

Bi-Band Balance.

I believe that it is quite safe to say that bi-band balance in radio receiver design was inaugurated by our "P.V.—P.J." system. Hitherto, it had not been possible completely to attain the condition without using inter-changeable coils.

The Kendall coil went a long way towards it—perhaps farther than anything else—but there were necessarily compromises.

All the requirements for first-class results on both

wave-bands are fulfilled in the "Dual Ranger."

There is virility throughout, by which I mean there is snap and life in the set at every degree of the dials and none of those lifeless patches that are so frequently encountered in sets that are not quite up to the mark as it were.

But also a condition of complete stability is present all the time, and you do not run in and out of "edgy" approaches to oscillation. The reaction control is flexible and

smooth, and the general selectivity is well above the average.

Altogether the "P.W." "Dual Ranger" tests out as a most attractive proposition, and behaves itself extraordinarily well both on distant station searching and on local station reception. Finally, it possesses the necessary high degree of selectivity to enable it to deal with modern ether conditions.

Once again we are introducing the ever-popular progressive principle. Next week we are describing the basic model and

subsequently you will be told how you can add pick-up switching and a loud-speaker output filter should you desire to install them.

The "P.W." "Dual-Ranger" will be presented with ordinary variable condensers in the first instance, and, subsequently, a model incorporating extender tuning will be detailed.

"P.W.'s" PROGRESSIVE PRINCIPLE IS APPLIED

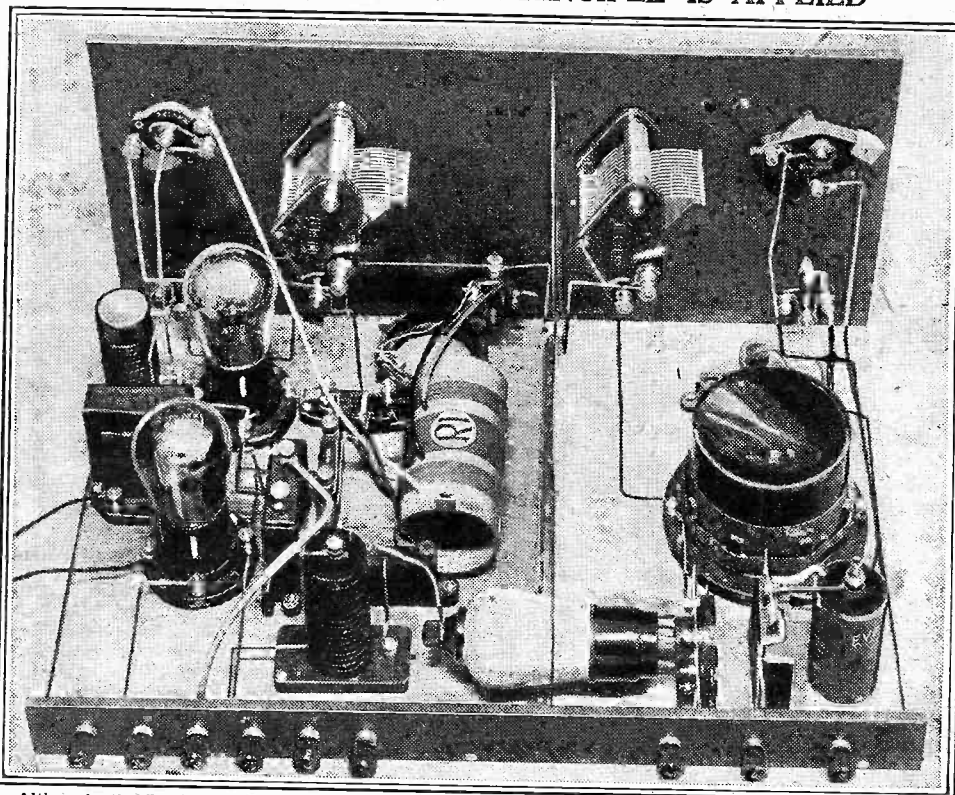

Although the Dual-Ranger is a complete, highly efficient set, as you see it in this photo, provision has been made for the addition of certain refinements for those who desire a "last word" luxury set.

The Tuning Condensers.

The dual-range coil which figures in both designs as a central component is one of the standard designs which have been on the market during the past year. If you happen to have one of these coils you can employ it with confidence, for the "Dual-Ranger" makes better use of it than any previous "hook-up."

THE COMPONENTS WE HAVE USED IN THE "DUAL-RANGER"

- 1 Panel, 16 in. × 8 in. (Wearite, Permeol, Goltone, Peto-Scott, Becol).
- 1 Cabinet to fit, baseboard 10 in. deep (Cameo, Peto-Scott, Osborn, Gilbert, Pickett).
- 2 .0005-mfd. condensers (Telsen, Polar, J.B., Cylden, Wavemaster, Astra, Formo). If above have plain dials, the following will be required:
 - 2 Slow-motion dials (Lotus, Telsen).
 - 1 .0005-mfd. solid dielectric condenser (Ready Radio, Telsen, Parax, Lotus).
 - 2 3-point wave-change switches (Ready Radio, Telsen, Lissen, Wearite, Goltone).
- 1 On-off switch (Lissen, Telsen, Ready Radio, Igranic, Graham Farish, Lotus, Goltone, Wearite).
- 1 .0001-mfd. differential reaction condenser (Telsen, Lotus, Ready Radio, Polar, Cylden, Graham Farish, Wavemaster, J.B.).
- 1 "P.W." Dual-Range Coil.
- 1 .002-mfd. max. compression condenser (Goltone, Formo, Sovereign, Telsen, Graham Farish, Colvern).
- 1 .1-mfd. fixed condenser (Igranic, T.C.C., Dubilier, Formo, Telsen, Mullard, Helsby, Ferranti, Ediswan, Hydra, Graham Farish).
- 1 .0003-mfd. fixed condenser (Ferranti, etc.).
- 1 .001-mfd. fixed condenser (T.C.C., as above).
- 1 1-mfd. fixed condenser (T.C.C., as above).
- 1 P.J.3 coil (R.I., Formo, Goltone, Parax,

- Melbourne, Wearite, Peto-Scott, Ready Radio).
- 1 Coil quoit (Peto-Scott, Sovereign, Ready Radio, A.E.D., Wearite).
- 2 oz. 30 D.S.C. wire for above.
- 1 Screen 10 in. × 7 in. (Parex, Peto-Scott, Wearite, Ready Radio).
- 1 2-meg. leak and holder (Graham Farish, Ferranti, Lissen, Dubilier, Mullard, Igranic, Telsen, Watmel, Varley, Loewe).
- 2 H.F. chokes (Lewcos and Varley, Telsen, Ready Radio, Lotus, Parax, Sovereign, Wearite, R.I., Peto-Scott, Graham Farish, Atlas).
- 1 L.F. transformer, medium ratio (Lotus, Telsen, Ferranti, R.I., Varley, Igranic, Lissen, Graham Farish).
- 1 50,000-ohm spaghetti resistance (Bulgin, Telsen, Ready Radio, Varley, Sovereign, Lissen, Igranic, Goltone, Lewcos, Peto-Scott, Graham Farish).
- 1 25,000-ohm spaghetti (Bulgin, as above).
- 2 Valveholders (Graham Farish, Lotus, W.B., Telsen, Igranic, Lissen, Clix, Wearite, Dario, Formo, Bulgin).
- 1 Do., horizontal mounting (W.B., Parex).
- 1 Terminal strip, 16 in. × 1½ in.
- 9 Indicating terminals (Belling & Lee type R, Igranic, Goltone, Clix, EeJex).
- Glazite, Lacoline, Quickwire, Jifflix, Flex, screws, etc.

- Battery Plugs (Belling & Lee, etc.).
- 1 Crocodile clip (Bulgin, Goltone).

ACCESSORIES.

LOUDSPEAKERS.—Celestion, Graham Farish, Mullard, Blue Spot, B.T.-H., Amplion, Undy.

VALVES.—1 S.G. valve (Cossor metallised S.G., Osram, Mazda, Eta, Tungram, Mullard, Six-Sixty, Dario).

1 detector valve (Osram H.L.2, Mazda, Mullard, Cossor, Tungram, Six-Sixty, Eta, Lissen, Fotos, Dario).

1 small power valve (Mazda, etc.).

(Milliamp consumption at 120 volts max. 16 milliamps).

BATTERIES.—H.T. 1, 120-150-volt super-capacity (Pertrix, Ever Ready, Drydex, Columbia, Magnet, Ediswan, Lissen).

1 1.5 or .9-volt G.B. battery for S.G. valve (Ever Ready, etc.).

1 9-15-volt G.B. battery to suit output valve (Ever Ready, etc.).

ACCUMULATOR.—Two-, four- or six-volt, to suit valve.

(Exide, Ediswan, Lissen, Pertrix, G.E.C.).

MAINS UNITS.—Heayberd, Tannoy, Regentone, Lotus, Ekco, Atlas, R.I. (State voltage and type of mains, and give details of set when ordering).

THE "P.W." DUAL-RANGER

£3-19-9 or 12 equal monthly payments of - 7/6

"P.W." DUAL-RANGER

	£	s.	d.
1 Panel 16 X 8 X 1/8 in., drilled to specification	5	5	6
1 Waldor cabinet, 16 X 8 X 10 in., with base-board	17	6	
2 Wavemaster .0005 mfd. slow-motion condensers	11	0	
1 ReadiRad .0005 mfd. solid-dielectric condenser	3	6	
2 Three-point wave-change switches	3	0	
1 On-off switch		10	
1 ReadiRad .0005 differential condenser	2	6	
1 Kendall dual-range coil	10	6	
1 T.C.C. .1 mfd. fixed condenser, type 50	1	10	
1 T.C.C. .0003 mfd. fixed condenser, type "S"	1	3	
1 T.C.C. .001 mfd. fixed condenser, type "S"	1	6	
1 T.C.C. .1 mfd. fixed condenser, type 50	2	10	
1 Sovereign pre-set condenser, type "H"	1	6	
1 P.J.3 coil	2	6	
1 Ready-wound coil quott	2	6	
1 Screen, 10 X 7 in.	2	0	
1 ReadiRad 2-meg. leak and holder	1	4	
1 Lewcos H.F. choke, type M.C.	2	6	
1 ReadiRad H.F. choke for S.G. circuit	4	6	
1 Lotus L.F. transformer, No. 1	5	6	
1 Lewcos 50,000-ohm Spaghetti resistance	1	6	
1 Lewcos 25,000-ohm Spaghetti resistance	1	6	
2 Junit valve holders	1	4	
1 Junit horizontal valve holder	1	9	
1 Terminal strip, 16 X 2 in.	1	4	
9 Belling-Lee terminals, type "R"	2	3	
1 Packet Jiffilux for wiring	2	6	
1 Siemens 1 1/2 v. S.G. cell, type G.T.		9	
3 Valves. Cossor Metal Coated S.G.215, Mullard P.M.1H.L. and P.M.2	1	19	0
Flex, screws, 1 crocodile clip, etc.			3
	£6	16	3

If you do not need the complete kit of parts, you can purchase any component you require separately.

Recommended Accessories

	£	s.	d.
1 Pertrix 120 v. Standard H.T. battery	15	5	6
1 Pertrix 9 v. grid bias battery	1	6	
1 Pertrix accumulator, type P.X.C.3	11	0	
1 Blue Spot speaker, type 44R.	2	12	6

Any other makes can be supplied if required.

Kit "A" (less Valves and Cabinet) **£3.19.9**
or 12 monthly instalments of 7/6

Kit "B" (with Valves less Cabinet) **£5.18.9**
or 12 monthly instalments of 11/-

Kit "C" (with Valves and Cabinet) **£6.16.3**
or 12 monthly instalments of 12/6

**COMPLETELY ASSEMBLED
DUAL-RANGER
£8.6.8**

With Cabinet and Valves, Aerial Tested,
Royalties paid.

Or 12 monthly payments of 15/3

TO INLAND CUSTOMERS—Your goods are despatched Post Free or Carriage Paid.

TO OVERSEAS CUSTOMERS—Everything Radio can be supplied against cash. In case of doubt regarding the value of your order, a deposit of one-third of the approximate value will be accepted and the balance collected by our Agent upon the delivery of the goods. All goods are very carefully packed for export and insured. All charges forward.

**Buy all
your radio from
Ready Radio Ltd**

159, BOROUGH HIGH STREET,
LONDON BRIDGE S.E.1

Telephone No. 3000 (Private Exchange)
Telegrams: Readirad, Sedist.

ORDER FORM To READY RADIO, LTD.
Eastnor House, Blackheath, S.E.3.

CASH ORDER. Please despatch to me at once the goods specified for which I enclose payment in full of	C.O.D. ORDER. Please despatch to me at once goods specified for which I will pay in full the sum of	EASY PAYMENT ORDER. Please despatch my Easy Payment Order for the goods specified for which I enclose first deposit of
--	---	--

£ £ £

Name

Address

Kits Required

P.W.17/10/31

SHORT-WAVE SIGNPOSTS

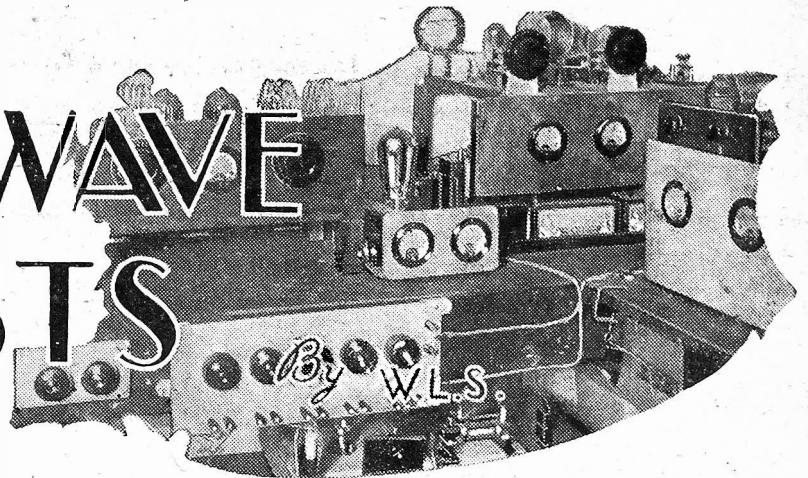

Following on a recent article in "P.W." concerning the construction of wave-meters for short-wavers, our popular contributor W. L. S. tells you how he tackles such a proposition.

ALL my readers who are recent converts to the short-wave field will agree with me that the "lost" sensation that prevails for the first week or so is very disconcerting. The feelings of a main-road motorist who suddenly takes to the lanes and by-ways are as nothing compared with the sense of desolation that pervades one!

For this reason—and, more important, for the reason that the sensation is renewed when one builds a new receiver—I wish to discourse for a little on wave-meters.

There are two very simple ways of making a short-wave wave-meter that is reliable enough for the "ordinary listener." One is simply to tune in all the stations you can, wait patiently until they announce, look up their wave-lengths in a list, and calibrate from them an absorption wave-meter.

An Absorption Wave-meter.

The latter instrument consists of a good variable condenser of about .0001 capacity and three coils. If you make one of three turns, one of six and one of ten, all of about 2½ in. diameter, you will cover the whole useful range of short waves.

As you log a station that can be identified, simply place the wave-meter near enough to the set to give the familiar "plop" as you run through the tuning position.

When you have found enough stations you can get busy with a piece of squared paper, and you will probably find it an easy matter to draw three nice curves.

A far better way, however, is to build a heterodyne wave-meter. The constructional details of my own have already been promised, and will duly be written up when I have finished making alterations and improvements to it. The latter, be it said, consist chiefly of making it smaller day by day, until it now resembles a *very* small biscuit tin in external appearance!

A Better Arrangement.

A heterodyne wave-meter, however, is a piece of apparatus that everyone can make without external assistance, since it consists merely of an oscillating valve. No more, and no less, than our old friend in the receiver that brings in all our goals.

The chief advantage of it is that one coil will suffice for *all* ranges, owing to the fact that harmonics are generated sufficiently well by the average oscillator to cover all the short-wave bands. Thus a coil giving a range of 60–120 metres is almost ideal. The harmonics will give us the other ranges

there is little or no difficulty occasioned by "picking the wrong harmonic."

We will imagine that you have your little oscillating detector in a box with a good slow-motion dial on the variable condenser. The H.T. should be cut down as low as it is possible to go, with the valve still oscillating over the whole tuning range.

Now, on your short-wave receiver, find one of the following stations:

Calibrating the Instrument.

Rome, on 25.4 metres, should be easy to identify because of the presence of G 5 S W immediately above him, heterodyning his "top edge." Late in the evening W 2 X A D on 19.56 metres is an easy mark. In the small hours of the morning W 2 X A F takes his place, the latter station's wave being 31.48 metres. After 8 p.m. you cannot fail to find the Moscow 100-kilowatt station on 50 metres dead. If you choose a Sunday or a Thursday you will find identification certain because the broadcasts on those days are in English.

This is where one has to be fairly careful. If the coil has been chosen to give a *rough* range of 60–120 metres (and if you make it

about the same size as the coil used for this range in your receiver, you should be all right), then you will have to set it to 100 metres to produce a "chirp" with Moscow. Leave Moscow tuned-in on your set until you find the "chirp" from the wave-meter.

Then leave the wave-meter severely alone and put your set down to Rome on 25 metres. Here you should find two chirps from the wave-meter. One will be the third harmonic on 75 metres, and one the fourth on 100 metres, which should be within a degree or so of the "Moscow" setting.

Obviously the latter is the one you want, so disregard the 75-metre one, except for noting roughly its dial reading.

Now find W 2 X A D on 19.56. Here you will find three chirps at least. You will have the third harmonic, perhaps, just below 60 metres, the fourth just below 80, and the fifth just below 100! But you know from the previous experiment where 75 metres came, so that you can identify the 80-metre chirp on W 2 X A D and add another tuning point. The 100-metre position, too, can be confirmed.

If your patience is still intact, find W 2 X A F on 31.48 and carry on. The

chirp you will find just below your 100-metre mark will obviously be the third harmonic on 95 metres odd, and the other one that should come near the bottom of the dial will be in the region of 63 metres, being the second harmonic.

Make a "Curve."

Here you may well call a halt, for you will have six or seven reliable spots marked on your dial, and will be able to draw a curve that gives quite a good degree of accuracy. This will mean, mark you, that you need never lose your way again, unless you are unfortunate enough to displace the harmonics one day when you have built a new receiver!

The confusion between them need seldom arise, however, on account of the number of stations that, even if they cannot be iden-

AN EASY-TO-MAKE WAVE-METER

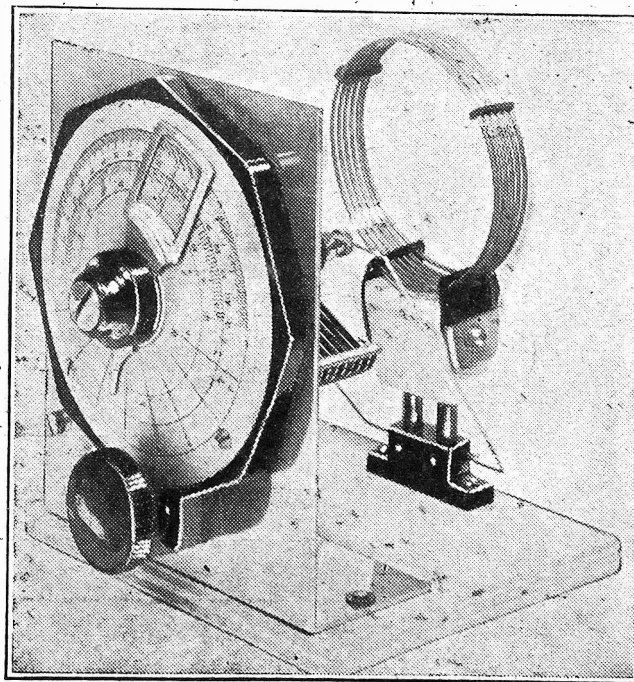

TELSEN CONDENSERS

TELSEN MANSBRIDGE TYPE CONDENSERS

Telsen have installed the most advanced plant in the world for the manufacture of Mansbridge Type Condensers. Only genuine Mansbridge foil paper and the finest linen tissue are employed in the exclusive method of manufacture. Every Telsen Mansbridge Type Condenser is hermetically sealed from the atmosphere and Post Office standards of insulation are adopted throughout. The preliminary research, the most modern plant in the world, the finest raw materials, the latest methods of manufacture and the final test, all combine to give Telsen Mansbridge Type Condensers a high insulation through years of service with freedom from breakdown. The type of construction employed makes them genuinely non-inductive.

The following values are guaranteed within 5 per cent :—

Cap. mfd.	500 Volt Test Price	1,000 Volt Test Price
.01	1/6	2/6
.04	1/9	2/9
.1	1/9	2/9
.25	2/-	3/-
.5	2/3	3/3
1.0	2/3	3/6
2.0	3/-	5/-

TELSEN FIXED MICA CONDENSERS

(Prov. Pat. No. 20287/30)

Telsen Fixed Mica Condensers are made in capacities from .0001-microfarad to .002-microfarad. They can be mounted upright or flat and the .0003-microfarad Telsen fixed mica condenser is supplied complete with patent grid leak clips to facilitate series or parallel connections.

Telsen Fixed Mica Condensers Price **6d.**

TELSEN

THE SECRET OF PERFECT
RADIO RECEPTION

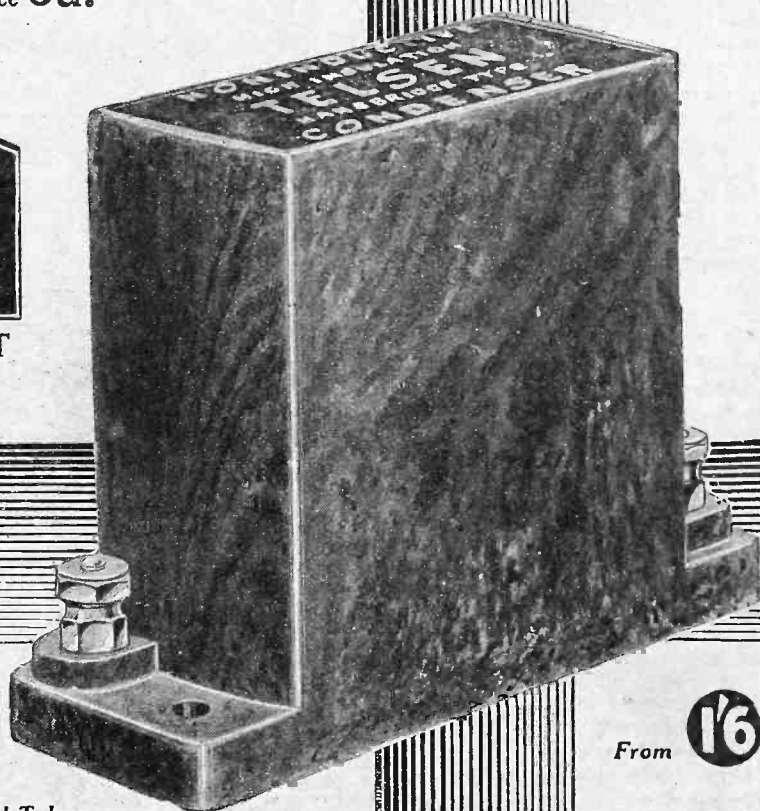
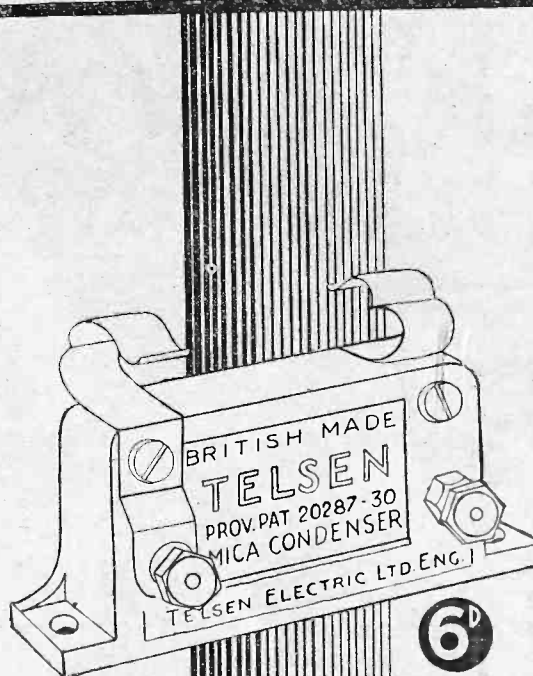

From **16**

NOTES FROM THE NORTH

With the details given by Mr. Edward Liveing, the North Regional Director, of his plans for this winter to hand, one is led to wonder whether the Regional staff in the North is large enough adequately to handle the studio work imposed upon them. This and other vital matters concerning the North are reviewed on this page.

By OUR SPECIAL CORRESPONDENT.

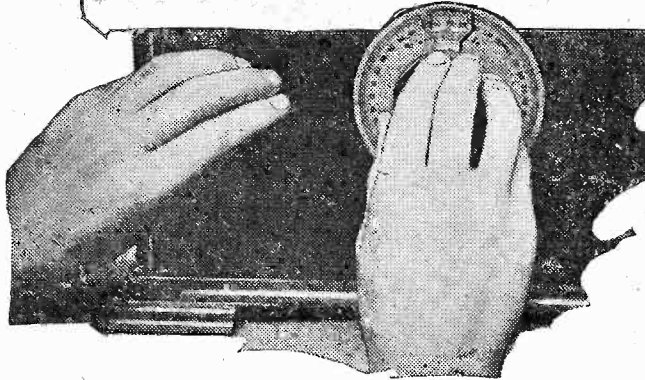

SINCE my last bulletin from the North appeared in POPULAR WIRELESS Mr. Edward Liveing, the North Regional Director, has given a very remarkable account to Northern listeners of the plans he and his staff have made for programmes this winter. Mr. Liveing's talk is one of the most encouraging things that has happened in British broadcasting during 1931.

Some Promised Programmes.

Here, briefly summarised, is the promise made by the North Regional director:

Orchestral.—Hallé Orchestra, ten concerts; Liverpool Philharmonic, eight concerts; Leeds Symphony, four concerts.

Choral.—Concerts by famous Northern choirs, including North Staffordshire Choral Society, Sheffield Musical Union, Leeds Choral Union, Leeds Philharmonic Society, Huddersfield Choral Society, and Huddersfield Glee and Madrigal Society.

Chamber Music.—Some of the Rodewald Concert Society's concerts will be relayed from Liverpool.

Radio Drama.—Productions to include a war play, "Red Night" (J. L. Hodson), "The Pageant of York" (L. du Garde Peach), and "Hobson's Choice" (Harold Brighouse) from Manchester. Also a play by the noted Yorkshire author, J. R. Gregson, from Leeds studio; and "The War of the Great Ditch," a play about the Roman wall, from Newcastle.

Theatrical Relays.—Excerpts of revues, pantomimes, and musical comedies will be relayed from Northern theatres.

Miscellaneous Concerts.—Thirty relays of the Manchester Tuesday Midday Concerts; twenty-eight midday concerts from Bradford; and five from Leeds University, by artists of both local and national repute.

"This material," said Mr. Liveing, "definitely places what is a regional service of the B.B.C. on a level with many of the national services on the Continent." That is a just claim. The North Regional station is showing what can be done in the way of alternative programmes when one programme comes from London and the other receives inspiration and material from a source outside London.

What of Scotland?

Of course, the material has to be in the region to start with, and I am wondering whether Mr. Cleghorn Thomson, at Edin-

burgh, will find as much good broadcasting material in Scotland when the Scottish Regional transmitter is in action next year. An interesting item of news from Edinburgh is that the Scottish Studio Orchestra is now under the direction of a young violinist from London, Guy Daines, who has succeeded Isaac Losowsky.

Mr. Liveing has consistently held that there is abundant material awaiting B.B.C. exploitation in the North of England. Now he is proving that contention up to the hilt, so far as programmes from outside sources are concerned. But what about studio programmes?

tion is that the studio orchestras at Manchester and Birmingham should be amalgamated to form a regional orchestra of eighteen players.

Vaudeville from Northern studios is not yet satisfactory, and the plays have been curiously patchy—sometimes an excellent production and other times an under-rehearsed and insufficiently polished presentation. Is the Regional staff big enough to give proper time and attention to studio programmes and at the same time to organise all these "O.B.'s"?

B.B.C. Economies.

I understand from the B.B.C. that the statement about the slowing-up of schemes of development, such as the new high power transmitter for Daventry 5 X X and the new studios for Leeds, is without

AN "ECHO" OF THE RADIO EXHIBITION!

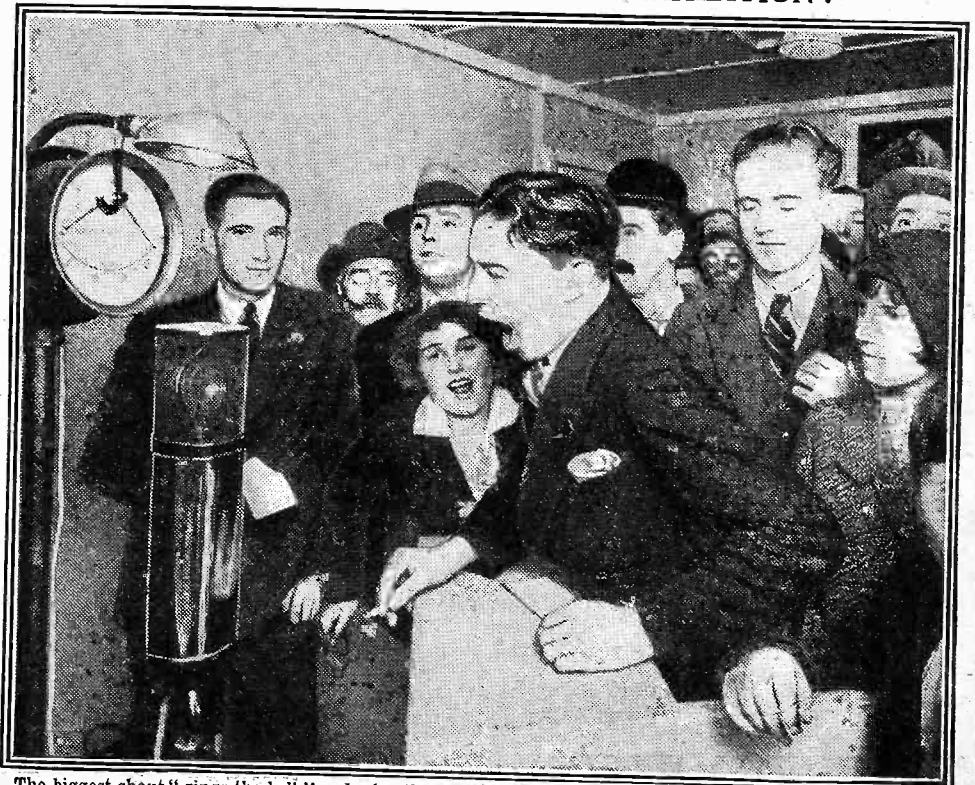

The biggest shout "rings the bell" and wins the prize. A scene at the "His Master's Voice" Modern Hall of Music during the recent radio show.

A Suggestion.

Apart from plays and the three talks which are to be given per week, Mr. Liveing did not mention studio programmes in his talk. Perhaps the less the B.B.C. says about its provincial studio orchestras the better.

The anæmic tone of an "orchestra" of nine cannot satisfy listeners who formerly enjoyed the Northern Wireless Orchestra, and who inevitably make comparisons with the B.B.C. Theatre Orchestra and other London orchestras. An interesting sugges-

foundation. The decision to forgo £200,000 revenue in two years indicates economies in the B.B.C., but I am told that other means will be found.

"Work will be started at Leeds as soon as practicable," states the B.B.C. "Structural alterations are necessary, and in view of the pressure of work at Broadcasting House we are unable to make an immediate start. We cannot yet say when it will be possible to move into the new building at Leeds, but there is no prospect of a change of premises this year."

TELSEN LOUD-SPEAKERS

TELSEN LOUD-SPEAKER UNIT

The Telsen Loud-speaker Unit is pleasing to the most sensitive ear. The deep notes of the bass, the brilliance of the soprano, and the crispness of diction are clearly reproduced without any distortion. It employs cobalt steel magnets, and the detachable rod which carries the cone is fitted with cone washers and clutch. The entire unit is enclosed in a beautifully moulded bakelite dust cover.

Telsen Loud-speaker Unit Price **5/6**

TELSEN LOUD-SPEAKER CHASSIS

The fully floating cone mounted on a flexible felt surround renders the Telsen Loud-speaker Chassis very sensitive, giving perfect balance of tone. It is unaffected by damp conditions because the cone material is practically non-hygroscopic. The Telsen Loud-speaker Chassis is substantially made and it is light in weight. Holes are provided for easy attachment to most of the popular makes of loud-speaker units. The Chassis may be readily fixed to a baffle board or cabinet by three or more wood screws.

Telsen "Popular" Loud-speaker Chassis (Diam. 11") Price **5/6**

Telsen "Major" Loud-speaker Chassis (Diam. 14½") Price **10/6**

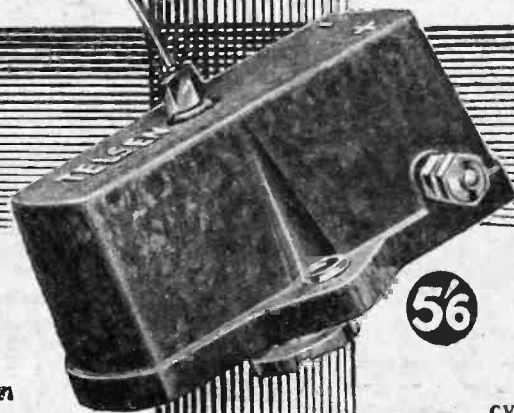
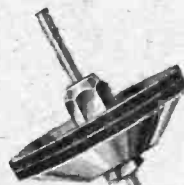
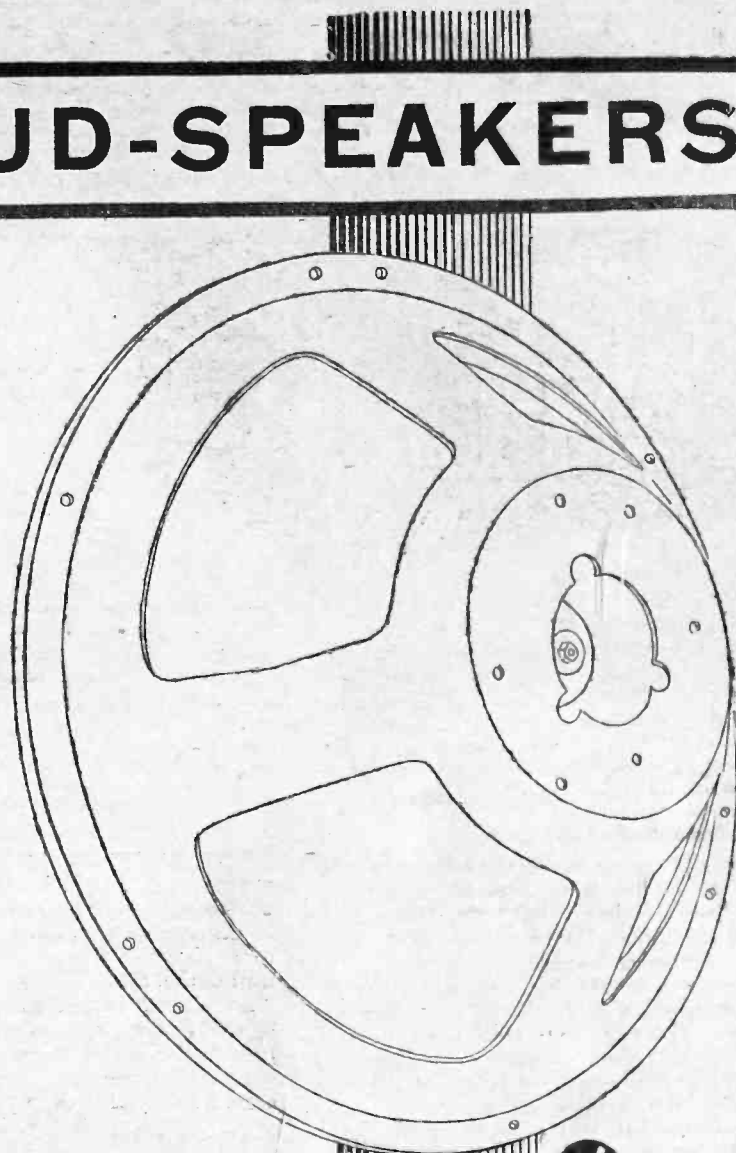

TELSEN

ALL-BRITISH
RADIO COMPONENTS



The coil used in the P.W. DUAL RANGER was designed by G. P. KENDALL, B.Sc.

CHIEF ENGINEER, READY RADIO.

Read what "Popular Wireless" writes:—

"The outstanding success of the last radio season was the Kendall Dual Range Coil."

"This Dual Range Coil undoubtedly constituted the best two-band inductance system of its time."

See pages 361 and 362 of this issue.

Be sure your coil is a genuine Kendall Dual Range Coil, obtainable only from Ready Radio. Price only

10'6

Kendall Dual Range Coils given an actual broadcast before despatch under the supervision of the designer, G. P. Kendall, Chief Engineer, Ready Radio.

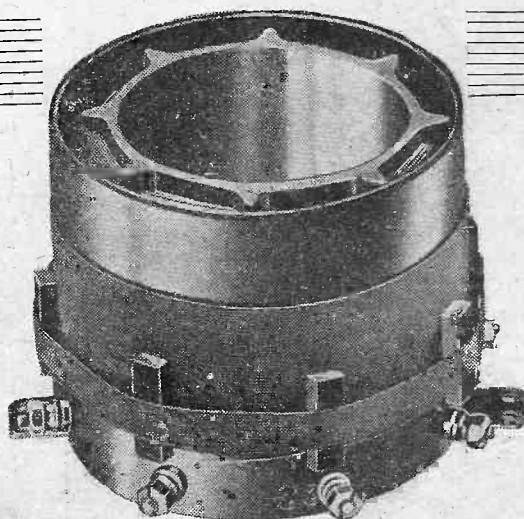

If you require a Kendall Dual Range Coil only, use Order Form below. If you require a complete "P.W." Dual Range Kit, turn to page 363



Ready Radio

SHOWROOMS:
159, BOROUGHS HIGH STREET,
LONDON BRIDGE; S. E. 1.

EASTNOR HOUSE
BLACKHEATH S.E.3
Telephone: Lee Green 5678
Telegrams: "Ready and Radio"

To READY RADIO, Ltd., Eastnor House, Blackheath, S.E.3.

Please send me, post free, one Kendall Dual Range Coil, for which I enclose 10'6.

NAME.....

ADDRESS.....

P.W. 17/10/31.

WHAT I SAW AT MANCHESTER

(Continued from page 368.)

permitting—your eyes rest next on the gaily-decorated stand constituting the exhibit of the Pertrix people.

Then who could fail at first glance to notice the wonderful exhibit of Messrs. Cossor away on the right?

Almost mechanically one makes one's way to the Cossor stand, for it is a particularly original effort which attracts your attention the moment you enter the hall.

Some Outstanding Exhibits.

Huge cut-out letters of the name Cossor support the counters on which are to be seen their well-known kit-sets and, of course, a full range of valves.

Just across the gangway another firm well-up in the valve world are exhibiting their valves and also their kit-sets on a futurist-looking stand which is decorated in such a variety of beautiful colours that I should require almost the rest of my space to describe them!

I refer to the Mullard exhibit, and here again the counters are supported in a very ingenious way by huge models of Mullard valves.

Incidentally, I heard from one of the Mullard people that their kaleidoscopic sign up in the gallery is the only one of its kind in the world, and it is an all-British invention.

the trade mark to be seen on all the Oldham batteries.

The Ediswan people, whose stand is close by, have got a novel scheme whereby when you press a button you can read from meters the various characteristics of one of their valves.

If the crowd around this part of the show was anything to go by, that valve should be very thoroughly tested by the time the "show" is over!

There's no mistaking in which direction you should go next, even if you don't overhear, as I did, a Mancunian remark of "Ba gum, looks like an Eastern Potentate's Palace!"

Such is the Ferranti stand, and that is just about what it does look like—blue, red and gold pillars, domes and suchlike, and I take off my hat to the Ferranti people for originality of design.

It really is a very creditable effort, and if you are able to go to the show there is not much fear of your failing to agree with my verdict.

The exhibits of two other firms well-known in the radio world are almost "next door" to the "Potentate's Palace."

First we come to R.L. Ltd., with a range of Stenode receivers on an "island" in the centre of their stand, with, all round, a representative selection of their various components which we know so well.

Then there is Igranic, on whose stand, among a full range of components, is to be seen one of their big public address amplifiers.

Brilliant Colour and Decoration.

An attractive exhibit of particular

I think I can honestly say that I have never been to any exhibition so brilliantly coloured and so gaily decorated as this present Northern National Exhibition. And it just makes all the difference to what might otherwise tend to become a monotonous assembly.

But there is certainly nothing monotonous about this show. No two stands are alike in arrangement or colour scheme—pleasing contrast everywhere.

Big Enough to Work In!

No sooner do you turn your attention from the modernistic Ekco exhibit than you come to the Siemens' stand with its old-world atmosphere obtained by an oak-panelling effect and electric candle illuminations.

And as for the giant models, why, on one stand—that of the Westinghouse Company—almost the whole stand is built up to look like one of their metal rectifiers!

Next Week!

In view of the serious wave-length situation in Europe, and the Conference in Rome, "P.W." is particularly pleased to announce a

A SPECIAL ARTICLE

from the pen of Mr. Noel Ashbridge,

CHIEF ENGINEER

of the B.B.C.

EXCLUSIVE! AUTHORITATIVE!

In next week's "P.W."

Order Now. Usual Price.

A RADIO APPEAL FROM KANSAS CITY

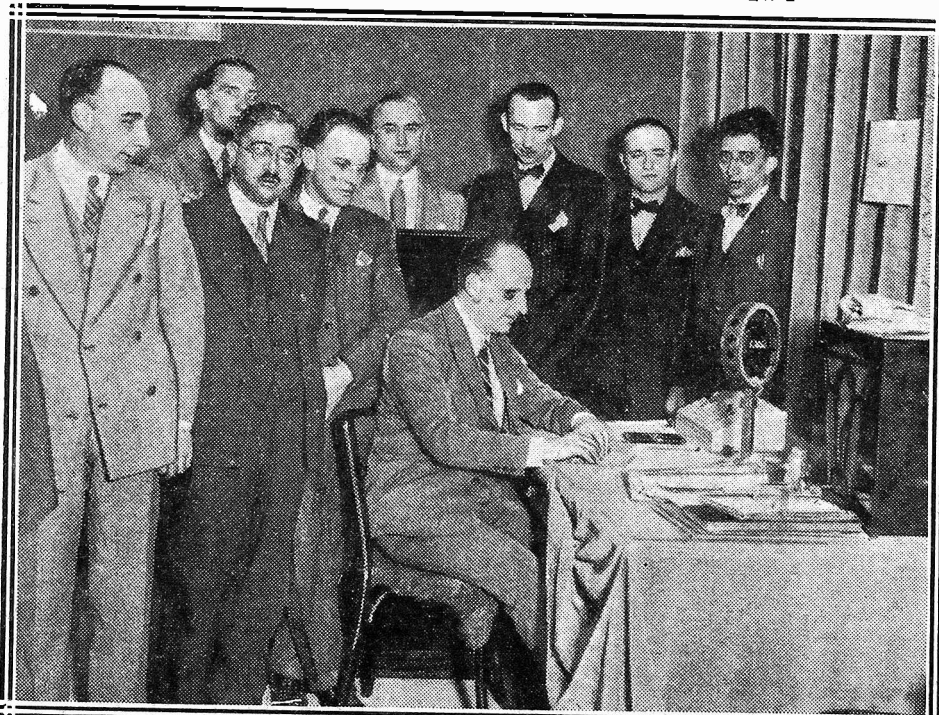

Capt. Georges Scapini, the blind head of the French War Veteran's Society, broadcasting an appeal from the Colonial Exhibition at Kansas City.

In this same gangway, a little bit farther down, is to be seen an original Oldham exhibit in the form of a large weather-gauge.

You no doubt know the kind I mean—a sort of double-fronted house out of which pops either the unwelcome old man or the fair maiden. Only in this case the figures are represented by the "Telsens".

interest to the home-constructor is to be seen on the Telsen stand.

Here, in addition to huge models of almost all the components they make, as well as, of course, samples of the same things normal size, there are several interesting sets made up from Telsen blueprints, which

That is certainly one of the biggest models in the whole show, and to give you some idea of its size the inside of it is in use as an office!

Then there are such notable firms as Lotus, Varley, Colvern, G.E.C., Formo, Ward & Goldstone, Exide, and dozens of others, each with their own particular colour schemes and original ideas for bringing forward the merits of their lines.

I never before realised that radio was so closely allied with art!

What has particularly impressed me about this first Northern Exhibition under the National status is that much more attention has been given this year to the exhibition of components and things of general interest to the home-constructor.

The show contains as much of interest to the home-constructor as to the man who wishes to purchase anything from the cheapest commercial set to the most expensive radio-gram.

At the time of writing, I may be inclined to have my doubts about the accuracy of the first weather-criticism in this article, for it happens to be raining!

But I have no doubts whatever about the worth-whileness of a visit to the Manchester Exhibition.

It really is a good show, and if you can manage a visit, even if you have to come a hundred or two hundred miles, take my tip and come—you won't go away dis-

Ready Radio

TESTED KITS

B.P. 3

THE NEW "B.P." 3

	£ s. d.
1 Ebonite Panel, 18 in. X 7 in., drilled to specification	5 6
1 "WARDOR" Cabinet to specification, with 10-in. baseboard	1 5 0
1 Lewcos Band Pass Coil	12 0
1 Lotus '0005 Double Gang Condenser with Disc Drive	1 5 0
1 ReadiRad '00075 Brookmans Condenser	3 6
1 A.E.D. Volume Control 500,000 ohms	8 6
1 ReadiRad on-off Switch	0 10
3 Junit Valve Holders	2 0
1 R.I. General Purpose L.F. Transformer, ratio 7-1	10 6
1 ReadiRad Standard H.F. Choke	4 6
1 R.I. General Purpose L.F. Choke	12 6
1 T.C.C. '0003 Fixed Condenser, type 34	1 6
2 T.C.C. '01 Fixed Condensers flat, "S" type (non-inductive)	5 0
2 T.C.C. 2-mfd. Fixed Condensers, type 50	7 8
1 ReadiRad 2-meg. Grid Leak and Holder	1 4
1 Lewcos 100,000-ohm Spaghetti Resistance	1 6
1 25,000-ohm Spaghetti Resistance	1 6
1 ReadiRad H.T. Fuse and Holder	1 3
1 ReadiRad Radiogram Snap Switch	2 9
1 Terminal Strip, 18 in. X 2 in., drilled to specification	1 6
11 Belling-Lee Indication Terminals, type "B"	5 6
1 Packet Jiffilinx for wiring	2 6
7 Belling-Lee Wander Plugs	1 2
2 Belling-Lee Spade Terminals	0 4
3 Mullard Valves to specification, PM2DX, PM1LF, PM2	1 7 6
Screws, Flex, etc.	0 8

TOTAL (including Valves and Cabinet) £8 11 6

If you do not need the complete kit of parts, you can purchase any component you require separately.

Kit A (Less valves and cabinet) £5-19-0

or 12 equal monthly instalments of **11 - 0**

Kit B (With valves less cabinet) £7- 6-6

or 12 equal monthly instalments of **13 - 6**

Kit C (With valves and cabinet) £8-11-6

or 12 equal monthly instalments of **15 - 9**

BATTERY EQUIPMENT

1 "B.P." Three, Kit "C"	£8 11 6
1 Pertrix 120 v. Standard H.T. Battery	15 6
1 Pertrix 9 v. Grid Bias Battery	1 6
1 Pertrix Accumulator P.X.C.3	11 0
1 British Blue Spot Speaker, type 45R	2 12 6

COMPLETE KIT £12 12 0

Or 12 monthly instalments of **1 3 6**

COMPLETELY ASSEMBLED RECEIVER, aerial tested and Royalties paid with all accessories for battery operation

£14 2 0

Or 12 monthly instalments of **1 6 0**

A.C. MAINS EQUIPMENT

1 New "B.P." Three, Kit "C"	£8 11 6
1 ReadiRad H.T. Unit and Trickle Charger	5 17 6
1 Pertrix 9 v. Grid Bias Battery	1 6
1 Pertrix Accumulator, type P.X.C.3	11 0
1 British Blue Spot Speaker, Model 100.D	3 3 0

COMPLETE KIT £18 4 6

Or 12 monthly instalments of **1 15 6**

COMPLETELY ASSEMBLED "B.P." THREE RECEIVER, aerial tested and Royalties paid, with A.C. Mains equipment

£19 14 6

Or 12 monthly instalments of **1 16 6**

INSTAMATIC OUTPUT

If you require an INSTAMAT instead of the choke-condenser output circuit add 11/2 to the cash price of Kits or 1/- per month to the Hire Purchase Terms. If you require an INSTAMAT MAJOR add £1.1.2 to the cash price of Kits or 2/- per month to the Hire Purchase Terms.

SEE PAGE 363 FOR ORDER COUPON.

Hear the "B.P." 3 and the "Dual-Ranger" demonstrated at our showrooms, 159, Borough High Street, London Bridge, S.E.1.

Cash or Easy Payments

Immediate Dispatch

Two Big Prizes
waiting to be Won!

£10 a WEEK for LIFE
or £3,000 CASH

in a Simple Picture Contest,
and

£1,000 and a
SALOON CAR
for a Phrase!

Both of these Splendid Prizes
MUST BE WON!

You'll find full details in this
week's issue of ANSWERS,
which also contains a

SUPERB ART PORTRAIT
ALBUM OF FILM STARS
FREE

This splendid gift is the
second of a series of Three
Grand Albums. The first was
presented with last week's
ANSWERS and the third will
be given next week. Together
the three contain PHOTOS of
over 140 FILM FAVOURITES
and all the STARS represented
in the Picture Contest will be
found in these Albums.

ANSWERS
BRITAIN'S
NATIONAL WEEKLY

Buy YOUR Copy TO-DAY—2d.

One of these will
RUN YOUR RADIO SET
FROM THE MAINS

IF you have electri-
city in your house,
you have the perfect
power for running a
radio set.

Electricity from the
mains is cheap, reliable,
and available whenever
you want it.

The conversion of the
alternating current —
usually supplied—to di-
rect current, suitable
for radio purposes, ne-
cessitates the use of cer-
tain units, including a
rectifier; and of the
various types obtainable
the Westinghouse Metal
Rectifier gives the most
satisfactory service.

Initially it is not expen-
sive; its all-metal con-
struction makes re-
newals unnecessary. As
to its length of life, ex-
haustive tests so far
have been unable to fix
a limit.

Let us send you our
booklet, "The All-
Metal Way, 1932." It
fully describes our high-
and low-tension units
required for building
battery eliminators and
trickle chargers, and for
running moving-coil
loud-speakers. The ac-
companying coupon,
with 3d. in stamps, will
bring you the booklet
by return of post.

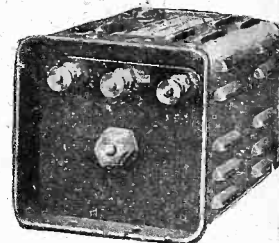

TYPE H.T.5.

Provided with three terminals and suitable for
use in the "Voltage Doubler" circuit for obtain-
ing full or half-wave rectification.
Output 120 volts at 20 milliamps.
Each 12/6

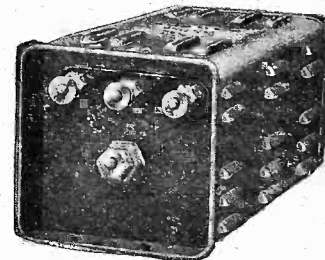

TYPE H.T.6.

Output 175 volts at 25 milliamps.
Each 15/-

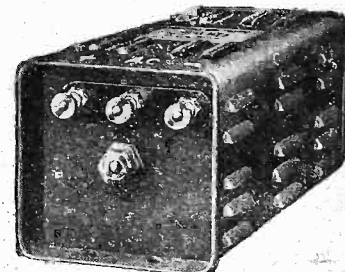

TYPE H.T.7.

Output 200 volts at 28 milliamps.
Each 17/6

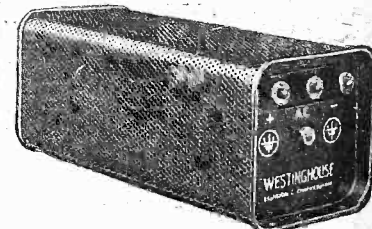

TYPE H.T.8.

Output 250 volts at 60 milliamps (after smoothing).
Each 21/-

WESTINGHOUSE

METAL RECTIFIERS

THE WESTINGHOUSE BRAKE & SAXBY SIGNAL CO., LTD.,
82, York Road, King's Cross, London, N.1.
Telephone: North 2415.

COUPON

PUBLICITY MANAGER, W.B. & S.S. Co., 82, York Rd., King's Cross,
London, N.1.—I enclose 3d. in stamps, for which please send me a copy of
"The All-Metal Way, 1932."

PLEASE USE BLOCK LETTERS.

NAME.....
ADDRESS.....

THE WONDER "P.W." DUAL RANGER

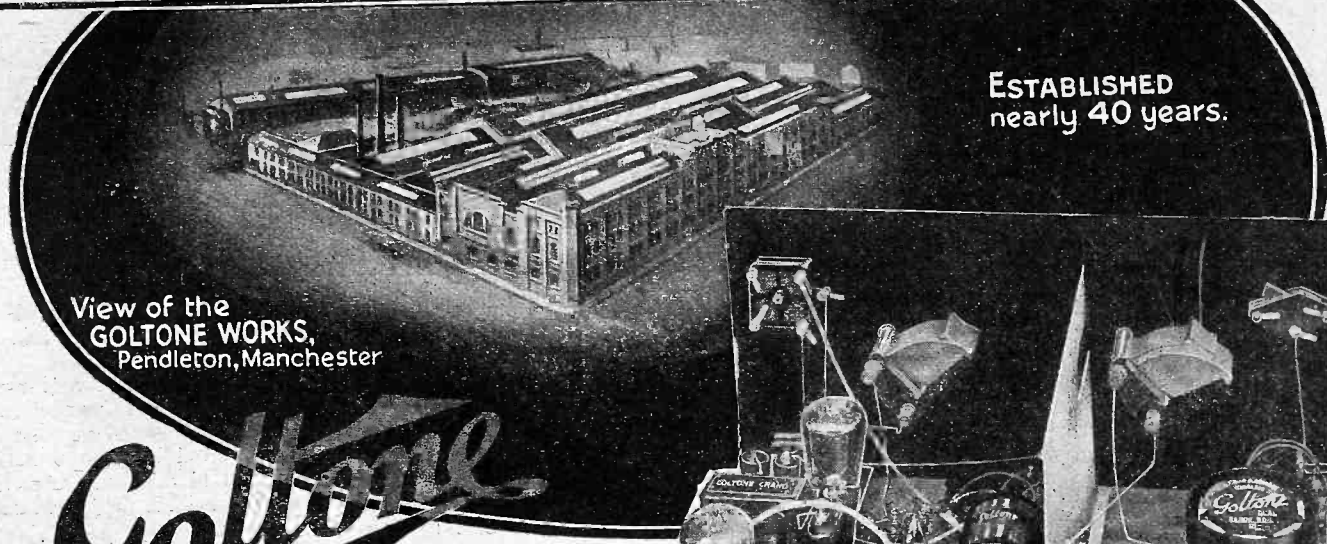

ESTABLISHED
nearly 40 years.

Goltone

REGISTERED

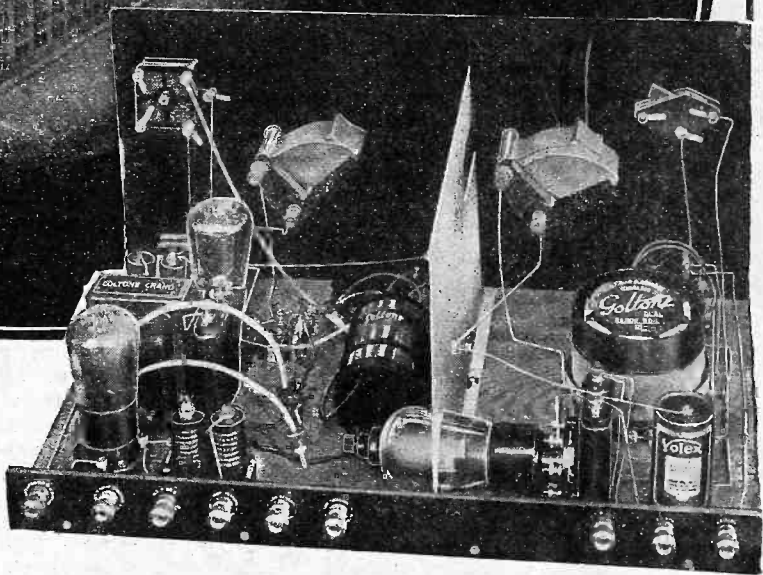

Approved "GOLTONE" KIT for "P.W." DUAL RANGER

£4.5.0

Containing specified components and sealed in robust container. Each component carefully tested. Full Instructions and Prints provided.

From all first-class Radio Stores. Refuse substitutes. Post coupon for full particulars.

Ward & Goldstone

PENDLETON. MANCHESTER L.D.

POST THIS COUPON TO-DAY
 To WARD & GOLDSTONE, LTD., Pendleton, MANCHESTER.
 Please send me full particulars of "GOLTONE" Kit for the "P.W." Dual Ranger.

NAME.....
 ADDRESS.....

P.W. 17/10/31

BROADCASTING IN IRELAND

2. A VISIT TO STATION FOIRLEATHA—2.R.N.

This week Leslie W. A. Baily, "P.W.'s" special correspondent who is touring Ireland on our behalf, describes the Dublin Broadcasting Station.

THIS is about my visit to Staisiun Foirleatha, Baile Atha Cliath. A translation thoughtfully provided in the heading of the official notepaper which invited me indicated that this means Broadcasting Station, Dublin; and, as I told you last week, I found the studios and offices of 2 R N at the Ard-oifig an Phuist, or General Post Office.

Gaelic is the official language of the Irish Free State, but although they say that it is spreading, the authorities are not blind to the fact that many people—even Irish!—do not know Gaelic; hence these translations provided on Government notepaper, on the name-plates of Dublin streets, and so forth.

The gentleman who had signed the appointment for my visit had done so in the native hieroglyphics. If you have ever seen a signature in Gaelic, you will understand why I arrived at the broadcasting station with no notion of his name. It turned out, in English, to be Seamus Clandillon, Director of Broadcasting for the Irish Free State.

When I told Mr. Clandillon about this, he retorted that his signature in Gaelic was not less clear than the signatures of certain high B.B.C. officials in English! Knowing these officials—who shall be nameless—I agreed!

Broadcasting is, of course, a valuable instrument for spreading the "national" language, but I was informed that the Government does not wish to use it as a means of propaganda, for this or anything else. The official policy is that Irish national interests should have their places in the Free State programmes along with everything else.

No Programme Delays.

Mr. Clandillon has been closely associated with such interests for many years. He is particularly well-known in Ireland for his work in reviving the old Irish folk songs.

All the members of his staff speak Gaelic, and one of them, Miss Mairead O'Grady, is a particularly fluent linguist. She has to be, because she is the

from English to Gaelic at a moment's notice.

Even the engineers are all-Irish. There are four at Dublin, four at the Cork relay, and the chief engineer is Mr. T. J. Carroll, an ex-Marconi marine man.

First I visited the control-room with Mr. Carroll. The three main studios have been built round this room, so that through large plate-glass windows in three of its sides the engineer on duty can watch activities in any or all three studios. This lay-out has proved valuable as an aid to slickness, and the Dublin station claims that for absence of delays between items its programme can challenge all others in Europe.

Two Types of 'Mikes.'

The studios are equipped with both the moving-coil (magnetophone) type of microphone used by the B.B.C. years ago and the Reiss (carbon) type which they now use, but the Dublin engineers favour the former. The microphones are connected to the input of Marconi amplifiers in the control-room, the output going to land-lines joining to the Dublin and Cork transmitters.

The Dublin transmitter is a mile and a half from the studios, near Phoenix Park. It was opened in 1926, and is one of the

famous Marconi Q-type sets, as used by the B.B.C. at Newcastle, Belfast, and other stations.

A wooden hut contains the transmitter (which has a Brussels wave-meter to indicate accuracy of wave-length), and the generators for providing the 6 kilowatts of power needed to drive the transmitter. The "sausage" aerial is supported between two 120 ft. poles.

I was interested to learn that the Cork transmitter is Western Electric apparatus, and is housed in a disused gaol. There is also a studio at Cork, used occasionally when local items are relayed by both the Irish Free State transmitters.

All the programme officials are concentrated at Dublin. There is a strong feminine element in the staff.

As well as Miss O'Grady, there is Miss Kathleen Roddy (Children's Hour), Miss McCarthy (secretary), and a permanent orchestra of six ladies, led by the well-known violinist, Miss Terry O'Connor. Mr. Clandillon hopes to increase the orchestra to sixteen permanently after October. The present orchestra is augmented occasionally to fifteen when opera is broadcast from the studio.

"Opera is practically as popular in Ireland as in Italy," Mr. Clandillon told me. "We have an opera company with a repertory of thirty operas, and we do them fortnightly."

For opera and orchestral concerts, No. 2 studio is used. This is a large room right at the top of the General Post Office. There is no draping, but I was told that, owing to excessive echo, it is probable that drapings will be introduced. Here, again, Dublin runs counter to the trend of activities in the B.B.C.

Ban on Politics.

Studios No. 1 (medium-sized) and No. 3 (talks) have undraped walls, but draped ceilings. The studios have a special electrically-driven ventilating plant.

Outside broadcasting in the Free State consists mostly of sports relays. Church services are never broadcast, and I was

THE TRANSMITTER AT DUBLIN

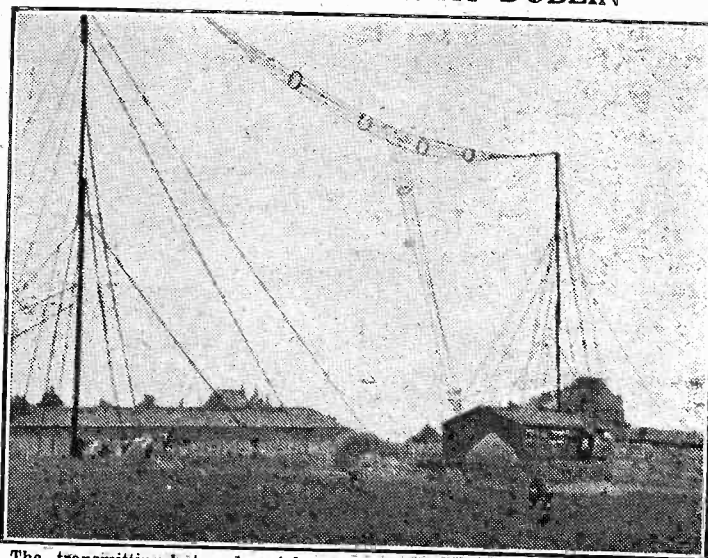

THE NEW B.P.

THREE

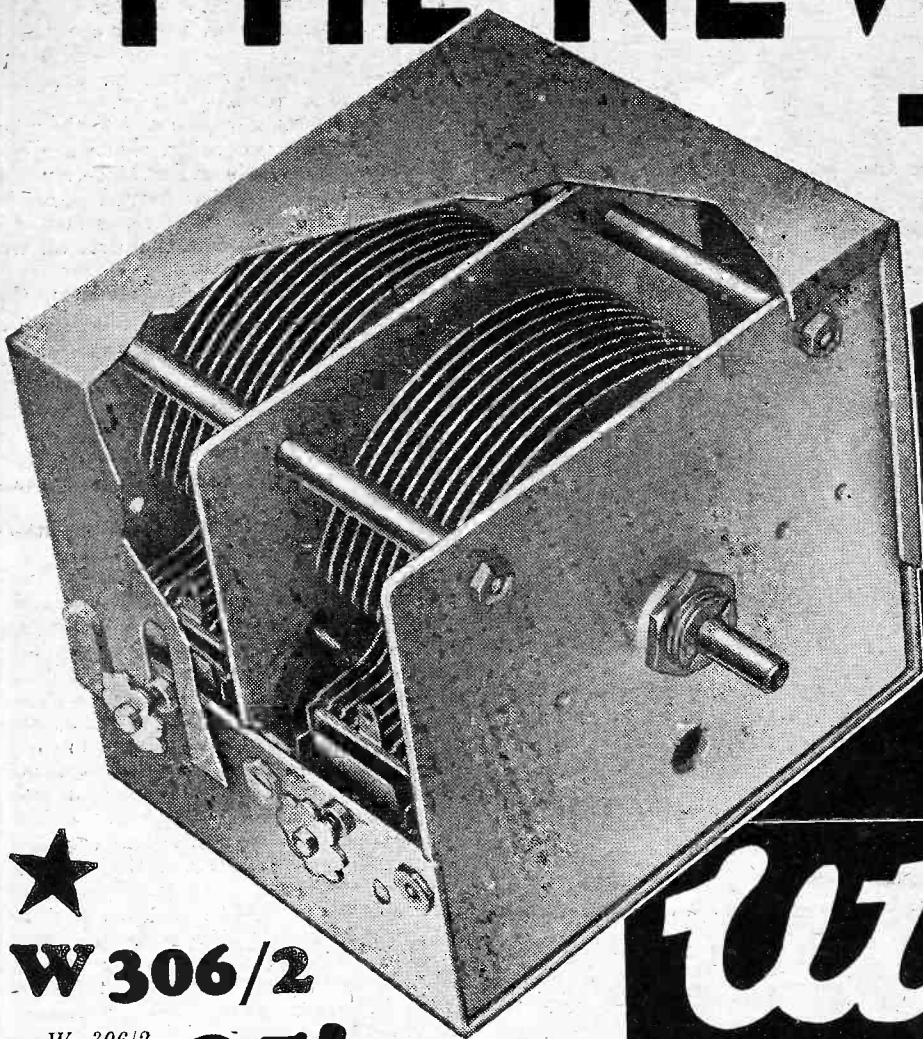

★
W 306/2
W 306/2
two gang
complete
with dial.
25'.

Utility

TUNED

Again "Popular Wireless" designers have specified 'Utility' Condensers, this time for the B.P. Three. For this fine 3-valve set the choice is Utility W 306/2, our very latest fully-screened condenser complete with trimmers.

This new condenser is so accurately made and adjusted that it is balanced within one half of one per cent. Never before has a British-made condenser with such a high efficiency ratio been available to the amateur, and he is now assured of the accurate hair-splitting tuning which is imperative if he wishes to get the utmost from his circuit.

Remember then to insist on the new Utility complete with Disc Dial, the dial specially made for it.

★ Send a post-card for the new "Utility" Catalogue.

WILKINS & WRIGHT LTD.

UTILITY WORKS, HOLYHEAD RD., BIRMINGHAM

AGENTS—London: E. R. Morton, Ltd., 22, Bartlett's Buildings, Holborn Circus, E.C.1; Scottish: E. B. Hammond, 113, Vincent Street, Glasgow; Lancashire and Cheshire: J. R. Lister, 93, Old Road, Blackley, Manchester; Westmorland, Cumberland, Durham, Northumberland, Yorkshire and Derbyshire: H. C. Rawson, Ltd., 100, London Road,

The following represents the complete range of these wonderful condensers.

SEMI-SCREENED

W 305/2, 2 gang	17'6
W 305/3, 3 gang	22'6
W 305/4, 4 gang	40'.

Disc Dial 2/6 extra

TOTALLY SCREENED

W 306/2, as illustrated	22'6
W 306/3, 3 gang	27'6
W 306/4, 4 gang	42'6

Disc Dial 2/6 extra

Always insist on Utility Condensers and Switches the finest in the World.

BROADCASTING IN IRELAND

(Continued from page 374.)

is a rigid ban on politics. A time-signal similar to the B.B.C.'s "six pips" is relayed from the Irish observatory at Dunsink, near Dublin.

The news arrangements are particularly interesting. The B.B.C. depends entirely on the news agencies for its supply of news, but the Dublin station taps other sources. Mr. Clarke Ryan, the news editor, sometimes goes out and obtains the reports himself, and another source of news is a short-wave receiving set in the control-room.

On the floor below the studios I found a spacious suite of offices, a gramophone library of 3,000 records, and a music library of 1,500 numbers. I was introduced to Mr. Seamus Hughes, the Assistant-Director, and I was told that the Music Director, Mr. Vincent O'Brien, was the man who "discovered" John McCormack.

An Interesting Experiment.

The talent for the Irish programmes is drawn mainly from the Dublin and Cork areas. As I explained last week, the Free State has only about £15,000 to spend on programmes this year. At this rate imported talent cannot be afforded.

Broadcasting in the Irish Free State is, in fact, conducted on a minor scale compared with broadcasting in Great Britain, but as an attempt at complete State control, and on account of its experiments with sponsored programmes, it is particularly interesting to England, which will have to decide five years hence whether its system—broadcasting run by an independent corporation under Royal Charter—is the best.

THE DUBLIN STUDIOS

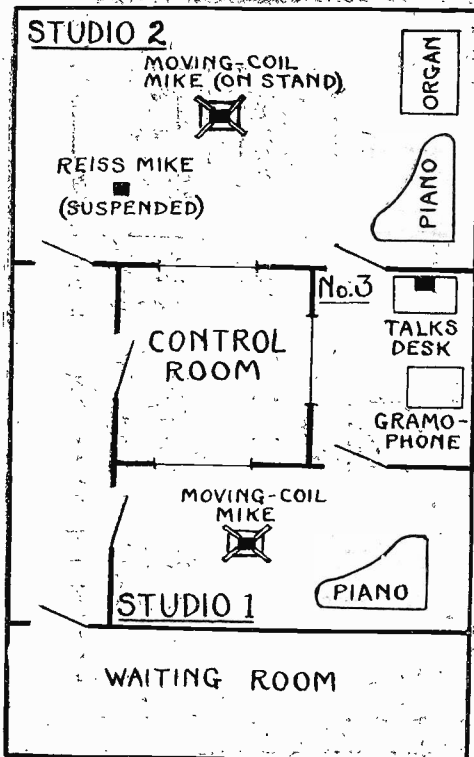

Alternatives are broadcasting by private commercial companies, as in America, which means sponsored programmes, or State control. Ireland is trying both.

DUBLIN'S BROADCASTING DIRECTOR



Mr. Seamus Chandillon, Director of Broadcasting for the Irish Free State, and his wife.

PRACTICAL POINTS FOR CONSTRUCTORS

A few words concerning the selection of components.

THAT very many people do buy cheap components is evident from the number of retailers who specialise in selling them.

It is improbable however that more than half of the purchasers discriminate between those components which may safely be bought cheaply and those which afterwards are going to make one say, "I wish I had paid a little more and got results like Jones gets!"

It is, of course, obvious that if you are going to build an O-V-1 set you are treading on safer ground if you economise than if you attempt to save pence on a highly specialised 2-V-1 or super-heterodyne.

Improvised Ganging.

For instance, you can save quite a lot of money by buying variable condensers at from two to three shillings each. If you use a simple detector-L.F. set with reaction and ordinary aperiodic or auto-coupled aerial tuning, then not much harm will result from using one of these condensers.

On the other hand, if you want to use a band-pass filter with ganged control, then it is going to cause you considerable annoyance and trouble if you think to economise by purchasing two or more of these cheap condensers and improvising a method of ganging.

Also the material of the dielectric is of great importance if you are going to use high-frequency coils. Many cheap compositions are used that would cause

much of the signal voltage picked up by the aerial would never reach the grid of the first valve.

Moderately cheap fixed condensers may be considered quite reliable providing they bear the name of a well-known firm. Shoddy condensers always give trouble. Those of the paper type if used for decoupling and smoothing are liable to short-circuit the H.T. supply and even without complete shorting to let current leak by.

This last remark applies also to the mica variety. The result being, that when one is used for coupling in an R.C. stage, a "plus voltage" (it is connected through the anode resistance to H.T. positive, remember) leaks on to the valve and upsets all the biasing arrangements!

When it completely breaks down, the result is better imagined than described.

Tips about Transformers.

The difficult part about transformer design is to make it pass on what it receives in the correct proportions. The high notes must be there, the low notes must be there, the middle will take care of themselves as usual.

The less you pay for a nameless transformer, the worse it is likely to be.

Of two of the same price, the heavier will be the better, providing the core is of the same material as the other. If one core is of iron and the other of high permeability alloy, then it is scarcely possible to judge without testing.

With a cheap and inefficient L.F. transformer a valve of low internal impedance should be used, a very awkward fact seeing that the lower the impedance as a rule the higher the current, and the cheaper the transformer the less current it will comfortably handle.

That is where the resistance-feed scheme comes in again.

Yet after all it pays to pay a little more.

With regard to cheap valve holders, scarcely more can be said than that all valve holders are cheap. There is therefore little reason to go in for any of the shoddy ones. The main fault with these latter is the composition of which the holder is made.

Slow Motion Dials.

Since good valve holders are so inexpensive, the makers of shoddy stuff have not been able to secure a market in this field at any rate.

It is always best to make sure, when buying a slow-motion dial, that an end stop is provided after each half revolution. Some quite expensive makes have not this provision, with the result that the dial slips on the condenser spindle and upsets all our readings.

A second important point is to see that there is no back-lash and, because a certain dial has toothed gearing, you must not assume that it is of necessity worse than one with some other type of drive. Toothed gearing certainly admits of more errors in design through inexpert workmanship, but I know of some quite good little dials that adopt this method of reduction.

Also, see that the method of fixing to the condenser spindle (and panel if necessary) is going to result in a firm and secure grip. There's nothing worse than trying to "reach out" with an uncertain dial.

Finally, never judge a component's worth in terms of money alone. Just because an item costs less than most others, it does not necessarily follow that

ALL SPECIFIED IN THE "DUAL RANGER"

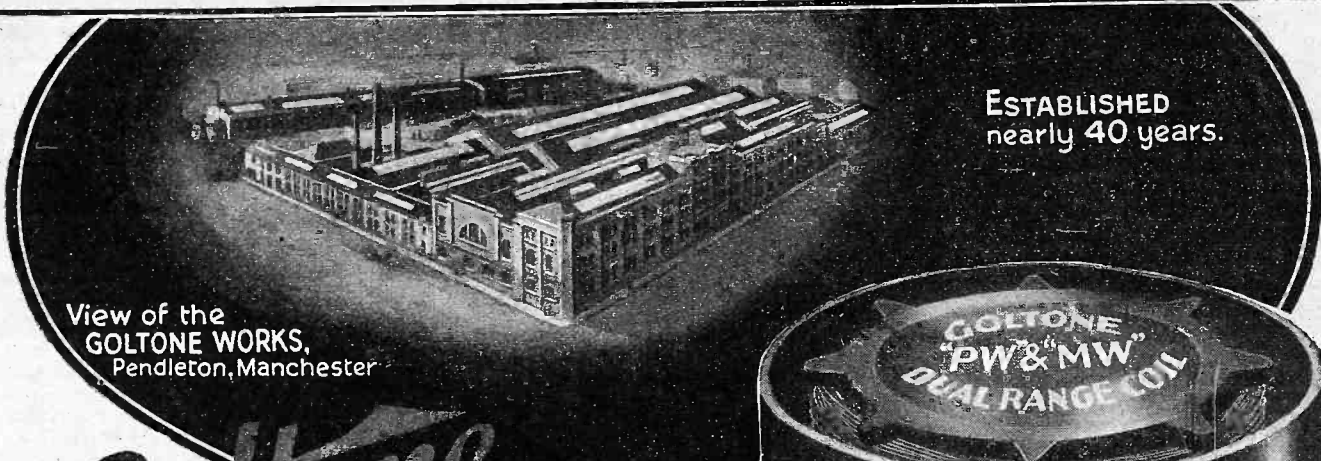

View of the
GOLTONE WORKS,
Pendleton, Manchester

ESTABLISHED
nearly 40 years.

Goltone
REGISTERED

The combination of a most up-to-date Bakelite Moulding Plant, with an Instrument Wire Dept. of nearly 40 years' experience, enables Ward & Goldstone, Ltd., to offer "Popular Wireless" Readers, components of the highest standard at competitive prices.

The effective performance and excellency in finish of "GOLTONE" COMPONENTS leads to their specification in all "Popular Wireless" circuits.

Other components for the "Dual Ranger"
P.J. 3 Coils - - - Price 2/- ea.
Wound Coil Quoits - Price 2/6 ea.



DW/12

"GOLTONE" "P.W." & "M.W." DUAL RANGE COIL as illustrated, DW/12

7/6

Each

Radio Catalogue with full particulars on request.

From all First-class Radio Stores—Refuse Substitutes—If any difficulty write direct.

Ward & Goldstone
PENDLETON MANCHESTER LTD.

FROM

1/-

"GOLTONE" COMPRESSION TYPE CONDENSERS.

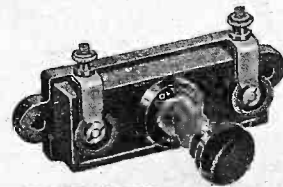

"GOLTONE" MIDGET FIXED CONDENSERS.

5^d



"GOLTONE" PUSH-PULL SWITCHES.

9^d

7^d

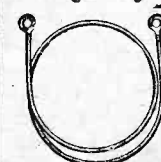

SPAGHETTI RESISTANCE LINKS, from

6^d

Ready drilled Panels, 16" x 8" x 1/8", mahogany. Price 7/-
Ready drilled Screen, 10" x 7" Price 2/-

FROM THE TECHNICAL EDITOR'S NOTE BOOK.

Tested and Found-?



THE EVER READY FORTNIGHT.

THE Ever Ready Co. initiated a great drive in connection with the selling of their batteries, and all over the country special window displays were to be seen competing in the trader competitions which are a feature of the campaign.

IGRANIC ANNOUNCEMENT.

Igranic Electric Co., Ltd., announce numerous price reductions in their existing and popular lines, and the addition of a number of new components to their list.

A FINE CHOKE.

Ferranti's have produced an inexpensive L.F. choke which they list as the B8. Remembering the reliability of Ferranti components, this B8 appears to me to be a specially attractive line.

It is built into a cleanly finished black case, having eyeletted holes for the base-board fixing screws. The terminal screws, which are of the milled and slotted variety, are fixed at the base of the component.

MAINS UNIT USES

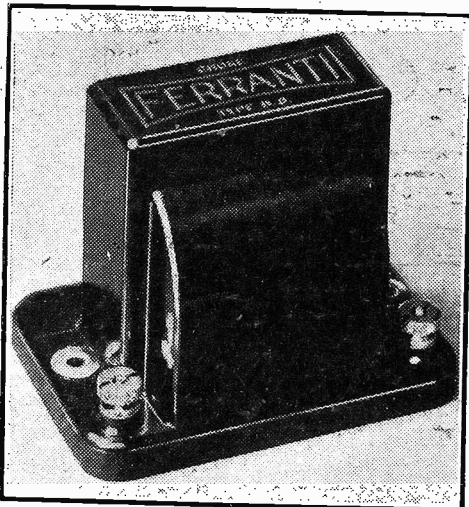

The Ferranti B8 choke can be used in mains units, as well as in set output circuits, for it can carry up to 45 milliamperes of current.

From an electrical point of view this Ferranti B8 choke stands out shoulders high above many others of a similar "price class." It retains a good 25 or 30 henries inductance when carrying the kind of current met in the average output stage.

You can embody it in your loudspeaker filter arrangement with the knowledge that you are getting all the advantages of a filter with none of the disadvantages that accompany the use of an inefficient choke.

"RIPOFLEX" SLEEVING.

Ripaults Ltd. are producing a varnished insulated sleeving which constructors should find very useful, particularly for the protection of leads that pass through or close to metal screening.

A NEW EXTENSER

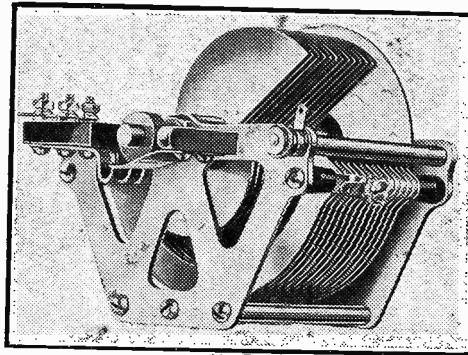

This is the J.B. Extenser, which is now, we believe, going into production. It will undoubtedly receive a very warm welcome, for it appears to be J.B. at their very best, more than which need not be said.

"Ripoflex," as it is called, is very flexible, although it is tough, and has high insulating properties. It is available in all the standard colours at reasonable prices.

USEFUL INFORMATION.

The new Lanchester loudspeaker catalogue, published by Lanchester's Laboratories Ltd., is notable in that it contains a number of interesting and informative articles by Dr. Lanchester himself on the use of loudspeakers.

A BATTERY FOLDER.

If you are facing the problem of L.T. or H.T. battery renewals I would advise you to send for the new "Pertrix" Battery folder which succinctly describes, the many types of "Pertrix" batteries that are now available.

A BRIGHT IDEA.

The new Benjamin catalogue is a fine piece of work, and besides describing the various Benjamin components in the usual way, it includes a large circuit diagram in which Benjamin valve holders and a Benjamin switch are shown synphotographically.

BLUE SPOT RECEIVERS.

I have just been reading some descriptive literature that has reached me which deals with the new Blue Spot receivers. These appear to be very fine propositions and I advise readers who may be thinking of buying a set and whose advice is sought by friends on the subject, to acquire the catalogues concerned.

FORMO GANGED CONDENSER.

One of the most interesting condenser productions of the year is the Formo gang with a shadow indicator. This is available in two- and three-gang assemblies, and the main features of design are found in both.

PLEASE NOTE.

Manufacturers and traders are invited to submit radio apparatus of any kind for review purposes. All examinations and tests are carried out in the "P.W." Technical Department, with the strictest of impartiality, under the personal supervision of the Technical Editor.

We should like to point out that we prefer to receive production samples picked from stock, and that we cannot in any circumstances undertake to return them, as it is our practice thoroughly to dissect much of the gear in the course of our investigations!

And readers should note that the subsequent reports appearing on this page are intended as guides to buyers, and are, therefore, framed up in a readily readable manner free from technicalities unnecessary for that immediate purpose.

By means of an ingenious arrangement of a semi-transparent scale and indicator light, the readings are sharply defined by a shadow moving through the scale.

There are two control knobs symmetrically placed towards the bottom of an artistic escutcheon. The one simultaneously adjusts all rotors and actuates the scale, and the other applies a trimming movement to the fixed vanes of one section.

This trimming movement is of generous proportions, and should be able to cope with any normal circuit discrepancy.

The main drive, which is accomplished through a kind of belt, is exceptionally smooth.

Altogether, the "Formo" gang is a notable piece of modern radio engineering.

SHOWN BY A SHADOW

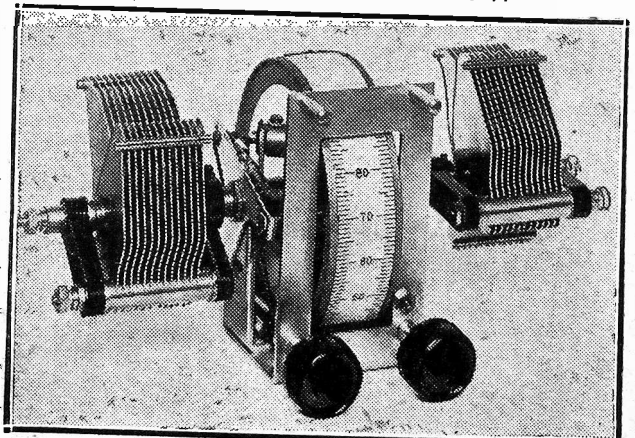

The "pointer" is actually behind the scale and its shadow is

A Valveless Amplifier!

—well-known inventor's brilliant achievement

The "Microbox" is one of the latest inventions of Mr. S. G. Brown, F.R.S., inventor of the very first loudspeaker, and a host of other devices, including the already famous Battery Superseder, which he introduced at this year's Radio Show. The "Microbox" is no bigger than the ordinary pick-up, yet it is a self-contained amplifier producing all the volume and rich tone of an expensive multi-valve reproducer. All you have to do is to change your present gramophone tone-arm and sound-box for the "Microbox" and connect it up to your loudspeaker. The little power required (10 volts at ½ amp.) can easily be supplied by a small accumulator. The only other component required—a transformer—is supplied with the "Microbox." The price of the two complete is 3 gns.

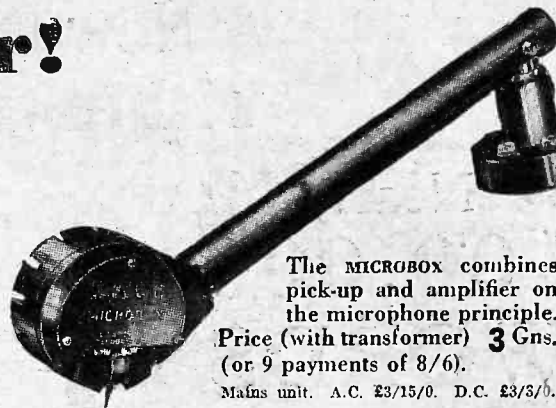

The MICROBOX combines pick-up and amplifier on the microphone principle.
 Price (with transformer) **3 Gns.**
 (or 9 payments of 8/6).
 Mafus unit. A.C. £3/15/0. D.C. £3/3/0.

Is yours a popular 'kit'?

—if so, here's something to interest you!

Excellent idea—the Kit. But not quite perfect unless you get a speaker worthy of the set, and a hiding place for your batteries. Well, you can get both in an S. G. Brown Kit-Cabinet Speaker. These S. G. Brown KIT-CABINET SPEAKERS are definitely built to save you time and trouble—and money. Scarcely worth while to make your own when you can walk away with one of ours having spent so little. They are priced from only 39/6. (See photograph and full description on right.)

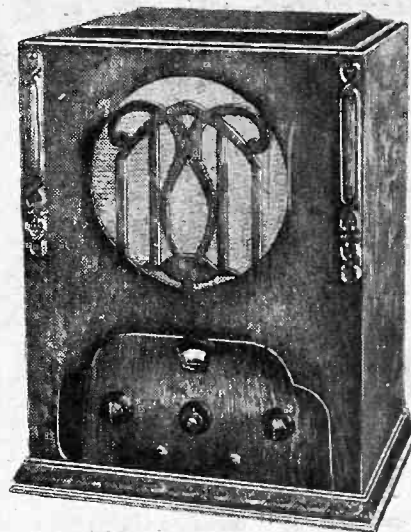

KIT-CABINETS.

MODEL 1. For Mullard 1932 3-valve Kit or Radio for the Million V.3 Kit (incorporates S. G. Brown SOLO Speaker). Price **47/6** (or 6 monthly payments of 10/-).

MODEL 2. Stand-on KIT-CAB. for 1932 Melody Maker, Osram 1932 Music Magnet, etc. Price (with Brown SOLO Speaker), 39/6 (or 6 monthly payments of 8/-).

Is your set 'muffled' by your loudspeaker?

—ten to one you'll answer 'No'—but are you sure?

Improvements in loudspeaker design have recently been so rapid that speakers which were the last word three years ago sound amazingly inefficient when heard beside such speakers as the new S. G. Brown permanent magnet moving coil (which costs only £4/7/6). Nine people out of every ten "muffle" perfectly good sets with old-fashioned speakers—and don't realise it. Are you quite sure you are not one of them? Go to your dealer and hear the new S. G. Brown Speakers for yourself. You'll know then whether you are doing your set justice, or not.

Send to 19 Mortimer Street, W.1, for free leaflet describing the FAITHFUL MODELS MADE BY

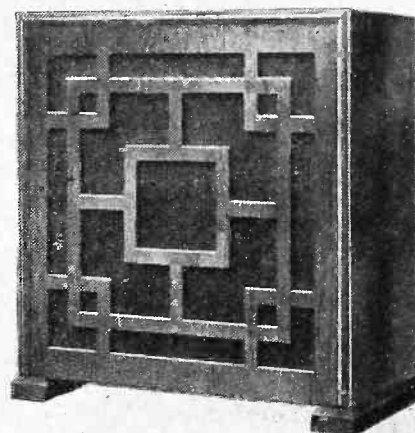

S. G. BROWN PERMANENT MAGNET MOVING COIL UNIT costs £4/7/6. Complete with handsome cabinet **£4/19/6** shown it costs (or 8 monthly payments of 13/6).

Yours faithfully

S G Brown

At Last— A New Dictionary for EVERY HOME within the reach of EVERY PURSE!

Nearly
**100,000
WORDS**

Accurately yet simply defined.

Over 300,000 shades of meaning clearly and interestingly differentiated.

Full etymologies.

Pronunciations simply indicated for the man-in-the-street and phonetically indicated for the scholar.

Hundreds of thousands of quotations illustrating phrases, modern usages and idioms.

A book for every home, every school, every library and every office.

**Binds into
One Large
Page Volume**

*The Only Dictionary Entirely Written
since the Great War!*

THE UNIVERSAL ENGLISH DICTIONARY takes each word in the English language and tells you what part of speech it is, how to pronounce it, how it came into English, its different shades of meaning, how it is used in typical phrases of everyday speech, and so on.

It has taken over eight years to prepare and it is to be sold in 52 weekly parts at sixpence a part. *Everyone* every day—Mother, Father, and boys and girls of school age—needs a good dictionary. The UNIVERSAL ENGLISH DICTIONARY is more than a *good* dictionary—it is the *only* dictionary of its kind. It is much more complete than the average desk dictionary, yet its form

—a single large-page volume—is most convenient. The UNIVERSAL is within the reach of all, for, by the method of publishing in weekly parts, its cost, binding included, is little more than the price of a daily paper for one year.

The value of such a work increases year by year. With the UNIVERSAL in your home your children have at hand a ready answer to almost every question. They will grow up equipped with a true knowledge and understanding of their most precious heritage—the English language.

This magnificent work is incomparably the finest general-purpose English Dictionary that has ever been published.

THE UNIVERSAL ENGLISH DICTIONARY

*Edited by a leading authority on the English Language
—Professor H. C. Wyld—Merton Professor of English
Language and Literature at Oxford University.*

**Buy PART 1
TO-DAY - 6^D.**

On Sale Everywhere

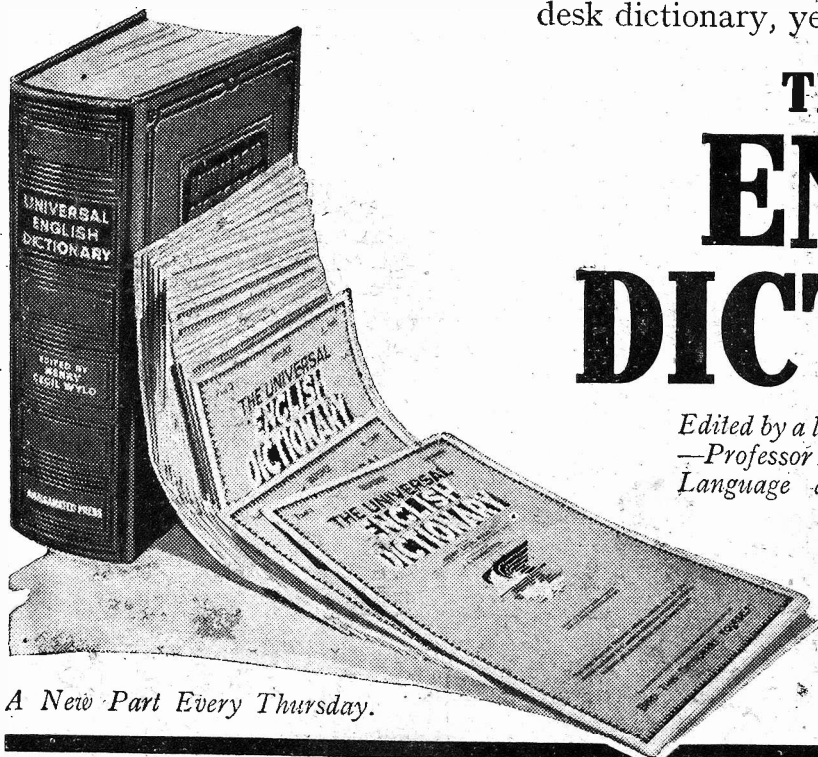

A New Part Every Thursday.

YOUR GUARANTEE OF EFFICIENCY FOR THE "DUAL-RANGER"



WEARITE DUAL-RANGE COIL

Used and recommended in all previous sets and circuits.

Price 12/6

P.W. & M.W. DUAL RANGE. (See special leaflet.)

WEARITE H.F. CHOKE

A component with a very fine performance: It covers efficiently the remarkable range from 10 to 2,000 metres without any marked resonances.

Price 6/6



- P.J.3 Coil - - - - 2/9
- Coil Quoit Former - - - - 6d.
- Panel, in Black, Mahogany or Walnut finish. Size 16x8 - 7/6
- 3-Point wave-change switch - 1/6
- On-off switch (insulated spindles) - - - - 1/-

SEE OUR GUARANTEE TAG IS ON EVERY COMPONENT YOU PURCHASE.

Write for free illustrated list.

Have you seen the Kingston-Wearite Home Recorder?

Write for special folder.

WRIGHT & WEAIRE LTD.
740, High Road, Tottenham,
LONDON, N.17.

Phone: Tottenham 3847/8/9.

WEARITE

BEFORE BUYING YOUR MAINS UNIT

Compare Outputs and Prices



You can't beat "ATLAS"

MODEL A.K. 22
ALL MAINS UNIT
For 1, 2 and 3
VALVE SETS

1 Tapping 60/80 volts,
1 Tapping 90/100 volts,
1 Tapping 120/150 volts,
Output 12 m.A. Trickle
Charger for 2v. L.T. accu-
mulators at 3 of an amp.
or 10-down and
9 monthly pay-
ments of 8/6 each

77/6

When you compare Mains Unit values, you will find that "ATLAS" gives a bigger output at a lower price.

Every "ATLAS" Mains Unit represents the last word in design and manufacture. Highly efficient components provide an abundance of steady power free from hum. Moreover, "ATLAS" running costs are so small as to be negligible.

"ATLAS" Mains Units are famous for their reliability and are fully guaranteed for 12 months.

Ask your dealer to-day for a demonstration of the Bigger Output Lower Priced Mains Units

You will find that the claims made for "ATLAS" Mains Units are fulfilled absolutely in use. If you require 20 m.A. at 120 volts, and the "ATLAS" Specification gives this output, then you can be sure you will get it.

The models illustrated are for A.C. Mains and incorporate the Westinghouse Rectifier. An "ATLAS" Mains Unit has been designed for conversion of every type of Battery Set. Send for a price list of the full range to the address below.

MODEL A.K. 260
ALL MAINS UNIT
for sets up to
4 VALVES

1 Tapping 60/80 v. (max. and min.), 1 Tapping 90/90 volts (max. - med. and min.), 1 Tapping 120/150 volts. Output 20 m.A. at 120 v. Trickle Charger for 2, 4 and 6 v. L.T. accumulators at 3 of an amp. or 10-down and 9 monthly payments of 10/- ca.

90/-

See the full range of "ATLAS" Units and Components at the Manchester Radio Exhibition, Stand No.

52

City Hall,
October 7-17.



"CLARKE'S ATLAS" MAINS UNITS

H. CLARKE & CO. (M.C.R.), LTD., Eastnor Street, Old Trafford, Manchester.
Phone: Trafford Park 1744-5-6. Grams: "Pirbright." Phone: "Manchester."
Southern Offices and Stores: Bush House, London, W.C.2. (Temple Bar 7130).



All Editorial communications should be addressed to the Editor, POPULAR WIRELESS, Tallis House, Tallis Street, London, E.C.4.

The Editor will be pleased to consider articles and photographs dealing with all subjects appertaining to wireless work. The Editor cannot accept responsibility for manuscripts or photos. Every care will be taken to return MSS. not accepted for publication. A stamped and addressed envelope must be sent with every article. All inquiries concerning advertising rates, etc., to be addressed to the Sole Agents, Messrs. John H. Lile, Ltd., 4, Ludgate Circus, London, E.C.4.

The constructional articles which appear from time to time in this journal are the outcome of research and experimental work carried out with a view to improving the technique of wireless reception. As much of the information given in the columns of this paper concerns the most recent developments in the radio world, some of the arrangements and specialities described may be the subject of Letters Patent, and the amateur and the trader would be well advised to obtain permission of the patentees to use the patents before doing so.

QUESTIONS AND ANSWERS

THE ANODE RESISTANCE FOR THE "POP-VOX."

T. T. S. (Cardiff)—"I would like to use an 80,000-ohm wire-wound anode resistance in the 'Pop-Vox,' instead of the 100,000 shown. Can this be done successfully, and if so, do I have to make the 10,000-ohm spaghetti in series with it a 30,000, or what?"

You can use the 80,000 instead of the 100,000, but there is no need to alter the value of the 10,000-ohm resistance as well. It would be better left at 10,000.

THE "COMET" THREE.

The following letters to the Editor are of such general interest to builders of the "Comet" and similar sets that we are reproducing them here instead of in the "Correspondence" columns:

The Editor, POPULAR WIRELESS.

Dear sir,—Referring to the reply given to E. C. F. (Liverpool) in your "Radiatorial" of September 26th. I experienced the same

trouble with my "Comet" Three—that is, no reaction on long waves. At first I suspected the coil, but this was found to be O.K. Next the '002 compression condenser fell under suspicion, but found not guilty. These two items being O.K., the reaction condenser had to come out, and although this was of a reputable make, and was stated to be '00015 capacity, I now have my doubts, because the insertion of a '0002 condenser of the same make immediately gave reaction effects over the whole of the long-wave band, where previously there had been none. Another alteration which gave a great improvement

YOUR BIT TOWARDS ECONOMY

Have you ever thought how difficult it is for a newsagent to order just the right number of copies of any particular paper each week? You can make his task much easier if you place a regular order with him. You will not only help him to order correctly and avoid waste but will make sure of getting your copy regularly each week.

on both wave-bands was the substitution of a P.M.2 D.X. valve for one of the H.F. type.

E. C. F. may find that his lack of reaction may be due to the same cause as that found in my set. So perhaps you would be kind enough to draw his attention to this letter.

Wishing the "P.W." and other wireless journals from the same "stable" every success.

Yours faithfully,

R. E. F. (Bletchley).

The Editor, POPULAR WIRELESS

Sir,—I notice that a number of your readers seem to find difficulty in obtaining satisfactory reception of long-wave stations on the "Comet"

(Continued on page 384.)

This machine-made battery will improve your set

A dry battery consists of a number of small inter-connected cells hermetically sealed in an insulated case. Once the battery is finished no adjustments can be made, no faults can be rectified. That is one reason why you should insist on a Fuller 'Super' H.T. Battery. This battery is machine-made and machine-tested. Here you see the zinc cans with the machine-measured supply of electrolyte. All parts and components are standardised. Nothing can go wrong. Any cell which deviates in the slightest degree from standard is automatically rejected. Therefore every Fuller 'Super' gives exactly the power which is marked on it. Fit one now and your wireless will take on a new lease of life. Full list of all sizes and other types on application:

Type F.1, 60 VOLTS, Price 7/5. Type F.2, 66 VOLTS, Price 7/11
Type F.3, 99 VOLTS, Price 12/4. Type F.4, 108 VOLTS, Price 13/9
Type F.5, 120 VOLTS, 15/3.

FULLER 'SUPER' BATTERY

EMISSION UP TO 20 MILLIAMPS

Visit us at the Manchester and Edinburgh Radio Exhibitions:
the Motor Show, Stand No. 316, National Hall Gallery

FULLER ACCUMULATOR CO. LTD., CHADWELL HEATH, ESSEX

Telephone: Seven Kings 1200. Telegrams: Fuller, Chadwell Heath.
Contractors to British and Overseas Government Departments, Railways, etc.

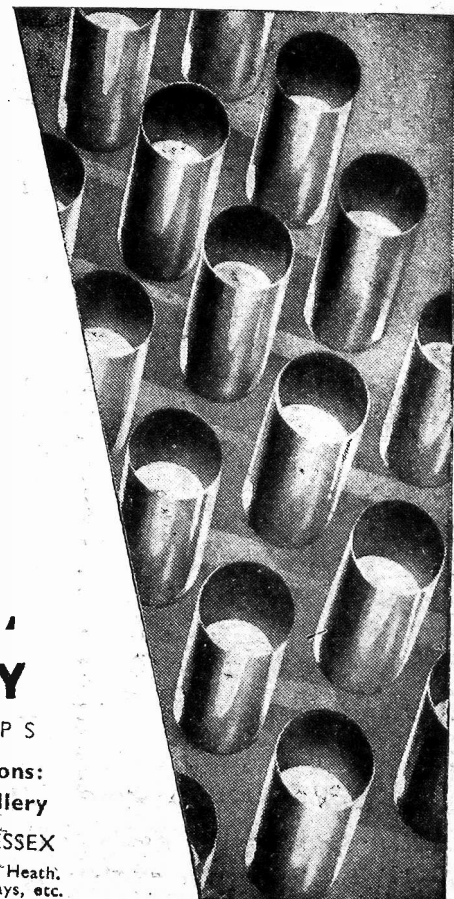

EVERYTHING *The G.E.C.* ELECTRICAL
your guarantee



*Cuts across all existing
2-volt valve standards!*

The Osram 2-volt battery Valve
with the **NEW, LONGER**

WEMBLEY FILAMENT

10% more for your money

10% GREATER ELECTRON EMISSION
THAN ANY OTHER 2-VOLT FILAMENT OBTAINABLE

This is the latest discovery of the G.E.C. Research Laboratories at Wembley. The "Wembley" filament means, that without loss of amplification, valves of amazing efficiency can be made with adequate electrode clearances. The avoidance of close electrode clearances results in:

1. Greater consistency between valve and valve.
2. Cutting out internal contacts and valve troubles.
3. Production of non-microphonic valves even under most exacting conditions of use.

Osram
2 VOLT BATTERY
Valves

Write for the Osram Wireless Guide (1931 Edition) and also Station Indicator card sent post Free on Request.

THE NEW "WEMBLEY"
FILAMENT MEANS
MORE RELIABLE
WIRELESS, PURER
TONE AND MORE
FOREIGN STATIONS.

SOLD BY ALL WIRELESS DEALERS

BRITISH PRODUCTS DESIGNED FOR BRITISH RADIO CONDITIONS

RADIOTORIAL QUESTIONS AND ANSWERS

(Continued from page 382.)

Three. In my own experience the "Comet" brings in the long-wavers fairly well. It may be of interest to other readers to learn of two little things which enhanced the value of my own "Comet" (built exactly to the "P.W." specification).

TWO TIPS WORTH TRYING.

- (1) I found the detector valve (H.L.210) set up bad microphonic howls, and gave no reaction on long waves, but I transposed this valve and the L.F. valve (L.210), using the latter as detector, and both troubles disappeared. (The—L.210, by the way, required practically no G.B.)
- (2) The spaghetti resistance between the first transformer and detector valve was very

MISSING LINKS, No. 19 AN H.T. UNIT FOR A.C. MAINS

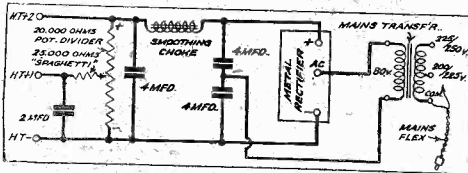

One of the "Components" was purposely omitted from last week's diagram, and here it is shown to be the smoothing choke, connected between two of the 4-mfd. condensers.

troublesome, causing crackling noises, especially if touched by hand or any other substance. Several makes of spaghetti resistance

were tried, with no improvement; but on the resistance being dispensed with entirely, everything was O.K.

Yours sincerely,

H. W. P. (Southampton).

[Will E. N. (Chertsey) and others please note that directions for changing the "Comet" to "Inter-wave" coupling were given in "P.W." No. 486 (September 26th, 1931), and for using P.J. coils instead of the dual-range type in "P.W." No. 488 (October 10th, 1931).]

MILLIAMMETER KICKS AND THE DISTORTION THEY INDICATE.

L. T. T. (East Grinstead, Sussex).—"My set has for years had a milliammeter in the plate circuit of the last valve, with facilities for taking it out of that position and placing it in the H.T. negative lead, also between detector's choke and primary, etc.

"It has proved of great assistance in checking H.T. supply, lost emission, and so on, but I have never been quite clear on the method of checking distortion with it.

"I am told that if it 'kicks' distortion is taking place. Why should it 'kick' because of that, as surely the plate current is fixed by grid bias and H.T. voltages, and it is the plate current that the milliammeter measures? Also, about upward and downward kicks. I have seen it stated in 'Radiotorial' that if the needle kicks up, grid bias is too high. But Mr. English says, in his article on 'Measuring the Power Supply' (page 240), that if the needle kicks up insufficient grid bias is applied. I should be glad if you could explain in simple words why the needle kicks at all, and also what it indicates when the kicks are up or downwards."

The best way to look at it will be from the point of view of the milliammeter itself. Its sole task in life is to indicate the current flowing through it, so when it is connected in the plate circuit of the last valve we expect it to show how many milliamps. are flowing there. These, as you know, depend on anode voltage and G.B.

In a typical case we might have an anode voltage of 200, with 20 milliamps indicated on the milliammeter when grid bias was fixed at 20. With these figures in mind, what do you think would happen if you altered grid bias to 10? Your own experience will tell you that anode current, as shown on the meter, would immediately increase. Probably you would get about 40 or 45 milliamps, instead of 20 (the H.T. being left exactly the same).

WHAT'S THE MATTER WITH THE SET?

Perhaps the switching doesn't work properly? Or some mysterious noise has appeared and is spoiling your radio reception?—or one of the batteries seems to run down much faster than formerly?

Whatever your radio problem may be, remember that the Technical Query Department is thoroughly equipped to assist our readers, and offers an unrivalled service.

Full details, including scale of charges, can be obtained direct from the Technical Query Dept., POPULAR WIRELESS, The Fleetway House, Farringdon Street, London, E.C.4.

A postcard will do. On receipt of this an Application Form will be sent to you post free immediately. This application will place you under no obligation whatever, but, having the form, you will know exactly what information we require to have before us in order to solve your problems.

LONDON READERS, PLEASE NOTE: Inquiries should NOT be made by phone or in person at Fleetway House or Tallis House.

as before), showing that reduced grid bias increases plate current.

While you were at it you might try the reverse process. This time increase grid bias up to, say, 30 or 40 volts, again leaving H.T. at 200 as before. One glance at your milliammeter shows that increased grid bias reduces the plate current.

Once having firmly grasped that relationship, you can apply it in the case of the kicking milliammeter. When it kicks upwards you can say to

(Continued on page 386.)

REALISM that gives Radio a sparkle of Romance

Once you hear the new MoToR Units or Loudspeakers you will understand why they are acclaimed to be the loudspeaker sensation of the year. Their startling brilliancy of tone, their punch and musical beauty are beyond comparison. Rich rendering of bass notes, bell-like clarity of high notes, give a new interest to listening-in . . . a sparkle of romance to your radio nights entertainments. Three MoToR Units, three corresponding Chassis assemblies and five beautiful Cabinet Speakers are priced to please your purse and to suit the output of your Set.

TEKADE RADIO & ELECTRIC, LTD.
147, FARRINGTON ROAD, LONDON, E.C.1

Northern Wholesale Distributors: L. KREMNER, Ltd.,
2, Bradshaw Street, Manchester. Agent for Scotland:
R. G. J. NISBET, 132, Renfrew Street, Glasgow, C.2.
West of England: BRUNWEC, Ltd., 28, Cumberland
Street, St. Paul's, Bristol.

MoToR SUPER UNIT
TYPE S8 **23/6**
This new MoToR Unit is a revelation in clarity, tone and power. Unapproached for superb workmanship at a more than reasonable price.

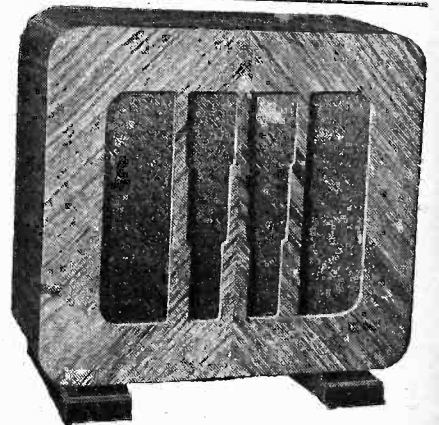
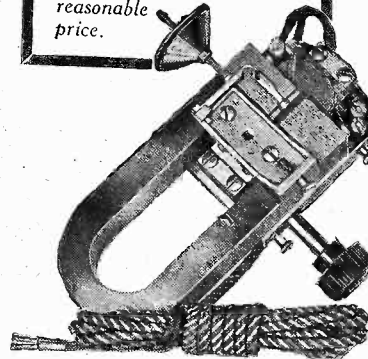

MoToR LOUDSPEAKER
"BETA" (Caucasian Walnut) **47/6**



"The Speaker is working on a one-valve . . . set and is giving wonderful results. It is flooding the village with music."

J. R. L., Penraig,
nr. Ross-on-Wye.

MOTOR

LOUDSPEAKERS · UNITS · CHASSIS

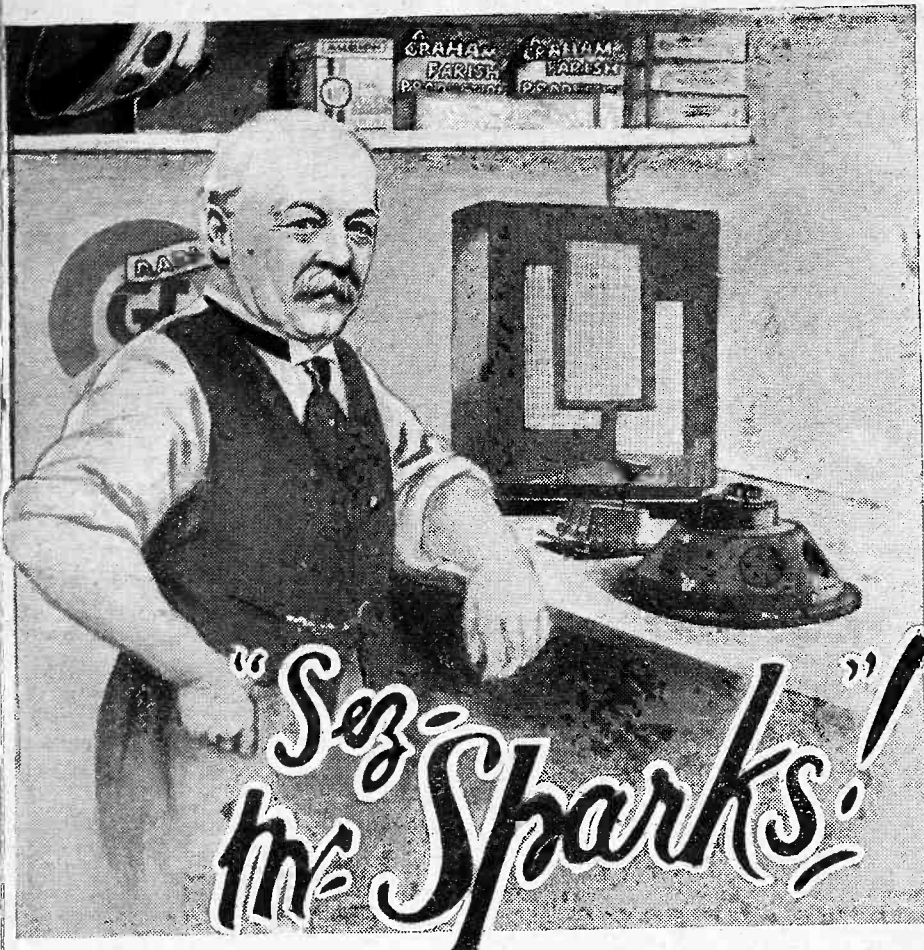

"MR. SPARKS," that's what they call me, sir, and I may say I'm proud of it. People don't give you a name like that unless they have a bit of respect for you, do they now, and a bit of a warm spot for you too, specially the ladies.

"Ladies? Why yes, sir, hundreds of 'em come in here. You see in a general way they're a bit cautious—don't want to be talked into buying a thing they don't understand, in a manner of speaking, so they makes quite sure who they're dealing with. Yes, sir, I reckon I've more lady customers than any dealer for miles around.

"Same with the gents—they come in more of an evening, of course, sometimes for a bit of advice or a few things for their set, but pretty near everyone asks my advice and, what's more, takes it too.

"What it comes to is this, I never to my knowledge let a customer down. I take care to have nothing here that isn't first class—it don't pay—not when you've a reputation to consider. Once or twice I've been caught. You've got to only handle goods what have a good name behind them, and what'll be a credit to you.

"Take this little 'SNAP' Speaker Unit for instance now—I only just got 'em in, but I knew it 'ud be all right directly I saw it on Graham Farish's Stand at Olympia. I even fixed one up to demonstrate without first testing it—and listen! Cost's five-and-six and as good as many at thirty bob!

"Same with all their goods—never get a complaint; they're just as particular as I am about the stuff they sells. So I just tells every customer the same—if

mucking about. Yes, sir, most of my customers is just as keen on Graham Farish now as what I am.

"You see, where it is these Graham Farish people make pretty near everything barring sets and eliminators—they're specialists at the game—been at it for years.

"If it's a speaker you want, here you are. 'Amazing' they call it—it's as true a description as you could find—42/-, or perhaps you want to build your own cabinet? Right! Here's their A.C.4 Chassis at 21/- . I always use their pick-up for selling Gramophone records 'cause every note comes out as if I had a performer here—32/6 they cost, and many a customer for a record or two has taken a pick-up with him—then I sell more records than ever.

"But when it comes to building sets—well, all the papers can tell you how, and pretty easy it is—if you put good stuff in—and good stuff means Graham Farish."

"You seem very keen on Graham Farish, Mr. Sparks."

"You're right there, sir, I am—I'm a bit too old to be bothered about sets that don't work when my customers build 'em, and I feel kind of responsible for the goods they use, so I always tell 'em to use Graham Farish parts, or I won't answer for the results."

Mr. Sparks will be happy to enlarge in these columns on topics of mutual interest to the readers of "Popular Wireless" and Graham Farish Limited, and a postcard to him, care of Graham Farish Ltd., will receive his careful consideration. The directors of Graham Farish Ltd. beg to state that the above article is intended to advertise their goods; they hope that Mr. Sparks will prove a popular and enter-

FOR THE DUAL RANGER

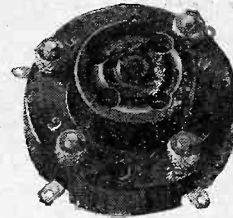

4-PIN VALVE HOLDERS.

Price 6d. each.

VARIABLE CONDENSERS.

'0001, '0003, '0005.

Price 2/- each.

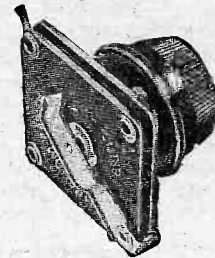

PUSH PULL SWITCH.

Price 8d. each.

FIXED CONDENSERS.

Fitted with plated terminals.

'00005 - '002 .. 6d.
'003 - '006 .. 1/-
'007 - '01 .. 1/6

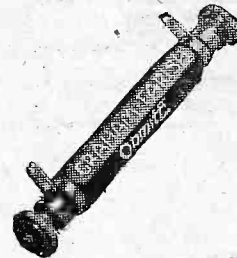
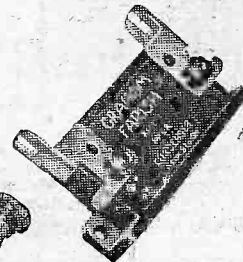

OHMITES.

All values from 500 ohms to 5 megohms.

1/6 each.

VOLUME CONTROL.

Potentiometer type, Price

3/6

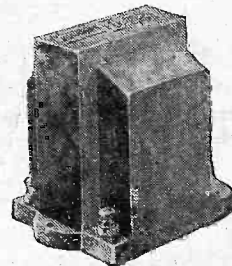
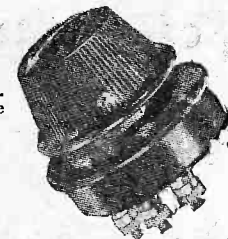

"SNAP" L.F. TRANSFORMER AND CHOKE.

Ratios 3-1, 5-1,

5/6 each.

CHOKE 5/- each.

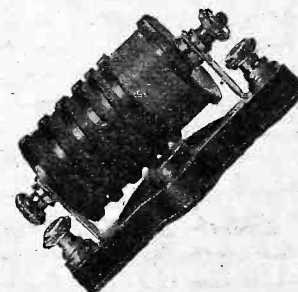

MULTIWAVE H.F. CHOKE.

Designed for all radio frequencies between 50 and 3,000 metres,

4/6 each.

GRAHAM FARISH

RADIOTORIAL QUESTIONS AND ANSWERS

(Continued from page 384)

yourself: "Hullo! Current has increased! Does that mean grid bias has been decreased?"

If, on the other hand, the needle kicks down to a lower value, you know that such an effect could be caused by raising the grid-bias voltage.

Next, remember that all the time the set is receiving a programme, voltages are being placed on the grid.

And when we consider those applied "programme" voltages, and their effects on anode current, we get to the heart of the matter.

The first point to bear in mind is that, unlike the true grid bias, these "programme" voltages are alternating, and every positive volt is instantly cancelled by a negative volt.

If a note is coming along in the form of, say, a 1,000-times-a-second alternating positive and negative voltage variations, it is obvious all the positive voltages will immediately balance out all the negatives.

NEXT WEEK SIXPENNY BLUEPRINT FREE

So the effect of a programme on the grid is really to alter the grid bias all the time, by equal positive and negative variations. And that promptly alters the plate current all the time, increasing and decreasing it.

But you will notice that in spite of all these changes the average grid bias will remain as it was to begin with. And the average plate current, also, has all its increases wiped out by all its decreases.

So, we can expect the milliammeter to remain perfectly steady even when the programme is tuned in strongly. Which is exactly what happens when there is no distortion.

But when the milliammeter kicks up or down it shows, there is distortion.

It shows that the equal and opposite voltage variations on the grid are *not* being accompanied by equal and opposite variations in plate current. And a common reason for that fault is incorrect grid bias.

You can easily see why if you examine the valve's "curve." It shows that over one straight portion of the curve equal grid voltage changes produce corresponding equal increases and decreases in anode current. But the valve must be biased to the centre of its straight portion to the left of zero grid volts, or the plate current will not always vary equally with grid volts.

It may for small values, but not for big ones. Suppose you start with a valve that is *biased too strongly* negative. What will be the effect on plate current and the milliammeter.

When the alternating voltages come along, the positive voltages increase the plate current by, say, 20 milliamperes; but the negative impulses, equally large in themselves, cannot likewise reduce the plate current by 20 milliamperes to correspond, because the valve is not working "on the straight." The current may drop only 18 milliamperes.

So the effect is that the negative voltages do not now completely cancel the effect of the positive voltages, but the latter are allowed to increase the average grid bias to some extent. And therefore up goes the plate current a little.

Consequently, the milliammeter kicks "up"—in this case about 1 milliamperes.

The opposite case is true, also. If there is too little grid bias to begin with, the negative "programme" voltages will be able to create their corresponding decreases in plate current, all right, but the positive "programme" voltages will not give the full corresponding rise in plate current.

So the equal alternating voltages will have an unequal effect on current. The average plate current will in this case be somewhat lowered. So the milliammeter will "kick down."

It is, of course, a somewhat involved process to explain without a diagram, but if you read the foregoing with a valve curve in front of you, you should have no difficulty in seeing the reason for the kicks, and what their direction indicates.

You will note, too, that the statement in Mr. English's article was inaccurate. It should have read: "If the needle kicks downwards insufficient grid bias is indicated, while upward deflections indicate the reverse."

CONNECTIONS FOR AN S.G. VALVE.

A. P. T. (Portsmouth).—"I cannot get my S.G. H.F. amplifier to work. The circuit was given to me by an acquaintance who has a set like mine, and he got wonderful results with it. I have not actually seen his set, but he told

me the dimensions of the cabinet for the unit and sent me a theoretical circuit to wire up.

"I am enclosing this, and also the layout, as I have got it wired in practice. Why is it that it will not work?"

TECHNICAL TWISTERS

No. 83. WIRING A.C. VALVES. CAN YOU FILL IN THE MISSING LETTERS?

As the heater current taken by A.C. valves is much than for battery valves, the wiring should be arranged accordingly.

It should be as short as possible, and of low to keep the voltage drop as low as possible.

To obviate hum being introduced into the set flex is usually recommended.

It is generally advantageous to employ the "armoured" variety of wire, and to this coating to prevent unwanted interaction.

Last week's missing figures (in order) were :
186,000. 300,000,000. 300. 300,000,000.

Your trouble is due to the fact that you have confused the screening grid and the plate terminal of the S.G. valve. As you know, the anode output from the ordinary three-electrode valve comes from the plate pin (which is opposite the grid pin on the valve holder). The S.G. valve has a screened grid as well as the ordinary grid, and it also has an extra terminal on the top of the valve. You have wired up on the assumption that the extra terminal on the top of the valve is connected internally to the extra grid of the valve. That is wrong, it goes to the plate.

BELLING-LEE RADIO CONNECTIONS

For safety, neatness and ease of connection. The patented loading device used in all Belling-Lee Plugs and Sockets, Anode Connectors, etc. Grips the whole flex neatly—wire, fray and rubber.

SAFETY PLUG AND SOCKET, both parts completely insulated, 6d.

S.G. ANODE CONNECTOR for safe connections to S.G. or Pentodes, tapped coils, etc., 6d.

BELLING-LEE BATTERY CORDS. Complete with engraved Wander Plugs and spring grip Spade Terminals. 5, 6, 7, 8, 9 and 10-way. 54 in. cords 4/- to 6/6. 30-in. cords, 2/6 to 5/-. With fuse 1/- extra.

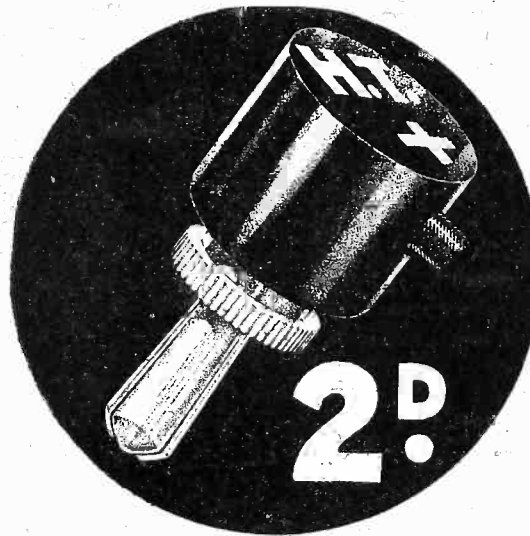

THE ENGRAVED WANDER PLUG WITH THE SPRING GRIP— FITS EVERY RADIO SOCKET

Powerful three-spring contact. Grips ANY battery socket, because each plug is tested in sockets larger and smaller than those of any battery made. Twelve permanent engravings to choose from. The whole flex neatly gripped—wire, rubber and fray.

BELLING-LEE
FOR EVERY RADIO CONNECTION

YOU CAN'T GO WRONG WITH BELLING-LEE FUSES

Made in two sizes, $\frac{1}{2}$ in. long for H.T. leads (60 m/a, 150 m/a and $\frac{1}{2}$ amp.) and 1 $\frac{1}{2}$ in. long for Mains leads (1, 2 and 3 amp.).

WANDER FUSE. Combined Wander Plug and Fuse, with 60 m/a fuse, 1/6.

SINGLE BASEBOARD FUSE-HOLDER, with $\frac{1}{2}$ amp. fuse, 1/3.

FLEXIBLE LEAD FUSEHOLDER, short type, with $\frac{1}{2}$ amp. fuse, 1/- (longer type, with mains fuse, 1/-)

TWIN BASEBOARD FUSEHOLDER for mains fuses (Regd. design) complete with two lamp fuses. Price 3/6. SPARE FUSES, all sizes, 6d. each.

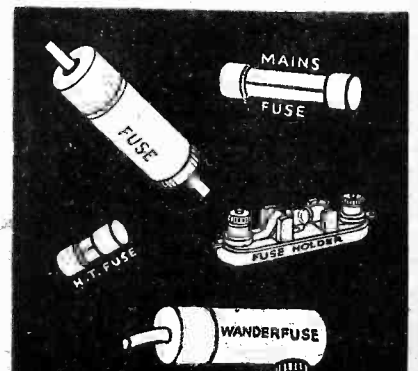

THE NEW TUNGSRAM POWER DETECTORS

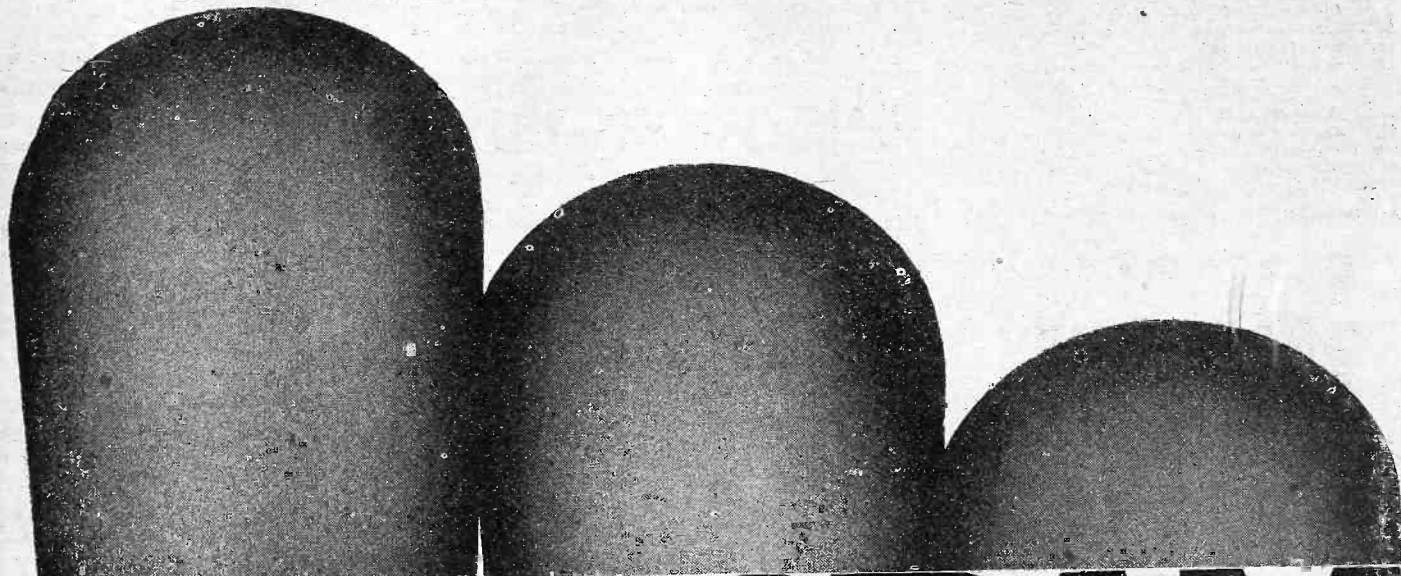

TUNGSRAM BARIUM VALVES

T.3123.



Here are three types from the complete new Tungsr-
ram range, particularly suitable for portable receivers:
PD220, a new and specially designed anti-micro-
phonic detector valve; P220, a new and extremely
efficient low current consumption power valve;
L210, an entirely new valve which is mainly
suitable as detector or first low frequency amplifier.
Characteristics are given below.

Type	Fil. Volts.	Fil. Amps.	Max. H.T. Volts.	Amp Factor.	Anode Resistance (Ohms).	Mutual Cond. m/a V.	Price
L210	2	.1	200	16	16,000	1.0	5/6
*PD220	2	.2	150	17	10,000	1.7	6/3
*P220	2	.2	150	7	4,500	1.5	7/9

*These types will be generally released during the early part of the season
Write to Dept S.T.3 for full particulars of the complete new range. Prices from 5/6 to 19/-.
Tungsr-ram Barium Valves are manufactured under one or more of the following Patent
Nos.: 289,762, 289,763, 311,705, and 313,151.

TUNGSRAM ELECTRIC LAMP WORKS (GT. BRITAIN), LTD.
Radio Department, Commerce House, 72, Oxford Street, London, W.1.

Makers of the famous Tungsr-ram Electric Lamps.

Branches in Birmingham, Bristol, Cardiff, Glasgow, Leeds, Manchester, Newcastle, Nottingham, Southampton.

Lamp, Valve and Glass Factories: Austria, Czecho-Slovakia, Hungary, Italy and Poland.
I.F.S. Organisation, Tungsr-ram Lamps & Radio, Ltd., 11, Burgh Quay, Dublin.
Tungsr-ram photo-electric cells: Navy "E" (for scientific measurement); £2 17s. 6d.



THE NEW 2 VOLT

101 HINTS AND TIPS

(Continued from page 352.)

Do not neglect the adjusting screw on your loudspeaker, as the exact distance of the permanent magnet from the diaphragm (controlled by this) is of great importance in getting maximum sensitivity.

If one of your telephone earpieces breaks down; remember that a wire across its two terminals may enable you to listen to the conclusion of the programme on the one earpiece.

Remember that great care is necessary in the handling of electric light wiring. It should not be undertaken by inexperienced persons.

When using mains units, remember that safety fuses are cheap and easily fitted, and that such apparatus should never be left at the mercy of inexperienced people or children.

On no account connect up a mains unit without reading the manufacturer's directions carefully, as serious damage may be caused by wrong connections.

Checking Charging.

A good voltmeter enables you to run the set economically, and not only indicates when battery renewal or re-charge are necessary, but enables you to check the work of the re-charging station.

If you use an H.T. mains unit, you should always switch this off when you switch the set off, and not rely on the on-off switch of the set to break both circuits.

A spare fixed condenser (.001 will do) fitted between the aerial terminal and the aerial lead is a worth-while precaution on valve sets which take their H.T. from D.C. mains.

If you are unable to get reaction when your condenser is all in, except towards the lower end of your tuning range, a small fixed condenser, usually .0001 or less, connected across the reaction condenser is an improvisation worth trying.

A grid leak inserted between the grid of the first L.F. valve and the wiring to this is useful in obviating troubles due to H.F. superimposed on L.F. (The value of the resistance should be about a quarter of a megohm.)

Trouble with reaction overlap is often due to the wrong H.T. voltage on the detector, to an unsuitable detector valve, or to a grid leak of wrong resistance.

Do not assume that a short-wave circuit is no good for long-distance reception owing to ploppy reaction until you have tried varying

Too much reaction is worse than none at all, for it is impossible to hear long-distance or good quality signals if your set is oscillating.

If you are interested in short-wave reception, but do not wish to build a special set for this, do not forget the possibilities of the "P.W." "Antipodes Adaptor," which plugs into your ordinary set and enables it to receive short-wave stations.

Tuning A Short-waver.

For accurate tuning on a short-wave set there are many advantages in mounting a small magnifying glass over the tuning-dial scale.

A useful safeguard against threshold howl in a short-wave set is the provision of a .5-megohm resistance across the secondary of the L.F. transformer.

One of the best methods of arranging a

"P.W." PANELS, No. 41—SHORT WAVES.

In addition to ordinary broadcasting, intended to cover areas adjacent to the broadcasting station, "short" waves are used for transmission to very distant places.

Great Britain has a short-wave station at Chelmsford, to link it with the Empire.

Although Chelmsford's programmes are not heard well in this country, the short wave-length used (25-53 metres) enables the transmissions to be picked up in places like India, Africa, America and Australia, when special short-wave coils are used for tuning.

the H.T. voltages on the detector, a different valve, wide variations of aerial coupling, variable control of filament resistance, and a small indoor aerial.

If a lead pencil of the HHH or HHHH hard type is soaked in water and half the wood removed, the lead itself embedded in the wood will be found to make a satisfactory emergency resistance for a potentiometer or similar purpose.

loudspeaker extension is by means of a plug and jack, the jack being of the type in which the circuit is closed when the loudspeaker plug is withdrawn from it.

Arc lamps as used for "sunlight" ray treatment are capable of causing tremendous interference with near-by receiving sets.

The most important wires in a short-wave set are those from the grid to the tuned circuit

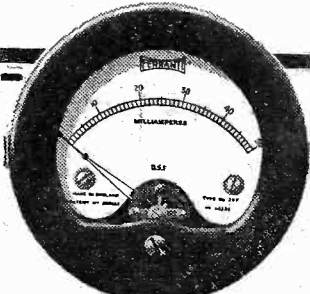
A reliable instrument in the plate circuit of the output valve is a valuable aid to true radio reproduction.

FERRANTI RADIO METERS

FERRANTI LTD. HEAD OFFICE & WORKS: HOLLINWOOD, LANCS.
LONDON: BUSH HOUSE, ALDWYCH, W.C.2.

A Ferranti Radio Meter in the circuit:

- 1 Shows the milliamps flowing in the anode circuit, so that the correct current can be determined.
- 2 Gives indications enabling the correct H.T. and G.B. voltages to be applied.
- 3 Enables any overloading in the output stage to be corrected.
- 4 Its use may prevent damage or destruction of costly valves, and—
- 5—its readings give an indication of the condition of the H.T. and L.T. Batteries.

H.T.
+

HELPFUL
CRITICAL
OUTSPOKEN
ENTERTAINING
FORCEFUL
UNIQUE
LIVE
FRANK
BRIGHT
CONSTRUCTIVE
TOPICAL
USEFUL
EXPERT



**Capt. P.P.
 Eckersley**

—world-famous as one of the pioneers of broadcasting with the Marconi Co. and the B.B.C.—is now Wireless Editor of *The Daily Mail*. His brilliant and outspoken article every Wednesday is one outstanding feature of the day-to-day service for the listener provided by The

**DAILY
 MAIL**

**AMPLION
 MOVING COILS
 for Home Constructors**

NOW no home constructors need be without the very finest reproductive equipment, with AMPLION Moving Coil units at such modest figures. These super-sensitive units will make a world of difference to your results on any circuit; there are many handsome cabinet models, or you can easily fit one to your existing cabinet.

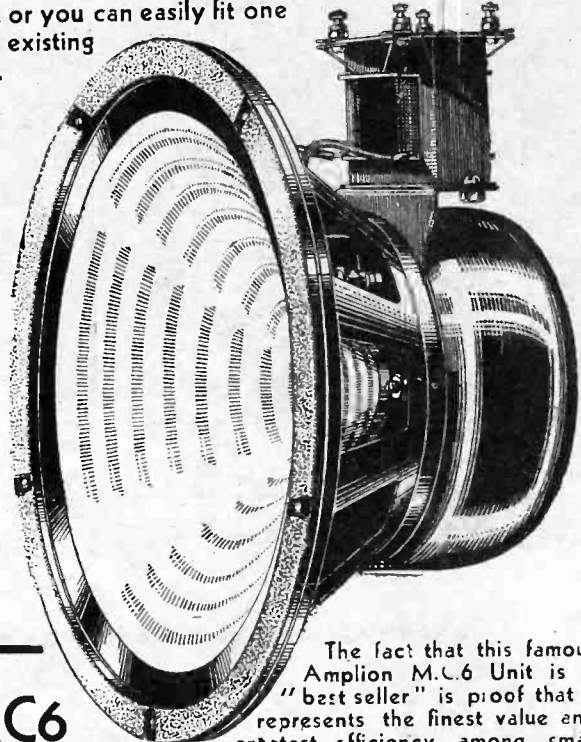

MC6
 UNIT, complete with Transformer,
67/6

D.C. ENERGISED MODEL (E.M. 644)

A MOST efficient unit for D.C. Voltages: 100/110, 200/240, very suitable for inclusion in A.C. sets. Full details of alternative methods of operation supplied with each model

UNIT ONLY **29/6**
 UNIT WITH matching transformer **42/-**

The fact that this famous Amplion M.C.6 Unit is a "best seller" is proof that it represents the finest value and greatest efficiency among small permanent-magnet moving coil speakers. Its reproduction and sensitivity are really remarkable, and it will handle without distortion adequate volume for all normal requirements. The universal transformer which is fitted enables the speaker to be correctly matched to either Power Super Power or Pentode output from standard British 2, 3 or 4 valve receivers, and provision is made for push-pull

M.C.9 UNIT

THIS is a permanent magnet type but larger and more powerful than the M.C.6. A matching transformer can be supplied at an extra cost of 15/-



M.C.9 UNIT ONLY £6
 (or on deferred terms)

THE REGENTONE TWO-VALVER

A remarkably inexpensive
and efficient all-mains
receiver described by
F. BRIGGS.

THE new Regentone two-valve receiver is designed for all-mains working, and will work on A.C. supplies of any voltage between 200 and 250 volts. Built into a moulded bakelite case, it is one of the "nattiest" sets I have seen, although it will work a large moving-coil speaker with ease, giving more than sufficient volume for ordinary domestic purposes.

Free from Hum.

The receiver employs a metal rectifier and is remarkably free from mains hum. Only by placing one's ear close to the loud speaker is it possible to hear the smallest trace of ripple and then only when there is no broadcasting going on.

Now, turning to the back of the receiver, eight plug holes will be found. There are three marked as follows, A1, A2 and A3, these being for the aerial. The first is only used when the receiver is situated close to a powerful broadcasting station, and when maximum selectivity is required. The second is for average conditions, and the last when an indoor aerial or a very short outdoor aerial is employed.

The remaining plug sockets are one for the earth connection, two for a pick-up, if

required, and two more for the loudspeaker. The three controls on the front panel are also very conveniently arranged.

On the extreme right is the wave-change switch and on the opposite side is the reaction control. The single tuning knob is situated right in the centre of the panel.

In operation, the set is extremely easy to handle and the merest novice should not have the slightest difficulty in handling it. At a distance of approximately twelve miles from the two London transmitters no difficulty was experienced in separating the programmes with the aerial, which was a fairly large one, plugged in the A2 socket.

The quality from the two local transmissions, as heard on a good moving-coil speaker, was first class.

By using a "spot" of reaction it was fairly easy to bring a few of the more

ATTRACTIVE APPEARANCE

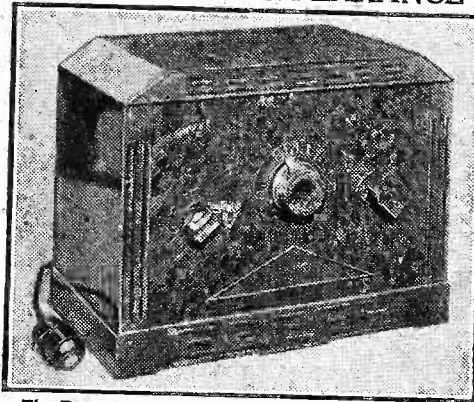

The Regentone A.C. set is built into a beautifully moulded bakelite case, and the controls are few in number and very easy to manipulate.

INSIDE THE SET

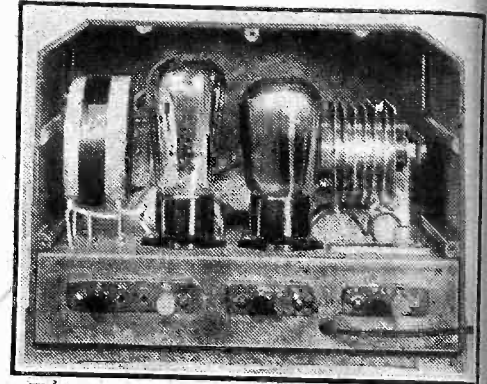

This photograph was taken with the back removed and clearly shows all the "innards." Note the dry rectifier on the right.

powerful foreigners as well. Among these Rome, Brussels and Radio Paris were particularly good, the latter came in at good loud speaker strength at all times of the day.

Wide Wave Range.

The wave-range covered is more than adequate. With the aerial connected to the A2 socket stations down to about 200 metres could be received, while the other end of the tuning condenser took one up to about 650 metres, which is well above the medium broadcasting band. On the long waves, zero on the pointer represented 850 metres, and with the knob turned right round to the maximum, 2,400 metres was reached.

Altogether the Regentone 2-valve set is a fine proposition and is representative of the best practice in up-to-the-minute British radio.



Make a
new circle
of friends

BY USING

ETA VALVES

A laugh . . . a whisper . . . a song will come over
the air to you rich and true when you're using ETA Valves.
Years of care went into the making of the ETA range, that's
why you had to wait . . . but now . . . insist on ETA Valves.

THE ELECTRICAL TRADING ASSOCIATION, LTD., Aldwych House, W.C.2
Telephone: Holborn 8139.
Agents: W. J. BYRNE, 21, Temple Lane, Dublin.
132, Renfrew Street, Glasgow.

FOR THE LISTENER

(Continued from page 344.)

themselves to Radio production. Others because of the weakness of the actors. But most of the failures have been due to the fact that the plays were poor plays in themselves. A poor play will never make good Radio.

What is a good play? Mr. Bernard Shaw has said that a play must contain 'a story and some characters.' A good play, therefore, must contain a good story and some good characters.

The characters must be interesting and well drawn. This is required in any good play, radio or otherwise. If a character is not interesting, that part of the play is dead.

Froth and Bubble.

The control panel can do pretty well what it likes with him; you can hear him driving furiously in a taxi along a road, or even more furiously in an aeroplane through the sky; he can hold conversations with ghosts and goblins; he can be in London one moment, in Arabia the next, in the South Seas the next after that; you can shoot him out of a gun to the Moon, or back into the year 1000 B.C., or forward into the year A.D. 4000; but if you are not interested in him, and don't really care whether he is dead or alive, all this will be mere froth and bubble, a mechanical excitement; it won't be a play.

He might as well be a sack of potatoes; and though it would be exciting enough to see a sack of potatoes shot to the Moon, you couldn't make a play out of it. It is the characters which make and play, and your interest in them keeps the play moving.

I often wonder how many persons listen to the Radio Plays. Comparatively few, I think. Not so many as listen to the vaudeville programmes, for example, or the Symphony Concerts. A few thousands, perhaps.

Most of these, I imagine, listen because they are fond of plays. Country folk very likely, who rarely get to a decent theatre. They have every right to be catered for. They must, in my view, be fed with good plays.

Stunts, Spooks, and Pageants.

I think that the Dramatic Section of the B.B.C. ought to make up its mind what sort of an audience it wants to cater for, and to concentrate on that. Out of the millions of listeners, it can in time get what audience it likes.

Nothing is so much wanted in the dramatic world just now as the creation of an audience which will demand plays of the highest possible order. There is no reason why the B.B.C. should not become, in this part of it, a kind of National Theatre, devoted to the provision of first-rate plays, old and new, if they are such as can be well produced in its medium.

But it seems to me to lack policy. We get plays of all sorts, good, bad, and indifferent. We get kaleidoscopic plays, pageant-plays, spook plays, Shakespeare cut into shreds, stunt plays without so much idea in them as would buy a penn'orth of second-hand toffee; and so on. I suppose the idea is to spread the net wide, and to catch as many listeners as possible. Along

New Times Sales Co

We can supply any accessory advertised in "Popular Wireless" on EASY TERMS. Send US your next order. We guarantee you every satisfaction.

ENJOY THE NEWEST IN RADIO THROUGH OUR REALLY EASY TERMS

MANUFACTURERS' KITS.

COSSOR 234 EMPIRE MELODY MAKER
Screened-Grid, Detector and Power.
With valves and cabinet **10/-**
CASH PRICE £6 15s. 0d. WITH ORDER
Balance in 11 monthly payments of 12/6. Finished Instrument. Royalties Paid, £7 10s. 0d. Cash, or £2 deposit and 11 monthly payments of 11/-.

MULLARD 3, 1932 TYPE
Screened-Grid, Detector and Pen-
tode. With valves less cabinet **11/11**
CASH PRICE £6 10s. 0d. WITH ORDER
Balance in 11 monthly payments of 11/11. Finished Instrument, with Valves and Cabinet. Royalties Paid, £7 17s. 6d. Cash, or £2 deposit and 11 monthly payments of 11/9.

OSRAM NEW MUSIC MAGNET 4
2 Screened-Grid, Detector and
Power. With valves and cabinet **19/8**
CASH PRICE £10 15s. 0d. WITH ORDER
Balance in 11 monthly payments of 19/8. Finished Instrument. Royalties paid, £11 15s. 0d. Cash or £2 deposit and 11 monthly payments of 19/6.

SIX-SIXTY CHASSIKIT, BATTERY MODEL.
Complete three gang band-pass
tuning. S.G., Detector and Pen-
tode. **12/7**
CASH PRICE with valves less cabinet £6 17s. 6d.
Balance in 11 monthly payments of 12/7.

SIX-SIXTY CHASSIKIT. (A. C. MODEL.)
Complete as above with A.C. **13/5**
Mains Valves. WITH ORDER
CASH PRICE with valves less cabinet £7 6s. 6d.
Balance in 11 monthly payments of 13/5.

ELIMINATORS

EKCO K.18 COMBINED H.T. ELIMINATOR AND L.T. TRICKLE CHARGER. Delivers 18 m/a and suitable for 1- to 5-valve sets. S.G., 50/80v., 120/150. Charges at 25 amp. at 2, 4 or 6 volts. Cash price £4 12s. 6d.
Balance in 11 monthly payments of 8/6.

ATLAS A.C. ELIMINATOR TYPE A.C.244. 3 Tappings, S.G., Detector and Power. Output 120 volts at 20 m/a. Cash price £2 19s. 6d.
Balance in 11 monthly payments of 5/6.

EKCO A.C.25 H.T. ELIMINATOR. Send Tappings—S.G. 50/80 volts, 100/150 volts at 25 m/a. Cash £3 17s. 6d.
Balance in 11 monthly payments of 7/1.

HEAYBERD H.T. UNIT "D" MINOR. Output 120v. at 20 m/a. Tapped at 80v., 100v. and 120v. Cash price £2 17s. 6d.
Balance in 11 monthly payments of 5/4.

EXIDE 120-volt. TYPE W.H., H.T. ACCUMULATOR, in crates. With 8/6
Cash price £4 13s. 0d.
Balance in 11 monthly payments of 8/6.

10/- down AND 11 MONTHLY PAYMENTS OF 10/10

V.3. RADIO FOR THE MILLION
Screened-grid Detec- CASH PRICE
tor and Power. With £5 : 17 : 6
Valves, less Cabinet.

NEW TIMES SALES PERMANENT MAGNET MOVING-COIL SPEAKER. With 6/11
In handsome oak french polished cabinet, order
with specially designed Epoch chassis, giving glorious tone and volume. With multi-ratio transformer. Cash Price £3 15s. 0d.
Balance in 11 monthly payments of 6/11.

AMPLION MOVING-COIL SPEAKER, TYPE M.C.6. Permanent magnet, with output transformer. Complete. With 6/2
Cash price £3 7s. 6d. order
Balance in 11 monthly payments of 6/2.

B.T.H. RK. MINOR PERMANENT MOVING-COIL SPEAKER. Handles output up to 2 watts. Cash price £2 10s. 0d.
Balance in 8 monthly payments of 6/-.

EPOCH PERMANENT MAGNET MOVING-COIL SPEAKER. Type A.2. With 5/9
Cash price £3 3s. 0d. order
Balance in 11 monthly payments of 5/9.

R & A "100" MOVING-COIL REPRODUCER. With tapped Input Transformer. With 5/4
Cash price £2 17s. 6d. order
Balance in 11 monthly payments of 5/4.

ORMOND PERMANENT MAGNET MOVING-COIL CHASSIS (No. 464), With tapped input transformer. With 6/-
Cash price £3 5s. 0d. order
Balance in 11 monthly payments of 6/-.

CELESTION PERMANENT MAGNET MOVING-COIL SPEAKER. Type 8. With 6/5
8 in. Reinforced Diaphragm, excluding input transformer. Cash price £3 10s. 0d. order
Balance in 11 monthly payments of 6/5.

LAMPLUGH, FARRAND, FERRANTI or GECOPHONE DYNAMIC INDUCTOR SPEAKER for perfect reproduction. Unit and chassis complete, ready mounted. Cash price £3 10s. 0d.
Balance in 11 monthly payments of 6/5.

N & K INDUCTOR DYNAMIC SPEAKER. Unit and Chassis Complete. With 6/5
Cash price £3 10s. 0d. order
Balance in 11 monthly payments of 6/5.

EPOCH J. I. PERMANENT MAGNET MOVING-COIL SPEAKER. In chassis form with multi-ratio input transformer. With 4/2
Cash price £2 5s. 0d. order
Balance in 11 monthly payments of 4/2.

GARRARD INDUCTION GRAMOPHONE MOTOR. Model 202. Mounted on 12-inch Nickel Motor Plate with fully automatic electric starting and stopping switch. With 5/4
Cash price £2 18s. 6d. order
Balance in 11 monthly payments of 5/4.

B.T.H. PICK-UP and TONE-ARM. With 4/2
Cash price £2 5s. 0d. order
Balance in 11 monthly payments of 4/2.

ESTABLISHED IN 1924—FIRST WITH EASY TERMS

NEW TIMES SALES CO. 56, LUDGATE HILL, LONDON, E.C.4.

Phone: Central 2716

(a) Please send me further particulars of

(b) I enclose s. d. as first payment for

NAME

FOR THE LISTENER

(Continued from previous page.)

I listen to most Radio Plays, partly because I like plays and partly because it is my job. I confess that, if it were not my job, I shouldn't listen to so many as I do.

I should have switched out of "The Lost Cause" at the end of the first five minutes. Because, as a play-lover, I ask first of all for good plays; well-constructed stories, with living, interesting characters.

I venture to suggest to the organisers of the Dramatic Section that it is worth while catering for me, and for listeners who are play-lovers like me. It would be better to build up an audience of listeners like us, and play up to us with the best material possible; to make a regular audience of us; rather than to spread the net, baiting it with stunts and curiosities, in the hope of catching Tom, Dick and Harry for an odd night or two—whose interest is not in plays, but merely in being tickled and amused for the moment.

MIRROR OF THE B.B.C.

(Continued from page 344.)

The author has changed his mind and withdrawn permission for a radio version of the play, which might have been very awkward were it not that sufficient time still remains to arrange something else for Mr. Robeson.

The famous Negro singer will now appear in a composite programme based upon the song and story of his race, the first half of which will consist of a revival of "Gods Trombones," which he gave about two months ago.

The other part of the programme will trace the expression of the Negro genius in English song and story from Uncle Remus to the jazz rhythmic songs, and listeners will hear Robeson sing Blues for the first time. I understand he will also give a recital of Vachell Lindsay's poem "Congo." The programme will be given on Friday, October 23rd, and repeated the following evening.

Vaudeville entertainments are showing a distinct improvement since the end of the summer holidays brought back to London many well-known artistes.

Good Vaudeville Coming.

This type of entertainment is still the most popular part of the broadcast programmes, irrespective of the fact that the all-round standard of excellence in broadcasting material has improved out of all recognition when listeners voted vaudeville to be what they wanted most two years ago.

The B.B.C. is well aware of our preferences in this direction, and intends to put on an average of two first-class shows each week during the winter, as well as a regular series of radio revues and other light features. Tuesday, October 20th, has a particularly good bill when Edith Day of "Rose Marie" fame and Robert Naylor (Tauber's understudy in "The Land of Smiles"), who have joined forces in a variety act, will make their first appearance together before the microphone. Geoffrey Gwyther, Isobel Elsom and Harold French, The Two Pairs, Clapham and Dwyer and eight members of the Male Voice Chorus will also take part.

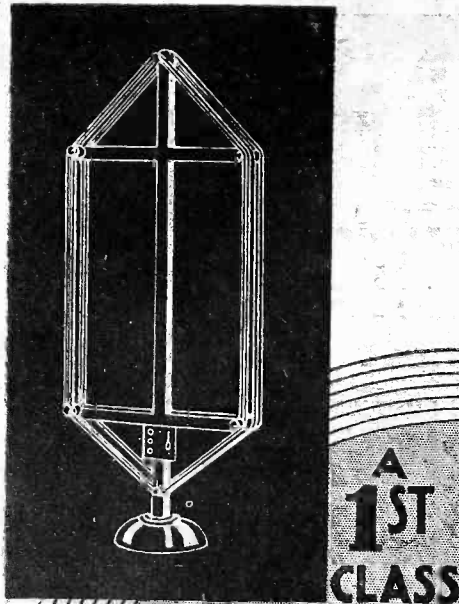

FRAME AERIAL FOR ONLY 20/-

A wonderful frame aerial at an amazingly low price. This aerial was especially designed for use with Super-het receivers, but can also be employed in any circuit with or without centretap.

The Ealex Frame Aerial has a definite minimum silent point.

AND THE EALEX SHORT WAVE CONVERTOR

which enables existing sets to be used for the reception of ultra-short-wave bands—thus giving you more and better programmes. Price only 60/-. Ask your dealer for full details, or write for leaflet A2 giving full details also of Ealex Byldurone Cabinet, Testing prods, Terminals, Plugs, and Sockets.

J. J. EASTICK & SONS
118 Bunhill Row, London, E.C.1

Phone: Metropolitan 0314/516

EALEX FRAME AERIAL

ONE MILLION SOLD ANNUALLY

That fact indicates their quality and extreme reliability. They are world-famous. Write today for the new illustrated lists and new low prices.



VALVE HOLDERS AND SWITCHES

Made by the Makers of the famous
W.B. PERMANENT MAGNET MOVING COIL SPEAKERS

WHITELEY ELECTRICAL RADIO CO., LTD., NOTTINGHAM RD., MANSFIELD, NOTTS.

Irish Free State Distributors: Kelly & Shiel, Ltd., 47, Fleet Street, Dublin.

ENGINEERS. Seriously, if you are earning less than £10 per week you cannot afford to carry on without reading "Engineering Opportunities." Whether you are an old hand or a budding apprentice, this 200-page volume will point to a worth-while future. Among other things the book explains the methods of our unique Appointments Department, gives details of all leading Eng. Exams. (A.M.I.Mech.E., A.M.I.E.E., B.Sc., G.P.O., etc.) and outlines modern Home Study Courses in Civil, Mech., Elec., Motor, Aero, Radio, "Talkie," and all other branches of Engineering. This book will alter your entire outlook and earning power. It is quite FREE. Send for your copy now.

BRITISH INSTITUTE OF ENGINEERING TECHNOLOGY,

401, Shakespeare House, 29/31, Oxford St., London.

LOUD SPEAKERS REPAIRED, 4/-

(Blue Spot a Speciality, 5/-)

Transformers 4/6, Headphones 4/6, all repairs magnetised free. Tested, guaranteed, and ready for delivery in 24 hours.

Discount for Trade. Clerkenwell 9069.
E. MASON, 44, EAST ROAD, N.1.

YOUR NEW CIRCUIT

Reg. Design 766670



Standard Type (Reduced View)

STRAIGHT or SUPER requires the "KINVA" SCREENED

H.F. CHOKE FOR BEST RESULTS

A high Inductance, Fieldless Choke at low price. 2/9

Free List explains why. If your dealer is not stocking, write

POSTLETHWAITE BROS. KINVER, STOURBRIDGE.

ADVERTISERS PLEASE NOTE!

The Rate for a one-inch single Column Advertisement is 30/-

Minimum Space Accepted: Half-an-inch .. 15/-

Send Remittance with instructions to

TECHNICAL NOTES

Some diverse and informative jottings about interesting aspects of radio reception.

By Dr. J. H. T. ROBERTS, F. Inst.P.

A Ganging Fallacy.

THERE is a popular idea that the two halves of a band-pass filter must necessarily be tuned simultaneously — by ganging their controls. This, however, is not so, and where ganging is used it is merely for the sake of ease of control.

There is no particular reason, apart from this, why the two parts of the filter should not be operated separately if desired. People often think that if they are not operated by ganged control, the proper action of the band-pass filter is lost.

Coupling for Selectivity.

This brings us to the general question of coupling circuits for the purpose of obtaining selectivity and I daresay some readers may also have the idea that the addition of a coupled circuit is a complicated business, or may have some adverse effect upon the original circuit.

As a matter of fact, however, it is often quite simple to add a coupled circuit and, although there will be a reduction of signal strength due to the interposition of the additional circuit, this need not be serious and is often more than counterbalanced by the extra selectivity which is gained.

For instance, take the case where the tuned circuit consists simply of the conventional coil and variable condenser, the aerial being connected to a tapping on the coil. Now, if another tuned circuit is introduced before this circuit, it is only necessary to remove the aerial connection from the tapped coil and connect it instead to the appropriate tapping on the coil of the additional tuned circuit, this circuit being then coupled through a (variable) condenser to a tapping on the coil of the original circuit.

There are thus three variable condensers, one in each of the two tuned circuits and one for the coupling. Of course, the aerial need not be connected directly to a tapping of the coil of the additional circuit, but may be coupled to the coil in any of the well-known ways.

Varying the Coupling.

With an arrangement of this sort, the amount of the coupling can be varied by adjustments of the coupling condenser. If the capacity is made very low, the coupling will be weak, and the signal strength will be cut down, although on the other hand the selectivity will be increased. Conversely as the coupling is increased, the signal strength will be improved, but the selectivity will not be so sharp.

There is, however, a limit to the extent to which you can go on increasing the coupling, for there comes a point where the separate resonances of the two circuits become pronounced; in other words, the whole circuit shows double-tuning.

(Continued on next page.)

TRANSFORMERS

Dario Transformers are made under a special process of wiring and insulating the different circuits. Notwithstanding their very low price they give marvellous results.

Ratios 1-3 and 1-5.

Constructor - - - 4/6

Normal - - - 5/-

Super - - - 6/-

Also available, extensive range of mains transformers and Filter Chokes.

DARIO SILVER OXIDE CHARGER

the best in the world. Enables you to charge your accumulators in your own home, 17/6.

DARIO SETS

The Dario S.G. 3 Battery Type Receiver now reduced to £5-17-6, complete with Dario Valves. Represents amazing value. Highly sensitive, gives wonderful volume. Renowned for its purity of reception.

The Dario Regional Straight 3 Transportable housed in an attractive oak modern cabinet complete with Dario valves and matched speaker - - - 24-17-6

Inside frame aerial 10/- extra.

Made in one of the most modern factories in the world under a special secret process, Dario valves incorporate the new Radio Micro Dull Emitter Filament which ensures great sensitivity, unequalled performance and utmost current economy.

DARIO UNIVERSAL BIVOLT - 5/6

DARIO SUPER H.F. BIVOLT - 5/6

DARIO SUPER POWER BIVOLT 7/6

etc., etc.

Also 4 volts and A.C. Mains types.

Write for illustrated folder giving full particulars.

Charge Your Own Accumulator at Home

There is no need to send your accumulator to a service station. Install the latest Heayberd Trickle Charger, Model A.C.2, and switch on to the Mains. Charging rate 1 amp. on 2, 4 or 6 volts accumulators. Fitted with Cover case and incorporating Westinghouse Rectifier this excellent Charger has been used and recommended by "Popular Wireless."

Price **35/-**

.....POST THIS TO-DAY.....

I enclose 3d. stamps for full lists of Heayberd Mains Products with circuit diagrams and valuable hints on their usage.

M

Address



MASTERS OF THE MAINS.

10, FINSBURY STREET, LONDON, E.C.2.

PERSONS REQUIRED

immediately to make Leather Matting; regular work supplied, cash paid weekly. Write: E. 14 "Everlast" Leather Matting Co., Wellingborough.

Cone Users— here you are!

Every user of a Cone Speaker is catered for with "Tonax." Each carton contains three chucks, linen washers, felt washers, and both deep and standard metal washers.

"TONAX"
Improved CONE ADAPTOR

Quickly and easily fitted to any Single or Double Cone Speaker using any unit. All rattle and distortion is eliminated, leaving reproduction pure and clean-cut. Full instructions in every box.

Single Cone Type	1/-
Double Cone Type	1/6

From all dealers or direct. Send P.O. to Dept. P. GARRATT STORES, 193, GARRATT LANE, WANDSWORTH, LONDON S.W.18.

THE PICTURE PAPER WITH THE MOST NEWS—
SUNDAY GRAPHIC
and Sunday News.

REMEMBER! "POPULAR WIRELESS" has the largest sale of any

TECHNICAL NOTES

(Continued from previous page.)

This is an effect often found with coupled circuits and although theoretically you can go on increasing the coupling beyond this point, there is no practical advantage in doing so.

There are, of course, many variations of the coupled circuit, of which the foregoing is one of the simplest examples. Beyond certain precautions for special cases, however, there is nothing difficult about the addition of tuned circuits, and if your set is not sufficiently selective, it is well worth while to consider going in for something of this kind.

Using the Controls.

The question of selectivity is closely bound up with the question of tuning and of getting the greatest number of stations of which your set is capable. I often find that people complain that their sets will not bring in a sufficient number of stations when, in point of fact, all that is necessary is attention to a few details, often overlooked.

Many people think that it should only be necessary to turn the tuning control, or controls, including reaction, and stations should come tumbling in. Well, of course, this is the ideal to be aimed at, but before you can expect this, you have to be sure that the set itself has been brought to the proper state of efficiency.

Let us consider the controls in the broad sense. There is the simple set with only one tuned circuit and reaction. Then there is the set with an H.F. stage, having two tuning controls, one for the H.F. and one for the detector, as well as a reaction control. Then there is the set with one tuning control operating two or three ganged circuits and also a reaction control.

Bringing Them In

If results are not satisfactory with the first type of set, you may turn your attention first of all to a band-pass tuner or wave-trap on the lines I mentioned earlier in these Notes. When you turn the tuning control, probably you pass over a succession of squeaks, and if so you have to find out why it is that these carrier-waves pass by in the form of squeaks instead of coming in as stations.

The reaction must, of course, be smooth and the set must not "plop" in and out of oscillation. Possibly the value of the high-tension on the detector requires altering, whilst again another very common fault—if the reaction is misbehaving—is too low a value of grid leak.

Another thing to try is a variable bias on the grid, by means of a potentiometer: this often helps considerably in obtaining smooth reaction. Make sure also that the value of the reaction condenser is not too large.

Tuning and Reaction.

It is essential to get the reaction smooth, and the tuning fairly sharp, before you begin to search in earnest for stations. Then you want to bring the reaction up to the point just short of oscillation and turn the tuning control very slowly, keeping pace with it by corresponding adjustments of the reaction—for in most sets you will find that the tuning and reaction adjust-

CLIX

"P.V. PLUS" KIT

Builders of this "Popular Wireless" set need all these Clix fittings for perfect contact.

10 Panel Terminals
6 Wander Plugs
2 Spade Terminals **3/6**

All correctly engraved. Buy a Clix Kit and save time and trouble.

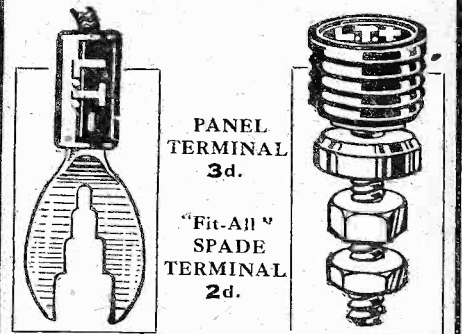

Folder "P" on request.

Cheapest PERFECT Contact

Lectro Linx, Ltd., 254 Vauxhall Bridge Road, S.W.1.

MAKE YOUR OWN HIGH TENSION ELIMINATOR AND ALL-POWER UNIT

"SENSITITE"

Eliminator Kits employing famous "Radcroix" Transformers.

KITS OF PARTS FOR:

H.T., A.C. Units
20 mA., 120 v., S.G. 60, Det. 80, Max. 120, £2 0 0
35 mA., 200 v., S.G. 65, Det. 75, Int. 150, Power 200 volts .. £2 15 0

H.T. and L.T.
12 Variable Voltages, 20 mA., 190 v., S.G. var., Det. var., Power 190 volts .. £3 5 0
Wiring Diagrams free. State A.C. or D.C.

THE WHOLESALE WIRELESS COMPANY
103, Farringdon Road, London, E.C.1.
Telephone: CLERKENWELL 5312

NEW "PURATONE" PROCESS 2 VOLT DARK EMITTER

H.F., L.F., VALVES 3/9
DET., R.C.

Power - 5/3

Super-Power 6/3 Screen-Grid 7/6

BRITISH MADE. FULLY GUARANTEED.

Actual Makers **RUBON LTD.**,
189, New King's Rd., London, S.W.6

PLEASE be sure to mention "POPULAR WIRELESS" when communicating with

TECHNICAL NOTES

(Continued from previous page).

alteration of the one involves alteration of the other.

If you have a high-frequency valve, with separate control, you want, as far as possible, to keep this "in step" with the aerial circuit. These two controls are usually a little bit out, and the amount of the discrepancy can best be determined by sharpening up the tuning.

When searching for stations you want to keep the two controls in step, having regard to the amount of apparent out-of-step which you have previously ascertained by test. In this way, and moving the controls very slowly, you should be able to bring in a good many additional stations.

With a set using ganged tuning, a good deal depends upon how accurate the ganging happens to be. With modern sets, you should not have much difficulty under this heading, but sometimes with older sets quite a lot of work is involved in getting the ganged circuits in tune.

Variable Ganging.

Often the ganging is not the same for longer waves as for shorter ones, and naturally this means that if the ganging is correct for one position, it becomes more and more "out" as you move away from that position.

With ganged circuits it is generally advantageous to have a certain amount of negative bias on the grid of the S.G. valve. It is also a good plan to see what can be done by adjustment of the aerial circuit to keep the ganging constant.

NEXT WEEK

A FREE BLUE PRINT

of the "P.W."

"DUAL-RANGER"

I haven't the space to go further into this question at the moment, but I want to say that if you are not getting all the stations you would like, or your set does not seem to "bring them in" like somebody else's, it is quite on the cards that a little time spent in adjustments, on the lines indicated above, may make all the difference and may bring out a performance from your receiver of which you never suspected it was capable.

H.F. in L.F. Circuits.

The presence of high-frequency oscillations in a low-frequency power stage is not always easy to show, but a very simple way of illustrating it was shown some time ago by the Mullard Valve Company. For the purpose of the demonstration a two-valve power stage was used with milliammeters to show the currents to the anodes.

Dangers of H.F.

It is very desirable to keep high-frequency oscillations out of the low-frequency part of the circuit for various reasons. For one thing, of course, they will interfere, often

Electrically Spot-Welded

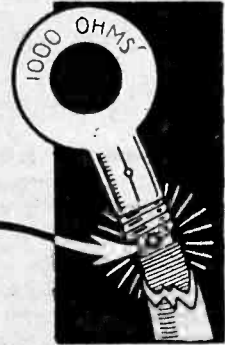

Bulgin Spaghetts are particularly recommended for use in the "Dual-Ranger" Set, described in this issue of "POPULAR WIRELESS" and for which a blue print is supplied in the issue of October 24th.

Once again the outstanding advantages of Bulgin Spaghetts have been emphasised. The unique method of ELECTRICAL SPOT-WELDING the resistance element to a copper winding secured to the tag, is the only satisfactory method of fusion with the hard nickel chrome wire. If this connection is not perfect the resistance link is liable to vary in value under load and in some cases an entire breakdown takes place. Bulgin Spaghetts are constant in value under prolonged usage. The original "Spaghetts," they have been proved in FARADAY HOUSE TESTS and remain UNCHALLENGED for quality and volume.

BULGIN SPAGHETTIS
Obtainable from all dealers
200 to 100,000 ohms
PRICES FROM **6d. to 2/6** according to size.



A. F. BULGIN & CO. LTD., Abbey Rd., Barking, Essex.

Telephones: Grangewood 3266 & 3267.

London Showrooms: 9, 10, 11, Cursitor St., Chancery Lane, E.C.4.

Telephone: Holborn 2072.

EASY PAYMENTS

"There's No Place Like HOLMES."

The first firm to supply Wireless parts on easy payments. Seven years advertiser in "Popular Wireless." Thousands of satisfied customers.

	Deposit	Monthly Payments
COSSOR KIT - - -	£6 15 10/-	11 of 12/6
OSRAM KIT - - -	£10 15 19/6	11 of 19/8
EXIDE H.T. Accum. 120v.	£3 6/-	9 of 6/8
BLUE SPOT 66R & CHASSIS.	£2 2/6 5/6	9 of 4/6
WUFA UNIT & CHASSIS	£2 4/5	9 of 4/5
AMPLION M.C.6 - - -	87 6 7/5	9 of 7/5
AMPLION Cone Speaker	15/-	4/6 3 of 4/-
EKCO Eliminator A.C.18	67/-	7/5 9 of 7/5
B.T.H. JUNIOR Pick-up	27/-	5/- 5 of 4/10

New Goods Obtained for Every Order. Send us a list of the parts you require and the payments that will suit your convenience, and we will send you a definite quotation. Anything Wireless. **H. W. HOLMES, 29, FOLEY STREET, Great Portland Street, London, W.1.** Phone: Museum 1414.

FOR YOUR RADIO COMPONENTS

A. T. HARRISON & CO.
Copper and Aluminium Screens by return of post.
Bakelite Moulds, Bakelite Mouldings.
Trade enquiries invited.
KINTORE WORKS, BERMONDSEY, LONDON, S.E.1.
Telephone: Bermondsey 1155

WET H.T. BATTERIES

Solve all H.T. Troubles.
SELF-CHARGING, SILENT, ECONOMICAL
IARS (waxed) 2 1/2" x 1 1/2" sq. 1/3 doz.
ZINCS, new type 10d. doz. 1/2 doz.
Sample doz. (18 volts), complete with bands and electrolyte. 4/1, post 9d.
Sample unit, 6d. illus. booklet free.
Bargain list free.
AMPLIFIERS, 30/-, 3-valve set, £5.
P. TAYLOR, 57, Studley Road,

It pays you to ask your Retailer for genuine guaranteed

WAVEMASTER

Variable Condensers and Extensers for all the latest Circuits

WEBB CONDENSER CO. LTD.,
42, Hatton Garden, London, E.C.1.

REPAIRS IN 48 HOURS

single ratio L.F. Transformers, Headphones, Loudspeakers (except Blue Spot). ONE YEAR'S GUARANTEE.
TRANSFORMER REPAIR CO., Post Free 3/9
953R, GARRATT LANE, LONDON, S.W.17 Terms to Trade

WIRELESS CABINETS

We can supply any type of cabinet ready to receive your radio set direct from our works at lowest costs.

Real Photographs, with sizes and prices of our latest models, also Woodworker's Pocket Guide of ready to assemble cabinets, will be sent on receipt of 3d. in stamps.

REDRUP & SON, Radio Cabinet Makers,
178, Albert Road, Southsea.

EXACT TUNERS

250 to 2,000 metres. Thousands of these tuners are in use, and we can strongly recommend them. No further coils are required. Send P.C. for particulars and circuits—FREE.

THE EXACT MANUFACTURING CO.,
Croft Works, Priory Street, Coventry.

B4.U. BUY your Moving Coil Speaker WRITE NOW FOR

42 pages of valuable information on how to secure REALISTIC REPRODUCTION.
BAKER'S Selhurst RADIO SURREY.
CROYDON SURREY.

PAREX

Products PAR-EXcellence
are used and recommended for the

"P.W." "DUAL RANGER"

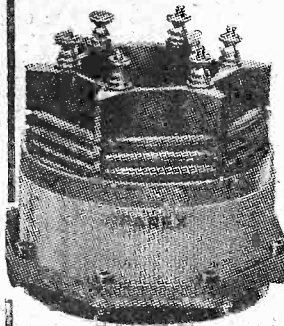

"P.W."
**DUAL
WAVE
COIL**
10"

The Finest
DUAL COIL
on the market

**HIGHEST EFFICIENCY
SMALLEST SELF-CAPACITY**

The only "P.W." Dual Coil with Tubular
Spacers and easily accessible Terminals.
APPROVED BY "P.W." & "M.W."
Each Coil Tested and Calibrated on
Actual Broadcasting.

- | | |
|--|-----|
| P.J.3 COIL | 2/6 |
| .0005 mfd. solid dielectric condenser | 2/6 |
| Wave-change switch 1/6, on-off switch | 1/- |
| Diff. reaction condenser | 4/6 |
| Screen, 10" x 7" with hole | 2/6 |
| H.F. chokes - each | 3/6 |
| Spag. resist. 25,000 ohm 1/6, 50,000 ohm | 1/9 |
| Horizontal mounting valve holder | 1/6 |

From your dealer, or direct from

E. PAROUSSI,
10, FEATHERSTONE BUILDINGS,
HIGH HOLBORN, LONDON, W.C.1.
Phone: Chancery 7010

EASY TERMS

WE supply all good quality Radio Receivers,
Components and Accessories on deferred
terms. We carry adequate stocks and can give
PROMPT DELIVERY.

- NEW HEAYBERD A.C. ELIMINATOR**
KIT C.150. Complete kit of parts for building
an H.P. Eliminator, including steel case. Out-
put 25 m.a., 150 volts. 3 H.T. Tappings, one
variable. Cash Price £3 16 0
Or 7/6 with order and 11 monthly payments of 7/-
- 12 EXIDE W.H. HIGH-TENSION ACCU-
MULATORS** (120 volts, 5,000 m/a). Higher
voltages if desired. Cash Price £3 15 0
Or 7/6 with order and 11 monthly payments of 7/-
Carriage charged on all orders from Scotland.
- N.K. FARRAND INDUCTOR LOUD-
SPEAKER UNIT.** Quality of reproduction
almost equal to a moving-coil speaker. Cash
Price £3 10 0
Or 5/6 with order and 11 monthly payments of 6/6.
- SET OF 3 VALVES, S.G., Dec. and Power.**
Mullard or Gossor. Cash Price £1 19 0
Or 6/- with order and 7 monthly payments of 5/4.
- NEW BLUE SPOT 6SR UNIT.** The finest
balanced armature movement on the market,
complete with large Cone and Chassis. Cash
Price £2 10 0
Or 5/- with order and 10 monthly payments of 5/-.
- NEW CELESTION MOVING-COIL L.S.
UNIT (PERM MAGNET), with Trans-
former.** Cash Price £4 5 0
Or 13/6 with order and 10 monthly payments of 8/-.
Send list of requirements, and quotations will be
sent by return.

LONDON RADIO SUPPLY CO.,
11, OAT LANE
NOBLE STREET, LONDON, E.C.2
TELEPHONE: National 1977.

The "TONIC"

Self-Generating Trickle-Charger Kit
will help you economise by keeping your 2 V. L.T.
accumulators fully charged at home. A boon to
town or country dwellers. 7/- each, postage 9d.
Williams, Netherend, Cradley, Birmingham.

Make

The DAILY SKETCH

TECHNICAL NOTES

(Continued from previous page.)

This particular trouble may be avoided by
introducing a high resistance into the
grid circuit of each of the valves, say not
less than about 250,000 ohms.

Capacity Reaction.

What is nowadays commonly called
capacity reaction is, as a matter of fact,
generally a combination of capacity and
magnetic reaction. The simple magnetic
reaction is, of course, the original type of
electromagnetic reaction between coils,
the position of which in relation to one
another can be varied by means of a control.

One of the great drawbacks of the old-
fashioned type of magnetic reaction is the
fact that every alteration of the reaction
adjustment means a corresponding altera-
tion of the tuning adjustment and vice versa.

The result is that if you bring up your
reaction to a point which makes the set
fairly sensitive and then start altering the
tuning, your reaction adjustment goes
immediately and in actual practice you
have to keep juggling about with the two
adjustments simultaneously.

Various schemes have been proposed
from time to time for giving so-called
constant reaction, that is to say, a reaction
adjustment which will be entirely in-
dependent of the tuning adjustment, but
although these constant reaction circuits
represent a great improvement upon the
older-fashioned schemes, it cannot be said
that they are absolutely a hundred per
cent. perfect so far as constant reaction goes.

For one thing, the coupling "constants"
vary according to the different frequencies
to which the grid circuit is tuned and to
the adjustment of the reaction condenser.

Isolating the L.F.

In most circuits of this type the anode
circuit of the detector valve is isolated
from the high-frequency current so as to
leave it only with the L.F. A high-fre-
quency choke interposed in the anode
circuit is better than connecting a condenser
by-pass unless, of course, a very large
capacity condenser is used, but often
this is impracticable for other reasons.

In the case of a multi-valve set capacity
reaction has the advantage, amongst others,
that it helps to keep the high-frequency
currents out of the L.F. stages, where they
would be liable to produce instability, or
actual distortion.

When a high-frequency choke is used in
connection with the capacity-reaction
arrangement, you do not need to be so
particular about the quality of the choke
as in certain other cases, for example in a
screen-grid circuit.

This does not mean to say that the
choke must not be reasonably good, but if
you have two chokes on hand and you want
to keep the better one for use in a circuit
where a good quality choke is needed,
you will quite probably find that the other
choke will be good enough for mere re-
action purposes.

Triostron Valves.

Will readers please note that the Triostron
valve shown on page 20 of our first gift
book is, in actual fact, one that has been

TANNOY Mains Units

WILL MAKE YOUR SET
ALL ELECTRIC for

9/2 and 11 payments of 8/8.
Cash £4.15.0.

TYPE G.B.1.

H.T. 150 v. at 15 m/a or 120 v.
at 20 m/a.

G.B. 3 tappings up to 12 v.

L.T. 2, 4 or 6 v. Trickle
Charger.

TYPE G.B.3.

Similar to above but with larger
outputs. Write for particulars.

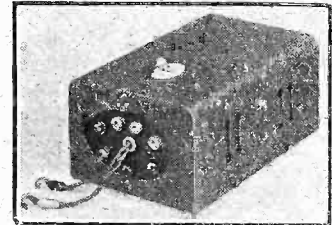

Write for illustrated list.

DALTON ST., WEST NORWOOD,
S.E.27.

MAINS TRANSFORMER REPAIRS.

If you have a burnt-out or faulty Mains Transformer
we will repair, rewind or remodel the same for you
at a very moderate charge. Send a postcard giving full
particulars, including purchase price, for quotation.

Special terms to the Trade
THE STURDY ELECTRIC CO.,
170, Gloucester Rd., NEWCASTLE-ON-TYNE.

GRAMOPHONE PICK-UP

Post free 7/6 Complete
Too cheap? Worth consideration,
but the T.E.P. Pick-up would be
full value at double the price.
Attractively finished in bronze
and aluminium. British made.
Fine Reproduction and Volume
Trade Enquiries Invited.
E. THORP, 4a, Market St., DOVER

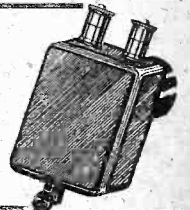

Write for Our

OCTOBER SALE LIST

Saves you Pounds!

Crammed with illustrations and details
of all sorts of fascinating and useful
gear, at very reasonable prices.

**MICROPHONES AND TELEPHONES,
RADIO AND ELECTRICAL
INSTRUMENTS, SWITCHGEAR,
MOTORS, GENERATORS.**

JUST SEND A STAMPED ENVELOPE.

ELECTRADIX RADIOS

248, Upper Thames St., London, E.C.4.
City 0191. Electradix, Cent, London.

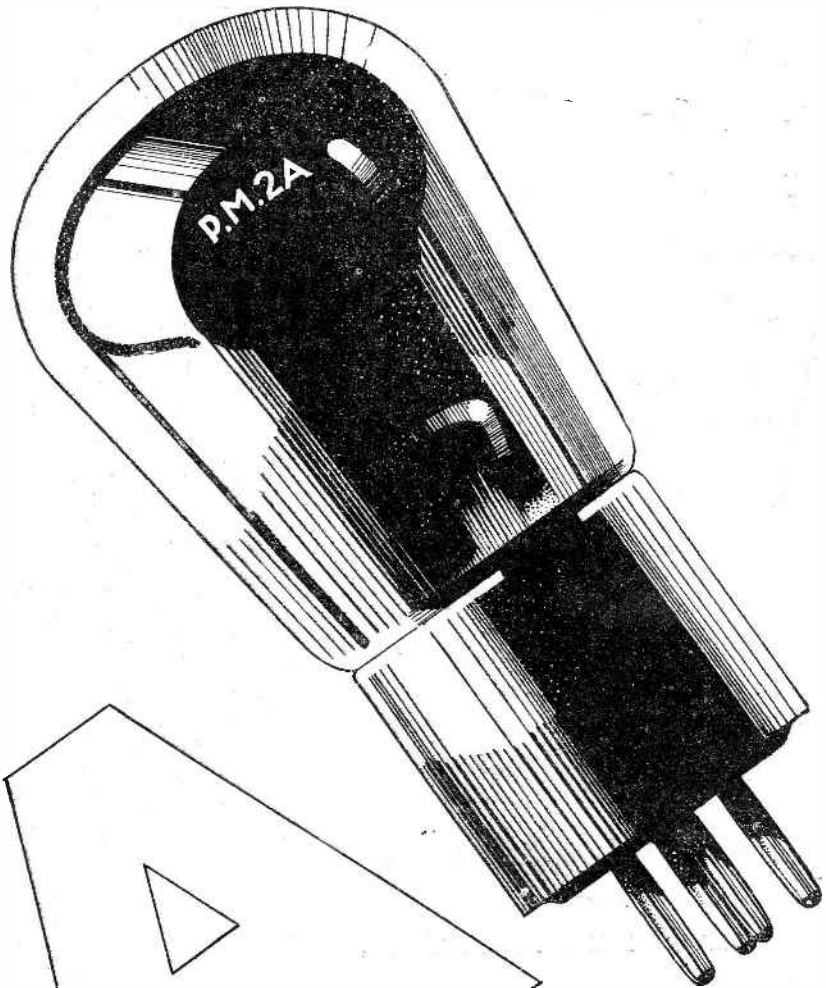

Performance has established the supremacy of Mullard valves. Every type in the Mullard 2-volt range does its job in the most efficient manner, and thus definitely improves the performance of your receiver. The P.M.2A, for example, the 2-volt power valve, has an amplification factor of 12.5, combined with a "slope" of 3.5mA./volt, giving an impedance of 3,600 ohms—an unusually low figure for a valve of this class. It thus makes the very most of even the weakest signals. Discover its effectiveness by fitting one in your receiver.

Price 10/6

Mullard

THE · MASTER · VALVE

Advt of the Mullard Wireless Service Co., Ltd., Mullard House, Charing Cross Road, London, W.C.2

A pleasure to look at ...
A joy to listen to!

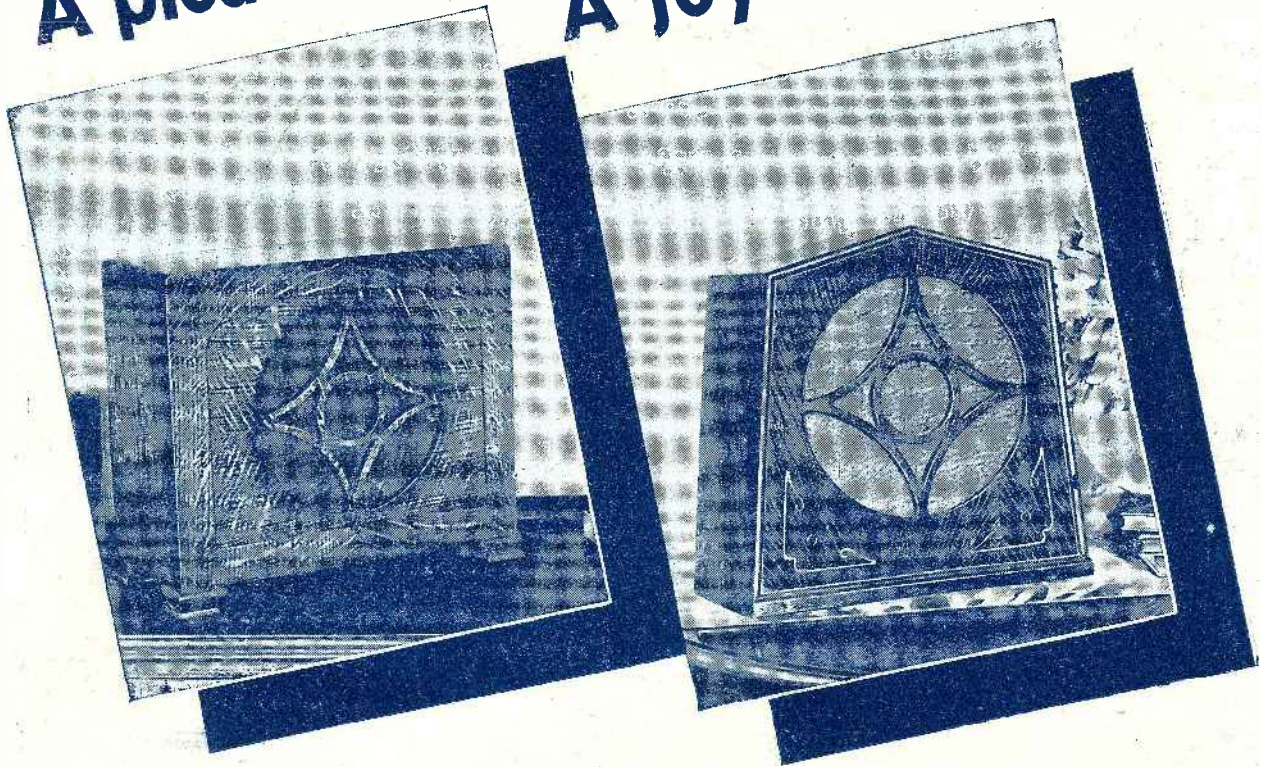

BRITISH MADE THROUGHOUT.

Illustrated above on the left is the
BLUE SPOT SPEAKER (in-
ductor type) 100D in Oak.
Price complete **63/-**

Illustrated above on the right is the
BLUE SPOT SPEAKER 44R
also in Oak. Price complete **52/6**

*Write for catalogue P.W.10. showing complete
range of speakers.*



TRADE MARK

Regd. Nos. 515639 & 516180.

ARENT they beautiful—these new **BLUE SPOT** Loud Speakers with their graceful lines, delightful proportions and lovely graining of fine quality woods. They will enhance any room, harmonise with any furniture.

And the beauty of their appearance is reflected in the beauty of their tone, the faultlessness of their reproduction. Harshness is a word meaningless in their presence, distortion and blurring are unknown to them. Their reproduction is life-like, unbelievably, astonishingly life-like. They make listening-in a pleasure—even the most exacting critic will admit their perfection.

Your dealer is proud to sell these speakers. He will demonstrate them with pleasure. Ask him to do so to-day.

Ask to hear the New **BLUE SPOT RECEIVERS**

—a triumph of modern technical skill. Ask for descriptive leaflet.

THE BRITISH BLUE SPOT COMPANY LTD.

BLUE SPOT HOUSE, 94/96 ROSOMAN ST. ROSEBERY AV., LONDON, E.C.

Telephone: Clerkenwell 3570. Telegrams: "Bluospot, Isling, London."
Distributors for Northern England, Scotland and North Wales: H. C. RAWSON (Sheffield and London) Ltd., 100, London Road, Sheffield: 22, St. Mary's Parsonage, Manchester: 183, George Street, Glasgow.

Autophonad

The "DUAL-RANGER" IS HERE! (See Page 430)

Popular Wireless

Every Thursday
PRICE
3d.

No. 490. Vol. XX.

INCORPORATING "WIRELESS"

October 24th, 1931.

A SIXPENNY BLUE PRINT

FREE!

Inside

Special Features This Week

THE WAVELENGTH PROBLEM

By The Chief Engineer of the B.B.C.

HOW YOUR SET WORKS

By Victor King

MYSELF AND THE MICROPHONE

By Paul Robeson

THE "NEW B.P." ON TEST

ON PAGES
433, 439
440 & 443

Ready Radio

EASTNOR HOUSE, BLACKHEATH

Phone: Lee Green 5678

'DUAL-RANGER'
MATCHED
KITS!

"The Most Efficient Choke We Have Tested"

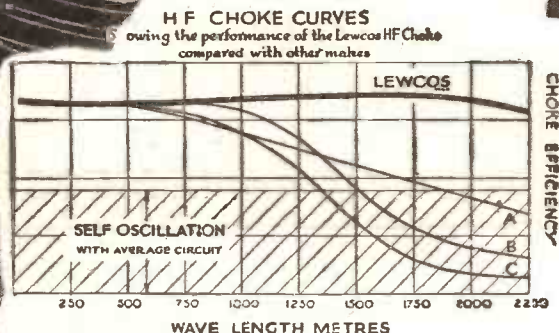

**SUPER H.F. CHOKE
REDUCED PRICE 6/-**

"We are pleased to report that the Lewcos H.F. Choke is, in our opinion, the most efficient choke we have tested, there being no sign of instability even when using 150 volts H.T. on the Anode of the S.G. Valve. The construction is massive and well finished, and its design places it in the front rank of high-class components."

An appreciation from Industrial Progress (International), Ltd., Bristol.

The above letter is a further appreciation of the unique qualities of the Lewcos H.F. Choke. The fine materials and high-class workmanship used in its manufacture make it supreme. The terminals are arranged, one at the top and the other at the base of the Coil, to eliminate the risk of additional self-capacity in the wiring of the receiver.

The H.F. Choke curves illustrated above show the astonishing performance and advantages of the Lewcos Choke over other makes.

Full particulars of the Choke, Ref. R.33, will be sent on request.

THE H.F. CHOKE IS SPECIFIED FOR THE "DUAL RANGER" RECEIVER DESCRIBED IN THIS ISSUE.

LEWCOS

RADIO PRODUCTS FOR BETTER RECEPTION

THE LONDON ELECTRIC WIRE COMPANY AND SMITHS LIMITED
CHURCH ROAD, LEYTON, LONDON, E.10.

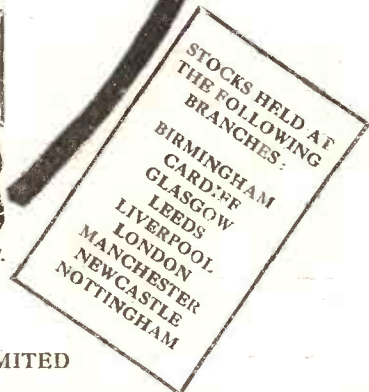

REASONS WHY YOU SHOULD USE MAZDA INDIRECTLY HEATED RECTIFIERS

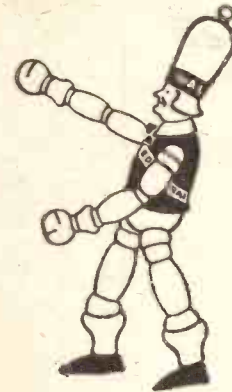

MAZDA INDIRECTLY HEATED RECTIFIERS

TYPE	PRICE
Full wave	
UU.30/250 - - -	12/6
UU.2 - - - -	15/-
UU.60/250 - - -	15/-

THE AMAZING

MAZDA THE BRITISH VALVES

THE EDISON SWAN ELECTRIC CO. LTD.
RADIO DIVISION:
155 CHARING CROSS ROAD, LONDON, W. C. 2



If you are using rectifying valves in your A.C. mains receiver there is a definite advantage to be gained by using **Mazda indirectly heated Rectifying Valves**. You are safeguarding the condensers, chokes and valves of your receiver. When you switch on an ordinary rectifying valve, operating temperature is reached considerably before that of the receiving valves. A surge is caused and damage is frequently done.

Mazda indirectly heated Rectifiers heat up with the receiving valves, and so afford you absolute protection.

EDISWAN RADIO

**“UNIVERSAL”
“P.W.” COIL**
as specified for the
“P.W.” DUAL-RANGER
5'6 **5'6**
EACH EACH



**OTHER
COMPONENTS
FOR THE
“DUAL-RANGER”**

P.J.3 Coils	-	-	-	s. d.
Specially wound Coil Quoits	-	-	-	2 0
“Universal” Pre-set Condensers, Type “H”	-	-	-	1 0
“Universal” Fixed Condensers	-	-	-	0 6
Push Pull Switches	-	-	-	0 6
3 Point Switches	-	-	-	0 9
“Universal” .0005 Variable Condensers	-	-	-	2 6
H.F. Chokes	-	-	-	2 0
1 M.F. Condensers	-	-	-	1 9
L.F. Transformers	-	-	-	3 6

Our Illustrated Catalogue Post Free on request.

Trade Supplied.

**UNIVERSAL ELECTRIC
SUPPLY CO., LTD.,
4, BROWN STREET,
MANCHESTER.**

'Phone:
City 3409.

Established
1892.

'Grams:
“Uniselco” Manchester.

Branches in all leading Lancashire Towns.

**B.T.H.
C2 LOUD
SPEAKERS**
BRAND NEW EX-
FACTORY. As Illustrated.
List price 45/-
OUR PRICE 15'/- EACH
Garr. Paid

15'/-

**Do
You
Know?**

Historical Signs—No. 2

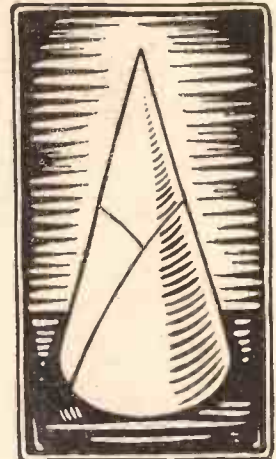

*The Sign of
the Sugar Loaf*

IN olden times sugar was sold to the grocer in conical loaf form. To indicate his trade, the grocer hung out the sign of the sugar loaf. Inns of to-day bearing the sign of “The Swan and Sugar-Loaf” indicate that in earlier days the landlord combined the sale of wine with that of other commodities.

Now no sign is needed to tell a man's calling, but T.C.C. has given you a means of recognising—at a glance—a condenser that is backed by the unique experience of 25 years' specialised research—they have put all their condensers in a green case—a sign that such a condenser has proved itself to be of downright reliability and absolute accuracy. Be sure of your next condenser—be sure it is a “condenser in the green case.”

Look for the initials
T.C.C.
on the condenser
in the green case

T.C.C.
CONDENSERS

The Telegraph Condenser Co. Ltd., Wales Farm Road, N. Acton, W.3.

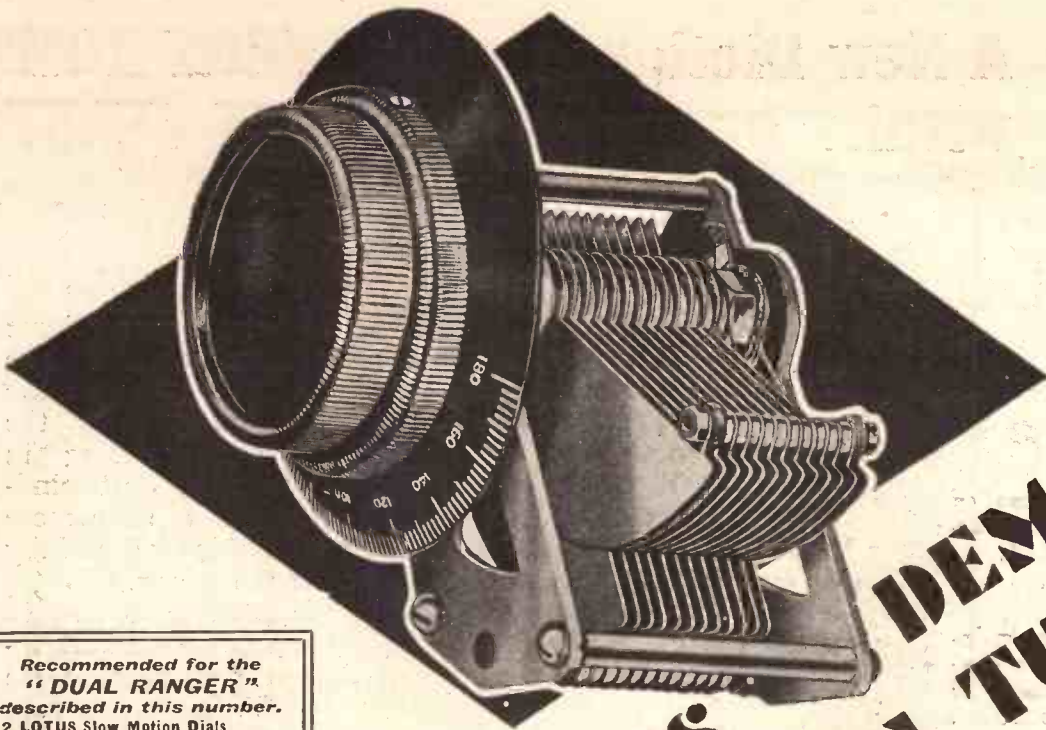

Recommended for the
"DUAL RANGER"
 described in this number.
 2 LOTUS Slow Motion Dials
 1 LOTUS L.F. Transformer
 2 LOTUS Valve Holders
 2 LOTUS H.F. Chokes
 1 LOTUS Differential Reaction
 Condenser

**MODERN SETS
 DEMAND
 PRECISION TUNING**

**SLOW MOTION
 LOG CONDENSER**

6/6

.0003 & .0005 CAP.

LOTUS Condensers afford the last word in precision tuning. Control is delightfully smooth and absolutely silent, while sturdy construction ensures a lasting accuracy and unfailing reliability.

Ask or write to-day for your copy of the LOTUS Component Catalogue. It is full of interest to the home constructor.

SLOW MOTION LOG CONDENSER

Constructed throughout of aluminium, this Component is highly efficient, perfectly smooth and noiseless in operation. A ball-drive integral vernier device is concealed in the spindle and both direct and slow drives are controlled by the double Knob-Dial supplied with the Condenser. With braided pigtail connection to rotor. Specially suitable for Super-Hets. The reduction gear is 7-1.

Capacities .0003 Type SM/3
 and .0005 Type SM/5

6/6 EACH.

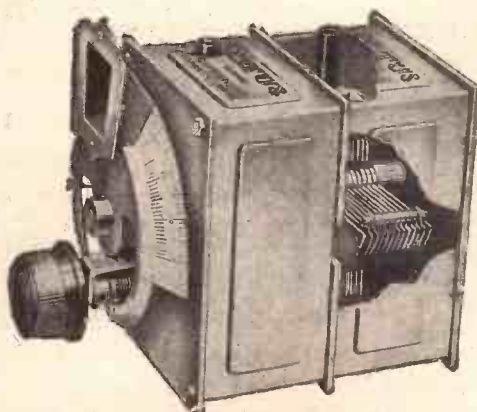

GANGED CONDENSERS

Specially heavy vanes and end-plates ensure a permanent accuracy of matching of 1% between units. Trimmers are accessibly placed and are easily adjusted by fingers or screw-driver. Each Unit is completely screened from the others, and pressed aluminium covers also protect the condensers from dust. These assemblies are smaller than most other gang condensers and are simple to assemble in all types of receivers.

2-GANG with Disc Drive
 Type DS/CH.2 **25/-**



RADIO COMPONENTS

LOTUS RADIO LTD., MILL LANE, LIVERPOOL.

At Last— A New Dictionary for EVERY HOME within the reach of EVERY PURSE!

Nearly
**100,000
WORDS**

accurately yet simply defined.

Over 300,000 shades of meaning clearly and interestingly differentiated.

Full etymologies.

Pronunciations simply indicated for the man-in-the-street and phonetically indicated for the scholar.

Hundreds of thousands of quotations illustrating phrases, modern usages and idioms.

A book for every home, every school, every library and every office.

**Binds into
One Large
Page Volume**

*The Only Dictionary Entirely Written
since the Great War!*

THE UNIVERSAL ENGLISH DICTIONARY takes each word in the English language and tells you what part of speech it is, how to pronounce it, how it came into English, its different shades of meaning, how it is used in typical phrases of everyday speech, and so on.

It has taken over eight years to prepare and it is to be sold in 52 weekly parts at sixpence a part. *Everyone* every day—Mother, Father, and boys and girls of school age—needs a good dictionary. The UNIVERSAL ENGLISH DICTIONARY is more than a *good* dictionary—it is the *only* dictionary of its kind. It is much more complete than the average desk dictionary, yet its form

—a single large-page volume—is most convenient. The UNIVERSAL is within the reach of all, for, by the method of publishing in weekly parts, its cost, binding included, is little more than the price of a daily paper for one year.

The value of such a work increases year by year. With the UNIVERSAL in your home your children have at hand a ready answer to almost every question. They will grow up equipped with a true knowledge and understanding of their most precious heritage—the English language.

This magnificent work is incomparably the finest general-purpose English Dictionary that has ever been published.

THE UNIVERSAL ENGLISH DICTIONARY

*Edited by a leading authority on the English Language
—Professor H. C. Wyld—Merton Professor of English
Language and Literature at Oxford University.*

**Buy PARTS 1 and 2
TO-DAY - 6^D. each.**

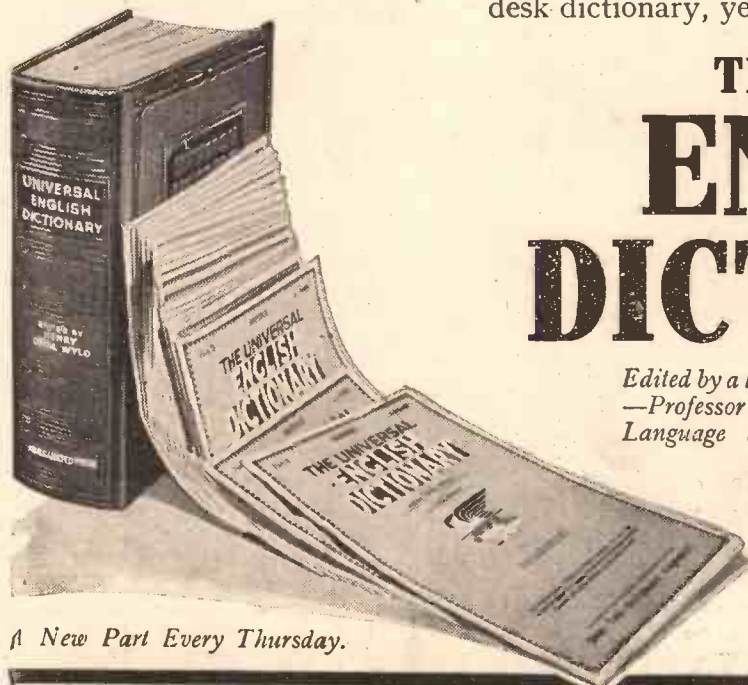

A New Part Every Thursday.

On Sale at all Newsagents and Bookstalls

MAINS RADIO FOR EVERY TYPE OF BATTERY SET



FOR **10/-** DOWN AND BALANCE IN EASY MONTHLY PAYMENTS

NO ALTERATIONS TO SET CONNECTED IN A MOMENT



MODEL A.C. 244.
H.T. UNITS for Sets up to 4 Valves. Output 20 m/A at 120v. 59/6 each or 10/- down and 8 payments of 7/- each.

MODEL A.K. 260.
ALL-MAINS UNIT for Sets up to 4 Valves. Output 20 m/A at 120v. Trickle Charger for 2, 4, and 6 v. accumulators. 90/- cash or 10/- down and 9 payments of 10/- each.



An "ATLAS" All-Mains Unit converts your old set to All-Mains operation, and endows it with a bigger range, greater volume, and better quality reproduction.

No alterations whatsoever are required to either Set or Valves. Connection and operation are as simple and safe as with dry batteries.

"ATLAS" All-Mains Units form the cheapest and most reliable source of Radio power yet devised. They ensure a constant and never-failing supply of H.T. Current and automatically recharge your accumulator between the periods of reception:

The "ATLAS" Model A.C. 188 won outright the 1930 Olympia Ballot for the best Mains Unit on the market. Since when it has never been equalled. Suitable for Sets up to 5 Valves, it provides 2 Variable H.T. Tappings of 0/100 and 0/120 Volts respectively, and one Fixed of 150 Volts. Output 25 m/A at 150 Volts. L.T. Trickle Charger for 2, 4 and 6 Volt Accumulators at .5 Amps. Size 10" x 5 1/4" x 3 1/2" to fit the space provided in portable and standard receivers. Incorporating the Westinghouse Rectifier, and fully guaranteed for 12 months.

Cash price, £6, or 10/- down and 7 monthly payments of 15/6 each, and one of 14/6.

Ask your dealer or write for full details of the complete range. There are models to suit every requirement.

H. CLARKE & Co. (M/CR). LTD.
Eastnor St., Old Trafford, Manchester. Trafford Park 1744-5-6.
Southern Offices & Stores: Bush House, London, W.C.2. Temple Bar 7130-

"CLARKE'S ATLAS"

MAINS UNITS

EVERYTHING NEW IN RADIO

IMMEDIATE DELIVERY

**C.O.D.
CASH
H.P.
as usual**

We are the largest Radio House in the Country, and in sending your orders to us there is no risk of delay. Orders executed on our famous 3-WAY PLAN—C.O.D., CASH or H.P. Express Service for everything Radio Guaranteed. New 116-page catalogue 6d., post free.

MANUFACTURERS' KITS

COSSOR MELODY MAKER, Type 234. Screened-grid, detector and power. Complete with specified valves and cabinet. Cash Price, £6 15 0. Balance in 11 monthly payments of 12/6. Finished Instrument. Royalties paid. £7 10 0. Cash only. **Send 10/- only**

OSRAM NEW MUSIC MAGNET. Improved version of the famous 4-valve set, 2 Screen-Grid, Det., and Power. With Valves and Cabinet. Cash Price, £10 15 0. Balance in 11 monthly payments of 19/8. Finished Instrument, Royalties paid, £11 15 0. Cash only. **Send 19/8 only**

MULLARD 3 1932 RECEIVER. Screen-Grid, Det., and Pentode. With Valves, less Cabinet. Cash Price, £6 10 0. Balance in 11 monthly payments of 11/11. Finished Instrument with valves and Cabinet. Royalties paid, £7 17 6. Cash only. **Send 11/11 only**

EKCO H.T. UNIT, Type A.C.25. For multi-valve sets requiring up to 25 m/a. 3 tappings. S.G., detector and 120/150 volts. For A.C. mains. Cash or C.O.D. Price £3 17s. 6d. Balance in 11 monthly payments of 7/1. **Send 7/1 only**

ATLAS A.C. ELIMINATOR TYPE A.G.244. 3 tappings—S.G., detector, power. Output 120 volts at 20 m.a. Cash Price or C.O.D. £2 19 6. Balance in 11 monthly payments of 5/6. **Send 5/6 only**

REGENTONE W.5 COMBINED H.T. ELIMINATOR AND TRICKLE CHARGER. One S.G., 1 variable and 1 fixed tapping for H.T. L.T. charging for 2, 4, and 6 volts. For A.C. mains. Cash Price £5 17 6. Balance in 11 monthly payments of 10/9. **Send 10/9 only**

REGENTONE ELIMINATOR, TYPE W.1F. Three tappings, S.G., Detector, and Power. Output 120 volts at 12 m.a. A.C. Mains. Cash Price £2 7 8. Balance in 5 monthly payments of 8/4. **Send 8/4 only**

AMPLION M.C.6 MOVING-COIL SPEAKER, permanent magnet, with output transformer. Complete. Cash Price, £3 7 6. Balance in 11 monthly payments of 6/2. **Send 6/2 only**

CELESTION PERMANENT MAGNET MOVING-COIL SPEAKER. Type R.P.M.8. 8" Reinforced Diaphragm. in Chassis form without input transformer. C.O.D. or Cash Price, £3 10 0. Balance in 11 monthly payments of 6/5. **Send 6/5 only**

BLUE SPOT PERMANENT MAGNET MOVING COIL SPEAKER. Complete with input Transformer. Cash Price, £3 15 0. Balance in 11 monthly payments of 6/11. **Send 6/11 only**

W. B. PERMANENT MAGNET MOVING-COIL SPEAKER P.M.3. Complete with 3-ratio input transformer. Cash Price, £2 12 6. Balance in 11 monthly payments of 4/10. **Send 4/10 only**

R. & A. PERMANENT MAGNET MOVING-COIL SPEAKER. Complete with multi-ratio input transformer. Cash Price, £2 17 6. Balance in 11 monthly payments of 5/4. **Send 5/4 only**

EPOCH A2 PERMANENT MAGNET MOVING-COIL SPEAKER. Fitted with multi-ratio input transformer. Cash Price, £3 3 0. Balance in 11 monthly payments of 5/9. **Send 5/9 only**

NEW B.T.H. "SENIOR" PICK-UP AND TONE-ARM. Complete. Cash Price £2 5 0. Balance in 11 monthly payments of 4/2. **Send 4/2 only**

PILOT PERMANENT MAGNET MOVING-COIL SPEAKER



Matches the requirements of all modern receivers. Includes a Unit designed and built specially for Peto-Scott by Epoch. Handles the smallest to the greatest input, and brings out most minute details of tonal quality with pure, full volume. A multi-ratio input transformer is fitted and provides for matching to all super-power and pentode valves. The handsome hand polished solid oak cabinet is built to give added depth of tone, and is fitted with ebonised base and side wings and silk covered fret.

£3 : 15 : 0 or 12 monthly payments of 6/11.

VOXKIT RADIOGRAM CABINET MODEL 1932



Accommodation for largest of Home-built receivers with a full size speaker as well as mains and battery equipment. Complete with motor board. Dimensions overall 39" high x 22" wide x 17" internal Panel 18" x 7" Baseboard 18" x 14 1/2". Speaker chamber 18" x 14 1/2" x 16". Panel 12 1/2" between moulding. **£4:10:0** or 12 monthly payments of 8/3

VOXKIT 1932 CONSOLE (Radio only)

Almost identical in appearance with the 1932 Voxkit Radiogram designed for Radio only. Dimensions 37" x 15 1/2" x 22" wide. Panel 18" x 7". Baseboard 18" x 12". L.S. compartment 18" x 14" x 12". Control Panel 12 1/2" wide. **OAK Price £3:15:0** or 12 monthly payments of 6/11.

KELSEY SHORT-WAVE ADAPTOR

Adds more stations to your set. Nothing more to buy—no valves or any extras. Plugs direct into your battery or eliminator-operated receiver. Receives short waves from all over the world. Easy to operate. Sent C.O.D. Postage free, or from your usual dealer. Mahogany cabinet. 7/6. **37/6** C.O.D. Pay the postman.

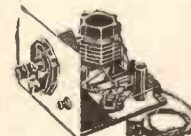

SPECIALLY RECOMMENDED

EPOCH J.1 PERMANENT MAGNET MOVING-COIL SPEAKER, with multi-ratio input transformer. Cash Price, £2 5 0. Balance in 11 monthly payments of 4/2. **Send 4/2 only**

GARRARD INDUCTION GRAMOPHONE MOTOR. Model 202. Mounted on 12-in. Nickel Motor Plate with fully automatic electric starting and stopping switch. Cash Price, £2 18 6. Balance in 11 monthly payments of 5/4 only. **Send 5/4 only**

FORMO "MINIVO" MAINS UNIT. For 1-, 2- and 3-valve sets. H.T. Output, 120 Volts at 20 Milliamperes. 1 Tapping, 50/90 Volts; 1 Tapping, 90/100 Volts; 1 Tapping, 120/150 Volts. Cash or C.O.D. £3 3 0. Balance in 11 monthly payments of 5/9. **Send 5/9 only**

ORMOND PERMANENT MAGNET MOVING-COIL CHASSIS (No. 464). With input transformer. Cash price £3 5 0. Balance in 11 monthly payments of 5/11. **Send 5/11 only**

KINGSTON-WEARITE HOME RECORDER. Complete with all equipment, including Microphone for recording own voice. Cash or C.O.D. £5 9 6. Balance in 11 monthly payments of 10/-. **Send 10/- only**

V 3 KIT

RADIO FOR THE MILLION

10/- DOWN

Powerful, selective and ultra modern. Employs screen-grid, detector and power valves. With valves, less cabinet.

Balance in 11 monthly payments of 10/10.

Cash Price £5 : 17 : 6

FINISHED INSTRUMENT

with valves and cabinet. Royalties paid. **Cash only. £7 : 8 : 6**

SIX-SIXTY CHASSIKIT (Battery Model). Complete three-gang bandpass tuning. S.G., Det., and Pentode. Cash Price, with Valves less cabinet, £6 : 17 : 6. Balance in 11 monthly payments of 12/7. Finished instrument with (10/6) Cabinet and valves. Royalties paid, £8 : 3 : 0. Cash only. **Send 12/7 only**

SIX-SIXTY CHASSIKIT (A.C. Model). Complete as above with A.C. Mains Valves. Cash Price, with Valves less Cabinet, £7 : 6 : 8. Balance in 11 monthly payments of 13/5. Finished instrument, with Cabinet (10/6); Royalties paid, £8 : 12 : 0. Cash only. **Send 13/5 only**

DYNAPLUS SCREENED THREE; Screened-Grid, Detector and Pentode. Kit "A" (less Valves and Cabinet). Cash or C.O.D. £3 12 9. Balance in 11 monthly payments of 6/10. **Send 6/10 only**

EXPRESS ORDER FORM

To PETO-SCOTT CO. LTD.,
Please send me C.O.D., CASH/H.P.

.....

.....

.....

for which I enclose
Cash, H.P. Deposit £ s. d.

Name

Address

.....

P.W. 24/10/1931.

PETO-SCOTT

PETO-SCOTT CO., LTD. Head Office: 77 CITY ROAD, LONDON, E.C.1. Clerkenwell 9406. 62 HIGH HOLBORN, LONDON, W.C.1. Chancery 8266. MANCHESTER: 33 WHITELOW ROAD, CHORLTON CUM-HARDY. Phone: Chorlton-cum-Hardy 2028. NEWCASTLE, STAFFS., 7 ALBANY RD. Phone: 67190

**WHAT
A
BOON!**

DUAL RANGER

The Author's Kit **FITS the
FREE BLUE PRINT**

PILOT AUTHOR'S KIT

The No Substitute Kit

**EXPRESS
KIT
SERVICE**

As chosen and first specified by the Technical Department of Popular Wireless. Officially approved, therefore, by an established technical authority you can trust implicitly.

Backed by Peto-Scott himself, twelve years' Radio Experience and a world-wide reputation. Enables the Author's published Set to be duplicated exactly in every respect.

PRICE LIST COMPLETE KIT PRICES

CHECK this list of parts with the Author's specification, photographs and diagrams on pages 361-362 of last issue.

1 Panel, 16" x 8"	a. d.	6 9
1 Baseboard, 10" deep		1 8
2 Telsens '0005 mfd. condensers with slow-motion dials		14 0
1 Ready Radio '0005 mfd. solid dielectric condenser		3 6
2 Ready Radio 3-point wave-change switches		3 0
1 Lissen on-off switch		1 0
1 Telsens '0001 mfd. differential reaction condenser		2 0
1 "P.W." and "M.W." dual range coil		12 6
1 Goltone '002 mfd. max. compression condenser		1 3
1 Igranon 1 mfd. fixed condenser		1 6
1 Ferranti '0003 mfd. fixed condenser		1 6
1 T.C.C. '001 mfd. fixed condenser		1 10
1 T.C.C. 1 mfd. fixed condenser		2 10
1 R.K. P.J.3 coil		2 6
1 Peto-Scott ready wound coil quito		2 0
1 Screen, 10" x 7", with hole for S.G. valve		2 9
1 Graham-Farish 2-meg. leak and holder		1 4
2 Lewcos and Varley H.F. chokes		9 6
1 Lotus L.F. transformer, ordinary ratio		5 6
1 Bulgin 50,000 ohms Spaghetti resistance		1 9
1 Terminal strip, 16" x 1 1/2"		2 0
1 Bulgin 25,000-ohm Spaghetti resistance		1 6
9 Belling-Lee Type R indicating terminals		2 3
Glazite, flex, screws, etc.		3 0
1 Bulgin crocodile clip		2 2
1 1.5 G.B. battery for S.G. valve		9
Author's Kit "A" Cash or C.O.D.		£4 8 2

KIT "A" Author's Kit less Valves and Cabinet £4.8.2

CASH or C.O.D. or 8/1 down and 11 monthly payments of 8/1

Kit "B" Author's Kit with Valves less Cabinet £6.7.2

or 11/8 down and 11 monthly payments of 11/8

Kit "C" Author's Kit complete with Valves and Cabinet £7.8.2

or 13/7 down and 11 monthly payments of 13/7

PILOT RADIO KIT PRICE CHART FOR OTHER FAVOURITE P.W. SETS

ITEM NO.	SET.	KIT "A," less Valves and Cabinet.	KIT "B," with Valves less Cabinet.	Kit "C," complete with Valves and Cabinet.
50	P.V. STAR (Author's Kit)	£5 11 11 or 10/3 down and 11 monthly payments of 10/3 CASH or C.O.D.	£7 10 11 or 13/10 down and 11 monthly payments of 13/10 CASH or C.O.D.	£8 18 5 or 16/4 down and 11 monthly payments of 16/4 CASH or C.O.D.
51	P.V. PLUS (Author's Kit)	£4 7 8 or 8/- down and 11 monthly payments of 8/- CASH or C.O.D.	£6 6 8 or 11/7 down and 11 monthly payments of 11/7 CASH or C.O.D.	£7 6 8 or 13/5 down and 11 monthly payments of 13/5 CASH or C.O.D.
52	B.P. THREE (Author's Kit)	£5 13 1 or 10/5 down & 11 monthly payments of 10/5 CASH or C.O.D.	£7 0 7 or 12/11 down & 11 monthly payments of 12/11 CASH or C.O.D.	£7 18 1 or 14/6 down & 11 monthly payments of 14/6 CASH or C.O.D.
54	COMET 3 FOUNDATION CIRCUIT	£4 0 0 or 7/4 down & 11 monthly payments of 7/4	£5 7 6 or 9/10 down & 11 monthly payments of 9/10	£6 7 6 or 11/8 down & 11 monthly payments of 11/8

DUAL RANGER C.O.D. ITEMS

Pay the Postman, we pay all post charges.

- 2 Telsens '0005 mfd. condensers with slow-motion dials 14 0
- Coil Equipment comprising "P.W." and "M.W." Dual-Range Coil, Peto-Scott Ready Wound Coil Quito and 1 R.I. P.J.3 Coil - - - 17 0
- 3 Valves as specified: Metallised S.G., Osram H.L.2, and Mazda P.220 - - - £1 19 0
- 1 Cabinet as specified £1 1 0

TRADE NOTE

Any reputable Dealer will gladly supply you with a PILOT AUTHOR'S KIT for The Dual Ranger. Don't accept a substitute kit made up of substitutes.

EXPRESS ORDER FORM

To PETO-SCOTT CO. LTD. Please send me C.O.D.,/CASH/H.P.

for which I enclose Cash/H.P. Deposit £ s. d.

Name.....

Address.....

P.W. 24/10/31

★ Any parts supplied separately if value over 10/-. Sent carriage paid or C.O.D. All post charges paid.

C.O.D. CASH H.P. as usual

PETO-SCOTT

PETO-SCOTT CO. LTD. Head Office: 77, CITY ROAD, LONDON, E.C.1. Clerkenwell 9406. 62, HIGH HOLBORN, LONDON, W.C.1. Chancery 8266. MANCHESTER: 33, WHITELOW ROAD, CHORLTON-CUM-HARDY. Phone: Chorlton-Cum-Hardy 2028 NEWCASTLE STAFFS: 7, ALBANY ROAD.



COMPLETELY SCREENED COILS

The coils used in the Cossor Empire Melody Maker are completely screened in metal "pots" entirely eliminating direct pick-up, thus further improving selectivity.



SERIES AERIAL CONDENSER

The variable Series Aerial Condenser permits adjustment of selectivity to give the fine tuning necessary to cut out powerful local stations.



EXTERNAL WAVE-CHANGE SWITCH

Wave Change Switching is effected by operating the switch at the end of the cabinet—"in" for long—"out" for short.



COSSOR METALLISED SCREENED GRID VALVE

Even better performance is ensured by the Cossor Metallised Screened Grid Valve which eliminates stray couplings thus improving selectivity.

All-British Screened Grid Radio

— a high power, 3-valve "All-Europe" Wireless Set for **£6.15!** at a record low price

NO matter how much you pay you cannot buy a more powerful 3-valve Receiver than the Cossor Empire Melody Maker. This remarkable Set incorporates all the most up-to-date features of design. Due to the efficiency of its Cossor Valves, the Cossor Empire Melody Maker has an outstanding performance. Its range is enormous. Its selectivity is remarkable. It will bring in all the main European

programmes even while your local station is working. — Even costly factory-built Receivers cannot give better results. The Cossor Empire Melody Maker is available in two types—Model 234 for use with batteries and accumulator and Model 235 which works from the electric light mains. Send at once for full particulars of the model that interests you—use the coupon below.

Supplied as a complete set of parts including valves & cabinet Obtainable from all the best Radio Retailers

COSSOR EMPIRE Melody Maker

MODELS 234 & 235
BRITISH MADE

Battery Model 234

Price includes latest types of Cossor Metallised Screened Grid, Cossor Detector and Power Valves, handsome oak cabinet and all parts necessary for home assembly of the complete Receiver as illustrated **£6.15**

Hire Purchase terms 15/- deposit and 9 monthly payments of 15/-

All-Electric Model 235

Price includes handsome oak cabinet, latest types of Cossor Metallised Mains Screened Grid, Metallised Mains Detector, Mains Power and Rectifier Valves, Cossor Heavy-duty Mains Transformer, all the parts necessary for assembling the complete Receiver and full size Constructional Chart. **£9.19.6**

Hire Purchase terms 20/- deposit and 10 monthly payments of 20/-



A. C. COSSOR, LTD., Highbury Grove, London, N. 5. Depots at Birmingham, Bristol, Glasgow, Leeds, Liverpool, Manchester, Newcastle, Sheffield and Dublin.

To Messrs. A. C. Cossor, Ltd., Highbury Grove, London, N. 5
Please send me free of charge a Constructional Chart which tells me how to assemble the Cossor Melody Maker.
(Fill in type required, viz. Battery operated or All-Electric.)
Name Address

P.W. 24/10/31
9189.

Popular Wireless

LARGEST NET SALES



Scientific Adviser:
Sir OLIVER LODGE, F.R.S.
Chief Radio Consultant:
CAPT. P. P. ECKERSLEY, M.I.E.E.
Editor: NORMAN EDWARDS.

Technical Editor: G. V. DOWDING, Associate I.E.E.
Assistant Technical Editors:
K. D. ROGERS, P. R. BIRD,
A. JOHNSON RANDALL.

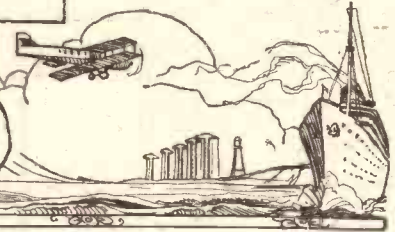

RADIO AS LUNG TONIC
"OHM, SWEET OHM"
"A HAT AND A HALF"
THE HUMAN SILKWORM

RADIO NOTES & NEWS

POT POURRI
WALES WEEK
DOVER AND JACK PAYNE
WHY THESE PIPES?

Radio as Lung Tonic.

AT the recent National Radio Exhibition H.M.V.'s held a "Loudest Shout" competition. Entrants took a short run, sucked in as much as possible of Olympian air, and then bawled at a gadget which registered their protest in decibels.

It is understood that town criers and railway porters were barred and that any receivers blown off the shelf had to be paid for. A number of competitors managed to register 22 decibels, and one lady created 21.5, shifting Mr. Wally Dumbley, of Wood Green, aged 45, piano-remover, off his feet on to those of a police-woman in multi, who seized him by the necktie and gave him four minutes of "third degree."

"Ohm, Sweet Ohm."

A REPORT from Kenya Colony states that when the telegraph service on a certain line broke down and was traced to a break in the wire, investigation showed that the local dusky ladies had been helping themselves to the wire from which to construct personal adornments.

Really, one can hardly blame them, for to see miles of that lovely stuff shining above them must have made them frantic with covetousness. When radio penetrates the native ranks we may expect to hear the "fans" boasting that their wives are worth so many ohms!

"A Hat and a Half."

TALKING of wire and lots of it reminds me that in the early days when we wanted to tune to the big wave-lengths we used coils of wire on ebonite formers some five or six inches in diameter and a foot or more in length, and that we referred to those horrors as "hats," doubtless with top-hats in mind.

"Stick in a hat and a half, with a holiday" meant "use one large coil coupled for reaction with one half the size," the "holiday" being the space between them.

The Human Silkworm.

AND again, that reminds me of Harvey Wilson, of Springfield, Mo., the human silkworm. This patient worker, in the course of making an induction coil large enough to produce 36-inch sparks wound *by hand* no less than 32 miles of wire. Talk about a cocoon!

I commend his industry to those of us who jib at the coil-winding which we need

nowadays for short-wave work. Years ago, I remember, I used to vent bad language over the winding of a few hundred turns on a pickle bottle or bit of ebonite rod. Such were our simple impedimenta before the war.

Pot Pourri.

OUR "Better Radio Guide" has earned a gratifying volume of praise from amongst your ranks, and on behalf of "P.W." I rises and acknowledges the same, hoping this finds YOU as it leaves us—bearing up.

GENERAL ELECTION RESULTS.

IS YOUR SET O.K.?

You will want to hear the results of the most important Parliamentary Election the British Empire has ever known. The results will be broadcast, and all your friends will be eager to know what happens on Polling Day. If your friends haven't got a set urge them to get one now—and the advertising pages in this issue will give you many valuable hints and tips about all kinds of receivers.

And about your own set—is it O.K.? Are the batteries fully charged? Are you sure the valves are not in the "dud" stage? Remember, Election Night will be a night when you simply cannot do without your wireless set. Bear the above points well in mind.

S. M. F. (Dover) has a family radio ghost which I promise to investigate and report on. He is grinding his (doubtless entirely natural) dentition over a nearby experimenter with violet rays. He need not tell me what happens to his radio, because I have, as I have said before, a man a few doors away with a whole museum of "ray" gadgets, who, on the Continent, would have been prosecuted once a week for the past five years. But—live and let live, eh?

Wales Week.

FROM to-day until November 1st Cardiff is to wallow in radio publicity. Special supplements in the "Western Mail," "Echo" and "Express," the use of empty shops for displays, illuminated cars, van procession, streamers, radio ball and cabaret (look you!), posters, fireworks and treasure

hunt—all those mighty forces are to be brought to the aid of British radio in Cardiff.

I hope that English firms will do what they can to help this effort.

Dover and Jack Payne.

S. M. F. (Dover) is grieving over the loss of Jack Payne & Co., owing to 261 metres being completely "dud" in Dover during the evening. The awful fact is that J. P. "fades" about twelve times a minute there; so says S. M. F.

I'm sure I cannot account for the tragedy. Perhaps it's that breakwater or the local coal-mine! Or the Downs? S. M. F. sends his love to my "grammy," but that brute is not responsive, having developed turntable wobble during my absence on Dartmoor. (No, Edgar; I am *not* the "Ringer.")

"Living Dangerously."

AMONGST the letters received by the B.B.C. in reference to the "talks" on "Living Dangerously" is one from someone who describes himself as a "young married man with a happy family." This lucky fellow confesses that he feels "ashamed" of his routine-ridden life and craves a chance "to live a man's life."

Bless us, what confusion of thought! The lot of the greater part of mankind is routine. Anyway, a real way of being a man is to do your duty as you see it, and there is no doubt where this young man's duty lies.

If this series of "talks" is tending thus to unsettle the minds of young family men, it were better discontinued.

Where the U.S.A. Excels.

I AM glad to be able to leave a controversial subject and pay ungrudging tribute to an activity in which America certainly does beat the world. I have it on the authority of the "Telegraph and Telephone Age" that in *nine months*, from October 1st, 1930, to July 1st, 1931, the Chicago police arrested no less than 10,085 persons through radio broadcasts to police cars.

In order that I shall not be guilty of deprecating the American "cop," I will assume that the whole 10,085 were law-breakers. Over 1,000 a month! And, of course, there must have been a lot more who were not arrested.

(Continued on next page.)

NEWS—VIEWS—AND INTERVIEWS (Continued)

Hail, Columbia! We "hand it to you." Will you grudge us Faraday when you have undisputed claim to such a noble record?

Polly Technique.

HERE is a joyous little jape adapted by me from the original. I apologise to the author of the authorised version! A man told his friend that he intended to go in for parrot-keeping as a paying hobby.



"Where will you keep 'em?" said the friend. "You've no room!" "Oh, in the sitting-room, I s'pose." "But that's where you

listen-in. What about the noise?" "Oh—they'll have to put up with that!"

More Lessons.

J. A. L. (near Selby) asks whether it is correct to say that one make of loud-speaker robs the H.T. battery more than another. It is quite incorrect to say so, for the L.S. of a modern set does not take any "juice" from the H.T.

Of loudspeakers which require an independent battery, one type may possibly need more current than another. As to his query about the alleged fault of his "Titan" Three, which ran down his grid battery in a week, I reckon he "shorted" the thing.

Please see correct wiring similar to that in Blue Print No. 54.

Why These Pipes?

AFTER rather an extensive survey of radio ads. during the past year, I have discovered that there is a growing fashion of displaying photographs of

strong-faced young men in whose strong faces are inserted tobacco pipes. Just look for these and observe the complete irrelevance of these pipe-stands to the subject matter of the ads.



One gentleman whose pleasant features are beginning to be advertised, is without a pipe. Perhaps he does not smoke a pipe, in which case why not depict him taking snuff or tapping a "gasper" on the back of his hand? Or demolishing a doughnut!

Short-Wave Clubs.

ALF MANN, o' Middlesbro', sends me a copy of the monthly issue of the International Short-Wave Radio League's official organ, "International Short-Wave Radio News," which no short-wave enthusiast should ignore.

Membership of the League costs one dollar per annum, and applications ought to be sent either to the League at Box 22, Boston, 30, Massachusetts, U.S.A., or 106, Lord Street, Southport, England. For one dollar you get the News, which is

simply a solid chunk of short-wave stuff, point-blank, straight from the shoulder, and no tripe by way of padding.

For the Enthusiast.

LIKEWISE, A. E. B. (Rotherhithe, S.E.) sends me the August issue of "International Short-Wave Club," the official organ of the aforesaid Club, whose headquarters is at Klondyke, Ohio, U.S.A. You can get this magazine for one dollar (4s. 2d.) per annum, and that fee includes membership of the Club, a membership certificate and a free question service.

My view is that all red-hot short-wave fellows should subscribe to both organisations. Mr. A. W. Mann, 62, Costa Street, Middlesbrough-on-Tees, England, will send

SHORT WAVES.

With reference to the Czecho-Slovakian experiment of hunting the fox by wireless and aeroplane, regret is expressed in the Shires that too few farmers in this country can be induced to see the advantages of wireless fox hunting.—"Punch."

"America absorbs nearly 45 per cent of the total world output of wireless apparatus," we read in ANSWERS. Personally, we'd be quite satisfied if it merely absorbed the one next door.

We have just heard a story from an American studio where it was found necessary to reproduce the sound of water pouring from a barrel on to some boards. Highly-paid technicians tried everything from pouring buckshot on a drum to rocking salt on a newspaper. Finally, one of the lesser mechanics suggested pouring water from a barrel on to some boards and, Hey Presto!

We read in a contemporary that the number of radio fans has increased enormously this year.

That probably accounts for that very cool summer we've just experienced.

A critic says that wireless is unsociable. Indeed, there's none so deaf as he who listens-in.

"Mixed programmes," I always can get. For I've just bought a cheap super-het; Most B.B.C. stations, With stray oscillations, Come in ALL AT ONCE on my set!

you a sample copy of "International Short-Wave Radio News" if you write for it, and Mr. A. E. Bear, 10, St. Mary's Place, Rotherhithe, London, S.E.16, will send you a copy of his club's magazine, but you will please enclose a 1½d. stamp in each instance

To Find Out Watt.

FRIGHTFULLY technical this week, am I not? But I simply must give you some bits from an article in "Radio Bulletin," of Bombay, about Ohm's Law, etc.

"To find out watt, multiply together with the number of volts and number of amperes. For example, 100 volts \times $\frac{1}{2}$ ampere = 50 watts." Is it not very simple? I am sure you must have already said, "Yes, it is so very simple. I thank you for that." Yes, thanks!

"Finally, we take Ohm's Law: 4 volts divided by 2 amps., the result is 2 ohms." What I want to know is: What happens to Ohm's Law if we take 10 volts divided by 4 watts? Perhaps some Mahatma can work it out.

Dr. Johnson's Sanity.

A PROPOS the B.B.C. organ's recent unfortunate mistake in slavishly adopting as its own Macaulay's statement that Dr. Samuel Johnson was half mad for the greater part of his life, I have had a letter from the Mayor of Lichfield, who registers a protest against that ridiculous allegation.

I am afraid our contemporary has not heard the last of the affair; for it is probably to be dealt with in other organs, probably on both sides of the Atlantic. The President of the "Johnson Society" for the year is not likely to lie down under the "tuts" of the "Radio Times," or to acknowledge himself to be mesmerised by Macaulay's booming prose.

What Did She Say?

EARLIER on this page I mentioned the story of the man with the parrot. I've just remembered another I saw recently.

A Lancashire man and his wife arrived at the railway station. "Ee, lass, Ah've forgotten t' radio."

"What d'ye want t' radio for?"

"Ah've left t' tickets on it, lass!"



"By the Deep Nine."

IF Marconi's wonderful device for taking marine soundings becomes generally adopted no more shall we hear the tuneful cry of the leadman, "By the deep nine. By the mark seven."

The primitive lead with its arming of tallow will serve only to secure samples of the sea floor, for comparison with the chart. The Echometer, which is the name of the radio sounding device, is worked from a four-volt accumulator and is as simple in operation as A.B.C.

A switch is pulled and the depth of the water is shown at once, quite accurately and many times a minute, on the indicator.

"Revoluting."

I LISTENED recently to a performance of an orchestral piece composed by A. Mossolov, and called "Factory—The Music of Machines." Luckily it lasted only

a few minutes, for I have never heard such a childish clatter, not even from Honegger and his pals.

The only future I can see for Mossolov is a job in the noise-making department of a broadcasting station, for his imitation of the noise of a factory at work was quite good; the mistake was in dishing it up as music.

The B.B.C. says of this Russian, "he has found a method of revolting which is all his own." I thank them for that word. It was revolting!



THE B.B.C. CHIEF ENGINEER EXPLAINS — THE WAVELENGTH PROBLEM

BY NOEL ASHBRIDGE *B.Sc. Lond.; A.M.I.C.E.*

IT is no exaggeration to say that the fewness of suitable wave-length channels is the reason why wireless communication does not develop with the sensational rapidity which was predicted 20 years ago.

When wireless telegraphy became a comparatively simple and sound proposition people with little or no technical knowledge, said that in a year or so everyone would be able to communicate with friends by wireless, that the ordinary telephone would become obsolete, and so on.

A "Full-House."

What would happen if we could use waves of a few centimetres in length for general purposes it is impossible to say but the fact remains that there are not enough normal channels for the existing services, assuming the use of present-day apparatus, both for transmitting and receiving.

This, in short, is the main reason why wireless communication cannot be more universally used, for example by business houses, railways, etc., for private telegrams and telephone conversations.

The difficulty is only felt directly by most people, through its effect on broadcasting. Quite naturally, every town of considerable size considers that it ought to have its own station.

Again, the B.B.C. receives from time to time letters complaining that, for instance, dance music was audible during the Epilogue on a certain Sunday evening. It is usually described as a scandal, and it is asked what is the use of the International Control Station at Brussels if transmitters are allowed to wander away from their correct wave-lengths.

Reasons For Interference.

In the majority of cases, it is found on investigation that the positions of the stations concerned were correct to within about 200 cycles per second, or even better, during the occurrence of the interference. The question arises, therefore, what was the cause of the trouble.

Since the stations were all on their correct wave-lengths, and cross-talk was not possible because British stations do not radiate dance music on Sundays, the interference could only be due to a foreign station. There remain two probable reasons why interference was heard:

(1) That the listener's receiver was not sufficiently selective.

An exclusive contribution in which Mr. Ashbridge outlines the main problems that confront him in arranging for a first-class broadcast service over Britain, and some of the steps that are being taken in an attempt to achieve this ideal.

(2) That the field strength of the British station was not sufficiently great in relation to that of the interfering foreign station for the standard separation of 9 kcs. between channels.

Strictly speaking (1) and (2) should be taken together, that is to say, the ratio of strength of the two stations must be a certain amount for reasonably clear reception assuming a receiver with a definite degree of selectivity.

It is necessary at this point to consider the nature of the interference which is

usually heard. This usually takes one of two forms, either the complete programme of the interfering station is heard more or less faintly as a background, or one hears what is termed side-band jamming.

When the whole programme is audible almost undistorted, it usually means that the cut-off of the high-frequency circuits of the receiver is not sharp enough, and the resonance curve is of such a shape that some response is given to frequencies many kilocycles away from the wanted carrier frequency.

"Whistling Grasshoppers."

Side-band jamming, as heard in a loud-speaker, is not unlike the noise made by a chorus of grasshoppers, but the cause of this noise is not always realised.

Let us assume that we have two stations separated by 9 kilocycles, each modulating with frequencies up to 9,000 cycles on either side of their respective carriers waves, and assume that the receiver is capable of giving good response up to 9,000 cycles.

One will hear, first of all, the heterodyne between the carriers of the two stations, but this is really not a serious difficulty, because it can be cut out by a filter without interfering very much with the quality.

However, we also have the side-bands of the two stations heterodyning together, in addition to one side-band of the unwanted carrier heterodyning with the carrier of the wanted station. The latter is the cause of what I have described as the grasshopper noise, in other words side-band jamming.

The heterodyning of the side-bands with each other does not seem to contribute much to this noise, because the volume of interference is usually about the same, whether the wanted station is modulating or not.

Deciding the "Cut-off."

The question arises at what frequency should the receiver cut off in the high-frequency circuits for the best all-round conditions of reception. It has been found experimentally that if a receiver cuts off at about 5,000 cycles in the high-frequency circuits, the ratio of field strength of the wanted to the unwanted station must be about 4-1 with a 9-kilocycle separation, if reasonable freedom from side-band jamming is to be obtained.

Again, measurements have been made of the strength of the sky wave (otherwise known as the indirect or reflected wave)

(Continued on next page.)

BRITAIN'S "STATION" BUILDER



A recent photo of Mr. Ashbridge.

THE WAVELENGTH PROBLEM.

(Continued from previous page.)

from various European stations over long periods, and it was found that the peak values of the field strength may be as high as 5 millivolts per metre, or even, in some exceptional cases, higher still.

This means that for fairly complete immunity from side-band interference we must first of all cut off sharply at 5,000 cycles, and even then there must be a ratio of field strength not less favourable than 4-1.

Minimum Strength Required.

In practice this would be found to be rather a pessimistic view of the situation because the extreme peaks of the sky waves from a distant station occur at infrequent intervals and in most cases the mean is roughly one quarter of the peak.

However, we are still faced with the fact that for acceptable reception from certain stations we must have a minimum strength of about 6 to 10 millivolts per metre at least. Even under these conditions we shall hear the peaks of the jamming stations, but the seriousness of this would vary to an extent with the behaviour of the Heaviside Layer on the particular night in question, and with the skill with which modulation was being adjusted at the distant station.

Of course, as the cut-off in the receiver is made higher, or when the ratio of field strength is lower the interference becomes greater. On the other hand, if we cut off at, say, 3,500 cycles per second, we can do with a much smaller ratio of field strength, but this does not give acceptable quality to anyone using something better.

At first sight one might doubt if anything is to be gained in these days by making a receiver give a good response to all frequencies between say 50 and 9,000 cycles per second, which always used to be looked upon as essential for first-class results.

"Quantity" Reception.

However, this essentially depends on where the receiver is to be used; if there is to be an available strength of, say, 50 millivolts per metre, then very high quality reception is still possible. It is in fact for this reason that at present we do not cut off in our transmitters at, say, 5,000 cycles per second.

It has to be remembered that with a 50 k.w. station the area which receives a field strength of 50 millivolts per metre or more, is more than 700 square miles for a

station using a wavelength in the neighbourhood of 350 metres.

On the other hand, when the available field strength is much less than this, an overall response above 5,000 cycles per second is actually harmful except during daylight. The general solution to the problem is to make the detector, low-frequency stage, and loudspeaker capable of reproducing the full audio-frequency range, while the high-frequency circuits should possess a widely variable degree of selectivity.

Variable Selectivity.

The degree of quality, that is to say the musical frequency band covered, will then depend on the degree of selectivity in use. To cover unfavourable conditions the H.F. circuits must be capable of cutting off sharply at between 4,000-5,000 cycles per second, without much loss of sensitivity.

Obviously, while this state of affairs lasts, the effective range of stations in the medium wave-band is limited, not by the minimum field strength necessary for good reception in a general way, but by minimum strength which will, so to speak, shout down the indirect ray from the neighbouring stations.

Of course, if the latter happen to be small stations, with a power of about 1½ k.w., then the limit of range is dependent only

LONG-RANGE LIFEBOAT RADIO

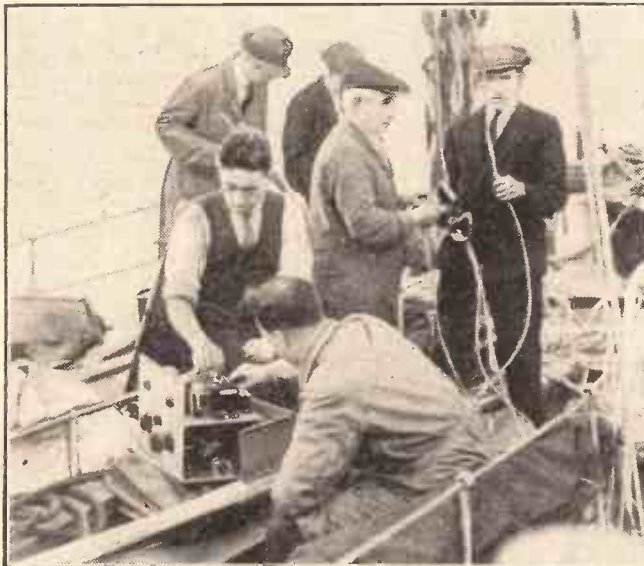

The new motor-boat which has been built for service in the Southern Hebrides, in Scotland, has been fitted with a compact radio outfit, having an unusually long range.

on the minimum field strength which in general is capable of drowning normal background "mush." This is usually taken at about 3 millivolts per metre.

On the other hand, if there are two 50 k.w. stations on the two neighbouring channels, we find that for good reception after dark the limit of range under present conditions corresponds to a field strength of the order of 10 millivolts per metre, and even inside this range there may still be appreciable side-band jamming at times.

Therefore, we can say that the whole of the area which lies between two circles having a radii of, say, 40 miles and 70 miles respectively, is deprived of a really good service after dark, entirely due to interference from the neighbouring stations.

Of course, such an area would not be defined in practice by anything approaching mathematical circles, since field contours are always very irregular.

Thus we have to consider whether it would not be possible to serve Europe as a whole better by having fewer stations spaced more widely apart. It would mean that some countries would have to use less channels, but even so the probable result would be a better service generally.

We have carried out experiments in this country to find out exactly what the effect would be of increasing the separation between stations from 9 kilocycles to 11 kilocycles, and we find that in very general terms the ratio of field strength which is necessary for clear reception with receivers in a selective condition, that is, having a cut-off at about 5,000 cycles, is halved with the larger separation.

Increased Separation.

Thus a little calculation will show that in general it would pay to increase the separation between stations even if the total number of channels for Europe had to be reduced in proportion to the increased separation.

However, opinion on this subject is not altogether unanimous, and in an international problem of this kind there are always complications, due to the fact that in the case of several countries commitments have been made which cannot be quickly modified. It remains to be seen what the general opinion of broadcasters will be after another winter season with a steadily increasing number of high power stations in operation.

Fortunately, in the case of the long-wave stations, the situation is not so serious, owing to the fact that the peak values of the indirect rays are comparatively small; in fact, as compared with the medium waves, there is little difference between day and night conditions. For this reason high unwanted field strengths on long waves are not encountered, at any rate, in this country at present.

TROUBLE WITH A "MOVING COIL."

A Loudspeaker Hint which may Improve Your Results.

I HAD a good deal of trouble lately with a moving-coil loudspeaker owing to the fact that the chamois leather "surround" had got set into a particular form which pulled the diaphragm and, of course, the moving-coil, out of its mean position.

I tried all sorts of dodges to get this back but could get no satisfaction until I dismantled the cone and fitted a fresh leather surround. The effect of the displacement was quite noticeable because if you gently pushed the cone back into position while the speaker was in operation, you could distinctly tell the improvement both in quality and volume.

I should say the volume went up by 30 or 40 per cent and then down again when you took your hand away and allowed the cone to go back into its permanent but displaced position. I think a good many of you who use moving-coil speakers would be well advised to check up in this way, just gently moving the cone slightly to and fro whilst the speaker is working.

J.H.T.R.

MYSELF and the MICROPHONE

by PAUL ROBESON



There are few greater or more outstanding figures in the vocal and dramatic worlds than Paul Robeson. Indeed, it is no exaggeration to say that his position is entirely unique. He represents a completely new phase of negro culture, and by unremitting efforts his attempts to re-create all that was best and most worth possessing in negro tradition are at last receiving their due reward. He has a perfect microphone manner, and his broadcasts always prove entirely popular. In this exclusive contribution he tells you of his early struggles and, reading between the lines, you can, if you read with sympathy and perception, discern something of his dogged courage.

SUCH advantages as I may possess I owe largely to my father, who started his own career under the greatest difficulties. In 1843, when he was born, America had barely settled down from the abolition of slavery, and the troubles which followed.

He had little money and no influential friends to help him, yet by dint of hard work and determination he succeeded in entering Lincoln University, and set out to prepare himself for the ministry.

His was a natural choice, for the great passion of his life was oratory, and he possessed a wondrously deep and powerful speaking voice. These were the days when public speaking was regarded as an art.

In England, Parnell and Gladstone were at the height of their fame, and night after night my father would declaim their resounding utterances for his own satisfaction and the family's edification. He had become a clergyman with a very considerable following.

By some chance, I inherited his vocal gift, and when this was fairly certain, he took me under his wing and mapped out a course of instruction.

Trained by His Father.

In some families this singling out of the youngest for special treatment might have led to trouble, but in ours it never did. In course of time my elder brother became a divine, my second a physician, and my one sister a schoolmistress. Never do I remember any of them being anything but kind and encouraging.

My father's method of training was personal, and possibly somewhat unique. Innumerable speeches by famous orators, both in England and America, were given me to learn.

During the day I prepared and examined them. Then, in the evening, I delivered the chosen oration before the family circle, and criticism and encouragement were duly forthcoming. By this means I rapidly became accustomed to speak before an audience, and my mistakes and shortcomings were immediately corrected.

My father's patience was phenomenal. He would take me word by word through

a speech, pointing out the beauty of a phrase, dwelling on a simile, or explaining the potency for good or evil of one particular inflection.

At a little later date I helped him in his church, reading the lessons and psalms, but I don't think that he ever actually entrusted me with the delivery of a sermon.

He Becomes a Barrister.

Thus the days went by until the time came for me to choose a profession. After a certain amount of discussion, it was decided that I should go in for the law, and to this end I was entered at a secondary school, and commenced another stage of my education.

Here my opportunities for public speaking

THE AUTHOR



A recent photograph of Paul Robeson, who contributes the accompanying fascinating autobiography in miniature.

were a little wider, and as by degrees I progressed upwards through the high school, Rutgers University, and finally Columbia University, I benefited by the more extended experience and scope that each of these establishments progressively presented. Primarily, of course, I was studying law, and it was from Columbia that I took my LL.B. and qualified as a barrister.

It must be remembered that my father was never a rich man. The calls of his parish were large and frequent, and he also had the education of my brothers and sister to take into consideration.

Famed as an Athlete.

Fortunately, university education is probably somewhat cheaper in America than it is in England—or, at any rate, is made available to a wider class of people—and I was able by a series of scholarships to make progress without throwing too great a strain upon his resources.

Truthfully, I myself was never really short of the things which mattered; nevertheless, like most young men, I experienced numerous occasions when a little extra money seemed particularly to be wished for. It was while I was at Rutgers that I first conceived the idea of using my voice to this desirable end, and so I proceeded to take a hall, bill myself, and make the necessary arrangements for a sort of one-man concert.

I should mention here, perhaps, a fact that was probably of great assistance to me in attracting an audience. About this time I had been playing a great deal of Rugger, and on this account my name was already fairly widely known.

Law and Politics.

I had been a member of the university side for about four years, and had gained the "letter" which is very much the equivalent of the English varsity "blue." In 1917, and again in 1918, I was selected for the All-America Rugby team, and at various times, also, I gained "letters" for baseball, basket-ball, and track events.

But to return to my concert. When the fateful evening arrived I was pleased to discover that I had gathered a reasonably large audience. My programme was some-

(Continued on next page.)

MYSELF AND THE MICROPHONE

(Continued from previous page.)

what mixed. First I sang a group of songs: then I orated for about twenty minutes, followed up by another group of songs, flourished about a bit and so on.

The evening was quite a success, and from time to time I repeated it. Everybody appeared to be satisfied, and as on these occasions I usually made about ten pounds, my experiment appeared to be justified.

Apart from the amazing experience of these little one-man shows, I was favoured by the fact that competitive public speaking has always been popular in the universities of America. The number of contests for which I entered must have been legion.

Often enough I managed to win, and to this, and the fact that I gained the freshman, sophomore, and junior prizes in oratory, and senior prize in extempore speaking, together with my "letters" for sports, I probably

guished clients it was felt that my colour would prove an insuperable difficulty.

This was absolutely true, and, moreover, it soon became clear that without the aid of politics the law for me could be nothing but a blind alley. I have never deliberately looked for fame, but I could not put my heart into a profession in which the prizes were absolutely denied to me.

The law as a career seemed hopeless, so for a while I played about in Harlem and busied myself with a play-producing society of which I had sometime before become a member. Our productions were popular, and we numbered among our patrons several quite distinguished people.

"The Emperor Jones."

Eugene O'Neill, Robert Edmond Jones, and that great critic, Kenneth McGowan, were frequently present. Indeed, O'Neill offered me the name part in "The Emperor Jones," when it was first written. Gilpin, who later played the part, was immediately hailed as "America's greatest actor."

I was at breakfast when I read the papers containing the news. For the life of me I could not help wondering what would have

Spirituals always have had a deep appeal, and they never fail to move an audience. Somehow there is something primitive and fundamental about them that finds a ready response in the hearts of all. Since then I have done much work with Laurence Brown both in America and in this country.

This concert work continued until the end of the summer of 1923, when I accepted an offer to come to England to fill my original rôle in "Voodoo," this time with Mrs. Patrick Campbell in the other leading part. This also was fine experience, and Mrs. Campbell was very kind and encouraging.

Later it was arranged with Mr. O'Neill that I should play Gilpin's part in the English production of "The Emperor Jones." As a matter of fact, this production was somewhat delayed owing to a slight hitch that occurred in the arrangements, but I was able to fill in the interval satisfactorily by a period of vocal work in conjunction with Miss Florence Mills.

A Liking for Mike!

"Show Boat," and my more recent production of "The Hairy Ape" are too recent to need much comment here. The latter, of course, was brought to an untimely end by the loss of voice of which I was the victim. Fortunately this was of a temporary nature, but I had no alternative but to rest.

As this short article is intended for a widely read wireless journal, I ought perhaps to mention the matter of broadcasting. As a matter of fact, I have little to say, for it is a medium in which I have always felt particularly at ease.

Perhaps it is that the enclosed and intimate atmosphere of the studio is akin to that of the living room where I delivered my prepared orations as a boy. True, no brotherly or sisterly criticism is immediately forthcoming, but my listeners, nevertheless, like my brothers and sister in those days, are free of restraint, and applaud or otherwise in the comfort and privacy of their homes.

"INDUCTOR" v. "MOVING COIL"

A Loudspeaker Comparison.

It is an interesting question whether the inductor or reed type of loudspeaker can give results equal to those of a moving coil. The question is raised afresh by the advent of the new Ferranti inductor speaker for which considerable claims are made—incidentally these claims, according to my own experience, are very well justified.

The point is that you cannot just compare any example of inductor type of speaker with any type of moving-coil speaker. In order to make a reasonable comparison it is necessary to take the average performance of the one type of instrument and compare it with the average performance of the other type.

In fact, the Ferranti people make the claim that their new inductor loudspeaker is actually superior to most of the moving-coil speakers on the market although it does not give, and is not intended to give, just the same results as their own moving-coil speaker.

It comes down to this, that a high-grade inductor or reed speaker is preferable to a medium grade moving-coil speaker.

J.H.T.R.

OUR RADIO CONSULTANT-IN-CHIEF "AT HOME"



Capt. Eckersley, with G. V. Dowding (left) and members of the "P.W." Technical and Research Dept., examining the first rough model of an interesting and valuable new device. We are unable at the moment to disclose details of this, but you can be sure, you will all hear about it in due course. Actually the device is an invention of Capt. Eckersley's, which he is developing in collaboration with the staff of "P.W.'s" Research Dept.

owe the fact that I was elected to the Senior Society of Cap and Scull, and awarded the Phi Beta Kappa key of the American University Academic Guild.

It was not until I had actually become a barrister that my troubles really started. Over here, law and politics are largely things apart. In America they are bound up with one another.

A Serious Set-Back.

Legal openings in many law firms are under the thumbs of the party organizers, and I had little taste to become a professional politician. There are, of course, a few firms big enough to assert their independence, but with their highly placed and distin-

been my fate if I had accepted. Had I missed the chance of a life-time?

However, shortly afterwards I received an offer to appear in "Voodoo," with Miss Margaret Wyncherley in the other leading part, and this time I agreed. It was fortunate that I did so, for the stage director was Augustine Duncan, brother of Isadora Duncan, and he taught me a very great deal.

The play was a success, and when it came to an end, as even the best plays do, I went into concert work with Laurence Brown, the distinguished musician and composer of melodies of the Southland. Our first recital was an unqualified success, and so great was the demand that three repeats were necessary.

HENRY'S HOOK-UP



CAREFULLY stored away in the United States National Museum at Washington is a piece of electrical apparatus which is famous the world over.

It is a very simple galvanometer—the first ever made. A type of instrument, of course, which would be scorned by any practical man at the present day, but, nevertheless, an exceedingly interesting instrument.

Its maker, Joseph Henry, the "Father of Induction," lived long in obscurity. He began life as a silversmith's apprentice.

A Brilliant Worker.

Later he became a school-teacher, and subsequently, through the sheer brilliance of his work, he gained for himself the post of Professor of Mathematics and Physics at Princetown University. Finally he was put in charge of the Smithsonian Institution at Washington, an American Institution somewhat analogous to our own Royal Institution in London.

Perhaps if Henry had never made this galvanometer, with its magnetised darning needle, and its turns of wire laboriously wrapped round with bits of silk, gathered, we are told, from a waste box, radio science might still have been a thing of the future.

Who knows?

At anyrate, it is certain that to Joseph Henry of Washington, U.S.A., the radio and electrical world owes a debt which is only justly repaid by the christening for all time of the unit of inductance—the "henry"—in his name.

Henry constructed several galvanometers,

THE FIRST GALVO

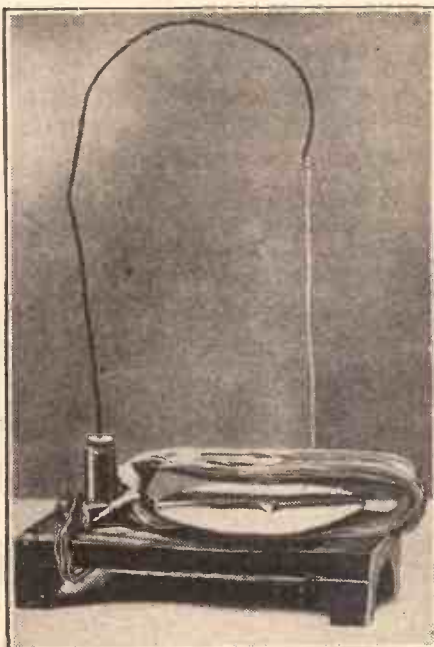

The original galvo constructed by Joseph Henry, which now rests in the United States National Museum at Washington.

We all refer to chokes of so many "henries," but here our contributor vividly presents a glimpse of a great, though far-off figure—Henry, the man!

but the one in the U.S. Museum at Washington seems to have been his earliest model, and, in many respects, his favourite one. He applied this instrument to many novel uses. He knew that the spark obtained when a Leyden Jar (as the old-time laboratory condensers are called) was discharged was derived from the electrical energy stored up by the Jar.

What His Instrument Showed.

Henry's accuracy of observation, coupled with the assistance of his newly-invented galvo, took him a stage further, however. He noticed that when the Leyden Jar was discharged through the galvanometer, that although the needle was always strongly deflected, it was not always deflected the same way.

Sometimes, for instance, the needle would be deflected to the right, whilst at other times it would go to the left.

A trivial observation, one might think, which, for many of us, would imply nothing at all. To the super-keen intellect of Henry, however, this variation in the deflection of his galvanometer needle implied something tremendously important.

Henry made his observations on this subject in 1842, and in the same year he wrote

"The phenomena requires us to admit the existence of a principal discharge in one direction and then several reflex actions backward and forward, each more feeble than the preceding, until equilibrium is obtained."

Discovery of High-Frequency.

In other words, Henry had noted and recorded for the first time the oscillatory nature of the discharge from an electrical condenser. He had discovered radio-frequency.

Henry understood the nature of his discovery perfectly clearly. He saw that when a condenser is discharged a steady stream of current is not obtained.

The current derived from the condenser, he noted, is oscillatory in nature, and from this realisation he went on to the inception and development of another mighty principle of radio science—the principle of Induction.

For some time Henry had known that a

rapid and interrupted flow of current in a circuit could set up a strange influence in a distant and altogether separate circuit. A current, he held, that "induced" a sort of replica of itself in another circuit. In his own words:

"A single spark from the prime conductor of a machine of about an inch long thrown on to the upper end of a circuit of wire in an upper room produced an induction sufficiently powerful to magnetise needles in a parallel circuit of iron in the cellar beneath, at the perpendicular distance of thirty feet, with two floors and ceilings, each fourteen inches thick, intervening."

A Land-Mark of Science.

Henry had found that the electrical inductive influence could pass through space and through solid matter. Just as a wireless

A MODERN MODEL

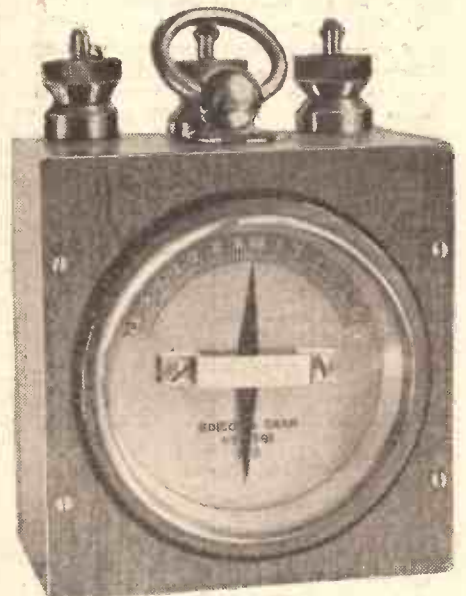

This is a modern galvo, and it bears little superficial resemblance to Henry's early effort. By the invention of this useful instrument he made a tremendous contribution to electricity in general and radio in particular.

wave travels outward into space from its aerial of origin, and produces, or, to be more correct, induces a replica of its originating current in the receiving aerial, so Henry's machine-generated sparks set up waves which travelled downwards into his cellar and thus enabled him to erect a series of observations which have long been regarded as one of the most prominent landmarks of science.

Reaping His Reward.

Henry, fortunately for himself, and in striking similarity to his English contemporary, the renowned Michael Faraday, lived long enough for his name to become well-recognised, for, as we have seen, he ended his days in charge of the great Smithsonian Institution at Washington.

CAPT. ECKERSLEY'S QUERY CORNER



Under the above title, week by week, our Chief Radio Consultant comments upon radio queries submitted by "P.W." readers.

Don't address your questions direct to Capt. Eckersley, a selection of those received by the Query Department in the ordinary way will be answered by him.

Super-Het Oscillator Harmonics.

G. M. (Norwich).—"It is often stated that the oscillator valve of a super-heterodyne receiver can be arranged so that few harmonics are generated. Is it possible to give a simple explanation of this?"

The point at issue is how to design an oscillator to give a very small harmonic content? Theoretically, a closed oscillating circuit, if energised from a pure sinusoidal source, does not in itself produce harmonics.

The conventional valve oscillator harmonics are created chiefly by the non-linearity of the actions involved in the valve itself. You will see, for example, that if the grid circuit is arranged so that the impulses applied to the grid give a voltage to the grid more positive than the filament, then grid current will flow.

This will put a load upon the circuits feeding the grid, and the voltage may fall from the value it should have been if these

HOW IT HAPPENS

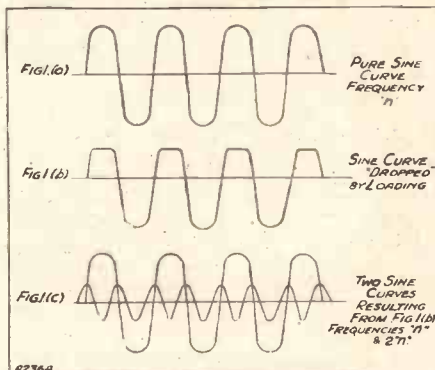

The maltreated curve (Fig. 1b) is equivalent to several sine curves as shown below (Fig. 1c.)

circuits had no work to do. Thus I have drawn in Fig. 1a a pure sinusoidal impulse, but in Fig. 1b I have shown what happens to the shape of this impulse if the positive tip of the impulse produces a current and is thus loaded.

The sine curve is no longer correctly shaped, its peaks are bitten off. It can be shown that if we have a curve of the shape shown in Fig. 1b, then it can be analysed into two (or more) sinusoidal impulses having different frequencies (see Fig. 1c), reproducing, in fact, what are called harmonics.

The most important factor in the design of a beat oscillator is to be sure that no grid current flows, and therefore that some permanent negative bias is applied to the grid. The grid-leak type of oscillator should, in fact, be avoided.

If both the grid circuit and anode circuit are tuned and negative is applied to the grid it is unlikely that any serious harmonics will be generated.

Hum from the Rectifying Valve.

R. Y. (Newcastle).—"My all-mains receiver, using indirectly-heated cathode valves and a normal full-wave valve rectifier for H.T. supply, used to hum badly when a transmitter was tuned in. If the receiver was de-tuned from the station the background was quite silent.

"I have found that the connection of two condensers, .1 mfd., one between one anode of the rectifier and H.T.— and the other from the other anode to H.T.—, has cured this defect, and the receiver is now almost silent so far as hum is concerned.

"What was the cause of this hum and why did the addition of the condensers cure the trouble?"

It is said that a rectifier valve, of its own sweet will, can generate high-frequency oscillations. This is probably said with truth, because I can remember twelve or thirteen years ago a Miss Summerhays, who worked in the Air Force research laboratories, showing that the three-electrode valve could generate oscillations without any appreciable impedance in either the anode or the grid circuit.

Assuming this to be the case and that a rectifying valve can do the same thing, it will be evident that the oscillations set up in this way will be picked up by the receiver and passed to the detector valve; and that, furthermore, the amplitude of these oscillations will be controlled by the voltages on the valve, and hence will be increased and decreased according to the momentary voltage of the alternating-current mains. Put it more simply and say that the high-frequency oscillations are modulated by the mains hum.

It is a little difficult to see, nevertheless, why tuning in the station should increase the hum, but it may be that it is only the fact that the receiver has been made sensitive. It appears that connecting a condenser, as you have connected it, prevents the rectifier generating oscillations and so removes the effect.

I must say I am not terribly convinced about it all and there may be something else coming in. If any readers of this query can throw valuable light on the subject I know all of us would be very grateful.

Morse Interference on a Super-Het.

J. S. (Woll Hall).—"I was recently listening to a super-het owned by a friend, and noticed that there was always a background of C.W. Morse on the wave-length to

which the set was tuned. Is this normal, or does it tend to show that the set was not functioning properly?"

I cannot be perfectly sure whether the background of C.W. which you heard on your friend's super-heterodyne set was due to jamming of a station transmitting on or near the wave-length to which the set was tuned, or whether the jamming was passed through to the intermediate-frequency stage and caused interference in this way.

As you probably know, a super-heterodyne receiver works on the principle of converting the frequency it is desired to receive to a lower frequency, by introducing a beat oscillator to heterodyne with the incoming signal. This means that the high-frequency amplification takes place at a lower frequency than the frequency to which the aerial circuits of the set itself are tuned.

There are, in fact, three radio frequencies present, that of the incoming wave it is

ONLY IN "P.W."

can you read Captain Eckersley's replies to listeners' own problems.

AND REMEMBER—

Captain Eckersley's technical articles appear only in the "Big Three,"

"POPULAR WIRELESS,"

"MODERN WIRELESS," AND

"THE WIRELESS CONSTRUCTOR."

desired to receive, that of the beat oscillator, and that of the intermediate frequency; the latter being equal to the difference between the two former frequencies mentioned.

In a particular case you might be receiving a frequency of 1,000,000 cycles (300-metres wave-length) and you might adjust the beat oscillator to 1,100,000 cycles, amplifying the signal before the second detector at a frequency of 100,000 cycles (3,000 metres).

If some jamming station were working on a wave-length of 3,000 metres, and unless special precautions were taken, this jamming station might be picked up by the intermediate-frequency circuits and appear in the loudspeaker as a jamming signal. There are ways and means of overcoming this effect; particularly, the intermediate-frequency stages should be very well screened, and there should be good filters between the aerial and the beat oscillator circuits.

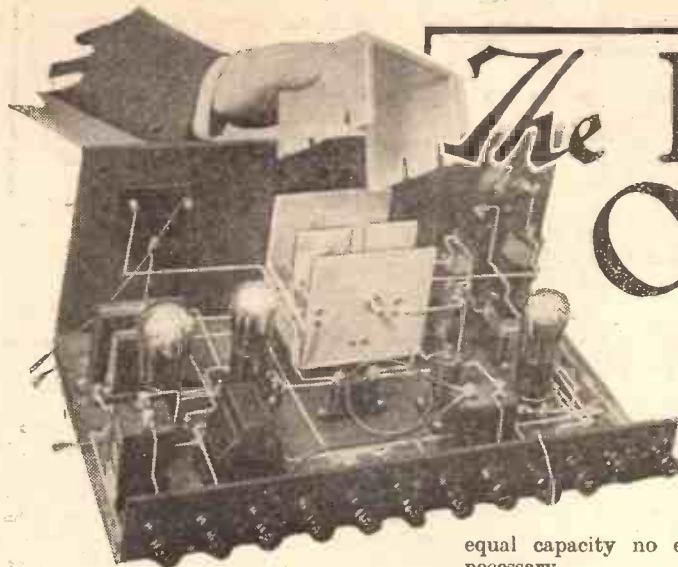

The NEW "B.P." ON TEST

Hints on the adjustment of a "star" set, recently described in "P.W.," our Query Editor here, tells you in detail how to get the very best results.

THE New "B.P." Three is, in operation, every bit as simple as the ordinary detector and L.F. receiver. The fact that band-pass tuning is incorporated in no way complicates matters. Rather is it the reverse, since the normal single-tuned circuit set requires a certain amount of "juggling" with the tuning and reaction controls in order to obtain the desired selectivity.

Automatic Selectivity.

With a band-pass receiver selectivity is automatically achieved, and the tuning operation is made easy by the use of a twin or ganged condenser. Moreover, this selectivity is obtained without the detrimental effect upon reproduction produced by reaction "up to the hilt" and series-aerial condensers.

When the panel of a band-pass design such as the New "B.P." Three is compared with that of a similar design not employing band-pass tuning the verdict cannot fail to favour the band-pass set on the score of simplicity, provided both receivers are intended to give a similar degree of selectivity.

The New "B.P." Three is compact—the band-pass coil takes up very little room—the layout is not critical. If a slight variation is made in the positions of the components it is probable that no serious ill-effects will occur.

This does not infer that any marked re-arrangement of the layout can be made. That would be fatal. The main point is that as the selectivity is automatic, so also is the layout automatic—it is conventional, and follows standard practice.

There is practically nothing to design in a set of this nature, and being non-critical it can be regarded as an excellent receiver for the beginner, who is frequently deterred by his fears as to his ability to copy a set design from the published description of the original.

Both Bands Covered.

The New "B.P." Three has a large "safety factor" both in its layout and the disposition of the wiring. The Lewcos band-pass coil covers the medium and broadcast wave-bands when tuned with a wind-gang-condenser of the type specified, and the windings are matched up so that with a "ganged" condenser with sections of

equal capacity no external trimming is necessary.

It is true that trimmers may be supplied by the condenser manufacturers as part and parcel of the condenser assembly, but these are only for finally balancing up the sections of the "ganged" unit, and once the two halves have been equalised the whole of the tuning is carried out on the single control on the panel.

This business of balancing or equalising the two sections of the twin condenser is best done on a weak transmission, and the final adjustment is the one which gives the best volume.

You may ask whether a simple band-pass set like the New "B.P." Three will enable

any two stations to be separated. The answer is "No"! Such drastic separation is impossible without complicated control, and its achievement would involve an appreciable overall loss of volume and probably a marked decrease in the high note response of the set.

For instance, you may be unfortunate enough to reside within the very shadow of two very powerful transmitters.

A Difficult Problem.

In a case of this nature it is extremely difficult to prevent one of the transmissions from "barging in" when you wish to listen to the other—assuming the two stations to be more or less of equal power and separated in wave-length only by a comparatively small amount.

The remedy is to employ some form of

rejector to wipe out the unwanted station, unless you are prepared to launch out and build something with additional tuned circuits.

On the other hand, it is possible that two stations may be working practically on top of each other. In order to obtain adequate separation in these circumstances, the band-pass circuit would have to be designed to have a very sharp "cut-off" and your reproduction would suffer owing to the cutting of sidebands.

The High Notes.

The results would resemble those you get when you adjust reaction up to the hilt—rather "boomy," because the high notes have gone.

These are abnormal conditions, and require very special treatment.

The New "B.P." Three is not intended to cope with abnormalities. It is an essentially practical design which, with its
(Cont. on next page)

"AN ESSENTIALLY PRACTICAL DESIGN"

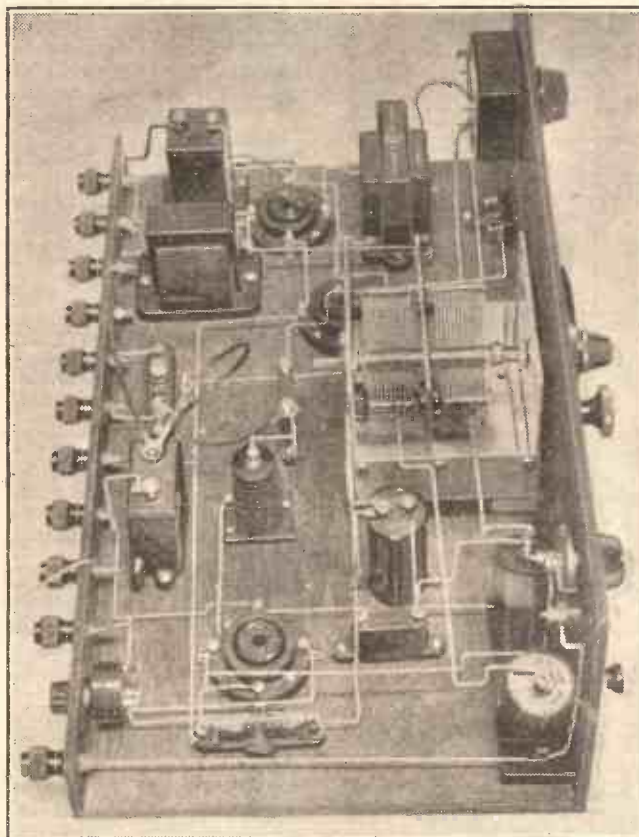

With its simplicity in operation and construction, its power and selectivity without loss of quality, the New "B.P." Three fulfils the needs of those listeners who require these qualities with the minimum of trouble.

THE NEW "B.P." ON TEST

(Continued from previous page.)

simplicity in operation and construction. its power and selectivity without loss of quality, fulfils the needs of those listeners who require these features with the minimum of trouble.

And now for details as to valves and voltages in order to obtain maximum results.

The detector valve should be an "HL" or "H" type, and is inserted in the valve holder marked V1 on the wiring diagram.

About the Valves.

An "L" type is required for the first L.F. stage (V2), and power or super-power for the output stage (V3).

The anode current will depend upon the particular output valve used, but for the average super-power valve it will be in the neighbourhood of 15 milliamps. With a small power valve it will be less.

It is advisable to employ an H.T. battery comprising cells of the larger type, such as a super-capacity battery.

The smaller types will run down quickly, and so the initial outlay is greater; the super-capacity battery will be much more economical in the long run.

Those who have the mains may prefer to have their H.T. from a mains unit. This should be capable of supplying not less than 20 milliamps, and the type of set together with particulars of the mains (A.C. or D.C., etc.) should be stated when ordering.

There are two H.T. positive terminals on the New "B.P." Three terminal strips. One of these (H.T. + 2) supplies the two L.F. valves, and requires the full voltage of the H.T. battery, viz., 120 volts. If a mains unit is employed the H.T. + 2 terminal should be connected to the "power" tapping on the unit.

Two "Taps" Only.

The H.T. + 1 terminal goes to the detector valve, and the H.T. voltage needed is in the neighbourhood of 60-80 volts. The final value can be obtained by trial on actual broadcasting, and the H.T. + 1 wander plug may be tried in the various tappings on the H.T. battery.

Those who use a mains unit will probably have a variable tapping on the unit. If so, this is the tapping which should be connected to H.T. + 1.

The H.T. - terminal on the terminal strip is joined to H.T. - on the battery or unit.

The two terminals marked L.S. go to the loudspeaker, and it is immaterial which way round these terminals are connected.

L.T. + and L.T. - are joined to the L.T. + and - terminals on the accumulator, and A and E to aerial and earth respectively.

If your mains are D.C. and you are using a mains unit, your earth connection should be taken to the "E" terminal on the unit and not to the "E" terminal on the set.

Grid Bias.

Now the G.B. voltages. G.B. + is inserted in the socket on the G.B. battery. G.B. - 1 in the 1½ volts tapping, G.B. - 2 in the 3-4½ volts tapping, and G.B. - 3 in the tapping which suits the particular output valve you are using.

If you look at the leaflet in the valve carton you will find that the valve makers specify certain grid-bias values according to the H.T. voltage. With 120-volts H.T. the grid bias usually varies from about 9 volts for a power to 18 volts for a super-power valve. Always apply too much grid bias rather than too little.

We will neglect the pick-up terminals for

THIS TIME SHE'S LISTENING!



Anita Page, the well-known talkie artiste, listens-in on the special short-wave portable used by Metro-Goldwyn-Mayer in connection with picture-taking expeditions.

the time being and confine ourselves to radio. Therefore the radio-gram switch knob should be turned to the position for receiving radio.

Before switching on the set check over the battery connections and make sure that they are all in order.

Then you can switch on the L.T. Also place the band-pass switch in the medium-wave position by pulling the knob towards you.

Some Tuning Tricks.

Rotate the reaction control knob anti-clockwise so that the moving vanes are not in mesh with the fixed vanes, and slowly rotate the ganged condenser knob until you have your local station. Adjust the ganged condenser for the best volume and apply a little reaction by turning the reaction condenser knob in a clockwise direc-

tion. This should increase the volume, but if you rotate the reaction knob too far the broadcasting will become distorted and finally the set will oscillate.

This indicates too much reaction, and you should never operate the receiver in an oscillating condition. If the volume is too great you can rotate the volume control knob and so adjust the strength to your liking.

When searching for a distant station you should always keep the volume control "all out," and try to keep the reaction as near the oscillation point as possible, but without the receiver actually oscillating.

This is the condition for the highest sensitivity. When you have handled the controls a few times you will soon get the knack of searching quickly and easily, the various adjustments becoming instinctive.

Use a Good Aerial.

The operation of the set is precisely the same on the long waves, except that the band-pass coil knob is pushed towards the panel.

Don't forget that this set is not suitable for use with a frame aerial, nor is it advisable to employ a small indoor aerial. The more efficient your aerial the greater the range and volume.

This is not a receiver which incorporates high-frequency amplification, so don't handicap it by connecting it to a poor aerial.

If you wish to use a pick-up you have only to join the two pick-up leads to the two pick-up terminals on the strip and place the radio-gram switch in position for gramophone. The radio side is then automatically cut out.

NEWCASTLE'S FUTURE.

Our Northern correspondent holds forth on a possible solution of the Newcastle Problem.

The B.B.C.'s experiments with ultra short-wave transmissions may ultimately lead to a solution to the Newcastle problem, by means of a Newcastle transmitter working on perhaps 7 metres wave-length, and providing an alternative programme to its immediate vicinity. For the time being, however, there is no change in the Newcastle situation, and I am informed by the B.B.C. that "the Newcastle question will have to be left, at any rate until international developments this winter are known."

Conditions Getting Worse.

These international developments with regard to the allocation of wave-lengths are of the utmost importance to Northern listeners generally. Interference from Continental stations is already bad on some parts of the wave-band and promises to become worse.

Two foreign stations, one on each side of North Regional (479 metres) are putting up their power. Langenberg (473 metres) will be working with 75 kilowatts probably next month; and the new Prague transmitter (487 metres) is testing with a power of 120 kilowatts. There is frequently a heterodyne on North National (301 metres) which is evidently due to Hilversum.

L.W.A.B.

THE FAMOUS FULLER "NON-SPILL" RANGE

also reduced
in price

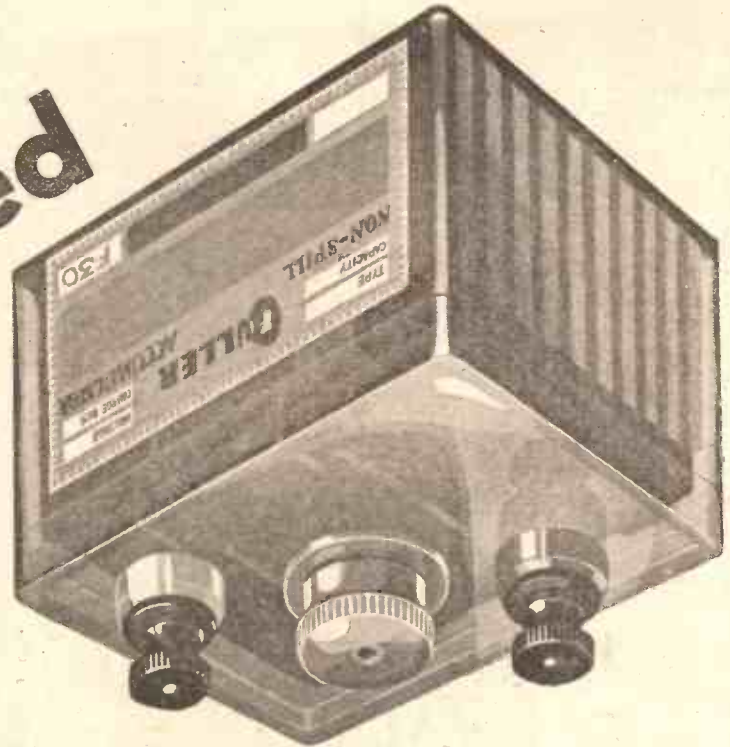

THIS WONDERFUL range of jelly-acid accumulators has become a great favourite with owners of portable receivers. The demand has increased ever since they were introduced, and because of the increased output Fuller are now able to reduce the prices of the whole range. All non-spill accumulators are now fitted with the Fuller patent double grease-cup terminals, and all are fully charged.

In every detail the Fuller "Non-Spill" accumulators are unchanged. The meticulous care taken in manufacture is at once apparent in every one sold. The plates are micro-porous pasted, finer and smoother in texture than the ordinary type, but much stronger in wear; they never crumble or break down. The separators are indestructible and there are large non-spill vents. Fuller 'Sparta' 2-volt "Non-Spill" Accumulator for Portable Receivers, Type JUA9 11/6. Capacity 22 amp. hours. Overall size $4\frac{3}{4}'' \times 2\frac{9}{16}'' \times 3\frac{1}{2}''$. Standard on well-known portables. Other sizes from 9/- upwards.

There are 16 different types in all sizes and capacities and suitable for all popular suitcase and transportable receivers. Full list of H.T. Dry Batteries and L.T. and H.T. Accumulators on request.

Visit us at the Edinburgh Radio Exhibition and the Motor Show—Stand 316, National Hall Gallery.

FULLER

SUPER BATTERIES

Contractors to British and Overseas Government Departments, Railways, etc.

FULLER ACCUMULATOR CO (1926) LTD., CHADWELL HEATH, ESSEX. Telephone: Seven Kings 1200. Telegrams: 'Fuller,' Chadwell Heath

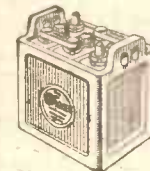

CAR & MOTOR CYCLE BATTERIES

—Acid proof patent double grease cup terminals — Micro-porous pasted plates — high capacity — long life — exceptional strength. Models for every Car and Motor Cycle.—List M.2.

SUPER H.T. DRY BATTERIES

—Machine made and tested throughout—long life—emission up to 20 M/amps. From 60 to 120 volts. Prices 7/5 to 15/3. Also complete ranges of Standard, Triple, Portable, and Grid Bias Dry Batteries, etc.—List D.3.



LONDON AND PROVINCIAL DEPOTS:

LONDON: Hanover House, 73-78, High Holborn, W.C. 'Phone: Chancery 7453.

BIRMINGHAM: 29, Guildhall Buildings, Navigation St. 'Phone: Midland 3103.

MANCHESTER: 19, Chapel Walks, Cross St. 'Phone: City 0857.

GLASGOW: 101, West Nile St. 'Phone: Douglas 4367.

BRISTOL: 28, Cumberland St. 'Phone: Bristol 7958.

LEEDS: 9, Mill Hill. 'Phone: Leeds 22865.

SHEFFIELD: 48, Sandford Grove Rd. 'Phone: Sheffield 51187.

HULL: 69, Ryde Street. 'Phone: 502Y2.

NEWCASTLE: 59, Side. 'Phone: Newcastle 24068-9.

SWANSEA: 10-11, St. Helen's Road. 'Phone: Swansea 3208.

BELFAST: 23a, University Rd. 'Phone: Belfast 5566.

DUBLIN: 17, Pearse Street, 'Phone: Dublin 44977.

EVERYTHING **The G.E.C.** ELECTRICAL
your guarantee

**OWNERS of the
OSRAM MUSIC MAGNET 4
AND THIS YEAR'S OSRAM FOUR (New Music Magnet)
can now convert their sets to
ALL-ELECTRIC (A.C.)
with the new**

GECOPHONE
**A.C. ALL POWER UNIT
and Conversion Parts**

**TENS OF THOUSANDS OF USERS CAN NOW
ECONOMISE AND ENJOY
ALL-ELECTRIC RECEPTION**

SOLD BY ALL WIRELESS DEALERS. MADE IN ENGLAND.

Conversion of the OSRAM MUSIC MAGNET 4 or this year's OSRAM FOUR (New Music Magnet) to A.C. operation is extremely simple—merely a few readjustments, a set of OSRAM A.C. Mains Valves and the GECOPHONE A.C. ALL POWER UNIT—then, consistent results, long range reception and ample power are always available.

WRITE for the ALL-ELECTRIC Constructor's Instruction Chart (which gives full particulars of the method of converting your OSRAM Music Magnet to A.C. operation). SENT POST FREE ON REQUEST.



GECOPHONE A.C. ALL POWER UNIT	£	s.	d.
Complete with Conversion Parts.			
PRICE	6	1	6
Set of OSRAM A.C. MAINS VALVES			
comprising 2 MS.4 OSRAM Valves			
1 MH.4 OSRAM Valve			
1 ML.4 OSRAM Valve			
PRICE	3	17	6
Hire Purchase Terms : Deposit	9	19	0
£1 5 0, 12 monthly payments 16/-			

SUPREMACY IN RADIO — G.E.C. Radio

Advt. of The General Electric Co. Ltd., Magnet House, Kingsway, London, W.C.2.

ADDING A PICK-UP TO — The "P.V. STAR"



MANY music-lovers will undoubtedly feel that the wonderful "P.V." Star needs the addition of only a pick-up to meet all his needs. That is the last touch which spells perfection in this ingenious little receiver design.

Moreover, the simple addition can quite easily be made at any time. It need not be done during the set's construction; that is why we did not mention it in the first place. Not everyone wants to use a pick-up with his set, but those who do will find the addition of an ordinary jack an extremely simple business.

The jack used is a fine-spring automatic (Igranic), which inserts the pick-up in the grid circuit of the detector valve, and at the same time breaks the filament lead to the screened grid valve. On removing the plug connected to the pick-up the reverse takes place. The filament connection to the S.G. valve is "made" again, and the grid of the detector once more goes to the grid condenser:

The jack has six contacts, one of which is not used.

The G.B.

The frame makes connection with the body of the plug, i.e. with one side of the pick-up, and is taken to a grid-bias negative plug, the latter being plugged into the ordinary G.B. battery at 1½ volts negative.

Of the other four connections all are made to springs, one makes connection with the grid of the detector and its adjacent spring with the grid condenser, grid and leak. Then, when the plug is inserted these two, which normally

By **K. D. ROGERS,**
who describes how the addition can be made without in any way upsetting the appearance or the radio operation of the original set.

spring together; are separated, and the one going to the grid of the valve now makes contact with the head of the pick-up jack. Thus the pick-up is inserted between grid and G.B. negative, and the radio feed to the detector is disconnected.

Switching the H.F. Valve.

There remain two connections. These are joined to two points in the filament lead to the S.G. valve, so that the continuity of

that lead is made by these two spring contacts coming together.

This they do when the pick-up plug is "out." On its insertion these two springs are forced apart and the filament connection to the S.G. valve is automatically broken.

The fitting of the jack is simple, it being mounted on a brass bracket to the rear of the output condenser, the latter being moved in a little to make room for the foot of the bracket. This latter should be of stout brass (½-in. thick), and be about ¾-in. wide.

The diagram shows how the wiring is carried out. If you compare it with the original wiring diagram of the set you will see it represents the detector and output part of the set, and that certain wires have been altered.

Actually both old and new connections are shown, the old ones that remain unaltered being dotted, the old wires that have to be removed being shown as double "tram" lines, and the new leads that have to be put in, as solid black lines.

By this means comparison between old and new connections can easily be made, and the chances of making a mistake are reduced.

In Words.

As a further check, however, we will give the wiring in words. Mount the jack so that the springs are uppermost—that is, the thick frame of the jack is below.

Then on the left, looking from the back of the set, you will have three connections and on the right two.

(Continued on next page.)

AN IMMEDIATE CHANGE-OVER

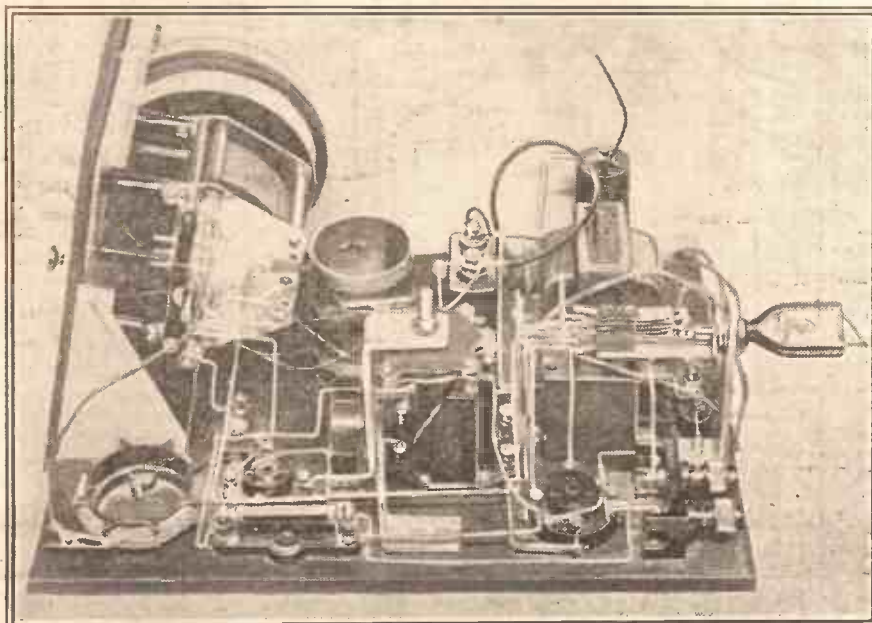

The pick-up jack is mounted on a simple brass bracket at the back of the set. The moment you insert the plug you switch the set over to "records" and disconnect the S.G. valve's filament circuit.

ADDING A PICK-UP TO THE "P.V. STAR"

(Continued from previous page.)

The contacts are shown in the diagram with the top one towards you and the next, further in towards the panel, and so on.

The centre left connection goes to the grid of the detector valve, the lead from the grid to the leak and the grid condenser having been removed.

The bottom right-hand connection goes to the grid condenser, which is now also joined to the grid leak again, but not to the grid.

Now break the lead between the filament of V_2 and the filament of V_1 and join the filament of V_3 to the top left contact of the jack. The broken end of the lead from V_1 filament becomes the top right connection.

The remaining contact is taken to a G.B. plug for insertion in the G.B. battery. And that is all there is to do.

Simple Change-over.

A slot cut in the back of the cabinet for the plug completes the alterations.

Now, whenever you require gramophone music you insert the plug (the G.B. negative plug from the jack can stay in the G.B. battery) connected to the pick-up, switch on the set in the usual way, and there you are.

Pull out the plug and immediately the set is ready for radio reception. By the simple inclusion of one jack you have turned your "P.V. Star" into a complete radio-gram receiver which will give you at will either radio or gramophone programmes of first-class quality.

Controlling Volume.

A volume control across the pick-up, or better still, a pick-up with volume control incorporated, will enable you to have your music loud or soft at will, and will prevent distortion due to overloading of the valves should the pick-up be a particularly sensitive one or should you be playing an unusually "loud" record.

This overloading problem is a very vital one, because a large number of modern pick-ups are capable of fully loading the type of valve

used in the detector stage, and in many cases will often overload it during the course of a record.

A volume control placed in the first stage input will obviate any such trouble, and besides preventing overloading of the first valve it will prevent such a state of affairs existing in subsequent stages.

It is very easy to cause distortion through this fault, and with gramophone reproduction a pre-receiver volume control is really a vital necessity.

THE NEW WIRING

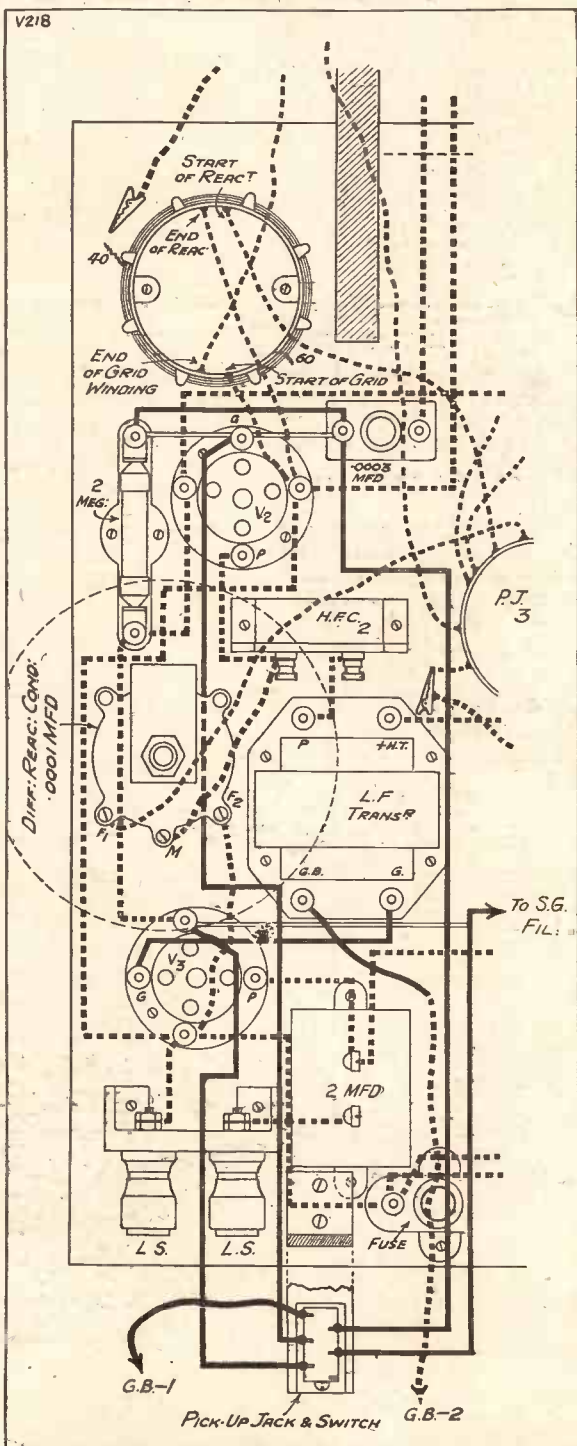

This diagram shows only that part of the set which is affected. The dotted leads are the existing ones which are left untouched, and the hollow leads are those which have to be removed. The new leads are shown as thick black lines.

RECORDS FOR PICK-UPS

How to choose those which will give you the best results.

THE choice of records for use with a gramophone pick-up is not a difficult matter, unless the pick-up to be used with them is of poor design.

A good pick-up, employed with a good amplifier, can tackle any modern record and make of it a programme far and away more lifelike than can the acoustic gramophone.

But if the pick-up, amplifier, or speaker of a radio gramophone outfit is off colour, then the result is likely to be far inferior to the efforts of the acoustic machine.

Two Points of View.

Electrical reproduction can aspire to far greater heights of "perfection" than the mechanical model, but it can also sink to even greater depths of distortion and music mangling.

There are two reasons why the owner of a radio-gramophone may want any particular record. (1) Because he likes the item and wants to hear it well reproduced; (2) Because he wants to use it as a test record to see if his outfit is doing its job properly.

In the first case care must be taken that records having passages on them that are likely to show up badly, due perhaps to peaks in the pick-up reproduction, are turned down; if possible, other renderings of the same number being chosen.

How to Avoid Disappointments.

Such a course is difficult and somewhat unsatisfactory, but unless the pick-up and its associated apparatus are beyond reproach a certain amount of disappointment in the reproduction will be inevitable. Obviously, a brass band record with plenty of high trumpet passages will sound horrible on a high-peaky pick-up.

The second case, concerning the man who wants a record for test purposes, is very different. Here he will go out to find records having particularly difficult or "peaky" passages in order to help him to find, and subsequently to remedy, faults in his outfit.

Brass band records, Jack Hylton and his band, Boyd Senter's clarinet solos, The Berlin State Orchestra—all will help to find weak points in the reproduction system.

Organ Records Not Useful.

Organ records, beloved of salesmen or other demonstrators, do not as a rule assist in such fault-finding. On the contrary, they are what I call "foolproof" records. They have little top stuff and few really difficult deep notes (especially the cinema organ recordings) and so they are easy "to play" and are not likely to show up any weak features in the pick-up arrangement.

For weak spots try tenor and soprano solos, heavy orchestral items, clarinet solos, brass bands, "brassy" dance orchestras, and piano recordings. Get a selection of these and you will soon find out where your reproduction is at fault—and you are sure to get some surprises.

Incidentally, certain passages will make a good gauge of the improvement or otherwise, made by any schemes that you may try to better reproduction.—G.W.

Specified for the P.W. "DUAL RANGER"



R.I. selection is your surest way of getting the best out of the "P.W." "Dual Ranger" circuit. Every R.I. component is designed, built and tested to a degree of accuracy that no ordinary productions attain. They safeguard your time and expenditure.

RI Laboratory Tested DUAL RANGE COIL

R.I. present the most amazing precision of construction and accuracy in this coil. It is bakelite moulded throughout, and embodies a self-centring arrangement of the inner and outer coils, which ensures absolute wavelength certainty under all conditions of temperature.

Every coil is subjected to exacting tests on the wavemeter and inductance bridge and in special "Dual Ranger" circuit apparatus. Note the clearly engraved terminal identification marks, simplified fixing lugs and beautiful finish.

12'6



Write for the New Season's Catalogue and "DUX" Technical Leaflet.

DUX

The **RELIABLE**
LOW PRICED
L.F. TRANSFORMER

INDUCTANCE 30 HENRIES

and a performance described by the Technical Press as equal to transformers four times the price. Study the technical facts and diagrams in the "DUX" leaflet (free from your dealer or us) which prove, before you buy, that "DUX" performance is absolutely right.

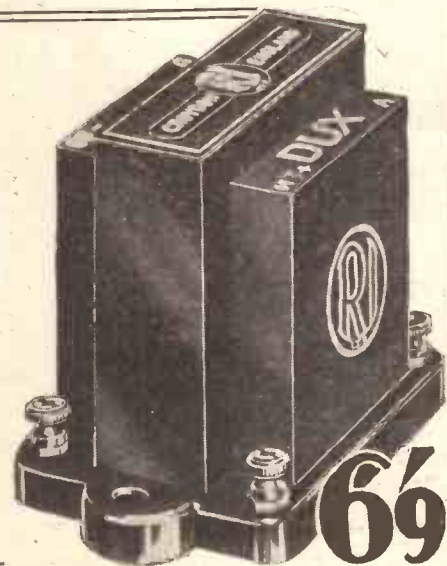

6'9

START **RI GHT WITH THESE COMPONENTS**

FERRANTI CONDENSERS AND RESISTANCES

FOR POWER SUPPLY UNITS

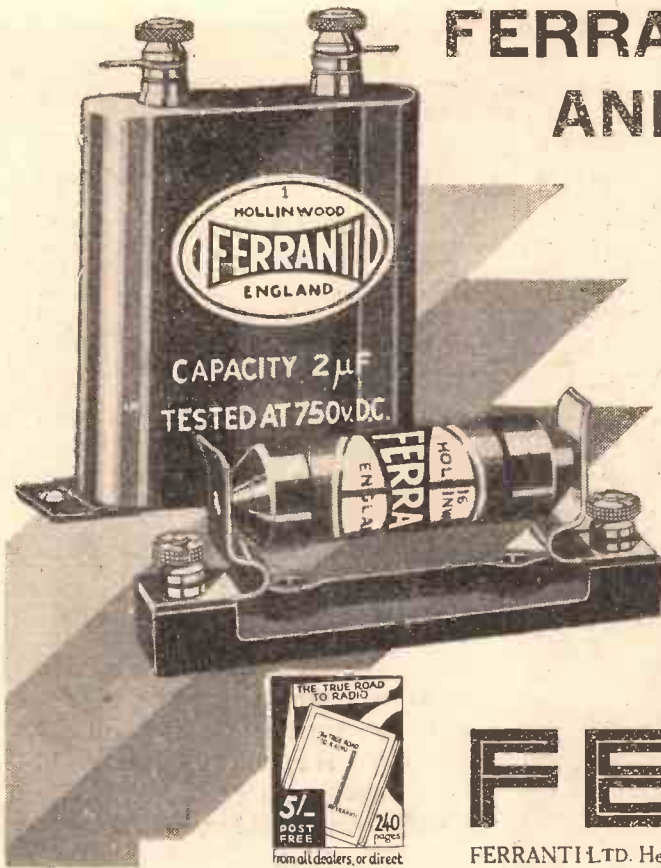

Most constructors will agree that to provide a Receiver with H.T. power from a dry battery or accumulator, if A.C. Mains are available, is like lighting the house with candles. It's out of date.

If your Set depends on batteries for its power—power that should be ample, constant and silent—and from batteries it seldom is—you will derive lasting satisfaction from a High-Tension Power Supply Unit.

In the construction of such a Unit it is of great importance to use components that can be depended upon to stand up to the severe conditions imposed.

As is to be expected, inferior components give inferior service, and are liable to break down under the electrical stresses set up, with possibly serious results to the Receiver and the components of which it is constructed.

Therefore, do not take unnecessary risks. Employ components designed with knowledge of the conditions they have to deal with, and built by Engineers with nearly 50 years' electrical experience behind them.

FIXED CONDENSERS for smoothing.
RESISTANCES for voltage dropping.
CHOKES and **MAINS TRANSFORMERS**.

FERRANTI issue free **CHARTS** for the construction of H.T. Power Supply Units to meet all conditions. A copy will be forwarded on request accompanied by 1½d. stamp.

WHATEVER YOU DO put in reliable components. It pays, on the Mains.

FERRANTI

FERRANTI LTD. Head Office & Works: Hollinwood, Lancs. London: Bush House, Aldwych, W.C.2

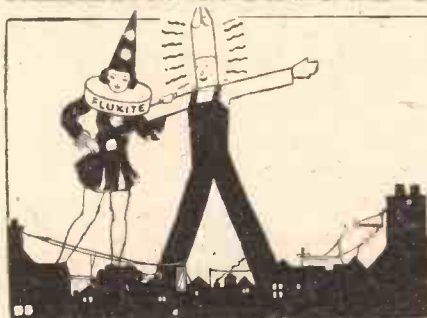

"We're Fluxite and Solder, the reliable pair, Famous for Soldering—known everywhere! We've soldered all connections, and here's the reward—Good Programmes come clearly From Home and Abroad!"

See that Fluxite and Solder are always by you—in the house, garage, workshop—anywhere where simple, speedy, soldering is needed. They cost so little, but will make scores of everyday articles last years longer! For Pots, Pans, Silver, and Brassware; RADIO; odd jobs in the garage—there's always something useful for Fluxite and Solder to do.

All Hardware and Ironmongery Stores sell Fluxite in tins, 8d., 1/4 and 2/8.

ANOTHER USE FOR FLUXITE
Hardening Tools and Case Hardening. Ask for Leaflet on improved method.

NEW "JUNIOR" SIZE, 4d. per tin.

FLUXITE SOLDERING SET

Simple to use and lasts for years in constant use. Contains special "small-space" soldering iron with non-heating metal handle; pocket blow-lamp, Fluxite, Solder, etc., and full instructions. COMPLETE, 7/6. or LAMP only, 2/6

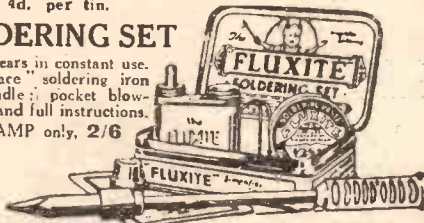

FLUXITE LTD.
(Dept. 324),
ROTHERHAM, S.E.16

ALL MECHANICS WILL HAVE

FLUXITE

IT SIMPLIFIES ALL SOLDERING

THE PRIDE OF OLYMPIA



Here is a beautiful Pedestal for set and speaker—the Camco 'Lincoln.' For grace of design and perfect construction it cannot be surpassed, and it has a rich shaded walnut finish. Special construction makes resonance and chatter impossible. It is suitable for all-mains or battery-driven sets. Only £5 17s. 6d. Send now for FREE copy of the 24-page Camco Radio Cabinet Catalogue.



CARRINGTON MFG. CO., LTD. Showrooms: 24, Hatton Garden, London, E.C.1.
Phone: Hol. 8202.
Works: S. Croydon.

NAME..... ADDRESS.....

P.W.16

**GREAT
WIRELESS
JOURNALS
USE THEM IN THEIR
EXHIBITION
SETS**

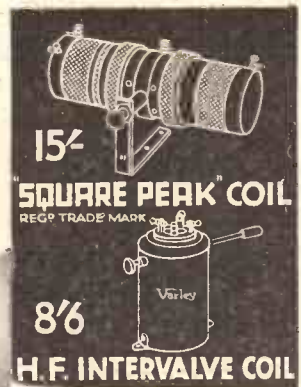

"SQUARE PEAK" COILS

[REGD TRADE MARK]

||||| **AMATEUR WIRELESS**
Sept. 19. **Olympian Three.**

||||| **MODERN WIRELESS**
Oct. 1931. **Super Quad.**

||||| **WIRELESS CONSTRUCTOR**
Oct. 1931. **Exhibition Four.**

||||| **WIRELESS MAGAZINE**
Oct. 1931. **Super Senior.**

Make your set selective with the Varley "Square Peak" Coil . . .

"Gives amazing selectivity . . . is fine for distance-getting . . . no interference from local stations."—*Amateur Wireless.*

"There cannot be many existing sets into which it could not be fitted."—*Modern Wire'ess.*

"With the Varley Coil there is substantially a square-peak resonant curve nine kilocycles in width."—*Wireless Constructor.*

"Cuts off interfering stations in a surprising manner."—*Wireless Magazine.*

NEW EXTENSER MODELS NOW READY, fitted with terminals in place of wave-change switch. Same prices as above—15/- and 8/6. Booklet on application.



HAVE YOU SEEN THIS GUARANTEE?



LONGER LIFE FOR LESS MONEY —guaranteed

The
**IMPROVED
LISSSEN
HIGH TENSION
BATTERY**

LONGER lasting power has been put into the Improved Lissen H.T. Battery—and a **LIFE GUARANTEE** is printed on the side of every Improved Lissen Battery you buy.

Prices, too, have been greatly reduced so that to-day when you buy a Lissen H.T. Battery you get much longer lasting battery for much less money than before.

Look for the Lissen Longer Life Guarantee—buy only at the reduced prices. Ask for “the Improved Lissen H.T. Battery”—stocked by all good radio dealers.

LISSSEN LTD., WORPLE RD., ISLEWORTH, MIDDLESEX.

60 VOLT
WAS ~~7/11~~
NOW **5'6**

100 VOLT
WAS ~~12/11~~
NOW **9'3**



If Sir John Reith Gave Me A Job

BY HERMAN DAREWSKI

LET me begin by stating that this article is not written in a spirit of carping criticism. I have nothing but admiration—and sympathy—for those at the B.B.C. whose task it is to meet and satisfy the demands of a vast circle of listeners with such varying and discriminating tastes as those of the British public.

When broadcasting first became possible it opened up an entirely new field of entertainment. It afforded unique opportunities not only in the transmission of running commentaries, talks, etc., but in the realm of drama, which could not be exploited by any other medium.

Tremendous Resources.

Have the B.B.C. realised the enormous assets at their command to anything like their full extent? I do not think they have.

Is this because the talent necessary for the exploitation of such possibilities is lacking, or that it has not been tapped?

Before I explain more fully I would ask listeners to take their minds back to the early days of broadcasting. In those days programmes were often inferior not because the B.B.C. failed to realise the possibilities of wireless, but because performers had not "tuned themselves," so to speak, to the requirements of radio entertainment.

To a large extent this is no longer true. Of late years a number of men and women have sprung up who have vividly illustrated the potentialities of this new medium; indeed, the radio has created a new firmament of stars who have completely changed our attitude towards broadcasting.

But as a brief perusal of the daily broadcast programme only too clearly indicates, there is a definite lack of such talent. Take, as an example, the field of drama.

No Initiative.

Why are the B.B.C. constantly falling back on adaptations of stage plays, when listeners have clearly illustrated their preference for dramas specially written for broadcasting? Surely the radio is big enough to stand on its own and attract artistes to write for it, without having to draw on second-hand material which, however attractive in its original form, cannot have the appeal of radio-born art.

To stress my point further, have the

The famous composer and conductor who, besides being an ardent film fan, is a well-known B.B.C. broadcaster, both as a playwright and as the conductor of "Herman Darewski's Band," offers some purely constructive criticism concerning the radio programmes.

B.B.C. made full use of the enormous resources at their command in regard to effects? Admittedly, the last year or two listeners have heard over the wireless one or two examples of radio drama which have clearly indicated what can be achieved by those possessing the necessary inventive ability, but we are still awaiting the masterpiece which will mark a definite advance in radio technique.

This all points to the fact that what the wireless needs more than anything else is a body of specially trained artistes who have

EMINENTLY QUALIFIED



Mr. Darewski has achieved such success in various realms of public entertainment that his views on broadcasting, given in the accompanying article, are bound to create considerable interest in "official" quarters.

been brought up, so to speak, in an environment of radio, and are fully capable of comprehending its possibilities, as well as its shortcomings, as a means of artistic expression.

Still In Its Infancy.

It is fairly obvious to an intelligent observer that radio art in England is still in its infancy. But the time will undoubtedly come when, as has happened in America, radio will create a new profession, bringing employment to thousands of people. What steps are being taken to assure that a sufficient supply of talent will be available to meet the demand when that time comes?

There are hundreds of young boys and girls in the schools who are beginning to take an interest in various forms of artistic expression. Why is no effort made to tap this source of potential talent before it is diverted to other spheres of art, such as the stage or the films?

At school a child learns something of the rudiments of playwriting and acting through appearing in plays produced during the term; he also acquires a knowledge of musical technique through learning to play the piano. But one thing he is not encouraged to do is to take an interest in the microphone.

Admittedly, linguistic and musical lessons are relayed to schools, but the child cannot be expected to take an interest in broadcasting so long as it is associated in his mind with lessons.

Waking-up At Last.

A short while ago the B.B.C. inaugurated a move in the right direction by broadcasting over the wireless a play written by a young boy at Eton. But I would go a step further. I would encourage children not only to write plays for the wireless, but I would insist that children played in them.

Surely it would be possible for the B.B.C. to promote a competition among schools for the best written wireless play? This could be broadcast in the Children's Hour from the school winning the prize, with specially selected pupils filling the different rôles.

Young children have a natural gift for acting, and since they are not likely to be affected by microphone fright, they would enter into the spirit of the play far more

(Continued on next page)

IF SIR JOHN REITH GAVE ME A JOB.

(Continued from previous page.)

naturally than would be possible under the critical eyes of an adult audience who have a tendency to make them self-conscious.

Imagine the interest and excitement that would prevail among young listeners on hearing "the next item will be a short playlet written by, say, Master John Bailey, aged ten," followed by a description of the cast giving the names and ages of the little players taking part in it.

Immature though many of the efforts might turn out, the sympathy of thought and ideas expressed would find a ready response among young listeners, while the novelty and the child interest would make an appeal to adults, thus creating not only a new interest in the microphone, but at the same time diverting potential talent among children into wireless channels.

Making Learning Pleasant.

This, however, would not be all. I would employ radio to do away with the drudgery associated in the child's mind with music. This is more important than it seems. It is only of recent years we have come to recognise music not merely as a recreation, an amusement, or a solace, though it can be all these things, but a great psychological liberating factor.

All children are musical. It is only when they are denied the opportunity to give expression to their innate musicality or their love for it is destroyed by wrong teaching that this instinct is lost.

The B.B.C. has been one of the first to recognise the value to a child of a musical education, but the relating to schools of lessons, however attractively arranged, is not enough. They must be allowed to take an active part in such broadcast. Why

not, then, broadcast an orchestra composed solely of children?

Talent in Children.

To those sceptical of the practicality of such a project I would say that it is not only possible, but, given the time, I would guarantee to form such an orchestra.

As proof of this, a short time ago at Bridlington, I organised a number of Children's Talent Competitions in singing, dancing, acting and instrumental playing.

The talent of some of the little competitors was so high I engaged three of them, all between the ages of ten and fourteen, to appear in the professional evening concerts, where they met with an amazing reception, not because they were children, but because of the excellence of their execution.

Nor do I see any reason why those children displaying outstanding musical talent should not be encouraged to write the music for such children's orchestras. That this is not outside the bounds of possibility was illustrated in a very convincing manner by my own son, Barrie, who at 14 wrote a waltz which I played before an audience of ten thousand, several of whom were so taken with it they came up afterwards to inquire its name.

Help From The Schools.

It is to the schools we must look, however, for our future radio stars. I think it would be a good plan if the B.B.C., as an incentive, were to grant certificates to those pupils passing successfully a microphone test either

in singing, speaking, or instrumental playing. Instructors from the B.B.C. might also advantageously be sent round the schools to instruct the pupils and, if necessary, the teachers, in the technical side of broadcasting.

Finally, why not broadcast children's talks? I can imagine few better ways of spending an entertaining and instructive ten minutes than listening to a child of

"ALL CHILDREN ARE MUSICAL"



Mr. Darewski suggests that children should be allowed to take active parts in broadcasting as they are in Germany, as the above photo illustrates.

twelve or fourteen, discussing over the wireless some such subject as "What I think of Dad" or "A Day at School."

I say instructive because, though we parents pretend to be blind to the fact, children also have their point of view. Why not give them an opportunity of expressing it? We might, you know, even learn something.

The talks could be written by the pupils as part of their ordinary school curriculum; only, of course, it would be necessary to instruct them beforehand in the art of writing for the radio. This is where the instructors of the B.B.C. would come in useful.

In these days, what is needed more than anything else, is international co-operation not only in the economic worlds, but in the exchange of ideas and opinions between the peoples of various nations. The wireless, by bringing children into touch with the thought of the outer world, and thus instilling into them a philosophy of national and international life, is the one medium by which this desired end can be attained.

"A DEFINITE LACK OF TALENT"



The Dramatic Control Panel at Savoy Hill. Mr. Darewski accuses the B.B.C. of using too much "second-hand" material, and says that there is a definite lack of talent displayed in the programmes.

A BELFAST BOTHER

An item of news from our
Northern Correspondent

A RATHER mysterious attitude towards the broadcasting of services has been taken up by the Roman Catholic authorities in Northern Ireland. Application was recently made by the B.B.C. for broadcast facilities, and it was turned down without explanation. Twice before since the opening of the Belfast station has similar application been made, with the same results.

Consequently Belfast is broadcasting regularly from a number of Protestant churches, but no Roman Catholic services are relayed. In the Irish Free State no services of any kind are broadcast.

L. W. R. B.

WIRELESS BATTERY CELEBRATES A "BIRTHDAY"

London Owner Amazed

Are you interested in longer life for your wireless batteries? If so, read this letter from Mr. Harris, of London.

Dear Sirs,

On the occasion of the first birthday of my 105 volt EVER READY POWER Battery put into use on the 21st March, 1930, I should like to congratulate you on its remarkable performance.

It has had an average use of 5½ hours per day on a 3-valve set—the majority of the time on the highest voltages for Continental reception.

My friends are all amazed at the clarity of reception and the length of service compared with other makes. I feel I owe you something more than the 24/- I originally paid over a year ago—and so this letter of congratulation and thanks.

Yours faithfully

F. W. HARRIS, London.

(This letter may be inspected at the offices of the Company.)

Twelve months—40 hours a week—and still in use! Magnificent proof of the message that the EVER READY Company has been proclaiming for years past! The most economical wireless set is the adequately powered set. And the most economical way to power your set adequately is to power it with EVER READY batteries—made by an exclusive process to suit every wireless set, including portables. Write for the free Ever Ready chart and get the battery that is made for your set—guaranteed to give satisfaction by the Company that has been making reliable batteries for over twenty-nine years.

**THE BATTERY
THAT LASTS
A LONG TIME**

THE EVER READY CO.
(GT. BRITAIN) LTD.,
HERCULES PLACE,
HOLLOWAY, LONDON, N.7



FROM THE TECHNICAL EDITOR'S NOTE BOOK.

**NEW R.I. CATALOGUE.**

All radio enthusiasts should make a point of acquiring the latest R.I. catalogue, for this embodies all the latest R.I. lines, among which are various components of first-rate quality at most competitive prices.

HEYBERD ALL-ELECTRIC UNIT.

One of the features that most appeals to me in the Heyberd Type "E" unit is that it has a pilot lamp fitted to its front

A SOUND PROPOSITION

The Heyberd Unit is a well-designed and well-made instrument.

panel. This provides a visual indication that the mains are switched on.

I also like the switches (there is one for L.T. and one for H.T.), for as these are operated, the words "on" and "off" appear.

Besides the three H.T. + outputs, this Heyberd unit has two sets of L.T. terminals, one pair supplying four volts four amperes for A.C. valves, and another pair across which are two volts for trickle-charging accumulators.

Either pair can, of course, be left unused when not required.

There are two models available, and model E provides up to 150 volts with a total H.T. current output of 25 milliamps. There is one variable tapping.

Model E 200 is similar, except that it is capable of giving up to 200 volts at 30 milliamps. These "E" units are available for all the usual voltages and frequencies.

Each is built into a stout metal case with a bakelite panel, conforms with the recommendations of the I.E.E., and is covered by the Heyberd comprehensive and generous guarantee.

We have had a sample unit to test and

Tested and Found-?

find it completely satisfactory. The outputs are right up to the claimed ratings and the smoothing and separation of good quality. The Heyberd "E" is, in fact, a unit which, both on account of its technical efficiency and its inexpensiveness, is worthy of the closest consideration on the part of all who are contemplating "going over" to the mains.

OSRAM VALVE WIRELESS STATION INDICATOR.

All "P.W." readers should write off at once for this handy little gadget. It is free for the asking, and is one of the neatest little things I've seen for some time. As it is obtainable merely by sending a postcard to the G.E.C., Magnet House, Kingsway, London, W.C.2, there is little need for me to say anything more about it here!

A PRICE REDUCTION.

The price of the well-known Ealex T.2 L.C. terminal has been reduced from 4½d. to 3d.

"GOLSTONE" SCREENED PANEL WIRING.

This is the latest product of Messrs. Ward and Goldstone, Ltd., and comprises a flexible, metal-sheathed wire which is particularly suitable for wiring S.G. and mains sets.

It is extremely well protected, for the actual conductor is first efficiently covered with rubber, and then a tough fabric tape is present between the rubber and the metal sheathing. Each coil of the material is tested at 500 volts before despatch, and judging by our own tests we should not imagine there is anything but a very small percentage of "throw-outs"!

The metal covering is quite continuous, and is easily earthed at any point.

"SPARTA" BATTERIES.

Referring to the statement which recently appeared in POPULAR WIRELESS that "the new Sparta Super range makes its appearance for the first time," the Fuller Accumulator Co., Ltd., ask us to point out that their Sparta range of batteries has been on the market for a number of years.

What is new is the Fuller super high-tension dry battery, but this makes no difference to the continuance of the Sparta range, which has been popular for a long time.

"SPEAKING OF SPEAKERS."

This happens to be the friendly title of the W.B. loudspeaker catalogue, a publication that should be in the hands of all who are looking for inexpensive but really efficient loudspeakers.

SOVEREIGN COMPONENTS.

The particular "Sovereign" volume control sent me is of brown bakelite and has a black milled knob with a white pointer. This is rather an unusual combination of colours, and as one gazes surprisedly at the article, one is apt to forget that when it is

PLEASE NOTE

Manufacturers and traders are invited to submit radio apparatus of any kind for review purposes. All examinations and tests are carried out in the "P.W." Technical Department, with the strictest of impartiality, under the personal supervision of the Technical Editor.

We should like to point out that we prefer to receive production samples picked from stock, and that we cannot in any circumstances undertake to return them, as it is our practice thoroughly to dissect much of the gear in the course of our investigations!

And readers should note that the subsequent reports appearing on this page are intended as guides to buyers, and are, therefore, framed up in a readily readable manner free from technicalities unnecessary for that immediate purpose.

fitted in a set the panel completely divides its two differently coloured portions!

In this position, the difference of colour does not matter a scrap. The Sovereign volume control retails at 4/6, and has a total resistance of 500,000 ohms.

By the way, I have since seen specimens of this component in several multi-colour finishes.

There is a "Sovereign" potentiometer for baseboard mounting which sells at 1/6; it is a robustly constructed component, and its adjustment is clean and firm.

The "Sovereign" compression type condenser is worthy of note by "P.W." readers. It is a quite attractive little job, and the useful .001 to .002-mfd. sells at 1/6.

TELSEN LOUDSPEAKER UNIT.

The Telsen loudspeaker unit costs a mere 5s. 6d., for which sum you were able to purchase only a not-too-good single telephone earpiece not so very long ago!

But the Telsen unit is much more than a detached headphone earpiece—it is, in fact, an electro-magnetic loudspeaker unit capable of driving a diaphragm with excellent effect.

We have used one of the samples sent us in an inexpensive loudspeaker construction, and as the details of this will be before you already, (see last week's P.W.) there will be no need for me to enlarge on this page upon the most attractively priced little item.

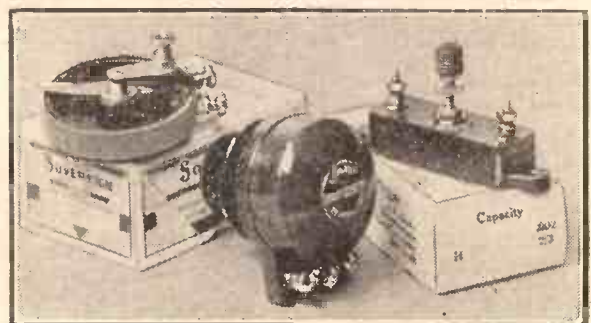
SOME "SOVEREIGN" SPECIAL TIES

Here are the Sovereign components mentioned.

TELSEN VARIABLE CONDENSERS

TELSEN BAKELITE DIELECTRIC CONDENSERS

These Condensers are of a new and improved type and of exceptionally compact dimensions. The moving vanes, which are interleaved with finest quality bakelite, are keyed on to the spindle so that they cannot be pushed out of line, and there is a definite stop at each end of the travel. The connection to rotor is made by means of a phosphor-bronze pigtail so that there is no crackling due to rubbing contacts. The connection to the stator vanes is absolutely positive—a very important point.

All Telsen Bakelite Condensers are supplied complete with knob.

Differential Condenser—

Capacities of '0003, '00015, '0001 Price 2/-

Reaction Condenser—

Capacities of '0003, '00015, '0001 Price 2/-

Capacities of '00075, '0005 Price 2/6

Tuning Condenser—

Capacities of '0005, '0003 Price 2/-

TELSEN LOGARITHMIC VARIABLE CONDENSERS

The Telsen Logarithmic Variable Condenser is of robust construction and high insulation. The H.F. losses are very low and the frame is braced at three points, so that the possibility of distortion and short circuiting is negligible. Substantial terminals are provided with alternative connection to the stator.

Telsen Logarithmic Variable Condenser—

Capacities of '0005, '00035, '00025 Price 4/6

TELSEN PRE-SET CONDENSERS

These Condensers have been carefully designed to give proper separation of vanes when the adjustment is unscrewed, which results in a very low minimum capacity, giving a wide range of selectivity adjustment when used in the aerial circuit.

Telsen Pre-set Condenser—

Made in capacities from '002 to '0001 mfd. Price 1/6

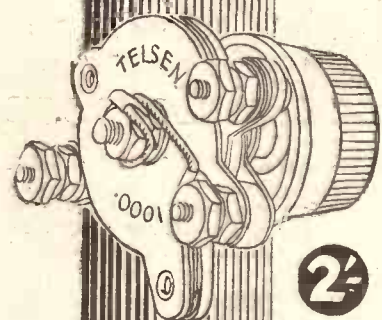

2/-

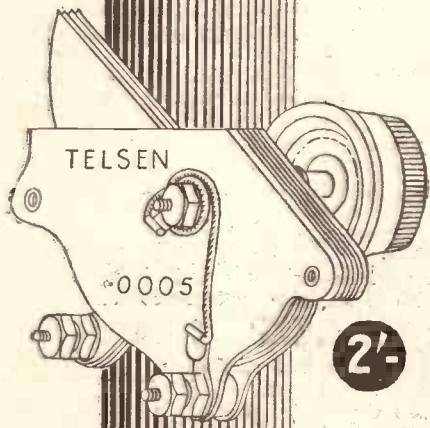

2/-

TELSEN

THE SECRET OF PERFECT RADIO RECEPTION

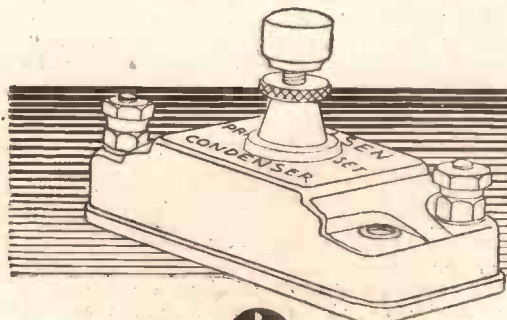

1/6

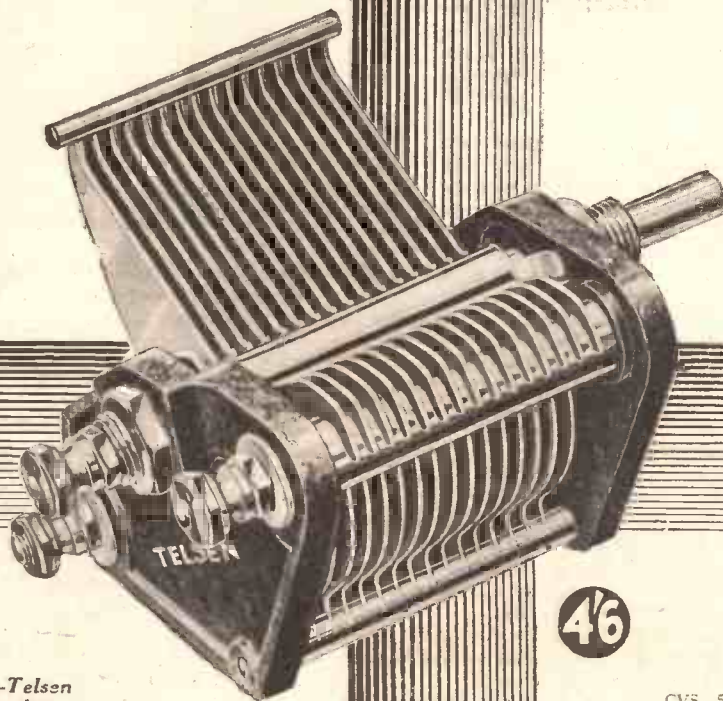

4/6

Send for the "Telsen Radio Catalogue" and book of "All-Telsen Circuits" to The Telsen Electric Co., Ltd., Aston, Birmingham.

"TUNING-IN" and "TUNING-OUT"

by
A Special Correspondent



The description of a new circuit invented by "P.W.'s" Scientific Adviser, Sir Oliver Lodge, F.R.S., in conjunction with Dr. Robinson.

SIR OLIVER LODGE'S discovery in 1897 of the principle of electrical tuning first made it possible to separate one wireless station from another. Before this time there was no such thing as selection. A receiving aerial simply picked up everything within range.

Sir Oliver introduced the idea of separation by means of different wave-lengths. He inserted "lumped" inductance and capacity in the transmitting aerial, and so made it radiate energy at one particular frequency, instead of sending out a wide "band" of frequencies.

How It Began.

In reception the aerial was similarly provided with adjustable inductance and capacity, so that it could be tuned up and down the frequency scale to co-operate with this or that transmitting station.

Here was the origin of the process of "tuning-in," now practised so sedulously by millions of listeners throughout the civilised world. A perfectly obvious idea one may be tempted to say, but like so many other apparently "simple" inventions, it needed genius to give it birth.

Since that time conditions have altered so much that the problem has taken on an entirely different angle. The ether, once comparatively peaceful, is now clamorous with broadcast programmes radiated from all quarters of the earth.

At the same time the simple crystal receiver has given place to the multi-valve set with a reception range which can be measured in hundreds and even thousands of miles. In short, the vexed question of the day is not so much how to "tune-in," as how to "tune-out"!

The Question of Quality.

If Sir Oliver Lodge had not invented the present method of selection by tuning, it is conceivable that we should have found some other way of separating one programme from another. That is as it may be, but meanwhile we have developed so far along the lines of electrical tuning, that we are finding out its weak spots.

The outstanding difficulty is that selectivity and quality will not go hand in hand

beyond a certain point. The more sharply a circuit is tuned, the less able it becomes to handle and transmit the high notes and particularly the harmonics which are so essential to the true reproduction of such instruments as the piccolo and violin and to the soprano and tenor notes in the human voice.

Ensuring Accurate Response.

What happens is that a sharply-resonant circuit is unable to follow quickly and accurately the changes in amplitude of the carrier-wave which carry the various microphonic frequencies through the ether. Some people prefer to regard these modulation signal frequencies as carried by side-bands, and say that for perfect reproduction

continuously on the tuned circuits, a periodic "damping" action is brought into play. This allows each impulse to build up sufficiently to give an accurate response and no more. When that point has been reached, the circuit is "damped down" so that it is ready to respond fully and faithfully to the succeeding impulse.

In this way full justice is done to every variation in amplitude, and a correct "balance" is maintained as between high notes and low without any sacrifice of selectivity.

The new method is still in the experimental stage, since it necessitates the use of a special type of valve, but the underlying principle may be explained as follows.

A COIL INSIDE THE VALVE!

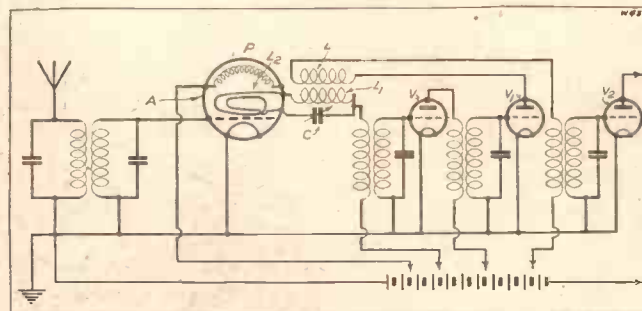

A special valve having a coil built into it figures in the Lodge-Robinson circuit described in this article.

the tuned circuits must have a "flat" characteristic—sufficiently broad, that is, to admit the side-bands as well as the carrier.

It amounts to the same thing, from another and equally tenable point of view, to say that a tuned circuit must be able to follow rapid changes in amplitude. And that is just where a highly-resonant circuit falls down.

The first impulse builds up or "hangs on" so long that it tends to overshadow the succeeding impulse, instead of allowing each successive impulse full and free play. That is, of course, unless special precautions are taken.

Sir Oliver Lodge, working in conjunction with Dr. Robinson—of Stenode Radiostat fame—proposes to overcome this particular difficulty in a very ingenious way.

Instead of allowing the signal to act

The special valve marked A is the first of a chain V, V_1, V_2 , of highly-tuned high-frequency amplifiers. A coil L in the plate circuit of the amplifier, V_1 , is back-coupled to a circuit L_1, C which comprises a winding L_2 mounted inside the bulb of the valve A.

The "Dead" Plate.

The winding L_2 serves two purposes. In the first place, it acts as an ordinary anode or output electrode to pass signal energy on through the amplifiers V, V_1, V_2 . In the second place, as the signal energy builds up, the current fed back through the coil L creates sufficient magnetic field in the winding L_2 to deflect a part of the electron stream inside the valve A on to a second or "dead" plate P, where it is dissipated.

Automatic Action.

In this way a signal impulse which would normally tend to "hang on" or persist too long, is cut short by the feed-back action of the coil L .

As the electron stream inside the valve A is diverted away from its proper outlet, the signal build-up is momentarily checked, and the tuned circuits are left free to respond immediately to the next incoming signal impulse.

The extent to which the electron stream is deflected is determined by the strength of signal currents flowing in the amplifier V_1 , so that the required checking action is entirely automatic.

TELSEN TRANSFORMERS & CHOKES

TELSEN L.F. & OUTPUT TRANSFORMERS

Telsen transformers have achieved fame in the radio world on account of the high standard of their quality and performance. Designed and built on the soundest engineering principles, these robust, full-size transformers will give not only efficient but enduring service.

TELSEN L.F. TRANSFORMERS

- Telsen "Ace" Transformer, Ratios 3-1, 5-1 Price 5/6
- Telsen "Radiogrand" Transformer, Ratios 3-1, 5-1 .. Price 8/6
- Telsen "Radiogrand" 7-1 Super Ratio Transformer .. Price 12/6
- Telsen Intervalve Transformer, Ratio 1.75-1 Price 12/6

TELSEN OUTPUT TRANSFORMERS

- Telsen Multi-Ratio Output Transformer, giving three Ratios of 9-1, 15-1, 22.5-1 .. Price 12/6
- Telsen Output Transformer, Ratio 1-1 Price 12/6
- Telsen Pentode Output Transformer Price 12/6

TELSEN L.F. CHOKES

- Telsen L.F. Intervalve Coupling Choke, 40 and 100 henrys .. Price 5/-
- Telsen Heavy Duty Power Grid L.F. Choke, 40 henrys .. Price 8/-

TELSEN OUTPUT CHOKES

- Telsen Output Choke (Plain), 20 henrys Price 8/-
- Telsen Output Choke (Tapped), 20 henrys Price 8/6

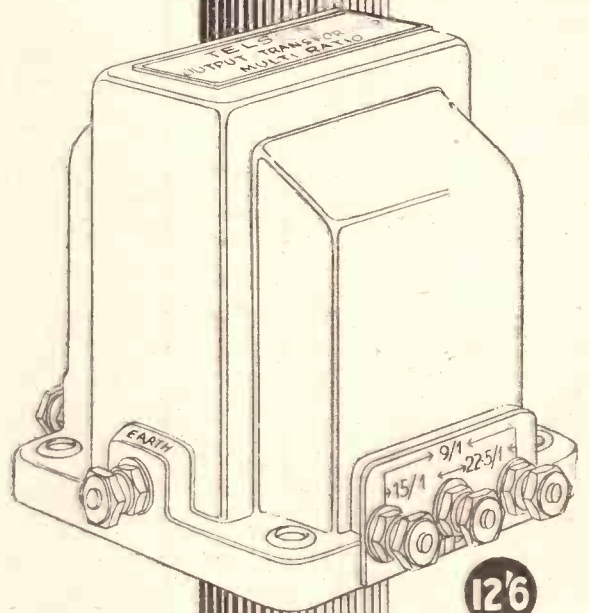

TELSEN

ALL-BRITISH
RADIO COMPONENTS

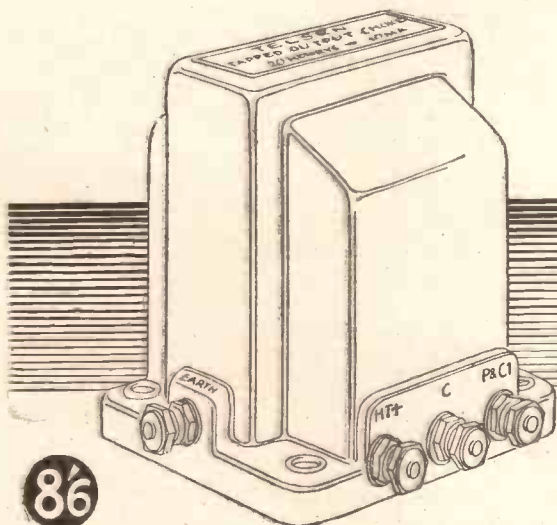

Send for the "Telsen Radio Catalogue" and book of "All-Telsen Circuits" to The Telsen Electric Co., Ltd., Aston, Birmingham.

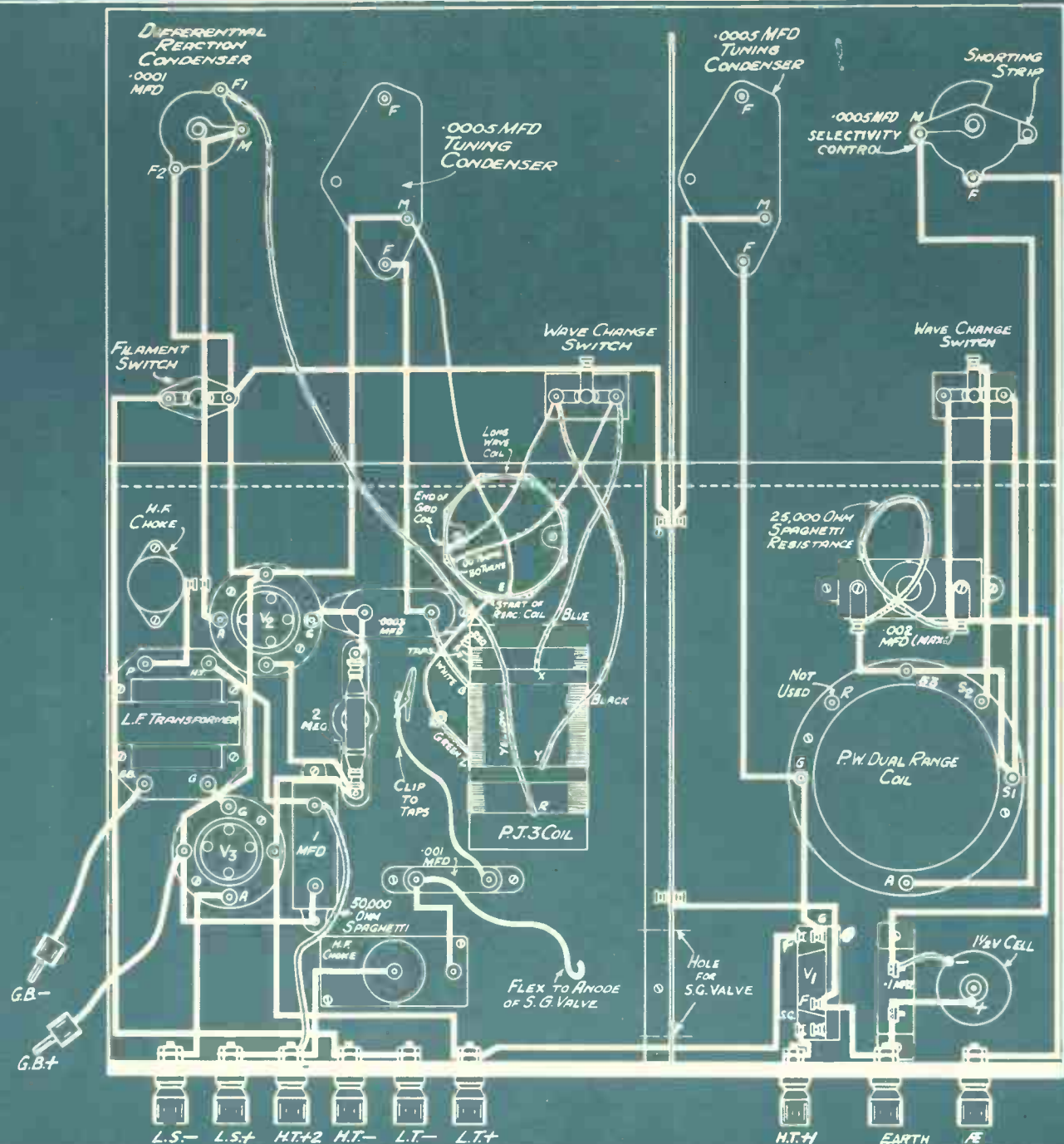

DRAWN BY: *WJ*
 CHD. BY: *SCL*
 SERIAL NO: 61

"P.W." Blueprint No. 61. THE "DUAL RANGER."

A highly efficient three-valver comprising a tuned S.G. H.F. stage, detector, and L.F., with wave-change switching. The tapping clip should be tried on the three tappings on the P.J.3 coil for best results. For long waves push wave-change switch knobs towards panel.

Valves; S.G. for V1; H.L. or special detector type for V2; power or super-power for V3. Voltages; H.T.+1, 75-90, H.T.+2, 120. Grid bias, 9-18 volts depending upon type of valve in V3 valve-holder. The .002-mfd. compression condenser should be varied until best results are obtained on long waves. Increasing its capacity increases selectivity and vice-versa. For long waves the panel selectivity control should be placed in the "shorted" position.

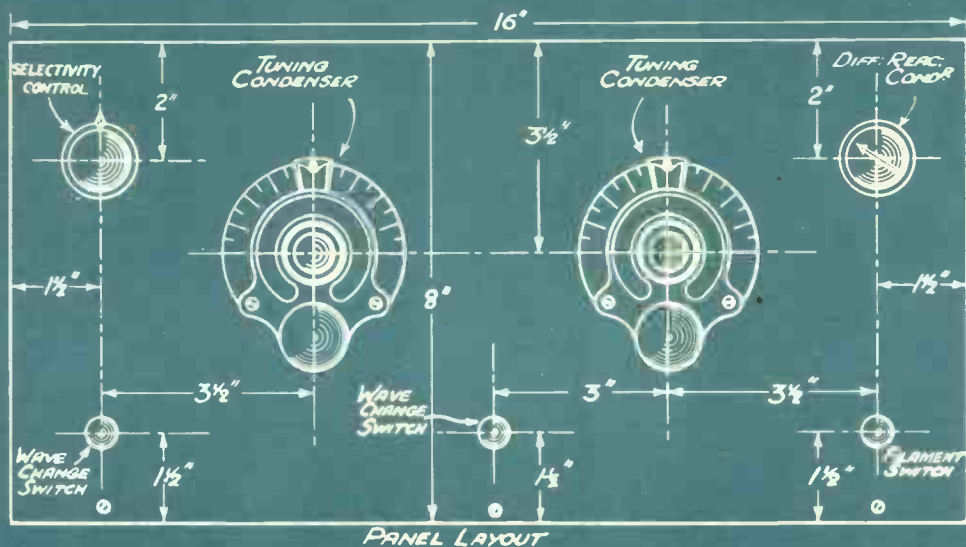
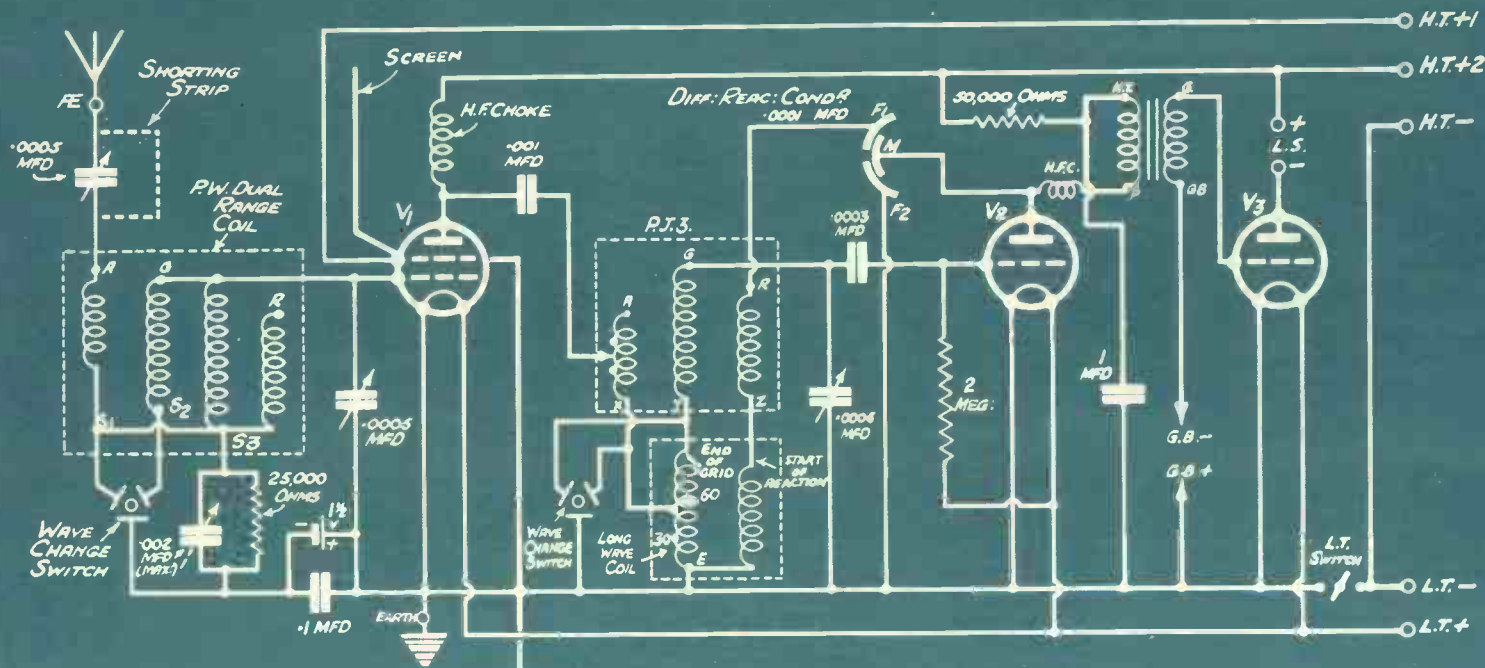

"P.W." Blue Print No. 61. Price 6d.
THE "DUAL RANGER"

Components and Materials

- 1 Panel 16 in. x 8 in.
- 1 Cabinet to fit, baseboard 10 in. deep.
- 2 .0005-mfd. condensers (if above have plain dials, two slow-motion drives will be required).
- 1 .0005-mfd. solid dielectric condenser.
- 2 3-point wave-change switches.
- 1 On-off switch
- 1 .0001-mfd. differential reaction condenser.
- 1 "P.W." Dual-Range Coil.
- 1 .002-mfd. max. compression condenser.
- 1 1-mfd. fixed condenser.
- 1 .0003-mfd. fixed condenser.
- 1 .001-mfd. fixed condenser.
- 1 1-mfd. fixed condenser.
- 1 P.J.3 coil.
- 1 Coil quito.
- 2 oz. 30 D.S.C. wire for above.
- 1 Screen 10 in. x 7 in.
- 1 2-meg. leak and holder.
- 2 H.F. chokes.
- 1 L.F. transformer, medium ratio.
- 1 50,000-ohm spaghetti resistance.
- 1 25,000-ohm spaghettis.
- 2 Valveholders.
- 1 Horizontal mounting type for S.G. valve.
- 1 Terminal strip 16 in. x 1 1/2 in.
- 9 indicating terminals, Wire, Screws, Flex, Crocodile Clip, Battery Plugs, etc.

BUILDING the "P.W." "Dual-Ranger" represents at the very most a couple of evenings' work, or perhaps it should be called pleasure. For it is a pleasure to construct a receiver so simple in layout and yet capable of giving such amazingly good results.

Even though you may never have made a set before, you will not have the slightest difficulty if you follow the blue print, in conjunction with the photographs of the original receiver, and the constructional hints which I am about to give you.

"Where do I start?" you will ask. Well, let me guide you.

Your first step will be to collect together the various components needed. These are given in the list on a following page.

Probably you have on hand some of the items named, so you can delete them before you go to your dealer and hand him the list.

On the other hand, if you have none and

obtained the various parts and proceed to describe the first operation, viz. preparing and drilling the panel.

Let me impress upon you the fact that special tools are not necessary. Most of you will already possess a carpenter's brace, a straight-edge of some kind marked in inches, and a scriber, such as a sharp nail, or anything with which you can scratch a line on the panel surface.

Pencil lines are inadvisable, because graphite is a conductor, and therefore any pencilled dimension lines would have to be very carefully removed.

Preparing the Panel.

Other tools needed are a screwdriver, a pair of wire-cutting pliers, a spanner for tightening the nuts, and a 3/8-in. drill with a square shank. This only costs a few pence.

The spanner can be dispensed with in some cases, because the pliers may serve

The "P.W." DUAL-RANGER



NOT ONE LEAD NEED BE SOLDERED

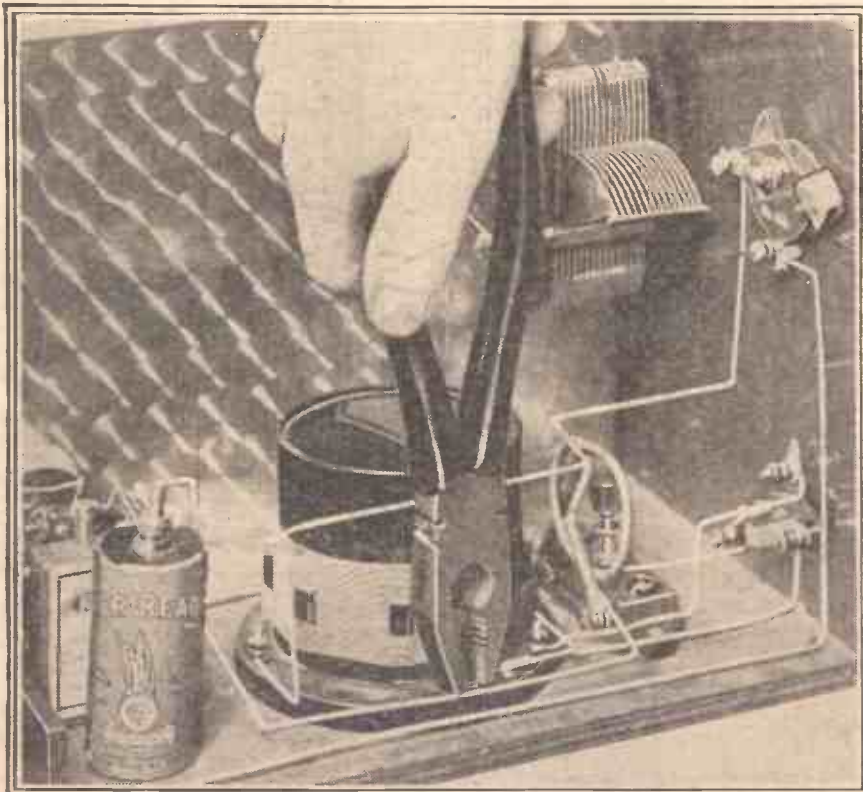

No soldering is necessary, but you should make the terminal connections tightly by the firm application of pliers.

wish to save yourself trouble, you can order a complete kit of parts from one of the firms specialising in this branch of radio.

How to Begin.

In addition to the parts named in the list you will require certain items, such as a quantity of tinned copper wire for connecting up, a yard or two of rubber-covered flexible, two wander plugs for the G.B. battery, and some small wood screws for fixing components to the baseboard.

The connecting-up wire can be either Glazite or bare tinned copper wire (about 18 gauge), over which you can slip Systoflex covering, or you can use those very handy little "Jifflinx."

I shall now assume that you have

quite well for tightening up purposes. Now place the panel on its face, and with the "panel layout" in front of you commence to mark off the dimensions for the panel components.

It is usual to do this work on the back of the panel, so that the highly polished face is not spoiled.

In order to make the dimensioning and marking off as simple as possible the condensers and switches have been arranged in two groups, with one wave-change switch on the vertical centre line of the panel. The dimensions for these two groups, as you will see from the "panel layout" diagram, are the same, and, moreover, there are no sixteenths or eighths of an inch to worry about,

**THE CONSTRUCTION OF
A "STAR" "P.W." SET
DESIGN IS DESCRIBED—**

There cannot be a single home-constructor in the Kendall Dual-Range Coil which has figured prominently as "P.W." "Dual-Ranger" employs one of these "P.V."-Coil-Quoit arrangement in such a way that

The "P.W." "Dual-Ranger" reaches an effective revelation in all-wave working. There is a flexibility and selectivity on long and ordinary waves that is tuning. Results that were hitherto thought possible in construction that for general simplicity, compactness and its own against any other

We are confident that the "Dual-Ranger" will be popular of our previous "threes," its attractiveness that all records will

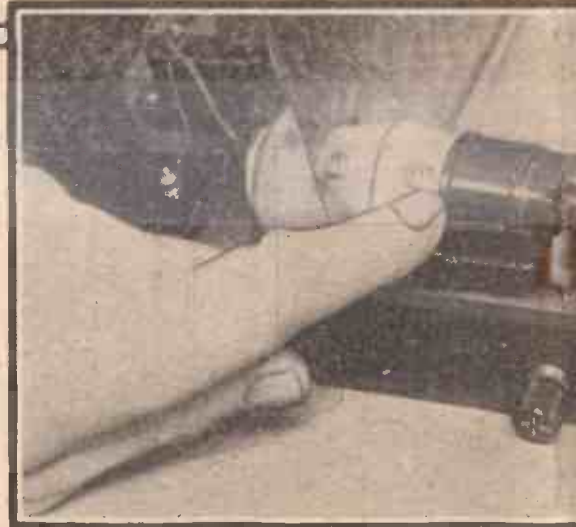

The S.G. valve lies through the screen.

DUAL- GER



By
A. JOHNSON
RANDALL.

country who has not heard of the famous eminently in so many successful sets. The notable components in conjunction with a that perfect "bi-band balance" is achieved. ness on both wave-bands that constitutes a ability and smoothness of reaction, plus power almost inaugurates a new era in two-band ble only with separate tuners are given in a less and inexpensiveness can more than hold quivalent design. ll achieve as great a success as the most ss is so patent there is no small possibility ll be broken.



which provides perfect shielding.

So you just take your scriber and straight-edge and scratch two lines, one vertical and one horizontal, the point where the lines cross each other being the drilling centre for the component.

You will get the idea from the dotted dimension lines on the "panel layout" diagram.

Some Hints for Drilling.

When you have marked the drilling centres for each of the components, take a sharpened nail or a centre punch and make a dent at each drilling point by giving the punch or nail a smart tap with a hammer. Don't forget to check over the measurements before you commence drilling.

When you are satisfied that all the dimensions are O.K. you can proceed to drill the holes. Incidentally, you must be careful here. Place a piece of wood, such as a scrap board, under the panel to give

of the strip and the remaining five terminals are spaced 1 in. apart respectively.

Then at the right-hand end we have the aerial terminal, 1 1/2 in. from the end of the strip, and two other terminals each 1 1/2 in. apart. There are three smaller holes along the bottom edge of the strip for fixing it to the baseboard.

When you have finished drilling all the holes secure the panel and terminal strip to the baseboard, making sure that the baseboard does not project below the bottom edge of the panel.

This is an operation where an extra pair of hands are useful for holding the panel and baseboard in position until the wood screws are well home.

Having finished this part of the job we can now start mounting the various components in their positions on the panel and baseboard—and, of course, the terminals

SIMPLE "HOTTING UP" ADJUSTMENTS ARE POSSIBLE

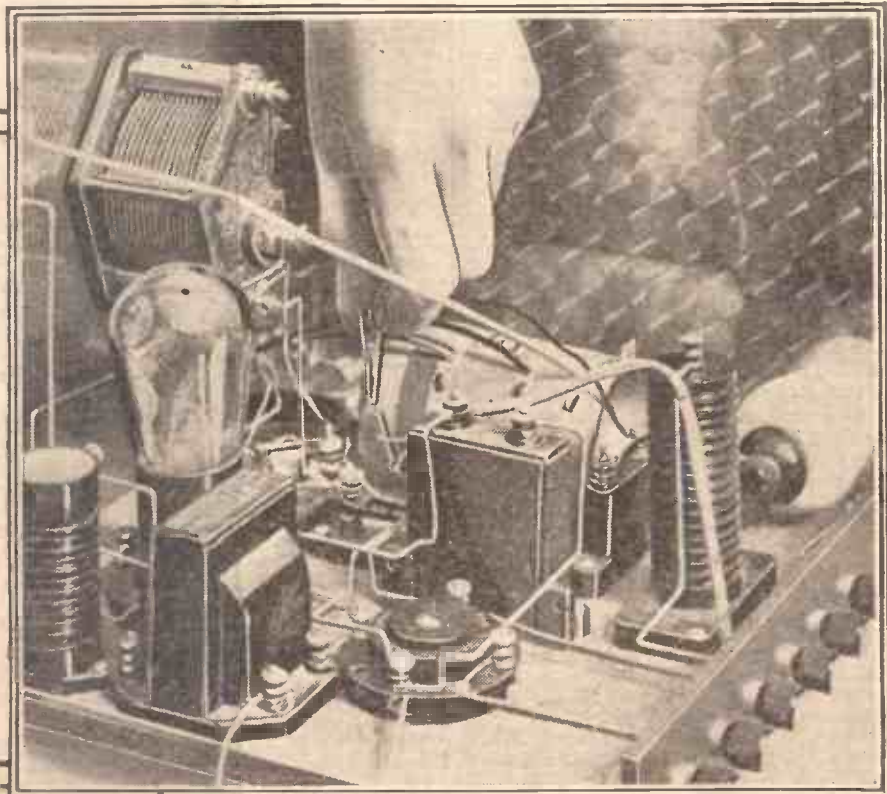

Clips are fitted so that you can adjust for exactly the selectivity you require.

the necessary support when the drill begins to bite.

Make sure that the panel doesn't rotate with the drill, and don't press too hard, otherwise you may chip the edges of the holes.

Apart from the 3/8-in. holes there are three smaller ones along the bottom edge of the panel for securing it to the baseboard. The centres for these holes should be approximately half the thickness of the baseboard up from the bottom edge of the panel. This completes the panel drilling, and the next item is to drill the terminal strip.

There should be no difficulty here. The dimensions are as follow; Looking at the terminal strip from the back the L.S. — terminal is 1 in. from the left-hand end

on the terminal strip.

The baseboard components should be positioned as shown in the photographs and blue-print, and at first screwed down *lightly*, in such a way that any of them may be removed in order to facilitate the wiring-up of the set.

The Selectivity Condenser.

There are one or two points which I should like to deal with before going any further. The first concerns the aerial series condenser (.0005 mfd.). This component is an ordinary solid dielectric type of variable condenser, but it has been arranged so that when the knob is turned into the position of minimum capacity (when the moving vanes are not engaging with the

(Continued on next page.)

THE "P.W." "DUAL-RANGER"

(Continued from previous page.)

fixed vanes) the condenser is automatically "shorted."

How is this shorting device fitted? It is quite simple and takes only a few minutes.

You just obtain a small piece of copper foil, or, if this is not available, a piece of tin or even lead foil.

Then you remove the nut on the right-hand corner of the condenser assembly (looking at back), and pass the piece of metal over the threaded bolt, bending the metal strip at right angles so that when the moving vanes are "all out" they make contact with the copper or tin foil. The nut is then replaced and tightened up.

Saving on the Screen

The bolt in question is, of course, one which passes through the fixed vanes and the two insulated end plates of the condenser. If your particular .0005-mfd. condenser is a Ready Radio or similar type, this little operation will not give you the slightest trouble.

Next, we come to the metal screen which shields the aerial end of the receiver from the H.F. portion. In the original receiver the screen was of copper (a standard 10 in. x 7 in., with a 1½-in. diameter hole for the S.G. valve). If economy is essential you may, without loss of efficiency, use instead a home-made screen consisting of a piece of 10 in. x 7 in. ply wood, to which is attached a covering of tin foil. The layer of tin foil can be stuck on with any adhesive such as secotone. If the hole is a little larger than 1½ in. no appreciable difference will be noticed in the results.

A further point concerns the positions of the coils in relation to the screen. In the original set the dual-range coil was placed so that the distance between the nearest

point on the winding and the screen was 2½ in. The P.J. coil was placed 1¼ in. from the screen.

If the coils are placed any nearer to the metal screen there is a likelihood of losses occurring.

The L.W. Coil Quoit

The long-wave H.F. coupling coil is a component you can very easily wind yourself. You will require a standard 2½-in. diameter (over ribs) coil quoit and about 50 yards of No. 30-gauge D.S.C. wire. Buy a little more than this to be on the safe side.

I expect your quoit will already have a couple of holes in it for anchoring the end of the winding. If so, pass one end of the wire two or three times through these holes and leave an inch or two of slack.

Now wind on 50 turns and at the 50th

turn make a loop in the wire an inch long, bringing this out to the side of the quoit.

The 50 turns you have just completed are the reaction turns, and the loop is the tapping marked "E" on the blue print. Put on a layer of Empire tape.

Then proceed to wind on another 30 turns in the same direction as before, and at the 30th turn make another loop in the wire. Carry on in the same way until you have completed a further 30 turns, and make a third tapping point.

Positioning the Valveholder

Go on winding for a further 90 turns and then cut the wire, anchoring it to a hole in the quoit so that there is no possibility of the winding coming apart.

Checking up the coil, we have a reaction winding of 50 turns finishing at "E," and continuing in the same direction without

cutting the wire, we then have a grid coil, having a total of 150 turns from the point "E." The whole of the winding is wound in the form of a hank, i.e. with no attempt to keep the turns in regular layers.

Possibly you will wonder how you can determine the correct position for the S.G. valve holder. I think the easiest method is to pass the S.G. valve through the hole in the screen, insert the valve legs in the sockets of the valve holder, and then to mark the position for the valve holder on the baseboard. You must remember to leave sufficient clearance between the

AN EXCELLENT BEGINNING

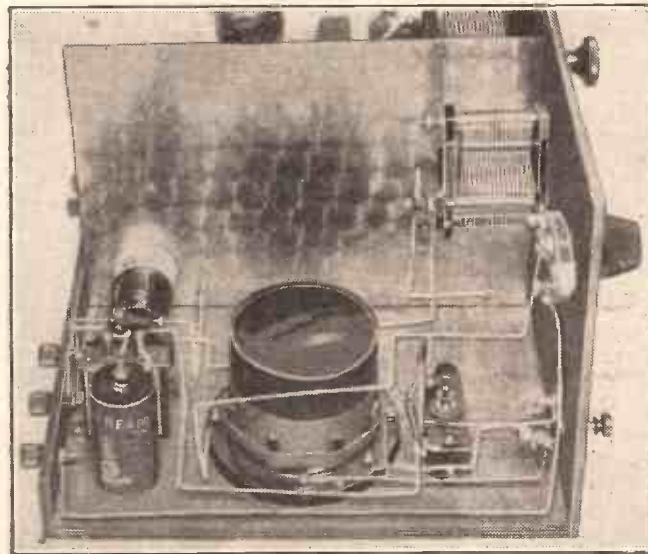

The Dual-Range Coil is included in the first stage of the set, while a "P.V." scheme provides highly effective inter-valve coupling.

CHOOSE YOUR COMPONENT MAKES FROM THIS LIST

- 1 Panel, 16 in. x 8 in. (Wearite, Permeol, Goltone, Peto-Scott, Becol).
- 1 Cabinet to fit, baseboard 10 in. deep (Camco, Osborn, Gilbert, Pickett).
- 2 .0005-mfd. condensers (Telsen, J.B., Polar, Cyldon, Wavemaster, Astra, Formo). If above have plain dials, the following will be required :
 - 2 Slow-motion dials (Lotus, Telsen).
- 1 .0005-mfd. solid dielectric condenser (Ready Radio, Telsen, Parex, Lotus).
- 2 3-point wave-change switches (Ready Radio, Telsen, Lissen, Wearite, Goltone).
- 1 On-off switch (Lissen, Telsen, Ready Radio, Igranic, Lotus, Goltone, Wearite).
- 1 .0001-mfd. differential reaction condenser (Telsen, Lotus, Ready Radio, Parex, Polar, Graham Farish, Cyldon, Wavemaster, J.B.).
- 1 "P.W." Dual-Range Coil.
- 1 .002-mfd. max. compression condenser (Goltone, Formo, Sovereign, Telsen).
- 1 1-mfd. fixed condenser (Igranic, T.C.C., Dubilier, Formo, Telsen, Mullard, Helsby, Ferranti, Ediswan, Hydra, Graham Farish).
- 1 .0003-mfd. fixed condenser (Ferranti, etc.).
- 1 .001-mfd. fixed condenser (T.C.C., as above).
- 1 1-mfd. fixed condenser (T.C.C., as above).
- 1 P.J.3 coil (R.I., Formo, Goltone, Parex, Melbourne, Sovereign, Wearite, Ready Radio).

- 1 Coil quoit (Peto-Scott, Sovereign, Parex, Ready Radio, A.E.D., Wearite).
- 2 oz. 30 D.S.C. wire for above.
- 1 Screen 10 in. x 7 in. (Parex, Peto-Scott, Wearite, Ready Radio).
- 1 2-meg. leak and holder (Graham Farish, Ferranti, Lissen, Dubilier, Mullard, Igranic, Telsen, Watmel, Varley, Loewe).
- 2 H.F. chokes (Lewcos and Varley, Telsen, Ready Radio, Lotus, Parex, Sovereign, Graham Farish, Wearite, R.I., Peto-Scott, Atlas).
- 1 L.F. transformer, ratio (Lotus, Telsen, Ferranti, R.I., Varley, Igranic, Lissen, Graham Farish).
- 1 50,000-ohm spaghetti resistance (Bulgin, Telsen, Ready Radio, Varley, Sovereign, Lissen, Igranic, Goltone, Lewcos, Peto Scott, Graham Farish).
- 1 25,000-ohm spaghetti (Bulgin, as above).
- 2 Valve holders (Graham Farish, Lotus, W. B., Telsen, Igranic, Lissen, Clix, Wearite, Dario, Formo, Bulgin).
- 1 Do., Horizontal mounting (W. B., Parex).
- 1 Terminal strip, 16 in. x 1½ in.
- 9 Indicating terminals (Belling & Lee type R, Igranic, Goltone, Clix, Eelex).
- Glazite, Lacollne, Quickwire, flex, screws, etc.
- 1 Crocodile clip (Bulgin, Goltone).
- Battery Plugs (Belling and Lee, etc.).

ACCESSORIES.

LOUDSPEAKERS. — Celestion, Mullard, Blue Spot, B.T.-H., Amplion, Undy.

VALVES.—1 S.G. (Cossor (metallised) Osram, Mazda, Eta, Tungram, Mullard, Six-Sixty, Dario).

1 Detector (Osram H-L2, Mazda, Mullard, Cossor, Six-Sixty, Eta, Lissen, Tungram, Dario).

1 small power valve (Mazda, etc.).

(Milliamp consumption at 120 volts max. 16 milliamps.)

BATTERIES (H.T.)—1 120-150-volt super-capacity (Pertrix, Ever Ready, Drydex, Columbia, Magnet, Ediswan, Lissen).

1 15 or 9-volt G.B. battery for S.G. valve (Ever Ready, etc.).

1 9-15-volt G.B. battery to suit output valve (Ever Ready, etc.).

ACCUMULATOR.—Two-, four-, or six-volt, to suit valve (Exide, Ediswan, Lissen, Pertrix, G.E.C.).

MAINS UNITS.—Heayberd, Tannoy, Regentone, Lotus, Ekco, Atlas, R.I. (State voltage and type of mains, and give details of set when ordering.)

KENDALL'S TEST

of the

"P.W." DUAL-RANGER

built with a

READY RADIO MATCHED KIT

Wonderful results . . .

Tremendous volume . . .

Selectivity exceptional . . .

Simple to build

BENNETT PARK LABORATORIES

Bennett's Park, S.E.3.

G. P. Kendall, B.Sc.

TEST REPORT ON "DUAL RANGER"

A model of the "DUAL RANGER" has been built in my laboratory using the components which I have specified for the Ready Radio Kit, and has been submitted to stringent tests.

Preliminary experiments were made to establish the entire suitability of the chosen components, and then the instrument was put through the usual reception tests under varied conditions. It was at once apparent that its extreme simplicity is no guide to its performance, for it gave most wonderful results, far ahead of the average receiver of its type.

Selectivity was found to be quite exceptional, and signal strength was really extraordinary for a three valver, more particularly on long waves. Radio Paris, for example, could be found and tuned in quite easily with reaction at minimum, and came up to tremendous volume when only moderate use was made of the reaction control.

Altogether I was very much impressed by the "DUAL RANGER" for it is capable of a most outstanding performance, bringing in the foreigners with real ease and certainty and, without the slightest difficulty, cutting out the local transmissions in any normal circumstances. Yet it is strikingly simple to build and to operate.

G.P. Kendall



G. P. KENDALL, B.Sc.,
CHIEF ENGINEER,
READY RADIO.

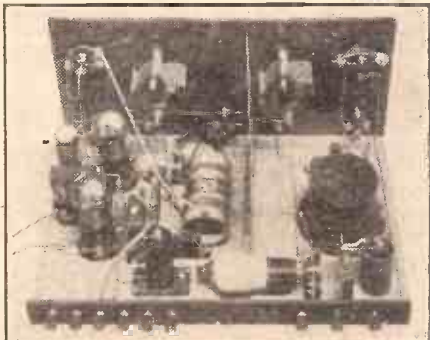

**NOW
TURN
TO
PAGES
439
440
443**

Ready Radio

THE MIRROR OF THE B.B.C.

GENERAL ELECTION BOTHER
TELEVISION DEVELOPMENT
— DRASTIC MUSIC CUTS —
EMPIRE BROADCASTING—
PROGRAMME POINTERS.

THE B.B.C. has been encountering a very thin time in settling the General Election broadcasts by party representatives. On previous occasions it has been possible to work through the Whips who assumed responsibility for evolving a generally acceptable plan.

But the Whips did not function this time. In some cases there were no Whips to function. So Sir John Reith, who carried through the whole of the negotiations personally, had to do the best he could out of a scramble.

Labour did not take at all kindly to the proposal that its case should be put only by Mr. Henderson and Mr. Graham. Already there was a good deal of resentment because of the earlier broadcasts of Mr. MacDonald and Mr. Snowden.

At the Scarborough Meeting of the Labour Party it was decided that if they

"P.W."
ALWAYS
LEADS!

Our claim to the largest circulation of any wireless paper is once again justified by the net sales certificate which we have received from Messrs. Price, Waterhouse & Co.

It shows that even over the six months' ending in mid-summer "P.W.'s" AVERAGE NET SALE WAS

129,806

copies per issue!

POPULAR WIRELESS
is the paper that made
WIRELESS POPULAR.

were returned to office, there would be swift retribution visited on Savoy Hill. Miss Helen Wilkinson is reputed to be one of the most zealous of the "Broadcasting Reform group" of Labour. The measures contemplated involve drastic changes to be applied by a completely new Board of Governors.

Television Development.

As I exclusively forecast some weeks ago, the B.B.C. is stirring itself about television. The confirmed report that television would be a service proposition in America by November, 1932, has set Savoy Hill researchers at work. It is understood that

Mr. Ashbridge, the Chief Engineer, is watching this personally.

Drastic Music Cuts.

Having cut salaries all round, and hung up expansion, the B.B.C. appears now to be reducing the money spent on programmes, particularly in music. I hear that the Bach Cantatas are to go; and I imagine that most listeners will regard this as a definitely silver lining in the black cloud of economy.

Other reductions are to be made on the music side, but I have not yet heard their particulars. Talkers are to get less and the allowances for the regional stations will be smaller by a substantial amount. I suppose all this is necessary but the effect on programmes will soon be felt.

Empire Broadcasting.

It is now assured that if the National Government is returned, one of its first measures will be to sanction the permanent Empire short-wave service from Daventry for which there has been clamouring for years past. This will be an advantageous move from all points of view, not least from the angle of trade and industry.

Programme Pointers.

I must confess that it was news to me to learn that George Mozart, one of the greatest music hall figures of the last thirty years, has never appeared before the B.B.C. microphone, which makes all the more interesting the fact that he will do so in a vaudeville programme arranged for London Regional and National listeners on Wednesday and Saturday, October 28th and 31st, respectively.

George Mozart has played at many famous London music halls and theatres, some of which are no longer with us. At the Pavilion he played for thirty-eight weeks in one year, and at the Palladium for thirty. He was a great favourite at the Alhambra, the Palace, the old Oxford and

the old Tivoli. None knew better than he what the public wanted, and none could give a better show. His first broadcast on October 28th will take the form of a series of race-course character studies, and what could be better for the day on which the Cambridgeshire will be run?

Polling Day for the General Election is on October 27th, and Mabel Constanduros and Michael, who are in the same "bill," will probably tell us how "Grandma," "Mrs. Buggins" and "Bert" went to vote, while we shall also hear a child singer



GONE UP!

This is Mr. F. Vivian Dunn, a violinist in the B.B.C. Symphony Orchestra, who has been appointed Director of Music of the Royal Marines. He is 23 years old.

of syncopated songs, Master Graham Payne, and Winnie Melville and Derek Oldham whose "turn" is always good.

Gillie Potter is in another vaudeville programme during the same week (National stations, October 26th) when there will also be a sketch entitled "Lunch for Two."

Looking still farther ahead to next month you may like to know that the Hulbert Brothers will be heard in a new programme called "Jack Hulbert's Follies"

(Continued on page 456.)

FOR THE LISTENER

Broadcast opera has always been a somewhat controversial subject, but most people will agree with the suggestions made below.

By "PHILEMON."

FOR the ordinary listener, broadcast opera is not likely to be a very popular form of entertainment. Most of us, tuning in to such an item, wonder what the dickens it is all about.

It may be in a foreign language. If it is in English, ten to one the listener won't be able to catch the words. Nothing will help him. The B.B.C. does not do much to help him. It is true that he will find in the Official Programme some account of the opera that is to be performed during the week; but usually it is rather dull reading.

I am surprised that the B.B.C., determined to make us a more musical people, does not do more to "popularise" Opera. I do not mean to make it cheaper, but to help us to understand it.

It is the easiest form of "grand" music to popularise in this sense. It has dramatic quality. It tells a story.

In most of the big operas, the characters are very interesting. The music itself is

often lovely, and sometimes thrilling. With a little encouragement and assistance, thousands of ordinary listeners might become lovers of Grand Opera.

But there is no encouragement. It would be a great help if, for five or ten minutes before the broadcast, some bright and knowledgeable man would tell us about what we are going to hear.

Missing the Hang of It.

Some time ago I listened to the First Act of "Der Rosenkavalier." I know it well, and enjoyed it for the umpteenth time. It is very delightful. But a listener, hearing it on his set for the first time, could not possibly have got the hang of it.

The announcer, indeed, occupied a moment in giving a vague sketch of the Act; superfluous to anybody who knew the Opera, useless to anybody who didn't.

(Continued on page 456.)

TELSEN DUAL-RANGE COILS

TELSEN DUAL-RANGE AERIAL COIL

The Telsen Aerial Coil is the very latest development in dual-range aerial coil design. It incorporates a variable series condenser which can be set to give any desired degree of selectivity, making the coil suitable for all districts whatever reception conditions may be. It has been tested in various parts of the country, and down to distances of five miles from Regional stations, a single tuned circuit will definitely separate the Regional programmes. This adjustment also acts as an excellent volume control and is equally effective on long and short waves. The waveband change is effected by means of a three-point switch. A reaction winding is provided and the primary and secondary windings are separated so that the aerial circuit can be isolated in mains driven or screened-grid receivers.

Telsen Aerial Coil with Variable series Condenser incorporated Price **7/6**

TELSEN H.F. TRANSFORMER AND AERIAL COIL

This Coil is primarily designed for H.F. amplification in conjunction with screened-grid valves. It is arranged so that it can be connected as a tuned-grid or tuned-anode coil, or alternatively as an H.F. Transformer.

It also makes a highly efficient aerial coil where the adjustable selectivity feature is not required. A reaction winding is incorporated. When used as an H.F. Transformer the wave-change is effected by means of a two-pole (four-point) switch. When connected otherwise a three-point switch should be used.

Telsen H.F. Transformer and Aerial Coil Price **5/6**

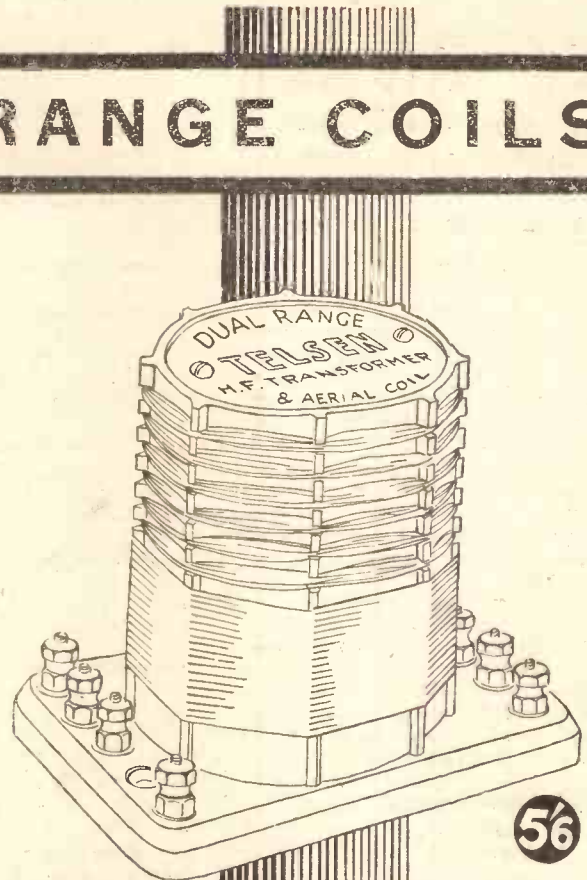

TELSEN

THE SECRET OF PERFECT RADIO RECEPTION

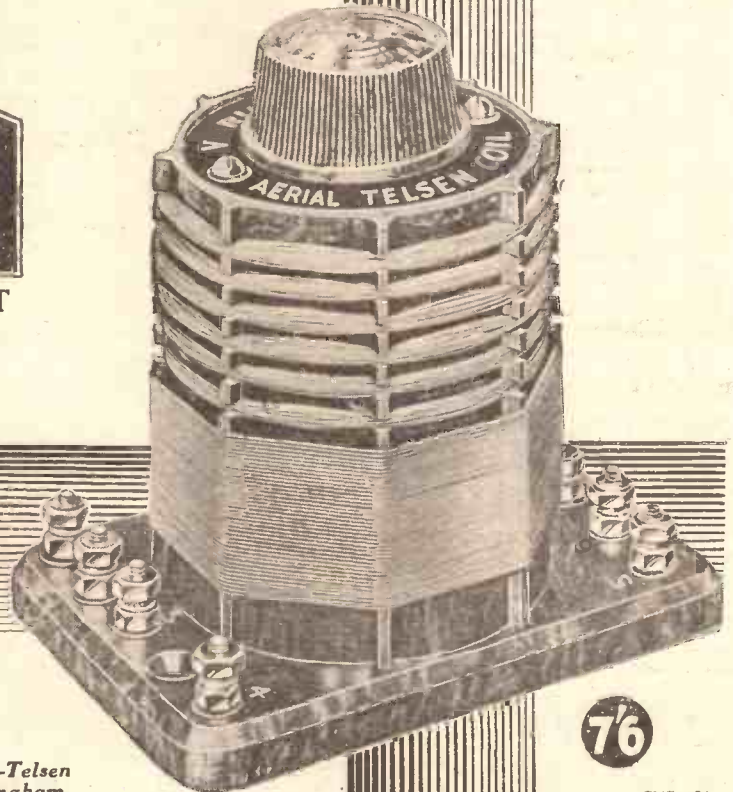

Send for the "Telsen Radio Catalogue" and book of "All-Telsen Circuits" to The Telsen Electric Co., Ltd., Aston, Birmingham.

WE have now fairly entered upon the very best portion of the wireless season. There is no need to wait until nearly bedtime before undertaking an ether tour of Europe: many medium-wave stations in fact are making themselves heard as soon as ever the light begins to fail.

This means that the long-distance enthusiast can get to work about five o'clock (or even earlier on gloomy days) with every hope of making a fair bag of foreign stations.

On the long waves a good many readers have heard a mystery transmission which appeared to belong to no station in the ordinary lists. As a matter of fact, it did not. It was the Dutch station Kootwyk conducting telephony tests.

Those Puzzling Broadcasts.

I understand that Kootwyk is not to become a broadcasting station, but will be reserved for commercial telephony. Other transmissions that have puzzled a certain number are those of the new high-powered Prague station. This station is still engaged in testing, but it will shortly come into regular operation. The transmitter is situated just outside Prague.

I have only recently heard the power of



Some practical distant-programme notes compiled by a special contributor who nightly searches the ether in order to obtain really up-to-the-minute information for "P.W." readers.

the station, which is 100 kilowatts at present but will work up eventually to 120. As soon as the new Prague transmitter is in operation he should provide wonderful volume in this country, for his long wavelength should mean a good range.

Trouble, though, may be caused in some localities by a heterodyne with the North Regional, which is on the neighbouring channel only 9 kilocycles away.

The long waves are a particularly good hunting ground just now. During the summer there was an unusual weakening noticeable in a good many of the long-wave stations, but all are now back to strength, and some that have not been heard for a long while are providing fine reception.

An Early-Closer.

One that I can recommend you to look out for is Reykjavik, the Icelandic station with a power of 21 kilowatts, whose wavelength is just above that of Kalundborg.

I notice, by the way, that this station

closes down rather early in the evening. Lahti, on 1796 metres, is sometimes to be heard quite well, though unless your set is super-selective you will have to choose a time when neither Huizen nor Radio-Paris are working, since Lahti is separated by only 7 kilocycles from each

of these stations.

On the medium-band stations are settling down to steady strength, and we are having much less of the variations that were so noticeable early in the month. Old friends which you have probably not heard for some time are now worth attention

A Selection of Good Stations.

Amongst these I can recommend Munich and Riga near the top of the band. The latter is often remarkably good. Lower down try for Lyons La Doua just below Langenberg. Immediately below Stockholm is Belgrade, who is worth attention, and you should always search for Madrid rather late in the evening.

Others which you may add to your bag are: Katowice, Bucharest, Lwow, Algiers (when Stuttgart is not working), Brno, Naples, Zagreb (just below Cardiff), Rennes, Lille, Leipzig, Gleiwitz, Nurnberg and—right down near the bottom of the band—Konigsberg on 217 metres.

THOSE who accuse me of never sticking to one set for more than a few days have triumphed again—I have made another this week! Strange to relate, the number of valves has been reduced. In fact, it can't be reduced any more, since this set uses one.

My general interference level with a two- or three-valver was so bad that, to receive distant signals in comfort, I always had to make use of the volume control. Then I had an idea that the "signal-to-mush" ratio would be still further improved by cutting out the L.F. altogether, and I did it.

As justification for my suspicions, I must say that I am delighted with the result. I receive all that I want to receive, without having my head nearly blown off every few minutes by atmospheric or local disturbances.

Completely Rebuilding the Set.

Looking up some very old notes of mine, I find that I said, in 1927, that if most of those people using two note-mags. were to remove them, they would find that they couldn't hear anything at all on what was left. I still hold to that theory, in a way, for I think that one tends to forget the detector when one has limitless amplification after it.

My change-over necessitated a complete rebuild, with the result that I now have the set in a most minute aluminium box, with two dials and a switch on the front, and six terminals on the back. The valve in use is still an indirectly-heated type, taking 4 volts 1 ampere, but I think it does my accumu-

SHORT-WAVE NOTES



Notes and views regarding an exciting and fascinating wave-band.

By W. L. S.

lator good to put a respectable load on it instead of always drawing 2 or so.

The man who uses one valve certainly has a fine field for experiment. He can just go ahead and see how much more he can get out of it, by such expedients as varying the L/C ratio, using different types of coils and aerial coupling, and playing with the grid condenser and leak.

Differences That Show Up.

Personally, I found that using a higher inductance coil and smaller capacity made a most marked improvement in sensitivity. This has never shown up much when L.F. amplification has been in use, probably because all signals were too loud to test with to permit proper comparison.

Now for the week's news, which is not too interesting, I fear. W 2 X A D continues to put good programmes over until about

9.30, when he is generally fading badly or uniformly weak. W 2 X A F, after 11 p.m., is decidedly good. W 8 X K is variable, but generally quite interesting.

Rome, I find, has fallen right off and is quite disappointing.

Perhaps I should make it clear that the above remarks do not concern the new single-valver, but my "stand-by" set that I always use for comparing conditions from one week to the next.

Certain regular correspondents of mine have suggested that it is time that we thought of organising another little competition, on similar lines to that run during the summer. Perhaps they are right. I will don my thinking-cap and try to evolve a fair method of scoring that will ensure that the best man wins.

The Call of The Jackass.

Numerous reports of the reception of Sydney (V K 2 M E) have been arriving for the past few days. I really think the influence that he has on the "getting-up" time of the British public is most surprising. Apparently quite a number of hardy souls rise punctually at 6.30 every morning for the express purpose of listening to the call of the laughing jackass!

Thanks especially to "G.H.F." of Sevenoaks, and "H.E.P." of Binley. The latter wants me to recommend him to a good short-wave set. My advice to him is to build a one-valver, play with it until he really gets plenty on it, and then add a stage of L.F.!

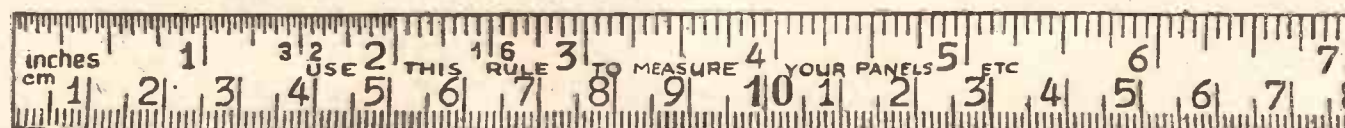

TYPICAL OF TELSEN VALUE

TELSEN VALVE HOLDERS (Prov. Pat. No. 20286/30)

The Telsen four and five-pin valve holders embody patent metal spring contacts which are designed to provide the most efficient contacts with split and non-split valve legs, and are extended in one piece to form soldering tags. Low capacity and self-locating.

- Telsen 4-pin Valve Holder Price 6d.
- Telsen 5-pin Valve Holder Price 8d.

TELSEN FIXED MICA CONDENSERS (Prov. Pat. No. 20287/30)

Telsen Fixed Mica Condensers are made in capacities from .0001 microfarad to .002 microfarad. They can be mounted upright or flat and the .0003-microfarad Telsen fixed mica condenser is supplied complete with patent grid-leak clips to facilitate series or parallel connections.

- Telsen Fixed Mica Condensers Price 6d

TELSEN GRID-LEAK HOLDER

The Telsen Grid-Leak Holder will hold firmly any standard size or type of grid-leak. Ample clearance is provided between the terminal screw leads and the baseboard (underneath,) preventing any surface leakage upsetting the value of the grid-leak. The terminals and fixing holes are accessible without removing the grid-leak.

- Telsen Grid-Leak Holder Price 6d.

TELSEN SPAGHETTI FLEXIBLE RESISTANCES

These are made in a range of values from 300—200,000 ohms with a maximum current varying from 42 m/a to 1½ m/a. The terminal tags are firmly fixed to the wire and clearly marked with their respective resistance values; they are impregnated with special insulating compound which renders them proof against corrosion.

- Telsen Spaghetti Flexible Resistances from 6d.

TELSEN FUSE HOLDER

This is a neat and inexpensive device which should be incorporated in every set as a precaution against burnt-out valves.

- The Telsen Fuse Holder firmly grips the standard radio fuse giving a perfect contact.
- Telsen Radio Fuse Holder Price 6d.

TELSEN GRID-LEAKS

Telsen Grid-leaks are absolutely silent and non-microphonic, and practically unbreakable. They cannot be burnt out, and are unaffected by atmospheric changes. Telsen Grid-leaks are not wire wound and therefore there are no capacity effects. Their value is not affected by variation in the applied voltage. Made in values from 1—5 megohms.

- Telsen Grid-Leak Price 8d.

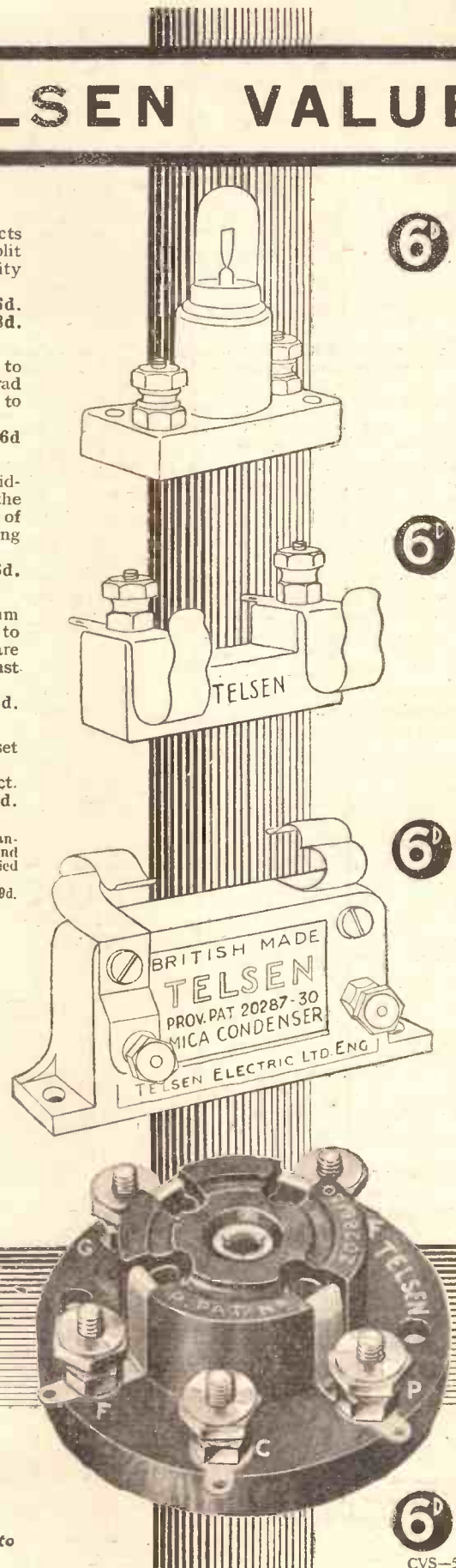

TELSEN

ALL-BRITISH
RADIO COMPONENTS

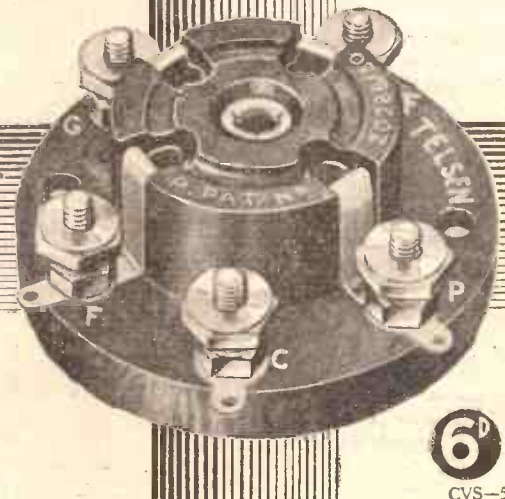

Send for the "Telsen Radio Catalogue" and book of "All-Telsen Circuits" to The Telsen Electric Co., Ltd., Aston, Birmingham.

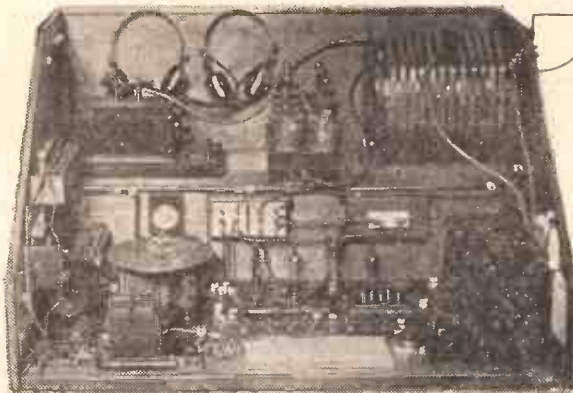

LOOKING BACK

by W.L.S

HAVING reviewed all that radio has to offer us for the 1932 season, I duly take off my hat to those who have made, or who are making, our radio what it is. In common with other "old-stagers," though, I cannot help viewing the whole business with mixed feelings. This is a privilege accorded to us all about this time of the year, and we soon feel better. Nevertheless there is, every autumn, a tendency to sit back in a comfortable chair and think of the "good old days."

Were they good old days, really? It is easy to say so, but should we truly enjoy ourselves if we were suddenly transported back to them by something like Mr. Wells' "Time Machine"?

Certain it is that one got more "kick" out of radio in, say, 1923 than one does now. But that was from the purely selfish point of view. One had the feeling of being one of the elect. People came for miles to see the largest wireless mast in the district and pondered upon what manner of man the owner might be.

Black Magic of '23.

There *were* people, be it said, who talked of black magic and didn't quite approve, even in 1923. And when they heard stories of a wireless enthusiast who was so completely, so absolutely mad that he got up at 3 o'clock every morning to hear America, or some such nonsense—well, I ask you!

Well, those days certainly *have* gone, and there is no recalling them. If we boast to our next-door neighbour about some achievement of ours, he merely retorts: "Well, you jolly well ought to get him, using an "S.G.P." circuit; why, with my little two-valver, I got and so on, ad nauseam!

It is interesting, always, to try to retrace our thoughts; it makes a good parlour game. As an elaboration of it, I have tried to retrace my various stages in radio, and to recall the happenings that conspired to put me on the lines I have been travelling on. I cannot help feeling that there are so many others who share my own experiences that an account of them might be interesting; and if I only succeed in reminding you of the atmosphere of the old times I shall have done something.

The Germ's First Bite.

The wireless germ burst out in all its ferocity while the patient was a small schoolboy. The sight of a spark coil or a Leyden jar in the laboratory conjured up inspiring visions of those heroes who travelled the globe in a little cabin surrounded by such marvels.

Polished knife-switches, rotating stud-

Our short-wave expert in a reminiscent vein. He asks you to take your mind back a few years and —But read the following racy article.

switches, and particularly streams of sparks across a quarter inch gap seemed to represent the greatest joys that life had to offer. Do you begin to sympathise, reader, or were you never quite so badly bitten?

His First Aerial.

The home—or that small corner of it in which such a mess was allowed—began to assume the appearance of an ancient alchemist's laboratory. Leclanché cells, coils of wire, small flash-lamp bulbs rigged up in brackets with wonderful reflectors, all showed the passion of the infant mind for something electrical. Occasional domestic set-backs were caused by a small contretremp, such as a steady stream of sal-ammoniac solution through the kitchen ceiling! But, then, the inventor's path has always been hard.

Next came the more devastating stage at which a replica of an aerial was slung up in the garden, although merely for the purpose of working a buzzer on the bottom

SHORT-WAVERS FOR AMERICAN POLICE CARS



Short-wave radio sets are being fitted on American police cars to assist in the war on gangsters.

fence. The thrill of seeing neighbours looking skywards more than compensated for the inability to read Morse at more than one or two letters per minute.

Finally, some patient friend, indeed a wireless wizard, even in those days, saved the situation by showing that the current catalogue price of a crystal set, namely, 17 guineas, was daylight robbery, and that one could actually be made for about one-seventeenth of that figure.

So the first crystal set materialised, and the entire family impatiently shared one pair of headphones when a certain very popular gentleman, now known to every "P.W." reader, made facetious remarks from "Wr-r-rattle," Chelmsford. Where the funds came from I certainly cannot remember now (unless from the sale of treasured model railways and the like), but a real, live single-valve set *did* materialise, less than six months after the crystal set first began to rectify.

What a Set!

And what a set! It occupied an entire table, with a vertical back taking two-pin mains-plugs into which the coils were inserted by lengths of flex. The tuning condensers were on the front of the table, the valve central, towards the back, and the total amount of wire must have run into scores of feet.

When the amateur transmitters were chased down from 440 metres to the 150-200 band, I followed in their wake. It took me three months to find out why that set would not work down there; then came the discovery that if the wires connecting up the condensers to the coils that they were tuning were less than two feet long, the set worked better!

Specialising on Short Waves.

More than one reader has written to ask me what made me take up short-wave work as my special branch of radio. It is difficult to answer this, but I think it was the fact that I started before broadcasting began. In order to give vent to the desire for "DX" in evidence even then, there was nothing to do but listen to the amateur transmitters. I soon discovered, as many others have done, that they were an interesting, human crowd, all united by a common bond, which I, in my humble way, felt that I shared.

So wherever they went I followed them. And it is a matter of history that they went steadily downwards, pioneering first one wave-band and then another, and always finding something new.

READY RADIO MATCHED KIT

for the
"P.W." DUAL-RANGER
for

£3 · 19 · 9

or 12 monthly payments of 7/6

READY RADIO TESTED KITS

KIT A - £3.19.9

Complete set of Components
(except Valves and Cabinet)
or 12 monthly payments of **7/6**

KIT B - £5.18.9

(with Valves less Cabinet)
or 12 monthly payments of **11/-**

KIT C - £6.16.3

(with Valves and Cabinet)
or 12 monthly payments of **12/6**

ORDER FORM

To **READY RADIO, LTD.**, Eastnor House, Blackheath, S.E.3

CASH ORDER Please dispatch to me at once the goods specified for which I enclose payment in full of

£

C.O.D. ORDER Please dispatch to me at once goods specified for which I will pay in full the sum of

£

EASY PAYMENT ORDER

Please dispatch my Easy Payment Order for the goods specified for which I enclose first deposit of

£

Name

Address

Kit Required

P.W. 24/10/31.

If you do not require a complete Kit, you can purchase any component you require separately.

See page 440 for full list of components



Head Office and Works:

EASTNOR HOUSE, BLACKHEATH, S.E.3.

'Phone: Lee Green 5678.

'Grams: Readirad, Blackvit.

Showrooms:

159, BOROUGH HIGH STREET, LONDON BRIDGE, S.E.1.

'Phone: Hop 3000.

IMMEDIATE DISPATCH of THE "P.W." DUAL-RANGER

from
Ready Radio

The DUAL RANGE COIL

was designed by

G. P. KENDALL,

B. Sc.,

CHIEF ENGINEER, READY RADIO

Be sure your coil is a genuine Kendall Dual Range Coil, obtainable from Ready Radio.

Price **10/6**

All Kendall Dual Range Coils are given an actual broadcast test before despatch under the supervision of the designer, Mr. G. P. Kendall, Chief Engineer of Ready Radio.

APPROVED LIST AT A GLANCE

"P.W." DUAL-RANGER

	£	s.	d.
1 Panel, 16 x 8 in., drilled to specification	5	6	
1 Waldor cabinet, 16 x 8 x 10 in., with base-board	17	6	
2 Wavemaster .0005 mfd. slow-motion condensers	11	0	
1 ReadRad .0005-mfd. solid-dielectric condenser	3	6	
2 Three-point wave-change switches	3	0	
1 On-off switch	2	6	
1 ReadRad .00015 differential condenser	10	6	
1 Kendall dual-range coil	1	10	
1 T.C.C. .1-mfd. fixed condenser, type 50	1	3	
1 T.C.C. .0003-mfd. fixed condenser, type "S"	1	6	
1 T.C.C. .001-mfd. fixed condenser, type "S"	2	10	
1 T.C.C. .1 mfd. fixed condenser, type 50	1	6	
1 Sovereign pre-set condenser, type "H"	2	6	
1 P.J.3 coil	2	6	
1 Ready-wound coil quoit, Type D.R.	2	0	
1 Screen, 10 x 7 in.	1	4	
1 ReadRad 2-meg. leak and holder	2	6	
1 Lewcos H.F. choke, type M.C.	4	6	
1 ReadRad H.F. choke for S.G. circuit	5	6	
1 Lotus L.F. transformer, No. 1	1	6	
1 Lewcos 50,000-ohm Spaghetti resistance	1	6	
1 Lewcos 25,000-ohm Spaghetti resistance	1	4	
2 Junit valve holders	1	9	
1 Junit horizontal valve holder	1	4	
1 Terminal strip, 16 x 2 in.	2	3	
9 Belling-Lee terminals, type "R"	2	6	
1 Packet Jifilinx for wiring	2	6	
1 Siemens 1½ v. S.G. cell, type G.T.			9
3 Valves. Cossor Metal Coated S.G.215, Mullard P.M.1.H.L. and P.M.2	1	19	0
Flex, screws, 1 crocodile clip, etc.]			3
	£6	16	3

If you do not need the complete kit of parts, you can purchase any component you require separately.

RECOMMENDED BATTERY AND LOUDSPEAKER EQUIPMENT

	£	s.	d.
1 Pertrix 120 v. Standard H.T. battery	15	6	
1 Pertrix 9 v. grid-bias battery	1	6	
1 Pertrix accumulator, type P.X.C.3	11	0	
1 Blue Spot speaker, type 44R.	2	12	6

Any other makes can be supplied if required.

COMPLETE KIT consisting of the above batteries and loudspeaker with one **READY RADIO KIT C.**

Price **£10.16.9** or 12 monthly payments of **£1**

COMPLETELY ASSEMBLED DUAL-RANGER with Cabinet and Valves, aerial tested, royalties paid.

Price **£8.6.8** or 12 monthly payments of **15/3**

With Battery Equipment and Loudspeaker as specified above.

Price **£12.7.2** or 12 monthly payments of **£1.3.0**

TO INLAND CUSTOMERS
—Your goods are despatched Post Free or Carriage Paid.

TO OVERSEAS CUSTOMERS—Everything Radio can be supplied against cash. In case of doubt regarding the value of your order, a deposit of one-third of the approximate value will be accepted and the balance collected by our Agent upon the delivery of the goods. All goods are very carefully packed for export and insured. All charges forward.

FOR

READY RADIO "DUAL-RANGER" KITS, SEE PAGE 439



Head Office and Works:

EASTNOR HOUSE, BLACKHEATH, S.E.3.

Phone: Lee Green 5678.

Grams: Readirad, Blackvil.

Showrooms:

159, BOROUGH HIGH STREET, LONDON BRIDGE, S.E.1.

Phone: Hop 3000.

ORDER FORM

To **READY RADIO Ltd.**
EASTNOR HOUSE, BLACKHEATH, LONDON, S.E.3.

CASH ORDER. Please dispatch to me at once the goods specified for which I enclose payment in full of **£**

C.O.D. ORDER. Please dispatch to me at once goods specified for which I will pay in full the sum of **£**

EASY PAYMENT ORDER. Please dispatch my Easy Payment Order for the goods specified for which I enclose first deposit of **£**

Name.....

Address.....

Kits required.....

Advt. of Ready Radio Ltd.



HOW YOUR SET WORKS

IF every process in the intricate chain connecting the broadcasting studio and your loudspeaker occupied two minutes of time, the B.B.C. would have to begin its programmes at least an hour earlier in order to conform to its published schedules!

But, as it happens, these processes are so rapidly carried out that they are, to all intents and purposes, instantaneous in action. Indeed, it takes longer for the artiste's voice to reach the microphone than it does for all the intervening events to occur.

Wireless and Sound Waves.

Electrical currents and radio waves travel about a million times as fast as sound waves. Take particular note of that "and" in the last sentence, for the two things are not the same. Also, there are only very general points of similarity between wireless waves and sound waves. Where they fundamentally differ is that the one comprises vibrations in air and the other can still carry on in and through a vacuum.

However, there won't be many "P.W." readers who are unaware of these elementary facts. And if in this and following articles I touch upon such items of common knowledge it will be only so that the necessary background of "placid pastures" is provided.

Perhaps you don't quite see what I mean. Well, when an explorer wanders into an

HOW YOU HEAR IT

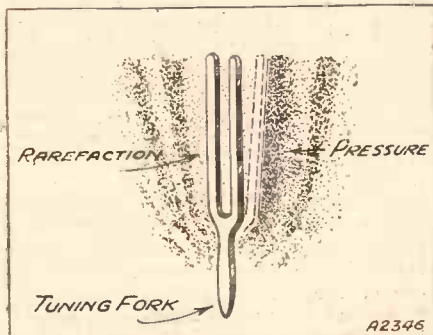

The vibrating prongs of a tuning fork alternately compress and rarefy the air around them as they move, and so set up "air waves."

entirely strange country he is bewildered by the total absence of familiar objects, and unless he is a genius it is unlikely that he will return with a coherent and understandable account of his travels.

On the other hand, the old and seasoned voyager who comes back from territory that he has got to know pretty thoroughly is generally full of yarns about particularities

By **VICTOR KING.**

The first of a special new series of articles in which a popular contributor throws a brilliant light on the interesting processes that occur in the fascinating chain that links you with the broadcasting studio.

that he has appreciated fully for the first time.

Therefore, I am going to try just as hard as I can to make those parts of my articles which may possibly fall under the heading of "common knowledge" in these enlightened days as interesting as I can, and interpolate some of the more technical points in such a way that you will take them in your stride, as it were. And, before you fully realise it, you'll be saying to yourself "That's fascinating. Never knew how those things linked up like that before."

The Start in the Studio.

At least, that is my aim—and I hope it'll prove to be a straight one!

Our journey starts in the broadcasting studio, where, we will suppose, Tommy Handley is singing a song to the accompaniment of Jack Payne's Dance Orchestra. Their joint efforts produce a medley of sound waves—the whole of the air of the studio is in a state of vibration.

Tommy Handley's contribution to this disturbance is caused by the movements of his vocal chords plus variations in the air stream from his mouth due to voluntary actions of his tongue, teeth, lips, etc.

This is a quite complicated process, and so we will stop the whole performance and ask Jack Payne to produce and strike a tuning-fork. Ping! He does so, and you hear a thin, clear note.

Pitch of the Note.

There are two things about this note that are immediately apparent; one is that it has a certain *pitch*, and the other that it has a certain volume or loudness.

The sound is produced by the steel prongs vibrating and so causing the air in their immediate vicinity to *rarefy* and *compress*. If your eye could follow the movements of the tuning-fork prongs you would be able to see that they waggle backwards and forwards many hundreds of times per second.

As they move forward in the one direction they press the air back. Air is compressible, and it can be squeezed up like indiarubber to occupy a smaller space when under pressure. That part of the surrounding air the

prongs move away from is attenuated or reduced to below its normal pressure.

These rarefactions and compressions are communicated outwards to the more distant air in the form of a series of similar effects which get weaker and weaker the farther you go from the centre of the disturbance, i.e. the tuning-fork.

They are called *sound waves*, but don't get the wave idea too much mixed up with waves in the sea. These are analogous only in that the crests of sea waves, where the water is lumped up above the normal level, can be compared with the compressions of sound (here the air is compressed above its normal pressure). The troughs of sea waves where the water has sunk below the normal level are comparable with the air rarefactions.

Facts about Frequency.

(The action of a loudspeaker diaphragm is fundamentally similar to that of a tuning-fork prong. It moves backwards and forwards and creates air-pressure waves.)

The loudness of the tuning-fork note depends upon the extent of the movement of the prongs. The bigger the waggle, the greater the noise, for the simple reason that the prongs impart greater pressure to the surrounding air.

The pitch of the note emitted is determined by the number of times per second the prongs vibrate. The faster they waggle,

BUILDING UP "TONE"

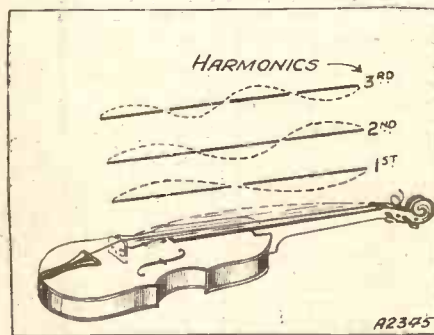

Sections of a violin string vibrate independently and so generate air waves of "harmonic frequency."

the higher the note. But you cannot vary the pitch or rate of vibration of a given tuning fork; this is *fixed* by the thickness and length of its steel prongs. However hard you strike it, the note remains the same.

If you made the prongs longer, they would waggle more slowly and the note would drop in pitch.

(Continued on next page.)

HOW YOUR SET WORKS

(Continued from previous page.)

And now we will ask the violinist to produce a note of exactly the same pitch from his instrument. He can vary the loudness by increasing the strength of his bowing, and that makes the violin string vibrate over a greater distance.

But the violin note sounds different from the tuning-fork note because it has an individual tone or *timbre* of its own, whereas the other has not. The reason for this is that a violin note does not consist only of the one fundamental vibration.

The violin string vibrates as a whole, and the frequency of its vibration (number of waggles per second) depends upon its length and tension. But, in addition, fractions of the string vibrate—halves, thirds, quarters, fifths, sixths, sevenths, etc.

And these produce independent, though much weaker, notes which are known as *harmonics*. And because these are due to sections of the string (they are, in effect, shorter strings) these *harmonics* or *overtones* will be of higher pitch.

Their frequency bears a definite relation to the frequency of the vibration of the complete string, which is known as the *fundamental* frequency. Supposing this is 256 vibrations per second (corresponding with middle C on the piano), then the first harmonic (halves of the string in vibration) will have a frequency of $256 \times 2 = 512$, the second (thirds) $256 \times 3 = 768$, etc.

About Harmonics.

Now, these harmonics are not theoretical conceptions, but are vitally practical. It is quite possible to eliminate the fundamental frequency of a note and leave only one or more of its harmonics, which are heard, of course, as notes of higher pitch, but much weaker in volume.

Indeed, this is the sort of thing that often happens in radio. A very low note is in evidence on many sets merely as a group of harmonics. The effect is a ghostly imitation of the full-blooded original note.

WHO WOULDN'T BE THERE?



Every ward in the new wing of the London Royal Northern Hospital is equipped with telephones, so that every patient can listen to the radio, there being separate sets in each room, enabling each ward to choose its own programme.

A violin is played by a bow being drawn across its strings, but a piano is operated by *percussion*; little hammers are made to strike the strings and set them into vibration. The moment after a string has been struck a *damper* (a felt-covered arm) comes down and stops the vibration. That is, unless the loud pedal is depressed.

Sounding in Sympathy.

When this is done the damper is made inoperative. Let us ask Jack Payne's pianist to strike a note with his feet hard down on the "loud-pedal." You will hear

REAL RADIO DRAMA



Four years ago Maurice Droegmann was a wireless favourite, and in 1927-28 he reached the zenith of his popularity. Then his sight began to fail; and finally, too blind to read the music, he disappeared from the B.B.C. programmes. Recently the B.B.C. vaudeville producer was walking along a street in the West End when he heard the strains of a violin. He stopped to listen, and recognised the tune as one written by Mr. Droegmann. He found the violinist, a blind man, standing on the kerb, playing like a virtuoso. It was the composer, Maurice Droegmann. The producer immediately took him to Savoy Hill, gave him a test, and engaged him on the spot for the first vacant date.

a marked difference; there is a hollow, resounding, *resonant* effect.

All the strings are free to vibrate as long as they like (until the loud pedal is released), and a number tend to vibrate in sympathy with the struck note.

If there were two pianos in the studio and the same note on the other were struck heavily, the effect would be

even more marked, for the sympathetic vibration is greater when the pitch is identical.

Here is a simple experiment. Depress the loud pedal on any piano and then loudly sing any note you like. It will be repeated by the appropriate string on the piano *resonating*.

Caruso's Trick.

That is how Caruso used to break wine-glasses. He would tap a glass with his finger, note the pitch of its vibration, and then let his superb voice go on that same

note. The glass would sympathetically vibrate so energetically that it fell to pieces.

They have to be very careful in regard to resonance when they instal large cinema organs, for before now big girders have been found to have *periods* of a musical frequency, and if one of those girders started to vibrate every time a certain organ key were touched it might be structurally weakened. At the least, there would be a distorting effect on the music when this unofficial instrument started to play!

HUM IN A MAINS SET.

A Hint on Testing the Transformer.

WITH A.C. electric sets it often happens that a certain amount of mains hum is produced by the transformer, and for some curious reason one transformer will give more trouble than another, whilst it is also curious that the same transformer, or rather two transformers apparently identical in make, will not always behave in quite the same way.

For reasons of this kind it is important to keep the transformer as far as possible from the detector stage, particularly where the L.F. coupling between the detector and the next valve is of the transformer variety.

Try R.C. Coupling.

The interaction between the mains transformer and an inter-valve transformer depends, of course, upon the relative positions and the relative directions of the cores of the two transformers, and I think everyone knows the best way to arrange the cores in relation to each other so as to

WHERE RECORDS ARE MADE



A group of radio experts who recently visited the H.M.V. factory at Hayes. Third and fourth from the left are Mr. A. Johnson-Randall and Mr. G. V. Dowding, of "P.W."

keep the stray interference to a minimum. If you are troubled with hum in the receiver and you want to test out whether this is due to the transformer reacting with one of the L.F. transformers, it is not a bad plan to try using a resistance coupling instead of the transformer coupling, as a temporary arrangement.

The resistance coupling will not pick up the hum in the way the L.F. transformer does, and therefore if you find that on removing the L.F. transformer and substituting the resistance coupling the hum disappears, it is fairly clear evidence that it is the transformer which is picking it up. A change in the transformer or its position may be necessary, or, of course, the resistance coupling may be left as a permanency.

CASH OR EASY PAYMENTS EVERYTHING FOR RADIO FROM READY RADIO

READY RADIO H.T. ELIMINATORS

(Designed and tested by Mr. G. P. Kendall, B.Sc.)

- R.1.—120 volts at 20 m.a.
3 H.T. Tappings £3 3 0
Or 8 equal monthly payments of **8/6**
- R.2.—120 volts at 20 m.a.
1st H.T. Tapping variable, 3 H.T. Tap-
pings, £3 10 6.
Or 12 equal monthly payments of **6/6**
- R.3.—175 volts at 25 m.a.
3 H.T. Tappings, £4 0 0
Or 12 equal monthly payments of **7/6**
- C.R.2.—120 volts at 20 m.a.
3 H.T. Tappings, 2 variables, also ½ amp.
trickle charger, £5 7 6
Or 12 equal monthly payments of **10/-**
- C.R.1.—120 volts at 20 m.a.
3 H.T. Tappings, also ½ amp. trickle
charger, £4 10 0
Or 12 equal monthly payments of **8/3**
- G.R.1.—120 volts at 20 m.a.
3 H.T. Tappings, also a ½ amp. trickle charger,
and grid bias tappings—1½ v., -4½ v., -13½ v.,
£5 0 0
Or 12 equal monthly payments of **9/3**
- G.R.3.—175 volts at 25 m.a.
3 H.T. Tappings, also ½ amp. trickle charger, and
grid bias tappings—1½ v., -4½ v., -13½ v.,
£5 17 6
Or 12 equal monthly payments of **10/6**
- A.R.3.—175 volts at 25 m.a.
3 H.T. Tappings, also 2 windings of 4 volt 3 amp.
A.C. Note, these windings can be used in parallel
to give 4 volts at 6 amp., £5 0 0
Or 12 equal monthly payments of **9/3**

B.T.H. R.K. MOVING-COIL LOUD-SPEAKERS

- SENIOR A.C., £7 15 0
Or deposit of 15/9 and 6 equal
monthly payments of **£1-4-10**
- SENIOR D.C., £5 5 0
Or deposit of 10/9, and 6 equal monthly
payments of **17/-**
- PERM. MAG., £5 12 6
Or deposit of 11/6, and 6 equal monthly
payments of **18/2**
- MINOR PERM. MAG. with matching transformer,
£3 1 6
Or 6 equal monthly payments of **11/3**

W.B. LOUD-SPEAKERS

- PM.1.—With Output Matching Transformer, £6 0 0
Or 12 equal monthly payments of **11/-**
- PM.2.—With Output Matching Transformer, £4 5 0
Or 12 equal monthly payments of **7/9**
- PM.3.—With Output Matching Transformer, £2 12 6
Or 7 equal monthly payments of **8/-**

The above list is a selection from Ready Radio's huge stock. Write for prices, etc., of any apparatus you require which is not listed above.

We maintain a stock of over £40,000 worth of Radio Apparatus of every make and description. Whatever you want, large or small, you can be sure it is in stock at Ready Radio ready for IMMEDIATE DISPATCH. AND you can buy either for Cash or by Easy Payments. Avoid delay and disappointment by ordering all your radio from Ready Radio.

GRAMOPHONE EQUIPMENT PICK-UPS

- A.E.D.—With Tone Arm No. 601.
Every note perfect. Negligible record wear.
Perfect tracking, £2 2 0
Or 6 equal monthly payments of **7/9**
- A.E.D. "Beta" type, with tone arm No. 612, £1 10 0
Or 6 equal monthly payments of **5/6**
- B.T.H. SENIOR, £2 5 0
Or 6 equal monthly payments of **8/3**
- BLUE SPOT, £3 3 0
Or 8 equal monthly payments of **8/6**

MOTORS

- COLLARO A.C. Induction, £3 0 0
Or 12 equal monthly payments of **6/-**
- COLLARO, Double Spring, B.30, £1 13 0
Or 6 equal monthly payments of **6/-**

KITS

- R for M.V.3, £5 17 6
Or 12 equal monthly payments of **10/6**
- MULLARD 1932, without cabinet, £6 10 0
Or 12 equal monthly payments of **12/-**
- COSSOR 1932, No. 234, with cabinet, £6 15 0
Or 12 equal monthly payments of **12/3**
- COSSOR, A.C. Mains, £9 19 6
Or 12 equal monthly payments of **18/3**
- SIX-SIXTY Chassis Kit, £6 17 6
Or 12 equal monthly payments of **12/6**
- OSRAM New Music Magnet 4, £10 15 0
Or 12 equal monthly payments of **19/8**

BLUE SPOT LOUD-SPEAKERS

- 44.R.—Cabinet Speaker in Oak, £2 12 6 (incor-
porates 66.R. Unit)
Or 7 equal monthly payments of **8/-**
- 100.D.—Inductor in Oak Cabinet, £3 3 0 (moving
coil quality at cheap cost)
Or 8 equal monthly payments of **8/6**
- GOLIATH 30 P.M. in walnut cabinet, £5 10 0 (mov-
ing coil reproduction at its best. Very
sensitive)
Or 12 equal monthly payments of **10/-**
- 66.R.—Unit and special chassis, £2 2 6
Or 6 equal monthly payments of **7/9**
- 100.U.—Inductor Unit Chassis, £1 19 6
Or 6 equal monthly payments of **7/3**
- Permanent Mag. Moving-Coil Speaker Chassis with
Output Matching Transformer, £3 15 0
Or 12 equal monthly payments of **6/9**

H.T. ACCUMULATORS

- FULLER, Type DMHG.—120 volt, 6,500 m.a. capa-
city, £4 1 0
Or 12 equal monthly payments of **7/6**
- FULLER.—150 volts, 6,500 m.a. capacity, £5 1 3
Or 12 equal monthly payments of **9/3**

H.T. BATTERIES

- PERTRIX.—150 volt Super Capacity H.T. Battery
No. 301, £1 11 0
Or 6 equal monthly payments of **5/9**

INSTAMAT OUTPUT TRANSFORMERS

- For Magnetic type Speakers, £1 7 6
Or deposit 10/- and 4 equal monthly pay-
ments of **5/-**
- For Moving-Coil Speakers, £1 17 6
Or deposit 10/- and 6 equal monthly pay-
ments of **5/-**

EPOCH LOUD-SPEAKERS

- J.1.—P.M. Moving-Coil Speaker with Matching
Transformer, £2 5 0
Or 6 equal monthly payments of **8/-**
- A.2.—P.M. Moving-Coil Speaker with Matching
Transformer, £3 3 0
Or 8 equal monthly payments of **8/6**
- 101½.E.—A.C. Mains Chassis only, without Rectifier,
£6 15 0
Or 12 equal monthly payments of **12/6**
- 101½.E.—A.C. Mains Chassis with Mains Transformer
and Westinghouse 2 amp. Rectifier, £10 0 0
Or 12 equal monthly payments of **18/3**

If near London Bridge, be sure to call at our Showrooms, 159, Borough High Street, (2 minutes from London Bridge Station). Phone: Hop 3000.



To READY RADIO (R.R.) LTD., Eastnor House, Blackheath, |S.E.3. Phone: Lee Green 5678. Grams: Readirad, Blackvil.

- CASH ORDER FORM. Please despatch to me at once the goods specified, for which I enclose payment in full of **£**
- C.O.D. ORDER FORM. Please despatch to me at once the goods specified, for which I will pay the full sum of **£**
- EASY PAYMENT ORDER FORM. Please despatch my Easy Payment order for the goods specified, for which I enclose first deposit of **£**

Name

Address

KIT REQUIRED

BROADCASTING IN IRELAND

By LESLIE W. A. BAILEY.

Concluding his tour in Ireland for "Popular Wireless," our special representative writes here of his visit to the B.B.C.'s outpost in Northern Ireland.

IN spite of the tossing up it gave me en route to Ireland, I admit that the Irish Sea has its good points. One of them is that it has given the Belfast broadcasting station a strong individuality.

Cause and effect! Do you see the connection? The molly-coddling of provincial stations by Savoy Hill is a bad thing. Enterprise, rivalry, initiative—these are things we need in British broadcasting, and they are characteristics which are not developed when a station is strapped tightly to the apron-strings of London.

That strip of ocean between England and Ireland has forced the B.B.C. to give the Belfast station a good deal of independence, and the result to-day is that the Belfast station is one of the most vigorous forces in the whole B.B.C. system

Real Alternative Programmes.

If the B.B.C. were to erect a twin-programme high-power station to provide Northern Ireland with alternative programmes, then Irish listeners would obtain full benefit of both this forceful local organisation and of the important National activities of the B.B.C. administered from London. Unfortunately, there are insufficient wavelengths to allow Ulster a twin-programme station, and so the plans are for a single-programme station of about 15 kilowatts.

50-50 Basis.

This, like the present 1½-kilowatt Belfast transmitter, will be fed with a mixture of approximately 50 per cent local programmes and 50 per cent London programmes.

The fact is that, with all credit to the fine work of the Post Office engineers, music relayed over

the long land-line and submarine cable between London and Belfast *does* suffer by the journey. There is a high-note and a low-note cut-off.

A Full Station Orchestra.

This is the reason why Belfast retains its own military band, its own chamber music quartet, and (alone among the provincial stations) its full-station orchestra. This is why, also, 2 B E is not restricted to local talent for its local concerts. It imports artistes and conductors from England.

Sir Henry Wood and Sir Hamilton Harty are among those who have conducted in the fine "No. 1" studio in Linenhall Street, Belfast. By the way, I was astonished by this studio. When it was opened in 1928, the B.B.C. did not make the song about it that it deserves, for it really is a very fine room.

It is two floors high, and purple, grey and gold combine in its distinctive colour

scheme. There is only one other studio at Belfast, however—a much smaller room—and it is evident that some day there must be further extensions.

By throwing the local men on their own initiative the geographical remoteness of Belfast has indeed had notable results. Here it was, under Tyrone Guthrie, that modern methods of producing radio drama were pioneered.

Concentration on Irish Drama.

Guthrie was followed at Belfast by John Watt, who similarly distinguished himself and was transferred to London. His successor, Sam Bullock, is concentrating more on Irish drama.

The famous Abbey Theatre Players, from Dublin, are now regular broadcasters from the Belfast studios.

The musical side of 2 B E's activities has been conducted with such energy by Godfrey Brown, the Music Director, that to-day the

musical life of Belfast revolves round the station orchestra. Of all the station's activities, indeed, I think that G. C. Beadle, the Station Director, and M. M. Dewar, his assistant, are most proud of its music.

Over a luncheon table Mr. Beadle (who has been here five years and was formerly at the London and Durban stations) told me about the ambitious winter programme.

Special Concerts.

"Our orchestra consists of 32 regular players and can be augmented up to 50," he said. "That there is a considerable musical public here you may judge from the fact that in April, May and June we held Saturday night symphony concerts

(Continued on page 446.)

THE MAIN STUDIO AT BELFAST

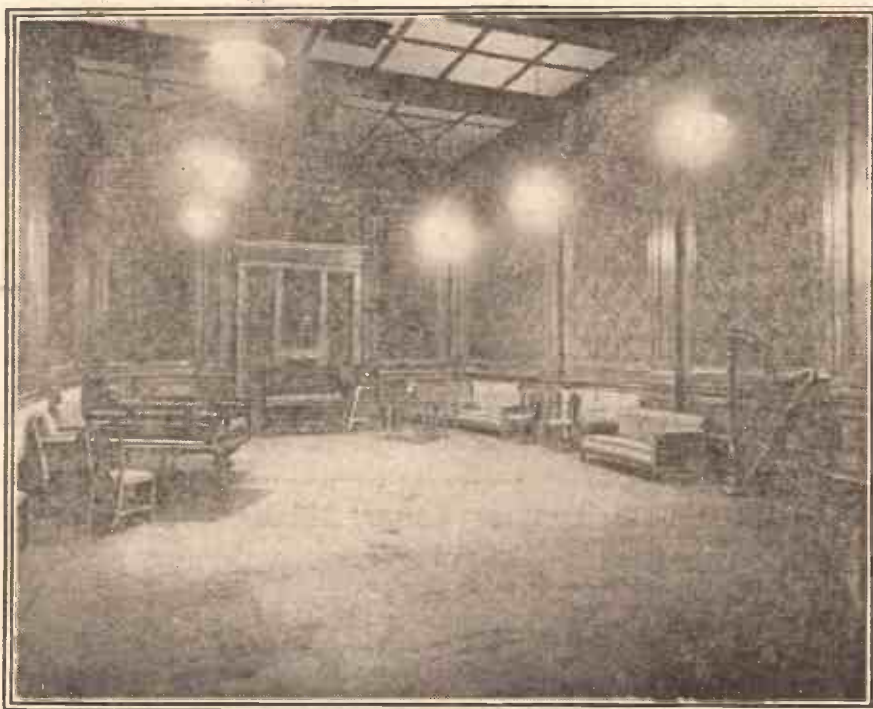

Purple, grey and gold is the colour scheme of 2 B E's No. 1 studio. Its height is equivalent to that of two of the storeys of the building in which it is erected.

RADIO TIMES

(Cont)

THE DAY

PROGRAMME

Dx. 42.

5 The Children's
 'Frightfulness at the T'
 (S. G. Hulan
 Another Toytow
 With Incident
 THE GERSHOM PA

10 WEATHER FORECAST
 BULLETIN; London
 and Bulletin for

6.30 The F
 BEETHOVEN'S
 Played

Sonata in A
 Andante
 Marcia

6.50 Mr.
 Sparrow

7.20 Lt.
 'The

7.30 Mr.
 Spirit of
 duction t

MR. DESMON
 the most pop
 over the wireles
 literary criticism
 every fortnigh
 dramatic and literary criti
 of that enterprising month
 Letters, now in its fourth y
 He will introduce
 'Literature
 of the

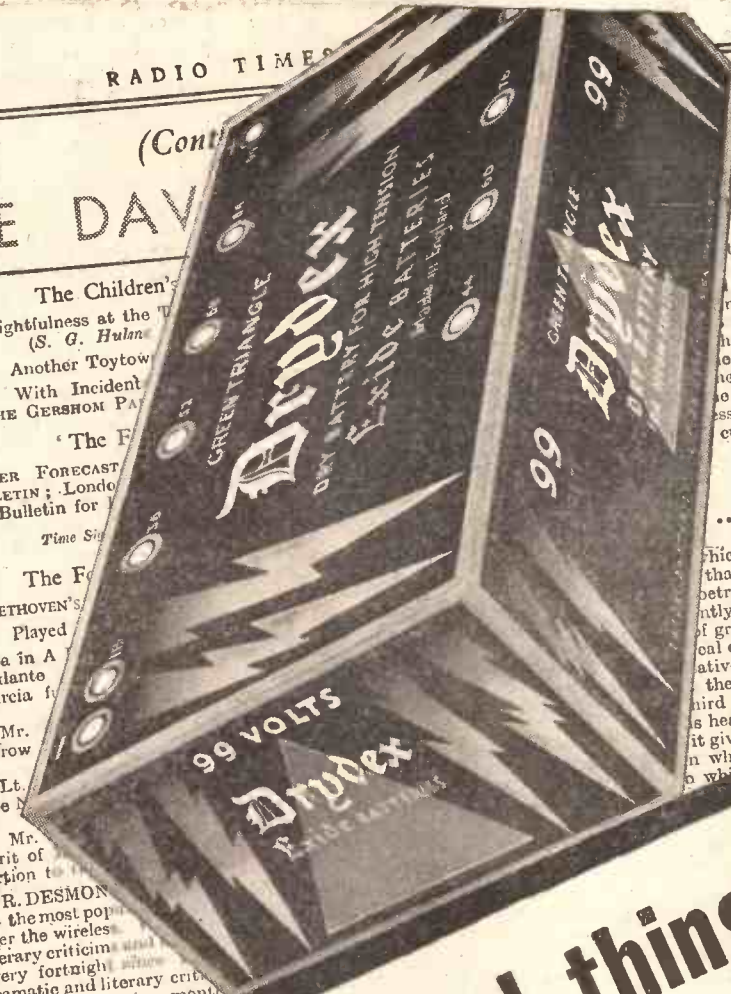

Get the good things good
 Get a Drydex

he has
 minction,
 graceful
 sanity,
 and small
 is Rach-
 the United
 o has ex-
 per had he
 so interests
 ssly jazzed
 curse from

.. Mossolov

which follows,
 that it is full
 poetry of which
 ntly a master.
 of great energy,
 cal excitement,
 ative section in
 the chief say.
 hird great tune
 is heard again in
 it gives way so
 in which the
 o whi

9.55 Shipping Forecast; New York Stock Mar
 Report Time Signal, Greenwich, at 10.0

' MOSAIC '—I

10.0
 IT seems possible—to judge from the vio
 criticism of past broadcasts of poe
 readings—that wireless is not a suitable med
 for poetry, or at least that some other for
 presentation might be more successful. A
 from any question of the destruction of
 intimate quality of poetry or of the difficul
 finding suitable readers, it is doubtful wh
 fifteen or twenty minutes of continuous poet
 likely to appeal to any but confirmed
 of poetry. It has, therefore, been decided
 a new variation in the form in
 poetry is broadcast. 'Mosaic'
 title of which is suggested by Mr
 definition of music as 'mosaic
 air'—is an experiment in which
 and poetry are to be combi
 express and interpret various
 Lyric poems or short excerpts
 by unity of subject or feeling,
 with pieces of music o
 appeal into a single v

DANCE MU
 x and his BAND,
 MONSEIGNEUR

vl. Greenwich, at 11

ONAI
 AMM

egior
 61.3

at Te
 by the Bair
 m. Vision; 261.

National

TH.

- ORCHEST. Traditional
- Song of t. and Orchestra
- HAROLD W. Mussorgsky
- Song of the
- SOLOMON and Orchestra
- Concerto, No. 2, in C Minor, for Pianoforte and Rachnmaninov
- (alla. marcia);

SOLOV, though he
 one, has already made a nam
 sia, for even in that land of shatterin
 stic revolutions, he has found a method
 revolting which is all his own. This work, con
 posed in 1928, is in the form of an overtur
 and its programme is simply the steady rhytl
 of a factory working at full pressure; tho
 behind the mere picture there is conveyed
 sense of awe and exaltation which cannot
 to possess: the man of imagination confront
 with the powerful weapons of attack and def
 man has set up under the very nose of an
 onistic nature.

Symphony, No. 4, in F Minor (Op. 36)
 Tchaik
 Moderato con a
 scherzo. Piz

Makers of world
 famous Exide
 offer greatest
 dry battery value

Obtainable everywhere from
 all good dealers in sizes and
 types to suit every wireless
 set. Also for torches, pocket
 lamps, cycle lamps and bells.

BROADCASTING IN IRELAND

(Continued from page 444.)

in the Ulster Hall in Belfast and had regular audiences of over a thousand.

"We also give a free concert in the City Museum every Wednesday afternoon. Next winter we shall give six concerts at the Ulster Hall, twelve at the Wellington Hall, five in association with the Belfast Philharmonic Society, and six will be relayed from Bangor, for which we are 'loaning' our orchestra to the local municipality. Mr. Brown, who started at the beginning and formed the orchestra, has played a tremendous part for the B.B.C. in Ireland."

Belfast does a considerable amount of outside broadcasting, under the direction of Mr. H. McMullan, and has this summer taken a leaf out of the North Region's book and started relaying seaside entertainments (here we see the value of inter-station rivalry).

Happy Balance Reached.

The Children's Hour is, of course, organised locally. All this local work necessitates a big staff, and Mr. Beadle told me that the total personnel, including engineers, is 39.

"I think," he added, "that we have now reached a happy balance between local and London material in our transmissions."

The transmitter is a mile and a half away from the studios at an electric power station, from which is obtained the 6 kilowatts of power needed to provide H.T., L.T., and grid-bias for the Marconi Q-type transmitter. The aerial is suspended between the power station's two tall chimneys.

The transmitter room is the usual spick-and-span place one expects of B.B.C. engineers, and the transmitter is quite conventional except that a stabiliser unit has been fitted, permitting deeper modulation.

Three land-lines connect the transmitter to the control-room at Linenhall Street, and two lines run from there to England.

Fifteen "O.B." points are also permanently connected to the control-room.

A dramatic control-room, an artificial echo room, a music library of 2,000 numbers, and executive offices fill the remaining accommodation at No. 31, Linenhall Street; or, as I think the B.B.C. should christen it, "Broadcasting House, Belfast."

MR. BEADLE, OF BELFAST



The Station Director of 2 B E. (Photo by Moore, Cophorn.)

TUNING CONDENSER CAPACITIES

A reader explains why, in his opinion, .0003-mfd. tuning condensers are preferable to .0005-mfd.

Dear Sir,—It seems to have become a standard now for manufacturers to design circuits tuned by .0005-mfd. condensers, and I consider it a pity that the old .0003 condenser has now fallen into disuse.

As you will gather, if a maximum capacity of .0005 mfd. is desired to tune to 600 metres, it is necessary for an inductance of 202 microhenrys to be used. Reducing the capacity by, say, .000005 (which would make an approximate change of 4 metres with the present S.L.F. design) we would

Popular Wireless, October 24th, 1931.

obtain a capacity reactance of 639 ohms as against 632 inductive reactance; disregarding coil resistance, this would leave an impedance of 7 ohms to a frequency of 5×105 cycles (600 metres). The percentage of current to current at resonance would be 15 per cent.

If, however, a .0003-mfd. condenser is placed in parallel with 337 microhenrys, the same frequency is resonant. Reducing capacity as before, to .000005, a capacity reactance of 1,274 ohms is obtained, as against 1,158 ohms inductive reactance. Disregarding coil resistance for simplicity, we have an impedance of 116 ohms to a frequency of 5×105 (600 metres), but here the percentage of current to current as resonance is .09 per cent.

Obviously, the smaller the capacity used, the nearer we approach the ideal of a square-peak curve — of course, always providing that it is possible to get the same tuning range of 3 — 1 as is possible with .0005-mfd. condensers.

Yours faithfully,
L. D. TRIGG.

S.W.9.

KEEPING ABREAST

A great dictionary that embodies the latest science.

WHILE there is a great deal of truth in what Alexander Pope once wrote that:

Words are like leaves; and where they most abound
Much fruit of sense beneath is rarely found.

Nevertheless it is only by means of words that we can convey our thoughts and wishes to others or learn from others what they are thinking.

Words indeed are very wonderful things, and it is not without good cause that they have been likened at different times to gems and gold and fire and swords and roads and ripples and nimble servants. They are indeed at some time or another all these things. There is a fascination about words and their origin and history and chequered careers, that few people realise.

New Ideas Produce New Words.

Some words seem to come as it were by spontaneous generation. There is a need for them, and they appear without any regular parentage and without first of all wandering about the world as do so many other words. Wireless, the "Talkies," and the sciences generally give us new ideas and new inventions almost weekly, and words come into existence at once to describe these things.

How the language grows in these days! Almost every day brings its new developments in science and its list of new words for the dictionary. Perhaps no period has been so prolific in adding to the language as the last year or two. Yet there has been no new dictionary compiled for some time to include all these new words.

The need has been met, however, at last. The Universal English Dictionary is to be published in 52 weekly parts at sixpence a week, and the first two numbers are now obtainable from all newsagents and bookstalls.

It is a great standard work that in the ordinary way would be published at many guineas and would be out of the reach of all but the well-to-do. But by issuing it in this form it is brought within reach of anyone, and the chance should certainly not be missed. It is a book that all intelligent people need if they are to keep themselves abreast of the times.

All the Latest Terms.

Those interested in scientific matters—wireless, electricity, and so on—will find here all the new and latest terms. The pronunciations are given, the derivations or life histories of the words are set forth, and their various meanings and shades of meaning clearly defined.

That the scholarship of the book is sound is proved by the fact that its Editor is Mr. Henry Cecil Wyld, B.Litt., M.A., the Merton Professor of English Language and Literature in the University of Oxford, while as a guarantee that it is produced in the best style we only need mention that its Managing Editor is Mr. J. A. Hammerton, the Editor of the Universal-Encyclopedia and many other standard works.

The Universal English Dictionary is of supreme use, but it is more than a work of reference; it is a fascinating volume full of romance. We come upon interesting surprises on almost every page. Who, for instance, would dream that the word Acoustic is a near relation of the word Custody?

Yet such is the fact, for while Acoustic is connected with the sense of hearing and sound, Custody also has in it the idea of hearing. A person in custody is one who is within hearing or who can be overheard. This is only one of scores of examples that might be quoted from the first part.

Readers of POPULAR WIRELESS will find the book an indispensable work of reference. It is the first time such a dictionary has been brought within easy reach of all.

THE MUSICAL DIRECTOR AT WORK



Mr. Godfrey Brown and the Belfast Wireless Orchestra preparing for work in the main studio.

THE WONDER "P.W." DUAL RANGER



View of the GOLTONE WORKS, Pendleton, Manchester

ESTABLISHED nearly 40 years.

Goltone

REGISTERED

Approved
"GOLTONE" KIT for
"P.W." DUAL RANGER

£4.5.0
LESS VALVES

Containing specified components and sealed in robust container. Each component carefully tested. Full Instructions and Prints provided.

From all first-class Radio Stores. Refuse substitutes. Post coupon for full particulars.

Ward & Goldstone
PENDLETON MANCHESTER LTD.

POST THIS COUPON TO-DAY
 To WARD & GOLDSTONE, LTD., Pendleton, MANCHESTER.
 Please send me full particulars of "GOLTONE" Kit for the "P.W." Dual Ranger.

NAME.....
 ADDRESS.....

P.W. 24/10/31

ALL THE WORLD ON ONE DIAL!

READ ALL ABOUT

THE "I.E." THREE

IN THE NOVEMBER

WIRELESS CONSTRUCTOR

No coils have to be changed to go from broadcast to short waves, no switches manipulated, you just turn the one tuning dial.

**A
MAGNIFICENT
THREE-VALVER
By
VICTOR KING**

It covers all wave-bands—long, medium and short—and reaches all countries of the world, giving an unlimited choice of fine alternative loudspeaker programmes.

Among the other fine constructional articles in this number you will find full details of:—

The D.C. "ACE"

A powerful all-mains receiver employing the new and highly efficient indirectly-heated D.C. valves.

The "AMPLITONE"

A special amplifier for adding to existing sets, which incorporates its own control, enabling tone to be varied at will.

THE PAGES OF THE
NOVEMBER

WIRELESS CONSTRUCTOR

ARE PACKED WITH UP-TO-DATE, FASCINATING RADIO READING

ON SALE EVERYWHERE.

PRICE SIXPENCE.

ALL SPECIFIED IN THE "DUAL RANGER"



View of the
GOLTONE WORKS,
Pendleton, Manchester

ESTABLISHED
nearly 40 years.

Goltone
REGISTERED



DW/12



The combination of a most up-to-date Bakelite Moulding Plant, with an Instrument Wire Dept. of nearly 40 years' experience, enables Ward & Goldstone, Ltd., to offer "Popular Wireless" Readers components of the highest standard at competitive prices.

The effective performance and excellency in finish of "GOLTONE" COMPONENTS leads to their specification in all "Popular Wireless" circuits.

Other components for the "Dual Ranger"
P.J. 3 Coils - - Price 2/- ea.
Wound Coil Quits - Price 2/6 ea.

Radio Catalogue with full particulars on request.

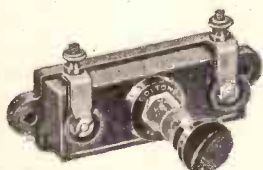
From all First-class Radio Stores—Refuse Substitutes—If any difficulty write direct.

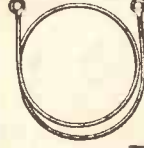
FROM	1/-	
"GOLTONE" COMPRESSION TYPE CONDENSERS.		
	5⁰	"GOLTONE" MIDGET FIXED CONDENSERS.
	9⁰	"GOLTONE" PUSH-PULL SWITCHES.
	7⁰	6⁰
SPAGHETTI RESISTANCE LINKS, from		
Ready drilled Panels, 18" x 8" x 3/8" mahogany. Price 7/-		
Ready drilled Screen, 10" x 7" Price 2/-		

"GOLTONE" "P.W." & "M.W." DUAL RANGE COIL as illustrated, DW/12
7/6
Each

Ward & Goldstone
PENDLETON. MANCHESTER LTD.



All Editorial communications should be addressed to the Editor, POPULAR WIRELESS, Tallis House, Tallis Street, London, E.C.4.

The Editor will be pleased to consider articles and photographs dealing with all subjects appertaining to wireless work. The Editor cannot accept responsibility for manuscripts or photos. Every care will be taken to return MSS. not accepted for publication. A stamped and addressed envelope must be sent with every article. All inquiries concerning advertising rates, etc., to be addressed to the Sole Agents, Messrs. John H. Lile, Ltd., 4, Ludgate Circus, London, E.C.4.

The constructional articles which appear from time to time in this journal are the outcome of research and experimental work carried out with a view to improving the technique of wireless reception. As much of the information given in the columns of this paper concerns the most recent developments in the radio world, some of the arrangements and specialities described may be the subject of Letters Patent, and the amateur and the trader would be well advised to obtain permission of the patentees to use the patents before doing so.

QUESTIONS AND ANSWERS

THE MAINS UNIT AND EARTH CONNECTIONS.

R. S. M. (Huddersfield).—"When running a mains unit from D.C. for a three-valve set, what is the difference between the negative main being earthed and the positive being earth?"

The important point of difference is the fact that the listener himself is always earthed, because he walks about on the earth or on something which is

connected to earth. Especially is this the case if he is walking on a damp surface, when his body from an electrical point of view can often be considered quite well connected to the earth.

If he touches electrical apparatus which also is earthed there will be no difference or potential (or only very little) between him and it. Consequently he will feel no shock. But if he touched electrical apparatus which is at a high voltage above or below earth potential, the current will tend to flow through him, and he will feel a more or less severe shock according to the circumstances.

Thus, in the case of a D.C. unit, if the negative main is earthed, the earth terminal on the set and all connections to it will be absolutely safe for the constructor to handle, for he, too, is at earth potential.

Filament, accumulator connections, the earth and aerial lead, in fact all the ordinary connections on the set, will be free from the possibility of trouble; the

only place where the shock could be felt by him is the H.T. positive wiring, or anything connected to the plates of the valves.

Very often, for reasons of its own, the electrical supply company earths the positive main, and where this is done the conditions from the point of view of the owner of a mains unit are completely reversed.

Now it is the H.T. positive wiring which is safe to handle, and he may with impunity touch the plates of the valves or the H.T. positive terminal on the mains unit without experiencing any shock. But all the H.T. negative wiring is now "alive."

The aerial or earth wires, the earth terminal, the filaments, the L.T. battery leads, are all liable to give a shock when touched because they may be relatively as far negative to the listener as formerly the H.T. positive wiring was positive to him. Obviously, apparatus of this kind should be used carefully, and purchased from a reputable firm that understands the possibilities of these potential differences and lays down designs on safety-first principles.

(Continued on page 452.)

WHAT'S THE MATTER WITH THE SET?

Perhaps the switching doesn't work properly? Or some mysterious noise has appeared and is spoiling your radio reception? —or one of the batteries seems to run down much faster than formerly?

Whatever your radio problem may be, remember that the Technical Query Department is thoroughly equipped to assist our readers, and offers an unrivalled service.

Full details, including scale of charges, can be obtained direct from the Technical Query Dept., POPULAR WIRELESS, The Fleetway House, Farringdon Street, London, E.C.4.

A postcard will do. On receipt of this an Application Form will be sent to you post free immediately. This application will place you under no obligation whatever, but, having the form, you will know exactly what information we require to have before us in order to solve your problems.

LONDON READERS, PLEASE NOTE: Inquiries should NOT be made by phone or in person at Fleetway House or Tallis House.

Lanchester

MOVING COIL

Speakers

COBALT STEEL PERMANENT MAGNET

High Sensitivity

Full Musical Response

Speech Perfect

Designed by F. W. Lanchester (the originator of the Lanchester Car) and produced under his personal supervision.

BEAUTIFULLY ILLUSTRATED CATALOGUE

Free & Post Free
WRITE FOR IT

WE SELL DIRECT TO PUBLIC ONLY

14
DAYS FREE TRIAL

Moving Coil Speakers
From £1:10:0 to £3:3:0
Complete in Cabinet
From £2:10:0 to £4:15:0

LANCHESTER'S  **LABORATORIES**
TYSELEY ... BIRMINGHAM

MAKE YOUR OWN RADIO-GRAM!

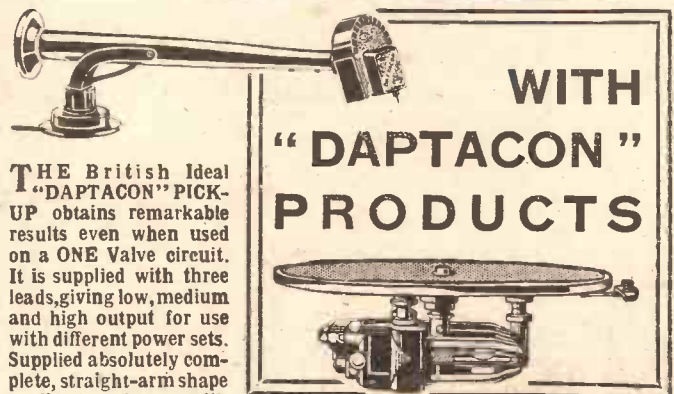

THE British Ideal "DAPTACON" PICK-UP obtains remarkable results even when used on a ONE Valve circuit. It is supplied with three leads, giving low, medium and high output for use with different power sets. Supplied absolutely complete, straight-arm shape as illustrated, or with Patent Carrier Arm which ensures dead straight "tracking" across record. Price either type **32/6**

THE "DAPTACON" UNIVERSAL ELECTRIC GRAMOPHONE MOTOR for both A.C. and D.C., covers voltages 100 to 200, and 200 to 250 A.C. or D.C. Can therefore be used anywhere by merely plugging into nearest electric-light socket. When used in Radio-gramophone, electrical interference is eliminated by a small condenser, supplied free. Price with 12-in. plush-covered Turntable and geared Speed Indicator **55/-**

The well-known "DAPTACON" products are on sale at leading dealers everywhere. Trade enquiries to: **BRITISH IDEAL PATENTS, Ltd., Green St., Brimsdown, Middlesex** Phone: Enfield 1741-1808, Or to the usual Factors.

The Mullard range of 2-volt valves provides a valve for every stage. An important addition to the range is the P.M.202, a super-power valve, specially designed for economy in low tension current consumption. It gives super-power output, with a filament consumption of only 0.2 amp. — no more than that of an ordinary power valve. It is thus particularly suitable for use in the output stage of portables and small battery-operated sets. Fit one in your receiver to-day. Price 13/6

202

Mullard
 THE MASTER VALVE

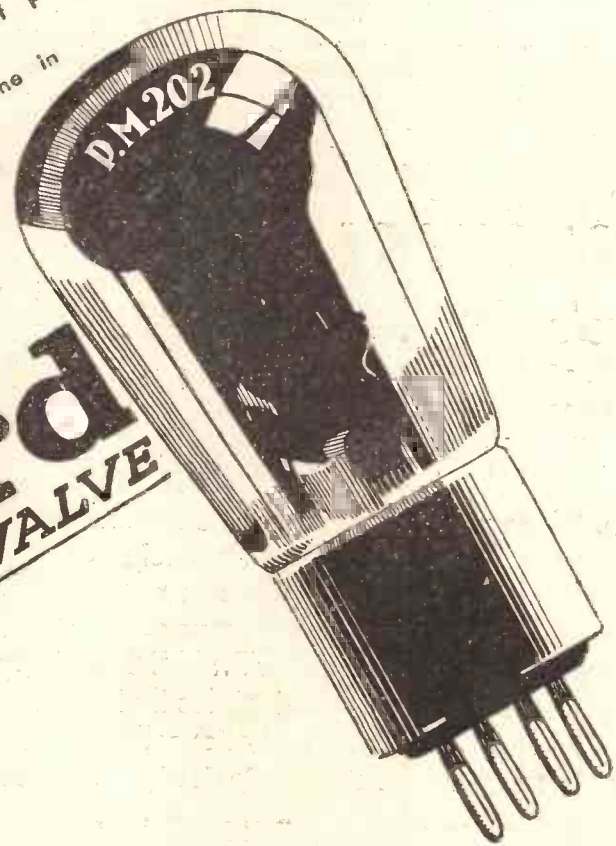

RADIOTORIAL QUESTIONS AND ANSWERS

(Continued from page 450.)

DRAWING A TUNING CURVE.

"JASON" (Uckfield).—"What is the right way to draw out a chart showing dial position and wave-length, by a curved line, like they often give with bought sets?"

Preparing a chart of dial readings is called "calibrating" the receiver, and it is easily done provided you have a clear idea in your mind of exactly what you want to do before you start. Here is the way to set about it.

Take a sheet of squared graph paper and draw, of convenient size (say six inches square), a faint outer framework, inside which the graph will be drawn. This six-inch square will now contain a large number

of small squares on which the "curve" is drawn. First, on the left faint line, draw a heavy black line and another heavy black line along the bottom of your square. The upright line on the left is to represent the various degrees on your dial, and the line at the bottom is to represent the wave-lengths of different broadcasting stations.

If your dial is divided into 100 degrees, place the 100 at the top of the left-hand line, 0 at the bottom, and mark the 10°, 20°, 30°, 40°, etc., off in equal spaces. Now, any position of the dial can be represented by a corresponding point on this line, for half-way between the 0° at the bottom and 10° will represent 5°, and quarter of the way between 80° and 90° will represent 82½°, etc.

The Wave-length Markings.

Now leave this for a moment and turn your attention to the wave-lengths to be marked on the bottom line. The wave-lengths in question are those which will be covered when the tuning dial is rotated between 0 and 100°; in other words, the minimum to maximum wave-lengths covered by the dials for any given coil.

Suppose your coil tunes from 200 to 550 metres approximately, then at the left-hand end of the bottom line you can mark 200, and at the right-hand end of this line 550.

The "ground work" is now complete, and all you have to do is to fill in the dial readings of as many stations as possible. Suppose, for instance, that one evening you are able to pick up the North National, and reference to the B.B.C. figures shows that this station is working on 301.5 metres. The dial reading we will suppose is exactly 10.

Take a ruler, lay it horizontally across the calibration chart, and mark a faint line which corresponds to 10° on the dial. Then twist the ruler so that it crosses the paper from top to bottom instead of from left to right, notice exactly where 300 metres on the wave-length line intercepts the line of 10 degrees, and, a trifle to the right of this (proportionally, to correspond with the 301.5 wave-length), mark in a dot. This will correspond, reading from left to right, with 10°, and also, reading up and down, with 301.5 metres.

Repeat this performance with as many stations as possible, and you will soon find that your points of interception tend to take the form of a more or less straight slope across the square. Get as many stations as you can, and if you are able to finish up

TECHNICAL TWISTERS

NO. 84. THE OUTPUT TRANSFORMER CAN YOU FILL IN THE MISSING LETTERS?

One of the advantages of a transformer-coupled output is that it diverts the current from the loud-speaker.

It also enables wide discrepancies in to be adjusted, by using the necessary ratio of to turns.

The need for such "matching" is due to the fact that efficient power transference is obtainable only when the effective impedance of the . . . is not less than that of the output valve.

Last week's missing words (in order) were : Greater. Resistance. Twisted. Earth.

with Budapest on approximately 550 metres, you will be at the top right-hand corner of our squared paper, instead of in the bottom left-hand corner where you started, and the stations will fall into more or less clearly defined lines between these two points.

When you have five or six stations marked in, the shape of this line will assist you to find other stations, for any progress on the dial will automatically show the corresponding increase on the wave-length scale.

(Continued on page 454.)

MISSING LINKS, No. 20 A GOOD SHORT-WAVE TWO.

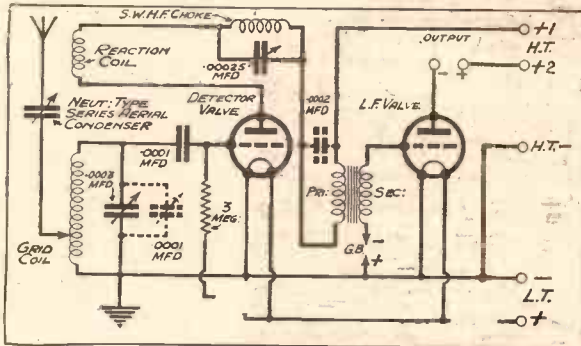

This is a popular and successful two-valve circuit for short-waves, but two of the components have purposely been omitted. Can you fill them in?

Look out for the answering diagram next week.

RADIO-GRAM ENTHUSIASTS!

Here's the way to the best possible reproduction

A well designed amplifier, a good moving coil speaker and—a B.T.H. Pick-up and Tone Arm. These are the ingredients for the finest reproduction of records. The recipe is recognised by leading Radiogram experts. And there's no need now to forego your B.T.H. Pick-up on the score of cost. The new B.T.H. "Minor" is a product of the same engineering principles that have made the "Senior" Model the standard of excellence where Pick-ups are concerned. Ask your dealer for a demonstration.



PICK-UP and Tone Arms



THE EDISON SWAN ELECTRIC CO. LTD.
155 Charing Cross Road, London, W.C.2

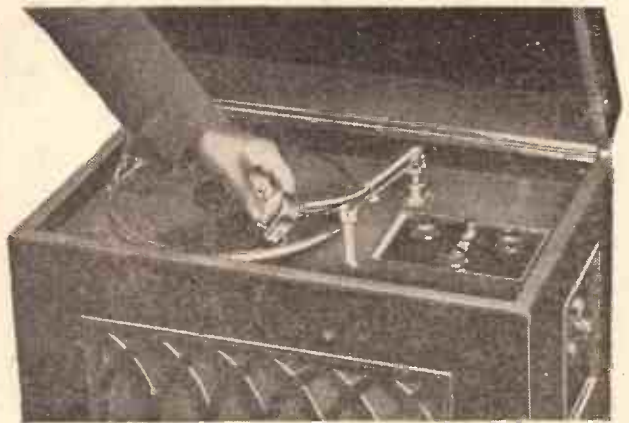

"Minor" B.T.H. Pick-up and Tone Arm. Price complete 27/6



"Senior" B.T.H. Pick-up and Tone Arm. Price 45/-



"Senior" B.T.H. Pick-up only with adaptors. Price 27/6



EVERYTHING **The G.E.C.** ELECTRICAL
your guarantee

YOU GET STATIONS

YOU'VE ONLY READ ABOUT BEFORE!



SPECIAL FEATURES

- 1 The two Screen Grid high frequency stages give extreme selectivity and sensitivity with an unrivalled range.
- 2 Enormous amplification with perfect stability is given by the complete shielding of H.F. Circuits.
- 3 Equal efficiency guaranteed on both wavelength bands.
- 4 Change of wavelength is effected by an external switch and the set need not therefore be opened.
- 5 Maximum ease in tuning with single knob controlling triple gang condenser.
- 6 Assembly is the essence of simplicity.
- 7 Volume control is provided not only to act as such, but to procure extreme selectivity.
- 8 Two terminals provided for connection to Gramophone Pick-up. Walnut Constructor's Cabinet of modern design with front panel to match.

Sold by all Wireless Dealers

OSRAM
"FOUR"

NEW MUSIC MAGNET

PRICE
£10.15s
Including OSRAM VALVES
GECOPHONE COMPONENTS
AND POLISHED HEAVY
WALNUT CONSTRUCTORS
CABINET

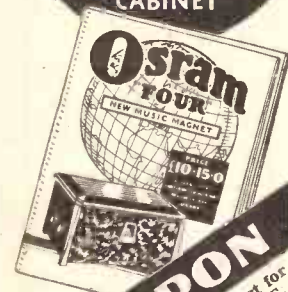

Stations without limit coming in all round the dial...each perfectly separated...at full volume and with amazing purity. All the usual easily-found stations, and besides—those stations which as a rule cannot be reached. The greater is the thrill when you get them on the OSRAM "FOUR" at full loud-speaker strength. This is the performance of this wonder set—the set that introduces an entirely new and improved conception of home-assembled circuits.

WRITE for the OSRAM "FOUR" Constructor's Instruction Chart, and learn all about this radio sensation. **FILL IN THE COUPON BELOW.** The clear directions given in these instructions will enable you to assemble the OSRAM "FOUR" without the possibility of mistake. It is crammed full of useful hints and tips, and contains a rapid guide for getting practically all Home and Continental stations. **SEND FOR A COPY TO-DAY.**

A BRITISH PRODUCT DESIGNED FOR BRITISH RADIO CONDITIONS

HIRE PURCHASE. You can either buy your OSRAM "FOUR" for cash or on these attractive **HIRE PURCHASE** terms—Deposit 25/- and 12 monthly payments of 17/-. Your dealer will give you full particulars.

ALL MAINS OPERATION. The OSRAM "FOUR" can be built for A.C. All-mains operation by means of the new **GECOPHONE A.C. All-Power Unit** and Conversion parts. This Unit can also be used to convert last season's "Osram Music Magnet 4."

SUPREMACY IN RADIO G.E.C. Radio

POST THIS COUPON
Please send me the Constructor's Instruction Chart for the OSRAM "FOUR" NEW MUSIC MAGNET.
Name _____ Address _____
The General Electric Co. Ltd.
Magnet House, Kingsway
London, W.4.2
P.W.

Cut out and paste on postcard, or enclose in unsealed envelope. Halfpenny postage in either case.

Advt. of The General Electric Co., Ltd. Head Office & Public Showrooms: Magnet House, Kingsway, London, W.C.2

RADIOTORIAL QUESTIONS AND ANSWERS

(Continued from page 452.)

if these points are made to intercept on the curve you can now draw. It sounds complicated to describe, but in practice it is singularly easy and will be found of the greatest assistance in identifying foreign stations.

COPYING OUR LAYOUT.

"WELFARE" (Leeds).—"I sometimes find a certain difficulty in copying the wiring diagrams faithfully. Are they always exact replicas of the set as regards positions, etc., and, if so, what is the best way to use the scale which is generally to be found on the diagram? The actual wiring positions can be followed from the photographs, and I notice these do not always correspond with the heavy black lines on the diagrams. I suppose the diagram lines have to be drawn partly for clarity's sake, and the photographs should be followed as indicators of the way the wires should run? Or is it a matter of not much importance?"

The position of the various components, size of baseboard, panel, etc., is all laid out to scale, and it is important that the relative positions should be adhered to as closely as possible.

The best plan is to use the scale by cutting a strip of stiff cardboard out for a "ruler." Place this against the scale and mark off "inches" on it to correspond with the scale measurements, and then

use this cardboard "ruler" to measure distances on the diagram, translating these to actual inches, etc., when working on the materials themselves.

For instance, if the cardboard "ruler" shows that a coil holder is "3 in." in from the end of the baseboard and beyond this at a distance of another 2 "inches" there is a neutralising condenser, the distances on the set itself will be three actual inches to the coil holder and two further actual inches to the neutralising condenser, etc.

The positioning of components is always carefully done on the plan, and should be followed accurately in practice, but the positions of the heavy black lines indicating which points are to be joined together are not intended to show the actual run of the wires themselves, because this could not be done on a flat surface properly, and for clarity's sake it is necessary to make the black lines cross at right angles, etc. (In the case of the wires themselves, often they are not close together, but one is higher than the other.)

In brief, the best plan is to follow the layout and the scale exactly as regards the panel positions of components and those on the baseboard, and then wire up the points indicated by the heavy black lines, but run the wires themselves in accordance with the photographs of the set, remembering that particular attention should be paid to careful spacing at the high-frequency or "aerial end" of the receiver.

WHY DOES IT RATTLE?—A LOUD- SPEAKER PROBLEM.

E. J. J. (Swindon).—"It is perfect in tone except that the loudspeaker sometimes rattles on certain parts of the programme. Why is that?"

When a loudspeaker appears to be freely responsive to some sound, but seems to be hampered and obstructed in its movements in response to the very loud passages, the probability is that when these

extra big movements are required of it, the armature has not sufficient room to travel. It touches the pole pieces of a permanent magnet.

This usually means that the loudspeaker is being asked to handle more power than it was designed for. In some cases a little improvement may sometimes be effected by re-centring the unit.

If this gets a little out of place it will tend to rattle for lower values of volume than it would if the driving rod were exactly opposite the centre of the cone. If, however, the speaker is properly and accurately fitted up, the cure is to reduce the input to it a little, so as not to call upon it for such a big response.

A volume control will enable the strength to be kept down to the necessary level, or failing this a slight de-tuning on very loud stations will often have a satisfactory result.

Unfortunately, not only the loudspeaker itself but the last valve, too, can easily be overloaded in this way. The symptoms are very similar, but

YOUR BIT TOWARDS ECONOMY

Have you ever thought how difficult it is for a newsagent to order just the right number of copies of any particular paper each week? You can make his task much easier if you place a regular order with him. You will not only help him to order correctly and avoid waste but will make sure of getting your copy regularly each week.

the rattle is not so sharp and obviously mechanical in nature when the loudspeaker is not the immediate cause of the trouble.

Increased high-tension and grid bias to correspond will then help to remove the matter, or failing this a "bigger" power valve can be used—one capable of being biased to a higher figure. Whatever the cause, the effect can be partially conquered by keeping the volume down a little.

THE "INSTAMAT" OUTPUT TRANSFORMER.

In the report on the "Instamat" Output Transformer, which appeared in "P.W.," dated October 10th, the price was given as 35s. This was incorrect, the correct price for this component being 37s. 6d.

"P.W." PANEL. No. 42.—USING A PICK-UP.

The principle underlying electrical reproduction is to apply the small voltages corresponding to the speech or music across the grid and filament of the amplifying valve, exactly as in radio.

Instead of low-frequency variations in the detector's plate current, it deals with low-frequency variations in voltage caused by the pick-up traversing the record.

In some cases the bias needed for radio is different from the bias required by the pick-up for the corresponding stage.



PM3



NEW PERMANENT MAGNET MOVING COIL SPEAKER AT 45/-

three-ratio output
Transformer extra 7/6

Handsome grained oak cabinet illustrated 30/-

This is the speaker that the Editor of "Radio for the Million" has so strongly recommended for use with the V3. Its Sheffield-made cobalt steel magnet weighs 5 lbs. Gives true and brilliant moving-coil reproduction for any 2 or 3-valve receiver. A great success on sheer merit. Made by the PIONEERS in PERMANENT MAGNET Moving-Coil Speakers. Write to-day for FREE art booklet "Speaking of Speakers."

The PM3 for the V3

MADE BY THE MAKERS
OF THE FAMOUS
W.B. VALVEHOLDERS AND SWITCHES.
WHITELEY ELECTRICAL RADIO CO., LTD., RADIO WORKS, NOTTINGHAM ROAD, MANSFIELD, NOTTS.
Irish Free State Distributors: Ke'ly & Shiel, Ltd., 47, Fleet Street, Dublin.

**"Popular Wireless" says so—Results prove it—
"Wearite" Components for the "Dual Ranger."**

WEARITE DUAL RANGE COILS
Used and recommended in all previous circuits.
Price 12/6 (see special leaflet).



P.J.3



P.W. & M.W. DUAL RANGE

WEARITE P.J.3. COIL
As specified for the "P.W."
"Dual Ranger." Price 2/9

WEARITE H.F. CHOKE
A component with a very fine performance. It covers effici-



HFO

ently the remarkable range from 10 to 2,000 metres without any marked resonances. Price 6/6

- Coil Quoit Former - - - 6d.
- Panel, in Black, Mahogany or Walnut finish. Size 16x8 7/6
- 3-Point wave-change switch - 1/6
- On-off switch (insulated spindles) - - - 1/-

See our guarantee tag on every component.

Write for free illustrated list.

Have you seen the Kingston-Wearite Home Recorder?
Write for special folder.

WRIGHT & WEARE LTD.
740, High Road, Tottenham, LONDON, N.17.

'Phone: Tottenham 3847/8/9.

WEARITE COMPONENTS

12/6

45/-

PERFECTION

Given an undistorted input the R. & A. "100" reproduces speech and music with a fidelity more nearly approaching the ideal than has yet been attained by any type of speaker. The sensitivity is such that perfect results are obtained with two-valve receivers, and also with large power amplifiers. Compare the R. & A. "100" with any speaker you may choose, and you will agree it is unequalled for sheer beauty of tone and brilliant response throughout the whole audible range. The R. & A. Multi-ratio Output Transformer to suit all power valves, including Pentodes, is modestly priced at 12/6.

Your dealer can supply. Write us for Illustrated Leaflet. Post Free.

REPRODUCERS & AMPLIFIERS LTD.
Frederick Street, Wolverhampton.

COMPONENTS

for the "Dual Ranger."

Obtain your components for the "Dual Ranger" from the leading West End suppliers. We have a reputation of many years standing behind all components supplied, and you may be sure when making a purchase from us that you will receive only components which will do justice. Call or write, we will be pleased to supply you with components for the "Dual Ranger."

PRICE REDUCTIONS

We have extensive stock of all Ferranti receivers. Here are two examples of the wonderful value offered.

Ferranti Inductor Console reduced from 22 gns. to 15 gns.	Ferranti Moving Coil Console reduced from 28 gns. to 18 gns.
---	--

Have you seen our 1932 Catalogue? Free to callers. By post 6d., refunded on first order.

WILL DAY LTD.

19, LISLE STREET,
LEICESTER SQUARE, LONDON, W.C.2
'Phone; Gerrard 4476.

FOR THE LISTENER

(Continued from page 434.)

The time thus squandered, plus about three minutes overtime granted to a rather prosy fellow talking about Galsworthy, made it happen that we arrived at Covent Garden halfway through the Prelude—so that the ordinary listener didn't even get the hang of that! This was really bad stage-management.

For those who know their Opera, there are distinct advantages in having it broadcast. For one thing, you are not distracted by the stage.

I recall the first occasion on which I saw the "Siegfried"; and how unpleasantly surprised I was, having been warned to expect the entrance of a youth, to find that Siegfried was a full-grown man weighing about fourteen or fifteen stone! Brunhilde also turned out to be a very massive woman.

The Operatic Embrace

These big parts require hefty persons: for the physical demand in the singing of them is enormous. And how Siegfried perspired! And how, at the end of that marvellous duet, these two masses of flesh seemed almost to squelch when they came together in an operatic embrace! It took off the edge of the romance of it!

It is well to see the stage setting, the actual picture of the scene, the persons and their movement—once. But once is enough for me! Afterwards I enjoyed the opera much better when I closed my eyes, listened to the music, and imagined the moving picture for myself.

As a matter of fact, in the days when I could afford to go to Covent Garden—and I proudly remember that I often went when I really couldn't afford it!—there were four of us, four enthusiastic young men living on the edge of our overdrafts; and we used to take one of those small boxes high up under the roof of the Opera House.

And when the performance began, we dropped off our little chairs, and sat on the floor of the box in the dark! So we heard the voices of Cornelius and Madame Saltzman-Stevens—this rather dates me in the "far backward and abysm of time"!—without the sight of their avoirdupois; and we each imagined our own Siegfried and Brunhilde. Happy days!

Great Stuff this Opera.

The floor of a box is not too comfortable a spot on which to sit through an opera, and so I am grateful to the wireless which enables me to substitute an easy chair and a fireside for the hard boards. Not that I enjoy it any more in such ease. Perhaps less.

One thing I miss—the sight of the conductor of the orchestra. Herr Nikisch was a favourite of mine. He was a little man. He looked a quiet, rather harmless, little man. But such was his power and personality that he made his orchestra as one instrument, and played it as easily as a boy plays a pipe.

I have never seen so eloquent a back. He did not throw himself about much at the desk; but in the great moments of the playing he seemed to tighten up into a little mass of explosive material and fling himself, now into the drums and trumpets, now into the fiddles—and brought the house down! Yes, opera is great stuff. I invite you!

MIRROR OF THE B.B.C.

(Continued from page 434.)

from National stations on Monday, November 9th.

The book is by Claude Hulbert and Paul England, with music by Harry S. Pepper. Jack Hulbert will act as producer and he will also take part with Cicely Courtneidge and the Hulbert Chorus, which, by the way, is something else quite new.

Having mentioned "Jack Hulbert's Follies" I must come back a bit to the next John Watt programme which is arranged for Tuesday, November 3rd, a lively evening of musical comedy numbers called "Songs from the Shows." It will be given by Tessa Dean, William Stevens, and the B.B.C. Theatre Orchestra and radiated from the London Regional aerial.

This season's Sunday evening Symphony Concerts, which opened this week (October 18th) under the conductorship of Richard Strauss, will be the last to be given in what is known as No. 10 Studio, the converted warehouse on the banks of the River Thames on the south side of Waterloo Bridge.

The Fate of "No. 10."

The future of this large studio, for which the B.B.C. is paying a rental of something like £2,000, and has spent hundreds of pounds in fitting out and lighting and providing office, instrument storage and cloak-room accommodation, is not yet decided, but it is more than likely that it will be disposed of to one of the gramophone companies, for whom it would be ideal for recording purposes.

LARGER AND BETTER THAN EVER!

THE NEW "LANGMORE" RADIO-GRAMPHONE CABINETS (No. G1)

These cabinets are very strongly constructed of selected Oak. Size overall, 3 ft. 6 in. high by 21 in. wide by 15 in. deep.

THE TOP SECTION. Size, 4½ in. high by 18 in. wide by 14 in. deep, gives ample accommodation for gramophone or pick-up.

THE CENTRE SECTION. Size, 10 in. high by 18 in. wide by 14 in. deep, is for the Wireless Set, to take a panel either 18 in. by 7 in. or 18 in. by 8 in.

THE BOTTOM SECTION. Size, 16 in. high by 18 in. wide by 13½ in. deep, gives accommodation for Loudspeaker and Batteries.

Wooden panels to fit, with oval aperture, 12 in. by 5½ in. 2/- extra.

The whole of the back is enclosed by double doors, so that all parts are easily accessible. ALL are fitted with hinged top, heavy platform to take a 12-in. turntable for the Gramophone, and a substantial baseboard for the Wireless Set.

BEAUTIFULLY FINISHED
JACOBAN OAK

THE MISCELLANEOUS TRADING CO., LTD.,
13 & 17, NEW OXFORD STREET, LONDON, W.C.1

Phone: Holborn 4894.



Price 49/6 each

Packed FREE and sent Carriage
Paid to any address in Gt. Britain.

Trade Inquiries Invited.

QUALITY AND QUANTITY MAKE

Player's
Please



THE FULL VALUE CIGARETTE

AN EPOCH PERMANENT MOVING-COIL SPEAKER

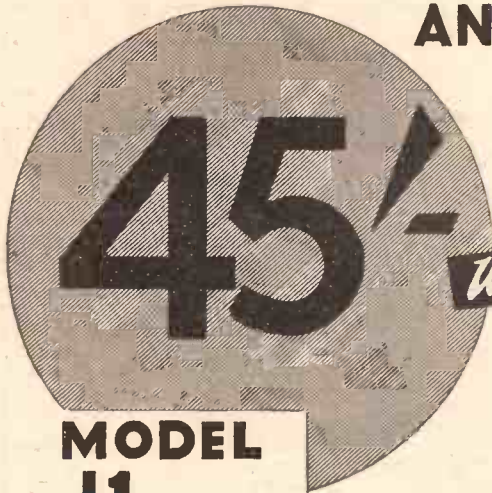

With 3-Ratio Input Transformer

MODEL J1

The lowest priced Permanent Magnet Moving-Coil Speaker on the market. Brings marvellous Epoch reproduction within the reach of all. Astounding value. Fitted with 3-Ratio Input Transformer, ready for use with any set employing Super Power or Pentode output Valves. Copper Plated massive cobalt steel magnet totally enclosed in aluminium casing. Linen-moulded one-piece diaphragm. Ask your Radio Dealer for it. He will gladly demonstrate this or any Epoch Model. If you have any difficulty send for name of nearest dealer or visit our New Demonstration Rooms.



Send for our large free
Art Booklet P.S.5

EPOCH RADIO MANUFACTURING CO. LTD. EXMOUTH HOUSE
At the junction of Farringdon Road & Rosebery Av. EXMOUTH ST., E.C.1

The Outstanding feature of the show



BRITISH GENERAL

BAND PASS IOKC. TUNING UNIT

At last—a Tuning Unit which gives the separation of 10 Kilocycles as laid down by the International Radio Convention, and yet gives full strength throughout the entire wave-band between 230 and 550 and from 800 to 2,000 metres.

PRICE
14/6
INCLUDING
COUPLING
CONDENSER

Of all dealers of repute or direct from the
manufacturers:

**BRITISH GENERAL
MANUFACTURING Co. Ltd.,**
BROCKLEY WORKS, LONDON, S.E. 4.

SOVEREIGN P.W. TUNING UNITS

Coil Quits, P.J. Coils and P.V. Coils now available by "Popular Wireless" are fitted to exact specifications by Sovereign. You can rely on these components doing everything "Popular Wireless" claims. You can rely on their quality. They're right because they're Sovereign—the Components that improve any circuit.



COIL QUILTS
of moulded bakelite with
lugs for mounting, 4 drilled
holes and slotted shoulders
to facilitate winding. Each
6d.



SOVEREIGN
L.F. Trans-
formers, Loud-
speakers,
Compression
Type Condens-
ers, H.F.
Chokes, Vol-
ume Controls,
Spaghetti Re-
sistances,
Mains Com-
ponents. SEND
FOR NEW
SOVEREIGN
CATALOGUE

P.J. COILS
No. 1, 2/- No. 2, 1/6
No. 3, 2/-
P.V. COILS
Per Pair, 6/6

See page 426 of this
issue for report o
Sovereign Component.

SOVEREIGN PRODUCTS LTD.
52/54, Rosebery Avenue, London, E.C.1

Do you say —

"Watmel" when you buy your components? If you do you are buying All-British components, thoroughly up-to-date, tested and guaranteed to do their job perfectly.

Take our coils for instance.

These coils have been specially made in view of modern broadcasting conditions. They are designed to such a size as to be most efficient for screening and they are .0005 condenser in width so as to keep wiring compact and short.

All contacts are gold-silver alloy which does not oxidise. This results in perfect low resistance contacts and reliable switchings. The screens are aluminium with a spring contact between top and bottom. The windings are arranged for all circuits.

Type S.A.1. Screened Aerial tuner with aperiodic aerial tapping for high selectivity. The idea of the coil being screened is that no direct pick-up is obtained. This tuner is suitable for straight receivers, and is tuned with a .0005 condenser and .0001 for reaction. This tuner can be adapted to any type of receiver. Price **8/6**



Type S.A.2. Similar to above but for use when reaction is not to be used. Price **8/6**

Type S.S.3. H.F. Tuner with reaction winding. Price **8/6**

Type S.S.4. H.F. Tuner without reaction winding. Price **8/6**

Band-Pass Aerial Units.

This type of Band-Pass Tuner has been designed on new lines. The aerial is aperiodic, coupled to the first tuner by choke feed, and a second Band-Pass inductively coupled to the first. The two tuners are carefully matched for ganged tuning and mounted on a metal base with copper earthing strip.

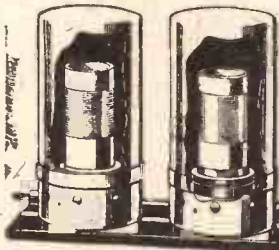

Type B.P.A.1. This unit is supplied complete with a special coil for choke coupling aerial. Complete set. Price **18/-**

Type B.P.A.S.2. The same as above but with extra H.F. Tuner with reaction winding suitable for screened-grid H.F. receivers. Complete with choke coupling unit. Price **28/6**

Write for Component Catalogue.

N.B.—We shall be pleased to supply circuit diagrams on application.

BUY



BRITISH

Watmel

"GETS THE BEST OUT OF ANY SET."

WATMEL WIRELESS CO., LTD.,
Imperial Works, High St., Edgware.

Telephone: Edgware 0323.

Trade Enquiries Invited.

M.C.4

THE "P.W." "DUAL-RANGER."

(Continued from page 432.)

anode terminal of the S.G. valve and the H.F. choke for the valve to be removed when necessary.

This question of clearance applies also to the other valves, and when arranging the layout it is as well to do so with the valves temporarily in position.

We have now completed the layout and the set is ready for wiring. Perhaps I had better remind you that the baseboard components must not come too close to the edge of the baseboard, since they may foul the cabinet fillets, thus making it difficult to place the set in the cabinet without cutting the fillets. I have in mind the H.F. choke, and the low-frequency transformer, but perhaps you will have already thought of this point.

About the Screen.

Now for the wiring. First of all, soldering is unnecessary, because terminals are provided on all the components. Secondly, perfect right-angle bends are not required, but neatness combined with careful spacing of the leads is essential. Slovenly, bunched-up wiring makes for inefficiency, and, after all, it is worth while spending an extra half an hour or so in order to obtain a ship-shape job, isn't it?

It doesn't matter whether you use Glazite or Systoflex covered wire to make the connections, so you may employ whichever method you prefer.

I advise you to commence with the leads nearest the panel and to work towards the back of the baseboard.

You will note that only one wire passes through the screen, and that is the one which goes to the L.T. + terminal on the S.G. valve holder. This wire must be insulated from the screen, and the hole in the screen should be large enough not to chafe the insulation covering.

There are also two terminals on the screen to which wires are attached. These terminals make contact with the screen itself, and in the case of the suggested home-made screen—with the tin foil.

Finishing Off.

As you join up each pair of terminals it is a good plan to tick off the equivalent wire on the blue print, and when you have finished the wiring you should check over every lead, satisfying yourself that no mistakes have been made. Do this before you connect up the L.T. and H.T. batteries.

There are two flexible leads for the G.B. + and G.B. —. These two leads terminate with two wander plugs, the G.B. + plug being inserted in the positive socket of the G.B. battery and the G.B. — plug in its appropriate negative socket, depending upon the particular valve used in the last valve holder.

The grid-bias battery can be attached to the inside of the cabinet, either in a couple of clips or after the style of the Siemens G.B. batteries, which are provided with a flap for attaching the battery to the cabinet.

The small cell on the right-hand (back) end of the baseboard is for applying a negative bias to the grid of the S.G. valve. Either a 9 volt or a 1½-volts dry cell will suffice.

PAREX

Products PAR-EXcellence

are used and recommended for the

"P.W." "DUAL RANGER"

"P.W."

**DUAL
WAVE
COIL
10'-**

The Finest
DUAL COIL
on the market



**HIGHEST EFFICIENCY
SMALLEST SELF-CAPACITY**

The only "P.W." Dual Coil with Tubular Spacers and easily accessible Terminals.

APPROVED BY "P.W." & "M.W."

Each Coil Tested and Calibrated on Actual Broadcasting.

P.J.3 COIL - - - - - 2/6

.0005 mfd. solid dielectric condenser 2/6

Wave-change switch 1/6, on-off switch 1/-

Diff. reaction condenser - - - - - 4/6

Screen, 10" x 7" with hole - - - - - 2/6

H.F. chokes - - - - - each 3/6

Spag. resist. 25,000 ohm 1/6, 50,000 ohm 1/9

Horizontal mounting valve holder - 1/6

From your dealer, or direct from

E. PAROUSSI,

10, FEATHERSTONE BUILDINGS,
HIGH-HOLBORN, LONDON, W.C.1.

'Phone: Chancery 7010

ENGINEERS. Seriously, if you are earning less than £10 per week you cannot afford to carry on without reading "Engineering Opportunities." Whether you are an old hand or a budding apprentice, this 200-page volume will point to a worth-while future. Among other things the book explains the methods of our unique Appointments Department, gives details of all leading Eng. Exams. (A.M.I.Mech.E., A.M.I.E.E., B.Sc. G.P.O., etc.) and outlines modern Home Study Courses in Civil, Mech., Elec., Motor, Aero, Radio, "Talkie," and all other branches of Engineering. This book will alter your entire outlook, and earning power. It is quite FREE. Send for your copy now.

**BRITISH INSTITUTE OF
ENGINEERING TECHNOLOGY,**

401, Shakespeare House, 29-31, Oxford St., London.

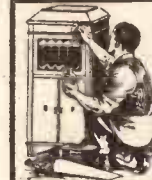

**YOU CAN BUILD A £40
GRAMMOPHONE
WITH OUR SCALE FOR 40/-
DRAWINGS FOR 40/-**

Book of instructions, 3d. Catalogue of Motors, Tone-arms, Sound-Boxes, latest internal Amplifiers, Gramophones, or Cabinets Free. Cash or terms.
V. BURT, 185 High St., Deptford

ELIMINATOR COMPONENTS for home constructors. Stamped addressed envelope brings Eliminator Diagrams, with prices of complete range of Mains components. **MAINS POWER RADIO, BROADWAY WORKS, EASTERN ROAD, ROMFORD, ESSEX.**



KAY'S CABINETS
The "Popular," 42" high, 21" wide, 14" deep, for panels 18" x 7". Can be adapted to other sizes by suitable free vignette. Speaker chamber 18" square fitted with 7-ply sub-baffle, hole cut to suit type of speaker used. Back wholly removable. Specially constructed of oak and richly polished. Price **30/-**.
Illustrated lists of 60 Cabinets free.
H. KAY, Cabinet Manufacturers,
Mount Pleasant Rd., London, N.17.

It pays you to ask your Retailer for genuine guaranteed

WAVEMASTER

Variable Condensers and Extensers for all the latest Circuits

WEBB CONDENSER CO., LTD.,
42, Katton Garden, London, E.C.1.



(INDOOR) (LOW-LOSS)

7 in 1 AERIAL

has eliminated unsightly, inefficient and costly outdoor aerials.

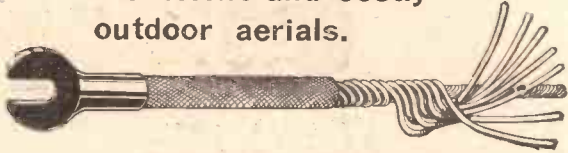

Price: 15ft. 3/9 20ft. 4/6 **LABORATORY TESTS PROVE 25% INCREASE IN SIGNAL STRENGTH**

See also page 462 Have you ever considered the fact that aerials are the only remaining parts of modern wireless reception that have lagged behind in the swift development of wireless?



Do not waste any more money on repairing your outdoor aerial. Simply place the FORMO Low-Loss Aerial around the picture-rail or other convenient place, and enjoy improved and trouble-free reception of stations you may never have heard before.

Packed in Strong Carton ready for use. Obtainable from all Radio Dealers. Catalogue from: **ARTHUR PREEN & CO., LTD.**, Golden Square, Piccadilly Circus, London, W.1. Crown Works, Southampton.

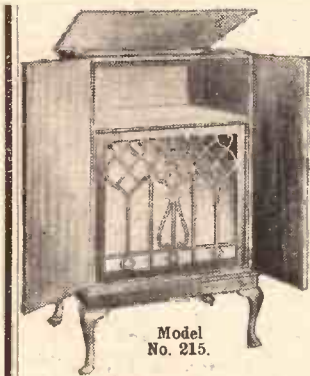

Model No. 215.

STAND No. 9 Block B SCOTTISH NATIONAL RADIO EXHIBITION, EDINBURGH, WAVERLEY MARKET, Nov. 11-21.

OSBORN READY-TO-ASSEMBLE RADIO CABINETS

There is an Osborn Cabinet for every set on the market.

Model No. 215 specified for the "Popular Wireless" Comet 2, Comet 3 and Comet 4. 4ft. high, 2ft. 2ins. wide, 1ft. 6ins. deep. Size of baffle board behind fret is 24ins. by 24ins. Metallic Fabric for the fret front is included. Opening at top and back. Cabinet takes panel 2ft. by 9ins. (or smaller).

PRICES: Machined, Ready to Assemble: Oak, 60/-; Mahogany, 65/-; Walnut, 75/-; Assembled, ready to polish, Oak, 80/-; Mahogany, 85/-; Walnut, 95/-; Assembled and Polished Oak, 100/-; Mahogany, 115/-; Walnut, 130/-. All Models carriage paid.

For 5/- extra cabinet made four inches higher and converted into a Radio Gramophone Cabinet, complete with Motor Board. Send 3d. in stamps for 56-page illust. catalogue **CHAS. A. OSBORN, Dept. P.W., The Regent Works, Arlington St., London, N.1.** Telephone: Clerkenwell 5095. And at 21, Essex Rd., Islington, N.1 (1 min. from the Agricultural Hall). Telephone: Clerkenwell 5634.

SEND FOR FREE CATALOGUE

CODWINEX

M.T. ELIMINATORS
Here's the greatest Eliminator value ever offered—
S.G.A. 12. For screened grid valves. Output 12 m.a. & positive tap. 50% POWER
S.G.A. T.12 as above with I.T. Trickle Charger for every type Models for A.C. or D.C. of set. For A.C. Def. Terminals. J. DYSON & CO., Ltd. (Dept. P.11.), 6 & 7, Godwin St., BRADFORD.

S.G.A. 12.

REMEMBER! "POPULAR WIRELESS" has the largest sale of any WEEKLY WIRELESS JOURNAL.

All Applications for Advertising Space in "POPULAR WIRELESS" must be made to the Sole Advertising Agents, **JOHN H. LILE, Ltd., 4, Ludgate Circus, London, E.C.4.**

'Phone: City 7261.

A NEW MOTOR masterpiece

Here is a loud-speaker unit that is different—a new MoToR balanced armature unit with powerful alternative double magnet, and super resistance tapings among units, amazing in its punch and tonal quality, and in its faithful rendering of speech. Ask your local dealer to demonstrate this or any other MoToR Unit or Cabinet Speaker or to give you the new MoToR booklet illustrating the complete range. Only in case of difficulty write direct to:—

TEKADE RADIO & ELECTRIC LTD.
147 Farringdon Rd., London, E.C.1.

PRICE **35/-**



Northern Distributors: **L. KREMNER, LTD., 2, Bradshaw St., Manchester.**

Agent for Scotland: **R. G. J. Nisbet, 132, Renfrew Street, Glasgow, C.2.**
West of England: **Bruno, Ltd., 28, Cumberland St., St. Paul's Bristol.**

How to Make a Sailplane

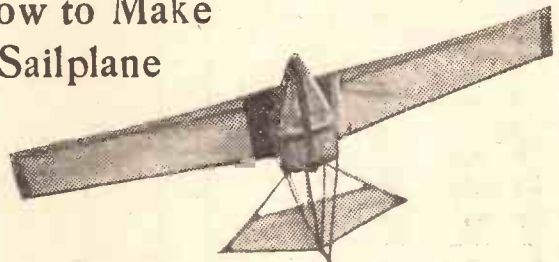

This ripping Model Sailplane—an engineless model aircraft—can be made in a spare hour for only a few pence. It will rival the performance of almost any self-powered model plane. You will find full details of how to construct this super-glider in the 1932 HOBBY ANNUAL, the finest book for the boy who is keen on making things and finding out how things work. This topping gift book is profusely illustrated with photographs and drawings that show "how" in the simplest way. There are also two large folding photogravure plates.

The Book for the Boy with a Hobby

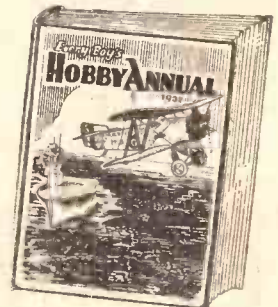

HOBBY ANNUAL

At all Newsagents and Booksellers - 6/- net.

Worthy of the Closest Consideration

"—We have found it completely satisfactory." The verdict of "Popular Wireless," after a thorough test of the now famous Heayberd All-Electric Unit.



Model E.150 incorporates provision for the present and future needs of your Receiver. Here is its specification:—

- H.T. 150 volts at 25 ma.
- L.T. 4 v. 4 amps. for A.C. Valves.
- L.T. 2 volts Trickle Charger.

Silver Embossed H.T. and L.T. Control Switches, Mains Pilot Lamp. Westinghouse rectification throughout. Polished Bakelite Panel. Ready to plug in

£6. 15s.

Model E.200 with output of 30 ma. at 200 v. **£7. 10s.**

Both Units are

GUARANTEED 3 YEARS.

Here is an Olympia H.T. "Winner"—

Model C.250—Outputs 60 ma. @ 250 v. or 200 v. Four tappings—three variable. Special smoothing arrangement giving perfect output. Suitable for any Receiver. Ready assembled in Case. Requires wiring up only . . . 137/6

Post This To-Day

I enclose 3d. stamps for full lists of Heayberd All-Electric Units, Mains Units, and Transformers with circuit diagrams.

M.....

Address.....



10, FINSBURY ST., LONDON, E.C.2

TECHNICAL NOTES

Some diverse and informative jottings about interesting aspects of radio reception.

By Dr. J. H. T. ROBERTS, F. Inst.P.

For "D.X." Fans:

WHEN you are troubled, apparently, by fading—which, of course, will apply more particularly to DX fans—make sure that the alleged "fading" does not come from within the receiver itself and is not, in fact, a particular variety of motor-boating.

The ordinary type of motor-boating, including high-pitched squealing, is so well known as not to need any comment. This is not very likely to occur if sufficiently large by-pass condensers are connected across the source of H.T. supply, whether this be a battery or a mains unit.

A Form of "Fading."

But in these days of improved amplifiers, adapted to reproduce the very low notes, it sometimes happens that a periodic waxing and waning sets in, which may be so slow in frequency that it may be mistaken for fading. This effect also shows itself occasionally in a very peculiar way by interfering with modulation of the incoming signal.

The strength of this effect and also its frequency depend upon the high-frequency and low-frequency amplifiers, much more upon the latter than upon the former, and as a general rule the greater the amount of amplification which you use, the more noticeable will the effect become.

Any experienced DX experimenter should not, however, have very much difficulty in observing the difference between true fading and this type of slow variation of signal strength due to causes within the set. For one thing the true fading is naturally more irregular than the artificial fading and as a rule its frequency is decidedly slower.

Anti-motor-boating.

If you have trouble of this kind and are not quite sure whether it is due to true fading or not, the best thing to do is to connect a good large capacity across the source of high tension, or if this does not do the trick try an anti-motor-boating unit in the anode circuit of the detector.

I have known cases in which it has been necessary also to put anti-motor-boating units in the anode circuits of the low-frequency amplifying stages. But in the majority of cases this type of trouble, unless it is very pronounced, will be got over by the shunt capacity across the high-tension battery or unit.

Grid-Leak Values.

Whilst on this subject, perhaps it may be worth while mentioning a point which may not be known to all of you, and that is that if you get a howling of the set or a peculiar intermittent or ticking sound when plenty of reaction is used, you may

(Continued on next page.)

You cannot imagine what real Radio reception is until you have tried...

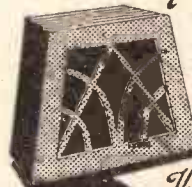

THE MINOR
£4.15.0

The new & improved Silver Ghost **Lamplugh** Inductor-Dynamic-Speaker

See and hear it at your Dealers or write to-day for full details...

The "Silver Ghost" Inductor Dynamic Speaker was designed to overcome that hollow boom type of sound reproduction associated with the moving-coil speaker without sacrificing volume. The perfectly natural tone of sound reproduced by the Inductor gives an entirely revolutionary meaning to what has previously been regarded as Speaker perfection. Moving-coil Speakers (P.M. type) with small magnets are low in efficiency and bear no comparison, to give efficiency approaching that of the Inductor. They require very large magnets making the price nearly double that of the "Silver Ghost" Inductor Dynamic. Listen to the World's Radio under the truly delightful conditions which only the INDUCTOR DYNAMIC SPEAKER can make possible.

Licensed under Farrand Patents and patent applications. Send for fully descriptive pamphlet and other interesting literature. Chassis only £3 10s. Ask also for details of the all-electric Inductaset at £17 17s. 6d.

S. A. LAMPLUGH LTD., Little Park St., Coventry

EASY TERMS

WE supply all good quality Radio Receivers, Components and Accessories on deferred terms. We carry adequate stocks and can give PROMPT DELIVERY.

- NEW HEYBERD A.C. ELIMINATOR KIT C.150. Complete kit of parts for building an H.T. Eliminator, including steel case. Output 25 m/a., 150 volts. 3 H.T. tappings, one variable. Cash Price ... £3 16 0 Or 7/6 with order and 11 monthly payments of 7/-.
 - 12 EXIDE W.H. HIGH-TENSION ACCUMULATORS (120 volts, 5,000 m.a.) Higher voltages if desired. Cash Price ... £3 15 0 Or 7/6 with order and 11 monthly payments of 7/-.
 - CARRIAGE cleared on all orders from Scotland.
 - N.K. FARRAND INDUCTOR LOUD-SPEAKER UNIT.—Quality of reproduction almost equal to a moving-coil speaker. Cash Price ... £3 10 0 Or 5/6 with order and 11 monthly payments of 6/6.
 - SET OF 3 VALVES, S.G., Det. and Power. Mullard or Cossor. Cash Price £1 19 0 Or 6/- with order and 7 monthly payments of 5/4.
 - NEW BLUE SPOT 6BE UNIT. The finest balanced armature movement on the market, complete with large Cone and Chassis. Cash Price ... £2 10 0 Or 5/- with order and 10 monthly payments of 5/-.
 - NEW CELESTION MOVING-COIL L.S. UNIT (PERM. MAGNET), with Transformer. Cash Price ... £4 5 0 Or 13/6 with order and 10 monthly payments of 8/-.
- Send list of requirements, and quotations will be sent by return.

LONDON RADIO SUPPLY CO.,
11, OAT LANE
NOBLE STREET, LONDON, E.C.2

TELEPHONE: National 1977.

WET H.T. BATTERIES

Solve all H.T. Troubles. SELF-CHARGING, SILENT, ECONOMICAL JARS (waxed), 2 1/2" x 1 1/2" sq. 1/3 doz. ZINCS, new type 10d. doz. Sacs 1/2 doz. Sample doz. (18 volts), complete with bands and electrolyte, 4/1. post 9d. Sample unit, 6d. Illus. booklet free. Bargain list free. AMPLIFIERS, 30/-, 3-valve set, £5. P. TAYLOR, 57, Studley Road, STOCKWELL, LONDON



TECHNICAL NOTES

(Continued from previous page.)

suspect that there is something wrong with the grid leak.

Either the grid leak may have too high a value, or it may be out of circuit altogether (which is equivalent to having a resistance value of infinity). Altogether, apart from the howling or other noises which may be set up from this cause, a defective or unsuitable grid leak is liable to cause very bad distortion and also to render the set insensitive. In fact, from the point of view of sensitivity alone, it is most important to have the grid leak correctly adjusted.

Directional Reception.

Beginners are often uncertain as to how to erect their aerials so as to take advantage of any directional properties which they may possess. The directional properties of a frame or loop aerial are, of course, very pronounced, but this type of aerial can easily be shifted about so as to bring it to the best position for any particular station which is to be received.

With an outdoor aerial wire, however, you have to make up your mind about the bearing of the station (or stations) which you want to pick up most generally, and even then other practical considerations may affect the direction in which you ultimately have to place your aerial.

A simple rule to bear in mind, at any rate, is that if the aerial is of the usual "L" type it should trail away from the station you want to pick up. If you imagine the aerial like a weather-cock and the wireless waves like the wind, then the direction of the aerial should be that which it would assume if blown by a wind having the same course as the wireless waves.

In the case of a "T" aerial with a down lead somewhere about the mid-point, the aerial is equally receptive to waves coming in either direction along the line of the aerial. You can, in fact, think of it as two "L" aerials with the horizontal parts pointing in opposite directions.

L.F. and Pentodes.

With a fairly sensitive pick-up, an ordinary low-frequency stage and a pentode stage are usually quite sufficient for any ordinary gramophone record, even when using a moving-coil speaker, but it is important to look after the biasing of the pentode valve, as you will often find that this is affected quite considerably by very small variations in the grid bias.

In many cases, in fact, to get the really correct bias, so that the valve will operate at maximum efficiency, it is necessary to use a potentiometer grid-bias adjustment.

If the valve is working at or about the mid-point of the straight part of its characteristic curve, it is surprising how small a voltage shift of the working point will cause distortion; sometimes even one volt or so will land you in trouble with grid current or partial rectification on loud signals.

What is Earth Potential?

Often in the case of home-made D.C. mains units amateurs do not introduce a condenser into the earth lead, owing to the fact that the negative terminal of the D.C. mains is supposed to be already connected

(Continued on next page.)

NOW . . . DUBILIER CONDENSERS at a price to suit everybody . . .



PRICES

Type 665	Each
'0001, '0002, '0003	
mfd.	6d.
'0005 mfd.	9d.
Type 670	Each
'0001, '0002, '0003	
mfd.	1/-
'0005, '001, '002	
mfd.	1/3d.
'005, '006 mfd.	1/6d.
Types 610 and 620—	
prices from 1/8d. to	
3/-	

This new range of Moulded Mica Condensers has been introduced in addition to our well-known Type 610 and 620 Condensers to fulfil the demand for a really high quality product at a price within the reach of everybody.

These Condensers are specially designed for use where high efficiency, compactness and lightness of weight are a consideration and are tested at 500 Volts A.C. suitable for 250 Volts D.C. working and are entirely British Made.

DUBILIER CONDENSER CO. (1925) LTD., DUCON WORKS, VICTORIA ROAD, N. ACTON, LONDON, W.3.

A GOOD JOB!

British Radio Constructors still show their recognition of a good job well done. Since their introduction Benjamin switches and valveholders have established unrivalled popularity.

They will continue to maintain their sterling quality.

Write for our New 1932 Radio Catalogue—it contains three very interesting and original circuits by a prominent designer.

The Benjamin Electric Ltd.
Tarriff Road, Tottenham, N.17.
Tottenham 1500.

BENJAMIN

EXACT TUNERS

250 to 2,000 metres.

Thousands of these tuners are in use, and we can strongly recommend them. No further coils are required. Send P.O. for particulars and circuits—FREE.

THE EXACT MANUFACTURING CO.,
Croft Works, Priory Street, Coventry.

CABINETS "DE-LUXE" PICKETTS

Remarkable Offer.

Usual Price	Makers' Price
£8 15 0	£6 18 0
£7 7 0	£5 10 0
£3 3 0	£2 7 0

SAVES YOU MONEY

The Superior QUALITY delights! A fine charm of style that people desire. Advantages also of PIANO-TONE Baffle and sound chamber (no distortion, no drumming). Quite new—as supplied to leading experts, B.B.C. and Radio Press: You may have ON APPROVAL and return at OUR expense if you wish to part with it! Deferred Terms 10/- or £1 monthly. Photographs and full details FREE!

PICKETTS, Radio Furniture Works (P.W.), Albion Road, Bexleyheath, Kent.

ONE-WEEK OFFER of BENCH DRILLS

Set of 9 Drills FREE

12/6

CARR. PAID

Manufacturer, forced by crisis to obtain cash at once, is sacrificing these high-grade 50/- BENCH DRILLS at 12/6 carr. paid for 7 days only. Seize this opportunity! Cut gears, steel spindle, Ball bearings, automatic adjustable feed. Fitted with 3-jawed chuck. Capacity 0 to 3/8 in. Will last lifetime. Set of 9 drills FREE. Send 12/6 to-day! Satisfaction or money back. Bargain list free.—JONES' STORES (Dept. P.W.), 100, TAMBURGH ROAD, CROYDON.

Make

The DAILY SKETCH

YOUR Picture Papers

THE FAMOUS



DUAL RANGE COIL

as specified for the "Dual-Ranger."



The Formo Dual Range Coil is scientifically tested and absolutely reliable. Universally acknowledged the best type for radio construction. It is of superior finish, being wound on a well-designed moulding with accessible terminals. For best results and easy assembly make sure that you get a "FORMO."

Price 12/6

FORMO-DENSOR



This product is the pioneer of small compression-type condensers, and for all purposes where some flexibility in capacity is required, the Formo-Densor is a product of assured reliability and precision.

Type F, J, & G 1/6 Type H 2/3

MID LOG LINE VARIABLE CONDENSER & VERNIER DIAL

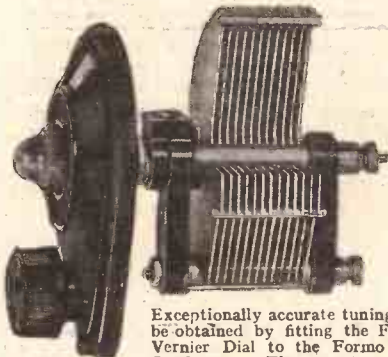

Exceptionally accurate tuning can be obtained by fitting the Formo Vernier Dial to the Formo Log Condenser. The aperture and scale of the dial are set at an angle of 30 degrees, thus ensuring easy reading.

Condenser 4/- Vernier 2/6

Obtainable from all Radio Dealers. Complete catalogue from—

ARTHUR PREEN & CO. LTD.,
Golden Square, London, W.1. Crown Works, Southampton. See also page 459

TECHNICAL NOTES

(Continued from previous page.)

to earth and to be, therefore, at zero potential.

Being connected to earth, however, and being at zero potential may be two very different things, as everyone knows who has had experience of a faulty earth connection for the receiver. A great deal depends upon the nature of the "earth" and also upon the current which is flowing to earth, that is, upon the potential which the earth lead would assume if it were not connected to earth.

It is not safe to rely upon one of the mains terminals being truly earthed, and altogether apart from this you are liable to get a good deal of "static" interference due to differences in the potentials of the earth terminal of the set and the earth terminal of the mains.

Super-het Coils.

The revived interest in the super-het which may now be said to be in full swing is largely due to the improvements in super-het coils, oscillators, filters and other components which have recently been made. A number of these types of coils were on view at the recent Radio Exhibition.

In cases where the super-het is not intended to be used with an ordinary outdoor aerial, it is very important to give careful attention to the frame aerial, because this may make all the difference to the operation of the receiver.

As I mentioned recently in these notes, there is a common impression that a frame aerial just consists of a few turns of wire wound more or less anyhow upon a frame of any convenient size; in point of fact frame aerials vary enormously in their efficiency and, furthermore, the aerial, especially in the case of a modern type of super-het circuit, should be designed specifically for the object in view.

If you contemplate going in for one of these super-het kits you should take very great care to get at the same time an aerial which matches the completed receiver.

A Useful Transformer.

Several attempts have been made at different times to introduce a variable or adjustable transformer, but for some reason transformers of this type never seemed to "take on" with the public.

The usual arrangement is a system of tappings but other methods have also been suggested, including adjustability of the relative positions of the primary and secondary and also adjustability of the position and form of the magnetic core.

In this connection one of the most interesting exhibits at the Radio Show was the "Instamat Major" transformer shown by the Ready Radio people, which is specially designed for readily matching the output valve and loudspeaker.

Variable Ratio.

It is adapted to carry the relatively heavy anode current met with in modern receivers and to feed into a low resistance reproducer such as a moving-coil loudspeaker. As you probably know, the "Instamat" transformer is provided with a pair of adjusting knobs by means of which it is possible to obtain any one of

(Continued on next page.)

Easy Terms

FIRST IN 1924 FIRST IN 1931

COSSOR 234 EMPIRE MELODY MAKER. Screened-Grid, Detector and Power. With valves and cabinet.

Cash Price £6 15s. 0d.

Balance in 11 monthly payments of 12/6.

V.3 RADIO FOR THE MILLION. Screened-Grid, Detector and Power. With valves less cabinet

Cash Price £5 17s. 6d.

Balance in 11 monthly payments of 10/9.

AMPLION MOVING-COIL SPEAKER, TYPE M.C.G. Permanent magnet, with output transformer. Complete.

Cash Price £3 7s. 6d.

Balance in 11 monthly payments of 6/2.

ATLAS A.C. ELIMINATOR TYPE A.C.244. 3 Tappings, S.G., Detector and Power. Output 120 volts at 20 m/a.

Cash Price or C.O.D., £2 19s. 6d.

Balance in 11 monthly payments of 5/6.

W.B. PERMANENT MAGNET MOVING-COIL SPEAKER. Complete with 3-ratio input transformer.

Cash Price £2 12s. 6d.

Balance in 11 monthly payments of 4/10.

ORMOND PERMANENT MAGNET MOVING-COIL SPEAKER. Chassis Model, complete with input transformer.

Cash Price £3 5s. 0d.

Balance in 11 monthly payments of 5/11.

We can supply any accessory advertised in "Popular Wireless" on **EASY TERMS.** Send 6d. in stamps for **NEW Catalogue.**

New Times Sales Co

56, LUDGATE HILL, LONDON, E.C.4
(Established 1924). Telephone: CENTRAL 2718.

JACOBAN POLISHED OAK RADIO-GRAMOPHONE CABINET



Cabinet with 4" clearance for the pick-up, Dome Lid, set compartment takes any panel up to 18 x 8", and 15 1/2" baseboard. Speaker compartment 16" high, 18" wide, and 15 1/2" deep. Overall height 38". 3" Baffle fitted. Removable back to cabinet.

Machined ready to assemble, 17/-.

Assembled ready to polish, 25/-.

POLISHED JACOBAN, 30/-

Packed free, cartage forward. Money returned if not satisfied.

FRANKS CABINETS 13, Martha Court, Cambridge Rd., London, E.2

WONDERFUL 16" SPEAKER CHASSIS.

Any unit easily fitted. Money back guarantee. Price 7/6. (Trade inquiries invited).

L. R. BANNISTER

14, Pembroke St., Cowley Rd., Oxford.

NEW "PURATONE" PROCESS

2 VOLT DARK EMITTER

H.F., L.F., DET., R.C. VALVES 3/9

Power - 5/3

Super-Power 6/3 Screen-Grid 7/6

BRITISH MADE. FULLY GUARANTEED.

Actual Makers **RUBON LTD.**,
189, New King's Rd., London, S.W.6

PLEASE be sure to mention "Popular Wireless" when communicating with Advertisers. Thanks!

TECHNICAL NOTES

(Continued from previous page.)

six different ratios from 10 to 1 to 25 to 1. The positions of the switches for these various combinations are indicated on the transformer case and the arrangement is not only extremely simple but also entirely satisfactory.

Loudspeaker Filters.

Some little time ago I had something to say in these notes about loudspeaker filters, and from a number of letters received from readers it looks as though this question of output circuits is not always as clear as it might be.

I have been asked several times what is the best form of output circuit, but as this depends to some extent upon circumstances, I think it may perhaps be useful to say a few words on them in general.

Direct Output.

When we speak of an output circuit we usually mean some special arrangement other than the ordinary direct output, although strictly speaking this should be classified as one form of output circuit. Leaving the direct-output circuit out of the question for the moment, the two other schemes are the transformer, and the choke and condenser filter.

The direct arrangement is largely used, especially in the case of small sets of not more than say a couple of stages and where the anode current is comparatively small. With the direct circuit the loudspeaker receives the H.T. current of the last valve through its windings and consequently, if this current is at all large, there is a danger of upsetting the magnetism of the loudspeaker and either damaging the instrument, or at any rate causing it to operate under adverse conditions.

Reducing H.T. Voltage.

There is a further reason against the use of the direct-output circuit, and that is that the loudspeaker is placed in series with the H.T. supply to the valve; if the resistance of a loudspeaker—the ohmic resistance, of course—is fairly large, say 2,000 ohms or more, and the impedance of the valve is comparatively low, it means that the H.T. voltage actually delivered to the valve is seriously cut down.

For reasons of this kind the direct-output circuit must be regarded as having very definite limitations, and the moment you come to the case of a receiver with a really respectable output, it is very much preferable to have recourse to one or other of the forms of special output circuit.

Used With Push-Pull.

The transformer-coupled output circuit is not so popular as the choke-filter output, except in one or two special cases; for instance, if a moving-coil loudspeaker is used or a push-pull circuit, then an output

(Continued on next page.)

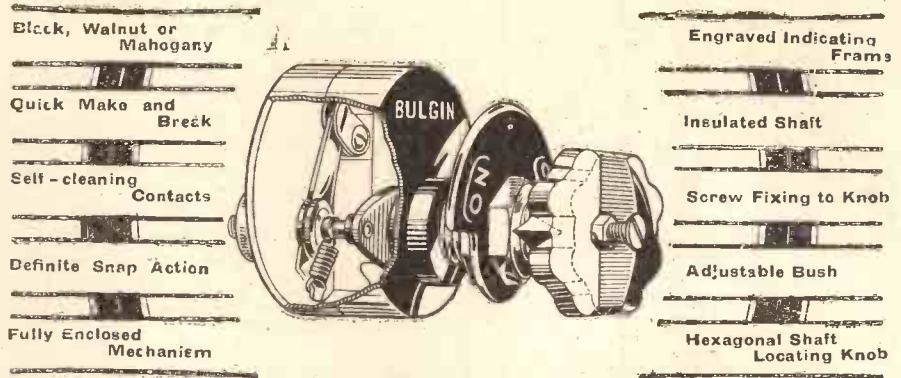

The Bulgin Rotary Switches represent the last word in design, efficiency and neatness. The 'ON-OFF' and 'RADIO GRAMO' Types constitute a perfectly matched pair eminently suitable for a modern radio receiver or radiogram. Years of experience as specialists in radio switches has enabled Bulgin to produce such switches at such a price.

Send 2d. postage for the new 75-pp. Illustrated Catalogue and Manual which also details the Bulgin Technical Service.

£.85. 'ON-OFF' 1/9

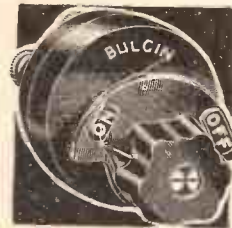

A. F. BULGIN & CO. LTD.
 ABBEY RD., BARKING, ESSEX

'Phones: Grangewood 3266 and 3267.
 London Showrooms: 9, 10, 11, Cursitor Street,
 Chancery Lane, E.C.4. 'Phone: Holborn 2072'

£.86. 'RADIO-GRAMO' 2/-



EASY PAYMENTS

"There's No Place Like HOLMES."

The first firm to supply Wireless parts on easy payments. Seven years advertiser in "Popular Wireless." Thousands of satisfied customers.

	Deposit	Monthly Payments
COSSOR KIT	£6.15	10/- 11 of 12/8
OSRAM KIT	£10.15	19/8 11 of 19/8
EXIDE H.T. Accum., 120v. £3	6/-	9 of 6/8
BLUE SPOT 66R & CHASSIS	£2.2/8	5/8 9 of 4/8
WUFA UNIT & CHASSIS	£2	4/5 9 of 4/5
AMPLION M.C.6	67/8	7/5 9 of 7/5
AMPLION Cone Speaker	15/-	4/8 3 of 4/-
EKCO Eliminator A.C.18	67/-	7/5 9 of 7/5
B.T.H. JUNIOR Pick-up	27/-	5/- 5 of 4/10

New Goods Obtained for Every Order.
 Send us a list of the parts you require and the payments that will suit your convenience, and we will send you a definite quotation. Anything Wireless.
H. W. HOLMES, 29, FOLEY STREET,
 Great Portland Street, London, W.1.
 'Phone: Museum 1414.

MAKE OR BUY A GRAMOPHONE

at a quarter shop prices, or buy Cabinets for Wireless. British double spring motor. 12" velvet turntable, swan arm, metal sound-box, amplifier, needle cups, for £21/10 p.p., and build your own Cabinet. Portable Gramophones from 15/6, postage 1/6. Motors from 7/6. Lists free. 64 pp. 1931 Catalogue No. 220, with Reduced Prices, Drawing and How to Make Gramos. 5d.
REGENT FITTINGS CO (P.W.), 120, Old Street, London, E.C.1.

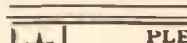

Engineers' Guide

Containing the widest choice of engineering courses in the world. Qualify for a well-paid post in Engineering by studying at home with The T.I.G.B. Become an A.M.I.C.E., A.M.I.Mech.E., A.M.I.E.E., A.F.R.Ae.S., etc. Training until Successful is Guaranteed for the one fee. WRITE NOW for "The Engineers' Guide to Success," stating the branch, post or qualification that interests you, to

THE TECHNOLOGICAL INSTITUTE OF GT. BRIT.
 26, Temple Bar House, London, E.C.4.
 Founded 1917. 17,000 Successes



To Success

FOR YOUR RADIO COMPONENTS

A. T. HARRISON & CO.
 Copper and Aluminium Screens by return of post.
 Bakelite Moulds, Bakelite Mouldings.
 Trade inquiries invited.
KINTORE WORKS, BERMONDSEY, LONDON, S.E.1.
 Telephone: Bermondsey 1155

★ PLEASE be sure to mention "Popular Wireless" when communicating with Advertisers. Thanks! ★

Sensitivity exceptional . . .
Tremendous volume . . .
Simple to build . . .

HEAR THE 'DUAL-RANGER' AT THE READY RADIO SHOWROOMS
 159, BOROUGHS HIGH STREET, LONDON BRIDGE, S.E.1
 (2 minutes from London Bridge Station). 'Phone: Hop 3000.

ELECTRADIX MICROPHONES

We have supplied thousands of Microphones during the past ten years for Wireless Transmission and Voice Amplification. These are still giving good service because they are robustly made. Fragile flimsy cased tin-lid Mikes soon fail. We have Mikes for every purpose from Pocket Voice Amplifiers to Home Talkie and Public Address Stand Models.

AND OUR PRICES ARE RIGHT!

You will find our Microphones remarkably cheap and efficient for all purposes. We have all types from 1/- to £20. Pendant: No. 11 (Single) 4/6; No. 7 (Special Panel) 12/6; No. 10 (Pulpit) 12/6; No. 8 (Hand) 15/-; No. 4 (Pedestal) 17/-; Nos. 1 or 5 (Announcer's P.A.) 65/-; Siesmo Microphones for Vibration Testing; massive brass body in Teak case, 10/6. Futograph Picture Recorders, new manufacturer's, £20 set for 45/-; Micro Transformers: 3/6, 5/-, 7/6 and 10/-; 3 Valve Amplifiers for P.A. off D.C. mains (Panatrop): £3:10:0. 3 Valve Portable Type: £2:15:0, fitted Mike Transformer.

METERS.

You would not attempt to navigate a liner with a vest-pocket compass. It is equally foolish to take electrical measurements with a cheap pocket meter of about 50 ohms per volt. They simply ruin H.T. batteries. Ask these questions first. Is the resistance not less than 500 ohms per volt? Is the accuracy to the Brit. Eng. Assoc. standard?

The DIXONEMETER answer is YES, and CHEAP at 50/- with Multipliers you can work at 2,000 ohms per volt. Send for Free Test Booklet.

TELEPHONES.

Per Pair s. d.

H.W. Sullivan's Wireless Light Headphones, new, 120 ohms	3	6
Ditto, store soiled un-boxed, 120 ohms	2	9
New High Res. Long Range Model, 8,000 ohms	4	3
S. G. Brown's Headphones with Headbands, 120 ohms	7	6
Ditto, 1,500 ohms	12	6

HOUSE TELEPHONES, 12/6 set of two complete stations.

Home Recorder Talkie Sets, £4 10s.

Over 1,000 electrical and radio gadgets will interest you.

A WONDERFUL STOCK OF RADIO AND SCIENTIFIC APPARATUS

Send us your inquiries for Moving Coil Speakers, Mains Sets, Chokes, Gramo-motors, Microphones, Recorders, Relays, Special Apparatus for Transmission and Testing, Dynamos and Motors, all sizes. Bridges, Galvos, Switch and Control Gear of every description in stock. Now ready. New Edition of 72-page Illustrated Catalogue, 4d. Send Stamped Addressed Envelope for November Sale List.

PROMPT DISPATCH OF GOODS EVERYWHERE.

ELECTRADIX RADIOS,
218, Upper Thames St., E.C.4.

St. Paul's and Blackfriars Stn.
Phone: City 0191.

REPAIRS

single ratio L.F. Transformers, Headphones, Loudspeakers (except Blue Spot). **ONE YEAR'S GUARANTEE.**

TRANSFORMER REPAIR CO., Post Free 3/9
553R, GARRATT LANE, LONDON, S.W.17 Terms to Trade



PAULETTE ALL WAVE TUNER

250-2,000 metres. No coils to change. Greatly improved selectivity and range. **PRICE, with Switch, 7/-** post paid. Send stamp for **FREE WIRING DIAGRAMS** of PAULETTE 3-VALVE SET. Easy to construct. Parts cost £2. 12. 6.

PAUL'S WIRELESS STORES,
43, Caroline Street, Cardiff.

TECHNICAL NOTES.

(Continued from previous page.)

transformer is used, the transformer ratio depending, of course, upon the type of speaker.

For instance, in the case of a moving-coil where the resistance is extremely low, a ratio commonly used is 25 to 1. Sometimes a transformer of equal ratio, that is, 1 to 1, is used with a high-resistance speaker, but in the latter case it is really better to use a filter circuit.

The Choke-Filter.

The most popular arrangement is the choke filter. This enables the D.C. current to be kept out of the windings of the loudspeaker, and is capable of a high degree of efficiency. The choke filter consists, as its name implies, of a choke and condenser, the latter being as a rule not less than two mfd. capacity.

The choke is introduced in series with the high-tension supply and the valve and has the effect of preventing the low-frequency part of the current from the valve going to earth through the H.T. source. The choke allows the D.C. current to pass, but the low-frequency component passes instead through the condenser and so via the loudspeaker to earth.

NEXT WEEK.

Two Fine Practical Articles.

Full details for

ADDING REFINEMENTS TO THE "P.V." PLUS

And how to

OPERATE THE "DUAL-RANGER."

Variation of Inductance.

It goes without saying that the D.C. resistance of the choke should be as low as possible, a common value being about a couple of hundred ohms. At the same time the inductance should be, say, 20 henries and this value should not drop very much with normal values of plate current.

Watch the Condenser.

As regards the condenser to be used in a choke filter output circuit, this should be very reliable; it is false economy to use a cheap or doubtful condenser in this position, because if a breakdown should take place within the condenser, the H.T. source—battery or unit—will be short-circuited through the loudspeaker to earth.

Perhaps I should hardly say "short-circuited" through the loudspeaker, but at any rate a very heavy load will be thrown upon it which may easily cause considerable damage.

MAKE YOUR SET UNIVERSAL

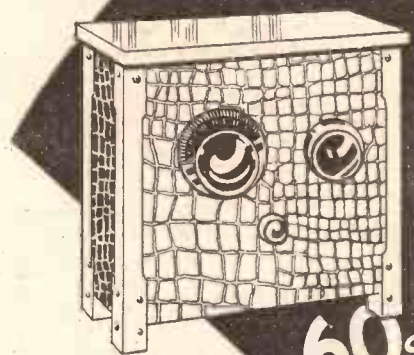

60s. Complete

EELEX SHORT-WAVE CONVERTOR

Are you able to receive the ultra short-wave stations with your existing set? No? Then you should not fail to investigate the EELEX Short-Wave Converter. This remarkable invention converts your present set into an all-station receiver, giving you the choice of a wide range of programmes on the 16-20 metre band. An additional coil for the 140-190 metre band is available at 5/- extra. **PRICE 60/-**
ALL MAINS MODEL 65/-

Have you read the two-page report in "Wireless World" Aug. 5, 1931. Write for List A.10.

J. J. EASTICK & SONS,
EELEX HOUSE, 118 Bunhill Row, London, E.C.1
Phone: Metropolitan 0314/5/6.

Enclose your set in this BEAUTIFUL CABINET

Here is a Cabinet of outstanding beauty at a really remarkable price. It costs only 24/6 and enables you to enclose all batteries, etc., giving a neatness and beauty of appearance worthy of your set. Constructed mainly of oak, finely

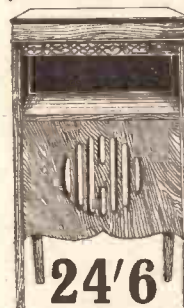

polished a rich nut-brown shade, this Cabinet stands 36 inches high. The panel space measures 18 x 7 ins. while the top is 21 ins. wide by 14 1/2 ins. deep. The loud speaker aperture is 10 ins. diameter and is covered with fine amber silk. There is a removable panel back giving free access to batteries and speaker. The deep-hinged lid enables the set to be removed bodily.

Decide now to have this fine Cabinet in your home. Money back if not entirely satisfied. Send to-day to

24/6
CARRIAGE AND PACKING FREE
England & Wales. 38, STROUD GREEN RD., N.4
(List of Furniture & Wireless Cabinet Bargains free on request).
SOLOCA MFG. WORKS
(Dept. P.W.)

LOUD SPEAKERS REPAIRED, 4/-

(Blue Spot a Speciality, 5/-)

Transformers 4/-, Headphones 4/-, all repairs magnetised free. Tested, guaranteed, and ready for delivery in 24 hours.

Discount for Trade. Clerkenwell 9069.
E. MASON, 44, EAST ROAD, N.1.

... HEARING is BELIEVING! ...

Hear the 'DUAL-RANGER' at the **READY RADIO SHOWROOMS**

Phone: Hop 3000

159, Borough High St., London Bridge, S.E.1,

(2 minutes from London Bridge Station)



**INDUCTOR
TYPE**

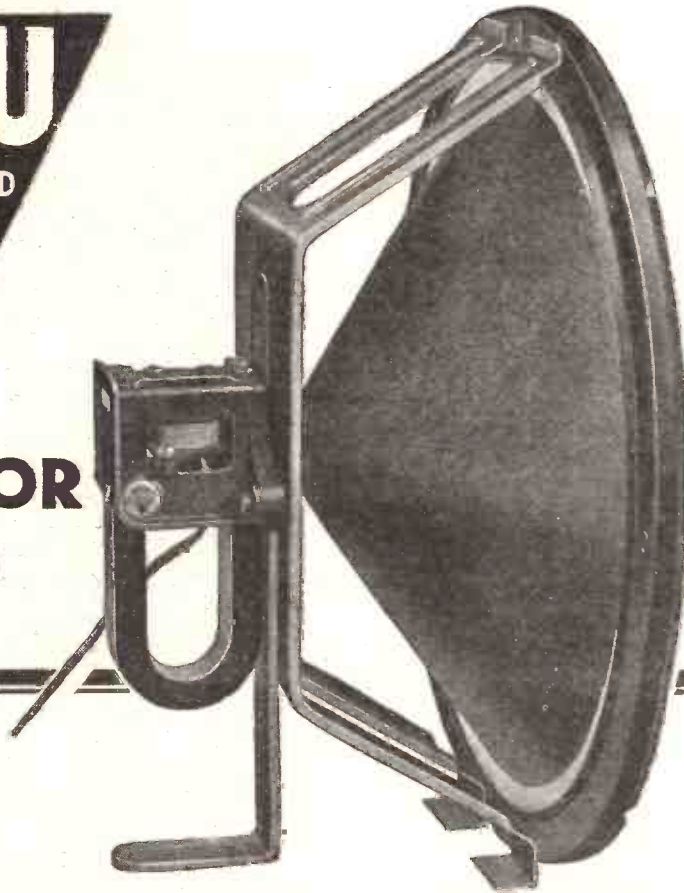

Owing to its extreme sensitivity the input should not exceed 1200 milliwatts.

A TRULY WONDERFUL UNIT

Blue Spot 100U is the equal of the most expensive Dynamic Speakers. That is a big claim but it is justified. Severe tests by experts have but served to prove the exceptional merit of this truly wonderful unit. There is nothing like it at anywhere near its price.

Every radio enthusiast who has not heard 100U should make a point of doing so at once. It can be used with any type of receiver and also with Pentode-Valves since no matching transformer is required. Its sensitivity is such that perfect reproduction with good volume is ensured from very small inputs. In the difficult bass notes particularly, its performance is genuinely remarkable. Distortion, muffling, rattle and discordancy are unknown to 100U. But hear it for yourself.

Price complete mounted to chassis

39/6

Write for catalogue P.W. 13 for details of Blue Spot units, speakers and receivers.



THE BRITISH BLUE SPOT COMPANY LTD.

BLUE SPOT HOUSE, 94-96 ROSOMAN ST. ROSEBERY AV., LONDON, E.C. 1

Telephone: Clerkenwell 3570. Telegrams: "Bluspot, Isling, London."

Distributors for Northern England, Scotland and North Wales: H. C. RAWSON (Sheffield and London) Ltd., 100, London Road, Sheffield: 22, St. Mary's Parsonage, Manchester: 183, George Street, Glasgow.

Your batteries yearly cost you pounds



—an EKKO Unit will give you trouble-free radio for 1/- a year and finish with batteries for ever.

Connect an EKKO Unit in place of your usual battery (no alterations to your set or wiring). Plug in to the electric light or power supply. Then switch on—that's all. You will be more than delighted by the improvement in the performance of your set.

The New EKKO Units surpass all previous achievements, embody many exclusive features and combine highest efficiency with greatest simplicity. Made by the Pioneers and leading Specialists of All-Electric Radio.

H.T. Units (A.C. & D.C.) from 39/6

Combined H.T. & L.T. Charger Units (A.C.) from £3:19:6

All-Power Units (H.T., L.T. & G.B.) from £6:0:0

All obtainable on Easy Payment Terms from as little as 3/8 per month.

Post coupon now for full details.

EKKO

ALL-ELECTRIC POWER UNITS

To: E. K. COLE, Ltd., Dept. A.14, EKKO Works, Southend-on-Sea.

Please send me full details of EKKO Power Units.

Name

Address

CAPT. ECKERSLEY ON BAND-PASSING (See Page 473)

Popular Wireless

Every Thursday
PRICE
3d.

No. 491. Vol. XX.

INCORPORATING "WIRELESS"

October 31st, 1931.



Full-size Wiring Diagram and Complete Constructional Details **GIVEN FREE** WITH EVERY **Ready Radio** See page 495
 "P.W." "DUAL-RANGER" KIT

The **NEW** **LEWCOS** BAND PASS FILTER

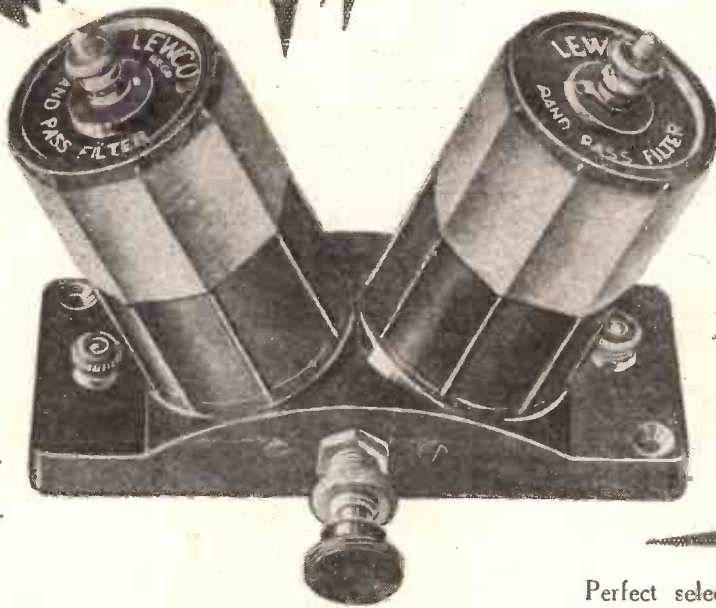

PRICE
12/-
(Screen 2 1/6
Extra.)



Perfect selectivity—the aim of all radio enthusiasts—can at last be achieved!

The New Lewcos Band Pass Filter, the product of exhaustive experiments in our Laboratories, gives maximum efficiency on both wave-length ranges (235/550 and 1000/2000). This has been obtained by the production of a Filter which is capable of giving a steep-sided and flat-topped response curve—ideal for super-selectivity and quality performance.

Try this new Lewcos component in your set; you will be astounded at the results.

Send for fully descriptive leaflet, Reference R 73.

LEWCOS RADIO PRODUCTS FOR BETTER RECEPTION

THE LONDON ELECTRIC WIRE COMPANY AND SMITHS LIMITED, CHURCH ROAD, LEYTON, LONDON, E.10

Only ORMOND could produce so perfect a Condenser!

The ORMOND No. 6 SLOW MOTION



NEAT
RIGID
ROBUST
PRECISE

Here again is manifested Ormond's intimate knowledge of modern radio requirements. In such a precision instrument, necessitating supreme care in its production, the Ormond high standard of manufacture is fully proved.

This new Ormond condenser is constructed of brass and is very robust. The vanes are perfectly rigid, being firmly secured to slotted spindles. Di-electric losses are reduced to a minimum by the special mounting of the fixed vanes support. The moving vanes are connected to the frame, thus eliminating stray capacity effects.

A slow-motion device, ratio approximately 9 to 1, is incorporated in the condenser and is controlled by the upper small knob, direct drive being obtained on the dial, which is engraved 0 to 180 degrees.

Easy to mount, "one-hole" fixing. Terminals and soldering tags for connections. Complete with 2½ in. dial and slow-motion control knob.

Cat. No.	Capacity	Price
R/484	.00025	6/6
R/485	.00035	6/6
R/486	.0005	6/6

This condenser is also available constructed of aluminium without slow-motion movement, and less dial, in similar capacities at 4/- each.



THE ORMOND ENGINEERING Co. LTD.
Ormond House, Rosebery Av., London, E.C. 1
Telephone: Clerkenwell 5334-5-6 & 9344-5-6. Telegrams: "Ormondengi, Isling."



EPOCH

PERMANENT MAGNET MOVING-COIL SPEAKERS

MODEL J.1 A Permanent Magnet Moving-Coil Speaker designed to bring Epoch reproduction within the reach of all. Lower in price than any other Speaker on the market with a performance comparable to instruments costing far more.

The 3-ratio Input Transformer included makes it ready to connect instantly to any set employing Super Power or Pentode Output Valves. Its massive cobalt steel magnet is totally enclosed in aluminium. One-piece moulded linen diaphragm. Make sure you hear this 45/- Permanent Magnet Moving-Coil Speaker first.

Ask your Radio Dealer for Model J.1. He will gladly demonstrate this or any Epoch Model. If you have any difficulty send for name of nearest dealer or visit our New Demonstration Rooms. Send also for our large free Art Booklet P.S.S.

With 3-Ratio Input Transformer

EPOCH RADIO MANUFACTURING CO. LTD.
EXMOUTH HOUSE, EXMOUTH STREET, E.C.2
At the junction of Farringdon Road and Rosebery Avenue.
Phone: Clerkenwell 6666

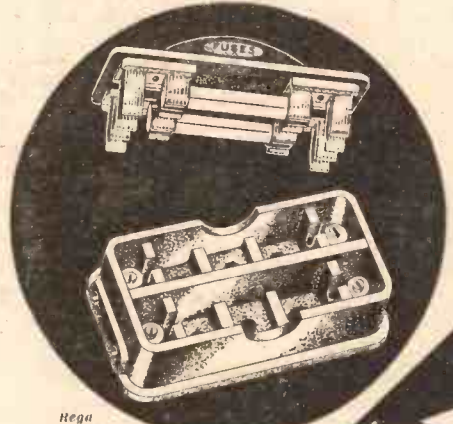

Rega design.

- TWIN BASEBOARD FUSEHOLDER, with two 1-amp. fuses for mains leads (illustrated above) .. 3/6
- WANDERFUSE, combined wander plug and fuse, with 60m/a. fuse, 1/6
- FLEXIBLE LEAD FUSEHOLDER, short type, with 1/2-amp. fuse .. 1/- (Longer type with mains fuse, 1/-).
- SINGLE BASEBOARD FUSEHOLDER, with 1/2-amp. fuse. The best method of mounting a fuse inside a set .. 1/3

Dealers will exchange fuses for other ratings at the time of purchasing any Belling-Lee Fuseholders.

A COMPLETE RANGE OF FUSES for EVERY REQUIREMENT

TECHNICAL REASONS

A fuse in a mains lead is a totally different proposition from a fuse in a H.T. or G.B. lead. In the mains lead it is unsound to use a lower rating than 1 amp, because the mere switching on and off of current creates a surge which might easily blow a fuse of lower rating. Further, in a mains lead, fuses should always be more than 1 in. long, to make arcing impossible. In H.T. and G.B. leads and rectifier circuits, on the other hand, it is unnecessary for fuses to go beyond 1/2 amp, even with multi-valve sets. Nor need they be longer than 1/2 in., even with a powerful H.T. supply. H.T. fuses should be kept as short as possible, for the fine high-resistance wire is liable to act as a coupling between the circuits and to set up "motor-boating" if too long.

That is why Belling-Lee now make their fuses in two lengths: H.T. ratings (60 m/a., 150 m/a., and 1/2 amp), 1/2 in. long; mains ratings (1, 2, and 3 amp), 1 1/2 in. long.

Spare fuses of all ratings are sold at 6d. each.

BELLING-LEE
FOR EVERY RADIO CONNECTION

Advt. of Belling & Lee, Ltd., Queensway, Ponders End, Mdx.

The No Substitute Kit
IMMEDIATE DELIVERY

DUAL RANGER

The Author's Kit FITS the FREE BLUE PRINT

PILOT AUTHOR'S KIT

The No Substitute Kit

As chosen and first specified by the Technical Department of Popular Wireless. Officially approved, therefore, by an established technical authority you can trust implicitly.

Backed by Peto-Scott himself, twelve years' Radio Experience and a world-wide reputation. Enables the Author's published Set to be duplicated exactly in every respect.

EXPRESS KIT SERVICE

PRICE LIST

CHECK this list of parts with the Author's specification, photographs and diagrams on pages 361-362 of October 17th issue.

1 Panel, 16" x 8" x 1"	8 9
1 Baseboard, 10" deep	1 6
2 Telsen '0005-mfd. condensers with slow-motion dials	14 0
1 Ready Radio '0005-mfd. solid dielectric condenser	3 6
2 Ready Radio 3-point wave-change switches	3 0
1 Telsen on-off switch	1 0
1 Telsen '0001-mfd. differential reaction condenser	2 0
1 "P.W." and "M.W." dual range coil	12 6
1 Goltone '002-mfd. max. compression condenser	1 3
1 Igranic 1-mfd. fixed condenser	1 6
1 Ferranti '0005-mfd. fixed condenser	1 6
1 T.C.C. '001-mfd. fixed condenser	1 10
1 T.C.C. 1-mfd. fixed condenser	2 10
1 R.I. P.J.3 coil	2 6
1 Peto-Scott ready wound coil quoit	2 0
1 Screen, 10" x 7", with hole for S.G. valve	2 9
1 Graham-Farish 2-meg. leak and holder	1 4
2 Lewcos and Varley H.P. chokes	9 6
1 Lotus L.F. transformer, ordinary ratio	5 6
1 Bulgin 50,000 ohms Spaghetti resistance	1 9
1 Terminal strip, 16" x 1 1/2"	2 0
1 Bulgin 25,000-ohm Spaghetti resistance	1 6
9 Beiling-Lee Type R indicating terminals	2 3
Glazite, flex, screws, etc.	3 0
1 Bulgin crocodile clip	2 2
1 1.5 G.B. battery for S.G. valve	9
Author's Kit "A" Cash or C.O.D.	£4 8 2

COMPLETE KIT PRICES

KIT "A" Author's Kit less Valves and Cabinet **£4.8.2**

CASH or C.O.D. or 8/1 down and 11 monthly payments of 8/1

Kit "B" Author's Kit with Valves less Cabinet **£6.7.2**

or 11/3 down and 11 monthly payments of 11/3

Kit "C" Author's Kit complete with Valves and Cabinet **£7.8.2**

or 13/7 down and 11 monthly payments of 13/7

PILOT RADIO KIT PRICE CHART FOR OTHER FAVOURITE P.W. SETS

ITEM NO.	SET.	KIT "A," less Valves and Cabinet.	KIT "B," with Valves less Cabinet.	Kit "C," complete with Valves and Cabinet.
50	P.V. STAR (Author's Kit)	CASH or C.O.D. £5 11 11 or 10/3 down and 11 monthly payments of 10/3	CASH or C.O.D. £7 10 11 or 13/10 down and 11 monthly payments of 13/10	CASH or C.O.D. £8 18 5 or 16/4 down and 11 monthly payments of 16/4
51	P.V. PLUS (Author's Kit)	CASH or C.O.D. £4 7 8 or 8/- down and 11 monthly payments of 8/-	CASH or C.O.D. £6 6 8 or 11/7 down and 11 monthly payments of 11/7	CASH or C.O.D. £7 6 8 or 13/5 down and 11 monthly payments of 13/5
52	B.P. THREE (Author's Kit)	CASH or C.O.D. £5 13 1 or 10/5 down & 11 monthly payments of 10/5	CASH or C.O.D. £7 0 7 or 12/11 down & 11 monthly payments of 12/11	CASH or C.O.D. £7 18 1 or 14/6 down & 11 monthly payments of 14/6
54	COMET 3 FOUNDATION CIRCUIT	CASH or C.O.D. £4 0 0 or 7/4 down & 11 monthly payments of 7/4	CASH or C.O.D. £5 7 6 or 9/10 down & 11 monthly payments of 9/10	CASH or C.O.D. £6 7 6 or 11/8 down & 11 monthly payments of 11/8

DUAL RANGER C.O.D. ITEMS

Pay the Postman, we pay all post charges.

- 2 Telsen '0005 mfd. condensers with slow-motion dials 14 0
- Coll Equipment comprising "P.W." and "M.W." Dual-Range Coll, Peto-Scott Ready Wound Coll Quoit and 1 R.I. P.J.3 Coil - - - 17 0
- 3 Valves as specified: Metallised S.G., Osram H.L.2, and Mazda P.220 - - - £1 19 0
- 1 Cabinet as specified £1 1 0

TRADE NOTE

Any reputable Dealer will gladly supply you with a PILOT AUTHOR'S KIT for The Dual Ranger. Don't accept a substitute kit made up of substitutes.

Send 6d. in stamps for new 116-page Radio Buyer's Guide.

EXPRESS ORDER FORM

To PETO-SCOTT CO. LTD. Please send me C.O.D./CASH/H.P.

for which I enclose Cash/H.P. Deposit £ s. d. Name..... Address.....

P.W. 31/10/31

★ Any parts supplied separately if value over 10/- . Sent carriage paid or C.O.D. All post charges paid.

C.O.D. CASH H.P. as usual



PETO-SCOTT CO. LTD. Head Office: 77, CITY ROAD, LONDON, E.C.1. Clerkenwell 9406, 62, HIGH HOLBORN, LONDON, W.C.1. Chancery 8266. MANCHESTER: 33, WHITELOW ROAD, CHORLTON-CUM-HARDY. Phone: Chorlton-Cum-Hardy 2023. NEWCASTLE, STAFFS: 7, ALBANY ROAD.

EVERYTHING NEW IN RADIO

IMMEDIATE DELIVERY

**C.O.D.
CASH
H.P.**
as usual

WE are the largest and oldest established Radio House in the Country, and in sending your orders to us there is no risk of delay. Orders executed on our famous 3-WAY PLAN—C.O.D., CASH or H.P. Express Service for everything Radio Guaranteed.

New 116-page Catalogue 6d., post free

MANUFACTURERS' KITS

COSSOR MELODY MAKER

Type 234.

10/- DOWN

● Screened-grid, detector and power. Complete with specified valves and cabinet.

Balance in 11 monthly payments of 12/6
Cash Price £6:15:0

FINISHED INSTRUMENT

Royalties paid.

Cash only £7:10:0

SIX-SIXTY CHASSIKIT (Battery Model). Complete three-gang band-pass tuning. S.G., Det., and Pentode. Send Cash Price, with Valves less cabinet. 12/7
£6:17:6. Balance in 11 monthly payments of 12/7.

Finished instrument with (10/6) Cabinet and valves. Royalties paid, £8:3:0. Cash only.

SIX-SIXTY CHASSIKIT (A.C. Model). Complete as above with A.C. Mains Valves. Cash Price, with Valves less Cabinet, £7:6:6. Balance in 11 monthly payments of 13/5.

Finished instrument, with Cabinet (10/6). Royalties paid, £8:12:0. Cash only.

DYNAPLUS SCREENED THREE: Send Screened-Grid, Detector and Pentode. Kit "A" (less Valves and Cabinet). Cash or C.O.D. £3:12:9. Balance in 11 monthly payments of 6/10. only

V 3 KIT RADIO FOR THE MILLION 10/- DOWN

○ Powerful, selective and ultra modern. Employs screened-grid, detector and power valves. With valves, less cabinet.

Balance in 11 monthly payments of 10/10.
Cash Price £5:17:6

FINISHED INSTRUMENT

with valves and cabinet. Royalties paid. Cash only. £7:8:6

EXPRESS ORDER FORM

To PETO-SCOTT CO. LTD.,
Please send me C.O.D., CASH/H.P.

for which I enclose
Cash, H.P. Deposit £ s. d.

Name.....
Address.....

P.W. 31/10/31.

EKCO H.T. UNIT. Type A.C.25. For multi-valve sets requiring up to 25 m/a. 3 tappings. S.G., detector and 120/150 volts. For A.C. mains. Cash or C.O.D. Price £3 17s. 6d. Balance in 11 monthly payments of 7/1.
Send 7/1 only

ATLAS A.C. ELIMINATOR TYPE A.C.244. 3 tappings—S.G., detector, power. Output 120 volts at 20 m/a. Cash Price or C.O.D. £2:19:6. Balance in 11 monthly payments of 5/6.
Send 5/6 only

REGENTONE W.5A COMBINED H.T. ELIMINATOR AND TRICKLE CHARGER. One Adjustable S.G., 1 variable and 1 fixed tapping for H.T. L.T. charging for 2 and 6 volts. For A.C. mains. Cash Price £4:12:6. Balance in 11 monthly payments of 8/6.
Send 8/6 only

REGENTONE ELIMINATOR, TYPE W.1F. Three tappings, S.G., Detector, and Power. Output 120 volts at 12 m/a. A.C. Mains. Cash Price £2:7:6. Balance in 5 monthly payments of 8/4.
Send 8/4 only

AMPLION M.C.6 MOVING-COIL SPEAKER, permanent magnet, with output transformer. Complete. Cash Price, £3:7:6. Balance in 11 monthly payments of 6/2.
Send 6/2 only

CELESTION PERMANENT MAGNET MOVING-COIL SPEAKER. Type R.P.M.8. 8" Reinforced Diaphragm, in Chassis form without input transformer. C.O.D. or Cash Price, £3:10:0. Balance in 11 monthly payments of 6/5.
Send 6/5 only

BLUE SPOT PERMANENT MAGNET MOVING COIL SPEAKER. Complete with input Transformer. Cash Price, £3:15:0. Balance in 11 monthly payments of 6/11.
Send 6/11 only

W. B. PERMANENT MAGNET MOVING-COIL SPEAKER P.M.3. Complete with 3-ratio input transformer. Cash Price, £2:12:6. Balance in 11 monthly payments of 4/10.
Send 4/10 only

R. & A. PERMANENT MAGNET MOVING-COIL SPEAKER. Complete with multi-ratio input transformer. Cash Price, £2:17:6. Balance in 11 monthly payments of 5/4.
Send 5/4 only

EPOCH A2 PERMANENT MAGNET MOVING-COIL SPEAKER. Fitted with multi-ratio input transformer. Cash Price, £3:3:0. Balance in 11 monthly payments of 5/9.
Send 5/9 only

NEW B.T.H. "SENIOR" PICK-UP AND TONE-ARM. Complete. Cash Price £2:5:0. Balance in 11 monthly payments of 4/2.
Send 4/2 only

PILOT PERMANENT MAGNET MOVING-COIL SPEAKER



Matches the requirements of all modern receivers. Includes a Unit designed and built specially for Peto-Scott by Epoch. Handles the smallest to the greatest input, and brings out most minute details of tonal quality with pure, full volume. A multi-ratio input transformer is fitted and provides for matching to all super-power and pentode valves. The handsome hand polished solid oak cabinet is built to give added depth of tone, and is fitted with ebonised base and side wings and silk covered fret.

£3:15:0 or 12 monthly payments of 8/11.

VOXKIT RADIOGRAM CABINET MODEL 1932 Accommodation for largest of Home-built receivers with a full size speaker as well as mains and battery equipment. Complete with motor board.



Dimensions overall 39" high x 22" wide x 17" deep. Baseboard 18" x 14 1/2". Speaker chamber 18" x 14 1/2" x 16". Panel 12 1/2" between moulding.
£4:10:0 or 12 monthly payments of 8/3

VOXKIT 1932 CONSOLE (Radio only) Almost identical in appearance with the 1932 Voxkit Radiogram designed for Radio only. Dimensions 37" x 15 1/2" x 22" wide. Panel 18" x 7". Baseboard 18" x 12". L.S. compartment 18" x 14" x 12". Control Panel 12 1/2" wide.

OAK £3:15:0 or 12 monthly payments of 8/11.

KELSEY SHORT-WAVE ADAPTOR Adds more stations to your set. Nothing more to buy — no valves or any extras. Plugs direct into your battery or eliminator-operated receiver. Receives short waves from all over the world. Easy to operate. Send C.O.D. Postage free, or from your usual dealer. Mahogany cabinet, 7/6. C.O.D. Pay the postman, 37/6

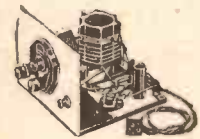

SPECIALLY RECOMMENDED

EPOCH J.1 PERMANENT MAGNET MOVING-COIL SPEAKER, with multi-ratio input transformer. Cash Price, £2:5:0. Balance in 11 monthly payments of 4/2.
Send 4/2 only

GARRARD INDUCTION GRAMOPHONE MOTOR. Model 202. D.C. Mains only. Mounted on 12-in. Nickel Motor Plate with fully automatic electric starting and stopping switch. Cash Price, £2:18:8. Balance in 11 monthly payments of 5/4 only.
Send 5/4 only

BLUE SPOT DYNAMIC TYPE SPEAKER UNIT AND CHASSIS. Type 100U. Cash or C.O.D., £1:19:6. Balance in 7 monthly payments of 5/5.
Send 5/5 only

ORMOND PERMANENT MAGNET MOVING-COIL CHASSIS (No. 464). With input transformer. Cash Price £3:5:0. Balance in 11 monthly payments of 5/11.
Send 5/11 only

ROLA PERMANENT MAGNET SPEAKER. Complete with Input Transformer. Cash Price, £2:17:3. Balance in 8 monthly payments of 7/1.
Send 7/1 only

PETO-SCOTT

PETO-SCOTT CO., LTD. Head Office: 77 CITY ROAD, LONDON, E.C.1. Clerkenwell 9406. 62 HIGH HOLBORN, LONDON, W.C.1. Chancery 8266. MANCHESTER: 33 WHITELOW ROAD, CHORLTON-CUM-HARDY. Phone: Chorlton-cum-Hardy 2028. NEWCASTLE TAFFS.: ALBANY RD Phone: 67100

TELSEN 1932 CIRCUITS

IMMEDIATE DELIVERY
NOW SUPPLIED AS PILOT AUTHOR KITS
C.O.D. CASH H.P. *as usual*

THE TELSEN 'CONQUEROR' THREE

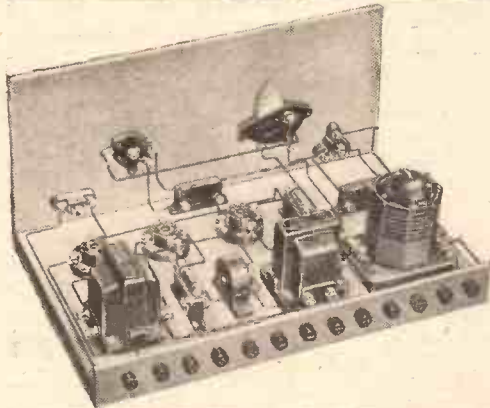

Kit contains all parts exactly as specified by Telsen. Also beautifully finished Oak panel ready drilled; baseboard; ebonite terminal strips; Clix terminals; connecting wire and screws, nuts, bolts, etc.

Kit "A" Author's Kit less valves and cabinet.
 CASH or C.O.D. **£1 19 9**
 or 9 monthly payments of **5/-**

Kit "B" with valves less cabinet.
 Cash or C.O.D. **£3 7 3**
 or 12 monthly payments of **6/2**

Kit "C" with valves and cabinet.
 Cash or C.O.D. **£4 4 9**
 or 12 monthly payments of **7/9**

Any parts supplied separately. If value over 10/-, sent Carriage Paid or C.O.D. We pay all post charges.

THE TELSEN 'COMMODORE' S.G. THREE

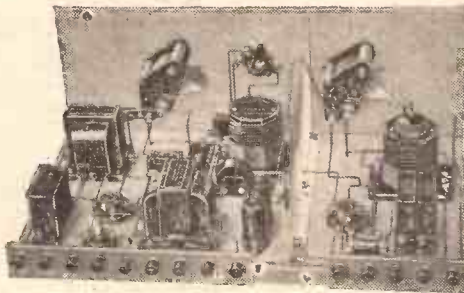

Kit contains all parts exactly as specified by Telsen. Also beautifully finished Oak panel ready drilled; baseboard; ebonite terminal strip; Clix terminals; connecting wire and screws, nuts, bolts, etc.

Kit "A" Author's Kit less valves and cabinet.
 CASH or C.O.D. **£4 5 5**
 or 12 monthly payments of **7/10**

Kit "B" with valves less cabinet.
 Cash or C.O.D. **£6 7 5**
 or 12 monthly payments of **11/8**

Kit "C" with valves and cabinet.
 Cash or C.O.D. **£7 4 11**
 or 12 monthly payments of **13/3**

Any parts supplied separately. If value over 10/-, sent Carriage Paid or C.O.D. We pay all post charges.

SEND 3d. in Stamps for FREE TELSEN BLUEPRINT GIVING FULL LIST OF PARTS, DIAGRAMS AND LAYOUT OF ABOVE SETS.

THE TELSEN 'SONGSTER' TWO

Kit "A" Author's Kit less valves and cabinet.
£1 11 9
 or 7 monthly payments of **5/-**

THE TELSEN 'Air-Marshall S.G.4'

Kit "A" Author's Kit less valves and cabinet.
£4 16 4
 or 12 monthly payments of **8/10**
 Prices of Kit "B" and Kit "C" upon request.

Peto-Scott Cabinets for Telsen Kits.

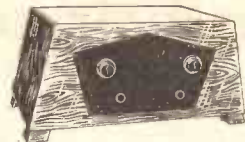

TABLE TYPE (with beautifully finished Oak Panel ready drilled).
 Conqueror Three Model **17/6**
 Commodore S.G. Three Model

CONSOLETTA TYPE.
 (with beautifully finished Oak Panel readydrilled. Speaker Compartment takes up to 12" diameter cone).
 Conqueror Three Model. "Commodore" S.G. Three Model. **35/-**

Fitted Telsen L.S. Unit & Chassis 11/- Extra.

EXPRESS ORDER FORM
 To PETO-SCOTT CO. LTD.
 Please send me C.O.D./CASH/H.P.

for which I enclose
 Cash/H.P. Deposit . £ s. d.

Name

Address

P.W. 31/10/31

PETO-SCOTT

PETO-SCOTT CO. LTD. Head Office: 77, CITY ROAD, LONDON, E.C.1. Clerkenwell 9406. 62, HIGH HOLBORN, LONDON, W.C.1. Chancery 8266. MANCHESTER: 33, WHITELOW ROAD, CHORLTON-CUM-HARDY. Phone: Chorlton-Cum-Hardy 2028. NEWCASTLE STAFFS: 7, ALBANY ROAD.



BATTERY MODEL

£6.15

Price includes latest types of Cossor Metallised Screened Grid, Cossor Detector and Power Valves, handsome oak cabinet and all parts necessary for home assembly of the complete Receiver (as illustrated at left) which is so simple that it can be easily built by anyone—even if they know nothing about Wireless.

*Five Purchase terms
15/- deposit and 9 month-
ly payments of 15/-*

All-British

**—latest
Screened
Grid circuit**

NO matter how much you pay you cannot buy a more powerful 3-valve Receiver than the Cossor Empire Melody Maker.

This remarkable Set incorporates all the most up-to-date features of design—latest screened grid circuit—completely screened coils—series aerial condenser—external wave-change switch and all-metal baseplate. Its range is enormous. Its selectivity



**ALL-ELECTRIC
MODEL**

£9.19.6

Price includes handsome oak cabinet, latest type Cossor Metallised Screened Grid Mains Valve, Cossor Metallised Mains Detector, Cossor Mains Power Valve and Cossor Rectifier, Cossor Heavy-duty Mains Transformer, all the parts necessary for assembling the complete Receiver (as illustrated above) and full size Constructional Chart.

*Five Purchase terms:
20/- deposit and 10
monthly payments of 20/-*

is remarkable. It will bring in all the main European programmes even while your local station is working.

The Cossor Empire Melody Maker is available in two types—Model 234 for use with batteries and accumulator and Model 235 which works from the electric light mains. Send at once for full particulars of the model that interests you—use the coupon below.

**Cossor
EMPIRE
Melody Maker**

MODELS 234 & 235



A. C. COSSOR LTD.
Highbury Grove, London, N.5.
Depots at Birmingham, Bristol,
Glasgow, Leeds, Liverpool,
Manchester, Newcastle
Sheffield and Dublin.

**Use this
coupon**

To Messrs. A. C. Cossor, Ltd. (Melody Dept.), Highbury Grove, London, N.5
Please send me free of charge a Constructional Chart which tells me
how to assemble the Cossor Melody Maker.
(Fill in type required, viz. Battery operated or All-Electric).
Name
Address

Popular Wireless

LARGEST NET SALES



Scientific Adviser:
 Sir OLIVER LODGE, F.R.S.
 Chief Radio Consultant:
 CAPT. P. P. ECKERSLEY, M.I.E.E.
 Editor: NORMAN EDWARDS.
 Technical Editor: G. V. DOWDING, Associate I.E.E.
 Assistant Technical Editors:
 K. D. ROGERS, P. R. BIRD,
 A. JOHNSON RANDALL.

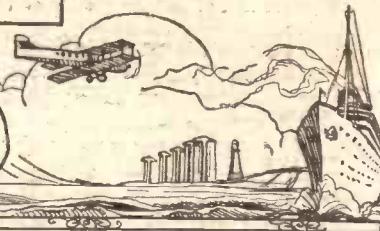

**A TRUE FRIEND
 HONOUR TO EDISON
 THE PORTABILITY OF
 PORTABLES**

RADIO NOTES & NEWS

**HOME CONSTRUCTION
 THE "JOCK" OF
 KHARTOUM
 AN INDIAN TRAGEDY**

A True Friend.

TALKING of the great drive against radio "pirates," a postal official told me of an amusing story of a biter who was bitten. Someone, somewhere, wrote to a certain local postmaster complaining that a "friend," next door was interfering by "howling."

A little later he wrote and said that a friend a few doors away on the other side was also a "howler." So the Post Office sent its stern-faced men to investigate, and while they were on the spot they took the opportunity to ask the "squealer" about his licence. *He hadn't one!*

Honour to Edison.

THOMAS ALVA EDISON, the grand old man of American inventions, has passed away. A worker to the end, a fine character, his life an inspiration for us all, he has gone to his own place, leaving the world poorer because of his absence, but the richer because of his sojourn here. He was modest, as the best men are; extravagant claims were sometimes made on his behalf by American admirers, but he never echoed or adopted them.

He was not a scientist of the front rank; in compensation for that he was enabled to help humanity in ways which humanity understands and appreciates more, perhaps, than it does epoch-making theories.

"P.W." humbly lays this tribute at his feet.

Home Construction.

THE answer to those people who ask whether home construction is worth while is to be found in (1) "P.W.'s" circulation; (2) "The Wireless Constructor" for November, and many other phenomena. In "The Wireless Constructor" there is an article about this question which may make you all the keener to carry on with the jolly old drill and file and screw-driver.

Besides that, you get practical articles on the making of the "I.E." Three—"one-dial tuning, no wave-change switching," and signals from all over the world; the D.C. "Ace," an all-mains two, giving three-valve results for drive cost of about 2s. 6d. a month, calculated on a four-hour day.

What about that for a sixpenny magazine—and there's lots more good meat in its pages!

The Portability of Portables.

I READ all the radio "trade" organs, and it is simply amazing to see how many thefts of portable receivers are recorded therein. Formerly I thought I was up against an advertising ramp; now I see

EXCELSIOR!



Here's an example for you! She didn't believe the insulators were quite clean enough, so—waiting till Mother was looking the other way—up she went!

that the portable is designed by providence to be the prey of radio gangsters.

Well, we must design a portable which, on being scrounged, will fire a Véry light, take a photograph and fingerprint record of the thief, and make chalk marks on the

route to the robbers' den, afterwards making a noise like "intoxicating liquor after 10 p.m." and firing a minute-gun.

The "Jock" of Khartoum.

I CAN assure H. R. H. (Khartoum), of the gallant Middlesex Regiment (he would be a Jock), that his letter has given us all keen pleasure, and Ariel an extra bit. We all hope that when the Second Battalion arrives home all its members will have the time of their lives.

H. R. H. went abroad in 1921, and did not hear a radio broadcasting set till 1928. Such is the price of Empire, the White Man's Burden, etc.

Jock's Choice.

H. R. H. (and what a nice set of letters) having begun (like all of us, by the way) with no knowledge of radio, studied "P.W." till he reached "Magic" Four standard. He says that the more he pulls that set down and rebuilds it the better it works.

He is going to try "Comet" Two, and after that the "New Coil" Five. Always glad to hear from him when there are startlers to report, and his kind Christmas wishes are reciprocated heartily.

An Indian Tragedy.

THERE are persistent reports that in the interests of economy the Indian State Broadcasting service is to be closed. That will delight the folk who have bought receivers, charm the traders with stocks of radio goods, put a lot of people out of work, and generally throw oil on India's troubled waters. Incredible folly!

I maintain, as I have done before, that the Indian radio service ought to be used far more, even at the cost of a subsidy from Imperial funds, than it ever was, and used against the thugs and law-breakers.

The Big "Bottle."

THE world's first valve weighed, I suppose, a few ounces. The very latest design, evolved by Metropolitan-Vickers, weighs nearly one ton; it is made of porcelain and steel, and has an output of somewhere round about 500 kilowatts, or, say, 670 horse-power.

With an output of that order of magnitude, they are saying, the broadcasting of

(Continued on next page.)

NEWS—VIEWS—AND INTERVIEWS (Continued)

power is brought nearer, though there yet remains the problem of how to pick up and use the power.

(An article on this latest radio wonder appears on another page of this week's "P.W.")

Pictures to Italy.

ALL things considered, the idea of sending pictures to Italy, who has given so many great pictures to humanity, is almost comic. However, such is progress, that the Postmaster-General has arranged a picture-telegraphy service with that country, the normal hours between London and Rome being 7 a.m. to 10 a.m., and 6 p.m. to 11 p.m. on weekdays, and 6 p.m. to 11 p.m. on Sundays.

Shades of the Romans, who colonised us for four centuries! How they would have loved to receive pictures of "our Marcus" in his uniform on the Wall at Londinium, or "the Emperor slushing the Picts in Northumbria."

Gramophone Note.

VERY rarely do I permit myself to recommend gramophone records to "P.W." readers, because tastes vary so widely. But I should like to mention "Francesca da Rimini" and "Suite No. 3 in G. Theme and Variations," both by Tchaikovsky. Gummy! They made me wriggle my toes with excitement and pleasure.

The wild sweep of the strings, the blood-rousing call of the brass! Such clean, brisk stuff. A middlebrow's ecstasy, perhaps, but I stand by Tchaikovsky. He is not a bit like Mr. Mossolov, who slung together that chunk of machinery noise.

The Tar Baby.

NEVER since I read the adventures of Brer Rabbit and the Tar Baby have I been so diverted as when I read the instructions of "Phyvenno" to his readers of the "Evening World," that they should coat their aerials with tar. Verily, their children will rise up and call him—

(hem!). I ask you! Imagine yourself with a coil of wire and a cauldron of tar. Just try it! Says "Phyvenno": "You must give it a coat of tar. Dip it in a bucket of tar and then let it drain and dry." Yes, please do! Says "Phyvenno": "If it has a lot of tar on it, it won't matter; let it stay on." I'll bet you will! And when you have a lot of tar on your hands, try methylated spirit.

In Defence of the B.B.C.

AT Worcester, early this month, Mr. Stanley Baldwin gave the B.B.C. some sauce. He said, "We have lived to a day when most of us try to talk

like the B.B.C." That, by the way, is wrong. We don't care how the B.B.C. talks so long as it is grammatical and polite.

Mr. Baldwin continued, "And, in the sacred name of progress, our language is gradually being formed on the model of the captions of the Hollywood films." That is in no way the fault of the B.B.C., which has exerted nothing but a good influence on its public in the matter of spoken English.

SHORT WAVES.

"Radio for Colney Hatch," runs a headline in the "Sunday Express."
"Here, here!" says we.

SUCH LANGWIDGE!

The following is an extract from a resident in Lagos:
"I am also blasted in my hopes of receiving England legibly for the reason that these damped atmospheric blasts all out, blast being science word meaning obliterate. You may not be so damped surprised to know that the gramophone here finds large favour, for it cannot blast."

We hear that one of the largest life insurance companies in America is responsible for the "keep fit" homilies with which the American business-man's loudspeaker greets the dawn.
"We like our clients to live as long as possible," an official of the company explained, "and the radio talks each morning encourage them to try."

"Wire you in-su-late?"
"Been out with my Gal-Ena!"

Speaking of the Radio Exhibition at Olympia the other day, one "wireless widow" remarked: "If they do discover a wireless set that will get any station in the world without difficulty, I'm sure my husband won't look at it. He likes difficulties."

"Musical Pillow. Radio novelty that lulls one to sleep," we read in the "Sheffield Independent."

That's no novelty in our house—especially during the Sunday programmes.

Husband: "It's some time since we had an evening at home together, my dear. I think I'll stay in this evening and listen to the radio."

Wife: "Well, if you want to listen to the radio you'll have to go out, my love. You may be able to hear it if you stand outside the pawnshop long enough."

The So-Called "Ghost Van."

SOMETHING approaching the dignity of a mystery is gradually surrounding the itinerant radiation-detectors which the Post Office is navigating here and there where "pirates" do congregate. The "News of the World," generally immune from my criticism, lets itself go too far when it says that the famous van can detect the presence "of unlicensed aerials, either indoor or outdoor."

I know of no electrical device which can determine whether a man has paid his taxes (dog water or radio), and I don't believe the Post Office can do it. All the "van" can do is to ascertain the presence of a radiating wire.

Applied Psychology.

ALL the same, I am not so certain that it is so sensitive or discriminating a direction-finder as we are led to suppose, and I am strongly inclined to think that this campaign, which is so ably supported by the Press, is largely a matter of

"bluff"—or, shall I say, applied psychology.

Moreover, as there are so many unemployed, would it not be just as efficacious to organize a huge house-to-house canvass by authorised inspectors drawn from the ranks of the workless? Altogether I do not quite like the flavour of this detective work, for it is too much like espionage. Perhaps we have got the licence business on the wrong basis.

Radio Missionaries.

INSPIRED by imagination which deserves a rich reward are the promoters of a new enterprise in the form of a company called "Pacific Radio, Limited." This firm, £100 strong, is to stock a motor vessel with short-wave receivers for sale to planters on the multitudinous islands of the South Pacific. Good luck to the venture. It's a far cry from Captain Cook to Captain Eckersley, but the world wags apace, my masters, and radio has penetrated to all corners of the world, so why not into all the cracks and crannies?



Relay News.

Opposition on the part of town councils to the proposals of firms desiring to establish radio relay (or re-diffusion) service has assumed various forms; in some instances, apparently, pure ignorance, in others, dread of an innovation, in others, terror of overhead wires and, in others, pressure by local radio dealers. But quite a new excuse has been found by Taunton. It was considered that the Council would get more money from the radio dealers in the town, in the shape of rates and for payment for current used up in charging batteries or running sets, than from the relay company. Why, this beats the financial genius of the Mayor and Corporation of Hamelin as evinced by their dealings with the Pied Piper!

Wireless Fox-Hunting.

IT is reported that in connection with a radio display at Pardubice, Czechoslovakia, wireless is to be used on aeroplanes to signal to valiant huntsmen in motor-cars the position of a fox, which will then be hunted by the aforesaid heroes till it is killed! I'm sorry! Radio has done so much that is useful and pleasant that to turn it to the purpose of assisting a small animal to be harried to death hurts my pride in the nobility of the human being. My full and uncensored opinion of fox-hunting by horse and hound alone would not be printed by any editor I have ever met or worked for. My opinion of a radio fox hunt would singe the very paper.



ARIEL.

HOW MANY BANDS DOES A BAND-PASS?

By Capt. P. P. Eckersley M.I.E.E.



Our famous contributor refuses to take things for granted and points out some often-overlooked snags in the applications of band-pass circuits.

DOES the band-pass pass too many bands? And how many bands will a band-pass pass if a band-pass does pass bands?

All of which is a way of asking whether some people haven't gone band-pass mad before asking themselves whether the thing has a hope of doing what they delude themselves into thinking it's doing.

I know we tried the idea out in the B.B.C. four or five years ago. It was Mr. Wilson who suggested the idea, but I expect even he won't claim absolute originality. I remember my brother writing out the theory of coupled circuits in 1905, using two pendulums, a piece of string to connect their supports, and one to count beats and hold a stop-watch. How time flies!

Why It Was Abandoned.

We abandoned the idea in the B.B.C. simply because it was so difficult to adjust a band-pass circuit. It was like one of those mercury puzzles where you have to get two equal bits of mercury into two little equal symmetrical holes; there's always too much in one or the other, or the mercury's careering about anywhere.

That was the state of affairs when each tuned circuit had to be adjusted separately by means of two separate condensers. Then the ganged condensers came along and, of course, the problem to keep the two circuits identical appeared solved, and people set about "band-passing" once more.

Now, the whole theory of the band-pass is based upon coupling two circuits of really identical L.C. value together so tightly as to produce the double hump effect. But the circuits surely must have identical "L.C." value. It is, I suppose, possible to get two separate inductances pretty closely matched.

About These Trimmers.

How much they vary with temperature, I do not know; but this is a problem with wave-meter work where accuracies of up to one in ten thousand are required. But now let us think of this condenser. Each of the units must, in theory, be the same. What

are they in practice? What are the requirements, anyway?

I suppose, at most, you require the two units of a ganged condenser to give you a difference of *not* more than 1,000 cycles between the two circuits they tune. But at a million cycles (300 metres) this is 1,000 parts in a million, or one in a thousand, or one-tenth of 1 per cent.

Shorter waves than 300 metres *are* used, and at 200-metres wave-length we require an accuracy between units of the condenser of one-fifteenth of 1 per cent. So here is a mechanical arrangement in constant use,



TAKEN AT TALLIS HOUSE.—A recent photo of "P.W.s" Chief Radio Consultant.

"P.P.E."

cheap, subject to large temperature variations, possible strains through warping of the panel which mounts it, asked to keep an accuracy, day in day out, of one-tenth of 1 per cent.

"Ah," say you, "of course, it can't do that." I quite agree; that's why we fit "trimmers," so that the user gets about right and then adjusts his "trimmer" thereafter. Well, that's all right, but good-bye to single adjustment and, bless me! good-bye to band-passing, surely!

How do you know by "trimming" whether you've got the exact square top? You may be distorting the characteristic, anyhow. You have gone away from band-passing. You're just messing about and calling it band-pass!

Experiments with "P.W."

No! I think that all it is is that people are getting some sort of coupled-circuit arrangement! And coupled circuits are essential in modern technique for many of the simpler sorts of receiver. So by all means *call* it band-pass, but ask how many bands does the band-pass pass if the band-pass does pass bands!

And what is my solution? I'll be hanged if I tell you yet, but I'm carrying out a few experiments with the Technical Staff of "P.W.," and we're feeling fairly satisfied, so far.

One thing I will say (and I have been saying it a bit lately): you cannot, I think, solve the problem of selectivity (which is the great problem, even on the local, to-day) by making coils tiny and calling them by a fancy name.

I may be wrong—I am always willing to be wrong; it would be such a new sensation—but I cannot see a circuit giving cheap price, small size, and the elimination of all side-band going in a medium local station field all at once. Get the European plan changed.

Wanted—a Curve.

Yes; then we can think again. At present I do not see the royal road to success. I think we can approach it, but if you bar that road by saying everything has got to be tiny and compact and cheap, and only one adjustment, and made up at home, and—well, it can't all be done, not even by calling it band-pass!

Now let's have an adequate, reasoned reply. All that will convince me is a "curve" of a typical band-pass circuit certified and found correct (and, of course, at every wave-length!).

All
The Leading Radio Writers
contribute to

MODERN WIRELESS

Britain's Leading Radio Magazine.

AMERICA'S GREATEST INVENTOR

A TRIBUTE TO THOMAS ALVA EDISON

By LAWRENCE W. CORBETT.

A BULLETIN in my evening paper a few days before his death reported a surprising rally in the condition of he who will always be regarded as one of the world's greatest inventors. "His vitality is 'amazing,'" continued the wireless report of the health of Thomas Alva Edison.

To those who knew him, and admired his vigour, it came as no surprise that a courageous battle against the inevitable should mark his sad yet serene departure from this life. And with this departure we lose one of the greatest benefactors to science and to mankind that the world has ever known, a man whose capacity to overcome the countless problems he set himself was exceeded only by the confidence with which his elders predicted in his youth that he would fail.

His Mother's Faith.

Indeed, the local doctors feared brain trouble, and even his teacher referred to him as "addled." He was fortunate, however, to have a mother who had been a teacher herself, and she believed that in proper hands her son would respond to the same degree as other children. Consequently, she took upon herself the task of instructing the young Edison in the necessary schoolings of life.

Apparently this "addled" youngster was quickly to display appreciation of his mother's efforts and, not altogether with her approval, we find him at the age of eleven already showing a decided interest in chemistry and other scientific subjects.

He had his own laboratory in the cellar, and when twelve years old he took a job as a train newsboy with the object of supplementing his pocket money so that he might have sufficient to continue his laboratory experiments.

These experiments were numerous, for, although he had every faith in the observations of Faraday (in whose volumes he delighted), Edison was never satisfied until he had tried out everything for himself.

An incident he recalled to me when I had the pleasure of meeting him at Orange, New Jersey, in 1926, serves as an amusing reminder of this.

Trying to Hatch Eggs!

"I had been missing from home for some hours," he told me, "and an anxious family organised themselves into a search party to scour the countryside for fear that I had suffered some mishap. I was eventually found quite near home,—in the barn, to be exact, sitting upon a few goose eggs which I had collected. My explanation, that I was endeavouring to emulate the broody hen, and at the same time prove to my satisfaction that eggs could be hatched by merely sitting upon them, failed to appease them."

Edison's aptitude for reading revealed itself at an early date. It was partly on account of a desire to have further access to books that he took on the job as train newsboy, for the route covered lay between his home town of Port Huron and Detroit, and a long daily stay at this latter city enabled him to devote many a leisure hour at the public library.

He had a remarkably retentive mind and rarely forgot anything he read which he believed might later be of use to him.

Many and varied were the incidents of his early life on the train. It was during this part of his career that the first symptoms of his lifelong deafness materialised. He had fitted up a part of the van used on the daily journey as a laboratory and was thus able to conduct his experiments as he journeyed to and fro.

No objections were raised, and Edison spent many a tiresome hour engrossed

HE MADE THE VALVE POSSIBLE



Edison with a modern radio set. It was his discovery of the "Edison Effect" which made possible the three-electrode valve.

in his chemistry as the train rattled over the metals. One day, however, in negotiating a particularly poorly laid piece of track, a jar of phosphorus was thrown from the shelf and set the van on fire.

Little damage was done, but at the next stop Edison was approached by the guard, who picked him up *by the ears*, and threw him off the train together with his belongings. He tells us that from that very day something snapped in his head, and his hearing was thenceforth impaired.

This sudden upheaval was at the time a severe setback to the youngster, whose small business had been unusually successful, and his whole career appeared to be ruined through this one small incident.

Shortly before, however, he had saved

from a runaway brake-van the son of a local station agent, who, in gratification, had volunteered to teach Edison telegraphy, a subject in which he was deeply engrossed.

He was now enabled to redouble his efforts in this direction, and a year or so later, at the age of sixteen, we find him employed as a regular operator in Canada. He spends several years at this occupation in cities all over the United States, and we next meet him arriving penniless in New York in 1869.

Up to this time, Edison's inventive genius is given little encouragement, but suddenly he is tendered the opportunity which sets him on the road to success, and from which there has been no turning. More from charity than anything else, he had been given shelter in the offices of the Gold Indicator Company, an organisation which rendered a skeleton ticker service to a group of subscribers in Wall Street.

The First Cheque.

This was shortly after the Civil War, when gold fluctuations were somewhat violent. The third day after his arrival in New York, the main control instrument went out of order, throwing the subscriber-brokers' offices into pandemonium.

Edison was the only one who could detect the trouble, and he was, as a result, given charge of the plant at the astounding (so it seemed to him) salary of 300 dollars per month. He was thus transformed overnight from a penniless beggar to a well-to-do engineer.

His progress from this time was rapid, and his genius for invention was at last appreciated. At the age of twenty-three Edison received his first payment for an invention (relating to the stock ticker).

He was astonished at being given a cheque by his employer for \$40,000, which, as he often related against himself, he cashed for small notes, which he carried away in a huge bundle. He afterwards sat up all night guarding his wealth, and only discovered on the morrow how simple it was to open a bank account and leave one's money in secure keeping.

With this \$40,000 Edison was able to open small factories in New Jersey, and he shortly had 150 men in his employ making stock tickers and other machines. He was constantly inventing and improving devices too numerous to mention here. One thing that does impress us, however, is the astounding energy of the boy, and, later, the man, Edison.

Indomitable Energy.

Even in his latter days he limited himself to six hours' sleep a night, and often when younger would work for days on end in his workshop, merely snatching an hour's sleep here and there on a wooden bench. He would awake fresh and with

(Continued on page 516.)

"P.V. PLUS" REFINEMENTS

OWNERS of "P.V. Plus" receivers can easily add various refinements to their sets and so make them veritable luxury instruments at little additional cost. And it may so happen that a large number of readers will be so attracted to the "refined" "P.V. Plus" that they will wish to make up the complete outfit. In that case, such constructors should meet with no difficulty at all in working only from the diagrams and photos accompanying this article, together with the full list of components which appears.

* * * * *

If you have a "P.V. Plus" set in your possession you can now add any one or more of four valuable refinements and so make the receiver an ambitious and luxurious radiogram. Further, the following instructions are so presented that new readers can, if so they desire, start right in at the commencement of building this magnificent "P.V. Plus" set.

* * * * *

figures in the original design. It is a rather more complicated switch than the type that is frequently used for pick-up control. But it does suit a number of useful jobs.

In the first place it enables you immediately to change over from records to radio or vice versa. It also functions as an on-off switch. Further, it switches the S.G. valve out of circuit when you are over to records, and so prevents waste of either H.T. or L.T.

New Panel Unnecessary.

You do not require a new panel for the additions, and with care it is possible to do the necessary drilling for the new components without removing the existing panel from the set, merely by tilting the receiver up on to its back and drilling from the front of the panel. But it is a better plan to remove the panel, although you need not remove all the leads from the panel components when you do this.

Even should you decide that you do not want either the Selector coil or the volume control, we still advise you to retain the panel position marked in the panel diagram for the component you do build in.

(Continued on next page.)

PLACING THE PANEL LIGHT

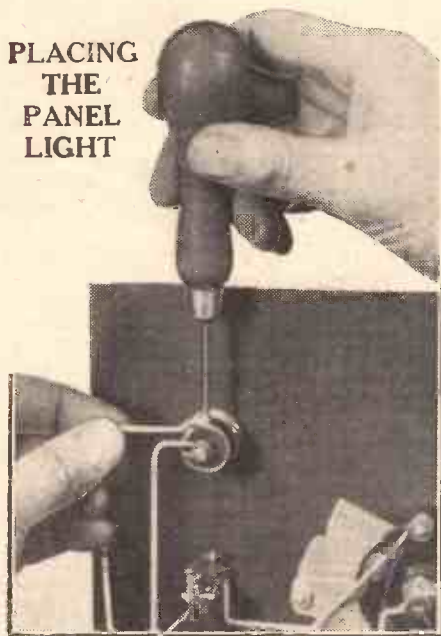

Nothing at all in the original set has to be altered in any way when you add the panel light.

But we will be mainly addressing ourselves to those already in possession of the original set. The main items which are added are a pick-up jack and control switch, an efficient pre-detector volume control, and a "P.W." Selector Coil. There is also a panel light, a most useful device in itself, which serves to balance the panel layout.

Take Your Choice.

Of course, there is no need to incorporate all these things if you feel you do not want them. On the other hand, you can build the items in at different times, incorporating the one now, another at some future date, and so on, a procedure that is in accordance with the popular progressive system invented by our Technical Editor.

And now for a few words about the additions themselves. The "P.W." Selector coil provides more selectivity and greater power on distant station reception. It is very well worth its place in any set of this nature, and its effect is far from being theoretical. You will "hear" it pulling its weight every time you search for foreign programmes. There will be greater volume and an increased flexibility.

Controlling the Volume.

The volume control is of the filament dimming variety, and operates in conjunction with the S.G. valve. It is particularly useful for dealing with local stations. It should be noted, however, that this control is quite independent of the pick-up.

If you desire a pick-up volume control we advise you to employ an external one. That is to say, arrange it in conjunction with the pick-up lead at the turntable end.

We decided to use a jack for the pick-up instead of terminals, as so many constructors prefer to be able to plug a pick-up connection in as desired, rather than have a permanent coupling between the gramophone and the set. However, the pick-up plug can be left inserted just as long as you like, and does not have to be removed when you switch over to radio.

The control switch replaces the simple on-off switch which

STILL GREATER SENSITIVITY

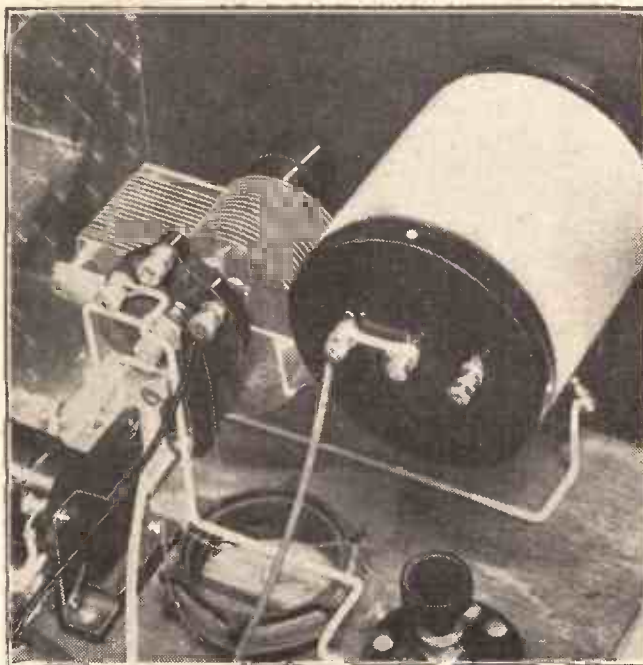

The "P.W." Selector coil contributes still greater sensitivity plus additional selectivity, and is a particularly worth-while refinement.

"P. V. PLUS" REFINEMENTS

(Continued from previous page.)

It is true that greater symmetry would be achieved were this item placed in line with the Extensers, but it might so happen

as possible exactly what modifications have to be made in the wiring.

The Extra Wiring.

The dotted leads are all those present in the existing receiver which do not have to be touched in any way. The hollow leads are the ones which must be removed, and the black leads are the new wires.

ONLY FOUR MORE HOLES TO DRILL

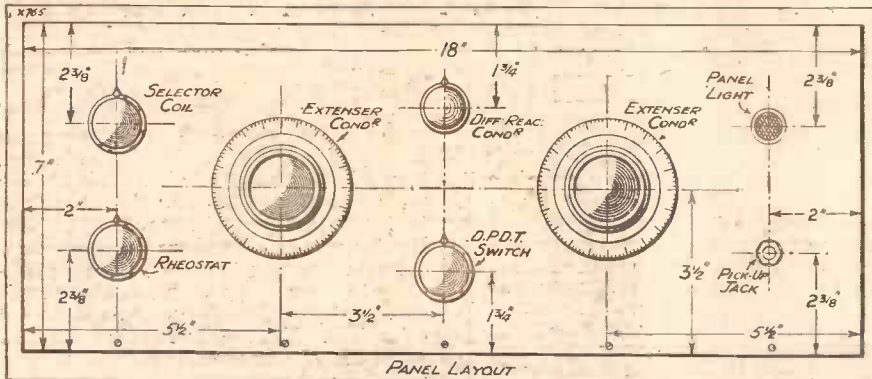

If you add ALL the extras, you will need to drill only four further holes in the panel in accordance with the above revised diagram.

that at a future date you may decide to take advantage of the other refinement. The same applies to the panel light and pick-up jack, although, perhaps, not quite as forcibly.

The revised wiring diagram has been very carefully prepared so as to indicate as clearly

If you are building the "P. V. Plus" for the first time, complete with refinements, all you have to do is to ignore the hollow leads and wire-in both the dotted and black ones.

And now for the additions in detail. If you wish to add the volume control, but

not the pick-up jack there is no need to change the switch. All you have to do is to mount the volume control on the panel and then remove that lead which joins "F" of the S.G. valve holder to the screen (this is shown as a hollow lead in the diagram).

Then connect the slider terminal of the volume control (which is an ordinary filament rheostat, as per the list of components) to "F" on the valve holder, and the other terminal of the volume control to the metal screen.

Alternatively, some of you might want to have the pick-up switching but not the volume control. In this case remove the hollow lead from the valve holder, as before, and join the "G" valve holder terminal to that point on the switch to which the rheostat volume control lead would have gone.

An Easy Addition.

The introduction of the panel light calls for no alteration whatever in the existing wiring. Its two leads are merely joined across the L.T. supply wires of V2. Actually, for sake of convenience, we have taken one of the panel light leads to one of the grid-leak terminals, but it will be seen that this terminal is directly joined to one of the filament terminals of the valve holder via a very short lead, so that the effect is identically the same. It should be noted that it is quite often possible considerably to shorten wiring in such a way as this.

It is a simple matter to fit the Selector coil. The flexible lead with a crocodile

(Continued on next page.)

THE COMPLETE COMPONENT LIST FOR THE REVISED "P.V. PLUS"

- 1 Panel, 18 in. x 7 in. (Peto-Scott, or Goltone, Parex, Permeol, Wearite).
- 1 Cabinet, with baseboard 10 in. deep to fit (Camco, or Pickett, Osborn, Gilbert, Ready Radio, Peto-Scott).
- 2 '0005-mfd. Extensers (Formo, or Cyldon, Wavemaster, J.B.).
- 1 '0001, '00012 or '00015-mfd. differential reaction condenser (Ready Radio, or Telsen, Lotus, Igranice, J.B., Dubilier, Formo, Cyldon, Polar, Parex, Graham Farish).
- 2 Valve holders (Lotus, or Telsen, Igranice, Lissen, Clix, Bulgin, Formo, Wearite, Dario, Graham Farish).
- 1 Horizontal-mounting valve holder (Junit, or Bulgin, Parex).
- 1 1-mfd. fixed condenser (T.C.C., or Telsen, Dubilier, Lissen, Ferranti, Igranice, Formo, Peto Scott).
- 1 '01-mfd. fixed condenser (T.C.C., or Telsen, Dubilier, Ediswan, Lissen, Ferranti, Mullard, Goltone, Igranice, Watmel, Graham Farish).
- 1 '001-mfd. fixed condenser (Telsen, etc.).
- 1 '0003-mfd. fixed condenser (Telsen, etc.).
- 2 H.F. chokes (Ready Radio and Telsen, or Leweos, Peto-Scott, R.I., Parex, Varley, Dubilier, Lissen, Lotus, Wearite, Sovereign, Atlas, Graham Farish, Tunewell).
- 1 600-ohm Spaghetti resistance (Bulgin, or Telsen, Igranice, Varley, Ready Radio, Leweos, Graham Farish, Peto-Scott).
- 1 2-meg. grid leak and holder (Dubilier, or Lissen, Telsen, Ferranti, Mullard, Ediswan, Ready

- Radio, Igranice, Graham Farish, Varley).
- 1 L.F. transformer (Igranice, or Ferranti, R.I., Telsen, Leweos, Mullard, Lotus, Graham Farish).
- 1 '001-mfd. compression condenser (Leweos, or Telsen, Formo, Sovereign, Goltone, Graham Farish, Polar).
- 1 P.J.2 coil (R.I., or Ferranti, Ready Radio, Sovereign, Parex, Peto-Scott, Leweos, Wearite).

- 1 Terminal strip, 18 in. x 2 in.
- 10 Indicating terminals (Igranice, or Eelex, Belling & Lee, Clix, Goltone).
- 2 Crocodile clips (Goltone).
- 1 Screen, 10 in. x 6 in. (Parex, or Ready Radio, Wearite, Peto-Scott).
- G.B., H.T., and L.T. plugs, etc. (Belling & Lee, or Clix, Eelex, Igranice).
- 2 Coil quoits (Wearite, or

THE NEW PARTS NEEDED

- 1 Selector coil (Ready Radio, or Wearite, Parex, Goltone, Peto-Scott, Magnum, R.I.).
- 1 Filament rheostat, 10-30 ohms max. (Wearite, or Ready Radio, Colvern, Igranice, G.E.C., Lissen).
- 1 Triple-pole rotary change-over switch (Wearite).
- 1 Panel light (flush type) (Bulgin, or Ready Radio).
- 1 Pick-up jack and plug (Bulgin, or Lotus, Igranice).

ACCESSORIES

- LOUDSPEAKERS.**—Celestion, Amphion, B.T.-H., Blue Spot, Undy, Mullard.
- VALVES.**—1 S.G. (Osram S22, or Mazda, Cossor, Mullard, Six-Sixty, Eta, Dario).
- 1 H.L. type (Mazda, or Osram, Cossor, Mullard, Eta, Fotos, Lissen, Tungram, Six-Sixty, Dario).
- 1 Power (Osram P2, or suitable 4 or 6 volt valves of similar characteristics can be used if desired).
- BATTERIES.**—H.T. 120-150-volt double or triple capacity (Ever Ready, Drydex, Magnet, Lissen, Pertrix).
- G.B., '9 or 1.5 volt (see above).
- G.B. 9 or 15-volt to suit output valve (see above).
- ACCUMULATORS.**—Voltage to suit valves (Exide, Ediswan, G.E.C., Lissen, Pertrix).
- MAINS UNITS.**—Heayberd, Regentone, Altas, R.I., Ekeco, Tannoy, Lotus (state details of set, voltage and type of mains when ordering).

REPLETE WITH REFINEMENTS



How the finished set looks when all the additions to it are made.

- 1 P.J.3 coil (Ready Radio, A.E.D., Peto-Scott, Sovereign, Ready Radio, Parex).
- 1 G.B. battery clip (Burton, or Bulgin, Wearite).
- Flex, screws, 4 oz. of No. 30 D.S.C. wire, etc.

"P.V. PLUS" REFINEMENTS.

(Continued from previous page.)

clip, which hitherto connected to the aerial terminal, comes out and the "A" terminal on the "Selector" is now wired to the aerial terminal of the set. Either "C" or "B" is joined to the Red lead end of the P.J.2 coil, and the terminals "C" and "B" on the Selector are themselves joined together either by extending the one lead or by means of a separate short length of wire.

It is vital that those two points should be joined together.

That completes the removals, but make certain that you have taken all these wires right away and have not upset anything else in the wiring. If you have to move another lead temporarily, get it back again before you go any further—in fact, make the completion of the lead elimination process the occasion for a pretty careful look around or you may get yourself in a tangle. The job is quite easy so long as you take it steadily.

The new wiring is the clearest part of the wiring diagram

nation immediately the set is turned on, and should glow out when you switch off. It should light on both the radio and the record sides of the control switch operation. The S.G. valve should become completely inoperative when the pick-up is in action.

FITTING THE SELECTOR COIL

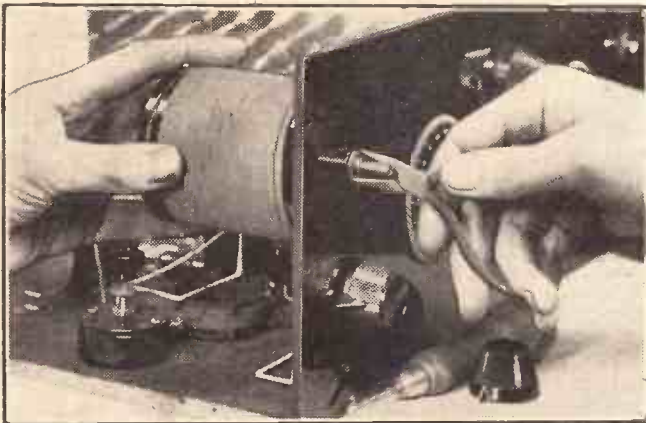

You will discover that plenty of room was left for the Selector coil. This is a one-hole mounting device, and is very easy to fit and wire in circuit.

The provision of pick-up switching necessitates the elimination of the present simple on-off switch and the fitting of a triple-pole change-over switch, one having terminals if you are unable to solder or do not want to undertake such work. It is essential that this switch should be of the specified type for it has three tasks to perform.

Glance at the theoretical diagram. You will note that the switch is, in effect, three single-pole change-over switches coupled together. The bottom three contacts function as an on-off switch. When the switch is in the neutral position the L.T. circuit of the set is broken, but the L.T. is switched on when the switch is thrown over to either side.

The Rotary Switch.

The central row of three contacts makes and breaks the L.T. circuit of the S.G. valve, while the top three switch the set from radio to records, or vice versa. If you get this arrangement firmly fixed in your mind it will make the wiring much easier and much more interesting.

We have already dealt with the necessary steps to take if you do not intend to build in both the pick-up gear and the volume control, so now we will handle the whole job *en masse*.

First of all, remove the on-off switch and all its wiring. It had three leads going to it and these come right out of the set. It is also necessary to take out the lead which joins the "F" terminal of the S.G. valve holder to the screen and the short lead between the grid terminal of the V₂ valve holder and the .0003-mfd. grid condenser.

THE CONTROL SWITCH IN POSITION

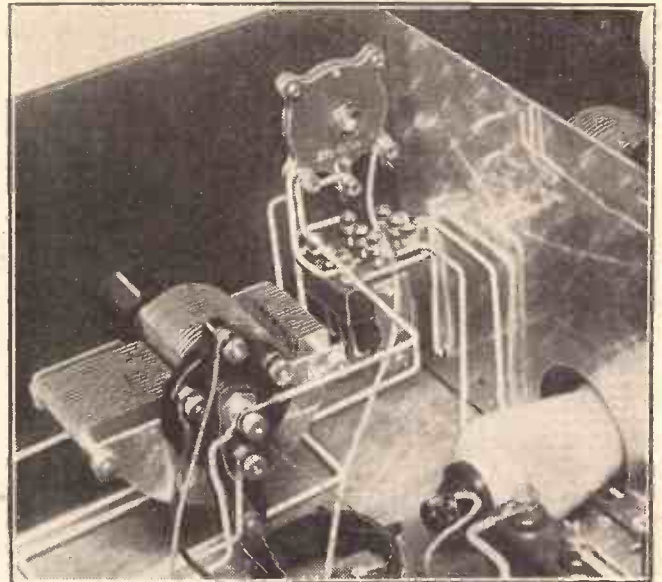

The combined radio-records and on-off switch is here seen wired up.

and we intended that this should be the case. The new leads are shown in black. If you find

yourself at all uncertain as to any one of these added leads, study the theoretical diagram, you will discover that this is particularly simple in this instance.

When you have finished the wiring it will be mighty easy to tell whether or not your efforts have proved successful.

The panel light should spring into illumi-

The volume control, as before mentioned, is effective only for radio reception but should give a very wide control—if everything is O.K. you should go from dead silence to full volume.

Improves Results.

The Selector coil is right out of circuit when it is switched round to either "B" or "C," but between these two points a most flexible adjustment will follow if all is well.

(Continued on next page.)

THIS IS THE NEW CIRCUIT

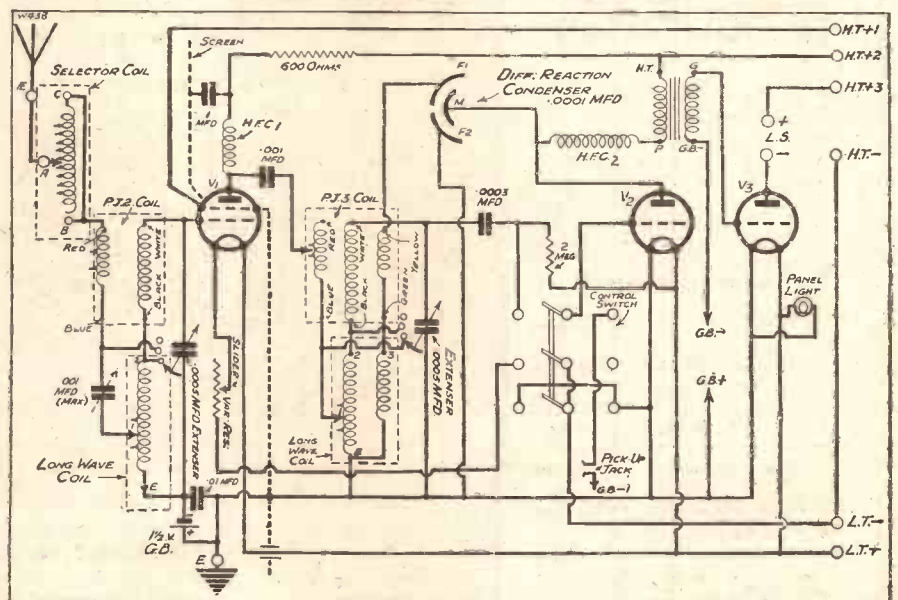

All the refinements are included in this diagram, and you will no doubt find it of interest to compare it with the original circuit.

"P.V. PLUS" REFINEMENTS

(Continued from previous page.)

There is no need constantly to re-adjust the Selector, use it as a kind of trimming device and give it a slight adjustment only every now and then as you proceed to search for stations.

At no adjustment will it give results inferior to those hitherto obtained, and, remember, it is passive on long waves—its function lies entirely on the ordinary broadcasting band.

The pick-up grid-bias lead can be plugged into the existing grid-bias battery and we suggest 1½ volts as the probable best value.

And now, for the benefit of new readers

who may be meeting "P.V. Plus" for the first time, we will briefly review the complete circuit.

The final "P.V. Plus" comprises a powerful three-valve loudspeaker set based on the popular Screened Grid H.F. detector and transformer-coupled L.F. grouping of valve stages.

Very Effective Tuning.

The tuning arrangements consist of "P.W." "P.J." coils in conjunction with coil quits, which carry the necessary long-wave windings.

On the long waves each P.J. coil is automatically switched into series with a Coil Quit winding by means of an extenser self-hanger, so that all the windings are useful employed.

For medium-wave reception the Coil

Quit windings are switched out of circuit, but as they are not magnetically coupled to the P.J.'s they do not interfere with reception any more than so many bunches of wire tied to the earth terminal of the set.

The selector coil roughly tunes the aerial for the medium waves, and adds vastly to the effectiveness of the circuit both in point of power and of station separation.

A small .001 mfd. compression type condenser is provided to enable the long-wave selectivity to be adjusted, and further elasticity in this is given by the Coil Quitappings.

The S.G. valve is biased in order to reduce its H.T. consumption to the minimum, and there is "P.W." Differential reaction to give really smooth regeneration and enable distant programmes easily to be tuned in.

ALL THE LEADS ARE SHOWN IN THIS DIAGRAM

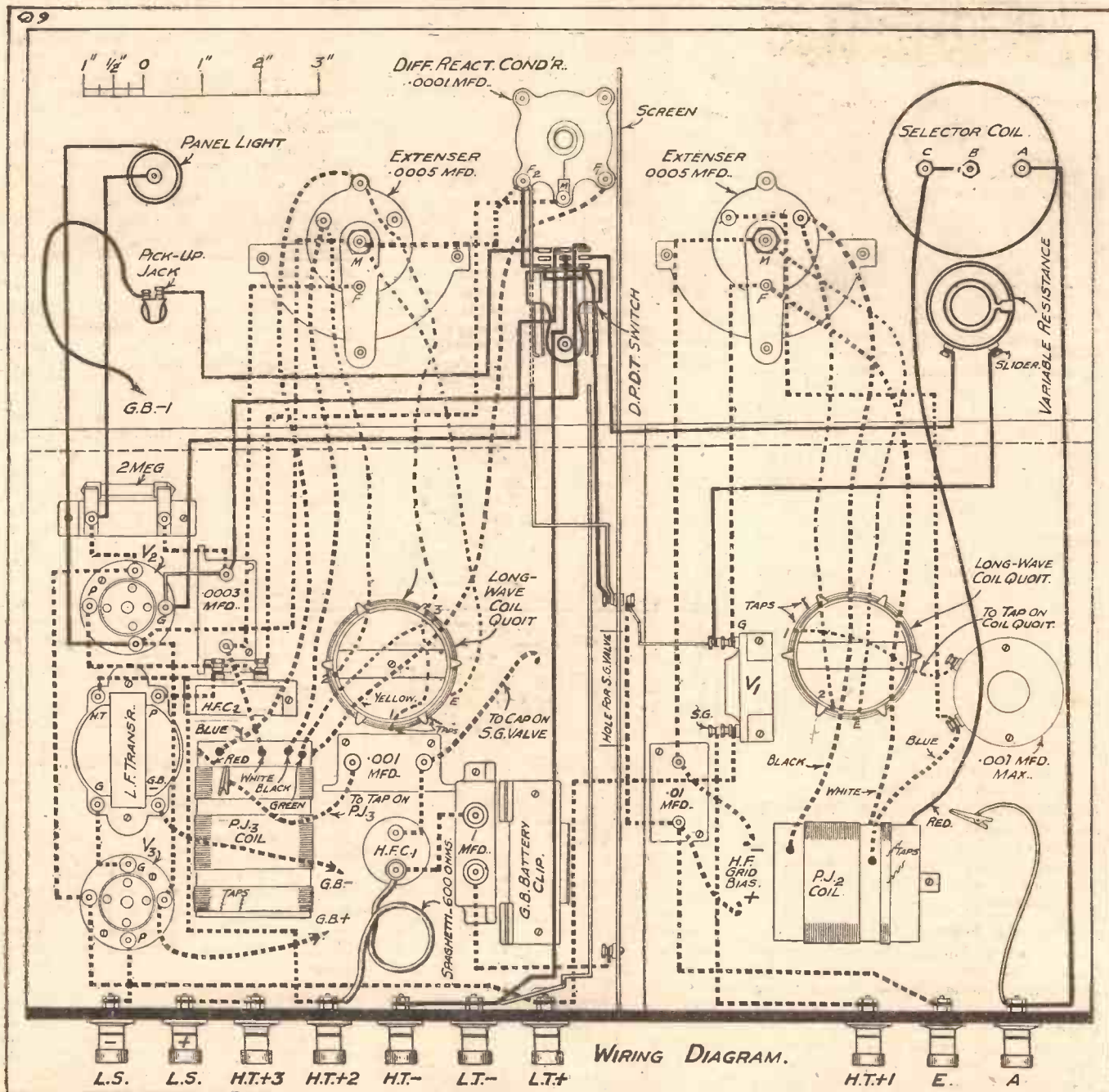

WIRING DIAGRAM.

The dotted leads are those which figured in the original set, and which remain untouched, and the black leads are the new ones. The hollow wires are those which have to be removed when the alterations are made. Do not regard the 800 ohms Spaghetti as a "hollow wire"—it does not have to be removed.

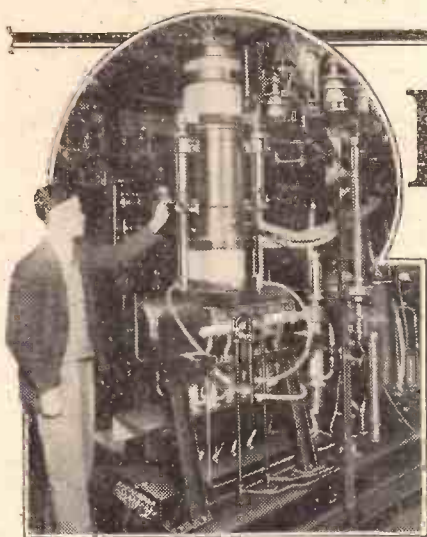

BRITAIN'S GIANT VALVE

More than twice as powerful as any other in the world, the very latest British valve has much more than mere size and power to recommend it! Read this account of its fascinating possibilities, which may have extraordinary effects on the development of electrical engineering.

By P. R. BIRD.

RELUCTANT though the rest of the world may be to admit it, it is an incontrovertible fact that the first valve circuit ever hooked up for radio reception was thought out and brought out by a British scientist, working in Great Britain.

It happened in 1904, and Dr. J. A. Fleming of University College, London, was at that time the only man in the world who had tried out a valve circuit for wireless reception.

Ten Feet High!

It is particularly fitting, then, that the absolutely last word—the wonder valve of the whole world—should belong also to Britain. The photographs will show that no words of mine can do justice to this truly tremendous tube.

It stands more than 10 ft. high, and it weighs over a ton! Evidently it is not the sort of valve you would think of using for your set.

And even if someone kindly gave it to you, you would certainly need a new accumulator to run it, for it requires a filament current of five hundred amperes. Moreover, not only is it the biggest valve in the world, but it is of a type hitherto almost unheard of.

As no doubt you have guessed, it is a transmitting valve. And so efficiently does it do its job that when it is placed in permanent position no fewer than fifty of the hitherto "latest" high-power valves will be put on the permanently retired list, while it does their work for them!

Alone, it is capable of operating the main transmitter at Rugby, the world's biggest radio station. And the really remarkable thing about this colossus is not its enormous size, but its extraordinary ingenuity. It is a complete break-away in valve design, and all the precedents have gone overboard.

Handling Huge Power.

As everyone knows who uses a super-power valve, one snag about handling big power in a valve is that the valve gets hot. And the more power you handle, the hotter it gets.

So that with transmitting valves which handle huge power, the danger is that the heat will melt the metal, melt the glass or in other ways impair the immensely high vacuum which is an essential feature of the valve construction.

For years research workers have pondered over the problems of maintaining a very high vacuum, handling enormous power, and at the same time dissipating the inevitable heat engendered.

No Glass Used.

It is now standard practice to pump many gallons of water round the anodes of large transmitting valves, to keep them cool whilst working, and at least one station in Europe (Warsaw on 1,411 metres) employs a water-cooled filament as well!

But one great snag was always present with these complicated valves, and that was that the slightest flaw in one of them represented a very heavy loss. Ordinary receiving valves are quite expensive enough, but even a wealthy broadcasting company has to think carefully about the renewing of

which worked in a vacuum that was sealed up during manufacture and therefore could not be tampered with—this latest monster is kept absolutely empty all the time it is in operation. And the result is that it can be dismantled.

If something goes wrong with its water-cooled steel anode (which, incidentally, weighs about three cwt.), the valve is not ruined. The pumps can be stopped, the whole thing can be taken adrift, and eventually the anode can be brought out into the open and there hit with a hammer if necessary.

Amazing Facts.

When the repairs are finished, it can rapidly be put together again, the whole valve reassembled, and placed back in operation in the course of a few hours. The vacuum, in fact, need

not now be considered a permanency, but it has become a part of maintenance, and as such comes into line with the filament heating, the anode cooling, and other precisely similar and common maintenance jobs.

And here are a couple of amazing facts. Every minute that the valve is in action, no less than 40 gallons of water must circulate round it to keep it cool enough to work. And such is the power-handling capability of it that even the grid

IT COMES APART!



A view of the amazing water-cooled anode, separated into sections.

valves when one valve replacement may mean anything up to £500.

In the last three years in the Research Laboratories of the Metropolitan Vickers Electrical Company, a valve which gets round all these difficulties has been thought out, and produced. Quite recently, the Americans were acclaiming proudly that they had produced a valve capable of handling 200 kilowatts, but this figure fades into insignificance beside the power-handling capability of Britain's biggest valve, which is capable of handling the staggering total of 500 kilowatts!

The reason that its glass does not melt is that it uses no glass at all in the construction, but is, instead, composed of a compound of steel, porcelain and copper. Unlike the old valves—the electrodes of

has to be water-cooled!

While the scientists of the world have been congratulating British scientists on this latest marvel, and marvelling at British inventive genius, their minds have been wondering and wondering whatever the end of it will be. For though designed primarily for wireless communication, this valve looks like revolutionising other fields of electrical engineering.

Enormous Possibilities.

The engineers, scientists and research workers are now realising that it could easily have been made much bigger. It appears to open the door to a hitherto unexplored domain, of enormous possibilities. But that is all in the future. In the meantime, there it is—Britain's giant valve.

LICENCES AND WAVE-LENGTHS!

A Trenchant Review of Britain's Position as a Leading Resident in the European Ether, together with some observations concerning microphone mannerisms.

AT the end of September, 3,930,577 wireless licences had been sold. And by the end of October the figure will be over 4,000,000.

During September, 272,000 licences were sold—a record! Yet 185,525 listeners allowed their licences to lapse during September and did not apply for new ones.

Consequently the net increase in licences for September amounts only to 86,475. What has happened to those 185,525 licences?

Very Nearly Perfect!

Have they joined the ranks of the wireless "pirates"—or have they given up subscribing to the B.B.C. because they dislike the programmes?

These latest licence figures remind one again of the tremendous significance of broadcasting to-day, for it is safe to assume that on an average for every licensed wireless set there are three listeners.

A B.B.C. official told me that he considers official licence figures could safely be multiplied by three—possibly by four. This means that by the end of October the B.B.C. broadcasts will reach on an average 12,000,000 people—or, if multiplied by four, 16,000,000 people.

And all these listeners are inevitably being influenced by the policy of the B.B.C.—a policy which is based first of all on first-class organisation, educational influence, standard pronunciation, a revival of the Puritan outlook, and a strict conformity to the ideals of conventionalism.

As an organisation, the B.B.C. is very nearly perfect, but it is machine-like; it lacks "the common touch." Perhaps "soulless" is too strong a word to use in connection with the B.B.C., but a policy which tends to overdo the importance of a pattern which looks askance at the very human significance of "Laudas, laudas toujours laudas" must sooner or later have serious psychological effects upon those who, by paying licence fees, continue to enable the B.B.C. to put its policy into practice.

Just Voices.

I offer one significant little example. In the old adventurous days of the British

Broadcasting Company, listeners felt the announcers to be personal friends. Rex Palmer—Cecil Lewis—Arthur Burrows—those names are but memories now. To-day the announcers are just—voices. They have no tangible existence.

No Human Contact.

There is no human contact. They are delightful to listen to, but somehow they are aloof. How good it would be, how that little human touch would come back again into broadcasting if, when listeners switched on of an evening, they could hear the friendly voice of the announcer saying: "Good-evening, everybody. This is Rex Palmer speaking."

A small point but, I venture to think, significant. The results of the present B.B.C. policy must not be looked for just yet. For all I know, they may prove amazingly beneficial in the long run; but,

A BAIRD TELEVISION NOVELTY



Mr. Baird pointing to a key component of his latest "modulated arc" a television scheme which is claimed to give improved results.

on the other hand, they may prove that listeners—perhaps unconsciously—have become listening robots, and that the B.B.C.'s present policy, however admirable in many ways it may be, is obviously producing a mass type. Psychologically it is interesting, but is it wise?

By the time this copy of "P.W." is in your hands news of the fateful conference of the International Broadcasting Union at Rome should be available. As I write these lines I cannot help speculating as to what will happen if the B.B.C.'s proposals for wave-length reform are rejected. Will

the B.B.C. leave the Union? Well—as you read this article you will probably know the answer!

After all, it's a fair offer the B.B.C. has made: each country to give up at least one wave-length. It would make a tremendous difference to the broadcast wave-band problem, and would considerably minimise the ever-growing evil of ether congestion.

For some reason or another France and Germany have proved strong opponents to this plan. In Brussels recently Mr. Ashbridge did his utmost to convince recalcitrant members of the Union that, unless they "got busy" the wave-length situation would soon be out of hand, and everybody would suffer.

But no! Mr. Ashbridge's arguments failed to persuade them, so the matter was left over for further discussion at Rome.

The B.B.C. state they will leave the Union if the Prague plan is not revised as they suggest.

A Struggle for Wavelengths.

The result would be chaos. Each nation would grab what wave-lengths it could—and a fine old mess would inevitably result.

Let's hope the delegates at Rome have seen sense, and that "P.W." readers will read these lines with the complacent feeling that I have written an unnecessarily pessimistic article!

G.B.

AVOIDING STRAY COUPLINGS

IN these days of high amplification and screening it is most important to space conductors properly and to avoid all stray couplings and capacity effects. In particular, grid and anode wires require to be properly spaced and also to be kept as short and direct as possible.

Most constructors are well aware of this, but at the same time, I have often seen sets built up in which there were quite unnecessary crossings of conductors and the various leads were not as short as they might have been.

It is well worth while to sit down for an hour or so and plan the layout on paper before fixing a single component. This will repay you in the end.

Of course, if you are working to a set design, such as those supplied in "P.W." from time to time, all this has been done for you, and all you have to do is to take care not to introduce any little "improvements" of your own.

Thin Conductors for H.F.

There is another point I should like to mention in this connection and one which does not seem to be generally known. The wires for carrying the H.F. currents do not need to be thick conductors, for the amount of current to be carried is extremely small. Furthermore, there is a more important reason still and that is that the thick wires will increase the electrical capacity.

Probably the reason for the thick wire is that it is thought to improve the appearance of the wiring. However, efficiency is surely the main consideration, and for this the H.F. conductors should be thin and short.

J.H.T.R.



This machine-made dry battery lives longest

You expect an H.T. dry Battery to do its job without supervision. You expect it to give long service. Then buy the battery that cannot go wrong, that is machine-made and machine-tested. This illustration shows the carbons around which has been moulded by machinery a measured quantity of depolarizer. No defective part, no weak cell can ever get into a FULLER 'Super' dry Battery. That is why it gives exactly the power it is labelled to give. That is why it outlasts other batteries and improves your wireless reception the moment it is installed. Fit a FULLER 'Super' and your wireless will take a new lease of life.

F.1.	60 VOLTS	—	7/5
F.2.	66 "	—	7/11
F.3.	99 "	—	12/4
F.4.	108 "	—	13/9
F.5.	120 "	—	15/3

Full List of other types and sizes with names of Local depots on application.

FULLER

'SUPER' DRY BATTERY

EMISSION UP TO 20 MILLIAMPS

Visit us at The Edinburgh Radio Exhibition.

FULLER ACCUMULATOR CO. (1926) LTD., CHADWELL HEATH, ESSEX
Telephone : Seven Kings 1200. Telegrams : Fuller, Chadwell Heath.
Contractors to British and Overseas Government Departments, Railways, etc.

THE MIRROR OF THE B.B.C.

JACK PAYNE TO TOUR?

IRON DISCIPLINE AGAIN—
SIR JOHN REITH AND SOUTH
AFRICA—COSTLY RELAYS.
ALEXANDER AND MOSE.

A PARIS newspaper published the story that Jack Payne is to take his "boys" for a Continental tour next year, thus emulating Jack Hylton, his keenest rival.

I do not see how the B.B.C. could spare its Dance Band long enough for the purpose, but perhaps the solution will be in getting in a relief band while Jack Payne is away. Mr. Payne, by the way, is still the champion letter-getter among broadcasters, although I understand that he is not far ahead of the Rev. Hugh Johnston, who does the Daily Service at 10.15.

Iron Discipline Again.

B.B.C. staff tell me that there is a return to the rigid line of some years ago, particularly in the matter of attendance. Office hours are being applied systematically, and woebetide defaulters.

This is believed to be in preparation for Broadcasting House, where it is intended to exact the maximum degree of smartness and punctuality.

129,806

Our claim to the largest circulation of any wireless paper is once again justified by the net sales certificate which we have received from Messrs. Price, Waterhouse & Co.

It shows that even over the six months ending in mid-summer "P.W.'s" AVERAGE NET SALE WAS 129,806 copies per issue!

POPULAR WIRELESS
is the paper that mule
WIRELESS POPULAR
"P.W."
ALWAYS
LEADS!

Sir John Reith and South Africa?

There are rumours that Sir John Reith will be asked to go to South Africa next summer to advise the Union Government on the formation and development of a federal broadcasting service on the lines of the B.B.C.

If this rumour is well-founded, Sir John will try to accept it for Imperial reasons. By a curious coincidence, if he does go, Sir

John will be meeting his former chairman, Lord Clarendon, now Governor-General of the Union.

Costly Relays.

Knowing something about the B.B.C.'s drastic economy methods and their decision to spend much less money on the programmes than hitherto, I am rather surprised to see that a concert is to be relayed from Vienna, in co-operation with the Austrian Broadcasting Company on Saturday, November 7th.

These long-distance relays cost a lot for the hire of land-lines, to which the B.B.C. contributes pretty handsomely, even though stations on the route to England pay a bit for the privilege of linking up.

If money must be saved on programmes there is no need for these fancy frills from foreign countries, which have no practical advantage since the powerful Continental stations can be tuned in on even the cheapest valve sets. Musically, they provide nothing so good as the B.B.C.'s own concerts.

However, there it is, and on November 7th we are to hear extracts from the works of Franz Lehar, who will himself conduct the Vienna Philharmonic Orchestra, the soloists being Adele Kern and Koleman von Patsky, of the Vienna Opera.

Alexander and Mose.

But for the fact that someone always goes to the utmost trouble to reveal the little secrets of the B.B.C.—though I can assure you that Savoy Hill has some secrets that never a word is breathed about!—listeners might still be thinking that Alexander and Mose were the real negro comedians they impersonate so delightfully with their droll humour that brings more laughs to listeners than some of the gabble which must sound more funny to those who say it than to we who have to listen.

Alexander and Mose have been all over the place since their last broadcast, which

took place a much longer time ago than we like, but it is good to learn that they have been invited to take part in a National Station vaudeville programme on Tuesday, November 3rd.

Stainless Stephen, Elsie Carlisle and Cecil Harrington and Norsena Feist are in the same programme, and we shall also hear a new "turn" called "The Old Moscow Balalaika Orchestra."

The date is not yet fixed, but it has been definitely decided that in the near future Tom Clare will broadcast a type of programme different from anything he has hitherto done before the microphone.

LORD GAINFORD AGAIN!



A great welcome was afforded to Lord Gainford, Vice-Chairman of the B.B.C., on his return to the microphone at the opening of the Northern National Radio Exhibition in Manchester.

FOR THE LISTENER

After an absence abroad our contributor listens critically to the vaudeville—and finds it good.

By "PHILEMON."

I FIND, after being away from England for some weeks, that one of the greatest joys is to get a vaudeville programme again in which I can see the jokes.

I am quite sure that Italian or German jokes are almost as good as English ones; but the worst about jokes in a foreign language is that they usually depend upon colloquialisms and little turns of speech which you don't understand unless you are intimate with the language in question.

Lost in the Alps.

You therefore miss the jokes; and a vaudeville programme in which you miss all the jokes is a pretty thin affair! The best argument I know for a universal language is that we should then be able to enjoy anybody's joke anywhere.

I sometimes tried to get these programmes from London while I was abroad; but it almost always happened that, at a critical point of the amusing story, the lightning would crackle between Monte Rosa and

the Matterhorn or somewhere, and the joke was lost in the Alpine snows. So that, on my return home, I gorged myself with vaudeville.

The Old Stagers.

I found myself chuckling at the silliest things, and greedily swallowing the hoariest chestnuts; for a poor English joke which you can understand is better than a good foreign one in which you miss the point.

I found the old favourites still going strong—Wish Wynne, Leonard Henry, the Hulberts, and the rest of them. Gillie Potter apparently still away, grouse-shooting, probably, on the moors of Hogs-norton. Leonard Henry is getting something of an old stager now at the microphone; but how well he wears! He reminds me of the American phrase, "The more you cut it, it's still poloney!"

The reason may be that, while others make jokes, Leonard himself is the greatest

(Continued on page 514)

THE WONDER "P.W." DUAL RANGER

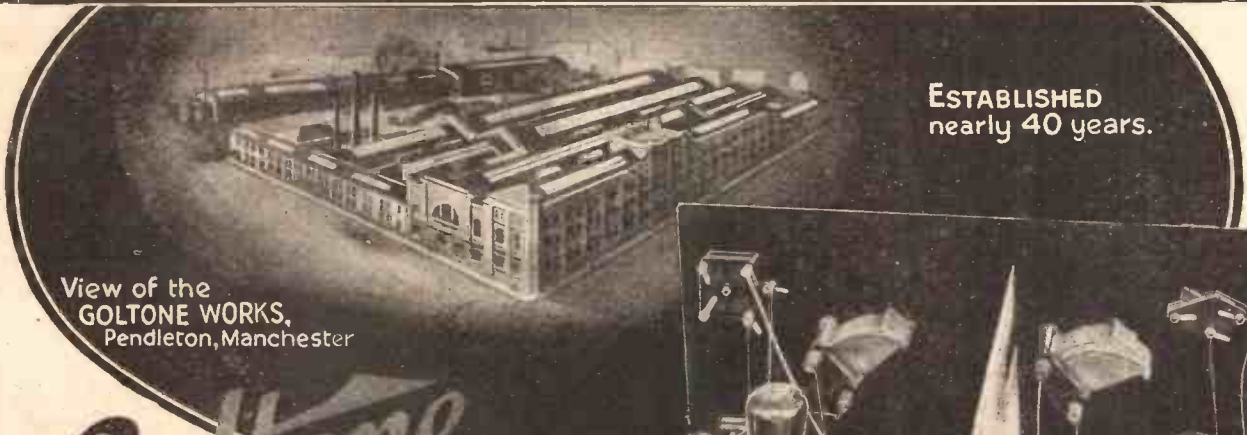

View of the GOLTONE WORKS, Pendleton, Manchester

ESTABLISHED nearly 40 years.

Goltone

REGISTERED

Kit of parts

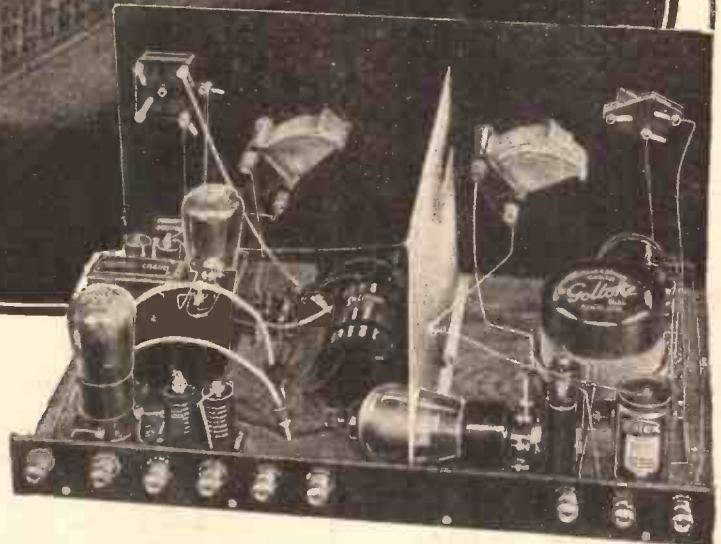

for the "P.W."

DUAL RANGER

Fully approved by Designers, the Technical Staff of "Popular Wireless"

£4.5.0

Containing specified components and sealed in robust container. Each component carefully tested. Full Instructions and Prints provided.

From all first-class Radio Stores. Refuse substitutes. Post coupon for full particulars.



POST THIS COUPON TO-DAY
 To WARD & GOLDSTONE, LTD., Pendleton, MANCHESTER.
 Please send me full particulars of "GOLTONE" Kit for the "P.W." Dual Ranger.

NAME.....
 ADDRESS.....
 P.W.31/10/31

These
TWO VALVES
make any 2 valve circuit

**BETTER FOR RANGE
AND VOLUME**

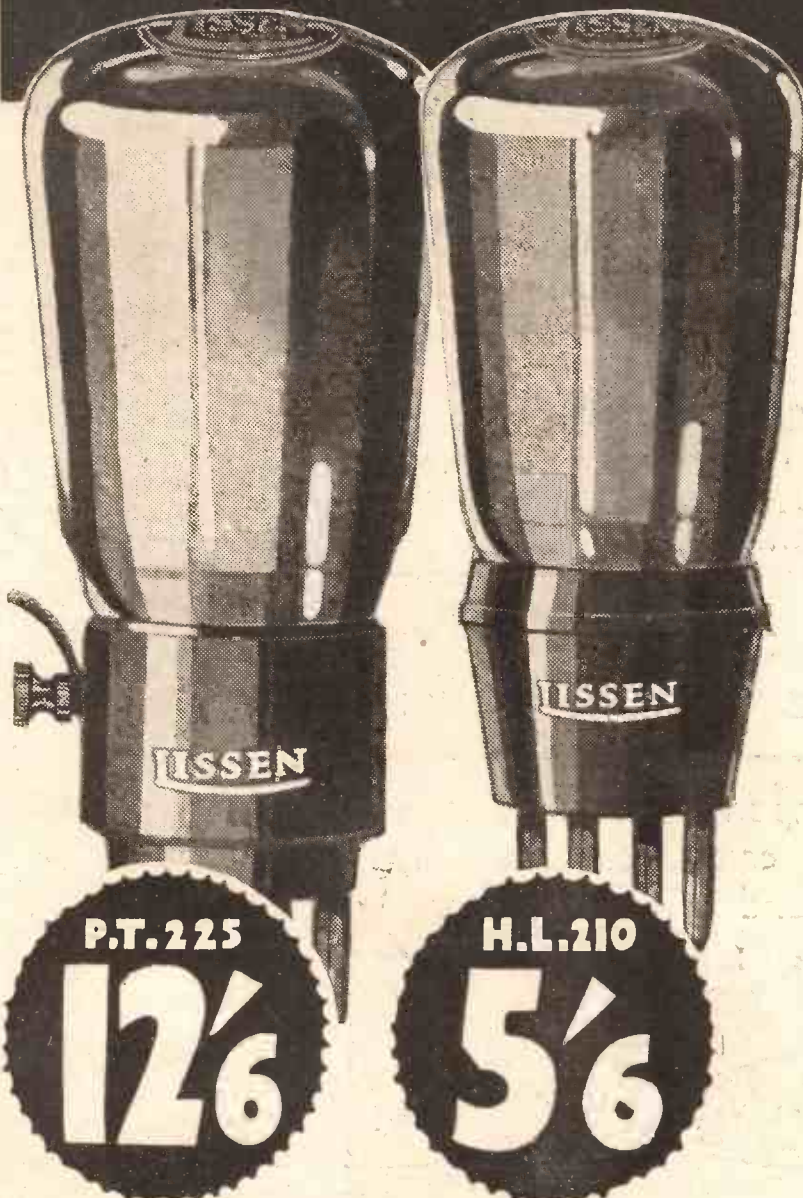

IF you would like your radio louder—if you want to get the Continental stations at fuller loudspeaker strength—if you have any two-valve set and would like to have it perform like a three—*replace the detector valve with a lively Lissen Detector and the power valve with a Lissen Power Pentode.* Immediately you will notice a tremendous step-up in volume on all stations—far greater liveliness in tuning, longer range and finer quality of reproduction.

To get these improved results you do not have to alter your receiver at all. Simply buy a Lissen Detector Valve H.L.210, price 5/6, and a Lissen Power Pentode P.T.225, price 12/6, and plug them in. The Lissen Power Pentode takes only 7mA of H.T. current, and can therefore be run off ordinary batteries. With these valves you get **IMMENSELY INCREASED VOLUME AND GREATER RANGE WITHOUT PAYING MORE FOR IT.**

LISSEN
VALVES

OTHER TYPES AND PRICES :—

H.210-5/6 L.210-5/6 P.220-7/- P.X.240-8/-
S.G.215-12/6 4-volt and 6-volt types also available.

LISSEN LIMITED, WORPLE ROAD, ISLEWORTH, MIDDLESEX

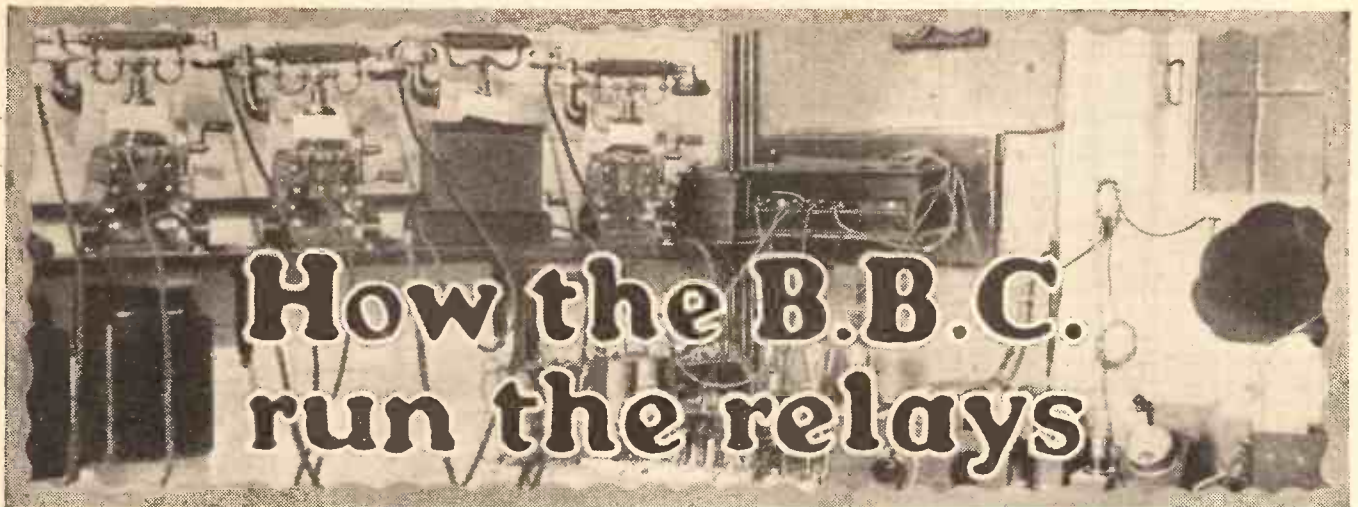

How the B.B.C. run the relays

"HOW is it that there is so little wave-length wobbling on the part of the relay stations?" I asked a B.B.C. engineer when down at the Plymouth station recently, after watching developments at the proposed site for the West Regional transmitter.

"It's because of the tuning-fork synchronisation," he said.

I looked vacant, and he hastened to explain.

"At each of the relay stations, including Plymouth here, there is a special drive arrangement for the transmitter controlled by, and oscillated via, a vibrating tuning-fork. Come round and see the tuning-fork at work."

I went.

"All the relay stations have the same type of gear, and nearly every one has the same tuning-fork drive. Every one works, of course, at the National common frequency of 1,040 kilocycles (288.5 metres).

"The local station here, like Swansea and Dundee, works with an output aerial energy of 0.16 kw. Newcastle has a power of 1.2 kw. and Edinburgh 0.4 kw.

"However, the tuning-fork gear works quite irrespective of power."

In the Oven.

All the apparatus at the Plymouth station is contained in a small wood-panelled room, and the actual valves, tuning coils, and condensers of the transmitter are mounted on wooden supports on low tables behind a safety barrier. Technically speaking, it would be true to say that, although the gear is old-fashioned, it is not out of date.

The relays have proved to be very reliable, and now that they are tuning-fork driven there is no question of their not adhering to their proper wave-length. As the fork is recent in comparison with the transmitter itself, it rather naturally has a modern appearance in comparison with the old-type meters and controls of the transmitter.

* * * * *

Have you ever wondered how Plymouth, Edinburgh, Bournemouth, and all the other relay stations, are kept synchronised on exactly 288.5 metres? Here our Special Correspondent, in a visit to the Plymouth station, describes how it is done.

* * * * *

The station official went to great trouble to sketch out on scraps of paper the essential features of the fork drive.

It appears that the essential gadget really

is an outsize in tuning-forks, and all the forks for any one wave-length (in other words, all the forks for the 288.5-metre relay stations) are made together, so that they have exactly the same vibration period.

I was shown, at the extreme end of the transmitter, a large steel box with the lid held on by wing nuts, and this houses an electric oven inside which the tuning-fork is mounted. This oven is switched on day and night, even when the transmitter is not going and there is at the side an electric Thermostat control, which switches off the power if the oven gets too hot.

The idea of this is to keep the fork at a constant temperature so that its length does not vary, and therefore it vibrates always at its proper note. Sticking out of the oven is a thermometer, and there is a little lens mounted on top of the steel box, through which the engineer in charge can see the height of the column of mercury.

Surrounding the two limbs of the fork are coils of wire connected up to the grid and anode circuits respectively of an ordinary receiver-type power valve in a metal box, immediately above the "oven."

How It Works.

So far, this is simple. The actual working of the fork is not quite so easy to explain. This power valve is really a low-frequency oscillator on account of the mutual coupling between the big grid and anode coils, the core of which is formed by the metal of the tuning-fork.

Just as the loose laminations of a transformer vibrate under the influence of the current passing through the windings, so the tuning-fork waggles as the power valve oscillates at low frequency; it sets up a kind of whining noise. The point is that once the fork has been started in vibration it controls the frequency of the oscillating valve.

The trouble, if such it can be called, is that here we have a valve definitely controlled in its oscillation, but the oscillation

(Continued on next page.)

A WARM SPOT AT BOURNEMOUTH

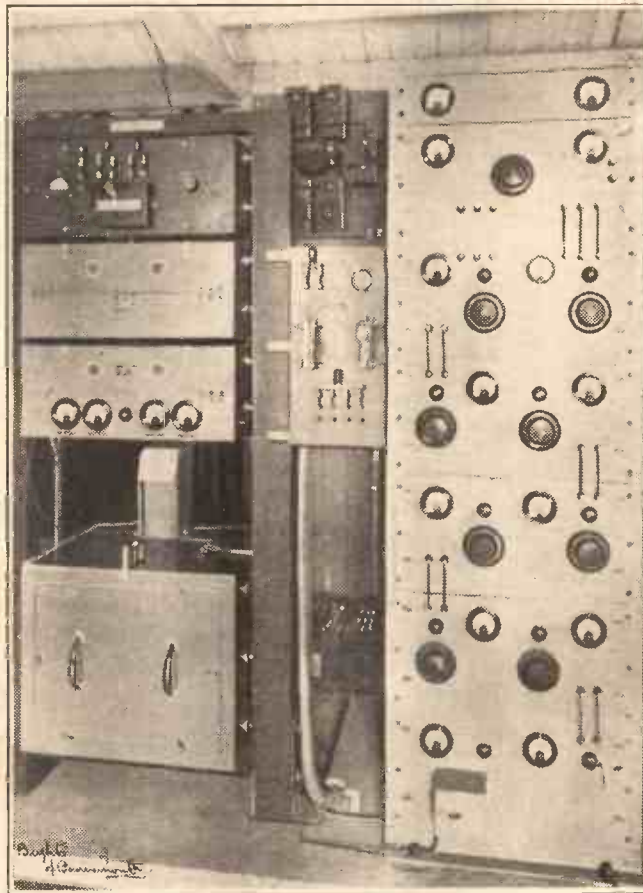

The tuning-fork panels at Bournemouth. The electric oven to which our correspondent refers can be seen at the bottom left.

HOW THE B.B.C. RUN THE RELAYS

(Continued from previous page.)

is at low frequency and not at the radio frequency of 1,040 kilocycles.

"Now," said the Plymouth engineer, "if you have grasped all that, see the way in which we step up the low-frequency vibrations of the tuning-fork, by selecting harmonics, to the radio frequency we need to keep the station exactly on its figure of 288.5."

He pointed to a grey-painted steel amplifier rack in the centre of the transmitter, and obviously one of the B.B.C. engineers' latest productions. It consisted of seven amplifier panels, one above the other, and each having a milliammeter in each valve's anode circuit.

A Successful "Double."

"These," he said, "are the frequency doublers which select the harmonics and so step up until we arrive at the exact frequency of 1,040. The tuning-fork, you see, is made to vibrate at a frequency which, by selecting the harmonics, gives us the radio frequency we want.

"The output of the last valve in this frequency-doubler rack is coupled to the grid circuit of the first drive valve in the transmitter, and this gives us the positive link which keeps the station dead on its wave-length."

I examined the gear and confessed I was tempted to twiddle some of the thirty knobs on the tuning-fork control panels, but this would have meant public disgrace! It would have caused Plymouth to wobble in wave-length, and furious would have been the B.B.C.'s postbag on the following morning!

There are nine main knobs which control the tuning circuits of the frequency doublers, and these are carefully set so that at each stage a harmonic is selected and amplified. The slightest variation would put the station out of synchronisation.

So sensitive are the amplifiers and doublers that accumulators have to be used

tuning-fork control," said the Plymouth engineer, "we sent reporters around with field-strength measuring sets, and they plotted out contour maps showing the height of hills in the locality, but the way in which the synchronisation of the relay stations caused mush areas in certain parts. "By slight alteration of the power of each

THE SYNCHRONISING GEAR AT PLYMOUTH

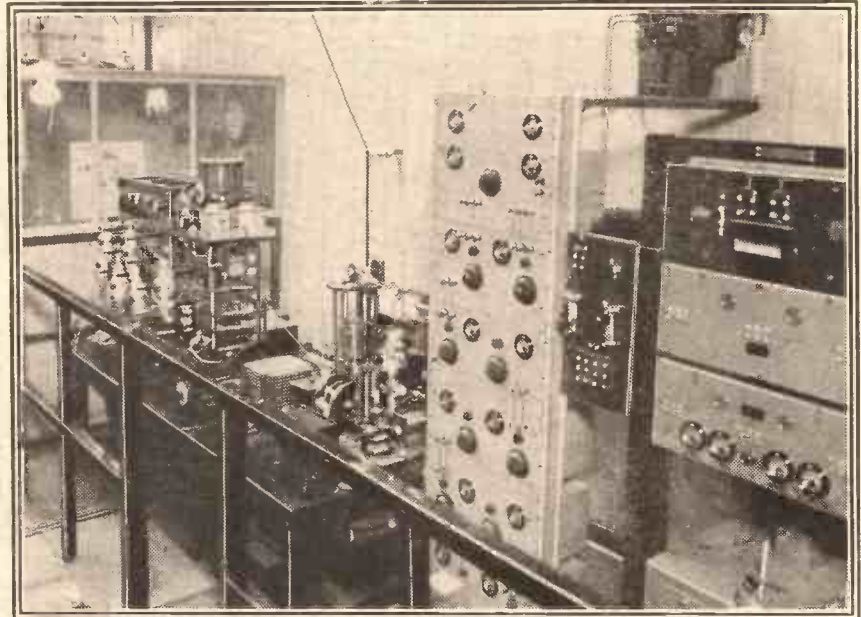

The Plymouth transmitter, showing the tuning-fork and frequency doubling apparatus in the foreground.

for high tension, low tension, and grid bias, it not being safe to allow dry batteries even for grid potentials. A battery which was not quite up to its full voltage might prevent one stage from working as a harmonic selector.

"When we first started up with this

station we have put these mush areas just where we want them, and I do not think there are many local listeners to relay stations who get bad service."

I asked if Piezo crystal control had been tried at the relay stations, and was told that, although the B.B.C. engineers had made a study of the way in which American broadcasters controlled their wave-lengths with crystals, they were of the opinion that in this country, where wave-lengths can be never definitely settled for more than six months or so at a time, there are big advantages in tuning-fork drive.

Hundreds of Pounds Each.

Also, where there are a large number of stations to be worked on the same wave-length as with the relays, it is easier to make a matched set of tuning-forks than to produce a number of crystals to operate on the same frequency.

"Of course," said the engineer in conclusion, "this fork control apparatus is not cheap. Each set costs several hundreds of pounds. Also, it is not easy to put in operation. When a fork drive is first installed, it takes hours of testing to get the frequency doublers properly set up and the fork stable.

"It is almost laboratory work; but once the doublers have been set and the oven heated to the correct temperature, then one can always get tuning-fork control stations working within a few minutes."

It may come as news to many readers to know that, far from considering scrapping relay stations, the B.B.C. is realising their importance afresh, and similar synchronisation may be tried when the new West Regional station starts up.

THE B.B.C. START THEIR TREK TO THE NEW HOME



A scene in the entrance hall of Broadcasting House, London. Quite a number of our broadcasters have already moved in, but the complete change-over will take quite a few weeks longer.

ALL SPECIFIED IN THE "DUAL RANGER"



View of the
GOLTONE WORKS,
Pendleton, Manchester

ESTABLISHED
nearly 40 years.

Goltone
REGISTERED

The combination of a most up-to-date Bakelite Moulding Plant, with an Instrument Wire Dept. of nearly 40 years' experience, enables Ward & Goldstone, Ltd., to offer "Popular Wireless" Readers components of the highest standard at competitive prices.

The effective performance and excellency in finish of "GOLTONE" COMPONENTS leads to their specification in all "Popular Wireless" circuits.

Other components for the "Dual Ranger"
P.J. 3 Coils - - Price 2/- ea.
Wound Coil Quoits - Price 2/6 ea.







"GOLTONE" "P.W." & "M.W." DUAL RANGE COIL as illustrated, DW/12
7/6
Each

Radio Catalogue with full particulars on request.

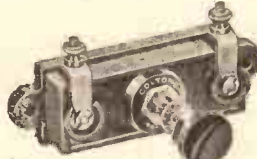
From all First-class Radio Stores—Refuse Substitutes—If any difficulty write direct.

Ward & Goldstone
PENDLETON MANCHESTER LTD.

FROM	
1/-	
"GOLTONE" COMPRESSION TYPE CONDENSERS.	
5°	
"GOLTONE" MIDGET FIXED CONDENSERS.	
9°	
"GOLTONE" PUSH-PULL SWITCHES.	
7°	
6°	
SPAGHETTI RESISTANCE LINKS, from	
Ready drilled Panels, 16" x 8" x 1/8", mahogany. Price 7/-	
Ready drilled Screen, 10" x 7". Price 2/-	

COMPLETING THE SCOTTISH REGIONAL

In this special article our Northern Correspondent gives the latest news about the progress of the Scottish Regional Transmitter, and deals with the wave-lengths to be employed.

THE other day I met Mr. Tudsberry, the B.B.C. Civil Engineer, and as he had just come from Westerglen, near Falkirk, he was able to give me an account of progress in the construction of the new Scottish Regional station there.

Excellent progress was being made, he said. The erection of Scotland's Regional was proving an easier job than the building of North Regional, where the "night-marish" climate of Moorside Edge had caused serious delays.

Choice of Wave-lengths.

At Westerglen work was going ahead speedily and the building was practically roofed in. They would start to install machinery in November. One mast was finished, and the other partly erected.

The date of the inauguration of transmissions is uncertain, but the B.B.C. states that it will be early next summer. The wave-lengths will be 288.5 metres for the Scottish National transmitter and 376.4 metres for the Scottish Regional.

The choice of wave-lengths is interesting for several reasons. I understand that 288.5 metres will remain the National common wave-length (used by such stations as Newcastle and Bournemouth).

Tuning-fork control apparatus to keep the Scottish National transmitter accurately on 288.5 metres will be installed, and because this is a common wave-length the range of the transmission (for all its 70 kilowatts of power) will be limited.

Station Separation.

The Scottish Regional transmitter will also be rated at 70 kilowatts. Its 376.4 metres wave-length is at present used by Glasgow. It is anticipated that when Scottish Regional is in full swing the Glasgow, Edinburgh, and Dundee stations will be scrapped, but Aberdeen will probably be retained.

The wave-length separation between the two Scottish high-power transmissions will be smaller than that at any other B.B.C. twin-programme station, and listeners in the Falkirk neighbourhood had better look to the selectivity of their sets.

How Many Kilocycles?

It is interesting to compare the separation in kilocycles:

Between London Regional and London National—306 kcs.

Between North Regional and North National—369 kcs.

Between Scottish Regional and Scottish National—243 kcs.

Good progress has been made by the Marconi Company in the construction of the transmitters for the Scottish Regional station. One transmitter, in fact, was exhibited at the recent Faraday Exhibition in London as an example of the latest radio achievement.

Scottish Regional will truly be Britain's most up-to-date station, for although the design is similar to London Regional and North Regional it incorporates improvements, the result of experience in working the other regional stations.

The Falkirk Improvements.

At Brookmans Park and Moorside Edge, for instance, it has been found that the large windows in the walls of the transmitter hall cause a dazzle, which makes it difficult for the engineers to read the metres on the transmitters; so at Falkirk the walls

grammes to Scotland (or a large part of it). One programme—the National—will be relayed from London via a new land-line which passes through Leeds, Newcastle, and Edinburgh.

The contrasting programme will consist partly of Scottish material, from the Edinburgh, Glasgow, and Aberdeen Studios and other local sources, and partly of excerpts from the London, North and Midland Regional programmes, relayed from England.

CONDENSER CONSIDERATIONS

Leakage and Simple Tests.

MOST of us have, at one time or another, had a leaky-grid condenser in which the leak was not confined to the grid leak, but was partly provided by the condenser itself. At first you might think that this was rather a good idea, but it isn't.

The better way is to use a condenser

LISTENING FOR RADIO ECHOES FROM SPACE



This is a scene at the Slough Radio Research Station, and shows Dr. Mary Taylor, who is seeking a mathematical formula which will explain Prof. Appleton's recently discovered echoes from space.

are being bricked-in and the transmitter hall will be lighted by a big skylight in the roof.

Another difference is that Falkirk will have only two masts. At Brookmans Park four masts support the two aerials; at Moorside Edge three masts do the same duty; but for Scotland the engineers have still further economised, by contriving a method of suspending the aerials on two masts.

Programme Arrangements.

Each will be 500 feet high and will weigh 40 tons. One is already finished and is a landmark for many miles around.

The chief purpose of this new high-power station, of course, is to give alternative pro-

above reproach and to employ a precise and constant amount of leak; then you know exactly what you are doing, whereas if there is a leak in the condenser itself you may never be out of trouble.

You are often recommended to test condensers by means of a pair of 'phones—getting the click on discharging the condenser after it has been charged for varying lengths of time. But this method, although simple and convenient, is not always reliable. A better method is by means of a megger.

In these days, however, really reliable small fixed condensers of British make are so cheap that there is no excuse for using a foreign-made condenser giving the trouble mentioned above. J.H.T.R.

TELSEN CONDENSERS

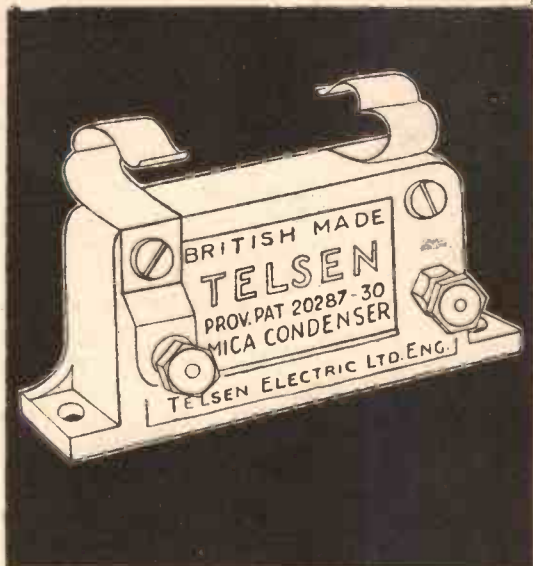
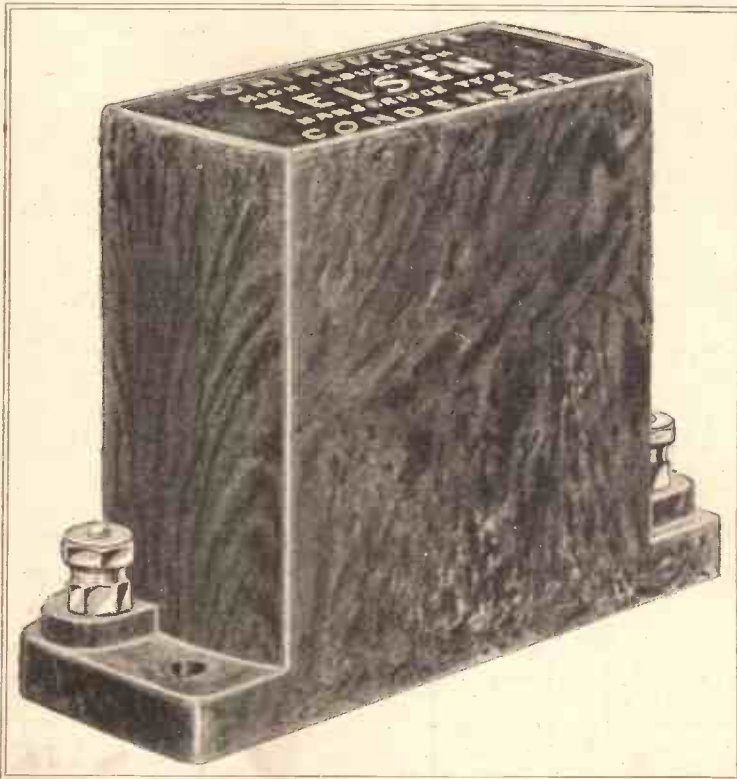

TELSEN MANSBRIDGE TYPE CONDENSERS

Telsen have installed the most advanced plant in the world for the manufacture of Mansbridge Type Condensers. Only genuine Mansbridge foil paper and the finest linen tissue are employed in the exclusive method of manufacture. Every Telsen Mansbridge Type Condenser is hermetically sealed from the atmosphere, and Post Office standards of insulation are adopted throughout.

The preliminary research, the most modern plant in the world, the finest raw materials, the latest methods of manufacture and the final test, all combine to give Telsen Mansbridge Type Condensers a high insulation through years of service with freedom from breakdown. The type of construction employed makes them genuinely non-inductive.

TELSON MANSBRIDGE TYPE CONDENSERS

made in capacities from .01 to 2.0 from 1/6

TELSEN

THE SECRET OF PERFECT
RADIO RECEPTION

CVS-59

TELSEN FIXED MICA CONDENSERS

(Prov. Pat. No. 20287/30)

Telsen fixed mica condensers are made in capacities from .0001 mfd.-.002 mfd. They can be mounted upright or flat, and the .0003 mfd. Telsen fixed mica condenser is supplied complete with patent grid-leak clips to facilitate series or parallel connections.

Telsen Fixed Mica Condensers. Price 6d.

Send for the "Telsen Radio Catalogue" and book of "All-Telsen Circuits" to the Telsen Electric Co., Ltd., Aston, Birmingham.

FROM THE TECHNICAL EDITOR'S NOTE BOOK.

Tested and Found—?



SOME "A.W." COMPONENTS.

I RECENTLY received a number of "A.W." Solid Dielectric Condensers for test. Included were Straight Line Tuning, Differential Reaction and Twin Gang types. They all appear to be soundly designed and made and their actions are smooth.

I particularly like the Twin Gang Type A.W.440. This is a very neat component. It is fitted with a fine one-knob control operating through smooth gearing, and there is also a trimming adjustment controlled by a knob rotating in the centre of the main adjustment. Complete with scale-illuminating light, the price of the device is only 13s.

A SMALL "GANG"

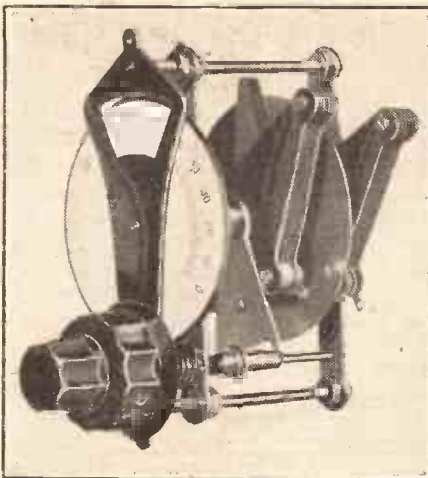

This "A.W." Two-Gang condenser is remarkably compact.

It cannot be used in all cases, but it has immediate uses in numerous circuits. As a matter of fact you will shortly meet this ingenious A.W. Twin-Gang in a unique "P.W." set, and will then be able to see for yourselves how remarkably compact it is.

WORTH SENDING FOR.

The latest "Polar" catalogue describing the various 1931-1932 Wingrove & Rogers lines has several particularly interesting features in it apart from categorical component announcements. For instance, there is an article entitled "A Word About Tub Condensers" that makes excellent and informative reading.

OF INTEREST TO CONSTRUCTORS.

"Lewcos" are distributing a book of blueprints free of charge to all applicants—a chance which "P.W." readers will no doubt take full advantage of. "Lewcos" are also ready with their new season's catalogue, another publication which is decidedly worth acquiring.

WEARITE COMPONENTS.

The latest Wright & Weaire's list describing the many fine and inexpensive Wearite components will be of special interest to "P.W." readers in that a number of Wearite versions of "P.W." coil designs are included.

"FOR EVERY RADIO CONNECTION."

This is the title of a Belling-Lee brochure, a tastefully artistic publication dealing with those wonderfully useful Belling-Lee terminals, etc.

CLIX CONSTRUCTOR'S KITS.

Lectro Linx have sent me one of their constructor's kits. These are assortments of terminals plugs and sockets suitable for particular receivers, and they propose to make up special kits of this nature for all the more popular of our set designs.

It appears to me to be an excellent scheme, and I am sure constructors will welcome the opportunity of acquiring all the above-mentioned items in so simple a manner instead of having to make out their own lists and purchase the items in separate lots.

Messrs. Lectro Linx have our best wishes for the success of their new venture, and we trust they will receive the enthusiastic and practical backing of amateur set builders.

FOTOS "NIPPER" TRANSFORMER.

L.F. Transformers tend to group themselves in classes roughly in accordance with their prices. There is first of all that "super" category ranging from about one pound to thirty shillings, and in it you find some extraordinarily fine components. Next comes the inevitable "medium" class, and, finally, we have the cheap L.F. transformer, and I am using the word in its monetary sense.

Some of the five or six shilling transformers are bad—there is no other term that fits. They are bad value for money even at the figures asked for them. A few of the higher priced transformers are not good value for money when their prices are compared with those of less expensive models, but I think it can be safely said that if you pay over 17s. 6d. you will not be able to buy a transformer that, as such, is "dud."

This proves the wiseness of always paying the most you can afford for an article if you are unable to form fairly expert judgments.

On the other hand, there are a number of L.F. transformers that are quite a bit too good for the average small set operating the average loud speaker. Their wonderfully straight curves are, in a sense, wasted. Little aural difference, if any, is noticeable if you change over to a less expensive transformer providing that is an honest proposition.

If it is just a hank of wire wound on a few old nails (or the technical equivalent) you will discover an immediate loss in amplification if not a depreciation in quality.

Among the soundly made L.F. transformers in the inexpensive class I can include the "Fotos Nipper." This little chap is quite a bit superior to many in its price class (it costs 4s. 6d.). Indeed, I prefer it to some of those I have tested that sell at higher figures.

Manufacturers and traders are invited to submit radio apparatus of any kind for review purposes. All examinations and tests are carried out in the "P.W." Technical Department, with the strictest of impartiality, under the personal supervision of the Technical Editor.

We should like to point out that we prefer to receive production samples picked from stock, and that we cannot in any circumstances undertake to return them, as it is our practice thoroughly to dissect much of the gear in the course of our investigations!

And readers should note that the subsequent reports appearing on this page are intended as guides to buyers, and are, therefore, framed up in a readily readable manner free from technicalities unnecessary for that immediate purpose.

A "REGENTONE" BOOK.

"All-Electric Radio" is the title of Regentone's list. In it are described the whole fine range of Regentone products, which includes their excellent mains units and their very attractive and low-priced Regentone Two-Valve mains set.

NEW DUBILIER FOLDER.

This describes the various Dubilier radio components and is a publication that should be in the hands of all constructors.

VALUE FOR MONEY



A very inexpensive L.F. transformer that reaches a good standard of efficiency.

TELSEN RADIO COMPONENTS



6^d

TELSEN VALVE HOLDERS

(Prov. Pat. No. 20286/30).

The Telsen four- and five-pin valve holders embody patent metal spring contacts, which are designed to provide the most efficient contact with split and non-split valve legs, and are extended in one piece to form soldering tags. Low capacity and self-locating.

Telsen 4-pin Valve Holder Price 6d.
Telsen 5-pin Valve Holder Price 8d.

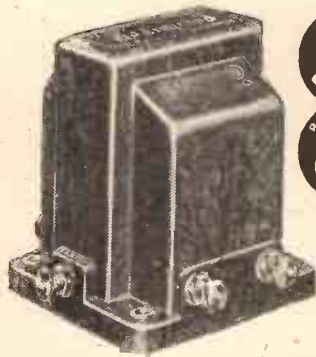

ACE
5/6
RADIOGRAND
8/6

TELSEN L.F. TRANSFORMERS

Ace, ratios 3-1 and 5-1 5/6 each
Radiogrand, ratios 3-1 and 5-1 8/6 "
Radiogrand Super, ratio 7-1 12/6 "
Intervalve Transformer, ratio 1.75-1 12/6 "

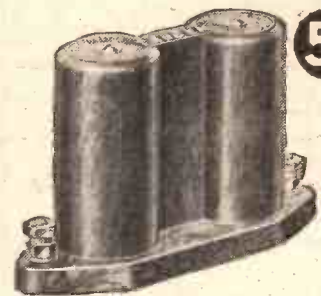

5/-

TELSEN BINOCULAR H.F. CHOKE

Hailed unanimously by the leading experts as the perfect H.F. Choke. The Telsen Binocular Choke is called for wherever highest efficiency is desired. Its highest inductance (180,000 microhenrys) and exceptionally low self-capacity (0.00002 mfd.) ensure a very high impedance at all wave-lengths, and its excellent efficiency curve is free from parasitic resonances. Price 5/-



5/6

TELSEN LOUD-SPEAKER UNIT

The Telsen Loud-speaker Unit is pleasing to the most sensitive ear. The deep notes of the bass, the brilliance of the soprano, and the crispness of diction are clearly reproduced without distortion.

It employs cobalt steel magnets, and the detachable rod which carries the cone is fitted with cone washers and clutch. The entire unit is enclosed in a beautifully moulded bakelite dust cover. Price 5/6

TELSEN

ALL BRITISH RADIO COMPONENTS

Also include :-

Output Transformers	12/6
H.F. Chokes from	2/-
Output Chokes	8/-
Power Grid Chokes	8/-
L.F. Coupling Chokes	5/-
Slow-Motion Dial	2/6
Fixed Condensers from	6d.
Pre-set Condenser	1/8
Variable Condenser	4/6
Spaghetti Resistances from	6d.
Loud-speaker Chassis	5/6
Fuse Holder	6d.
Grid Leak Holder	6d.

Send for the "Telsen Radio Catalogue" and book of "All-Telsen Circuits" to The Telsen Electric Co., Ltd., Aston, Birmingham.

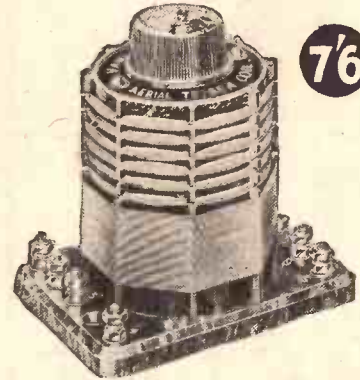

7/6

TELSEN DUAL-RANGE AERIAL COIL

It incorporates a variable series condenser and is suitable for all districts. It has been tested in various parts of the country, and down to distances of five miles from Regional stations, a single tuned circuit will definitely separate the Regional programmes. A reaction winding is provided. Price 7/6

Telsen H.F. Transformer and Aerial Coil Price 5/6



9

TELSEN GRID-LEAKS

Telsen Grid-leaks are absolutely silent and non-microphonic, and practically unbreakable. They cannot be burnt out and are unaffected by atmospheric changes. Telsen Grid-leaks are not wire wound and therefore there are no capacity effects. Their value is not affected by variation in the applied voltage.

Made in values from 1-5 megohms.

Telsen Grid-leak Price 9d.

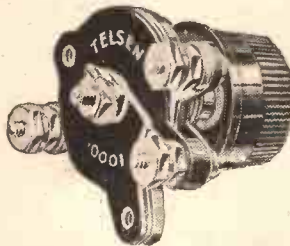

2/-

TELSEN BAKELITE DIELECTRIC CONDENSERS

The moving vanes are keyed on to the spindle and there is a definite stop at each end of the travel. The connection to rotor is made by a phosphor-bronze pigtail so there is no crackling due to rubbing contacts. The connection to the stator vanes is absolutely positive—a very important point. All Telsen Bakelite Condensers are supplied complete with knob.

Differential Condenser—

Capacities .0003, .00015, .0001	Price 2/-
Reaction Condenser—Capacities .0003, .00015	Price 2/6
.0001	Price 2/-
Tuning Condenser—Capacities .0005, .0003	Price 2/-

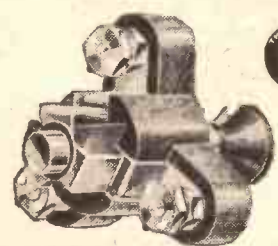

1/3

TELSEN PUSH-PULL SWITCHES

(Prov. Pat. No. 14125/31).

The Telsen Push-Pull Switches employ a proper electrical knife switch contact and are soundly constructed on engineering principles. The centre plunger is wedge-shaped, so that as it is pulled out it forces the inner fixed contacts outwards, tightly gripping the moving contacts. There is no fear of crackling with Telsen Push-Pull Switches. Their low self-capacity makes them suitable for use in H.F. circuits.

Two-point	Price 1/-
Three-point	Price 1/3
Four-point (2 pole)	Price 1/6

CAPT. ECKERSLEY'S QUERY CORNER



Under the above title, week by week, our Chief Radio Consultant comments upon radio queries submitted by "P.W." readers.

Don't address your questions direct to Capt. Eckersley, a selection of those received by the Query Department in the ordinary way will be answered by him.

The Howl and the Resistance.

E. H. T. (Manchester).—"In my receiver, which incorporates two L.F. transformer-coupled stages using indirectly-heated A.C. valves, a very high whistle is heard when receiving a strong transmission, but the connection of a 5,000-ohm resistance across the output choke prevents this fault, without impairing the tone of the reproduction.

"What is the cause of the whistle, and why does the addition of the resistance stop the trouble?"

A little difficult to answer from the information given. You say there's a high note when receiving a strong transmission. Yes, but isn't there sometimes the same whistle when receiving a weak transmission too?

I think there is—I shall assume there is. And I shall give my explanation thus:

When two stations transmit on two separate frequencies of carrier-wave which are 9 kilocycles different, they produce in a receiving set output a "note" of 9,000 cycles (9 kilocycles, that is, and equal to their difference frequency).

Of course, if the low-frequency circuits of the receiver are designed so that they give little or no amplification at the higher frequencies (say from 6 to 9 thousand cycles sec.), this "beat note" between the carrier-waves of two different stations will not be heard.

Connecting a resistance across your choke probably lowers the amplification of the valve at high frequencies, and so if the low-frequency circuits do not amplify the high heterodyne, a beat note or 9-kilocycle (second frequency difference note), or whatever you like (or I like, in this instance) to call it, and so you do not hear this note.

On the other hand your low-frequency

circuits may be oscillating and the connection of the resistance across the choke may produce sufficient damping and prevent the oscillation.

To prove what is happening tune your set in the daytime to (say) the North Regional (because it's close to you), and listen if the note is there. If it is, it's low-frequency oscillation. If it isn't it's heterodyne. Now take your set and detune it so that it does not pick up any station. Is the note still there?

If "Yes," it's certainly pure low-frequency oscillation, and so try decoupling. If "No," but if the note comes back on North Regional in the daytime, it's low-frequency oscillation caused by high-frequency getting into the low-frequency circuits.

Use a high-frequency filter between detector and note magnifier like the one in my sketch.

Cutting Down Filament Volts.

T. W. M. (Highgate).—"My A.C. mains receiver employs a directly-heated output valve. Until recently this was of the 6-volt type, but now I wish to change to a 4-volt.

"What is the correct procedure with regard to the mains transformer? Should

ONLY IN "P.W."

will you find

Radio Questions answered by
CAPTAIN ECKERSLEY.

I insert a resistance in each of the filament leads, or could one suitable resistance be used in either lead?

"On the other hand, would it be better to obtain another transformer?"

It's best to obtain another transformer.

Putting a resistance in series with the primary is all right though, provided the secondary feeds only one valve. Thus more current flows in the primary as more current is taken from the secondary. All may be well, all valves having primary resistance, right value, etc., etc. When one valve burns out, then the current in the secondary reduces and so the current in the primary reduces, so the volts drop across the primary, resistance lessens, and the secondary volts go up and another valve burns out, and the same process repeats until all the valves burn out!

But with one valve it's quite all right because if it burns out it doesn't matter about the secondary volts rising. If you put a resistance in the secondary it's all right, but if there are other valves connect as shown in my sketch.

If there are 4-volt valves which used to be 6-volt valves this won't do, and the resistance in series with the filaments (secondary) will be all right provided there is only one valve, otherwise the same effect as talked about above takes place.

Lastly see that the total current taken by the new valve (or valves) is not greater than taken by the old. If you had a load of 6 volts 2 amps. you must not make the new load 4 volts 3 amps.—stick to the 2 amps. and no more.

It's best to buy a new transformer unless you have only one valve to change and that valve takes no more current than the old valve.

A Question of De-coupling.

W. H. B. (Eltham).—"I have been advised that when a pentode is used in the output stage of an A.C. mains receiver, coupled to the loudspeaker by a tapped choke output filter (the loudspeaker leads being taken from the centre point of the choke, and H.T.—), it is necessary to use a choke decoupling device in the H.T. feed to this valve to prevent probable coupling with the anode current supply to the remaining valves of the receiver.

"As all the other valves, that is, detector and two S.G. H.F., are individually decoupled, I am doubtful whether this advice is correct."

So am I! The only point is that decoupling must be thorough.

The danger is that the decoupling between detector and last stage is not good enough if only the detector is decoupled—(never mind about H.F. valves, these decouple easily).

Thus to make assurance doubly sure it might be better to decouple both output and detector. It's merely a question of degree not principle.

AN H.F. FILTER.

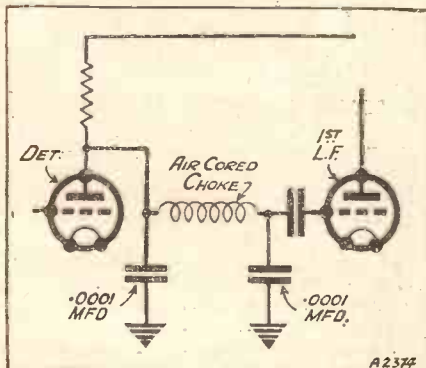

This is the arrangement recommended to E. H. T. (Manchester) by our Chief Radio Consultant.

CHANGING FROM "6" TO "4."

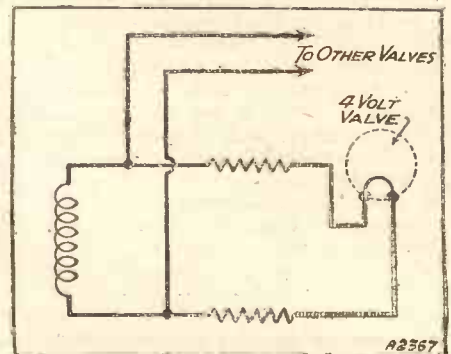

How resistances are connected to "drop volts," across the 4-volt valve.

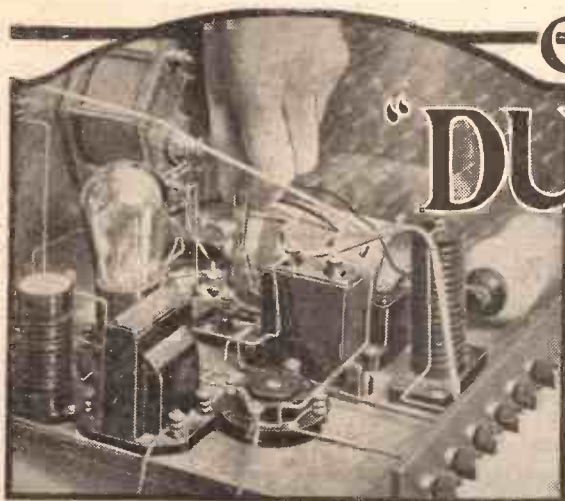

OPERATING THE "DUAL-RANGER"

Here are some practical hints on handling the fine set described in last week's "P.W." And the condensed information on the Blue Print which was then presented to every reader is expanded fully, so as to enable every builder of the "Dual-Ranger" to get first-class results in regard to both distance and quality.

THE circuit of the "Dual-Ranger" has been aptly described as the wedding of two famous coils.

In the aerial circuit we have the well-known "P.W." dual-range coil—a compact unit which readily lends itself to the inter-wave system of eliminating break-through on the long waves.

In the detector circuit there is the adaptable and highly efficient "P.J." coil which, although a comparatively recent development, has been used with great success in many "P.W." designs.

Coupled together in one circuit these two coils, each of which has its own special advantages, provide the backbone of an inexpensive three-valver which for power, range and selectivity ranks second to none.

That Chaotic Ether.

The chaotic state of the ether at the present time, particularly on the medium broadcast waveband makes the technician's life a difficult one.

On the one side he is assailed by demands for sets possessing great reaching-out powers.

On the other by requests for higher selectivity in order that a transmission when it has been received can be listened to in comfort, completely free from interference by other stations.

And the difficulty is this! When you increase the H.F. amplification you automatically increase the volume of all stations an equal amount, and your improved sensitivity is of little use to you unless you can provide a higher degree of selectivity to cope with the greater volume.

A Very Difficult Task.

Unfortunately, selectivity and sensitivity do not go hand in hand, because enhanced selectivity usually involves a loss in volume, and vice versa.

Hence to effect a really satisfactory compromise is a task which requires considerable technical skill combined with weeks, and frequently months, of patient research work.

Selectivity and sensitivity are not the only essentials. With the advent of the Regional scheme we have had to contend with a trouble known as "break-through."

When a set is switched over to the long waves there is a tendency for the local medium wave transmitter to "break in" and spread over a portion of the long-wave tuning range. Naturally, this interference

may prevent the reception of Continental stations operating on the 1,000-2,000-metre waveband. Means must, therefore, be provided to cut out this particular form of interference, otherwise the receiver loses much of its value.

Above all, the set must be perfectly stable, economical both in first cost and upkeep, and capable of reproducing the broadcast music in its proper proportions of light and shade.

The Valves to Use.

Such is the "Dual-Ranger"—the latest product of the "P.W." Research Department.

In order to get the best out of the set, it is necessary to follow out these hints concerning the valves, voltages, and adjustments. Before we can commence the preliminary tests we must connect up the batteries and insert the correct valves in the three valve holders. For V1, that is, the H.F. valve holder, we shall require an ordinary S.G. valve. This is passed through the hole in the screen (marked "Hole for S.G. valve" on the blueprint), and gently inserted in the V1 valve holder.

The flexible lead ("Flex to anode of S.G. valve") is then joined to the anode terminal on the top of the S.G. bulb.

In the detector valve holder (V2) we can use one of the special detector valves, or alternatively an "HL" or H2 type.

The third valve holder (V3) requires a valve capable of handling sufficient energy to work a loudspeaker at good strength, so here we need a power type or even a super-power valve if the local station comes in at great strength.

Incidentally, a super-power valve does not give greater volume than a power valve. The advantage of the super-power type is that it does not overload so easily and in consequence it is better able to handle large inputs without distortion. In cases where the highest amplification is required, such as on weak transmissions, the power type is preferable.

Choosing the H.T. Battery.

Hence, the reader who resides near a powerful Regional transmitter will be well advised to purchase a super-power valve, and the listener who is situated some distance from a broadcasting station will probably get better results with a small power type.

One other point to remember in connection with this question of power or super-power valves is that the super-power type requires more anode current, therefore the drain on the H.T. battery is heavier.

In choosing the H.T. battery, preference should be given to the super-capacity types, since these are cheaper in the long run, and far more serviceable than those which are made up of cells of the smaller size.

Using a Unit.

If the mains are available, there is no reason why a mains unit should not be used for providing H.T. The output, however, should be not less than 20 milliamps when a small power valve is employed, and 25-30 milliamps for a super-

(Continued on next page.)

SCREENED FROM THE DETECTOR

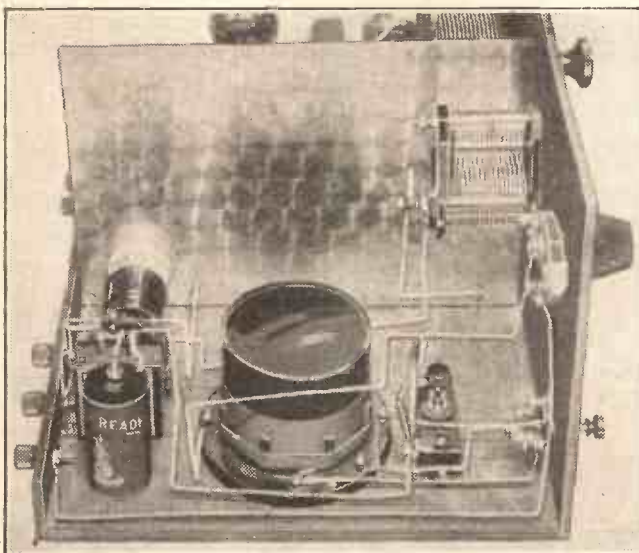

The plain screen effectively prevents unwanted feed-back between the high-frequency and detector stages.

OPERATING THE "DUAL-RANGER"

(Continued from previous page).

power valve. In order to obtain maximum results with a mains unit it is desirable to leave a margin of safety, and not to run it at the full load.

The L.T. supply should be obtained from an accumulator, and those who utilise the mains for H.T. can also do their own charging by choosing a mains unit which incorporates a trickle charger.

The Valve Voltages.

The "Dual-Ranger" is designed solely for valves of the battery-operated type, and is not suitable for valves of the D.C. or A.C. indirectly-heated types. The design of an "all mains" receiver is an entirely different proposition, and requires special treatment.

Now about the voltages: There are two H.T. + terminals. H.T.+1 goes only to the screening grid of the S.G. valve, and the correct voltage is 75-80. H.T.+2 supplies the anode of the S.G. valve, the detector, and the output valve so the maximum voltage of the H.T. battery should be applied to this terminal; 120 volts is the usual value.

The H.T.— terminal on the battery or mains unit is, of course, joined to the H.T.— terminal on the strip. L.T.+ and L.T.— on the accumulator are connected to their respective terminals on the terminal strip.

Concerning the Grid Bias.

There are also two flexible leads marked G.B.+ and G.B.— on the blueprint. G.B.+ is inserted in the + socket of the grid-bias battery, and G.B.— in the socket giving the correct value of grid bias for the particular output valve (V3) used.

The correct value of grid bias depends upon the H.T. voltage and the valve, but the valve makers always supply a list of recommended values either in their catalogues or on the leaflet enclosed with the valve.

It is absolutely essential to adhere to the

valve manufacturer's instructions on this point, and if the valve is under-biased it is highly probable that it will be ruined. In addition, too little grid bias causes distortion and increases the drain on the H.T. battery or mains unit.

If you refer to the blueprint you will notice that a 1½-volt cell is joined across a 1-mfd. condenser near the earth terminal.

ON DUTY IN THE "DUAL-RANGER"

- 1 Panel, 18 in. x 8 in. (Wearite, Permcoll, Goltone, Peto-Scott, Becol).
- 1 Cabinet to fit, baseboard 10 in. deep (Camco, Osborn, Gilbert, Pickett).
- 2 0005-mfd. condensers (Telsen, J.B., Polar, Cydon, Wavemaster, Astra, Formo). If above have plain dials, the following will be required:
 - 2 Slow-motion dials (Lotus, Telsen).
 - 1 0005-mfd. solid dielectric condenser (Ready Radio, Telsen, Parex, Lotus).
 - 2 3-point wave-change switches (Ready Radio, Telsen, Lissen, Wearite, Goltone).
 - 1 On-off switch (Lissen, Telsen, Ready Radio, Igranice, Lotus, Goltone, Wearite).
 - 1 0001-mfd. differential reaction condenser (Telsen, Lotus, Ready Radio, Parex, Polar, Graham Farish, Cydon, Wavemaster, J.B.).
 - 1 "P.W." Dual-Range Coil.
 - 1 002-mfd. max. compression condenser (Goltone, Formo, Sovereign, Telsen).
 - 1 1-mfd. fixed condenser (Igranice, T.C.C., Dubilier, Formo, Telsen, Mullard, Helsby, Ferranti, Ediswan, Hydra, Graham Farish).
 - 1 0003-mfd. fixed condenser (Ferranti, etc.).
 - 1 001-mfd. fixed condenser (T.C.C., as above).
 - 1 1-mfd. fixed condenser (T.C.C., as above).
 - 1 P.J.3 coil (R.I., Formo, Goltone, Parex, Melbourne, Sovereign, Wearite, Ready Radio).
 - 1 Coil quoit (Peto-Scott, Sovereign, Parex, Ready Radio, A.E.D., Wearite).
 - 2 oz. 30 D.S.C. wire for above.
 - 1 Screen 10 in. x 7 in. (Parex, Peto-Scott, Wearite, Ready Radio).
 - 1 2-mek. leak and holder (Graham Farish, Ferranti, Lissen, Dubilier, Mullard, Igranice, Telsen, Watmel, Varley, Loewe).
 - 2 H.F. chokes (Lewcos and Varley, Telsen, Ready Radio, Lotus, Parex, Sovereign, Graham Farish, Wearite, R.I., Peto-Scott, Atlas).
 - 1 L.F. transformer, ratio (Lotus, Telsen, Ferranti, R.I., Varley, Igranice, Lissen, Graham Farish).
 - 1 50,000-ohm spaghetti resistance (Bulgin, Telsen,

This is an ordinary dry cell which can be purchased for a few pence at any radio store or electricians. Its function is to apply a small negative bias to the grid of the S.G. valve.

We have now dealt with the valves and their voltages, thus leaving four terminals unconnected on the terminal strip. These are the aerial, earth, and two loudspeaker terminals (L.S.+ and L.S.—).

The Earth.

In the normal course of events the earth lead is joined direct to the earth terminal on the strip, but if the H.T. is being obtained from a D.C. mains unit, the earth lead is taken direct to the special earthing connection on the unit, no connection being made to the terminal on the strip.

The aerial lead is joined to the A terminal on the strip, and the loudspeaker to the two L.S. terminals.

Some speakers have to be connected a certain way round, in which case it is usual to provide some indication as to which of the two tags at the end of the loudspeaker lead is positive. Sometimes the positive tag is red, or alternatively it may be marked with a cotton stripe. If your particular speaker is so marked connect this tag to the L.S.+ terminal.

- Ready Radio, Varley, Sovereign, Lissen, Igranice, Goltone, Lewcos, Peto-Scott, Graham Farish).
- 1 25,000-ohm spaghetti (Bulgin, as above).
- 2 Valve holders (Graham Farish, Lotus, W. B., Telsen, Igranice, Lissen, Chix, Wearite, Dario, Formo, Bulgin).
- 1 Do., Horizontal mounting (W. B., Parex).
- 1 Terminal strip, 16 in. x 1½ in.
- 9 Indicating terminals (Belling & Lee type R, Igranice, Goltone, Chix, Eelex).
- Glazite, Lacolite, Quickwire, flex, screws, etc.
- 1 Crocodile clip (Bulgin, Goltone).
- Battery Plugs (Belling & Lee, etc.).
- 1 Pick-up jack and plug (Igranice type P86).
- 1 Output choke (Igranice, Midget, R.I., Lissen, Varley, Ferranti, Telsen, Lotus).
- 1 2-mfd. condenser (Ferranti, Telsen, Dubilier, T.C.C., Formo, Helsby, Hydra, Igranice).

ACCESSORIES.

- LOUDSPEAKERS.—Celestion, Mullard, Blue Spot, B.T.-E., Amplion, Undy.
- VALVES.—1 S.G. (Coscor (metallised) Osram, Mazda, Eta, Tungsram, Mullard, Six-Sixty, Dario).
- 1 Detector (Osram HL2, Mazda, Mullard, Coscor, Six-Sixty, Eta, Lissen, Tungsram, Dario).
- 1 Small power valve (Mazda, etc.). (Millamp. consumption at 120 volts max. 18 milliamps.).
- BATTERIES (H.T.—1 120-150-volt super-capacity (Pertrix, Ever Ready, Drydex, Columbia, Magnet, Ediswan, Lissen).
- 1 1½ or 3-volt G.B. battery for S.G. valve (Ever Ready, etc.).
- 1 9-15-volt G.B. battery to suit output valve (Ever Ready, etc.).
- ACCUMULATOR.—Two-, four-, or six-volt, to suit valve (Exide, Ediswan, Lissen, Pertrix, G.E.C.).
- MAINS UNITS.—Heayberd, Tannoy, Regentone, Lotus, Ekco, Atlas, R.I. (state voltage and type of mains, and give details of set when ordering).

This completes the terminal connections on the set and we are now ready to receive broadcasting.

Adjusting the Tapping.

Attach the spring clip (marked "Clip to taps" on blue print) to one of the tappings on the P.J.3 coil. The "A" tap is the best one to start with. Then place the two wave-change switches in the medium-wave positions by pulling the two knobs towards you, and switch on the valves.

For the time being place the knob of the selectivity control so that the moving vanes are fully in mesh with the fixed vanes and rotate the reaction condenser knob in an anti-clockwise direction.

Next rotate the two tuning condenser dials, keeping them roughly in step until you hear a station. Adjust each condenser to give you the loudest volume and then rotate the reaction condenser knob in an anti-clockwise direction. This should produce an increase in strength, but you will notice that if you go on turning the knob the broadcasting will start to get distorted until finally the set bursts into oscillation.

The Limit of Sensitivity.

The point at which distortion occurs is the limit of sensitivity, and no useful purpose is served by applying more reaction.

Don't forget that after each adjustment of the reaction control it is desirable to re-adjust the two tuning condensers slightly.

(Continued on page 496.)

THE L.F. DECOUPLING

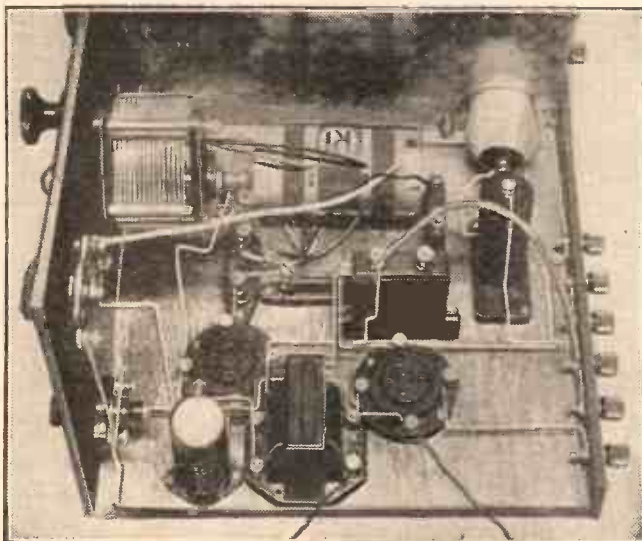

Adequate L.F. separation is secured by the 50,000-ohm spaghetti in conjunction with the 1-mfd. condenser, to which it is attached.

FREE

FREE

FULL-SIZE wiring diagram

with

Complete constructional details

FREE TO EVERY PURCHASER

OF A

"DUAL RANGER" MATCHED KIT

BUILDING MADE SIMPLE!

With a Ready Radio "P.W." "Dual-Ranger" Kit, you have in addition to the FREE FULL-SIZE WIRING DIAGRAM a packet of the famous JIFFILINX for wiring. There is no need for soldering, and construction is simplicity itself.

You can build this wonderful receiver for

£3.19.9 or 12 monthly payments of 7/6

Read what Kendall says about it:—



"... most wonderful results. Far ahead of the average receiver of its type. Selectivity exceptional . . . signal strength really extraordinary . . . outstanding performance . . . bringing in foreign stations with real ease and certainty. Strikingly easy to build and operate.



Hear the "Dual Ranger"
at our Showrooms, 159,
Borough High Street
(Two minutes from
London Bridge Station)



Order Form
on page 497.
See also page
501.

OPERATING THE "DUAL RANGER"

(Continued from page 494.)

The effect of reaction upon the tuning is, of course, very small.

There are two methods by which you can increase the set's selectivity.

For all ordinary purposes, the selectivity

as before, but it is advisable to adjust the knob on the .002-mfd. compression condenser and to notice the effect upon the volume and selectivity.

Stopping "Break Through."

Screwing down the knob increases the capacity, and also increases the selectivity and freedom from "break through."

Although there is a 30 and 60-turn tapping on the long-wave coil quoit, for all normal purposes the 60-turn tap will give the best volume.

The 30-turn tapping is only required in special cases, but it may be tried when exceptional selectivity is needed. The commercial versions are only supplied with one tap, viz., at 60 turns.

Although it is most unlikely that you will have any trouble from instability on the H.F. or L.F. sides, in extreme cases, such as those produced by mains unit back coupling, it is advisable to increase the size of the 1-mfd. decoupling condenser to 2 mfd.

In addition a 600-ohm resistance can be joined in series between the H.T.+1 lead and the screening-grid of V_1 . A 1-mfd. condenser is then connected from the screening grid to the metal screen. These modifications are of course only necessary when the H.T. coupling effect is abnormal.

You will notice that in this receiver H.T.— and L.T.— are joined together on the terminal strip, the filament switch being connected to the H.T.— terminal. So don't insert a fuse between H.T.— and L.T.— unless you first of all transfer the

L.T.— lead from the H.T.— to the L.T.— terminal on the strip. Otherwise, the fuse bulb will light up, and the valve filaments will not receive any current.

TELEVISION AND THE NORTH REGIONAL

From a Northern Correspondent

THE B.B.C. having signified its willingness to allow the North Regional station to relay the Baird television transmissions (at present limited to London Regional), the Baird Company's engineers have tested the landlines between London and Moorside Edge.

The frequency characteristic was found to be quite good, but there is some difficulty in sending a television image up to Moorside Edge owing to phase-change on the long landline. This trouble is not considered to be serious, however, and it is anticipated that it will soon be overcome. The North Regional station will then relay the Baird transmissions.

At present it is difficult to obtain good television reception in the North, owing to fading on London Regional reception.

LONDON'S BIGGEST STUDIO

From a Correspondent

WHEN I visited Broadcasting House the other day I found feverish activity in the big studio on and below the ground level. Swarms of workmen were hard at work in this concert hall, which is far from finished.

I was told by Mr. Tudsberry, the B.B.C. Civil Engineer, that it has been necessary to reduce the accommodation for spectators from 1,000 to 750. This is because a "bite" has been taken out of the gallery, for acoustical reasons.

Part of Broadcasting House is, of course, occupied, and Mr. Tudsberry expects to have the work "very well forward" by the New Year. He told me that the report that part of the Savoy Hill premises will be retained is incorrect.

A CURRENT-SAVING BATTERY!

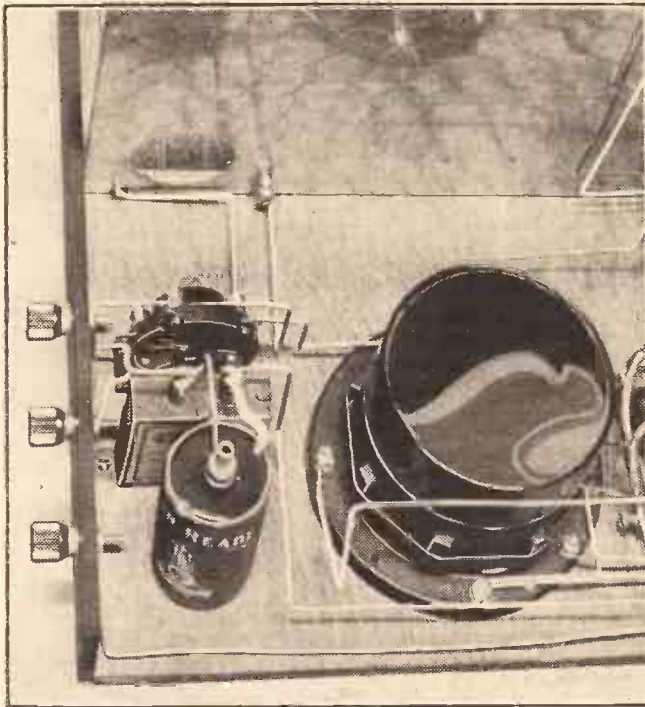

The H.F. grid-bias cell shown in the foreground has a very long life, and ensures economy of high-tension current consumption.

control on the panel is sufficient, especially when you are dealing with a distant station which you wish to receive clear of some other transmission on a not very adjacent wavelength.

Some listeners, however, may be situated in districts where local station trouble is prevalent, and it is for the benefit of these that we have provided three tappings on the P.J.3 coil.

On the Long Waves.

The "A" tapping gives maximum volume and minimum selectivity. To increase the selectivity the tapping clip is removed from the "A" tap and attached to one of the other tappings. When experimenting with these taps, the selectivity control should be kept at its maximum capacity setting (moving vanes all in) otherwise a true comparison between the various tappings will be impossible. Afterwards the selectivity control can be adjusted as necessary.

Long Waves: The tapping clip has no effect on the long waves, and is left in position. The two wave-change switch knobs are pushed towards the panel, and the knob of the selectivity control is rotated so that the moving vanes make contact with the shorting strip.

This cuts the condenser out of circuit. The method of tuning is precisely the same

MOUNTING THE S.G. VALVE

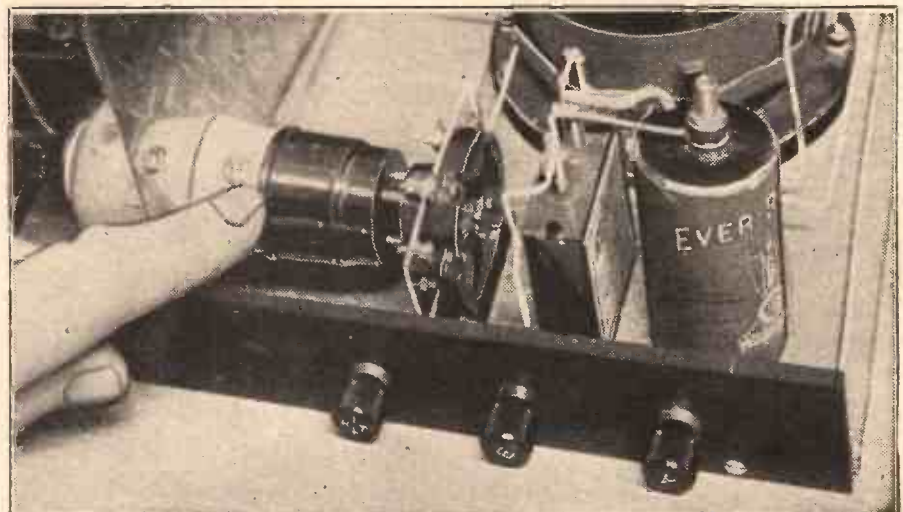

If the H.F. valve has to be removed, always disconnect the batteries first, as it is easy to have an expensive accident unless this is done.

IMMEDIATE DISPATCH of the *Ready Radio*

"P.W." DUAL-RANGER

APPROVED LIST AT A GLANCE "P.W." DUAL-RANGER

	£	s.	d.
1 Panel, 16 x 8 in., drilled to specification	5	5	6
1 Waldor cabinet, 16 x 8 x 10 in., with base-board	17	6	
2 Wavemaster .0005 - mfd. slow-motion condensers	11	0	
1 ReadiRad .0005-mfd. solid-dielectric condenser	3	6	
2 Three-point wave-change switches	3	0	
1 On-off switch	10	10	
1 ReadiRad .0005 differential condenser	2	6	
1 Kendall "P.W." dual-range coil	10	6	
1 T.C.C. .1-mfd. fixed condenser, type 50	1	10	
1 T.C.C. .0003-mfd. fixed condenser, type "S"	1	3	
1 T.C.C. .001-mfd. fixed condenser, type "S"	1	6	
1 T.C.C. .1 mfd. fixed condenser, type 50	2	10	
1 Sovereign pre-set condenser, type "H"	1	6	
1 P.J.3 coil	2	6	
1 Ready-wound coil quoit, Type D.R.	2	0	
1 Screen, 10 x 7 in.	2	0	
1 ReadiRad 2-meg. leak and holder	1	4	
1 Lewcos H.F. choke, type M.C.	2	6	
1 ReadiRad H.F. choke for S.G. circuit	4	6	
1 Lotus L.F. transformer, No. 1	5	6	
1 Lewcos 50,000-ohm Spaghetti resistance	1	6	
1 Lewcos 25,000-ohm Spaghetti resistance	1	6	
2 Junit valve holders	1	4	
1 Junit horizontal valve holder	1	9	
1 Terminal strip, 16 x 2 in.	1	4	
9 Belling-Lee terminals, type "R"	2	3	
1 Packet Jiffilinx for wiring	2	6	
1 Siemens 1½ v. S.G. cell, type G.T.	1	9	
3 Valves. Coscor Metal Coated S.G.215, Mullard P.M.1H.L. and P.M.2	1	19	0
Flex, screws, 1 crocodile clip, etc.			3
	£6	16	3

If you do not need the complete kit of parts, you can purchase any component you require separately.

TO INLAND CUSTOMERS—Your goods are despatched Post Free or Carriage Paid.
TO OVERSEAS CUSTOMERS—Everything Radio can be supplied against cash. In case of doubt regarding the value of your order, a deposit of one-third of the approximate value will be accepted and the balance collected by our Agent upon the delivery of the goods. All goods are very carefully packed for export and insured. All charges forward.

Kit A Complete set of Components (except Valves and Cabinet) **£3.19.9**

OR BY EASY PAYMENTS

of 12 monthly payments of **7.6**

Kit B (with Valves less Cabinet) **£5.18.9**

OR BY EASY PAYMENTS

of 12 monthly payments of **11.0**

Kit C (with Valves and Cabinet) **£6.16.3**

OR BY EASY PAYMENTS

of 12 monthly payments of **12.6**

 *Hear the "P.W." Dual-Ranger demonstrated at our Showrooms, 159, Borough High Street, London Bridge, S.E.1.*

- Full Size Wiring Diagram and all Constructional Details
- **FREE!** See page 495.

CASH or C.O.D. ORDER FORM

To: **READY RADIO LTD.,**
Eastnor House,
Blackheath, S.E.3.

Please dispatch to me at once the following goods:

for which (a) I enclose (cross out line) £
(b) I will pay on delivery (not applicable)

Name

Address

P.W. 31/10/31.

To: **READY RADIO LTD.,**
Eastnor House,
Blackheath, S.E.3.

Please dispatch to me the following goods:

for which I enclose first deposit of £

Name

Address

P.W. 31/10/31.

EASY PAYMENT ORDER FORM

Your batteries yearly cost you pounds



—an EKCO Unit will give you trouble-free radio for 1/- a year and finish with batteries for ever.

Connect an EKCO Unit in place of your usual battery (no alterations to your set or wiring). Plug in to the electric light or power supply. Then switch on—that's all. You will be more than delighted by the improvement in the performance of your set.

The New EKCO Units surpass all previous achievements, embody many exclusive features and combine highest efficiency with greatest simplicity. Made by the Pioneers and leading Specialists of All-Electric Radio.

H.T. Units (A.C. & D.C.) from 39/6

Combined H.T. & L.T. Charger Units (A.C.) from £3:19:6

All-Power Units (H.T., L.T. & C.B.) from £6:0:0

All obtainable on Easy Payment Terms from as little as 3/8 per month.

Post coupon now for full details.

EKCO

ALL-ELECTRIC POWER UNITS

To: E. K. COLE, Ltd., Dept. A.15
EKCO Works, Southend-on-Sea.
Please send me full details of EKCO Power Units.

Name

Address



HOW YOUR SET WORKS

At last we are ready for the studio performance to commence, and the time has now arrived for us to move over to the microphone. The full orchestra operates, the vocalist sings, and the whole studio quivers with sound waves.

The studio audience (if any) hear the result because their ear drums vibrate and their aural nerves communicate these vibrations to their brains.

"Mike" is not unlike a human ear in many ways. For instance, in place of the thin skin that forms the ear drum it has a thin metal diaphragm, and as the sound waves impinge on this it is set into vibration.

In the Studio.

Behind the diaphragm there is a quantity of carbon (see Fig. 3). The electrical resistance of this mass of carbon changes with the varying pressures imposed upon it. That is to say, it will enable more or less electricity to pass through as it is packed together with varying degrees of pressure in accordance with the movements of the diaphragm.

If you were to press the diaphragm in with your finger the current flowing through the microphone would leap up to colossal dimensions, and listeners would hear a very loud click.

Some of the microphones used by the B.B.C. are exceedingly sensitive, and can

A MICROPHONE CIRCUIT

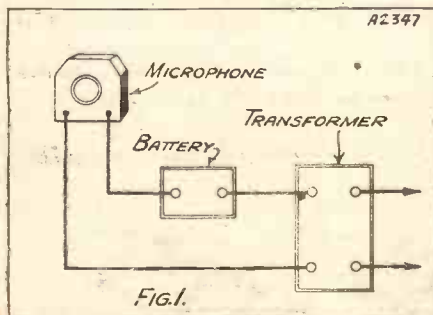

This is how the microphone is usually connected up.

be actuated by extremely tiny noises, but others are deliberately made insensitive. For instance, it is not required that the microphone used by the commentator at a football match should be able to pick up everything that is going on around (a separate mike is usually used for "crowd noises"). So it is made sufficiently insensitive to operate properly only when the speaker speaks clearly and closely into it. Subsequently, a bit of extra amplification is given to the electrical energy to compensate for this lack of sensitivity.

In his second article of a fascinating and informative series, Victor King tells you how a B.B.C. microphone changes sound waves into electrical impulses, and how these impulses ultimately mould patterns into the radio waves.

However, you will probably be unable to appreciate that point properly until we have dealt more fully with the part "Mike" plays in the radio chain.

The diagrams Fig. 1 to Fig. 4 are variations on the same theme. They all show, in different forms, an elementary microphone

AS SEEN IN SYMBOLS

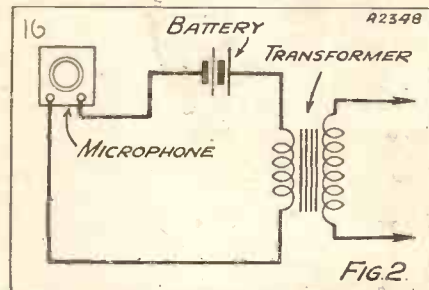

And here you see the Fig. 1 circuit in a conventional diagrammatic form.

circuit—the circuit in which the sound waves are, for the first time, reproduced as electrical impulses.

It is, in fact, the microphone's job to carry out this transformation and I have already given you a hint as to the way in which it does it.

The microphone circuit comprises a battery (similar to the kind you use for the L.T. on your set), the one winding of an L.F. transformer and the microphone itself.

Transmitters in Miniature.

But before I go any further I must interpolate that I do not intend to do more than deal very briefly with the electrical processes involved in a radio transmitter. Next week we commence a condensed description of radio reception, and the elementary principles of electricity and magnetism will be included in this.

And when this series of articles is completed, I hope you will find that most of the gaps I shall have left in this present summary of wireless transmission will be automatically filled up. You see, a transmitter is in many respects very similar to a receiver, and if you have a fair idea of the

functioning of the one it is not at all difficult to dig out the other.

But to return to our microphone circuit. Even when the microphone is not in action a certain amount of current will flow from out of the one terminal of the battery through the mike and the transformer winding back to the other battery terminal.

One of the diagrams shows the microphone as a zig-zag line with an arrow through it. This is the symbol for a variable resistance, and that is what the microphone is when sound waves are causing its diaphragm to vibrate.

The Amplifier's Action.

The amount of current that will flow in the circuit depends upon the resistance that is offered against its flow. If the resistance is large the current will be small; if the resistance is small, the current will be large.

Thus it follows that if the resistance varies, the current must also vary. And so the sound waves, acting on the microphone, produce current variations in the microphone circuit.

These current variations are passed on to an amplifier by means of the transformer.

The amplifier, as its name suggests, magnifies the electrical impulses.

In the meantime, the bulk of the transmitting gear is at work producing current variations of an extremely high frequency

(Continued on next page.)

HOW IT OPERATES

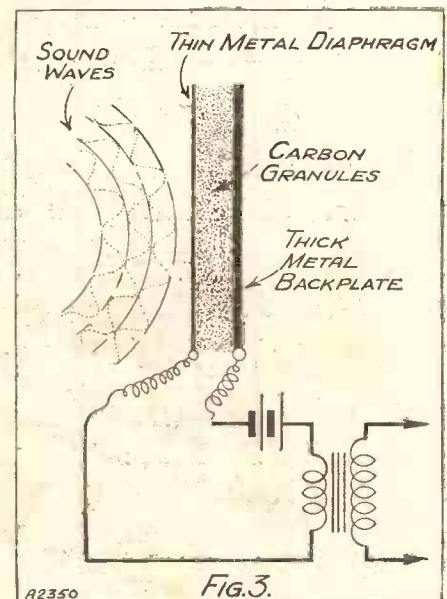

This diagram is intended to illustrate the working principle of a "mike."

HOW YOUR SET WORKS

(Continued from previous page.)

in a similar manner to the way in which a radio receiver can be made to oscillate (and in so doing interfere with the reception of other listeners) by the over-application of the reaction control—of which more anon.

As the current impulses generated by the microphone faithfully follow the sound waves, it is obvious that these will be of similar frequency. That is to say, the sound wave created by the middle C note of a violin will be represented in the microphone circuit by a current that varies 256 times per second in strength.

THE MEANING OF MODULATION

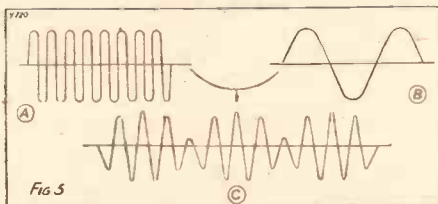

The "carrier" wave (A) has the low-frequency microphone currents (B) impressed on it, and thus assumes the new form C.

That is a *Low Frequency* (L.F.). But the radio transmitter produces current variations of something in the neighbourhood of one million per second, and that is a *High Frequency*.

Diagrammatically, we can represent these Low and High Frequencies as at A and B in Fig. 5, although, of course, the H.F. comprises many more times the number of variations per second than can be squeezed into a small drawing and still convey the idea clearly.

Combined with the Carrier.

The next step in the process of getting Jack Payne "on the air" is to combine the microphone currents and that steady High Frequency current that is being

generated. This business is known as *Modulation*.

A kind of effect as shown at C in Fig. 5 is obtained. The High Frequency current, while still preserving

its regularity of variation in terms of Frequency, also rises and falls in strength in accordance with a pattern of the exact shape of the Low-Frequency current variations. Rather cunning, isn't it?

After this the H.F. current is led to the aerial and made to dash up and down that. This creates a disturbance in the ether, and other waves, which are not unlike sound waves in form, are radiated over the countryside.

What is this ether? Well, it certainly isn't another name for the atmosphere, for wireless waves pass through windows and

walls and through spaces where there is no air with the greatest of ease.

As a matter of fact, it is still quite debatable as to whether or not there is such a thing as this ether, and some scientists hold that wireless waves are magnetic influences for which no material conducting substance is needed.

However, you need not worry much about this. But do not fall into the not uncommon error of presuming that wireless waves are air disturbances.

Also, do not think of them as electrical currents. They certainly are not that. They are phenomena caused by the electrical currents in the transmitting aerial and, in due course, they generate electrical currents in the aerials of listeners.

Wireless waves travel at the uniform speed of approximately 300,000,000 metres per second (about 186,000 miles).

Therefore, they vary in length in accordance with number that are emitted per second.

Frequency and Distance.

Obviously if, say, one million waves were produced in a second the first one could have travelled only 300 metres during that period of time, for the *Velocity* is a fixed factor. So 1,000,000 are crammed into that distance. Therefore, the length of each wave is 300,000,000 divided by 1,000,000, i.e., 300 metres.

Do you see the relationship between Wave-length, Frequency, and Velocity?

Should I have left you rather hazy, don't let that perturb you, for you will be meeting all these things again, and in more detail, when you come to radio reception. This is to be dealt with by somebody else, and I am sure he will provide you with some very interesting reading on the subject.

FLOOD-LIGHTING YOUR SET

By A. V. D. HORT.

A LAMP fitted to your receiver can be made to serve a double purpose. If placed in a suitable position, it will act as a pilot lamp to remind you when the receiver is switched on, and it will also illuminate the panel and dials. A lamp of this sort may be fitted to any receiver.

If you are already using the A.C. mains and A.C. indirectly-heated valves, you can put it in very easily, with the assurance that the cost of running it will be practically negligible.

You simply connect the lamp in parallel with the valve filaments. Provided that you are not already taking the maximum permissible load from the filament winding of the mains transformer, you will have an ample margin for the addition of this slight extra load

A satisfactory way of fixing the bulb on the panel is shown in Fig. 2, while Fig 1 gives the electrical connections. A brass screw-socket for a standard flash-lamp bulb is pushed through a $\frac{3}{8}$ -in. hole in the panel, and is secured from the back by means of two bolts through the holes in its base.

One connection goes direct to a filament terminal on the nearest valve-holder, the

QUITE EASY TO FIT

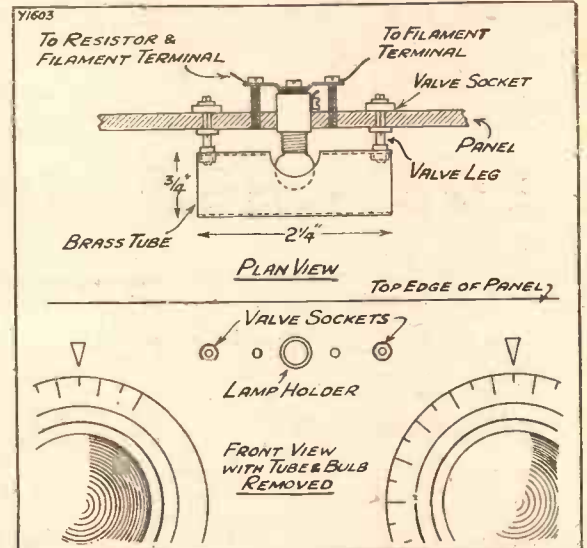

Fig. 2. The full working details reveal the simplicity of the fixing.

other through a fixed resistor on the panel or baseboard to the other filament terminal.

It is advisable to include this resistor, which may have a value of 4 or 5 ohms. The brilliance of the light will be but little affected, while the life of the bulb will be materially increased.

On the front of the panel a piece of brass tube, suitable dimensions for which are given, fits over the bulb and directs the light sideways in both directions over the panel and on to the dials, at the same time preventing it from dazzling the operator. Two valve legs are screwed to the ends of the tube, to fit into sockets on the panel. A hole is cut out at the centre of the tube, large enough to clear the bulb.

When you have fitted a pilot lamp like this, you will always have a visible warning that the mains are connected to the receiver, and you will be able to operate the receiver in the darkest corner of the room with a clear view of the dial readings.

NEGLECTIBLE COST

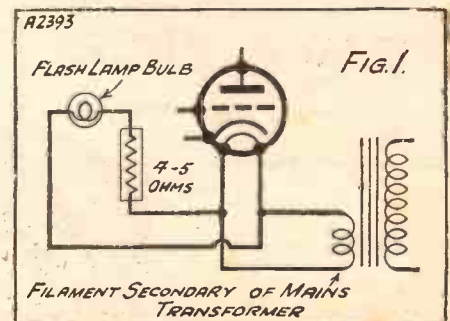

The cost of running such a lamp in conjunction with an A.C. set is almost negligible.

Specially Recommended Accessories for the "P.W." Dual-Ranger

FOR CASH OR EASY PAYMENTS

RECOMMENDED BATTERY AND LOUDSPEAKER EQUIPMENT

1 Ready Radio Kit "C"	£	s.	d.
1 Pertrix 120 v. Standard H.T. battery	6	16	3
1 Pertrix 9 v. grid-bias battery	15	6	
1 Pertrix accumulator, type P.X.C.3	11	0	
1 Blue Spot speaker, type 44R.	2	12	6
	10	16	9

Any other makes can be supplied if required.
COMPLETE KIT as above

£10.16.9

or 12 monthly payments of

20/-

If you wish to use an H.T. Eliminator with your "Dual Ranger" we recommend the Ready Radio Type R.1. Gives 120 volts at 20 m/a., 3 voltage tappings. Price £3.3.0.
IF ORDERED WITH A "DUAL RANGER" KIT ADD £3.3.0 TO THE CASH PRICE, OR 6/- PER MONTH TO THE MONTHLY PAYMENTS.

**FULL-SIZE WIRING
DIAGRAM AND ALL
CONSTRUCTIONAL
DETAILS FREE!**

See Page 495

Showrooms:
159, Borough High St.
London Bridge, S.E.1
Phone: Hop 3000

THE DUAL RANGE COIL

was designed by

G. P. KENDALL

B.Sc.

Chief Engineer, Ready Radio.



Be sure your coil is a genuine Kendall "P.W." Dual Range Coil. Get it from Ready Radio!

Price **10/6**

All Kendall Dual Range Coils are given an actual broadcast test before despatch under the supervision of the designer, Mr. G. P. Kendall.

COMPLETELY ASSEMBLED "P.W." DUAL-RANGER

with Cabinet and Valves, aerial tested, royalties paid.

Price **£8.6.8**

or 12 monthly payments of

15/3

With Battery Equipment and Loudspeaker as specified above:

Price **£12.7.2**

or 12 monthly payments of

23/-

**COME AND HEAR
THE "P.W." DUAL-
RANGER, AT OUR
SHOWROOMS, 159,
BOROUGH HIGH ST.,
LONDON BRIDGE.**

2 minutes from London Bridge Station

Ready Radio

Head Office and Works:
EASTNOR HOUSE,
BLACKHEATH, S.E.3
Phone: Lee Green 5678
Grams: Readirad, Blackvit
Advt. of Ready Radio, Ltd.

AT the end of the summer I was rather afraid that when stations returned to the big strength that we associate with autumn and winter reception there might be a very nasty crop of heterodynes, especially on the medium wave-band.

On the face of it it seemed that something of the kind was more than probable, but I am glad to be able to report that one's fears have proved to a great extent groundless, and that only a few of the good stations are seriously affected by heterodyne interference.

Archangel Interferes!

The reason why it seemed that such trouble might arise is this. In summer time the range of low-powered stations becomes very restricted; therefore, even if they are not adhering strictly to the 9-kilocycle separation, they do not cause interference with others.

But in winter time a half-kilowatt or even a quarter-kilowatt station with a good aerial system sometimes achieves almost miraculous ranges, and may heterodyne another transmission coming from a place hundreds of miles away. Last year, for instance, Vienna was sometimes interfered with by the small Russian station at Archangel.

One may say that the vast majority of the heterodynes which now spoil reception are due to stations which indulge in wave-

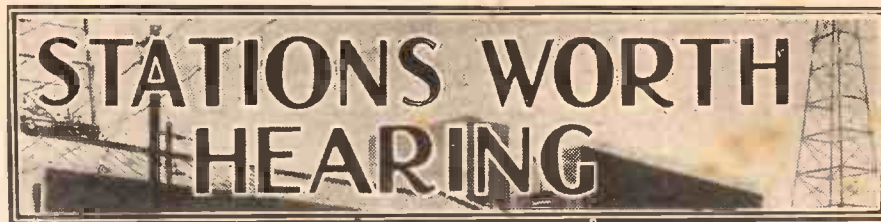

Some practical distant-programme notes compiled by a special contributor who nightly searches the ether in order to obtain really up-to-the-minute information for "P.W." readers.

length wobbling or wave-length wandering. It is greatly to be hoped that the international agreement upon which the Prague plan is based will be so tightened up in the near future that a stop will be put to both wobbling and wandering.

The long wave-band is providing magnificent reception just now; in fact, even with a portable set using its own small aerial you can take your pick of the well-known long-wavers and be sure of good reception. The only long-wave stations which occasionally show slight weakness are Huizen and Zeesen. I believe that in the north Oslo is frequently found to be heterodyned, but in my locality it is very seldom that a whistle is noticeable.

Below 250 Metres.

In summer and early autumn the lower part of the medium wave-band is not a very happy hunting ground for the long-distance man, partly because fading is so apparent and partly because the small amount of capacity in parallel with the tuning coils at low settings brings out to the full the effects of atmospheric when these nuisances are about.

become more and more worthy of attention. At this time of year low-powered stations using shortish wave-lengths can span uncanny distances.

Those Swedish Relays.

You may in fact spend an amusing evening in collecting quite a number of the quarter-kilowatt Swedish relays. It is difficult to identify them since all or nearly all transmit the Stockholm programme, but you can often do so by comparing their settings with those of known stations.

Besides the Swedish relays there are some good stations in this part of the band. Königsberg, Warsaw No. 2, Lodz, and Nuremberg are all worth adding to the log; and then there is, of course, Trieste, whom you cannot fail to find if you work downwards from the London National by way of Leipzig, Horby, Toulouse PTT, and Gleivitz.

A little higher up there is a belt from 263 to 281 metres, which should be thoroughly searched on good nights. This contains Moravska-Ostrava, Lille, Bremen, Rennes, Heilsberg, Bratislava, and Copenhagen.

THE only item of news during the past week that seems worthy of comment is the sudden return of extremely good conditions on the amateur wave-bands. All the high-powered stations at this end seem to be working regularly with the Antipodes, both on 40 metres (early in the mornings) and on 20 metres (at mid-day and in the early afternoon).

All the World

On the afternoon prior to writing these notes I logged fifteen Australians, three New Zealanders, one man in Malaya, six in Dutch East Indies, one Philippine Islander and a Hong Kong station. All this during about two hours, using one valve. So who can say that conditions are bad?

In view of the absence of other news I propose to deal with some of the more interesting letters and queries that have been accumulating.

There are two very nice reports of VK 2 ME from W. H. R. (Plymouth), and 2 BCS (Channel Islands). The former still finds a thrill in listening to Australia's announcements of the time—ten hours ahead of our own—and mentions the "signing off" formula—"Good-morning, good-afternoon, good-evening, everybody."

W. H. R. also finds good stuff coming from W 2 X A F and Radio Maroc on

SHORT-WAVE NOTES



Notes and views regarding an exciting and fascinating wave-band.

By W. L. S.:

32.26 metres, but finds, in common with myself, an erratic touch about anything below the 25-metre band. Other stations mentioned as good are W 3 X A L and W 8 X A L.

116 Different Countries.

R. H., of Teddington, being laid up in bed for a while, consoled himself with a Kelsey adaptor and two L.F. stages, and is duly rewarded by being admitted to the order of H. A. C. Incidentally, two or three gentlemen seem to think that this means "Heard All Countries!" Of course, the "C" stands for "Continents." South America is taken as a sixth, and only telephony counts.

I don't think anyone can yet claim to have heard all countries. I, personally, find from my log that I have heard 116 to date, but I think a good many of our hot receiving men can beat me on that.

The 32-Metre "Mystery."

W. H. B. (of Newcastle) is kind enough to supply some details about the German station that works in the vicinity of W 2 X A D. He did a lot of concentrated listening on this station while homeward bound from Buenos Aires, and consequently heard it under more favourable conditions than most of us are able to do.

Apparently the station never announced "Königswusterhausen," but the interval signal "HA" in Morse was heard. This, of course, is the identification of Hamburg, on the broadcast waves.

W. H. B. also suggests that some of the talk about a "mystery station" on 32 metres or so that announces in Spanish may be answered by reference to W 2 X A F's programmes in that language for the benefit of Central and South America.

His last query is concerning the "creep" of a transmitter after it has first been started up. He has logged this effect on G 5 S W and Pontoise, and I believe it is simply due to the warming up of various parts of the apparatus under load.

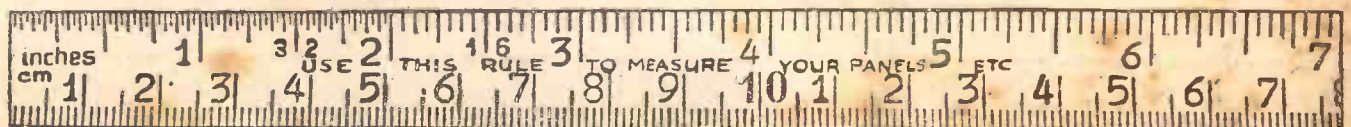

MUTUAL CONDUCTANCE 6.5
 ANODE RESISTANCE 11,500
 AMPLIFICATION FACTOR 75



AC2/HL

METALLISED

IN THE MAZDA RANGE OF MAINS VALVES

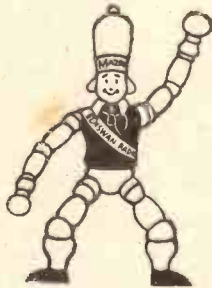

This valve is one of the new metallised types in the Mazda mains range. Its high mutual conductance and low anode resistance make it an ideal power grid detector. Amazingly sensitive to small currents it can also be used with great success as an intermediate L.F. Amplifier. Performances like that given by the AC.2/HL are typical of Mazda mains types. When you purchase a Mazda valve you are getting a product of Mazda resources—Mazda engineering skill—Mazda research.

You can buy these valves at all good radio dealers.

MAZDA MAINS VALVES

TYPE		PRICE
A.C. MAINS		
AC/HL ...	Clear	15/-
AC.2/HL ...	Metallised... ..	15/-
AC/SG ...	Clear or Metallised	22/6
AC/S.2 ...	Metallised... ..	22/6
AC/P ...	Clear	17/6
AC/P.1 ...	Clear	20/-
AC/PEN ...	Clear	25/-
D.C. MAINS		
DC/SG ...	Clear	22/6
DC/HL ...	Clear	15/-
DC/P ...	Clear	17/6
DC/PEN ...	Clear	25/-
DC.3/HL ...	Clear	15/-
DC.2/P ...	Clear	17/6
DC.2/PEN ...	Clear	25/-

THE AMAZING

MAZDA

THE
 BRITISH
 VALVES

THE EDISON SWAN ELECTRIC CO. LTD.
 RADIO DIVISION:
 155 CHARING CROSS ROAD, LONDON, W.C.2



EDISWAN RADIO

TWO RADIO SUNDAYS

in GERMANY

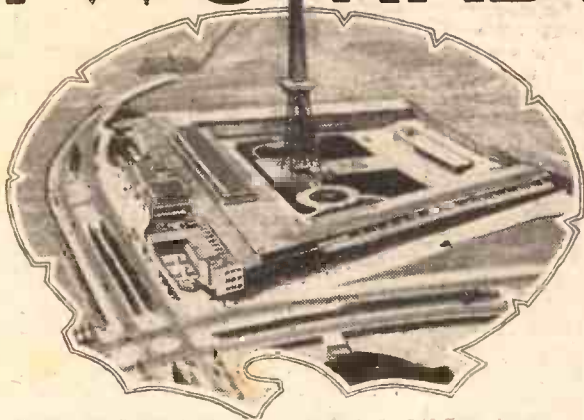

An entertaining description—exclusive to "Popular Wireless"—of radio reception on Sundays in Berlin and Munich. You have often envied those cheery programmes provided for continental listeners—read below an account of how they strike the man on the spot.

FROM OUR SPECIAL CORRESPONDENT.

SUNDAY in Berlin: a very gay affair, *nicht wahr?* Being English, and not a born townsman, I do not like it, for obviously one day in the week was made for rest, and only the Germans and the French seem to be able to keep up the high-pressure seven days in every week!

As a visitor staying with a German schoolfriend, I didn't have much chance to complain, though; and as we are both radio "fans"—*Fernempfang-Freund* is the proper term, I believe—we saw what the other side of a German Sunday is like.

Compare the two Countries.

Outside, the streets were thronged, and the theatres and *Tanzlokal* (dance-clubs) were packed; in contrast, the radio entertainment seemed very dull, but I dare say it would seem bright enough compared with B.B.C. Sabbath fare. Compare for yourself as I describe what we received.

To start with, we had no set; not set of our own, that is! My friend's portable was undergoing repairs at the local *Radio-geschäft*, and we had to rely on the communal radio set with which the block of flats where we were staying was equipped.

In our rooms we had a loudspeaker and two plug points. The *Gerät* itself was in the basement, and could be tuned to either Witzleben, Mühlacker or Heilsberg when the night porter felt inclined to move the knobs.

As a preliminary we went down and gave the night porter our compliments (and a tip), and told him of our desire to search the German ether. Otherwise we should have spent an evening tuned to Witzleben!

Then we plugged in our little dynamic speaker.

Witzleben was on—that is, at about five o'clock. There was some light orchestral music of the Sandler variety from one of the big hotels, the Hotel Bristol, I believe, and we enjoyed this for an hour or so, having nothing much else to do.

Readings of German Prose

At about half-past six they switched back to the studio for a reading by one of the popular *literateurs* of the moment, Gustav Stolze, of his own works. German prose never did appeal to me!

They have so much of it on the wireless, too. Whenever you hear a man talking from a German station you can be sure that he is giving a news bulletin, telling topical stories, or "reading from his own works"!

So we got on the house 'phone to the basement porter and told him that Herr Stolze

was not appealing to us nor to anybody else in the building; and within ten seconds Herr S. faded out in favour of, first, a sports talk from Mühlacker (relayed from Frankfurt), and then a recitation on some prosy subject from Heilsburg.

It didn't sound very hopeful. We 'phoned again and begged a little Koenigswusterhausen, only to be told that the set wouldn't work properly on the long waves.

We looked up the Sunday items in one of the German programme papers and found that we certainly weren't missing much by missing Koenigswusterhausen. According to schedule there was a talk on just at that

too, a passion for opera, and keep digging out operas of which the average Englishman, accustomed to "*Faust*", "*Carmen*" and so on, has never heard before.

We listened, and it seemed quite good fare. But it was spoiled by late news and—yes—another sports bulletin given during the rather lengthy intervals.

A Rather Novel Feature

Without asking for it, the opera suddenly faded out and we were switched on to Mühlacker; rather rough, I thought, on the "*Don Carlos*" enthusiasts in the other flats.

Anyway, it brought us in the middle of a novel feature which the programme paper called "Another Hundred Minutes Without Chamber Music and Symphonies." Apparently there are some German listeners who feel in the same way that we do about the B.B.C. and the preponderance of these things.

More News

The programme seemed to be made up largely of gramophone records, hardly justifying the title, but nevertheless certainly not chamber music or symphonies; it's an idea that might be recommended to the "Stunt" Department of the B.B.C.

Then the porter must have gone to sleep or to the local beer-garden. Not even our frantic 'phoning would shift him from Mühlacker, and so we had to listen to further news and sports bulletins, and a time signal at 9.25.

The news was trivial (to an Englishman, at least; my friend seemed interested), and the sports bulletins dealt with the activities of certain walking clubs. We could have pulled the speaker out and switched off, of course, but there was dance music to follow, and we didn't know when the talks would stop.

Eventually along came the gramophone

(Continued on page 506.)

AMONG THE MEN OF MUNICH

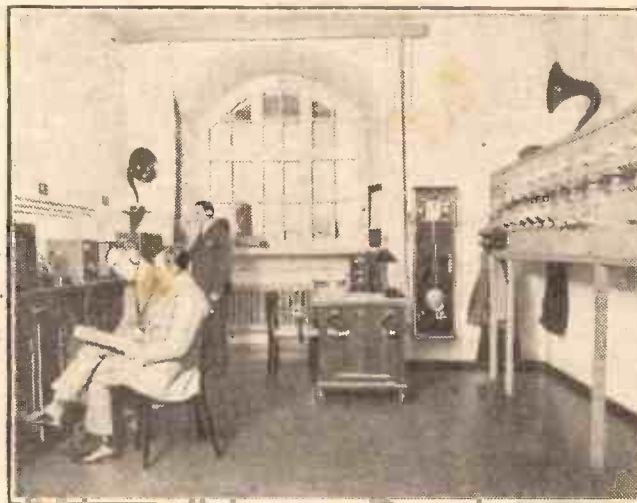

Some of the engineers at work in the control room of the Munich station, which operates on a wavelength of 533 metres.

moment, and another talk and a sports bulletin when this had finished.

We begged more Witzleben, and got it just as the sports bulletin was finishing.

The only fun I had out of the sports bulletins was to hear the way in which the announcers dealt with the names of English Rigger clubs. I hope Mr. Hibberd and the others at Savoy Hill are more accurate in their German!

A Passion for Opera

An opera was announced from the studio, and it turned out to be "*Don Carlos*," one of Verdi's; never heard of it before. It's strange how the German stations have,



Switches may appear to play a comparatively insignificant part in a wireless receiver. If, however, their functions and positions are considered, it will be seen that sound design and construction are of paramount importance.

Most radio switches are entirely unsuitable for the high-frequency side of a receiver, where losses and bad and noisy contacts cannot be tolerated. With this in mind, J. Sieger, the famous radio engineer, has designed the new LOTUS Universal Switch. This is a unique rotary switch with self-cleaning contacts, which is provisionally patented by virtue of its design. The switch can be ganged in different ways, and is especially suitable for wave-change switching in any position.

Type US/3 - 1/6

Write for leaflet giving suggestions for use of the switch, and a copy of the LOTUS Component Catalogue. Every home constructor should have one.

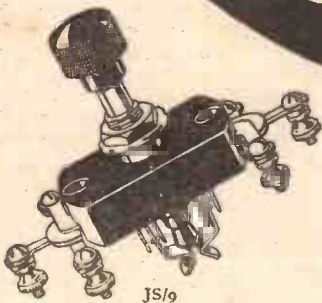

JS/9
The LOTUS Jack Switch,
D.P.D.T. 4/-



BS/20
The LOTUS Battery
Switch. 1/6

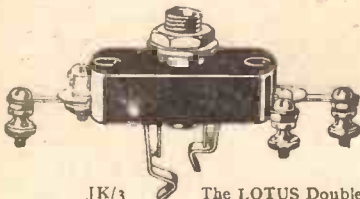

JK/3 The LOTUS Double
Circuit Jack. 2/6

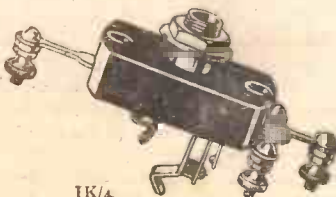

JK/4
The LOTUS Single Filament
Control Jack. 2/6



JP/1
The LOTUS Jack Plug. 2/-



RADIO JACKS & SWITCHES

LOTUS RADIO LTD. - MILL LANE, LIVERPOOL.

TWO RADIO SUNDAYS IN GERMANY.

(Continued from page 504.)

records for a quarter of an hour. Then we made the unpleasant discovery that we had actually not been listening to Mühlacker, but to the Frankfurt programme still relayed on 360 metres.

And within a few minutes Mühlacker switched back to its own studio for programme announcements and a news bulletin! It seemed incredible, but really it's true.

The German Dance Bands.

At long last the announcer concluded and switched us back to Frankfurt's gramophone line. That at last seemed interesting, for many of the records were German, and were of bands which one cannot hear in England. Dance enthusiasts would have been interested, too, for there is quite a different rhythm in some of the recordings.

I idly wondered if these dance records were making a blasphemous background to the B.B.C.'s religious activities on 360 metres; but then I realised that it was about 11 o'clock, and the B.B.C. would be asleep!

We switched off and went to bed long before the records were over.

During the week we had to go down to Munich, and as there was a prospect of being able to stay there over another week-end my friend went down to the radio shop for his portable set.

I went with him, and thereby realised that although my conversational German is fair, I am like a newborn babe when it comes to radio technical terms in German. The *Verkäufer* patiently tried to make me understand, but I came to the conclusion that it's bad enough to be troubled about selectivity without having to call it by a name like *Abstimmungsschärfe*.

But with reference to Munich; or should I say München?

We found that it was very difficult to get the B.B.C. stations, probably because so much of the distance was over land, and for the same reason the French stations were weak.

Reception at Munich.

The local station, which is on about 533 metres, was, of course, at fine strength on our tiny frame aerial, and we still had access to Heilsberg, Koenigswusterhausen, and the rest.

Here is our Sunday programme from München. During breakfast at ten o'clock we listened to a relay from some place, perhaps the Cathedral, where a Mass (including a big choir and a fine organ) was being broadcast.

At eleven there was a studio programme of light orchestral stuff, and this, I believe, went on to about mid-day, but we went out for a stroll. There was "canned" music when we came back at about half-past twelve.

A Chess-match Relay.

This went on for an hour or so until, just as we were finishing lunch, they switched on to another studio for a "relay" of a chess match and a course of instruction for chess players. Chess is, of course, much more popular in this part of the world than it is, say, in England.

Following this there was a Children's Hour: not my ideal Children's Hour. There was far too much talking and fairy-story telling; far too little music. I fear that Uncle Columbus and the others would be in for a rough time if they copied the München example.

Then they switched over to the Breslau line, and for a while there was a rather interesting "O.B." Interesting, that is, for the people who live here.

It was the tenth anniversary celebrations of the Upper-Silesian Plebescite, coming from the Stadium at Beuthen. We listened

Witzleben, which was taking light music from a popular place, the Café Berlin.

I have often found Witzleben doing light programmes of this kind, and there is no doubt that the general programmes broadcast from the Berlin transmitter would be very acceptable to the average British listener, more so, I think, than those broadcast from any other German station; when the talks are not on, of course, or the sports news!

Going back to the München station again, we found, according to programme, that there would be talks, news and so forth till after dinner; so we pulled in Bordeaux-Lafayette, and I brushed up my French by listening to the very interesting *journal parlé*.

Tame Radio Sundays.

In the evening from München there was a vocal and orchestral concert of light opera and musical comedy selections; rather B.B.C.-ish, I thought, and the early close-down at eleven o'clock was depressing and not at all in keeping with the neighbouring Hofbrauhaus, which was still full of merry-makers.

Finally it was to the Hofbrauhaus that we went and forgot this second tame radio Sunday in the enjoyment of München beer and radishes! At midnight on a Sunday, London offers no such alternative entertainment to radio!

THE "PORTLAND" PLACE OF BERLIN



Particular interest attaches to this view of the recently-completed German headquarters in Berlin, on account of the new B.B.C. building in Portland Place, London, W.

to it for a while; there were addresses, many of them, and a large amount of choir singing and so forth, very well done as an outside broadcast.

Quite a Lot of Relaying.

It bored me after a while, and it was rather disappointing to find that nearly every other station was taking this Breslau relay, even Koenigswusterhausen, Heilsberg, and Witzleben. A very inferior light music concert from Mühlacker held me, though, until tea-time, at about 4 o'clock, when München came back to its own studio and started to give the same sort of thing.

I turned the frame Mühlacker-wards (finding a "Women and Books" literary talk in progress) and then to Langenberg, which was relaying our local München programme. Hamburg, I found, was relaying Hanover, and the best station was

screened-grid stage of high-frequency amplification, for instance, the anode circuit may be brought to the point of oscillation and the aerial circuit to the same state.

In order to get these two critical adjustments, the voltages applied to the anode and the screening-grid of the valve must be adjusted with great care so that the greatest possible amplification can be obtained.

By-Pass Arrangements.

The shielding in the set and also the provision of proper bypass arrangements become particularly important, and by careful attention to these it is much simpler to attain the critical adjustments mentioned above without running into oscillation.

As regards the grid bias to be applied, it is important not to overdo this, but the exact grid bias voltage will depend upon circumstances.

LONG DISTANCE RECEPTION

How to get
maximum
efficiency and
selectivity.

WHEN you are out for long-distance reception and selectivity—the two frequently go hand-in-hand—you want to take the greatest possible care of all the adjustments of the circuit.

If you are using a screened-grid stage of high-frequency amplification, for instance, the anode circuit may be brought to the point of oscillation and the aerial circuit to the same state.

In order to get these two critical adjustments, the voltages applied to the anode and the screening-grid of the valve must be adjusted with great care so that the greatest possible amplification can be obtained.

By-Pass Arrangements.

The shielding in the set and also the provision of proper bypass arrangements become particularly important, and by careful attention to these it is much simpler to attain the critical adjustments mentioned above without running into oscillation.

As regards the grid bias to be applied, it is important not to overdo this, but the exact grid bias voltage will depend upon circumstances.

Join the new Radio Cult!



CONVERTS YOUR OLD BATTERY SET INTO AN ALL-MAINS RADIO

COSTS ONLY 1d. A WEEK TO RUN

ANY MODEL DELIVERED TO YOU FOR ONLY 10/6 DOWN

Balance in Easy Monthly Payments



BATTERY ELIMINATORS

“MULTIVO” “VOLTEX” “MINIVO”

H.T. OUTPUT: 25 milliamperes 1. variable tapping-0/100 volts. 1 tapping .. 50/90 .. 1 tapping .. 150 .. Trickle charger for 2-, 4- and 6-volt accumulator at .5 amps. CASH PRICE £5 9 0	For indirectly-heated valves. H.T. OUTPUT: 25 milliamperes. 1 variable tapping-0/100 volt. 1 tapping .. 50/90 .. 1 tapping .. 150 .. L.T. OUTPUT: 4 volts 4 amps. (Raw A.C.) CASH PRICE £5 5 0	H.T. only. Output: 120 volts at 20 milliamperes. 1 tapping .. 50/90 volts. 1 tapping .. 90/100 .. 1 tapping .. 120/150 .. CASH PRICE £3 3 0
--	--	--

ASK YOUR DEALER TO DEMONSTRATE, OR WRITE NOW FOR Fully illustrated Catalogue "E" to:

ARTHUR PREEN & CO., LTD.,
GOLDEN SQUARE, PICCADILLY CIRCUS, LONDON, W.1.
Crown Works, SOUTHAMPTON.

AMPLION OFFER YOU

FOR **25/-**

the A.C.6



A.C.6.—Contained in a handsome oak cabinet, this beautifully finished cone speaker embodies a unit of improved design. This is not only constructed to work with a small set but will also handle the output of powerful receivers without distortion.

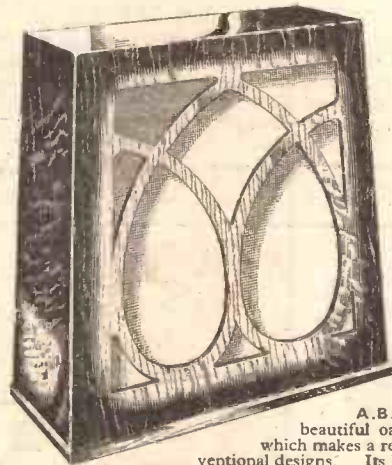

FOR **50/-**

the A.B.4

A.B.4.—The modern lines of this beautiful oak cabinet have a severity which makes a refreshing change from conventional designs. Its handsome exterior houses a highly efficient speaker—a balanced armature model with provision for matching to power or pentode outputs. Fifty shillings is indeed a small price for such volume and crisp reproduction. Same model in Walnut 59/6.

And FOR

67/6

the M.C.6

M.C.6.—An extremely efficient moving coil unit, a permanent magnet which is quite as sensitive as a balanced armature speaker, and thus quite suitable to work with ordinary 2, 3, or 4 valve receivers. The matching transformer, fitted as standard, enables the unit to be correctly matched to any output.

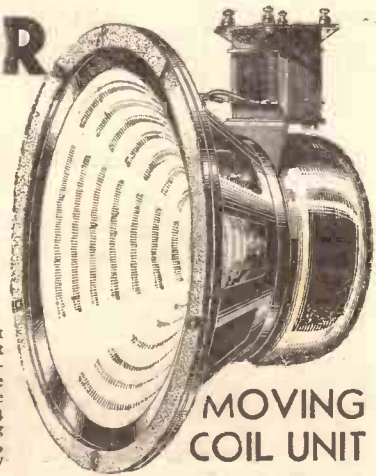

MOVING COIL UNIT

GRAHAM AMPLION LTD., 26, Savile Row, LONDON, W.1



All Editorial communications should be addressed to the Editor, POPULAR WIRELESS, Tallis House, Tallis Street, London, E.C.4.

The Editor will be pleased to consider articles and photographs dealing with all subjects appertaining to wireless work. The Editor cannot accept responsibility for manuscripts or photos. Every care will be taken to return MSS. not accepted for publication. A stamped and addressed envelope must be sent with every article. All inquiries concerning advertising rates, etc., to be addressed to the Sole Agents, Messrs. John H. Lile, Ltd., 4, Ludgate Circus, London, E.C.4.

The constructional articles which appear from time to time in this journal are the outcome of research and experimental work carried out with a view to improving the technique of wireless reception. As much of the information given in the columns of this paper concerns the most recent developments in the radio world, some of the arrangements and specialities described may be the subject of Letters Patent, and the amateur and the trader would be well advised to obtain permission of the patentees to use the patents before doing so.

QUESTIONS AND ANSWERS

THE NUMBER OF POLES.

B. H. L. (Derby).—"What does the term 6 poles (or any number of poles) mean in reference to loudspeakers. Also, what does the 'ratio' of a transformer mean, for example, ratio 3-1 or 5-1?"

To understand the reference to poles, you must remember that every magnet has two poles—one a north and the other a south. Even if you break

a magnetised bar in two, each half has two poles—a north and a south.

It sometimes happens that the loudspeaker manufacturer requires not one powerful magnet but an equivalent force, from a number of smaller magnets. And when magnetic power is distributed over a number of separate units in this way, the arrangement (whether of the permanent magnet or electro-magnetic type) can be described as having so many poles.

It is in this sense that you have seen the term used. Re your second question, the ratio of a transformer is dealt with in another question this week. (See answer to D. C. W., Dover.)

THE L.F. TRANSFORMER.

D. C. W. (Dover).—"I am very interested in the way that wireless works. Although I

have no time to study the thing properly, I should appreciate a few hints about the working of an L.F. transformer, which up to now is a complete mystery to me.

"I know that two of its terminals are called 'Primary' and two the 'Secondary.' But why? What does the transformer do to the plate current which flows through it? Why do we have 1-1 transformers or 3-1 transformers? In fact, what is a transformer? And how does it work?"

The L.F. transformer is a comparatively simple piece of apparatus, but to understand its action in any degree you must appreciate what Faraday proved many years ago—that every electric current flowing through a wire is always accompanied by a considerable magnetic field existing around that wire.

(Continued on page 510.)

WHAT'S THE MATTER WITH THE SET?

Perhaps the switching doesn't work properly? Or some mysterious noise has appeared and is spoiling your radio reception?—or one of the batteries seems to run down much faster than formerly?

Whatever your radio problem may be, remember that the Technical Query Department is thoroughly equipped to assist our readers, and offers an unrivalled service.

Full details, including scale of charges, can be obtained direct from the Technical Query Dept., POPULAR WIRELESS, The Fleetway House, Farringdon Street, London, E.C.4.

A postcard will do. On receipt of this an Application Form will be sent to you post free immediately. This application will place you under no obligation whatever, but, having the form, you will know exactly what information we require to have before us in order to solve your problems.

LONDON READERS, PLEASE NOTE: Inquiries should NOT be made by 'phone or in person at Fleetway House or Tallis House,

IT'S A FERRANTI!

On this one point at any rate, the whole of the Electrical and Radio world is in agreement:

No higher tribute can be paid to the all-round excellence of a transformer than to say "It's a Ferranti."

FERRANTI

A.F. TRANSFORMERS



FERRANTI LTD.
Head Office
& Works:
HOLLINWOOD,
LANCASHIRE.
LONDON: Bush
House, Aldwych,
W.C.2.

PRICES:

AF3. Ratio 1 to 3 $\frac{1}{2}$	25/-
AF4. Ratio 1 to 3 $\frac{1}{2}$	17/6
AF5. Ratio 1 to 3 $\frac{1}{2}$	30/-
AF6. Ratio 1 to 7	30/-
AF7. Ratio 1 to 1 $\frac{1}{2}$	30/-
AF8. Ratio 1 to 3 $\frac{1}{2}$	11/6

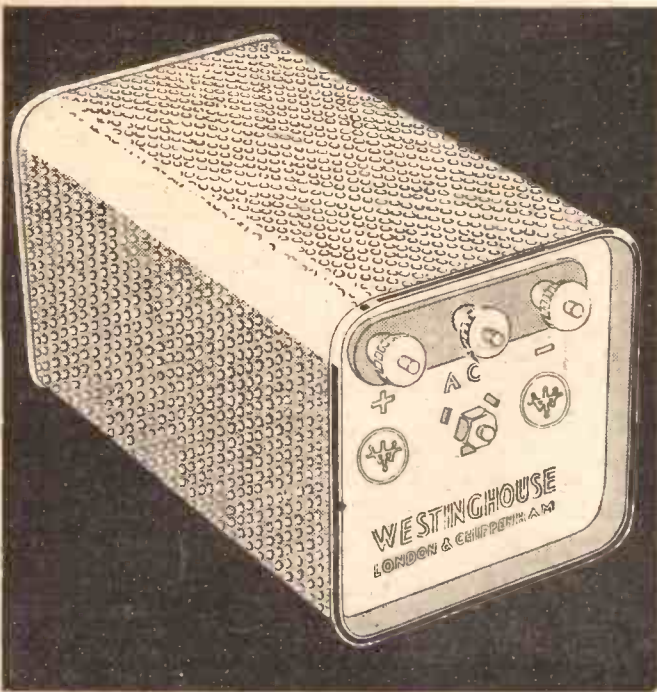

YOU can use this H.T.8. or one of its brothers, for running your radio set from the electricity mains; "The All-Metal Way" tells you how.

The 1932 edition of "The All-Metal Way," which will be sent on receipt of the coupon with 3d. in stamps, gives the information required to build an H.T. eliminator or trickle charger, and details for running moving-coil loud-speakers from A.C. Mains. This well-known book has been completely revised, and questions not fully dealt with in our 1931 issue are now discussed in detail.

The H.T.8 has an output of 250 volts 60 m.a. (after smoothing). Its price is 21/-. Other H.T. types are from 12/6.



METAL RECTIFIERS

THE WESTINGHOUSE BRAKE & SAXBY SIGNAL CO., LTD.,
82, YORK ROAD, KING'S CROSS, LONDON, N.1.
Tel.: NORTH 2415.

COUPON

PUBLICITY MANAGER W.B. & S.S. Co.,
82, York Road, King's Cross, London, N.1.,

I enclose 3d. in stamps, for which please send me a copy of "The All-Metal Way," 1932.

PLEASE USE BLOCK LETTERS.

NAME.....

ADDRESS.....

P.W. 31/10.

100% BRITISH MADE

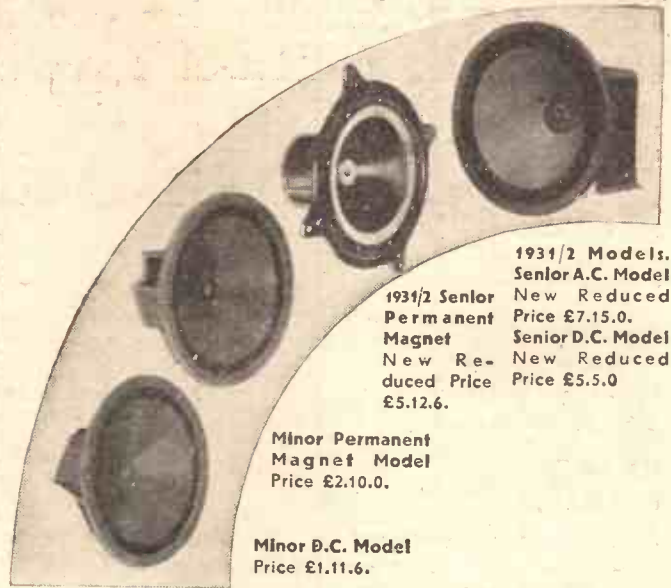

1931/2 Models.
Senior A.C. Model
New Reduced
Price £7.15.0.
Senior D.C. Model
New Reduced
Price £5.5.0

1931/2 Senior
Permanent
Magnet
New Re-
duced Price
£5.12.6.

Minor Permanent
Magnet Model
Price £2.10.0.

Minor D.C. Model
Price £1.11.6.

**-and it
costs
less**

If you must have the best possible reproduction it means a B.T.H. R.K. There are many new models available now. In the R.K. range, from the "Minors" at 31/6 (field excited model) and 50/- (permanent magnet) to the Senior A.C. R.K. at £7:15:0, there is a model specially suited to your requirements.

Ask your dealer for a demonstration and full particulars.

GREENWICH
TIME FROM THE
MAINS



Have you seen the Edison A.C. Mains Electric Clock? Ask your radio dealer. Prices from 45/-.

B.T.H.



**MOVING COIL
REPRODUCER**

EDISWAN RADIO



THE EDISON SWAN ELECTRIC CO. LTD.
Radio Division: 155 Charing Cross Road, London, W.C.2

W.177

RADIOTORIAL QUESTIONS AND ANSWERS (Continued from page 508.)

When the current starts to flow the field always starts to build up. All the time the current is flowing the field exists around the conductor. When the current ceases to flow, the field collapses.

There are some extraordinarily interesting consequences resulting from this. For just as the electric current will not flow along the wire without creating magnetism, so that magnetism cannot be created across a second wire without causing electric current to flow in it!

The Secondary Current.

And thus if two wires are placed very close together but not touching, and a current is made to flow in one of them (called the primary), its magnetic field will cut across the neighbouring wire (the secondary) and produce a second current in it.

Moreover, every change in the primary current will be reflected by changes in the secondary current.

If the wires are equal, say 50 turns in the primary and 50 turns in the secondary, the effect will be approximately equal too. But if the secondary has twice as many turns as the primary, the effect will be to produce about twice as high a voltage in the secondary as in the primary.

It is quite impossible to give even a brief outline of the many uses to which such a device can be put or of the manifold rules governing its construction and operation. But probably enough has been said to enable you to form a picture of its functioning.

The primary of an intervalve transformer is that coil which is connected at one end to the terminal marked H.T. + and at the other end to the terminal marked P. The secondary winding (which generally has more turns) is joined to the terminals marked G and G.B. —.

If it has three and a half times as many turns as the primary the transformer has a ratio of 1 to 3½. If it has double that number, the transformer has a ratio of 1 to 7, etc.

In addition to the two coils which are the basis of the transformer, it has a core, of soft iron or alloy, which by helping the magnetic action plays an enormous part in the operation.

A good transformer is highly efficient and almost as much power can be drawn from its secondary as is fed into its primary. In other words, there is but very little loss in the instrument itself.

As electrical power is the product of voltage and current, it will be realised that when the voltage is stepped up (by increasing the number of turns on the secondary in proportion to the primary, so as to get a greater voltage in the secondary) the current which can then be drawn from the secondary will be correspondingly smaller than the current in the primary. Otherwise, more power would be drawn from the secondary than was put into the primary which of course, is unthinkable.

A CALIBRATED WAVEMETER.

D. N. B. (Stretford).—"I am making up a heterodyne wavemeter and wish eventually to calibrate this very accurately by means of harmonics. Before getting the very exact readings, I should, however, like to test it on broadcast stations and get a rough idea of the range covered.

MISSING LINKS, No. 20 A GOOD SHORT-WAVE TWO.

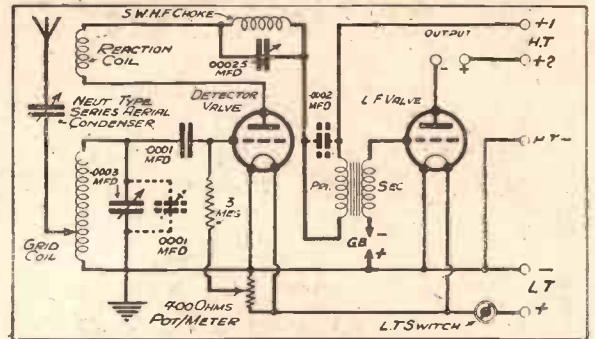

Completing the diagram given last week, this shows that the two missing "components" were a 400-ohms potentiometer, for grid potential control, and the L.T. switch.

"I have never seen one described and should be glad of a few hints on the subject."

We should draw up a calibrated chart for the heterodyne wavemeter, very much like an ordinary calibration except that it should be on a large scale and done of course, with the utmost possible accuracy. You will find some helpful hints in the article called "Station Fixation," which was published in "P.W." Nos. 481 and 482 (August 22nd and 29th, 1931.)

In general, the best plan is to use your receiver to tune accurately to a number of reliable stations—such as the B.B.C. stations whose wavelengths are checked very accurately indeed—transferring the readings, so obtained to the chart of the heterodyne wavemeter.

Therefore, the procedure is to tune in very accurately to some powerful station such as London Regional, very accurate checkings being obtained by undoing the aerial, keeping the receiver gently oscillating, and with the aerial lying close to the first tuned grid circuit, adjust the receiver's tuning condenser to zero "beat."

(Continued on page 512.)

"P.W." PANEL. No. 43.—"STAGES."

To amplify a weak current into a powerful one, a single valve is generally insufficient. So the first amplification is applied to another valve, and this, if necessary, to another, and so on.

Each step in the process is called a "stage."

One common 3-valve arrangement comprises a high-frequency stage, the detector stage, and a low-frequency stage. Another utilising three valves, is detector, followed by two stages of low-frequency.

The term stage includes not only the valve, but the necessary associated couplings as well.

SOVEREIGN MAKERS OF BETTER RADIO COMPONENTS

ANNOUNCE A NEW CONDENSER FOR MODERN SET BUILDERS



ON SALE AT ALL RADIO DEALERS

Send for our new free catalogue describing the complete range of Sovereign Radio Components. Send direct for name of nearest dealer if you have difficulty in obtaining these.

Consistent with Sovereign policy of keeping in step with Modern Radio, we have introduced a new type Fixed Condenser specially for the requirements of modern receivers described in this journal. It is housed in compact case of solid moulded bakelite. Prices of this condenser are sensationally low for such a quality component. Obtain this and all other Sovereign lines from your dealer.

Tested at 750 V.D.C.		Tested at 1,000 V.D.C.	
1 mfd.	2/-	1 mfd.	2/6
25 mfd.	2/-	25 mfd.	2/6
5 mfd.	2/-	5 mfd.	2/6
1 mfd.	2/3	1 mfd.	3/-
2 mfd.	2/9	2 mfd.	4/6

Use "P.W." Tuning Units made by Sovereign.

SOVEREIGN PRODUCTS LTD. 52/54 Rosebery Av., LONDON, E.C.1
CLERKENWELL 2788.

High-Grade RADIO GRAMOPHONE CABINET

of exclusive modern design, hand-made and polished on Queen Anne legs.

Figured Oak £5 : 5 : 0
Figured Walnut or Mahogany £5 : 19 : 6
Carriage Paid.

THE ACME OF CRAFTSMANSHIP

Radio-Gram Cabinets from £3 : 19 : 6 to £21
Wireless Cabinets - - - from £2

Photographs and 30-page illustrated Catalogue Free.

Cabinets made to order a speciality. Furniture at Maker's prices.

**GILBERT,
CABINET MAKER,
SWINDON.**

Estimates Free. Estd. 1866.

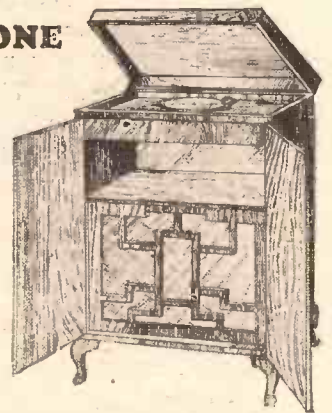

OSBORN READY-TO-ASSEMBLE RADIO CABINETS

There is an Osborn Cabinet for every set on the market.

Model No. 215. A Queen Anne Radio or Radio-Gramophone Cabinet, 3 ft. 10 ins. high, 2 ft. 2 ins. wide, 1 ft. 6 ins. deep. Size of baffle board behind fret, 24 ins. X 24 ins. Metallic fabric for fret front included. Opening at top and back. Cabinet takes panel 2 ft. X 9 ins. or smaller.
PRICES: Machined ready to assemble: Oak £3 10 0. Mahogany £3 15 0. Assembled ready to polish: Oak £4 10 0. Mahogany £4 15 0. Assembled and polished: Oak £5 10 0. Mahogany £6 5 0. All models Carr. Paid. Send 3d. in stamps for 56-page Illustrated Cat.

**STAND
No. 9
BLOCK B.**
Scottish National Radio Exhibition, Edinburgh, Waverley Market.
NOV. 11-21

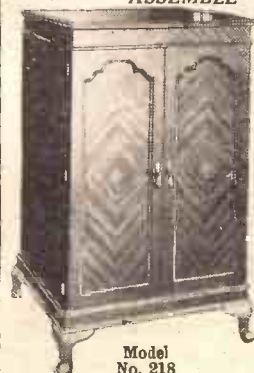

Model No. 218

CHAS. A. OSBORN, DEPT. "P.W."
The Regent Works, Arlington St., London, N.1. Telephone: Clerkenwell 5095. And at 21, ESSEX ROAD, ISLINGTON, N.1. (1 minute from the Agricultural Hall). Phone: Clerkenwell 5634.

BLUE SPOT aids to BETTER RECEPTION



BLUE SPOT REJECTOR WAVETRAP

This is probably the most efficient wavetrap in existence. Designed to cover the medium wave-band, it makes the eliminating of interference exceptionally easy. Three alternative couplings are provided so as to give a higher or lower degree of selectivity according to local requirements. Price **15/-**



BLUE SPOT MAINS DISTURBANCE ELIMINATOR

A very neat little component which effectively eliminates disturbance from the mains. It is simply plugged into your supply socket and your set plugged into it. Designed for use with broadcasting sets only, it will counteract the disturbance induced by electro-vibratory apparatus which are in use at the same time as the wireless receiver. Price, complete **10/6**

SEND FOR CATALOGUE P.W. 14

THE BRITISH BLUE SPOT COMPANY LTD
BLUE SPOT HOUSE • 94/96 ROSOMAN STREET • ROSEBERY AVENUE • LONDON • E.C.1

Tel.: Clerkenwell 3570. 'Grams': 'Bluospot, Isling, London.'
Distributors for Northern England, Scotland and North Wales:
H. C. RAWSON (Sheffield and London) LTD., 100, London Road,
Sheffield; 22, St. Mary's, Parsonage, Manchester; 165, George
Street, Glasgow.



REGISTERED

TRADE MARK.

TEST then Rest

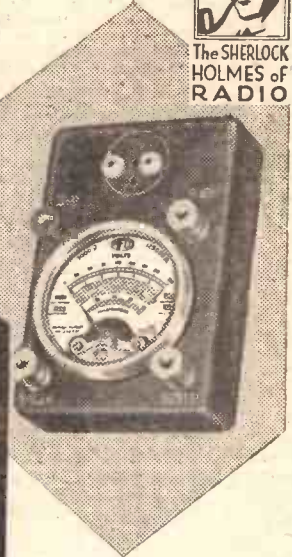

Assured

With the "All-In-One" Radiometer you can instantly check the performance and efficiency of any Valve, Circuit, Battery or Component. This little instrument tests everything—in a few minutes—with absolute certainty. If the "All-In-One" Radiometer says such a thing about any part of a set—then it is so!

Think of the time, trouble and money you could save if you had an "All-In-One" Radiometer of your own. Then look at the amazingly low price—12/6. You'd save that over and over again in a year, by entirely cutting out costly guesswork and also being independent of the need for expensive expert assistance. Ask your Radio Dealer to demonstrate the "All-In-One" Radiometer. See how efficient it is—how speedy—how economical. Obtainable at all Stores and good class Radio Dealers.

Booklet free from Patentees:
Pifco Ltd., High St., Manchester

**TESTS VALVES
FILAMENT ••
ANODE & GRID
COMPONENTS
AND CIRCUITS
H.T. AND L.T.
MILLIAMPS
Everything!**

PIFCO A4 IN ONE RADIOMETER

STANDARD MODEL 12/6 DE-LUXE MODEL 22/0

Standard Model shown above on left. For Battery Operated Sets only. Price 12/6.

De-Luxe Model shown above on right. For Battery Operated Sets, Electric Receivers and Mains Units. Price £2 : 2 : 0

RADIOTORIAL QUESTIONS AND ANSWERS

(Continued from page 510.)

This as you doubtless know, is the silent point in the middle of the whistle which is caused by "tuning through" a carrier-wave. When the condenser is adjusted exactly half-way between the two points where the whistle is just audible, remove the aerial and notice if the beat note changes.

If not, you are sufficiently accurate for all practical purposes, otherwise slight retuning will be necessary, and you can then start off the heterodyne wavemeter.

It is never good practice to use these instruments immediately they are switched on, so after allowing a minute or so for the valve to get thoroughly warmed up, tune in the condenser slowly until a very loud beat note is heard in the telephones or L.S. on the receiver. This indicates that the wavemeter is exactly in tune with the receiver, the exact wavelength of which you know.

When you have located a number of stations in this way, as carefully as possible, you will have obtained a pretty good tuning curve and will have an excellent idea of where your harmonics should fall.

The actual tuning by harmonics is rather complicated and may not be easy unless you have well-prepared the tuning chart beforehand and know just where to look for the harmonics which, of course, are not very strong, except, perhaps, the "second harmonic."

A RELIABLE CRYSTAL SET.

P. C. (Reading, Berks).—"I am going to make a crystal set for my mother who lives quite near to the Bournemouth station. As she is rather feeble I want to get over the fiddling with cat's-whisker and adjustment troubles, and I propose to use a carborundum crystal which I understand never needs re-adjusting.

"The trouble in fitting this up is that I am not quite sure about the pressure to apply on it, although I understand it can be quite a heavy contact, and also I am very uncertain about the battery which should be used with it.

"Could you give me the connections for this, when joined to an ordinary plug-in coil

and condenser tuning circuit? If you will give the detector side of the leads which go to the tuning circuit that will be sufficient, as I understand everything except the unusual detector connections."

Carborundum in contact with a steel point or blade should make an excellent crystal set.

The pressure may be quite considerable, say, up to 1 lb. or more, and once set, with correct voltage applied from the battery, the set will remain sensitive, without the slightest need for adjustment of any kind.

We suggest that you fix the tuning rather than have a condenser adjustment, as when this has been done there need be nothing movable on the set at all except a switch or switches which put it off.

In order to get the correct voltage required by the carborundum you can use an ordinary Bell battery and a 1,000-ohm potentiometer (or thereabouts).

There will also be required a fair-sized by-pass condenser, such as .001 mfd., the steel contact and carborundum crystal and, of course, a pair of telephones. The connections will be as follows:

The earth side of the tuned circuit will go to one telephone terminal, the remaining telephone terminal will go to the carborundum detector.

The steel contact side of the detector will go to the slider of the potentiometer and also to one side of the by-pass condenser (.001 mfd.).

The remaining side of this by-pass condenser will go to the other end of the tuning circuit, and will go to the negative terminal of the battery, and to one end of the potentiometer.

The other end contact of the potentiometer should be joined to an ordinary on-off switch.

The remaining side of this switch should go to the positive of the bell battery. This completes the connections, and if you do not get good results at the first attempt, try the effect of reversing the wires to the terminals of the dry battery.

Overcoming Threshold-Howl

R. M. (Johannesburg).—"What are the points to watch when trying to overcome threshold howl in a short-wave set?"

In general, the set troubled in this way should have potentiometer control of the grid potential, and another almost fundamental necessity is some decoupling or anti-motor-boating device, unless the H.T. supply is particularly "clean" and considered incapable of giving trouble in this direction.

Extra bypassing condensers will often help, and changing over the primary leads to one of the L.F. transformers and the use of different values of grid

leak (and grid condenser, if necessary) are often found to be effective. Sometimes the valve is the culprit, and a different valve will effect a cure, even although the circuit is not touched in any other way.

High resistances can be employed to overcome the fault, either across the secondary of the transformer or between the grid of the L.F. valve and its secondary.

Yet another cure is an H.F. choke inserted between the grid of the low-frequency valve and the secondary of the transformer, and other places in which an H.F. choke or chokes may be tried are in the detector plate lead from H.T. or in the 'phone leads.

Finally, it will be found that the use of an output filter is of great assistance in overcoming this type of trouble.

TECHNICAL TWISTERS

No. 85.—VALVE CURVES. CAN YOU FILL IN THE MISSING LETTERS?

The curve of a valve shows how two of its variable factors, such as the volts and are related.

It is generally drawn up to show against the same scales several almost-parallel curves, to indicate somewhat different initial circumstances.

"Static" valve curves can be very misleading, as they show conditions unlike those met with

Curves showing the corresponding relations under working conditions are necessarily more elaborate. They are known as curves.

Last week's missing words (in order) were: Anode (or Plate). Impedance, Primary, Secondary. Load.



L 210
PD 220
P 220
PP 230
DG210

Here are five new types from the complete new Tungstram range: P.D.220—a new and specially designed anti-microphonic detector valve, Price 6/3; L210, an entirely new low consumption detector and amplifier valve, particularly suitable for portables, Price 5/6; P220—a new and extremely efficient low milliamper power valve with a slope of 3 mA./V., very useful in portable and small sets, Price 7/9; PP230—a new multiple grid output valve having the extremely high magnification factor of 60, consuming less mA. than a power valve, Price 16/-; and the DG210 bi-grid oscillator-modulator valve, specially designed for super-heterodynes, Price 13/-.

Write to Dept. ST3 for full particulars of the complete new range. Price from 5/6 to 19/-.

TUNGSRAM ELECTRIC LAMP WORKS (Gt. Britain) Ltd.
Radio Department, Commerce House, 72, Oxford Street, London, W.1.

Makers of the famous Tungstram Electric Lamps.

Birmingham, Bristol, Cardiff, Glasgow, Leeds, Manchester, Newcastle, Nottingham, Southampton, London, Lamp, Valve, and Glass Factories in Austria, Czechoslovakia, Hungary, Italy, and Poland.

I.F.S. Organisation, Tungstram Lamps & Radio, Ltd., 11 Burgh Quay, Dublin.

Tungstram Photo Electric Cells: Nava "E" (for scientific measurement), £2 17s. 6d.; Nava "R" red sensitive cell (for matching devices), £3 3s. 0d.; Nava "EH" (for talkie work) £3 13s. 6d.



Quality Radio for £6.6.0

SEVEN VITAL FEATURES

- Self-Contained Loud Speaker ● Band-Pass Tuning and Pentode Output giving Astonishing Selectivity and Power ● Economical Battery Consumption ● Full Broadcast Range (230-550 & 1,000-2,000 metres) and Easy Operation ● Entirely New and Simple Colour-Coded Assembly without Soldering ● Fixed Pick-up Sockets ● Compact Walnut Cabinet ●

At its amazing low price the Zonophone Kit Set brings Quality Radio within the reach of the most modest purse. The simple and ingenious construction of this set is praised by expert and amateur alike.



GRAMOPHONE ENTHUSIASTS!

The Zonophone Pick-up is the finest value in the world at

15/=-

AND OF COURSE ZONOPHONE BATTERIES

Highest Efficiency
Greatest Economy

ZONOPHONE KIT SET

Famed alike for  Radio and Records

Prices shown do not apply in Irish Free State.

KNIFE-EDGE SELECTIVITY

Chops off the Stations

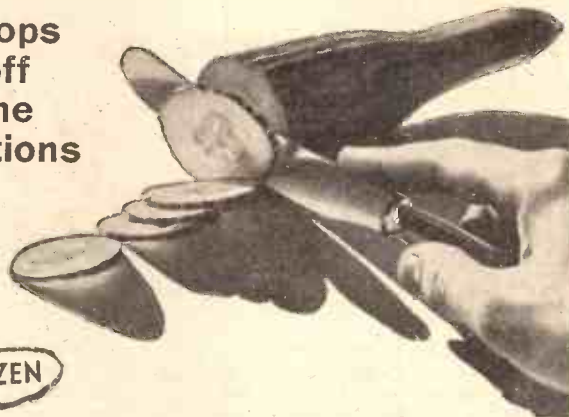

HUIZEN

ROME

FRANKFURT

NATIONAL

OSLO

HEILSBURG

MADRID

SIMPLY, easily, you can now get one station after another—clear cut and cleanly separated—by fitting this wonderful new ganged condenser.

IDEAL TUNING

The British Radiophone Ganged Condenser will give you accurate tuning—firm and smooth with no slipping—holding the programmes with absolute rigidity.

An entirely new and novel method of construction assures a very high degree of accuracy.

OUR GUARANTEE is for a maximum error of only half a millionth part of a microfarad plus 1%!

- 2-Gang Condenser 18/- Dustproof Metal Cover 3/-
- 3-Gang Condenser 28/- Dustproof Metal Cover 3/6
- 4-Gang Condenser 38/- Dustproof Metal Cover 4/-
- Oxidised Silver Escutcheon and Drive Assembly complete with pilot lamp attachment 5/-

Write for Illustrated Descriptive Brochure to

THE BRITISH RADIOPHONE LTD.,
Aldwych House, Aldwych, W.C.2.
Telephone: HOLBORN 6744.

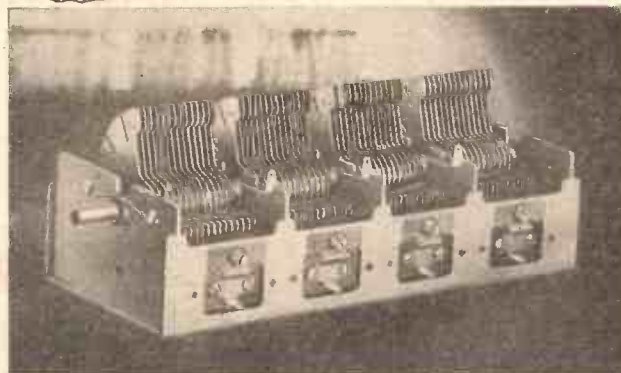

RADIOPHONE GANGED CONDENSERS

BEWARE THE POWER THIEF

Is Electrical leakage robbing you of money—and the power your Set needs?

ELECTRICAL cell to cell leakage has been definitely eliminated. Smooth top H.T. Accumulators with their 10-volt single glass cell provide direct electrical connection between terminals. This power leaks away causing serious waste. In the lively 'O' H.T. Accumulator this cannot happen. Each 2-volt cell is separated from its neighbour by an air-gap. All the power you have paid for is stored up, being released only when working your Set—there can be no "falling off" in voltage—your Set gets all the power it needs. Write for free booklet—it tells you all about it.

TWO TYPES
Standard 10-volt Unit
(2,750 milliamps)

5/6

Extra large capacity
(5,500 milliamps) per
10-volt Unit

6/9



LIVELY 'O'
H.T. ACCUMULATORS

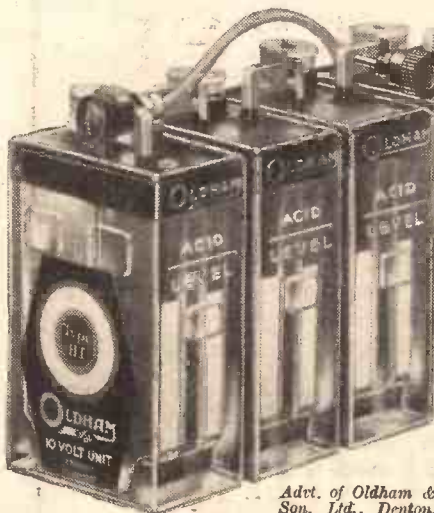

Advt. of Oldham & Son, Ltd., Denton, Manchester

FOR THE LISTENER

(Continued from page 482.)

joke of all. "Peep-Bo-Hemia" was a good show; and I suppose everybody in it realises, as we do, how much of its success depends upon Leonard.

New Blood.

I have asked from time to time for "new blood" in our vaudeville programmes. So far, when it has been found, it has not proved to be of quite the same quality as the old blood.

The weakness of these programmes is their unevenness; the gaps between the stars being so often filled with very second-rate stuff. I admit improvement; but there is still a long way to go. I understand that the B.B.C. has its representatives all over the country on the look-out for good material; but they don't seem to have much luck in their fishing. Only rarely is the reign of an old favourite threatened by a newcomer.

I do not care much for the audition system by which, apparently, the new broadcasters are chosen. If you put a candidate in a studio with a microphone and make him perform for five minutes before invisible auditors in another room, I don't see either how he can do justice to himself, or how the "judges" have any real chance of spotting the winners.

Those Auditions.

I myself secured the other day an audition for a young actress, an amateur, whom I knew to be exceedingly promising. She was listened to for five minutes in various snippets of recitations—giving her no chance at all—and was turned down. In a fortnight's time she had been snapped up by a theatrical manager to play the lead in a No. 1 Touring Company with a West-End play—a great success.

The B.B.C. missed her. I imagine that, with the present system of selection by auditions, they will miss a good many similar chances.

The new edition of the Ridgeway Parade pleases me very much. When Holt Marvell and Philip Ridgeway knock their heads together, sparks fly. Long life to this combination, which is almost as "marvellous" (beg pardon!) as it ought to be.

Many of the shows of this kind which are offered to us from time to time are like old pearls strung on a new thread—with the pearls somewhat the worse for wear. Or, to vary the metaphor, some of them are rather like the hash which follows the joint later in the week. But with the Ridgeway Parade you feel that you are cutting fresh off the joint all the time.

A Little Too Fast?

My one complaint about it—a very little one—is that it is a shade-too lively. It is taken at such a speed, with such vim and gusto, that I often miss the twiddledy-bits which connect up one item with another. Audibility and clearness should never be sacrificed for speed.

It is a common failing with many broadcast items that the speaker or the actor, having to get a good deal into a short time, is inclined to rush it. The tempo of anything on the air should, in my judgment, be one degree slower than the same thing on the platform or the stage.



25/-

POST 1/-
EXTRA
OR WITH
TESTED
S.G.
VALVE

37/6

POST 1/-
COMPLETE
READY FOR
IMMEDIATE
USE

SEND NOW

AMAZING RESULTS ARE BEING REPORTED FROM USERS OF THE S.R.S. SCREENED-GRID CONVERTER

Immediately converts ANY set into an extremely powerful screened-grid receiver without alterations of any kind. To use, it is only necessary to put your aerial on the converter, and a lead from the converter then goes to your set aerial terminal. Ordinary straight detector 2 or 3 valve sets become powerful 3 and 4 valve S.G. sets. Can also be used on sets already having S.G. valves.

TESTED BY "POPULAR WIRELESS." Here are some of their remarks: "Extremely neat and compact. Does its work well. Adds great selectivity and power to any set. Extremely simple to use."

Long or short waves at the touch of a switch. Solidly constructed throughout AND RESULTS GUARANTEED. Send for leaflets, testimonials and interesting short-wave leaflets.

STONEHOUSE RADIO SUPPLIES, 54, Union St., Plymouth, Devon.

DO YOU KNOW that the world-famous S.R.S. short-wave adaptor converts any set immediately into a short-wave receiver. Price **18/6**

ONE MILLION SOLD ANNUALLY

That fact indicates their quality and extreme reliability. They are world-famous. Write today for the new illustrated lists and new low prices.



VALVE HOLDERS AND SWITCHES

Made by the Makers of the famous W.B. PERMANENT MAGNET MOVING COIL SPEAKERS

WHITELEY ELECTRICAL RADIO CO., LTD., NOTTINGHAM RD., MANSFIELD, NOTTS.

Irish Free State Distributors: Kelly & Shiel, Ltd., 47, Fleet Street, Dublin.

Amazing fineness of adjustment **Unprecedented perfection of reproduction**

100%
improvement
in tone & volume
on any unit
previously
marketed

Gone can be the artificiality—the “sound thinness” which has hitherto characterised ALL speakers—the new Undy “8” and “4” pole Units ensure a “human” rendition of voice and music. It is indeed a marvellous revelation of tone, quality and truth. Here’s an amazing test that must interest you. Impartial experts, assembled in a large Hall, could not distinguish natural sounds from the sounds reproduced by the Undy Units. You, too, can enjoy the same perfect reproduction. The new “Undy” 8 is fitted with tappings to suit valves of low or high impedance as desired. **GUARANTEED FOR 12 MONTHS.**
Go to your dealer and hear it for yourself.

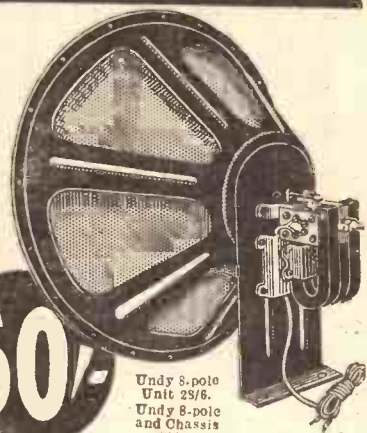

Undy 8-pole Unit 28/6.
Undy 8-pole and Chassis 50/-.

50/-

The New **UNDY** *Dynamic* **8 pole**

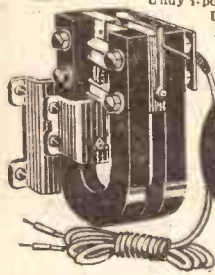

Undy 4-pole Unit and Chassis 28/6.
Undy 4-pole Unit 15/-.
Also a very fine selection of cabinets.

28/6

Brit. Pat. 336930.

obtainable from all wireless stores
Sole Representative for Gt. Britain and Ireland: J. Hemelik, 8, Cullingworth Road, London, N.W.10 Telephone: Glad. 3033

YOUR OPPORTUNITY!

The Editor of “Modern Wireless” has great pleasure in announcing an absolutely unique gift to every reader of the November “M.W.”

In addition to a magnificent shillingworth of radio reading, next month’s number of “Modern Wireless” will contain:

FREE

A GIANT MAP of the **WORLD'S BROADCASTING STATIONS**

FREE

Never before has such a map been sold at any price—let alone been given away. Beautifully printed in colours, with reference index, it measures 32" x 25", and clearly shows radio broadcasting on a world-wide basis, for the very first time!

EVERY STATION WITH ITS OFFICIAL WAVE-LENGTH

INDISPENSABLE TO LONG-DISTANCE RECEPTION

UNOBTAINABLE ELSEWHERE AT ANY PRICE

You can reap the advantage of this unparalleled feat in radio journalism by making sure of your copy of the **NOVEMBER**

MODERN WIRELESS

ONE SHILLING

ON SALE EVERYWHERE—Oct. 31st.

ORDER NOW!

new

THE PURETONE

An All-British Loud-speaker Unit for
7/6

This is the latest unit and incorporates the most modern and up-to-date improvement. Every inflexion of tone is brought out to its best in the "Puretone."
The light and shades of speech and music are reproduced perfectly. Crackle and distortion are completely absent. True to life reproduction is the essence of the "Puretone."

It is a loud-speaker unit different both in design and construction to anything else on the market and we guarantee the *Puretone* for one year.

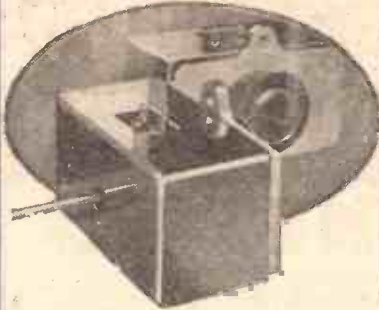

Provisional application patent numbers
18442/31 and 17937/31.

- *BRITISH MADE AND GUARANTEED.
- *HIGHLY SENSITIVE.
- *A VERY TRUE TO LIFE REPRODUCTION.
- *VERY ROBUST—NOT A SCREW OR BOLT IN ITS CONSTRUCTION.
- *AND ONLY 7/6.
- *SPECIALLY CONSTRUCTED CONE FOR USE WITH THE PURETONE, PRICE 2/6. (Not essential).

Ask your local dealer to let you hear one. It's blue! you can't miss it and
"SPEAKS FOR ITSELF."

N.B.—Orders dealt with promptly. If you have any difficulty in obtaining a unit, write direct to us—giving the name of your local dealer—and we will send you a "Puretone" by return of post.

Trade enquiries invited.

BUY BRITISH COMPONENTS

The WALTER PURETONE loudspeaker unit

J. & H. WALTER, LTD.

31a, FARM LANE, FULHAM, S.W.6.

Telephone: Fulham 5645

(N.C. 101).

AMERICA'S GREATEST INVENTOR.

(Continued from page 474.)

his mind alert to the day's plans. He was rarely ill.

Edison's contribution to wireless is far-reaching. In 1883 he discovered—what has since become known as the "Edison Effect"—that a plate placed near the filament of an incandescent lamp acted as a shield, and produced a "shadow."

Fleming later made use of this effect as, likewise, did De Forest. Every modern valve is based upon this discovery, without which modern-day broadcasting would not be possible. Another Edison contribution to the wireless art was in connection with the carbon microphone.

No Floodlighting Then!

Edison has disclosed that he himself was on the verge of developing wireless, and while he gave credit to others, could never explain how it came about that he missed the great discovery when being so close to it. His discovery of "Ethereic Force," in 1875 had important bearing on modern radio theory.

Perhaps one of the greatest Edison inventions was that of 1879—the incandescent electric lamp. In October of that year he constructed a lamp which, guarded day and night, actually burned for forty hours!

When I visited him, Edison recalled that it was only about fifty years ago that he gave a public demonstration of electric lighting at his place in Menlo Park. Special trains had to be run to accommodate the people who flocked to this awe-inspiring demonstration of what was the forerunner of modern electric lighting displays.

During the War.

We all know that Edison introduced the phonograph, and his motion-picture camera and telephone discoveries were revolutionary, but few realise to what extent his capabilities ran. When I saw him in 1926 he was experimenting in one-piece cement houses.

During the war he worked for the U.S. Government, and directed his activities to studying such subjects as: Quick turning of ships; oleum-cloud shells; under-water searchlights; mining Zebrugge harbour; night glasses; devices for detecting submarines, etc. Altogether considerably more than a thousand patents have been issued to him.

Throughout his career we find Edison always underestimating the monetary value to a buyer of his patents. It was one of the biggest shocks of his life when a British representative cabled him "thirty thousand" for one of his patents. He accepted and received a cheque for £30,000. He had expected \$30,000.

His Recipe for Success.

It has been possible to record here just a few of the milestones in the career of a very great man—a man who started life, so they tell us, with an addled brain. That we cannot all be born with such an "addled" brain is our misfortune. We can at least make an effort to live up to his definition of genius which, so his lifelong confidante, William Meadowcroft, tells us, was: "Hard work, stick-to-it-iveness, and common sense."

CLIX

Fitments recommended for use with the

"P.W." "DUAL-RANGER"



HOOK, RING or SPADE TERMINALS 2d.



"VICEGRIP" WANDER PLUG 1 1/2d.

ANODE CONNECTOR Horizontal or Vertical 3d.



Vertical Connector



PANEL TERMINAL 3d. Folder 'P' Free.

Cheapest PERFECT Contact

Lectro Lincz, Ltd., 254, Vauxhall Bridge Road, S.W.1

MAINS TRANSFORMER REPAIRS.

If you have a burnt-out or faulty Mains Transformer we will repair, rewind or remodel the same for you at a very moderate charge. Send a postcard giving full particulars, including purchase price, for quotation. Special terms to the Trade.

THE STURDY ELECTRIC CO. 170, Gloucester Rd., NEWCASTLE-ON-TYNE.

ENGINEERS. Seriously, if you are earning less than £10 per week you cannot afford to carry on without reading "Engineering Opportunities." Whether you are an old hand or a budding apprentice, this 200-page volume will point to a worth-while future. Among other things the book explains the methods of our unique Appointments Department, gives details of all leading Eng. Exams. (A.M.I.Mech.E., A.M.I.E.E., B.Sc., G.P.O., etc.) and outlines modern Home Study Courses in Civil, Mech., Elec., Motor, Aero, Radio, "Talkie," and all other branches of Engineering. This book will alter your entire outlook, and earning power. It is quite FREE. Send for your copy now.

BRITISH INSTITUTE OF ENGINEERING TECHNOLOGY, 401, Shakespeare House, 29/31, Oxford St., London.

LOUD SPEAKERS REPAIRED, 4/-

(Blue Spot a Speciality, 5/-)

Transformers 4/-. Headphones 4/-. all repairs magnetised free. Tested, guaranteed, and ready for delivery in 24 hours.

Discount for Trade. Clerkenwell 9069. E. MASON, 44, EAST ROAD, N.1.

VOLUME!

Let your Cone (or Horn) Speaker give that Moving Coil Quality and ample distortionless volume without extra valves by adding the "Magna" Amplifier (Pat.) Something new in amplifiers, for it is worked by L.F. supply only. Needs no valves, alterations to set, wiring, or expensive parts, and is very compact. Actually GUARANTEED to amplify reception three times. Special Electrode material, Reed, and Rubber Blocks, 2/6. Together with full-size, clear, constructional drawings and diagrams. Simple to construct. —Agent, L. Cook, 182, Cranston Road, S.E. 23.



YOU CAN BUILD A £40 GRAMOPHONE WITH OUR SCALE FOR 40/- DRAWINGS FOR 40/-

Book of instructions, 3d. Catalogue of Motors, Tone-arms, Sound Boxes, latest internal Amplifiers, Gramophones, or Cabinets Free. Cash or terms. V. BURT, 185 High St., Deptford

TECHNICAL NOTES

Some diverse and informative jottings about interesting aspects of radio reception.

By Dr. J. H. T. ROBERTS, F. Inst.P.

"Anti-Mobo Devices."

ALTHOUGH many amateurs are troubled with motor-boating and oscillation troubles and resort to the use of an "anti-mobo" device, they are not always clear as to the cause of the trouble or how the anti-motor-boating unit cures it. Let us take for simplicity the case of a three-valve set, detector and two low-frequency, in which the H.T. negative is a common terminal for the filaments of all the valves. The voltages produced from one stage are impressed by one means or another upon the grid of the next succeeding valve.

Methods of Coupling.

There are, of course, different methods of coupling—which is the name given to the system or arrangement by which the passing on of the voltage is secured—but in order to make the description clearer we may assume that the coupling consists of a resistance through which the fluctuating currents pass; it is easy to see that if varying currents are passing through a resistance there must be varying voltages developed at the ends of this resistance, these voltages corresponding to the currents.

Perhaps this is putting the cart before the horse, because in fact the application of the varying voltages precedes the generation of the corresponding currents, the currents being due to the voltages rather than the voltages being due to the currents.

Unwanted Couplings.

At any rate, for our purpose all we have to consider is that the interposition of a resistance into the circuit causes voltages to be developed at the ends of this resistance. Now this applies until we get to the last valve where there is no further coupling required and where there is apparently no resistance, at any rate no resistance corresponding to the coupling resistance in the case of the previous stages.

If this were in reality the case we should not be troubled with the particular type of motor-boating which we are considering. But let us suppose that there is resistance—I mean a fair amount of resistance—in the H.T. battery or whatever the H.T. unit may be.

Then this resistance is common to the various stages and the result is that the voltages which are set up across its ends by fluctuating currents flowing in the anode circuit will react back upon the detector circuit imprecisely the same way as any other type of reaction or regeneration.

I always think "feed-back" is a very clear and explanatory term. The vicious circle set up in this way will probably give rise to oscillation and motor-boating, but even if it does not become as bad as this, it will almost certainly cause serious distortion on loud passages.

(Continued on next page.)

New Times Sales Co

CHOOSE FROM THE NEW 1932 RADIO AND BUY IT ON EASIEST OF EASY TERMS

MANUFACTURERS' KITS

V.3. RADIO FOR THE MILLION
10/- down AND 11 MONTHLY PAYMENTS OF 10/10
CASH PRICE £5 : 17 : 6
 Screened-grid Detector and Power. With Valves, less Cabinet.

COSSOR 234 EMPIRE MELODY MAKER
 Screened-Grid, Detector and Power. With valves and cabinet
10/-
CASH PRICE £6 15s. 0d. WITH ORDER
 Balance in 11 monthly payments of 12/6. Finished Instrument. Royalties Paid, £7 10s. 0d. Cash or £2 deposit and 11 monthly payments of 11/-

ELIMINATORS

EKCO K.18 COMBINED H.T. ELIMINATOR AND L.T. TRICKLE CHARGER. Delivers 18 m/a. and suitable for 1- to 5-valve sets. S.G., 50/80v., 120/150. Charges at 25 amp. at 2, 4 or 6 volts. Cash price £4 12s. 6d. Balance in 11 monthly payments of 8/6.

ATLAS A.C. ELIMINATOR TYPE A.C.244. 3 Tappings, S.G., Detector and Power. Output 120 volts at 20 m/a. Cash price £2 19s. 6d. Balance in 11 monthly payments of 5/6.

SPEAKERS

W.B. PERMANENT MAGNET MOVING-COIL SPEAKER P.M.3. Complete with 3-ratio input transformer. Cash price £2 12s. 6d. Balance in 11 monthly payments of 4/10 order

AMPLION MOVING-COIL SPEAKER, TYPE M.C.6. Permanent magnet, with output transformer. Complete. Cash price £3 7s. 6d. Balance in 11 monthly payments of 6/2 order

B.T.H. RK. MINOR PERMANENT MOVING-COIL SPEAKER. Handles output up to 2 watts. Cash price £2 10s. 0d. Balance in 8 monthly payments of 6/- order

EPOCH PERMANENT MAGNET MOVING-COIL SPEAKER. Type A.2. Cash price £3 3s. 0d. Balance in 11 monthly payments of 5/9 order

R & A "100" MOVING-COIL REPRODUCER. With tapped input transformer. Cash price £2 17s. 6d. Balance in 11 monthly payments of 5/4 order

MULLARD 3, 1932 TYPE Screened-Grid, Detector and Penode. With valves less cabinet
11/11
CASH PRICE £6-10s. 0d. WITH ORDER
 Balance in 11 monthly payments of 11/11. Finished Instrument, with Valves and Cabinet. Royalties Paid. £7 17s. 6d. Cash, or £2 deposit and 11 monthly payments of 11/9.

OSRAM NEW MUSIC MAGNET 4
 2 Screened-Grid, Detector and Power. With valves and cabinet
19/8
CASH PRICE £10 15s. 0d. WITH ORDER
 Balance in 11 monthly payments of 19/8. Finished Instrument. Royalties paid, £11 15s. 0d. Cash or £2 deposit and 11 monthly payments of 19/6.

SIX-SIXTY CHASSIKIT. BATTERY MODEL. Complete three gang band-pass tuning. S.G., Detector and Penode.
12/7
CASH PRICE with valves less cabinet £6 17s. 6d. Balance in 11 monthly payments of 12/7.

SIX-SIXTY CHASSIKIT. (A. C. MODEL.) Complete as above with A.C. Mains Valves.
13/5
CASH PRICE with valves less cabinet £7 6s. 6d. Balance in 11 monthly payments of 13/5.

EKCO A.C.25 H.T. ELIMINATOR. Send Tappings—S.G. 50/80 volts, 100/150 volts at 25 m/a. Cash £3 17s. 6d. Balance in 11 monthly payments of 7/1 only

HEAYBERD H.T. UNIT "D" MINOR. Output 120v. at 20 m/a. Tapped at 80v., 100v. and 120v. Cash price £2 17s. 6d. Balance in 11 monthly payments of 5/4 order

EXIDE 120-volt. TYPE W.H., H.T. ACCUMULATOR, in crates. Cash price £4 13s. 0d. Balance in 11 monthly payments of 8/6 order

ORMOND PERMANENT MAGNET MOVING-COIL CHASSIS (No. 464). With tapped input transformer. Cash price £3 5s. 0d. Balance in 11 monthly payments of 6/- order

CELESTION PERMANENT MAGNET MOVING-COIL SPEAKER. Type RPM8. 8 in. Reinforced Diaphragm, excluding input transformer. Cash price £3 10s. 0d. Balance in 11 monthly payments of 6/5 order

BLUE SPOT DYNAMIC TYPE SPEAKER UNIT and CHASSIS. Type 100U. Cash price £1 19s. 6d. Balance in 7 monthly payments of 5/5 order

ROLA PERMANENT MAGNET MOVING-COIL SPEAKER. Complete with input transformer. Cash price £2 17s. 6d. Balance in 8 monthly payments of 7/1 order

EPOCH J. I. PERMANENT MAGNET MOVING-COIL SPEAKER. In chassis form with multi-ratio input transformer. Cash price £2 5s. 0d. Balance in 11 monthly payments of 4/2 order

We can supply any line, and components advertised in this journal can be supplied on H.P. Make out your requirements and let us quote by return.

ESTABLISHED IN 1924—FIRST WITH EASY TERMS

NEW TIMES SALES CO. 56, LUDGATE HILL, LONDON, E.C.4. Phone: Central 2716

(a) Please, send me further particulars of

(b) I enclose s. d. as first payment for

NAME

ADDRESS

P.W. 31/10/31.

60 ma. at 250 Volts with the NEW MAINS UNIT

Recognising the demand for a high power Unit giving perfect freedom from hum, Heyberd have designed the finest Mains product this season. Guaranteed Three Years against breakdown, Model C.250 is a Unit suitable for every Receiver.

MODEL C.250
Alternative outputs of 250 v. or 200 v. @ 60 ma. Four H.T. tappings—60/80 v., Variable S.G., 0-150 Variable, 100-200 Variable, 250 Fixed. Special smoothing. Westinghouse rectification. Polished Steel Case. Ready assembled. Requires **137/6** wiring up only. Point-to-Point Diagram. L.T. 4v. 6 amps for A.C. Valves 8/- extra.

I enclose 3d. stamps for full details of the new Mains Units together with circuit diagrams on the latest Transformers.

Name.....
Address.....



10 Finsbury Street, London, E.C.2.

TECHNICAL NOTES

(Continued from previous page.)

Separating Circuits.

Now what we want to do in order to mitigate this trouble is to decouple or separate out the resistance which is causing the trouble—in the present case this is the unwanted resistance of the H.T. battery or unit—so that it is not in effect common to the different circuits.

The anti-mobo unit consists of a rather high value resistance and a fairly large capacity condenser. The way in which this is connected into the circuit depends upon particular conditions, but in the simple case which we are considering it would be connected between the high-tension battery and the coupling resistance of the detector stage.

If transformer coupling is used then the anti-mobo resistance is connected, of course, to the transformer. The filament wiring is connected via the condenser to that end of the stabilising resistance remote from the high-tension unit.

Now although this seems very simple it has a great influence upon the circuit conditions. The detector anode circuit is separated by a high resistance from the anode circuit of the output valve and, furthermore, each anode circuit now has a separate path of its own for speech currents.

The voltage variations will, of course, still be produced at the ends of the resistance of the H.T. battery, but instead of getting into the coupling resistance of the first stage they have an easier path between the plate and the filament than by way of the anode resistance which produces the coupling effects.

In this way the tendency for feed-back between the output and the detector stages is eliminated or practically eliminated, and so the distortion due to interaction is avoided.

Choose Your Values.

It goes without saying that in order to achieve the best results from the unit the values must be properly chosen. The value of the stabilising resistance, for example, must be fairly high and, as a rule, this is of the order of about 25,000 ohms.

Again, the capacity of the condenser should be as high as you can conveniently make it; 4 microfarads is none too much and it should theoretically not be less than 2 microfarads. As with most advantages gained, there is a corresponding drawback, but in this case it is really very small.

It is this: a somewhat higher value of H.T. is necessary in order to make up for the voltage which is dropped across the stabilising resistance, but this in practice does not amount to very much and is an insignificant matter when you consider that the anti-mobo unit may make all the difference between being able to use the set and not being able to use it.

Stiffening Cones.

I wonder how many of you have tried starched linen for loudspeaker cones? I was trying some diaphragms of this kind recently with very good results. You can use linen, cotton, silk or any other light material and this seems to have advantages over ordinary buckram, which is generally rather heavy and stodgy.

(Continued on next page.)

ELECTRADIX HEADPHONE BARGAINS!

War Office Economy Sale of Huge Parcel of New Headphones and Single Earpieces. A wonderful opportunity of buying Headphones at a price below the wildest cut price ever imagined.

LIGHT HEADPHONES		FIELD HEADPHONES	
	Per pair s. d.		s. d.
H.W. Sullivans Wireless Light Headphones, new, 120 ohms	3 6	Double Field Headphones D.III with all-leather Headbands and cords, L.R.	2 6
Ditto store-soiled, unboxed, 120 ohms	2 9	Ditto pairs without Headbands	2 0
New High Res. Long Range Model, 8000 ohms	4 3	Single phone with cord each	11
S.G. Brown's Headphones with Headbands, 1500 ohms	12 6	WEGO VALVES	
		The famous Western Electric Peanutt Valves, List 8/6 for	4 0
		Power Valves, 4-pin, same make, 200 m.w. output	4 6
		Weston Relays	35 0

Siesmo Microphones

Send your enquiries for all Wireless and Laboratory apparatus.

Write for Catalogue

ELECTRADIX RADIOS, 218 Upper Thames St., LONDON, E.C.4.

BUILD YOUR RADIO-GRAM IN A CAMCO CABINET

The cabinet illustrated costs only £5.10.0. Just think how splendid your set will look in this Cabinet. Send for 24-page Catalogue to:

CARRINGTON MFG. CO. LTD. Showrooms: 24, Hatton Garden, London, E.C.1. Phone: HOL. 9202. Works: S. Croydon.

FREE

Name.....
Address.....

P.W. 17



The "WAVERLEY."

Introducing

THE WONDERFUL NEW "PORTER" PERMANENT MOVING-COIL LOUDSPEAKER

Complete with
Multi-Ratio
OUTPUT
TRANS-
FORMER

Suitable for all
valves including
PENTODES

52/6

or 10/- down and
5/3 monthly for
9 months.

AMAZING

—VALUE
—TONE
—VOLUME

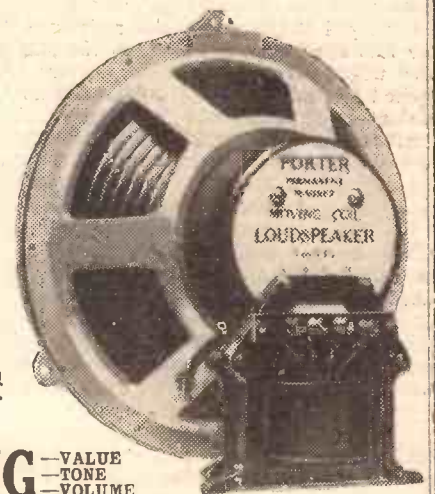

Sent on 7 days' approval against cash

Write for Literature.

VERY GENEROUS TERMS TO TRADERS.
PORTER—WELLOWGATE—GRIMSBY

TECHNICAL NOTES

(Continued from previous page.)

One of the advantages also of the starched diaphragm is that you can leave the circular edge untreated so that this forms a flexible link with the ring of the chassis. Of course, instead of using starch, which is apt to be affected by moisture, you can use the conventional celluloid varnish or shellac varnish. Incidentally, shellac varnish, contrary to the belief of many experimenters, is affected to an appreciable extent by moisture, and is in that respect inferior to celluloid varnish.

A Common Question.

Readers often ask me what is the best kind of valve to use in the detector position, and whether such-and-such a valve will be suitable. Inasmuch as the detector is, in a sense, the vital spot of the whole receiving circuit, it is not surprising that this question should exercise the minds of set users.

Changing the Detector.

Like so many other questions in connection with radio circuits, this one cannot be answered off-hand, as so very much depends upon circumstances. It depends for one thing on the values of the different components and also very much upon the signal strength which is to be handled by the detector.

Generally speaking, I prefer to use in the detector position a valve of moderate impedance, because the liability to overload such a valve is less, and also it is fairly adaptable to different types of coupling.

With a valve of this kind it is, of course, better to use a fairly high anode voltage, in the region of 100 volts or even more. A further advantage of the moderate impedance valve is that it is very flexible with regard to reaction, and will be found to suit most reaction arrangements.

Watch Anode Current.

At the same time, you have to bear in mind that the anode current with this type of valve may be perhaps more than you bargain for in the detector position; it may be, for instance, 3 milliamps or even more, but in these days of mains units and heavy-duty H.T. batteries this is a minor point if you are getting good all-round results.

Sometimes a so-called resistance-capacity valve will be very suitable in the detector position, but you have to keep an eye on the impedance of the valve, particularly if it is to be used with transformer coupling; it may be that the impedance is too high for satisfactory results with transformer coupling.

On the other hand, it should work quite satisfactorily with resistance-capacity coupling when more or less normal magnification is desired, together with a good standard of quality.

Upsetting Reaction.

If you are contemplating a change-over of the valve which you are using in the detector position, remember that the change may involve consequential changes in the reaction circuit. For example, the condenser may have to be increased in capacity or the reaction coil may need a larger number of turns.

(Continued on next page.)



DARIO REGIONAL

STRAIGHT THREE TRANSPORTABLE

A really good receiver that gives wonderful reception for both home and foreign stations! Remarkable for its selectivity and tonal quality. Housed in an artistic oak cabinet incorporating matched speaker. Most economical H.T. Consumption, no more than 7 milliamperes.

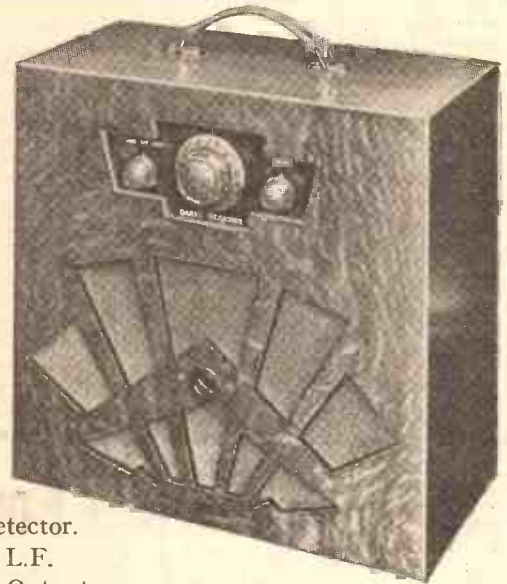

Dario Super H.F. Bivolt as Detector.
Dario Universal Bivolt as first L.F.
Dario Hyper Power Bivolt as Output Valve.

Type A, for outside aerial, £4 17 6
Type B, with inside frame aerial, £5 7 6
(Complete with valves)

DARIO S.G. Battery Type

Extremely selective, easily tuned, and gives wonderful volume with purity of reception. Its handsome appearance makes it an attractive addition to any home. The Dario S.G.3 Battery Set has one stage of high frequency using the famous Dario Screenodion, followed by the Dario Super Detector acting as detector, and the Dario Hyper Power in the L.F. stage.

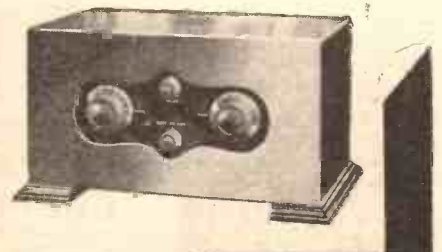

Reduced to
Complete with Dario Valves £5 17 6
Free leaflet on application.

IMPEX ELECTRICAL LTD.,
538, High Road, Leytonstone, London,
E.11.

DARIO VALVES, TRANSFORMERS, CHARGERS, ETC.
All Dario products are efficient, well finished and cheap

GIVE YOUR OLD BATTERY SET

a New Lease of Life!

By fitting—



9/- DEPOSIT

9/- PER MONTH

The Philipson SAFETY ALL-POWER UNIT

(Patent No. 353,357 Under Licence.)
WESTINGHOUSE RECTIFIERS.

H.T. — 3 tappings — 60/75v., 0/120v., 130v., at 20 m.a. Price:
L.T. — 2v., 4v. and 6v.
G.B. — 11v., 41v. and 10v. **£4.17.6**

The set itself may be quite good, but it can never give first-class results while subject to a voltage that is never constant and is always decreasing! And then look at all the trouble and expense of new batteries every so often!

Write for details.

Made by the makers of "The Safety All Electric Band-Pass 3."

PHILIPSON & CO., LTD. Est. over 50 years.
ASTLEY BRIDGE, BOLTON.
Phone: 2038. Grams: Safety, Bolton

EASY PAYMENTS

"There's No Place Like HOLMES."

The first firm to supply Wireless parts on easy payments. Seven years advertiser in "Popular Wireless." Thousands of satisfied customers.

	Deposit	Monthly Payments
COSSOR KIT	£6/15	10/- 11 of 12/6
OSRAM KIT	£10/15	19/6 11 of 19/8
EKXIDE H.T. Accum., 120v.	£3	6/- 9 of 6/8
BLUE SPOT 66R & CHASSIS	£2/2/6	5/6 9 of 4/6
WUFA UNIT & CHASSIS	£2	4/5 9 of 4/5
AMPLION M.C.6	67/6	7/5 9 of 7/5
AMPLION Cone Speaker	15/-	4/6 3 of 4/-
EKCO Eliminator A.C.18	67/-	7/5 9 of 7/5
B.T.H. JUNIOR Pick-up	27/-	5/- 5 of 4/10

New Goods Obtained for Every Order. Send us a list of the parts you require and the payments that will suit your convenience, and we will send you a definite quotation. Anything Wireless. H. W. HOLMES, 29, FOLEY STREET, Great Portland Street, London, W.1. Phone: Museum 1414.

REPAIRS IN 48 HOURS single ratio L.F. Transformers. Headphones, Loudspeakers (except Blue Spot). ONE YEAR'S GUARANTEE.
TRANSFORMER REPAIR CO. Post Free 3/9
563R, GARRATT LANE, LONDON, S.W.17 Terms to Trade

It pays you to ask your Retailer for genuine guaranteed
WAVEMASTER
Variable Condensers and Extensers for all the latest Circuits
WEBB CONDENSER CO., LTD.,
42, Hatton Garden, London, E.C.1.

EXACT TUNERS
250 to 2,000 metres. Thousands of these tuners are in use, and we can strongly recommend them. No further coils are required. Send P.O. for particulars and circuits—FREE.
THE EXACT MANUFACTURING CO.,
Croft Works, Prlory Street, Coventry.

TECHNICAL NOTES

(Continued from previous page.)

If you wish to avoid these additional changes, therefore, it is better, if you must make a change in the detector, to use another valve the characteristics of which are as near as possible to those of the original one.

A Transformer Trouble.

I mentioned some time ago some trouble which I had with a low-frequency transformer in which there was a break in one of the windings, the interruption of the circuit, however, being intermittent; this gave rise to a most mysterious behaviour of the circuit, and it was quite a long time before the cause of the trouble was discovered.

Just recently I have had another case where the set was very troublesome and noisy, and this was found to be due to a transformer; there was not an actual break, but there was a serious leakage between the windings. Fortunately, present-day transformers (the one in question was rather an old one, by the way) are so well made that this particular kind of trouble is really very rare.

Leakage Resistance.

If there is any leakage of this kind it is liable to produce all kinds of noises, and also, apart from this, to upset the quality seriously.

If the transformer happens to have a rising characteristic in the higher frequencies, this will tend to be cut out by the leakage. Different transformers behave very differently in these conditions, and you cannot draw any very hard-and-fast rule. With some transformers the effect of such a resistance, even a very high resistance, is most pronounced.

Managing the Output.

The careful management of the output stage is one of the most important points in getting the best from your receiver as regards quality and volume, and the greater the output the more important does its management become.

Perhaps the two principal points are the adjustment of the grid bias to suit the output valve (and to suit the high-tension used with it) and also the suiting of the output to the loudspeaker. This latter is a chapter in itself and often involves the question of an appropriate form of output coupling, which I have referred to in these Notes recently.

Over-bias and Under-bias.

As regards the grid bias, the simple rule is to make this as large as possible, other things being equal. The larger the bias you can apply, the smaller will be the current drain from your H.T. battery or unit—and with a multi-valve set taking plenty of juice in the various other stages, every bit of economy helps.

But if the grid bias is seriously above the proper value, you will get distortion. It is, however, probably better to have your output valve slightly over-biased rather than under-biased.

It is easy to start with about the amount of bias recommended and then to increase this little by little to discover by actual test just how much bias the valve will stand.

EASY TERMS

WE supply all good quality Radio Receivers, Components and Accessories on deferred terms. We carry adequate stocks and can give PROMPT DELIVERY.

- NEW HEYBERD A.C. ELIMINATOR KIT G.150.** Complete kit of parts for building an H.T. Eliminator, including steel case. Output 25 m.a., 150 volts. 3 H.T. tappings, one variable. Cash Price ... £3 16 0
 - Or 7/6 with order and 11 monthly payments of 7/-
 - 12 EKXIDE W.H. HIGH-TENSION ACCUMULATORS** (120 volts, 5,000 m.a.). Higher voltages if desired. Cash Price ... £3 15 0
 - Or 7/6 with order and 11 monthly payments of 7/-
 - Carriage charged on all orders from Scotland.
 - N.K. FABRAND INDUCTOR LOUD-SPEAKER UNIT.**—Quality of reproduction almost equal to a moving-coil speaker. Cash Price ... £3 10 0
 - Or 5/6 with order and 11 monthly payments of 6/6
 - SET OF 3 VALVES, S.G., Det. and Power.** Mullard or Gossor. Cash Price ... £1 19 0
 - Or 6/- with order and 7 monthly payments of 5/4
 - NEW BLUE SPOT 66R UNIT.** The finest balanced armature movement on the market, complete with large Cone and Chassis. Cash Price ... £2 10 0
 - Or 5/- with order and 10 monthly payments of 5/-
 - NEW CELESTION MOVING-COIL L.S. UNIT (PERM. MAGNET),** with Transformer. Cash Price ... £4 5 0
 - Or 13/6 with order and 10 monthly payments of 8/-
- Send list of requirements, and quotations will be sent by return.

LONDON RADIO SUPPLY CO.,
11, OAT LANE
NOBLE STREET, LONDON, E.C.2
TELEPHONE: National 1977.

Use the

"TONAX"

Improved

CONE ADAPTOR

for the "Inexpensive Loudspeaker" described in Popular Wireless.

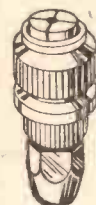

No buzz or chatter caused through badly fitting parts is possible where "Tonax" is employed. Of precision construction it is easily fitted to any type of cone speaker using any unit. A secure gripping of the reed and a snug fitting into the cone ensures pure, clean-cut reception.

Single Cone Type - 1/-
Double Cone Type - 1/6

Three chucks, linen, felt and both deep and standard metal washers, in every carton. Ask for the 1932 model.

From all dealers or direct. Post 2d.
GARRATT STORES
(Dept. P) 193, GARRATT LANE, S.W.18.

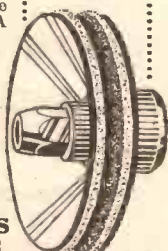

KAY'S CABINETS
The "Popular," 42" high, 21" wide, 14" deep, for panels 18" x 7". Can be adapted to other sizes by suitable free vignette. Speaker chamber 18" square fitted with 7-ply sub-baffle, holecut to suit type of speaker used. Back wholly removable. Soundly constructed of oak and richly polished. Price 30/-
Illustrated lists of 60 Cabinets free.
H. KAY, Cabinet Manufacturers.
Mount Pleasant Rd., London, N.17.

FOR YOUR RADIO COMPONENTS
A. T. HARRISON & CO.
Copper and Aluminium Screens by return of post.
Bakelite Moulds, Bakelite Mouldings.
Trade inquiries invited.
KINTORE WORKS, BERMONDSEY, LONDON,
Telephone: Bermondsey 1155 S.E.1.

WET H.T. BATTERIES
Solve all H.T. Troubles.
SELF-CHARGING, SILENT, ECONOMICAL JARS (waxed), 2 1/2" x 1 1/2" sq. 1/3 doz. ZINCS, new type 10d. doz. Sacs 1/2 doz. Sample doz. (18 volts), complete with bands and electrolyte, 4/1. post 9d. Sample unit, 6d. Illus. booklet free.
Bargain list free.
AMPLIFIERS, 30/-. 3-valve set, £5.
P. TAYLOR, 57, Studley Road, STOCKWELL, LONDON



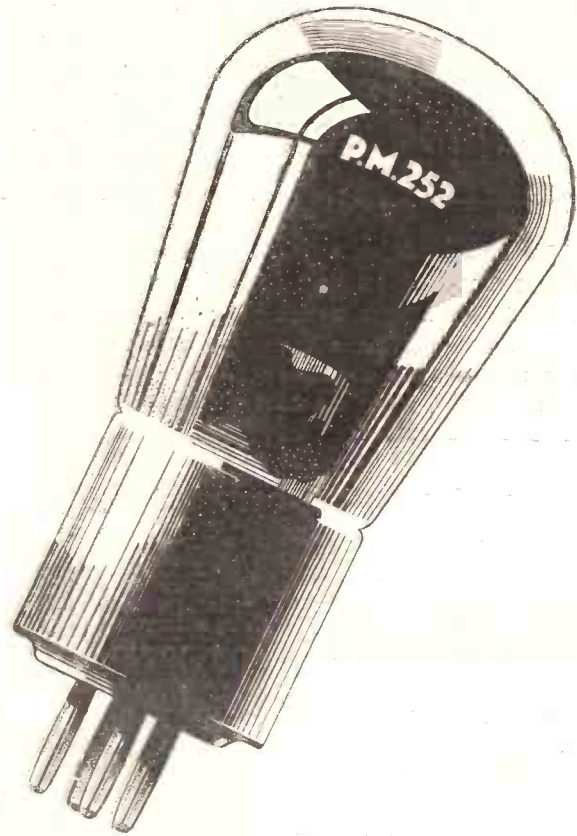

It is not enough that Mullard 2-volt valves are providing faultless reproduction for millions of satisfied listeners. The work of research and improvement continually goes on. It has produced a re-designed P.M.252, with greatly improved characteristics. This is the 2-volt super-power valve. It is designed as an output valve for battery operated receivers, where it is desired to operate powerful speakers at full volume. Buy one to-day from your dealer.

PRICE 13/6

Mullard
THE MASTER VALVE

Adv. The Mullard Wireless Service Co., Ltd., Mullard House, Charing Cross Road, London, W.C.2. Arks

Growth!

AND MORE EMPLOYMENT FOR BRITISH WORKPEOPLE

Business building is like set building—results depend entirely on what is put into it.

Real, scientific knowledge, untiring research, thorough workshop production and careful finish—all these have won a demand for **R.I.** components which to-day, because of their absolute reliability and low price have necessitated more factory space, more machines, and above all, more British labour.

GET THE BEST FROM YOUR CIRCUIT WITH THESE
—the most successful component developments of 1931

The PARAFEED

Universally acknowledged by exponents of the Parallel Feed system of amplification to be the best transformer in existence for its job. N.P.L. curves prove this by high and uniform amplification of

25 to 8000 CYCLES **8/6**
Inductance 100 Henries

DUAL RANGE COIL

R.I. present the most amazing precision of construction and accuracy in this coil. Bakelite moulded throughout, every coil is subjected, before release, to exacting laboratory tests on wavemeter and inductance bridge.

12/6
Get the new R.I. Catalogue

DUX The Transformer for the Million. Credited by the technical press with a performance equal to transformers at many times its price. Published technical facts and diagrams available from your dealer or us, post free.

INDUCTANCE 30 HENRIES **6/9**



"Parafeed"



"DUX"
The Leader



1930

NEW EXTENSION ADDED 1931

The Advertisement of Radio Instruments Ltd., Croydon, England. 'Phone: Thornton Heath 3211.

T.A

Printed and published every Thursday by the Proprietors, The Amalgamated Press, Ltd., The Flectway House, Farringdon Street, London, E.C.4. Advertisement Offices: Messrs. John H. Lile, Ltd., Ludgate Circus, London, E.C.4 (Telephone: City 7261). Registered as a newspaper for transmission by Canadian Magazine Post. Subscription Rates: Inland and Canada, 17/4 per annum; 8/8 for six months. Abroad (except Canada), 19/6 per annum; 9/9 for six months. Sole Agents for Australia and New Zealand: Messrs. Gordon & Gotch, Ltd.; and for South Africa: Central News Agency, Ltd. Saturday, October 31st, 1931. S.S.