

HIGHEST CIRCULATION OF ANY WIRELESS PAPER

Popular Wireless

Every Thursday
PRICE
3d.

No. 376. Vol. XV.

INCORPORATING "WIRELESS"

August 17th, 1929.

Special COUPLING DEVICES Number

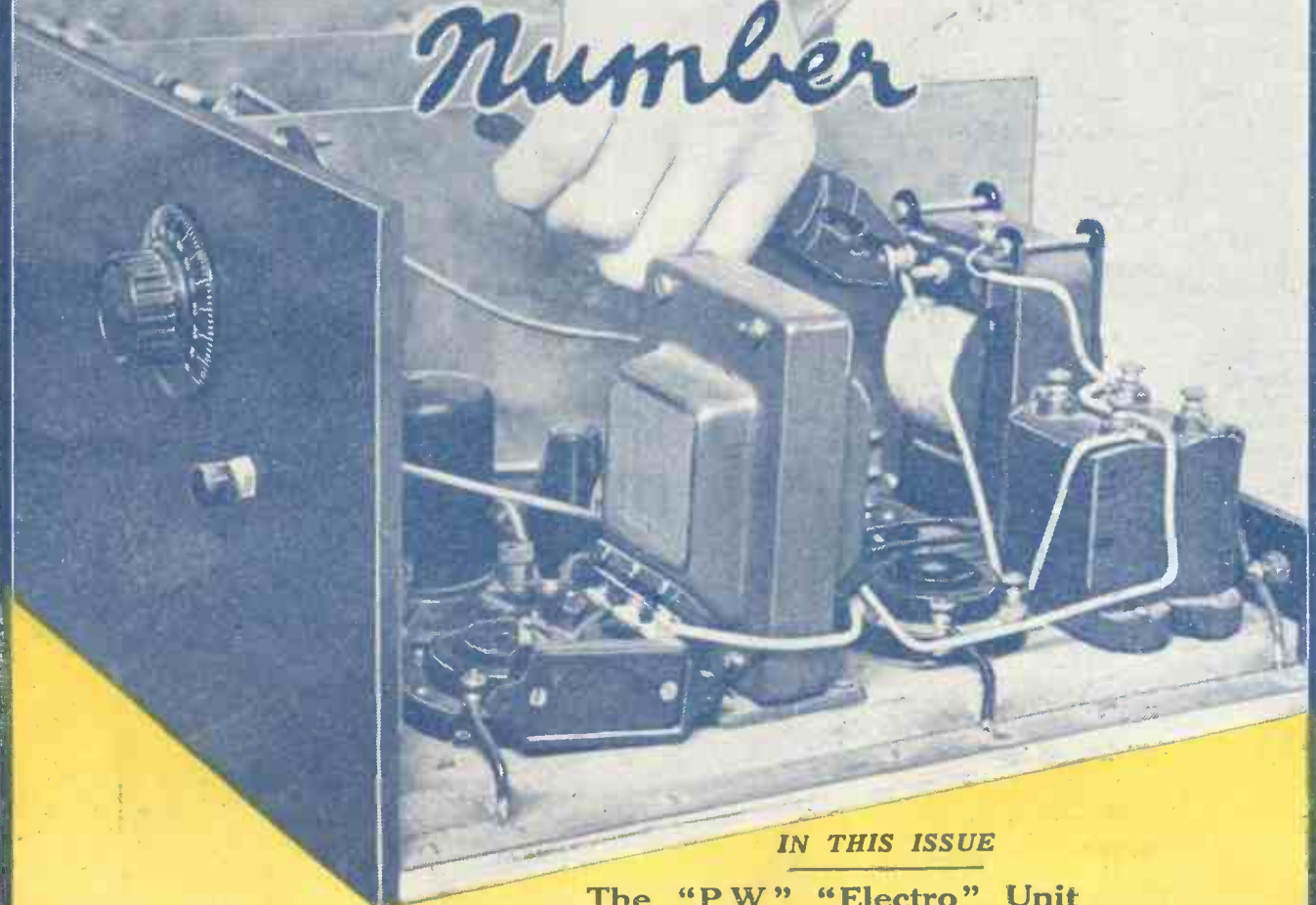

IN THIS ISSUE

The "P.W." "Electro" Unit
Output Circuits. Amplification v. Quality
Operating The "Antipodes Adaptor." Sifting Distortion

INTERLOCKED CONSTRUCTION

SHOCK PROOF!

NOISE PROOF!

BREAK PROOF!



**TRIPLE-LOCKED
ELEMENTS**

**INDIVIDUAL
MOVEMENT
IMPOSSIBLE**

**ELECTRICALLY
WELDED JOINTS**

**PERMANENT
ALIGNMENT OF
ELEMENTS**

Under this wonderful new Cossor method of manufacture all the parts inside the valve are rigidly locked together. Element by element the valve is built up like a bridge. Each part helps to support and stiffen the whole construction. Each part is immovably locked in position giving a solidity and strength never before attained in any valve. Even the hardest shock cannot upset its wonderful performance—its enormous range and amazing power. The Cossor Screened Grid Valve retains its characteristics throughout its unusually long life. Demand Cossor for your Screened Grid Receiver. There is no substitute for the Cossor patented system of Interlocked Construction.

COSSOR Screened Grid Valve

Made in 3 voltages
for use with 2-, 4-, or
6-volt Accumulators

Technical Data.

Cossor 220 S.G. (2 volts, 2 amps.)
410 S.G. (4 volts, 1 amp.)
and 610 S.G. (6 volts, 1 amp.)
Max Anode Volts 150, Impedance
200,000, Amplification Factor 200
Grid Bias 1.5 volts at max anode
volts. Price (any type) **22/6**

Get full details of this
wonderful Cossor Valve—
write for leaflet L16.

A. C. Cossor, Ltd., Highbury Grove, London, N.5.

 8759

Popular Wireless



Scientific Adviser:
 Sir OLIVER LODGE, F.R.S.
 Editor: NORMAN EDWARDS.
 Technical Editor: G. V. DOWDING, Grad.I.E.E.
 Assistant Technical Editors: K. D. ROGERS,
 P. R. BIRD, G. P. KENDALL, B.Sc.,
 A. JOHNSON RANDALL.



**"BREMEN'S" RADIO.
 THE SCAPEGOAT.
 5 S W IN ASSAM.
 WAVELESS WIRELESS.**

RADIO NOTES & NEWS

**RADIO AND RAIN.
 SOUTHWARD HO!
 SUNDAY PROGRAMMES.
 DEVONSHIRE (S)CREAM.**

Southend Getting Finnick.

AH HA! Oh ho! What's this? Southend-on-Estuary has actually been and gone and made it an offence to let off loud speakers in public. My! Aren't we putting on airs! It's the result of all this culchah which the B.B.C. spreads about. Now, the next thing to be tackled is the odour of fried hake and boiling nut-oil which enfolds the place in the evening.

The "Bremen's" Radio.

GERMANY'S monster liner, "Bremen," has an unusually fine wireless equipment and no less than nine operators to work it. The main transmitter has a 3-kilowatt aerial energy and a band of 500-3,000 metres. There is a short-wave transmitter of 700 watts, 13-105 metres, and an I.C.W. set of 250 watts, 175 metres and 600-800 metres. All these sets can be worked automatically at 150 words per minute.

For Emergencies.

IN addition, there is an emergency set operated from accumulators and four of the life-boats are fitted with transmitting and receiving sets. The ship has eight receivers and a direction-finder, one receiver being permanently adjusted for the reception of S.O.S. on 600 metres and operating a loud speaker. What a change from the first ship set with its Rlumkorf coil spark transmitter and coherer detector, almost all of which could be accommodated on a couple of card-tables!

New Honour for Marconi.

WHILST on the subject of ships it may be of interest to record that the Navigazione Generale Italiana, one of Italy's two biggest shipping lines, is to build another monster vessel for the Genoa-New York trade and will call it the "Guglielmo Marconi." The significance of this really lies in the fact that while this famous line, the oldest on the Mediterranean, has named a number of its boats after eminent men it has never before used the name of a living man.

The Scapegoat.

THE other day in Berlin those German police dropped heavily upon one unfortunate Fritz and ordered him to remove his aerial. The victim had the temerity to appeal to the Court, whereupon the police argued that a large number of

aerials would disfigure the city. "Ah," replied the Court, in effect, "but this is only one aerial and you can't blame one thing for what may be the sins of many. So lerremalone!" Now all the police can do is to wait till Berlin is disfigured and then have all the aerials down.

5 S W in Assam.

IN case it may turn the scale in favour of an improvement of the service (beg pardon, B.B.C., not *service*, only experiments) from 5 S W I should like to mention that I have received a nice note from B. J. M. P. (Assam), who says that 5 S W is the star turn out there, beating

P C J. But—and a big "but"—they want the programme extended and they want a news service. Perhaps Mr. Thomas could use a little persuasion in the right quarter. He is quite at home with lords and knights. By the way, how many people can say offhand where Assam lies?

Waveless Wireless.

A WALTHAMSTOW reader, very much in earnest, tells us that he has evolved what he considers to be the only plausible theory of wireless. Incidentally, there is no room for waves in his theory. One does not wish to seem to sneer at original thought, but it would be interesting to learn from

our friend exactly what he objects to in the current theory of wave production, reproduction and detection, as explained, for instance, by Sir Ambrose Fleming.

GRASSY GRAZ!



Living up to its name, the Graz (Austria) broadcasting station is set in sylvan surroundings.

The "Round" Valve.

REFERRING to Mr. F. Jacquet's article on the "Valve Vacuum" in our issue of July 27th, the North London Valve Co., Ltd., write to point out what is undoubtedly a slip on the author's part. The article states that the absorbent material in the top of the tube was heated in order to retain the desired vacuum—that is, to keep the valve "hard," or in a state of high vacuum. Now, actually the pip was heated in order to drive gas out of the absorbent material, and thus "soften" the valve—i.e. lower the vacuum. I wish however, to join issue with the North London Valve Co. on one other point in their letter.

(Continued on next page.)

NOTES AND NEWS.

(Continued from previous page.)

Old versus Modern Valves.

THEY say: "No other valve has been invented that was such a good detector on account of this control"—the control referred to being that of the degree of the vacuum. I think it would be more just to say that, having once hit the right characteristic with a given valve—they all differed from each other—the results were remarkably fine, but that this type of valve was unstable and short-lived compared with present-day types.

Joys of Early Valve Users.

THE photograph of the "Round" valve in Mr. Jacquet's article gave me cold shivers. For one thing, it took me back to the war; for another it reminded me of strenuous hours during which I had to strike matches and heat the "pip" with one hand, and take down messages with the other. Then, these valves had a charming habit of going "blue glow" all over at critical moments—i.e. becoming ionised. The filaments were fat white things, prone to flop over and touch the grid. No! Give me the valve of to-day, please!

Radio and Rain.

THE late drought must be one of those factors which the "radio-makes-rain" cranks find inconvenient to fit into their formula. So far as I can make out, their idea is that when it rains too much the overplus is caused by radio; but when it doesn't rain at all the rain we don't get is *not* caused by radio. And when the weather suits them—well, that's just Nature. I was disappointed that nobody blamed radio for the Great Frost of this year.

Eric, or Multum in Parvo.

MR. ERIC DUNSTAN appears to have mastered the secret of living life fully. Before he invaded broadcasting he had put up a most varied and interesting career, and his experiences with radio have been no less hectic, including two major "dust-ups" with two employers. Since leaving the B.B.C. he has entered daily journalism as a radio critic (qualifications unknown!), got himself fever—scarlet, I believe—and has burst into the "talkie" trade. In the words of the cliché, this young man should go far—but omni-directionally.

Southward Ho!

TWENTY-FIVE years after taking Scott to the Antarctic for the first time his good little barque is again on her way there. But with what a different equipment! Wireless, a direction-finder, and an airplane. The radio apparatus includes a 1½-kilowatt "quenched spark" transmitter and a special short-wave set. The spark set will work on 600, 705, and 800 metres, and the other on 26.59 and 36.5 metres. I hope to hear that this short-waver has been picked up by some of you. Call-sign V P M Q.

The Burden of Spain.

IN order to provide revenue for the broadcasting services a decree has been made in Spain imposing licence fees on listeners. The fees are not heavy but are probably commensurate with the value of the programmes. On a crystal set the

Don will have to let go of the equivalent of 2s. 8d. per annum, and he can pay this in quarterly instalments of eightpence. On a valve set he must pay tenpence a quarter. The levy on transmitting sets will be at the rate of 5 per cent ad valorem.

Death of Wireless Official.

BRITISH wireless operators and cable men will receive with great regret the news of the death of Mr. E. R. Tuck, which occurred on July 19th. Mr. Tuck was the General Secretary of the Association of Wireless and Cable Telegraphists, and had built up the Association since 1912 into a very useful organisation. He was a cheery soul and the perfect secretary, and

SHORT WAVES.

A FEW "HOWLERS."

"Wireless is a voice from a box about sponges and where they grow, and other weered subjects. The masters seem to like this, and quarrel about turning knobs."

"Either is everywhere except between programmes. So then London takes a little piano music till it comes back."

"A valve is electric light through a gridiron on a plate."

"Wave-length is the length of waves, and you measure it on a condenser with a killercycle."

"SOUTH POLE CALLING."

Direct broadcasts from the Antarctic exploration ship, the "Discovery," while she is in the South Polar seas, are suggested in Australia. This should make an ideal heat-wave entertainment.

"Bulletin & Scots Pictorial."

SPEECHES GO ON FOREVER.

First Wearied Voter: "What did you think of McBuncombe's speech over the wireless last night?"

Second W.V.: "Oh, I think they ought to have given him a shorter wave-length."—"Radio News."

An advertisement appeared recently in an Indian journal expressing a desire for a person to fill the position of chief snake-charmer to a respectable family, and radio companion for a boy of eight.

We presume the snake has to be kept under control in case the programmes get on his nerves.

GREYHOUND RACING BY WIRELESS.

When hares of tin and hounds of grey
Were racing madly to and fro,
Then people near and far away
Could feel it all through 2 L O.

And so the country came to share
The city's very latest craze,
For wireless hastens through the air
And serves us all, in divers ways.

For what more thrilling than to hear
The newest course that coursing shapes,
While o'er the air comes to the ear
The hairless hare's hair-breadth escapes.

the operators owe him a tremendous lot for his pertinacious and dogged work on their behalf.

Heard the "Bremen"?

E. M. H. and J. S., who do not give their full addresses, say that on July 18th they picked up the "Bremen" on 36.5 metres. The vessel was at the time (9.45 p.m.) calling an unidentified American station in English. If any other short-wave lads got this transmission I should be glad to have further details. Call-sign D D A U. My correspondents were using modified "Sydney" Two's.

Flying Aptitude.

AT the recent International Aero Exhibition at Olympia there was a very popular device called the Reid Sigrist Flying Aptitude Indicator for the determination of the physical and mental

suitability of people becoming pilots. Heaps of folk submitted to the test, but Mr. H. Henry, London sales representative of the Chloride Electrical Storage Co., Ltd. was the winner. Curiously enough the instrument was worked by the Chloride Co's "Exide" batteries.

Devonshire (S)cream.

SOMETHING is "up" down in Devon. Reports received up to the time of writing (Aug. 8th) are to the effect that a mysterious outfit consisting of a sort of a motor-car coupled to a large wheeled cabinet, a cross between a gypsy caravan and a horse-knacker's cart, has been seen by alarmed natives to be acting most suspiciously. At times the whole issue has appeared to be swimming; at others it has remained still for hours, the only sign of life about it being the wet legs and uncensored remarks of what we suppose to be a chauffeur. What can it be? See our next week's issue. Don't miss this thrilling *éclaircissement*.

Interesting Possibility.

IT is reported from Germany that the German Broadcasting Company is to assume financial responsibility for the 1930 Bayreuth Festival, thus ensuring the continuance of that famous orgy of Wagnerian music. The Company will have the right of broadcasting the operas and, this being so, I wonder whether the B.B.C. would be willing and able to give us a few re-broadcasts of some of the more popular parts of them?

Death to "Atmospherics."

IT has long since been agreed that the road to victory over X's is through the study of their origin and nature, and in this work picture transmission is to play an important part. After the normal B.B.C. picture programme special Fultograph transmissions will send out a grid of straight lines, both horizontal and vertical. Any "atmospherics" affecting the receiver will deform these lines to an extent varying with its intensity in a given place. By comparing the pictures received in various parts of Europe the range and intensity of an individual "X" can be determined.

Marine Telephony.

CAPT. Q. C. R. CRAUFURD, R.N., who is said to have discovered in 1907 that an elevated "aerial" is not a necessity, urges that lifeboats ought to be fitted for wireless telephony reception, and states that had the Rye boat been so equipped she would have heard the recall from the Foreland. He suggests an "aerial" of insulated wire, passed round the outside of the boat, and he adds that the method has been tried and found O.K. It is to be hoped that the matter will receive the earnest attention of the authorities.

These Sunday Programmes.

A GOOD deal of agitation is going on with regard to the absence of a Sunday lunch-time programme. My view is that although we should like to have one we ought to consider the B.B.C. employees. Let them have a clear half-day on Sundays, please, and improve matters from the listeners' standpoint by beginning the afternoon programme at 2.30 or 3.0 p.m., and the evening one at 8.0 p.m., getting the services and appeals over by that hour.

ARIEL.

SIFTING DISTORTION

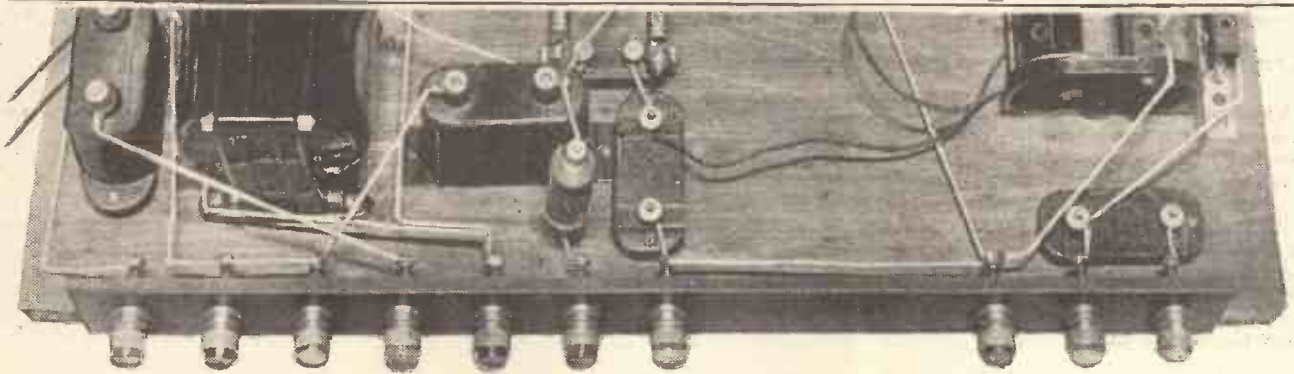

ANYONE who tries to visualise what is happening inside an ordinary three-valve set will be able to see how easily distortion may arise there through interaction. Take the case of a "Det. and 2 L.F.," which is the usual arrangement for a three-valve set. The filament of every valve is joined to the H.T.—. The plate current of the detector (which we will call V_1) has to pass through the coupling device (usually a resistance). The voltages which are produced in the coupling resistance (which we will call R_1) are impressed across the coupling condenser on to the grid of the next valve.

Instead of a resistance a transformer primary might be employed here, but whatever the means employed to couple the



Well-made wire-wound resistances should be employed as stabilising resistances, to carry the current without deteriorating.

detector to its next valve, the effect is that the "speech" voltages are amplified and finally passed to V_3 , which operate the loud speaker. From this we see that if fluctuating or "speech" currents are made to pass through a resistance, fluctuating voltages will develop, which, suitably applied, will reappear as sounds in the loud speaker.

Coupled by the Battery.

Now let us think of the plate current of V_3 . From the plate of this (output) valve there is a path through the loud speaker, through the H.T. battery, and then via the H.T. negative lead to filament, and so back through the valve. Apparently there is no resistance in this circuit to cause coupling effects, but actually this is not the case; for the H.T. battery, especially if an old one, has a resistance of its own, and it is this spurious resistance which causes so much of the trouble of motor-boating and distortion.

Not only is the H.T. battery a resistance across which voltages will be set up by any

An interesting article dealing with the operation of de-coupling (anti-motor-boating) devices, as an aid to pure reproduction.

By P. R. BIRD.

fluctuating currents flowing in the plate circuits of V_1 and V_3 , but its chief misdemeanour from a distortion point of view lies in the fact that it is a resistance which is common to both these circuits.

Providing Alternative Paths.

Linked together by this spurious H.T.B. "resistance," no sooner does the detector (V_1) affect conditions in V_3 , than V_3 "hits back" and affects conditions in V_1 . This completes a vicious circle, giving rise, if not to actual oscillation and motor-boating, at least to distortion of certain loud passages when the currents taken from V_3 are heavy and cause particularly noticeable voltage effects across the resistance.

To sift out this distortion an anti-motor-boating device consisting of a high-value resistance and big condenser is used.

A diagram is supplied with the unit showing how it should be connected. In our case the "anti-mobo" resistance would be joined between the H.T.B. and the detector's coupling resistance (or transformer, as the case may be). That side of the anti-mobo-resistance which is farther from the H.T.B. is joined through the large fixed condenser to the filament wiring.

That is all there is in the way of wiring alterations, yet the effect on the circuit can be very great indeed. Before the alteration was made all current flowing in the last valve's plate circuit passed through the H.T.B., which was acting as a resistance connected also in the detector's circuit. Interaction was thus inevitable.

Resistance and Condenser Values.

After the stabilising unit is in place, conditions are quite different. For one thing, the plate circuit of the detector valve is separated by a high resistance from the plate circuit of the last valve. And, more important still, each plate circuit now has a separate path of its own for speech

currents and no common resistance to couple the two and cause instability.

Undoubtedly the V_3 plate current will still tend to give rise to a voltage variation in the H.T. battery, which will be felt at the detector's + plug, and will be transmitted along the lead from there. But such a voltage variation, instead of crossing R_1 and so complicating matters by coupling up the detector to V_2 again, finds that an easier path back to the filament lies waiting for it via the fixed condenser in the stabilising unit.

Effect on H.T.

Thus the tendency for V_3 to react upon V_1 will be eliminated entirely, or greatly reduced, and the distortion consequent upon such unwanted interaction will disappear. The whole success of the device lies in the sifting of the currents, and providing suitable values are used in the stabilising unit, this is easily within its scope.

Usually the stabilising resistance has a value of 30,000 ohms or more (always a high resistance), whilst the capacity of the condenser in the unit is invariably very high—generally not less than 2 mfd. and often 4 mfd. or more. (The greater this capacity the less impedance it offers, so that obviously the larger it can be the better.)

In practice the only disadvantage of de-coupling by one of these units is the fact that the H.T. positive plug to which it is attached, must be moved up a little higher on the H.T. battery to compensate for the voltage drop across the stabilising resistance. This is a very small price to pay for the advantages gained.

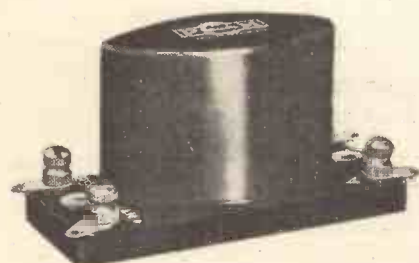

So great is the amplification with a good modern transformer (such as the Mullard, shown here), that de-coupling devices are more necessary now than they were with less efficient instruments.

THE B.B.C. AND PRONUNCIATION.

Comments upon the amusing situation that has arisen out of the B.B.C.'s official rulings on the subject of spoken English.

By THE EDITOR.

OUR readers may remember that not so long ago the B.B.C. published a list of some 322 words with which announcers were reported to have had difficulty. Furthermore, the B.B.C. added to this list its official views on how these words should be pronounced.

There has been rather an amusing sequel to this, for the Society for the Preservation of Pure English submitted the B.B.C.'s list to a Committee of five critics, all of them very eminent men—Lord Balfour, Earl Grey, Earl Russell, Mr. Granville Barker and Dr. Onions.

A "Humourous" Example.

The results of the deliberations of these learned men, after having carefully considered the B.B.C.'s list, have now been published in the form of a pamphlet by the Society, under the editorship of the Poet Laureate, Dr. Bridges, and it is amusing to note that no less than ninety-nine of the B.B.C.'s proposals met with opposition from one or more of the gentlemen who served on the Committee. Against thirteen of the B.B.C.'s decisions a majority vote was cast.

This result is well calculated to make listeners wonder what to do about pronunciation. If a B.B.C. announcer happens to mention the word "humour," just to take one example, and pronounces it "umour," no doubt many readers wonder whether he has dropped an aspirate. But it is a fact that there is one school of thought which maintains that the "h" in "humour" is silent, and when we find eminent people like Lord Balfour, Earl Grey, Earl Russell, Mr. Granville Barker and Dr. Onions all disagreeing about some of the words in the B.B.C.'s list, it is only to be expected that the average listener, hearing words broadcast with which he is unacquainted, begins to wonder whether, from the pronunciation point of view, he is not between the devil and the deep sea!

The Society for the Preservation of Pure English has set itself up as a sort of umpire, and its review of the B.B.C.'s list of words shows it sometimes as supporters of the B.B.C. and sometimes as objectors. The debate is really of considerable interest, especially when we look at some of the words which have been imported from abroad. For instance, the word "envelope."

When Judges Disagree.

Nine people out of ten pronounce it "onvelope," but the correct pronunciation is "envelope." Another word is "entourage." The B.B.C. wants us to pronounce this word something like this—"on-tor-aazh"; but this word has now been Anglicised with the accent on its second syllable, and consequently should be pronounced: "entourage," or "intoorage."

Another word—which, of course, is French—is "ennui" (weariness or boredom). This is recommended by the B.B.C. to be pronounced like "onwee," but in the opinion of Dr. Bridges and Lord Balfour it should be pronounced in its French form.

Everyone who has been to a music-hall has seen written up the word "fauteuil," and if you have ever stood outside a music-hall, near the box office, and heard people asking for a seat bearing this name, you will have realised how one word can be pronounced in a variety of ways. The B.B.C. recommend that the word should be pronounced like "fo-till," but four of the judges profoundly disagree with this recommendation.

Mr. Eric Dunstan the other day had occasion to give the Chief Announcer at the B.B.C. a smart rap on the knuckles for

NEXT WEEK !!

In the next issue of "P.W." full details will be given of a set specially built in response to readers' requests.

It is a straightforward Det. and L.F. receiver called

THE "PRESTO" TWO

The set is easy-to-make and to operate, and there is sure to be a big demand for

NEXT WEEK'S "P.W."
USUAL PRICE 3d.
ORDER YOUR COPY NOW

pronouncing "Cliveden" in a way with which Mr. Eric Dunstan disagreed. Nevertheless, we note that Mr. Dunstan has since apologised, for he finds that the Chief Announcer was right after all!

Don't Take It Too Seriously!

The best way to treat this pronunciation campaign of the B.B.C.'s is not to take it too seriously. Even the B.B.C. have been rapped on the knuckles by the Committee above referred to, and no doubt some even greater authorities will come along in due course and rap certain members of the Committee's knuckles because of their adjudication upon the pronunciation of certain words.

If the B.B.C. were to follow up this pronunciation campaign with another campaign urging phonetic spelling, then their good work would undoubtedly be of definite value. As it is, pronunciation will always be a matter of controversy, and

whether the B.B.C. will ever persuade the majority of its patrons to adopt the Savoy Hill methods of pronunciation is a matter of considerable doubt.

Nevertheless, curious as it may seem, many people find these pronunciation problems a spark of gaiety in programmes which they find otherwise rather dull.

We understand that the B.B.C. are becoming more and more convinced that the future of broadcasting lies in outside broadcasts. A great deal has been done lately to enhance the success and popularity of outside broadcasts, especially relays from theatres, cinemas and outside entertainments generally.

More Outside Broadcasts?

Of course, the summer months have provided the B.B.C. with some excellent opportunities for demonstrating the technical advances which have been made in outside relays. For instance, the Tattoo at Aldershot was a very great success, and we understand that extraordinary care is being taken to make the relaying of the Schneider Trophy competition the most successful of all outside broadcasts.

Again, the B.B.C. have been lucky in having many bans removed from outside broadcasts. Two or three years ago the idea of broadcasting the Cenotaph ceremony was regarded with horror, but the trend of development cannot be stopped, and more and more it is becoming clear that the microphone is finding its way into quarters which at one time were regarded as sacrosanct.

That the day is drawing near when a microphone will be installed in the House of Commons, few can doubt; and that will be the greatest test of all, for many of our readers who have listened to debates in the House of Commons will realise that the B.B.C. have there a problem which will prove a hard nut to solve when they come to deal with acoustics, and the difficulty, not only from the technical point of view of placing a microphone so that all parts of the House will be within proper range, but of selecting the speeches which will prove of most interest to the general listener.

As an experiment, half an hour of Question Time would be interesting. It is more than likely that in the next two or three years parts of the Chancellor of the Exchequer's Budget Speech will be broadcast direct from the House.

ITEMS OF INTEREST.

If you have a milliammeter connected in the common high-tension lead, remember that it should be shunted by a large condenser.

H.T. batteries should not be placed in an exposed position when in use, for not only does the dust which collects become detrimental after a time, but the accidental placing of a metallic object such as a knitting-needle on the battery might either ruin it or give rise to sparking.

When rigid wires are to be soldered together they should not be placed end-on, but one should be bent to run parallel with the other for a $\frac{1}{2}$ of an inch or so, to provide an ample surface for the joint.

AMPLIFICATION v. QUALITY

NO special number of "P.W." devoted to "coupling devices" would be complete without something about the above age-old problem. Throughout the whole of L.F. practice as applied to radio reception one comes up against the necessity of compromises based upon those two opposing interests. You get it all the way from the simplest of two-valve sets right up to large multi-valvers.

Of course, the business is much more complicated when finances are a serious matter and it is a question of getting the most out of the smallest possible outfit.

This amplification versus quality business is met with to a certain extent in the H.F. side of the set, but it will not take us long to deal with that. For the purposes of this article I think a brief reference to reaction is all that is needed. It might cause confusion if we endeavour to tackle selectivity.



The "Hiflux" L.F. transformer has a ratio of 3-1, and is one of the latest types designed by the General Electric Co.

You can boost up signals by means of regeneration, and a modicum of regeneration is undoubtedly permissible, but if you push a receiver to its limits very serious distortion will inevitably occur. You should be able to achieve the volume you desire, particularly from the local station, with your reaction control very close to the minimum setting.

Building Up Volume.

On the L.F. side, do not forget that effective magnification depends upon both the coupling between the valve stages and the valves themselves. In regard to coupling a step-up of voltage by means of a step-up coupling transformer gives increased amplification. For practical purposes the amplification given by a valve is indicated by its amplification factor. That is to say, a valve which has an amplification factor of 15 according to its special charac-

A perennial problem again reviewed in the light of modern progress in the design of radio components.

By D. GLOVER.

teristics will magnify much more than one which has only 6 or 7.

Now in regard to the coupling: you can get these days nearly as uniform transference of energy by means of a transformer as with resistance capacity or other forms of coupling. At one time the ruling was, transformer for amplification and resistance for purity, but progress in transformer design has been such that this dictum no longer applies. Indeed, one of the departures from perfection which is present in the curves of some transformers to-day is frequently beneficial. It gives you a greater magnification in one of the areas of frequencies where the average loud speaker is inefficient. The loud speaker is rather the black sheep of the family these days.

Mixed Couplings.

At this point you might quite rightly ask why it is that any other form of coupling at all is considered, if you can get as good results with greater magnification using transformers?

Well, where there is only one stage of L.F. it is now universally admitted that transformer coupling has no rival, but when two or more L.F. stages are considered the valve question crops up.

If you have unlimited H.T. at your disposal and can afford to buy and use large power and super-power valves there is nothing against you developing enormous volume, providing you make the necessary arrangements to deal with the energy, but small low-frequency or power valves can be overloaded quite easily.

Therefore, when you see a combination of resistance and transformer coupling in a medium sized set you know the designer has endeavoured to produce respectable

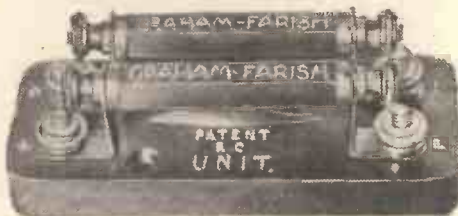

The Graham-Farish R.C. coupling unit has detachable anode and grid resistances. The coupling condenser is contained in the base.

volume without the very great danger of overloading normal types of valves.

Where, as in most cases, you are limited to 120 volts, or perhaps 150 volts H.T. at maximum, and cannot afford much in the way of H.T. current, the valves themselves need to be very carefully chosen. You will find that, generally speaking, the greater the amplification factor of a certain type, the less it will handle in the way of input without overloading.

The Important Valve.

It is the constant aim of valve designers to produce valves that will both amplify to a considerable extent and handle large inputs. Not so very long ago a super-power valve suitable for the last stage of, say, a

A compact and efficient transformer made by the B.T.H. Co., Ltd. A substantial iron core is used, and the instrument is supplied in various ratios.



five-valve set would have been considered good to have had an amplification factor of 5 or 6 (some were as low as 3 or 4), but nowadays there are plenty of valves having the power to handle more energy and have greater magnification qualities.

The Pentode provides an apt illustration of the strides that have been made in valve design. There is no doubt that you can obtain enormous amplification with the Pentode, but you have to be careful that you do not overload it. It cannot handle much larger inputs than are passed on from an ordinary detector valve. Even so, the results approximate that possible with two ordinary valves.

The problem of amplification versus quality is intimately bound up with the valve. Valve overloading is probably the most common cause of serious distortion. It occurs in every other loud-speaker set you hear. The reproduction is excellent for normal speech and quiet passages in music, but when the brass band blares out forté, the reproduction completely breaks up and becomes painful to listen to.

LATEST BROADCASTING NEWS.

SOME GOOD SHOWS COMING.

ONE UP FOR SCOTLAND!—
AUTUMN "TALKS" NEWS—
"SOCCER" PLANS AND HOPES.

THE Productions Department under Mr. Val Gielgud—another of the brilliant young men discovered and developed in the Information Branch of the B.B.C.—is doing particularly good work these days, and nothing is contributing so greatly to its success as the favourable reports on its activities from listeners which arrive after every transmission for which it is responsible.

It is interesting, therefore, to take a peep into future arrangements. On August 29th, listeners will hear a dramatic fantasy "The Pierrot of the Minute," by Ernest Dowson, for which music has been specially composed by Mr. Stanford Robinson, Chorus Master at Savoy Hill, who will conduct the performance. The play, however, has only three characters, just one more than another play "The Man with the Flower in His Mouth," by Luigi Pirandello, which will be given in the London studio the same evening.

Two days later another entertainment, written, composed and produced by Ernest Longstaffe, will be broadcast. It is described as a rustic revue, and is called "Too-Ral-i-oo-ral-i-ay," and the cast includes Tommy Handley, Jean Allistone, Alma Vane, Foster Richardson, Stanley Vilven and the Revue Chorus and Orchestra. This should be a good show.

On Wednesday, September 4th, there is to be a performance of "The Thing That is Plain," the first wireless play by Naomi Mitchison, a sister of Professor J. B. S. Haldane and a niece of the late Lord Haldane, while on Thursday, September 12th, "Squirrel's Cage" is down for a repeat performance.

One Up for Scotland!

Mr. David Cleghorn Thompson, the B.B.C.'s Regional Director for Scotland, and his Highland lieutenant, the great Neil Maclean, are particularly happy just now. Some time ago the wireless traders invited listeners to give opinions on their favourite features of the broadcast programmes, and the result showed an overwhelming vote for purely Scottish items.

Of course, the Scottish administrators knew they were working on the right lines, even without the ballot, but no doubt they will be glad to receive this fresh token of public confidence, especially after the very rough handling they have been receiving from headquarters in London. The next parcel, rolled up to the size of a full hour, is "on" from Glasgow on Monday, August 26th, when there will be Scottish orchestral music and Scottish songs by Mae Johnston (soprano) and George Cunningham, an English baritone. Och aye!

Autumn "Talks" News.

Several important series of new talks are to be included in the autumn programmes

arranged by the London headquarters of the B.B.C. Perhaps the most outstanding is a series of individual opinions, in the form of a symposium, on the tendencies of the times which are to be given under the general title of "Points of View" by some of the leading thinkers and writers of the day.

These talks will be given at 9.15 p.m. on Mondays from September to December, and the first is by Mr. G. Lowes Dickinson, the author of "A Modern Symposium." It is hoped that Mr. H. G. Wells, Dean Inge, Sir Oliver Lodge, and Professor J. B. S. Haldane also will take part.

Another series for London and 5 X X only will be given on Tuesday evenings under the alluring heading of "While

London Sleeps." These talks will be much on the lines of the "My Day's Work" series, except that they will be given by such people as, a River policeman; a coffee-stall man, and a Covent Garden porter. There are, of course, many other professional and industrial workers who could be included in what promises to be an exceedingly attractive batch of talks.

The list also includes talks for motorists, talks on travel books, wireless chats on set maintenance, and others on the work of Parliament given by women M.P.'s.

"Soccer" Plans and Hopes.

A glance at future programmes reminds us that the summer is slipping past, while the preliminary announcements about this

year's Wireless Exhibition, which takes place at Olympia in September, help us to realise that daylight saving will soon give way to long, dark evenings when "the wireless" will come into its own again, only more so than ever.

To many people the cricket season (although from the point of view of weather the best for several years) is going all too quickly, but they must recognise the claims of the big ball which will soon be booted about on a thousand Soccer pitches.

On Saturday evening, August 31st, at 7.15 p.m., that popular broadcaster Mr. George F. Allison is talking in the London Studio on "The Prospects for the Coming Soccer Season."

A BROADCASTING MONKEY.



"Miss Dallas," of Texas is a regular broadcaster from W F A A, and is supposed to be the world's only broadcasting monkey.

TECHNICAL NOTES.

By Dr. J. H. T. ROBERTS, F.Inst.P.

LOUDSPEAKERS.

DIAPHRAGM AND UNIT—ANOTHER STEP FORWARD, ETC.

I HAD an opportunity lately of testing a new Squire double-cone loud-speaker unit. This loud speaker, as many of my readers probably know, consists of two vellum cones facing in opposite directions, and secured together at their apexes (or apices, to be strictly correct), this point being, of course, attached to the driving rod from the loud-speaker unit.

The two floating cones, which are 15 in. and 8½ in. diameter respectively, are made of waterproof material, with fabric suspension and the whole arrangement is mounted in an aluminium cradle frame.

The intention of the two cones is to give better response throughout the whole of the usual register, the small cone being more responsive to the higher frequencies, and the larger one to the lower frequencies.

On trial I found this loud speaker gave excellent results, certainly superior to those obtained with a similar loud speaker using only a single large cone.

Diaphragm and Unit.

In so far as the performance of the loud speaker is affected by the actual diaphragm it is only to be expected that the use of two diaphragms in this way should give a more even response. But, of course, this does not get over any resonances or non-uniformity in the operation of the unit itself.

The diaphragm, or diaphragms, can at the best only reproduce the mechanical vibrations which issue from the loud-speaker unit, and therefore it is equally important to make certain of the best possible operation in the unit itself.

Another Step Forward.

At the same time, I think that in many loud speakers a good deal of distortion and non-uniformity is attributable to the operation of the diaphragm, and therefore I consider that the use of two coupled diaphragms of different sizes (and therefore different characteristics), as in the Squire

(Continued on page 736.)

OUTPUT CIRCUITS

A highly interesting and practical article in which the various methods of coupling a loud speaker are discussed. The author shows, in a simple manner, the desirability of separating the speaker windings from the D.C. in the anode circuit of the last valve.

By K. D. ROGERS.

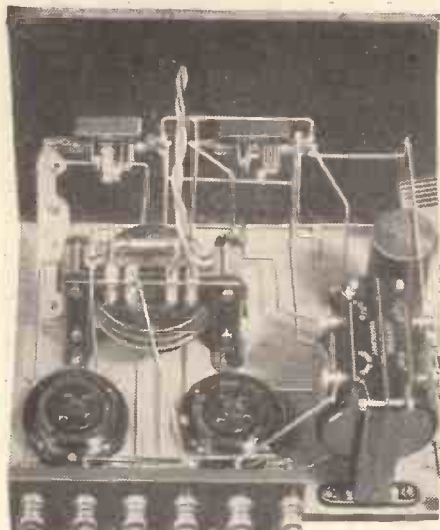

THERE are three main types of output circuit, namely, the direct circuit, the transformer-coupled circuit and the choke-filter output. Taking them in the order mentioned, we can almost say that they are in inverse order of merit.

For small sets the directly-coupled circuit in which the loud speaker is placed direct in the plate circuit of the last valve is quite all right for the average speaker, but in a large set it is far more advantageous to couple the loud speaker by means of a transformer or other output circuit.

The reason for this is that this procedure avoids passing the direct current through the windings of the loud speaker; which steady plate current, if at all heavy, will tend to saturate the core of the loud speaker windings, and render that instrument considerably less efficient. In addition, the high resistance of the loud speaker tends to cut down the H.T. supply to the valve, and this is rather a serious matter.

Output Transformers.

It is much better to have a 200 or 300-ohm output choke or transformer primary rather than a 2,000-ohm loud-speaker winding in series with the H.T. battery and the last valve.

Therefore, it is advisable in practically every case to use an output circuit of some

transformer consists of a 1 to 1 or a 1 to 25 ratio, according to the type of speaker to be used, or some special ratio as used for one well-known cone type of speaker.

Where a 1 to 1 ratio is employed, as in the case of the ordinary high resistance speaker, there is no advantage in using the transformer, and the writer would prefer the output-filter circuit, but where a moving-coil speaker is employed, the 1 to 25 ratio is necessary if the moving coil be of the low-resistance type, and here the transformer is essential. It can be used in conjunction with a filter output, but there is no advantage in doing this, for in the majority of cases the transformer primary can be placed in the plate circuit of the valve and the secondary is taken to the moving coil.

The third example, that of the filter output, is the one most popular in this country and is extremely efficient, giving



A compact R.C. unit—the Metro-Vick. The anode and grid resistances, together with the coupling condenser, are contained in the base. The unit can also be obtained without the valve holder.

as it does an easy method of de-coupling (in a D.C. sense) the loud speaker from the valve.

It consists essentially of a low-frequency choke and a large condenser of the order of 2 mfd. The choke is placed in series with the H.T. and the valve, and prevents any of the L.F. component from the valve going through the H.T. battery back to earth.

Low D.C. Resistance.

The D.C., of course, flows through the choke and the valve, but the L.F. component being blocked by the choke flows through the 2-mfd. condenser, one side of which is joined to the plate of the valve. From this condenser it goes on to the loud speaker, and from there to earth.

This means that all the low frequency is passed through the loud speaker and all the D.C. is passed through the choke, so that the loud speaker has no constant current flowing through it and only has to deal with the low-frequency impulses, or "speech" currents.

The choke itself should be of as low a D.C. resistance as possible, say something of the order of 200 or 300 ohms, while the inductance should not drop seriously below 20 henries at ordinary plate currents. There are some very well-made chokes on the market (R.L. Pye, Wearite, Varley, and many more of the well-known makers) which are quite suitable for ordinary sets up to five or six valves. Where very heavy outputs are being employed, such as with an L.S.5A. or two L.S.5A.'s in parallel, a rather more special choke is necessary, but these also can be obtained from the makers mentioned.

The Condenser Value.

It is advisable when buying a choke to make sure that it will carry the current required without saturation of the core, and without very serious loss of inductance. A 28/14 choke, for instance, has an inductance of 28 henries falling to 14 henries at about 100 milliamperes. As the average set does not take up much more than 20 to 25 milliamps, at the outside, this choke is extremely suitable for ordinary work.

The condenser should be of the high voltage type, tested to at least twice the D.C. voltage you are going to employ, in order that no breakdown shall occur, thereby shorting the H.T. battery or eliminator through the loud speaker to earth.

A 2-mfd. condenser will do in this position, but it is far better to have the 4-mfd. type in order to offer a low impedance to the L.F. impulses.

Some people prefer to have another 4-mfd. condenser between the loud speaker



The Telsen "Ace" transformer is an instrument retailing at a very moderate price. It is made in two ratios and has been designed chiefly for use in portable sets.

sort rather than place the loud speaker direct in the plate circuit of the last valve.

Coming to the transformer-coupled circuit, these are not generally used in this country unless moving-coil loud speakers are employed, or some form of push-pull circuit is used. As a rule, the output

The Edison Bell "Diamond" transformer is made in two ratios, viz., 4-1 and 5-1. The windings and iron core are completely enclosed in a metal screening case.



and the earth, though in the writer's opinion this is not by any means essential. It should be noted that the loud speaker should be taken to earth. It is far better than taking the loud speaker across the choke, and in series with the condenser, as is done in some circuits.

OPERATING THE "ANTIPODES ADAPTOR."

Some practical hints on getting the best results from the ingenious short-wave unit described in "P.W." last week.

By G. T. KELSEY.

WERE I addicted to pessimism I should probably commence this further article on the 1929 "Antipodes Adaptor" by stating that quite possibly you may not hear the Antipodes for weeks!

But that, in most cases, would hardly be true, and in any case short waves and pessimism do not go well together.

The fact remains that your "Antipodes Adaptor" will certainly not live up to its name until you have gathered some experience of short-wave operating, and if therefore you have already constructed one on the lines of that described in the last issue of "P.W." and have so far failed to "get beyond the Continent" do not be unduly alarmed.

A distance of something like 11,000 miles separates us "ethrally" from our friends down under, and although successful reception can be achieved with only two, and in many cases just one L.F. stage, such reception is only possible when the "Adaptor" is adjusted with great care to its most sensitive condition.

Smooth Reaction Essential.

In the first case, it is imperative for the reaction control to be absolutely smooth, and this should not be difficult to obtain since reduction of the H.T. voltage on the reactor valve will usually do the trick, and as I pointed out in the last article the efficiency of the detector valve will not in any way be affected by this procedure.

Variation of the capacity of the neutralising condenser may also be found helpful when adjusting the receiver, particularly if you strike any "dead spots," which, "translated," means narrow bands of the

tuning range over which the set refuses to oscillate.

In this connection, you may at times find it necessary to alter the position of the tapping clip on the grid coil, but in general, this clip should be used as near to the grid end of the coil as possible providing the set will oscillate satisfactorily over the whole range.

A very common trouble on short waves is that of "hand capacity" when tuning the receiver, and unfortunately trouble of this nature is not always easy to overcome. To give an example of the sort of thing meant by hand capacity, supposing a station can be tuned in at good strength when the hands are on the tuning condensers, but that as soon as they are removed the station vanishes, seemingly quite automatically.

Hand Capacity.

If you should experience anything of this nature, do not try and work the "Masklyne stuff" on the rest of the family, but try a new earth. You will probably find it will make a great difference.

In the original tests of the 1929 version, hand capacity was not noticeable to any appreciable extent, and you will probably find your own adaptor the same. But if you should experience any trouble, the best way out is to fit an extension handle to the reaction condenser.

Now a few words as to the stations "receivable" on the new model, and the positions in which you will probably find them. But first let me emphasise the necessity for dead slow rotation of the tuning condenser with the receiver just oscillating.

Starting at the lower end of the tuning condenser, that is to say, with the plates all out, the first station (probably to your disgust!) will most likely be the British one, 5 S W. Just above the setting for this station comes K D K A at roughly 25 metres, and when last I heard him I might add that he was "coming over" at great strength.

We now jump a band of about five metres and strike our popular friend 7 L O on 31 metres. This is where the fun begins, and you should find P C J (Holland), 2 X A F (America), and 3 L O (Australia) all within the next few degrees.

Some General Points.

The most important of the short-wave telephony stations are given in the table on this page, and so that you shall not listen for hours in vain when stations are not transmitting, the usual transmission times are also given.

To conclude this article on operation (you will probably be far too busy with the actual unit to pay very much more attention), there are one or two general points which will no doubt be of interest.

First of all, by using a No. 60 centre-

tapped or X coil in the grid socket, and a No. 35 or 50 coil in the reaction holder, the "Adaptor" can, under certain circumstances, be used on the broadcast band. There may not appear to be very much point in this since the main object of the unit is to change the existing set from broadcast to short waves, but it is a very useful point to bear in mind when testing the unit.

It is, of course, on the broadcast band that the 0001 condenser and the A₁ terminal come into use, and the aerial lead-in must be transferred from the terminal on the neutralising condenser to the aerial terminal on the strip.

The second point concerns sets with two transformer-coupled L.F. stages with which it is desired to use the "Antipodes Adaptor." If there should be any tendency to L.F. instability, or if reaction is difficult to control at certain parts of the tuning dial, try placing a .25 meg. resistance across the secondary winding of one of the transformers. It might also be found helpful to reverse the leads to one of the primary windings.

STATIONS YOU SHOULD HEAR.

WAVE-LENGTH.	LOCATIONS and CALL-SIGN.	TIMES OF TRANSMISSION.
19-56 m.	W 2 X A D Schenectady, America.	Sun. from 8.30 p.m. Mon., Wed. & Fr. 11 p.m.
25-25 m.	W S X K Pittsburg, America.	Sun. 4.30 to 5.30, and 6 to 8 p.m.
25-53 m.	5 S W Chelmsford, England.	Daily, except Sat. & Sun., from 7 p.m.
31 m.	7 L O Nairobi, Kenya.	Daily 6 to 8 p.m.
31-28 m.	2 F C Sydney, Australia.	At intervals.
31-4 m.	P C J Hilversum, Holland.	Thurs. 7 to 9 p.m. & midnight to 1 a.m. Fri. 1 to 2 a.m., 2 to 4 a.m., and 7 to 9 p.m. Sat. 1 to 7 a.m.
31-48 m.	W 2 X A F Schenectady, America.	Mon., Tues., Thurs. & Sat. from 11 p.m.
31-55 m.	3 L O Melbourne, Australia.	Sun. 8 to 9 p.m.
43-5 m.	1 M A Rome, Italy.	Sun. 5 to 7.30 p.m.

FOR YOUR NOTEBOOK.

When using a multi-range voltmeter or ammeter always assume that the volts or amps. to be tested will be a little over rather than a little under the expected voltage or amperage, for whereas a shunt resistance can easily be altered for a lower value if necessary, the switching on of excessive volts or amps. may ruin the instrument.

Although a slavish adherence to makers' instructions regarding H.T. voltage and grid-bias voltage is not necessary, it is as well to remember that such figures are worked out for the benefit of listeners, and therefore they should only be departed from in cases where the valve owner is quite sure of the effect of the modification he is making.

Sensitive measuring instruments should not be placed close to powerful motors, dynamos, loud speakers, or mains units, as they may easily be seriously impaired in this manner.

Powerful permanent magnets, as used for moving-coil loud speakers, or electro magnets, such as M.C. pot windings, create strong magnetic fields in the space around them, and therefore are to be shunned whilst wearing a delicate watch, which may easily become magnetised.

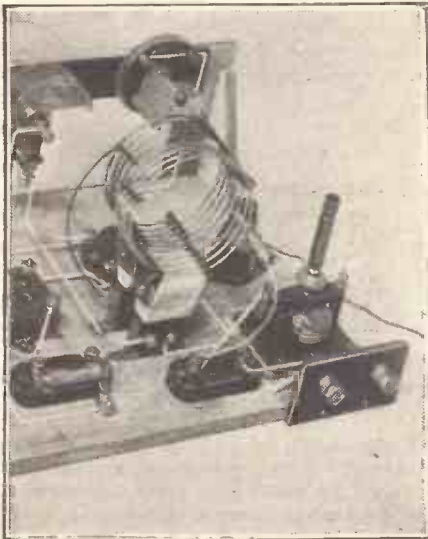

Spacing and wiring must be carefully done at this end of the unit, where all the important components are placed.

The "P.W." "ELECTRO" UNIT



ACCUMULATORS are very useful things. In very many instances there is no practical alternative as an L.T. supply. But if you have the electric power mains laid on you are not making the most of your opportunities if you do not use them for the supply of both H.T. and L.T. Once you do this the set ceases to require maintenance, and becomes as care-free a device as the electric lights themselves. You switch on the set when you want music, and you switch it off as required, and that is all there is to it.

The D.C.-H.T. unit has hitherto been regarded as the simplest of all mains devices, with the possible exception of battery chargers. And the common equipment for a D.C. fan is an H.T. unit, an accumulator for the L.T., and a battery charger. This last saves the periodical trip to a charging station.

Simpler Than A Charger.

But if you look at the accompanying photographs you will find that there is now available an L.T. unit for D.C. mains which is even simpler than a charger. I have no need to tell you what it consists of, because you will be able to see this at a glance. It is a completely safe and practical alter-

* * * * *

Here is a very easy way to get L.T. from D.C. mains. The "Electro" is probably the simplest mains unit of an efficient character that has ever been evolved.

Designed and Described by
G. V. DOWDING, Grad. I.E.E.

* * * * *

to run than a charger, for the simple reason that there are no conversion losses.

Even so, of course, the power dissipated is much greater than when an accumulator is being used, but not, of course, while an accumulator is being charged. However, the running costs of the unit are by no means high, although they do not compare favourably with an A.C. unit. This very simple L.T. unit will probably cost you 4d. or 5d. a week if you run your set regularly for three hours per day, but there will be little or no deterioration, so that I expect it actually works out more economically than battery operation, as there are no maintenance charges.

Perfect Current Limiter.

The mains are connected directly to the filaments of the valves, and an electric-light bulb is placed in series, and it is to the use of this lamp that the unit owes its safety factor.

The lamp is a perfect current limiter, for you use the bulb as a resistance, and its resistance element is completely protected. If you short the output terminals of the unit nothing happens except that the lamp glows a little brighter. The large fixed condenser of the electrolytic variety short-circuits the irregularities that cause hum.

The unit will function quite well without the condenser, and many people will find that the hum is not objectionable. Even on my mains, which are notoriously noisy, the hum without the electrolytic condenser is audible only while there are pauses in transmission.

The foundation of the simple structure of this unit is a wooden baseboard, preferably of teak. The batten lamp-holder is raised a little by placing washers or nuts between it and the baseboard in order to allow the connecting wires to come away

freely. Well-covered wire, such as Glazite, should be used for connecting purposes.

The terminals should be of a type designed for mains units, and I can thoroughly recommend the Belling-Lee plugs and sockets for the job. I do not advise that the unit should be built into a cabinet unless ordinary metal filament lamps of higher voltage rating than the mains are used.

Choosing The Lamps.

Some slight warmth is generated, particularly by gas-filled bulbs, and this would play havoc with the rather unseasoned wood of which many cabinets are built. A good scheme is to mount the unit high up on the wall out of the reach of unauthorised fingers. The lamp or lamps can then contribute towards the illumination of the room.

Now as to the choice of a suitable lamp. In the installation of the unit you will require a voltmeter reading from 0 to whatever the valves are rated at—2, 4, or 6. With this voltmeter you should test across the L.T. terminals with the set connected to the unit. Never have the bulb glowing while the L.T. circuit is open. In order to guard against this happening, make a point of always leaving the unit connected to the set and of switching off the outfit at the power point or plug.

As a further precaution, short the L.T. circuit on your set by joining the two terminals together with a piece of wire. If you run the unit with its output circuit open the whole voltage of the mains will be thrown on to the

(Continued on next page.)

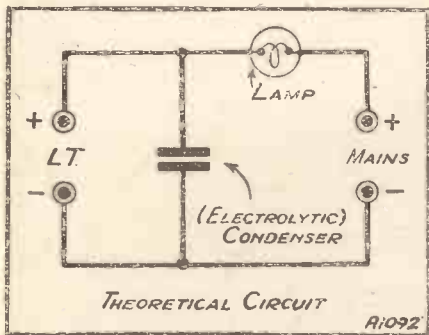

native to an accumulator. Its initial cost is low, and it is a very easy thing to make. You can rig it up within the hour without hurrying the work.

This particular L.T. unit owes its inception to the fact that I found, during certain experiments, that the consumption of an average electric-light bulb very closely approximates that of an average receiver. This L.T. unit, by the way, is much cheaper

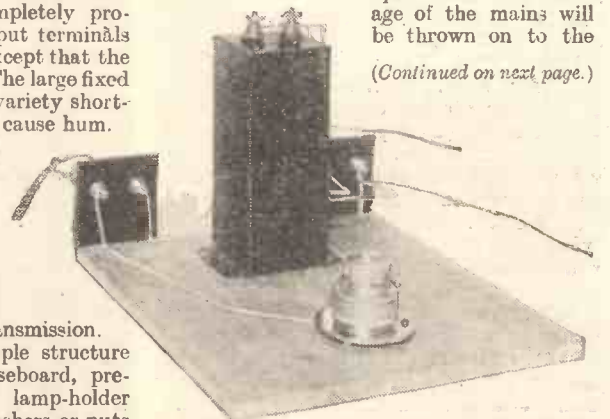

One fixed condenser, a lamp-holder and a few terminals. Pieces of ebonite and bits of wire are all that is needed for this effective L.T. Battery Eliminator.

THE "P.W." "ELECTRO" UNIT.

(Continued from previous page.)

electrolytic condenser, with fatal consequences for that component.

During your initial experiments I would advise you to have the electrolytic condenser disconnected, only bringing it into

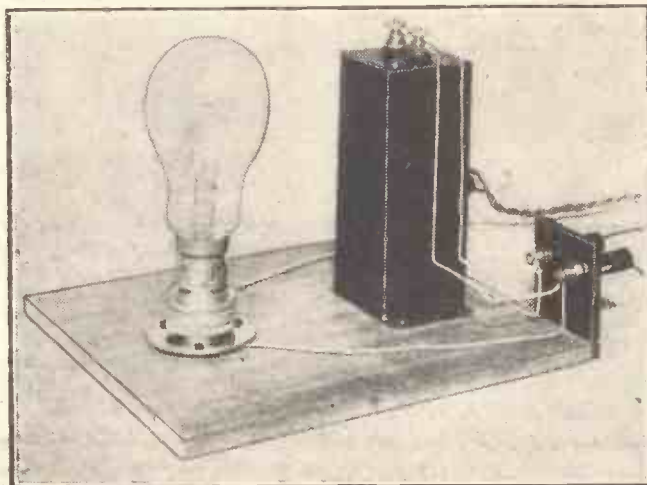

This little unit has been tested on D.C. mains in three different districts, and hum-free results were achieved with all three supplies, using sets varying as much as between Det. and L.F.'s and four valves using S.G. valves.

circuit after you have the whole outfit bellowing broadcasting at you.

Now, to locate the type of bulb you want, first of all calculate the total power consumption of your valves. If you are using three of the .1 ampere types the figure will be .3 ampere. Multiply this by the voltage of your mains. For the sake of an example, we will say that they are 210 volts. The answer is 63, and that means that you will want a lamp of something near 63 watts power consumption.

For Awkward Conditions.

Any of those 60-watters you are using in the house can be employed. Probably the first one will give you a close enough reading on your voltmeter. A variation of a few watts one way or another will amount to nothing across the L.T. terminals. In actual fact the lamp you use can vary as much as 50 ohms in resistance without ill-effect.

If none of the 30-, 60-, 75-, or 100-watt lamps you have in the home prove suitable, you will have to buy one or go to a higher voltage rating of lamp to get the required resistance in circuit. I say to a higher voltage rating because obviously you cannot go lower without imposing too much load on the lamp. If your mains are of 200 volts, you can use 210-, 220-, 230-, or 250-volt lamps, although they will not provide you with as much illumination!

In very awkward instances it may be necessary to have two lamps in parallel. In this case you would want two batten holders on your baseboard. Obviously, with lamps of varying wattages in parallel you can achieve any results. The combinations possible by this means, and with bulbs of different voltage ratings, are

illimitable, but with such combinations you will not be able to work on watts, but will have to treat the lamps purely as resistances. You can find the resistance of a bulb by dividing the voltage rating into the watts and then dividing this answer into the voltage rating. You then get the ohms of resistance.

An H.T. Unit Input.

There has been nothing included in this unit that is not vital to its operation. And it needs nothing else for it to give good results, but you might find it convenient to have the mains on-off switch mounted on the baseboard so that you can control the set by this means instead of at the power point or plug.

Also, if you contemplate several valve changes in the future it is convenient to have a voltmeter connected permanently across the L.T. terminals. Should you use an H.T. unit in addition to this L.T. accessory, it is important that there should be no mains negative connection to the H.T. unit. There should be only one wire con-

nected to the H.T. unit input, and that is the positive.

The H.T. negative is automatically applied by the L.T. circuit. If you connect a mains L.T. wire to the H.T. unit as well, you may cause an unpleasant short-circuit. You need not strive after an exact L.T. voltage, and although no doubt many will consider this advisable, note how an accumulator varies. When a 6-volter is brought back from the charging station it will register 6.4 volts or over, whilst just before you take it back for recharging it will have dropped to 5.4 volts or so.

Reliability.

If you do achieve an exact 6 volts for your L.T. unit it will stay at 6 volts so long as your mains continue to serve you, and this is a point very much in favour of the device.

If you desire exactitude you can place a power rheostat in series with the lamp or lamps, a rheostat capable of handling the total current of the valves. On an "M.W." version of this new L.T. unit I

have included such a rheostat, although I have seldom found it essential.

The simple "P.W." outfit has been tested on the Research Department's 210-volt mains, and on mains with as awkward a voltage as 150. In all cases little difficulty was experienced in achieving the exact current figure required. Variations in lamps of similar ratings have been found. These are not dangerous variations, but variations such as give you a choice between 5.7

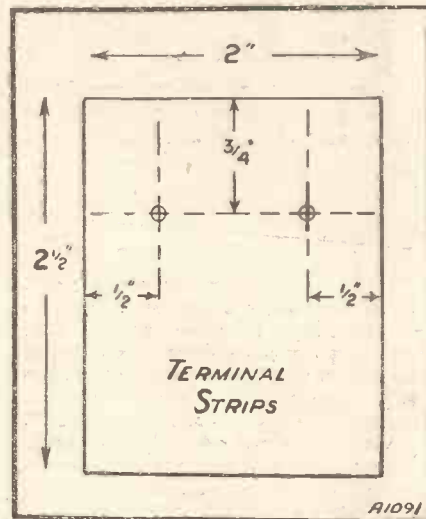

and 6 volts, for instance. In one case a 210-volt 60-watt lamp was noted to give a showing of 1.8 volts, while another of the same rating brought this up to 2. Three 2-volt .1-amp. valves were in use.

There are one or two other details in regard to the installation of this simple unit which will be covered in the "Radio-torial" columns during the next week or two.

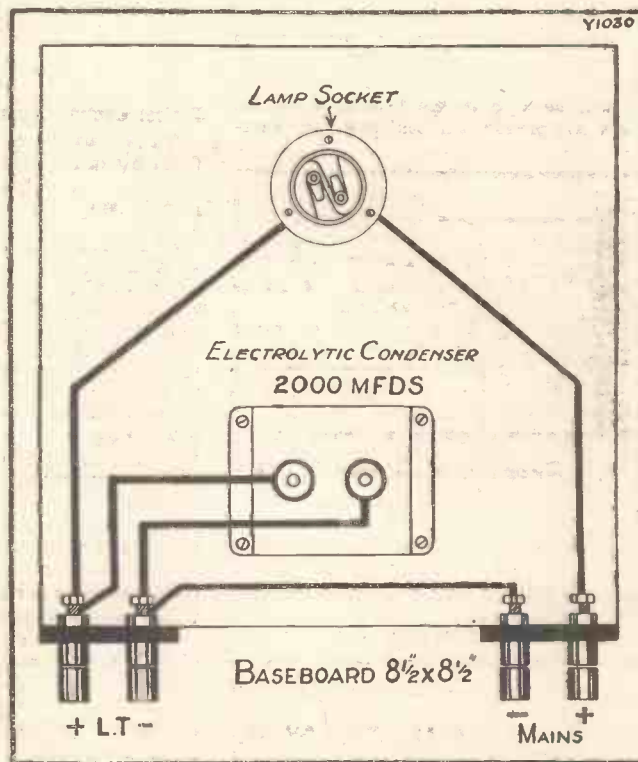



*The Set
Manufacturers
are fitting*

THE HYPERMU L.F. INTERVALVE TRANSFORMER

From all quarters of the globe where wireless is known and practised have come acknowledgments of the remarkable advance and improvement in sound reproduction that the employment of this transformer ensures.

Amateurs, Experts, technical and practical, have testified. Writers of articles in the wireless press have been lavish in their praise. To reproduce the testimonial letters would demand space in many pages of this journal.

For gramophone reproduction it outclasses every other form of L.F. Amplification.

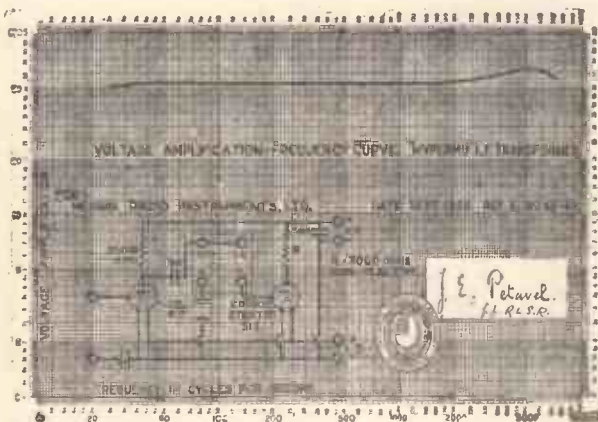

*Meanwhile write for the New
R.I. Catalogue and "Hypermu"
Brochure which shows the
practically perfect curve.*

*"HYPERMU" L.F. Intervalve Trans-
former. Gives the greatest and most uniform
amplification of any commercial intervalve
transformer. Weight, 14 ounces. Size,
3" x 1½" x 3". A midget in size, 21/-
a giant in performance. Price 21/-*

Specialists in Sound Reproduction

RADIO INSTRUMENTS LTD.,
12, HYDE ST., NEW OXFORD ST., LONDON, W.C.1



DUBILIER FOR DURABILITY

R.C. COUPLING UNIT. Complete with Dumet-71 ohms.



COMBINED R.C. COUPLING UNIT AND VALVE HOLDER. Complete with 8/6 Dumetohms

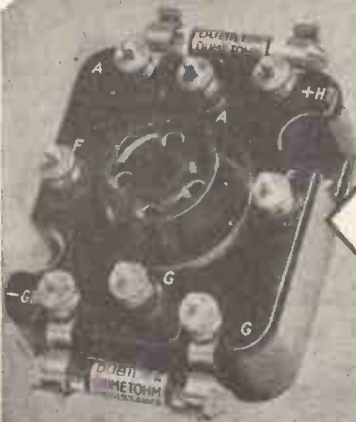

H.F. CHOKE. Four types to meet all uses. Each 4/6



"TOREADOR SCREEN-GRID FOUR." This set incorporates the latest developments in Receiver design—full constructional details free on request.

DUBILIER RADIO PRODUCTS

If unobtainable from your dealer, write direct to us giving his name and address.



Dubilier Condenser Co. (1925) Ltd., Ducon Works, Victoria Road, N. Acton, London, W.3.

© 52/C

The Wonderful NEW

Brown "VEE" UNIT



HERE is the sensational new Brown "Vee" Unit. It is the biggest Radio development of recent years. For only £2 (the Unit costs 25/- and the Chassis 15/-) anyone can assemble, in two minutes, a loud speaker that gives fine mellow tone and better volume than you have ever heard before. It recreates the living artiste—in a degree that is positively uncanny. Soon your Dealer will have stocks. Make sure to hear the "Vee" Unit before you buy your loud speaker.

The Unit Costs	Chassis with Cone
25/-	15/-
S. G. BROWN, Ltd., Western Avenue, N. Acton, W.3.	

"AS BRITISH AS BRITANNIA"

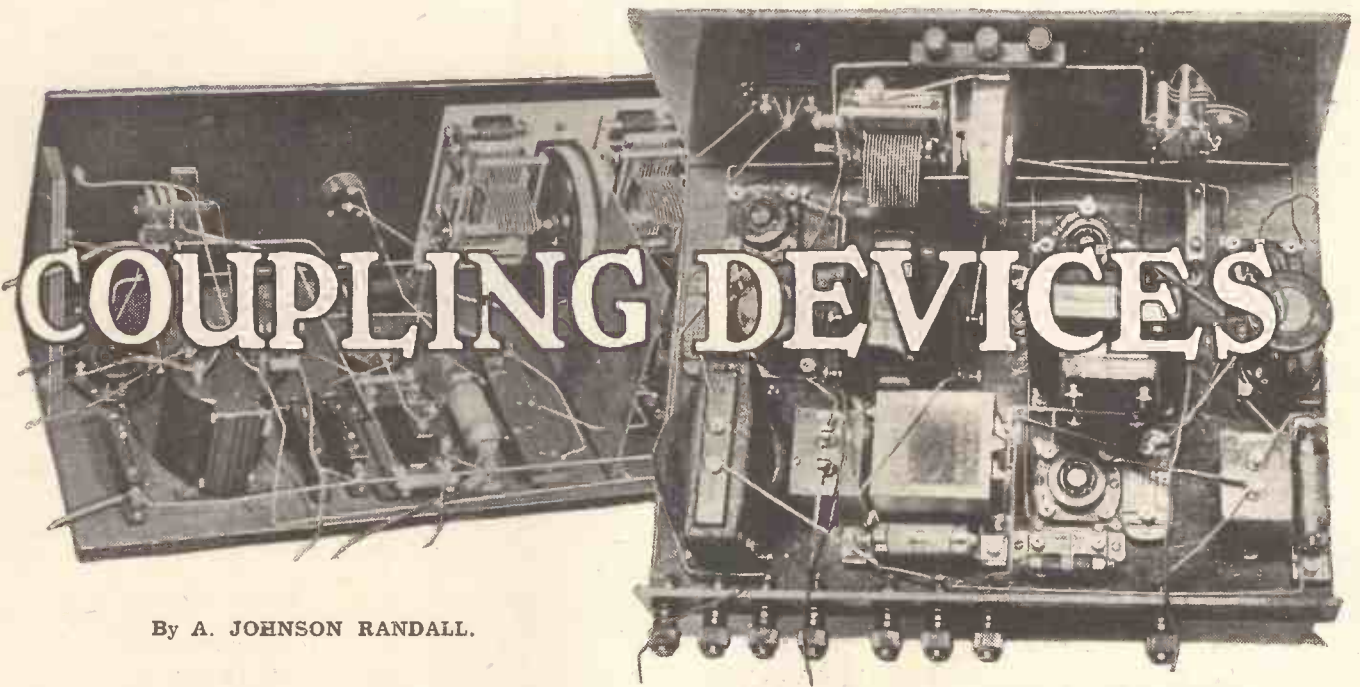

By A. JOHNSON RANDALL.

THE efficient amplification of broadcast programmes in order to bring them up to good loud-speaker strength, is one of the most important factors in the design of the modern wireless receiver. The methods which we employ to couple together the low-frequency stages have a marked effect upon both the faithfulness of the reproduction and the actual step-up in volume.

For the benefit of the beginner, we may say that an L.F. coupling device is a unit with which we link two valves together electrically in order to make the existing signals louder. As previously stated, it is not only a question of magnifying the signals. It is essential that the amplified speech or music should be an exact counterpart of that which was previously audible.

Three Methods.

It is this fact that makes the design of the coupling device itself so important, and the research engineers attached to the various manufacturing radio firms in this country have given the problem a great deal of attention.

In general there are three methods of coupling low-frequency valves together.

The faithfulness of your reproduction as well as the volume is largely dependent upon the low-frequency side of your set. In this article the author describes in a comprehensive and simple manner the more popular methods of L.F. coupling, and devices used therein.

These are choke, resistance capacity, and transformer. Of these only two have achieved great popularity, namely, resistance capacity and transformer coupling. The choke method is very good, but unfortunately it is more expensive than resistance capacity, and apart from the fact that the magnification is very slightly greater it has no particular advantages over the former method.

Now, it is usually considered that resistance-capacity coupling will give the most faithful reproduction, provided the values for the various components are carefully chosen. In fact in a really good design it is possible to get very nearly perfect reproduction, that is to say, a straight line response curve from, say, 30

cycles to 8,000 cycles. In practice, however, there is really no outstanding advantage in going so low down the frequency scale, since the average loud speaker will not produce musical notes much below 100 cycles.

Hence it will be seen that the most economical scheme is to match up the response curve of the amplifier with that of the average speaker. There are, of course, exceptions to this; but one must consider chiefly the type of loud speaker which the average listener can afford. Even so, manufacturers in their efforts and enthusiasm to turn out a perfect coupling device have designed units which are capable of giving an almost perfect response curve, and in addition these units are sold at an attractive price.

Resistance Coupling.

To couple one valve to another by means of the resistance-capacity method we require three components. There is the anode resistance, which is inserted in series with the H.T. supply and the plate of the valve; the coupling condenser, which goes between the plate of one valve and the grid of the

(Continued on next page.)

FOUR FINE LOW-FREQUENCY TRANSFORMERS.



The R.I. "Hypermu" transformer (left) makes use of magnetic material of high permeability and is capable of giving a very excellent response curve. Next, we have the well-known Ferranti A.F.50. This instrument has a ratio of 3-1 and a primary inductance of 120/150 henries. The Igranic Type "J" transformer (third from left) weighs only 10 ozs. and is very suitable for sets where space is limited. On the extreme right is the Cossor transformer which has a ratio of 3-1 and a large primary winding.

HERE ARE SOME FIRST-CLASS L.F. TRANSFORMERS AND

next; and the grid resistance, which permits the use of grid bias and at the same time allows the valve to function properly. Now, these are absolutely essential components, and one can connect them up separately, choosing the different values for oneself, or alternatively one can purchase a complete unit of suitable make.

Suitable Values

By investing in a unit the listener safeguards himself against the risk of unsatisfactory results, since the values incorporated in the commercial R.C. units have been carefully experimented with and can scarcely fail to give satisfaction. On the other hand, many listeners prefer to wire up the parts themselves, and to experiment with various values with the object of increasing their knowledge and at the same

But, unfortunately, as the anode resistance value increases so the higher musical frequencies which are reproduced tend to fall off, and so we are apt to lose a little of the brilliancy in our efforts to obtain the very highest amplification. 250,000 ohms, however, whilst not giving the greatest volume which can be obtained, certainly strikes a mean between volume and quality. If, however, the valve used is one of the H.F. type and not specially designed for resistance-capacity coupling, the anode resistance can have a value of 100,000 to 150,000 ohms and will be found quite suitable. The reader may ask the reason for not using an R.C. valve in every case. Well, much depends upon the circuit used. Let us assume that the R.C. stage is to follow the detector valve, and that the detector circuit incorporates some form of reaction. Now, in most cases, an H.F. type of valve gives better reaction on moderate anode voltages than one of the R.C. type.

Since a higher value of anode resistance cuts down the anode current and also the voltage applied to the anode of the valve, it is obvious that a fairly low value of resistance is more likely to give a freely oscillating detector circuit than a higher value. This is an instance where we have to suit the value of the anode resistance to the circuit in use, and it is a fact that must be remembered in purchasing any of the commercial R.C. units.

The Coupling Condenser

Next we come to the coupling condenser. Now this condenser has two functions to perform. The first is that it must permit as many as possible of the broadcast music and speech frequencies to be passed on to the grid of the following valve. Its value is, therefore, very important. Secondly, the actual D.C. insulation of the condenser must be very high, because if there is a small leak a certain percentage of the anode voltage applied to the plate of the preceding valve will be passed on to the grid of the next valve and distortion may be produced. Therefore, it is usual to employ mica dielectric in these condensers. Moreover, the value of the condenser must be such that it is constant under all normal working conditions, and does not vary with temperature or the state of the atmosphere.

Lastly, the grid-resistance must have a value to suit the other two components, and in addition must be perfectly reliable electrically. Now the various values chosen depend upon a number of factors, and it is

not possible to go into the matter in any detail in this article. In the average circuit, where an R.C. stage immediately follows the detector valve, the anode resistance may have a value of between 100,000 and 250,000 ohms; the grid condenser .006 mfd. to .01 mfd.; and the grid resistance 1 to 2 megohms.

These values give a very good frequency response characteristic, but there are, of course, many other combinations which also give excellent results.

Special Features

Many manufacturers knowing the preference which the constructor has for choosing his own values, make up R.C. units having detachable clips for the anode and grid resistances, thus making it possible for the listener to experiment as much as



One of the Burndept wire-wound anode resistances.



A well-made L.F. transformer—the Ediswan.

time judging for themselves the difference in magnification and quality when certain changes are made.

Speaking generally, the higher the value of the anode resistance the greater is the magnification, provided, of course, a suitable valve is used. It should be borne in mind, however, that one cannot go on increasing the value of the anode resistance indefinitely, and that some sort of compromise has to be made. With the average R.C. valve probably the best all-round value for the anode resistance is about 250,000 ohms, although one can go up to .5 megohm and obtain greater magnification.

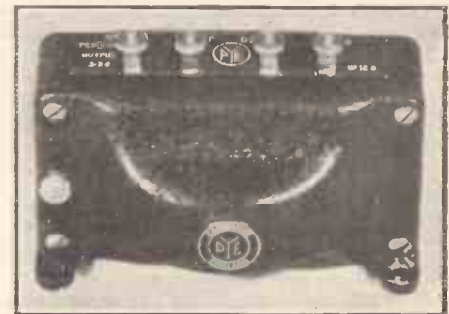

The Fye transformer is of the metal shrouded type, the terminals being arranged along the top for easy wiring.

he wishes. Among these manufacturers may be mentioned Messrs. Dubilier, H. Clarke & Co., Graham-Farish, Mullard, Edison Bell, and Lissen Ltd., etc.

It is also interesting to note that the Igranic Electric Co., Ltd., market a dual-

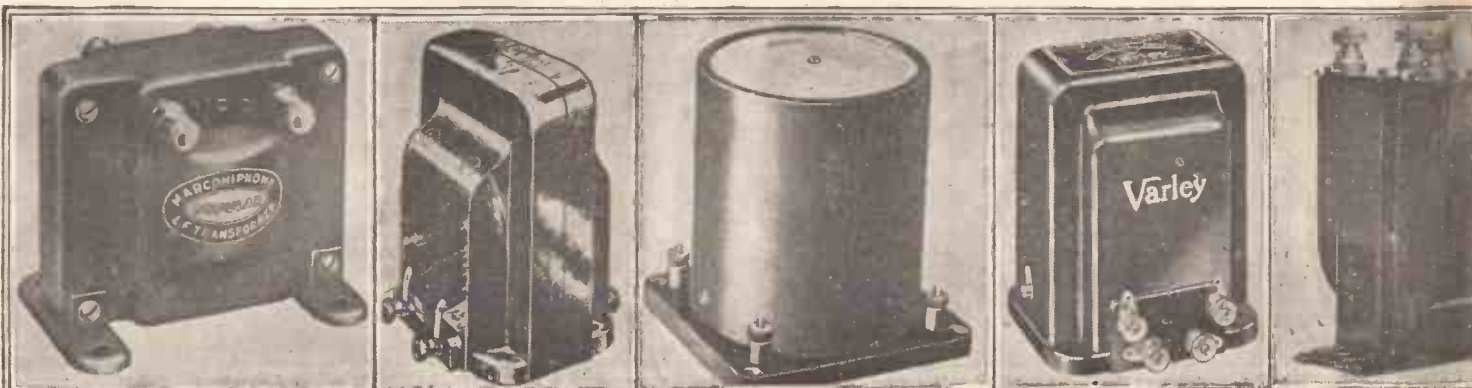

A typical selection of L.F. coupling devices. Reading from left to right these are: The Marconiphon "Poplar," a compact instrument fitted with reversible feet to facilitate wiring. The new Varley push-pull transformer. The Brandes popular model. The Dubilier and Ormond R.C. units. (In the case of the Dubilier unit it

R.C.C. UNITS FOR THE CONSTRUCTOR TO CHOOSE FROM.

resistance-capacity coupling unit which enables anode resistances of two different values to be employed alternatively, by the rotation of a two-way switch which is incorporated in the unit. The object of this scheme is to provide a low-value anode resistance in order to preserve a high standard of reproduction on powerful signals, while at the same time permitting the use of a much higher value for the reception of weak signals.



A popular transformer selling at the remarkably low price of 8s. 6d.—the Lissen.

The firms already mentioned in addition to supplying units with detachable clips for experimental purposes also market complete coupling units with the anode resistances and grid leaks already in position. Messrs. Varley who market the bi-duplex wire-wound resistance-capacity couplers, have three types. Type A has an anode resistance of 200,000 ohms, a grid leak of 1-megohm, and a coupling condenser of .008 mfd. Type C has a lower value of resistance, namely 100,000 ohms, a .01 mfd. coupling condenser, and a .75-megohm grid leak. Type D has an anode resistance of 30,000 ohms, and a coupling condenser of .12 mfd., and a grid leak of half a megohm. These three types are suitable for various valves and the impedance ranges are given in the makers' lists.

L.F. Transformers

It is interesting to note that the N.P.L. curves for these show a very excellent frequency response. In the Mullard resistance-capacity coupling unit a grid stopper is provided in order to minimise the risk of H.F. currents getting through into the L.F. stages, and so introducing distortion.

Messrs. Eric J. Lever also market complete R.C. units in two types. These units are both compact and reliable.

Next, we come to transformer coupling. Now, it is generally acknowledged that a transformer will give greater amplification than a resistance-capacity stage. On the other hand it has been somewhat difficult until recently to obtain high quality reproduction with a transformer unless it was of a very excellent type. During the past year or so, however, manufacturers have concentrated on this problem, and there are now instruments on the market which will give reproduction indistinguishable aurally from that obtainable with the best R.C. coupling. Most readers will know that a transformer consists of an iron core upon which is wound a primary and a secondary winding.

Step-up Ratio

The primary winding carries the anode current to the plate of the valve and the secondary winding is connected between the grid and grid-bias negative of the following valve. Now a good transformer has a primary winding consisting of a very large number of turns, thus giving it a high inductance value. This is essential from the point of view of quality. Moreover, in order to obtain a big increase in volume, the secondary winding must consist of more turns than the primary.

If we divide the number of turns on the primary winding into the number on the secondary we get what is termed the ratio

of the instrument is to be efficient a large amount of iron must be used for the core. Unfortunately, apart from the mechanical side of the question, directly we attempt to use a very large secondary winding the standard of reproduction tends to fall off,



A compact light-weight component specially suitable for portable sets is the Philips.

owing to the distributed capacity between the turns, which has an effect upon the higher musical frequencies.

On the other hand, if we endeavour to obtain a big step-up by using a smaller primary, then both amplification and the reproduction of the lower frequencies decreases, hence both from the electrical point of view and the mechanical standpoint, it is essential to effect a compromise in design. The modern transformer therefore consists of a large primary and a step-up ratio in the neighbourhood of 3 to 1. Such instruments are usually called the low-ratio type because there are certain other types of transformer on the market which are used for special purposes and which have a much higher ratio than this.

The Windings

The design of a really first-class transformer requires a large amount of skill, both from the theoretical and from the practical standpoint. For instance, various methods have been adopted for winding the primary and secondary in order to minimise the chances of mechanical failure.

It is a well-known fact that when any transformer is working there is a tendency for the turns to move in sympathy with the received impulses, and in consequence there

(Continued on next page.)



In the Carborundum Company's R.C. unit the anode and grid resistances are readily detachable.

of the transformer and manufacturers aim at obtaining the highest practical ratio whilst maintaining a high standard of quality. It can easily be seen that if the primary is to consist of a very large number of turns, then in order to obtain a high step-up ratio the transformer itself will have to be somewhat bulky. In addition, if



ing. The Lissen "Super" which is neatly enclosed in a brown bakelite case and is supplied in two ratios. The Formo "True Scale" L.F. unit which utilises auto-choke will be noted that the grid and anode resistances are detachable.) The latest Lotus transformer and the Brown, which is made in two models.

COUPLING DEVICES.

(Continued from previous page.)

is a danger of a breakdown occurring. Manufacturers have given this point considerable attention, and this has resulted in various special methods of winding. Then again, the capacity of each winding, particularly the secondary, must be kept down, and the usual scheme is to wind on the turns in sections as distinct from the old method of placing the secondary directly over the primary.

Well-Known Types.

We in this country are in a very fortunate position in having so many first-class transformers on the market to choose from. For example, we have the excellent A.F.3, A.F.4, and A.F.5 transformers marketed by Messrs. Ferranti. This well-known firm has, of course, been associated with transformer design for many years, not only for wireless receiver purposes, but also in connection with power stations and electricity supply. One therefore expects the Ferranti transformer to be a first-class article as a matter of course.

The makers' curves show that the instruments are capable of giving extremely faithful reproduction, whilst the ratio chosen, namely $3\frac{1}{2}$ to 1, ensures a big step-up in volume per stage. It should be remembered when incorporating a Ferranti transformer in a set that the primary winding has a small fixed condenser permanently connected internally across the terminals. Therefore no other condenser should be added externally across the two primary terminals since it is liable to have an effect upon reproduction.

Among the other super types of transformer on the British market may be mentioned the Igranic type G, which has a ratio of 3.6 to 1; the R.I. super-straight line and "Hypermu" transformers, the Lissen Super, the Varley, Pye, Mullard, Marconiphone, B.T.H., etc., etc.

Valve Impedance.

The R.I. "Hypermu" is a recent design, and the makers recommend the use of a form of coupling which is virtually a "parallel feed." The anode current to the valve, instead of passing through the primary winding, is fed through a 30,000-

It must always be remembered that with any L.F. transformer it is essential to use a suitable type of valve in series with the primary winding, otherwise the results claimed by the manufacturers cannot be obtained. All of the published curves are taken with valves of a certain definite impedance, and it will be found that in practically every case the transformer makers specify the valve impedance to be chosen for use with their particular instrument. The transformer and the valve must always be considered together.

There is at the present time, a tendency for transformers to get smaller. This does not mean that the amount of iron used in the core is being cut down, neither does it mean that a deliberate sacrifice in the efficiency of the winding is being made in order to reduce the size of the instrument. The fact is that certain of the manufacturers have reduced the bulk of their transformers by using cores of a special high permeability material and by using windings of alloy wire and not copper.

The Mullard "Permacore" transformer is one of this type. The primary winding

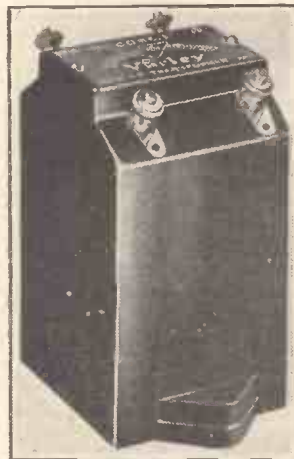

The recently introduced Varley Nicore transformer. It is claimed that the instrument is capable of giving practically a dead-straight-line frequency response when connected in circuit in accordance with the makers' directions.

space is a consideration, such as in portable sets.

Apart from the more expensive transformers designed to give super quality, there is a number of others which have been designed to fulfil the requirements of those who do not require such expensive instruments. For instance, there is the Marconiphone Popular model which retails at 12s. 6d.; the Lissen, which is remarkable value at 8s. 6d.; the R.I. General Purpose; the Igranic type J; the Lamplugh "Quality" transformer; the Dunham, the Goltone "Junior," etc., etc. These instruments, whilst selling at a moderate price, are all capable of giving very good results.

Messrs. Varley are also turning their attention to nickel-iron core transformers which they are marketing under the name

of Nicore 1 and Nicore 2. The makers claim that the instruments are capable of giving a straight-line frequency response with an overall amplification of over 70 when connected as an ordinary transformer. It is also stated that when the resistance-feed method of coupling is employed, a dead straight line from 50 to 6,000 cycles with an amplification of approximately 60 is obtained.

The Present Trend.

If one can judge from the present trend of design, transformer manufacturers will soon be divided into two schools. On the one side we shall have those who are concentrating upon instruments which employ an alloy core and possibly special wires for the primary and secondary windings, while on the other hand there will be those who prefer to use ordinary transformer iron for the core and copper for the primary and secondary windings.

There is, of course, no such thing as the perfect instrument and in the development of the science it is only natural to expect some difference of opinion among designers. The fact remains that whether the instrument employs an iron or an alloy core, it will give excellent results provided it is made by a well-known firm, and that it is connected in circuit in conjunction with a suitable type of valve as recommended by the manufacturers.

So far we have not mentioned push-pull amplification. This method has never achieved any great popularity in this country, but there is no doubt that it has certain advantages, particularly in cases where a very large volume has to be handled.

Push-Pull Amplification.

With a push-pull transformer it is necessary to use a special push-pull output transformer to feed the loud speaker, and in general push-pull amplification is more expensive in its first cost than ordinary straightforward transformer coupling. The volume handled by the ordinary domestic wireless receiver is scarcely sufficient to warrant its use in the majority of cases, but when it comes to the question of filling a large hall or giving an open-air demonstration then push-pull amplification is worthy of every consideration. There are certain firms who market specially designed push-pull output transformers and among them may be mentioned Messrs. Ferranti, R.I. Ltd., Varley, Pye and Igranic, etc.

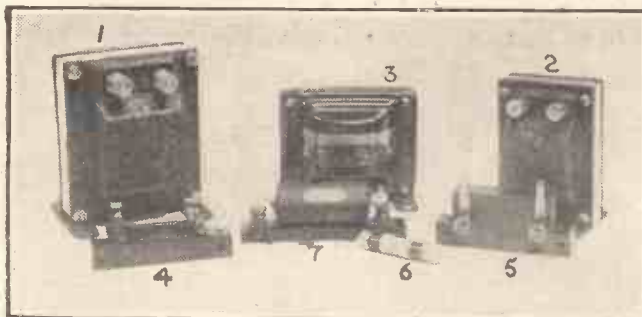

A group of components manufactured by Messrs. Ward & Goldstone. Among them may be seen: 1, The Goltone "Grand" L.F. Transformer; 2, The Goltone "Junior," and 3, the Goltone L.F. Choke.

ohm anode resistance, and the speech impulses are passed to the primary via a 1-mfd. condenser. The N.P.L. frequency curve for this instrument shows that it is capable of giving remarkable reproduction.



The Brandes type "E" L.F. transformer utilises an alloy core and has a high primary inductance. The case is of bakelite.

FERRANTI TRANSFORMERS

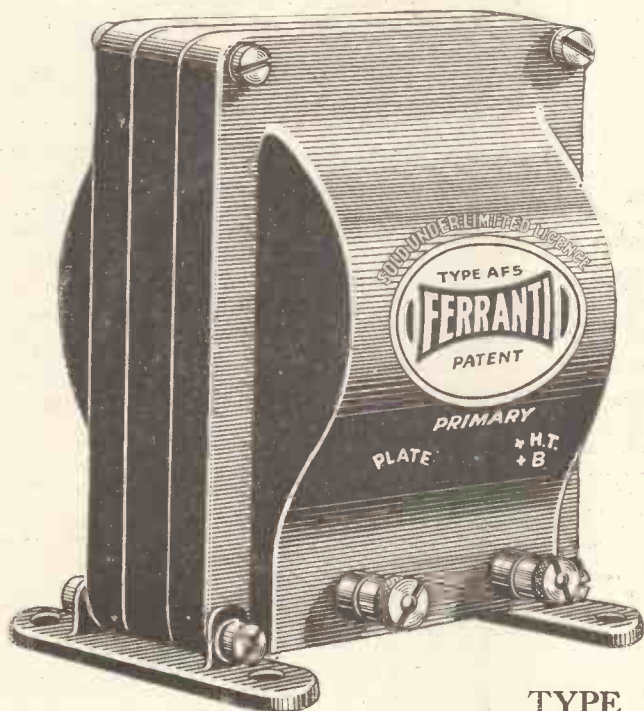

STILL
MAINTAIN THEIR
PRE-EMINENCE
AS THE FINEST
AUDIO-FREQUENCY
COUPLINGS
AVAILABLE

TYPE AF5.

30/-

Their guaranteed characteristics, together with their fine workmanship and almost entire immunity from breakdown, render them the final choice of the Radio connoisseur.

Ferranti Transformers are incorporated in the best Receivers, they are used in Sound Film Amplifiers and in connection with the manufacture of Gramophone Records—in fact, everywhere where Quality is the first essential.

FERRANTI LTD.

HOLLINWOOD

LANCASHIRE

FROM THE TECHNICAL EDITOR'S NOTE BOOK

Tested and Found—?



MAGNUM REACTION CONDENSER.

A NEAT little reaction condenser is the latest addition to the range of components due to Messrs. Burne-Jones & Co., Ltd. It is eminently suitable for inclusion in "P.W." receivers where such a device is specified. The design is on straightforward lines. There is a small ebonite back plate and on this are mounted the fixed vanes which carry two terminals which, for cross connections, are very useful.

Connection to the moving vanes is made by a terminal mounted on the ebonite back plate, a metal strap from this being locked to the bush. A feature of this "Magnum"

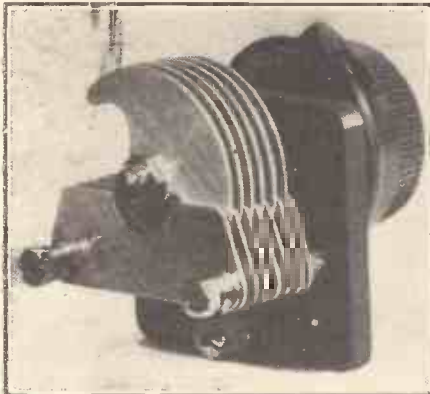

The new "Magnum" Condenser.

condenser is that its movement is stiff, though smooth. The stiffness is probably deliberately introduced, and a certain degree of this quality is undoubtedly desirable in small reaction condensers. Nevertheless, we are of the opinion that the "Magnum" condenser sent us has a slightly too stiff movement, although no doubt the precise adjustment we look for in Burne-Jones' components will be achieved when the article is in production.

MARCONI S.G. VALVES.

I can never handle an S.G. valve without experiencing a certain amount of national pride. The practical screened-grid valve is definitely a British innovation. It is true that the principles of it were demonstrated previously, while multi-electrode valves in general are comparatively ancient conceptions, but the hard fact remains that the arrival of the first British S.G. valves in America created a radio uproar.

There was a mighty rush to obtain them and specimens were sold up to £70 each.

And, by the time America went into the production of screened-grid valves, they were familiar to almost every amateur in this country.

And there is no doubt about it that the "S.G." is a wonderful device. In theory and construction it is moderately straightforward. The following

words from a leaflet accompanying the new Marconi screened-grid valves could not be improved upon for conciseness and lucidity of explanation.

How S.G.'s Work.

The capacity between the grid and plate of an ordinary three-electrode valve gives rise to reaction effects in high-frequency circuits. Although many neutralising systems have been devised, none of these are satisfactory when more than a limited wavelength range is to be covered, and to avoid oscillation a certain degree of amplification has to be sacrificed.

Marconi Type S.610 contains an extra grid placed between the usual control grid and the plate. This screen grid is connected directly to some point on the H.T. battery, between 60 and 90 volts being applied. While it does not seriously impede the flow of electrons from filament to plate, it almost entirely overcomes the capacity "feed back" from plate to control grid.

As a result, a far higher magnification per stage becomes possible, and provided that adequate precautions with regard to screening and wiring of the circuit are taken, no reaction effects should arise to limit the efficiency.

The filament of Marconi S.610 is surrounded by a normal type grid. Outside this there is the screen grid, of rectangular shape and carrying at its lower extremity a circular plate reaching almost to the glass bulb. Control grid and filament connections are to the usual pins in the cap. The screen grid is joined to the normal anode pin and the anode itself to a terminal at the top of the bulb.

The screen grid overcomes "feed back" reaction within the valve. To obtain full benefit of the high magnification it is also necessary to ensure that external feed back of energy from one circuit to another cannot occur. This "feed back" may take place inductively and capacitatively between coils, condensers and parts of the wiring. Clearly, then, if absolute stability is to be assured, adequate stage by stage screening must be used. A screen round coils or condensers alone is insufficient except perhaps for one stage, as considerable interaction may still occur in the wiring and other components.

And yet to achieve the remarkable characteristic of this new S.610 Marconi valve you would quite logically assume that some other factors were at work; something that was harnessing the electrons and making them do much more than double their ordinary work.

The type S.610 has quite ordinary filament characteristics; that is, it consumes 1 ampere at 6 volts, and its anode volts are rated at 150 maximum, 60 to 90 screened-grid volts being specified. And yet an amplification factor of 210 is obtained. The impedance of the valve is 200,000 ohms, so that in order to achieve colossal amplification a proportionally high impedance anode circuit is essential.

It is said that the S.G. valve is insensitive. This is, of course, less than half a truth, inasmuch as a valve cannot be said to be

either selective or insensitive. Its direct functions are associated only with rectification or amplification. The circuit in which the valve becomes a factor, or the set in which the valve is used, has to be criticised on that count.

The truth is that the S.G. valve provides such enormous amplification that it generally replaces two ordinary valves with their accompanying two tuned circuits and, in this way, selectivity begins to suffer, unless precautions are taken.

Very Attractive Proposition.

Further, there is none of that distributed reaction to reduce circuit resistances and damping, and thus build up, on the wrong sort of foundation, a satisfactory degree of selectivity.

The S.G. valve, used properly, is a very attractive proposition, and it is clear that its wonder is not as yet fully appreciated.

There is a 4-volt Marconi valve of the screened-grid high-frequency type now available, and this is the S.410. Its characteristics are filament volts 4; filament

Traders and manufacturers are invited to submit radio sets, components, and accessories to the "P.W." Technical Department for test. All tests are carried out with strict impartiality under the personal supervision of the Technical Editor, and readers are asked to note that this weekly feature is intended as a reliable and unbiased guide as to what to buy and what to avoid.

current 1; anode volts 100 to 150; screened-grid volts 60 to 90; amplification factor 180; impedance 200,000 ohms. Both the S.610 and the S.410 are extremely efficient valves, and mark a definite step forward in valve design.

VARLEY COMPONENTS.

We have now received full details of the large range of fine components the Varley people are placing in production. The range includes L.F. chokes for all purposes, intervalve L.F. transformers and transformers for mains units.

In due course, we will be publishing reports on these Varley products, and readers will be able to examine their excellent specifications.



Mr. F. W. Straw, wireless and gramophone dealer of Colchester (left with microphone), and his portable outfit with which he attends sports meetings for a moderate charge. His service consists of broadcasting the results of each event, interspersed with musical items supplied by gramophone records.

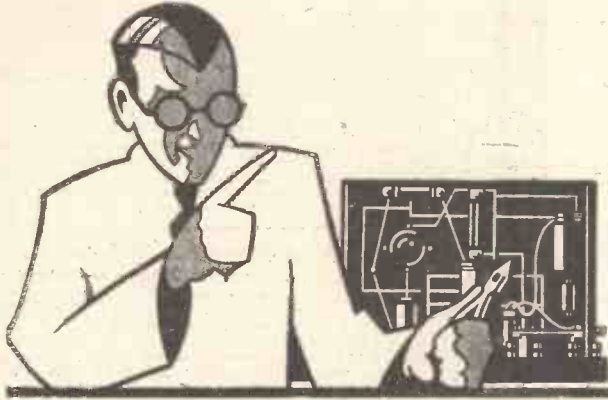

MEET THE
LEWCOS
(REGD.)
H.F. CHOKE!

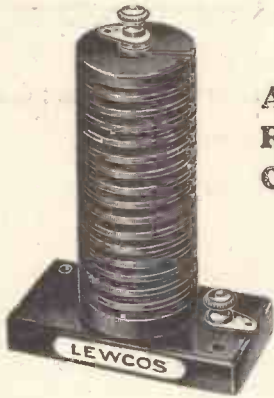

**A CHOKE WHICH
 REALLY DOES CHOKE
 ON ALL WAVEBANDS
 FROM 20 TO
 2000 METRES**

The finest quality materials and the high-class workmanship used in the manufacture of the LEWCOS H.F. CHOKE make it supreme. Equip your set with a LEWCOS H.F. CHOKE and be confident of perfect reception. A chart showing its performance and full particulars will be sent on application.

PRICE 9/6 EACH

**THE LONDON ELECTRIC WIRE
 COMPANY AND SMITHS LIMITED,
 Church Road, Leyton,
 London, E.10**

Trade Counter and Cable Sales:
 7, Playhouse Yard, Golden Lane, E.C.1.

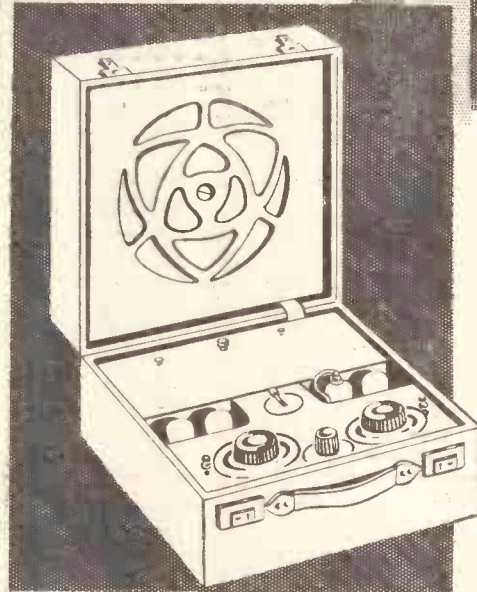

Beneath the trees, on the river, beside the sea, magic minstrelsy entertains the company with living music from across a continent — Burndept Portable Radio is your modern troubadour.

**LET THE WANDERING MINSTREL
 ACCOMPANY YOU . . .**

Like the Minstrels of old, you can now carry your music and your entertainment with you. Take a Burndept Screened Portable wherever you go—to tennis, or picnics, or holidays—and dance to continental bands or listen to the best music at home and abroad. The Burndept Screened Portable gives you the choice of some 20 programmes at clear loud-speaker strength — its magic is complete within a handsome attache case. Thousands of lovers of the open-air this summer are discovering the reliability, the simplicity and the perfection of the

Burndept

SCREENED PORTABLE

Hear the Burndept Screened Portable at Keith Prowse, Harrods, Mudie's or the leading dealers in all parts of the country.

4 valves, including Screened Grid; enclosed cone loud-speaker; calibrated wavelength scales; single switch for long and medium waves; fitted with turn-table. Complete in crocodile grained hide or mahogany cases:

£25 . 12 . 6

Write for Catalogues and Hire Purchase Terms to:

**BURNDAPT WIRELESS (1928) LTD., EAST-NOR HOUSE, BLACKHEATH,
 LONDON, S.E.3**

A "P.W." WHITE PRINT.

The Editor, POPULAR WIRELESS.
 Dear Sir,—May I draw your attention to the excellent performance of one of the sets of your White Print series, No. 9.
 A little over three months ago I built this Short-Wave set as an experiment, and I had never worked on high frequencies before. Since that time I have had over 1,100 telegraph and telephony stations between 15 and 50 metres, the chief being: V K-3 L.O., W 2 X A F, W 2 X A D, and W 2 X O. The others are chiefly amateur stations of 61 different countries in all parts of the world. Of this number 13 are British Colonies, and no slow-motion dial, and part of the time I had only 30-40 volts on the last valve.
 Thanking you for the circuit of a most wonderful set, and wishing your paper all success.
 Yours faithfully,
 A. D. STENNING.
 North Harrow, Middlesex.

"P.W." "RANGE FINDER."

The Editor, POPULAR WIRELESS.
 Dear Sir,—I have been interested in wireless for some time now, but never so much as I am to-day during continually taking in your valuable paper. In June, 1928, I constructed the "P.W." Range-Finder," and at once found it a great success, so I made it into a complete set, with a three-valve Rehnart, making an H.F. Det. and two stages of transformer-coupled amplification, followed by a choke filter, which I found improved the tone and volume. I have made no end of tests, and on several occasions bagged 55 stations in one evening, varying from R 5 to R 9. Since the alteration of wave-length on June 30th, 1929, my average bag has been 45, but apart from Turin, which I find has been jammed badly on most nights, the programmes have been perfect when atmospheric have allowed. Of a day-time Langenberg is just nice, till 5 G B starts, Brussels week-ends are the same, but Huizen, which I find this week are on 208 metres, is enormous volume. After 10 o'clock at night I have had to use volume control on the following stations: Budapest, Vienna, Brussels, Katowitz, Frankfurt, Toulouse, Hamburg, Gletwitz, Turin, Kaiserslautern, Leipzig, Horby, Nurnburg, Cologne, and Plesburg. So I don't think I have got anything to grumble at, in fact I congratulate the "P.W." Research Department for turning out such a good unit. So, wishing "P.W." every success in the future, I will close.
 Yours faithfully,
 A. LONG.
 Dagenham, Essex.

A MAINS VALVES CIRCUIT.

The Editor, POPULAR WIRELESS.
 Dear Sir,—During the past six months I have been experimenting with indirectly-heated mains valves, and I venture to think that the receiver developed from these experiments may be of interest to many of your readers, as an indication of what can be done with these valves in the way of producing a really powerful receiver. I enclose a circuit drawing. Indirectly-heated mains valves give considerably more amplification than their equivalents for battery

CORRESPONDENCE.

A "P.W." WHITE-PRINT.

"P.W." "RANGE FINDER"—A MAINS VALVES CIRCUIT.

Letters from readers discussing interesting and topical wireless events or recording unusual experiences are always welcomed; but it must be clearly understood that the publication of such does in no way indicate that we associate ourselves with the views expressed by our correspondents, and we cannot accept any responsibility for information given.—EDITOR.

operation, so that it is easy to see that the range of this set even on a frame is very great. All the high-powered stations on the long-wave band come in at fine volume even during broad daylight, as do many of the good ones on the short band. At night, of course, there are many dozens of good transmissions well received.

In conjunction with a good centre-tapped frame aerial the selectivity is all that could be required. Kongsgrusterhausen being easily separated from Daventry 5 X X. The quality of reception is very fine, and there is a distinct absence of valve noises and mush usually associated with a powerful set such as this. The set is absolutely stable over both broadcast bands with the full rated voltages on all the valves. There is no sign of motor-boating or kindred troubles, accounted for by the fact that a very complete system of de-coupling is employed.

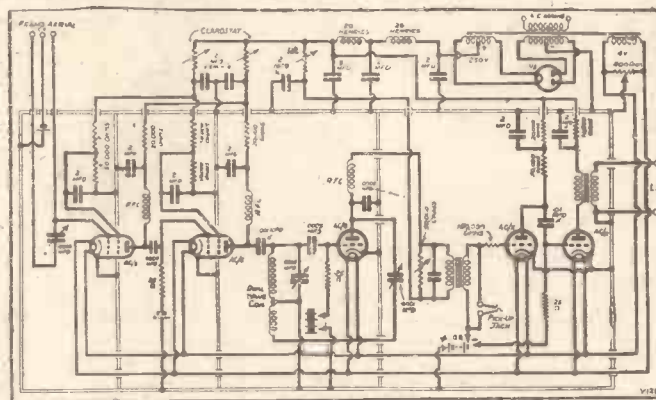

This is the full circuit described by Mr. Watt.

Wave-band switching is effected by two switches: one incorporated in the frame, and the other on the panel. The three variable resistances in the anode feed leads are enclosed inside the set, and once put to their correct values need not be touched. Each section of the set is completely screened. It is important that the L.F. portion of such a set as this be screened, otherwise there will be interference from the frame aerial and, further, interaction with the mains apparatus might be set up.

The screening-grid voltages were obtained through potentiometers, which is accepted as the best modern practice. A special aperiodic coupling high-frequency choke is used to couple V_1 to V_2 . This has an extra high impedance. To connect V_2 to V_3 , shunt-fed tuned grid is used. Among the several reasons that prompted this was the damping introduced by the H.F.C. as an aid to stability.

Using A Pick-Up.

Rectification can be by grid leak or anode bend at will by putting a positive or negative bias on the grid of the detector respectively. I can find little to choose between the two methods as regards quality; the first being perhaps the more sensitive. Experiment indicated that the only satisfactory method of volume control was by a variable resistance across the primary of the L.F. transformer, all the others tending to introduce hum; and as it was desired to control volume to both L.F. valves, the transformer stage had to be placed first, which, although unusual, proves perfectly satisfactory in practice.

Another feature which is unusual is the method used to connect a pick-up into the circuit. A single open jack is used, wired as in the drawing. It is absolutely essential with mains valves that the leads to the grids be the absolute minimum in length, otherwise hum is apt to be introduced, so that to break the grid lead by the insertion of a jack in the ordinary way would be fatal. The filaments of the unused valves are not switched out when the pick-up is in use, as this would upset the high-tension adjustments owing to the decreased load.

A node current is obtained from a transformer giving 250 volts at 60 millamps in conjunction with a Marconi U.5 rectifying valve. In addition, the transformer has a 4-volt secondary giving 6 amps for the filament current.

In conclusion, I may say that by careful packing it has been possible to build the whole set with all mains apparatus into a cabinet measuring only 26 in. by 12 in. with the usual 7 in. panel, without detracting in any way from the efficiency of the circuit.

Yours faithfully,
 P. STEWART WATT.
 Aberdeenshire.

SINCE my last week's note about complete screening of receivers as a cure for severe outside interference, I have given the whole thing up as a bad job! Complete screening of my receivers results in no appreciable improvement regarding interference, a distinct falling-off in signal strength and the sudden arrival of hand-capacity effects which have never been present before!

I shall look into the matter of a different layout in the same cabinet, but it is fairly obvious, from the results I have observed so far, that practically all the interference that worries us on the shorter waves is picked up on the aerial, and that screening is very little help. Perhaps someone will suggest using an indoor aerial and screening that!

A Home-Made Eliminator.

I have been experimenting with a home-made H.T. eliminator (working from A.C.), and also with one of the commercial variety, in conjunction with my own short-waver. The commercial eliminator (quite a well-known make) produces a terrific hum when the set is just on the point of oscillation, and the home-made one, with rather more smoothing, does not.

SHORT-WAVE NOTES.

By W. L. S.

Yet these two are indistinguishable in their performance on the broadcast wave-lengths. Strange though it may seem, I believe it is an alteration in the set that is going to put matters right where the commercial one is concerned. I am incorporating an efficient H.F. filter in the detector H.T. lead which will, I believe and hope, reveal the cause of the trouble. The slightest trace of H.F. feed-back through the supply, when the latter is derived from A.C., seems to cause severe hum, and I think the extra smoothing in the detector H.T. lead of my own eliminator is merely having the same effect as another resistance (or an H.F. choke) with an efficient by-pass to earth incorporated in the set.

Incidentally, on the subject of eliminators, when one wishes to use one for short-wave work, I have found that it always pays to insert an L.F. choke in the low-voltage tapings, if these are provided by the

series-resistance method. When a potential divider is used, I don't think much trouble is experienced, but where the eliminator incorporates either a fixed resistance or a "Bradleyohm," "Clarostat," or similar device, quite a small L.F. choke in series with it will be beneficial.

Readers' Own Results.

As these notes are to be considerably longer every third week, I propose to keep any circuit diagrams, sketches, etc., that I come across, and that are likely to be of interest, and to serve them up with every third week's notes. And may I remind readers once again that I always appreciate their opinions, and particularly accounts of their own experiences, which are always interesting. It is impossible to make these notes interesting to all if I am confined to my own doings and my own opinions, about which no one probably worries very much.

Several readers, by the way, have asked queries about my own wave-meter, and I propose to disclose a few details of that remarkable instrument shortly. Meanwhile, I am making it sufficiently presentable to face the camera without a blush, as it is of rather a crude nature at present, to put it mildly.

INSTANT RESPONSE



Vernier Dial, 4/9.

Dual and Single Drum Dials from 9/-.

Reaction and Differential Condensers from 4/9.

No fiddling about with nuts and connections once you've built your set with Lotus Components—easy to fix, quick to assemble, neat, compact and utterly reliable, Lotus Components work together in perfect harmony and ensure instant response and fulfilment of your highest hopes.

Every Lotus unit is faultlessly accurate—every one is compact, practical and of the latest and best pattern. All good circuits recommend Lotus Components; they are the best and safest choice for every set.

Use
LOTUS COMPONENTS
for the
MULLARD AND OTHER
ADVERTISED CIRCUITS.

From all radio dealers.

LOTUS COMPONENTS

The Lotus range includes L.F. and Power Transformers; Variable, Reaction and Differential Condensers; Valve Holders; Drum Dials; Flat Vernier Dials; Dual Wave Coils; H.F. Chokes; Coil Holders; Jacks; Switches; Plugs, etc. Send for literature.
Garnett, Whiteley & Co., Ltd.,
Lotus Works, Liverpool.

Causton

The HEART of a Portable Set is the H.T. BATTERY



TO ensure the most satisfactory results, the high-tension battery in a portable set should be the very best: obtainable—a Siemens—specially designed and constructed for the purpose, combining minimum size and weight with maximum efficiency. Siemens Portable H.T. Batteries are British made throughout, and are obtainable from your dealer.

POPULAR TYPE
VALUE FOR MONEY

No. 1202. 100 volts.
Size 10 $\frac{1}{2}$ " x 5 $\frac{1}{2}$ " x 3"
high.
18/-



STANDARD TYPE
FOR BEST PERFORMANCE

No. 830. 99 volts,
with grid bias
included. Size
9 $\frac{1}{2}$ " x 5" x 3"
high.
17/-
No. 831. 108 volts.
10" x 5" x 3"
high.
18/-

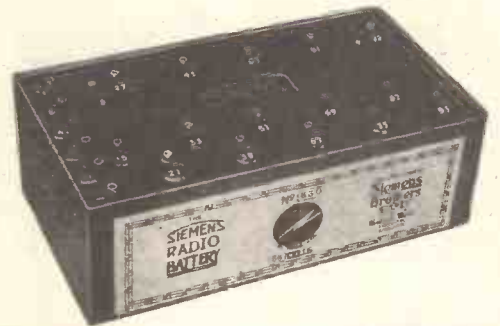

HIGH CAPACITY
TYPE

Provides nearly
TWICE the out-
put of current
of the ordinary
type.
No. 1075. 126 volts.
Size 10" x 6" x 4"
high.
25/-
No. 1077. 108 volts.
10" x 5 $\frac{1}{2}$ " x 4"
high.
21/6
No. 1088. 126 volts.
9 $\frac{1}{2}$ " x 5 $\frac{1}{2}$ " x 4 $\frac{1}{2}$ " high
25/-
(For National
Portable Set).

SIEMENS

PORTABLE RADIO BATTERIES

SIEMENS BROTHERS & CO. LTD., WOOLWICH, S.E.18

THE MOST FAMOUS OF ALL LOUD SPEAKERS

CELESTION

Now obtainable at big price reductions

Model	Old Price	New Price
C 10 ..	£5 10 0 ..	£3 15 0
C 12 ..	£7 5 0 ..	£5 12 6
C 14 ..	£13 10 0 ..	£11 0 0
C 24 ..	£24 0 0 ..	£20 0 0

These substantial reductions are made possible only by reason of the greatly improved production facilities, made available in the new and extensive Celestion factory.

Obtainable from any high-class Radio Dealer.

Write for free Booklet to:

CELESTION, LTD., Dept. B, KINGSTON - ON - THAMES.

THE VERY SOUL OF MUSIC



All Editorial communications to be addressed to the Editor, POPULAR WIRELESS, Tallis House, Tallis Street, London, E.C.4.

The Editor will be pleased to consider articles and photographs dealing with all subjects appertaining to wireless work. The Editor cannot accept responsibility for manuscripts or photos. Every care will be taken to return MSS. not accepted for publication. A stamped and addressed envelope must be sent with every article. All inquiries concerning advertising rates, etc., to be addressed to the Sole Agents, Messrs. John H. Lile, Ltd., 4, Ludgate Circus, London, E.C.4.

The contructional articles which appear from time to time in this journal are the outcome of research and experimental work carried out with a view to improving the technique of wireless receivers. As much of the information given in the columns of this paper concerns the most recent developments in the radio world, some of the arrangements and specialities described may be the subject of Letters Patent, and the amateur and the trader would be well advised to obtain permission of the patentees to use the patents before doing so.

QUESTIONS AND ANSWERS.

CUTTING OUT ONE STATION WITHOUT BRINGING IN ANOTHER.

G. W. (near St. Albans).—"As I have no volume control I have to detune the set a little to bring down London to the required strength, putting both the H.F. and the aerial dials out of tune a little. Sometimes I can get exactly the volume I require without trouble. At other times, although I can get the volume right, I bring in another station, and waste time finding the correct position for volume without interference. What is the best way of detuning in such circumstances?"

Where two dials have to be detuned in this way the correct procedure is to turn one dial up a little and the other down a little until the required degree of volume is obtained. It does not matter whether it is the H.F. or the aerial condenser which is turned up, so long as the other condenser is turned down, thus throwing the two circuits right out of tune with each other, as well as out of tune to a lesser degree with the station whose programme it is desired to reduce in volume.

THE "P.W." STANDARD LOADING COIL.

L. W. (Loughborough, Leics).—"As half the pleasure in wireless lies, in my opinion, in contriving as many parts for oneself as possible, I should like constructional details of the 'P.W.' Standard Loading Coil, preferably with sketch."

The main points in construction can be gathered from the accompanying illustration, which shows (left) the arrangement of the terminals, the method

of arranging the turns (centre), and (right) the other end piece and method of supporting the coil.

Those who desire to do so can obtain one of the standard formers (Burne-Jones, Paroussi, Ready Radio, Wright and Wearre, etc.) which has a series of saw-cuts in the ribs. These form slots for the winding, and in each of these must be wound 27 turns of 26 D.S.C. making 216 turns in all.

Tappings can be brought out in any convenient fashion, at 25, 60, and 80 turns, counting from the beginning, which should be labelled 0. The end of the winding should be marked 216.

If a ready-made former is not to be employed a piece of ribbed "Becol" tube may be used, 1 1/2 in. long, and 3 in. diameter over the ribs. In this case eight saw cuts should be made, right down to the full depth of the ribs, and each about 1/16 in. wide. A space of 1/4 in. should be left between these cuts.

Any desired method of mounting may be employed, but of course no metal must be placed in the field of the coil.

CONNECTIONS FOR AN OUTPUT CHOKE.

V. L. (Bristol).—"I got a 20-henry L.F. choke and a 2-mfd. condenser with the idea of installing choke output for the set, but since purchasing this I find there are several ways of doing this, and I should like your opinion as to the most effective and most convenient method."

Provided the condenser is a good quality one, able easily to withstand a higher working voltage than that which is applied to the plate of the last valve, you can use the standard one-condenser-output type of connections which are detailed below.

Undo the loud-speaker leads, and across these terminals connect your choke. On one side the choke will now be connected to the H.T. battery, and on its other side to the plate of the valve. That end of it which is thus connected to the plate of the valve should now be joined externally to the new condenser (leaving the connections to the plate as formerly), and the remaining side of this 2-mfd. condenser should be joined to one of two new loud-speaker terminals.

(Continued on page 732.)

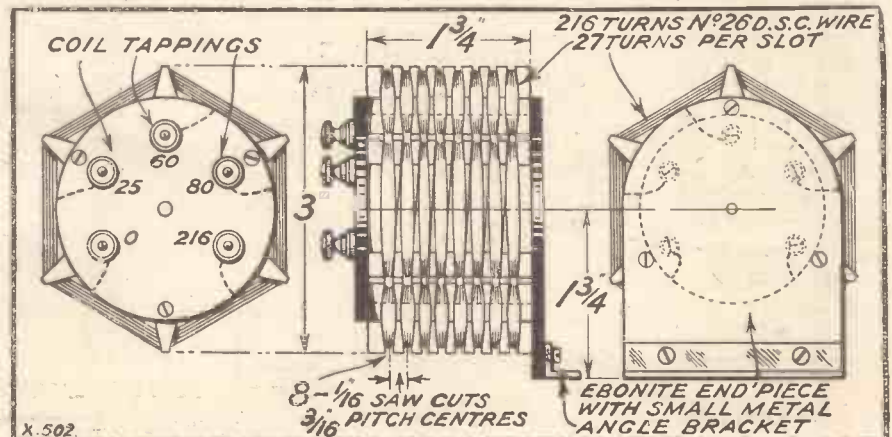

X. 502

POWER
POWER



— clear & steady—
serene & tranquil
that's **EVER READY**

Sets with Power Valves requiring a heavy emission of current need Ever Ready Popular Power Batteries to give satisfactory and economical service.

POPULAR POWER	60 volts	..	13/6
"	64 "	..	14/6
"	99 "	..	22/-
"	105 "	..	26/-
"	120 "	..	27/-

EVER READY
BRITAIN'S BEST BATTERIES

TELSEN
TRANSFORMERS



12/6 =

**BRITISH
MADE**

The RADIOGRAND, as shown above, is a component of outstanding merit and remarkable value. Used by all the high-class set manufacturers and sold everywhere. TELSEN ELECTRIC CO., LTD. Head Offices: MILLER STREET, BIRMINGHAM.

S'easy, now!

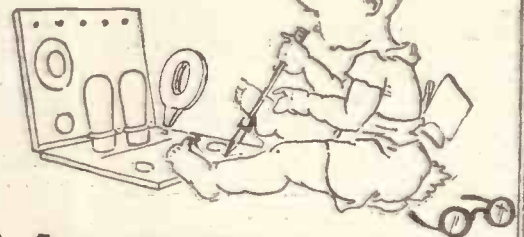

Soldering was a hard job before

FLUXITE

came along

FLUXITE is sold in tins, price 8d., 1/4 and 2/8. **SOLDERING SET Complete**

Another use for Fluxite: Hardening Tools and Case Hardening.

Ask for leaflet on improved methods. **FLUXITE LTD.,** (Dept. 324), Rotherhithe, S.E. 16.

7/6

or LAMP only 2/6

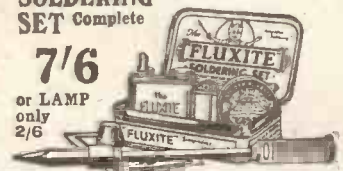

- IT SIMPLIFIES ALL SOLDERING

RAYMOND'S

27 & 28a, LISLE ST., LONDON, W.C.2
Come to LEICESTER SQUARE TUBE
This address is at the back of Daly's Theatre
Phones: Gerrard 4637 and 2821

HOURS OF BUSINESS EVERY DAY 9 to 8
SATURDAY 9 to 8
SUN. MORN 11 to 1

MASTER THREE STAR
3 Spring V. holders, Combined wave coil, Permascore L.F., Climax L.F., H.F. Choke, Battery Switch, J.B. 0005, J.B. 00035, Mullard 0003 and 2 meg. holder, 0001 fixed, panel brackets, spades, 8 plugs, Flex, Links, 4 engraved terminals, Baseboard, all screws, Aluminium panel ready drilled (or chrome, if preferred), Grid Bias, Handsome American Type Cabinet, hinged lid, 3 Mullard valves.
FIRST PAYMENT 15/-
and 11, MONTHLY payments of 16/11.

"TITAN" UNIT WE STOCK

Rugin, Ferranti, Ekco, Ampton, Gelesion, Igranic, Lissen, M.P.A., Ediswan, Casor, Sig-Bisty, Colvern, Cydon, McMichael, Watmel, Lewco, Folar, Climax, Ormond, J.B. Pye, Polymet, T.G.C. Dubilier, Lotus, W.B. Philips, Mullard, and all standard components, valves, etc.

ORMOND
S.M. Drum Dial, 5/-; Rheostats, 6, 15, 30 ohm, 2/-; Midget 0001 max., 4/-; Log. 0005 and 4 in. Dial, 6/-; Log. 0003 and 4 in. Dial, 5/9. S.L.F. No. 3 same price. We always stock all ORMOND PARTS.

APPROVED EDITOR 15/-

"TITAN" THREE
"P.W." 2/2/29. Kit of parts approved by Editor. 0005 Variable S.M. Dial, Micro 0005, Lissen L.F. 8/6 (add balance other), 2 Switches, TITAN COIL UNIT, R.I. H.F. Choke, 0002 and 2 of 0003 fixed, 2-meg. Leak, Holder, 2 Mansbridge Condensers, P.W. Standard Screen, 2 H.T. Fuses, 11 Engraved Terminals, Strip, Screws, Wire, Flex, Plugs, Baseboard, 14 x 7 Panel. Above usually 72/6. Reduced until August 30th ... **60/-**
Post 1/- U.K. Nett Cash.

MUST BE CLEARED
SPLENDID 3 VALVE LOUDSPEAKER SETS
READY TO USE.
In Handsome Cabinet.
Receives London, S.B.S.XX, and many Continental Stations.
65/-
Nett Cash, Carr. and Packing 3/6
STRAIGHT 3 CIRCUIT, OR MASTER 3 STAR CIRCUIT
JUST SWITCH ON—THAT'S ALL.
Complete with 3 Dull Emitter Valves, S.M. Dial. All parts on Baseboard. Hinged Lid. Various Panel Designs.

SPECIAL INCLUSIVE PRICE FOR CASH ORDERS OVER 25/- Please send list.

C.O.D. ORDERS OVER 10/- PAY POSTMAN (U.K.)

Kits of Parts for ALL CIRCUITS. EASY PAYMENTS on many lines over £3 in value. No large first payment. No overcharging. All goods Value for Money.

HANDSOME OAK POLISHED SPEAKER CABINETS 13 x 13 x 6
Fret front various designs.

12/11 Post 1/3
BLUE SPOT 25/-
66K (101)
During August the Cabinet, 12" Cone and Blue Spot 66K 4-Pole adjustable balanced armature model,
27/11 The Lot Carr. 1/-
Or with Triotron 4-Pole Unit **22/6**
1/- Postage.

ALWAYS READ OUR WEEKLY ADVTS. "P.W."

RADIOTORIAL QUESTIONS AND ANSWERS

(Continued from page 730.)

The remaining one of these terminals is joined to the L.T. negative wiring, and when the loud speaker is connected across these terminals it will be found that it works just as well as formerly, but with the additional advantage that no steady current is being driven through it from the H.T. battery.
Do not forget that with the type of loud speaker which has an adjusting screw it may be necessary to alter this slightly when the speaker is changed over to the new loud-speaker terminals, because its most sensitive adjustment will necessarily be different under the new conditions.

NUMBER OF TURNS FOR AERIAL AND FOR GRID COILS.

F. S. (Norwich).—"This year I am going to try and see what I can do with an H.F., Det., 2 L.F. as straightforward as possible. As I have accumulated a number of plug-in coils, do you think these are quite efficient for aerial and grid circuit coupling, and, if so, what coil sizes should I use?"

Well-made plug-in coils are very efficient, and with this type you have the advantage that the coupling between the aerial and grid circuit is easily variable over wide limits.
The size of the aerial coil affects the degree of selectivity available, and as you are situated at some distance from the transmitting station this factor will probably not be very important in your case. If, however, you were close enough to the local station you would need to use a very small coil in the aerial

"P.W." TECHNICAL QUERY DEPARTMENT

Is Your Set "Going Good"?
Perhaps some mysterious noise has appeared and is spoiling your radio reception?—Or one of the batteries seems to run down much faster than formerly?—Or you want a Blue Printer?

Whatever your radio problem may be, remember that the Technical Query Department is thoroughly equipped to assist our readers, and offers an *unrivalled* service.

Full details, including scale of charges, can be obtained direct from the Technical Query Dept., POPULAR WIRELESS, The Fleetway House, Farringdon Street, London, E.C.4.

A postcard will do: On receipt of this an Application Form will be sent to you free and post free immediately. This application will place you under no obligation whatever, but having the form you will know exactly what information we require to have before us in order to solve your problems.

LONDON READERS PLEASE NOTE: Applications should NOT be made in person at Fleetway House or Tallis House.

socket to get enough selectivity to cut out the local station, even though in so doing you would be sacrificing a little of the volume on distant stations.

The actual size of the aerial coil to be used depends partly upon the size of the aerial, for if you have a large aerial you should use a fairly small coil; while, on the other hand, a small aerial necessitates a rather larger coil. In normal circumstances the aerial socket requires a No. 25-, 35-, or 40-turn coil to cover the 250-600 metre wave-band.

When changing over to the long waves a 75- or 100-turn coil is required for the aerial socket. In the secondary or grid socket the correct coil will be a No. 60 or No. 75 for the lower wave-band, but for long-wave reception you will require a No. 250-turn coil in the secondary socket.

THE LEVEL OF THE ELECTROLYTE.

"ACID" (Shaftesbury).—"Is it a fact that the accumulator plates should never show their heads above water?"

The plates of the accumulator should always be covered by the electrolyte, and if in time, through evaporation or other cause, the level falls, this must be raised again to prevent the plates becoming exposed to the air inside the accumulator.

Normally, any electrolyte losses which occur in this way should be made good by distilled water, because it is only water which has evaporated and the acid is at full strength, though it is of smaller volume than it should be. If, however, owing to the accumulator having been handled carelessly some of the electrolyte

(Continued on page 734.)

LISTENERS FLY

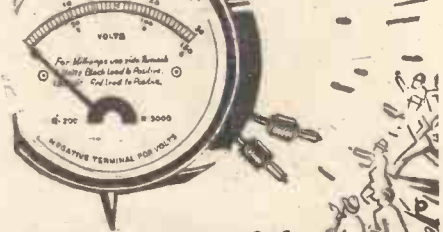

to the wonderful WATES "three in one" VOLT-AMP RADIO TEST METER

This wonder meter has proved itself the most handy and useful testing instrument in the Radio world.
Available from dealers everywhere, including Halford's and Curry's Stores, or by post direct, with instructions for use and the New Wates Formula which enables accurate Eliminator readings to be taken with this meter. No valve set user should be without it!

Readings.
0-150 volts
0-6 volts
0-30 milliamps

GET THIS EXTREMELY HANDY CASE.

Pleasing appearance. Substantially made with smart mottled black finish, Purple plush base and cabinet lined lid, well-made fittings. From dealers or by post direct. Get yours NOW.

THE STANDARD WET BATTERY CO. (Dept. P.W.), 184-188, Shaftesbury Avenue, London, W.C.2.

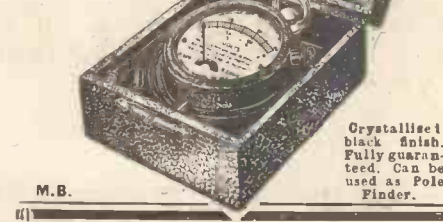

M.B. Crystallised black finish. Fully guaranteed. Can be used as Pole Finder.

PLEASE be sure to mention "POPULAR WIRELESS" when communicating with Advertisers. THANKS!

EASY TERMS

We SPECIALISE in the supply of all Good Quality Radio Sets, Components and Accessories on Easy Terms. We can give you efficient service, and our terms are low. No postage or packing charges. Send us your list of requirements and a quotation will be sent by return.

London Radio Supply Company, 11, OAT LANE, NOBLE STREET, LONDON, E.C.2. NATIONAL 1977.

Player's Please

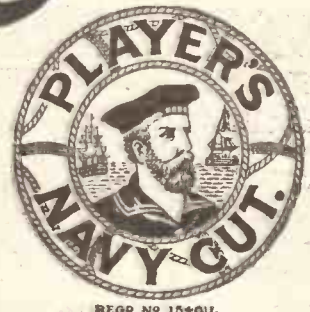

REGD No 154011

N-C-C 207

IF YOU FANCY YOURSELF AS A

WIRELESS CONSTRUCTOR

You ought to get to know all about the

“S.M.L.” THREE *By PERCY W. HARRIS, M.I.R.E.*

☞ Covering Short, Medium and Long Waves, this set was designed in response to requests from the public. It is a just-what-you-want receiver, and full details will be found in the **SEPTEMBER** issue of **THE WIRELESS CONSTRUCTOR**.

☞ In addition there are many special articles of great interest to listener and experimenter, and full directions enabling you to

BUILD THE WIRELESS CONSTRUCTOR ALL-ELECTRIC GRAMOPHONE

NOW ON
SALE
Everywhere

MAKE SURE OF YOUR COPY!
THE WIRELESS CONSTRUCTOR

September
Issue
Price 6d.

WHY WASTE MONEY

ON COSTLY H.T. REPLACEMENTS?

Standard Batteries are proved sound economical H.T. Absolutely reliable and efficient. Improve reception and maintain a constant pressure of non-sagging current that eliminates "background." Self-regenerative. Recharge themselves overnight. Voltage maintained by replenishment of elements at long intervals, when battery is again ready for further use. No other attention necessary. Neat, compact, simple.

THOUSANDS IN USE PLACE YOUR ORDER NOW

STANDARD

SAFETY RECHARGE

PERMANENT H.T. BATTERIES

Obtainable from Halford's Stores, Curry's Stores, and all radio dealers, on cash or deferred terms.

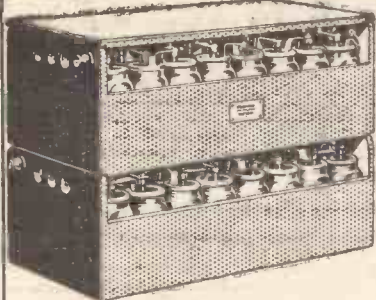

ANY VOLTAGE OR CAPACITY SUPPLIED FROM 7/6 DOWN

Illustrated (assembled complete) is No. 3 size battery, specially suitable for 3 valves or over. Super Capacity. Cash £2 17s. 9d. or down and 5 equal monthly payments of 10/1 Popular model, 96 volt unit for 2 valves. Cash £2 3s. 1d., or 7/6 down.



Send now for interesting free book.

THE STANDARD WET BATTERY CO. (Dept. P.W.), 184-188, Shaftesbury Avenue, London, W.C.2.

HEADPHONES REPAIRED 4/-

Transformers 5/-, Loudspeakers 4/-. All repairs re-magnetised free. Tested, guaranteed and ready for delivery in 24 hours. Discount for Trade. Clerkenwell 9069. E. MASON, 44, East Rd., City Rd., N.1.

Advertisements

As far as possible all advertisements appearing in "Popular Wireless" are subject to careful scrutiny before publication, but should any reader experience delay or difficulty in getting orders fulfilled, or should the goods supplied not be as advertised, information should be sent to the Advertisement Manager, "Popular Wireless," 4, Ludgate Circus, London, E.C.4.

RADIOTORIAL QUESTIONS AND ANSWERS

(Continued from page 732.)

is actually split, there will be a loss of acid as well as of distilled water, and in such a case it is necessary to add a little more acid of the correct specific gravity. Generally speaking, this is a job for an experienced service station rather than for the listener himself.

THE HARTLEY CIRCUIT.

M. T. C. (Stockwell, London, S.W.).—"I wish to make up a one-valve Hartley circuit for telephone reception of long-distance stations. The set is to be used in Berkshire during the winter, and I have all the components except the reaction condenser. What type should this be and what are the connections?"

The Hartley circuit requires a small reaction condenser, so we should obtain one of the .00005-mfd. midjet type condensers, wiring this in series with a .001-mfd. (or thereabouts) fixed condenser, in order to prevent possible reaction shorting effects.

The connections are as follows: Aerial terminal to one side of the aerial coil holder. Remaining side of the aerial coil holder to earth terminal, to a flexible lead which must be connected to the centre tap on the grid coil, to L.T., H.T., and to one of the filament terminals. The remaining filament terminal is connected to one side of the 2-meg. leak and to the on-off switch.

The remaining side of the on-off switch goes to L.T. + terminal. The grid socket of the valve holder is joined to the remaining side of the 2-meg. leak and



It is essential for the choke employed in an output filter circuit to have a substantial iron core and a winding of low D.C. resistance. The R.I. choke (shown above) is of this type and has a D.C. resistance of 260 ohms. It is rated at 28/14 henries, the lower value indicating the inductance when actually carrying 100 milliamperes.

to the fixed condenser .0002 or .0003 mfd. Remaining side of this grid condenser is joined to one end of the grid coil holder and to one side of the main variable tuning condenser .0005 mfd.

The other sides of this coil and of this condenser are joined together and connected to the moving vanes of the variable reaction condenser. The fixed vanes of this condenser go to the .001-mfd. fixed condenser formerly referred to, the other side of which is taken to the plate terminal on the valve holder, and to an H.F. choke.

Finally, the H.T. + terminal is taken to one of the telephone terminals, and the last connection is that of the remaining telephone terminal to the remaining side of the H.F. choke. When expertly handled the circuit is capable of excellent long-distance reception.

FIXING THE GRID BIAS IN THE "TITAN."

D. E. (near Letchworth, Herts).—"I am building up the 'Titan' from the Blue Print, but, although all the connections are clear, I do not quite see where the grid-bias battery actually stands. Is it on the baseboard or outside the set?"

For the sake of compactness no space was left for the grid-bias battery on the baseboard, but it was intended that this little unit should be attached to the back of the cabinet, near to its right-hand end. Special clips for this purpose can be obtained from most dealers.

You will find, too, that in the case of some batteries they are provided with a special cardboard flap specially intended to hold the battery in this way inside the lid.

BULGIN

RADIO PRODUCTS

HIGHLY EFFICIENT SHORT WAVE CHOKE

8 to 80 Metres

Designed for one purpose only, this choke is giving satisfaction to thousands of short wave enthusiasts.

PRICE 3/0

EACH.



A. F. BULGIN & CO. 9-10-11, Cursitor St., Chancery Lane, London, E.C.4

ELECTRICAL BARGAINS ELECTRADIX

1,000 Ediswan Immersion Heaters for liquids 110 or 220 volts. List, 30/-; Sale, 3/6. Brand new. Bed Heaters, 4/-. Electric Hot Plates, 7/6. Electric Soldering Irons, 6/-. Complete Kit, 7/6. Belling Electric Towel Dryers, 50/-. Metaphone House-office Telephones, fitted anywhere, 12/6 pair. New 3-Valve Sets, 30/-. Loud Speakers, 12/-. Microphone Buttons, 1/-. Power Valves, 4/6. Electric Motors from 5/- each. .001 Condensers, 6d. 600-Volt Dynamos, 70/-. 2-Volt Accumulators, 6/-. Send stamped addressed envelope for August Bargain Sale List.

ELECTRADIX HOUSE, 218, Upper Thames Street, E.C.4.

REPAIRS

Any make of L.F. Transformer, Loudspeaker or Headphones repaired and despatched within 48 HOURS—TWELVE MONTHS' GUARANTEE with each repair. 4/- Post Free.

Terms to Trade.

TRANSFORMER REPAIR CO., "Repairs" Dept., 214, High Street, Colliers Wood, London, S.W.19.

The Picture Paper with the MOST News - SUNDAY GRAPHIC -

ENGINEERING OPPORTUNITIES

ENGINEERS

Free

A.M.I.A.E. A.M.I.C.E. A.M.I.E.E. A.M.I. MECH.E.

A BOOK YOU MUST NOT MISS! "ENGINEERING OPPORTUNITIES" is the most complete hand-book on Engineering Exams. and Courses ever produced. It describes over 60 Exam. and home study courses in all branches of Mechanical, Electrical, Motor and Civil Engineering, including WIRELESS.

We ALONE Guarantee—"NO PASS—NO FEE." This book should be in your hands—it is a mine of valuable information and advice. We offer it FREE. Write for your copy now, stating branch or Exam. which is of interest.

BRITISH INSTITUTE OF ENGINEERING TECHNOLOGY, 101, Shakespeare House, 29-31, Oxford St., London. IMPORTANT—NOTE NEW ADDRESS!

ADVERTISERS PLEASE NOTE!

The Rate for a one-inch Single Column Advertisement is 30/-

Minimum Space accepted: Half-an-inch .. 15/-

Send Remittance with instructions to:

JOHN H. LILE, LTD., 4, LUDGATE CIRCUS, LONDON, E.C.4

P.R.

THE ONLY VALVE WITH A WRITTEN GUARANTEE AS TO PERFORMANCE AND LIFE.



2 Valves or more sent POST FREE.

Sent C.O.D. if desired.

Telephone: City 3783.

ASK YOUR DEALER FOR THEM. ACCEPT NO OTHER.

All orders executed by return of post.

INSIST ON YOUR DEALER SUPPLYING YOU WITH P.R. VALVES

Why pay fancy prices when you can get a perfectly finished British made valve with a superior coating giving astonishing selectivity with a minimum H.T. consumption, which is the general opinion of the thousands who use P.R. Valves? There are many valves on the market, but none are guaranteed—Ask yourself why. The P.R. guarantee covers seven months with the right—not a favour remember—but a right to exchange the valve under the guarantee. All you have to do is to post any defective valve to us, complying of course with the terms of the guarantee which is attached and enclose a note stating defect—You will receive a new valve by return of post.

LIST OF P.R. STANDARD DULL EMITTERS.						
3/6	Type.	Fil. volts.	Amp.	Imp. ohms.	Amp. fac.	
EACH Postage 4d.	PR 2	2	.095	28,000	13	H.F. Det.
	PR 3	2	.095	15,000	8	L.F.
	PR 4	2	.095	60,000	32	R.C.
	PR 9	3.5-4	.063	24,000	14	H.F. Det.
POWER 6/6 Each Postage 4d.	PR10	3.5-4	.063	15,000	8.7	L.F.
	PR11	3.5-4	.063	65,000	40	R.C.
	PR17	5-6	.15	24,000	17	H.F. Det.
	PR18	5-6	.15	15,000	9	L.F.
SUPER-POWER 10/6 Each Postage 4d.	PR20	2	.15	7,000	6	Power
	PR40	4	.15	8,000	6	"
	PR60	6	.15	8,000	6	"
SCREENED GRID 15/- Each Postage 4d.	PR120	2	.3	3,800	4	S.P.
	PR140	4	.2	4,000	4	S.P.
	SG25	2	.2	220,000	150	S.G.

OUR OFFER

If you have not already tried P.R. Valves send remittance as per list—We will post you a valve or a set of valves, for seven days' trial. If you are not fully satisfied, return parcel for full refund. You take no risk whatever. We replace all breakages and execute orders by return of post. No delay—the promptest service in the Country. P.R. PRODUCTS (Dept. C), P.R. HOUSE, 14, NEWGATE ST., LONDON, E.C.4

The NEW SCREENED GRID, S.G.25. Now available, Price 15/- post free.

Tell us your set—we will send correct Valves. Matched Valves 1/- extra.

P.R. PRODUCTS (Dept. C), P.R. HOUSE, 14, NEWGATE STREET, LONDON, E.C.4

Opposite G.P.O. Tube Station.

A NEW VERNIER DIAL



Black, 3/- Walnut,
Brown, 3/- Mahogany

(Black supplied unless otherwise stipulated).
Centre Knob Nickel Plated.

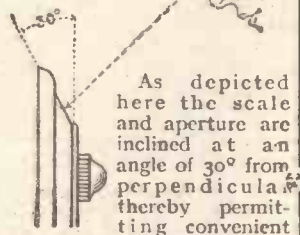

As depicted here the scale and aperture are inclined at an angle of 30° from perpendicular thereby permitting unobstructed view of scale without need to crouch or stoop.

SMALL—EXTREMELY ELEGANT—EFFICIENT

MECHANICALLY PERFECT. POSITIVE BRASS CONTACT drive on SOLID BRASS SCALE, ensuring SMOOTH MOVEMENT with absolutely NO BACKLASH. NO SLIP. ROBUST in Construction and TROUBLE-FREE.

3/- The DIAL you would Buy even at DOUBLE THE PRICE 3/-

CROWN WORKS, CRICKLEWOOD LANE, LONDON, N.W.2

WEARITE COMPONENTS

NEW WEARITE IRON-CORED H.F. CHOKE

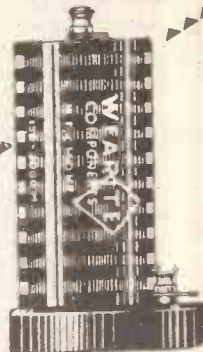

WEARITE IRON-CORED CHOKE
Price 6/6

A wonderful achievement in H.F. Choke design. Inductance 500,000 microhenries, D.C. resistance only 200 ohms, self-capacity 3.5 mmf. Effective over the remarkably wide range of 10 to 2,000 metres. Centre-tapped. Negligible field. For all circuits requiring a high efficiency H.F. Choke.

OTHER WEARITE H.F. CHOKES

Heavy duty (eliminator) Choke 10/6
Standard Choke 6/6
Short-wave Choke 4/6

Write for illustrated list and full particulars.

WRIGHT & WEAIRE, LTD.
740, High Road,
TOTTENHAM, LONDON, N.17
Telephone: Tottenham 3647/8.



**USEFUL & VARIED
FREE GIFTS**
ARE NOW OFFERED TO SMOKERS OF

SUNRIPE
the Quality Cigarettes

10 for 6^d 20 for 1/-
AND

SUNRIPE
THE 'Out-of-the-rut' PIPE MIXTURE
NOW 10½ per oz

ILLUSTRATED
GIFTS LIST
SENT POST
FREE ON
APPLICATION
TO



The Sunripe Survey
Dept J
175 SHOREDITCH
LONDON E.1.

WET H.T. BATTERIES

Solves all H.T. Troubles.
SELF-CHARGING, SILENT, ECONOMICAL.
JARS (waxed) 2½" X 1½" sq. 1/3 doz.
ZINCS, new type 10d. doz. 8/6 1/2 doz.
Sample doz. (18 volts), complete with
bands and electrolyte, 4/1, post 9d.
Sample unit, 6d. illus. booklet free.
Bargain list free.
AMPLIFIERS, 30/-. 3 VALVE SET, 25.
P. TAYLOR, 57, Studley Road,
STOCKWELL, LONDON.

SUPER-MICROPHONES

New, highly sensitive, made on the latest principle, a vast improvement over all other types; will pick up whispered words from a distance of several yards, also strongly amplify and transmit speech and music over a distance, through Loud-speaker or Headphones. Splendid instruments for making Detectaphone, Deaf-aid, Loud-speaking Telephone, Announcements through Loud-speaker, Amplifier for Crystal or Valve Sets, Electric Sound Detector, Experiments. No other Microphone of equal sensitiveness known; each instrument finely black enamelled and fitted with a 3 ft. silk flexible connecting cord. Despatched by return post 8/6
Exclusively SUPER MICROPHONES were used by Mr. Barnes-Jones in his wonderful invention of the Fog-Compass described in the "Times" and other Papers of July 16th, 1929.
SPECIAL MICROPHONE TRANSFORMER for connecting Super-Microphone to Radio Head-phones, Loud-speaker, Valve Set, or Valve Amplifier 6/- Full Directions for use of Super-Microphone for many purposes and Diagrams of connections free.
FREDK. ADOLPH, Actual Maker. Phone: 27, Fitzroy Street, London, W.1. Museum 8329

Make
THE DAILY SKETCH
YOUR Picture Paper.

For the Best in Radio
WILL-DAY LTD.
(THE BEST IN THE WEST)
10 LISLE STREET, LEICESTER SQUARE, LONDON, W.C.2.
Telephone: (Home) 4942, 4943 and 4944. (Day) 4941. (Night) 4940. (City) 4941.
OPEN TILL 7 P.M.
WRITE FOR OUR CATALOGUE
POSTAGE 6d. FREE TO CALLERS

TECHNICAL NOTES.
(Continued from page 714.)

loud speaker, is a valuable step forward in loud-speaker design. Moreover, it has the merit that the additional cost is insignificant.

Astatic H.F. Chokes.

An interesting unit which I have recently had the opportunity of examining is the "dual astatic" high-frequency choke which has just issued from the research department of R.I. Ltd.

The increasing use of the screen-grid valve has brought to light many of the imperfections of existing H.F. chokes which have previously been considered suitable enough for ordinary purposes. With the S.G. valve, however, the requirements in a choke are much more stringent.

Function of a Choke.

As you know, the function of the H.F. choke is generally to act as a barrier to any H.F. components of currents pressing in the anode output circuit of the valve. It is necessary that a barrier should be introduced in this way, not only for satisfactory operation of reaction devices, but also to prevent amplification of H.F. currents in the L.F. section of the receiver.

Energy Absorption.

If a high-frequency choke is to be suitable more or less for a variety of circuit arrangements in the modern radio receiver, it is essential that the energy absorption shall be extremely small when voltages are applied to it over the wave-lengths (or frequency bands) for which it is intended to be used; if this should not be the case the choke will reduce the strength of reception to a greater or less extent on any wave-lengths on which absorption takes place.

It is claimed for this new "dual astatic" choke that it covers all broadcasting wave-lengths without a flaw, and it is entirely free from resonant peaks and blind spots. It is declared, in fact, to function efficiently over the entire broadcasting wave-lengths between 200 and 600 metres and 1,000 and 2,000 metres. Curves show that with a dual astatic H.F. choke a very high percentage maximum resonant voltage is obtained over the wave-length ranges mentioned above, whilst with certain other types of H.F. choke great fluctuations in the percentage maximum resonant voltage occur at different wave-lengths and at some points the percentage is very low.

Earthing Transformers.

Is it always necessary to earth the core of a low-frequency transformer and to have the transformer encased in an earthed metal cover? In the majority of cases the L.F. transformer is contained in a metal case and, as a rule, this carries a terminal or is otherwise arranged so that it can conveniently be connected to earth. As you know, this frequently has the effect of overcoming instability in the circuit and avoiding low-frequency oscillation or howling.

On the other hand, however, many low-frequency transformers are not encased at all and no particularly convenient means is supplied for connecting the core to earth, whilst others again are totally enclosed in a sheath of bakelite or some other insulating composition. In these cases it is sometimes practically impossible to earth the core, even if one wished to do so.

Depends Upon Circuit.

The question whether the earthing of the transformer is necessary for the avoidance of howling depends to a large extent upon the conditions in the circuit. If only one transformer is used you will generally find that it is scarcely necessary to have it connected to earth, but most experimenters find that if more transformers than one are used the earthing of the cores and metal covers (if any) is an advantage.

Here, again, however, it is quite impossible to say exactly what the position will be until the conditions are known definitely, for example, the kind of valves which are used in the low-frequency amplifier part of the set, the degree of amplification obtained, and so on.

Curiously enough, whilst I have found that earthing the cores and metal covers is an advantage more often than not, at the same time I have sometimes found conditions in which the reverse was the case.

Compensating Leads.

The position of the loud speaker in relation to the receiving set is a matter in which (unlike some other matters in radio) there is a good deal of latitude allowable. As you know, the leads from the output terminals of the set to the loud speaker may be of considerable length without any serious interference with the quality of the reproduction, although in some cases it may

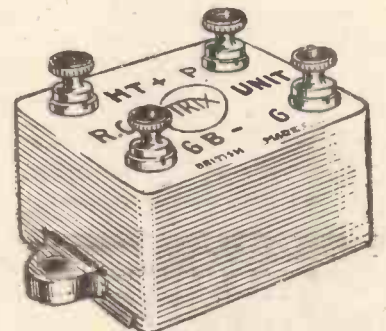

A compact and efficient little component, the Trix R.C.C. Unit, made by Eric J. Lever (Trix), Ltd.

be desirable to introduce special means for compensating the effect of the long leads. The freedom permissible with the leads to the loud speaker is in striking contrast to that in the case of the leads to a gramophone pick-up, for example, which, may be in the grid circuit.

In view of the fact that the loud speaker may be placed at any reasonable distance from the receiving set, it is a convenient practice to place the receiver itself in some position which is handy for aerial and earth connections and then to put the loud speaker wherever it may be required. On the other hand, many listeners employ only very short loud-speaker leads, and keep the loud speaker in close proximity to the receiver, although this may not by any means be the best acoustical position in the room.

**Don't Forget Your
WIRELESS
CONSTRUCTOR
for September.**



LOWEST CONSUMPTION-HIGHEST EFFICIENCY

Enormous H.F. amplification without the use of any external neutralising is the outstanding advantage of the new Mullard P.M. Screened Grid valve. So great is this amplification factor—actually from 60 to as much as 80 per H.F. stage—that one Mullard Screened Grid Valve may advantageously be employed where two H.F. stages are now necessary. Moreover, reaction can often be dispensed with entirely, thus simplifying receiver design and greatly improving quality.

The screened grid is additional to the usual filament, grid and anode, and is situated between the grid and the anode, effectively screening one from the other and reducing capacity feed back to a minimum. The connection to the screen is through the normal anode pin, the anode being connected to a terminal on the top of the valve. Thus the Mullard Screened Grid Valve can be plugged into any standard type of valve-holder.

Mullard

THE · MASTER · VALVE

**PERFECTED
SCREENED
GRID VALVES
BY
MULLARD
—GET DOUBLE
THE DISTANCE!**

- ¶ The lowest possible anode and filament consumption is achieved by the skilful design and construction of the new improved Mullard Screened Grid valve.
- ¶ The 4 volt (P.M. 14) takes a filament current of only 0.075 amp, while the 2 volt valve (P.M. 12) requires no more than 0.15 amp. This is due to months of laboratory research, testing and counter-testing and to the remarkable efficiency of the wonderful Mullard P.M. filament.

VARLEY

FOR L.F. CHOKES



The man who has a real knowledge of the technical side of radio will be quick to appreciate the value of our many years of experience in the winding of chokes for ordinary electrical purposes. This past experience has been of incalculable help in tackling the more difficult problem of producing L.F. Chokes for radio receivers. The relationship between iron and copper, the positioning of the different elements, etc., right down to the actual coil-winding itself—all these problems have been successfully solved in the light of our past experience.

We are now able to market a range of L.F. Chokes which is second to none in the British Isles—in fact, the new Varley Constant Inductance L.F. Choke (20 henries over the whole range of from 0-100 m.a.) can lay claim to advantages unknown to any other L.F. Choke of the present day.

Full particulars of any of these L.F. Chokes on application:—

Standard L.F. Choke, 20 henries	£1 0 0
Constant Inductance L.F. Choke, 20 henries over the whole range 0-100 m/a	£1 1 0
Dual L.F. Choke, 75 Henries, series resistance 700 ohms	£1 1 0
Pentode Output Choke, 2 ratios for high resistance speakers	£1 1 0
Low Tension L.F. Choke, for 3 amperes	£1 0 0
Push-Pull Output Choke, for high and low resistance speakers	£1 1 0



Advertisement of Oliver Pell Control Ltd., Kingsway House, 103, Kingsway, London, W.C.2. Telephone: Holborn 5303.