

ANOTHER "TITAN" SUCCESS THIS WEEK

# Popular Wireless

Every Thursday  
PRICE  
3d.

No. 360. Vol. XV.

INCORPORATING "WIRELESS"

April 27th, 1929.



## No Batteries!

# THE D.C. "TITAN" THREE



### OTHER SPECIAL CONTENTS

THE "P.W." STATION SELECTOR. SECRETS OF SEARCHING  
MAKING YOUR OWN COMPONENTS (Third Complete Article)

"P.W." WHITE PRINT No. 21

THERE'S ONLY ONE WORD FOR EVERY GOOD RADIO PRODUCT—

# DUBILIER



## H.F. CHOKE

Four types to meet all uses **4/6** Each

## R.C. COUPLING UNIT

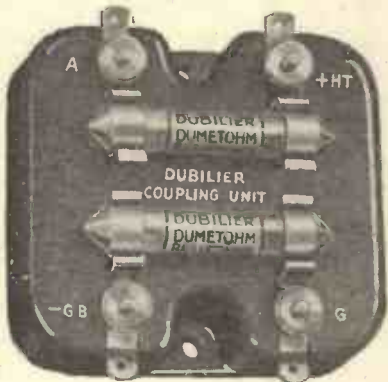

Complete with Dumetohms **7/-**

With Valve Holder Complete with Dumetohms **8/6**

## DUBILIER for DURABILITY

**"TOREADOR SCREEN-GRID FOUR."**  
This set incorporates the latest developments in Receiver design—full constructional details free on request.

# DUBILIER

RADIO PRODUCTS

If unobtainable from your dealer, write direct to us, giving his name and address.



Advt. of Dubilier Condenser Co. (1925), Ltd., Ducon Works, Victoria Road, N. Acton, London, W.3.

© 232/C

Lotus Components will make the best of your set!



Lotus Dual Wave Coils, 15/-, 16/6, 21/-.

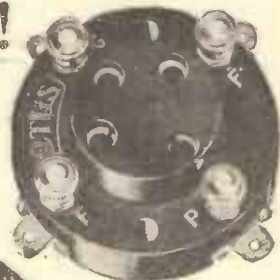

Lotus Valve Holder, 1/3.

Clear, untroubled reception, the capacity to do well all that the designer claims—these are what you expect when you build a set, and what you get if you choose Lotus Components.

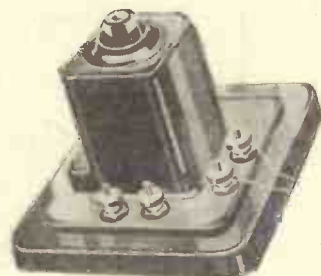

Lotus Remote Controls, from 30/- for two rooms.

For every Lotus unit is neat, strong and accurate, carefully made from the best materials, tested and tried before coming to you.

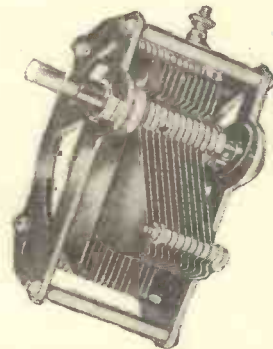

Lotus Variable Condensers, from 5/-.

Give your set every chance by using Lotus Components. Every dealer sells Lotus.

From all radio dealers.

# LOTUS COMPONENTS

Garnett, Whiteley & Co., Ltd., Liverpool

# MARCONI

## TYPE HL 210 The Most Efficient 2 volt

# GENERAL PURPOSE VALVE



### MARCONI TYPE HL210

Fil. volts ... 2.0 max.  
Fil. current ... 0.1 amp.  
Anode volts ... 150 max.  
Amp. factor ... 20  
Impedance, 23,000 ohms

To obtain the utmost assistance and volume from your circuit Marconi Valves are essential. The characteristics of Marconi HL210 2-volt General Purpose Valve ensure the highest possible efficiency in neutralised H.F. Detector or initial L.F. stages.

PRICE:  
**10/6**

Write for Marconi Valve Catalogue No. 520. The best valve for your own receiver will gladly be recommended on receipt of the necessary details of the circuit.

TESTED *once*

TESTED *twice*

TESTED *3 times*

Not only are all components of Marconi Valves tested at every stage of manufacture, but before they can get into the purple box bearing the name Marconi, the completed valves have to pass the following triple test:—

- (1) The "qualifying" or Factory Test.
- (2) The "passing out" or Stock Test.
- (3) The "third degree" or Headquarters Test.

Marconi Valves are consistently good because they are triple tested.

The Marconiphone Co., Ltd., 210-212, Tottenham Court Rd., London, W.1  
Showrooms: 210-212, Tottenham Court Road, and Marconi House, Strand, W.C.2

# ONLY

In the Cossor Screened Grid Valve all the inherent weaknesses of valve design have been eliminated. By means of the wonderful new Cossor system of construction—illustrated here—each element is rigidly secured top and bottom. Even under the hardest blow individual movement is impossible. The Cossor Screened Grid Valve is

## SHOCK-PROOF !

Noises in a valve are generally due to loose elements. In the Cossor Screened Grid Valve the elements *cannot* become loose because they are rigidly braced together and because every joint is scientifically welded. The Cossor Screened Grid Valve is

## NOISE-PROOF !

Even the heaviest shock cannot disturb the perfect alignment of the electrodes in the Cossor Screened Grid Valve. It is the most robust and the most dependable Screened Grid Valve made in Great Britain. The Cossor Screened Grid Valve is

## BREAK-PROOF !

For any Screened Grid Receiver choose Cossor. Accept no substitute—for there is no adequate substitute for the Cossor system of Interlocked Construction.



### Technical Data.

Cossor 220 S.G. (2 volts, .2 amps.) and 410 S.G. (4 volts, .1 amps.) Max Anode Volts 150, Impedance 200,000, Amplification Factor 200, Grid Bias 1.5 volts at max-anode Volts.

Price (each) **22/6**

A. C. Cossor Ltd., Highbury Grove, London N.5.

# Cossor Screened Grid Valves— HAVE INTERLOCKED ELECTRODES



1. Here you see the double length of Cossor filament famed for its colossal emission. Note the seonite bridge holding it rigidly in position.



2. Around the two stout grid supports is wound the first grid, electrically welded at twenty-five points.



3. Note the enormous strength and rigidity of the screen. See how it is built on four stout supports and capped by a metal bridge-piece anchored to seonite insulator.



4. Finally, observe the construction of the anode. Actually two rectangular nickel plates are used and for greater rigidity each is diagonally ribbed.

# Cossor Screened Grid

BRITAIN'S STRONGEST AND MOST  
DEPENDABLE SCREENED GRID VALVE

# Popular Wireless

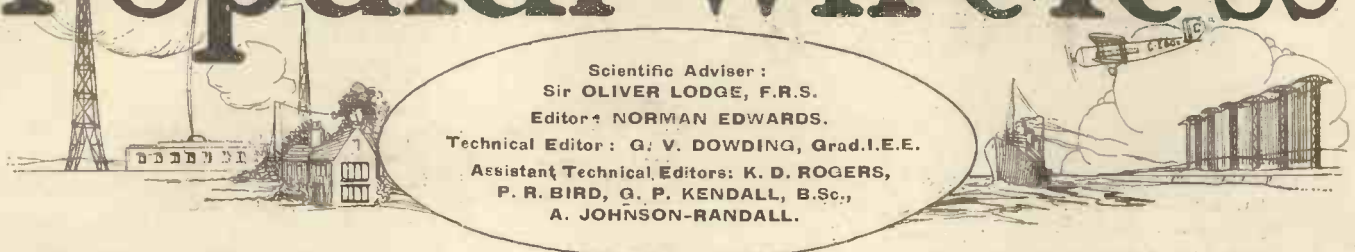

Scientific Adviser :  
 Sir OLIVER LODGE, F.R.S.  
 Editor : NORMAN EDWARDS.  
 Technical Editor : G. V. DOWDING, Grad.I.E.E.  
 Assistant Technical Editors: K. D. ROGERS,  
 P. R. BIRD, G. P. KENDALL, B.Sc.,  
 A. JOHNSON-RANDALL.

## RADIO NOTES AND NEWS.

Home Talkies—The Sleuth—Manchester's New H.Q.—Charging by Leclanchés—Portables and Licenses—Thoughts on Aerials—The Hilversum Concerts.

### "Home Talkies."

MR. DOWDING'S recent demonstration of his "Home Talkies" made a great impression on those who "know" and those who "see." The former recognise its eminent practicability for synchronising sight and sound effects; the latter see in it the beginning of a great new branch of the home amusement industry. Just imagine sitting at home and hearing a famous orchestra play, via gramophone, and at the same time seeing a film of the band and its conductor playing the same piece.

### More "Home Talkies."

A CORRESPONDENT who has evidently discovered that I am lukewarm towards the B.B.C. system of "talks," writes to say that he has turned those talks to good account; he has, so to speak, turned water into wine, the very thin water of "adult education," into the rich wine of humour. He waits until 2 L O and 5 G B are both delivering potted boredom and then switches rapidly from one to the other. And he assures me that the result is most laughable. I am obliged for the tip.

### Highbrow Experiments.

I AM not clear as to what Mr. Gielgud's job at the B.B.C. consists of, but judging from the first fruits—so far as they are apparent to outsiders—it consists of trying out new-fangled, academic ideas on the public. Having masked the actors, he may probably disguise the voices of the announcers and the identity of the stations. All proper names may be expected to disappear from the "Radio Times," which will be disguised as the "Treacle-benders Gazette." Capt. Eckersley will, no doubt, be disguised as the night-watchman, and the 2 L O cat will be trained to pretend to be a rabbit.

### The Sleuth.

OUR pup, whose adventures occasionally creep into my notes, stole away last week and nearly electrocuted himself on the railway lines. A large policeman brought him back, and whilst waiting in my study—I think they were opening a bottle of my pet b—lemonade—he espied my radio set. I was told that when he left he requested my presence at the

police-station with my dog licence and wireless licence. They will have to fetch me. But what are we coming to?

### "The Law's a Hass."

WHEN some authors, composers and publishers of music claimed royalties from a French boot shop which had a set going for the amusement of its customers, the Paris Tribunal of Commerce held that a shop is not a public place. I am rather glad that the bootshop won, but I

Sweden, 21 in Great Britain, and 20 in Germany; France and Spain had 12 each, and Finland 9. At the end of 1928 there was a total of 189 stations, Sweden and France having 31 each, Germany 26, and Great Britain 20. Russia is not included. At the end of 1928 there was no station in Portugal, Roumania, Albania or Greece. The highest-powered station is Lahti, Finland, with 40 kw.

### Manchester's New H.Q.

THE new B.B.C. North Regional studios and offices are now situated at Broadcasting House, Piccadilly, Manchester, in part of the Manchester and County Bank Building, and overlooking the municipal gardens. There are three studios, the largest being two storeys high, 54 feet long and 35 feet wide and containing a gallery which accommodates 80 people. There are also a "sound effects" studio and an echo room.

### Charging by Leclanchés.

I AM indebted to H.L.M. (Warwick) for some data in connection with the charging of an accumulator from a Leclanché battery. His set is called upon to take 0.35 ampere from a 20 a.h. accumulator for about 20 hours a week. After three months' use his accumulator voltage is 2.05 on load, having delivered about 90 a.h. This certainly looks as though the primary battery had a useful hand in the business. I think we should all be interested to have some facts about the Leclanchés. Do they not polarize? And how long do the zincs last?

### A Test Described.

H. L.M., thinking that I was inclined to doubt the efficiency of this method because I threw in a jocular remark about the "humble Leclanché," staged a test. Three Leclanchés were connected to one secondary cell, with an ammeter and shunt. Voltage across accumulator, 1.88, charging current 0.64 ampere. In three hours the voltage was 2.09, and charging current 0.54 ampere. I suggest that the whole crux of the matter is economics. Does the method provide the required energy cheaper than others?

(Continued on next page.)



Dr. J. H. T. Roberis, F.Inst.P. (left) and Mr. G. V. Dowding, Technical Editor of "P.W.," looking at the latest thing in "Talkies"—the Radio-scope.

am doubtful about the technical legal finding. I fancy that there is nothing so public as a shop, especially a barber's. If a shop is not a public place, why are the public without discrimination as to class or status, begged to enter? I have yet to know of the shopkeeper who would refuse to admit an ex-convict or a wife-beater.

### Growth of Radio.

A MEMORANDUM issued by the Union Internationale de Radiophonie of Geneva reveals some interesting facts. At the end of 1925 Europe had 135 broadcasting stations, of which 23 were in

## NOTES AND NEWS.

(Continued from previous page.)

the other consideration is whether it is less trouble.

### Portables and Licences.

THE Postmaster-General's decision that one radio licence will cover not only the household receivers but a portable set as well will be very popular. It is not only a concession but has the virtue of clearing up what was a hazy point to many people. But users of portable sets should bear well in mind the fact that they are required to carry their licences with them when they are out with the receivers.

### Mr. H. de A. Donisthorpe.

WE think our readers ought to know that the two photographs illustrating "Television Apparatus" and "Photoelectric Cell," which appeared in Mr. Dowding's article in our issue dated March 23rd, showed Mr. H. de A. Donisthorpe demonstrating this apparatus before the Electrical Associations for Women last February, to whom he addressed a lecture on the "Progress of Radio and Modern Day Application for the use of Thermionic Valves."

### An Old One Re-Dressed.

HAVE you heard that one about the young Irish shop-assistant? A customer entered and said that he required a set, but that it must be one which would work off the mains. "I want it without batteries," he said. Pat, a new hand at radio, was sorely puzzled and went behind the cash-desk to think. Presently he returned to the counter and replied: "Sorry, sir! We have run out of that kind. Will you have it without valves?"

### One Leads to Another.

HERE is a radio version of another jape. A certain clubman, having dined not wisely but too wetly, went home, sat down before his radio set and went to sleep. Presently his man thought it was time to get him to bed, so he shook his employer's shoulder and said, "Are you listening-in, sir?" "Oyesh!" was the reply. "Hear anything, sir?" "Nossing!" "Have you tuned-in, sir?" "Oyesh!" "Well, why don't you tune-in again, sir?" "No fear! T-tell 'em I've broken down."

### Thoughts on Aerials.

OUR respected contemporary, "Reynolds' News," advises those crystal users "who need to conserve all the energy they can," to have their aerials "due magnetic north and south." A bit of magic, no doubt. I have heard there is virtue in sleeping with the bed N.-S., though exactly what that virtue is I never learned. Anyway, I should hate to have my aerial N.-S. if most of the stations I wanted were E.-W. "Reynolds'" adds that not everyone can manage this, "but if there is room to put up a pole it should not be forgotten." No! Don't forget the pole—two ends, with wood in the middle. This should point due up and down.

### Pity the Poor "Fan."

I HAD a few visitors during Easter, and having put in a new set I proudly switched on and sat down to gloat. I gloated alone. Here is a sample of what my company said. "What are?" "Hearts are! Not too much soda." "We've got the odd."

"And she said she paid seven-eleven-three a yard for it." "No, the doctor held out ab-solutely no hope, and she's—" "So I told the policeman to take a look at my licence. I always keep a ten-bob note clipped to it, you know." "Took the last trick with a—" "Just a pain—here. Feel it. Feel that lump—there?" "That part where the hero stabs himself." "Play, Elsie! I want to show Jim that one-step—er—do you mind?" etc.

## SHORT WAVES.

Fair Lady: "Why is it you never speak above a whisper when you're dancing here?"

Partner: "Well, you know, they broadcast the band from here, and it's practically certain my wife's listening-in."—"Radio News of Canada."

A correspondent writes to ask if there is any chance of the number of talks over the wireless being reduced. Poor man! Hasn't anyone told him about the General Election?

Remarkable freak reception results have been reported of late. One amateur, we understand, says it is quite a usual occurrence for him to get Turkey and Brussels on an "ordinary dinner plate."

But that's nothing, we get Greece off the gas stove, and China off the dresser every day.

### NO KEYHOLE WORK.

Radio Salesman: "Good-morning, madam. With this fine six-valve set you can listen in on what all the world is doing."

Coloured Prospect: "No, sah, ah believes in minding mah own business, sah!"—"Radio News."

This Week's Exaggerator.—The amateur (fisherman) who said he caught an "atmospheric" so big that it broke the telephone cord, bit his grandmother, and then jumped back into the ether.

His Sunday he spends in the quietest way His ear to the radio most of the day, While the tools of his garden are left where they are, And he doesn't go out in the old family car To the country as much as you'd think that he might, For his church is the radio, morning and night.

To the hymns and the prayers he listens alone As he sits in his room at his radio phone, And Grandma refuses to come and join in, Unless she's dressed up from shoe-top to chin. For the way she was brought up, she says, was to seek Not the blessing divine in the clothes of the week.

### Can It Be a "Death-Ray?"

O. L.C. (S. Norwood) has a strange tale to unfold, in which mystery is mingled with humour. After a loud piece of music a thick glass tumbler in line with his loud speaker made a noise like a tumbler—and "split clean in half." Evidently a simple case of resonance; some note had the same frequency as the natural frequency of the tumbler, and overdid it. I have heard that Caruso could shiver a tumbler by singing into it, and some people declare that the walls of Jericho were shattered by acoustic means—you recollect that there was a mass attack by trumpets.

### The Hilversum Concerts.

THE Kolster-Brandes Sunday concerts from Hilversum, on 1,071 metres, at 5.45 p.m., are still going strong and quite reasonably have provoked much enthusiastic comment. The programmes look almost too good to be true, considering that from 6 p.m. or thereabouts begins the long, long blank in British Broadcasting.

### "Ariel" Runs Wild.

DREAMING of a B.B.C. with, in a few years' time, some million odd pounds for an income, I heard in imagination a few items which will not be beyond technical possibility, when one considers the growth of radio-telephony. Even now I should think they could broadcast the sounds from a Spanish bull-ring, music from the Barcelona Opera House, and the bells of Seville Cathedral. I heard (in my dream) the call to prayer by the muezzin, and the fervent *Allahs* of the worshippers; the strange music of the Hindoo wedding and the lone *tom-tom* of the jungle; the war-drums of the Congo and the *sgee-sgee* of the Zulu war-dance.

### Still Running.

I HEARD the bull-frog chorus of Malaysia, the nightly roars of lions as you hear them down the Niger, the hunting whine-snarl of the tiger, the trumpeting of the elephants of Burmah, and the pandemonium of the Indian parrots as they leave the trees at dawn. I heard again the music (so-called) of the Chinese theatre, the sunset gun of the lonely and far-off British outpost, and the snapping of the halyards as the flag is lowered. Given the wires and the wireless circuit, an imaginative producer could bring to stay-at-home John Citizen half the wonder and the glamour of the great round world. *And it is coming*, as sure as nothing stands still in this progressive century.

### King's College Centenary.

LUCKY listeners with money to give away are reminded that one of London's oldest colleges—King's College—has to struggle consistently against financial difficulty, while its teaching has been as advanced as in those universities where an endowment capital is assured.

Some of the discoveries, inventions and investigations made in the laboratories there during the last hundred years are: electric telegraph, Prof. Sir Charles Wheatstone, F.R.S., and W. F. Cooke; invention of Daniell cell, J. F. Daniell, F.R.S.; discovery of existence of electro-magnetic waves, Prof. James Clerk Maxwell, F.R.S.; and quantitative basis of the design of the filament of the thermionic valve, Prof. O. W. Richardson, F.R.S. So if you can help the Centenary Fund, good luck to you!

### Wanted, A Name!

A. C.B. (Luton) puts a poser for those interested in christenings. It's like this: He began with a "Chitos," one-valve variety; added one L.F. stage and later modified it in various small ways. Falling in love with the "Antipodes Adaptor," he fell upon "Chitos" with a 'eavy' and and from the ruins arose the "A.A." 2-valver. This last set has since been mixed up very suspiciously with the "Titan" family and now lacks a name of its own. What offers?

### Swiss Plans.

TWO exclusive wave-lengths are reported to have been allocated to Switzerland, 406 metres and 489 metres. As a result the Swiss authorities are planning to reorganise their broadcasting system. Under the projected arrangements there will be two main stations, at Zurich, for the German-speaking population, and one at Lausanne for the French-speakers.

ARIEL.

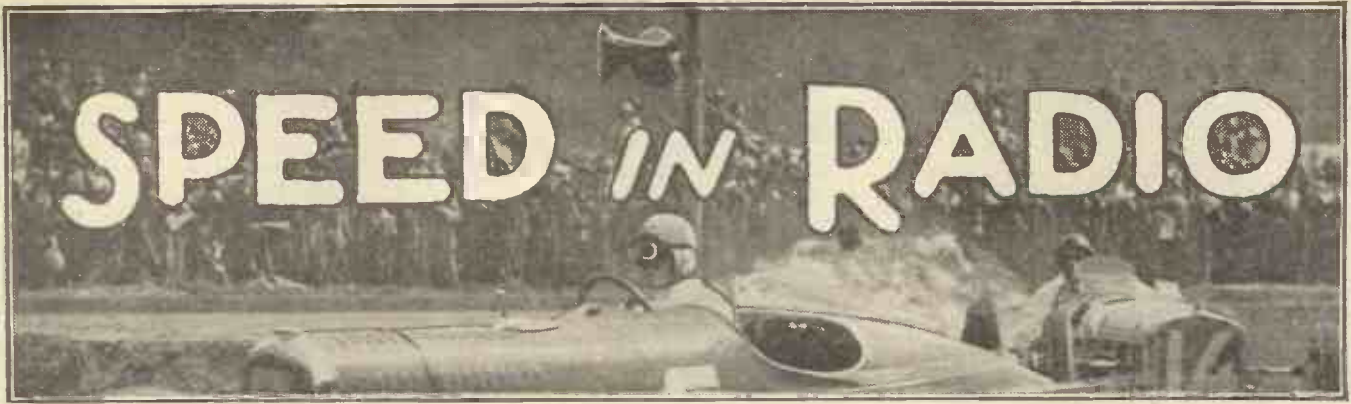

A MILLION miles a minute—such a speed is unthinkable, yet anyone possessing a wireless set is coming up against speeds infinitely greater than this every time they listen in. For wireless waves travel at speeds well over 11 million miles a minute.

Wireless, in fact, is purely a matter of terrific speeds. In broadcasting the sound-waves dart across the studio at 1,100 feet per second and set up electrical impulses in the microphone which vibrate at speeds up to 10 or 20 thousand times a second. We refer to these impulses as low-frequency vibrations, but how infinitely fast they really are compared with the ordinary movements of mankind.

At 50 or 60 thousand miles a second, dependent on the circuit, these impulses speed on down the microphone lead, through amplifiers, and yet still more amplifiers, until they are in the telephone wires leading to the transmitter. Here their speed falls slightly, but even now is rarely less than 30,000 miles per second, and so they pass into the wireless transmitter.

#### Low-frequency Vibrations.

Now we realise why vibrations up to 10 or 30 thousand times a second are called low-frequency vibrations—it is because impulses are vibrating on the transmitter, not at 20 thousand times per second, but at speeds approaching millions of times per second, dependent, of course, on the wave-length of the station. On a station with a wave-length of 300 metres, for instance, the impulses are vibrating a million times per second.

These high-frequency vibrations surging up and down the aerial circuit of the transmitter are creating the carrier-wave on which our low-frequency impulses are carried to your receiver at a speed of 186,000 miles per second, or 11 million 160 thousand miles a minute, and in this speed we have the greatest velocity known to science.

It is interesting to note that if a broadcast is taking place from the Albert Hall, the wireless listeners 50 miles away who are tuned to London will hear the broadcast before the people in

\* \* \* \* \*

"If a broadcast is taking place from the Albert Hall, wireless listeners 50 miles away will hear the broadcast before the people in the top gallery of the hall."

By J. DALY.

\* \* \* \* \*

the top gallery of the hall. The difference in the time, of course, is only a fraction of a second, but it is definitely there.

Just as at the transmitting end the speed of the broadcast matter was increased from 1,100 feet per second to 186,000 miles per second, so at the receiving end the reverse process occurs, and the speed is reduced from 186,000 m.p.s. to 1,100 feet per second.

#### Phenomenal Speeds.

All over the wireless apparatus we have high speed phenomena taking place. Atoms and molecules vibrating at speeds of thousands of miles per hour; the electrons, which make up the electric current, jumping from atom to atom along the wires at speeds ranging from 10,000 to 100,000 miles per second. High-speed chemical action in the accumulator, electrons jumping across from the filament to the plate of the valve in less than 1/16,000 part of a second, in the average circuit. For every second of time which passes millions of electrons leave the H.T. battery or pass into it.

The difference between a long wireless wave and a short wave is merely a matter of speed—the difference between wireless waves and other ether waves, such as light or X-rays, is again speed—speed of vibration.

The longest wireless waves used commercially, i.e. about 25,000 metres wave-length, are created by impulses in the aerial which vibrate at 12,000 times per second, whereas ultra short waves of 1 metre are created by impulses vibrating at 300,000,000 times per second.

Still shorter electro-magnetic waves vibrate at a frequency of 1,000,000,000,000 times per second; heat waves at 100,000,000,000,000 and light waves at 100,000,000,000,000,000 times per second.

A light ray would become a wireless wave if we could find some method of decreasing the frequency of the light ray; or an X-ray would become a light ray in the same way. How simple television would be if we could discover an easy method of frequency conversion.

Instead of wireless being confined to its narrow band of wave-lengths we could use some of the other ether waves for wireless communication, and thus ease off the ether congestion.

The suggestion has been advanced that wireless waves will presently be the high speed carriers of all things. Everything will be converted into wireless waves and transmitted in this fashion, just as sound-waves are converted into wireless waves to-day.

#### Is Ether Detectable?

Another interesting suggestion is that the ether—which a great physicist has said is still necessary—eludes our discovery because it is in a state of high velocity. The ether vibrates at such a colossal speed that matter offers no resistance to it at all and the ether passes through matter or matter passes through the ether without leaving a trace because of this rapidity of vibration.

Quite possibly there may be something in this theory, because we know that the higher the frequency of ether waves the more easily will they penetrate matter. Therefore, it is conceivable that there may be frequencies of vibration which are so enormous that matter will not affect them in the slightest, and nothing of a material nature can ever hope to detect them.

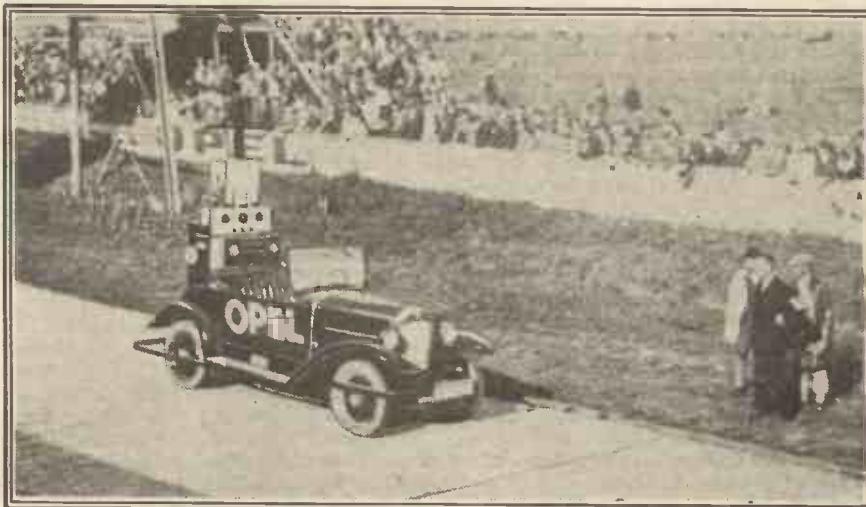

A motor-car being controlled by radio at the Opel races in Germany. The car can be controlled at a considerable distance and can be made to run in either direction.

## THE B.B.C. AND THE F.A.

A commentary upon the important question of broadcasting sporting events.

By THE EDITOR.

WE publish in this issue, under the heading "Latest Broadcasting News," in a report from one of our most reliable broadcasting correspondents, details of the B.B.C.'s arrangements for broadcasting a running commentary of the Cup Final at Wembley.

As our readers will remember, the Football Association recently decided that the B.B.C. would have to pay for the privilege of broadcasting a running commentary of the match from the actual ground. After a good deal of argument, the B.B.C. eventually offered to pay £50 to any charity for the right to broadcast the Cup Final as an ordinary running commentary. The Football Association authorities, however, made up their minds to refuse this offer and, if we remember rightly, it was intimated that a fee of something like £200 would be required.

### Comparatively Limited Audience.

Now, the Cup Final Match can only be seen by a certain number of people. We do not profess to be experts of football, but we learn from the daily newspapers that thousands and thousands of people who want to attend the match will be unable to do so because of lack of accommodation. And those thousands of people whom the Football Association authorities cannot accommodate—they being, we take it, keen football fans—naturally hope that they will be able to hear the running commentary on the match.

But the attitude of the Football Association is such that this pleasure is denied them. We quite agree with the Football Association authorities that some sort of a fee should be paid by the B.B.C. We consider £50 a fair offer. Considering that the B.B.C.'s finances are not inexhaustible, as so many people seem to think they are, a fee of £50 is reasonable for one item in its programme.

It is no good comparing what people pay in the aggregate to go and see the match, because, in any case, thousands of them can't gain admittance. This is a case where comparisons, as regards fees, are not only invidious but ridiculous; and why the B.B.C. should offer £50 to any charity that the Football Association cared to name is probably explained by the fact that the B.B.C. did not wish to create a precedent by paying for the right to broadcast a football match.

### Eye-Witness Accounts.

However, there are undoubtedly faults on both sides; the B.B.C. for assuming that it has rights in such matters, which do not necessitate the payment of a fee, and the Football Association authorities for being so inconsiderate and, in fact, so "touchy" over the whole matter. We do not think the thousands of people who will be unable to see the match will be too pleased with the Football Association authorities for their attitude in this matter.

However, according to one of our special broadcasting correspondents, in whom we have the greatest confidence, we under-

stand that the Football Association have even taken legal advice as to whether they could restrain the B.B.C. from giving an eye-witness account of the match!

We now understand that eight experts engaged by the B.B.C., each provided with a typist, will go to the match. They will time the match into eight fifteen-minute periods, and every fifteen minutes one of these experts will leave the ground, proceed to a nearby rendezvous, and telephone his account of the match direct to the B.B.C., from whence it will be broadcast.

So listeners, after all, will get a full description of the game, even if only by instalments, and each instalment will only be fifteen minutes late. It will be interesting to see what the Football Association authorities do about this. By the time this issue is on sale, the day of the match will nearly have arrived, but our readers, if they watch the newspapers, will probably

scheme includes the allotment of the following wave-lengths to Great Britain, and in due course the B.B.C. will have the right to allot these wave-lengths to the particular stations under their control.

	Metres.	Kilohertz.
Davertry 5 X X	1,553	193
	232	1,238
	261	1,148
	289	1,040
	301	995
Other stations	310	968
	356	842
	377	797
	399	752
	479	626

This reshuffling of the wave-lengths will not, we think, cause a great deal of inconvenience to listeners, and there will be no question of the majority of sets not being able to tune over these wave-bands.

But exactly how long this Prague plan will remain in force is a matter for some speculation. The Brussels plan, which came into force last January, certainly did not work well, and until a certain amount of Government control is exercised abroad, over the conduct of broadcasting on the technical side, any wave-length plan will never prove 100 per cent efficient. The

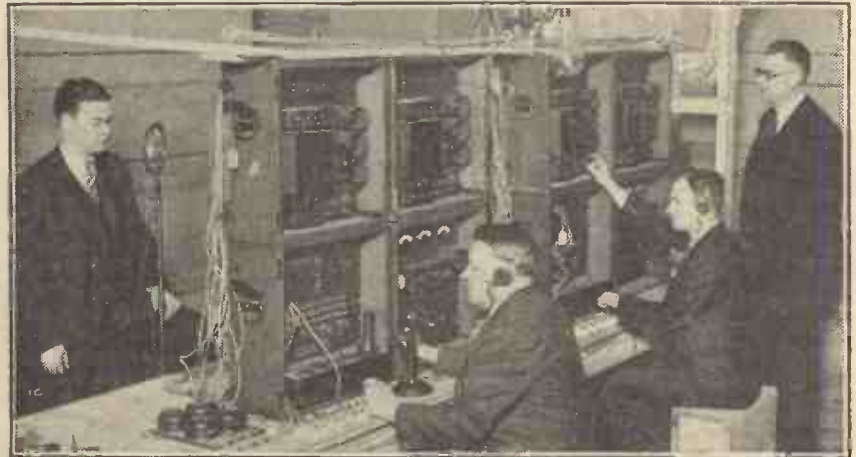

An extraordinary amount of preparation is required for the simultaneous broadcasting of national events. This is some of the apparatus used to relay a Presidential speech in America.

see the result of this very interesting clash between the B.B.C. and the Football Association.

### Another Wave-length Shuffle.

At long last the secrecy about the Radio Congress at Prague boils down to this: that the Brussels Plan is washed out, and the Congress has decided that, pending further technical developments, it is impossible to hope much for a great improvement by a re-adjustment of wave-lengths and the possibility of listeners hearing foreign stations without interference.

The Congress, after its deliberations, has now decided that listeners should concentrate on hearing local stations! What the possessor of a decent long-range set thinks of this probably need not be repeated here!

However, many of the delegates regret this conclusion from the point of view of promoting international contact through radio, and although they don't seem to have much confidence in their recommendations, they have decided to wash out the Brussels plan and have now created what they call the Prague plan. This new Prague

trouble is that some continental stations will not adhere to any plan in practice.

They send their representatives to conferences, and they agree in principle to stick to certain wave-lengths. But, as our readers know, a good many of these stations are constantly off their wave-lengths, and interference persists.

### Will Prague Plan Last?

If there were some sort of penalty to be incurred by the directors of stations who do not conform to the regulations as regards wave-lengths, then there might be some hope of a satisfactory wave-length understanding between continental countries and Great Britain.

A man is fined in this country if he exceeds the speed limit or if he fails to take out a dog licence or a gun licence, and it is a pity that there cannot be an international law fining a Government, or the broadcast concern responsible, if the technical requirements in connection with wave-lengths are not observed. By the look of it, we give the new Prague plan a life of not more than three months.



# The P.W. "Station Selector"

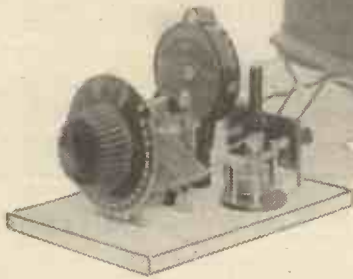

Here is a remarkable little unit with which you will be able to separate stations and receive the one you desire free from interference. It is not "just another wave-trap."

Designed by  
THE "P.W." RESEARCH AND CONSTRUCTION DEPARTMENT.

**M**OST of you are at various times faced with the problem of having to separate one station from another. Unless your set was designed to have an exceptionally high degree of selectivity, that is, the property of receiving stations without interference from others; it is quite probable that you have often had to put up with a background from a strong station having a wave-length close to that to which you are tuned.

### Unwanted Stations.

This trouble is getting worse because the number of broadcasting stations is increasing. In consequence, it is very helpful to have some means whereby the existing receiver can be rendered more selective, particularly if it is used for the reception of distant programmes.

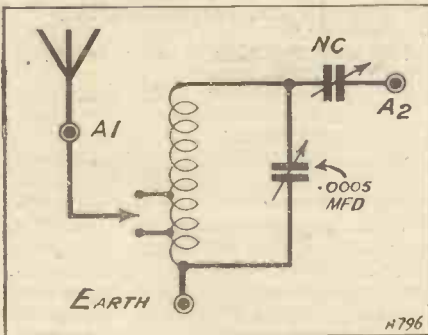

The more powerful the set the greater the likelihood, in many cases, of interference from unwanted stations. If the available magnification or "reaching out" power of the receiver is such that it will bring in twenty or thirty stations on the medium wave-band at good strength some interference is practically certain to be experienced unless the design is exceptionally selective.

Take, for examples, a modern detector followed by two low-frequency valves or alternatively a screened-grid H.F. valve with one or two low-frequency stages. Each of these sets would be capable of bringing in all the well-known continentals both on the medium and long wave-bands.

But would it be possible to receive absolutely any selected programme clearly and free from interference? With a straightforward design it would be very doubtful in many cases. The reason for this is that in order to get sufficient selectivity the number of tuned circuits would have to be increased and this would, of course, make the set more complicated, both to build and to operate.

Hitherto, it has been the usual practice to employ a wave-trap to cut out the unwanted station. Well, there is nothing whatever against this scheme if the interfering station happens to be the local, because then the wave-trap can be adjusted and switched into circuit when it is desired to tune in some other programme.

### The Long Waves.

If, however, the interference is largely due to continentals working on near wave-lengths a wave-trap begins to show up rather badly since it has to be carefully readjusted for each interfering station. In addition, on the long waves it is not at all easy to produce a wave-trap that really is efficient. A type that is effective on the medium wave-band may be quite ineffective in separating two such stations as 5 X X and Radio-Paris.

In view of this the "P.W." Research and Construction Department

carried out a series of experiments with various arrangements in an endeavour to produce a device which would be effective in increasing the general selectivity of an existing set on both the medium and long waves. Two of the essentials were easy operation and the ability to cut out interference with no serious loss of volume. Moreover, the arrangement had to be simple and inexpensive. The "Station Selector" is the result of these experiments. It is actually a simplified and very inexpensive version of the "Titan" Tuner.

The unit can be "hitched on" to any set, irrespective of the number of valves, and the improvement in selectivity so obtained is remarkable.

The "Selector" consists of a plug-in coil of the X type, i.e. a plug-in coil with tapings.

This coil is tuned with a .0005 mfd. variable condenser, and the scheme is up to this point rather similar to a wave-trap, but the method of coupling it to the existing set is entirely different.

If you examine the diagrams you will notice that a neutralising condenser is used. Now, this condenser is not employed for

(Continued on next page.)

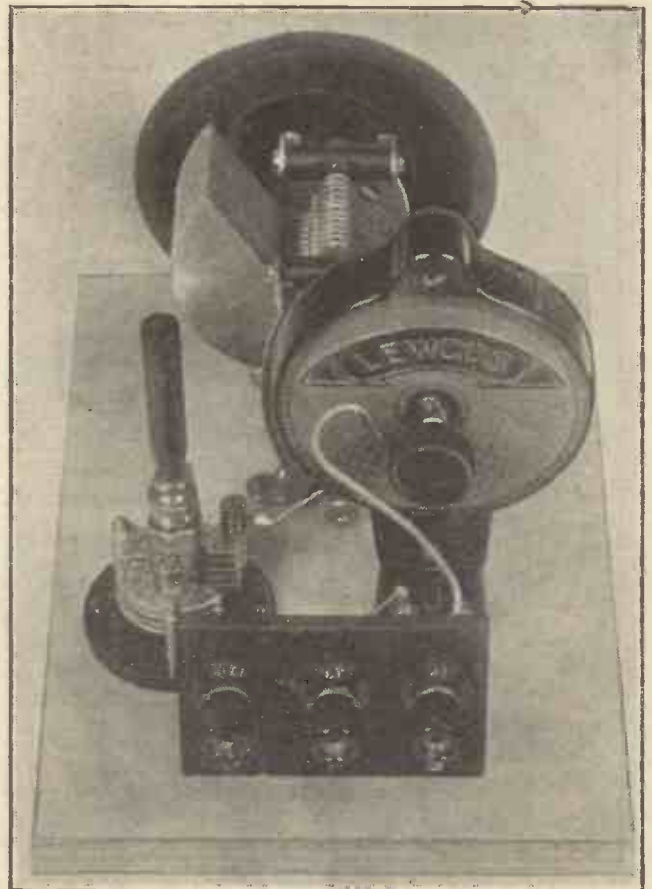

This photograph shows the completed unit. The terminals, reading from left to right, are: A2, which goes to the aerial terminal on the set; E, which is joined to earth; and A1 to which the aerial lead is attached.

**THE P.W.  
"STATION SELECTOR."**

(Continued from previous page.)

neutralising purposes, but was chosen because a neutralising condenser has a very small capacity, which is just what is required.

The addition of this extra tuned circuit, namely, the X coil and .0005 condenser is, in itself, a great aid to selectivity, but it is assisted by the fact that the condenser coupling it to the set is also variable. Therefore, if extreme selectivity is desired the "neutralising" condenser can be adjusted so that its capacity is practically at a minimum, but of course, in these circumstances one would have to be prepared to sacrifice volume.

**Building the Unit.**

Now, suppose we turn to the actual building of the unit. You will see that the one described is made up in more or less

experimental form. This is the most inexpensive method, but you can, if you wish, mount the variable condenser on a vertical panel and use a cabinet to match up with your set.

This is solely a matter of individual choice and has no bearing upon the successful working of the unit. The procedure adopted, namely, that of placing the components on a baseboard, simplifies the construction and, unless appearance is the deciding factor, is a good course to follow.

To attempt to describe the construction of the unit is unnecessary, because it is merely a matter of screwing down a few

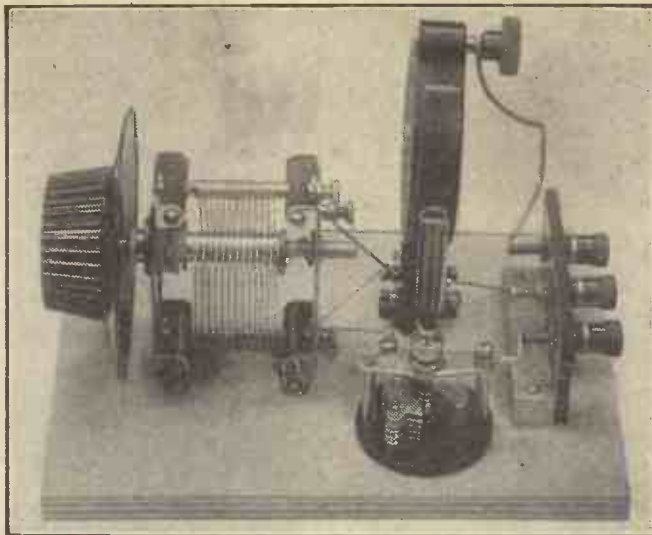

In practically every case the "neutralising" condenser is used with the moving vanes completely in mesh. It is only in extremely rare cases that it becomes necessary to weaken the coupling by decreasing the value of this small condenser.

components to a wooden baseboard and then connecting up six leads.

One of these leads, incidentally, is a flexible, one end of which is attached to terminal A<sub>1</sub>, and the other to either of the tappings on the X coil.

To connect the unit to the set, terminal A<sub>2</sub> is joined to the aerial terminal on the set itself, and E to the earth terminal on the set, to which the earth lead remains connected. The aerial lead goes to terminal A<sub>1</sub> on the unit.

**COMPONENTS REQUIRED.**

- 1 Baseboard, size 8½ in. x 6 in.
- 1 .0005 mfd. variable condenser for baseboard mounting. (Examples are the Lissen and Formo.)
- 1 Coil-socket baseboard-mounting type (Lotus, Igranic, Burne-Jones, etc.).
- 1 Neutralising condenser (Burne-Jones, Igranic, Lissen, Bowyer-Lowe, Peto-Scott, etc.).
- 1 terminal strip about 3 in. in length and 2 in. wide.
- 3 Terminals (Igranic, Eelex, Burton, Belling & Lee, etc.).
- Some tinned copper wire, flex, etc.

Now, on your X coil you will find two tappings. To commence with choose the larger one. Place the neutralising condenser at its maximum capacity. In the case of the type shown in the photographs this would be with the plates completely in mesh.

For the medium wave-band of 250-500 metres you will need a No. 60 X coil, and for the 1,000-2,000-metre band a No. 200 or 250 X.

**Operating Hints.**

Try the medium wave-lengths first. Tune in a distant station with the unit disconnected, preferably choosing one of the transmissions with which you have been troubled with interference. Now connect up the unit—it only takes a few seconds—and rotate the .0005 condenser until you again hear the desired station. Possibly you may have to adjust your tuning condenser in the set a little, but if the transmission is a powerful one this will not be absolutely necessary.

(Continued on page 230.)

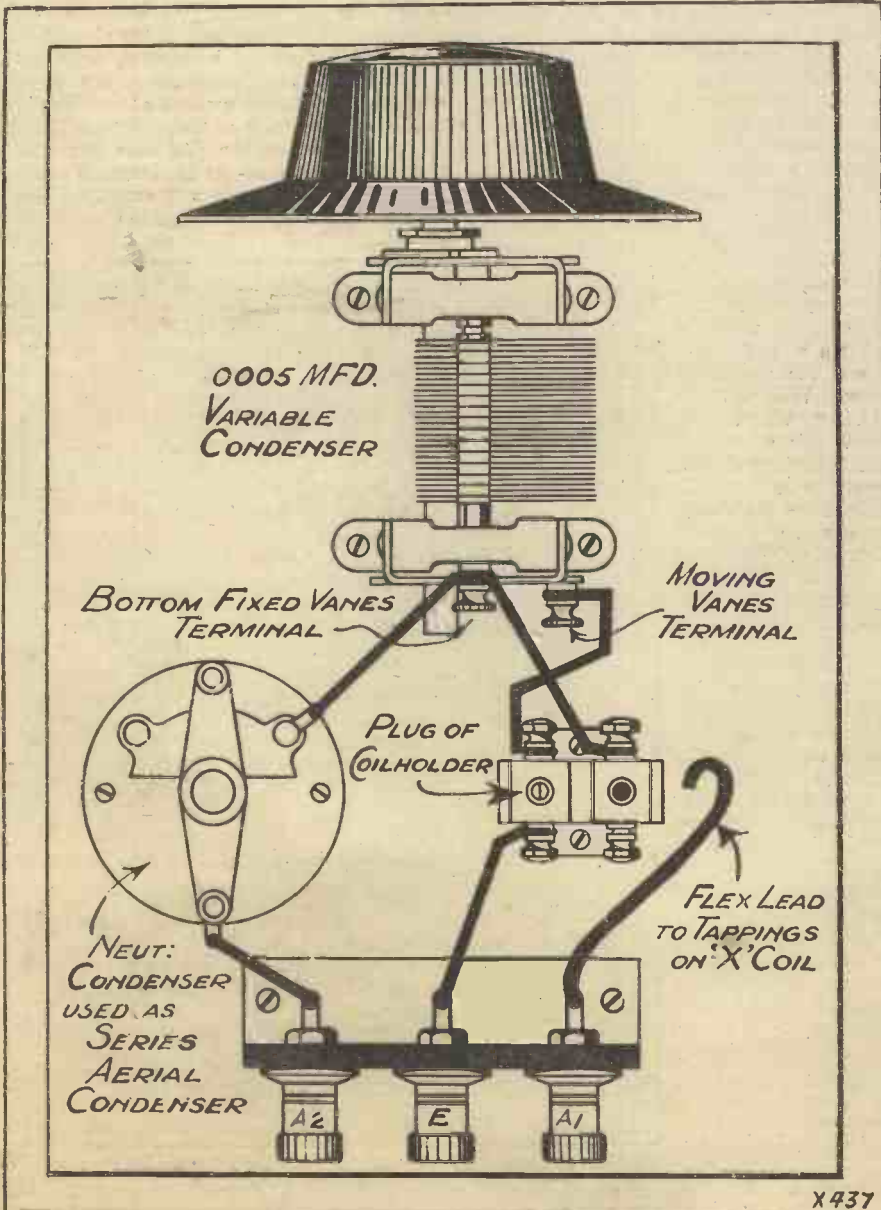

X437



# MAKING YOUR OWN COMPONENTS

## 3. VALVE HOLDERS.

**V**ALVE holders are so inexpensive and good nowadays that you may wonder why we should think it worth while to include them in this series, especially when it is remembered that it is decidedly difficult to make a good anti-microphonic type oneself. However, we have found that they offer so much scope for ingenuity that it would be a pity to leave them out.

### Holders for Special Jobs.

Moreover, by thinking things out carefully you can devise types of holders which will suit some special purpose you have in mind much better than anything you can buy. For example, in many sets you can get a

give some actual examples later on. Since our main object is to produce holders which will enable us to suit special purposes we do not intend to tell you how to make them entirely out of scraps from the junk box; we do not think that the question of economising enters seriously into the matter in the case of this component. After all, you can buy holders for one shilling upwards, and there is not much scope for saving there!

First of all, about the socket portion proper; if you like to make things as far as possible from the raw materials you use some brass tube for this purpose. Obtain some which is just a nice fit for a valve pin, cut it up into sections about  $\frac{3}{8}$  in. long, and then drill the necessary four holes in the correct positions in a piece of  $\frac{1}{4}$ -in. thick ebonite; these holes should be of a size in which the pieces of brass tube are a really tight driving fit. Smear the inside of each hole with a little Seccotine and drive in the piece of brass tube, making them all come nearly flush with one surface of the piece of ebonite.

This is to be the upper surface of the finished holder, and the idea of sinking the sockets just a trifle below the level of the surface is to prevent the filament pins of the valve being touched across the wrong points as the valve is put in. On the under side of the piece of ebonite the brass tubes will project a little, and here you can solder on the necessary leads.

Small terminals for the connections should be placed at the four corners of the square piece of ebonite (about  $1\frac{1}{2}$  in. square is a suitable size) and the holder is finished. Instead of terminals, of course, you could

use small brass screws and nuts, the counter-sunk heads of the screws being on the underside and the nuts holding soldering tags. Mounting the holder calls for some scheme to support it about a quarter of an inch above the baseboard, on account of the projections on its underside, and this is easily managed.

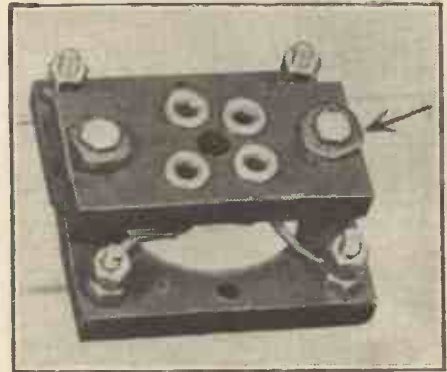

The anti-microphonic holder advised for the detector valve. The arrow indicates a washer of sponge rubber; there is another one between the upper and lower portions of the holder to complete the springing arrangement.

Drill two holes for fixing screws, place wood screws through these and slip over their shanks washers about  $\frac{1}{4}$  in. thick between the holder and the baseboard before driving in the screws. You will probably find something suitable in the way of thick washers or bushes in the scrap box, e.g., the insulating sleeves from Clix battery plugs, which are a little longer than  $\frac{1}{4}$  in., but serve very well. Failing anything suitable, get some ebonite tube of about  $\frac{3}{8}$  in. diameter and cut up some suitable lengths to form the necessary supporting bushes.

(Continued on page 232.)

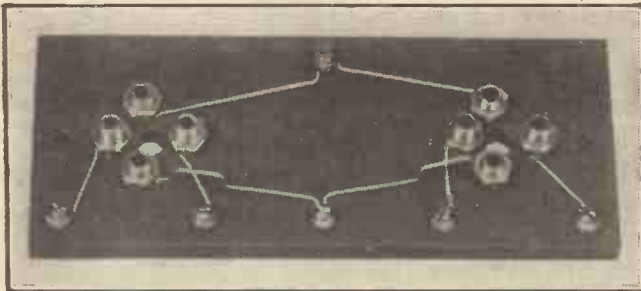

An underneath view of the two-valve strip. Note the absence of soldering and the method of bringing out the connections. The filaments are wired in parallel.

particularly neat and compact lay-out if you have at hand a strip containing two or three valve holders made up as one unit. A two-socket strip, for example, can carry the two L.F. valves of a set, and will enable you to make that set a good deal more

This is the third of a new series of articles prepared in response to numerous requests for instructions for the actual construction of components at home. Each item in this series has been assembled and carefully tested (with measurement of value where necessary), and the reader can be certain that he will be successful if he follows the specification carefully.

compact and workmanlike in appearance than if you had used two separate holders.

It is very much a matter, then, of devising schemes for holders to suit special purposes,

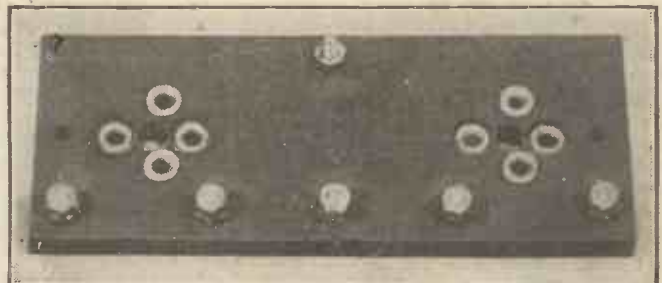

The rigid type of two-valve strip. The terminal at the back is for one filament connection. Those along the front are (left to right) plate, grid, filament, plate, grid.

## LATEST BROADCASTING NEWS.

## B.B.C. DEFIES THE FOOTBALL ASSOCIATION

### "L.G.M." INTRODUCES HIS FRIENDS—THE STORY OF JOAN OF ARC—ELIMINATING THE DRUDGERY—TALKS BY BOYS AND GIRLS.

ON this Saturday (April 27th) the B.B.C. will make its attempt to baffle and discomfit the Football Association. The latter having refused to accept the B.B.C. offer of £50 for charity for the right to take the Cup Final at Wembley as an ordinary running commentary, the B.B.C. promptly announced that it would do an eye-witness account of the match at 6 p.m. Needless to say this did not improve relations between the authorities involved. Much bitterness and many arguments were employed on both sides.

#### Eight Eager Experts.

The Football Association were known to have sought legal advice as to whether they could restrain the B.B.C. from its eye-witness account. It is only now, however, that the real intentions of the B.B.C. are disclosed. What is actually to be attempted is something not much different from a running commentary. Eight experts are to be employed each with a typist: the time of the match will be divided into eight fifteen minute periods, the experts will leave the ground every fifteen minutes and proceed to a near-by flat in direct telephone contact with the B.B.C. transmitters.

The result will be to give listeners throughout the country a full description of the game by instalments only about fifteen minutes late. Suitable music from a studio will fill-in the intervals. The transmission will be in progress from just after three o'clock to just after five.

Now the question is what if anything can the Football authorities do about it? If they thought they might have stopped an eye-witness account, they will certainly try to prevent this.

#### "L. G. M." Introduces His Friends.

From 5.15 to 6 o'clock, on April 30th, Mr. Mainland, "L.G.M." of "The Daily Mail," well-known as the Zoo authority in London's Children's Hour, will introduce his more intimate friends at the Zoological Gardens.

The studio for this programme will be the laboratory of the Reptile House, and the wireless pram will be again on tour. In order to make sure of success special telephone lines are being installed to reach to pivotal points such as the habitats of the Sea-lions, the laughing kingfisher, the Myna bird, Parrot House, Elephant House, Lion House, Aga-aga bird, and JO-JO Kafusallam Monk. hole. This should be a singularly entertaining and interesting transmission.

#### The Story of Joan of Arc.

One of the few anniversaries which have so far escaped the notice of Savoy Hill as worthy of a special programme is that associated with the deeds of Joan of Arc.

This year is the fifth centenary of her entry into Orleans.

The story of her exploits will bear retelling, since it is fairly safe to wager that most listeners, except those still attending school, have in any case forgotten most of the details. Listeners can test the accuracy of this statement by tuning into London and other stations at 9.15 p.m. on Wednesday, May 8th, when Miss Eileen Power will give a talk about this heroine who, it is generally agreed, was one of the outstanding figures of History,

#### Eliminating the Drudgery.

Those housewives who are always complaining—and husbands will say this applies to the majority—about the difficulties and worries associated with their domestic duties and the headaches and physical exhaustion of coping with them, should put aside their irksome tasks at 10.45 a.m. on Monday, May 6th, and listen to the first of two talks to be given by Miss Spielman in the London Studio on the problem of domestic fatigue.

Miss Spielman is a member of the Institute of Industrial Psychology, and has recently returned from an extensive tour of

America, where she studied domestic conditions, with particular reference to domestic fatigue. It has long been the boast of American women that, with their highly developed labour-saving devices, household work in the States is a pleasure compared with the drudgery which English women have to perform.

In her first talk Miss Spielman will endeavour to ascertain some of the most generally experienced difficulties of listeners by describing those which still confront women on the other side of the Atlantic. Only in this way can comparisons be made. Correspondence will be invited and Miss Spielman's second talk, on Monday, May 20th, will be in the nature of a reply to the points raised by listeners.

#### Talks by Boys and Girls.

For some years regular talks have been given at Savoy Hill and other stations dealing with practically every aspect of the work of young peoples' organisations, such as Boy Scouts, Girl Guides, and clubs of one sort and another, whose aim is to educate (while entertaining at the same time) that important section of the community known as the rising generation.

There is no doubt that these talks have had far reaching and beneficial results, but it is felt by those best able to judge, that some variation in style is essential, if the good effects achieved are to be maintained, and indeed increased.

A step in the right direction is a new series of twelve talks, the first four of which will be given by boys and girls themselves, under the chairmanship of a headmaster or someone responsible for club organisation.

The speakers have been selected after consultation with many of the leading organisations.

## HAS HE ANY REACTION?



An interesting zoological experiment on the Continent to ascertain how animals regard radio.

#### TECHNICAL NOTES.

By Dr. J. H. T. ROBERTS, F.Inst.P.

## INSULATING MATERIALS

BAKELITE AND "HAVEG"—H.F. HEATING, Etc., Etc.

THE material known as Bakelite which has been very largely used for radio panels and for a hundred-and-one other electrical uses, has now been still further improved and in its new form is known as "Haveg." The new material appears to be made from the same products as bakelite but has an admixture of asbestos fibres. From the list of acids which it will withstand it seems to have considerable commercial possibilities, especially where acid or alkaline solutions are to be used.

The new material is said to be unaffected by non-oxidising inorganic and organic acids and certain other reagents. It withstands a temperature up to about 130

degrees centigrade and is very light in weight, having a specific gravity of only 1.6. Its strength and other mechanical properties are also very remarkable.

#### H.F. Heating.

Every radio experimenter, nowadays, is conversant with the method of heating the electrodes of a valve during manufacture (more particularly the anode) by means of high-frequency currents, induced therein by a high-frequency oscillatory coil placed around the bulb of the valve.

This is an extremely simple method of producing what has been called "action" (Continued on page 239.)

**AN INTERESTING STATION.**

The Editor, POPULAR WIRELESS.  
Dear Sir,—On Good Friday evening, at 10.15. I picked up an exceedingly strong signal, and eventually tuned in a Czecho-Slovakian station.

The station called for reports of the test, and naturally I have sent one.  
It tunes in at about 40 on a dial of 180 degrees, is exceedingly strong—the reception was equally as loud as 5 G B on the loud speaker, using a four-valve ordinary straight circuit, and between 10.20 and 10.40 p.m. I listened to fox trots, orchestral numbers, songs, etc.

I don't know whether any of your listeners have heard this station, or whether the latter has been transmitting very long, but it is certainly a very interesting one to tune in.

Yours faithfully,  
J. L. V. BULLMORE.

Acton, W.3.

**THE "PENTODE" THREE.**

The Editor, POPULAR WIRELESS.  
Dear Sir,—Seeing no one give any details as regards your set, the "Pentode" Three, so far, here are a few details which would interest you. Perhaps somebody is sure to say I am exaggerating, but if they want proof let them apply to me. My aerial is about 70 ft. long and 25 ft. high.

I have got altogether on the broadcast band alone about fifty stations which will work the L.S.: thirty of them come in as loud as the local (London), which is approximately five miles away. I can't tune in on my present L.S. the volume (full) on London and 5 G B. Rome (3 kw.) comes in as loud as one wishes. Edinburgh (-13 or -25 kw., I am not sure) comes in quite plainly to be heard about 12 to 15 ft. away. And this L.S. of mine is soft in tone, as I have compared it with others. I am taking this set out with me abroad, and I shall give you particulars as to how it works, etc., in the Malay States. Thanking you for a successful design, here's success always to "P.W."

Yours sincerely,  
H. SINGH.

P.S.—I can get Morse galore, besides listening to six or seven amateurs on Sundays. Could you give the address of G. G. N. F. West Norwood, as I wish to communicate with him. I get him as loud as London. Put it in "P.W." and oblige. Thanks.  
West Norwood, S.E.

**S.G.'S AS DETECTOR.**

The Editor, POPULAR WIRELESS.  
Dear Sir,—Just now I am using a Mullard S.G. valve as a detector and find it works very well indeed. I found a slight improvement joining the Plate to the Screen Grid and 50-volt H.T. An R. I. and Varley transformer follows (G.P. type) 4-1. Mr. Harry Simmons might try the above connection.

Yours faithfully,  
LEONARD WARREN.

Aldrie.

**THE "S.W.2"**

The Editor, POPULAR WIRELESS.  
Dear Sir,—May I add my appreciation of the "S.W.2" set of "P.W." December 22nd.  
It is good for a range of 17 to 1,700 m., also on buried aerial regarding which I will give further details. Really it is a fine all-wave set.

Yours faithfully,  
W. J. COOKE.

P.S.—After an interval of four months, P. C. J. is now coming in at old strength.  
Ventnor, I.W.

**CORRESPONDENCE.**

**AN INTERESTING STATION.**

**THE "PENTODE" THREE—FILADYNE IN GIBRALTAR—A "TITAN" R.C.C. SET.**

Letters from readers discussing interesting and topical wireless events or recording unusual experiences, are always welcomed; but it must be clearly understood that the publication of such does in no way indicate that we associate ourselves with the views expressed by our correspondents, and we cannot accept any responsibility for information given.—EDITOR.

**FILADYNE IN GIBRALTAR**

The Editor, POPULAR WIRELESS.  
Dear Sir,—The following experience may be of interest to your valuable paper.

I have made up the Filadyne one-valver, and added two stages of transformer amplification. (See below). With this Filadyne three-valver I get tremendous results, on the loud speaker and headphones, using only 40 volts H.T. I have made several other three-valve sets (including the New-Comer to Radio) and got no better results than the Filadyne.

I have tried to change the coil (L<sub>1</sub>) for a plug-in coil No. 60, and I find it to work the same.

I get the following stations at full loud-speaker strength: Toulouse, Barcelona, Seville, Naples, Turin, Genoa, Rome, Rabat (Morocco), and a few others. On headphones I get all the rest very loud.

An old reader of your valuable paper,  
Yours faithfully,  
GERARD W. BALDWIN.

Gibraltar.

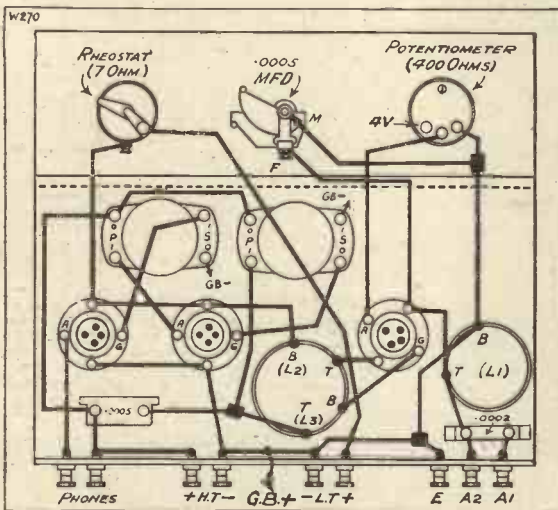

**A "TITAN" R.C.C. SET.**

The Editor, POPULAR WIRELESS.  
Dear Sir.—A few weeks ago I wrote to your Technical Queries Dept. requesting a special circuit to my requirements. It was to be equivalent to the "Titan" 3 in the H.F. and detector part, and was to have three R.C.C. low-frequency amplification stages, using the valves I specified. They were: Ediswan 6-volt standard cap. S.G. valve. Detector, Mullard P.M. 5B. 1st L.F., Mullard P.M. 5X. 2nd L.F., Mullard P.M. 6. 3rd L.F., Mullard P.M. 256 (super power).

The reason for the choice of valves in that order is obviously to enable each successive stage to handle an increasing grid swing without distortion. You were asked to arrange for every valve to be fitted with anti-mobo devices, for 120 volts H.T. to be used throughout and to provide filtering arrangements to prevent H.F. currents reaching the L.F. side of the receiver. I also stipulated that all values of resistances, condensers, grid leaks, etc., should be so arranged to give as nearly as possible dead straight-line output from 50 to 10,000 cycles per second.

I must say in gratitude to your paper, that the way you have carried out your job shows you to be complete masters of the subject, and the performance of the set which I made up to your instructions has surpassed my wildest expectations.

I am not going to give a long list of stations received since no-one ever reads them. One Sunday night, however, I picked up at loud-speaker strength 47 stations, this with ample volume for comfort in a 15 x 15 ft. drawing-room. Those many who have built the "Titan" 3, and know its capabilities must realise how infinitely superior this circuit is.

I have no means of telling exactly what range of notes it will reproduce, but I particularly followed a piece of Chamber Music to see if anything was missed of the bass instruments; nothing was missed, however, the very lowest notes were rendered equally with all others, and the same applies to very high violin notes.

In spite of your advice to the contrary, I had to fit a resistance in the plate circuit of the S.G. as motor boating was very troublesome. I noticed also that motor-boating was occasionally caused by the very low notes.

I have substituted the grid leak of the first L.F. valve with potentiometer of equal resistance as a volume control, as this enables one to use the reaction condenser to increase selectivity and still keep the volume within reasonable limits.

The huge volume available also makes it possible to use the most selective tapings on the coil, which is an obvious advantage.

Before any of the transformer fanatics write pulling this to pieces, I want to say that this set has been tested for quality against a three-valve set employing the very latest type of expensive L.F. transformers with the very best frequency response curves available, on the same loud speaker. The owner of the latter set quite freely admitted what is obviously true, in spite of all that is said to the contrary by transformer fans, that the transformer is not yet made and probably never will be that can equal correctly designed R.C.C.

Yours sincerely,  
C. C. S.

Rock Ferry.

**SHORT-WAVE NOTES.**

By. W L. S.

TWO or three readers scored over me this week by reporting reception of 2 ZI. Georgetown, British Guiana, on about 43.8 metres. The average strength with which he is being received in this country at present seems to be slightly above that of W2 X A F. I have heard him myself for three nights, and a marvellously good signal he seems to be putting out.

I am afraid he will not last like this through the summer, since the South American amateurs are coming through abnormally well at this time of year, and always fall off later.

5 S W appears to have moved to about 32 metres or so. Please do not take this as official, as I have merely listened to him for about two minutes immediately previous to writing this. I will take his wave-length accurately and report fully later.

"H. W. D." sends in an imposing list of stations logged on the "Short-Wave" Two and seems very happy. Another

correspondent from the same part of the world is complaining that he can hear nothing on it but a very fine specimen of threshold howl in a very good state of preservation. I think this particular gentleman's trouble is much too low a value of H.T. on the detector. Raising it to about 85 volts should cure things.

**The Missing Continent.**

"A. G. M." complains that Asia is his one missing continent on telephony, and wants to know of a powerful telephony station there. What about Bandoeng and the other Java stations, "A. G. M."?

PLB, PLC and Co. are very easy to receive, on various wave-lengths above 15 metres.

I have decided recently that three valves are well worth while, as a rule, for telephony reception, but not for C.W. The extra "background" that is produced when the set is oscillating is a trial, but in the state in which it is used for receiving telephony there is really not much difference noticeable. On 3 L O some time back I was switching in and out an extra L.F. stage, and I decided on the spot that it was well worth while. One must, however, either incorporate switching or a volume control of some kind.

"S. W." (appropriate initials) thinks that layout is more important than anything else in a short-waver, and I am inclined to agree with him. He thinks the position of the components is more important than their values! I would hardly go as far as this, but a bad layout will definitely make a bad set.



## SECRETS OF "SEARCHING."

**T**O tune in distant stations on an ordinary receiver you must first of all have a reasonably clear dial. If the local station monopolises one third or more of the dial a wave-trap is essential, and when correctly set will reduce the local station's programme to two or three degrees. Assuming that the dial is fairly clear what is the best way of receiving foreign stations?

### How Much Reaction Required?

Frankly, the whole secret of success lies in the handling of the reaction control. If you have too little reaction, then your set is not sufficiently sensitive and you will not hear the weaker stations. If on the other hand you have too much reaction, you will still fail to receive the foreign programmes, and in addition your set will be giving out squeals and squeaks and will be upsetting the reception of all your neighbours. What then is the fair amount of reaction to give, and how can this be assured for any particular station?

The answer to the first part of the query is—use as little reaction as possible to get the necessary strength and always keep below the "oscillation point" (what is meant by the oscillation point will be explained in a moment). The giving of the correct degree of reaction for any particular station is a matter of judgment, common sense, and practice. It is important to note that on the reaction dial one cannot mark the dial for a certain station and then reset it at another time and duplicate the results.

With a tuning dial this is quite O.K., for if a station does not alter its wave-length the adjustment will still be the same. On a reaction dial it is quite useless, for all sorts of conditions combine to alter circumstances and, consequently, the reaction adjustment is never fixed in a certain spot for a certain station but must be turned carefully backwards or forwards, according to the strength of that station, etc. But it

\*-----\*

An Article for the Beginner who  
is Ambitious for Long-Distance  
Results, but is not At Home with  
the Tuning Controls.

By A. NIGHTINGALE.

\*-----\*

is quite easy to control reaction properly provided you set about it in the right way.

The following method is recommended because it really does not cause interference with the neighbours, and yet if practised properly will enable any intelligent listener with a valve set and decent aerial to pick up more foreign stations than he knows what to do with. The kernel and heart of the whole matter is to be able to adjust the tuning dial to cover various wave-lengths and at the same time keep the set *nearly but not quite* oscillating.

### An Object Lesson.

If you listen-in when there is no local broadcasting station working, you can, in a few minutes, give yourself a thoroughly sound object lesson in the use of reaction. Set the tuning dial half-way round for a start, and place the reaction control at zero, making sure that all batteries, etc., are connected up as usual, and that the set is in working condition. Now bring up the reaction control *slowly*. Just a few degrees at the time.

Listen carefully to the loud speaker, or preferably to the 'phones, and notice exactly what is happening as the result of moving the reaction dial. Do not touch the tuning—just the reaction—listening carefully all the while.

The probability is that at first you will notice no difference. As you advance another 3 or 4 degrees listen very carefully and presently you will hear in the 'phones a very faint hissing, breathing noise. This is what the Americans call "tube noise," but this is really a misnomer, for as a matter of fact it is really caused by all sorts of little atmospheric disturbances as well as by the valve itself.

Continue to advance the reaction control 2 or 3 degrees at a time, and you will notice that

the "tube noises" get distinctly louder. (If you go back again to zero you will find they will stop altogether. Come back to the same point again and you will be able to hear them again.)

The reason that you are hearing these noises is that the increase in reaction is making the set more sensitive: The further you go the more sensitive it becomes, up to the oscillation point. Presently, as you advance the reaction still a little further the noise will grow perfectly distinct and also you may hear weak transmitting stations which previously were inaudible. So, still leaving the tuning dial alone, continue slowly to advance the reaction until the hiss in the 'phones is quite distinct. Then if you continue to advance you will come to a point where there is a more or less distinct "plop" followed by a rather louder *continuous* breathing or hissing noise. This is oscillation, and you have gone too far. For good reception you must be *below* the oscillation point, so turn back the reaction dial immediately.

What you have got to remember is this. With the reaction all out the set is comparatively insensitive. As you increase reaction the set gets more and more sensitive. But the moment your set starts oscillating you must "come back a bit" in order to get just below the oscillation point.

If this were all, handling reaction would be a very easy matter—but we have not

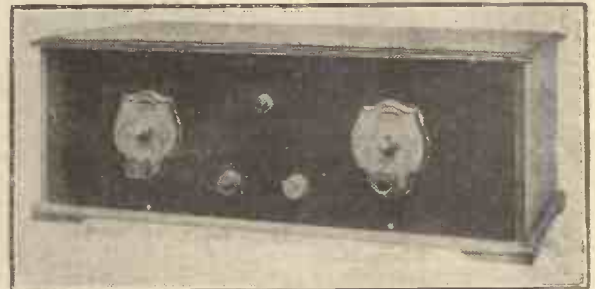

If the set has an H.F. dial as well as aerial tuning, these two must be kept "in step," and reaction adjusted as explained in the article.

yet considered the effect of tuning. Unfortunately, the tuning and reaction dials are not independent of one another, but every time you alter one the other needs a little readjustment, too. And as you keep altering the tuning to find different stations you must keep altering reaction, too, to keep "in step."

### The Effect of Tuning.

A little further experiment will demonstrate this. First set your tuning dial mid-way, and then bring up reaction carefully until the set is very, very nearly—but not quite—oscillating. Now leave reaction alone, and see what tuning does.

You will find that when set thus, the effect of "tuning down" to lower wave-lengths is to send the set over the oscillation point; whilst if you "tune up" to higher wave-lengths you draw away from the oscillation-point. Consequently, to keep the set just below oscillation when tuning, you must not leave reaction alone, but gently increase it as tuning goes up, and gently decrease the reaction as the tuning goes down! And when you can do that successfully without making the set oscillate you will find that foreign stations fairly fall in, and you will have solved the problems of long-distance reception.

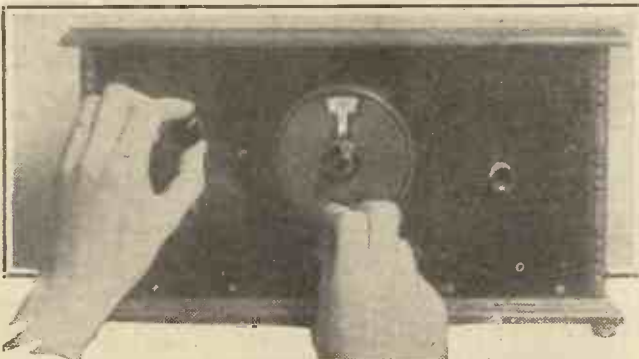

As wave-length goes up, reaction can be increased. As wave-length is lowered it must be reduced correspondingly.



# FOR THE SET BUILDER

### HYDROMETERS.

**H**YDROMETERS for testing the specific gravity of accumulator electrolyte usually take the form of glass tubes with bulb ends.

The stems of the tubes bear graduated marks in degrees. The bulb is weighted to cause the tube to float upright in a liquid. According to the specific gravity of the liquid tested the buoyancy of the tube is greater or less, and the graduated stem is more or less immersed; readings of the scale are taken at the liquor level. The correct specific gravity of accumulator acid at (nominal) "no charge" is 1,200, and this division of the scale is usually calibrated in red, for easy observation.

### A RADIO LUBRICANT.

**A**N excellent material for lubricating the rubbing surfaces of various radio components, such as rotating spindles, crystal detector parts, and so on, can be made as follows:

Take a very soft lead pencil (Grade BBB is the best), open it along the centre, and extract the inner lead.

Grind up this lead into a fine powder, and then sieve it through a piece of coarse muslin fabric. The sieved powder will consist of very fine graphite, and, as such, its lubricating properties will be found to be very efficient.

Rubbed over the surfaces of any moving parts in a radio receiver, it will prevent wear from occurring, and, of course, as graphite is an electrical conductor, the thin film of the material so placed on the rubbing surfaces will in no way interfere with their electrical efficiency.

### HOME-MADE TERMINAL BUSHES.

**N**OW that metal and even wooden panels are more popular than in former days the subject of terminal bushings has naturally assumed greater importance.

Ebonite terminal bushings can, of course, be obtained from most dealers at reasonable prices. Nevertheless, such articles can be made very cheaply indeed from a piece of ebonite tubing whose internal diameter is just sufficient to take the shaft of the terminal.

In order to convert such a piece of ebonite tubing into efficient bushes for use with metal or wooden panels, cut sections from the tubing, each section being long enough to enable approximately  $\frac{1}{4}$  in. of it to protrude on each side of the panel. Such sections will now constitute the terminal bushes.

For use, the bushes should be soaked in hot water for a few minutes, in order to soften them. They should then be inserted quickly in position, and the terminal nuts screwed home as rapidly as possible. In this way, the tightening pressure of the nuts will compress the  $\frac{1}{8}$  in. of the bush which protrudes at each side of the panel, thereby creating a flange which will effectively insulate the terminal from its surroundings.

### A SCREW-DRIVING IDEA.

**O**NE frequently sees in various wireless papers constructors have a difficulty in placing small screws over the holes where they are to be screwed in when the hand cannot be used. Now this is how to do it: Get a piece of thin wire, and bend as sketched, and place the screw in the slot, and lower over the hole. This enables one to hold the screw upright, and also to get the screwdriver into the slot. Remove the wire when the screw is partly screwed down. The same applies when removing the screw. Put the slot in the wire under the head of the screw, which can then be lifted out after unscrewing.

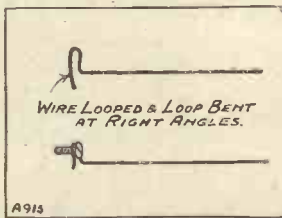

## FOR YOUR NOTEBOOK.

Although condenser-controlled reaction is delightfully smooth, many people believe that magnetic reaction will come into favour again owing to the superior "snappiness" which is obtainable by this method on distant stations.

If the aerial lead-in wire is affixed to the external aerial by means of a twisted joint this should be soldered, or bad contact will develop quickly.

Even soldered joints deteriorate rapidly in the open air in this country, so unless yours are large and generous blobs of solder, it is a good plan to examine them occasionally so as to make sure that they are sound.

### CURING CRYSTAL-SET HUM.

**C**RYSTAL receivers seldom give trouble from an interference point of view. Nevertheless, some crystal enthusiasts do suffer now and again from a most annoying hum in the 'phones of their instruments.

Such a type of disturbance is, of course, generally due to the proximity of a generating station, or to some portion of the electric-lighting circuit of the house which may happen to be running closely parallel to a part of the aerial circuit of the set. Also, the trouble may be due to some peculiarity of the electric mains running outside the house, and perhaps in the neighbourhood of the earth plate of the receiver.

### The Best Method.

Naturally, the best method of eradicating such a trouble is to ferret out its cause in a logical manner, and, having found it, to remove it. In many cases, however, this line of procedure is, unfortunately, not practicable.

However, quite an efficient little method of dealing with the crystal-set hum trouble consists in placing a moistened finger tip on the earth terminal of the receiver. In the large majority of instances this will result in the disappearance of the annoying hum, the latter disturbance, of course, instantly returning after the finger-tip has been removed from the terminal.

### Fairly Permanent.

In such cases, however, the elimination of the hum may be made more or less permanent by attaching a 5- or 6-ft. length of bare wire to the earth terminal of the set, and by allowing it to dangle loosely on the floor. Alternatively, the free end of the latter wire may be connected to a metal plate laid upon the floor, or again the wire may be attached to some extensive metal object in the room, such as, for example, a kitchen range, a steel or brass fender, a gilt-framed picture of large size, and so forth.

This extra loose earth connection, acting as it does owing to the setting up of a means of capacity leakage, has the effect of allowing the oscillations responsible for the troublesome hum to leak away to earth.



# THE RADIO PATROL

THE radio results obtained by the West Riding Police have been extremely encouraging. The detection of criminals by a series of police stations on the outskirts of the West Riding (Yorks) area equipped with wireless enables a ring to be drawn round any fugitive or gang "wanted." The stations have their own particular call-signs, and are staffed by expert operators.

By the aid of wireless an important message can be tapped out at headquarters, or sent by microphone to the stations equipped, and within the space of a minute 21 divisions of the West Riding Police, with a force of 1,500 men, and who cover 1,634,621 acres, are in possession of the information and instructions, which are put into operation at once.

It is hoped that shortly every village policeman will have a wireless set in his home and be able to be in direct communication with headquarters by wireless.

It is certain that within a short time the police authorities will have a high-power station that will enable them at all times to be in direct communication with the British Isles and abroad.

Above: A portable receiving and transmitting set used by the West Riding Police. This set was in use when the King and Queen last visited Bolton Abbey. Below: Sending out a message from headquarters.



Making some of the sets used by the Radio Patrol. At Wakefield, the headquarters of the West Riding Police, there is a combined receiving and transmitting apparatus that has a radius of some hundred miles.

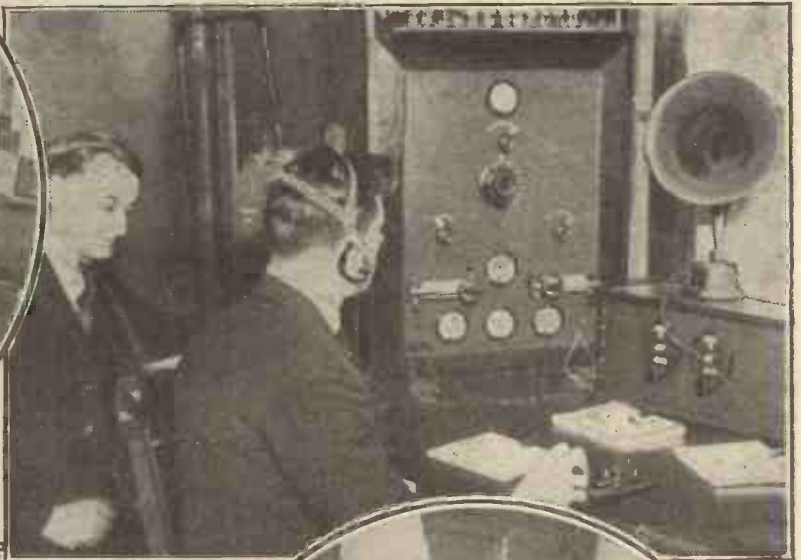

The apparatus is worked at 1,000 volts, the high and low tension being taken from the same motor generator, which is driven from the 110-volt mains. The messages can be tapped out to the South of England and Wales. The current goes through a modulation system by which speech is produced, and for Morse by the circuit being broken by a key placed between the grid leak and the filament negative. These sets are easily rigged up for flying squads, who can receive and send instructions en route within a distance of from 50 to 70 miles. They are worked by 12-volt accumulators, which drive motor generators, each producing 1,000 volts.



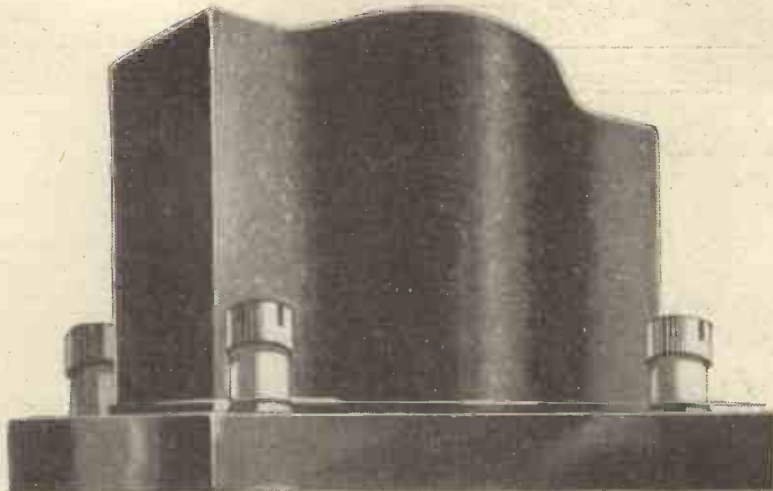

# PHILIPS TRANSFORMERS

With a Philips Transformer Type 4003 natural tone and faithful reproduction are ensured by the uniform amplification curve between 200 and 10,000 cycles. Even at a frequency as low as 50 the amplification is over half the maximum. It is electrically screened and the terminals on the base simplify the connections. The base measures  $3\frac{1}{2}$  ins. by  $1\frac{1}{2}$  ins. and the height is 2 ins.—an ideal size for use in portable receivers.

PRICE  
**25/-**

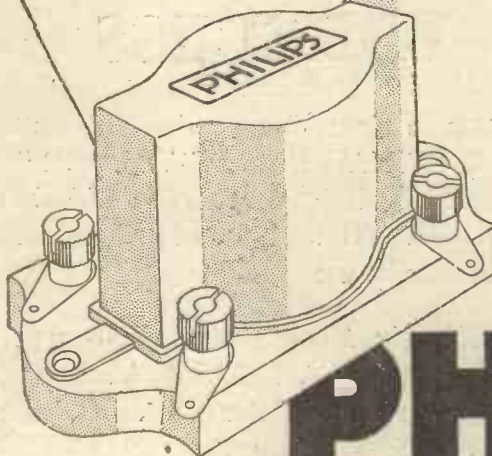

# PHILIPS

*for Radio*



Invaluable to  
**THE HOME CONSTRUCTOR**

Two New  
**"BEST WAY" WIRELESS BOOKS**

**"Best Way" No. 328.—Modern Valve Sets.** Contains full constructional details of four receivers. A "WAVE-CHANGE ONE-VALVER" to cover long and short waves by the operation of a switch, a "TWO-VALVE AMPLIFIER," the "'BEST WAY' WAVE-CHANGE THREE," and "THE HOME CIRCLE FOUR," a set specially designed for family use.

**"Best Way" No. 329.—This Year's Star Sets.** Tells you how to build another four specially-designed receivers. "AN ALL-WAVE TWO-VALVER" which covers all wave-lengths from 2,000 to 20 metres, "A ONE-VALVE AMPLIFIER," "A REGIONAL CRYSTAL SET," and the "S.G. AND PENTODE THREE"—a receiver of the most up-to-date type, capable of remarkable results.

EVERY SET MINUTELY DESCRIBED

*On Sale Everywhere.*

*PRICE 6d. EACH.*

FROM THE TECHNICAL EDITOR'S NOTE BOOK



**SHORT-WAVE COILS.**

OWNERS of 1928-9 Cossor "Melody Maker" sets should be interested to learn that Cason Mouldings, of Lower Edmonton, London, N.9, have produced some short-wave coils especially suitable for this set. These new Cason ultra short-wave coils are sold at 12s. 6d. per pair complete with an instruction leaflet. The coils tune between about 17 metres and 43 metres, thus covering such stations as 2 X A D, 5 S W, 2 F C, 2 X A F, and several others.

These are all moderately reliable stations and there are, of course, many others in this band within the scope of these coils. We have tested the coils both in a "Melody Maker," and in another three-valver using a screened-grid valve. The "Melody Maker" particularly responded excellently. Indeed, it might then have been specially built for the reception of short-wave stations. The Cason coils are well made and nicely finished. That they are efficient will be gathered from the foregoing remarks.

**NEW MULLARD COMPONENT.**

Messrs. Mullards recently sent us one of their new P.M. grid leak and condenser holders. The holder is designed to carry a Mullard P.M. grid leak and a Mullard P.M. condenser or, of course, either of these separately. It is fitted with three terminals, one terminal representing the common connection between one end each of the condenser and grid-leak.

The other two terminals are fitted with a small strap, thus facilitating the connection of the two components in parallel, or by removing this connecting strap, the condenser and grid leak can be connected in the series fashion required in grid-leak rectification or resistance-capacity-coupled circuits.

The combined grid-leak and condenser holder fitted complete with a .0003 mfd. condenser and a 2-megohm grid-leak is sold at 7s. 6d. The holder alone costs 3s.

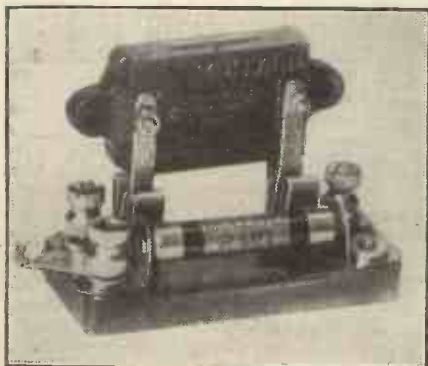

The Mullard P.M. Grid-Leak and Condenser assembly.

It is a robust and nicely finished piece of work, and the base is of moulded bakelite. You can mount it on a baseboard by means of only one screw through a central hole.

**NEW OSRAM L.S.5 A.**

The Osram L.S.5A., which always was one of the aristocrats of the super-power class, has recently been modified. Originally the maximum anode voltage considered safe at which to operate the L.S.5A. valve was 350 volts, but in order to bring this rating into line with its companion valves the L.S.5 and L.S.5B. the actual rating was fixed at 400 volts.

The present tendency to operate the L.S.5A at the full 400 volts sometimes results in the valve being under biased, resulting in an excessive dissipation at the anode and loss of emission due to over-heating. Therefore, the makers decided to

Traders and manufacturers are invited to submit radio sets, components and accessories to the "P.W." Technical Department for test. All tests are carried out with strict impartiality, under the personal supervision of the Technical Editor, and readers are asked to note that this weekly feature is intended as a reliable and unbiased guide as to what to buy and what to avoid.

increase the amplification factor slightly to its rated figure of 2.5.

At 350 volts on the anode it is possible with a valve fitted with the L.S.5A. filament to keep the amplification factor and impedance down to very low figures, and for some time past the actual amplification factor, if measured carefully, would have been found to be more of the order of 2 than 2.5 as rated.

The advantages of the modified valve, state the makers, are that it will now deliver the same large output in milliamperes required by a valve of this class, with the advantage of less input in grid volts. A smaller grid bias is now required, and the new operating point of grid bias enables the valve to work at a more useful part of its curve, the chances of anode-bend rectification which might result by an attempt to restrict the watts dissipation to the rated figures of 13.5 are reduced.

The modified Osram L.S.5A. valve actually has better characteristics in practice than the older valve, and has the advantage of an equivalent power output for a smaller grid voltage swing. The characteristics of the Osram L.S.5A. are 5.25 filament volts; .8 amp. filament current; amplification factor, 2.5; impedance, 2,750 ohms.

With 400 volts on the plate, some 100 volts grid bias is needed. It is not the sort of valve the amateur would choose for a Det., L.F. set, and can only be used with advantage in the last stage of a powerful multi-valver. Readers may find it of interest to note that when it is operated at its maximum anode voltage, with correct grid bias, the power dissipated exceeds by some watts that of an amateur transmitter. We have tested this new L.S.5A. and can appreciate the improvement. The old L.S.5A. was a most excellent valve, and that the new one is definitely better indicates its sterling qualities.

**PRACTICAL ELECTRICIAN'S POCKET BOOK.**

We have just received our copy of the thirty-first edition of this useful book, and it is interesting to note that this year it has been entirely revised and re-written from cover to cover and is not, therefore, in any sense of the word, a mere annual re-issue of the old pocket-book. We notice that the radio section is right up-to-date and that there is a tabular list of power stations throughout the British Isles, giving details of the supply voltages and the system in force in each case. This should be of the greatest value to mains unit enthusiasts. This pocket-book, which is published by "Electricity," 93, Long Acre, London, W.C.2, costs 2s. 6d. and, with its 600 pages packed with valuable facts and data, is most excellent value for money.

**AN ENTERPRISING FIRM.**

Messrs. A. H. Clarke & Co., of Manchester, are now producing a number of Atlas battery eliminator leaflets printed in four languages.

**PRICE REDUCTIONS.**

The Amplion Junior hanging cone type A.C.2 loud speaker has been reduced in price to 21s. The Amplion Standard Open Cone, which is designed to stand or hang, is now priced at 39s. 6d.

**PHYSICAL PRINCIPLES OF WIRELESS.**

This is one of the latest monographs on physical subjects published by Methuen & Co., Ltd., at 2s. 6d. net. The author is J. A. Ratcliff, M.A. There is a foreword by Professor E. V. Appleton. It is, of course, a work of an advanced nature, although there is much interesting information well within the scope of the average amateur.

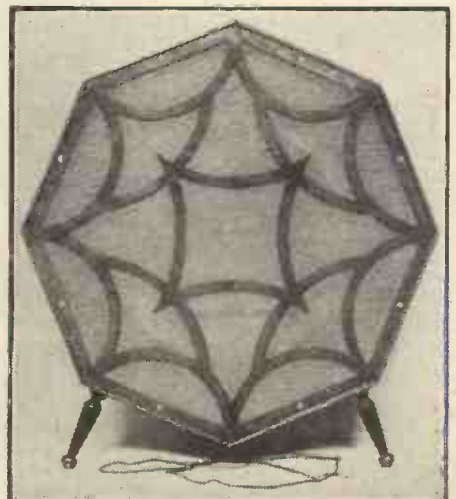

One of the several fine loud speakers marketed by F. Squire, of Stoke Newington.

IN introducing this design for a "D.C." version of the "Titan" Three to the readers of this journal, the writer will attempt to describe a similar type of set possessing all the virtues of the original, less the attendant battery troubles, that is to say, a receiver deriving all the "battery" currents from a direct-current supply.

Of course, it will be realised that to achieve this object the set must necessarily

be more complicated as well as more expensive, by reason of the various smoothing chokes and by-pass condensers required to smooth the current obtained from the mains.

In the latter connection, the set fulfils every expectation, as it is remarkably silent in action, consistent with the minimum amount of mains equipment.

The actual circuit arrangement, if one ignores for a moment the smoothing

#### COMPONENTS REQUIRED.

- |   |  |
|---|--|
| <p>1 Ebonite panel, 18 in. x 7 in. x <math>\frac{1}{4}</math> in. or <math>\frac{3}{8}</math> in. (Becol, "Kay-Ray," Resiston, Ripault, Trelleborg, etc.).</p> <p>1 Cabinet, 18 in. x 7 in. x 12 in. deep, complete with baseboard (Pearl, Cameo, Aircraft, Raymond, Gilbert, Pickett, Lock, etc.).</p> <p>1 .0005 mfd. variable condenser (Ormond drum drive type in set. Other drum drive types which will suit are the J.B., Cyldon, Uility, Dubilier, etc. If desired, an ordinary type of condenser and dial can be used).</p> <p>1 "Titan" coil unit (Wearite, Ready Radio, Paroussi, Burne-Jones, Peto-Scott, Ward and Goldstone, etc.).</p> <p>1 3-point wave-change switch (Bulgin, Wearite, Pioneer, etc.).</p> <p>1 .00005 mfd. miniaturre action condenser (This capacity is available in various makes of reaction condensers, namely, Dubilier, Burton, Cyldon, Igranic, J.B., etc.).</p> <p>1 0-300 or 0-200 milliammeter, flush mounting type (Sifam, Ferranti, Weston, etc.).</p> <p>1 1 or 2 megohm potentiometer type volume control (Gambrell, Igranic, Burne-Jones, R.I.-Varley, etc.).</p> <p>1 Standard screen, 10 in. x 6 in., with <math>\frac{1}{2}</math> in. ledge (Burne-Jones, Paroussi, Ready Radio, Wearite, etc.).</p> <p>2 28/24 henry L.F. chokes (R.I.-Varley in original).</p> <p>2 Special heavy duty H.F. chokes (Wearite).</p> <p>1 150-henry L.F. choke (Pye).</p> <p>1 Universal output transformer (Marconiphone).</p> <p>1 L.F. transformer, low ratio (Lissen, Ferranti, Cossor, Brown, Igranic, Phillips, R.I.-Varley, Mullard, Marconiphone, etc.).</p> <p>3 Sprung valve holders (Lotus, Igranic, W.B., B.T.H., Benjamin, Burne-Jones, Formo, Bowyer-Lowe, etc.).</p> | <p>1 H.F. choke (Lewcos, Burne-Jones, R.I.-Varley).</p> <p>1 1,500-ohm wire-wound resistance, to carry 150 milliamperes (Truvolt type T 15 is shown. Rothermel or Hamley).</p> <p>3 400-ohm baseboard potentiometers, used as resistances. One can be 50 ohms, as shown (P<sub>1</sub>) but 400 ohm preferable (Igranic, etc.).</p> <p>3 4-mfd. condensers, tested 750 volts D.C. or slightly less (Hydra, Mullard, Dubilier, Ferranti, T.C.C., etc.).</p> <p>7 2-mfd. condensers, usual low test voltage (T.C.C., Ferranti, Mullard, Dubilier, Hydra, Lissen, etc.).</p> <p>1 2-mfd. condenser, tested 750 volts D.C. (Hydra, Ferranti, Dubilier, Mullard, T.C.C., etc.).</p> <p>2 .0003-mfd. and 1 .001-mfd. fixed condensers (Dubilier, T.C.C., Mullard, Lissen, Clarke, Goltone, Igranic, etc.).</p> <p>1 1-mfd. Mansbridge condenser, usual low test voltage (T.C.C., Lissen, Dubilier, Mullard, Hydra, etc.).</p> <p>1 150,000-ohm (approx.) wire-wound anode resistance to drop voltage on screened grid of S.G. valve (R.I.-Varley, Igranic, Lissen, Mullard, Dubilier, Ferranti, etc.).</p> <p>1 2-meg. grid leak and vertical grid-leak holder (Dubilier, etc.).</p> <p>1 60,000-ohm anode resistance (Ferranti, R.I., Dubilier, Mullard, Lissen, Precision, etc.).</p> <p>1 Bayonet-type lamp holder for baseboard mounting, complete with plug and long flex, for attaching to mains plug.</p> <p>2 Pieces of ebonite, one <math>3\frac{1}{2}</math> in. x <math>\frac{1}{4}</math> in., and one 3 in. x <math>\frac{1}{4}</math> in. x <math>\frac{1}{4}</math> in.</p> <p>5 Fully insulated terminals, markings according to diagram (Belling &amp; Lee).</p> <p>Quantity of No. 24 S.W.G. tinned copper and 2 m/m Systoflex, or alternatively Glazite.</p> <p>2 Panel brackets, complete with screws.</p> |
|---|--|

# The "TITAN" D.C. TH



circuits, agrees entirely with the original "Titan" specification and also includes a universal output transformer, so as to allow the use of either an ordinary 15-ampere power valve or 4-volt 15-ampere pentode valve, the latter conforming to modifications given in a further article on the original "Titan" Three.

#### An Attractive Proposition.

Although it must be admitted the internal arrangement of this D.C. version of the "Titan" Three is more complicated, yet fortunately the panel controls are hardly greater in number than usual, and simply consist of the tuning condenser, reaction control, wave-change switch, and volume control, with an 0-300 milliammeter (not a control) as a guide to the correct current passing through the receiver.

The cost of the various parts, including cabinet and valves (one a pentode) is approximately £19 10s. to which need only be added the cost of a loud speaker. Considering the only upkeep cost is for the current drawn from the mains, being about 36 watts, it will be agreed the receiver

This remarkable receiver is the result of considerable experiment and will be a boon to the constructor who has D.C. mains. No batteries whatever are required, all the energy being derived from the electric-light supply.

represents an attractive proposition, even taking into account the initial cost.

Turning to the theoretical diagram, we find the circuit conforms in its main details exactly to the original.

The filaments of the three valves are joined in series via various resistances, milliammeter and L.F. chokes, and the pressure is reduced to the requisite number of volts at 15 ampere by means of a series resistance variable from 0 to 1500 ohms.

With regard to the high-tension voltage, this is brought to suitable values by means

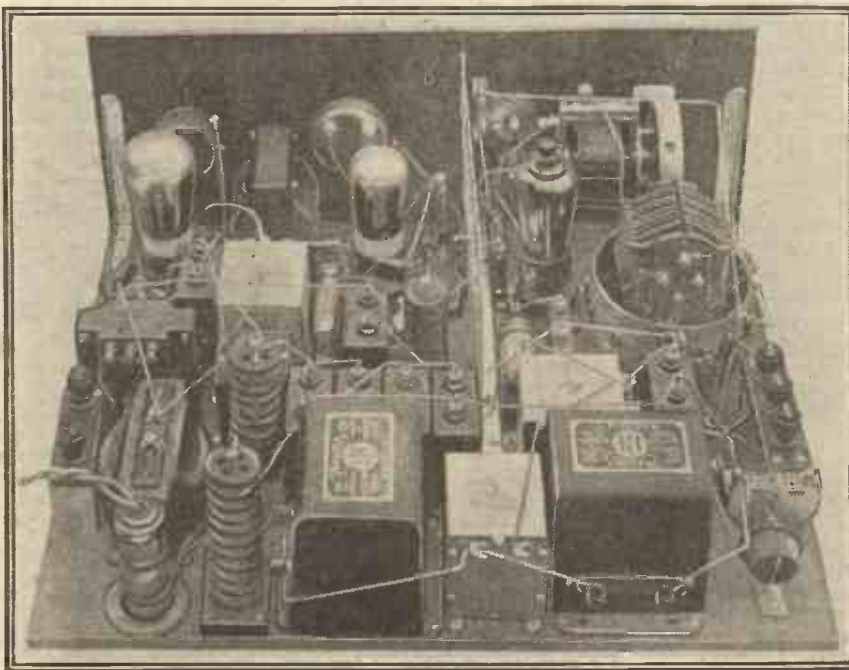

No space has been wasted in the design of this set, as the photograph shows. It must not be forgotten, however, that no batteries are needed, and the set is complete as shown above.

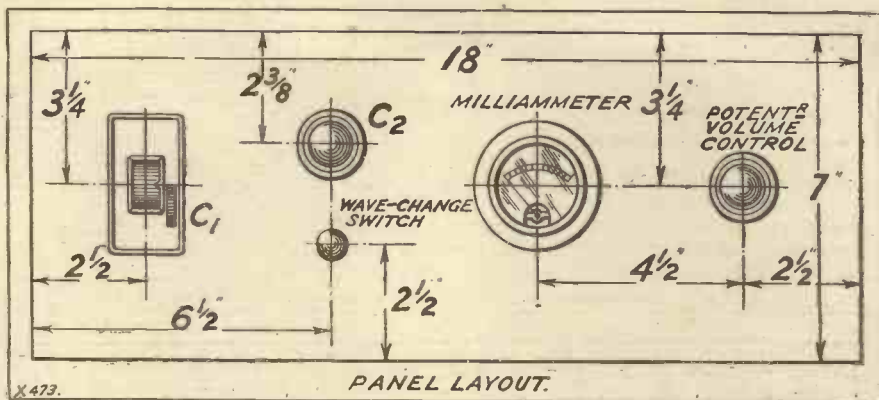

that joining both H.F. chokes in series with each other in the negative lead suppressed the "hum" altogether.

When this latter circuit was tried on another D.C. supply, only in this case with negative "earthed," the result was similar.

In addition, there are a number of minor round holes, including those for the panel brackets and a suitable number for the screws for attaching the panel to the baseboard.

of series resistances, by-passed by fixed condensers, the combined resistance and condenser in each case also acting as an anti-motor-boating device.

In the case of the pentode auxiliary grid, the normal resistance is replaced by an L.F. choke of 150 henries inductance, because the choke, as well as being slightly more effective than the resistance in a "de-coupling" sense, also has a lower D.C. resistance and, therefore, allows a greater H.T. voltage to be automatically applied, thus resulting in better amplification.

Nominally, the receiver can be employed with any D.C. supply between 200 and 250 volts, but, unfortunately, owing to the limitations of the L.F. chokes and other factors, it is not suitable for voltages less than 200 volts.

**Eliminating Mains Hum.**

Another point in connection with the circuit arrangement and one which should prove of interest to other D.C. mains users, concerns the use of the two H.F. chokes in series with the negative mains lead.

The original advantages of the now famous "Titan" Three are maintained in this set, which is based upon that popular receiver.

Designed and described by G. V. COLLE, "P.W." Technical Staff.

Originally the set was built and tested in North London, the D.C. supply being 240 volts, with the positive pole "earthed." The first arrangement tried made use of a special H.F. choke in each mains lead and with a pentode in the last stage, the "hum" was unpleasant. Short-circuiting the H.F. choke in the positive lead did not affect the "hum," but treating the other similarly increased the mains noises some 50 per cent.

No doubt the steep slope characteristic of the pentode valve was responsible for the increase, as compared with an ordinary power valve, but it is interesting to note

**Construction.**

Looking at the set from a practical point of view, it is, to all intents and purposes, a 50 per cent screwdriver job, a 25 per cent drilling and a 25 per cent wiring and soldering proposition.

There are five major holes in the panel, one of which is irregularly shaped for the drum dial, and another being a round hole of large diameter for the milliammeter; the dimensions of the former hole can be taken from a special paper template supplied with the drum dial and the latter from actual measurements on the particular milliammeter purchased.

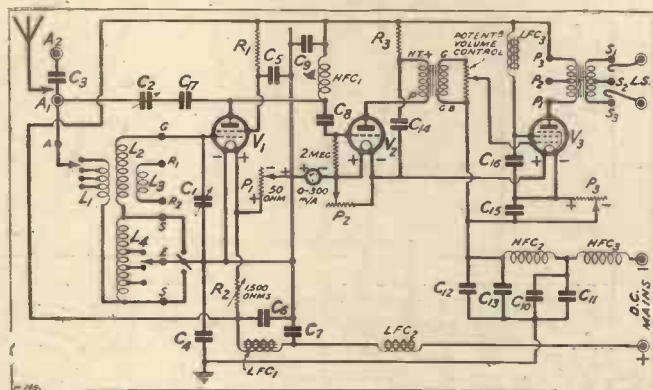

The Theoretical circuit of the "Titan" D.C. Three.

The larger holes may be made either with a fret saw or by drilling a series of smaller holes around the inside line of each particular one inscribed on the panel, (Continued on next page.)

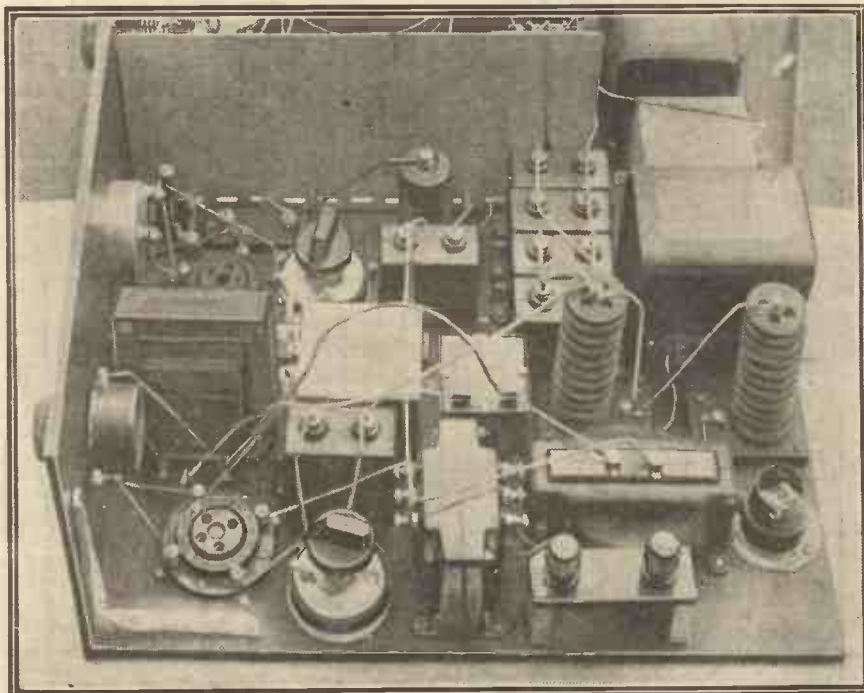

The L.F. and detector end of the "Titan" D.C. Three receiver. Note the special output transformer (with six terminals) in the foreground.



# Why ACCUMULATOR BATTERISE? Just "Plug in-That's all!"



"Ekco-Lectric" H.T. Unit 3F.12. D.C. model £1-17-6 complete.

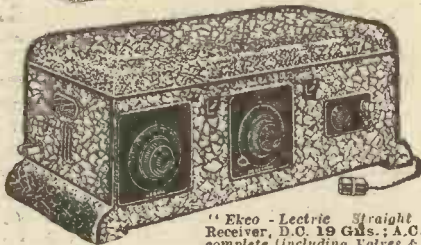

"Ekco-Lectric Straight Three" Receiver, D.C. 19 Gns.; A.C. 21 Gns. complete (including Valves & Royalty).

## "EKCO" "EKCO-LECTRIC" RADIO RECEIVERS AND POWER SUPPLY UNITS

Model	H.T. UNITS	Current Output	Voltage Tappings	PRICE COMPLETE	
				D.C.	A.C.
				£ s. d.	£ s. d.
IF.10	10 MILLIAMPS	For 1 to 3-valve sets, or those requiring not more than 10 milliamps.	60 or 90 or 120 ..	0 17 6	—
2F.10	12 MILLIAMPS	For 1 to 3-valve sets, such as 1929 Cossor. Special tapping for Screen Grid Valves.	60 and 120 ..	1 9 6	3 13 6
3F.12			"S.G.," 60, 120/150..	1 17 6	3 13 6
3FA.20	20 MILLIAMPS	For 1 to 5 valve sets, or those requiring not more than 20 milliamps.	30 fixed, 60 fixed, 120 fixed	2 10 0	4 18 6
IYA.20	20 MILLIAMPS	For 1 to 5 valve sets, or those requiring not more than 20 milliamps. Incorporating Westinghouse Metal Rectifier.	0-120 var., 120 fixed..	2 18 6	5 8 6
3FB.20			30 fixed, 60 fixed, 120 fixed	—	6 15 6
IVB.20	60 MILLIAMPS	For 1 to 10 valve sets, or those requiring not more than 60 milliamps.	0-120 var., 120 fixed..	—	7 5 0
4F.60			30 fixed, 60 fixed, 120 fixed	3 12 6	7 2 6
IV.60	120 MILLIAMPS.	Super-Power..	0-120 var., 120 fixed, "Power" fixed	3 18 6	7 13 6
2V.60			0-120 var., 0-120 var., 200 fixed	5 0 0	8 12 6
IV.120	60 MILLIAMPS	For 1 to 10 valve sets, or those requiring not more than 60 milliamps.	0-120 var., 0-120 var., 200 fixed	7 15 0	15 11 0
CV.120			—	9 15 0	—
C.1.A	"ALL-POWER" UNIT FOR D.C. MAINS. 60 Milliamps. H.T. 0-120 var., 120 fixed "Power," L.T., 1-6 volt up to 6 amp. G.B. up to 21.		—	—	2 12 6
T.500	TRICKLE CHARGER. Charges 2, 4 or 6 volt accumulators, from A.C. Mains at 1/2 amp. continuously		For 10 and 20 milliamp range	—	3 13 6
R.20	RECTIFIER UNITS. For attaching to D.C. units ..		For 60 milliamp range	—	5 0 0
R.60	For use on A.C. mains		—	19 Gns.	21 Gns.
"EKCO-LECTRIC STRAIGHT THREE" RECEIVERS. FOR WORRYLESS WIRELESS. Just "Plug in-That's all!"				(Complete with Valves and Royalty)	
ISOLATING TRANSFORMER. For isolating Loud-speaker or Phones from set where a power supply unit is in use ..				—	15 0

OBTAINABLE ON EASY PAYMENTS FROM ALL RADIO DEALERS.

"Ekco-Lectric" Power Supply Units complete from 17/6 D.C., and 52/6 A.C. Write for free illustrated "Ekco-Lectric" Booklet!

## THE "TITAN" D.C. THREE.

(Continued from page 228.)

have been soldered (or clamped) to the shank of each terminal, and also until the components adjacent to the strips have been placed in position, otherwise some difficulty may be experienced in making all the components fit into place.

As a matter of fact, constructors are advised to undertake the layout of the baseboard at the time of fitting the strips.

Once screwed into position, it is only necessary to check such points as the terminal positions on the transformers and coil unit before commencing wiring. As in many other receivers, the constructor will probably make his own choice of the type of wiring material to be employed.

### Use Covered Wire.

Bare wire alone must *not* be used because readers should remember the set is operated from the mains, and any risk of a short circuit between two adjacent wires will probably incur a certain amount of danger to the set in general.

In the same manner, it must be remembered that when first testing the receiver, the plug connected to the lead which normally goes to the mains socket must be first inserted in the socket provided for "mains input" on the baseboard itself, the plug at the other end of the flex leads then being inserted into the point from which the mains current is to be derived.

We will now assume the D.C. "Titan" Three is ready for testing, but before

doing so there are one or two minor adjustments to be made to the baseboard resistances and output transformer.

First of all, set the arm of the T15 Truvolt (1,500 ohms) at maximum resistance, that is away from the side which is connected to the L.F. choke and 4 mfd. condenser. Then turn the arm on the 400-ohm resistance (R) controlling the grid bias on  $V_3$  to a point approximately one quarter of a turn from the positive end.

### The Baseboard Resistances.

Should the constructor intend fitting a pentode 15 ampere valve in the last stage, the connections to  $P_1$  (plate) and  $P_3$  (H.T. +) terminals on the output transformer will remain as shown in the wiring diagram. On the other hand, the connections will be  $P_1$  and  $P_2$  (the latter H.T. +) if the last valve is to be of the ordinary power type.

In either case full instructions accompany every output transformer supplied, so that as far as the secondary connections are concerned, they may be based on the instructions given on the leaflet. For ordinary purposes  $S_1$  and  $S_3$  will suit the general run of loud-speaker windings.

There now remain the two baseboard resistances  $R_1$  and  $R_2$ , which are connected in parallel with the filaments of  $V_1$  and  $V_2$  respectively. The one across the filament of  $V_2$  should be set slightly under a quarter of a turn from the end connected to the negative of the filament, while the one across  $V_1$  must be adjusted by experiment, using a voltmeter in a manner to be described later.

Now plug in the valves which will be in the following order: Screened-grid valve

( $V_1$ ), 2, 4 or 6 volts and taking 15 ampere filament current; detector valve ( $V_2$ ), H.F. type, 2, 4 or 6 volts, 1 ampere; L.F. valve ( $V_3$ ), either 4-volt 15 ampere pentode or, alternatively, for smaller volume, a 2-, 4-, or 6-volt small power valve consuming 15 ampere filament current.

In every case, and whatever makes of valves are incorporated, it is advisable, if not essential, to measure the voltage set up across the filament of each valve, once the 1,500 ohm Truvolt on the baseboard has been adjusted to pass 150 milliamperes, as shown on the meter on the panel.

The L.T., G.B., and H.T. voltages can be measured with either separate voltmeters of suitable scale readings or else by a triple range or universal meter, such as the Ferranti.

Next week the writer hopes will complete the notes on the operation and adjustments of the various resistance controls.

## THE "P.W." STATION SELECTOR.

(Continued from page 216.)

You will now find that there is much less interference and it is almost certain that your chosen transmission will be clear and free from the undesirable interference. If it is not, experiment with the smaller tapping on the X coil, and reduce the value of the coupling condenser. (This last is very rarely necessary.) When you have used the unit once or twice in this

(Continued on page 232.)

# STOP!

YOU CAN NOW CHARGE  
YOUR ACCUMULATORS AT HOME

— or —

WORK YOUR WIRELESS SET

— by —

GAS, PETROL, ELECTRICITY, STEAM,

— or —

anything that gives Heat will do it!

### "THERMATAIX"

converts heat into Electricity without the use of either valves, liquids, or moving, deteriorating fragile parts. When the Gas or Petrol burners are lit, or a switch or steam turned on, according to type required, "THERMATAIX" at once begins to generate a steady Electric Current, and will do so for ever, as long as there is Heat.

"THERMATAIX" is everlasting and cannot wear out.

Testimonials and Descriptive Leaflet sent on Application.

Prices are from £4-17-6. Write at once, and secure immediate delivery.

**MATHESON & KEMP, Ltd.** Head Office & Works: 106/6a, High Street, SOUTHAMPTON  
LONDON OFFICE: 12, Grosvenor Gardens, S.W.1



Pat. No. 255822.

The three types for immediate use supplied from stock are for use with Gas, Petrol, or Electricity. The sizes are for 6 volts, 4 volts, or 2 volts, and the output a half or 1 ampere.

Some of those to whom we have supplied these types are:— Over 200 Gas Companies, the Woolwich Army Experimental Department, the Dutch, Italian and French Armies, the R.A.F., and (with specially built models) the British Railways, Doctors, Architects of note, Colleges, Universities, Radio Clubs, and Big Game Hunting Expeditions for use in Africa and India.



# RECEPTION YOU'VE HEARD OF BUT NEVER EXPERIENCED.

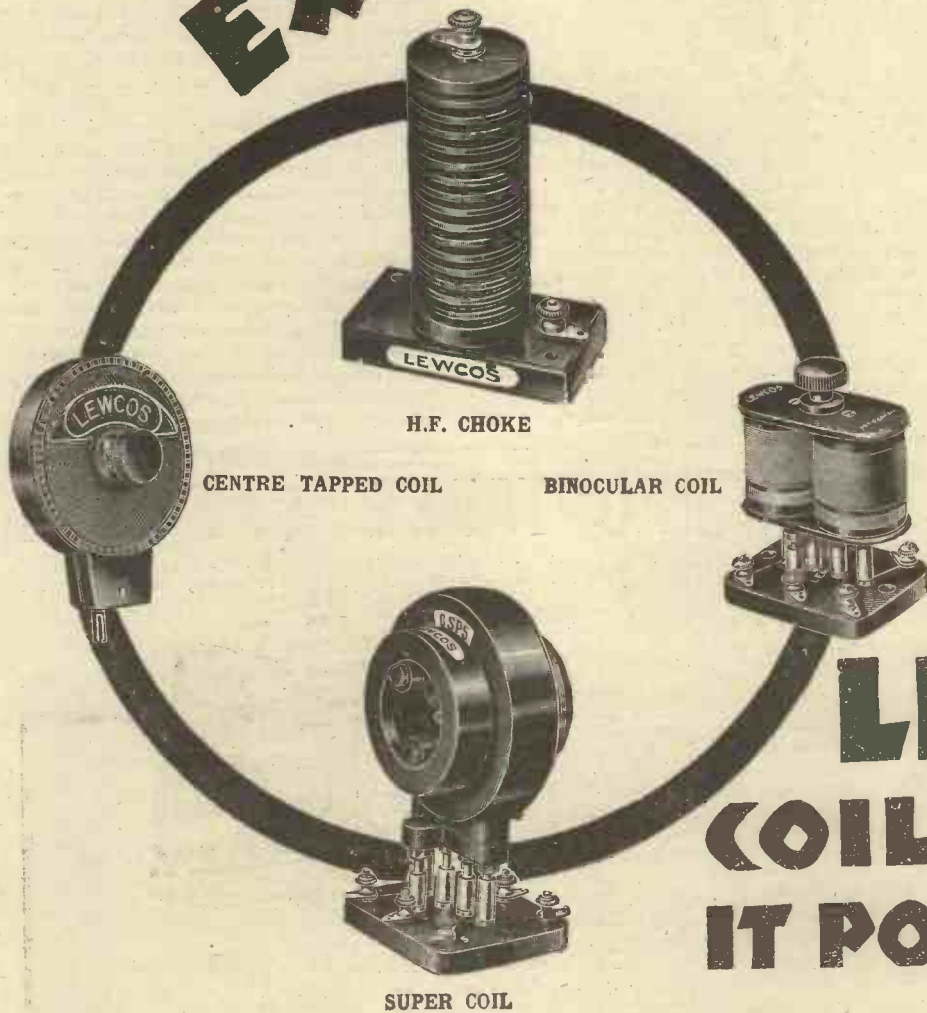

H.F. CHOKE



CENTRE TAPPED COIL

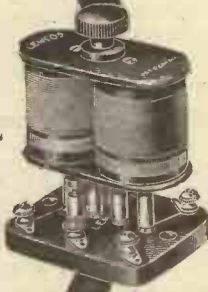

BINOCULAR COIL

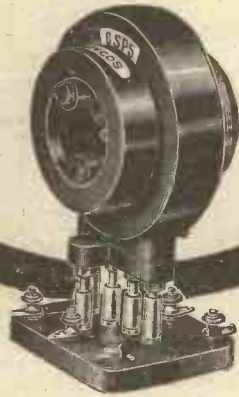

SUPER COIL

*free!*

Send for one or more of these interesting leaflets.

- R.33. High Frequency Choke.
- R.34. Centre Tapped (C.T.) and Double Tapped (X) Coils.
- R.35. Q Coils.
- R.36. Standard 6-Pin Coils.
- R.37. Binocular Coils.
- R.38. Dual Screened Coils.
- R.39. Wavetrap.
- R.40. Fixed Potentiometer.
- R.43. Super 6-Pin Coils.
- R.47. "OSG" H.F. Transformers for Screened Grid Valves.
- R.48. Dual Range Coils, un-screened.
- R.45A. Sheet illustrating range of Lewcos Radio Products.

# LEWCOS COILS MAKE IT POSSIBLE!



LEWCOS RADIO PRODUCTS FOR BETTER RECEPTION

Ask Your Dealer For  
**GLAZITE**  
BRITISH MADE REGD  
 COLOURED CONNECTING WIRE

THE LONDON ELECTRIC WIRE COMPANY AND SMITHS LIMITED,  
 CHURCH RD., LEYTON, E.10. 'Phone: Walthamstow 2531. 'Grams: "Lewcos," Phone, London

## COUPON

To The London Electric Wire Company and Smiths Limited  
 Church Road, Leyton, London, E.10.  
 In accordance with your offer in "Popular Wireless"  
 please send me leaflet(s) No. ....  
 (Signed) .....  
 Address: .....  
 Date: .....

## THE "P.W." STATION SELECTOR.

(Continued from page 230.)

manner you will begin to find that it is not necessary to disconnect it from the set at all.

After a little practice it will be possible for you to rotate the unit variable condenser in step with the tuning dial on the set, bringing in station after station with negligible interference. Remember that it is only necessary to experiment with the coupling condenser in extreme cases. For most purposes it can be left with the moving vanes fully in mesh.

The procedure on the long waves is exactly the same as for the medium wave-band, except for the fact that a No. 200 or 250 X coil should be used in place of the No. 60.

### Results on Test.

It is interesting to note the results obtained with one of these units on test. With a set of average selectivity, namely a Det. and 2 L.F., it was found that Langenberg and 5 G B could not be separated. When the receiver was tuned to Langenberg, 5 G B came through at roughly equal strength. The unit was then brought into action and Langenberg was heard entirely without interference from 5 G B. In addition, there was a space between the two in which another station was found.

It might be thought that the use of the unit would reduce the volume of a given station slightly, and in spite of the fact that the average set of medium size has a reserve of power sufficient to compensate for any small drop this might be considered a drawback.

It should be remembered, however, that in order to obtain greater selectivity with the set it would be necessary to weaken the aerial coupling by using a smaller aerial coil or a lower tapping.

When the unit is connected, however, a larger aerial coil can be used in the set, and in consequence it is often possible to get the desired station more strongly with the aid of the unit, and, of course, quite free from interference.

## MAKING YOUR OWN COMPONENTS.

(Continued from page 217.)

The method described using brass tube for the sockets, calls for more accuracy and better tools than most of us can provide, so in the examples photographed we have indicated a much simpler method. Here we have used some panel mounting "Ealex" sockets, which are a good fit for valve pins and have nuts to secure them and also grip the connecting wires if desired. As a safety precaution the plate and grid sockets at least should be countersunk a little below the surface of the ebonite.

This type of holder, of course, is not

sprung, so it is not advised for the detector valve. For the L.F. stages, where microphonic effects are very unusual, it is quite useful and a few can be made up and kept at hand. A more useful form of this type is illustrated in the photos of a double holder for the two L.F. valves. The example is only one way of doing it, of course, and quite a number of different types can be made up.

### The Double Holder.

The example, however, is quite a useful type, and you may like some details. The positions of the terminal screws is given in a caption, and the dimensions of the holder are, length 5 in., width 2 in. The valve holders are placed 3 in. apart (centre to centre). By the way, you will see holes drilled in the ebonite in the centre of the holders illustrated. This is simply a suggestion for one way of reducing the capacity and losses between the individual points of the sockets. If you have a fret-saw you can carry this skeletonising process much further.

Now about the anti-microphonic holder advised for the detector valve. The photo really gives you almost all you need, but these extra details may help. The lower piece of ebonite is 2 in. square, and the circular hole is 1½ in. in diameter. The piece of ebonite carrying the sockets is 2 in. by 1 in., and pieces of sponge rubber (e.g., Sorbo) are cut to form washers for "springing" as indicated. The leads must, of course, be of light flex. By the way, do not tighten the securing nuts too much upon the rubber washers, or springiness will be lost.

1829

1929



## KING'S COLLEGE, UNIVERSITY OF LONDON, URGENTLY APPEALS to INDUSTRY

to support it on the occasion of its Centenary.  
On the completion of One Hundred Years since its foundation, an appeal is made for

**£350,000**

to meet the requirements of MODERN EDUCATION.  
The Science Laboratories and College Buildings need to be improved, and DONATIONS will be gratefully acknowledged by  
THE TREASURER, KING'S COLLEGE, LONDON, W.C.2.

## PORTABLE CABINETS

as specified in the "Wireless World," April 17th

for the  
**S-G**  
MULTIPLE-VALVE  
PORTABLE SET

**30/-**

Carriage 3/- extra.

In blue, black, brown and maroon finish. Components for above approx., including Valves . . . . . **£12.15.0**

Details on request.

Any set of Components or complete sets, including Loud Speaker, etc., supplied on Easy Payments. For example £5 worth of goods will require £1 deposit and 10 monthly payments of 9/-.  
Write for details and agreement form.



**For the Best in Radio**

**WILL DAY LTD.**

(THE BEST IN THE WEST)

19 LISLE STREET, LEICESTER SQUARE, LONDON, W.C.2.  
Telephone: (2 Lines) Regent 0921 and 0922      Telegrams: Willday, London

**THIS GENUINE "AGFA" 5/-  
FOLDING CAMERA MONTHLY**

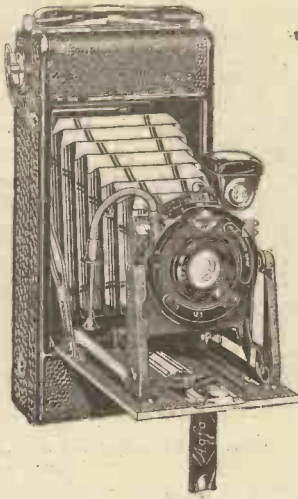

For real trouble-free photography and simplicity of operation, this fine Camera stands unrivalled. It will afford you hours of sheer enjoyment, because, with it, you can take portraits, groups, landscapes, and every kind of subject with the certainty of good sharp results.

To approved orders I will send this Camera and a spool of film (six exposures) for a first payment of 5/-. Full price of Camera and Spool is 51/6, balance of which may be paid by monthly instalments of 5/-.

Full instructions and a "Beginners' Guide" are sent with every Camera. Films to fit may be obtained everywhere. Why not send along your order Now and take up a most fascinating hobby.

**SPECIFICATION**  
High grade Anastigmat F.8 Lens, with 3 stops. Automatic 3 speed (25-50-100) bulb and time shutter. Cable release. Close up attachment. Brilliant reversible View Finder. Two tripod sockets. Beautifully finished. Opens and closes in one operation. Pictures, 3 1/4 x 2 1/8 ins.

POST YOUR ORDER TO:—AMBROSE WILSON, LTD. (P.W. Dept.),  
60, Vauxhall Bridge Road, London, S.W.1.

**BEST RESULTS  
WITH  
GOLSTONE  
"TITAN"  
COIL  
UNIT**

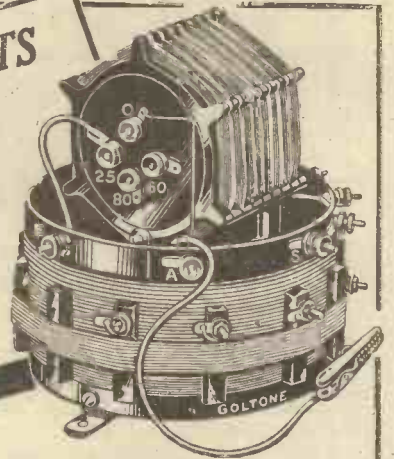

**GOLSTONE "TITAN" COIL UNIT**

A Super-efficient and High-Grade Unit for "P.W." "TITAN" Circuits. **15/-**  
List No. T.C.15. EACH.....

From all first-class Radio Stores. Refuse Substitutes. If any difficulty write direct.

TO USERS OF COSSOR "MELODY MAKER."  
"GOLSTONE" PLUG-IN ULTRA SHORT WAVE COILS enable reception of AMERICAN and other ultra short wave stations throughout the world. CM/U ... **7/6** per pair

Send for interesting illustrated Radio Catalogue FREE on request.



London Depot:  
5 & 6, Eden Street,  
Hampstead Road,  
N.W.1. Phone:  
Museum 4032/3.

**THE 100% Broadcast Receiver**  
BUILD and OPERATE in ONE EVENING

FORMO Screened Grid



BRITISH Components Throughout  
Send for Catalogue.

**FAMOUS FORMO COMPONENTS as used in this Set and in ALL NOTABLE PUBLISHED CIRCUITS**

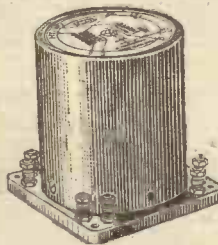

TRANSFORMER-OUTPUT FILTER CHOKE 25/-

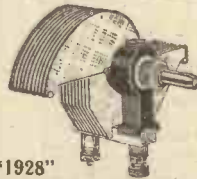

"1928" LOG CONDENSER 5/-  
'0005 '00035 '00025

"De Luxe" Model 6/-  
'0005 '00035 '00025 '00015



COILS SG 1 & 2. 10/6 each



FORMO-DENSOR 2/-  
In four variable capacities

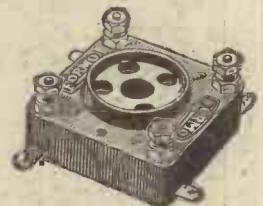

VALVE HOLDER 1/3

THE FORMO CO., CROWN WORKS, CRICKLEWOOD LANE, LONDON, N.W.2.

The PEERLESS MOVING COIL LOUD SPEAKER CHASSIS

for TRIOTRON, HEGRA & BLUE SPOT Loud Speakers. Cone sturdily constructed on aluminium chassis. An excellent line at a reasonable price. Further particulars from—

THE BEDFORD ELECTRICAL & RADIO CO., LTD., 32, Campbell Rd., BEDFORD.



PRICE 7/6

**Use the EFFICIENT PANEL**



For the D.C. "TITAN" THREE and all other popular circuits.

The original BECOL Low Loss Former, made in sizes 1 in. up to 4 in. outside diameter, in lengths up to 36 in.

Write for BECOL Handbook on Wireless Circuits, giving full data on windings and illustrations. Price 4d. post free.

DO NOT BE PUT OFF WITH AN IMITATION, LOOK FOR TRADE MARK

Sole Makers: THE BRITISH EBONITE CO., LTD., HANWELL, LONDON, W.7

# RADIOTORIAL

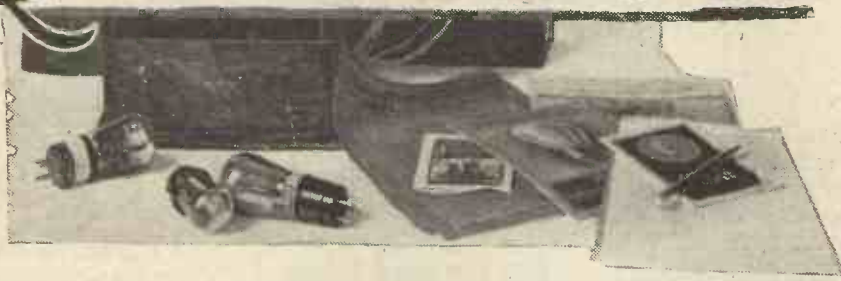

All Editorial communications to be addressed to the Editor, POPULAR WIRELESS, Tallis House, Tallis Street, London, E.C.4.

The Editor will be pleased to consider articles and photographs dealing with all subjects appertaining to wireless work. The Editor cannot accept responsibility for manuscripts or photos. Every care will be taken to return MSS. not accepted for publication. A stamped and addressed envelope must be sent with every article. All inquiries concerning advertising rates, etc., to be addressed to the Sole Agents, Messrs. John H. Lile, Ltd., 4, Ludgate Circus, London, E.C.4.

The constructional articles which appear from time to time in this journal are the outcome of research and experimental work carried out with a view to improving the technique of wireless receivers. As much of the information given in the columns of this paper concerns the most recent developments in the radio world, some of the arrangements and specialities described may be the subject of Letters Patent, and the amateur and the trader would be well advised to obtain permission of the patentees to use the patents before doing so.

## QUESTIONS AND ANSWERS.

### DO YOU KNOW HER ?

S. W. P. (Slough).—"It was an Italian station working on about 385 metres, but the announcements were made by a woman. Do you know if there is a woman announcer at Genoa ?"

Yes, the announcements from Genoa are made by a woman, and this practice is also followed by the Milan station, but the wave-length in this latter case is 504 metres, so it would be Genoa that you heard.

### NEUTRALISING A TUNED-ANODE RECEIVER.

HENRY (Walthamstow).—"Since fitting the set with new valves it is much better than it has ever been, but unfortunately there is a tendency for it to become too lively, owing, I suppose, to the better characteristics of the valves employed. Oscillation is pretty fierce at times, although there is no reaction control, and it has occurred to me that if I could neutralise the set it would probably prevent this, improve selectivity and ensure that the neighbours were not interfered with whilst it was being handled by someone incapable of detecting whether it was oscillating or not.

"The only reference to neutralising a tuned-anode set that I can find is one in which it says that the necessary reversal of phase is obtained 'in the usual manner,' but by means of a separate winding, for which a plug-in coil must be used. This sounds all right, but alas! I do not know what the connections should be.

"I think it would be quite possible as the set is to arrange another coil close to the tuned-anode coil if you can tell me how to connect it up and what size it should be."

All that will be necessary in the way of components is the coil, single-coil holder, and a neutralising condenser. This latter should be mounted close up to the grid of the high-frequency valve between this and the coil holder so that all the wiring is kept as short as possible.

The neutralising coil holder should be mounted close to the tuned anode inductance, though a space of, say, a quarter of an inch between the windings is often advantageous, this partly depending upon the kind of coil used. When this coil holder has been mounted in place the connections are as follow:

Grid of H.F. valve to one side of the new neutralising condenser. Remaining side of this condenser to one side of the neutralising coil holder. Remaining side of this coil holder is connected to the nearest H.F. filament lead. (The two last-named leads, i.e. that from the neutralising condenser to the coil and from the coil to the filament, should in the first experiments be flexible so that they can be changed over if necessary.)

In order to get the phase reversal the relative connections must be correct, and the easiest way to ensure this is to allow for flexible leads for reversal if necessary, in order to get the correct neutralising effect. With such an arrangement the size of the extra coil is generally about the same as that in the tuned-anode circuit, but as much depends upon the tightness of coupling, etc., it may be necessary to experiment a little here before hitting upon the exactly right arrangement.

Neutralisation is carried out in the ordinary way, and this modification should certainly affect a great improvement in the range of the set, in the ease with which it can be handled and in stability generally.

### THAT SPRING CLEANING.

H. M. BUSHEY (nr. Watford).—"In the fever of spring cleaning I started upon my wireless box and was appalled by the numbers

(Continued on page 236.)

## The SQUIRE "UNIVERSAL"



The Squire "Universal" Cradle in girder section burnished and enamelled aluminium, complete with Kraft Cone .. 18/6  
Polished aluminium Base for same .. 3/6  
Set of 4 Oxy-silver Chains .. 3/6



HERE is the ideal Loud Speaker Cradle. You can mount it in the lid of your portable set, fix a stand for table use, or suspend it from the ceiling by chains. The quality, finish and rigid construction are identical with those which have made Squire Cradles deservedly famous, and each "Universal" is supplied with a Kraft Cone ready made up and fitted. It is merely necessary to fix your Triotron, Blue Spot or other unit according to simple instructions.

FREDK. SQUIRE,  
24, LESWIN ROAD, N.16.

Showing the extremely shallow dimensions which make the Squire "Universal" ideal for Portable Receivers.

# WEARITE

## COMPONENTS

### TITAN SETS

"Titan 3," "Titan 2," "Titan Tuner," "Radiano"

"TITAN" COIL UNIT (Immediate delivery from stock)	s.	d.
H.F. CHOKE - - - - -	6	6
L.T. WAVE-CHANGE SWITCH, G 23 - - -	1	6
L.T. SWITCH, G 22 - - - - -	1	0
10 x 7 COPPER SCREEN - - - - -	4	6
PAXOLIN PANEL, MAHOGANY OR BLACK, DRILLED - - - - -	6	6
PAXOLIN STRIP, MAHOGANY OR BLACK, DRILLED - - - - -	1	9
STANDARD LOADING COIL - - - - -	7	6

GRID BIAS BATTERY CLIPS, PER PAIR 6

METAL SCREENS FOR ALL CIRCUITS

WAVETRAP, as recommended by Mr. Kendall in February 9th issue - each 15 0

WRITE FOR LISTS.

## WRIGHT & WEAIRE, LTD.,

Telephone: 740, High Rd., Tottenham, N.17  
Tottenham 3847-3848



## DR. NESPER TEKADE TRICKLE CHARGER

100 v. to 125 v. & 200 v. to 240 v. A.C.

For Charging  
2- & 4-v.  
Accumulators

**29/6**

For Charging  
2-, 4- & 6-v.  
Accumulators

**38/6**



Simply fix plug into lampholder, then attach spade terminals to accumulator and switch on.

A 4-volt accumulator can be charged any time the Set is not in use at cost of 1d.

**ASK YOUR DEALER.**

**DR. NESPER LTD.,**  
Colindale Avenue, Hendon, London, N.W.9

**TE KA DE**

# Little before mend

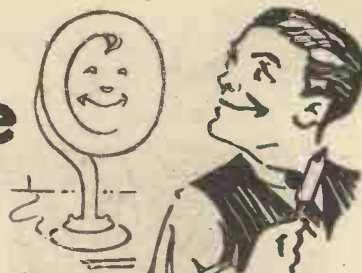

# saves much after spend



## FLUXITE

simplifies all soldering

FLUXITE is sold in tins, price 8d., 1/4 and 2/8.

**SOLDERING SET COMPLETE**

Another use for Fluxite: Hardening Tools and Case Hardening.

**7/6**

Ask for leaflet on improved methods.

or LAMP only, 2/6

**FLUXITE LTD.**  
(Dept. 324),  
Rotherhithe,  
S.E.16.

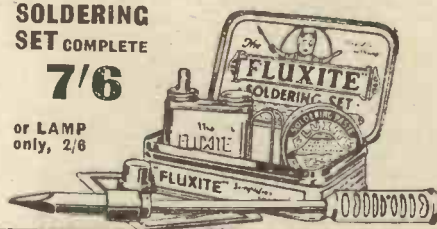

## "P.W." Pulls Orders from every part of the world!

TELEPHONE 2306



**The Stonehouse Radio Supplies**  
Wholesale Manufacturers.

Your Ref.  
Our Ref. RP/AM.

54 Union Street

Plymouth,  
Devon.

April 10th, 1929.

The Editor,  
Messrs. John H. Little, Ltd.,  
"Popular Wireless",  
4, Ludgate Circus,  
LONDON, E...C.4.

Dear Sir, We feel it is our duty to let you know the really wonderful results of advertising in your journal, in response to our various adverts re our S.R.S. ultra short wave coils for the original and New Cosson "Melody Maker" receivers. We have received orders and inquiries from practically every part of the world, and almost every letter bears the inscription "Seen in "Popular Wireless", truly a world wide tribute to the reaching powers and circulation of your journal.

We are,  
Yours faithfully,  
STONEHOUSE RADIO SUPPLIES.

P.S. You have our permission to use this letter in any way you may wish.

## NOW ON SALE

Full constructional details of  
**The "Radiano" Three**  
and  
**The "Concert" Four**  
are obtainable in Envelope form in

**THE WIRELESS CONSTRUCTOR**  
**ENVELOPE SERIES** Price 1/6  
**ON SALE EVERYWHERE**

By post, 1/9, from Wireless Constructor Envelopes, The Amalgamated Press, Ltd., Bear Alley, Farringdon St., London, E.C.4

## DX Short-wave COILS



For short-wave work specify the famous DX Coils. Experts use them wherever Radio is known.

Wound 3 in. diameter; fit standard coil holders. Tinned copper, 16 gauge; open core; can be tapped anywhere by alligator clips.

3, 5, 7 and 9 turns.

**7/6**

The Set of four.

**DX COILS, LTD., LONDON, E.8.**



# READY RADIO TITAN PARTS

USE ONLY APPROVED COMPONENTS.

SPECIFIED FOR TITAN D.C. THREE

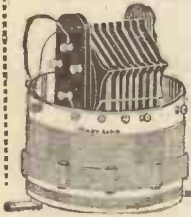

COIL UNIT STANDARD SCREEN  
15/- 10 x 8  
2/6

As originally specified and approved by the Editor of "Popular Wireless."

EVERY COIL GUARANTEED.



## ORIGINAL TITAN THREE KITS

(APPROVED BY "POPULAR WIRELESS.")

READY FOR IMMEDIATE DESPATCH!

- KIT A** Complete, valves excepted .. £4- 7-0
- KIT B** Complete with Detector, Screen Grid and Power Valves .. £6-12-6
- KIT C** Complete with Detector, Screen Grid and Pentode Valves .. £7- 5-0

All kits include special connecting links which OBVIATE SOLDERING. Official blue print and full instructions are also included.

### READY RADIO SUPPLY CO.,

159, BOROUGH HIGH STREET,  
LONDON BRIDGE S.E.1.

Grains  
Ready Hop  
5555 London.

Tel. No.  
Hop 5555.

(Three minutes from London Bridge Station.)

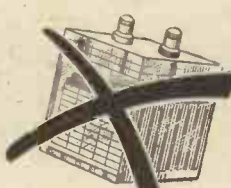

## Obsolete!

Cut out that bugbear of Radio—the unreliable and costly accumulator that's always "letting you down." Instal a

### "RADIOVOLT"

(Patent Applied For.)

#### L.T. UNIT (A.C.)

and enjoy trouble-free reception.

- NO SPECIAL VALVES
- NO ALTERATIONS TO SET
- NO TRICKLE CHARGERS
- NO ACCUMULATORS

It takes 3 minutes to fit and is guaranteed for 7 years.

Write now for particulars to—

**RADIOVOLT MFG. CO., 20, Old Compton Street, London, W.**

Tel.: Gerrard 7182.

#### EASY TERMS

25/- down and 6 monthly payments of 25/-

COMBINED L.T. and H.T. ELIMINATOR (5 Variable Tappings)

28/- down and 11 monthly payments of 28/-

## LISENIN PATENTED POSITIVE CONE GRIP PLUGS, SOCKETS, SPADE ENDS, ETC.

Famous the world over for utmost efficiency and hardest wear and tear.



SAFETY PLUG FOR MAINS  
4½°

BANANA PLUG AND SOCKET  
4°



WRITE FOR FREE BOOKLET!  
**LISENIN**

1P, EDGWARE ROAD, LONDON, W.2.

## INVALUABLE TO EVERY AMATEUR & CONSTRUCTOR

# "POPULAR WIRELESS" BLUE PRINTS

of Tested Circuits

The following is a list of the "P.W." 6d. Blue Prints for Constructors in stock, showing the different circuits available.

P.W. BLUE PRINT Number.

1. DETECTOR VALVE WITH REACTION.
2. OUT OF PRINT.
3. 1-VALVE L.F. AMPLIFIER.
4. CRYSTAL DETECTOR WITH L.F. AMPLIFIER.
5. H.F. (Tuned Anode) AND CRYSTAL WITH REACTION.
6. H.F. & CRYSTAL (Transformer Coupled, without Reaction).
7. 1-VALVE REFLEX AND CRYSTAL DETECTOR (Tuned Anode).
8. 1-VALVE REFLEX AND CRYSTAL DETECTOR (Employing H.F. Transformer, without Reaction).
9. H.F. AND DETECTOR (Tuned Anode Coupling, with Reaction on Anode).
10. H.F. & DETECTOR (Transformer Coupled, with Reaction).
11. OUT OF PRINT.
12. OUT OF PRINT.
13. 2-VALVE REFLEX (Employing Valve Detector).
14. OUT OF PRINT.
15. OUT OF PRINT.
16. H.F. (Tuned Anode), CRYSTAL DETECTOR AND L.F. (With Switch for Last Valve).
17. CRYSTAL DETECTOR WITH TWO L.F. AMPLIFIERS (With Switching).
18. 1-VALVE REFLEX AND CRYSTAL DETECTOR, with 1-VALVE L.F. AMPLIFIER, Controlled by Switch.
19. OUT OF PRINT.
20. OUT OF PRINT.
21. THE 2-VALVE LODGE "N."
22. "THE GUARANTEED REFLEX."
23. THE 1-VALVE "CHITOS."
24. THE "SPANSACE THREE." Three-Valve Receiver employing 1 Neutralised H.F. Valve, Detector with Non-radiating Reaction Control and 1 L.F. Valve.
25. OUT OF PRINT.
26. A "STRAIGHT" 4-VALVER (H.F., Det. and 2 L.F. with Switching).
27. OUT OF PRINT.
28. A "MODERN WIRELESS" 5-VALVER (H.F., Det. and 3 L.F.).
29. AN H.T. UNIT FOR DIRECT-CURRENT MAINS.
30. A REINARTZ ONE-VALVER.
31. OUT OF PRINT.
32. THE "CUBE SCREEN" THREE (H.F., Det. and L.F.).
33. A "KNIFE EDGE" CRYSTAL SET.
34. AN H.F. AND DETECTOR TWO-VALVER.
35. THE "UNIVERSAL THREE" (Det. and 2 L.F. stages resistance-coupled).
36. THE "SPANSACE FOUR" (H.F., Det. and 2 L.F.).
37. THE "LONG SHORT" CRYSTAL SET.
38. A TWO-VALVE L.F. AMPLIFIER.
39. THE "SYDNEY" TWO.
40. THE "SUPER SCREEN" THREE.
41. THIS YEAR'S "CHITOS" ONE-VALVER.
42. THE "Q AND A" THREE. A simple set (Det. and 2 L.F.).
43. THE "INEXPENSIVE FOUR."
44. THE "ECONOMY FIVE." For long-range loud-speaker work.
45. A SIMPLE A.C. H.T. UNIT.
46. THE "REGIONAL" THREE.
47. THE "WAVE-CHANGE" ONE.
48. THE "REGIONAL" CRYSTAL SET.
49. THE "ANTIPODES ADAPTOR."
50. THE "ANY MAINS" TWO.
51. OUT OF PRINT.
52. THE "BANDMASTER."

## ALL "POPULAR WIRELESS" BLUE PRINTS 6d. EACH

All orders for these Blue Prints should be sent direct to the "Popular Wireless" Queries Department, Fleetway House, Farringdon Street, London, E.C.4, enclosing a stamped addressed envelope and a postal order for 6d. for each Blue Print ordered.

## RADIOTORIAL QUESTIONS AND ANSWERS

(Continued from page 236.)

Correct spacing in a crystal set is of as much importance as in a valve set, in fact more, because in the valve set any losses which occur in this way may be made up for by the amplification of the valves, but in a crystal set one is entirely dependent on the energy picked up by the aerial and passed on to the telephones. As bad spacing can result in a good deal of this energy being lost it is obvious that it should be avoided in order to get the maximum output from the 'phones without the leakage or loss which is liable to accompany carelessly arranged wiring.

### TOO TRUE!

"CURIOUS" (Sale, Cheshire).—"Is it a fact that an ordinary one-valve receiving set can act like a transmitter and send out signals if it is given too much reaction?"

Alas! this is quite true, and a very great many listeners give their sets far too much reaction, so converting them into miniature transmitters, and thus unfortunately interfering with other people's programmes! When a set is misused in this way it is capable of causing disturbance over quite a large area, and every time its tuning controls are adjusted it causes a chirp, or squeal or squeak in neighbouring sets receiving the broadcasting programme.

If the tuning dial is not adjusted but is left "set," with too much reaction, the effect is completely to destroy the quality of neighbouring reception as well as to affect the strength of it. Consequently, great care should be taken not to let a set act in this way, for it is not only the neighbouring sets which are affected, but the quality of the programme of the receiver itself is very inferior compared to what it might be if the set were properly adjusted.

In order to help listeners to get the best results from their receivers the B.B.C. have issued a non-technical booklet dealing in clear language with this

**WHEN WRITING**  
to the Technical Query Department  
**DON'T FORGET**  
that every letter must contain a  
**STAMPED ADDRESSED**  
:: :: ENVELOPE :: ::

subject of Oscillation, and it will be forwarded free on application to the nearest broadcasting station or to The B.B.C., 2, Savoy Hill, London, W.C.2.

### MATCHING THE DIALS.

D. D. (Exeter).—"The most puzzling thing about it is that the aerial and H.F. dials are completely out of step. Both are '0005 mfd., but the one across the split-secondary winding will not tune down low enough for the aerial condenser, but gets to its zero when the aerial is arranged at about 80. Does this mean that I ought to use a smaller H.F. condenser?"

It is usual to use quite a small condenser across the split-secondary type of transformer, because this was designed for an effective capacity of only about '00025 mfd.

If you have a spare '0005 mfd. fixed condenser on hand you might try connecting this in series with the present '0005 mfd. H.F. condenser across the split secondary, although, of course, the correct thing to use would be a '00025 mfd. variable. (The connections for the two condensers in series would be as follows: one end of the secondary to the variable condenser, other side of the variable condenser to one side of the fixed condenser, other side of the fixed condenser to the remaining side of the secondary, all other circuit connections remaining as usual. Probably this dodge will enable you to bring the two dials much more nearly "into step.")

### A SWITCH FOR A PICK-UP.

"BERT" (Cape Town).—"At present I pull out the detector valve and put in the pick-up plug, but I should like to arrange a switch for this, so that I can switch over from radio to the gramophone. What would be the connections?"

You will require for your purpose a single-pole double-throw switch, the centre contact of which

(Continued on next page.)

## THERE MUST BE A REASON

Why the tens of thousands who listen in praise Celestion.

## INCOMPARABLY SUPERIOR

British Materials. British Craftsmen. British Through-out. Thorough testing. Such a combination is essential to produce an instrument which can definitely rank as "Incomparably Superior"

# CELESTION

The Very Soul of Music.

The only sure proof of our Statement is to hear Celestion yourself. You can do so without obligation at any good Wireless Dealers, or at our Showrooms. Models range from £5.10.0 in oak or mahogany. Made under Licence.

The new Celestion Booklets are free and give you briefly and interestingly all particulars. Mail the coupon below for your copy now!

CELESTION LTD. (DEPT. B),  
KINGSTON - ON - THAMES.

Showrooms:  
106, VICTORIA STREET,  
LONDON, S.W.1



Model C10, £9.10.0

WHEN A BETTER LOUD-SPEAKER  
IS MADE - CELESTION WILL  
MAKE IT.

Please send me a copy of the New Celestion Booklet! Post to Celestion, Ltd. (Dept. B), Kingston-on-Thames.

NAME .....

ADDRESS .....



## ECLIPSES EVERY METER VALUE

**WATES**  
"three in one"  
**VOLT-AMP**  
RADIO TEST METER

### THREE READINGS ON ONE DIAL.

This wonderful feature incorporated in the Wates Meter has caused a stir throughout the Radio World. Every preconceived notion of meter value has been swept away. This amazing Meter tells you all you want to know—NOW a variety of single-purpose testing instruments are a totally unnecessary waste and expense. The Wates Meter gives three dead-beat readings from one clearly engraved dial. It is in every sense a precision job. Exceptionally handsome appearance. Fully guaranteed. Dead-beat readings. From your dealer or direct with explanatory free leaflet.

Stocked by Halford's Stores, Curry's Stores, and All Radio Dealers.

READINGS:  
0—150 VOLTS.  
0—6 VOLTS.  
0—30 MILLIAMPS.  
Res. 5,000 ohms.

PRICE

**8/6**

Crystallised black finish, Fully guaranteed.

THE STANDARD  
WET BATTERY  
Co. (Dept. P.W.)  
184-188, Shaftesbury Ave.,  
LONDON,  
W.C.2.

Can be used as a Pole Finder.



### Three in One

M.B.

**WET H.T. BATTERIES**  
Solve all H.T. Troubles.  
**SELF-CHARGING, SILENT, ECONOMICAL.**  
JARS (waxed) 2½" X 1½" sq. 1/3 doz.  
ZINCS, new type 10d. doz. SACS 1/2 doz.  
Sample doz. (15 volts), complete with bands and electrolyte, 4/1, post 9d.  
Sample unit. 6d. Illus. booklet free.  
Bargain list free.  
**AMPLIFIERS 30/- 3 VALVE SET 4s.**  
P. TAYLOR, 57, Studley Road,  
STOCKWELL, LONDON.

**HEADPHONES REPAIRED 4/-**  
Transformers 5/-. Loudspeakers 4/-. All repairs re-magnetised free. Tested, guaranteed and ready for delivery in 24 hours.  
Discount for Trade. Clerkenwell 9069.  
E. MASON, 44, East Rd., City Ed., N.1.

The **MIRACLE**  
**Super Long Range 5-Valve PORTABLE**  
Balance payable by easy monthly instalments. Every description of Radio apparatus on Easy Terms. Also Gramophones and Records. Illustrated Lists Free.  
Yours for 10/-  
DOWN  
WORLD'S WIRELESS STORES, WALLINGTON, SURREY



## RADIOTORIAL QUESTIONS AND ANSWERS

(Continued from previous page.)

should be connected to the grid of the detector valve, all other connections being removed from this point.

One of the side contacts of this switch should now be joined to that part of the circuit which previously went to the grid of the detector, i.e. the grid condenser and leak. Thus when the switch is thrown over to this side it restores the original connections and the set is ready for "radio."

To the other side of the switch run a lead to that point on the pick-up which was previously connected to the grid terminal. The other active point on the pick-up which was joined to filament or grid bias is joined by means of a flexible lead terminating in a black plug to the requisite number of negative volts on the grid-bias battery.

### ISOLATING THE LOUD-SPEAKER LEADS.

"HENPECK" (Sheffield).—"Just between ourselves my love for radio has suffered a severe eclipse, and not only did I fall in love with one of those 'cuties' that Jack Payne sings about, but we got married and have just experienced our first spring cleaning. And 'here's the sting,' as the wasp said.

"I wanted to run some nice thick leads for the loud speaker right across the drawing-room, but the 'cutie' in question got very excited about it and said, whereas she would not mind a thin white wire she would not have those great unsightly clothes lines made of rubber covered stuff running across her drawing-room! She does not mind thin wire (about 22 D.C.C.) as this is practically invisible, and can run along the picture-rail.

"In a rough hook-up I found that it works O.K. as far as the loud speakers are concerned, but as the wires must necessarily be close together and run rather a long way I should like to know if my choke-output system (sketch enclosed) is really giving me adequate protection from battery shorts, etc., or, if not, whether I could modify it a little so as to afford this?"

At present your choke-coupling system uses only one fixed condenser, and this is really inadequate for the purpose you have in mind. All you need do, however, is to purchase a second 2-mfd. and connect this in the lead that now goes direct from one loud-speaker terminal to H.T. neg. Make the alteration at the set end, not near the loud speaker, and you will thus afford complete protection.

### TECHNICAL NOTES.

(Continued from page 218.)

at a distance." The amount of energy produced in the electrodes of the valve is sufficient to heat them, in the course of a few seconds, to a bright red heat and this has the effect of releasing most of the occluded gas in the electrodes so that the bombardment of the electrodes by the electron stream from the filament, when the valve is subsequently in use, does not cause any further release of gas which would upset the vacuum.

This method of high-frequency induction is now used in quite a variety of industrial operations, where an object which is not get-at-able (usually an object within a vacuum) has to be quickly heated without the use of any electrodes to lead a current through it.

### Industrial Uses.

One of the latest examples of high-frequency induction heating comes from the Bureau of Metallurgical Research of the Carnegie Institute of Technology, where manganese has been prepared in a state of purity much in excess of anything previously obtained.

(Continued on next page.)

# free -

## Conversion Charts for the 1927



This illustration shows the 1927 type Cossor Melody Maker after conversion. The original dials may be used if desired though the latest pattern Cossor Slow Motion Dials are recommended.

**Get knife-edge selectivity—1000 miles range and better all round performance from your 1927 Cossor Melody Maker with the—**

# Cossor Melody Maker

Send at once for a copy of this large Conversion Chart which tells you how to rebuild your 1927 type Cossor Melody Maker to get knife-edge selectivity—1000 miles range—more stations and better all-round performance. It tells you all

about the wonderful Cossor Conversion Kit which includes all the parts you need for making your 1927 Melody Maker into a modern Screened Grid Receiver. The chart shows how simply this can be done—only two holes to drill, a slight re-arrangement of the wiring—that's all. You can easily do it in an evening. A full size baseboard plan is included. On the back of the Chart you will find full instructions for operating your converted Cossor Melody Maker—how to cut out the local broadcast and bring in station after station at full loud-speaker strength. Don't delay—post the coupon now for your copy of the Cossor Conversion Chart.

# Cossor CONVERSION KIT

### CONTENTS:

- One Cossor Screened Grid Valve Type S.G. 220.
- One Screen Assembly.
- Two Cossor Coll Holders.
- Two Cossor Coils (for 250-600 metres).
- One Cossor H.F. Choke.
- One Rheostat with knob.
- One Reaction Condenser with knob.
- One Fixed Condenser .1 mfd.
- Connecting Wire Insulating Sleeving.

# 57/6

**COMPLETE**

N.B. - Your Wireless Dealer can also supply, if required, two Cossor slow Motion Dials at 3/6 each and one Cossor L.F. Transformer at 21/-

**Mail this Coupon NOW!**

Please send me free of charge one of your Conversion Charts which tells me how to rebuild my 1927 Cossor Melody Maker.

Name .....

Address .....

27/4/29

A. C. Cossor Ltd. Highbury Grove, London, N.5.

# The Easy Way TO PERFECT RADIO

In addition to their own extensive range, PETO SCOTT offer YOU Every known Radio Receiver or Component—all on

## EASY TERMS

The following list is merely representative, and we ask you to fill in the coupon below or send us a list of your requirements.

- Cosmor Melody Maker. Send only 10/-, balance in 11 monthly instalments of 14/7.
- Mullard Master Three Star. Send only 10/-, balance in 11 monthly instalments of 15/3.
- Leading Makes of H.T. Eliminators from 4/7 down, balance in 11 monthly instalments of 4/7.
- Celestion C.12 Speaker. Send only 13/4, balance in 11 monthly instalments of 13/4.
- Exide 120 volt H.T. Accumulator, with crates. Send only 6/11, balance in 11 monthly instalments of 6/11.
- "Titan" 3. Complete kit of components. Send only 10/-, balance in 11 monthly instalments of 8/1.
- All Leading Makes of Portables from 21/- first payment.
- Build your own set the Easy Way NOW! Our Catalogue contains all leading makes of Receivers, Accessories, Kits of Components for the Home Constructor.

Mail Coupon in unsealed envelope under i.d. stamp.

## PETO SCOTT LTD.

Please send me your big Illustrated Lists.

NAME.....  
 ADDRESS.....  
 P.W. 27/4.

Free Demonstrations and Advice by Qualified Engineers at our Shops—

77, City Road, London, E.C.1.  
 62, HIGH HOLBORN, LONDON, W.C.1.  
 4, MANCHESTER STREET, LIVERPOOL.  
 33, WHITELOW ROAD, CHORLTON-CUM-HARDY, MANCHESTER.

### KAY'S CABINETS

This Cabinet soundly constructed of Oak and equipped with Baseboard Runners. Fall Front, Hinged Top. Polished rich Jacobean. 36" high For 45/- panels up to 18" wide ...  
 Also made to accommodate any Popular Set. Quotations for Specials by return. Illustrated Lists Free.  
 H. KAY, Cabinet Manufacturer, Mount Pleasant Road, London, N.15.  
 Phone: WALTHAMSTOW 1626.

50/- as shown

## LOEWE RADIO

4, Fountayne Rd., Tottenham, N.15

14,000 SUCCESSSES is the record of The T.I.G.B. If you, too, wish to advance to a well-paid post in any branch of engineering, T.I.G.B. home-study training offers you the surest means of achieving the success you desire.

## Free!

100 PAGES

ENGINEERS

This 100-pp. book furnishes the most complete information ever published about the many professional qualifications open to engineers such as A.M.Inst.C.E., A.M.I.Mech.E., A.M.I.E.E., &c.; describes over 150 Courses; tells how employers every week fill vacancies with T.I.G.B. students; and is crammed with matters of interest to every engineer. If you are ambitious, The T.I.G.B. can help you—write TO-NIGHT for your FREE copy of "The Engineer's Guide to Success," to—THE TECHNOLOGICAL INSTITUTE OF GREAT BRITAIN, Established 1917. 209, TEMPLE BAR HOUSE, LONDON, E.O.4.

## TECHNICAL NOTES.

(Continued from previous page.)

Pure manganese has a bright silver lustre and, unlike many pure metals, which are soft and ductile, it is extremely brittle and is hard enough to scratch glass. The pure metal is distilled from crude metallic manganese, placed in a special crucible over which another crucible is inverted to condense the manganese vapour. The whole is placed in a closed silica tube connected with a vacuum pump and heated, as already mentioned, by high-frequency induction, using an alternating current of several amperes at a frequency of 20,000 cycles.

### Daylight Transmission.

I have received a copy of a paper entitled "The Daylight Transmission of Wireless Waves over Sea Water" issued by the Broadcasting Company of Australia, and written by Mr. R. O. Cherry, M.Sc., Research Physicist at the National Philosophy Laboratory of the University of Melbourne. This paper contains a very interesting account of some important measurements

## NEXT WEEK

Make sure of your copy of the

## MAY NUMBER

## of MODERN WIRELESS

Full of interesting, informative and constructional articles by leading Radio authorities.

On Sale May 1st. Price 1/-  
**ORDER YOUR COPY NOW!**

and observations with regard to the field intensity of wireless signals from a large number of broadcast stations; measurements of this type in connection with radio transmission date back from about 1905.

### Cause of Variation.

It might be expected that the transmission over sea-water (inasmuch as there are no considerable variations due to trees, hills and so on, as in the case of the transmission over land) would be fairly regular, but in actual practice it is found that various irregularities occurred, these being due principally to the following causes: (1) Variations in the output from the transmitting aerial; (2) variations in the receiving apparatus; (3) irregularities introduced during transmission. The first two obviously have no particular connection with the question of transmission over land or sea, but as a matter of fact the irregularities observed were found to be due only in small part to conditions 1 and 2 and mainly to condition three.

### H.T. Safety Box.

I mentioned in these Notes some little time ago the Ferranti Safety Box, which is designed to accommodate the H.T. supply unit and to make it safe and in compliance with the Regulations.

(Continued on next page.)

# THOUSANDS now get AMERICA, AFRICA, AUSTRALIA on their COSSOR MELODY MAKERS

Just interchange your present coils with the new GASON 1929 ULTRA SHORT-WAVE COILS—only 12/6 pair. Full instructions sent with Coils.

**GUARANTEE**  
 Money refunded, less postage, if dissatisfied and returned within 7 days of purchase. From all dealers or direct from us G.O.D. or P.O., post free.

**WRITE FOR FREE FOLDER!**  
**GASON MOULDINGS,**  
 Dept. P. Chiswick Road, Lower Edmonton, London, N.9

Extract from "Ama-teur Wireless," 16th March, 1929, by the well-known expert, J. H. Rayner, B.Sc., A.M.I.E.E.  
 Soon after 11 p.m. we picked up a carrier, 2 XAF, America, and obtained at music and speech of good loud speaker strength. Coils are recommended to readers.

Remember that in the better weather Ultra Short-Wave Signals are much stronger.



BY USING THE AMAZING GASON ULTRA SHORT-WAVE COILS 12/6 PAIR

**NOTE REDUCED PRICES!**  
**"TROMBA" THE WET H.T.**  
 SACS, 1/5, 2/-, ZINCS, 8d., 10d., and 1/4 doz. JARS, 1/3 doz. "3 in 1" meter, 6/6. Send 1/4d. for booklet, 6d. a cell, 1/- range of samples. TROMBA ELECTRICAL Co. (Dept. W.), 51, Chalk Farm Road, Camden Town, N.W.1. (Hamstead 0023).

## REPAIRS

Any make of L.F. Transformer, Loudspeaker or Headphones repaired and despatched within **48 HOURS—TWELVE MONTHS' GUARANTEE** with each repair, 4/- Post Free.  
 Terms to Trade.  
**TRANSFORMER REPAIR CO.,**  
 "Repairs" Dept.,  
 214, High Street, Colliers Wood, London, S.W.19.

## BURY YOUR CONTACT TROUBLES WITH THIS CLIX SPADE.



CLIX Spade Terminals are obtainable either nickel or lead-plated. The latter, for use with accumulators, offers less resistance to the flow of L.F. current, and is not easily affected by acid.  
 The patented method of wiring these terminals ensures a positive grip, perfect contact and no risks of shorts. Red or Black insulators. Specified for the "New Roadside Four" by P. W. Harris.  
 Write for the Clix Catalogue.  
**LECTRO LINK LTD.,**  
 254, Vauxhall Bridge Rd., S.W.1

Patented.  
**2d.**  
 EACH

## EASY TERMS

We specialise in the supply of all good quality Radio Apparatus on deferred terms. All well-known kits of parts now supplied from stock. **LOWEST TERMS.** Send List of requirements to **LONDON RADIO SUPPLY CO.,** 11, OAT LANE, NOBLE ST., LONDON, E.C.2.  
 Phone: NATIONAL 1977

**TECHNICAL NOTES.**

(Continued from previous page.)

Messrs. Ferranti have since submitted some further samples of the safety box together with some information, which I pass on in case you may be contemplating building a supply unit.

The safety problem in connection with the use of supply mains for radio purposes has not until recently been given the attention which it demands and, when it is borne in mind that an experimenter may receive serious injury by contact with some types of supply mains, it is obviously very desirable that the possibility of such contact with any apparatus connected directly to the mains should be carefully avoided. The Ferranti Safety Box claims that this safety is assured with the minimum trouble.

**Complying with Regulations.**

The box is made of steel and is fireproof; it is provided with a three-core flexible cable; the wire core, being for earthing purposes, should normally be connected to the earthing pin of the power plug in order to comply with the Regulations: if no power

**DON'T MISS IT!**

In the MAY issue of

**The WIRELESS CONSTRUCTOR**

is a full description of

**The New "Roadside" Four**

—a fine portable set designed by PERCY W. HARRIS, M.I.R.E.  
SECURE YOUR COPY NOW.

plug is available no connection should be made to this lead. A double-pole switch and a fuse are provided and these are arranged so that, on the lid being lifted, the apparatus inside is automatically disconnected from the mains; it is connected to the mains again when the lid is closed.

You will remember that some little time ago Ferranti issued five charts showing a number of satisfactory supply units using the safety box. It has since been found that the original box was rather too small for the average user and accordingly a more convenient size has now been placed on the market. Full information with regard to the construction and operation of mains-supply units generally, as well as copies of the charts referred to, may be obtained by communicating with Ferranti Limited, Bush House, London, W.C.2.

**Loud-Speaker Developments.**

A very interesting paper, entitled "Loud Speakers and Their Development," was read before the Royal Society of Arts recently by Mr. R. P. G. Denman, M.A., of the Science Museum, South Kensington, Dr. W. H. Eccles, D.Sc., F.R.S., being in the chair.

This paper, which is very long and extremely comprehensive, cannot possibly be quoted to any extent in the space  
(Continued on next page.)



This fine portable receiver embodies the many virtues of the original "Roadside" Four, plus screened-grid sensitivity, remarkable quality, and wave-change flexibility by means of a simple switch.

**PORTABLE CABINETS** as shown above. Complete with panel and baseboard, speaker grille fitted, chassis for frame aerial, covered real Rexine in rich brown colour. Support type hinges, and carrying handle. Carriage and packing 2/6.  
**SPEAKER UNIT AND CONE, 21/-** 2 v. Unspillable Acc. from 10/-, 99 v. H.T. Ripaults 16/6, Hellesen, 18/-, 2 v. Screened grid, 22/8, 2 H.F. at 10/6. Power 12/6 (Ediswan, Marconi, Six-Sixty, Mullard, Osram.)

**C.O.D. SEND ORDER. PAY POSTMAN.** (U.K. Only). Must be over 5/- value.

**HANDSOME OAK POLISHED SPEAKER CABINETS** 13 x 13 x 6



**12/11** (POST 1/3)  
Cannot guarantee exact pattern of front panel, but all good designs.  
**Genuine Ideal Blue Spot 66K (101) 25/-**  
**ADJUSTABLE MODEL 4 POLE BAL. ARMATURE** Or **CABINET, GENUINE BLUE SPOT 35/-** Post Free

**NOTE THIS OFFER** —> & 12 in. BUCKRAM CONE

**TRIOTRON VALVES** and **TRIOTRON UNIT**

H.F., Det., R.C., 5/2 each; Power, 6/9. 2-v. or 4-v. Post 4d. (10/- Free). **4 Pole Balanced Armature 17/6** Carr. Paid



Or with Cabinet as shown above and 12" Cone **27/6** Post Free

**ALUMINIUM CRADLE CHASSIS** with 10 in. floating Cone for Baffle **7/11** Post 9d.  
**EXTRAS**  
1,000 Mile Range on your 1927 Gossor. Screen assembly, 2 Coil Holders, Peto-Scott Reaction, McMichael Binocular H.F. Choke, Peerless Rheostat, Dubilier 1 mfd. Insulated Wire, Aerial and Anode Coils (2), 200/600 metres. Post free, 25/-  
Gossor S.G. Valve S.G. 220 . 22/8. 2 Gossor Pattern S.M. Dials for 6/- Pair Long-Wave Coils, 12/6.

**K. RAYMOND**  
27 & 28a, LISLE ST., LONDON, W.C.2  
Come to LEICESTER SQUARE TUBE  
This address is at the back of Daly's Theatre  
Phones: Gerrard 4637 and 2821

**HOURS OF BUSINESS EVERY DAY**  
9 to 8  
**SATURDAY**  
9 to 9  
**SUN. MORN.**  
11 to 1

**—NOW FOR PORTABLES—**

For the River, For Home, For Tennis, Picnics, Dances, in fact Anywhere  
**THE NEW "ROADSIDE" FOUR**

described by Mr. Percy Harris, Wireless Constructor, May, 1929

**KIT OF COMPONENTS**

UTILITY MITE .0005	10/6
2-POLE C/O SWITCH	5/-
IGRANIC L.F. TYPE "J"	17/6
4 LOTUS VALVE-H.	5/-
LISSEN R.C.C. UNIT	4/-
PYE & MEG. LEAK	1/-
LISSEN 2 MEG.	1/-
MAGNUM CHOKO	7/6
IGRANIC P.M. NEUT.	5/6
DUBILIER 2 MFD.	3/6
2 LISSEN .0003	2/-
R.C.G. .01	3/-
DUBILIER .001	3/-
DUBILIER & MEG.	2/6
LISSEN .002	1/6

Ferranti Anodes, all with holder, 3,000 ohms, 5/-, 40,000, 4/-, 20,000, 4/-. Above parts, including the following: Frame Aerial wire, D.C.C. wire, plugs, spades, flex, on and off switch, grid leak holders, brackets—

**Total (Carr. Paid) 85/-** (Cash with Order.)

**THE CABINET FOR 32/6** With full Kit of Parts ONLY (Carr. 2/6)

**THE COMPLETE SET READY TO USE (Tax Paid)**

Supplied to approved a/c.s.  
**30/- and 10 payments of 25/-**

**WE STOCK**

**WHOLESALE & RETAIL**  
Bulgin, Ferranti, Eko, Amplion, Celestion, Igranic, Lissen, M.P.A., Ediswan, Gossor, Six-Sixty, Colvern, Cyclon, McMichael, Watmel, Lewcos, Polar, Climax, Ormond, J.B. Pye, Polymet, T.O.C., Dubilier, Lotus, W.B., Philips, Mullard and all standard components valves, etc.

**Lewcos Q Coils**

Q.A. 15/- Q.A.M. 21/- Q.A.R. 21/- Q.S.P. 21/- Q.S.G. 21/-

**OSRAM MUSIC MAGNET**

Kit of Parts & Valves, £8 : 12 : 6. BOOKLET FREE.

**"TITAN" 3** P.W. 2/2/29

This Kit of Parts is officially approved by EDITOR, "Popular Wireless."  
-0005 Variable with S.M. Dial (LOTUS, ORMOND or POLAR), Micro .00005, LISSEN L.F., 8/6 (any other L.F. add balance), Wave-change Switch, L.T. "TITAN" COIL UNIT, 3 Sprung V.H. R.I. VARLEY or LEWCOS H.F. Choke, one .0002 and two of .0003 fixed, 2 meg. Leak and Holder, 2 DUBILIER, Mansbridge The Lot for LISSEN, Standard Screen, 2 H.T. Fuses, Terminal Strip, 11 Terminals (engraved), Wire, Screws, Flex, Plugs, and 14 x 7 Grade A Ebonite Panel. Post Free, U.K. C.O.D. 2/6 extra.

**ILLUSTRATED CATALOGUE**

(144 pages). 1/- refunded on first 10/- order.

**TITAN COILS** 15/- TRADE SUPPLIED.

**S.G. VALVES**

MULLARD, SIX-SIXTY, GOSSOR, OSRAM, MARCONI, EDISWAN, ALL AT 22/6 EACH.

**GLEARTRON VALVES SCREEN GRID**

2-volt, 12/6; usual types, 4/-; R.C. or Power 6/- Post 3d.

**DARIO RADIO MICRO SUPER POWER**

2-v. or 4-v. G.P. . 5/6 Super Power . 7/6 Super H.F., 2-v. or 4-v. . 7/8 Post 3d.

**QUOTATIONS FOR SETS OF PARTS**

OVER 25/- IN VALUE (where possible)

**SPECIAL COUPON (73)**

FOR EVERY 30/- you spend retail YOU CAN buy ONE of the following for **3d.** each extra (on this Coupon)

H.F. Choke, Silk Loud-Speaker Cord, 9-volt Grid Bias, Pair Panel Brackets, .0001 Reaction, 2 mfd. Mansbridge, 100 ft. Insulated Aerial, 4- or 5-way Battery Leads, 30 ft. Coloured Connecting Wire, S.M. Dial, 12 yds. Lead-in, Fuse and Holder, 15 Nickel Terminals, 60K Coil, Permanent Detector, Battery Switch, .0003 and 2-meg. Leak, 6-pin Coil base, 12 yds. Twin Flex, 100 ft. Indoor Aerial.  
**NOT AVAILABLE ON HIRE PURCHASE GOODS**

# Easy Terms

**YOU CHOOSE  
YOUR GOODS  
WE PAY FOR THEM**

— Immediate delivery —  
No troublesome enquiries.

**ALL ADVERTISED GOODS  
IN THIS PAPER SUPPLIED**

Let us know your requirements.  
We will quote you per return.

**SEND FOR OUR  
ILLUSTRATED CATALOGUE**  
Giving details of all the latest Radio  
Receivers, Components and Accessories.

**New Times Sales Co.,**  
56, Ludgate Hill, London, E.C.4.  
Phone: Central 2716.

## SUPER-MICROPHONES

highly sensitive, latest improved watch type, will pick up the faintest sound, quiet conversation, etc., from a considerable distance, also strongly amplify and transmit Speech and Music through Loud-speaker or Headphones. Best Microphone obtainable for making Detectaphone, Deaf-aid, Loud-speaking Telephone, Public Address Speaker, Amplifier for Crystal or Valve Set, Electric Sound Detector, Experimental Work. Each guaranteed efficient. With long connecting cord attached. **6/6**

**MICROPHONE TRANSFORMERS**  
100 : 1 ratio, designed to obtain best possible results from above Microphone when connected to phones, loudspeaker or valve set. Prim. and Sec. terminals, fitted, full directions and diagrams of connections free. By return **4/6** post ..

**FREDK. ADOLPH, Actual Maker,**  
27, Fitzroy Street, London, W.1

### TRANSFORMERS.

30/- L.F., H.T. & L.T. for 22/6, 22/6 chokes for 17/6, 5 years' guarantee, post free. Small L.F. or choke, 8/6. Satisfaction or money back.  
**C. W. BELLS, 17, BRAMPTON STREET, CHELSEA, LONDON.**

## THE NEW CROXSONIA RADIO PANEL SENSATION

ASTOUNDINGLY LOW PRICES ANY SIZE CUT

POSTAGE FREE WRITE FOR NEW FOLDER

Size	Matt.	Gloss Black	Mahog. Finish
10 ins. x 8 ins.	1/8	2/6	3/4
12 ins. x 8 ins.	2/-	3/-	4/-
14 ins. x 7 ins.	2/1	3/1	4/1
16 ins. x 8 ins.	2/8	4/-	5/4
21 ins. x 7 ins.	3/1	4/6	6/2

Other Sizes  $\frac{1}{4}$ d.sq.in.  $\frac{3}{4}$ d.sq.in.  $\frac{1}{2}$ d.sq.in.

Above prices post free.  $\frac{1}{8}$  in. thick. Free from surface leakage. Will not fade.

WRITE, CALL, OR 'PHONE CLERKENWELL 7363.

Agents' Addresses:—  
JOHN HENRY SMITH, 139, Anlaby Rd., HULL.  
A. STREDWICK & CO., 27, The Mkt., CHATHAM.  
BOYNTON & CO., LTD., 73, St. Andrew St., B'HAM.  
Samples and Prices to Trade. DEPT. P.

**CROXSONIA**  
10, SOUTH STREET MOORGATE EC2

## TECHNICAL NOTES.

(Continued from previous page.)

available here, but I advise all experimenters who are seriously interested in the question of the design and the improvement of loud speakers (and I think this is one of the matters which is probably of most popular interest amongst radio fans) to take an opportunity either of obtaining a copy of the paper or of consulting it in the records of the Royal Society of Arts, which may be found at the Patent Office Library and at many other libraries.

The paper contains a complete survey of the development of loud speakers and of the physical and psychological questions which enter into the function of hearing. Questions of overtones, audibility, frequencies, etc. are gone into in most uncommon detail and references are given to the work of a large number of experimenters in different countries. Another very interesting point which is dealt with is the question of the power which is reproduced from a loud speaker and the relation of the output to the input energy.

### The First Moving-Coil L.S.

I would like to quote one short paragraph from the paper which would appear to indicate that to Sir Oliver Lodge belongs the credit of designing the first moving-coil loud speaker.

"Shortly after the introduction of the reed-driven cone came news of the development of the now well-known moving-coil hornless loud speaker. The principle of this form of drive had been patented as long ago as 1894 by Sir Oliver Lodge, who connected the moving coil to the diaphragm of a microphone and so caused it to actuate a second coil connected to a further microphone.

"This in turn operated a third coil which carried a light wooden disc forming the loud-speaker diaphragm. In this way he obtained a sensitive microphone relay for weak wireless signals transmitted by the induction method. Portions of the apparatus have been found and presented to the Science Museum by Sir Oliver Lodge and these are exhibited."

I am very glad to be able to quote this little paragraph as Sir Oliver Lodge has never been prominent in advancing claims on his own behalf, notwithstanding that he has been responsible for a great deal more in radio science than is commonly realised.

### Well-known Experimenters.

Amongst other well-known names mentioned in the paper are those of Dr. N. W. McLachlan, Captain H. J. Round, Captain A. G. D. West and Mr. P. K. Turner.

I would like to conclude my reference to this very important paper with just one other quotation.

"Bearing in mind the remarkable improvements that have been made during the six years under review, it would obviously be unwise at this stage to assume the mantle of prophecy.

"With the huge financial resources of the gramophone and motion-picture industries to foot the bill, it is probable that the most striking developments of the future will be made in the large auditorium instruments, and that the small domestic loud speaker will either remain in its present form or else will gradually give place to small-scale examples of these types.

British made.  
Prov. Pat.  
29144/28.

Grips like a vice

Holes for wanderplugs.



# BULLDOG BATTERY

Turned up end prevents top twisting when screwing up.

**Economise in H.T. Replace faulty cells easily. Tapping every 41 volts. Grips like a vice. Guaranteed electrical contact.**

**FOR FREE SAMPLE ENCLOSE stamped address—ed en-vel-ope.**

# BATTERY CLIP

**1/6** Postfree in 1 Doz. Lots and Per Doz. over.

FROM ALL DEALERS OR DIRECT TO—

Discard Flimsy Battery Clips and fit "BULLDOGS."

**CALYX MANUFACTURING CO.**  
945, Romford Road, E.12.

## ELECTRADIX BARGAINS

**April Edition  
of our  
Surplus Bargains  
in  
Radio and Electrical  
Goods ready**

Send stamped addressed envelope for large Sale List.

**ELECTRADIX RADIOS,**  
218, Upper Thames St., London, E.C.4

Free!

# ENGINEERS

ENGINEERING OPPORTUNITIES

A.M.I.A.E.  
A.M.I.C.E.  
A.M.I.E.E.  
A.M.I.MECH.E.

**A BOOK YOU MUST NOT MISS!**  
"ENGINEERING OPPORTUNITIES" is the most complete hand-book on Engineering Exams. and Courses ever produced. It describes over 60 Exam. and home study courses in all branches of Mechanical, Electrical, Motor and Civil Engineering, including WIRELESS.

**We ALONE Guarantee—"NO PASS—NO FEE"**  
This book should be in your hands—it is a mine of valuable information and advice. We offer it FREE. Write for your copy now, stating branch or Exam. which is of interest.

**BRITISH INSTITUTE OF ENGINEERING TECHNOLOGY,**  
101, Shakespeare House, 28-31, Oxford St., London.  
**IMPORTANT—NOTE NEW ADDRESS!**

The Picture Paper with the MOST News  
—SUNDAY GRAPHIC—

EVERYTHING RADIO ON EASY TERMS

Write to WOOLDRIDGE'S, 20 and 22, LISLE STREET, LONDON, W.C.2.

**T**HE unit illustrated in this week's White Print is intended to be regarded as something of a "de luxe" design, with exceptionally thorough smoothing and various refinements not to be found in the simpler types. Naturally, therefore, it is moderately expensive to build, the cost of the parts being about £7, without a cabinet.

The unit will give very large outputs without loss of "smoothness" in the current, provided, of course, that really good chokes are used. As a matter of fact, with a suitable type you will find that the unit will safely give much larger currents than any ordinary set, even quite a big one, can take.

**Excellent Smoothing.**

The special object we had in mind in producing the design was to cater for the larger type of set, where a considerable number of separate H.T. taps is required, and where smoothing and prevention of motor-boating is specially important. Accordingly, we provided four separate positive taps, all adjustable as to voltage, and the smoothing circuit is a particularly efficient one.

This smoothing arrangement is so good that on any ordinary mains the output is quite silent so far as a loud speaker is concerned. A faint hum is just perceptible on 'phones with a good-sized set; but, of course, one does not use 'phones with a large receiver. This, by the way, was only noticed during a test on rather bad and noisy mains.

If you look at the circuit diagram below you will see how this rather unusual degree of silence is obtained. The mains current, upon entering the unit, passes first through one of the chokes, and from the further end of this a 2 mfd. reservoir condenser is shunted across to negative (the choke, of course, is in the positive side of the circuit).

**The Detector Tap.**

At this point the current is fairly well smoothed, and would serve in many cases for a small set, but to get the special degree of silence at which we were aiming it is next taken through another smoothing choke, across the further end of which another reservoir condenser, this time of 4 mfd., is shunted to negative.

An extra device which helps to eliminate the slightest remaining hum will be found in the lead to one of the positive terminals (H.T. + 2). This terminal is intended for the detector valve of the set, and you will observe in series

**THE "P.W." "WHITE PRINTS."**

**A UNIQUE SERVICE FOR OUR READERS.**

**White Print No. 21. :: :: :: A D.C. H.T. Unit.**

This week we publish the twenty-first of our White Prints. This page may be easily and safely torn out—along the dotted line overleaf—and the "White Print" filed. In due course you will thus have available an encyclopædic collection of the best circuits used in modern radio practice. A "White Print" will be published on the last page every week in "P.W." until further notice.—THE EDITOR.

with the lead an extra choke, while from the terminal itself the usual 2 mfd. by-pass condenser is shunted down to negative.

This arrangement serves a double purpose: first it acts as an additional smoothing circuit for the detector valve. It prevents any faint hum which might come through

simple indeed. The voltages on H.T. + 1 (intended for the H.F. valve), H.T. + 2 (detector), and H.T. + 4 (L.F. and power) are adjustable in steps, and this will be found quite adequate for normal sets.

**Voltage Adjustment.**

It is done by means of a device called a "potential divider" or "mains potentiometer" of the tapped type. This component (in the make illustrated) has a series of sockets along the top, and in these sockets the plugs from the inner sides of the H.T. + 1, H.T. + 2, and H.T. + 4 terminals are inserted at suitable points to obtain the desired voltages. (A good high-resistance voltmeter can be used to measure these voltages.)

The terminal H.T. + 3 gives a continuously adjustable voltage, and this is intended for the screening electrode of screened-grid valves. The voltage in this case cannot be measured with a voltmeter, and so it should be adjusted by trial on a weak signal (quite easily done). The control here is by means of the variable resistance on the panel, which only carries a small current, and so need not be of the heavy-duty type.

**Earthing Precautions.**

Next comes the question of the earthing of the set, which must never be done direct when working from D.C. mains, in case the positive happens to be the one earthed at the power station. Instead, connect the earth lead to one of the earth terminals on the front of the unit, and connect the other to the "E" terminal on your set. This brings the 2 mfd. condenser C<sub>7</sub> in series in the earth lead, and prevents the mains from being shorted.

Another safety precaution which should be taken to comply with the latest recommendations is that

all the metal cases and iron cores of the components must be earthed. This is quite easy; just run wires round among the fixing screws of all these components in the unit, so that they are all "bonded" together, and then take a lead from this bonding to the earth terminal which you intend to use as the real earth, NOT the one you intend to connect to the "E" terminal on your set.

**COMPONENTS.**

- 1 Panel, 7 in. × 9 in. × ½ in.
- 1 Cabinet and baseboard, 14 in. deep.
- 2 Heavy-duty smoothing chokes, inductance about 20 henries, resistance not to be more than about 300 ohms each.
- 1 Smaller L.F. choke of about 20 henries (anything up to 100 henries is suitable, but 20 will do). Resistance here does not matter.
- 1 Potential divider, 10,000 to 25,000 ohms.
- 1 Variable high resistance, about 500,000 ohms maximum (a higher value can be used, if available).
- 5 2-mfd. condensers, rated at not less than 250 volts working, not test.
- 2 4-mfd. ditto (same rating).
- 7 Fully-insulated terminals.
- 3 Battery type plugs, flex, and adapter for connection to mains, wire, sleeving, etc.

the main smoothing filter on very bad mains from reaching the detector and being amplified up by the L.F. stages. Secondly, it acts as an effective anti-motor-boating device for this valve, and will suffice to secure stability with the great majority of sets.

From each positive terminal down to negative you will see that there is either a 2 or a 4 mfd. condenser, and while these are intended chiefly as by-pass condensers,

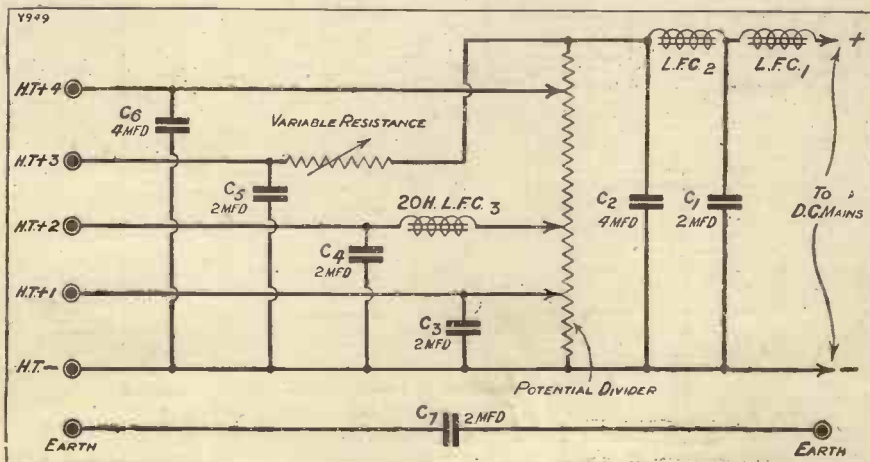

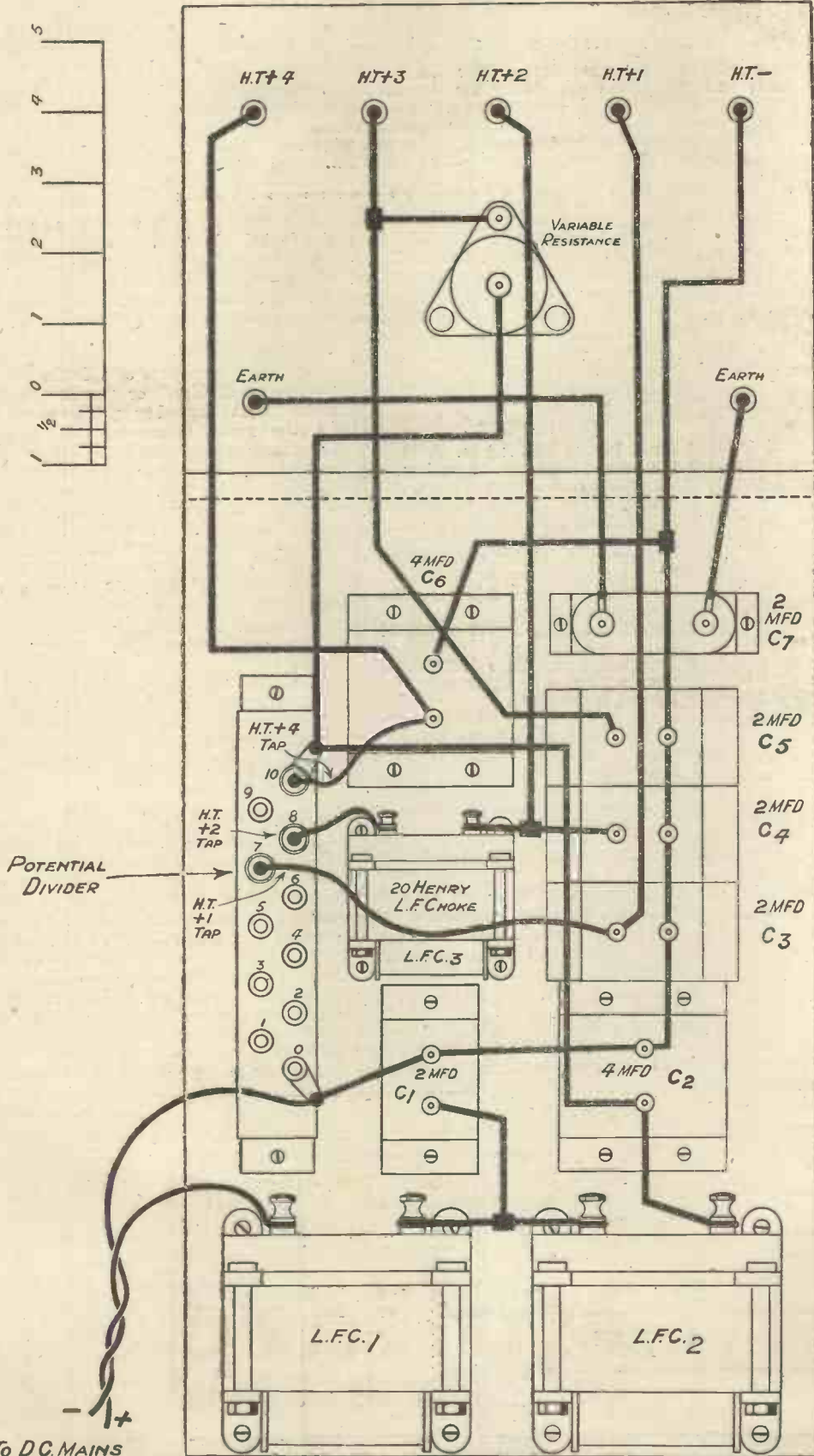

CUT ALONG THIS DOTTED LINE

WIRING DIAGRAM.

# IT'S RESEARCH THAT BREAKS RECORDS

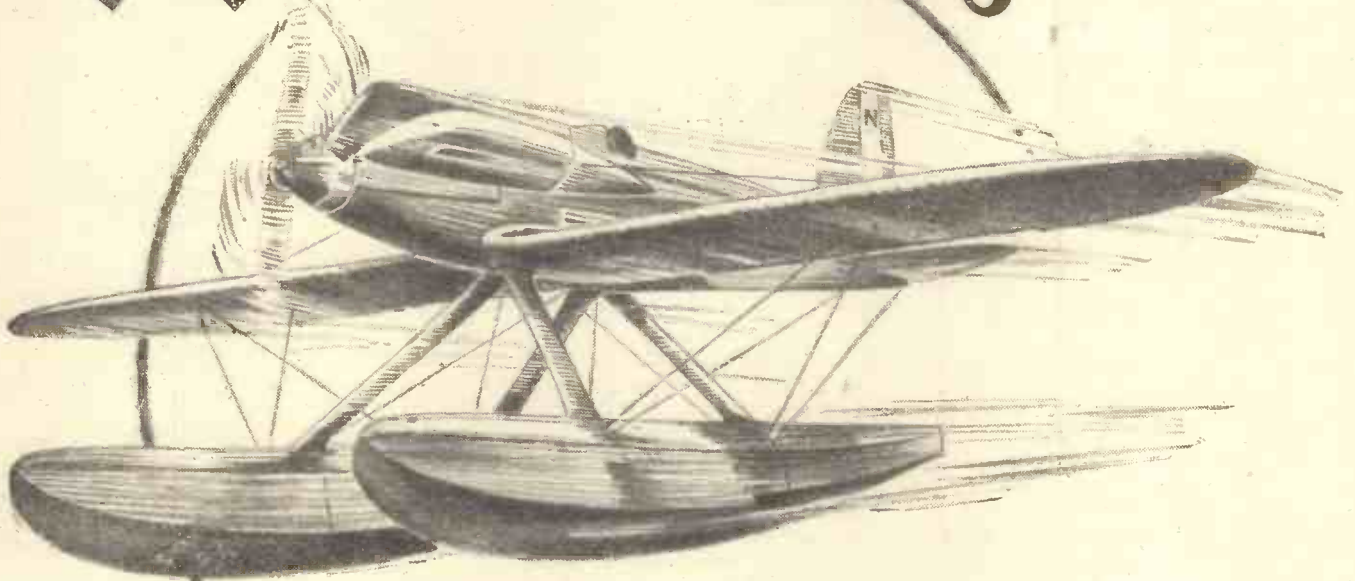

Because months of patient research have been devoted to their perfection, Mullard Pentode and Screened Grid valves break all records for super-efficient performance. They have the lowest current consumption combined with the highest efficiency of any valves of their type on the market.

We have never used the public as our research department. We wouldn't risk losing even one of our friends to satisfy an experiment, certainly not after all the years we've been together, up and down every European broadcasting station.

You can take our word for it, Mullard Pentode and Screened Grid Valves are perfect to the last detail, modern to the minute. Otherwise they wouldn't be stamped with the Mullard P.M. monogram.

## Mullard

**THE · MASTER · VALVE**

Advert:—The Mullard Wireless Service Co., Ltd., Mullard House, Charing Cross Rd., London, W.C.2.

# Famous Bi-duplex Wire-wound Components



RESISTANCE CAPACITY COUPLER  
 Type A £1 : 0 : 0  
 .. C 17 : 6  
 .. D 16 : 0

The word 'Bi-duplex' is known by wireless enthusiasts in every corner of the British Isles as a guarantee of efficiency and reliability. This famous winding which dates back as far as 1896 has been perfected in succeeding years, and its use has enabled us to-day to produce components of whose performance we are justly proud.

Look at our Bi-duplex wire-wound Anode Resistances—they are regarded to-day as the standard for comparison not only in this country but in many parts of the world. Not only do we make a complete range of standard Anode Resistances, but in addition, tapped and variable resistances—both Bi-duplex wire-wound—can be had in a wide range of values suitable for practically all requirements.

The R.I. & Varley Bi-duplex wire-wound H.F. Choke first became popular because of its wonderful degree of reliability—this advantage was later eclipsed by its phenomenal range of choking efficiency, and to-day it is probably the most popular H.F. Choke on the market.

Our Bi-duplex wire-wound R.C. Couplers—specified for the original Mullard Master Three—played no small part in popularising Resistance Capacity Coupling. The results obtained with these R.C. Couplers—as shown in the National Physical Laboratory Curves—stamp them for ever as being one of the big achievements of modern radio science.



H.F. CHOKE 9/6

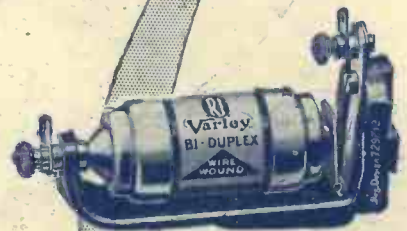

ANODE RESISTANCES  
 Prices, complete with Universal Holder for Vertical or Horizontal mounting, from 5/6 to 17/6.



THE MARK OF BETTER RADIO

Kingsway House, 103, Kingsway, London, W.C.2.

Telephone: Holborn 5303.

Printed and published every Thursday by the Proprietors, The Amalgamated Press, Ltd., The Fleetway House, Farringdon Street, London, E.C.4. Advertisement Office: Messrs. John H. Lile, Ltd., Ludgate Circus, London, E.C.4 (Telephone: City 7261). Registered as a Newspaper for transmission by Canadian Magazine Post. Subscription Rates: Inland and Canada, 17/4 per annum; 8/8 for six months. Abroad (excepting Canada), 19/6 per annum; 9/9 for six months. Sole Agents for South Africa: Central News Agency, Ltd. Sole Agents for Australia and New Zealand: Messrs. Gordon & Gotch, Ltd. Saturday, April 27th, 1929. R/R