

THE WIRELESS PAPER WITH THE LARGEST CIRCULATION

Popular Wireless

Every Thursday
PRICE
3d.

No. 312. Vol. XIII

INCORPORATING "WIRELESS"

May 26th, 1928.

The "ANTIPODES ADAPTOR"

Star Model



SPECIAL FEATURES THIS WEEK

Home-Made Headphones. Systematic Set Searching
 Radio Meters. L.F. Instability and Distortion
THE "SUMMER" ONE
 (An inexpensive and very easily transportable portable)

What Are The Short Waves Saying?

And a full description of the above illustrated Star Model of The "Antipodes Adaptor," the remarkable unit which enables one to transform an ordinary broadcasting receiving set into an efficient short-waver.

THE WINNER



In
**DARK BLUE
 CONTAINERS**

60 VOLTS **7/-**

66 VOLTS **7/6**

99 VOLTS **11/6**

9 VOLTS GB **1/3**

On
COST & SERVICE

these Batteries provide

**THE FINEST
 H.T. VALUE
 OBTAINABLE**

EVER READY ^{Regd}

BRITAIN'S BEST BATTERIES

Their pure tone makes listening worth while

THE NEW PHILIPS TRANSFORMER

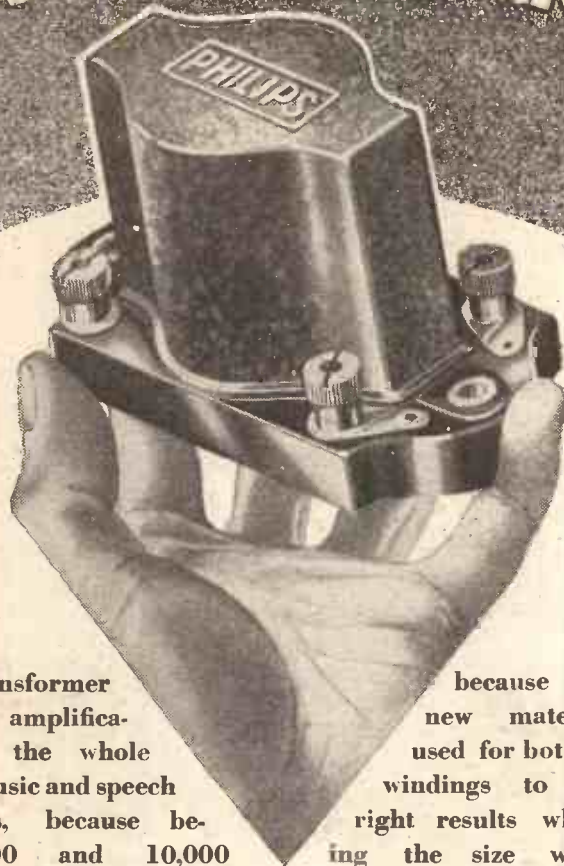

Philips Transformer gives even amplification over the whole range of music and speech frequencies, because between 200 and 10,000 cycles amplification is absolutely constant and at even as low as 50 cycles it is well over half of the maximum. Intermediate and high frequency oscillations are not amplified, because beyond 10,000 cycles amplification rapidly diminishes to zero. The size is convenient and compact

because special new materials are used for both core and windings to give the right results while keeping the size within the smallest limits. Consequently Philips Transformer ensures very rich tone and faithful reproduction, prevents distortion and maintains purity, takes little space on the mounting board and is easily fitted, even to existing sets. The ratio is 3-1. Dimensions: Base $3\frac{1}{8}'' \times 1\frac{3}{4}''$. Height 2".

25'

PHILIPS

for Radio

COSSOR brings them in



COSSOR Valves bring you the pick of Europe's broadcast on the wonderful Cossor "Melody Maker." They give you purity of reproduction as well as distance. Cossor Valves bring success to any Receiver. Use them in yours.

Post this Coupon today!

Please send me a copy of your large constructional chart, "How to build the Cossor 'Melody Maker.'"

Name.....

Address.....

P.W. 26/5/28

Cossor Valves improve any Set.

Popular Wireless

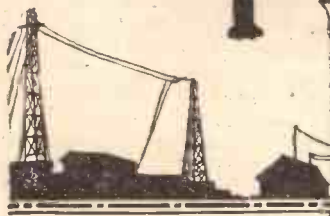

Scientific Adviser :
 Sir OLIVER LODGE, F.R.S.
 Editor :
 NORMAN EDWARDS.
 Technical Editor : G. V. DOWDING, Grad.I.E.E.
 Assistant Technical Editors: K. D. ROGERS, P. R. BIRD,
 G. P. KENDALL, B.Sc., A. JOHNSON RANDALL.

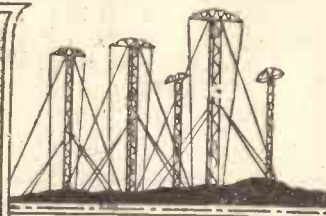

RADIO NOTES AND NEWS.

Touch and Go—Paradise Found—A Little Duck—This Season's Wagner—Portables—Bright Spots.

Rectification.

A FEW issues ago, in a rhapsody on the "Sydney" Two, I absent-mindedly ascribed the design of that set to Mr. G. V. Dowding. The fact is, the "Sydney" Two was an inspiration of Mr. G. P. Kendall, B.Sc., Chief of our Research and Construction Department, and the bouquet I mistakenly presented to Mr. Dowding is hereby cancelled and replaced by a laurel wreath for our invaluable Mr. Kendall. Mr. Dowding has plenty of trophies, anyway—and the following few paragraphs will amply compensate Mr. Kendall.

Amplification.

WE are indebted to G. A. S. (Ross-on-Wye) for a decisive testimonial to "Sid the Second" and, incidentally, a terrific answer to the Elston school of thought. In December last, he made the "Sydney" Two to our specification except that he used an "Ideal" 2-7-1 transformer, and apart from a slight lack of smoothness in reaction, on short waves only, he finds that it is the ideal set. It gives him something a.m. or p.m., at any time, and the praises he is good enough to sing about it make good reading for us all here. I doubt whether any design has enjoyed such a success.

And the Results.

OUR friend sends us his list of "kills." No less than fifty-six stations

have been received and identified. Ten of these were tuned-in on loud-speaker, eight of which were German stations and the remaining two Manchester and London. Besides Great Britain, the stations "took him to" nine countries, including America. Six stations were tuned-in on telephones, and worked up to loud-speaker strength, namely, 5 X X, 5 G B, Langenberg, Cardiff, W G Y and P C J J. Many other stations

were received but are not yet identified. On two, I repeat two, valves, gentlemen. And an indoor aerial.

Grand Finale.

G. A. S.—who knows what he is gas-sing about—has added two single-coil holders to this set, and is thus able to receive on all waves. Which revelation tempts me to make another, namely, that

MILLIONAIRE MARVIN'S MUSICAL MASTERPIECE!

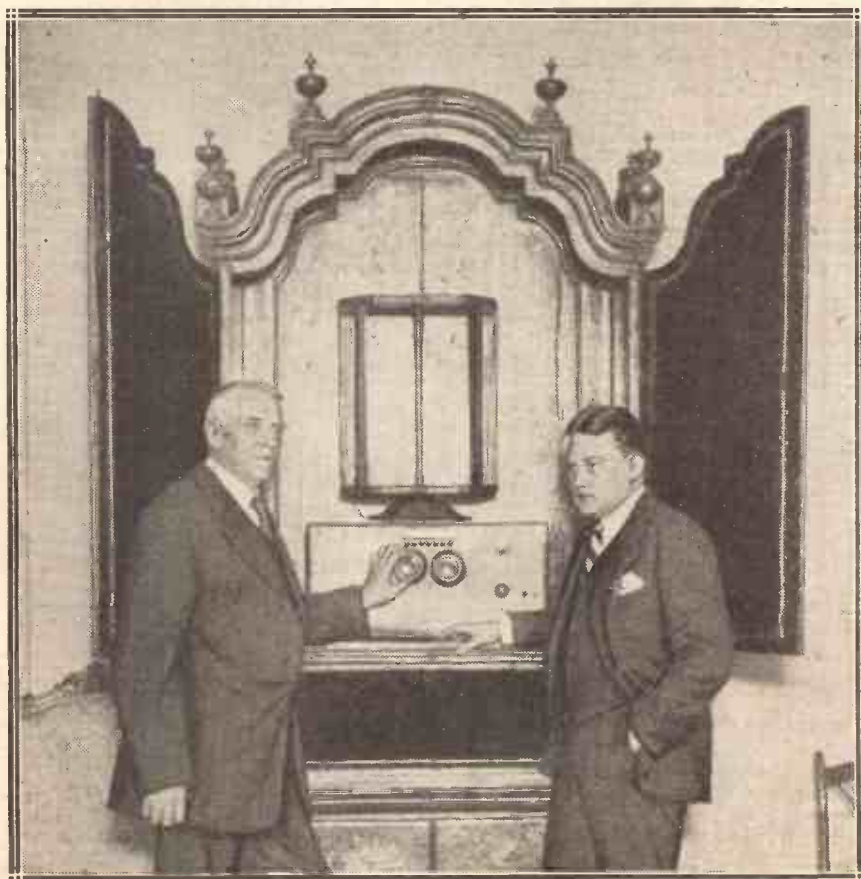

It took over five years to build this remarkable radio receiver, the property of Harry N. Marvin, a retired millionaire inventor. There are no tuning dials, but switches are provided, by means of which the programme of any one of ten different stations can be reproduced at will.

in the June issue of "Modern Wireless" there will be described the "Sydney Two De Luxe." This "last word" in design, whilst retaining all the virtues of the original "Sydney" Two provides for reception on all wave-lengths by means of single-coil changing, and is a monument to the skill of our Research and Construction Department. I confidently expect to hear news of it from scores of delighted readers.

This Season's Wagner.

WONDERFUL what we can get for half a sovereign a year! Sports of all sorts, stations of several nations, Captain Eckersley in full spate, the nightingale's mellifluous silences—and Wagner from "the Garden." *Sich* Wagner, too; the real grand opera stuff, all German and noisy. My outstanding impressions are: A lot of strong talk, I think from the orchestra; the painful effort in

(Continued on next page.)

NOTES AND NEWS.

(Continued from previous page.)

the voice of a male singer whose buttons must have been wired on; and a sense of increased admiration of Wagner's mind.

An Ingenious Escape.

SOMEONE played a funny trick on Marconi's the other day. Apparently quite in the ordinary way of business a person telephoned to their Central Radio office asking for a messenger to be sent to a City address to collect a radiogram. Messenger on arrival found the place locked, bolted and barred. Raised Cain with the bell and succeeded in raising the janitor also. Explained his errand and was admitted. Toddled up to the office of the firm he was after—and found a locked-in clerk, who expressed his gratitude for his release. That clerk should go far!

Touch and Go.

SNOOPING through Francis Bacon's "Novum Organum" (published in 1620), I hit on an interesting example of a great thinker feeling his way to a truth to be established long after his death—and missing it by an unlucky chance. He says, "So incredible did it appear to me that the images or rays of heavenly bodies could be conveyed at once to the sight through such an immense space, and did not rather take a perceptible time in travelling to us. But this suspicion as to any considerable interval between the real time and the apparent afterwards vanished entirely."

Hard luck! So near and yet so far. 186,000 miles per sec.!

Heard These?

HAVE you heard the story of the Aberdonian who asked for a rebate of 5s. in respect of his licence fee because he was deaf in one ear; and for a further rebate of 2s. 6d. because his wife could not listen-in, owing to his being a bachelor? And that one about the dweller in Auld Reekie (Edinburgh)—pronounced Enbro—who claimed damages from the B.B.C. on account of the disturbance caused to his gramophone by his neighbour's loud speaker. In a postscript he offered to swap his gramophone for a super-het. and a place on the free-list of the "Radio Times."

Portables.

THE "trade" is going "all out" on portables this season, to judge by the trade papers. But I incline to the view that the great mass of the public will not be quite happy until some genius finds a method of introducing aluminium into accumulators. Compactness is not everything; weight is the master-point, in these days of small cars and pillions.

Paradise Found.

WE shall soon need a modern Milton to sing the story of the radio listener's paradise. The latest claim comes from a chilly place—not at all inappropriate, I suppose—namely, the region of the Selkwick Mountains, Alaska. The place is 60 miles north of the Arctic Circle, and it is called Shungnak. Here reception is perfect throughout the twenty-four hours. and Mr. and Mrs. Moore,

Government school teachers, claim that their log is a record which will earn them the world's championship. Let 'em have it, and give me the sun and 2 L O.

America Realises It.

A NEW YORK message states that 1,500 "announcers" in America are to compete for a gold medal offered by the Academy of Arts and Letters, and the one that has the best enunciation and the purest English is supposed to be the winner. I have grave forebodings as to this. Are Americans fit judges of those two qualities? Besides, our Uncle Rex has the best enunciation, and the purest English is said to be heard in Aberdeen!

Answers to Queries.

HOW can I cure 'motor-boating'? Bore, carefully, a three-eighths hole in the petrol tank, one-eighth from the bottom. Shortly afterwards it will be observed that the boat ceases from moting. "What really is an insulator?" A lump of something connected in series with the

SHORT WAVES.

Sir Oliver Lodge describes the human eye as a radio receiver. Some of the ladies manage to do a good deal of broadcasting with it, too. —"New York Herald Tribune."

Mrs. A: "What do you think of our radio?"

Mrs. B: "Wonderful! Even your static is so much more powerful and distinct than ours." —"Science and Invention."

A prominent bookmaker has now installed the latest radio receiver procurable at a cost of several hundred pounds.

It is said he is very grateful to the public for the gift.

HIS RECEPTION.

Mrs. Listener (after having watched her harassed husband trying to tune in his newly constructed set for about two hours): "Got anything, dear?"

Perspiring Husband: "Yes, a headache." —"Popular Radio Weekly."

One of the Midland stations is broadcasting a "Summer" programme next week. What optimists!

EAR—EAR!

Rip: "Doesn't your wife enjoy the radio set you gave her?"

Snorter: "That's impossible, old man. It's all listening, you know." —"Science and Invention."

Dear Old Lady (entering wireless store): "I just want a cat's hair, please!"

When pogo-men were battering The roadway's concrete skin (A process most nerve-shattering), And digging themselves in,

Blind 2 L O

Said: "Here, you know, We cannot stand this din!"

"The world has cocked an ear for us, And soon we shall commence, The ether's realm is clear for us; The atmosphere is tense, And would you spoil The fruits of toil? It isn't common sense."

The pogo-men were practical, They felt that it would be An error more than tactical To act discourteously. Said they: "We'll drop Our tools and stop; In fact, it's time for tea."

Since London's such a riot, you'd Do well, I think, to go, When seeking peace and quietude, Quite close to 2 L O.

For calm and deep Shall be your sleep Whene'er they give a show.

"Touchstone" in "Morning Post."

aerial to provide a leak to earth, thus preventing aerial burn-outs. "Who invented wireless?" About 349 men, all Americans except one, who was called Geo. Washington. "What is gassing?" Noises made by the faces of people engaged by the B.B.C. to educate us.

World-Wide News Service.

A GUERNSEY amateur claims to receive 3 L O (Melbourne) regularly. At 8 p.m. on Sunday evening he hears 3 L O announcing that the time is 6 a.m. Monday, and he then listens to 3 L O giving, orally, the news received in Morse from Rugby. This note was published in a Guernsey paper, got across to 3 L O, was re-published in their own organ, which came to England and landed on "Ariel's" doormat. Here it goes again. Chinese papers, please copy. But, I say, what a wonderful world we live in.

Each End Alike.

THEY have it in Australia; we have it here. And I presume that the bears at the North Pole and the penguins in the Antarctic also discuss it. What? Private enterprise or Government control? The latest reported attack on radio is that of Mr. Fenton, an Australian M.P., who is so hurt to know that the licence fees do not accrue to the Government that he is conducting an agitation in favour of the State control of broadcasting. His slogan is, of course, "Monopoly," but what is worse than a State monopoly? Spanish tobacco! French matches! Ugh!

New Menace to Cables.

WHEN cable interests begin to say how bad radio is, how it can be tapped, how it fades, and so forth, we in return point out how vulnerable are cables, how they can be tapped, cut, eaten by sharks, damaged by rock-edges; how cable-stations can be bombarded, bombed, raided by landing-parties, etc. Now, it seems, peace hath her dangers no less than war, for the cable at the Isle of Man was recently burnt through by a picnic fire, and the island was cut off from the mainland for 28 hours!

A Little Duck.

A CANADIAN lady, writing to an English agricultural paper about the absolutely too heavenly and divine radio programmes of the Manitoba Agricultural College, states that about three years ago they put on a poultry course. This aroused my sluggish interest, because I am partial to a poultry course, with stuffing, force-meat and a ham. But on reading further I found the thing to be a matter of "marks," with a diploma at the end. Personally, I prefer a cheroot and a brandy liqueur at the end of a perfect course.

Bright Spots.

MAY 28th.—5 G B. Our old friends "The Roosters." May 29th.—2 L O and 5 X X. A mystery play, "The Survivor," with an interlude by Michael Hogan and our Mabel. I have seen an outline of the play and it looks good. May 31st.—5 G B. Popular orchestral programme by the Birmingham Studio Symphony Orchestra. An Australian singer, Gertrude Johnson, is to take part.

ARIEL.

MORE and more broadcasting stations are establishing short-wave relays. The four chief pioneers are still at work. PCJJ, once of Eindhoven but now located at Hilversum in Holland, works, regularly on 30.2 metres on Tuesdays, Thursdays and Saturdays, his transmissions being finely received in many parts of this country.

As a rule his signal strength is best during daylight hours, so that this is a transmission to look out for during the coming summer. Like most short-wave stations, PCJJ is only at his best, strange as it may seem, if you are far enough away from him. The ultra-short waves have a funny little habit of skipping an area of varying width round the transmitting aerial; hence those who live on or near the coast of East Anglia may complain of weak signals or bad fading.

Popular "Yanks."

The great American station WGY began relaying a long time ago. Both of his main short-wave children continue to give an excellent account of themselves. On 31.4 metres 2XAF is to be heard on Mondays, Tuesdays, Thursdays and Saturdays, whilst 2XAD is on the air with a wave-length of 21.96 metres on Sundays, Tuesdays, Wednesdays, Thursdays and Fridays. In addition to their great strength and to the ease with which they can be received with an efficient short-wave set these two transmissions are exceedingly interesting since they serve as a very striking example of the utterly different properties that are associated with the various wave-bands below 100 metres.

In winter-time 2XAF is nearly always an excellent signal, showing fine strength and very little fading, but as the summer draws on it becomes less and less reliable, though he has usually a strong period just before dawn breaks. Exactly the opposite is the way in which 2XAD behaves. He is a splendid summer signal, but in winter-time he is generally only moderate, unless he is at work early in the evening.

The reason for these apparent inconsistencies is this. Waves of the order of 30 metres travel best when it is dark over the whole of the distance covered. Since Eastern Standard Time is five hours behind our own it is six o'clock in Schenectady when we tune in 2XAF at 11 p.m. Darkness therefore prevails between the transmitting and the receiving aerial in winter-time. As summer approaches it is broad daylight in Schenectady at 11 p.m. over here, and at mid-summer the only time when we can hope to hear 2XAF well is at about 3.30 a.m. in the morning.

A Famous Pioneer.

Ten metres lower down the scale conditions are entirely different. Here reception is at its best when it is daylight at either the transmitting or the receiving end. Hence we obtain strong signals from 2XAD during the summer and hear him well in winter-time only when he is doing an afternoon transmission, as for instance, when he is relaying an account of a football match, or carrying out a test. The reader

WHAT ARE THE SHORT WAVES SAYING?



 Some reliable information regarding
 the activities of the broadcasters
 operating on the short waves.
 By T. BELL.

may think it strange that PCJJ, whose wave-length is quite close to that of 2XAF should have the greatest signal strength in broad daylight. The reason is probably that the one station is so comparatively close and the other so distant.

The fourth pioneer is KDKA, who has been relaying his main transmissions on a variety of short wave-lengths for a long time now. KDKA may be regarded as an all-the-year-round station since he seldom uses less than two wave-lengths below 100 metres, and occasionally employs as many as three—"you pays your money and you takes your choice!"

Smaller Fry.

The most powerful transmission is that whose wave-length is at present 62.5 metres, though it has varied during the last couple of years between 58 metres and 64 metres.

Usually it is receivable at good strength at almost any time of the year, though last summer for some unexplained reason it was barely audible for a couple of months. In addition, there is a transmission on 26.8 metres which is generally well received in summer-time, and another, just started, on a wave-length in the neighbourhood of 43 metres.

Amongst the more recent of the American short-wavers there are many which deserve attention. Prominent among them on 16.02 metres is 2XG of Rocky Point, Long Island, who is usually to be heard working on Mondays and Fridays at about 6 p.m. This station has an enormous reserve of power, and if you happen to tune him in when he is really letting himself go you will be astonished at the enormous volume of sound received even with a rectifier and a single low-frequency valve. Normally, he is at loud-speaker strength on favourable evenings with two note-magnifiers.

WLW has a short-wave relay on week-days with a wave-length of 52.02 metres. Though the power employed is only some 500 watts, loud-speaker reception is frequently possible on a three-valve set. On 54 metres WCGU of Brooklyn is regularly at work from 11 p.m. onwards,

and WIZ transmits experimental programmes at frequent intervals of 43.35 metres. Dropping down the scale, we have on 30.91 metres 2XAL, the short-wave relay of WRNY. This station is at work from midnight onwards on Tuesdays, Wednesdays, Fridays, and Saturdays, and excellent reception is often obtained, especially in winter-time.

Of the more distant transmissions 3LO of Melbourne, Australia, on 32 metres, is that which is most attractive to us since it comes from a far-away portion of our own Empire. Try for him on Sundays from half-past six onwards. Both signal strength

and quality are often nothing short of amazing.

European Stations.

Two wonderful stations are those in the Dutch colony of Java. The senior of these is ANH, which began operations a year or more ago, and surprised all short-wave enthusiasts by the excellence of his transmissions. He has now been rather outdone by the new station ANE. The former works at present only on Saturdays between 12.40 and 2.40 p.m., with a wave-length of 16 metres; the latter is to be heard on Tuesdays and Thursdays between 4.40 and 6.40 p.m. on 31.93 metres and on Mondays between 12.40 and 2.40 p.m. on 15.93 metres.

With the exception of Holland it was some time before European countries realised the possibilities of short-wave broadcasting. We have now a B.B.C. relay station, 5SW at Chelmsford, which works on 24 metres and transmits every evening from 7 p.m. onwards. Don't forget the skip area if you find that you cannot receive 5SW well. Little of him is heard in this country except in places a good many miles from Chelmsford. Quite a number of Continental countries are now blossoming out as short-wave transmitters. Vienna has a fine transmitter whose call sign is ATH, working on a wave-length between 43 and 44 metres. Germany is responsible for Docberitz with a wave-length of the same order. Rome has been busy for some time past on a wave-length of 45 metres with station IAX. This is a splendid transmission, coming through usually with hardly any fading.

France's Short-Wavers.

Though the Eiffel Tower was the first of all broadcasting stations, France lagged behind until recently in the matter of short-wave work. Now she has three really fine transmissions, all of which should be looked for. Radio LL works frequently on 61 metres, coming in at great strength; Lyons may be picked up on week-days between 4.30 and 5.30 p.m. on 40.2 metres, and the Eiffel Tower is now conducting experimental transmissions on 31.1 metres either in the mornings or in the afternoons. The strength obtainable from this station is simply astonishing, and fading is the exception rather than the rule.

Lastly, mention must be made of the amateurs, who are at their busiest during most of the day on Sundays.



If your 'phones break down, or if you have a "dud" pair on hand, you can easily convert them into electro-static reproducers at negligible cost.

By A. V. HORT, B.A.

ELECTRO-MAGNETIC telephones are reliable pieces of apparatus, and it is not a common event for them to fail, unless, of course, they are grossly overloaded so that the windings are burnt out. Failures due to loss of magnetism by the permanent magnets are bound to occur in time, but good magnets will remain sound for a very considerable period. It is distinctly annoying, however, to be cut off from the broadcast programme when the 'phones do chance to give out. One has a perfectly good receiver working, and no means of converting its output into audible sounds.

Telephones operating on the electro-static principle have received little attention from designers of this class of accessory, mainly because, in simple forms at any rate, the electro-static instrument is not nearly so sensitive as its electro-magnetic counterpart. The attractive feature of the electro-static telephone is the ease with which it can be constructed. In fact, if your headphones break down, you can in a few minutes convert them to the electro-static type, so that you can get signals through, even if they are weaker than before.

A Simple Test.

An experiment with the parts of a fixed condenser will show you the possibilities in a moment. All you require is two pieces of tinfoil about 2 in. square, and three slips of mica of slightly larger area. Put the tinfoil and mica together to form a mica dielectric condenser, and bind them in position with a piece of adhesive tape.

It is important to note that it is impossible to use electro-static telephones unless the receiver is fitted with an output filter. The condenser you have made up is to be connected across the output of the receiver, and unless there is a choke to pass the direct H.T. current, there will be no supply for the anode of the last valve. (See Fig. 3.)

Connect two leads from the output of the receiver to the two pieces of tinfoil, and hold the little condenser close to your ear. You will find that you can hear the programme. The sounds will not be loud, and they will be rather "scratchy." The effect

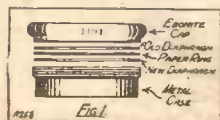

is that the L.F. impulses passing through the condenser are causing a mutual attraction and repulsion of the pieces of tinfoil. These are acting as small vibratory diaphragms. If you soak the whole condenser in melted wax and clamp it tightly together while it is setting, you will not be able to get any sound from it at all.

From this experiment you will see that the parts needed for an electro-static earpiece are two pieces of thin metal, preferably springy, and something to hold them a small distance apart. This is most easily accomplished in practice by making use of the earpieces and diaphragms of a pair of ordinary headphones.

If you wish to make the conversion permanent, take out the permanent magnets and pole-pieces, but there is actually no need to disturb these.

Take off the cap of an earpiece and remove the diaphragm. You will probably find also a thin paper ring under the diaphragm. If there is not one, cut one out. Make it of the same external diameter as the diaphragm, and about 1/8 in. wide. Cut out also a disc of metal of the same size as the diaphragm. Any metal will do, but the disc must be quite flat. Now you are ready for a preliminary trial of the earpiece. Assemble the parts as shown in Fig. 1, the paper ring being placed between the two diaphragms, with the original diaphragm uppermost. Connect one lead from the receiver to the case of the earpiece (assuming that this is of metal), so as to connect with the new diaphragm. Scratch a little of the paint off the top diaphragm, where it shows through the hole in the centre of the

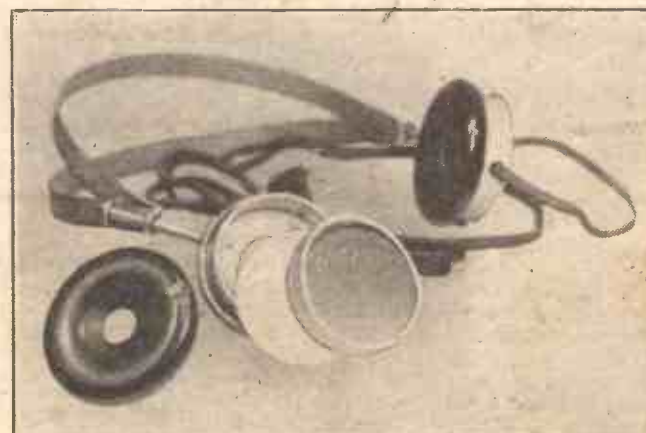
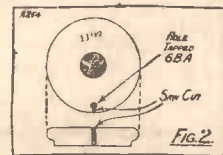

Showing one "converted" earpiece, with the two diaphragms, the paper ring and the cap with the contact screw in position. These home-made telephone receivers are not, of course, as sensitive as the properly manufactured type, but they give very clear results, and can be easily made with simple materials.

cap, so that you can hold a lead in contact with it at this point.

Signals should sound quite clear. If they are scratchy or very faint, try separating the diaphragms a bit more by inserting another paper ring between them.

More Permanent.

To make a more permanent job of the top connection, follow the diagram, Fig. 2. Make a sawcut in the edge of the cap of the earpiece, drill a small hole at the end of the cut, and tap the hole 6 B.A. Countersink the hole, and

put in it a 6 B.A. countersunk screw. When you have screwed the cap hard down on the diaphragms, turn this screw home till it makes contact with the top diaphragm. You will have to scrape off the paint round the edge to ensure a good contact. Solder the end of an insulated wire to the head of the bolt, and carry this lead away down the sawcut. Be careful that no uninsulated portion of this lead touches the metal case.

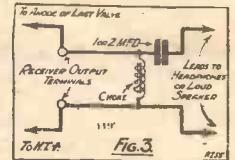

'Phones and Loud Speakers.

Headphones made in this way are handy in an emergency. They are also suitable for use in conjunction with a loud speaker. When the loud speaker is working and someone wants to listen with headphones, the usual procedure is to connect the 'phones in the receiver circuit so that they do not get too much volume, or to put a resistance across or in series with them. As the electro-static 'phones described are not nearly so sensitive as the ordinary pattern, you will find that quite good headphone strength is obtainable when they are connected actually in series or parallel with the loud speaker.

ODD ITEMS.

The aerial power of the Chelmsford, 5SW, short-wave experimental station is 15 kw.

Forty turns of 24 D.C.C. wire on a 2 1/2 in. cardboard tube, with a .0003 or .0005 variable condenser connected across it, constitutes an excellent wave-trap; to connect it to the set, wind the aerial lead round and round the outside of the coil for about a dozen turns.

When trimming an ebonite panel the clogging of the file can largely be prevented by covering it with French chalk.

It is rumoured that a new high-power station is to be erected at Oslo?

The "ANTIPODES ADAPTOR" STAR MODEL

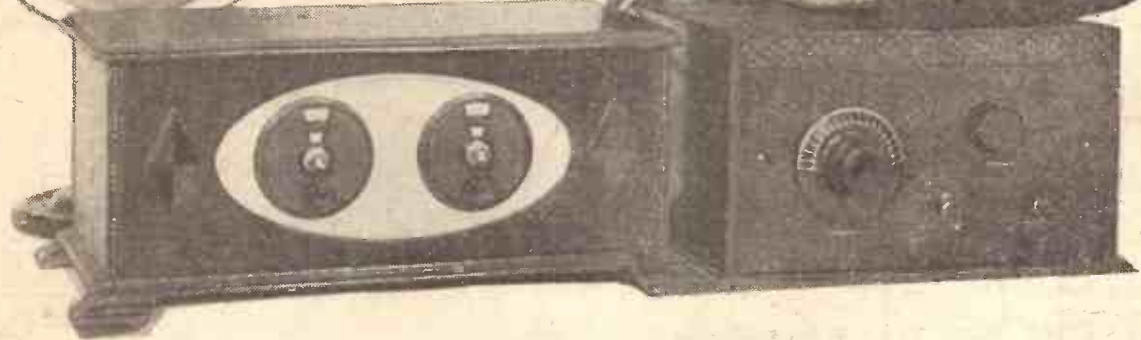

FOLLOWING upon the publication of the "Antipodes Adaptor" in "P.W." No. 303, several requests have been received from readers for a de-luxe version incorporating an upright panel, base-board, and slow-motion dials.

The original version, it will be remembered, was designed with a view to keeping the cost of construction as low as possible, and consequently such "luxuries" as slow-motion dials were purposely omitted, their

* * * * *

In response to many requests here is the de-Luxe version of an easily-made one-valve unit, which will enable YOU to pick up Australia direct.

Designed and Described by
G. T. KELSEY.

* * * * *

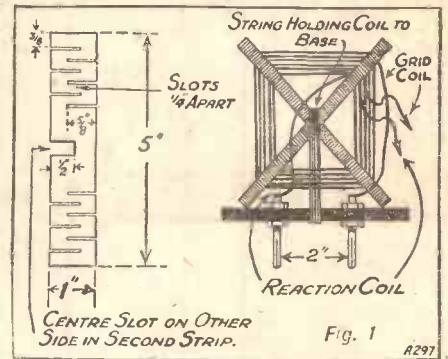

that the unit is designed to plug into any "straight" set with one or more L.F. stages, thereby turning it into an efficient short-wave receiver.

Let it be said at the outset that the Star Model illustrated on this and following pages is undoubtedly an improvement upon the old arrangement. In the first instance—and this is a very important

point in connection with short-wave receivers—the use of slow-motion dials makes the set much more simple to operate.

(Continued on next page.)

YOUR SHOPPING LIST.

- 2 .0003 variable condensers (Igranic in original unit. Any good make).
- 2 Slow-motion dials (any pattern giving a really smooth slow drive).
- 1 Grid condenser and leak, .0003 and 2 meg. (Clarke, Dubilier, Igranic, Lissen, Mullard, T.C.C., etc.).
- 1 Valve holder, anti-microphonic type (Benjamin, Bowyer-Lowe, Burndept, Burne-Jones, Igranic, Marconiphone, Pye, Redfern, W.B., etc.).
- 1 Single-coil mount (Burne-Jones, Lotus, Peto-Scott, etc.).
- 1 Potentiometer, 490 ohms, baseboard type (Lissen in original. Any similar type. 200 ohms, will serve).
- 1 Ebonite panel, 12 in. x 7 in. (any good branded material).
- 1 Small ebonite sub-panel, 2 in. x 5 in.
- 1 Cabinet (see note in text re size), and baseboard 8 1/2 in. deep.
- 1 Valve plug (this can be home-made from an old valve base if desired. Obtainable from Messrs. Lectrolinx, Lissen, etc.).
- 1 Sheet of copper, 12 in. x 7 in.
- 1/2 lb. of No. 22 D.C.C. wire, and ebonite, etc., for construction of cross former.
- Flex, clips, valve legs and pins, and Glazite, etc.

places being taken by—shall we say—the rather crude method of extension handles.

Crude it may have been, yet judging by reports many readers succeeded in hearing signals from the "Antipodes," which was a good indication of its efficiency.

For the benefit of readers who did not see the original article it should be explained

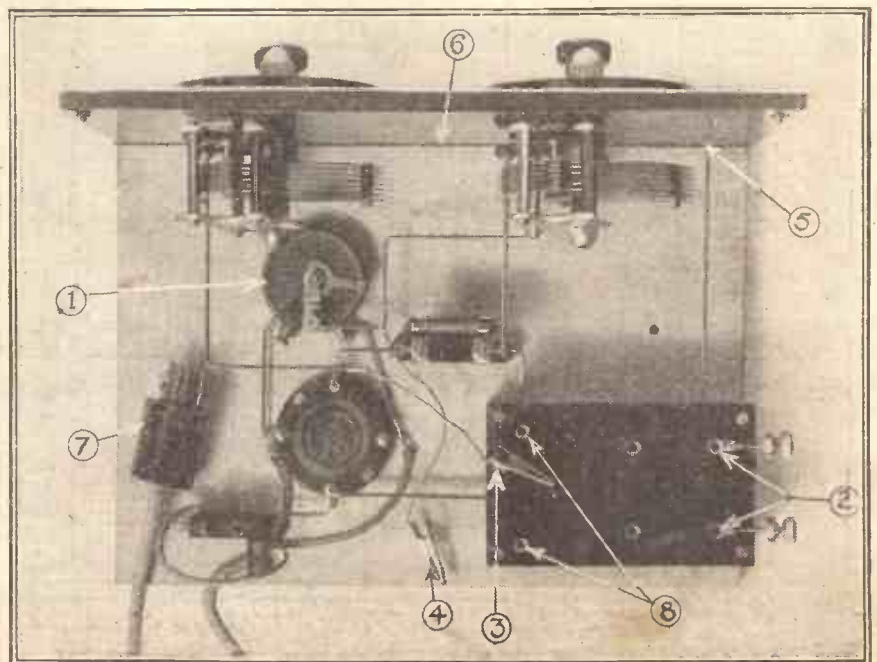

(1) Potentiometer; (2) terminals fixed to soldering tags; (3) reaction clip; (4) grid-coil clip; (5) wire joined to screen; (6) metal screen; (7) the plug that goes to your set; (8) cross-coil mounted here.

THE "ANTIPODES ADAPTOR" STAR MODEL.

(Continued from previous page.)

Further, the troubles from hand-capacity effects, to which all short-wave sets are prone, have been cut down very considerably by the use of a copper panel screen.

For those readers who are technically inclined, the circuit diagram is shown in Fig. 2, from which it will be seen that the arrangement remains almost the same as the original circuit. It was felt that little could be done to improve matters in this respect; however, there are two small modifications, a few words about which may be of interest.

A Valuable Refinement.

The first is the inclusion of a potentiometer. As a general rule the circuit is most sensitive with the grid leak connected to L.T. +. On the other hand the smoothest reaction control is often obtained

with the leak to the opposite pole of the accumulator. Quite obviously, both these features are very desirable in a short-wave set, and thus, by a potentiometer with the grid leak connected to the slider, it is an easy matter to place the grid return as near to the L.T. + end as is consistent with smooth control.

Improved Coils.

Next, then, we come to the other improvement, and this is in connection with the cross coil. By arranging the grid and reaction coils as two separate windings on the cross former, the moving vanes of the reaction condenser can be placed at earth potential—another step in the elimination of hand-capacity effects.

Despite the fact that the set is a de-luxe version, there are so few components in it that the total cost should not be very much greater than that of the original adaptor. There is certainly a cabinet to consider, but the extent of the "decorations and elaborations" in this respect is a point which can be adjusted to suit individual requirements.

As will be seen from the various illustrations, the cabinet employed for the original

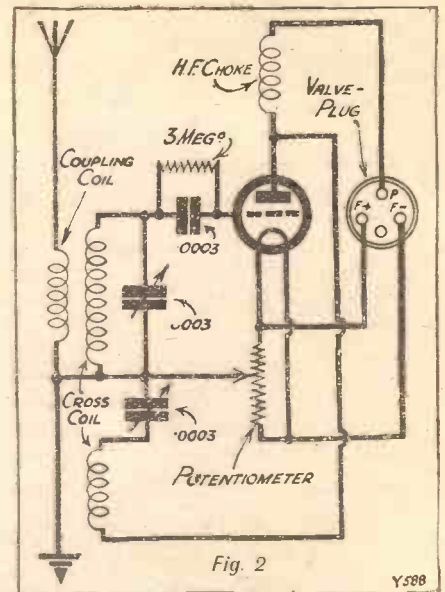

Fig. 2

Y588

adaptor is rather a handsome affair, but it may be of interest to mention that the oval front was home-made from plywood. If it is desired to make a replica of the original as far as the casework is concerned, then a cabinet 18 in. long will be required, whereas without the oval front one having a length of 12 in. will suffice.

A full "shopping list" is given elsewhere in the article, and little else need be said in this respect.

The first part of the constructional work is in the preparation of the panel. First, it should be scribed to conform with the panel lay-out diagram. It should then be clamped to the drilling board with the copper screening sheet underneath. This method possesses the advantages that both the panel and screen are drilled in one operation, and also the holes in each become accurate in relation to one another.

If you have chosen to make the set exactly to the original, then a sheet of Bristol board, which has previously been thoroughly dried in an oven, should be placed in front of the panel and holes made in the appropriate positions.

The Sub-Panel.

The panel and screen (and, if used, the Bristol board) should next be secured to the baseboard. The use of a reasonably thick baseboard dispenses with the necessity for angle brackets, since ample support is obtained from the wood screws along the base of the panel.

This stage reached, let me digress for a few moments to give some details of the sub-panel. All the necessary dimensions for cutting and drilling can be obtained from the back-of-panel diagram, and when prepared it should be secured to the baseboard by means of two small wooden end pieces about 1 in. high. Two blocks of wood, the same length as the end pieces and about 1/2 in. square, form a convenient method of fixing, either by glue or wood screws.

As will be apparent from the photographs, this small sub-panel is fitted with six valve legs. Under the two end ones (on the right looking from the back) soldering tags are fixed to which, ultimately, terminals are soldered for the aerial and earth leads.

The few components which remain to be

(Continued on next page.)

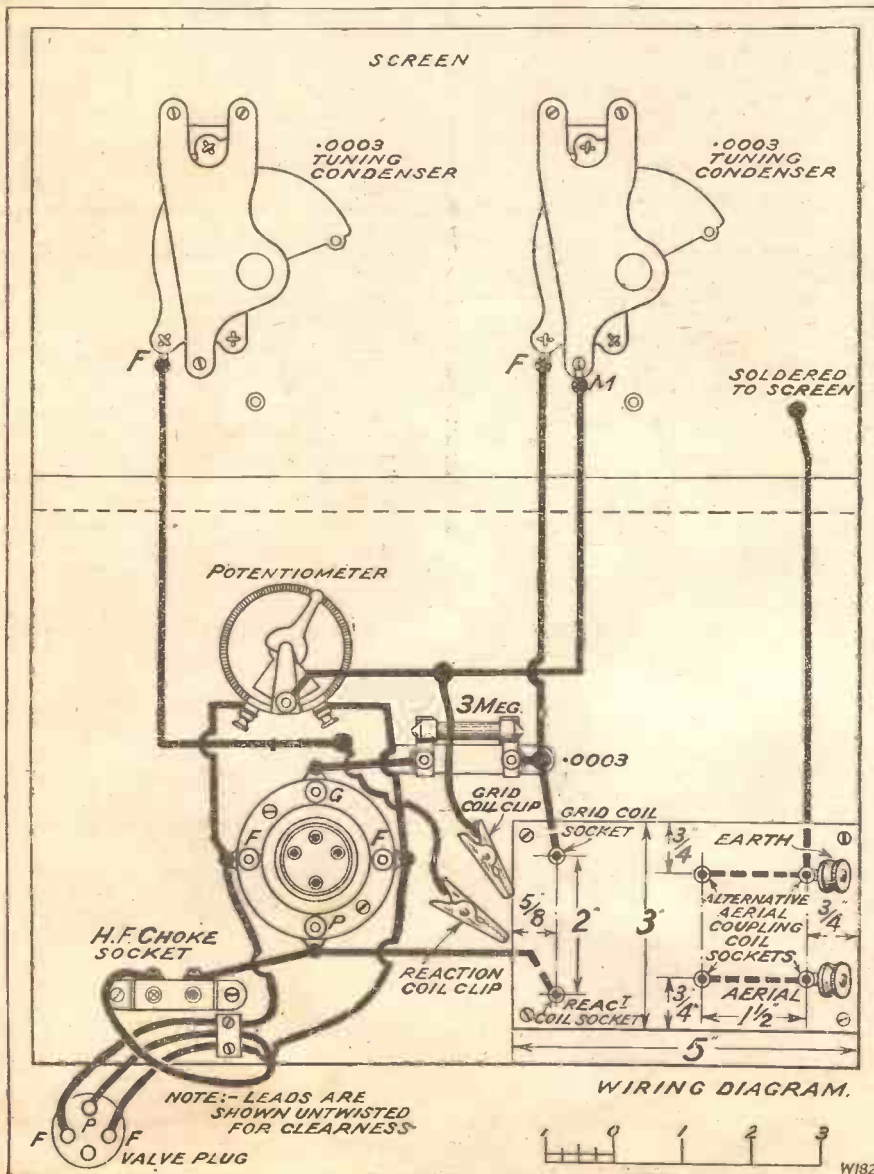

**THE
"ANTIPODES ADAPTOR"
STAR MODEL.**

(Continued from previous page.)

fitted can next be dealt with, and when all are secured it only remains to make what few connections there are.

Those readers who read the original article will recall that there was a special way in which to connect the filament leads to the plug in order to ensure that a particular one went to L.T. +. With the new design this can be ignored, and it does not matter which way round the leads are connected since adjustments can be made on the potentiometer.

the outer winding should each be connected to a pin. Contact to the two wires in the centre is made by the use of spring clips. In passing it should just be mentioned that the outside winding on the cross former is the grid winding and there is, therefore, a right and wrong way of plugging it into the sub-panel.

In the de-luxe model the aerial coil, which, in the original version had only a wooden rod for support, now has a small base all to itself. The coil consists of about five turns, and all details as to mounting can be gathered from the drawing in Fig. 3.

Now remove the detector valve in your present set, place it in the adaptor and in its socket fix the plug. That simple operation connects to the unit all the necessary batteries, and with the aerial and earth leads attached and the 'phones on, it will be a simple matter to find an

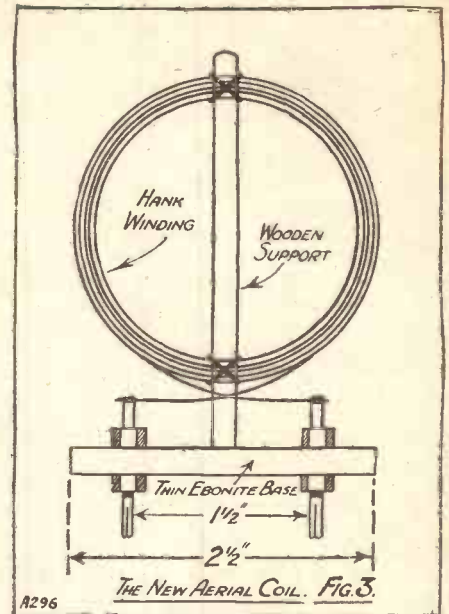

A296

answer to that all important question of "will it oscillate?"

First, with the grid tuning condenser (the left-hand dial) at zero, increase the capacity of the reaction condenser until the set commences to oscillate.

An Oscillation Test.

If any doubts exist as to whether the set is oscillating, touch with a moistened finger the grid socket of the cross coil, whereupon, if such is the case, a double "click" will be heard, one upon touching and one when withdrawing the finger.

The failure of the set to oscillate may be due to the use of insufficient H.T. voltage, and if trouble exists experiments should be made in this direction.

The set is now ready for testing on signals.

With the reaction condenser so placed that the set is just oscillating, and commencing with the tuning condenser at zero, slowly turn this latter until a "chirrup" is heard. If it is a carrier-wave it should of course be resolved in the usual manner by decreasing slightly the capacity of the reaction condenser.

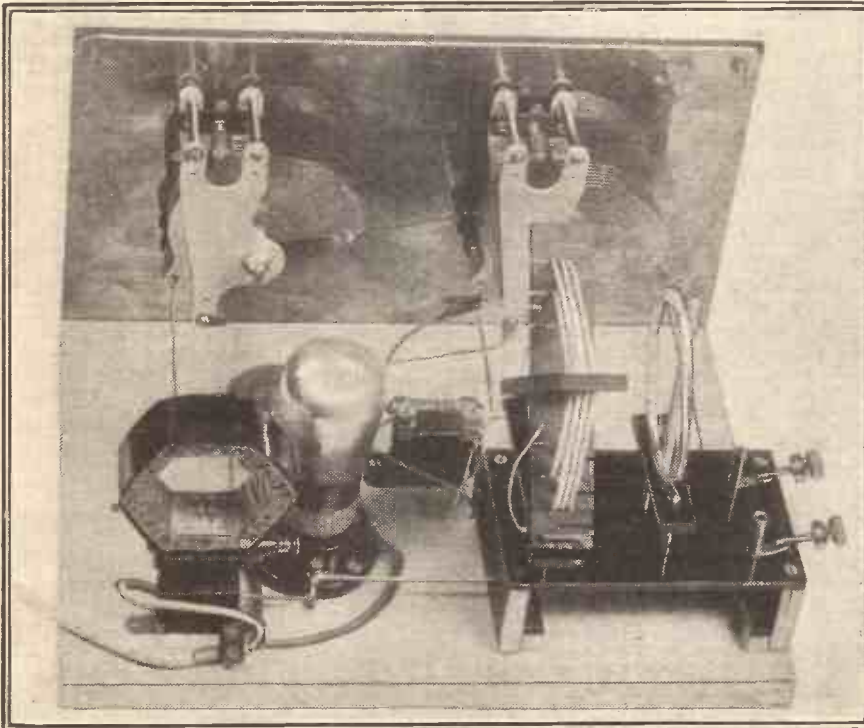

The little "bridge" near the plug-in coil is used to hold the cable firmly in position.

Having, it is hoped, made the set constructional work quite clear, the next procedure is in the making of the special coils. First comes the cross former, all the required details for the construction of which can be obtained from Fig. 1. As was mentioned previously, the windings are slightly different from the original, and it would therefore perhaps be advisable to go rather fully into this matter.

Completing the Coils.

Commencing in the second slot from the centre, having, of course, secured the end of the wire, wind on three turns spaced about 1/8 in. Next, cross over and, being careful to proceed in the same direction, wind on a further three turns in the next slot up, at the termination of which the wire should be cut off and secured.

The fourth and fifth slots from the centre carry the second winding, which is done in the same way and same direction as the first winding.

With regards to the connections, the start of the inner winding and the end of

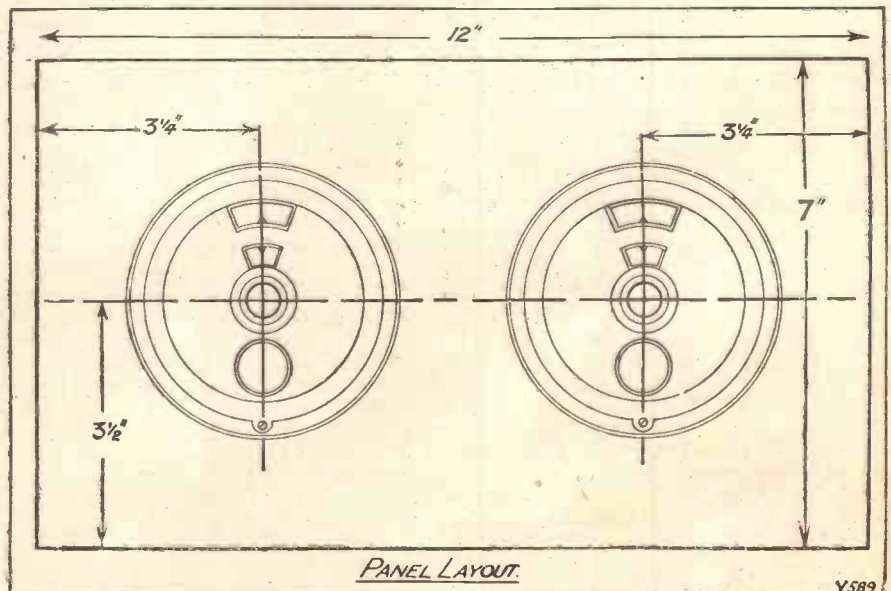

Y589

THE ROW ABOUT 5 G B.

Further Details of Captain Eckersley's Hectic Manchester Meeting.
By THE EDITOR.

MORE explicit details are now to hand regarding Captain Eckersley's recent visit to Manchester, when, during question time, the acrimonious nature of the questions fired at the gallant captain occasioned his now famous retort that people in Manchester seemed to think everybody at the B.B.C. blithering idiots.

But there is never smoke without fire, and it is interesting to look into this debate, at which "P.P.E." gave as good as he received. According to authentic Press reports, there was a first-class display of amateur radio talent at this meeting, but it seems that the questions which were fired at Captain Eckersley were of such a nature

NEXT WEEK.

SPECIAL BIRTHDAY NUMBER.

that rational answers by him were made almost impossible.

The chief bone of contention seems to have been 5 G B, and speculation was rife as to Captain Eckersley's interpretation of its possible consistent range for good reception. Captain Eckersley did his best to try and make it clear to the Manchester hecklers that Daventry Junior is, and always has been, purely an experimental station.

Our readers will remember that this is absolutely true, for 5 G B was erected solely with the intention of providing the B.B.C. with an experimental station wherewith to obtain the necessary data before the Regional Scheme was started upon.

But in Manchester it seems that the reception from 5 G B is by no means satisfactory, and that, despite the fact that the B.B.C. never guaranteed it being satisfactory (in the sense that it should please listeners in all parts of the country), Manchester amateurs seem to be aggrieved because the station was not erected in the North.

Not a "Service" Station.

5 G B is really a tit-bit. It does not come into the list of B.B.C. service stations, and it is curious that Manchester amateurs, who are supposed to be among the élite of radio men in this country, should so misinterpret the B.B.C.'s policy and should heckle Captain Eckersley because of this.

Manchester must put up with 5 G B until the Regional Scheme is well under way, and it is not fair to attack the B.B.C. because reception from 5 G B in Manchester is not all that it might be. It must be borne in mind that the behaviour of 5 G B, when noted over a length of time, will provide the B.B.C. with invaluable data with regard to the real service Regional Scheme.

If the B.B.C. had put up 5 G B deliberately with the idea of it being a service

station, and then it was proved that Manchester was not getting good reception, Manchester amateurs and listeners generally would have had something to kick about. As it is, they are not so much quarrelling with their bread-and-butter as with their jam.

It was interesting to note that at this Manchester lecture Captain Eckersley stated definitely that the high-power Regional Scheme stations will be put into practice directly the scheme, as a whole, has the sanction of the Postmaster-General. We all know that the new high-power North London station has now been sanctioned, but it remains to be seen how long it will be before the Postmaster-General allows the erection of the other stations.

When the nearest Regional Scheme station to Manchester is put up, the B.B.C. may be trusted to see that the lessons learnt from 5 G B will be incorporated in the station, and that reception from the new Regional Scheme station will be all that could be desired from a bona-fide service station.

But, meanwhile, to pick holes in a station which is designed and operated purely for experimental purposes is neither fair nor logical, and is not what we expect from Manchester.

2 Z Y's Transmissions.

There was perhaps more truth in the arguments and questions raised regarding the quality of transmissions from 2 Z Y.

Although the B.B.C. are constantly trying to improve the frequency range of all stations, and although 2 Z Y has had many improvements made to it, it still seems that the Manchester Station is not quite what it should be.

But perhaps Captain Eckersley may be excused for some of the retorts he made at this meeting. In one particular case he gave his definition of an amateur as one who can do the job much better than a professional. On the whole, an interesting lecture, and we wish we had attended!

A VALVE-HOLDER SWITCH.

By H. J. B. C.

MANY cases arise in receiver construction where it becomes necessary to cut off the filament supply to one valve and yet leave all the other connections intact. This is particularly so when it is desired to neutralise a high-frequency stage, for under these circumstances the filament must be rendered inoperative but the plate and grid leads must not be touched, and the valve, of course, has to be left in the sockets.

If there is an individual rheostat, either baseboard or panel mounting, controlling

the filament voltage to the particular valve, the process is simple for it merely means turning the resistance arm to the "off" position. Another popular method is to include a form of contact breaker in the filament circuit to the valve so that contact can be broken when desired without upsetting any other connections.

If a flexible lead is used, and this is joined under the valve filament terminal head, the breaking of the circuit is also quite straightforward, but it is frequently desired to have permanent connections to the valve holder and yet be in a position to break the circuit *at the valve holder itself*.

Under these circumstances the following simple adaptation of the valve holder has shown itself a very useful dodge, and it has the advantage that the normal function of the valve holder is in no way impaired, while the component itself is also not damaged. With a valve holder similar to Lotus, W.B., etc., it will be noticed that there are four holes in the moulded base for passing through wood screws to hold the component to a baseboard.

Very Easily Made.

Countersink the under side of one of these holes so that the head of a 4 B.A. screw can be accommodated without projecting beyond the under surface. By means of one or two packing washers, a soldering tag and a 4 B.A. nut, hold this screw tightly in position so that the top of the nut is level with the top of the ordinary filament terminal nut.

Procure a small piece of brass 1 in. long, $\frac{1}{8}$ in. wide and $\frac{3}{32}$ in. thick, and, after rounding off each end, drill a hole in one end, slip it over the filament screw, and it can then be held in any position by the terminal nut. With a round file cut a semicircle at the other end of the brass strip in order that the strip can pass under the head of a knurled nut on the 4 B.A. screw (see accompanying photograph).

By wiring the filament connection to the soldering tag on the new 4 B.A. screw and not to the normal filament position, the circuit can be made or broken by merely bridging the brass strip across the two screws and holding it down with the

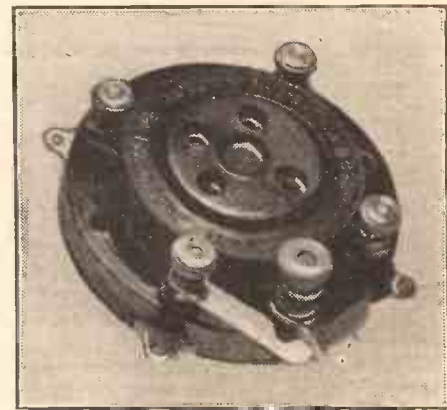

An additional terminal, a brass strip, and the switch is complete.]

terminal heads, or loosening them and swinging the strip away from contact. The idea is simple but very effective, will prove valuable on many occasions, and can be made up in a few minutes by any constructor.

THE symptoms of instability in L.F. amplifiers are very marked. We will deal first of all with a transformer-coupled amplifier. When a high degree of amplification is aimed at in a second L.F. stage it not infrequently happens that howling takes place owing to oscillation at audio-frequency.

The greater the degree of amplification the stronger are the feed-back effects due to inter-electrode capacities, and the more necessary therefore does it become to take the greatest possible care in the lay-out and wiring of the note-magnifying portion of the set. All leads should be kept as far apart as possible, and if switches are used at all in amplifiers of high efficiency they should be very carefully chosen.

Often low-frequency howl can be cured by changing over the primary leads of one of the transformers. Shielded components should always be used in such circuits, and the shields should be earthed.

Effect of "Dud" Battery.

These precautions, however, may fail entirely to remove the trouble. In this case it is probably due to unwanted couplings provided by the resistance of a common high-tension battery. A good quality high-

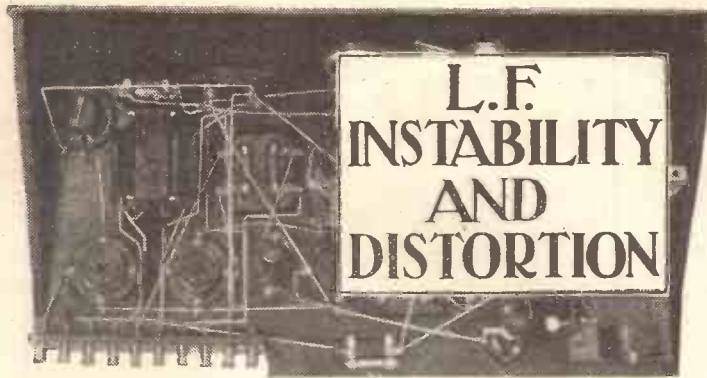

This article concludes the author's practical "Tracking L.F. Troubles" article, the first section of which appeared last week under that title.
 By R. W. HALLOWS, M.A.

high resistance in the plate battery can be counteracted by the use of large shunting condensers. I have tried at times condensers with capacities up to 6 mfd. without finding that they made any appreciable difference.

Instability may be caused by a leakage into the note-magnifying part of the set of radio-frequency impulses which manage to make their way through the rectifying valve. The effects of this will be most marked if the amplifier is used for short-wave reception.

It is the most usual cause of that annoying effect known as threshold howl. This straying of H.F. impulses may be absolutely prevented by the use of a filter circuit between the rectifier and the first transformer as seen in Fig. 1.

H.F.C. 1 and H.F.C. 2 are high-frequency chokes. C₃ and C₄ are fixed condensers with a capacity of about .0003 mfd. For reception on the broadcast and higher wave-lengths standard

radio-frequency chokes of good make will serve excellently; for the ultra-short waves suitable chokes may be made by winding 50 turns of No. 34 D.C.C. wire on a tubular former 1 in. in diameter.

Too High Leak Value.

Instability in the resistance-coupled amplifier is nearly always due, provided that due care is paid to the wiring and the lay-out of components, to the use of a grid leak of too high a value with one of the note-magnifying valves. In this case the trouble may take the form known as "motor-biking."

When the value of the leak is not very much too high very slow choking may occur. Here no howling is heard, and the symptoms resemble those of genuine fading. Signal strength declines over a period lasting

possibly many seconds. Then, after a sound often mistaken for an atmospheric, it returns suddenly to normal and the decline starts once more. All of these symptoms can be cured by the use of a grid leak of the proper value.

To go fully into all the causes of distortion in low-frequency amplifiers is beyond the scope of the present article; one can indicate only some of the more common causes and their cures.

To take transformer-coupled circuits first, the most usual cause of distortion, given transformers that are capable of faithful reproduction, is the use of unsuitable valves. It is of the utmost importance, too, to see that the grid bias is so adjusted that the working point is as nearly as possible in the middle of the straight portion of the characteristic to the left of the zero line. Any distortion produced by the first note-magnifying valve will be magnified by the second, with horrible results from the loud speaker.

Use a Milliammeter.

A milliammeter wired in the H.T. neg. lead acts as an infallible detector of overloading. For good reception its needle should remain absolutely steady when the strongest signal is coming in. You can easily see whether the first low-frequency valve is being overlooked by tuning in the local station sharply, switching off the last valve and watching the needle. If there is any wobble after the grid bias has been adjusted, then this valve is being overloaded and it should be replaced by one of lower impedance.

It is essential that the last valve of an amplifier, whatever the coupling may be, should be capable of handling without distortion the energy reaching its grid. For any kind of loud-speaker reproduction a small power valve is required in the last holder, and if a volume of sound sufficient

(Continued on next page.)

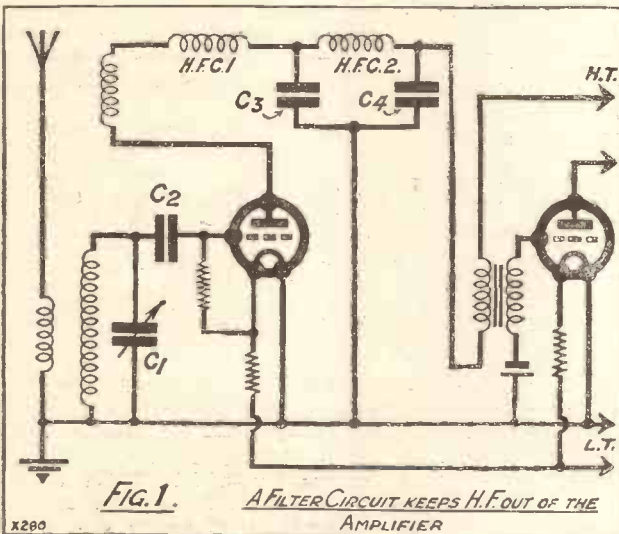

tension battery when new has a comparatively low resistance, but it must not be forgotten that this increases rapidly when the battery has been in use for some time, and goes on increasing daily.

A decrepit H.T. battery may therefore cause low-frequency instability of a most annoying kind. An instance of this occurred to me recently with a two-stage transformer-coupled amplifier which had just been completed. When first tried out it howled dismally, and battery coupling was suspected.

To make sure, a separate plate battery was used for each of the two valves. The amplifier at once became as docile as could be wished, and it continued to function well when a common H.T. battery in good condition was substituted for the old one.

It has been said that the evil effects of

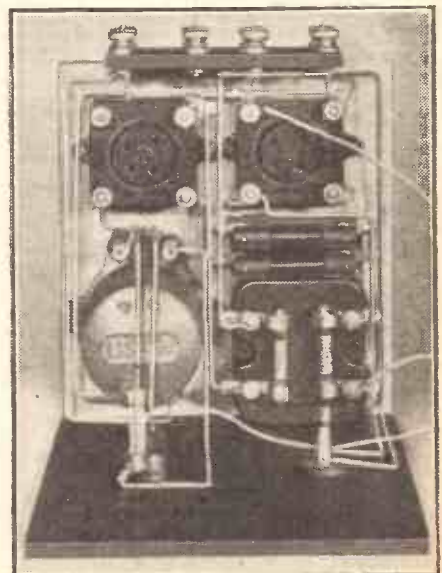

An L.F. amplifier on the L.F. portion of a set can be very compactly assembled, as is the above two-valve arrangement, but indiscriminate "packing" and very close leads can cause instability.



From A CORRESPONDENT.

OF late, considerable interest has been aroused in radio circles by the announcement of important new discoveries relating to the manufacture and design of lead accumulators. As the outcome of numerous experiments conducted by Monsieur Fery, the well-known French physicist, it appears probable that one of the major troubles experienced by the amateur who depends upon accumulators for his high- or low-tension supply will be obliterated, and "sulphation" will be known no more.

Closer Investigation.

Though this trouble is not nearly so prevalent nowadays as it was in the early days of broadcasting, it is still of sufficient importance to make the announcement particularly welcome, and readers will no doubt be interested to learn something of the nature of the discoveries mentioned.

These resulted primarily from a closer investigation of the generally accepted

peroxide, whilst the negative plate carries only spongy lead, the electrolyte being, of course, dilute sulphuric acid, and that when the cell is discharged both the positive and the negative plates carry plumbic sulphate.

Revised Theory.

This latter compound is an insulating sulphate and obstructs the action of the cell. Below 1.8 volts, however, the formula of this sulphate ($PbSO_4$) was found to differ slightly from its normal value when the cell was above that voltage—a change never very clearly understood, but sufficiently recognised to warrant the familiar precaution always to recharge the cell before its voltage fell to the figure mentioned.

From M. Fery's experiments it appears that the positive plate carries a higher oxide than the peroxide (PbO_2), and that it is only during discharge that this oxide is reduced to the peroxide, whilst on the negative plate plumbous sulphate, Pb_2SO_4 , a conducting sulphate, is produced. This

theory was investigated by exhaustive experiments, and on the results outlined the theory appears to be correct.

Peculiar Design.

The outstanding result of all these experiments is that M. Fery has designed a new type of cell in which sulphation, as ordinarily understood, becomes practically impossible. In the new design particular attention had been paid to the elimination of any oxidising agency which might operate upon the negative plate, and, consequently, air is excluded. The negative element consists of a single layer of paste lying upon the bottom of the cell, the positive plate being placed horizontally above it.

In this manner it has been possible to afford the negative plate protection from the air, and also from any bubbles of oxygen which might be generated on the positive plate. The objection naturally occurs to one that particles from the upper plate might fall upon the lower one, but this has been removed by the interposition between the two plates of a layer of porous silica material.

Extended tests of the new cell have been made, both in charged and discharged conditions, without any sulphation becoming apparent; moreover, the loss of charge when standing on open circuit is considerably less than that which usually occurs with a cell of the conventional type. On the whole, it seems that M. Fery's cell constitutes a decided advance in the design and manufacture of the lead accumulator.

L.F. INSTABILITY AND DISTORTION.
(Continued from previous page.)

to fill a big room is needed a super-power valve should certainly be employed.

In resistance amplifiers again the first low-frequency valve is enormously important. In the Fig. 2 circuit, for example, we might employ for reception of the local station a detector of the high impedance R.C. type with a resistance of from .5 to 1 megohm in its plate circuit. The plate magnification so obtained is very great indeed, and if we are not careful V_2 may be overloaded.

Unless the incoming signal is on the weak side it seldom pays to use an R.C. valve in the first low-frequency stage. The milliammeter used as previously described will tell us whether the first L.F. valve is being overloaded.

Generally speaking, the amplitude of the oscillations reaching the grid of V_2 in the Fig. 2 circuit from the local station will be such that a high-impedance valve will be quite unable to handle them without distortion. A medium impedance valve may be satisfactory, but only the milliammeter can tell us whether in its stead we require a "first L.F." valve or even a small power valve.

High Plate Voltages.

In resistance-coupled amplifiers, as indeed in most note-magnifiers, it is bad practice to strive after too high a degree of amplification per stage where purity is looked for. Supposing that we use very high values for R_2 and R_3 in the Fig. 2 circuit in order to make the most of the magnification factor of the valve. We are likely to lose no small amount of the real music sent out by the transmitting station and brought in to the rectifier by the receiving aerial. Do not therefore err by pushing up your anode resistance values.

Lastly, remember that note-magnifying valves demand high plate voltages. If you starve them in the matter of plate voltage

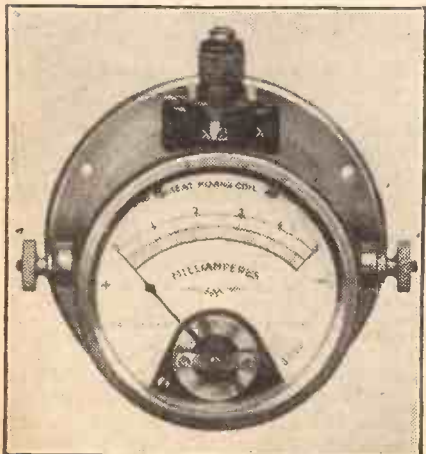
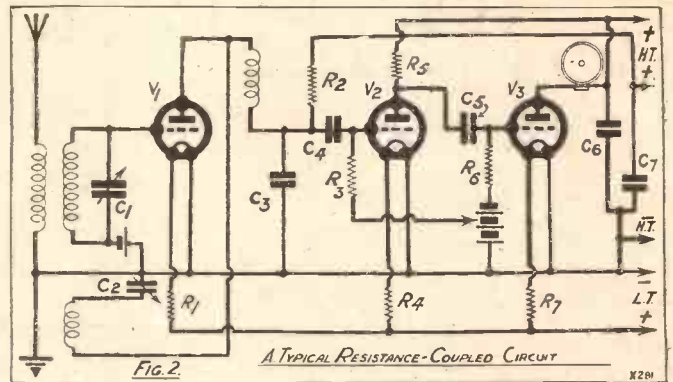

A milliammeter wired in the H.T. negative lead acts as an infallible detector of overloading.

you shorten the useful portion of the straight part of the characteristic and cut down the amount of energy with which they can deal without distortion. Do not, I beg you, join those (and there are, unfortunately, many of them) who say:

"This talk about high-tension voltages is all rot; my set will work with only 40 volts." Their sets do work after a fashion, but their loud speakers—often their too loud speakers—reproduce but a travesty of what the B.B.C. stations send out.

DON'T MISS
The Special
BIRTHDAY NUMBER
of
POPULAR WIRELESS
NEXT WEEK
Usual Price. Out on Thursday.

ALTHOUGH we hear a lot about simplifying radio sets, the average receiver looks a pretty complicated box of tricks to its owner when he comes to try and locate a fault in it. Is the fault in one of the low-frequency stages, or is it the aerial input to the set which is at fault? Is the high-frequency valve really amplifying? These and many similar questions call for systematic searching of the set in order to trace the trouble.

Fortunately, this is very easily done, and the reader need not fear that a milliammeter or other expensive instrument is necessary. For if one knows where to look, the set can be very systematically and thoroughly searched with the aid of only a humble crystal and an ordinary pair of 'phones. In every set there are certain "cross roads," where the traffic may be intercepted and examined, and even a tyro can do this satisfactorily, provided he takes the ordinary precautions against wires accidentally touching one another.

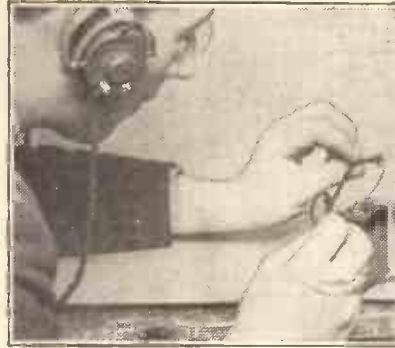

SYSTEMATIC SET SEARCHING

By P. R. BIRD.

A practical article for the amateur radio Sherlock Holmes.

with the grid leak in place, or out. An inspection of the diagram will show that this is practically the same as the points 5-6, the only difference being that a slightly different tapping point on the filament circuit is chosen, and listening at the point 7 will serve to check the conductivity of the grid condenser which was not included when we were listening at the point 5.

So far we have dealt with high-frequency currents and consequently we have had to use a crystal detector as well

as telephones to ascertain what is happening. In the circuit shown in Fig. 2, which shows the ever-popular detector and two low-frequency valves, we shall need a crystal and telephones only across the points 1-2.

Radio Cross-Roads.

In this, as in the previous diagram, high-frequency currents will be flowing here, so that the crystal is necessary to rectify them; but at the remaining "cross roads," 'phones only will be necessary, for the signals will have passed the detector and therefore will be audible in the telephones.

In a circuit of this type (which, by the way, is almost exactly like the Mullard Master Three and certain other popular arrangements) a pair of telephones across the points 3-4 will tell us whether the first valve is working correctly.

Valves 2 and 3 may be out of circuit at the time, and, as before, we can test the effects of reaction by turning the reaction condenser. If all appears O.K., we can connect up again and connect our telephones across the points 5-6—i.e. connect them in place of the primary of the L.F. transformer. Amplified signals here will show that the set is functioning correctly up to this point, so that we can restore the primary connections and pass with the telephones to the points 7-8.

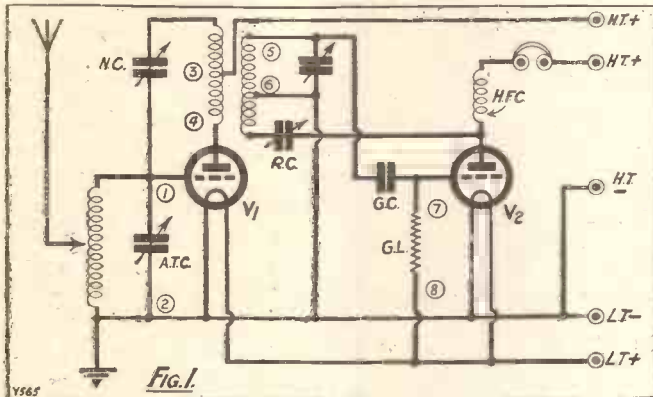

The pairs of numbers (1-2, 3-4, etc.) show the strategic listening points.

Dealing first with trouble tracking in high-frequency circuits, we will suppose that the set is an ordinary H.F. and detector as illustrated in Fig. 1. This represents a typical H.F., Det. circuit with a valve neutralised in the popular split-primary method. The pairs of numbers 1-2, 3-4, etc., serve as points at which we can listen-in to the signals running through the set.

As these are high-frequency currents we shall need the crystal detector to make them audible, so this is connected to one of the 'phone tags. Then a flexible lead is attached to the remaining crystal detector terminal, and another to the remaining telephone terminal, and we can listen-in to the set stage by stage.

What is Wrong?

The first question is, is the aerial pulling its weight? To determine this we have to connect our improvised detector across the points marked 1-2. By connecting the crystal and telephones across these points we have in effect a simple crystal set, as a glance at the diagram will show, so that for this first test we can pull out the valves and H.F. transformer, as they will not be in use, and there is more room without them. If the aerial-earth circuit is O.K., signals of ordinary crystal strength will be heard in the telephones when they are placed across

1-2. Should results be unsatisfactory, we know that the fault lies either in the earth or the aerial leads themselves, or in the tuned circuit consisting of the aerial coil and tuning condenser.

Having made sure that this part of the receiver is working correctly, we can put back the H.F. valve and the H.F. transformer in the receiver and see whether the valve is really amplifying properly. To do this we connect our detector across the points 3-4, i.e. the H.T. plus lead that goes to the centre tap on the primary, and the plate of the valve.

If the H.F. valve is functioning properly we shall now hear the amplified signals, stronger than they were previously at points 1-2. (Unsatisfactory results would, of course, mean that the trouble lies in the H.F. stage which cannot be functioning properly if no signals are heard across the points 3-4, the place where they are transferred to the detector valve circuit.)

If the set is O.K. up to this point the effect should be tried of tapping the signals across the points 5 and 6, that is to say, across the H.F. tuning condenser. Good signals here will show that the H.F. transformer is O.K., and if the test is first made with the reaction condenser set at zero, and then this is advanced slowly towards maximum, we can see the effect of reaction upon the receiver. (In this case, of course, the detector valve would have to be inserted, as it is the plate current of this that furnishes the reaction. The first test across the points 5-6 did not need V₂ to be in circuit, as there will be signals across these points if the first H.F. valve is amplifying at high-frequency and transferring its energy into the secondary of the H.F. transformer secondary.)

Finally, the telephones and crystal could be tried across the points 7-8, either

Finding the Fault.

If, when connected up to the point 7-8, we get very weak and unsatisfactory signals, we know that the fault must lie in the low-frequency transformer, for this systematic set-searching has shown that stage by stage the receiver is functioning correctly up to this point, and if signals are quite O.K. at the points 5-6 and have vanished at the points 7-8, they have obviously become lost in the transformer itself.

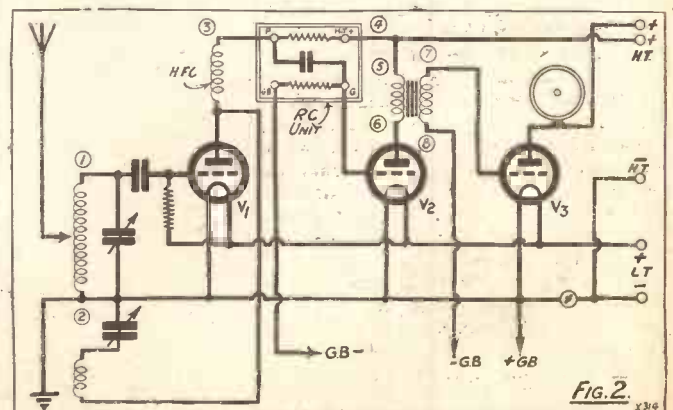

Here the numbers show how to test a Det. and 2 L.F. set.

TECHNICAL NOTES.

By Dr. J. H. T. ROBERTS, F.Inst.P.

ADJUSTING CONE SPEAKERS

LOCAL INTERFERENCE—CONDENSERS TO EARTH—PECULIAR DISTORTION—TUNGSTEN FILAMENTS.

Adjusting Cone Speakers.

OWING to transport and rough handling a cone loud speaker is apt sometimes to get out of adjustment. For proper operation it is essential that the pin should be correctly centred in the collar at the apex, and if the movement of the loud speaker is shifted away from dead centre there may be a strong tension upon the pin: this limits the amount of power which the instrument can handle without distortion.

A proper adjustment may easily be made in the following simple way, which is sent to me by a reader. What is required is a source of A.C. (A.C. electric-light mains) and a resistance of about 2,000 ohms (which may be 2 or 3 low wattage lamps in series). The loud speaker is then connected to the electric-light mains through this resistance, and an A.C. hum will be heard from the speaker, the set-screw of the loud-speaker collar having been previously loosened.

The screws holding the frame should now be slightly loosened and the actuating mechanism of the speaker should be very slightly shifted from side to side and up and down until the sound is at a minimum, showing that there is the minimum engagement between the pin and the loosened collar. In these circumstances, although the hum from the diaphragm will be a minimum, there will probably be a considerable amount of rattling at the collar. The current is then disconnected and the set-screw of the collar is tightened up again upon the pin.

Local Interference.

I wonder how many readers suffer seriously from local interference? There is such a lot of talk about interference from neighbouring radio receivers, that one is rather apt to overlook the large amount of interference that must come from other sources. On making a few inquiries I have been surprised at the number of cases in which interference of this kind is experienced, and there must be many other cases where the interference occurs but is not recognised by the owner of the set.

I have a letter before me from a reader, Mr. J. Colley of Teignmouth, who is a radio engineer and has studied this question in his own district very carefully. He gives me full particulars of various cases of interference, and one especially where a local cinema is the offender. Referring to some recent remarks of mine, when I mentioned the question of cinema interference, he says: "I read all your articles in POPULAR WIRELESS, and was specially interested in the one which referred to cinema interference.

"The set is 100 feet from a cinema loud-speaker installation, and the high-tension for two moving-coil loud speakers (several hundred volts) is produced by a motor generator. The local electric supply is 230 volts 50 cycles A.C. There have

been so many complaints that the Post Office sent an engineer down specially to investigate. I hear that the Post Office is doing a good deal of work in this matter of radio interference by machinery.

Condensers to Earth.

"Six microfarad condensers through each brush of the generator to earth make no difference and the motor generator is contained in a steel box and the wiring to the loud-speaker, etc., is all lead-covered.

"It is curious that the interference can be avoided sometimes when the set is

detuned. A screened coil set does not seem to improve matters and a portable with frame aerial picks up the interference badly. The best I can get is two-valve strength from a four-valve set, which, down here, is not sufficient to work a loud speaker properly. I have tried both series and parallel wave-traps, but in no way can I get reception worth having, even from 5 X X, when the cinema is working.

Peculiar Distortion.

"A peculiar effect is that there seems also to be distortion when the cinema is working, for the cinema apparatus is switched on and off frequently, and when it is switched off the quality at once becomes normal.

"I write this for your information and that of your readers, as I have had much help from your various articles. The best I can do, I find, is to use a suitable circuit and take off the earth wire."

The foregoing description given by my correspondent is so complete that it is

scarcely necessary to comment upon it, but I should be interested to receive from my readers accounts of any similar experiences which they may have had. In writing, it is best to give a fairly full and detailed account of your experiences, mentioning any minor points, even though they may not seem to you to have much direct bearing upon the matter.

Tungsten Filaments.

At a recent scientific meeting in London a lecture was given by Mr. C. Paterson, the well-known engineer, on the manufacture of tungsten, and particularly the production of tungsten filaments.

Tungsten is a very peculiar metal and, compared to most

(Continued on page 467.)

DOES IT WANT CHARGING ?

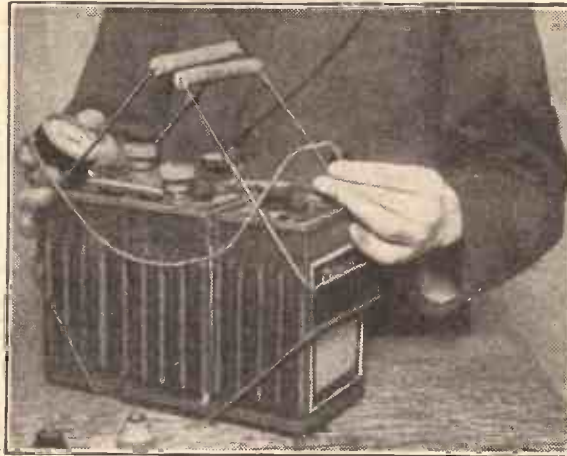

The voltage test is a good one, but to be really valuable it should be carried out when the accumulator is delivering its full quota of filament current to the set.

NEWS FROM SAVOY HILL.

FROM OUR OWN CORRESPONDENTS

EARL BALFOUR TO BROADCAST

B.B.C. MUSIC: POSSIBLE NEW POLICY—TROUBLE ABOUT THE DERBY, Etc., Etc.

Earl Balfour to Broadcast.

THE speech of Lord Balfour, President of the English Speaking Union, which he is making at the tenth anniversary dinner of that body at the Café Royal on Friday, June 15th, is to be broadcast from London and most other stations. Lord Balfour will occupy the half-hour allotted for the broadcasting between 9.20 and 9.50 p.m., with an important speech on Anglo-American friendship.

B.B.C. Music: Possible New Policy.

At a dinner party during his recent "Midlothian Tour," Captain Eckersley revealed the interesting news that the B.B.C. is now reviewing the whole of its

policy on music. With the prospective advent of the Regional Scheme, and the simultaneous improvement of international exchange of programmes, Savoy Hill is debating whether it may not be possible to dispense with practically the whole of its orchestral organisation.

One thing appears to be decided, and that is that all orchestras outside London will give way to trios in the near future. The future of London's orchestra is in the balance. The idea of developing a world orchestra is no longer in such favour.

The reason for this change appears to be that as part of the work of the Union Internationale de Radiophonie, Germany

(Continued on page 466.)

ANY constructor or listener who takes a pride in the operation of his wireless set with a view to securing the best working conditions and true reproduction must recognise that this condition is met best by being in a position to make certain measurements of current and voltage as far as the sources of low tension, high tension, and grid bias are concerned.

Let me illustrate the foregoing remarks by a case which occurred only this week. A friend of mine had a receiver incorporating Reinartz reaction which failed to oscillate over the whole of the range for long and short waves, the set in question being a detector followed by two low-frequency coupled stages which should have given him at least half a dozen stations on the loud speaker.

An Obscure Fault.

He had tried various H.T. voltages, a number of valves in the detector position of both high and low impedance, but still failed to get that control of volume which should have been apparent with the set. A new accumulator was purchased, since for some reason he suspected his other model of being in a poor condition, but a further test produced no better results, and on someone telling him that he ought to find out whether his H.T. battery had run down, by measuring the voltage with a meter, he bought an instrument of the cheap pocket variety.

Reaching home that night he immediately measured the voltage of his H.T. battery. Ah, here was the fault, for it only registered 60 volts instead of the 100 marked against the sockets.

Feeling pleased with his discovery, he obtained a new H.T. battery, and in a state of great expectation connected it to the set in lieu of his old one, and listened for the glorious burst of volume he felt sure would come, but although he tried out every H.T. tapping, he failed to achieve his object.

In desperation, the old and new H.T. batteries were joined in series and a further assault made, but the only effect was to bring about impure reproduction and a failure to oscillate. I found my friend in rather a desperate frame of mind when I arrived on the scene, so at once offered to lend a hand.

A Misleading Measurement.

As far as his voltage measurements were concerned a glance at the meter he had employed was sufficient to show that he had been led to an erroneous conclusion on that score. On bringing along a reliable high-resistance voltmeter, I found his original H.T. battery registered 90 volts as against his reading of 60, so the trouble did not lay in that direction, and in a short while it was traced to very long and high-resistance lead-in and earth wires, and proper reaction effects were soon brought about by the insertion of a fixed series aerial condenser.

The best solution, of course, would have been the shortening of these leads and the substitution of a more efficient earth, but

RADIO METERS



Meters form the eyes of the true radio experimenter, for without them he is almost completely ignorant of what is taking place in his receiver.

By H. J. BARTON CHAPPLE,
W.Sch., B.Sc. (Hons.), A.M.I.E.E., A.C.G.I., D.I.C.

conditions of environment precluded this. In any case, the set functioned quite well with the expedient adopted, and my friend is now a much wiser man.

His low-resistance voltmeter had taken such a heavy current from the battery when making measurements that the readings were quite false, whereas if he had secured a reliable high-resistance instrument in the first place, he would have been spared the expense of a new accumulator and H.T. battery.

The illustration should impress upon readers that, although measuring instruments serve a very useful purpose and are really indispensable in many directions, they must, in the case of voltmeters, be of

life and a gay one as far as the filaments are concerned. Similarly, a voltmeter will enable not only the voltage at the receiver terminals to be found, but also that actually existing between plate and filament for the valve itself.

Voltage Drops.

The fact is often overlooked that there is a loss of voltage in the resistances, inductances, chokes, etc., which constitute the circuit between valve anode and battery, and by calling in the aid of a reliable meter these details can be elucidated and the best working conditions determined. While a hydrometer reading gives perhaps the best indication of the state of the charge held by the L.T. accumulator, voltmeter readings are particularly useful guides in this direction.

As far as the milliammeter is concerned, it is often stated that this is even more essential than the voltmeter. It gives an indication of H.T. current consumption, so that adjustment of the proper voltage, both H.T. and G.B., can be made for economical working, the life of the H.T. battery being prolonged thereby.

Tracking Distortion.

To ascertain whether the valves are the cause of distortion in a receiver the milliammeter can be pressed into service. By joining it in the plate circuit of the last valve it is possible to note whether there is any appreciable movement of the needle when signals are being received.

If there is, then overloading is present due to insufficient H.T. or incorrect G.B., or more possibly as the outcome of the use of an unsuitable valve—i.e. one incapable of handling the power. Of course, the unsteady reading may be due to an inherent defect in the valve itself, but this can be proved quite readily.

Again, by including the milliammeter in the plate circuit of the detector valve, it acts as a reliable indication of oscillation. When using grid-leak rectification the application of reaction causes the meter needle to show a gradual current decrease, a violent kick occurring when oscillation actually takes place.

The list of uses can be still further added to, such as, for example, resistance measurements, continuity tests, intermittent contacts, etc., but enough has been said to point out the obvious advantages open to those in possession of meters.



An accurate meter, at a popular price, made by Ferranti Ltd.

sufficiently high resistance to cause no undue drain on the batteries when measurements are being made, and in the case of ammeters or milliammeters possess a low resistance, so that the constants of a circuit are not altered when the meter is inserted in series for taking readings, and, if desired, may be left in as a permanent connection.

Three Useful Ranges.

I always make a practice of using one or more instruments during the course of tests, the type chosen depending upon the work in hand. In the case of measurements and tests on an ordinary broadcast receiver, recourse is made invariably to a triple range Ferranti meter, the favourite model being the

THE "ANTIPODES ADAPTOR."

The Editor, POPULAR WIRELESS.

Dear Sir,—I feel I must let you know what splendid results I am having with the "Antipodes Adaptor." I have made up two short-wave sets before, but owing to bad conditions, such as aerial screening by telephone wires on all sides, and electric-light wires running almost directly overhead, I could get nothing but a tremendous buzz, which could be tuned in but not out, with faint speech and music sometimes, so I gave up short-wave work for the time as a bad job.

So it was not with much hopes of success that I started building "A.A."; in fact, if I had not had the parts by me I don't suppose I should have done.

But, anyway, I did, with the following alterations: 4 meg. grid leak, 0002 reaction condenser, and R.1-Varley H.F. choke. I plugged it into my straight three and switched on, quite expecting the old buzz, but there was not a sound of it, so I tried for oscillation, and found plenty all round the dial.

Next I tried for some stations, and up to the present have received the following:

- PCJJ on 30.1 metres. Vol. R.8., no fading, on loud speaker.
 2 X A P on 31.4 metres. Vol. R.7, fading noticeable, on loud speaker.
 K D K A on 43 metres. Vol. R.5., rapid fading, on loud speaker.
 T R L on 42 metres, Copenhagen. Vol. R.7, no fading, on loud speaker.
 2 N M (Mr. Marcuse's station) on 32.5 metres. Vol. R.6, slight fading, on loud speaker.
 3 L O (Melbourne) on 32 metres. Vol. R.4-5, slight fading, on loud speaker.
 2 F G (Sydney) on 28.5 metres. Vol. R. 2-3, bad fading, on 'phones.
 Radio Lyon (Rhône) on 40.2 metres. Vol. R.6, slight fading, on loud speaker.

Also, what I suppose is the two-way telephone between here and America, but they gave no details, and I was using an experimental coil of 3 turns grid 3 reaction and 3 aerial, with the tuning condenser nearly at the minimum setting. Speech was quite clear, though I should say approx. 1,520 metres.

Has anybody received 2 X A D and 5 S W on "A.A." yet? If so, I wonder if they would give details of coil, please, as I have not had a trace of either.

Thanking you for an exceptional short-wave circuit.

Yours faithfully,

F. BURNEY.

Herts.

THE "PROGRESSIVE" FOUR.

The Editor, POPULAR WIRELESS.

Dear Sir,—First I wish to offer my thanks and congratulations to Mr. Dowling for his very fine series of constructive articles on his "Progressive" Four.

Well, I hooked up that set, but used plug-in coils in both aerial and det. circuits and then added two choke-coupled L.F. valves, also choke-filter output and I think it capable of holding its own with the best. I have had reception from sixteen countries, including U.S.A. and Canada.

Yesterday, January 22nd, I put in 4 S.W. coils, but could not get anything properly, so still with the 'phones on I pulled out the 4 S.W. coils and then Morse came in lovely without a coil in the set, so I thought I would just see if I could pick anything up. I picked up speech and heard someone calling: "Hello, New York!" Then a family conversation, and then a voice: "I am speaking to you from Ottawa, Canada; it is quite nippy to-day. It is twenty below to-day." Then more private talk, and then "good-bye." Then what I took to be the female operator at Ottawa again calling New York before they were cut off.

CORRESPONDENCE.

THE "ANTIPODES ADAPTOR."

THE "SYDNEY" TWO— SWINGING-COIL REACTION.

Letters from readers discussing interesting and topical wireless events, or recording unusual experiences, are always welcomed; but it must be clearly understood that the publication of such does in no way indicate that we associate ourselves with the views expressed by our correspondents, and we cannot accept any responsibility for information given.—EDITOR.

I can tune in Daventry 100 miles without earth or aerial; in fact, with the aerial earthed, and if I grip the aerial terminal of the set I can get it on the loud speaker.

Yours faithfully,

A. F.

Rotherham.

THE "SYDNEY" TWO.

The Editor, POPULAR WIRELESS.

Dear Sir,—I originally built the "Sydney" Two, and had excellent results with same, and when particulars of "Antipodes Adaptor" came out I saw it was just the sort of thing required, and built it, but modifying it to suit the tuning and reaction arrangement of "Sydney" Two.

My main set is a straight O-v-2, and on Saturday night (Sunday morning) I listened on loud speaker to W.G.Y. giving speeches of welcome to the Atlantic fliers, who also gave a short speech each. Every word was distinct.

I think "P.W." leads the way for designs. Please accept the thanks of a reader from No. 1, and more power to your elbow.

Yours truly,

E. E. H.

Abertridwr.

THE "LO-COST" CRYSTAL.

The Editor, POPULAR WIRELESS.

Dear Sir,—In a recent issue of POPULAR WIRELESS you recommend the "Lo-Cost" Crystal Set. I am pleased to inform you that I have given it a trial, and am delighted with the results of so simple a set. I have made many crystal sets, and more costly; but this beats anything I have yet attempted. I strongly recommend it to all amateurs. I not only tuned in my local station, but by adjusting the clips I tuned in the Manchester station, being 35 miles away. I shall recommend it to all my wireless friends. Best wishes.

Yours truly,

E. G.

Goldenhill, Stoke-on-Trent.

SWINGING-COIL REACTION.

The Editor, POPULAR WIRELESS.

Dear Sir,—I am quite in agreement with your correspondent, J. C. G., when he states that

"swinging-coil" reaction can be quite as efficient as "Reinartz" reaction. I have myself reverted to this system after 12 months of the latter, and find it equally efficient on all wave-lengths. As regards short-wave reception, I can obtain efficient reaction coupling between 17 and about 40 metres without changing the plug-in coils. The reaction is particularly smooth if the grid-leak return is taken to a potentiometer across the L.T. I am using a Lissen friction geared coil-holder, Ormond vernier condenser dial, and earthed metal lining to panel. The spindle of the coil-holder is also earthed.

Yours faithfully,

VICTOR B. DUPÈRE.

Herts.

The Editor, POPULAR WIRELESS.

Dear Sir,—My experience with swinging-coil reaction is like J. C. G.'s. On the long waves and on the broadcast band swinging-coil reaction builds up volume evenly and smoothly up to the point of oscillation. On the short waves it is quite as satisfactory down to 30 metres, but lower than that I cannot get a whisper. Hoping to hear from some reader of "P.W." who can go lower than 30 metres with this method of reaction.

Yours faithfully,

J. B.

Co. Wexford.

HOME BROADCASTING.

The Editor, POPULAR WIRELESS.

Dear Sir,—I have been a reader of "P.W." for some considerable time, and would like to describe a little experiment of my own which will no doubt be of interest and amusement to readers.

I ran a length of twin flex from my set (1 H.F., Det. and 2 L.F.) to another room in which we have our piano, at this end of the flex I connected a horn type loud speaker to serve as a microphone. I next removed my H.F. transformer and connected one flex lead to the aerial side of "grid leak and condenser" (which are in parallel), and the other lead to earth circuit. I then connected another loud speaker to the output terminals in the usual way, and found much amusement in transmitting musical items from one room to the other. For best results I found it necessary to let the earth wire remain connected, and reverse speaker connections to the best advantage, at the transmitting end.

I turned out my H.F. valve as it was cut out of circuit.

Grid bias, H.T. and valves remained, set as usual, and I also found it necessary to leave the reaction coil plugged in, as it, of course, comes in circuit with the H.T.

Best wishes to "P.W." It is the best weekly I know of.

Yours faithfully,

A. J. PEIRCE.

Sussex.

"A WONDERFUL CIRCUIT"

The Editor, POPULAR WIRELESS.

Dear Sir,—Some time ago I made up one of Mr. Dowling's novel Filadylne receivers. Using only one valve I have tuned in dozen of stations with absolute clearness, using telephone receivers. Two or three stations I have tuned in a loud speaker sufficiently strongly to hear them all over the room. The strength of the little set is almost equal to that of a three-valve possessed by my friend. The Filadylne is a wonderful circuit and must surely be one of Mr. Dowling's greatest inventions.

Yours faithfully,

W. K. R.

London, E.C.10.

SHORT-WAVE NOTES.

By W. L. S.

I HAVE been asked several times lately whether I consider that it will be long before broadcasting is carried out exclusively on the shorter waves, and the 200-600-metre band relegated to the ship and shore spark stations. My answer is, most emphatically, that I do not consider that this is likely to happen for many years, if at all.

The short-wave bands are being proved to be much more reliable than they were at first thought to be, but their very nature makes them in many ways quite unsuitable for broadcasting except over very long distances. For instance, there are times during which a broadcasting station on a certain wave-length could not be received by any receiving station nearer than 600 miles.

These times, of course, would be different for different wave-lengths, but they would always exist. Thus, to carry on a twelve-hour service a broadcast station would

have to make three or four changes of wave-length during the day. As long as we have listeners we shall always have those who want absolutely foolproof sets, and how would they fare with a "movable" programme of this type?

Wonderful Success.

I think short waves will, however, be utilised to an even greater extent for long-distance communication between commercial stations. Already the air is full of them, below 50 metres particularly, and they still

continue to descend. In these cases, where we have expert operators at both receiving and transmitting ends, there is no real objection to a change of wave-length every hour, if the results justify it.

Of course, the few short-wave broadcast stations that do exist have met with wonderful success and become extraordinarily popular. I think this is, however, chiefly due to the listeners of the type who derive more enjoyment from the knowledge that the station is some thousand miles distant than from the actual programme they are receiving.

I think also that short waves will become even more reliable than they are at present when a little more experimental work has been carried out. As a matter of fact, much of the unreliability attributed to them when they were first "discovered" has since been put down rather to the freakishness of the apparatus used than to the particular wave-lengths employed!

HAVE you built your portable for this season yet? Probably not, because most of us have a habit of leaving that important job until the last week before our holiday is due, and then rushing it through in great haste when it is suddenly realised that the time is drawing very near. Why not begin in good time this year, and have the set ready for picnics and outings all through the summer?

Just what kind of portable to build is always a difficult question to decide. Certainly, it is very pleasant to be able to gather round and listen to the programme on a loud speaker, and it is likewise very convenient to use a folding frame aerial; but all this requires two things on your part; (a) a fair amount of available cash, and (b) a pair of strong arms or a car to carry the outfit. A very large number of people limit themselves to quite a small set, considering that the outlay and weight are not worth while to obtain loud-speaker



For example, no full-sized variable condensers are required; both the tuning and reaction controls being of the miniature .0001 mfd. type, which are small and light, as well as inexpensive. The set itself need not cost you more than about 25s. In addition, you will want a small 2-volt unspillable accumulator, and a small H.T. battery of about 30 volts. (The Siemens 14F fits the available space nicely.)

Here is a really and truly "all-in" portable one-valver which gives excellent results and costs very little to make.

By THE "P.W." RESEARCH DEPARTMENT.

The circuit chosen for use in the "Summer" One is a simple one which can be depended upon for good sensitivity and a moderate amount of selectivity (quite as much as you are ever likely to need with a portable). There are two special features, the first being the provision for variations of aerial coupling. This is done by placing the tapping clip on the end of the flex lead from the aerial terminal; either on one of the lowerappings on the coil (try each in turn on any given aerial), or on the same tapping as the clip on the end of the flex lead from the grid condenser.

Suiting Different Aerials.

The first scheme gives auto-coupling, which is usually best with full-size aerials, and the other provides direct coupling for use with small aerials. The second tapping clip (the one on the end of the flex lead from one side of the grid condenser) enables you to obtain two different ranges of wavelengths, and so cover the whole broadcast band with so small a tuning condenser.

This is the other special feature of the set, and you will find that with the clip on the 90th turn tapping you can get stations up to about 450 metres. For those stations between, say, 400 and 550 metres
(Continued on next page.)

COMPONENTS AND MATERIALS.

- 1 Attache-case, about 8 in. x 13 1/2 in. inside dimensions, and about 4 1/2 in. to 5 in. deep.
- 2 .0001 mfd. miniature type variable condensers (Peto-Scott in set, Cyldon, Ormond, or any small type).
- 1 On-off switch (Lotus in set, Benjamin, Igranic, Lissen, etc.).
- 1 H.F. choke (C.D.M. in set. Any compact type, Burne-Jones, Igranic, Lissen, Ormond, etc.).
- 1 Sprung valve holder (Igranic in set. Any standard type, Benjamin, Bowyer-Lowe, B.T.H., Burndept, Burne-Jones, Lotus, Pye, W.B., etc.)
- 1 .001 mfd. and 1 .0003 mfd. fixed condenser (Clarke, Dubilier, Goltone, Igranic, Lissen, Mullard, T.C.C., etc.)
- 1 2-meg. grid-leak and clips or holder (Dubilier, Igranic, Lissen, Mullard, etc.).
- 4 Terminals.
- 1 Ebonite strip, 3 1/2 in. x 2 1/2 in. x 1/4 in.
- 4 pieces of wood, 3/8-in. thick, cut to the sizes and shapes shown in the wiring diagram.
- 2 Tapping clips.
- 2 H.T. plugs (Clix, Eelex, etc.).
- 2 Small sockets (Clix, Eelex, etc.).
- 2 Valve pins or special spring pins, such as the Clix and Eelex types. (These are for the coil fitting.)
- 1 Insulating tube, 3 1/2 in. x 2 1/2 in. (Pirtoid in original. Any good material).
- Wire for coil, flex, material for wiring-up, etc.

merely a compact little set in a carrying case, but it is a properly worked out complete receiving equipment arranged in a really convenient way for carrying about. It is so small and light that you really and truly can carry it quite long distances without getting an aching arm, and packed away in the case are all the accessories needed, including a reel of wire for an aerial, earth pin and lead, H.T. and L.T. batteries, 'phones, and long- and short-wave coils.

The whole outfit, too, can be made very cheaply indeed. The fibre dispatch case in which it is assembled costs only 3s. 9d. in a Fleet Street shop, and you will see for yourself that only a very small number of components are called for in the set itself, and these are of types costing very little.

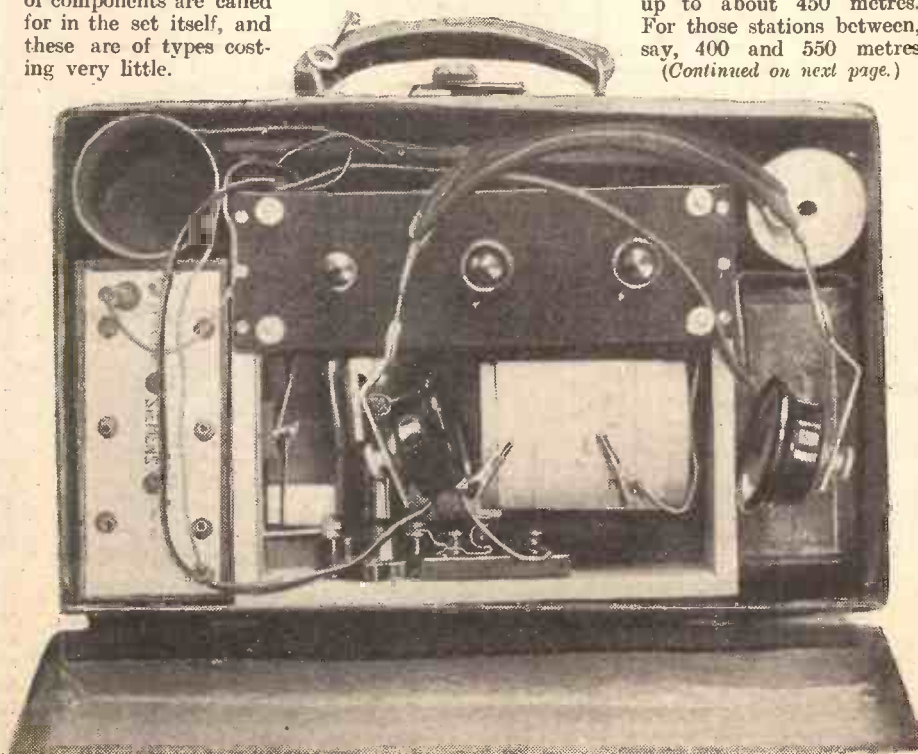

Careful packing will get all the accessories inside the case. Note the reel of wire for the aerial.

signals, while further to simplify the set they are content to use a length of wire slung over a tree as an aerial, which again permits a smaller number of valves to be used.

Real Portability.

To meet the needs of believers in this kind of portable we have produced the "Summer" One, which you see in the various photos herewith. This is not

THE "SUMMER" ONE.

(Continued from previous page.)

you should put the clip on the end of the coil. This scheme enables you to work always with only a small capacity across the coil and so obtain particularly loud signals.

You will not find the construction of this little set at all difficult, although you will have to cut some pieces of wood to various special shapes. This is easily done, however, with the kind of saw we all possess, and all the dimensions you need can be

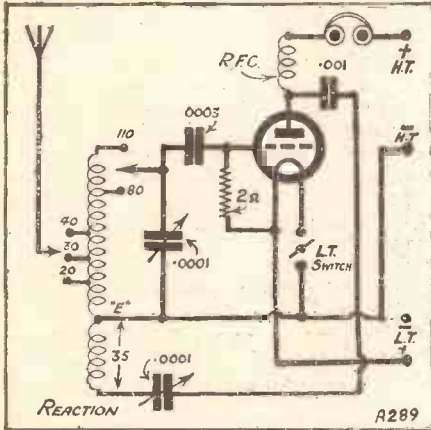

The theoretical circuit of the "Summer" One. "E" is the earth terminal.

got from the diagrams, so that we need not waste time by describing everything in words.

One or two special points call for explanation, however. First of all, you will notice that the piece of wood carrying the coil sockets is cut to a rather peculiar

shape, and this was done to make it easy to get the valve in and out of its socket. This piece of wood must be of a well-seasoned dry sort, since the coil sockets are mounted direct in it, without separate insulation, and we must not have leaks here. If the wood is well dried there need be no fear of trouble.

So far as the rest of the constructional work is concerned you will find the photos and diagrams will give you all the information you need, and it only remains to describe the coils. The basis in each case is a piece of insulating tube $2\frac{1}{2}$ in. diameter and $3\frac{1}{2}$ in. long. At each extreme end of these you should fix something like a valve pin or a "Clix" spring plug, so that they come $3\frac{3}{8}$ in. apart. The two corresponding sockets (Clix again) on the wooden base in the set must, of course, be similarly spaced.

Winding the Coil.

Now for the windings: on each coil there are two windings, one for reaction and one for tuning purposes, the latter being provided with certain tapings. On the low-wave coil the tuning winding has a total of 110 turns (of No. 26 D.S.C. wire), and the reaction coil comprises 35 turns (of No. 34 D.S.C.), both in the same direction, that is, as though one wire a continuation of the other. Note this point carefully, for it is important.

Here are detailed instructions for setting about the winding of the low-wave coil: first, scratch the letter R on the tube beside one of the pins. This will serve to indicate that this is the one which goes into the socket marked "Reaction" on

the wiring diagram (another letter R on the set itself will be useful later).

Now secure the end of your No. 34 D.S.C. wire (first baring the end, of course) under the "R" pin, and proceed to wind on 35 turns in a single close layer (push the turns up tight with your thumb-nail). This done, cut the wire and secure the end by passing it through a small hole in the tube, take it along inside and fasten

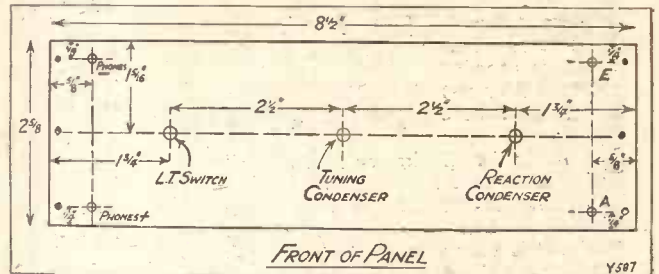

it under the pin at the other end (this is the "E" pin).

Next, make another small hole in the tube close beside the one you used in finishing off the last winding, pass the end of the No. 24 D.S.C. wire through this, take it along inside the tube, and secure it under the "E" pin, along with the termination of the reaction winding.

Making Tappings.

Now, you can proceed with the tuning winding, beginning close up to the reaction coil (leave only about $\frac{1}{8}$ th in. space between them), and putting on the 110 turns in a single, close, tight layer as before. As you put on this winding you should make tapings at the 20th, 30th and 40th turns (these are for the aerial clip), and also one at the 80th turn (for the other clip, which controls the tuning range), and this is easily done by twisting up a small loop, to be scraped bare later, at each point. On arriving at the finish (which will be close to the "E" pin), cut off the wire and secure it by passing it through two small holes in the tube, leaving about $\frac{1}{2}$ in. projecting for the attachment of a clip when required.

The coil is now complete, and you can fit it into its socket (take care that it is the right way round) and proceed to test out the set. It is best to do this on an ordinary aerial and earth at first, and this is the way you should do it: you will require a 2-volt valve of the H.F. type (D.E.L.210, P.M. 1 H.F., 210 H.F., S.S.2 I.L.F., etc.), and you should insert the plugs in the H.T. battery so as to give it the maximum voltage available.

First Tests.

Place the aerial clip on the 30-turn tapping, and the other clip on the end of the tuning coil. Now proceed to vary the tuning condenser, keeping the set all the while just below the oscillation point by adjusting the reaction condenser, and you should easily pick up 5 G B, in practically any part of the country. That having been done successfully, move the "wave-length" tapping clip down to the 80-turn tapping, and try for the nearest ordinary main station, and when this has been found try moving the aerial clip to each tapping in turn until you find the best one.

Then take a run round the tuning

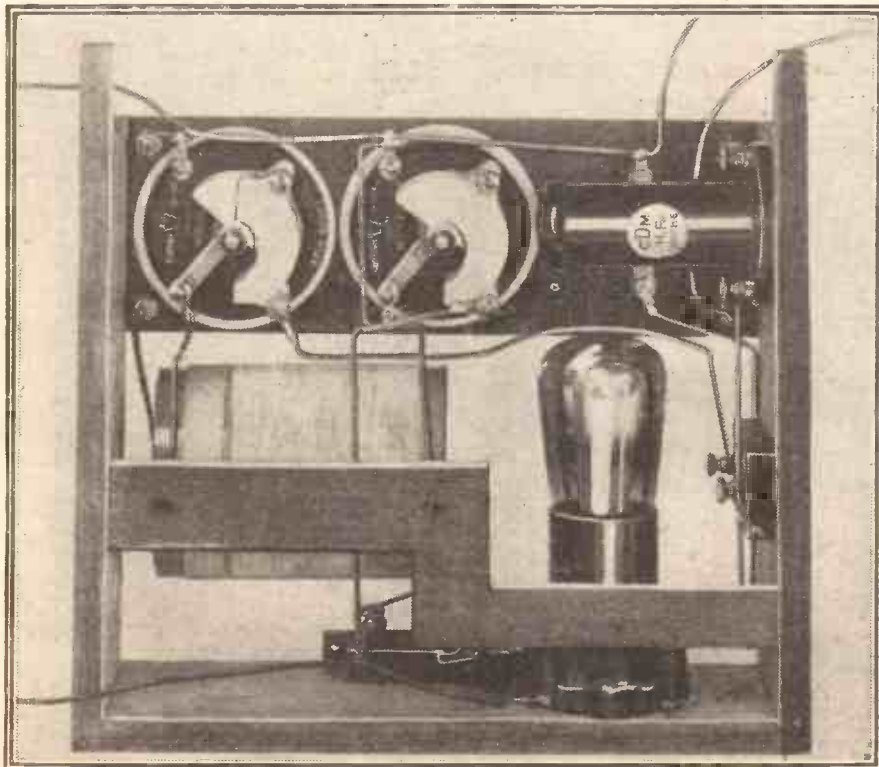

Although the set is so compact, the wiring is quite accessible.

(Continued on page 456.)

OPERA STARS AT COVENT GARDEN

Great artists are assembled at Covent Garden. They are going to broadcast to you. You will hear singers you have never heard before, and you may never hear them again. Take full advantage of your present opportunities therefore. Be sure you use pure H.T. current in your set for the forthcoming opera broadcasts—such pure D.C. current as you will get if you use the Lissen New Process Battery. You will start listening earlier—you will continue listening longer if you have a Lissen New Process Battery in your set. Because the song is clearer, the music sharp and wonderfully distinct, and you will get true light and shade in the reproduction. This fine quality lasts right through the longest programme.

No other battery gives the same fine current—the same sustained power as the Lissen Battery because in no other battery do you get the new process and new chemical combination which is used only by Lissen, and which is now such an established success that it is in practically universal use wherever fine broadcast reproduction is appreciated.

10,000 radio dealers sell the Lissen Battery—ask for it in a way that shows you will take no other.

60 volt (reads 66)	7/11
100 volt (reads 108)	12/11
60 volt (Super Power)	13/6
9 volt Grid Bias	1/6

Pocket Battery 5d. each, 4/6 doz.



THE "SUMMER" ONE.

(Continued from page 454.)

condenser in search of foreign stations, and so become accustomed to the handling of the set. The number of foreigners you pick up will soon convince you that no efficiency has been lost in making the "Summer One" so compact!

By the way, no graduated dials or scales were fitted to the condensers on the original set, because it hardly seemed worth while to do so. The point is that since the set is constantly used with different kinds of aerials, no permanent readings can be expected, and so gradations are of no use and one might as well be content with the plain knobs and pointers supplied with the condensers (the Cyldon "Bébe" condenser has a miniature graduated dial fitted as standard, so the point does not arise in this case).

Make-shift Aerials.

Having got a general idea of the handling and behaviour of the set, you will be ready to take it out into the country and try it with make-shift aerial and earth arrangements. Now, some people like to carry

with them a long length of posh rubber-covered flex for the aerial, which they fix high above the ground by climbing trees, and this is no doubt a very worthy proceeding, since it guarantees good, strong signals from two or three stations almost everywhere.

However, it involves some strenuous effort and a certain amount of extra weight to carry, so it is suggested that (at first, at any rate) you should try taking a bobbin of No. 24 D.C.C. wire in the case and throwing a 20 or 30-foot length of this as high as you can in whatever trees or bushes are available. You will find even so poor an aerial will almost always give you quite adequate signals up to 20 or 30 miles from a main station, and much further from 5 G B and 5 X X.

Earthing Methods.

For the earth you can quite well use simply another similar length of wire lying on the ground and acting as a "counterpoise," since this again will serve perfectly well at all moderate ranges. For greater distances it may be desirable to use an earth-pin, which may be simply a piece of 1/4 in. brass rod of a length to fit nicely inside the case, and provided with a short length of wire to connect it to the set. This pin, of course, should be inserted in the dampest ground you can find.

Finally, you will probably be interested to see in next week's issue a short article describing the experiences of a member of the technical staff who took the "Summer One" away with him for a week-end in the New Forest. (Note: Details of the high-wave coil for 5 X X will also appear in the same issue.)

WET H.T. BATTERY HINTS.

If the zinc for wet H.T. batteries is amalgamated at home it should be remembered that the solution of mercury perchloride is very poisonous, and if allowed to come into contact with wounds or broken skin the results may be serious.

To prevent evaporation of the solution during the summer, a thin layer of light oil should be poured on to the electrolyte after the cell is filled.

When the electrolyte is poured into the wet cell it is essential that it should not be allowed to splash the container, or any part of the cell which is not to be submerged, or the cell will certainly give trouble due to creeping.

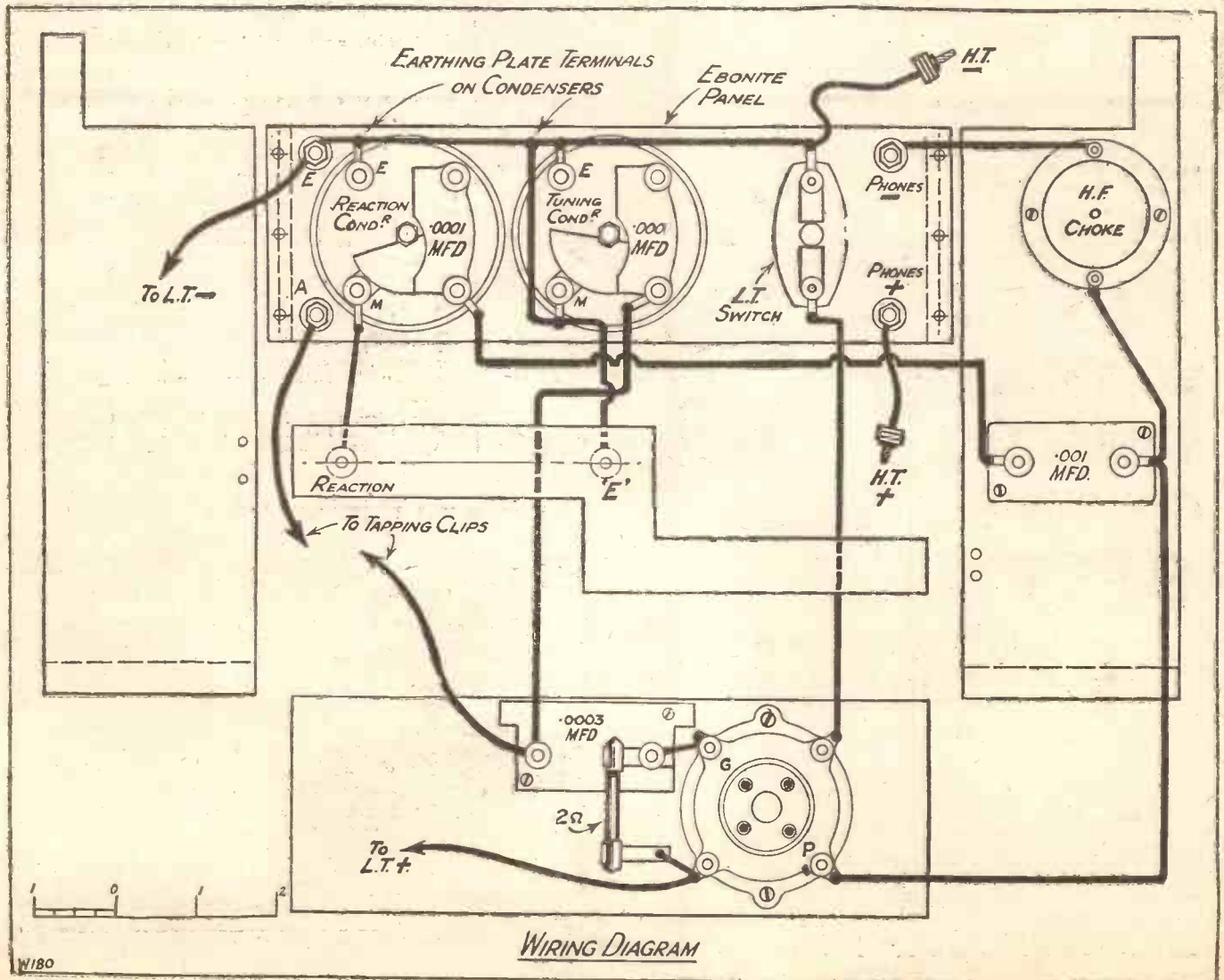

**EKCO'S LATEST AND GREATEST—
BRAND NEW PERMANENT TRICKLE CHARGER**

52/6
RETAIL

"EKCO" Permanent Trickle Charger

CHARGES accumulators safely, silently and soundly from A.C. Mains. Voltages of 100 to 120 or 200 to 250 with frequencies of 40 to 100 cycles in each case. Self-contained with a sturdy step-down transformer constructed of highly-insulated windings which supply required voltage and current to a Westinghouse Patent Metal Rectifier, that completely dispenses with the bugbear of valves and their expensive renewal. **NO REPLACEMENTS OR MAINTENANCE COSTS ARE NECESSARY.** Will last many years without attention. Size 6½ inches by 4 inches by 4 inches. Efficiency guaranteed second to none. In metal case with extremely neat bronze-oxided finish. Charging rate is ½ amp. continuously to 2, 4 or 6v. cells. Charging rate when electricity is 6d. per unit is approximately 80 hours for 6d.

Two models are supplied:
T.500 for 200-250v. 40-100 cycles. | T500a for 100-120v. 40-100 cycles.

E.K. COLE LTD "EKCO" WORKS, DEPT. A.,
LONDON ROAD, LEIGH-ON-SEA.

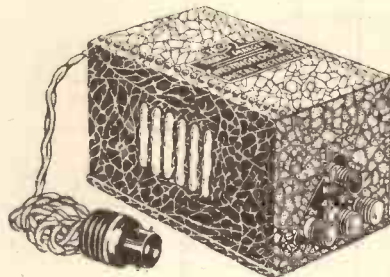

*Supremely Efficient
Lowest in Price
Neatest in Appearance*

**RESTORE
ITS OLD
ZEST
WITH A
TOUCH
OF THE
BEST**

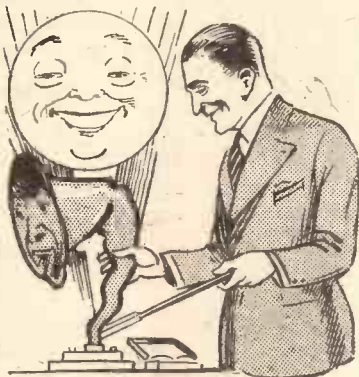

**FLUXITE
SOLDERING
SET—complete
7/6
or LAMP only, 2/6.**

FLUXITE
—IT SIMPLIFIES SOLDERING

All Hardware and Ironmongery Stores sell **FLUXITE** in tins, price 8d., 1/4 and 2/8. Another use for Fluxite—Hardening Tools and case Hardening. Ask for leaflets on improved methods.

FLUXITE LTD.,
(Dept. 324),
Rotherhithe, S.E.16.

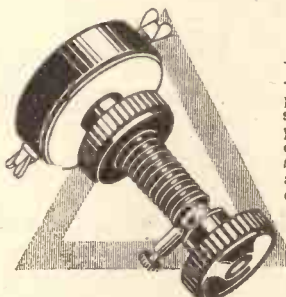
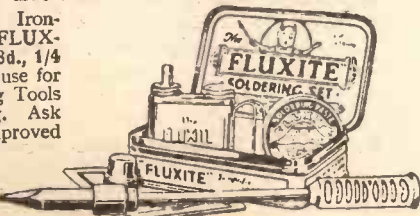

SAFETY FIRST

INSTALL the Marconiphone Combined Lead-in Tube and Earthing Switch—it definitely protects your receiver against lightning. The special convenience of this Marconiphone product is that though it earths the aerial outside, the switch is controlled from within the house. The switch is positive in action and can be fitted in a few minutes to any door or window.

PRICE 7/6, from all radio dealers.
THE MARCONIPHONE COMPANY LTD.,
210-212, Tottenham Court Rd., London, W.1.

MARCONIPHONE
COMBINED LEAD-IN TUBE AND
EARTHING SWITCH



Price from 2/6

FORMO-DENSOR

FOR USE AS
Neutralising Condenser
Aerial Condenser
Grid Condenser
Reaction Condenser
Phasing Condenser
Tone Control Condenser, etc.



A sound variable condenser which fills a long-felt want. Specially designed to take the place of the hitherto generally used Fixed Condenser.

5 Capacity ranges, and each in Baseboard and Panel models.
22, CRICKLEWOOD LANE, N.W.2
Phone: Hampstead 1787

BUY FORMO HANDBOOK. Practical Circuits, Blueprints of two sets, etc., 1/-.



All Editorial Communications to be addressed to The Editor, POPULAR WIRELESS, Tallis House, Tallis Street, London, E.C.4.

The Editor will be pleased to consider articles and photographs dealing with all subjects appertaining to wireless work. The Editor cannot accept responsibility for manuscripts and photos. Every care will be taken to return MSS. not accepted for publication. A stamped and addressed envelope must be sent with every article. All inquiries concerning advertising rates, etc., to be addressed to the Sole Agents, Messrs. John H. Lile, Ltd., 4, Ludgate Circus, London, E.C.4.

The constructional articles which appear from time to time in this journal are the outcome of research and experimental work, carried out with a view to improving the technique of wireless receivers. As much of the information given in the columns of this paper concerns the most recent developments in the radio world, some of the arrangements and specialities described may be the subject of Letters Patent, and the amateur and the trader would be well advised to obtain permission of the patentees to use the patents before doing so.

QUESTIONS AND ANSWERS.

"FIELDLESS" COILS.

H.L.P. (Nottingham).—"A friend of mine brought me back from America a book describing the construction of a three-valve set, for which tremendous long-distance reception is claimed. The diagrams look pretty much the same as British diagrams, but there is one thing that puzzles me, and that is the use of 'fieldless' coils.

"In two places the coils are marked 'fieldless coils,' and I am not sure what this means, or whether I can get coils of this type in this country. Can you tell me?"

Fieldless coils are those in which special steps have been taken to reduce the area over which the magnetic field of the coil is distributed. As you are probably aware, the high-frequency electric currents flowing in any coil are accompanied by corresponding magnetic fields, which rise and fall with every fluctuation of the high-frequency current.

These magnetic fields sometimes exist for a space of inches around the coil, and consequently they can give rise to all sorts of undesirable coupling effects. Where there is plenty of space, such coils can be well separated from each other and from the neighbouring wiring etc., so that undesirable interaction is not troublesome; but when building specially-compact receivers, or those in which the design calls for certain components to be placed in close proximity, steps have to be taken to reduce the magnetic fields of radio-frequency coils.

If, for instance, two half coils are used, wound in opposite directions and suitably spaced, the field due to the current in one half will tend to nullify the effect of the field due to the current in the other half, and consequently the external magnetic field of such a coil is greatly reduced.

There are several types of such fieldless coils obtainable, (all relying on this general principle of the opposition of the magnetic fields) the most popular ones being astatic coils and toroid coils.

A DUD EARTH.

B. B. W. (Newmarket, Cambs.).—"I do not know anything about the theoretical part of wireless, but I can tell good results from bad, and I know that my one-valve set is not half as good as it was a couple of months ago. Two of my friends have had a go at it at different times, and one has tried his own battery and valve upon it. After all their trouble the only thing they can suggest is that the earth is wrong. As the earth is buried, and in a very awkward place to get at, I should like to know if there is any way of testing it, short of digging it up."

(Continued on page 460.)

BRITISH GENERAL TRANSFORMER.

SOME time ago we received a British General Super Shrouded L.F. transformer, and this has since been given a series of careful tests. It is a large, well-assembled component, and has a distinctive shape. And on the cleanly moulded top insulating plate the four substantial terminals are widely spaced. The ratio of the particular model sent us is 3-1, and the price 18s. 6d.

The transformer has an efficient magnetic circuit containing plenty of iron, and does not evince vibration when used in the conventional position in an average receiver. The primary winding has ample inductance.

We found that this British General transformer gave good results when used in either a first L.F. stage or as a final coupling subsequent to R.C.C. in a four-valve set comprising two stages of L.F. and one of H.F. Amplification was distinctly good, pointing to a successfully high degree of efficiency on the part of the transformer in point of energy transference. The tone of the output was good, there being a very excellent proportion of bass and an absence of serious peak effects on the upper register.

PHILIPS' TRICKLE CHARGER.

The object of a trickle charger is to supply an accumulator with a long charge at a low rate. The Philips' Trickle Charger, 1017, a sample of which was recently sent us for test, is for use with A.C. mains and is a remarkably compact device. It employs a valve rectifier and, although the valve is very readily accessible, it is plugged in in such a manner that it is completely enclosed. The charger is completely automatic and is



BRITISH GENERAL TRANSFORMER—PHILIPS' TRICKLE CHARGER—MAGNUM SHORT-WAVE CHOKE—AN EFFICIENT POWER TRANSFORMER, Etc., Etc.

Traders and manufacturers are invited to submit wireless sets and components to the "P.W." Technical Department for test. All tests are carried out with strict impartiality in the "P.W." testing room, under the supervision of the Technical Editor, and the general reader is asked to note that this weekly article is also intended to provide a reliable and unbiased guide as to what to buy and what to avoid.—EDITOR.

provided with a switch which brings it into operation the moment that the receiving set is switched off.

This change-over switch also cuts off the H.T. supply-unit connections should such be used. A special feature is that should for some reason or other the mains voltage fall off, the discharging of the accumulator cannot take place for the working of the charger is stopped. When the mains voltage is normal again it automatically recommences charging. Further, accidental

short circuits cannot do harm to the instrument. It is therefore a safe and simple article.

The cost of running it is almost negligible and it is necessary only to employ a small and inexpensive accumulator, one of 3 or 4 ampere hours capacity being quite sufficient. The charging rate of the device is in the neighbourhood of .2 amps, although this can be reduced if necessary by means of an additional series resistance. In

(Continued on page 464.)

"IT'S THE TOBACCO THAT COUNTS"



*Player's
Please*



REGD. No. 154,011

N.C.C.42

PLAYER'S "MEDIUM" NAVY CUT CIGARETTES 10 for 6^p - 20 for 11¹/₂^p

RADIOTORIAL QUESTIONS AND ANSWERS

(Continued from page 458.)

It is quite easy to test the earth connection, the best method being the comparative one. All you need for the purpose is a fairly long length of flexible wire, or of ordinary wire as used for coils if flexible wire is not obtainable.

First of all, tune in your set to a fairly weak signal and listen carefully to the strength of reception, preferably during a talk. Then disconnect the present earth lead from the set and join the temporary flexible wire there, the other end of this being taken to a water tap or some other really good earth connection which can conveniently be joined up for the purpose of the test. (Make the connection to the new earth as good as possible, or otherwise the test will necessarily be inconclusive.)

It may be necessary to retune a little on the set owing to the different length of lead in the earth wire, but if your present earth connection is really poor the new temporary lead will have the effect of improving reception considerably. Consequently you should either make this a permanent connection, or else overhaul the old lead, which is obviously in need of renewal.

TRANSFORMER OR RESISTANCE FIRST ?

T. T. (Framlingham, Suffolk).—"I am going to build a two-valve amplifier, low frequency, using one resistance-capacity and one transformer stage. Which should come first?"

The answer to your question depends upon what kind of set you are going to use the amplifier with. If it is to be a valve set, your best way will be to use the resistance stage first, followed by the transformer stage. If, however, your set is a crystal set you should use the transformer immediately after the crystal, and follow this by the resistance-capacity coupling to the last valve.

SHARP TUNING.

E. J. (Handsworth, Birmingham).—"Sharp tuning has long been a fetish of mine and recently I added a potentiometer to the first valve in order to help in this direction. To my surprise, I found that instead of helping

there was a distinct decrease in selectivity with the use of the potentiometer. Why is this?"

The omission of circuit details from your letter leaves us rather in the dark as to the exact cause of the effect you are experiencing, but possibly you have been attempting to use a potentiometer without a by-pass condenser? In such a case the advantage due to the exact adjustment of the potentiometer may be more than nullified by the high resistance introduced by the potentiometer into that circuit.

You can easily test if this is the cause of the trouble by connecting a fixed condenser of about 1 mfd. capacity between the filament lead and the slider of the potentiometer. If the added resistance was the cause of the lack of selectivity the addition of the by-pass will completely remove the trouble.

H.T. FROM THE MAINS.

G. W. (Ilford).—"I am taking the H.T. from the direct-current mains, but what I cannot understand is this: If I touch the plate of a valve or the loud speaker, or any other H.T. positive lead I do not feel any effects. But sometimes when I touch the accumulator on the earth terminal, I feel quite a powerful shock. What can be the cause of this?"

Symptoms such as you describe are probably due to the fact that it is the positive lead of the mains which is earthed in your case, and not the negative lead, as in most D.C. systems. When this is done all the H.T. positive wiring is at the same potential as earth, but the L.T. wiring is at the full voltage of the mains below earth potential.

To avoid unpleasant results we should take great care with the insulation of the set, making sure that all the battery leads are well covered and protected from accidental contacts, and that the set is well supplied with fuses, etc.

AN H.T. WANGLE.

H. W. R. (Sheffield).—"Originally the set was designed for all the four valves to take the same H.T. voltage, but lately I have found that by using another H.F. valve I have got far superior results. The only trouble is that this valve requires 120 volts,

(Continued on page 462.)

A DET. AND 2 L.F. SET.

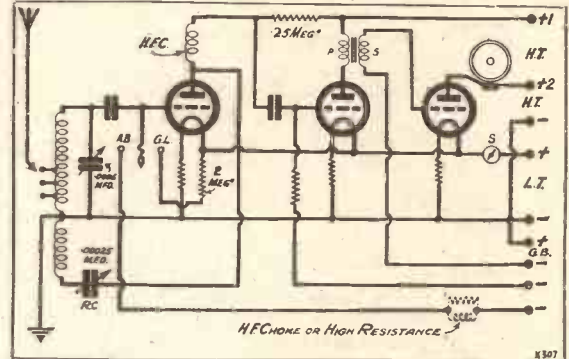

The correct connections of the Det. and 2 L.F. receiver, giving alternative anode-bend or grid-leak rectification, are shown above.

In the "What is Wrong?" diagram last week the following mistakes were shown:

The earth lead was tapped into the reaction coil; in the anode-bend position the grid was connected direct to G.B. neg. (instead of through a resistance or H.F. choke); an L.F. choke was used in place of an H.F. choke; the L.F. transformer windings were reversed; H.T. negative was omitted and a neutrodyne condenser was used instead of a reaction condenser.

INTERFERENCE?

—here's the remedy!

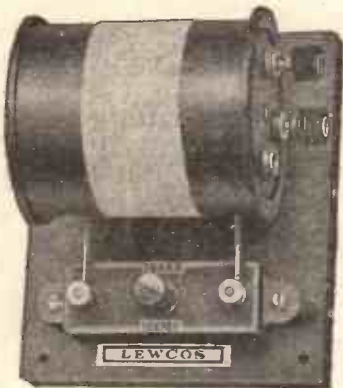

Ref. No. WT4, 250-400 m.
Ref. No. WT5, 350-550 m.
Ref. No. WT15, 1000-1500 m.

13/6

If you have difficulty in getting alternative programmes without interference from the local station—try this LEWCOS Wave-trap. The results are astounding. Obtainable through all good Radio dealers. Full particulars with each unit.

THE LONDON ELECTRIC WIRE CO. & SMITHS LTD.
Playhouse Yard, Golden Lane, London, E.C.1

LEWCOS WAVETRAP

REGD.

BUY AND BUILD DUBILIER



No effort is spared to see that not a single Dubilier component leaves the works until it has successfully withstood the most exacting tests; and not only are they good to start with, but the rigorous regard to detail in their expert design and workmanship ensures that their efficiency is steadfast.

Whatever components you require, ask for them by their name in the Dubilier Catalogue, which will be sent post free on application. If your dealer cannot supply, send to us direct, mentioning your dealer's name and address.

DUBILIER
CONDENSERS

DUBILIER
Regd. Trade Mark.

*Dubilier Built
is Better Built*

Advt. of Dubilier Condenser Co. (1925), Ltd.,
Ducon Works, Victoria Road, North Acton, W.3.

© 155

'Ideal' speaker reproduction for 37/6

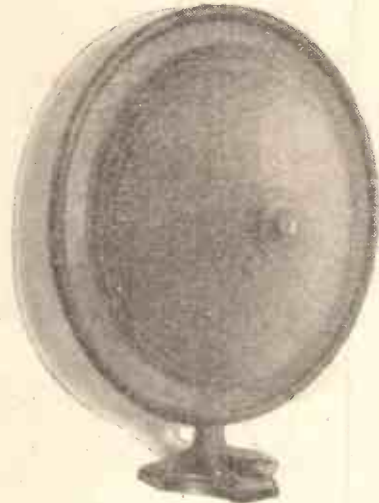

The popular 'Ideal 44' Cone Speaker at a reduced price

Right from its introduction the popularity of the 'Ideal' Cone Speaker has been indicated by continually climbing sales. This increasing demand has enabled us to revise production costs and we are now able to offer our 44 model at a reduced price.

Everyone who has heard the 'Ideal 44' is eloquent of the purity of its reproduction; its range of interpretation; its exceptional quality at either extreme of the scale.

You would not believe that such a speaker was obtainable at such a price, yet you can prove it to your satisfaction in your own home to-day—your dealer is selling the 'Ideal' Cone Speaker at the new reduced price of 37/6.

This price reduction applies also to the 'Ideal' Loud Speaker Kit from which you can build up the 'Ideal 44' in your own home.

For the home construction the 'Ideal' Four-Pole Balanced Armature supplied as a separate unit exactly as embodied in the 'Ideal 44.' Supplied complete with two padded washers on threaded spindle, 25/-.

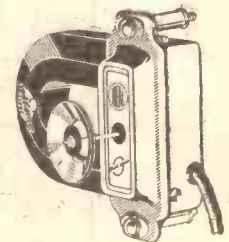

The **IDEAL**
44
CONE
SPEAKER

F. A. HUGHES & CO., LTD.,
Dept. (W.2), 204/6, Great Portland
Street, LONDON, W.1.



RADIOTORIAL QUESTIONS AND ANSWERS

(Continued from page 460.)

whereas I am using 200 volts on all the other valves. Is there an easy way for overcoming the necessity for a separate H.T. supply to this valve?"

One easy way of getting round the difficulty is to apply a suitable negative grid bias to the first valve, the value for this bias being found as follows: Divide the value of the excessive voltage by the amplification factor of the valve, which gives the maximum number of negative volts that will be necessary. In your case the surplus H.T. is 80 volts, so that if you are using a valve with, say, an amplification factor of 20, the maximum negative grid voltage that will be required is four.

THE "SYDNEY" TWO.

"THOMAS" (Bognor, Sussex).—"Will the 'Sydney' Two really pick up signals direct from Sydney in Australia?"

You could have saved yourself both time and money, "Thomas," by referring to recent "Correspondence" columns of "P.W.," where many readers have recorded their experiences in picking up Australia direct on this simple receiver.

USING A METAL PANEL.

F. R. K. (Hereford).—"First I polished up the cabinet a bit, then I added an L.F. valve, and eventually I took the set to pieces and decided to rebuild the whole thing again. As I am very tickled with the look of those metal panels I wonder whether there is any harm in using that kind instead of an ebonite one?"

The only snag with metal panels is that they are liable to afford unexpected conductive paths unless the insulation of all the components mounted upon the panel is good. This is especially true where jacks are used for phones, etc. So before replacing the ebonite panel with a metal one we should make very certain that all your panel components are properly insulated where necessary.

AN R.C. COUPLING FAULT.

L. M. (Epping).—"When one of the transformers burned out I decided to replace it with an R. C. coupling unit. Using the values stated on my diagram (enclosed) the results were simply awful, and after a lot of tinkering about I gave it up as hopeless, and was going back to a transformer when a friend suggested lending me his own spare R.C.C. unit.

"We tried this, and to my astonishment there was an immediate and great improvement over the original set, signals being much clearer all round, and I believe even louder, if anything, than before. So I purchased a similar unit, and am very happy with it now: but what I cannot make out is that I have since found that the values used are the same as those I was using in my unit before. Why was it that I could not get good results then?"

In all probability the coupling condenser that you were using in the first place was faulty, with the result that a certain amount of the high-tension voltage was being applied to the grid of the second valve. Any leakage of this sort (even a small one), will completely spoil reproduction, but when you changed over to the purchased unit you were using a properly insulated condenser, and so the trouble was absent. (Many thanks for your helpful report upon the work of your "Chitos" Two, and congratulations upon your results.)

AN ABSORPTION WAVE-METER.

"SHORT-WAVE WALLAH" (Rangoon, Burma).—"Can you tell me what is the principle upon which an absorption wave-meter works?"

Practical details vary somewhat according to whether the instrument is to be used for a transmitter or receiver, etc., but the fundamental principle upon which the instrument works is quite easy to understand. In the case of an absorption wave-meter for short-wave reception, for instance, the instrument consists of a suitable coil and calibrated condenser.

Like any other wave-meter it is placed at a convenient distance from the set so that no more interaction than is necessary takes place, in which position

it will absorb very little energy from the set unless the latter is tuned *exactly* to the wave-meter's wave-length. In consequence, a simple way of using it is to allow the receiver to very gently oscillate for a moment, turn the wave-meter condenser round slowly and listen in on the telephones until a point is reached when the receiver suddenly stops oscillating. This will happen only when the wave-meter is adjusted exactly to the tuning of the set (and is then absorbing the maximum amount of energy from the receiver), and thus this cessation of oscillation gives a very convenient indication of when the circuits are in tune with one another.

BACK NUMBERS OF "P.W.," "M.W.," AND "THE WIRELESS CONSTRUCTOR."

S. A. (Benson).—"Where can I get Back Numbers of 'Modern Wireless' and POPULAR WIRELESS?"

Back numbers of POPULAR WIRELESS and of its associated journals, "Modern Wireless" and "The Wireless Constructor," can be obtained upon application to The Amalgamated Press, Ltd., Back Number Department, Bear Alley, Farringdon Street, London, E.C.4.

DISCHARGING AN ACCUMULATOR.

"ECONOMICAL" (Berwick-on-Tweed).—"I had to save up so long for it, that I want to treat my new accumulator with all possible consideration. I understand that taking too much current out of it shortens its life, and I want to know what is the maximum current that I should take out of it? (It is a thirty actual ampere-hour accumulator)."

The damage due to over-discharge begins when more than one-tenth of the actual hour rating is taken from the battery. But if you want to be especially careful and to treat it with the greatest possible consideration, one-twelfth or one-fifteenth of the "actual" rating can be considered as the limit. You will see that even if the latter figure is adopted you will have plenty of current and will be able to take up to two amperes for your set.

TRANSFORMER TROUBLE.

T. F. (Liverpool).—"I am using a moving-coil loud speaker, and while experimenting

(Continued on page 464.)

GOOD NEWS FOR SET BUILDERS

In response to the urgent demand for first-class sets for family use, Mr. PERCY W. HARRIS, M.I.R.E., has now prepared the

Wireless Constructor Envelopes

The first two of this series are NOW on Sale, price 1/6 per envelope (by post 1/9).

Envelope No. 1.—THE RADIANT THREE. A famous loud-speaker set which you can build in an hour or two—no soldering necessary and a wide range of components to choose from.

Envelope No. 2.—THE CONCERT FOUR. Made of standard parts, all easily obtainable, this is a *highly-sensitive, long-distance set, giving powerful reproduction of wonderful quality.* Covering both long and short wave-lengths, with a switch for 3 or 4 valves, it is essentially a set to enjoy, both in building and operation.

In each envelope you will find every detail of the set simply explained; photographic reproductions and diagrams are included, as well as a full-size Blue Print.

NOW ON SALE ————— Price 1/6

By post 1/9, from Wireless Constructor Envelopes, The Amalgamated Press, Ltd., Bear Alley, Farringdon Street, London, E.C.4.

THE NEW IDEA

Wireless all over the house from your **COSSOR Melody Maker**



INCREASE the enjoyment and comfort of good reception. Don't have a good set and restrict it to one room. Reception from your Cossor Melody Maker can take place in every room in the house—**independently—simultaneously—and without interference, if you fit a Lotus Remote Control.**

You can wire two rooms yourself in half-an-hour at a cost of a few shillings. Ask your retailer for a free blueprint or send a postcard to the makers.

For your Melody Maker you need: 1 Lotus L.T. and H.T. Relay, 2 Filament Control Wall Jacks, 2 Jack Plugs, 21 yds. 4-strand wire, 30/-.

Similar outfit, but for set using L.T. Accumulator and H.T. Eliminator, 45/-.

This wires two rooms. Each additional room, 7/6 extra.

Recommended by the designers of the Cossor Melody Maker.

LOTUS REMOTE CONTROLS

Made by the makers of the famous Lotus Buoyancy Valve Holders, Lotus Vernier Coil Holders, and the Lotus Jacks, Switches and Plugs.

GARNETT, WHITELEY & Co., Ltd.,
Lotus Works,
Broadgreen Road, Liverpool

SELFRIDGE'S

England's Radio Headquarters
and
Perfect Radio Reception for All
NEW WIRELESS SETS FOR OLD
Better Radio Reception

Wireless Sets of any make whatsoever taken in Part Exchange

We are now prepared to allow for wireless sets of any make whatsoever—the bare set only need be returned to us, not the valves, batteries, or speaker, whatever condition it may be in, from one made by a scientific firm down to that made by the absolute amateur and schoolboy—and allow for a One-Valve Set, £2 for a Three-Valve Set, £6 for a Two-Valve Set, £4 for a Four-Valve Set, £8 for a Five-Valve Set (or more) £10

This allowance will go towards the purchase of one of the Gecophone—1928 only—Receivers detailed in this announcement—and, of course Selfridge's complete assurance of absolute satisfaction and thorough dependability is behind every one of these sets purchased.

"GECOPHONE" FIVE-VALVE PORTABLE RECEIVER WITH CONE SPEAKER, INCLUDING ACCUMULATOR.
The beautifully designed Five-Valve Long Range Receiver Portable Set with Cone Loud Speaker. CASH PRICE, less allowance for old set... .. **£30**
Deferred Payments 40/- monthly. Carriage Free.

Prices quoted below include latest type Cone Loud Speaker and H.T. Batteries, but not Accumulator.

"GECOPHONE" THREE-VALVE STABILISED RADIO RECEIVER AND GRAMOPHONE REPRODUCER.
Giving beautiful reproduction of speech and music: Manufacturers' List PRICE, £23 14 6, less allowance for old set. Deferred Payment—Monthly Payments of 30/-.

FOUR-VALVE RADIO-RECEIVER AND GRAMOPHONE REPRODUCER.
A long range receiver. Manufacturers' List PRICE, £27 19 6, less allowance for old set. Deferred Payment—Monthly Payments of 40/-.

"GECOPHONE" FOUR-VALVE RECEIVER AND GRAMOPHONE REPRODUCER.
Super-selective and super-sensitive. PRICE, £35 11 6, less allowance for old set. Deferred Payment—Monthly Payments of 40/-.

"GECOPHONE" TWO-VALVE RADIO RECEIVER AND GRAMOPHONE REPRODUCER.
Only available to those returning Crystal Sets and one set of headphones. Manufacturers' List PRICE, £13. On our Deferred Payment System—if returning old set. Twelve Monthly Payments of 20/- Carriage Free.

"This World Famous Store—needs no sign o'er the door."
Selfridge & Co., Ltd., Oxford St., London. Phone: Mayfair 1234

Crystallised in "CELESTION" are the 6 essentials of the Ideal Loudspeaker

EVEN RESPONSE.

Not only on the low, but on the middle and the high frequencies, assuring natural reproduction from both speech and music.

EXTREME SENSITIVITY.

Sensitive to the output from the weakest set.

ADJUSTMENT.

Ability to produce weak as well as very heavy signals without re-adjustment.

UNAFFECTED by CLIMATE.

Impervious to humidity and changes of temperature.

IMPROVES WITH AGE.

Improves and does not deteriorate with the passing of the years.

DISTINCTIVE APPEARANCE.

An excellent loudspeaker breathes craftsmanship in appearance, so careful and capable is the workmanship wrought upon it.

AND TOO, IT IS BRITISH.

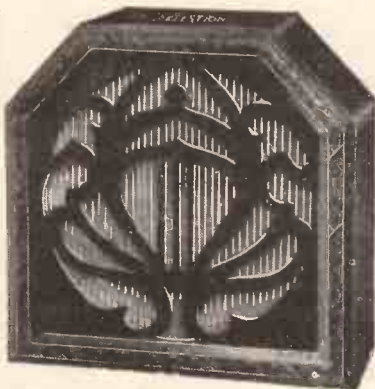

MODEL C.12.

Models range in oak and mahogany from £5-10-0 to £25.

Write for "Celestion" illustrated folder and also for new Gramophone Pick-up leaflet.

CELESTION

The Very Soul of Music

Write to Dept. B,

THE CELESTION RADIO CO.,
Hampton Wick, Kingston-on-Thames.

Showrooms: French Agents:
33/35, VILLIERS ST., CONSTABLE & CO.,
W.C.2. PARIS

RADIOTORIAL QUESTIONS AND ANSWERS

(Continued from page 462.)

and fitting it up I accidentally put the full voltage of the H.T. battery across the primary of the low-frequency transformer. It is a large capacity battery and I do not think it did much harm. But as reproduction ever since then seems to be decidedly below par and "wooden," I wonder whether it is possible to do any damage to the transformer in this way?"

We are afraid that you have damaged the L.F. transformer, especially if the battery voltage was high, as it is quite possible in such a case to damage the winding or the magnetic properties of the instrument. (The fact that it was a large capacity H.T. battery capable of supplying plenty of current was against you and not in your favour in this instance.)

THAT WOODEN PANEL.

"SHORT-WAVE WILLIE" (Willesden Green).—"My friends laugh at me for using a wooden panel for short-wave work, but I get pretty good results all the same. I do not want to go to the expense of fitting ebonite unless you think there would be a great improvement."

"P.W." TECHNICAL QUERY DEPARTMENT

Is Your Set "Going Good"?

Perhaps some mysterious noise has appeared and is spoiling your radio reception?—Or one of the batteries seems to run down much faster than formerly?—Or you want a Blue Print?

Whatever your radio problem may be, remember that the Technical Query Department is thoroughly equipped to assist our readers, and offers an unrivalled service.

Full details, including a revised scale of charges, can be obtained direct from the Technical-Query Dept., "Popular Wireless," Fleetway House, Farringdon Street, London, E.C.4.

A postcard will do: On receipt of this an Application Form will be sent to you free and post free, immediately. This application will place you under no obligation whatever, but having the form you will know exactly what information we require to have before us in order to solve your problems.

If tested for direct current with high voltages the resistance of ebonite is tremendously high compared with that of dry wood. But in high-frequency short-wave work, the advantages of ebonite over wood are often not so very marked. In fact, wooden panels can be used quite successfully, provided they are really dry and seasoned. The probability is that if you replace your wooden panel with an ebonite one you would not be able to notice a scrap of difference in the results, though this, of course, is not to say the ebonite would not have a higher all-round efficiency.

SWITCHING OFF AN A.C. MAINS UNIT.

N. F. W. (London, S.W.19).—"Which is the right way to switch off an A.C. mains unit—filaments off first, or H.T. switch first? I find that opinions on this question are very evenly divided amongst my friends; but all agree that valves and condensers are liable to injury if the switching is not done in the proper order. So which is right—filaments off first, or off last?"

For an A.C. mains unit the procedure is different from that recommended for a D.C. mains unit, and probably this fact accounts for the lack of agreement between your friends.

The rule for an A.C. mains unit is that the filaments should be turned off last, and turned on first. That is to say when switching off, cut out (a) mains and (b) filament; when switching on turn on (a) filament and then (b) mains.

APPARATUS TESTED.

(Continued from page 458.)

operation we found this Philips' Trickle Charger perfectly satisfactory, and as far as we can see it has no snags whatever. The price is £3 5s., complete with valve, and for such a well-designed, robust and useful instrument this appears to be reasonable.

MAGNUM SHORT-WAVE CHOKE.

Messrs. Burne-Jones and Co., Ltd., have produced a short-wave H.F. choke suitable for receivers tuning from about 10 to 100 metres. Outwardly it has exactly the normal appearance of the normal Magnum H.F. choke. This, as "P.W." readers will know, is remarkably compact and has its special windings enclosed within a small, tapered cylinder. The reaction H.F. choke used in a short-wave receiver is a very important item. It is, in fact, a sort of keystone in the assembly. There are only a few H.F. chokes which are really efficient on the low waves and our tests certainly proved that the Magnum H.F. choke can be included in this category. The price of the component is 7s. 6d., and it bears the usual evidences of the sound design and construction of all the other Magnum components.

AN EFFICIENT POWER TRANSFORMER.

The Wholesale Wireless Company Ltd. recently sent us one of their "All-Power" Croix transformers. The component is designed, among other things, to drive K.L.1 type valves. It also comprises windings providing 200-0-200 volts for full wave rectified H.T. At this voltage it will deliver quite safely up to 30 milliamps, but it can be considerably overloaded without serious effects. On the L.T. side it gives 3-0-3 volts at 1.5 amperes. When giving 1.6 amperes for driving the filament of a U.5 type of rectifying valve there is a slight fall in voltage, but the 5.8 is ample for the purpose. At this 3 0 3 voltage there is sufficient current for running two or four A.C. valves taking up to 8 amperes. A resistance can, of course, be used with the 4-volt type of mains valve. The transformer is guaranteed for one year and retails at 36s.

AN OMISSION.

The price of the "KABI" American Type On-and-Off Switch was omitted from Messrs. London Radio Supply Co.'s advertisement in our last issue. The price of this device is 1s. 6d., post free.

USEFUL WANDER PLUG.

Messrs. J. J. Eastick & Sons, Ltd., have produced a wander plug which they style the T.14, and which has the advantage that it can be used with batteries where the sockets are larger than the standard sizes. The pins are made of hard spring brass and have double slots. Constructors who have experienced trouble owing to the widely varying socket dimensions of H.T. batteries and many of the wander plugs previously available will welcome this new Eastick line. The makers state that they are now being standardised on a number of sets and that many running contracts have been obtained. This shows good sense on the part of the manufacturers concerned.

MODERN WIRELESS

On Sale June 1st

Price 1/-

THE "SYDNEY" TWO DE LUXE

Every amateur has heard of the famous "SYDNEY" TWO—the Det. & L.F. short-wave receiver with which so many readers have had remarkable results.

The "M.W." research department has now evolved a high-class version of this wonderful set, and full details will be found in the issue of "Modern Wireless," on sale June 1st.

A great point about this new version is that the set is suitable for reception on *all wave-lengths*—it is not confined to the short-wave band. Simple coil changing makes the set an efficient receiver of the ordinary broadcasters.

Place an order for your June "M.W." now, and don't miss the "SYDNEY" TWO DE LUXE.



NEWS FROM SAVOY HILL.
(Continued from page 450.)

may be supplying the broadcast music of the whole of the Continent, including England. Thus, if this scheme materialises, the B.B.C. would dissolve all its symphony orchestras and the organisation existing behind them and spend the funds thus released on technical improvements badly needed.

Trouble About the Derby.

Geoffrey Gilbey, who was to have broadcast a running commentary on the Derby, is understood to have withdrawn after an acute disagreement with the B.B.C. It is recognised that Mr. Gilbey is easily the best commentator the B.B.C. has for its sporting work. This year the B.B.C. asked him to do his job at Epsom from a crowded corner of the Press stand. This he resolutely declined to do, and the B.B.C. look like throwing him over. More will be heard of the incident before the "Big Race" is won!

The Microphone at the Cenotaph.

Next Sunday, May 27th, will see the microphone at the Cenotaph for the first time. The struggle to secure permission has been long and bitter, but at last the diehards have been beaten. On Whit Sunday the B.B.C. will take from the Cenotaph the British Legion service. Two microphones will be used, one attached to a lectern on the north, or Trafalgar Square, side of the Cenotaph, so fitted as to be completely hidden, and the other in a tree on the eastern, or Embankment, side of the carriageway, where the choir is to be stationed.

A lorry in a garage in an adjacent mews will provide the control point. The service will start sharp at 5 p.m. with the strokes of Big Ben, picked up from the spot and not by the special microphone in the bell-tower. The service will be conducted by the Dean of Westminster, the Very Rev. W. Foxley Norris, and includes, "O God, Our Help in Ages Past," "All People that on Earth do Dwell," "Last Post," Reveille," and National Anthem.

No More Cricket Commentaries.

The B.B.C. has wisely abandoned its running commentaries of cricket matches. Except for an infinitesimal proportion of "fans" these running commentaries last summer were endurance contests in abject dullness. In future eye-witness accounts of the play will be given later in the day.

A Successful Appeal.

So successful was the recent appeal from 5 G B by Sir John Robertson for the Lord Mayor's Fund for the National Association for the Prevention of Tuberculosis that the Lord Mayor, Alderman A. H. James, has been able to forward a cheque for £1,000 to the association—one of the largest donations which has ever been received from a provincial appeal. There seems little doubt however, that the B.B.C. is accepting and putting over far too many appeals. Some quite deserving causes draw a blank. Sir Thomas Horder's appeal for the effort being made by the Red Cross Society to deal with rheumatism by special clinics had practically no reward at all. Savoy Hill would be well advised to limit its appeals to one a month, and, if necessary, "pool" the results.

SIX-SIXTY
CONE SPEAKER
PAPER
HAS PROVED TO BE
THE BEST CONE
MATERIAL
MANUFACTURED
THOUSANDS USE IT
AND ARE
SATISFIED
Sold in two sizes
12" diameter and 18" diameter
PRICES 2/6 & 3/6
Ask your dealer, or write us
The Electron Co., Ltd.,
122-124, Charing Cross Road,
London, W.C.2

WET H.T. BATTERIES
Solve all H.T. Troubles.
SELF-CHARGING, SILENT, ECONOMICAL.
JARS (waxed) 2 1/2" X 1 1/2" sq. 1/3 doz.
ZINCS, new type 1 1/4 doz. 8ACS 1/2 doz.
Sample doz. (18 volts), complete with
bands and electrolyte, 4/3, post 9d.
Sample unit 6d. Illus. booklet free.
Bargain list free.
AMPLIFIERS 1-VALVE 19/-, 2-VALVE 30/-,
2-VALVE ALL-STATION SET 5/-
P. TAYLOR, 57, Studley Road,
STOCKWELL, LONDON

EKCO FAMOUS
ELIMINATORS FOR
LOW 1st PAYMENT
MODEL M.2.A.C.
Still another great line brought to you by the Noted House of P.D.P.
Everything Wireless supplied on Easy Terms. Low First Payment and Balance Monthly.
Send Lists of Requirements to:
P.D.P. CO., LTD., 121, CHEAPSIDE. Telephone: City 9846.

THE "RAPID" POLE FINDER (PAT. APPL. FOR)
An Ingenious Instrument with many uses.
Indispensable to all engaged in Electrical Work.
For currents from 1 to 250 volts.
Send postcard to-day 4/- for descriptive list. POST FREE
(One-third actual size.)
Arrow in contact with negative (-) wire of an electric circuit shows purple colour.
PATENTERS AND SOLE MANUFACTURERS:
NEW WILSON ELECTRICAL MFG. CO., LTD.,
18, Fitzroy St., London, W.1. Museum 8974.

EVERYTHING
RADIO
EASY TERMS
ON
WOOLDRIDGE RADIO CO. LTD.
17 LISLE ST. LEICESTER SQUARE
& 12. LONDON, W.C.2.

THE PERFECT TERMINAL

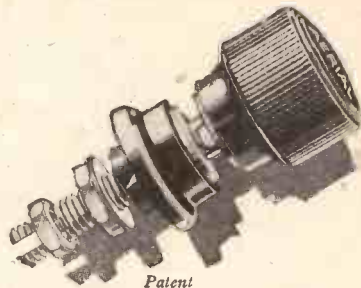

For perfect design, finish and workmanship, Belling-Lee Terminals are unequalled. Chosen by all the leading Wireless Journals, and by manufacturers of sets and battery eliminators.

- PRICES:**
Type "B." Illustrated, sold in an attractive carton carrying a year's guarantee. Price 9d. each.
Type "M." As type "B," but non-insulated. Price 6d. each.
Type "R." Cheap competitive insulated terminal with rotating name. Price 3 1/2d. each.

Illustrated catalogue free on request.

BELLING-LEE TERMINALS

BELLING & LEE, Ltd., Queensway Works, Ponders End, Middlesex.

PLEASE be sure to mention "POPULAR WIRELESS" when communicating with Advertisers. THANKS!

ADANA AUTOMATIC SELF-INKING PRINTING MACHINE
NEW ALL-STEEL SUPER-MODEL

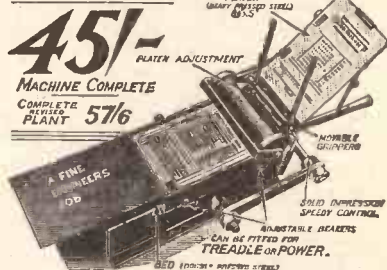

The Machine that is Built from the experience of over 10,000 Users of the old Model.

Over 15,000 users of Adana Printing Plants, saving enormously in their own work, and hundreds making an excellent living. Government Departments, Large Printers and Big Stores are amongst the many successful owners. Will print any matter from CHEMIST'S LABEL to an ILLUSTRATED MAGAZINE at a really commercial speed, including Perforating and Creasing. Simplicity to the extreme, no special skill required. Hundreds of boys producing school magazines. Real Printers' metal type, cast, all complete accessories and fully illustrated instruction book included in plant. Two-coloured illustrated particulars and samples of work sent on receipt of stamp.

BUILT FOR COMMERCIAL USE.
Machines can be shipped abroad C.O.D. cash against documents in London. Goods F.O.R. Twickenham.
THE ADANA AGENCY
is a complete organisation for the supply of Printing Office Equipment of every description. Controlled by most highly skilled and long experienced men of the Printing World. (DEPT. PW/9), 17, CHURCH STREET, and 34, KING STREET, TWICKENHAM.

Make
The DAILY SKETCH
YOUR Picture Paper

TECHNICAL NOTES.

(Continued from page 450.)

other metals, has some remarkable properties which cause it to require special treatment. For one thing, it is virtually impossible to melt tungsten (or, to be more exact, the melting point is so high and the difficulties due to oxidation and so on are so great that it is impracticable to manufacture the metal by melting, as in the case of most other metals).

The metal is chemically produced in the form of a heavy black powder, which is then treated thermo-mechanically in such a way as to produce the solid metal, which may subsequently be worked much after the same fashion as any other metal. When tungsten has been produced in bars it is first of all "swaged" until it is reduced to a convenient working diameter. ("Swaging" consists in a rotary hammering process, by which the diameter of the metal is gradually reduced and the length, of course, at the same time increased. It is roughly equivalent to "drawing" a metal through a die, but "swaging" may be used in cases where, for various reasons, "drawing" is impossible. Ordinary sewing needles and such-like articles are usually produced by what is equivalent to an automatic swaging process.)

Drawing the Wire.

When the tungsten wire has been sufficiently swaged down it may be drawn through dies of gradually decreasing diameter, until eventually it may be drawn out in the diameter required for valve filaments.

In view of the way in which the tungsten has to be worked, it has been for some years past very difficult for manufacturers to find means of giving fine tungsten filaments reasonable tensile strength. A careful study, however, of the crystalline nature of the metal, together with various methods of treatment and the introduction of small quantities of certain additional substances, have resulted in fine tungsten wire being produced in a remarkably tough and robust condition.

Counterpoise Aerials.

Although counterpoise aerials are not very commonly used—at any rate, by broadcast listeners—and to the radio amateur are more of theoretical than practical value—nevertheless there are some cases in which, owing to the impossibility of finding a good earth connection (or to other conditions) it is desirable to employ a counterpoise instead. Counterpoise aerials are, as a matter of fact, quite extensively used, in certain special cases, in commercial and other aerial systems.

A counterpoise aerial is, in effect, a condenser which is provided to act as a balance to the capacity of the aerial itself. Since we want to get electrical oscillations to and from the aerial through the receiving set, it is obvious that we must have some capacity on the opposite side of the set to the aerial, into and out of which the surges of electricity can flow. In the ordinary way a good earth connection provides the best of all capacities.

(Continued on next page.)

Be certain!

There are certain battery features on which good reception utterly depends. High recuperative powers—strength—

long maintenance of rated voltage—long efficient service—silent smooth working.

And all these qualities depend on the size of the cells. SURE-A-LITE cells are the largest and most efficiently designed of their type.

Don't experiment. Be certain. Buy the batteries that are proved best in design and performance—buy SURE-A-LITE. Look for the SURE-A-LITE sealed dust-proof container—guaranteed perfect condition so long as the seal is unbroken.

SURE-A-LITE

BRINGS MOST IN — GIVES MOST OUT

REGISTERED TRADE MARK

Wholesale Stockists:

Irish Free State:

J. P. Digby & Partner,
Corn Exchange, Dublin.

Northern Ireland:

Eirco Ltd.,
31, Rosemary St., Belfast.

"Supra" 66 volts ..	7/11
"Supra" 108 volts ..	14/3
"Giant" 66 volts ..	10/6
"Giant" 108 volts ..	17/6

"Power" Batteries, 66 volts 16/6; 108 volts 27/6; most economical in the long run because capacity is 2½ times greater than that of "Supra" at just over twice the cost.



THE BATTERY COMPANY,
92, HURST ST.,
BIRMINGHAM

The Better Battery

DO YOU WANT TO BE AN ENGINEER?

"THE ENGINEER'S GUIDE TO SUCCESS"

Tells how we can help YOU.

Send for free copy to-day.

40 Engineering Courses arranged for home study fully described. Preparation for all Engineering Exams. Tuition until pass. No time limit. Advice free.

THE TECHNOLOGICAL INSTITUTE
(Established 1918)

209, Temple Bar House, London, E.C.4.

AT LAST! A DIXIRON

A really reliable Electric Soldering Iron.



Light and well-balanced in weight, beautifully finished. Complete with flex cord and adaptor. Effectively handles the large as well as the small jobs. Loading 75 watts, and supplied for voltages of 100, 110, 200, 220-250. GUARANTEED FOR ONE YEAR. State voltage when ordering. Price 12/6 and 15/-, post free, from—

ELECTRADIX RADIOS,
218, Upper Thames Street, E.C.4.

THE LITTLE CELLS THAT SATISFY.

Eton Primary H.T. Battery P.I. Porous Pot Cells, S1 and S2 Sac Cells. All complete.

	1-cell	6-cell	12-cell	30-cell
P.I	6½d.	3/3	5/9	14/-
S.1	6d.	3/-	5/3	12/-
S.2	4½d.	2/6	3/10	9/6

Send 1½d. stamp for booklet giving full particulars to—
THE ETON GLASS BATTERY CO.,
46, St. Mary's Road, LEYTON, E.10

D-XELLENT!

DX IN-PLUG COILS

From No. 25 1/- to No. 500 4/-

DX SHORT-WAVE SET
4 Coils Nos. 3, 5, 7, 9 ... 7/6

"P.W." Test Report, March 10:—"The fact that one of the first stations tuned in was 3 L O of Australia is ample proof that the coils are efficient."

If unable to obtain send P.O. 7/6.
DX COILS LTD., LONDON, E.8.

HEADPHONES REPAIRED 4/-
Transformers 5/-. Loudspeakers 4/-. All repairs remagnetised free. Tested, guaranteed and ready for delivery in 24 hours.
Discount for Trade. Clerkwell 1795.
MASON & CO., 44, East Rd., City Rd., N.1.



For SIFAM RADIO METERS and be safe!

Send for Free Leaflet "Distortion" to Dept. F, SIFAM Ltd., 10a, Page St., Westminster, S.W.1. N.1.

ALL APPLICATIONS FOR ADVERTISING SPACE IN "POPULAR WIRELESS" MUST BE MADE TO THE SOLE ADVERTISING AGENTS, JOHN H. LILE, LTD., 4, LUDGATE CIRCUS, LONDON, E.C.4.

FOR CONVENIENCE SAKE

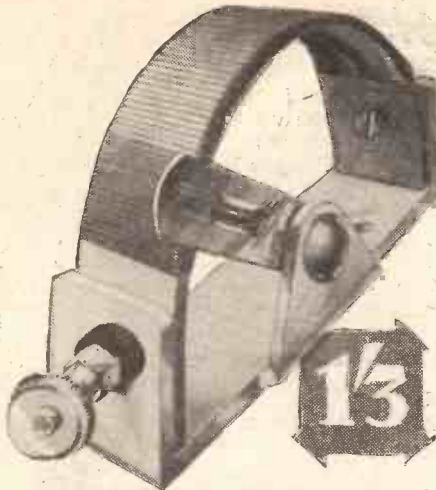

The "Peerless" Varistor occupies minimum space and stands clear of wiring, making adjustment more convenient in every way.

Best quality resistance wire is used for windings. Terminals are fitted in the most convenient position and the phosphor-bronze arm is easily accessible. Five types—3, 6, 10, 15, and 20 ohms. For efficiency and convenience use

PEERLESS VARISTOR

From all good dealers or—
BEDFORD ELECTRICAL & RADIO CO., LTD.
 22, Campbell Road, Bedford.
 London: 21, Bartlett's Bldgs., Holborn Circus, E.C.4.
 Glasgow: 113, St. Vincent Street; C.2.

REPAIRS

Any make of L.F. Transformer, Loudspeaker or Headphones repaired and despatched within **48 HOURS—TWELVE MONTHS' GUARANTEE** with each repair. 4/- Post free.

Terms to Trade.

TRANSFORMER REPAIR CO.,
 "Repairs" Dept.,
 214, High Street, Colliers Wood, London, S.W.19.

S.O.S. BATTERY TESTER

FREE WIRELESS GUIDE

FREE UPON REQUEST

VOLTMETER

Double Scale
0/6v and 0/120v 5/6

Reliable Instrument.

Tells immediately if full or empty

Only 3/6. Vent Plug Type 1/6

J.H. TAYLOR & CO.
 4, RADIO HOUSE, MACAULAY ST., HUDDERSFIELD 0/6v. only 3/6

The World's Finest H.F. Choke

SPECIALLY recommended for all receivers with 2 or more stages of H.F. because the Climax biocular method of winding gives no field effects.

The only effective H.F. Choke for both long and short wave work.

High self inductance. Low self capacity. One-hole fitting.

Ideal as anode or reaction choke in any circuit.

The Climax H.F. Choke **8/6**

From all dealers.

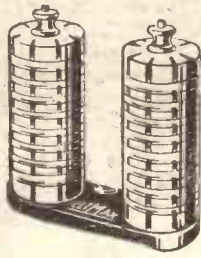

"Insist on the name 'CLIMAX.'"

CLIMAX

Climax Radio Electric Ltd., Quill Works, Putney, S.W.15.

A YEAR AHEAD

The Picture Paper with the **MOST News**
— SUNDAY GRAPHIC —

TECHNICAL NOTES.

(Continued from previous page.)

How They Work.

But in the absence of a proper earth connection (and there are, as a matter of fact, special cases where a counterpoise is actually preferable to an earth connection) a counterpoise serves the same function, and we have simply a system in which electrical oscillations can flow to and fro between the upper capacity—represented by the aerial; and the lower capacity—represented by the counterpoise, the receiving set being situated electrically between these two points and so being subjected to the oscillatory currents.

It is sometimes supposed that the counterpoise should lie directly beneath the aerial, and that it should be, in effect, a replica of the aerial itself.

Position of Counterpoise.

It is true that in most cases it is somewhat preferable to have the counterpoise vertically below the aerial, but this is by no means essential, and as to the counterpoise being a replica of the aerial, this is in practice generally far from being the case. Also, some experimenters imagine that the counterpoise should be as near as possible to the earth, or should be connected to the earth. This again is a mistaken notion: there is no necessity to connect the counterpoise to earth and the question as to whether the counterpoise should be as near as possible to the ground depends entirely upon circumstances: in certain cases it might be desirable to have it very close to the ground, whilst in other cases this would be undesirable. A counterpoise aerial is one of those rather peculiar things that depends upon a number of factors, and if you are installing a counterpoise it is well worth while to test it actually in different positions and in different formations, so as to find out the best way in which to use it.

Line Fluctuations.

I often receive letters from distant parts of the world, frequently from India, Australia, South Africa, and South America, and here is a letter from a reader in Canada, Mr. S. Langhelt, 86, Hamilton Boulevard, Regina, Sask., Canada, on the question of the fluctuation of the voltage of the electric-light mains, and the effect of this upon the operation of H.T. mains supply units. Mr. Langhelt says "I like reading your Notes in POPULAR WIRELESS. They help one to keep abreast with wireless technique in the Old Country. Your Notes in the March 24th issue of POPULAR WIRELESS say a few words on the difficulty in the regulation of transformer outputs. Enclosed you will find a 'schematic' of a line-voltage regulator. Supply line-voltages have a tendency, at certain hours of the day and night, to fluctuate considerably from their specified value, and I take it for granted that such is the case in England. Each rise gives a jump in the H.T.appings on the supply-unit, producing instability in the receiver."

Automatic Regulator Needed?

My correspondent then goes on to describe in considerable detail a special balancing system which he has devised for keeping the actual supply voltages to the receiver fairly constant and refers to

diagrams of the arrangements. He concludes rather optimistically: "Now all that seems to be needed is an automatic line-voltage regulator and then we shall have to look in other directions for some little thing to worry our heads about!"

I do not know what the conditions may be in Canada generally, or in his locality in particular, but I do not remember noticing that the fluctuations in line voltage have ever caused any very serious disturbance of radio reception conditions within my own experience. I have, however, observed quite considerable variations in line voltages, especially on alternating current.

It would be interesting to have readers' experiences on this point, and as to the alleged need for some simple form of line-voltage regulator.

Automatic Relay.

With the increased popularity of the trickle-charger system for low-tension batteries, especially in America, a simple but very convenient device has been introduced and is being adopted, which is in the form of an automatic relay-switch to throw the charger out of action when the battery is connected to the set, and into action when the set is shut down. In the ordinary way it is a very simple matter to have a double-pole double-throw switch upon the charger.

But although this is convenient it assumes that the battery with trickle-charger is handy to get at.

WILL YOU HELP?

AN APPEAL TO ALL WHO LOVE CHILDREN.

FOUNDED seventeen years ago by the readers of LITTLE FOLKS MAGAZINE, the LITTLE FOLKS CHILDREN'S HOME at Cooden Beach, Bexhill-on-Sea, every year nurses back to health and happiness some hundreds of sick and convalescent children from the Queen's Hospital for Children in London, of which the Duke of York is President. At this delightful home the little sufferers obtain, first, the benefit of sunshine and fresh sea air and, when they are well enough, the exquisite delight, often experienced for the very first time, of romping on the sands and paddling in the surf.

Will you help? Every pound subscribed to the LITTLE FOLKS HOME will help to lighten the burden on the Queen's Hospital and enable the LITTLE FOLKS HOME to carry on, unhampered by financial worries, its splendid work of bringing sunshine to lives of little ones and roses back to the cheeks of those who have been long ailing. If your child has happily recovered from sickness will you send something—what you can afford—five pounds!—a pound!—a shilling!—as a thank-offering? Or will you send what you can with a prayer that your little one may continue to enjoy the blessing of good health—a blessing which the LITTLE FOLKS HOME does so much to restore to innocent sufferers.

Any amount will be gratefully received. Donations should be sent to: "The Editor, Little Folks Magazine, The Fleetway House, Farringdon Street, E.C.4, who will acknowledge all amounts, however small. Please send quickly!"

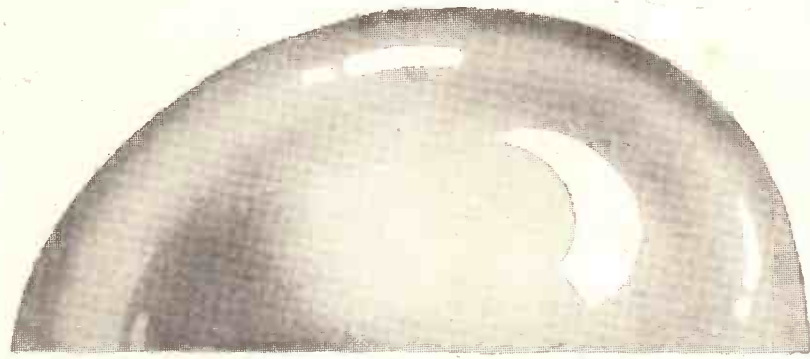

Mullard

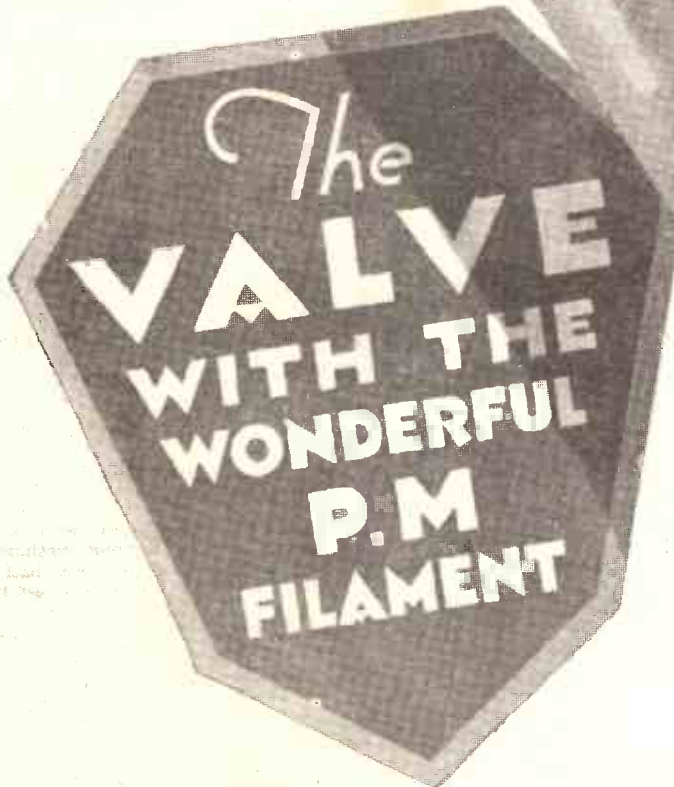
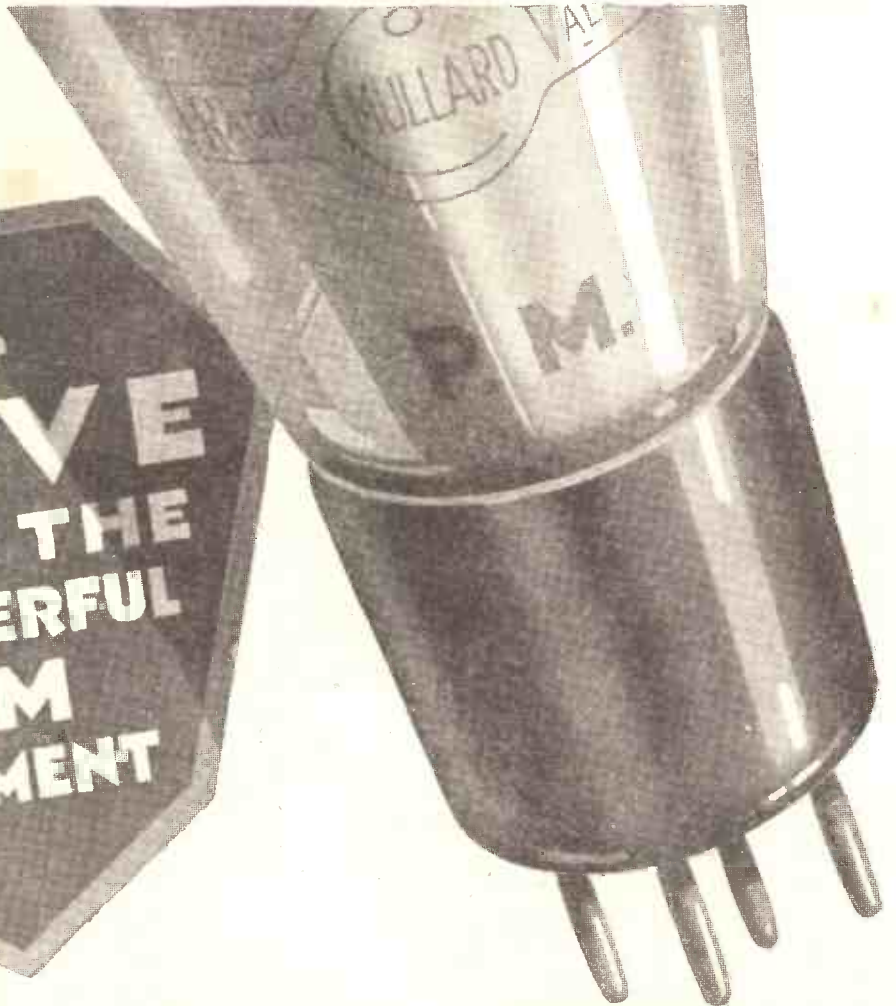

THE · MASTER · VALVE

The new **BABY DIAL** fits all **TUNERS**

R.I.
AND
Varley
LTD.



*SLOW MOTION DIAL.
Actual Size, 2 1/4" diameter.*

Here's a tremendous boon to everyone who owns an R.I. and Varley Tuner! This new Baby Dial fitted to one of our tuners will give even greater accuracy and finer tuning.

Beautifully constructed, moderately priced, and easily fitted, this Baby Dial is made with machine-cut teeth, solid pinion, and positive gearing which effectively eliminates all slip and backlash.

By fitting this dial (Ratio 14 to 1) to your Tuner, you will ensure the maximum degree of accuracy and selectivity.

A useful adjunct to already appreciated and world-famous R.I. and Varley components.

*Orange Label (List No. Y.128).
Tuner Reaction Dial. Scale 0-130
Blue Label (List No. Y.129).
Universal Condenser Dial.
Scale 90-0-90.*

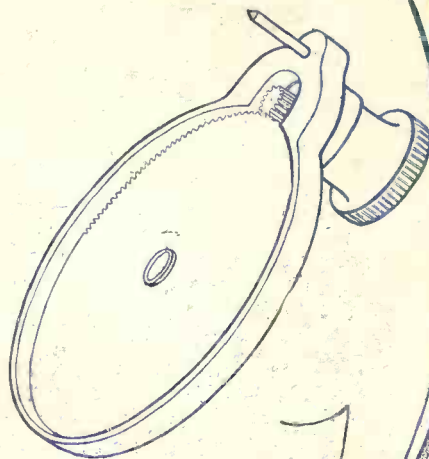

3/9
RATIO
14 to 1.



R.I.

Varley
LTD.

THE MARK OF BETTER RADIO

Kingsway House, 103, Kingsway, London, W.C.2.

Telephone: Holborn 5303.