

TELEVISION : SOME AUTHORITATIVE FACTS (See Page 7.)

Popular Wireless

Every Thursday
PRICE
3d.

No. 300. Vol. XIII.

INCORPORATING "WIRELESS"

March 3rd, 1928.

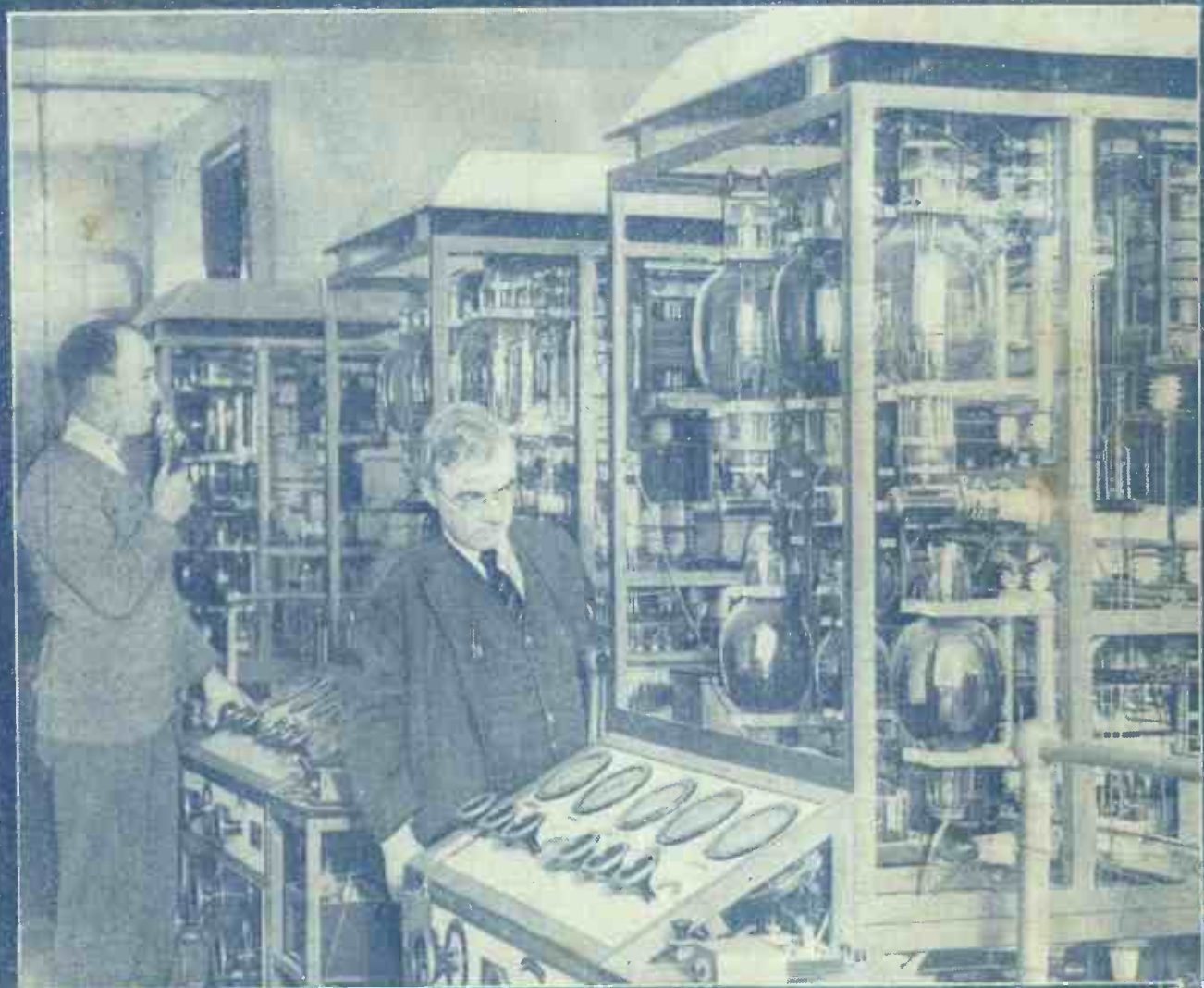

Building a Home "Television" Outfit.
A WARNING TO OUR READERS.
By G. P. Kendall, B.Sc.
Our cover photograph shows the transmitting room at the new Air Ministry Radio Station at Mitcham.

YOUR FRIENDS WILL CONGRATULATE YOU!

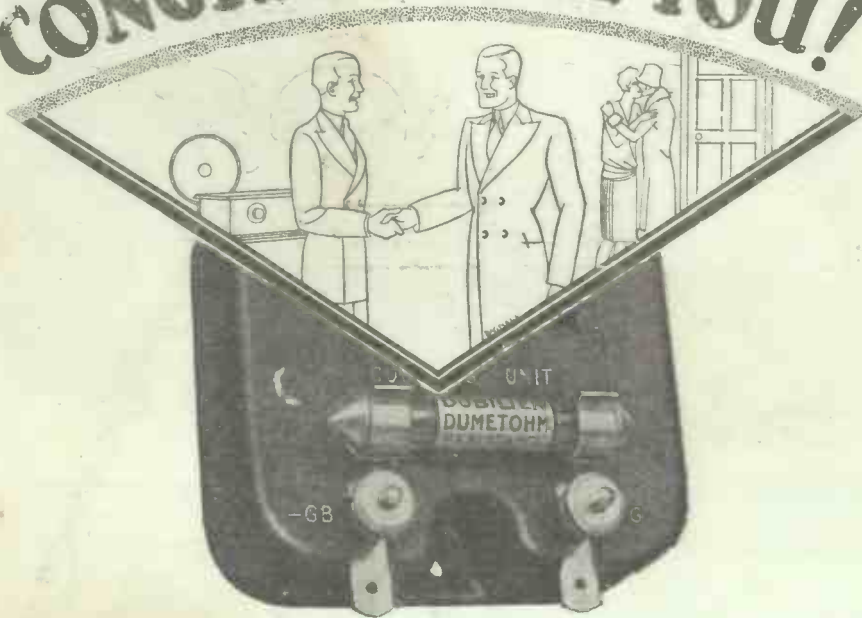

—on the improved performance of your set; on its remarkably increased clarity of reception with yet sufficient volume: meanwhile they might wonder at the cause. They would be astonished if you told them — that it was due to your having fitted a Dubilier R.C. Coupling Unit to your set.

Some may tell you they have tried Resistance Capacity Coupling as the recommended means of obtaining purer amplification, but with a disappointing decrease in volume. Yet the fault lies not in the method—mostly it emanates from the various components in the set having been carelessly selected.

Thousands are now being delighted by the purer reproduction, combined with adequate volume, which their sets have given since they installed the Dubilier R.C. Coupling Unit—proof enough of the supremacy of the Dumetohm for R.C. Coupling.

The Dubilier R.C. Unit will take Dumetohms of various values to suit your particular requirements, an advantage second only to that of price; for this efficient component costs no more than 7/-.

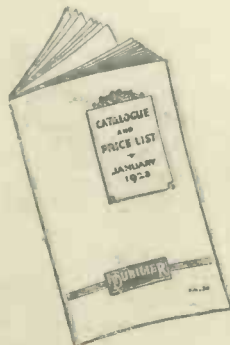

Adv. of The Dubilier Condenser Company (1925), Ltd., Ducon Works, North Acton, London, W.3. ©119

**DUBILIER
DICTA**



No. 8

There was a man who considered himself destined to become a great singer; wherefore he dreamed of his voice moving vast crowds at Covent Garden. And as, day by day, he dreamed, he sang constantly; until a neighbour reproached him for his imperfect playing of a saxophone.

Whereupon his dream was shattered.

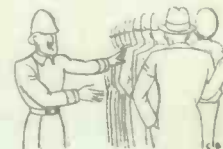

Nevertheless it happens vast crowds are moved by his voice at Covent Garden; for he cries to them "Move on" as he stands on point duty.



Moreover, there was a man who had a Wireless Set; and strange sounds came forth from his loud-speaker. They were not of France, nor of Germany, neither were they of Italy. Verily, thought the man, they are of Wallooloo land; and the man was proud of his achievement; but a neighbour declared them to be of distortion.

Whereupon the man's dream was shattered.



Nevertheless, his neighbour prevailed upon him to fit a Dubilier R.C. Coupling Unit to his Wireless Set; whereupon its reproduction so vastly improved that the man forgot his unhappiness.

Whether the above appeals to you or not, what undoubtedly will appeal to you is the Dubilier R.C. Coupling Unit, embodying the famous Dumetohms.



Back to Methuselah

Of all the good things a Marconi Valve offers you, one of the most outstandingly good is its very, very long working life. Marconi Valves are very Methuselaha (or is it Methuselae?) for age. And they are one hundred-per-cent bullmen for work.

Read this for instance, Mr. E. Revill, Tadworth, writes, Feb. 9th, 1928.

"I have one of your L.T.1. type valves, which has been in constant use for practically six years . . . and the filament is still intact."

Take now the D.E.P.215. Try it alongside any 2-volt low-frequency power amplifying valve you've got. Hear the difference. Note the volume. See how clear and true it is. Then measure the current from your L.T. Battery and realise what an economist this good valve is.



TYPE D.E.P. 215
Low-Frequency Power-
Amplifying Valve for
2-volt accumulators.



Price 12/6
Fil. volts - 2.0 max.
Fil. current - 0.15 amps.
Anode volts - 120 max.
Amplification Factor 6.25.
Impedance - 6,250 ohms.

FREE ADVICE

Our Engineers will furnish free advice as to best possible valves for your set if details of the circuit and any valves at present in use are given.

MARCONI VALVES

-do everything that a valve should do

COUPON
BOX P.,
MARCONIPHONE
COMPANY LTD.,
210/212, TOTTENHAM
COURT RD., LONDON, W.1.

Please send Marconi publication 443L.

NAME
ADDRESS

P.W.14.

A SHILLING
PICTORIAL
BLUE PRINT

OF

FREE! *To Every Reader of* MODERN WIRELESS

Three Popular Sets of the Year.

- THE COSSOR "MELODY MAKER"
- THE EDISWAN "R.C. THREESOME"
- THE MULLARD "MASTER THREE"

Together with a long and comprehensive article on the above sets by Mr. G. V. Dowding, who tells constructors many valuable and interesting things about the operation, care and general maintenance of all three receivers—how to get best results, how to locate and cure faults—and dozens of other practical hints to greater efficiency.

The Pictorial Blue Print shows the three circuits in detail and with great simplicity. Values are shown for all components.

IT IS A BLUE PRINT YOU CANNOT DO WITHOUT
AND IS GIVEN FREE WITH

MODERN WIRELESS
ON SALE MARCH 1st PRICE ONE SHILLING

*Order Your
Copy Now!*



Does the Power Station keep your set going?

Does it supply you with music as well as light and other home comforts?

With the Met-Vick 5 Mains Set this is now possible. It is just plugged into a lamp socket or wall plug and switched on, like any other Electric Appliance, and all the little annoyances of accumulators that *will* run down, and H.T. batteries that cost so much and last such a short time, trouble you no more.

Inherently better than a battery operated set, the reproduction is so near perfection that to ask for more is hypercritical. Selectivity and range are outstanding features, and the controls, while quite simple to use, do respond to that little extra skill of the sympathetic operator which is so delightful.

With the Met-Vick 5, it is at last possible to obtain a wireless receiving set which will always give the satisfaction that only comes from really brilliant performance, and which will remain a constant source of pleasure and interest to all who hear it.

Ask your dealer for a copy of Brochure 7117/9, or write to the makers.

Those who are content with the alternative programme of their Local and Daventry Stations, but who desire the advantage of Mains operation cannot do better than obtain the Met-Vick 3 Mains Set fully described in List 7117/10.

MET-VICK

VALVES, COMPONENTS & SETS

R
Z130

METRO-VICK SUPPLIES, 155, CHARING CROSS ROAD, LONDON, W.C.2.

EUROPE IS HERE!

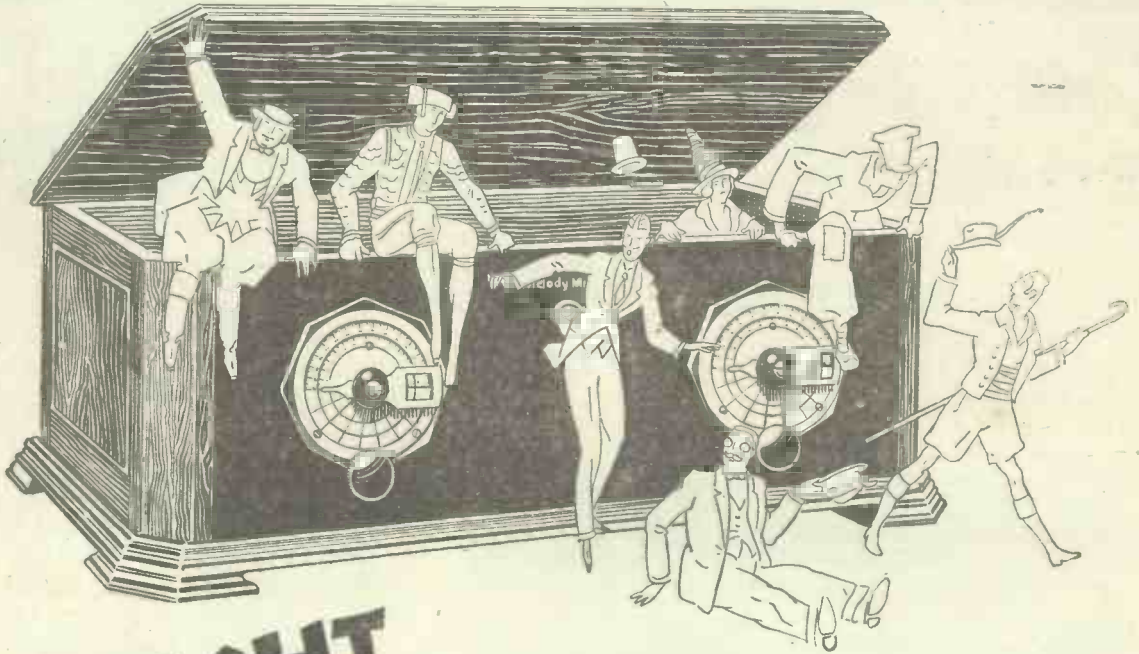

BROUGHT TO YOUR HOME

Good evening, everybody! We're here! Germany, France, Switzerland, Holland, Italy and Spain. We're brought every night to thousands of homes, by the wonderful Cossor "Melody Maker." We come to cheer the lives of the people with music, song and speech.

Anyone can build the Set that brings us. Not an atom of Radio knowledge is needed. No technical skill is necessary. The free chart your Dealer will give you shows you how to do it. Everything has been made as easy as A.B.C. It's no more difficult than your boy's Meccano. There's no soldiering to thwart you. No blueprint to puzzle you. Just follow the instructions and in a few hours you'll build a Set that is better than many factory-built Receivers costing twice the price. A Set, too, that is as easy to work as it is to make.

Ask your Dealer for "How to build the Cossor 'Melody Maker,'" and bring us to your home. If he has not a copy, a postcard to A. C. Cossor, Ltd., Highbury Grove, London, N.5, will bring it by return.

BY THE WONDERFUL

COSSOR "Melody Maker"

Advt. A. C. Cossor, Ltd.
Highbury Grove, N.5.

Popular Wireless

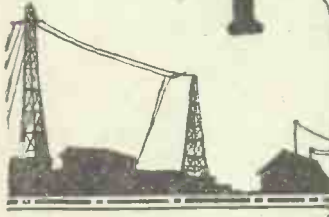

Scientific Adviser :
 Sir OLIVER LODGE, F.R.S.
 Editor :
 NORMAN EDWARDS, M.Inst.R.E., M.R.S.L., F.R.G.S.
 Technical Editor : G.V. DOWDING, Grad.I.E.E.
 Assistant Technical Editors : K. D. ROGERS, P. R. BIRD,
 G. P. KENDALL, B.Sc., A. JOHNSON RANDALL.

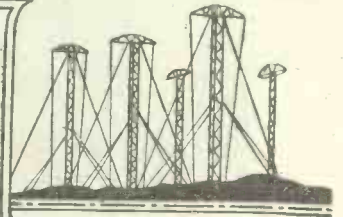

RADIO NOTES AND NEWS.

Kalundborg—The Latest Marvel—A Record Meeting?—Cologne on a Crystal Set!—France Breathes Again—Safety First—Royal Listeners.

"Merrie England."

WHAT did you think of those two performances of "Merrie England?" Is not this opera a delight? The B.B.C. should repeat it six times a year, and do the same with Liza Lehmann's "Song Cycle," and Gounod's "Faust."

Kalundborg.

UNDER a recently-published photograph of the Kalundborg station we mentioned that we had not received many reports of its reception. Our readers promptly remedied the matter, writing in overwhelming numbers. Please accept our thanks for all the letters; it is difficult to pick out any for special mention. They all agree that this station is a "star"; some report slight fading and Morse interference; unanimously agreed that but for this and a few other Continentals, the B.B.C. would lose a lot of licence money.

The Latest Marvel.

TALK about the genie in the bottle! It's come true at last. A Glasgow paper, describing Mr. Baird's transatlantic experiments, says, "Meanwhile, wireless communication in Morse was being kept up between the chemists at 3s. and 7s. per bottle, or direct, post free, from," etc. I am surprised that a Scotsman should buy bottled Morse when such a large free supply is available. Why doesn't the B.B.C. bottle Chamber Music and sell it as weed-killer? It's a long time since they branched out into a new business.

The Broken Promise.

I AM reminded by a reader that when 5 GB was put into service the B.B.C. promised that its programmes should be free from "Talks," but that these have at last begun to creep in. Too bad! Enough to give one the heebie—GB's! Will the B.B.C. kindly overhaul its records relating to this matter, and, as Captain Cuttle would say, "When found, make a note of?"

A Record Meeting?

NOT all British learned societies are old-fashioned and conservative, for surely the very successful joint-meeting of the British Institution of Electrical Engineers in London and its

American counterpart in New York, held by means of the wireless telephone service, was bang up-to-date. All went without a hitch, and speeches and votes of thanks were exchanged; loud speakers were used for reception. Pretty good, eh? Three thousand miles of water, or thereabouts, and twelve hundred miles of land line!

New Valve Test.

JUDGING by the trend of science, the best way to test a valve is to put it under a steam-hammer. The Edison Swan Electric Company states that they gave a railway porter a case of 50 Edison valves (P.V. 2) to test. Instinctively he threw the case on the line in front of an express train. The valves were then collected and taken to the mortuary; 41 sat up and asked for a cigarette—quite O.K.; 4 were past hope; 2 had broken filaments; 2 were distorted but had intact filaments, and 1 was like the eleventh little nigger-boy—not there. Why not use triplex glass? And did they search the station-master for the fiftieth valve?

Cologne on a Crystal Set!

THIS is not one of those yarns so beloved of the Ancient and Honourable Order of Cat's-whisker knights, but a pretty way of putting what the B.B.C. may make possible this month, during its experiments with Continental relays. The first attempt will be on March 11th, 10.5 p.m. to 10.30 p.m., when the Legia Choir from Liège will be relayed by 2LO and 5XX; the second on March 12th, 8.0 p.m. to 9.0 p.m., when the same stations will relay an opera or concert from Cologne. "Where is that lovely music from?" says the wife. "Oh—de Cologne."

PCJJ.

WE are informed that PCJJ will transmit, until further notice, on Tuesdays and Thursdays, from 15 to 19 G.M.T., and on Saturdays from 14 to 17 G.M.T.

Amateur Transmitter.

MR. D. E. PETTIGREW, 20, Hollin Park Mount, Oakwood Lane, Roundhay, Leeds, asks me to say that he hopes to be transmitting before long on 150-200 metres, under the call-signal G 2 D P. He is fully licensed. But—

AMERICA'S "TELEVISION" PROGRESS.

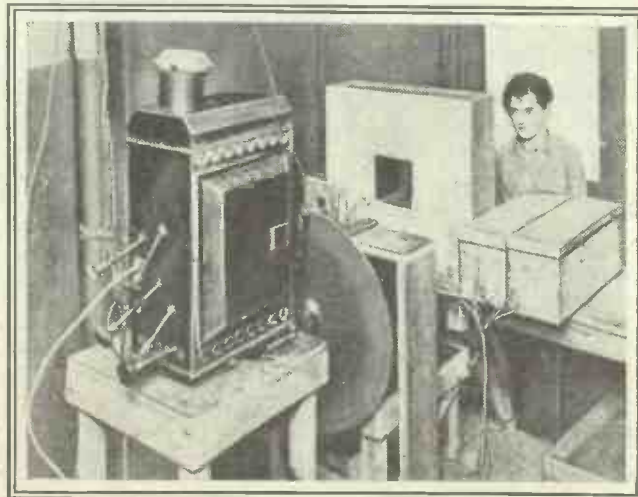

This is the "television" transmitting gear used in the recent demonstration staged by Dr. Alexanderson, the Research Engineer of the American General Electric Co. Backed by a mighty organisation, this scientist has been unable to show that true "television," or, shall we say, useful television, is, as yet, even a remote probability.

The Over-Ruling Passion.

IT is sad to read about the Rochdale lad, aged 21, who having been denied a transmitting licence in 1925, was discovered in 1927 to be sending like one o'clock. Cautioned and ordered to dismantle. That was in June, but in October he was found to be in full blast again. Now somebody has had to find £10 5s. 0d. to satisfy the law, and

(Continued on next page.)

NOTES AND NEWS.

(Continued from previous page.)

the gear is forfeited. One cannot condone his law-breaking, but nevertheless a youngster with an enthusiasm like that ought to be encouraged by the issue of a licence.

More Shakespeare.

There was an old monk of Medina,
Who tried to get Stoke on galena,
Though he listened and prayed
Till his ears were quite frayed

Fill in the missing line. No prizes!

Wireless Classes.

I HAVE pleasure in drawing further attention to two series of radio classes which are being held by Captain Jack Frost, on Tuesdays, 7.15 p.m., at the Streatham and Tooting Literary Institute, Bec Secondary School, Beechcroft Road, S.W.17, and Putney Literary Institute, Putney Secondary School, West Hill, S.W.15, on Wednesdays, at 7.15 p.m. These classes, which are really nothing but jolly and interesting club meetings, are crying out for more members of both sexes. Fee: 2s. to Easter, or 4s. to Midsummer. If you want more details before you enrol in person, please write to either of the Institutes.

France Breathes Again.

THE decree forbidding any private station except Radio-Paris to broadcast came as a blow to the French people and to many in this country. Luckily, however, it was recently decided that the matter is one for the Council of Ministers and the French parliament, and so the decree has in effect been quashed. Whatever may be the disadvantages of the B.B.C. monopoly, our method certainly saves our nerves from shocks due to the threatened closure of all our stations while the Government thinks.

His Majesty, the Customer.

QUITE a lot of interest has been shown by readers in the various kinds of treatment meted out by traders to customers, and I have under my hand sufficient libellous material to blow up the Law Courts. One of the funniest letters was from a Scot, who was plainly scandalised to the point of apoplexy. He bought a—a sort of a coil, which wouldn't behave; complained to the seller; seller said: "Coils reversed" and connections must therefore be reversed, but "if you do not feel disposed to do this, return the coils and I will wind 'em properly." Mon! I tell ye! Return the coil and lose a week's broadcasts for which I can get no rebate from the B.B.C.? Hoot!

A New Idea.

THE radio trade shows no lack of enterprise and ingenuity, and my post generally contains a lot of "literature" which is well worth perusal. Only to-night, for instance, I have received from Harlie's a neat folder with illustrated descriptions of some components which make the coins burn holes in one's pocket, and in this folder is a "log," giving names, call-signs and wave-lengths of stations, with spaces for dial settings and notes. A handy thing for the radio man. For discriminating set builders the Harlie components are well worth examination.

A Present for a Good "Ariel."

TALKING of "trade" literature, which I have to study in the interests of "P.W.'s" ten million readers, I thankfully acknowledge the gift of a copy of "The Rag Bag," an Annual produced by the University of Manchester. It proved to be, as the donor hoped, a reviver. From cover to imprint it is a colossal "skit," exceedingly witty and laughter-provoking. How I wish the Editor would issue a "P.W." Annual on the same lines. Even the ads. in this tonic are humorous. I quote one gem from the text. "What is at the bottom of the Manchester Ship Canal?" Answer: "Lancashire." I am always open to such refreshers, including complete sets of Hardy, Conrad and Bennett.

Scientific Note.

A PUZZLED "P.W."-ite sends me a clipping from some of the aforementioned "trade literature," wherein an H.T. battery is advertised as providing "pure D.C. current," and asks what kind

Tonsorial Note.

MY revelation a few weeks back about my red whiskers has evoked a number of letters, mostly sceptical. Being now a marked man I am looking for a good permanent dye. I saw some of my talkative co-lunchers again last week and observed their ill-concealed nervousness as one of them described a most wonderful circuit. But I had the danger-signal tucked into my collar.

"Safety First."

I WAS telling a friend about the little flash-lamp gadget mentioned in my Notes of February 18th, and he said, why not connect the lamp permanently in series with the filament, so that it can act as a safety-fuse? The idea looks good, especially for sets entirely operated from the mains.

The "Variocycle."

WHAT'S this about the alleged new wonder-unit designed by a Worthing man? I gather that it is a component which takes the place of the aerial tuning condenser, coil-holder and coils. This knowledge, plus the name, points to an improved type of variometer. Bare wire is wound off one threaded drum on to another, which is made of ebonite; "dead end" effect is said to be absent. May be very efficient but does not sound novel, and I myself prefer good plug-in coils. A reader who draws my notice to this, says he cannot often get 5 G B at full L.S. strength on his 4-valve set at Willingdon, near Eastbourne. For goodness sake, why not? Friend, you need a radio doctor, not a variocycle. Are you screened by the Long Man of Willingdon?

SHORT WAVES.

SIMPLIFIED.

Teacher: Johnny, how do you spell Schenectady?
Johnny (without hesitation): W G Y.—
"Radio News."

REACTION—The morning after that bachelor night party.

A SLIGHT DIFFERENCE.

"Is your neighbour's set portable?"
"No, insupportable."

Bold Fellow: The B.B.C. announcer who said: "Good-night, everybody. I'll see you all later at the night clubs."—"Sunday Pictorial."

Broadcasting is still in its infancy; that is why we hear so much howling.

LOCATION UNSUITABLE FOR RECEPTION.

Mouse No. 1: Why aren't you going to be married here at Station 2 L O? Don't you think this nice basement is suitable for the wedding?

Mouse No. 2: No, indeed! I don't think any self-respecting mouse should marry beneath her station.

An enterprising housewife puts the clothes-horse in front of the loud speaker whenever political speeches are broadcast.

A novel method of drying the washing by hot air.

THIS EVOLUTION.

As a culminating effort in the history of broadcasting talks the B.B.C. has acquired a parrot which is being trained to appear before the microphone.

This culture broadens slowly down from precedent to precedent.—"Daily Herald."

A Radio Announcer named Bevan was out motoring with his family of seven.

When his steering gear broke
He said to his folk—
"We're now changing over to Heaven."

of current is that? Answer: We have hitherto demanded only voltage from our H.T. battery. The current is thrown in as a gift. D.C. current is a sort of cousin, twice removed, to L.F. frequency; bred from A.C. current out of H.F. frequency. Very sporting!

Royal Listeners.

AMPLIONS tell me that the mother of the King of Roumania has acquired one of their cone loud speakers. "Radiomania in Roumania," eh? This firm is to fit up the Melbourne Motordrome with twenty loud speakers. So Britain still has a shout coming.

The Business Touch Again.

I CAN see that if Britain is to increase its trade it must encourage the colonies to migrate to our shores, for some of them appear to be populated by a race of hard-bitten bargain-biters. Here is a letter, just received from a certain coral strand. "Dear Sir, dear sir or madam, advertising to the adverts in your esteemed advt. columns you are hereby requested to enrol my name and address as agent for only best engineering houses in realm. Principals required to send numerous samples, returnable if not sold presently, and quote highest discounts to guaranteed Br. Citizen, vaccinated and passed 2nd class Freehand Drawing." Yes, sar!

Radio, Rain, and Heat.

DORLAND Advertising, Ltd., have sent me a pamphlet called, "Climate and Commerce." The idea is that with this to guide him the British trader will know when to export his goods. I fancy the radio trader does not care a hoot about rainfall so long as he gets his cash. I have, however, taken the trouble to analyse the figures. If you make umbrellas you should export to Bombay in July, it is the rainiest place on earth then, with Rangoon a good second. On the other hand, if you make refrigerators you should try the Nagpur (India) market in May, when the average temperature is 94.46 degrees.

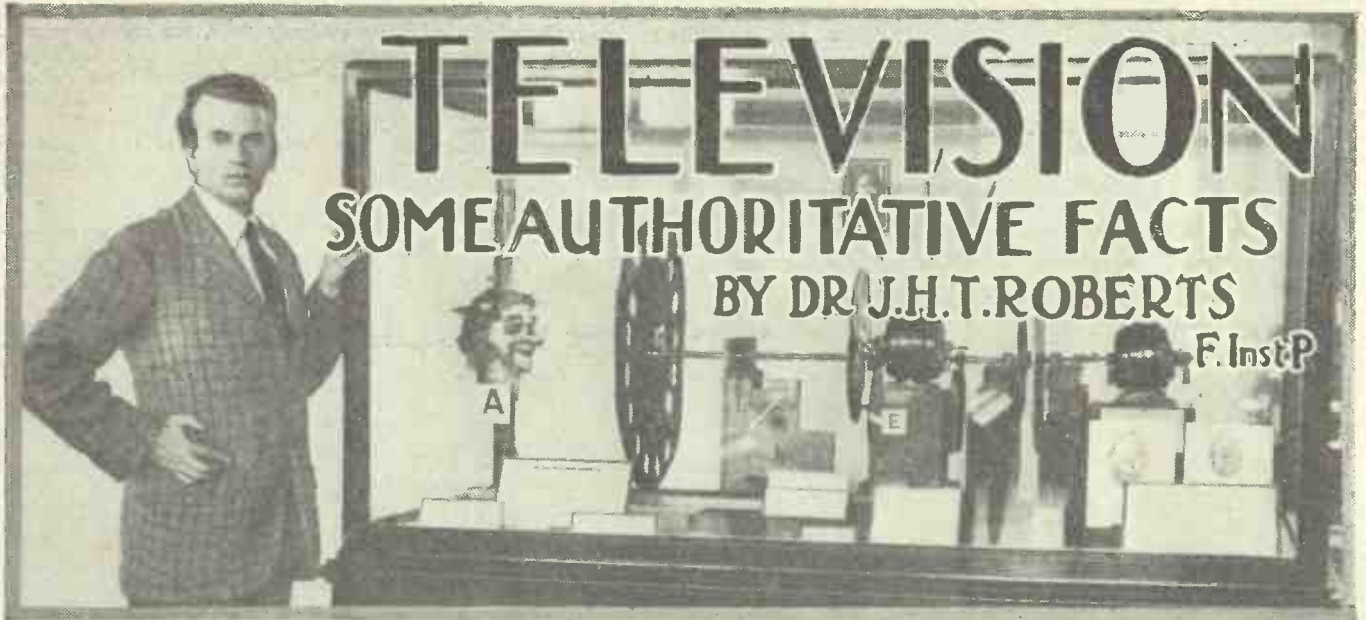

Below we publish an article on the problems of Television by our Scientific Consultant. Dr. Roberts is one of the most distinguished of the younger generation of British scientists. He has been connected with three British Universities, and has been engaged in scientific research for over ten years with conspicuous success, having collaborated with some of the leading scientists in the world, such as Sir J. J. Thomson and Sir E. Rutherford. Dr. Roberts worked at the world-famous Cavendish Laboratory of the University of Cambridge, and after numerous academic honours and various important scientific posts he has specialised in the commercial and industrial applications of science. Dr. Roberts has marked characteristics of moderation and caution in all his opinions, and, therefore, we think his views on Television should be of peculiar interest and value to the public.

THE EDITOR.

IN view of the interest which has lately been aroused by the phrase "seeing-by-wireless," I have been requested, as Scientific Consultant to this journal, to set out some of the facts as to what has already been accomplished in this direction and as to the likelihood of further progress in the near future.

The idea of seeing-by-wireless, on a screen, a moving picture of events taking place at the same moment many miles away is certainly one to seize the imagination and, therefore, it might be expected that any suggestion that such a thing was an accomplished fact would give rise to considerable interest in the public mind. People have by now become so accustomed to the representation of moving events as shown by the cinema that they are probably ready to believe that similar representations of simultaneous moving events may be possible by means of radio.

What Has Been Accomplished?

If you could go into a cinematograph theatre and see on the screen the same kind of pictures that you are used to seeing at present but with the added knowledge that the events portrayed were actually taking place at that moment miles away, you would indeed feel that a wonderful aid had been given to mankind.

When the public hears the phrase "seeing-by-wireless" there is little or no doubt that something along the lines I have just sketched is what arises in their minds. If they are told that "seeing-by-wireless" is an accomplished fact they quite naturally expect—without giving any serious thought to the matter—that they are going to see something more or less equivalent to what

they see in their ordinary daily experience, or what is put before them at a cinematograph theatre.

Now let us turn to the question of what has actually been accomplished by television. The subject of television (seeing-by-

wireless) is one which has engaged the attention of experimenters in several parts of the world for some years past. The best-known investigators in this field are probably Dr. Alexanderson, the Chief
(Continued on next page.)

SENDING PHOTOGRAPHS BY RADIO.



By means of the apparatus shown above, photographs sent from 111th Avenue, New York, via the Peumore (Long Island) broadcasting station, were picked up in the home of a New York scientist. After reception they required developing and fixing, just like an ordinary photograph.

TELEVISION.

(Continued from previous page.)

Consulting Engineer to the General Electric Company, New York; Dr. Ives, of the American Telephone and Telegraph Company; Mr. C. Francis Jenkins, United States; Mr. J. L. Baird, of London; and Mr. Mihaly, Germany.

Most of these investigators claim to have demonstrated television in a more or less rudimentary form over distances ranging from a few miles to a couple of thousand miles (across the Atlantic), and hopes have been expressed that the quality and "definition" of the transmitted pictures will be improved in the near future.

As to the actual transmission of crude moving representations, there is no reason to doubt the claims made by various investigators. Indeed, it is a comparatively simple matter to send, either by line-conductor or by radio, crude representations of a simple object such as a face or a hand. But I do not think the most optimistic sponsor of television would pretend for a moment that television is out of its infancy, or that (unless enormous improvements be made in the quality, detail and recognisability of the transmitted images) it is of much service beyond that of a scientific toy.

Distance No Real Difficulty.

In passing, let me remark that the transmission of a moving representation by radio over a considerable distance (2,000 miles across the Atlantic) is a matter of scarcely more difficulty than the transmission of representations over a distance of two yards, although in the former case it is obviously much more spectacular. The point I want

RADIO AID TO ART.



"When something lively comes on I imagine horses moving, and that makes me want to draw them," says this twenty-three-year-old Surrey workman, who has had an oil-painting accepted for exhibition in the Dublin Salon.

to bring out is that, having accomplished radio-transmission of moving pictures at all, the increase in the distance between the sending and receiving stations involves comparatively little further technique.

If television has any real future it lies, in my opinion, not in the increase of the distance over which moving representations

are sent, but in the improvement of the quality, recognisability and "detail" of the moving pictures received. Up to the present, television transmissions have been confined to simple objects such as a face or hand where, even in the absence of "detail," it is possible to recognise the object. If television can be so improved that objects can be transmitted which require for their recognition enormously greater detail then television will be entering the realm, so to speak, of practical politics.

Take, for instance, a view of the interior of a room, which is the kind of scene so commonly forming the background of a cinematograph picture. Here the objects upon which interest centres, namely the actors, occupy a comparatively small part of the whole picture area and, consequently, very much greater detail is necessary in the picture as a whole in order that the details of objects, themselves small compared with the whole picture, may be faithfully brought out.

An Enormous Difficulty.

I will show by a more detailed examination of the *modus operandi* of present-day television systems that the step from the transmission of a simple object, such as a face, which occupies virtually the whole of the picture, to the transmission of a view of a distant scene or of the interior of a room, or even to the transmission of a face in any close detail, is a step of enormous difficulty.

My readers may think that, although this step may be one of great difficulty, it is not necessarily insuperable when we have regard, as we must do, to the way in which the seemingly insuperable difficulties in other directions have been surmounted. At one time aviation by heavier-than-air machines seemed impossible, and, indeed, it might well have remained so had it not been for the invention of the internal combustion engine which completely revolutionised the science of aeronautics. Radio telephony (as used in broadcasting) might have been impossible but for the invention of the thermionic valve. Moreover, as a scientific man I should be the last to assert that anything was absolutely impossible, even flying to the moon, or perpetual motion.

But if by "television" we mean the transmission and reproduction of something equal to, or even comparable with, an early cinematograph show, then it seems to me that the technical difficulties are so enormous as to constitute as near as may be an insuperable obstacle to any progress very much beyond the present achievement, unless some totally new principle or system be discovered.

In order to appreciate what are the technical difficulties involved in this problem, let us consider for a moment the technique of television.

When we look at an object by the eye in the ordinary way, we receive rays of light from the *different parts* of the object, and these rays are focussed upon different parts of the retina of the eye in corresponding positions. The rays of light from the various parts of the object are received *simultaneously*, and consequently the vision of the whole object is *simultaneously* perceived.

It is a very simple matter to transmit moving pictures if we rely on rectilinear propagation of radiation as with ordinary light rays. But when we attempt to get

"Progress has been held back in all these systems I have mentioned, however, by the fact that it is extremely difficult—impossible, some will tell you—to construct a mechanism to achieve a speed and accuracy necessary for television. To have any appreciable detail, a picture made up of dots, squares or patches, as television pictures are, should have at least 10,000 dots. When the picture is flashed on the screen ten times a second to give it the appearance of continuous movement, that means that 100,000 dots of light and shade have to be 'seen' separately and in exact order, and transmitted every second—which needs mechanism more delicate than most.

"Professor Max Dieckmann, whom I met in Munich, has scrapped his apparatus which depended on mechanism. His receiver uses streams of electrons, like that of M. Holweck, and now he is trying to make use of electrons at the sending end.

"I shall watch Dieckmann. All the other men will make progress during the year, but unless they discover some revolutionary new idea, any machine they bring out will not be able to approach detail of cinema pictures."

(Extract from an article on Television by Wm. J. Brittain, in "The Review of Reviews.")

away from the use of directional radiation (as used by Nature in the faculty of vision) and to send out radiation more or less at random (as in broadcasting), which radiation carries, impressed upon it, features which are characteristic of the picture, and which are capable, with appropriate appliances, of being transformed back into a representation of that picture, then we enter an entirely new field of technique.

It is obvious—or, at any rate, it seems to me obvious, and I think it is universally agreed—that for transmission of pictures by line or by radio it is necessary to convert the picture, so to speak, into a *series* of effects, which effects are transmitted in a chronological or time-succession; in other words, *one after another*. These effects—which, to be more particular, we may now call "impulses"—are received at the receiving end in the appropriate way, and are built up to re-form the reproduction of the original picture.

Present "Television" Systems.

In television systems the method employed by all investigators, so far as I am aware, is to "explore" the object—a picture, a face, or whatever it may be—by means of a spot of light, or by the focus of an optical system, or by some equivalent. Let us suppose, for simplicity, the object is explored by a small spot of intensely bright light, and let us also suppose, for simplicity, that the "object" is a picture 10 in. square. The exploring spot of light may start at the top left-hand corner and travel rapidly downwards along the left-hand edge until it reaches the lower left-hand corner, after which it commences again at the top, but a little bit to the right, and follows a second path close and parallel to the original one. In this

(Continued on next page.)

TELEVISION.

(Continued from previous page.)

way it rapidly traverses a series of parallel lines, starting at the left-hand edge and progressing across the picture, and finishing at the right-hand edge. Of course, instead of moving always from top to bottom, it may vibrate up and down, and the motion may be from right to left, or the lines of exploration may be of a circular character, and so on.

The amount of the light which is reflected from the picture will obviously depend upon whether the exploring spot is passing over a dark or a light portion of the picture. If it is passing over a dark portion, less light will be reflected, and conversely. The reflected beam thus varies in intensity

"I do not wish to be unduly sceptical," says our Scientific Consultant, "nor do I seek to minimise in any way the efforts and achievements of those who are studying this problem. . . . But, at the same time, I feel that the obstacles in the way of any appreciable further progress are so enormous that undue optimism ought not to be indulged in."

or strength in accordance with the features of the picture as the exploring spot passes over them.

Now it will be evident that the exploring spot will be unable to pick out objects or details of the picture which are smaller than itself. Therefore, in order that fair detail may be picked up from the transmitted picture, it is essential that the exploring spot be at least as small as the details which are to be brought out.

Analysing the Picture.

Let us take, as a very rough notion, a square spot 1-20th in. square. When this spot has travelled down the picture at the left-hand edge, and is making its second journey, it will be clear that its second path should as nearly as possible be edge-to-edge with its first path, without either overlapping or leaving a space. If perfect conditions are secured, the exploring spot must make 20 excursions in the space of an inch along the upper edge of the picture; or, if the picture is 10 in. wide, a total of 200 excursions in order to get across the picture. The whole picture must be explored in this way in a period of time which is smaller than 1-16th of a second, as the whole system depends upon what is known as the "persistence of vision."

Here are the "Snags."

It has been found that if the eye receives a number of separate but slightly differing impressions at the rate of not less than about 16 per second, they are not distinguishable as separate impressions, and the brain receives them as a continuously-moving effect. As a matter of fact, although 16 pictures per second must be sent, the actual time for the exploration of the picture is considerably less than 1-16th of a second; and, to put the most favourable construction on it, we may put it down as 1-25th of a second. It has even been estimated by some experts in America as being 1-80th of a second. However, let us take it as 1-25th of a second for the moment.

The exploring spot, then, has to make

200 tracks across the picture in 1-25th of a second, or it makes one passage across the picture in 1-5,000th of a second.

Now let us see what is going to happen when the spot is passing over a fairly small detail of the picture. Let us suppose that the detail in question is a man's eye; and that it occupies an area of 1-20th of an inch square in the picture. The exploring spot will travel over this feature (since it has to travel 10 in. in 1-5,000th of a second) in 1-1,000,000th of a second (one millionth of a second).

The variation of the intensity of light in the picture which is to be transmitted is sent out as a modulation upon a radio carrier-wave. If we use a wave-length of about 100 metres (which is about the kind of wave-length that investigators in this field have used) we have a carrier-wave frequency of approximately 3,000,000 vibrations per second. Therefore, we have to impose upon

this carrier-wave a modulating feature which persists over the duration of only three oscillations or waves of the carrier-wave itself.

I will not attempt to enter into the question as to the possibility of modulating a carrier-wave at this enormous frequency, or into the still more vexed question as to the handling of such modulation frequency by the valve apparatus either at the transmitting or at the receiving end. Those who are expert in the theory of radio transmission and reception by valve apparatus will readily appreciate that this is an extreme problem.

The figure of 1-1,000,000th of a second was arrived at by considering a detail of 1-20th in. square in a picture 10 in. x 10 in. But, as a matter of fact, this is stating the problem in far too easy terms, for, in order to obtain proper "detail" to make the picture comparable with a real picture as ordinarily understood, it would be necessary to give the equivalent of a much finer "screen," and it is probable that by the time really adequate conditions were reached we would find ourselves called upon to transmit details of the picture, the transit time of which was 1-10,000,000 or 1-20,000,000th of a second, or even considerably less.

It must also be remembered that the exploring apparatus at the transmitting end and the corresponding apparatus at the receiving end are basically mechanical, and it is not difficult to appreciate that extreme mechanical refinements are necessary *properly* to explore a picture in a manner to correspond to a "screen" of even so coarse a grade as 50 to the inch.

More Difficulties.

But this is by no means the only difficulty involved. At the transmitting end, the light received from the exploring spot must be made to operate a light-sensitive device, such as a "photo-electric cell." This device must be able to respond to *variations* in the strength of luminosity, which may in any case be feeble in average strength, and, furthermore, it must respond faithfully at the enormous speed of variation which has been indicated above. Television experimenters have, as a rule, maintained secrecy with regard to their photo-electric pick-up devices, but from my general experience of this subject (and I think other scientific men will have no hesitation in agreeing with me) it seems exceedingly unlikely that a photo-electric device, capable of responding to variations in an already feeble illumination and at a rapidity represented by a change in 1-20,000,000 of a second, will be forthcoming in the near future.

In thus outlining the main difficulties involved in television, and in stating, in effect, my opinion that television, so to speak, "has a very long way yet to go," I do not wish to be unduly sceptical as to the prospects of development, nor do I seek to minimise in any way the efforts and achievements of those who are studying this problem in different parts of the world. But at the same time I feel that the obstacles in the way of any appreciable further progress are so enormous that undue optimism and pious hopes ought not to be indulged.

It may be that some totally new principle will be discovered, but at present that appears to be extremely unlikely.

So far as I am concerned, I can only say that if anyone can reproduce, by television, moving pictures even remotely comparable with those shown by the present-day cinema, and if they can do this within the next ten years, they will have accomplished something which is entirely beyond my humble expectation or the expectation of any of the distinguished scientific friends with whom I have ever discussed this matter.

DON'T DO IT!



A sure way to spoil an H.T. battery is to short it. This can be easily done by carelessly putting a metal pencil, cigarette-case, or similar object on the battery. This is a sure way to spoil a battery that might with fair treatment have lasted months longer.

BUILDING A HOME "TELEVISION" OUTFIT!

In the first issue of "Television" the constructor is invited to build a home television outfit and, as we have always made it our business to advise amateur constructors, we publish below an impartial but critical review of the instructions given.

By G. P. KENDALL, B.Sc.

MY own attitude towards this televisor is that of the keen constructor exploring for the first time what seems superficially a most fascinating field for experimental work. Naturally, one's first impulse is to inquire what results will be forthcoming when the apparatus has been built, and, after reading the whole article carefully, it was realised that the instrument seemed to be of the nature of a working model rather than a practical equipment for reproducing images transmitted from a distance. All that should be expected, apparently, is that simple objects placed in one part of the apparatus will be reproduced in outline at another point in the same instrument.

An Expensive Valve.

One's next thought is obviously as to the cost of the outfit, and at first sight this does not seem likely to be very heavy. On looking into the point a little more closely, however, two features are discovered which put a very different complexion on the affair. First, it is to be observed that the last valve of the L.F. amplifier "should be of the transmitting type (for example, a Mullard O.40)."

Now, the O.40 valve costs £2 15s., according to my list, and requires an 8-volt accumulator large enough to supply its filament with the necessary 2.4 amps, which means a pretty big battery (remembering that there are four other valves as well). In some cases it may be possible to run this filament with A.C. from a step-down transformer, but there are considerable difficulties.

The other financial point concerns the H.T. supply, and here one learns that "As much as 600 to 700 volts may be necessary on the circuit shown to give a bright image." (NOTE.—No circuit is shown in this article.) At this point it becomes obvious that the cost is going up by leaps and bounds. Where is one to get a 600-volt direct-current supply capable of running a valve as big as the O.40?

The H.T. Problem.

The problem is a familiar one to the amateur transmitter, who realises its difficulty. One of the simplest and most satisfactory solutions is to use a high-tension motor generator running either from the mains or a 12-volt accumulator of considerable size, but the cost of such a machine will be in the neighbourhood of £20 to £25, unless one is very lucky in getting an ex-Government outfit really cheap. Again, it is possible to make a rectifying and smoothing apparatus to work from A.C. mains with a step-up transformer; but even so the expenditure will be heavy, and the job is most emphatically one for a really experienced experimenter who is familiar with the risks.

So much for "What will it do?" and

"What will it cost?" Now comes the final question, "Will it be easy to make and operate?" Here again my first impression on looking over the design and considering its construction was that nothing very difficult was involved. Certainly, the actual constructional work seemed such as any reasonably handy man with a few tools could tackle successfully, but on turning to the operating side I was very greatly surprised (I choose my words carefully) to find that no less than FIVE stages of TRANSFORMER-COUPLED L.F. amplification are recommended in quite a matter-of-fact fashion.

I do not propose to go very far into technical details on this point, but I think that it should be pointed out that to stabilise and operate such a circuit is an extraordinarily difficult task for even a fairly experienced experimenter.

It is a job from which a good radio or telephone engineer would shrink if he were limited to the resources of even quite a well-equipped amateur.

A Grave Danger.

Finally, what about the difficulty of handling the "600 to 700 volts" which is advised for the H.T. supply to the last valve? Having had some experience of high-power amplification work for moving-coil speakers, the first thing which strikes me here is the very serious danger involved in the use of voltages like this without far more elaborate precautions than any ordinary constructor is likely to think of taking, unless he is most solemnly warned and unless appropriate safety devices are explained in detail. The risk is a very grave one. Such voltages are quite capable of administering a *fatal* shock.

AMERICA'S ATTEMPTS AT TELEVISION.



Backed by the gigantic resources of the General Electric Company, Dr. E. F. W. Alexanderson is tackling television problems at Schenectady, N.Y. He is shown above (left) inspecting an outfit designed for television in the home.

BARREL switches combine some of the advantages of lever-operated panel switches with those of the open switchboard type. A barrel-switch can have quite heavy contacts, and yet it can be mounted behind the panel, operated by a single knob in front of it. The switch shown in the photograph was made to carry fairly heavy currents, while neatness of the exterior of the apparatus was a consideration.

The component shown provides for a 4-point double change-over, but by making the shaft longer or shorter switches may be made on similar lines of any required size. The minimum length of shaft required between the blades of the switch is $\frac{3}{8}$ in., to allow clearance between the contacts. To lower the capacity between the contacts, the distance between the blades is $\frac{3}{8}$ in. in the switch illustrated.

HOW TO MAKE PANEL SWITCHES

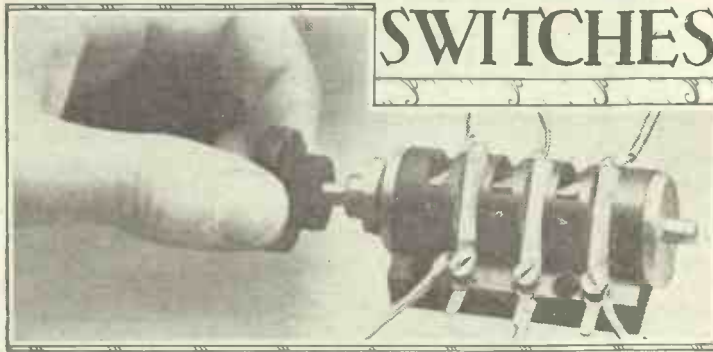

* * * * *

A little patience, very little skill, and some pieces of "junk" are the main ingredients of a neat, efficient, double-pole, double-throw, push-pull type of switch.

By A. V. D. HORT.

* * * * *

are placed between the blades to space them.

The frame of the switch is constructed as shown in Figs. 2, 3 and 4, the top and ends being screwed together. Small spacing washers are let into the ends, as bearings for the shaft. When the completed shaft is in the frame, mark the positions for the rows of contact clips. Three clips are needed for each blade, bolted through the top of the frame. On assembling the switch, the blades should pass smoothly in and out of the clips, the bevelling of their edges assisting this motion. To prevent the blades

from passing right out of the clips, stops are fitted in one end plate.

The switch is most conveniently mounted with bolts through the panel and the front end of plate. The shaft projects through the panel, and a knob is fitted for operation.

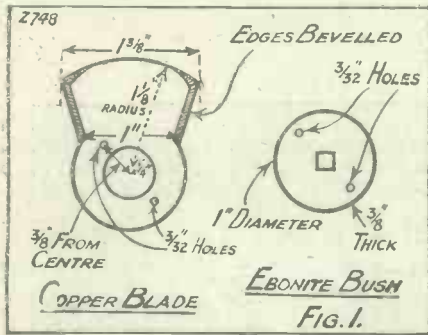

The shaft is a variable condenser spindle, which has a squared portion in the middle. Ebonite bushes are "keyed" on the shaft by means of square holes through their centres, and the switch-blades are mounted on the bushes, so that they are insulated from the shaft. Fig. 1 gives the dimensions of the parts needed for one blade and its bush. The blade is cut out of No. 20 gauge copper sheet. A $\frac{3}{8}$ -in. hole is drilled through the centre of the bush, which is cut from 1-in. ebonite rod.

Mounting the Blades.

Then the shaft is heated, and the squared portion is pushed through the hole to cut its own "keyway." Do not have the shaft too hot—just hot enough for it to burn its way through slowly is sufficient, or the bush will be damaged. Drill the $\frac{1}{8}$ -in. hole in the blade, and the two smaller holes outside this.

Place the blade on the bush, with its

large hole concentric with the square hole in the latter, and mark on the ebonite the centres of the small holes. Drill them about $\frac{1}{8}$ in. deep, put on the blade again, tap in two pins of No. 14 S.W.G. wire, and file them off flush with the surface of the blade. The blade is then ready for mounting on the shaft.

Constructing the Frame.

Put on one end of the shaft a nut, a flat washer, a $\frac{1}{8}$ -in. thick ebonite bush, and the blade and $\frac{3}{8}$ -in. bush, in that order. Prepare the next bush and blade, but do not mark the centres of the pinholes in the bush yet. Assemble the second blade on the shaft

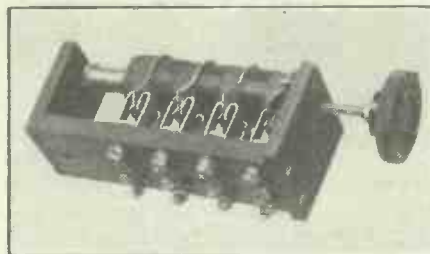

Here is the completed switch. The one shown in the heading photograph is a commercial type of barrel switch.

with its bush, and align the edges with those of the first blade. Slide off the blade and bush together, taking care not to separate them, and mark the centres of the pinholes on the ebonite. This procedure ensures that the blades are correctly aligned when the switch is assembled.

If the shaft is too long for the blades, the "spare" part of the squared portion may be filled with large condenser spacing washers, the whole assembly being clamped with nuts at each end. In the switch shown extra $\frac{3}{8}$ -in. bushes

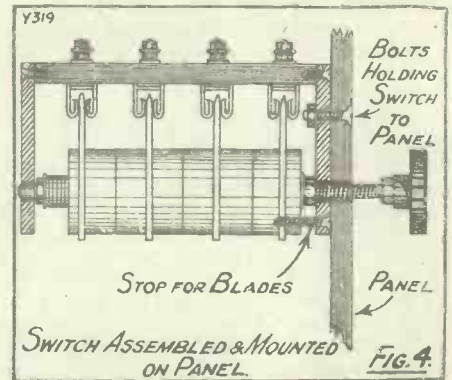

B.B.C. BREVITIES

2 L.O. the London Station, was opened on October 14th, 1922.

The Birmingham Station began broadcasting on November 15th, 1922, and the Manchester Station started on the same day.

It was on Christmas Eve, December 24th, 1922, that the Newcastle Station called the British Isles for the first time.

Cardiff commenced its official broadcasting career on February 13th, 1923.

Glasgow gave its first programme on March 6th, 1923.

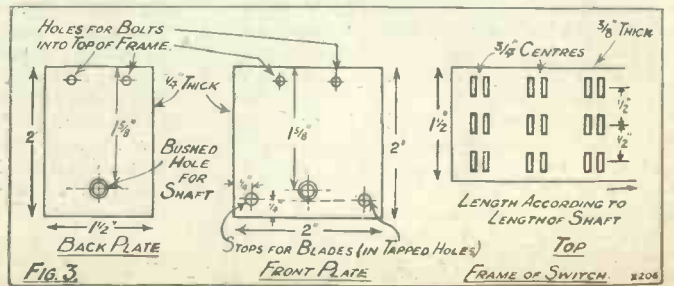
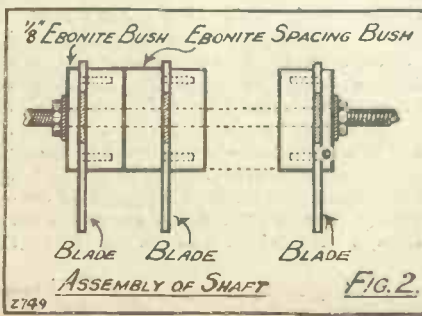

TECHNICAL NOTES.

By Dr. J. H. T. ROBERTS, F.Inst.P.

METHODS OF AMPLIFICATION

THE "LIGHT" SPEAKER—LIVES OF RADIO SETS—SUPPLY DEVICES.

Methods of Amplification.

THE amplification of gramophone record reproductions by means of pick-ups is usually effected by simple low-frequency amplification of the electrical impulses received from the pick-up device. According to one system, however, the electrical impulses from the electrical pick-ups are used to modulate the high-frequency oscillations in a self-excited oscillatory circuit, the energy from which is then transferred to the high-frequency input side of the receiving circuit (usually to the detector) by means of a plug-jack or alternatively by a throw-over switch. The receiving circuit may thus be connected either to the aerial (for reception of broadcast) or to the oscillator circuit which, as already mentioned, is modulated by the electrical signals from the gramophone pick-up.

Quite good results can readily be obtained by means of an electro-magnetic pick-up, the making of which is within the scope of the home constructor, and a number of constructional articles dealing with this component have already appeared.

In view of the great popularity of wireless receivers, it seems to me that the method of electrical reproduction from the gramophone is likely, in course of time, to supersede altogether the direct method of reproduction from the record as used exclusively in the gramophone of a few years ago.

"Light" Speaker.

There have been, during the last couple of years, all kinds of artistic devices incorporating loud speakers, the ornamental exterior taking the form of figures, vases, lamp-shades, ships and so on; the "ship" variety seems to be having quite a run of popularity in the 'States at the present time.

I see that a rather ingenious form of combined ceiling lamp and loud speaker has been designed by C. A. Volf, a well-known American radio engineer, and is known as a "light" speaker. It is designed so that any standard reproducer unit may be used with it.

Apart from the shell of the device being in the form of a lamp, it has the rather novel feature that it includes both a horn and a cone loud speaker. There are two separate reproducer units, the sound from the upper one passing up a vertical tube, then being reflected downwards, whilst the lower unit is directly connected by means of a driving pin to the centre of the cone, the latter being in a horizontal position and forming the lower external part of the whole device.

The horn type of loud speaker is generally better for the reproduction of higher-pitched tones, whilst the cone speaker is adapted for the reproduction of lower notes; by the use of these two together it is claimed that faithful reproduction of the whole of the audio scale is obtained.

Lives of Radio Sets.

How long should a radio set last? This is a question which is often asked by beginners or those contemplating the purchase of a set, although the question seems rather a curious one to the experienced experimenter since, in the ordinary way, apart from the valves and the batteries, there is nothing in the set itself to wear out. It is hardly like a motor-car where, in the course of normal use, there is definite wear and tear.

It would probably be true to say that with ordinary care the essential components of a radio receiving set should last indefinitely, and the receiver should only die of "old age" in the sense that the circuit or the components might become obsolete.

Of course, with any carelessness in the

handling of the set, or even with an accident that may happen to the most cautious user, such a thing as a burnt-out transformer or condenser may result, but it is a simple matter to replace a component of this kind at relatively small cost.

The valves naturally have a limited life, but even these, especially if of any of the better-class modern makes, should last for a very long time with careful handling. Of course, the real maintenance cost of a set relates to the high-tension and low-tension batteries, particularly the former.

Supply Devices.

If one of the various electric supply devices is used for the H.T. and L.T., there is really no appreciable wear and tear or deterioration of the receiver, except in regard to the valves, and here again, as I have already indicated, the improvement in valve manufacture has been so rapid during the past two or three years that the present-day receiving valve is a remarkably stable and long-lived component. A receiver equipped with high-grade valves and provided with an electric supply device operating from the mains for the H.T. and L.T. and grid bias, is just about as near a no-trouble outfit as can reasonably be expected.

"MIKE" AT AN ELECTION.

Are you in favour of broadcasting politics? Opinion seems very sharply divided on this question, some considering it would be very boring. Meanwhile, "Mike" is peacefully penetrating into election campaigns, and, as shown above, is invading village greens in these causes.

NEWS FROM SAVOY HILL.**FROM OUR OWN CORRESPONDENTS.****A REMARKABLE PLAY.**

MISS CABLE ON TIBET—BELFAST NEWS—A NEWCASTLE EVENT.

A Remarkable Play.

Here is something about "Rampa," the important four-act play by Max Mohr, which has had a great success as a stage production, and which Mr. Cecil Lewis has translated and adapted for radio. It is the story of a man, who after the death of his partner in the frozen Northern wastes, becomes friendly with bears and other animals until eventually, using only their language, he loses the power of real speech. Later, when rescued, he is bought by the proprietor of a travelling circus, manacled

and exhibited in a cage as a "beast man."

Subsequently he becomes the property of a doctor, who by experiments restores him to a natural human being, though the only gratitude the benefactor receives is that the man goes off with his wife. We last see him, standing on the quay-side watching boats leave for the North, longing to return to his former animal companions, and convinced of the hypocrisy of human nature. "Rampa" is in the London programme for Wednesday, March 7th.

(Continued on page 38.)

The "Handyman" Two

PART II.

Embodying the ever-popular "Det. and L.F." circuit, this home-made receiver is efficient on both long and short waves. In this article the final details are given, including the method of constructing coils for Sydney (N.S.W.), East Pittsburg, and the other short-wave stations.

By G. P. KENDALL, B.Sc.



CONTINUING the general description of the "Handyman," it is to be noted that in addition to the usual features of a detector circuit, there are two devices

setting which gives you the smoothest reaction control combined with the loudest signals. As a rough guide it may be mentioned that this is usually about two-thirds

ing the constructional work, which can otherwise be followed out from the diagrams and photos. The reaction condenser used in the original set was an Ormond, and this has two sets of fixed plates, and one of moving. To obtain the full capacity the two sets of fixed plates are joined together, whereas in most other types only one connection would be made. This point is mentioned lest someone using an alternative

POINT-TO-POINT CONNECTIONS.

One filament socket of each valve holder to one side of each respective rheostat.

Remaining sides of rheostats joined together, to one end of the potentiometer winding and to one side of the L.T. switch.

Other side of L.T. switch to the L.T.+ terminal.

L.T.— to H.T.— terminal, to the G.B.+ plug via a flexible lead, to the remaining end of the potentiometer winding, to the remaining filament contacts on the valve holders, to the earth terminal, to the extreme right socket on the 4-socket base for the aerial coil unit, and to the moving vanes of the reaction condenser and the secondary tuning condenser.

Fixed vanes of the reaction condenser (there are two sets of fixed vanes, and they should be joined together by a piece of wire) to the right hand reaction socket on the aerial coil unit base.* The socket is the second from right looking at set from back of baseboard.

Remaining reaction socket to one tag of the .001 mfd. fixed condenser.

Other side of .001 mfd. fixed condenser, to the plate of the 1st valve holder and to one side of the H.F. choke.

Other side of H.F. choke to the IP of the L.F. transformer.

OP to the H.T.+1 terminal.

Grid of the 1st valve holder to one side of the grid-leak holder and to one side of the .0003 mfd. fixed condenser.

Other side of .0003 to the left-hand socket on the aerial coil unit base, and to the fixed vanes of the secondary tuning condenser.

Remaining side of grid-leak holder to the handle (or slider) on potentiometer.

OS of the L.F. transformer to the grid of the 2nd valve holder.

IS to the G.B.— plug via a flexible lead.

Plate of 2nd valve holder to the L.S.— terminal.

L.S.+ terminal to the H.T.+2 terminal.

Aerial A1 terminal to one side of the two plate air condenser.

A2 terminal to the remaining side of the condenser and to the aerial coil tapping clip via a flexible lead.

provided to enable the best results to be obtained on short waves. The first of these is a small fixed condenser, which can be brought into circuit in series with the aerial by connecting the aerial lead to the terminal A_1 instead of A_2 .

Short Wave Features

This condenser is exactly the same as the one used for the same purpose in the "Sydney" Two, and consists of two pieces of copper sheet mounted horizontally with a slight space (about $\frac{1}{8}$ in. at first; adjust later by bending) between them, on a strip of ebonite. A detailed diagram of this condenser will be given in "Radiatorial" next week for the use of readers who do not possess "P.W." No. 284.

The other point is the use of a potentiometer to adjust the grid potential of the detector valve (through the grid leak), and this is a very useful feature on all waves. A very little experimenting with the position of the slider will enable you to find a

of the way from the positive round to the negative end of the potentiometer.

Just one point calls for mention concern-

make should be puzzled by the extra connection on the wiring diagram.

Operating the set is simple. For the detector a valve of the H.F. type is advised, with a small power or L.F. valve in the other socket. (If you are very near to your

(Continued on next page.)

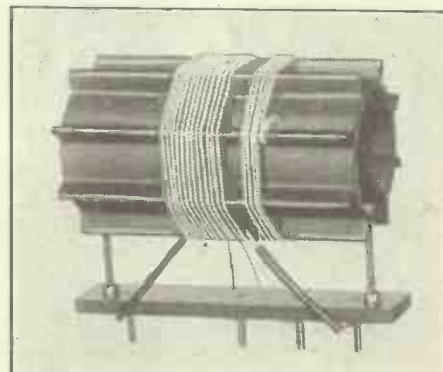

This is the coil for stations working on 45 metres. The tuning with this coil will go up as high as 60 odd metres for K D K A, etc.

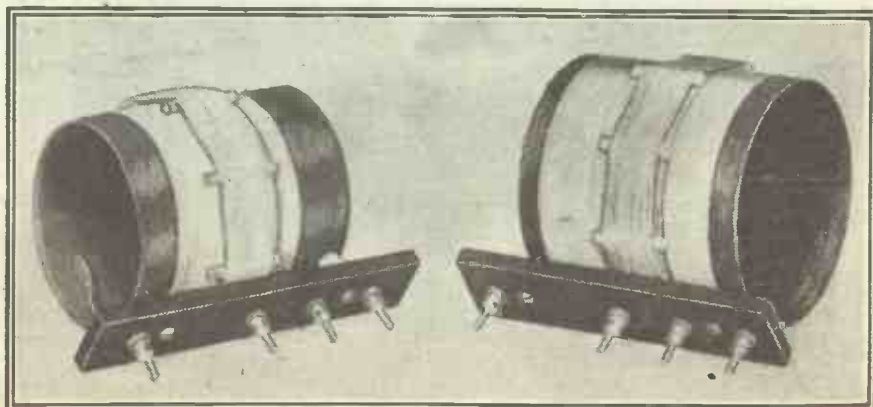

To the left is the coil for your local station and others below 600 metres, whilst to the right is that for Davenport, 5 X X, Hilversum, Zeesen (Berlin), and the other excellent long-wave transmissions now "on the air."

THE "HANDYMAN" TWO

(Continued from previous page.)

local station and get very strong signals a power valve is most desirable). The H.T. on the terminal H.T. +1 should be about 60 volts, or perhaps a little less, for most valves. At least 100 volts is desirable on H.T. +2 for loud-speaker work.

One other point. Do not forget to try the tapping clip on each aerial tapping point in turn.

The coils used in the "Handyman" are exactly the same as those employed in the "Reinartz One Valver," described in "P.W." No. 273, but the specification will be repeated for the benefit of those who may not possess this issue, commencing with the unit for the ordinary B.B.C. waves.

It is wound upon a piece of insulating tube, 3 in. in diameter and 3½ in. long, and consists of three separate windings. The largest is the secondary, consisting of 50 turns of No. 24 double cotton-covered wire in a single layer, the ends being secured by passing them through small holes in the tube in the usual way. The beginning of this winding is half an inch from one end of the tube, and the finish is about an inch and a quarter from the other end of the tube, leaving a space upon which the reaction winding will be placed. This consists of 30 turns of No. 32 double-silk-covered wire in the same direction as the secondary.

THE AERIAL COIL.

Over the top of the finishing end of the secondary is wound the aerial coil, consisting of 25 turns of No. 24 D.C.C. in the same direction as the secondary. This winding is supported away from the secondary by a simple scheme. Eight pieces 1½ in. long are cut from one of the sticks used as stiffening in a packet of "Glazite," and equally placed round the coil, being held by a rubber band until gripped by the winding. Tapping points are made at the tenth, fifteenth, and twentieth turns as winding proceeds by twisting up a small loop in the wire which is subsequently scraped bare, so that a tapping clip may be attached. The end is also fastened off and left projecting to the extent of about half an inch for the same purpose.

The coil is mounted upon a strip of ebonite 5½ in. long and 1 in. wide, carrying four "Ealex" plugs. It is attached by two brass screws and nuts, and spaced away from the strip by means of two of the insulating sleeves which are supplied with the plugs, and which are not otherwise required. These are slipped over the screws, between the ebonite strip

and the coil former. The screws, of course, are placed near the ends of the former.

The base or socket into which the coil plugs consists of another strip of ebonite 6 in. long and 1 in. wide, carrying four "Ealex" sockets, and fastened to the baseboard by means of two screws passed through two more of the insulating sleeves, so supporting it just clear of the wood. Looking at the wiring diagram, the spacing between these sockets is 1 in., 1 in., 2 in.

The connections are as follow. With the coil placed in the set, imagine that you are looking at it as it would be seen in the wiring diagram. Then to the right-hand pin is connected the finish of both aerial and secondary windings. The other end of the secondary goes to the left-hand pin. The reaction coil is connected to the two middle pins, the end nearest the secondary going to the right-hand pin,

The "Handyman" Two complete. The cabinet is a home-made one, built from a set of parts, and full details of this part of the construction at work were given in last week's issue of "Popular Wireless."



and the end furthest from the secondary to the left-hand pin.

The coil for the Daventry range is made in exactly the same way, but on a 3½-in. diameter former, and the details are as follow: Aerial, 80 turns of No. 34 S.S.C. wire (with a tapping at 60); secondary, 170 turns of No. 34 S.S.C. wire; reaction, 60 turns of No. 34 S.S.C. wire.

Until quite recently the reception of short waves was decidedly a hobby for the ultra-enthusiastic amateur, who was often so keen on the subject that he took only a passing interest in ordinary broadcast reception. We have all heard his favourite theory to the effect that the only correct procedure is to have one set for broadcast reception, and another very special one for short waves.

As a "counsel of perfection" this is all

very well, but short-wave reception is now appealing to a much wider circle, simply because there is now a good deal of actual broadcasting going on below 100 metres, and to the ordinary listener the idea of two separate sets seems an extravagance.

In the case of the "Handyman" Two, however, by taking particular pains to include the special features desirable in a short-wave receiver it has been found possible to get really good results on short, medium and long waves merely by plugging a suitable coil unit into the holder. Details

of the special short-wave coil follow, but first some notes should be given on short-wave working in general.

The first thing which you must realise is that the tuning and reaction adjustments are both much more critical on the lower waves, and a lighter touch must be cultivated in consequence. You must learn to turn the tuning dial *very* slowly and carefully, lest you miss stations altogether, and to adjust reaction very delicately.

Again, you must adjust the set very carefully so that the smoothest possible reaction control can be got, and this is done by trying different voltages on H.T. +1, and adjusting the position of the potentiometer slider. You will probably find that reaction becomes smoother as you take the slider towards the negative end, but if you go too far strength of signals will suffer.

The Valves Recommended.

Now as to valves. In all the well-known makes the H.F. type will enable you to get plenty of reaction, but the use of cheap foreign valves (especially 2-volters) may lead to trouble, and it may then be necessary to use one of the power type as detector to get the set to oscillate.

The short-wave coil is wound on a standard Redfern former, 5 in. long, 3 in. diameter, with 8 ribs. The windings for a unit to cover about 35 to 70 metres are as follows. Secondary, 12 turns No. 24 gauge wire (bare or covered) spaced out to occupy about 1 inch. Aerial winding (primary), 5 turns of the same wire, with a tapping loop twisted up at the third turn. Reaction, 6 turns of No. 34 D.S.C. wire wound in a saw cut in the ribs immediately underneath the end of the secondary nearest the aerial winding, and in the same direction as the secondary.

To enable you to get down to the stations working between 20 and 35 metres (2 X A F, Sydney, etc.) you will need another unit with 6 turns secondary, 4 primary (tap at 2), 5 reaction, made in the same way.

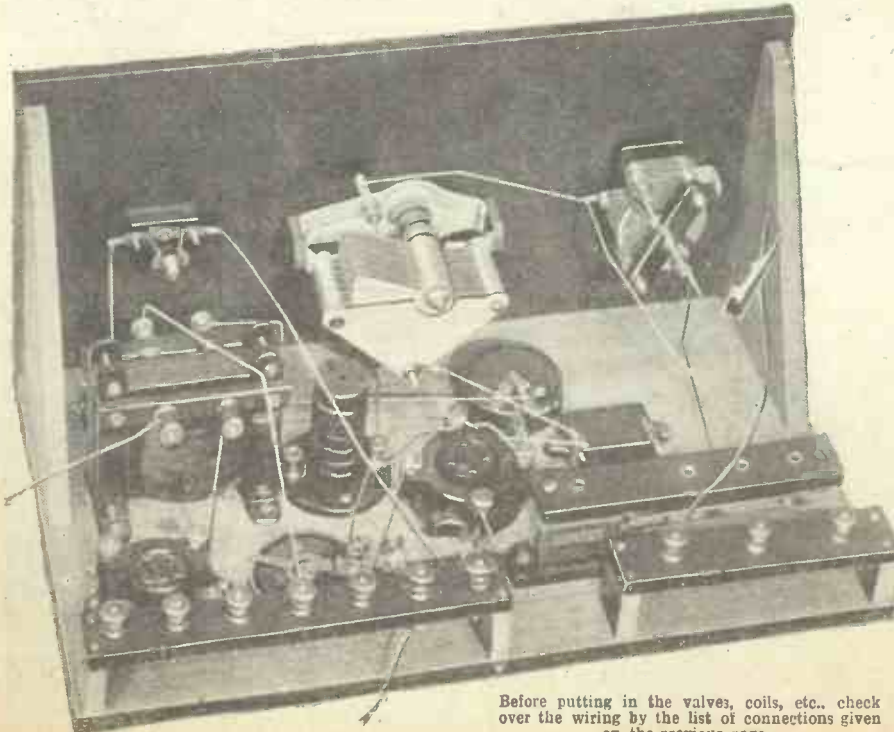

Before putting in the valves, coils, etc., check over the wiring by the list of connections given on the previous page.

Exquisite Music- on Headphones!

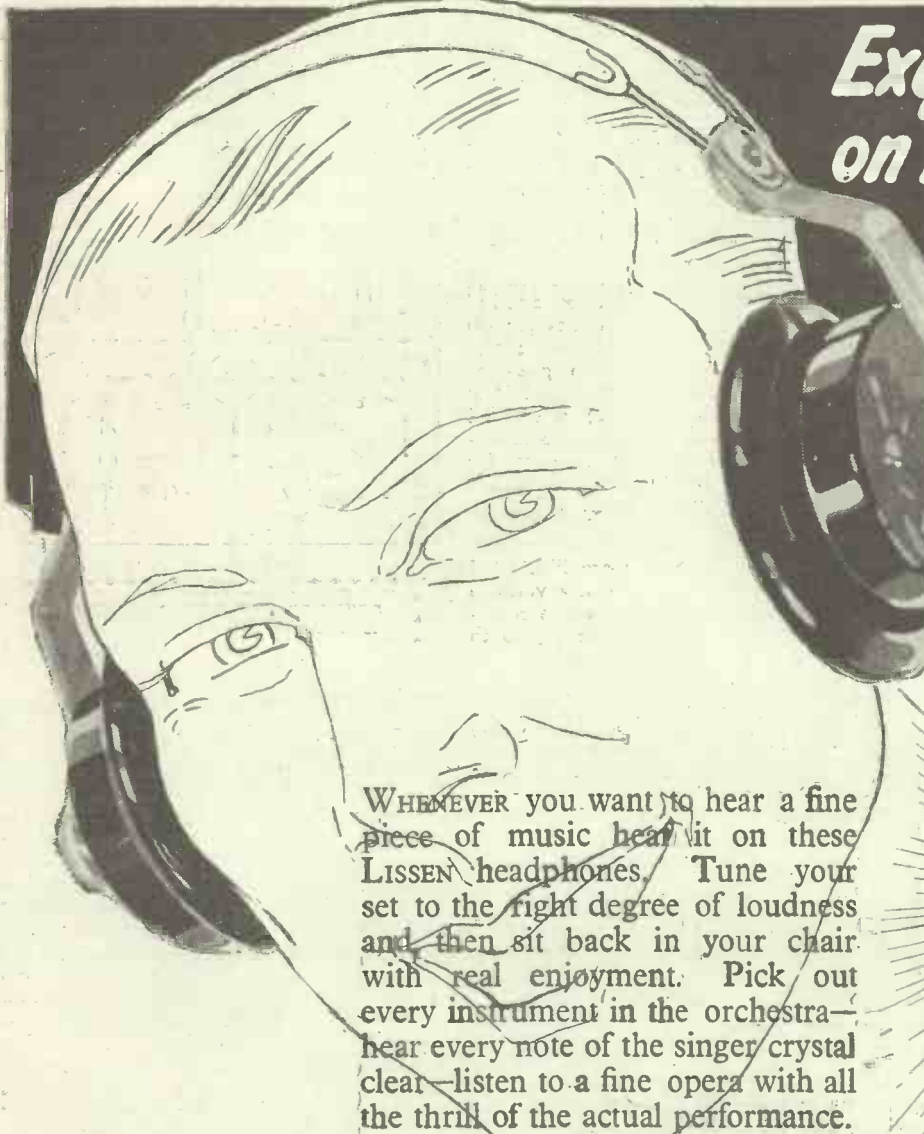

WHENEVER you want to hear a fine piece of music hear it on these LISSEN headphones. Tune your set to the right degree of loudness and then sit back in your chair with real enjoyment. Pick out every instrument in the orchestra—hear every note of the singer crystal clear—listen to a fine opera with all the thrill of the actual performance. You can sit for hours with these LISSEN headphones on—they're so light you will hardly know they're there.

Every lover of fine music should possess at least one pair.

Cords will not twist or tangle but will always hang straight down no matter how the head may be turned or twisted. The two ear-pieces are extremely sensitive and are exactly matched in impedance. They settle at once into comfortable positions and may be secured there by a single movement of a special ball joint.

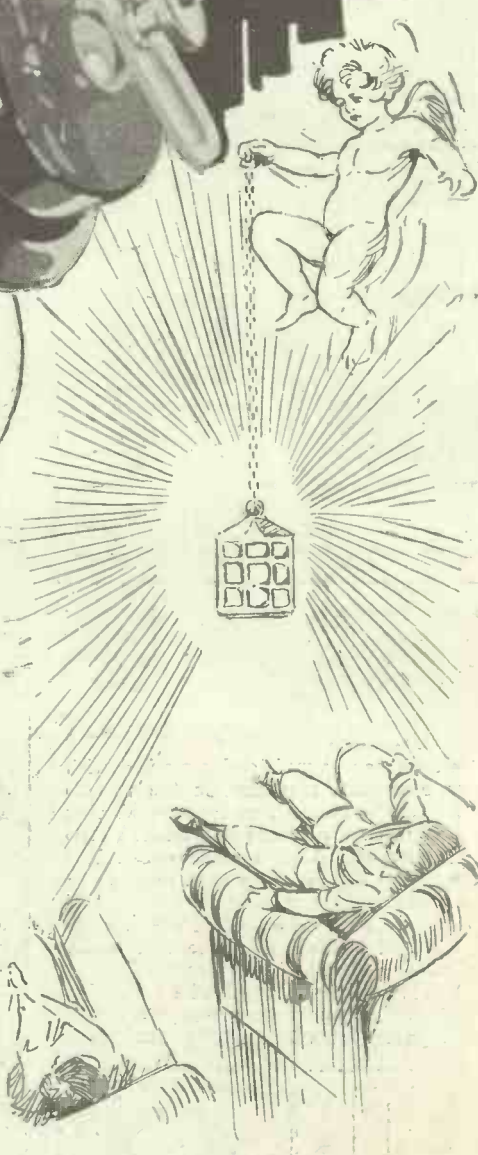

8'6

LISSEN HEADPHONES

LISSEN LIMITED (Managing Director: Thos. N. Cole), 8-16, FRIARS LANE, RICHMOND, SURREY

HOW TO CONTROL VOLUME

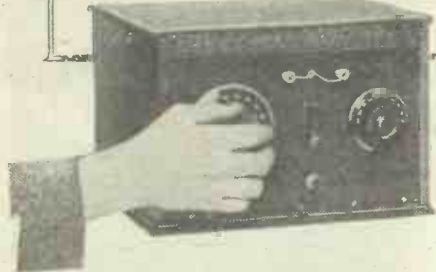

Correct and incorrect methods compared and explained in an interesting manner.
By O. J. RANKIN.

VOLUME control means the regulation of the degree of sound from the loud speaker. This is usually effected by switching L.F. amplifying valves in or out of circuit, but, owing to the almost universal use of the modern "point one" dull-emitter valve, such a method is becoming less popular, and it is becoming more usual

of a detector valve will cause distortion, as will also the dimming of the L.F. valve filaments. Three common make-shift methods, often tried but seldom adopted, are: (1) Detuning the aerial circuit; (2) decreasing the H.T. battery current; and (3) altering the value of the grid-bias battery. With the first mentioned it is sometimes possible to obtain a decided decrease in volume with very little distortion, but the two latter methods can, for obvious reasons, only result in failure, distortion being unavoidable.

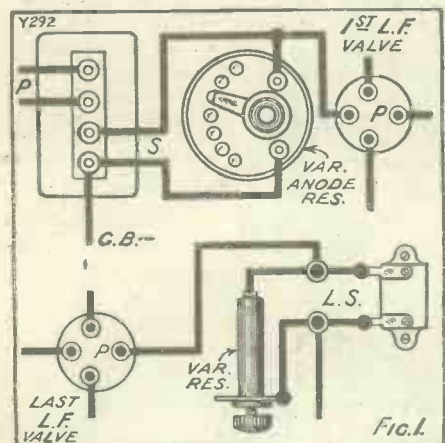

Use of Potentiometers.

Other common mistakes are illustrated in Fig. 1. In the upper sketch a variable resistance (usually a tapped anode resistance having a value of from 15,000 to 100,000 ohms) is connected directly across the secondary winding of the first L.F. transformer, and in the lower sketch a variable resistance (having a similar value) is shunted across the loud-speaker terminals. Both methods are incorrect, and should be avoided at all costs.

Fig. 2 shows the correct method of connecting a variable resistance across the secondary terminals of the first (low-ratio) L.F. transformer. Here the resistance consists of a 500,000 ohms potentiometer, and it will be seen that the "ends" of this go direct to the transformer and the arm to the grid of the L.F. valve. This is the only method whereby the input to the grid of

to dispense with complicated switching systems and employ the more simple and practical method of inserting a variable damping resistance in a suitable part of the circuit.

An Easy Method.

In the case of a multi-valve receiver with a stage of H.F. amplification the volume may often be reduced, without introducing distortion, by dimming the filament of the H.F. valve, and it will sometimes be found advantageous to place the H.F. rheostat on the panel so that it may be adjusted, if necessary, to give the desired effect. The rheostat, of course, should be well made, and capable of smooth adjustment.

It is, however, a great mistake to imagine that the same method may be adopted when no H.F. valve is used. Dimming the filament

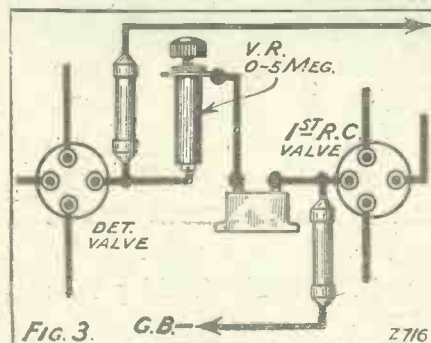
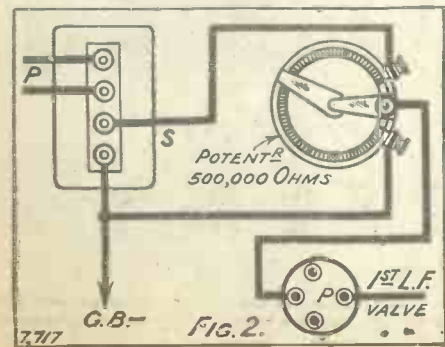

the first transformer-coupled L.F. valve may be controlled effectively without impairing the purity.

In the case of a detector valve followed by one or two resistance-capacity coupled amplifiers, good results are often obtained by placing a variable grid leak in series with the plate of the detector valve and the first coupling condenser in the manner shown in Fig. 3. The maximum value of the leak should be 5 megohms, and if arranged to short out at the zero position the volume may be adjusted from full strength down to one-tenth full strength without causing distortion.

Generally, however, the arrangement shown in Fig. 4 will be found more satisfactory. Here the first coupling condenser is connected to the plate of the detector

valve as usual, but the first grid leak is replaced by a 500,000 ohms potentiometer, one side of which is joined to the other side of the first coupling condenser, the other side to the negative grid-bias wander-plug, and the moving arm to the grid of the first L.F. valve. This gives a perfectly smooth control without affecting the purity, and the method can be highly recommended for use in conjunction with resistance or choke-coupled amplifiers.

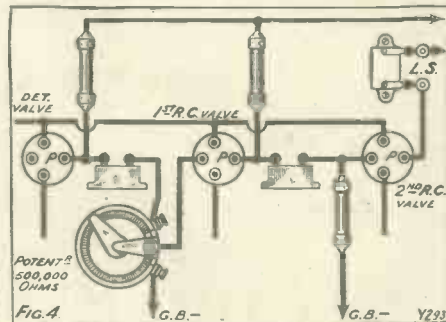

TELEPHONE EXTENSIONS.

NO doubt many of us, at some time or another, have wished to run a 'phone extension to another room, perhaps to an invalid in bed, and have also wished to work the loud speaker direct from the set at the same time. Now, in the ordinary course of events, the volume at the end of the extension would be loud-speaker strength, at any rate far too great for ordinary listening on 'phones, but there is a method by which the volume can be cut down to comfortable 'phone strength, and yet in no way affect the loud speaker.

A Simple Scheme.

All that need be done is for a fixed condenser of fairly small capacity, say .0003 mfd., to be inserted in series with the extension lead joined to H.T.+, the capacity determining the volume; if desired, a miniature variable condenser, such as the Formodenser, could be used, and this would act as a volume control. The diagram should clear up any difficulties.

Should reproduction be inclined to be in any way coarse, a .001 mfd. fixed condenser shunted across the 'phones may modify the tone favourably.

An additional advantage is the fact that no H.T. current wanders through the leads to cause any voltage drop.

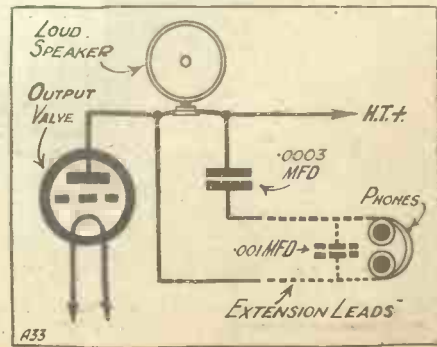

JAZZ

WITH ITS MEDLEY OF INSTRUMENTS



but they make a wonderful harmony of the medley. And you catch the real spirit of jazz when you have a Lissen New Process Battery in your set. Your valves, like its power, never distort, and you get that clear reproduction without which jazz loses its infectious gaiety. The pure D.C. current of the Lissen Battery is flowing always so noiselessly, so smoothly, and so abundantly that every instrument is clear and distinct, every note and every word is clear and loud. The oxygen content of the cells, due to the new process and chemical combination known only to Lissen, is so great that throughout the longest programme your loud-speaker utterance is natural and true from first to last. You get months and months of use out of the battery and delightful reproduction all the time. You can buy a Lissen Battery at 10,000 dealers. Ask for it in a way that shows plainly you want it and will take no other.

60 volts (reads 66) 7/11. 100 volts (reads 108) 12/11. 9 volts (Grid Bias) 1/6. 60 volts (reads 66) Super Power 13/6.



LISSEN

New Process

BATTERY

LISSEN LTD. (Managing Director, Thos. N. Cole), 8-16, Friars Lane, Richmond, Surrey.



"ONE GOOD TURN
DESERVES ANOTHER"

N.C.C.384.



REGD No 154011.

IT has often seemed to me to be a strange fact that the use of iron pyrites has never really "taken on" in this country. Probably, of course, the reason for this may be looked for in the comparative scarcity of the mineral in good sensitive condition in the British Isles, and in the superabundance of the galena mineral which is shipped over here from mines in France and in Spain.

But is iron pyrites exactly scarce over here? Vast quantities of the mineral are shipped to England from Italy for the purpose of manufacturing sulphuric acid; but, quite apart from this fact, there are regions up and down England in which specimens of the pyrites may be picked up by the roadside or hammered out of quarries, and, very often, quite 60 per cent of the mineral so obtained provides an excellent material for crystal-set working.

I am still more than ever confirmed in this opinion by the fact that from time to time readers send me specimens of sensitive minerals which they have picked up in

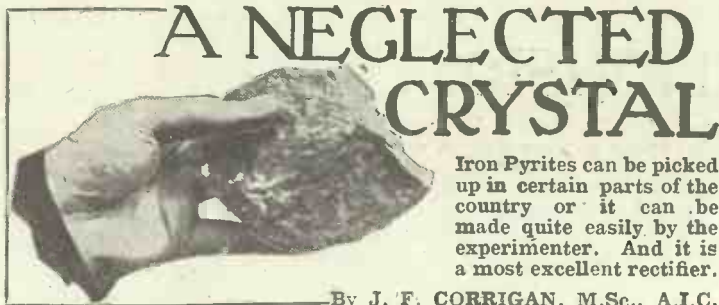

A NEGLECTED CRYSTAL

Iron Pyrites can be picked up in certain parts of the country or it can be made quite easily by the experimenter. And it is a most excellent rectifier.

By J. F. CORRIGAN, M.Sc., A.I.C.

Iron pyrites, again, will rectify well when used in a perikon or semi-permanent type of detector in contact with a fragment of tellurium. The volume obtained from such a contact is generally less than that derived from the lighter type of contact; but nevertheless the rectifier so formed is a stable and enduring one, and it will therefore commend itself to the attention of valve-crystal enthusiasts.

A word now as to the nature of the mineral. Iron pyrites, as is more or less well known among wireless amateurs, consists for the most part of iron sulphide (FeS₂). Generally it is admixed with natural impurities, which influence its sensitive properties to a very considerable extent. Perfectly pure iron pyrites is hardly a rectifier at all.

Detectors for Nothing.

Quite a number of the specimens of iron pyrites which can be found up and down this country in rocks, quarries, on the roadsides, and, very often, on the seashore, contain as much as 2 per cent by weight of selenium. Other specimens, also, contain a little tellurium. Other iron pyrites specimens, again, are contaminated with copper, manganese, and other metals; whilst quite a large number of specimens coming from Australia contain gold.

Iron pyrites exists in many different forms, but in almost every case its colouring is identical. You can at once recognise a specimen of the pyrites by its bright lemon-yellow colour. Generally, too, the surface of the mineral has quite a polished appearance, although this is not the case with every specimen.

The pyrites is found (in England) sometimes in the form of irregular-shaped masses

of mineral which do not show any particular crystalline formation. Nevertheless, on breaking up such lumps of mineral, they will often be found to exhibit good sensitive properties. Again, iron pyrites often occurs in the form of single crystals, or clusters of cubical crystals which present the appearance of having been fused together in a furnace. As a matter of fact, such has actually been the case, for their crystalline

formation has taken place when the earth's surface was still molten, and the cubical crystals have resulted from the very slow cooling of the molten mass.

It is for such reasons that cubical iron pyrites crystals are sometimes found adhering to the surface of soft rocks, the mass of crystals illustrated in the photograph (Fig. 2) being an example of this type of crystalline formation of iron pyrites.

Contrary to the general opinion, iron pyrites in a fairly sensitive form may be



These specimens of iron pyrites, all of which rectify well, were collected in Derbyshire during the course of one afternoon.

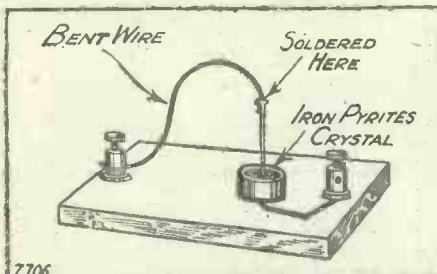

This simple detector is all you need to get good results with iron pyrites.

various districts, such crystals almost invariably turning out to be composed of iron pyrites.

The great characteristic of iron pyrites as a radio rectifier is the high degree of tonal purity which it produces in the reception. For this reason, the pyrites not only makes an excellent rectifier for crystal-set use alone, but it is also very well adapted for use in crystal-valve receivers. Used in sets of the latter description, a crystal of iron pyrites often removes "mush" and extraneous noise from the reception, and, should a loud speaker be employed in conjunction with the set, the tonal purity of the reception will often be startlingly improved in consequence.

Extremely Simple to Make.

Iron pyrites can be used as a rectifier in many ways. Generally, however, it is best employed with a fairly rigid cat's-whisker contact. The exact nature of the metal contact is not very material to the results obtained, though it is probably true that a brass, phosphor-bronze, or a steel contact gives rather better results than any others. An ordinary pin or needle used in contact with iron pyrites, in the manner illustrated in the diagram (Fig. 1), will give excellent results, despite the crudity of the arrangement. A fairly heavy contact is necessary, although, of course, such a contact must not be as heavy as that obtainable in the case of a zincite-tellurium or similar "perikon" type of rectifying contact.

prepared artificially, and with a minimum of expense and trouble. The material necessary for the process comprises merely a handful of iron filings, and a similar quantity of powdered sulphur.

Construct Your Own Crystals.

Mix two parts of the sulphur with one part of fine iron filings, and stir them intimately together, so that they form a yellow-grey mixture, and heat it strongly in a non-luminous gas or spirit lamp flame. A chemical reaction will take place within the tube. The contents of the tube will glow red hot, even when the tube is removed from the flame.

After the red glow has finally died down, the tube should be left to cool. Afterwards, it should be broken, and the contents extracted. They will be found to consist of a grey, coke-like porous mass, having, sometimes, a yellow-greenish cast about them. Careful testing of this material will prove it to possess considerable rectifying powers if used with an ordinary cat's-whisker contact.

In fact, a perfectly synthetic or artificial form of iron pyrites will have been prepared. Amateurs interested in the simple preparation of this substance should experiment with varying relative proportions of sulphur and iron pyrites before they arrive at the final form of the pyrites most satisfactory for crystal use.

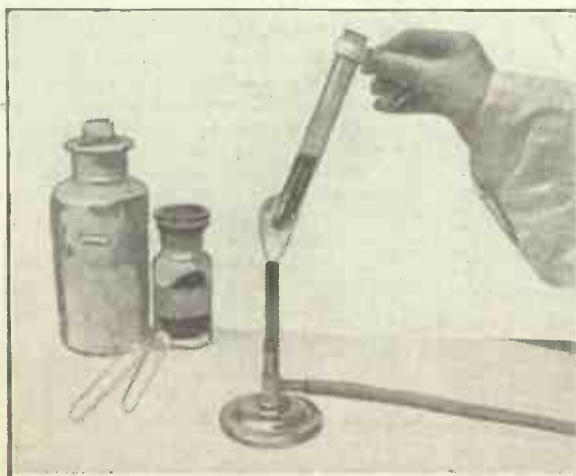

The heating of the mixture of iron filings and sulphur in a test tube, which is a process in the simple method of preparing synthetic iron pyrites described by Mr. Corrigan.

TELEVISION.

"In view of the fact that apparatus for making home television sets is now obtainable . . . we are forced to take a more serious view of what we have, perhaps, regarded hitherto as the natural excitement and optimism of certain parties interested in recent television experiments."

By THE EDITOR.

STATEMENTS: in connection with television have been made in this journal and in "Modern Wireless" and the "Wireless Constructor," in an endeavour to provide our readers with a truthful account of the progress made, and an accurate explanation of the problems which confront television experimenters—and, further, an explanation of the reason why certain known television systems are faced with such definite limitations that true television can only be realised by the discovery of a new system.

These statements, and the various explanatory articles we have published would, we hoped, at least provide our readers with information which would enable them to judge the television problem in right perspective—necessary in view of the hys-

SIR OLIVER LODGE'S VIEW.

"It should be emphatically pointed out to the public that Television is still very much in its infancy, and still requires time and careful scientific investigation.

"The idea of transmitting the Boat Race with any degree of success by wireless according to any known system is absurd.

"And as for the idea of placing Televisor receiving sets on the market at the present time, with Television in its present undeveloped stage, this is too optimistic."

terical and exaggerated reports which have been so current of late in connection with television.

"Carping Critics."

However, in view of the fact that apparatus for making home television sets is now obtainable, and certain information has been published instructing the amateur how to make these home "television" sets, we are forced to take a more serious view of what we have, perhaps, regarded hitherto as the natural excitement and optimism of certain parties interested in recent television experiments.

In the first issue of a journal devoted to television we find the following statement:

"There is no doubt about it that television is an accomplished fact in spite of the verbose statements to the contrary which have been made in certain quarters, and in spite of the pseudo-scientific arguments, designed to prove the impossibility of its achievement, which have been loudly voiced by carping critics. Mr. Baird has publicly demonstrated it in this country innumerable times, and according to a recent newspaper announcement has lately transmitted between London and New York."

And in the same issue this statement:

"In the meantime we, from our own knowledge of this new science, would strongly advise the public to take no heed of the irresponsible remarks of ignorant critics; for it must not be over looked that the actual knowledge of these same carping critics is but little greater than that of the 'Man in the Street,' and their practical achievements in the field of television, nil.

"The Baird Company, secure in the knowledge of the results which it has already obtained, will, we feel sure, treat such worthless criticisms with the supreme contempt which they deserve, and continue to work steadily towards the realisation of the plans which it has made."

In the above extracts we find reference to "pseudo-scientific arguments" and to carping critics with knowledge very little greater than the "Man in the Street." And the hope is expressed that the Baird Co. will "treat such worthless criticisms with the supreme contempt which they deserve," etc.

Scientific Views.

All perfectly good journalese and quite amusing if regarded as such, but remember there are shareholders in the Baird Co., besides many hundreds of thousands of people deeply interested in television, who might be persuaded by such statements that the criticism which points out the real facts about television may be biased, and further, based on "pseudo-scientific" knowledge, etc., etc., and consequently not worth considering.

And so, although we feel sure that the majority of our technical readers clearly understand the technical problems of television, and the criticisms we, among others, have made with regard to television, we feel it only fair to the readers of POPULAR WIRELESS, and to all those who are interested in television, to provide them with the views of some of the eminent scientific authorities with whom we have consulted on the question of television.

In this issue we include the views of our Scientific Adviser-in-Chief, Sir Oliver Lodge. A wireless pioneer and a scientific authority of wide-world fame, such as is Sir Oliver, needs no further introduction, nor does Dr. J. H. T. Roberts, F.Inst.P., whose scientific experience, based on years of research work at the Cavendish Laboratory, Cambridge, with Sir J. J. Thomson and Sir Ernest Rutherford, and whose inventive genius was fully demonstrated during and after the war, is more than well known among those privileged to judge what is "pseudo-scientific" and what is not.

The Right Perspective.

The views of these two eminent scientists are published elsewhere in this issue, and we intend, in future issues, to publish the views of other scientific authorities, for it is our definite intention to keep our readers informed of the facts about television, and not to encourage them by optimistic and inaccurate statements about the possibilities of television.

We have, as we have stated many times, admiration for the work done by Mr. Baird, and we realise—none more fully—the value of his pioneer work.

But that pioneer work must, in the interests of scientific truth, and in the interests of the large public interested in television, be judged accurately and in the right perspective, and we can only hope that Mr. Baird will not countenance the exaggerated impressions which have been current of late with regard to the progress of television and in par-

ticular with regard to the prospects, scientific and otherwise, of his particular system.

"In view of the recently reported transmission of pictures between London and the United States, it may be as well to point out that television is hardly a practical matter yet. The transmission is an important event, but it does not denote that the problem of television has been solved.

"A face can be seen by a few spectators, and might be recognised if the subject is well known, but detail is missing. This is due to the fact that no practical method has yet been evolved to transmit more than a somewhat blurred image, and to the fact that sufficiently effective apparatus for transmitting light into electricity is yet unknown.

"The picture cannot be sent as a whole, but has to be sent in a multitude of pieces with such rapidity that the succession of pieces may affect the eye as a complete picture. Breaking up the image in this way is technically known as "searching." When the pieces are unduly large, a blurred representation results. The limit to the smallness of the pieces is governed by mechanical considerations in the transmitting apparatus.

"Due to the lack of a highly-sensitive photo-electric cell, intense light has usually to be used, and only the parts so lighted can receive adequate representation."

(From the "Yorkshire Post.")

"It was satisfactory to find so much had been achieved in the fifteen or sixteen years' work. It was disappointing to find that Baird still puts his faith to his mechanical system of splitting up the image into the points requisite for television, for no wheel can revolve at the rate which would be needed to give the fine points requisite for clear vision."

(Extract from an article by the Wireless Correspondent writing in the "Leeds Mercury.")

A SIMPLE SCRIBER.

A SCRIBER for the purpose of marking out ebonite panels before cutting can very easily be made, as the accompanying illustration depicts.

Procure an ordinary pen-holder and, with the aid of a sharp knife, carefully split one end of it for a distance of an inch or two. Squeeze a little secotine, or other form of liquid glue, into the slit thus made, and then insert a strong needle into the slit so that it projects into the wood for a distance of at least an inch.

Bind the end of the pen-holder with a number of turns of thin but strong cord or string, as shown in the illustration, and finally give the turns of cord a rubbing



A photograph of the complete scriber.

over with the liquid glue so as to hold them tightly together. Allow the glue to harden over a period of twelve hours, after which the scriber will be ready for use.

Such an implement will not only be useful for the purpose of marking out ebonite sheets, but it will also serve a purpose in picking out sundry pieces of dirt which have been allowed to collect in an out-of-the-way corner of the set. In fact, the scriber made as above can be put to all sorts of uses.

The "POPULAR" ONE-VALVE AMPLIFIER.

Here is an efficient L.F. amplifier suitable for attaching to any sort of set. Next week the same circuit will be incorporated in "flat-panel" design for those who prefer this arrangement. Designed and constructed by the "P.W." Research and Construction Department.

Described by
A. JOHNSON-RANDALL.



DO you sometimes sigh for that little bit of extra power on distant stations? Perhaps you have wished that your set, which gives you such good telephone strength, would work a loud speaker, and thus enable you to listen to the broadcast programmes in greater comfort. If so, here is a simple and efficient single-valve amplifier which will enable you to realise these hopes.

This unit can be joined up to any existing crystal set, valve set, or, in fact, to any receiver not already employing two

actual circuit and most of the components are identical. The reason for these two entirely different lay-outs is to enable the constructor to choose which of them better matches his existing set. Some reader may have one of the older pattern flat-panel receivers. If so, the second lay-out will be more suited to his needs than the one which incorporates the vertical panel and baseboard. On the other hand, the possessor of a more recent design will prefer the American type of lay-out, as described in this article.

Now let us look at the vertical panel

amplifier. You will see that there are two knobs on the panel. One is fairly large and the other is a simple push-pull switch. The idea of the larger knob is to give you a control of volume so that you can adjust the strength of the signals to suit your own requirements. For instance, if the station you are listening to is overpoweringly strong a slight adjustment of the knob will tone down the signals to a comfortable strength.

The L.F. Transformer.

The push-pull switch is just an independent filament control to the amplifier valve. Now look at the components on the baseboard. In this particular unit a very efficient but rather expensive transformer has been used. To obtain the best results it is not advisable to economise when purchasing this component. On the other hand, if you do not wish to spend

25s. or 30s., there are a number of moderately priced but very good little transformers on the market. If you
(Continued on next page.)

- 1 Ebonite Panel, 7 in. x 7 in. x 1/4 in.
- 1 Baseboard, 7 in. x 9 in.
- 1 Cabinet to fit.
- 1 Sprung type valve holder.
- 1 Baseboard variable resistor (Lissen).
- 1 L.F. transformer (R. I.-Varley).
- 1 .0005 fixed condenser, and base (Igranic), only required for R.I. transformer.
- 1 push-pull switch (L. & P.).
- 1 500,000-ohms potentiometer (Centralab, Rothermel Radio Corporation).
- 8 terminals marked as follows: H.T.+, H.T.-, L.S.+, L.S.-, L.T.+, L.T.-, and two marked "Input."
- 1 Terminal strip, 4 1/2 in. x 2 in.

transformer-coupled stages of L.F. It is particularly suitable for sets which give very loud telephone strength, but not quite enough volume to operate a loud speaker. Perhaps you will wonder why a transformer has been chosen instead of a resistance. The reason is that a transformer amplifier has a much more universal application than any other type and, in addition, will give greater magnification.

Different Designs.

In this, and in the continuation next week, you will see two apparently different designs. One of them utilises the popular American vertical panel and baseboard scheme. The other makes use of an ordinary flat-top panel, all the components being mounted on the panel itself. In each case, however, you will see that the

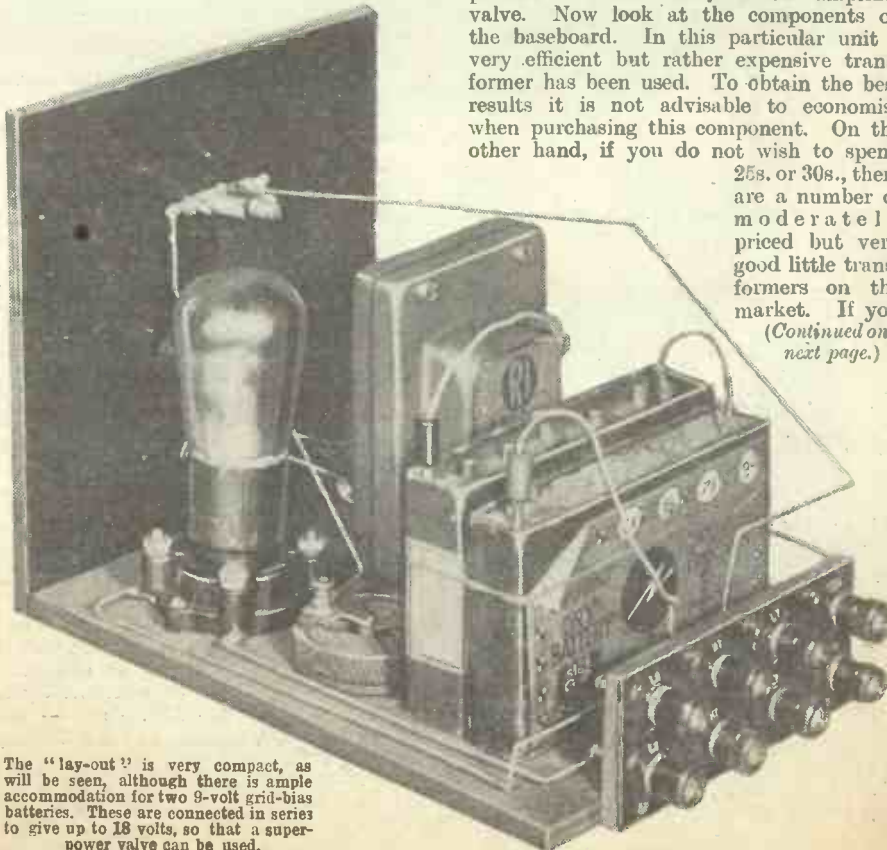

The "lay-out" is very compact, as will be seen, although there is ample accommodation for two 9-volt grid-bias batteries. These are connected in series to give up to 18 volts, so that a super-power valve can be used.

THE POPULAR ONE-VALVE AMPLIFIER.

(Continued from previous page.)

decide to buy one of these cheaper instruments, then I would suggest that you choose one having a ratio of about 3 to 1.

The transformer in the unit has connected across its primary terminals a .0005 fixed condenser. This will not be necessary with transformers of other makes and if you prefer to use some other type, then you will not need to include the fixed condenser in your list of components.

Constructional Details

The actual construction of the amplifier is very simple and there is no reason why the whole of the work should not be completed in a single evening. Drill the holes in the panel first. For the filament "on-and-off" switch and the volume control you will need a $\frac{3}{8}$ -in. twist drill. You will also require a small terminal strip which can be screwed to the back of the baseboard. The terminal holes can be arranged in two tiers of four, and it is usual to space them 1 in. apart.

This strip may be a piece of $\frac{3}{16}$ or $\frac{1}{4}$ in. ebonite, $4\frac{1}{2}$ in. long and 2 in. high.

The transformer connections which are shown apply only to the R.I.-Varley straight-line super transformer. For makes

having the more usual method of marking the terminals, the two "input" terminals would be joined to OP and IP. IS would go to G.B.—and that side of the volume control which is shown connected to terminal 5 on the R.I. transformer. OS would be joined to the other side of the 500,000-ohm potentiometer.

The actual wiring up is so very simple

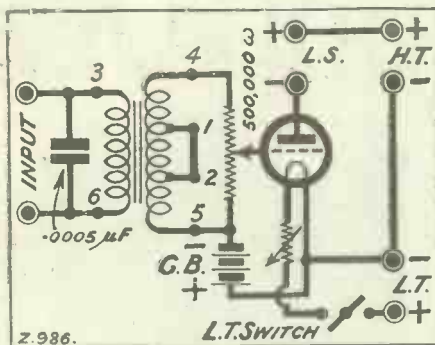

that it is difficult to find any points which need explanation. It is a matter of individual choice as to whether bare tinned-copper or covered wire shall be used. Some constructors may prefer to employ one of the insulated wires, such as Glazite. This certainly forms an effective guard against accidental "shorts" and is probably to be advised in the case of the beginner. On the other hand, bare wire is easier to handle and, provided fairly stiff "busbar," say, 16 gauge, is used there is very little danger of any of the leads touching, especially if they are well spaced. Do not forget to leave sufficient room for the grid-bias batteries on the baseboard.

Connections

There are two shown in the photograph. Each battery has a value of 9 volts and the two are joined in series. You will only need two batteries if you intend to use a super-power valve.

The method of connecting up the unit to the existing receiver will be as follows. The two input terminals should be joined to the existing "output" or telephone terminals in the set. H.T.+ will be connected inside the set to one of these 'phone terminals. Take the top input terminal to this telephone terminal which is joined to H.T.+ L.T.+ and L.T.— will be connected to a lead which goes to your existing accumulator or alternatively to the L.T.+ and — terminals on the set. There is no need to join the H.T.— lead from the H.T. battery to the H.T.— terminal on the

existing set, because one lead, namely, that to H.T.—, on the unit will suffice, provided a common H.T. battery is used throughout. Plug in a lead from H.T.+ on the unit to the 120-volt tapping on the H.T. battery and join up your loud speaker to L.S.+ and —.

Valves and Grid Bias

As stated previously, the grid-bias battery is placed on the baseboard, and the value of this battery will depend on the type of valve you intend using in the socket of the amplifier. If signals are not extremely powerful an ordinary small power-valve, such as the Marconi or Osram D.E.5, Cossor 610L.F., B.T.H. B4, Mullard P.M.6, etc., can be used in this socket. On the other hand, if signals are very loud indeed, then perhaps you will prefer a "super"-power valve. If you employ an ordinary small-power valve you will only need about $7\frac{1}{2}$ volts grid bias and a single 9-volt battery will be adequate. If you think that you will prefer one of the super-power valves then about 16 volts grid bias will be required, and you will have to purchase two 9-volt batteries, placing them in series by joining the positive

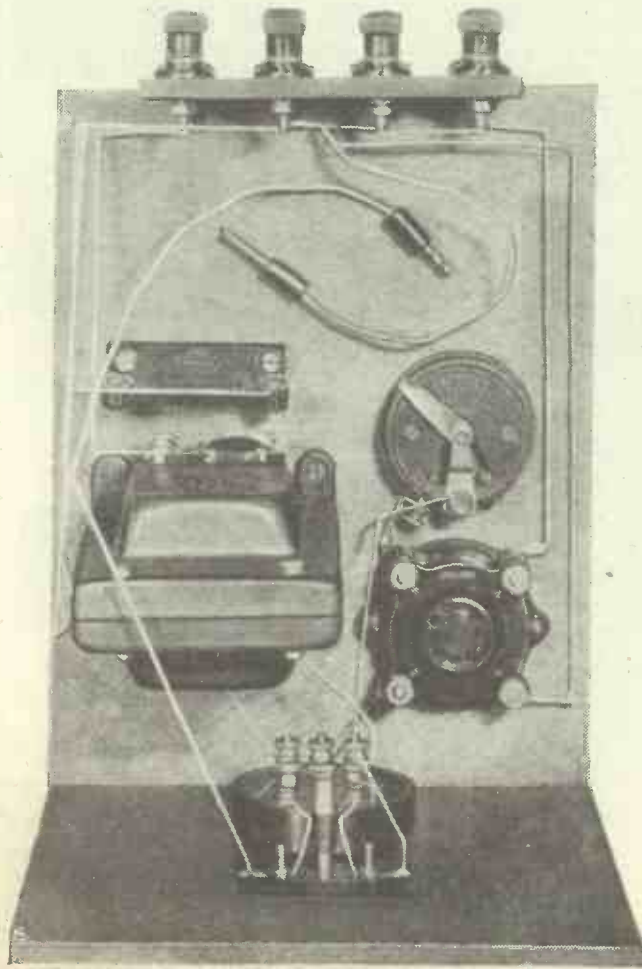
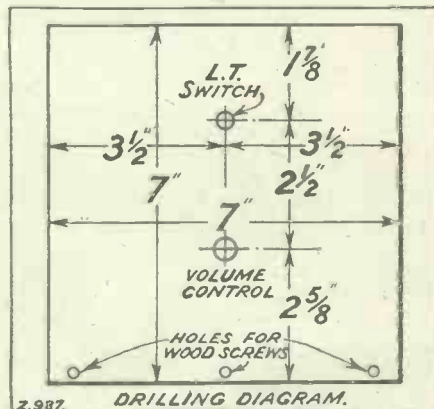

You can see the three connections to the potentiometer volume control in this view of the amplifier, which will also help you to position the components correctly on the baseboard.

socket of one to the negative socket of the other. In this way you will be able to obtain any value of grid bias from 1 $\frac{1}{2}$ to 18 volts.

If your set does not already include an L.F. stage it is very unlikely that a super-power valve will be required. A super-power valve does not give louder signals, but it is designed to handle great volume. Hence it is only in those cases where the signal strength is big that such a valve is necessary. I mention this because it is sometimes thought that replacing a power valve with a super-power valve will bring about an increase in volume. This, of course, is incorrect, and you should only purchase the latter if you find that your power valve will not deal with the volume you require, without distortion.

Alternative Components

I have said nothing about the suitability of 2-volt valves for use with this unit. The 2-volt type are quite satisfactory, and any small power valve in this class can be employed. Another point which may puzzle the constructor concerns the value of the baseboard filament resistance.

For 6-volt valves when used in conjunction with a 6-volt accumulator, or 2-volt valves employed with a 2-volt cell, this resistance may have a maximum value of 5 or 7 ohms. You will only need a small

(Continued on page 25.)

YOU GET MORE FROM MARCONIPHONE L.T. ACCUMULATORS

It is the *plates* that mean most in any accumulator. How strong they are—how long they can resist the incessant attack of the acid. That's where a Marconiphone scores. The immensely strong plates are made from a new and *improved formula especially to resist acid attack*. How well they do so is proved by the immensely long and useful service they give. All parts of Marconiphone Accumulators are protected by an electro-lead deposit against sulphuric fumes and there is a host of other features that ensure un-failing service under even the severest conditions. A glance below will show you six good reasons why "You get more from Marconiphone."



1
The Plates—the heart of every accumulator—specially constructed to resist the attack of sulphuric acid.



2
The Separators, made from the finest ebonite, thus eliminating the impurities frequently encountered with other material.



3
The substantial Container, made from the finest quality celluloid, allows easy inspection of acid level.

PRICES:

2 volt.	30 amp. hours.	13 6
2 volt.	40 amp. hours.	16 0
4 volt.	30 amp. hours.	£1 7 0
4 volt.	40 amp. hours.	£1 12 0
6 volt.	30 amp. hours.	£2 0 6
6 volt.	40 amp. hours.	£2 8 0

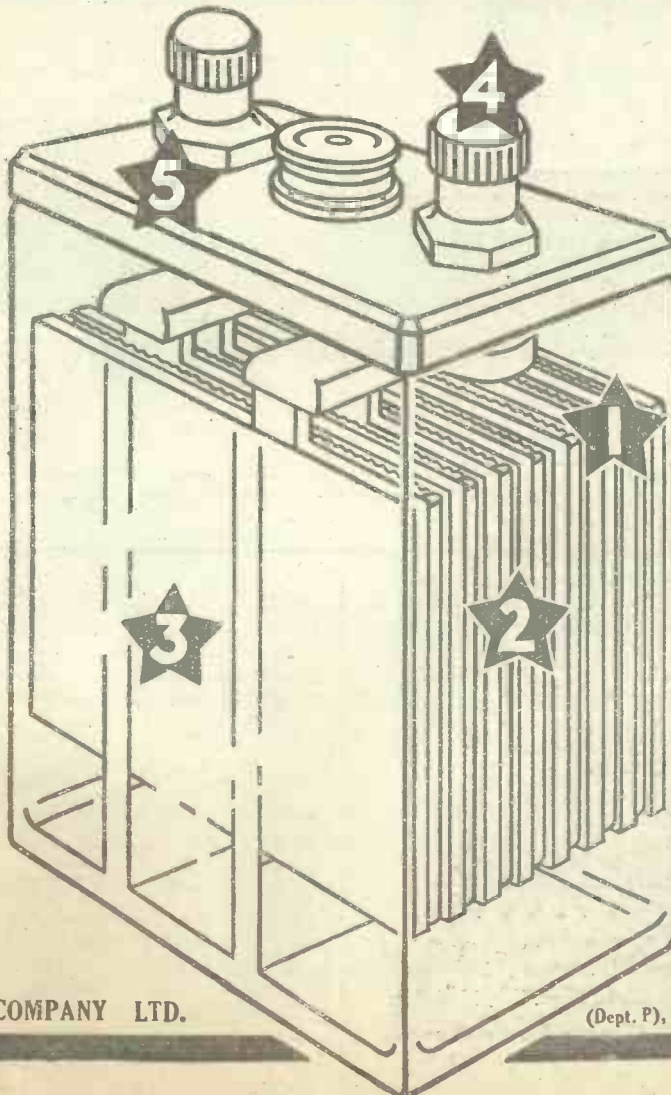

4
The Terminals are shrouded in bakelite—the finest insulating and acid-protecting medium.



5
The Flush Top can be cleaned in a moment after recharging.



6
It is a guaranteed Marconiphone product, built entirely at our modern Dagenham factory.

Send

now, mentioning "Popular Wireless," for Publication No. 438, fully describing the complete range of Marconiphone Wireless Apparatus.

THE MARCONIPHONE COMPANY LTD.

(Dept. P), 210-212, Tottenham Court Rd., W.1.

PLUG IN FOR POWER

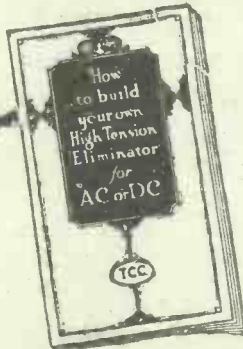
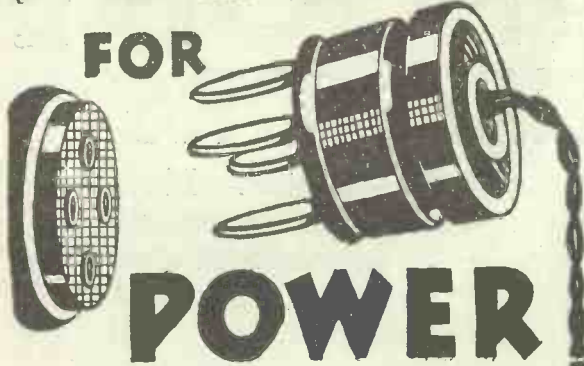

FOR YOUR
COSSOR
"MELODY
MAKER"

CONSTANT—ECONOMICAL—SAFE

CONSTANT. Power from the mains is even, steady and silent. Entirely dispenses with run down battery annoyance and H.T. crackle.

ECONOMICAL. Power from the mains costs less than a penny per day. No more recharging expenses.

SAFE. An H.T. Eliminator built the T.C.C. way is a unit of proved reliability. Using T.C.C. 600 volt Condensers, it is safe.

The T.C.C. book "How to build your own H.T. Eliminator" will convince you how simple it is for you to build this efficient unit. It is free—of course.

Write for it to-day and—

GET YOUR POWER FROM THE SWITCH

T.C.C. CONDENSERS

I enclose 1d. stamp. Please send a copy of "How to build your High Tension Eliminator for A.C. or D.C." to:

Name

Address

P.W., Mar. 3

SEND COUPON TO-DAY

To Telegraph Condenser Co., Ltd., Wales Farm Rd., N. Acton,
London, W.3.

CA 1961

NO MORE JACK TROUBLES

Now you can eliminate the old, messy soldering troubles when fixing Jacks and Switches. The famous Lotus Jacks and Switches are being made with terminals instead of soldering tags. The terminal makes as good a permanent connection as the most expert soldering job.

Lotus Jacks and Switches are made of finest bakelite, with nickel silver springs and pure silver contacts. To establish reliable connections in any set you make, choose Lotus Jacks and Switches. They occupy the minimum space—only 1½ in. behind the panel.

The Lotus Coil Holder holds the heaviest coil in position. The moving block cannot fall. Prevents fading away of volume. Vernier movement reduces speed of moving coil block by eight times. For left or right hand.

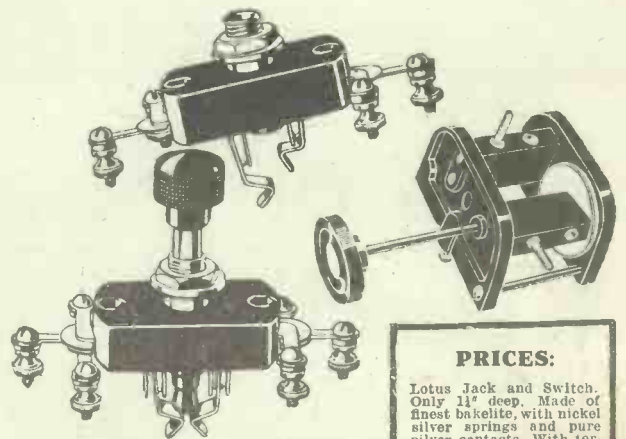

LOTUS JACKS · SWITCHES · PLUGS

Made by the Makers of the famous
Lotus Remote Control and Lotus
Buoyancy Valve Holder.

PRICES:

Lotus Jack and Switch. Only 1½" deep. Made of finest bakelite, with nickel silver springs and pure silver contacts. With terminals. Jack No. 3, 2/6; others from 2/- to 3/-; Jack Switch No. 9, 4/-; others from 2/9.

Lotus Jack Plug. Spring sleeve fitment supplied. Can be used with any Jack. Bakelite mouldings, nickel-plated brass parts. Price 2/-.

Lotus Coil Holder. 2-way, for outside panel mounting, 7/-; 3-way, 10/6; for inside baseboard mounting, with 6-in. handle, 8/-; 3-way, 12/6.

GARNETT, WHITELEY & CO., LTD.,
Broadgreen Road - LIVERPOOL.

THE POPULAR ONE-VALVE AMPLIFIER.

(Continued from page 22.)

portion of the total resistance in circuit for 2-volt valves, say, approximately 1 ohm. For 6-volters about 4 ohms will be necessary, or roughly one-half of a 7-ohm winding. Only use one H.T. lead, because if H.T. — is joined to L.T. + in the set the L.T. battery will be short-circuited. Therefore, leave the H.T. — terminal on the set blank, unless you intend to use two separate H.T. batteries.

Note.—The list of components on the first page indicates the parts actually used in the set. It is, of course, understood that components of any good standard make can be chosen throughout. For example, in the case of the valve-holder the following good alternative makes are available, Ashley, Benjamin, Bowyer-Lowe, Burndept, Burne-Jones, Lotus, Pye, W.B. For the fixed condenser, the usual range of Clarke, Dubilier, Lissen, Mullard, T.C.C., etc., are available, and so on.

POINT-TO-POINT CONNECTIONS.

- Join L.T.+ to one side of filament "on-off" switch.
- Other side of filament switch to moving arm of baseboard resistor.
- Other side of baseboard resistor to one filament terminal on valve holder.
- Join L.T.— to H.T.— and to remaining filament terminal on valve holder.
- Join top "input" terminal to terminal 6 on L.F. transformer, and to one side of .0005 condenser.
- Join other "input" terminal to remaining side of .0005 condenser and to terminal 3 on transformer.
- Join terminals 1 and 2 together. Connect terminal 5 to one side of volume control, and terminal 4 to other side of volume control.
- Connect centre terminal on volume control to G of valve holder.
- Join H.T.+ to L.S.+ and L.S.— to P on valve holder.
- Join flexible lead for G.B.+ to L.T.—.
- Join other flexible lead for G.B.— to terminal 5 on L.F. transformer.

DO YOU KNOW THAT—?

Eight motor-cars, with portable sets, are maintained by the Canadian Government, to investigate cases of interference with broadcasting caused by power, lighting, or other electrical apparatus.

A gang of thieves in Berlin were recently tracked down

down the offenders and discovered accidentally that the apparatus had been stolen.

The best-equipped radio hospital in the world is at Miami Beach, Florida. Every patient has a complete radio set for himself with a separate aerial, so that he may tune in any programme he pleases instead of listening to the same programme as the other patients, as in most hospitals.

According to reports from Russia there are now fifty-six broadcasting stations in the Soviet territories, five being situated in Leningrad and nine in Moscow.

Dr. J. A. Fleming, of University College, London, took out the original patent for the thermionic valve detector on November 16th, 1904.

New Zealand is reputed to be the long-distance listener's paradise. Owing to the extraordinarily good conditions, a New Zealand listener has been able in one day to re-broadcast Holland in the morning, listen to W G Y Schenectady for two hours in the afternoon, and finish by tuning in the Tokio, Japan, programme on the loud speaker for an hour in the evening.

The Irish Free State issues free receiving licences to blind persons.

To enable them to film outdoor scenes in which many actors are concerned, the Paramount Famous-Lasky Corporation has been licensed to operate a portable radio telephony transmitter in California. By this means the director of the picture will be able to communicate with actors beyond the range of his megaphone.

Unlike most modern broadcasting stations

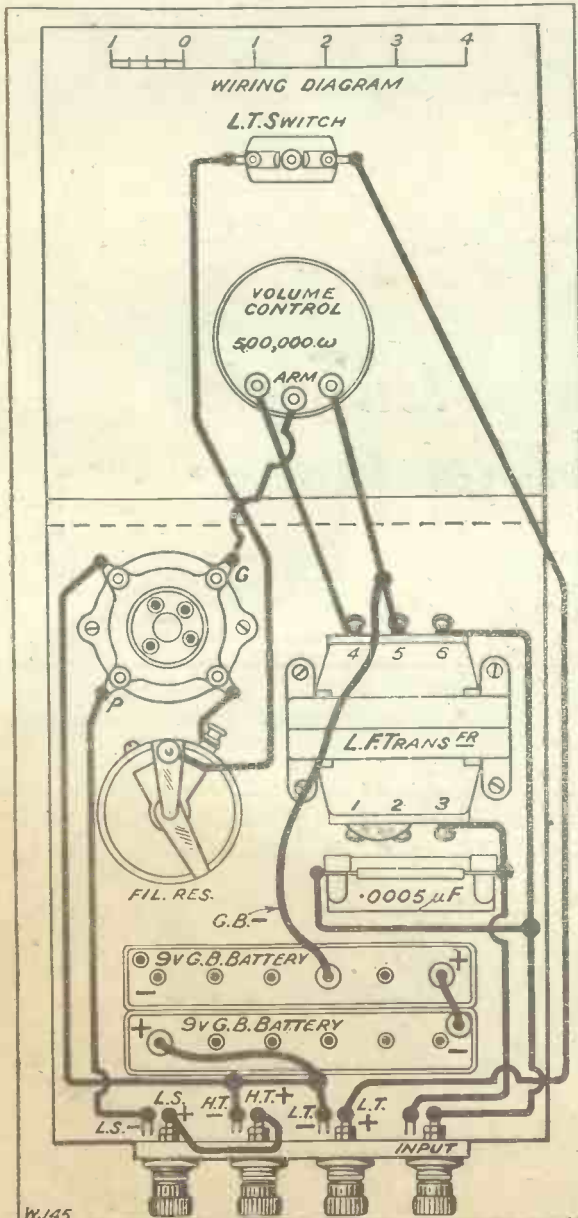

In its American style of cabinet the little amplifier makes an attractive addition to any modern receiving set equipment.

by the police as a result of a wireless set which they had stolen being unskillfully handled and allowed to oscillate, thus spoiling the programmes of a detective who lived near! He tracked

the new Copenhagen transmitter has not been placed in a country site, but is erected in the centre of the city.

Microphones are being installed in the Danish Houses of Parliament so that the speeches can be broadcast,

RECEPTION OF KALUNDBORG.

The Editor, POPULAR WIRELESS.
Dear Sir,—I see in this week's issue of POPULAR WIRELESS that you have not received many reports of reception of Kalundborg in this country, and am therefore sending you the following in the hope that it may be of some interest to you.

I can receive the above station any evening at sufficient strength (loud speaker) for a medium-sized room, in fact, at certain times I have to detune slightly in order that the volume shall not become uncomfortable.

My set is a straightforward three-valver, Det. and 2 L.F. (transformer coupled), and being now over two years old, would probably cause some of the present-day experts (R.C.C., etc.) to turn up their noses in contempt. However, I have built some, and heard most, of the up-to-date receivers and cannot yet find anything to touch the above for either volume, range, or purity of tone.

I can get from 28 to 30 stations on the loud speaker, including, on the long waves, Hilversum, Radio-Paris, Daventry, Kalundborg, Zeesen, and Motala, and on the broadcast band such distant ones as Vienna, Prague, Breslau, San Sebastian and Barcelona. Not so bad for an old-fashioned set. Also, on the only occasion on which I sat up for America, I received Schenectady, New York, at splendid headphone strength.

My aerial is quite an ordinary one, single wire, 60 ft. long, 31 ft. high at free end and 24 ft. at lead-in end, while the valves are all Mullard, 2-volts.

May I also say how much I have enjoyed your recent sarcasm at the expense of Chamber Music and Symphony Concerts. The programmes contain a disgusting amount of this heavy, depressing, absent-minded sort of stuff.

By the way, what about asking the Technical Staff to give us some more short-wave circuits? I have now got practically all I want on the longer waves, and having built the "Sydney" Two, am looking for some more short-wavers to try my hand on.

Wishing you and "P.W." every success, I am,
Yours faithfully,
HORACE L. CLARKE.

Wolverhampton, Staffs.

The Editor, POPULAR WIRELESS.

Dear Sir,—You ask for reports of reception of Kalundborg.

It is one of my best quality and most reliable stations.

I have two sets of my own design and construction, four- and six-valvers: on the former Kalundborg gives good loud-speaker results after dark, fair in daylight. On the six-valver first-class loud-speaker

CORRESPONDENCE.

RECEPTION OF KALUNDBORG

BOMBAY AT L.S. STRENGTH—THE COLOMBO STATION.

Letters from readers discussing interesting and topical wireless events, or recording unusual experiences, are always welcomed; but it must be clearly understood that the publication of such does in no way indicate that we associate ourselves with the views expressed by our correspondents, and we cannot accept any responsibility for information given.—EDITOR.

results all day and requires a "Losser" in A.T. circuit at night.

Hilversum I get better quality than Daventry, which is supposed to be our best station.

I wonder if the B.H.C. realise that a regional station on the lower broadcast band will be utterly useless on the South Coast owing to terrific spark interference? There must be a million inhabitants there bound to the long waves.

Yours faithfully,
WM. A. LUCAS.

Hastings.

BOMBAY AT L.S. STRENGTH.

The Editor, POPULAR WIRELESS.

Dear Sir,—My attention has been drawn to the Indian note published in your issue of January 7th, 1928, on page 946. It appears that the writer of the note doubts my statement which appeared in the report of my interview by the "Broadcaster" that the Colombo station is received in "Bombay at loud-speaker strength on a five-valve set."

I have to say that my statement is absolutely correct, and it is not my own experience but the experience of several hundreds of other set owners who have received Colombo on loud-speaker strength on five-valve sets, and very often on a four-valve set also. If my statement has been properly read by the writer of the note in your magazine, he would

have noticed that it was in reply to a question about the reception conditions in India that I gave this fact as an illustration.

The reception conditions in India are sometimes so favourable that even on a two-valve set very often stations as far away as 1,000 to 1,200 miles have been heard at phone strength. That is to say, recently my own experience on a two-valve Bower-Lowe Short-Wave receiver which was adapted to receive broadcast band reception on a home-made coil was interesting.

As you know, this set is not designed for medium wave-length reception, and still it received in Bombay Calcutta programmes on two valves. You may be aware that the Calcutta station is of 3 kw. and the distance between Bombay and Calcutta is nearly 1,200 miles. Of course, this is an exceptional instance, but there are several instances on record that on a three-valve set Calcutta and Colombo have been received at phone strength.

Hoping the above may be of interest to you.

Yours faithfully,
for Bombay Radio Co., Ltd.,
ABDULLA FAZALBHOY,
Managing Director.

Bombay, India.

THE COLOMBO STATION.

The Editor, POPULAR WIRELESS.

Dear Sir,—With reference to page 946 of your issue of 7th instant, under subheading "Indian Note" the particulars given regarding the Colombo Wireless Broadcasting Station are not quite correct.

The official power of the transmitter is 1.75 kw. and crystal range at least 25 miles round Colombo.

The Colombo Broadcasting service is an excellent one and developing steadily among a people who are entirely unaccustomed even to the idea of broadcasting.

With regard to your surprise at Colombo being heard in Bombay on five valves, it may be interesting to you to know that in Colombo, Bombay can be heard well at strong telephone strength on a single valve set of a certain design, and also on a two-valve (det. and 1 L.F.) short-wave receiver of Simmonds' design with suitable coils. The distance is 900 miles (approx.) from Colombo.

Calcutta, on the other hand (1,200 miles away), is not a success from Colombo on these sets, probably due to hill screening. It is, of course, easily heard on multi-valve sets further inland to the east.

Yours faithfully,
J. S. DINWIDDIE,
Member of Committee,
Ceylon Amateur Radio Society.

Colombo, Ceylon.

Build your set on a solid Burndept foundation —

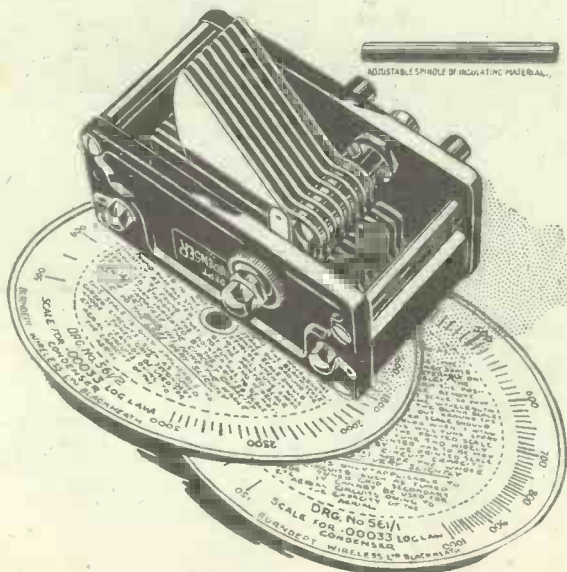

BURNDEPT VARIABLE CONDENSERS.

Each supplied with insulated spindle and metal earth shield to eliminate hand-capacity, but without dial or knob.
Log-Law Condensers: '0003 mfd., 15/-; '0005 mfd., 15/6.
Set of 8 printed wave-length scales (150-3000 metres) 1/6.
Square-Law Condensers: '00007 mfd., 13/6. '0005 mfd., 13/6.

JUST as the cobbler says "There's nothing like leather," so the wireless constructor of experience says "There's nothing like Burndept!" Whatever type of receiver you make, build with Burndept Components and more than half the task of getting good results is over. Your local radio dealer will tell you so, too. Have you seen the new Burndept Variable Condensers? Put them in your set and you will secure easier tuning, freedom from "hand-capacity," and improved signal strength. These condensers are used in the latest Burndept Receivers and in certain Admiralty sets. Let us send you the Burndept Catalogue—it will give you plenty of ideas.

BURNDEPT

Components

Offices: Blackheath, London, S.E.3.
London Showrooms: Bedford Street, Strand, W.C.2.

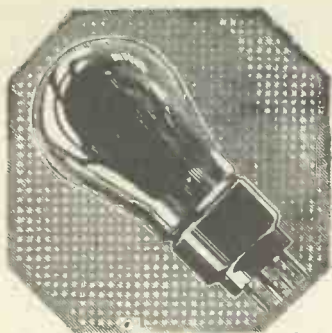

Not a subtle difference but a great change

When you change over to B.T.H. Nickel Filament Valves—as you are bound to do, now or later—you won't have to listen carefully for the promised improvement. It will be immediately and obviously apparent.

These remarkable new valves have a greater emission than other 2-volt valves of corresponding types, and they give a greater volume and better quality of reproduction. Moreover, they give these results for a longer period than other valves.

You owe it to your set to equip it with B.T.H. Nickel Filament Valves.

B. 210 H R.C. and H.F.	B. 210 L General Purpose	B. 215 P Power
Fil. Volts . . . 2	Fil. Volts . . . 2	Fil. Volts . . . 2
Fil. Amps . 0.10	Fil. Amps . 0.10	Fil. Amps . 0.15
Max H.T.V. 150	Max H.T.V. 120	Max H.T.V. 120
10s. 6d.	10s. 6d.	12s. 6d.

The above prices are applicable in Gr. Britain and N. Ireland only.

B.T.H. NICKEL FILAMENT VALVES

B.T.H. NICKEL FILAMENT VALVES



NICKEL FILAMENT VALVES

Made at Rugby in the Mazda Lamp Works

The British Thomson-Houston Co. Ltd

2905



LET ME BE YOUR FATHER.

I have acted as father and adviser to thousands of others. I give advice free, and when I do so I feel the responsibility of a father, either in advising a career or in guiding our students to success. Having been the self-constituted father and adviser to thousands of others, it is possible I may be able to help you and guide your footsteps so that you may make a success of your life.

Thousands of people think they are in a rut simply because they cannot see the way to progress. This applies particularly to Clerks, Book-keepers, Engineers, Electricians, Builders, Joiners, etc. They do not realise that in these particular departments the demand for the well trained exceeds the supply, also they do not realise that about 1s. per week will pay for all necessary books and tuition, and that by studying in spare time they can qualify for the higher and better paid positions. In Technical trades and in the professions employers are frequently asking us if we can put them in touch with well trained men. Of course, we never act as an employment agency, but it shows us where the shortage is. In nearly every trade or profession there is some qualifying examination, some hall-mark of efficiency. If you have any desire to make progress, to make a success of your career, my advice is free; simply tell me your age, your employment and what you are interested in, and I will advise you free of charge. If you do not wish to take that advice, you are under no obligation whatever. We teach all the professions and trades by post in all parts of the world, and specialise in preparation for the examinations. Our fees are payable monthly. Write to me privately at this address, The Bennett College, Dept. 106, Sheffield.

J.W. Bennett

F.R.S.A., M.I.Mar.E.,
A. I. Struct.E., M.B.I.P.S., etc.,

Governor of

THE BENNETT COLLEGE, Ltd., SHEFFIELD.

NOTE. We have special courses on all the following subjects, and we can combine courses to meet all requirements.

COMMERCIAL	INSURANCE—Con.	TECHNICAL—Con.
Accountancy	Motor, Fire, Life,	Matriculation
Advert. Writing	Marine,	Metallurgy
Salesmanship	Employers' Liability.	Motor Engineering
Army Certific. Courses	TECHNICAL	Naval Architecture
Auctioneering and Estate	Teacher of Handicrafts	Pattern Making
Auditing [Agency]	Applied Mechanics	Post Office Examinations
Banking	Architectural Drawing	Quantity Surveying
Book-keeping	Building Construction	Road Making
Civil Service	Clerk of Works' Duties	& Maintenance
College of Preceptors	Boiler Engineering	Sanitation, Shipbuilding
Commercial Arithmetic	Boiler Making	Structural Engineering
Commercial Law	Chemistry	Surveying and Levelling
Company Law	Civil Engineering	Surveyors of Works, R.E.
Costing. Economics	Concrete and Steel	Telegraphy & Telephony
English and French	Draughtsmanship	Town Planning
Executorship Law	Electrical Engineering	Wireless Telegraphy
Foreign Exchange	Practical Mechanical	Works Managers' Course
General Education	Engineering	MINING.
Modern Business Methods	Engineering Costing,	Fireman's Exam.
Police Entrance and	Quantities and	2nd Class Mine Manager
Promotion Courses	Specifications	1st Class Mine Manager
Secretaryship	Foundry Work	H.M. Inspector
Workshop Organisation	Heat Engines	Mining Elect. Engineer
INSURANCE	Internal Combustion	A.M.E.E.
Exams. for Agents and	Engines	Mining Mech. Engineer
Officials F.C.I.T.	Marine Eng. B.O.T.	Mine Surveyor
	Mathematics	

1930 CIRCUIT in 1928!!!

"P.P.V." Forges Ahead with the "1930/Three."

THE "1930/THREE," the simplest 3-valve "P.P.V." circuit, yet gives power of average 5-valve set. Just two fixed home-made basket coils, and a dozen connections, bring these reports: "Sit in my chair and hear America on speaker in comfort." "Receives 34 stations on speaker." "Eleven loud-speaker stations on indoor aerial in London." "Receives Glasgow on speaker in London." "Berlin far too loud for comfort"—and hundreds of others. The "1930/THREE," best 3-valver by "P.P.V." Designed by B. Bartram exclusively for "P.P.V." The simple, absolutely selective "build-it-in-two-hours" circuit. Just ordinary parts, obtainable anywhere. Blue prints, full size, copious instructions. Price 3/- (Royalty included). Send P.O. for 3/-, or send for further particulars, also lists of "P.P.V." circuits advertised in "P.W." since 1924. Write, wire, phone or call for lists and a bagful of wireless literature.

PRESS EXCLUSIVES. (Friends of a million amateurs.)
29, PATERNOSTER ROW, LONDON, E.C.4.



APPARATUS TESTED

TWO GECOPHONE ACCESSORIES—RIPAULTS H.T. DRY BATTERY—DIONOID ACCUMULATORS—THE STEWART-WARNER REPRODUCER.

operate a moving-coil loud speaker with complete faithfulness.

Quite recently the G.E.C. people sent us one of their B.C.1660 new type gramophone pick-ups. It is a neat little piece of gear and with its bright aluminium and steel has a very business-like appearance. It appears to be moderately light on records.

New "Modern Wireless" Feature.

With a moderately heavy needle (half-tone) there is a very little chatter and the damping appears to be thorough. Nevertheless, it gives a very bright reproduction and faithfully follows all variations from the highest to the lowest notes. It feeds into the set an input much better than the average set and loud speaker is capable of handling.

To appreciate its real efficiency one requires to employ a first-class outfit, including a moving-coil loud speaker. Nevertheless, with a device such as this you would be able to operate your set with results equal in every respect, and perhaps even better than, the broadcast reception. And, by the way, if you desire to learn something about "Radio and the Gramophone" and its advantages, and obtain practical hints and tips, we would advise you to read the new section starting in MODERN WIRELESS dealing with this modern and interesting subject.

We have also had a Gecophone cabinet cone loud speaker on test. It is a handsome instrument. A special feature is the deep and rigid cone, and this probably contributes in no small measure to the good results the loud speaker gives. It handles

(Continued on page 39.)

Traders and manufacturers are invited to submit wireless sets and components to the "P.W." Technical Department for test. All tests are carried out with strict impartiality in the "P.W." testing-room, under the supervision of the Technical Editor, and the general reader is asked to note that this weekly article is also intended to provide a reliable and unbiased guide as to what to buy and what to avoid.—EDITOR.

TWO GECOPHONE ACCESSORIES.

THE attractive feature of an alliance of the radio-set with the gramophone is that however old-fashioned the latter may be it can be made to give results equal to the most expensive modern instrument. All the gramophone has to do is to provide a turntable which will rotate at certain definite speeds. The rest of the work is left to the radio outfit and to that important link, the "pick-up."

Providing your set has two stages of low-frequency amplification it can be linked to a gramophone. The pick-up replaces the sound box on the tone arm of the gramophone, and the two leads which come away from it are joined across the grid and filament of the detector valve. This, broadly speaking, is all that has to be done, although refinements, such as transformers, pitch controls, and so on, can be introduced by the more advanced amateur if he requires to

MARCONIPHONE FOR MODERN L.F. AMPLIFICATION

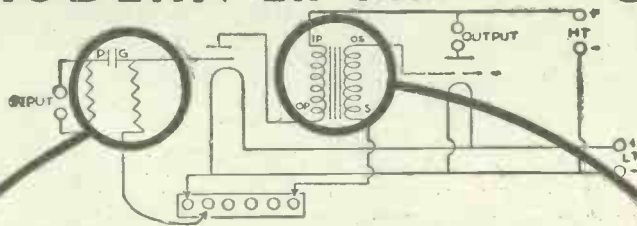

Marconiphone Amplifying Devices build up whispers into voluminous sound, yet never do they sacrifice tone purity for the sake of volume—harshness and distortion have no place in a receiver built from Marconiphone components—especially if Marconi Valves are used.

For the first L.F. stage use one of the new Marconiphone R.C. Units. Remarkably compact, they maintain their stated value under all conditions with absolute silence. There are two types: Type "A" for valves of medium impedance, 8s. Type "B" for high magnification valves, 7s. 3d.

Follow this with the famous "Marconiphone" Ideal Transformer—proved distortionless throughout the musical scale and guaranteed against electrical and mechanical defects for twelve months in ratios 2.7 to 1, 4 to 1, 6 to 1, 8 to 1, 25s. each.

Send for Publication 453 giving full particulars of all Marconiphone Wireless Apparatus, mentioning "Popular Wireless."

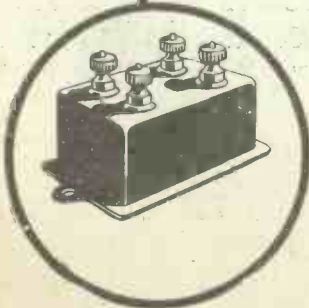

THE MARCONIPHONE CO., LTD. (Dept. P), 210-212, Tottenham Court Road, W.1.

£300 A YEAR FOR YOUR SPARE TIME!

Wonderful New Invention YOU can Make and Sell under My Patent!

REALLY, genuinely, you can make at home and in your spare time a sum of extra money up to £300 per year. The work is of fascinating interest. It will open up to you new ideas, new vistas of money-making; provide many of those luxuries and necessities which you have so long wished for, and give you occupation just at those hours



fringement or interference with your market. Only one person in 50,000 of the population is allowed to manufacture under my Royal Letters Patent, in order to ensure unrestricted marketing. Let me hear from you NOW before somebody else is granted the licence and the extra income that can so easily become yours.

Simply forward the coupon below and, by

when time is apt to hang heavily on the hands. Others are doing this by

working my enormously successful patents. Why not you? It costs you nothing to write for full particulars, and you can then see for yourself exactly what you can do.

My patents are in very great demand in the field of wireless and electricity—so much so that

I GUARANTEE your profits, and further guarantee to protect you against any in-

IN THE COMFORT OF YOUR OWN HOME YOU CAN DOUBLE YOUR INCOME. The work is a delight. You can keep at it just as long as you like each day or week. No "plant" or machinery is needed. A spare-room or even the kitchen table can serve as your profit-making "factory"—and the children can help too!

return of post, I will send you every particular with which you may wish to be acquainted. It is those who

seize opportunities who succeed. Take this opportunity NOW.

"MAKE-MONEY-AT-HOME" COUPON.

To THE ENGLAND-RICHARDS CO., 115, King's Lynn, Norfolk.

Sirs,—Please send me at once, and FREE, full details as to how I can Make Money at Home in my spare time. I enclose 2d. stamp for postage.

Print your name and address boldly in capital letters on a plain sheet of paper and pin this coupon to it.

Popular Wireless, March 3rd, 1928



THE lights are dimmed, the fire is glowing red, and the cat is curled up on the rug before it. You lie back in your fatherly old chair, pipe between your teeth, to be thrilled for an hour by the music of your Brown Loud Speaker.

What more would ye, my Masters?

This Brown H.3. Loud Speaker is as much a stickler for the truth as are the more expensive Brown instruments. Yet it only costs 60/-.

Brown H 3 LOUD SPEAKER

Stocked by all good Dealers and made by S. G. Brown, Ltd., Western Ave., N. Acton, London, W.3.

LOEWE RADIO

The Famous

LOEWE High Vacuum Resistances
LOEWE and High Vacuum Block Condensers

LOEWE RADIO

Should be installed in every wireless receiving set.

They are

- Free from atmospheric influences.
- Moisture and dust proof.
- Free from losses.
- Fully guaranteed.

Delivery from stock.

Ask for illustrated leaflet.

LOEWE RADIO COMPANY LIMITED.,

4, Fountayne Road,
Tottenham, London, N.15.

Telephone: Tottenham 2076.



All Editorial Communications to be addressed to The Editor, POPULAR WIRELESS, The Fleetway House, Farringdon Street, London, E.C.4.

The Editor will be pleased to consider articles and photographs, dealing with all subjects appertaining to wireless work. The Editor cannot accept responsibility for manuscripts and photos. Every care will be taken to return MSS. not accepted for publication. A stamped and addressed envelope must be sent with every article. All inquiries concerning advertising rates, etc., to be addressed to the Sole Agents, Messrs. John H. Eile, Ltd., 4, Ludgate Circus, London, E.C.4.

The constructional articles which appear from time to time in this journal are the outcome of research and experimental work, carried out with a view to improving the technique of wireless receivers. As much of the information given in the columns of this paper concerns the most recent developments in the radio world, some of the arrangements and specialities described may be the subject of Letters Patent, and the amateur and the trader would be well advised to obtain permission of the patentees to use the patents before doing so.

QUESTIONS AND ANSWERS.

A TUNING "PUZZLE."

A. L. (Westhoughton, nr. Bolton, Lancs.).—
"May I join my congratulations to other readers on the capabilities of the 'Sydney' Two? Every night for a month I have been able to listen to K D K A from 11 p.m., sometimes as loud and clear as the local station 15 miles off.

"One thing has puzzled me, and that is the position of the earth clip, and I am sure other users have been likewise at a loss. I have never been able to tune in anything lower than 40 metres, not a whisper of 2 X A D or 2 X A F. Looking at the coil from the front I receive K D K A with A clip on the fifth turn from the left, G clip on last turn, and earth clip on the extreme right. I am sure other users of the 'Sydney' Two would welcome enlightenment on the point.

"I have also a three-valve Unidyne which I would not change for all the super, and ultra sets ever issued.

"List of stations I log on any good night on the loud speaker, using one-valve Unidyne and 2 L.F.: Manchester, Dublin, Liverpool, Milan, Prague, Frankfort, Toulouse, Langenberg, Vienna, Brussels, Radio-Paris, Huizen, Hilversum, Koenigwusterhausen, Kalundborg, Breslau, Hamburg, Stuttgart, also Mersey clockboard lightships."

We do not quite understand your difficulty with the 'Sydney' Two, A.L., unless it is that you have not read the instructions in the article properly, and you are not varying the positions of all the clips correctly. You say that you have picked up K D K A any old night from 11 p.m. onwards at good strength, but have never received a whisper from 2 X A D or 2 X A F.

As a matter of fact, 2 X A D and 2 X A F have been coming over not only as well as K D K A but considerably better, and it would appear, therefore, that the reason you have not received them is that you are not tuning properly. If the earth clip is placed on the extreme right of the coil the wave-length to which the set will tune is chiefly determined by whether the grid clip G is on the last turn of the coil or is put at some intermediate point between the two.

If you are keeping it on the last turn you will not tune down much below 40 metres, because even with the condenser all out the inductance which you have in circuit is sufficient to cover that wave-length. But move the G clip down towards the earth clip and immediately in effect you have a smaller tuning coil, consequently you tune down lower and the stations previously outside your tuning range will come romping in.

(Continued on page 32.)

The CHLORIDE ELECTRICAL STORAGE CO., LTD.,

have such keen appreciation of the efficiency and reliability of

CLIX

FITMENTS

THAT THEY RECOMMEND
"CLIX" PARALLEL PLUGS
exclusively for use with their famous
EXIDE BATTERIES

Look for the
"CLIX" COUNTER SHOWCASE
at your dealers.

It contains the famous "CLIX" fitments—everything you need to ensure simple, safe connection. You can equip your set with "CLIX" for a few pence and save the possibility of endless trouble through faulty contacts.

LECTRO LINX LIMITED
254, Vauxhall Bridge Road, S.W.1.
Telephone: Victoria 5120. Telegrams: "Trolinx Churlon."

Sterling

MANSBRIDGE TYPE CONDENSERS

In Sterling Condensers unquestionable quality and reliability are bought at an extremely low price. In a Sterling Mansbridge Type Condenser the dielectric is protected against dielectric breakdown, is tested to 300 volts and enclosed in a strong metal case. For trouble free condenser efficiency under all conditions, specify "Sterling."

THE MARCONIPHONE COMPANY, LTD.
(Dept. P.), 210-212, Tottenham Court Road, W.1.

Capacity.	Price.
	s. d. s. d.
.01 mfd.	1 9
.05 mfd.	1 9
1 mfd.	1 10
2 mfd. 2 3	
25 mfd. 2 3	
3 mfd. 2 3	
4 mfd. 2 7	

Capacity.	Price.
	s. d.
5 mfd.	2 7
1 mfd.	2 10
2 mfd.	2 10
4 mfd.	7 6
6 mfd.	11 6
10 mfd.	18 0

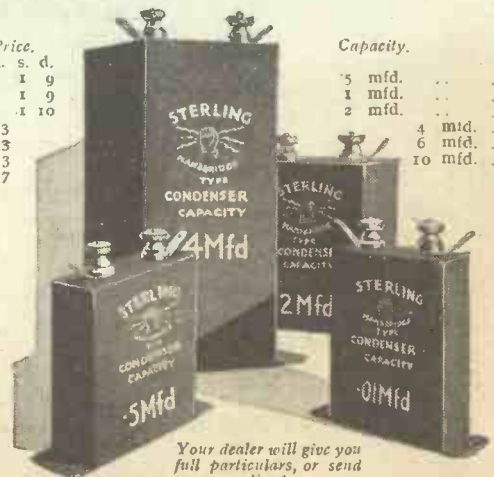

Your dealer will give you full particulars, or send direct.

Lewcos Coils for all modern circuits

We are now making coils for the **MASTER THREE.** Details upon request

- Supplied in the following types:
- Split Primary Transformer.
 - Split Secondary Transformers.
 - Reinartz Transformer.
 - Split Secondary Tapped Primary.
 - Aerial Coil.



Patent No. 277876.

Binocular Coils are the latest Lewcos development in six-pin Coils. They are interchangeable with the popular types and can be used in a standard Lewcos Screen, although for use in multi-stage receivers they are sufficiently fieldless without screening. All dealers can obtain them for you. Full particulars and prices gladly sent on request.

THE LONDON ELECTRIC WIRE CO. & SMITHS LTD.
Playhouse Yard, Golden Lane, London, E.C.1.

LEWCOS Binocular Coils

GIGANTIC SUCCESS OF THE REDUCED PRICES P.R. VALVES FINEST LONDON MADE L.F., H.F., R.C. & DETECTOR IN 2 & 4 VOLTS NOW ONLY OLD PRICE 8/6 3/6

TRADE ENQUIRIES INVITED.

P.R. SUPER DULL Emitter VALVES challenge comparison with ANY OTHER VALVE ON THE MARKET. Don't imagine for one moment that they are rubbish—such as bankrupt stocks or foreign valves. On the contrary, they are the latest product of one of the finest equipped factories in London. Years of experiment and research are behind every P.R. VALVE, and before leaving the Works every valve passes the most exhaustive tests. Experimenters can have every confidence in P.R. VALVES. It was only by the lucky discovery of new elements and new methods of manufacture that the P.R. VALVE at 3/6 became an established fact. Hitherto, it had been sold at 8/6. THE NEW PRICE BRINGS A GOOD VALVE WITHIN THE REACH OF EVERYBODY.

Tell us what your circuit is. We can help you to select the right valves. Remember that R.C. Valves require at least 110 volts and can take more with advantage.



THEY WILL SAVE YOU POUNDS. NO BETTER CAN BE BOUGHT ANYWHERE.

THE WORLD'S BEST VALVE. THE WORLD'S BEST VALUE.

Type	Fil. Vts.	Fil. Amp.	Imp. Ohms.	Amp. Fac.	M/C
P.R.1	2	.06	35,000	15	.4
P.R.2	2	.06	25,000	12	.3
P.R.3	2	.06	18,000	8	.44
P.R.4	2	.06	120,000	40	.33
P.R.5	2	.15	40,000	20	.5
P.R.6	2	.15	30,000	15	.5
P.R.7	2	.15	12,000	6	.5
P.R.8	4	.06	23,000	15	.65
P.R.9	4	.06	19,000	9.5	.5
P.R.10	4	.06	11,000	6	.55
P.R.11	4	.06	120,000	40	.33
Power Valves	2V	.20	6,000	5	.82
	4V	.15	4,000	4	1.0

3/6

Post and Packing 3d.
2 Valves for 6/9 Post and Packing 6d.
3 Valves for 10/- Post and Packing 6d.
4 Valves for 13/- Post and Packing 9d.
THEY CAN'T BE BEATEN

Phone your order: CITY 3112. Pay the Postman C.O.D. WRITE, 'PHONE or CALL.

Sets of Valves made up to any requirements. MATCHED VALVES for intermediate stages specially selected 1/- per set extra.

OUR GUARANTEE

All valves despatched by return of post under guarantee of Money Back in Full if not satisfied. All valves are carefully packed and breakages replaced.

P.R. VALVES

Dept. 24, 29, PATERNOSTER ROW, LONDON, E.C.4.



Price from 2/6



5 Capacity ranges, and each in Baseboard and Panel models. 22 CRICKLEWOOD LANE, N.W.2 'Phone: Hampstead 1787

FORMO-DENSER

A sound variable condenser which fits a long-felt want. Specially designed to take the place of the hitherto generally used Fixed Condenser. For use as:

- Neutralising Condenser
- Aerial Condenser
- Grid Condenser
- Reaction Condenser
- Phasing Condenser
- Tone Control Condenser

BUY FORMO HANDBOOK. Practical Circuits Blueprints of two sets, etc., 1/-

RADIOTORIAL QUESTIONS AND ANSWERS

(Continued from page 30.)

Remember that the amount of coil in use is the amount between the earth clip and the G clip, so that the nearer these two are together the lower is the wave-length to which the set will tune. (Thanks for your report upon the reception with your Unidyne receiver. It is certainly extremely good, for regular results.)

AN ADAPTABLE CRYSTAL SET.

R. H. W. (Leeds).—"Can I have a crystal set that I can experiment with? I should like to try loose coupling and all sorts of different circuits, but I can't keep building new sets all the time, so I want one I can change over and try different circuits with. (But crystal, not a valve, because here in LS (Leeds), £ s. d. is scarce.)"

Just the set for your purpose is described in the March issue of "Modern Wireless." It is called the "Centurion" Crystal Set, because there must be about one hundred ways of connecting it up. Very cheap to build, too!

TUNING THE "PROGRESSIVE" TWO.

W. W. M. (Sunbury, Middlesex).—"Since writing you last I have completed the 'Progressive' Two, and after some little trouble have got it to work fairly well.

"Am using a 60 Lewcos centre-tapped coil, two P.M.5X valves with 40 volts H.T. I find that using the second tapping from the bottom of the coil, as you suggest, I can hear practically nothing; the fourth seems to be best. Have tuned in about 20 stations and they all come in on the top half of the tuning condenser dial (Ormond S.L.F.), e.g.:

Station	Reading
5 GB	177
2 LO	147
Dublin	132
Not identified	92

"Also, the A.T.C. comes down to zero for best signals at about 120 on the tuning condenser, after that it seems to be no further use.

"Should I be satisfied with this, or do you think a change in the aerial coil would improve matters?"

"Aerial is a good 100 feet long and about 29 feet high."

Although you have succeeded in tuning in about twenty stations the set is very heavily handicapped because the two tuned circuits are now "out of step." Instead of the A.T.C. being set to zero when the other condenser is set to 120, both dials should read the same, or about the same. At present your two condensers are right out of step, and we should certainly not be satisfied with this state of affairs.

Near the end of your letter you say the "aerial is a good one hundred feet long," and that, W. W. M., is where you have "missed the boat." By having an extra long aerial you have in effect mistuned the circuit and, consequently, you should either shorten your aerial or use a much smaller aerial coil. As a matter of fact, we should be inclined to do both; that is to say, we should first of all shorten the aerial to a maximum of about 70 feet, including the lead-in, and then try also the effect of a smaller aerial coil.

You will find that the tuning of the H.F. circuit will be unaltered, but the aerial-tuning-condenser will now read an approximately equal number of degrees. Consequently, both condensers will be set near the top of their readings for 5 GB, both will be round about 132 for Dublin, and below that the aerial tuning will be just as critical as that of the other condenser. When both circuits are tuned correctly the stations will come tumbling in on the lower half as well as on the upper half of the scale. If it is not convenient to shorten your aerial or reduce the aerial coil as suggested, you can do it electrically by means of a series condenser. Get one of the little '00025 mfd. variable condensers, as used in the "P.W." Standardised Wave-trap, and set it nearly "all out," after which it will not require readjustment. (You will find the best setting for it very easily in practice.)

RADIO AND THE GRAMOPHONE.

"COLUMBIA" (Cheltenham, Glos).—"This working a loud speaker by gramophone is just the thing I have been looking for. Where can I get details of a three- or four-valve set on these lines?"

You will find many interesting details about gramophone pick-ups in the March number of "Modern Wireless," now on sale. In this March issue, also, is a full description of "The Radio-Gram" Four, a powerful set suitable for broadcast or gramophone reproduction.

(Continued on page 34.)

WHAT IS WRONG ?

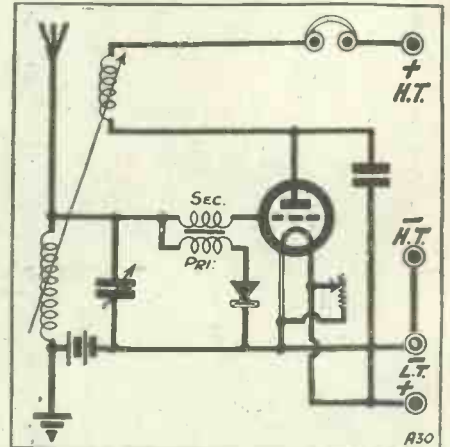

The above diagram is supposed to represent the connections of a one-valve Hale receiver. But it is wrong, and would not work properly.

Next week the correct diagram will be given, and, to test your skill, we shall continue to publish every week a diagram in which a mistake (or mistakes) has been inserted. The correction will be published the following week.

No prizes are offered, but by following this series and trying to solve the problems, week by week, the reader cannot fail to learn a lot about radio circuits.

REFUSE IMITATIONS!



Standard Size panels supplied in three finishes, Black polished, Black Mat, and Grain polished, carefully packed in attractive cartons. Every panel and piece of ebonite guaranteed and made by British hands.

Apply for particulars of our new foot-proof 4 and 6 contact Former with bases ready for winding, directions and fully illustrated booklet, Price 6d.

ORIGINAL PRIZE-WINNING "BECOL" LOW LOSS FORMER, No. 5. 3 inch diam. overall.

Insist on a Beacol Low Loss Former, the Former "with a reputation," incorporated in sets that have taken four first prizes and gold medal, a proof of their superiority. Supplied in cut lengths, 3 in., 4 in., 6 in., packed in cartons, and standard lengths of 3 ft.

Specify



Registered Trade Mark.

products



DIAL CALIBRATION FOR CROSSLEY BAND BOX.

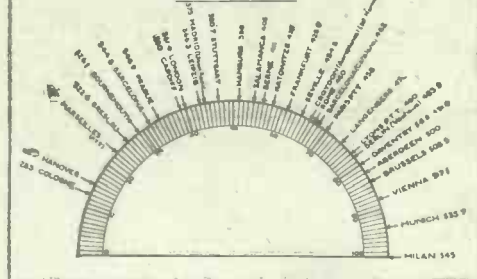

How to get There !!!

Between 20 and 30 Continental towns can be visited each night with a **BAND BOX**

If you would listen to Madrid, Rome, Langenberg, Milan, etc., you can positively do so with one of these truly remarkable six-valve sets. The size is only 17x8x5 1/4 and the cost is £16-16-0 for the set. Demonstrations can be arranged in your own home by appointment. Single knob control and the tuning is simplicity itself.

Write in for Free Booklet.

ONLY A FEW LEFT. AMPLIFEX LOOP AERIAL, the finest loop aerial yet devised, and the best for the reception of European Broadcasting. To clear, 30s.

OUR INTERNATIONAL RADIO CATALOGUE (3rd edition) will be sent to all enthusiasts sending 6d. to cover cost of postage and packing.

WILL DAY, LTD.

(The Best in the West)

19, Lisle Street, Leicester Square, London, W.C.2

Telephone (2 lines): Regent 0921 and 0922.

Telegrams: Titles, Westrand, London.

The "Modern Three"

BUILD THE "MULLARD MASTER THREE" WITH RIDLEY PARTS

2 Terminal Strips, 2 1/2" by 2" by 1/2"	£	s. d.
4 Terminals		Free
1 Coil Base, 6-Pin		0 4
1 .0005 Condenser S.L.F.		1 0
1 .0003 Condenser S.L.F.		3 9
1 H.F. Choke		3 6
3 Valve-holders		4 6
1 Cabinet	1	0 0
1 Pair Brackets		0 8
1 6-Pin Coil, B.B.C.		7 6
1 2 v. Accumulator D.F.G.		8 6
1 P.M. 1 A Valve		10 6
1 P.M. 1 L.F. Valve		10 6
1 P.M. 2 L.F. Valve		12 6
1 100 v. H.T. Battery		8 6
1 Grid Battery		1 0
1 R.C. Unit, Lissen		4 0
1 L.F. Transformer, Lissen		8 6
1 Cond. and Leak, Fixed		2 0
1 Switch, Benjamin		1 0
2 Spade Terminals		0 2
8 Wander Plugs		0 8
1 Panel, 18" by 7" by 4"		2 6
3 Yds. Red and Black Flex		0 5

RIDLEY, RIGHT for RADIO

Everything sold by this House is guaranteed to give entire satisfaction, or money will be refunded in full. This covers you against dissatisfaction. If your requirements are not included below—write giving details. **POSTAGE PAID ON PARCELS VALUE 10/- upwards, below that sum add postage.**

BUILD THE "COSSOR MELODY MAKER" WITH RIDLEY COMPONENTS

2 S.L.F. Variable Condensers, .0005	£	s. d.
2 Slow Motion Dials		8 0
1 .0001 Fixed Condenser		5 6
2 .0003 Fixed Condensers		1 0
1 .002 Fixed Condenser		2 0
1 .001 Fixed Condenser		1 6
1 2-microfarad Condenser		1 0
2 Grid Leak Clips (Lissen)		2 3
1 Grid Leak, 4 megohm (Lissen)		1 0
1 Grid Leak, .25 megohm (Lissen)		1 0
1 Grid Leak, 3 megohm (Lissen)		1 0
3 Valve-holders		3 0
1 Lissen Transformer		3 0
2 Panel Switches		8 6
1 Variable Resistance for B.B. mounting		1 6
9 Terminals		1 0
Connecting wire, insulated		0 9
1 yd. Systoflex Covering		1 3
1 Black Panel, 21 in. by 7 in.		0 3
1 Black Terminal Strip, 21 in. by 1 1/2 in.		3 6
1 Cabinet, 21 in. by 7 in.		1 6
1 210D "Cossor" Valve		10 6
1 210RC "Cossor" Valve		10 6
1 210P "Cossor" Valve		12 6

£5 15 0

£5 0 0

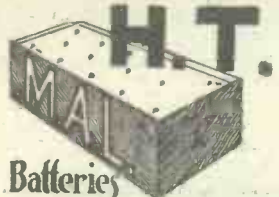

Batteries for your Wireless!
RIDLEY'S price 4/11
60 volts

Postage 6d.
I sell more Batteries than every other Wireless Dealer in the district combined I think, simply because the M.A.L. stands pre-eminent for long life and good service. 60 volts 100 volts 8/6. **4/11**

All well-known makers' parts in stock—state requirements.



DUND'S LOUD SPEAKER
The finest value obtainable, full size, well finished, gives perfect reproduction 25/-. Carriage 1/-.

72-yd. COILS RED AND BLACK FLEX, usually 10/6. My Price, 6/9.
Devicon Variable Condensers, .001, 2/- each.
Catwhiskers, 10 a 1d.
Miniature Ebonite Switches, 9d. each.
4 1/2-volt Flash-Lamp Batteries, 3/6 per doz.
Neutron Crystals, 11d. each.
Hertzite Crystals, 6d. each.
.0002 Devicon Variable Condensers, 3/6.
4-volt Frelat Valves, 3/- each.
4-volt Frelat Power Valves, 3/- each.
Murray Valve-holders, 6d. each.
Antimicrophonic Valve-holders, 10d. each.

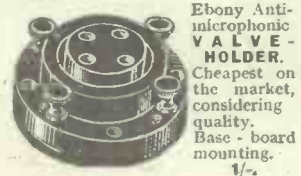

Ebony Anti-microphonic VALVE-HOLDER.
Cheapest on the market, considering quality.
Base-board mounting. 1/-.
Leather Accumulator Carriers, 1/3 each.
Single Circuit Plugs and Jacks combined, 3/-.
H.T. Voltmeters, 0-130, 4/3 each.
Bretwood Var. Grid Leaks, 2/- each.
Cleartron 6-volt Valves, 2/6 each.

30-ohm and 6-ohm Rheostats, 9d. each.
Mans. Fixed Condensers, .5, 6d. each.
.25 Fixed Condensers, .25, 6d. each.

JACKS AND PLUGS
Single Circuit Jack, open, 1/3.
Double Circuit Jack, closed, 1/6.
Filament Jack, Single, 1/9.
Filament Jack, Double, 2/3.
Plugs, 1/6, 2/- and 2/9 each.
S.P.D.T. Switches, 6d.
D.P.D.T. Switches, 9d.
.0005 S.L.F. Condensers, 3/6.
Push-pull Switches, 9d.
Baseboard Rheostats, 11d.
8-in. Panel Brackets, 6d.
Bars Solder, 3d. each.
Fluxite, per tin, 4d.
Back-of-Panel 2-way Coil-holder, geared, 2/6 each.
Valve Windows, 6d. each.
Transfers, per packet, 3d.
Voltmeters, single reading, 2/-.
Hydrometers, 2/- each.
Grid Leaks, 6d. each.
"Sovereign" Coil-holders, 9d. each.
Brown H2 Loud-speakers, shop-soiled, usually 50/- Offered at 35/-
Basket Coil-holders, 9d. each.
China Valve-holders, 4 1/2d. each.
.0003 Condenser and Grid Leak, 2/- each.
Scrap Ebonite, 8 square inches a 1d. (in 5/- parcels only).



ADDITIONAL OFFERS

Electron Aerial Wire, 100-ft. coils, 1/8 each.
Superial Aerial Wire, 100-ft. coils, 2/6 each.
Edison Bell Fixed Condensers, .0001, .0002, .0003, .001, 1/- each.
Benjamin Rheostats, 6 and 30 ohms, 2/9 each. Lissen panel type, 7 and 35 ohms, 2/6 each.
Microstats, baseboard type, 3/- each.
Resistance Capacity Coupling Units, Ediswan, 7/-; Lissen, 4/-; Cosmos (unit only), 8/-; with Valve-holder, 10/-.
Coil Plugs, wedge type, nickel connections, per doz., 4/-.

Coil-holders, Lissen 2-way, 4/6.
Mansbridge Condensers, 1 mfd., 2/6; .2 mfd., 3/6.
Edison Bell Low Loss Coil-holder for baseboard mounting, 1/-.
Benjamin Filament Switch, 1/- each.
Colvern 6-pin Bases, 1/6; Formers, 4/6.
Basket Coil-holders, 9d. each.
Neutralising Condensers, Colvern panel type, 3/6; baseboard, 3/8.
Grid Leak Holders, 6d. each.
Panel Brackets, 6 in. and 9 in., per pair, 9d. and 1/-.
Edison Bell H.F. Chokes, 4/6 each.

CABINETS

10" x 8"	Mahogany, 14/6	Oak, 12/6
16" x 8"	Mahogany, 17/6	Oak, 15/-
21" x 7"	Mahogany, 25/-	Oak, 20/-
18" x 7"	Real Oak, 22/6	

Add 1/- carriage.

CECIL RIDLEY
"RADIO HOUSE," MIDDLESBROUGH
"Phone: 1366 M'bro."

WONDERFUL OFFER OF COSSOR MELODY COILS!
Remarkable value, price **4/6** each.

Insulated Name Terminals, 3d. each.
2-way Geared Coil-holders, long handle, 2/6.
Also back-of-panel 2-way Coil-holders, 2/6.
Croix Transformers, 3/6.
Dunda's Transformers, 5-1, 4/6.

Crocodile Clips, 2d. each.

ASK FOR COMPLETE CATALOGUE POST FREE.

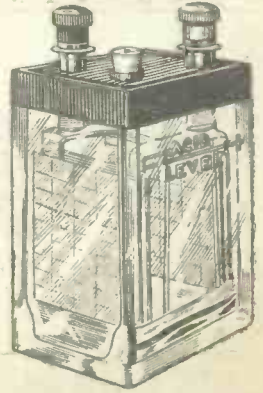

2-VOLT ACCUMULATORS
In enclosed glass cases, large plates, strongly made, 10 hour actual. Price, each **3/6**
Add 6d. postage.

THE IDEAL PATENT FOUR- POLE BALANCE ARMATURE UNIT FOR THE CONE TYPE LOUDSPEAKER

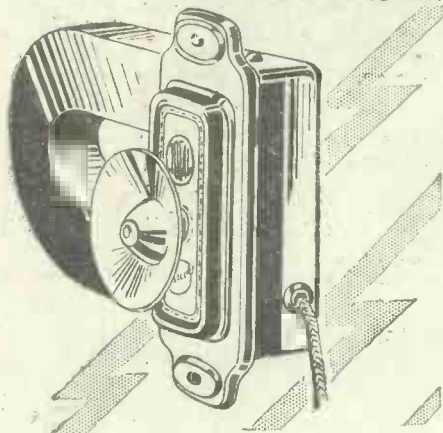

A customer writes us: "It is indeed an 'Ideal' Unit."

It is ideal because the results obtained are perfect. The Unit is of the Patent balanced Armature type, a special steel is used for the magnets; which makes it extremely sensitive. Further, the Armature is carefully damped to cut out all resonances which are liable to distort reception.

The Unit is complete with padded felt washers to receive your own cone.

A wireless critic writes: "At a cost of under 30/- it makes one of the best cone loudspeakers anyone could desire."

Price 25/-

The "Ideal" Blue Spot Cone Loudspeaker (Model No. 44)

at £2:2:0 complete, includes this famous balanced armature unit. It is fitted with a 16-in. free-edge cone which is capable of taking great volume of sound without blurring. It reproduces both the upper and the lower tones with faithfulness, it requires *no adjustment of the driving unit* whatever the power of the volume being used.

Can be supplied in the form of Home Constructor's Kit.

F. A. HUGHES & CO., LTD.,
204-206, Great Portland Street,
London, W.1

Telegrams—"Distancing, Wesdo, London."

Telephone—Muscum 8630 (Three lines).

Manchester Office—185, Princess Street.

Telephone—City 3329.

—so we labelled it

BLUE SPOT

RADIOTORIAL QUESTIONS AND ANSWERS

(Continued from page 32.)

THE LODGE "N" CIRCUIT.

H. J. (Harold Wood, Essex).—"A friend of mine who lives in Cape Town has written to ask where he can get particulars of the famous 'N' circuit invented by Sir Oliver Lodge. He wants full particulars of how to build a two-valve set which is not capable of causing interference with neighbours. And he tells me that this 'N' is the only set of the kind in the world. Can you let me know where I can get an envelope or a book dealing with the constructional details of a set?"

Full particulars for constructing a two-valve Lodge "N" circuit are given on the "P.W." Blue Print No. 21. This can be obtained from the Technical Query Dept. (price 6d., postage extra).

IMPROVING CRYSTAL-SET RECEPTION.

D. A. J. H. (Finchley, N.).—"My little son has been so delighted with the 'Lo-Cost' Crystal Set which we made from the instructions in your paper that I feel I must write to thank you at once. It gives amazingly good reception from London and has actually received 5 GB, the Daventry Experimental Station. Is there any way of increasing its strength on 5 GB, I wonder?"

Unfortunately the strength of a crystal set is strictly limited. However good and however sensitive it may be—and the "Lo-Cost" is both good and sensitive—there is a definite limit as to the strength of signals it can give in the telephones. Unlike a valve set, in which batteries and other forms of local power are utilised, the energy that works a crystal set is derived directly from the broadcasting station which is being tuned in. In this particular instance there is a great deal of energy developed by the Daventry Station.

THE TWO METHODS.

This enormous electrical energy is radiated outwards and upwards and downwards from 5 GB's aerial in the form of electro-magnetic waves, travelling in all directions with the speed of light. At very short distances from the Daventry aerial these waves are strong, so that, although an aerial within, say, ten miles of 5 GB's aerial would pick up only a tiny proportion of the total energy being sent out, even this fragment would be quite enough to give tremendously strong telephone signals. At distances farther away from the transmitting aerial the area covered by the fast travelling signals becomes so tremendous that only a very small proportion of the energy radiated can be picked up in an aerial. Thus you will readily see that at your own distance from the Daventry station it must be only an incredibly minute fraction of the power passing into space from Daventry's aerial that reaches your own aerial, and works your little "Lo-Cost" receiver. Yet that very small fraction so truly represents the total energy, that the voice which is controlling the latter is reproduced with such fidelity by your set that anyone knowing it would be able to recognise the speaker! Looked at in this way the marvel is not that the signals are rather weak but that there are any signals there at all. Yet it is quite natural to want to make them as loud as possible, and in order to do this you will see from the foregoing that there are only two possible methods in which this can be done. The first method is to increase the amount of energy picked up. Obviously the only way to do this is to have a good aerial so that you pick up as much of the energy that is being radiated as possible.

AVOID LOSSES.

The second way in which you can increase strength is to make sure that there are no losses anywhere. Remember that the little currents of the aerial are travelling through your set to earth, and it is in this journey that they work the receiver. If, therefore, you bring the lead-in near to any earthed object there will be a tendency for the energy to hop away to earth across the intervening space instead of passing to the set. Naturally energy which is bypassed in this way represents so much energy lost, and therefore it behoves you to get the aerial and earth system as efficient as possible in order that all the energy that is being put into the aerial should actually pass through the set, and work the telephones. By taking every care to get the highest possible efficiency you can conserve the energy and thus ensure that your little crystal set is working at its maximum efficiency. If even then there is not sufficient power for your requirements, the only thing to do will be to utilise the latent power that lies in a battery or dry cell, harnessed to that modern miracle—a valve.

THE WAVE-TRAP CRYSTAL SET.

"Wiry" (Friern Barnet, London, N.).—"I see that on page 1231, 'P.W.' 298 (February 18th), it says the wire for the Standard Wave-trap is No. 26, but in the description of the trap in 'Radiotorial' it says 28 wire should be used. Which is right?"

The number of the D.C.C. should have been 28, not 26.

"THE NEARER THE BONE . . ."

S. J. (Bradford, Yorks.).—"We used to live about four miles further out and then I could not hear Bradford at all well. But now we have come closer in I can hear it as plainly as anything. Why is that?"

Although wireless is the newest science, it obeys the old laws of distance. Every yard that you move farther in towards the broadcasting station is a yard towards perfection. And in broadcasting as in carving, "The nearer the bone the sweeter the meat."

POSITIVE AND NEGATIVE LOUD- SPEAKER TERMINALS.

G. W. (Beeston, Notts.).—"My loud-speaker terminals are not marked positive or negative. Can you tell me the best means of ascertaining one from the other?"

It is not easy to tell which is the positive and which the negative terminals, although it can be done. The usual method of determining this depends upon the fact that if a small current is run through the loud speaker the magnetism resulting from this current will either assist or oppose the permanent magnetism of the loud speaker, according to whether the battery supplying the current is connected correctly or incorrectly.

In practice the experiment is generally carried out as follows. The horn and its support are removed from the loud speaker and the latter is suspended at a convenient height with the permanent magnet exposed to view. Leads are connected to the loud-speaker terminals and taken to a battery, which can be cut in or out at will by means of a switch. Then the magnet is magnetically "loaded" by pins or other small objects, the idea being to attach a load to it as heavy as it can magnetically bear. When the magnet is fully loaded, the battery should be switched in and the effect upon the load should be noted. If the switching-in appears to have no effect upon the load reverse the battery terminals and switch in again. Should the load fall off when the battery connections have been reversed, this will indicate that the battery connections are now the wrong way round, and that its magnetism is opposing instead of assisting the permanent magnet. By careful manipulation it is possible so to load the magnet that every time the battery is reversed the load falls off. When the correct position for holding the load has been definitely ascertained in this way, mark the loud-speaker terminal which is connected to the positive of the battery with a plus and that which is connected to the negative of the battery with a minus mark. This will ensure that the plate current of the valve which flows from the H.T. positive will be connected to enter the loud speaker at its positive terminal and leave at its negative.

WHAT IS RE-RADIATION?

D. W. (Chatham).—"I picked up Hamburg quite clearly on the crystal set, but when I told my neighbour (who has a three-valve set) he said he was tuned to Hamburg at the time, and I was only getting 're-radiation.' What does that mean?"

Re-radiation from a valve set often occurs when reaction is used. What happens in such cases is that the valve set picks up some of the weak signals from Hamburg, and by means of reaction it *strengthens its own input*. Consequently the originally-weak signals are magnified till they are quite strong, and if this process is carried far enough the valve-set receiving aerial may actually commence to transmit some of Hamburg's signals to neighbouring aeriels! This is called re-radiation. If your aerial is close to the other one it is probable that you were picking up Hamburg via next door by re-radiation.

IS NEUTRALISING WORTH WHILE?

T. W. A. (Dundee).—"I find neutralising is a difficult and troublesome job, and as the set seems to work O.K. without being adjusted exactly I am wondering if it is really necessary?"

It is a shame not to neutralise a set which is supposed to be neutralised, for it means losing several distinct advantages. For one thing the correct adjustments and handling of the set is easier when once it has been neutralised, and it does not then cause interference with neighbouring sets.

Quite as important is the effect upon sensitivity—a long-distance set that is badly neutralised will not bring in half the stations which it is capable of getting when the neutralising adjustment has been made properly.



The Sign of Expert Workmanship.

The productions of V.C. Bond of which this beautiful wireless cabinet is an example, have already achieved the renown they deserve.

This cabinet is only one of a large range of styles and sizes all made by experts in our workshops. Individual designs receive prompt and experienced attention.

Another example of Vee Cee Bee workmanship is provided by this bedroom chair and trouser press which serves a double purpose as a piece of furniture and as a silent valet.

Write to-day for free illustrated particulars to

ACTUAL MANUFACTURERS

V. C. BOND & SONS,

61, The Grove, Mare St., Hackney, London, E.8.



* Phone: Clissold 0883.
* Grams: "VeeCeeBee," Hack. London.

Established 1899.

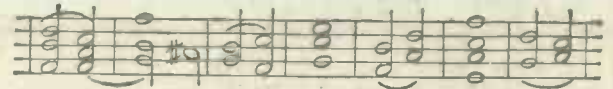

A large volume of sound!

You get full volume from the "Gem"—not a breathless whisper. It is a full-sized Speaker to which you can listen without strain. It treats the music kindly, too, being careful not to burr the edges.

The only small thing about the "Gem" is its price—the Trade is amazed that it can be made and sold for

30/-



Be kind to your ears by having the "Gem." Send for List and Name of Dealer who will demonstrate.

LONDON RADIO MFG. CO. LTD.

Head Office and Works:
STATION ROAD, MERTON ABBEY,
LONDON, S.W.19

Telephone: WIMBLEDON 4658
S.D. 10-4



FULL SIZE
30%
ONLY

Every user says
"MARVELLOUS"

Good News for Set Builders!

In response to the urgent demand for a first-class 4-valve set for family use, Mr. PERCY W. HARRIS, M.I.R.E., has now prepared

The WIRELESS CONSTRUCTOR ENVELOPE No. 2

In this envelope—obtainable at all bookstalls, price 1/6—will be found full constructional details of a magnificent and inexpensive receiver, called

"THE CONCERT FOUR"

Made of standard parts, all easily obtainable, it is a highly-sensitive long-distance set, giving powerful reproduction of wonderful quality. Covering both long and short wave-lengths, with a switch for 3 or 4 valves, it is essentially a set to enjoy, both in building and operation.

The WIRELESS CONSTRUCTOR ENVELOPE No. 2

NOW ON SALE. PRICE 1/6

By post, 1/9, from the Amalgamated Press, Ltd., Bear Alley, Farringdon Street, London, E.C.4.

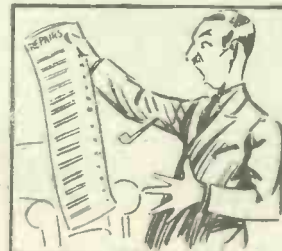

SAVE MUCH SPENDING

BY
TIMELY
MENDING
WITH



FLUXITE

it simplifies soldering

All Hardware and Ironmongery Stores sell FLUXITE in tins, price 6d., 1/4 and 2/8. Another use for Fluxite—Hardening tools and Case Hardening. Ask for leaflets on improved methods.

FLUXITE SOLDERING SET-complete

7/6

or LAMP only

2/6

FLUXITE LTD.
Dept. 324, Rotherhithe, S.E.16

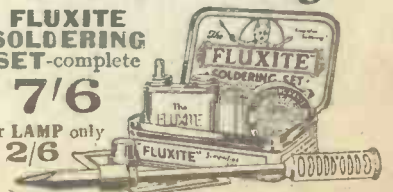

"Radielle"

H.T. SUPPLY UNITS
THE A.C. MODEL K4.

Price £5-17-6

Complete with "PHILIPS' 506" Valve.
Royalty 12 6 extra.

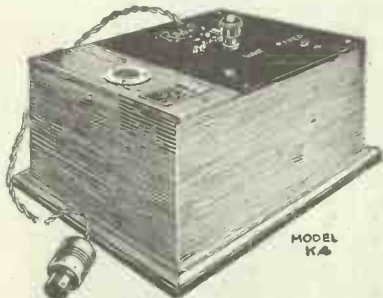

MODEL K4

LAMP - SOCKET RADIO

The Model K4, with output of 15 m.a. at 125 volts, is a very efficient full-wave rectifier giving ample current for sets using up to four ordinary or three ordinary and one power valves. On A.C. Mains the employment of a "Radielle" Battery Charger (£3.10.0) in conjunction with a "Radielle" H.T. Supply Unit forms an excellent and practical method of obtaining both H.T. and L.T. from the mains. The Battery Charger is connected permanently to the Accumulator in use on the set, and can be left on charge whilst the set is in use.

From all good dealers or direct from—

THE RADIELLE COMPANY LTD.
18a, Haverstock Hill, Chalk Farm, N.W.3.
(Facing Chalk Farm Tube Stn.)
Phone: Hampstead 1934.
ILLUSTRATED LIST POST FREE.

SHORT-WAVE NOTES.

APPARENTLY the transatlantic telephone has at last forsaken its old pitch and started up on short waves. On about 19 metres, one half of it may be heard, the other half being on about 20 metres, although sometimes I have heard them both in the neighbourhood of 16 metres. Since the British station and the American are almost the same strength, it appears that the only reliable way of telling which is which is by the strong accent generally noticeable on one "half"!

A really sensitive short-wave receiver has a most disturbing habit of picking up all sorts of "transmissions" other than those for the reception of which it is intended. A few days ago I had been carrying out some tests with a new microphone, and left it lying loose on the bench, with its long flex leads simply trailing along and then dropping on to the floor.

Judge my astonishment when, on running my fingers along the edge of the table, very loud rustling noises, obviously due to the microphone, were heard in the headphones. When someone spoke quite a foot away from this microphone (which was lying face down on the bench) very clear and intelligible speech in the 'phones resulted.

Peculiar "Strays."

Annoying sounds in a short-wave set may often be traced to such improbable causes as tools rubbing together on the table, or even bits of wire making intermittent contact at quite a considerable distance from the set. A friend informed me once, in all seriousness, that he had to keep his box of "stray" wires of all shapes and sizes outside the room. If it were brought anywhere near the set, a lorry passing down the road caused all the wires to shake, and produced quite a severe storm of atmospherics in the receiver!

It is well worth the little time spent to try the effect of supporting your receiver on boxes or small ebonite legs, not with any motive of insulation, but simply to ensure that the coils are really well above the level of the table.

I always prescribe this simple alteration in cases where the owner of a short-wave set is having difficulty in getting his receiver to oscillate right down in the lower ranges, and it generally has a beneficial effect. On my own, which is always supported by three valve boxes, the action of removing them and lowering the whole thing to the table level has the effect of raising the minimum wave-length of a given coil and condenser from 14 metres to nearly 16 metres!

A long, low aerial is very often found to give really excellent reception, particularly in cases in which the main aerial is somewhere near a source of artificial interference, such as electric trains or trams.

I sometimes use my transmitting counterpoise as a receiving aerial, and interference certainly is considerably lessened. The one trouble that I have not yet succeeded in overcoming is the persistent trouble on 20 metres, or thereabouts, from L.G.O.C. bus magnets, which are more or less selectively tuned to that wave!

PANEL PLATE TUNER

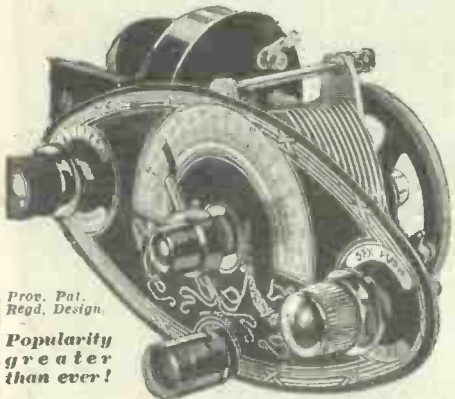

Prov. Pat. Regd. Design.

Popularity greater than ever!

In itself half a set, no ebonite panel is required. No coils to change. Can be fitted to any form of Cabinet. Black and Gold or Silver finish. Supplied with diagrams for building 2 or 3 valver, assuring final efficiency.

35/-

This is just one of our attractive lines — there are many others. Enquire of your dealer or write us.

LAMPLUGH BRITAIN'S BEST RADIO

"LAMP-LOO"

S. A. LAMPLUGH, LTD.,
KING'S ROAD, TYSELEY, BIRMINGHAM.
Representatives for London and Southern Counties:—
G. C. Shore & Co., 28, Newman St., Oxford St., W.1.

Reliability

WIRELESS COMPONENTS
GIVE UNEQUALLED SERVICE

Order from this List and save money.
Orders 5/6 value, carriage paid.
Under 5/6, 2d. per 1/- for packing, etc.

<p>WIRELESS CABINETS</p> <p>For Panels 7" high Width 8" Hinged lid, Oak, 12" 17" 14" 17/6; 18" 18/6. Mahogany 1/- ex.</p>	<p>KEY SWITCH</p> <p>One-hole fixing 1/-</p> <p>Send for Free Copy RELIABILITY WIRELESS GUIDE No. 999 with Electrical Supp.</p>	<p>D.P.D.T. ANTI-CAPACITY SWITCH</p> <p>One-hole fixing. Off position. Self cleaning contacts</p>
--	---	--

BASEBOARD NEUTRALISING CONDENSER	3 6
SIX-SOCKET COIL BASE, WITH TERMINALS	1 6
DOUBLE-SCALE VOLTMETER, 0/6 0/120 v.	5 6
SEARED VERNIER TWO-WAY COILHOLDER	3 0
VERNIER FRICTION-DRIVE CONDENSER DIAL	3 6
DOUBLE-FOLE ANTI-CAPACITY SWITCH, 2-WAY	3 0
EX.-GVT. 120-OHM SULLIVAN'S HEADPHONES	3 5
ERICSSON '0005 MFD. VARIABLE CONDENSERS	3 9
S.O.S. THREE-BEAD HYDROMETERS	3 6
R.A.F. TELEPHONE & MODULATION TRANSFORMERS	5 6
HANDLID 46-PIN COIL FORMER & INSTRUCTIONS	1 3 0
EX.-GVT. 1-MFD. MANSBRIDGE CONDENSERS	2 0 0
PERLANTE TRANSFORMERS, AF3, 17/6, AF3, 25/-, AF3 30 0	5 6
DOSSOR MELODY-MAKER COIL, "GOL TONE"	5 0 0
LISSEN H.F. or L.F. CHOKE COILS, RECOMMENDED	5 6
A.I. & VARLEY GEN. PURPOSE L.F. TRANSFORMER	15 0
BRITISH STANDARD VALVES, ALL TYPES, EACH	5 0 0
OLDHAM 10-VOLT H.T. ACCUMULATOR UNITS	5 6
FERRANT TRANSFORMERS, AF3, 17/6, AF3, 25/-, AF3 30 0	5 6
LISSEN BATTERIES, 60 v. 7/11; 100 v. 12/11; 9 v. 1 6	1 6
HEADPHONES, B.T.H. 15/-; RELIABILITY ADJUST.	5 0 0
CANENT L.F. TRANSFORMERS, 7/-; CROIX, 8/6	5 0 0
NEW CLAYTON FRONT CUTTING, Per lb.	1 3
FLASHLAMP BATTERIES 4-VOLTS, DOZEN LOTS	3 10
HIGH-GRADE IGRAMIO H-TYPE VARIOMETERS	4 6
BACK-OF-PANEL 2-WAY VERNIER COIL HOLDERS	3 3

J.H. TAYLOR & Co

4, RADIO HOUSE,
MACAULAY ST., HUDDERSFIELD

Mark of Reliability

Mutim!

ON THE BASEBOARD!

When your set gets out of hand, take the one vital step that ensures the perfect balance necessary to secure harmonious, distortionless reception—fit a Sifam Meter and tune with your eyes on the dial. FREE leaflet "Distortion" from (Dept. P. S.I.F.A.M., 10a, Page Street, Westminster, S.W.1.)

WET H.T. BATTERIES

Solve all H.T. Troubles.

SELF-CHARGING, SILENT, ECONOMICAL.

1ARS (waxed) 4" x 4" sq 1/3 doz.
INCS new type 11d. doz SACS 1/2 doz
Sample doz (18 volts), complete with bands and electrolyte, 4/3, post 9d
Sample unit 6d. 18 page booklet free.

Bargain list free (VALV) 30/-
2-VALVE A.C. STATION SET 6s.

P. TAYLOR, 57, Studley Road, STOOKWELL, LONDON

PLEASE be sure to mention
"POPULAR WIRELESS"
when communicating with
Advertisers. THANKS!

EVERYTHING RADIO EASY TERMS

ON

WOOLDRIDGE RADIO CO. LTD.
17 LISLE ST. LEICESTER SQUARE
LONDON, W.C.2.

ASTOUNDING

results are obtained from circuits embodying our L.F. Transformers which are British made throughout.

The "RADIOGRAND"

is a component of the very highest quality typical of a firm that has specialised in one particular instrument and achieved a reputation for outstanding excellence. Though moderately priced, design, materials and workmanship are such that these Transformers stand unrivalled for general efficiency.

12/6 RATIOS
5-1 and 3-1.



"ACE" 8/6

Ratios 5-1 and 3-1.

This is a smaller instrument built to give first-class results, yet of a size and weight that render it particularly suited for Portable Sets where compactness is an essential feature.

TELSEN
L.F. TRANSFORMERS
Radio's Choice

If unable to obtain write

TELSEN ELECTRIC Co., Ltd.,
Head Office & Works: 207 ASTON RD., BIRMINGHAM.
London Agents and Distributors: The Sel-Ezi Wireless Supply Co., Ltd., Greek Street, Soho.

Your dealer will supply on 14 days' free trial. Every Instrument guaranteed 12 months.

NO CRYSTAL SET USER SHOULD BE WITHOUT THE NEW NON-VALVE MAGNETIC

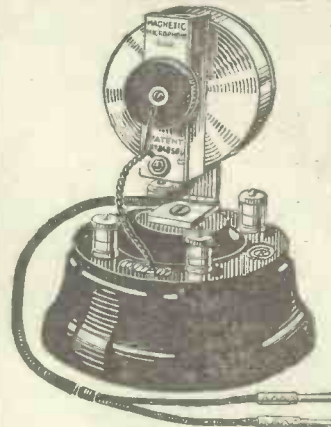

MICROPHONE BAR AMPLIFIER

(Patent No. 248581/25.)

which operates a loud speaker direct from any crystal set up to six miles or more (according to strength of original reception) from main Broadcasting Stations; or makes weak reception loud and clear in headphones under any conditions. A great boon to deaf persons. May be used with small valve sets.

Works perfectly on one or two dry cells; no other accessories required.

PRICE **34/-** POST FREE (Without Battery).

every Amplifier Guaranteed. 2 Dry Cells (lasting 3 months) 4/-

NO Valves, Accumulators or H.T. Batteries. Fragile Parts. Distortion.

NOTHING TO GET OUT OF ORDER. A CHILD CAN ADJUST IT. Write to-day for illustrated literature, free.

May be obtained from your Dealer, or from Sole Manufacturers and Patentees: **NEW WILSON ELECTRICAL MANUFACTURING Co., Ltd.** 18, Fitzroy St., Euston Rd., London, W.1. Phone: Museum 8974.

BETTER RECEPTION BY USING



TREBLE-DUTY TERMINALS

and the danger of a wrong or accidental connection is practically impossible. Any wire or tag, spade or pin, can be securely held; wires need not be soldered, as shaft is slotted at the end and a nut supplied. You can make at least six connections to each terminal if you wish. Terminal parts are standard EEX fittings, and can be used for other purposes. 36 varieties of indicating tops and also 6 colours.

Write to-day for your copy of Catalogue T31 to: J. J. EASTICK & SONS, Eex House, 118, Bunhill Row, Chiswell St., London, E.C.1.

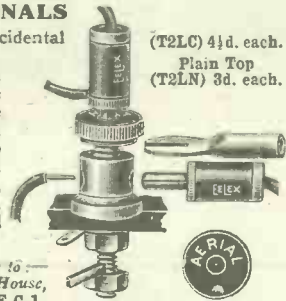

(T2LC) 4½d. each. Plain Top (T2LN) 3d. each.

SAXON GUIDE TO WIRELESS

1928 EDITION 192 PAGES ENTIRELY REVISED

First edition of this book was issued 18 months before broadcasting commenced. We originated drilled panels, we eliminated soldering, and our latest sets are as much in advance of others as they were in 1921. Read this book and you will know more about wireless than many who are now posing as "experts" and "radio engineers," and you can build the finest sets obtainable.

FULL INSTRUCTIONS, with clear wiring diagrams, are given for making CRYSTAL AND SINGLE VALVE-SETS, ONE- AND TWO-VALVE AMPLIFIERS, THE FAMOUS SAXON 4-VALVE TUNED ANODE SET, also an EXTREMELY EFFICIENT FIVE-VALVE RECEIVER.

Particular attention is drawn to our latest 1928 TWO- and THREE-VALVE LOUD-SPEAKER SETS which eliminate coils entirely and cover all wave-lengths from 200 to 2,000 metres by merely turning a knob. Any beginner can make these sets in 192 PAGES, two or three hours.

NO SOLDERING NO DRILLING, NO KNOWLEDGE REQUIRED. 1/3 POST FREE.

Money refunded if book returned in 7 days. SAXON RADIO CO. (Dept. 14), SOUTH SHORE, BLACKPOOL.

A New Paper! A Witty Paper!!
A Topical Paper!!! A Paper You'll Like!!!!



"LONDON CALLING"

NEW in every sense of the word, bright, original, artistic, dealing with the lighter side of life in a vivacious vein. Witty and topical comments on matters of the moment, Gossip from the theatre, Art straight from the easel and Sport straight from the stable—a pithy weekly review for men and women of the world. Caricatures and humorous drawings by our most brilliant black-and-white artists. The freshest and most amusing paper you have ever seen.

LONDON CALLING
WIT AND GOSSIP OF THE WEEK
2d WEEKLY

Buy a Copy TO-DAY

"ALL THE FUN OF LONDON FAIR"

Economise in floor space

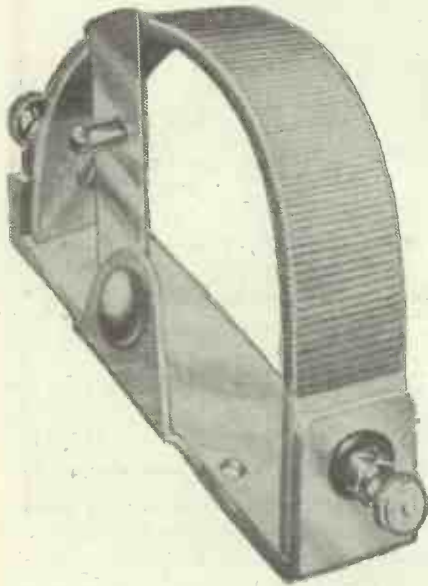

The "PEERLESS" VARISTOR stands up on the baseboard, taking only a fraction of the usual space. It can be fitted on an already crowded panel. The adjustable phosphor-bronze arm is easily accessible. The windings are of best-quality resistance wire, wound tightly on insulating fibre. Terminals are fitted in the most convenient position. You can buy 5 types—3, 6, 10, 15 and 20 ohms. *The "Peerless" Varistor is fine for the Cossor "Melody Maker."*

From all good dealers or direct:—

PEERLESS VARISTOR

BEDFORD ELECTRICAL & RADIO CO., LTD.
22, Campbell Road, Bedford.
LONDON: 21, Bartlett's Bldg., Holborn
Circus, E.C.4
GLASGOW: 113, St. Vincent St., C.2

1/3

NEWS FROM SAVOY HILL.

(Continued from page 12.)

Miss Cable on Tibet.

Even in these twentieth-century days, when explorers are discovering hitherto unknown tribes and unearthing buried cities of the past, comparatively little is yet known of Tibet, the "Forbidden Land" as it is called, beyond the vastnesses of the snow-capped Himalayas. There will thus be something unique in the missionary talk which Miss Mildred Cable is giving at 5.30 p.m. on Sunday, March 4th, in the London studio entitled "The Dancing Rituals of the Tibetan Lamas."

Miss Cable, with the Misses Eva and Francesca French, has had considerable experience in China with the China Inland Mission, and a few years ago lived for some time in the far North-West of the isolated province of Kanzu, making preparations to undertake the dangerous and wonderful trek across Central Asia to Siberia. The privilege they had of entering Tibet, the country closed to travellers, except to the few who can approach it from the Chinese border, was almost unprecedented and their experiences, which listeners will hear this afternoon, are certain to be of the greatest interest.

Belfast News.

A running commentary on the ceremony of the reopening of the Parliament of Northern Ireland will be broadcast at 11.45 a.m. from the Belfast Station on Tuesday, March 6th. During the same evening the Ulster Station is paying a tribute to its neighbours across the water by giving an all-Scots programme, the chief feature of which will be a one-act play entitled "The Lost Piper," which deals with an old Scots legend of the eighteenth century. The play is founded on a tradition that a subterranean passage extends from Musselburgh Sands to Edinburgh, through which many years ago a certain piper wagered he would walk playing his pipes the while.

A Newcastle Event.

Songs and choruses, some of them devoted entirely to the North Country, are included among the contributions of the Wallsend Male Voice Choir, in a programme they are giving under the direction of Mr. George W. Danskin, in the Newcastle studio on Monday evening, March 5th. Two short sketches entitled respectively "All Square" and "The Healing Herb," which Mr. E. A. Bryan, of Gateshead, has specially written for broadcasting, will be performed during the same evening, the cast being drawn from the Repertory Company.

Talks—A New Departure at Cardiff.

Dr. Olive Wheeler, Professor of Education at the University College, Cardiff, who is to give a talk on "Psychology for Parents—Early Developments" on Tuesday, March 6th, has lectured in many parts of Great Britain on educational psychology. She is the author of various books and papers on this subject, on which she is a great authority.

The Culprit



How often can you put your finger on the culprit? the faulty part that mars reception. The panel, perhaps the greatest offender, is often the least suspect because its faults are hidden.

Trouble free reception is based on an efficient panel. To obtain one—the only one—worthy of your confidence, insist on—



Resiston Panels come in 13 stock sizes in black and Mahogany-grained. From 6 in. x 9 in. in black, 3/5, to 8 in. x 30 in. Mahogany-grained, 19/-.

"24 HOURS CUT PANEL SERVICE."

Advt. American Hard Rubber Co. Ltd. Fore St., E.C.

1973

THE LITTLE CELLS THAT SATISFY.
Eton Primary H.T. Battery P.I. Porous Pot Cells, S1 and S2 Sac Cells. All complete.

	1-cell	6-cell	12-cell	30-cell
P.1	6½d.	3/3	5/9	14/-
S.1	6d.	3/-	5/3	12/-
S.2	4½d.	2/6	3/10	9/6

Send 1½d. stamp for booklet giving full particulars to—
THE ETON GLASS BATTERY CO.
46, St. Mary's Road, LEYTON, E.10

REDUCED TO 10/6
Balanced Armature Cone Unit. This instrument is the finest value offered to the Radio public. Gives a greater output for a given input than any other cone unit. It is not a converted earpiece, but a unit designed for the manufacture of Cone Speakers. Our 136-page catalogue has all the latest and best in Radio and Electrical. Send to-day. FREE.

Post free, 10/6, complete with Cone Washers and Cord.

ELECTRIC (GRAFTON) COMPANY
Dept. P.W., 54, Grafton St., Tottenham Court Road, W.1

To all Advertisers

PLEASE note that communications concerning advertising in

POPULAR WIRELESS MODERN WIRELESS WIRELESS CONSTRUCTOR

must be made to
JOHN H. LILE, LTD.,
4, Ludgate Circus, London. E.C.4
(Phone: City 7261)
and NOT to the Editorial or Publishing Offices.

APPARATUS TESTED.

(Continued from page 28.)

both the high and the low notes successfully, and although it is probably more than usually sensitive it can deal with heavy inputs. It is the kind of speaker that looks well in any room, whatever its furnishing, and will give pleasing results with practically any type of receiver.

RIPAULTS H.T. DRY BATTERY.

It will probably be remembered that a few weeks ago we mentioned that we had received a "self-regenerative" type H.T. dry battery from Messrs. Ripaults for test. It is claimed for this type of battery that internal resistance has been entirely overcome and that the capacity output and life has been increased to a considerable degree. The actual battery we have had under test is the triple-capacity type, model H.M., a 90-volter which sells at 29s. 6d. The maximum discharge advised for this battery is 18 milliamps. The approximate life in hours is stated to be 335 hours at a 20-milliamp discharge rate. At 100 hours per month aggregate use this gives a life of three and a third months approximately.

The sort of modern set with which it could be used is a five-valve receiver employing power valves. On the test we gave it we exceeded the maximum discharge advised and after delivering a current of 21 milliamps for well over 300 hours the battery is still capable of doing somewhat lighter work probably for some time. It will be seen that Messrs. Ripaults have not overrated their battery and have, in fact, given a conservative estimate of its life.

We have also carefully tested one of the smaller types and find this similarly satisfactory. The term "self-regenerative" as applied to these Ripault H.T. batteries does not mean that they are capable of living for ever and ever, but that they quickly depolarise and give consistent and long service.

DIONOID ACCUMULATORS.

We have recently had the opportunity of examining and testing an accumulator manufactured by the Dionoid Battery Co., Ltd., of Prince of Wales' Road, Darnall, Sheffield. The accumulator is of special construction and has many points of interest.

It has, for instance, a removable metal carrying handle, while the glass container is enclosed in a thick, protective casing, a window being provided to enable the acid level to be checked. Very strong precautions against the effects of acid attacks on the various parts have been taken by the use of a special enamel. This appeared to us to be a particularly sound battery, and one that should give long and reliable service.

THE STEWART-WARNER REPRODUCER.

We have had on test a loud speaker due to the Cooper-Stewart Engineering Co., Ltd. It is a very heavy instrument, and its main construction is an imposing metal casing. But it is very nicely finished in antique bronze-green, ornamented with attractive tracery in a kind of Grecian style. If the projection is somewhat restrained, speech is clear and the speaker's register is wide. The price of this accessory is £6 15s.

POWER

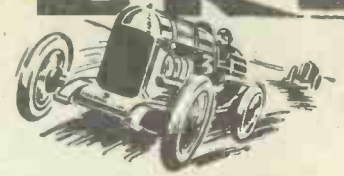

Sure-a-lite batteries are the most powerful because their cells are larger, more efficiently designed and more carefully assembled than those of other makes.

That is why Sure-a-lite H.T. batteries possess recuperative powers to a very considerable degree. That means that they have exceptionally long life and maintain their rated voltage for remarkably long periods.

They are the batteries *par excellence* for high efficiency, long life and silent working.

The new Sure-a-lite "Supra" marks the latest advance in battery construction, and now incorporates Grid Bias tapped every 1½ volts to 6 volts at the old price of 7/11. It is supplied sealed and with a deep dust-proof cover.

Rely on the battery experts—and ask your radio dealer—he knows!

SURE-A-LITE

BRINGS MOST IN — GIVES MOST OUT

REGISTERED TRADE MARK

"SUPRA," 66 volt 7/11
 "GIANT," 100 volt 14/3
 "GIANT," 66 volt 10/6
 " " 100 volt 17/6

These incorporate Grid Bias tapped 1½ volts to 6 volts.

The Battery Company,
 92, Hurst St., Birmingham



THE BETTER BATTERY

CONDENSERS of QUALITY!

No mass production methods are employed in the manufacture of Camden Condensers. Every Condenser is stamped with a Serial No., and accompanied with a guarantee of 6 months' real service. Telegrams: KAMELCO, Telephone: Runcorn 109.

Send for list and prices to
 Camden Electrical Co., Stanley Chambers, Runcorn.

HEADPHONES REPAIRED.

Rewound and re-magnetised 4/- per pair. Loud Speakers repaired 4/-. Transformers rewound 5/- each. All work guaranteed and tested before delivery. Write for Trade Prices. Phone: Clerk. 1795. MASON & CO., 44, East Rd., City Rd., N.1.

NO VALVES!

The "NEW MAGNO" Micro Amplifier is GUARANTEED to amplify crystal (or valve) reception 3 to 10 times. For 2/6 we supply blue prints giving full-size constructional details and diagrams, together with ample length of sensitive Electrode, Reed and Screws for making micro part. By fitting these to a spare phone, anyone can cheaply make an efficient amplifier, without H.T. Buttons, Valves, etc. Worked by 1½ v. dry cell only. Agent: L. Cook, 182, Cranston Road, S.E.25.

The HOME for your WIRELESS SET

OUR STANDARD CABINETS

are DUSTPROOF and house the whole apparatus, leaving no parts to be interfered with. All you do is UNLOCK & TUNE IN.

Made on mass production lines, hence the low price. Provision is made to take panel up to 30 in. wide and baseboard 20 in. deep. Carriage paid and packed free England and Wales. Thousands supplied with full satisfaction.

From £4 15 0. Write to-day for descriptive pamphlet and suggestions for adapting your receiver or panel in our Standard Cabinets.



MAKERIMPORT Co. Dept. 5, 50a, Lord Street, LIVERPOOL

RADIO REGISTERED PANELS

7x 6, 1/3
 8x 6, 1/4
 10x 8, 2/1
 10x 9, 2/4
 12x 10, 3/-
 14x 12, 4/-
 14x 7, 2/7
 16x 8, 3/2
 8x 5, 1/2



9x 6, 1/7
 11x 8, 2/3
 12x 8, 2/6
 12x 9, 2/10
 14x 10, 3/5
 16x 9, 3/6
 21x 7, 3/7
 24x 7, 4/-
 Min. thick. Post Free.

Money back guarantee that each and all Panels are free from surface leakage. Megger test Infinity. CROXSONIA CO., 10, South St., Moorgate, E.C.2

Phone: Clerkenwell 7853
 Agents: John Henry Smith, 139, Anlaby Rd., Hull.
 L. H. Helyar, 82, Chamberlin Rd., Norwich.
 A. Stredwick & Co., 27, The Market, Chatham.
 Boynton & Co., Ltd., 34, Bradford St., Birmingham

D-XELLENT! DX-IN COILS

From 1/- D X COILS, LTD. London, E.8.

TRADERS GET YOUR COMPONENTS AND CABINETS AT THE RIGHT PRICES. Send for illustrated list. Dept. P.W., PERSEUS RADIO, Burton-on-Trent.

EASY PAYMENTS

LOUD-SPEAKERS, HEADPHONES, H.T. ACCUMULATORS. Anything Wireless. Send a list of the parts you are requiring, and we will send you a quotation on monthly payments. H. W. HOLMES, 29, FOLEY STREET, Phone: Museum 1414. Gt. Portland St., W.1.

ALL APPLICATIONS FOR ADVERTISING SPACE IN "POPULAR WIRELESS" MUST BE MADE TO THE SOLE ADVERTISING AGENTS, JOHN H. LILE, LTD., 4, LUDGATE CIRCUS, LONDON, E.C.4.

ELECTRADIX BARGAINS

THE DIX-ONEMETER. The 55 Range "Rolls-Royce" of Radio. An instrument of exact precision reading, 40 micro-amp. to 20 amps., 2 millivolts to 2,000 volts. Measures Crystal Signals or Resistances from 50 ohms to 50 megohms. Instrument De Luxe, 55/-. Multipliers, each 6/6. New A.C. Model ready. (See leaflet.)

INSTRUMENTS. We are specialists and makers. Our stock is the finest in London. Multi-Range. Testers, A.C. and D.C. Resis. Capacity and Inductance Bridges. Microammeters and all panel meters at rock-bottom prices. Moving Coil Milliammeters from 15/-.

WAVEMETERS. Large stock of all ranges at greatly reduced prices. Townsend's from 35/-.

GYROSCOPES. £25 Navy Torpedo in mahogany case. Beautiful workmanship. Price 15/-.

RELAYS. Western, 25/-; G.P.O., 40/-; Magnetic Relays, 10/-; Dixon Fila. Distant Control Switches, auto. on and off, 15/-, list 30/-.

TABLE ELECTRIC PROJECTORS for Photo Slide Floodlight or Television experiments. 4 lenses, swivel stand. Cord and plug for 220 v. Sale 25/-.

PRECISION CONDENSERS, POLAR. Full dial sq.-law, .0003 mfd., 3/6; .0005 mfd., 4/6; list 12/6. Panel 3-gang Triple, 8/-, list 15/-. Penton .001 Panel, 1-hole fixing Varia. Condensers, 2/6, list 8/-. Polar Rheos., 1/3, list 4/6. Polar Panel 2-way Coil Holders, 2, 9, list 7/6. Polar Varia. H.F. Transformers, 300/500, 3/6, list 8/6. L.F. Gambrell, Inter-valve, 7/6, list 15/-. Polar Variometer panel and dial, list 21/-. Sale 8/6. Polar Detectors, Everset, 1/9. Double-wound Chokes, 4/6.

ELECTRIC HEATERS, at under half cost. Immersion, 4/-; Hot plates, 7/6; Irons, 10/-.

Massage Vibrator Sets, 21/6. Soldering Irons, 12/6.

LOUD SPEAKERS. 5 gns. Violina Cabinet is the greatest bargain ever. Wonderful tone. Sale, 25/-.

Western Electric new, 2,000 ohms, reduced from 35/- to 15/-; T.M.C. Loud Speakers, 2,000 ohms, 10/-; Texas Cone, 2,000 ohms, with cord, 25/-.

SPEAKER PARTS. Pleated Paper, 2/-. Twin 12 in. nickel rims, 5/-. Reed phones, with needle, Brown's "A", 13/6. Skinder Reed Units, 2,000 ohms, 8/-. West. Electric Balanced, 10/6. Cones, 2/-. Cone paper, 15 ins. square, 1/-. Ampicore, 2/-. Crystal Amplifiers, 15/-.

MICROPHONES for Speech or Detaphone. Skinderviken, 3/-. Fitted on Reed phone, 13/-. Complete in oak case with 100/1 transformer, 25/-. Amplify. button, 1/- each. Transformer, 4/6 and 7/6. Micro-Insets, 1/-, Microphones, Hand, 5/- and 15/-. Electric Bells, 1/6. Morse Keys with cover, 2/6. Aerial Line Erecting Sets, 2/6 each. Heterodyne Blocks, 4/6.

VALVE BARGAINS. A.C. to D.C. 50 m/a Cossor. B.T.H. M.O., etc., with holder 8/6. List 25/-.

8-v. Grid Bias Battery, 1/-, 60-v. Batteries, 7/11.

MAINS UNITS. The DIX D.C. No live Terminals. Humless Filter, 3 taps, 30/-. De Luxe Model with Meter, 40/-. A.C. Unit with Control and 3 taps. Special Filter, £4 10s. Condensers: 2 mfd., 3/9; 4 mfd., 6/6; 10 mfd., 15/-; Fullertype Chokes, 200, 600, 1,000 ohms, 1/6. Power Chokes, 1,000, 1,400, 3,000 ohms, 4/6. 2 Electrode Rectif. Valves, 7/6. Transformers, 220 volts to 3, 5, or 8 volts, 12/6. To 20 volts, 14/6. Double wound for H.T. from A.C. mains, 220 volts, two centre tap secondaries for H.T., 20 m/a., 25/- each; 50 m/a., 37/6. New 8-v. Grid Bias Battery, 1/-, 11/- doz.

MELODY-MAKER L.F. Ironclad Transformers, give purest reproduction, 10/-. Inductance Wire E. and C.C. Copper, Sale 1/6 lb. Paxolin Tubes, 3 by 23, 4d. each, quarter usual price.

20 m/a. Eliminator Meters, 7/6. Large Steel Horse-Shoe Magnets for Coil Speakers, 3/6. Bargain Sale of Transmitters and Receivers, 1 to 6 Valves, now on. Send 4d. for our 72-page illus. catalogue. It will save £4.

ELECTRADIX RADIOS,
218, Upper Thames Street, E.C.4

TECHNICAL NOTES.

(Continued from page 12.)

L.F. Amplifiers.

A low-frequency or audio amplifier may be considered satisfactory if it amplifies the signals impressed upon it sufficiently to operate a loud speaker with adequate volume, and if it does so without distorting the signals to an extent sufficient to become noticeable in the output from the speaker. Proper performance in this respect can only be obtained when the amplifier has been correctly designed and, what is perhaps even more important in practice, when it is properly operated.

The overall characteristic of an amplifier is often quite different from the characteristic of any individual stage, and this is particularly true of transformer-coupled or impedance-coupled amplifiers. It is probably due, in some cases, to coupling in the plate-supply, whereby regenerative effects are produced which induce changes in the overall frequency characteristic of the audio system. Effects of this kind are also present sometimes in resistance-coupled amplifiers, and give rise to the effect which is referred to as "motor-boating."

Peculiarities.

The solution of difficulties of this kind is to design the amplifier so that it has a flat characteristic, or else to design two units to have a flat characteristic, and then to arrange the circuit carefully so that regenerative effects shall not be present to any appreciable extent. This usually necessitates feeding of the grid and plate circuits through resistances or choke coils, and by-passing the circuits with suitable condensers.

Limits of Transmission.

In some modern transformers the design is such as to cut out audio frequencies much above 5,000 cycles per second. This has the effect of excluding various extraneous valve noises, high-frequency heterodyne whistles and so on, which are usually above the figure mentioned. In any case, it is known that frequencies much above about 5,000 do not add appreciably to the quality of the reproduction and can, therefore, be eliminated without loss. It is doubtful, indeed, whether the majority of broadcasting stations really transmit notes of more than about 5,000 cycles.

Many amplifiers have a tendency to oscillate at high audio and supersonic frequencies, but if the amplifier is designed to give little or no amplification to frequencies of this order, the tendency of the amplifier to oscillate will be counteracted.

Sound Characteristics.

The characteristics of the human ear in relation to atmospheric sound-waves have become increasingly important with the advent of broadcast receivers and many other modern acoustical devices and have, therefore, received much greater attention than formerly from scientific investigators during the past few years. Some very interesting and remarkable facts have been discovered. It is evident that there is a minimum intensity below which the average ear ceases to be conscious of any sound and there is, in the same way, a maximum

intensity, but in the latter case, if the intensity exceeds a certain value, the ear becomes conscious of a sensation of pain rather than of sound.

The upper and lower limits of pitch of sounds are well-known, the lower pitch being about 30 cycles per second, and the upper limit varying with the individual between about 15,000 and 40,000 cycles.

The number of separate types or sensations of sound which the ear can appreciate and distinguish is large; it has been found to be upwards of 300,000.

Pressure-Changes.

One of the most striking observations relates to the great difference in pressure-change which can be appreciated by the ear. If we take the minimum pressure-change which occurs in a sound only just audible and the pressure-change in a sound which is becoming unbearably loud, we find that the latter is about 100 million times greater than the former. The energy-ratio of these two quantities is actually ten million million.

The sensitivity of the ear to variations in loudness is, on the other hand, very poor. With weak sounds, a change of about 25 per cent in loudness is necessary to be properly distinguishable, whilst with louder sounds a change of about 10 per cent is detectable.

The appreciation of slight differences in pitch varies considerably with the individual, but generally it is found that at medium and high frequencies a change in frequency of about 0.2 to 0.3 per cent can be detected, whilst at low frequencies a change in frequency of about 1 per cent is necessary.

TRADE MARK **RD40 . 2/-**

RED DIAMOND

A RADIO EXPERT writes:—

"I have now thoroughly tested your RD40 Detector, both on crystal and reflex sets. I have found it very satisfactory in every way, it is very efficient."



Shield for same 6d.

"RED DIAMOND"

THE RECOGNISED DETECTOR FOR ALL CIRCUITS USING CRYSTAL RECTIFICATION. By Insured Post 2/3 or 2/9 with shield. Can be mounted on brackets or through panel. Once set always ready. Not affected by vibration. Each one is tested on broadcast before despatch, and is perfect. Of all high-class Radio Dealers or Sole Makers:—

JEWELL PEN CO., LTD.
(Radio Dept. 4E)
22 Gt. Sutton St., LONDON, E.C.1.

MULLARD MASTER THREE

Pure Aluminium. 4/3 EACH
Black Finish. Post Free.

J. W. BAILEY. Wireless Supplies,
522, Coventry Road, BIRMINGHAM.

COMPLETE SETS, LOUD SPEAKERS,
COMPONENTS, Etc.,
supplied for all circuits, including
the Mullard Master 3, Cossor
Melody Maker, also the new
circuits featured
in this issue.

EVERYTHING WIRELESS
ON EASY PAYMENT TERMS

Send list of requirements, and best monthly terms will be quoted by return.

THE P.D.F. COMPANY, LTD.,
41, GREAT TOWER STREET, LONDON, E.C.3.

REPAIRS

Any make of L.F. Transformer, Loudspeaker or headphones repaired and despatched within
48 HOURS—TWELVE MONTHS' GUARANTEE
with each repair. 4/- Post free.

Terms to Trade.

TRANSFORMER REPAIR CO.,
"Repairs" Dept.
214, High Street, Colliers Wood, London, S.W.19.

ADVERTISEMENTS

As far as possible all advertisements appearing in "P.W." are subjected to careful scrutiny before publication, but should any reader experience delay or difficulty in getting orders fulfilled, or should the goods supplied not be as advertised, information should be sent to the Advertisement Manager, "Popular Wireless," 4, Ludgate Circus, London, E.C.4.

Distance to the very edge
Volume to fill the house
Purity . . . to give radio the breath of life

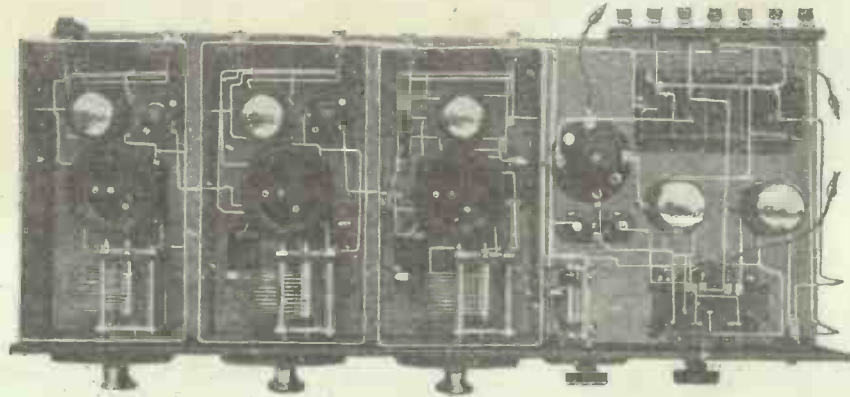

The Free Blueprint simplifies building to a degree that everyone may duplicate the original set wire for wire without the least difficulty.

The instructions for building this master receiver have been divided to cover six enjoyable evenings, making success certain.

THE great set for you is the Raleigh P.M.
 You will be amazed at the remarkable power which its five valves have at their command.

Imagine how much greater one's radio enjoyment would become if possessed of the Raleigh P.M. Once and for all radio from the Continent would find a welcome with all the members of your family. Their prejudice against "foreign stations" which you have almost despaired of ever breaking down, would vanish during your first half-an-hour's test. Think of the untold pleasures to which you will be able to treat them and your friends.

It is hardly creditable that two high-frequency stages are able to reach out to any part of Europe as one feels inclined to direct them.

Yet it is definitely the case, as hearing

is believing. On the long waves one journey round the dial brought in eight stations; most other sets satisfy themselves with four.

If your radio set is to provide your family with a variety of distant programmes at a volume as intensive as the local, it should embody not less than two high-frequency valves.

It must not be assumed that a large set is difficult to handle because it employs a large number of valves. The true state of affairs is rather to the contrary. A group of stations may be tuned-in on the Raleigh P.M. which by comparison almost place a slightly lower powered valve receiver into the category of the crystal set.

It is scarcely believable that the simple addition of two or three valves may completely transform a radio receiver so that it will always provide its owner with more programmes than will ever be called upon to deliver their entertainment. Such an overwhelming supply of music from opera to jazz, from musical comedy to the concert-hall, is at the call of any reader who owns a Raleigh P.M.

Fill in the coupon to-day.

STATION.	Aerial	1st H.F.	2nd H.F.
Unidentified 1	76.5	75	76
Radio Paris	71	68.5	65.5
Daventry	64	59	58
Eerlin	44	44.5	44
Unidentified	34.5	33	36.5
Unidentified	31	22	33
Unidentified 1	26.5	20	28
Hilversum	25	24.75	25
Budapest	94.5	92	93
Munich	88	80	80
Vienna	85	80.25	86
Brussels	83.5	85	85
Daventry (5G3)	81	82	83
Lappenberg	77	78.5	78.5
Oslo	75.5	77	77
Rome	73.25	75	75
Breslau	71.5	73.5	73.5
Frankfurt-on-Main	69	71.25	71
Cracow	68	70	70
Berne	65	68	67.5
Glasgow	63	67.5	67
Plymouth	62.5	66	66
Hamburg	62	65	65
Toulouse	60.75	61	61
Manchester	58.5	62.5	62.5
Stuttgart	58	62	62
London	56	50	57
Koenigsberg	45.5	50	50
Bournemouth	44.5	49	49
Paris	44	48	47
Dublin	43.5	47.5	46.5
Breslau	42	47	45.5
Newcastle	41	45	45
Belfast	38	44	42
Nuremberg	37	43.5	40.5
Liverpool and Hanover	36	41	41
Innsbruck	34.5	40	39
Edinburgh	34	37.5	38
Sibbi U and Cassef	31.5	33.5	32
Lille	29	31	29.5
Toulousa	27.5	28.5	27.5
Bremen	26	27.5	25
Gleiwitz	25	26	25
Muenster	23	23	23
Orebro	22.5	20.5	19
Halmstad	10	8	8

THE MULLARD RALEIGH P.M.

The PUBLISHERS, 63 Lincoln's Inn Fields, London, W.C.2. Please forward free, complete instructions, blue print and No. 4 RADIO FOR THE MILLION, to build this master receiver.

NAME.....

ADDRESS.....

F.W.7.

Mullard
MASTER · RADIO

MR. PERCY W. HARRIS GETS SUPER QUALITY WITH ANY SET

You can get just the same if you use the components this eminent wireless expert recommends. And what a list of R.I. and Varley products! First, there's the Straight Line Super Transformer, whose National Physical Laboratory Curve is your guarantee of real efficiency. (This transformer is so arranged that it can be used either as an ordinary transformer or as a push-pull input.) Then there's the Push-pull Output Transformer which has a greater area of iron core than any other on the market. Our Bi-duplex winding—now world-famous—is incorporated in the other two components specified. One of these is an Anode Resistance, and the other the Multi-cellular H.F. Choke. It is essential to use a really efficient H.F. Choke—the R.I. and Varley has a wave-length range greater than that of any other on the market—for no matter how good the L.F. Transformer or R.C. Coupler may be, distortion is bound to result if stray H.F. currents pass through the H.F. Choke.

It would hardly be possible to refer to SUPER QUALITY without mentioning our Bi-duplex wire-wound Resistance-Capacity Coupler, for this component has done more to bring real music into the homes of tens of thousands than any other on the market.

Lastly, there's our wonderful little General Purpose Transformer—costing only 15/-, which is literally sweeping the country to-day. It has been specified for the Mullard Master 3, and POPULAR WIRELESS refers to it as "An excellent Transformer, which falls very little short of those in the one-pound class."



Push-Pull Output Transformer, 22 6

Bi-duplex wire-wound Multi-cellular H.F. Choke, 9 6



Straight Line Super Transformer, 25 -

Bi-duplex wire-wound Anode Resistances Complete range of sizes up to 500,000 ohms. Prices, complete with universal holder, 5/6 to 17/6.

SPECIALISTS IN
L.F. AMPLIFICATION



THE MARK OF

BETTER RADIO

Kingsway House, 103, Kingsway,

London, W.C.2. Telephone: Holborn 5303.

Printed and published every Thursday by the Proprietors, The Amalgamated Press, Ltd., The Fleetway House, Farringdon Street, London, E.C.4. Advertisement Office: Messrs. John H. Lee, Ltd., 4, Ludgate Circus, London, E.C.4. Registered as a newspaper for transmission by Canadian Magazine Post. Subscription Rates: Inland, 17/4 per annum; 8/8 for six months. "Abroad, 19/6 per annum; 9/9 for six months." Sole agents for South Africa: Central News Agency, Ltd. Sole agents for Australia and New Zealand: Messrs. Gordon & Gotch, Ltd.; and for Canada: The Imperial News Co. (Canada), Ltd. Saturday, March 3rd, 1928.

£1,000 Television Challenge | Cossor "Melody Maker"

Popular Wireless

Every Thursday
PRICE
3d.

No. 301. Vol. XIII.

INCORPORATING "WIRELESS"

March 10th, 1928.

£1,000
FOR
WIRELESS TELEVISION
"P.W."
CHALLENGES
Mr. BAIRD

(See Page 47)

First of Two Special Articles on
The "Problem of Television"

By
SIR OLIVER LODGE

Read the Facts About the Topic of the Day

ON ALL POINTS

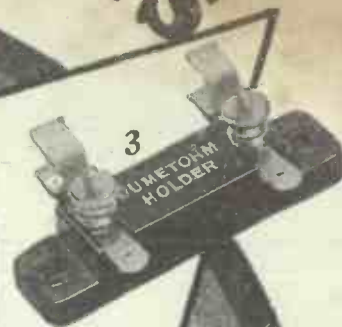

When you have built your Cossor "Melody Maker" you will want to be proud of your achievement—you will want your friends to praise its performance.

Messrs. Cossor have given you a fine circuit in which to use their valves; but besides using reliable valves you must have the other components equally reliable—if you would obtain the best results.

By embodying the Dubilier components here featured you will ensure perfect functioning in these parts at least.

On all points of performance Dubilier products are the "stars" in every good circuit.

(1) *Dumetohm*.—Specified for the Cossor "Melody Maker." 4 megohms 2/6, .5 megohms 2/6, 3 megohms 2/6.
 (2) *Dubilier Mica Condenser*, Type 620, for "Melody Maker."—.0003 mfd. 2/6, .0001 mfd. 2/6, .0003 mfd. 2/6 (including clips), .001 mfd. 3/-, .032 mfd. 1/-.
 (3) *Dumetohm Holder* for "Melody Maker."—2 at 1/- each.
 (4) *Dubilier Mansbridge Condenser* for "Melody Maker."—Type BB, 2 mfd. 3/6.

If unobtainable from your dealer write direct to us

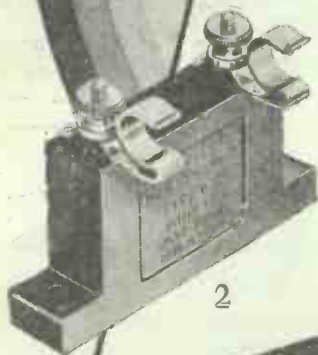

DUBILIER

THE "STARS" IN EVERY GOOD CIRCUIT

**SUSTAINED
POWER**
The
secret
of constant
volume

There is great POWER in a Marconiphone Long-life H.T. Battery. *Sustained* power that brings fresher, more vivid volume to your receiver—and maintains it to the end. Right through hundreds of programmes—smooth, life-like tone—never a trace of “crackle” or ripple.

It is the specially large cells, the unusually small internal resistance, the purity of the chemical compounds and metals and the infinite care in manufacture and assembly that account for this easy-flowing supply of *sustained* energy.

Buy, now, a large capacity Marconiphone H.T. Battery—the months to come will prove the wisdom and economy of your choice.



Marconiphone High Tension Batteries.

B.510	66 volts	£0 12 6
B.1570	108 volts	£1 1 0
B.517	60 volts	£1 0 0
B.497	66 volts “Popular”	£0 9 6
B.496	108 volts “Popular”	£0 15 6

Marconiphone Grid Bias Batteries.

B.500	9 volts	£0 2 0
B.251	16 volts	£0 3 6

Full particulars from your dealer, or send direct, mentioning “Popular Wireless.”

THE MARCONIPHONE COMPANY LTD.
(Dept. P.) 210-212, Tottenham Court Road, W.1.

MARCONIPHONE
LONG LIFE
HIGH TENSION BATTERIES

—and the wiring?
GLAZITE, of course!

Made in Red, Blue, Green, Yellow,
 Black and White.

Price 10d. per 10 ft. coil; 9d. per
 packet of four 2 ft. lengths (assorted
 colours).

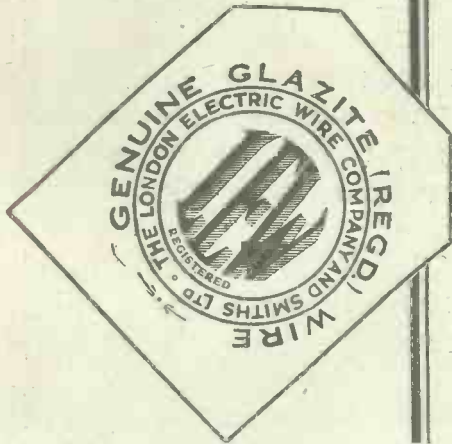

It is no surprise that GLAZITE is specified in the Cossor "Melody Maker." Since the earliest days of wireless, constructors have proved Glazite to be the simplest and most practical way of wiring every set. Despite many imitations it is still unchallenged in popularity; for only in Glazite do you get the high quality and expert workmanship which is essential if you are to avoid wiring faults. Always ask for GLAZITE by name and insist upon seeing the LEW mark on the label.

THE LONDON ELECTRIC WIRE CO. & SMITHS, LTD.,
 Playhouse Yard, Golden Lane, London, E.C.1.

As specified in the Cossor "Melody Maker"

Make sure of your copy of the March issue of

MODERN WIRELESS

To every reader is presented a pictorial Blue Print illustrating three of the most popular sets of the year:

**THE COSSOR "MELODY MAKER," THE EDISWAN
 R.C. "THREESOME," AND THE MULLARD "MASTER
 THREE"**

In addition to a long and comprehensive article upon the successful handling of these famous sets, the March issue is packed with practical radio value-for-money.

Articles by the leading radio technicians—Constructional details for several splendid sets—Radio and the Gramophone—in fact every phase of wireless is well represented in the March number of

MODERN WIRELESS

Obtain Your Copy NOW.

Usual Price 1/-

(Advance Notice.—A Special Solodyne Double Number of "Modern Wireless" is being prepared for April!)



BRITISH TRI-COLOUR VALVES

THE 'STANDARD' OF COMPARISON

If you use Two-Volt Valves, why not use the best? "Cosmos-Met-Vick" Short-path Valves, in the 'tri-colour' styles, Blue Spot, Green Spot and Red Spot are, by virtue of their special construction, inherently more efficient than any valves built on stereotyped lines. Hundreds of testimonials support this statement. They have become a 'standard' with which other valves are compared.

For your High Frequency stage or Resistance coupling you want the S.P. 16/B Blue Spot, your Detector needs a Blue Spot or perhaps the S.P. 16/R 0.09 Amp. Red Spot. For Transformer or Choke coupling use the S.P. 18/G Green Spot. Your Last Stage Valve must be an S.P. 18/RR Red Spot.

Combinations of these S.P. valves will astonish you if you have not already had experience of them. If you are a constructor you will know, if not ask your dealer which Cosmos Met-Vick Valve to buy for each stage. These valves are so sensitive and so full of kick and pep that you may require advice as to the type or types for your particular circuit.

Booklet 4117/3, which also gives particulars of S.P. 6 Volt Valves, and the remarkable 'Cosmos' Met-Vick A.C. Mains Valves, sent free on application.

MET-VICK

VALVES, COMPONENTS & SETS

METRO-VICK SUPPLIES LTD., 155, CHARING CROSS ROAD, LONDON, W.C.2.

R
V84

ALL EUROPE AT YOUR FIRESIDE!

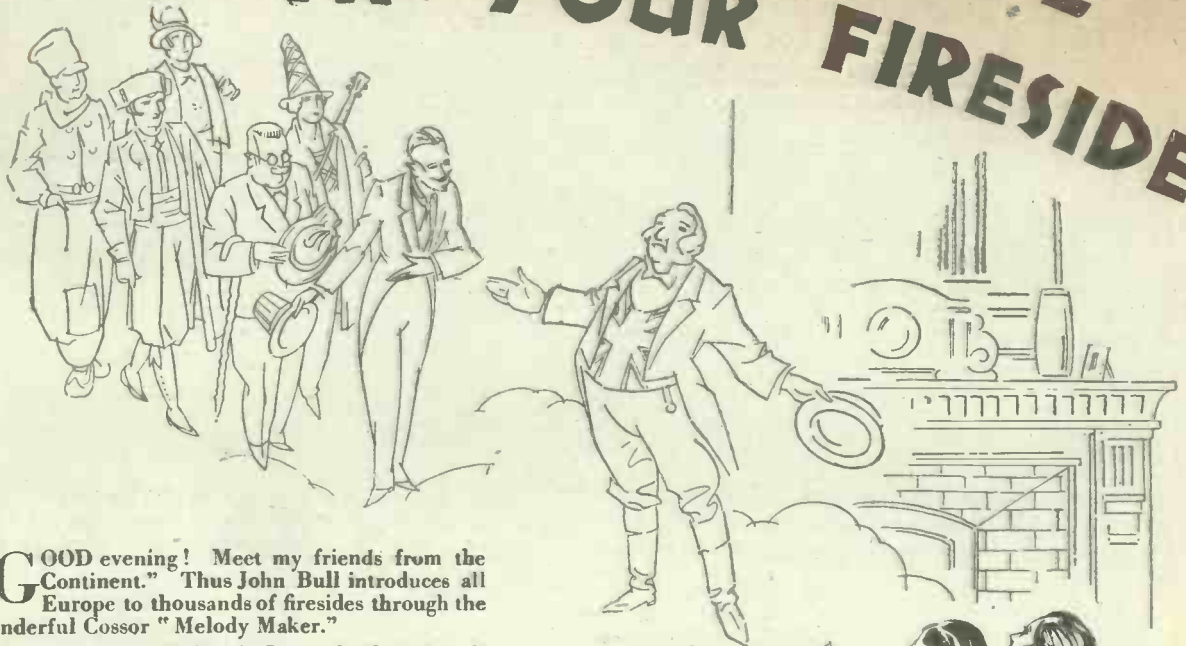

“GOOD evening! Meet my friends from the Continent.” Thus John Bull introduces all Europe to thousands of firesides through the wonderful Cossor “Melody Maker.”

France, Germany, Holland, Switzerland, Italy and Spain,—any or all, whenever you want them on a Set you can build yourself. Tens of thousands have already done so—people who don't know the first thing about Radio. For nothing so simple has ever been known before. Every step is clearly set out in the full-size chart “How to build the Cossor ‘Melody Maker,’” free from your Dealer. It's as simple as Meccano. There's no blue-print to puzzle you; no soldering to thwart you. If you follow the instructions you can't go wrong. In a few hours you'll build a Set that is better than many factory-built Receivers costing twice the price. Ask your Dealer to-day (or send a P.C. to A. C. Cossor, Ltd., Highbury Grove, London, N.5.) for “How to build the Cossor ‘Melody Maker,’” and build the Set that brings the broadcasting of Europe to your fireside.



THROUGH THE
WONDERFUL

COSSOR

“Melody Maker”

Adv. A. C. Cossor, Ltd.,
Highbury Grove, N.5

CA 1976

Popular Wireless

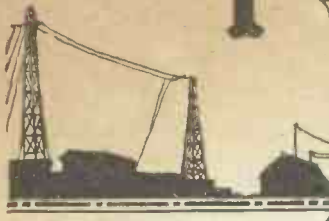

Scientific Adviser :
 Sir OLIVER LODGE, F.R.S.
 Editor :
 NORMAN EDWARDS, M.Inst.R.E., M.R.S.L., F.R.G.S.
 Technical Editor : G.V. DOWDING, Grad.I.E.E.
 Assistant Technical Editors : K. D. ROGERS, P. R. BIRD,
 G. P. KENDALL, B.Sc., A. JOHNSON RANDALL.



RADIO NOTES AND NEWS.

The Royal Radio Refuses—Reports on PCJJ—SOS Results—Amateurs Arise!— Listeners Honoured—B.B.C. and Welsh Music—Ariel's Programme.

Royal Radio Refuses.

QUITE a small incident, that of His Majesty's complaint at the British Industries Fair that he could not get Berlin free from London, and yet it has a peculiar charm for radio fans. It is very pleasant to think of the head of the Empire sitting down for a quiet spell at the dials. I'll wager that he, like us, feels the glow of triumph when an elusive station is at last extricated from the general "mush."

A Blow to "Big Bill"

AN unexpected sequel to the King's mild protest is the letter which has been addressed to him by the American League for the enforcement of the Radio Act, sympathising with his inability to get Berlin. The League's aim is to eliminate several hundred broadcasting stations in order to relieve the congestion of the ether, and they have called a listeners' strike. I doubt whether "Big Bill" of Chicago will recover from this blow.

Weather and Wireless.

I DO not propose to poach on the preserves of the newspapers by solemnly explaining why radio does not cause rainy weather, spots before the eyes, and Bright's disease. But just in passing, I should like to point out that a review of the correspondence shows that a large number of people still imagine either that a broadcasting station emits sound waves or that the atmosphere is the medium which carries the broadcast energy. One hardly expects everybody to study physics, but I should have thought that the current theory of E.M. radiation would have sunk in by now.

What is Ether?

IS ether a solid of terrific density or an airy nothingness? Personally, I should describe it as the name given to the something (if any) left behind when all the "matter" is (theoretically) removed from a container. If I wanted to be journalistic, I should say that it is "the substratum of the Universe." I am obliged to T. S. (Edinburgh) for a very professor-like and textbook-like theory of ether, too long to quote. Frankly, I am fed up on ether theories, which are numerous enough to fill a volume an inch thick—

which I never read. My reading of physics leads me to say that the ether is just another name for α . Mebbe; mebbe not.

Reports on PCJJ.

PLEASE address to Philips Lamps, Ltd., 145, Charing Cross Road, W.C.2. Information desired: Difference (if any) in reception now and before PCJJ moved. Any fading? When? Signal strength and quality. Is it heterodyned? Is wave-length constant? When are signals strongest? Please give details of receiver. The wave-length is 30.2 metres.

Transatlantic Telephony.

THIS service has now been extended to Stockholm, the calls being operated in the London Trunk Exchange by a "through" telephone cable circuit. That the Swedes can now barter Stockholm tar

for the more aromatic products of Cuba by word of mouth really is romantic. Great interest is focussed on the forthcoming trials of telephony to Canada via Bodmin "beam." If they are successful, the Marconi Company will have reason to congratulate itself on the biggest thing it has done in its twenty-five years' career.

S.O.S. Results.

THE very useful S.O.S. service of the B.B.C. was more successful during 1927 than during 1926. I presume that is because there were more listeners in 1927. In 1927 802 S.O.S. messages were broadcast, as against 1,072 in 1926; but 42.39 were successful, whereas the figure for 1926 was 38.4. The true results of the service are not reflected by these figures, however, as a large number of them are registered "Unknown?"

(Continued on next page.)

A VERY "MOVING" EPISODE AT HILVERSUM!

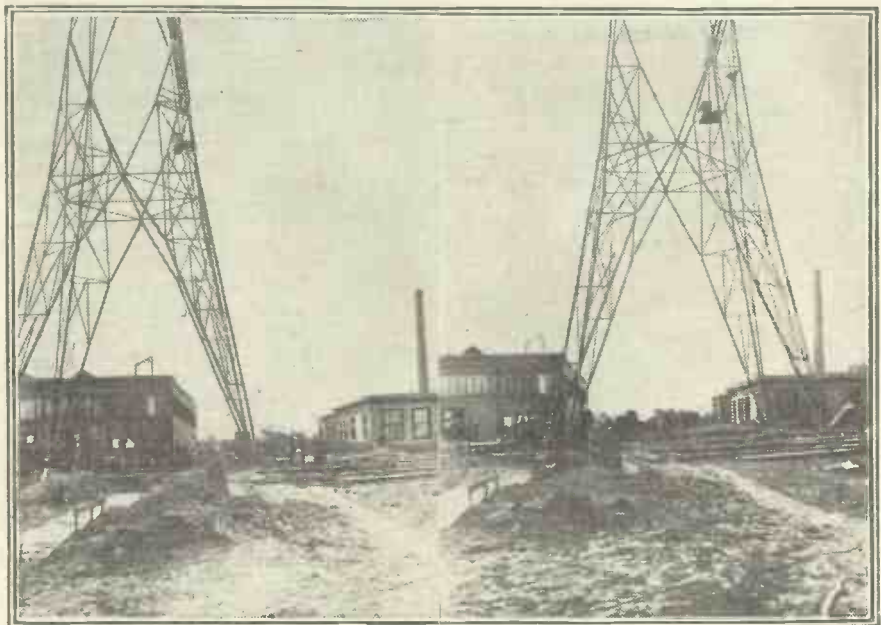

There was no doubt about it—the mast was in the way, said the Hilversum engineers. And they decided to move it, though it weighs about 35 tons, and is 230 ft. high! The pictures above show (left) the original position, and (right) the new location, 66 ft. away. The aerial was not dismantled, but during the operation was slackened off as the mast was moved.

NOTES AND NEWS.

(Continued from previous page.)

Educated or Ignorant?

O. F. C. (Derby) objects to my minor campaign against Chamber Music. He says that "the ignorant assume that music is provided for the mere tickling of the senses," and that C.M. contains 99 per cent of beauty to the educated listener, the odd 1 per cent being "interesting" on its own account. Out of deference to O. F. C., who has a perfect right to appreciate C.M. and to be an educated listener, I refrain from comment, but I would like to know whether music is "the food of love" or a problem in acoustics.

"Practical" Television.

JUST as I was sitting down to write these Notes, Messrs. Ernest Benn, Ltd., and the Postmaster-General conspired to drop through my letter-box a prospectus of a book entitled "Practical Television" by Mr. E. T. Larner, of the Post Office. I hope that the word "practical" is not intended to be a reflection on Mr. Baird, who contributes a foreword. The price is half a guinea, and the book is said to include full details of the Baird "televisor."

"Ham's" and "Pro's."

G. E. B. (Wood Green) quotes some words of praise addressed by Senatore Marconi to amateurs in regard to their work on short waves, and then, possibly because he does not realise that the problems and aims of the amateur and the "pro." are quite different, proceeds to belittle Marconi's work by claiming most of the short-wave glory for amateurs. No amateur living could have designed a Beam station to give a commercial telegraph service with Australia at 100 words a minute for hours at a stretch, and no "pro." would sit up half the night to exchange a few words with Australia on a $\frac{1}{4}$ kw. We must remember that the stars differ in their glory, and return generosity for generosity.

Amateurs, Arise!

PLEASE turn to my last Note in "P.W." for February 18th. In regard to this the chairman of the Association of British Radio Societies informs me that the Journal of the Association, "British Radio," is making preparations to deal with transmitters' interests, and invites correspondence on the subject. Address: 50, Garswood Road, Moss Side, Manchester. I hope "Ariel" will be favoured with a copy of the journal.

The "Chosen" People.

IF you want a job, you just trace your family tree back till it gets to Scotland by fair means or otherwise, and then you address your affliction to a Scotch director—and there's bound to be one on the board. Sir John Reith has divulged the fact that in applying for his position on the old B.B.C., he added, "No doubt you knew my people in Aberdeen." Well, a firm run by a Scot is generally well run. And it is only fair to point out that of the first eight stations erected by the B.B.C., Glasgow and Aberdeen were respectively the sixth and seventh.

Humour on the Bench.

WHILST dealing with a case of radio "piracy," a Hull magistrate found out that the Post Office official who detected the "pirate," had tested the set. "Do you charge anything for testing?" he asked. "Oh, no sir," replied the P.O. man. "Because," went on the merry cadi, "I have one that needs testing. Will you call and see if I have a licence?" (Laughter.) I laughed, too, when I read about it.

Many Listeners Honoured.

I HAD no idea, until "H." (Glasgow) told me, that Calvary Church, East Pittsburg, sends greetings during its service to many listeners over here. Glad to hear it! Shows that they listen-in to the right stuff on Sundays. My friend H. wants me to follow suit, because, he says,

SHORT WAVES.

An enthusiastic listener had to return a pair of earphones he purchased because they would not reach to his ears. His neighbour, hearing about this, remarked—as neighbours will—that he always knew him to be a highbrow.

"So you want a position as lumber salesman? Have you had any experience in this line?"
"Yes, sir; I used to sell Radio Logs."

TO SIR JOHN REITH.

To you, Sir J., our debt we owe is high and wide and deep;
You soothe our early morning nerves, your wave-lengths waft us asleep.
Culture on easy terms consoles; but from the 'phones we flee
When humour passed as up-to-date turns out to B.—B.C.—"Passing Show."

Another Finnish Concert is soon to be broadcast, we understand.
Yes, but when are the talks going to?

"Hurling by radio" runs a headline in the Manchester Evening Chronicle.
That's nothing; father hurled ours across the room the other day.

Service Station Proprietor: "Was there much deposit on Jones's battery?"
Bright Assistant: "None at all—Mr. Jones just said to charge it."

For radio lecturers and listeners-in:
The more we are together, the unhappier we shall be.

"A correspondent gives his opinion that a low low crystal coupled to two valve amplifiers, each with grid bias, is an admirable set for a loud speaker," we read in a London newspaper. It sounds 2-L. O. w. to us.

Wife, in exasperation: "For pity's sake, George, stop tinkering with that wireless set. It's working perfectly!"
Husband: "Is it my set or yours, my dear?"
—"News of the World."

it will do me good. I don't want to be done good on Sundays at midnight. I am then asleep, dreaming of "P.W.'s" circulation.

B.B.C. to Subsidise Welsh Music.

PRESUMABLY as a set-off against its refusal to open an all-Welsh station, the B.B.C. has undertaken to support financially a scheme for a "National Orchestra of Wales," which is to perform in public and broadcast nationally. Well, good luck to the scheme. Let us hope that the rest of us may be privileged to hear the new orchestra occasionally. But suppose the Scots want a National Bagpipe Brigade! Could not the Law Lords prove it to be illegal?

"My Programme."

TALK on "Pickles." (Cancelled.)
Chamber Music. (Breakdown of plant.)
Symphony, "The Death of Zgoldski."

by Xzjqp. First performance in England. (Composer and conductor arrested for cruelty.)

An Hour's Vaudeville. Including jokes about red noses, mothers-in-law, hen-pecked husbands, greyhound racing and short skirts; also songs at the piano by weak-voiced throw-outs from the "chorus." (Banned by the P.M.G., the Undertakers' Union, and the executors of Marie Lloyd and Dan Leno.)

The Wrong Inference.

THE B.B.C., far from reading the real moral of the success of the "My Programme" series, which I pointed out some weeks ago, professes that it has helped to show that it is impossible to find a programme which will please everybody. Good gracious! Every purveyor of entertainment regards that truth as axiomatic before he begins. The popularity of "My Programmes" showed that the listeners know what they like and that the B.B.C. does not. It is simply the bogies of education and uplift which are robbing the B.B.C. of the public's esteem.

Note for Listeners.

ON March 11th the B.B.C. will relay, via 2 L O, from Liège, the Legia Choir in "Les Emigrante Irlandais," "La vielle chanson," and "Le Rossignol." And on March 12th the second act of Mozart's opera, "Figaro," from Cologne. On March 17th it will be possible to hear a description of the England-Scotland Rugby match played at Twickenham, sent from 2 L O and 5 X X.

Another "Live" Society.

NAMELY, the Croydon Wireless and Physical Society (Hon. Sec., Mr. H. T. P. Gee, 51-52, Chancery Lane, W.C.2). Its meetings are held on Mondays at 5, Altyre Road, E. Croydon, and the syllabus up to June 18th looks fine. Nothing like joining a good radio club if you want to learn what's what in wireless.

Direct or Relayed?

WITH regard to the point raised by J. R. W. (Derby) about the difficulty of knowing whether reception is direct or relayed, C. L. S. (Lewes) mentions that he also heard W G Y via Stuttgart, but felt sure it was a relay because he noticed "the very quick fade of a short-wave transmitter, and then the usual five-minute fade found on German stations." C. L. S.'s keen observation does him credit, and his inference was correct; but I am afraid that the fading effects are not reliable enough as indicators of the origin of signals. I should welcome more letters on the subject.

Adding Injury to Insult.

EVEN when the demon "howler" is discovered you must be very careful how you remonstrate, for to accuse a person of oscillating is coming to be regarded as akin to calling him a wife-beater. Hear the epic of the Two Men of Mitcham, as reported in the police-court news:

Said Mann to Miles, "You howl like mad."
Said Miles to Mann, "You're just as bad."
Said Mann to Miles, "Let me advise—"
Said Miles to Mann, "Take two black eyes."

ARIEL.



WIRELESS TELEVISION

A £1000 Challenge to Mr Baird

THE greatest public interest has been aroused by the announcement of the recent transatlantic television experiment, conducted by Mr. Baird, of the Baird Television Development Company, and wireless experimenters and enthusiasts are naturally looking forward to the advent of wireless television as a practical possibility. Wireless television—real vision at a distance—is, in the opinion of scientists, quite possible. The world waits for it hopefully. But will it come as a development of the methods already being experimented with—or must some entirely new line of experiment be sought for and pursued?

Mr. Baird has publicly stated, after describing the television sets of parts now



A tray of dice and marbles.

being sold to the public as elementary and enabling only crude silhouettes to be received: "It is from this beginning that I hope to instruct and guide amateurs so that they will be able to receive the television broadcasts now being sent out from our station in Long Acre. Anyone listening in with a wireless set on 45 metres, after midnight, will hear a peculiar humming sound. The amateur with a televisor will be able to transform this curious sound into pictorial images."

The Conditions.

From other statements made by Mr. Baird, at various times, it is clear that he believes the system on which he is now working to be capable of greater development, sufficient at any rate to justify the installation of home television receivers.

While realising the value of Mr. Baird's pioneer work on television, the Editor of POPULAR WIRELESS and "Modern Wireless" and his scientific consultants remain unconvinced that much progress, further than that already achieved at present, can be made along the lines on which Mr. Baird is working and, in the interests of the readers of these two papers and of wireless science generally, they issue to Mr. Baird the following friendly challenge, which they sincerely hope he will accept.

POPULAR WIRELESS and "Modern Wireless" will pay to Mr. Baird the sum

of £1,000 if he will televise, by wireless over a distance of not less than 25 yards, the items mentioned below, under the conditions specified and in the presence and to the satisfaction of a select committee of competent investigators, to be appointed by the Editor. The detailed conditions of the challenge are set out below:

1. Three faces to be recognisable, together or separately, by the members of the committee. These three faces will be decided upon by the members of the committee, but they shall be three faces which are sufficiently familiar to the members of the committee so that under reasonable circumstances they shall be recognisable when televised by wireless. The committee shall not be informed as to the order in which these faces shall be televised.

2. That the committee shall be able to identify five simple solid geometrical models, singly, in slow motion, and televised in a sequence to be chosen by the Editor.

3. That the committee shall be able to recognise and state the number of dice and marbles shown in motion on a flat tray or board—the number of dice and marbles combined not to exceed twelve.

4. That the committee shall be able to recognise four animal toys grouped together and in slow motion. The members of the committee must be able to identify the animals these four toys represent. Only animals which might reasonably be found in a box of toy animals as sold in an ordinary toy shop will be used.

5. That Mr. Baird shall televise by wireless a clock face, the hands of which he may artificially rotate at the transmitting end, and at a speed to be left to his own discretion but which must be recognisable by the committee at the receiving end, and in such a way that when the hands are not rotated the members of the committee shall be able to tell the time on the clock.

It is a condition of the above challenge, should Mr. Baird decide to take it up, that the committee shall not be required to witness more than three separate attempts; and, further, that when such attempts are made, such experiment shall not extend over a period exceeding two hours.

Power Supply.

All demonstrations must be made in London, and the electrical power used at the transmitting and at the receiving ends must be derived from two distinct and separate sources. A mutual power supply will not be permitted.

The above conditions, even if fulfilled, would not, of course, mean that a practical television service could be started, but it would indicate that some progress in the Baird system has been made.

The Committee.

In making this friendly challenge to Mr. Baird in the hope that he will win the £1,000 prize we offer, it is a condition that he formally takes up the challenge within seven days of the publication of this issue of POPULAR WIRELESS. If, at the expiration of that period he has not written to us formally accepting the challenge we shall assume that our offer is declined.



Simple geometrical figures.

Should Mr. Baird accept the challenge, the offer holds good for a period of six weeks from the date of his formal acceptance of the terms of the challenge as set out above.

We, on our part, undertake the appointment of an impartial committee of four investigatory members, two of whom at least shall be qualified scientific men. Neither the Editor nor his staff, nor any consultants connected with the paper in any way whatever, will be on the investigatory committee.

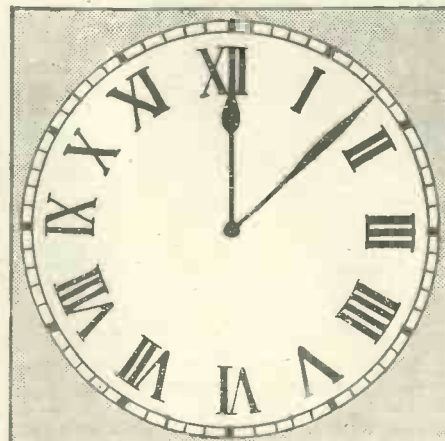

Drawing of the type of clock face, which we ask Mr. Baird to televise by wireless.

NEW JACKS FOR OLD.

By R. W. HALLOWS, M.A.

Jack switching forms a very convenient method of varying wireless circuits, but it sometimes happens that the particular type of jack required is not available when wanted. In this article our contributor indicates how jacks can be altered to suit various types of circuits.

THERE must be many readers who have on their receiving sets jacks of the plain double and single circuit type which, though they enable a valve or valves to be cut out at will, do not control the filaments. They would like to fit filament jacks, but are not enamoured of the idea of scrapping their existing components and of laying out money upon new

fixing. The arms are the hooked contacts, which are forced against either the sleeve or the body of the plug as it is inserted, and the leaves are the shorter metal pieces. The arms and leaves are separated by insulating blocks made of a greyish insulating substance. In the frame are two threaded holes spaced about one centimetre apart, whilst there are large

plain holes, similarly spaced, in the arms, leaves and insulating blocks. Through these, when the jack is assembled, pass the insulating tubes, and through them again the screws which hold the parts together.

Dismantling the Jack.

Now let us see how the double closed jack (Fig. 2) can be turned into one of the double filament pattern (Fig. 3). Begin by taking it to pieces. Besides the frame, the insulating blocks, the insulating tubes and the screws, you have two arms and two leaves. Looking at Fig. 3 to discover what your requirements are, you see that you need one arm and four leaves.

The arm must be that which makes contact with the point of the plug (4 in Fig. 2, and *d* in Fig. 3). One of the leaves (*b* in Fig. 3) needed is longer than the others. This longer leaf is made by cutting down the sleeve arm (1, in Fig. 2) of the double closed jack.

The remaining leaf is easily made from a piece of springy sheet brass or German silver. You will need also two or three more thin insulating blocks, which you can cut from $\frac{1}{8}$ -in. ebonite. Through these drill in the proper positions 4 B.A. clearance holes, and *not* holes large enough to pass the insulating tubes. Probably the screws will be too short owing to the increased number of insulating blocks used; should this be so others of greater length must be used.

Additional Spacers.

You also need a small insulating piece to enable the arm *d*, in Fig. 3, to move the leaf *b*. This is made in the following way: Make near the end of leaf *b* a hole with a drill of about No. 30 Morse size or a little smaller. Cut off a short piece of $\frac{3}{8}$ in. ebonite rod and place it in the chuck

of the hand drill, allowing rather more than $\frac{1}{8}$ in. to protrude. Fix the drill horizontally in the jaws of the vice and get a friend to turn the crank for you. Hold a file against the protruding end of the ebonite rod and turn it down until it will just pass through the hole drilled in leaf *b*. Remove the piece of rod from the chuck and trim off the wide part until its length is equal to twice the thickness of an insulating block.

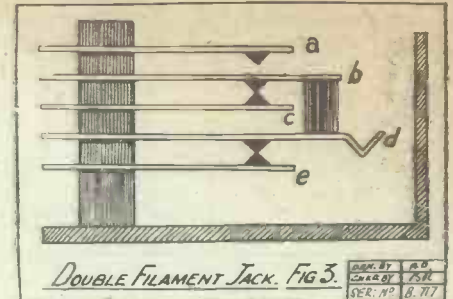

Now pass the small end through the hole drilled in leaf *b* and file down until it is rather less than $\frac{1}{16}$ in. above the surface of the metal. Heat up a poker or an old soldering iron, and with it touch the protruding tip of ebonite, as shown in Fig. 4. This will cause it to soften, and as soon as it has cooled it will be found that the connector is firmly fixed to the arm.

We are now ready to begin assembling the jack. The first thing to do is to place an insulating block between leaf *e* and the arm *d*, and to discover how many of the

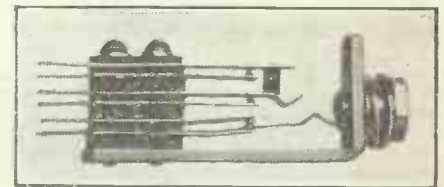

new blocks that you have made must be placed below the former in order to take the latter up to the proper height. If the arm is too low the plug will not go in smoothly, and both the arm and leaves *a* and *b* will be strained as it is inserted; on the other hand, if it is too high it may not force the arm away from leaf *e* or cause leaf *b* to make proper contact with leaf *a*. For the packing below leaf *e* use the blocks that you have made.

All the other blocks should be those obtained when dismantling the double closed jack. Now put the jack together, spacing the parts as shown in Fig. 3, and when you have clamped down with the screws the job is nearly done. It only remains to make quite sure that when the plug is not in place leaf *d* is making contact with leaf *e*, and leaf *b* with leaf *c*, and that when the plug is inserted contact is broken between leaves *d* and *e*, and *b* and *c*, and made between leaf *a* and leaf *b*.

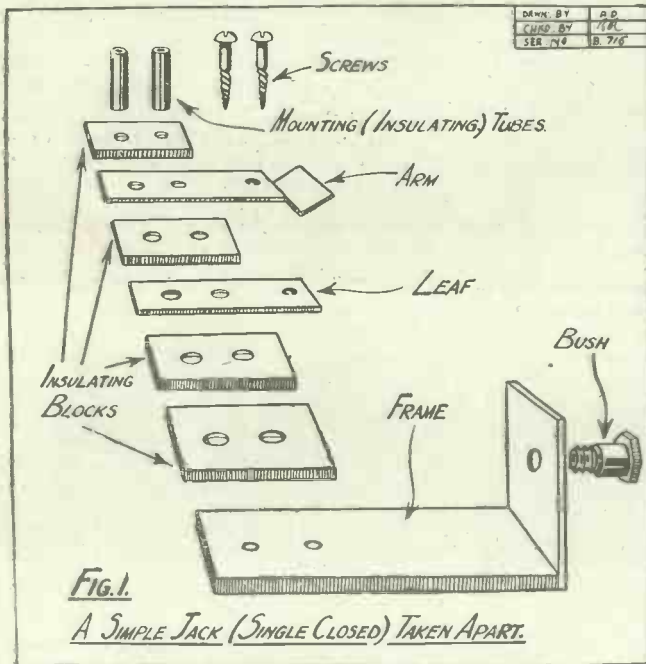
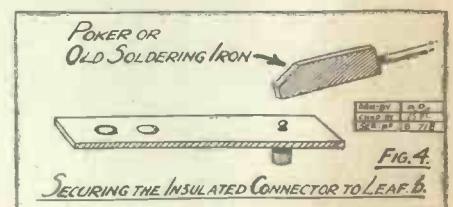

ones. Actually there is no need for any scrapping, since by the exercise of a little ingenuity it is a comparatively simple business to convert almost any type of jack into any other. If, for example, you possess the common combination of a double closed jack and a single open you have almost all the parts needed for making double and single filament jacks.

Fig. 1 shows the component parts of a simple jack, in this case of the single closed circuit pattern. The foundation of the device is the frame, into one end of which screws the bush, thus providing a one-hole

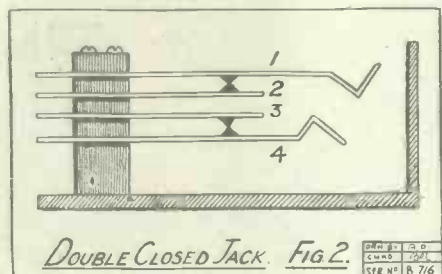



Mr. Franklin Dyall and the "Rose Bowl" Loudspeaker, in "The Silent House."

ALTHOUGH the number of broadcasts from the West End theatres are necessarily limited, owing to the existence of the agreement between the West End Managers' Association and the British Broadcasting Corporation, which only allows a certain number of outside broadcasts in each year, the question always arises after the broadcast of a popular musical show as to whether the legitimate stage has suffered or is suffering from the effects of broadcasting.

In my experience of the theatre I have had the opportunity of studying closely the feelings of the "powers that be" in the theatrical world. The views of those who control the variety side of public entertainments are well known, but in the world of legitimate musical shows and West End theatres, however, opinions as to the merits and disadvantages of wireless are more or less divided.

Fifty per Cent "Dud."

One in every two shows broadcast is a failure. Three of the musical shows which were broadcast and which I liked best of all were "No, No, Nanette," "Lido Lady," and "Lady Be Good." It would be unfair to give the names of the failures. It is enough to state that even the B.B.C.'s worst revue was better than any of these three shows.

To my mind, the B.B.C.'s latest broadcast of a musical comedy was a great disappointment. I am referring to "Oh, Kay!" The only point in its favour was the singing of Miss Gertrude Lawrence. It is a pity the B.B.C. decided to broadcast what is known to be an unsuitable show for radio. It is difficult enough to broadcast a good show with the best results.

When the B.B.C. broadcasts shows like "Oh, Kay!" it is then that they are

DOES BROADCASTING HARM THE THEATRE?

instrumental in causing people to believe that wireless is harmful to the theatre.

The following opinions, however, are representative of what those in the theatre feel about it.

Sir Gerald du Maurier.

I must admit that I am a great admirer of modern wireless and its value as an entertainment for the millions. Personally, I do not think it is harmful to the theatre. For instance, the type of entertainment given over the wireless can never prove a serious competition of the fare given at a West End theatre. The two entertainments are as the poles apart.

Where wireless can and does harm the theatre is in its broadcasting of shows. If the show, as seen at the theatre, is excellent, and the broadcast is a poor one, then it does inconceivable harm in the fact that a great many people will base their conclusions by what they have heard on the wireless. The theatrical manager has to be very careful about the broadcasts of his plays, otherwise he will very soon find out that a bad broadcast can kill a good show, as easily as a good broadcast can turn a failure into a success.

Miss Evelyn Laye.

Broadcasting should not harm the theatre; it should, in fact, prove a decided help. As I have never actually been on the management side of a theatre, I cannot answer the question as fully as I would like to. In my mind there are two separate publics, one for wireless and one for the theatre. It is ridiculous to suppose for one moment that because someone has had a wireless set installed he will no longer go to the theatre. I do not think the wireless set produces the perfect entertainment that will keep the listener away from legitimate entertainment.

A Symposium of Views.
Collected by "ARIEL."

ment. On the contrary, it should prove a fillip to their theatre-going tastes.

Mr. Nelson Keys.

I have always looked upon wireless with awe. It would not amaze me to hear of anything it does;



Miss Binnie Hale.

but I am convinced in one thing, and that is that it emphatically does no harm to the theatre. The only harm it can do, and that is unconsciously, is by giving unfaithful reproductions of popular entertainments taking place in the theatre. It must be a very difficult task to find suitable stage shows that are suitable wireless shows. It is a task I should not like to be entrusted with. So many musical shows and even straight plays rely on their situations for effect. Modern humour in a modern play would rarely get over but for its comical situations and the personality of the artistes.

No Harm Done.

That kind of play does itself a lot of harm by being broadcast. Otherwise I do not see what harm broadcasting can do to the theatres, unless it is by adverse criticism of all the shows running, a thing it has not yet done, and which I don't suppose for one moment it is ever likely to do.

Miss Binnie Hale.

I should think that broadcasting does very little harm to London theatres and London shows. Certainly it has not reached the stage of perfection that it can keep away audiences from the theatre, and in my opinion it never will. Broadcasting is an attraction entirely on its own. It is an admirable entertainment in its own way, but I do not think for a moment it will ever prove a serious rival to the theatre.

In the provinces there are some who might prefer to stay by the fireside and listen to the London programme in preference



Mr. Jack Hulbert.



Mr. Nelson Keys.

(Continued on next page.)

AVOIDING BREAKDOWNS.

A word of warning to the owner of a multi-valve set.
By P. R. BIRD.

NOW that multi-valve sets are becoming increasingly common it should be more generally realised that the output stage of such a receiver involves breakdown-dangers which are not met with in the smaller sets. The anode current handled by a large modern power valve represents a great deal of energy, and if this energy is underrated or wrongly applied it may easily result in an expensive breakdown.

Many multi-valve set users do not yet trouble to turn off their filament current before they adjust the high tension to the last valve. Yet a sudden making or breaking of a comparatively heavy current such as that flowing through the output circuit of a modern receiver, sets up sudden surges of current which may entail a heavy strain upon the parts in circuit.

The Output Circuit.

A glance at Fig. 1, which represents a typical output circuit of a modern receiver, will make the position clear. The anode circuit comprises an H.T. supply, a valve, and an output winding. Considering these three in turn, if the H.T. supply is of the dry-cell type of triple-capacity battery the full load should not be called for or interrupted suddenly, if this is avoidable. So neither of the H.T. plugs should be adjusted unless the filament has been switched off first. The filament current "bridge" builds up and dies down comparatively slowly according to the emission of the valve being altered as the heat due to the L.T. is applied, so the interruption caused by the filament switch is a comparatively harmless one.

From the point of view of the valve itself, it is equally advantageous to switch on the high-tension current slowly, if possible. As the working emission from the filament is in the neighbourhood of 20 or 25 milliamps, it is obvious that an unnecessarily sudden "pull" should be avoided.

Finally the very sudden switching on or off

of a heavy anode current involves a certain strain upon the apparatus connected across the output terminals. Whether this be the loud speaker itself, a low-frequency choke, or the primary windings of a low-frequency output transformer, it is evident that a powerful magnetic field exists at this point, and the frequent sudden making and breaking of this field may easily damage the instrument. Therefore, for the sake of all the apparatus connected in the output circuit,

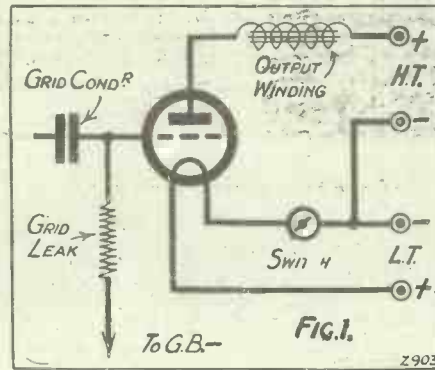

it is not advisable to adjust either the H.T. negative or the H.T. positive plug while the filament is glowing.

The Effect of Grid Bias.

There is one other point which may not be apparent on the first examination of Fig. 1. The normal anode electron flow from H.T. negative to H.T. positive via the valve and the output choke is a comparatively steady one, subject to variations due to signal voltage on the grid of the valve. The "impedances" through which this current flows are the valve itself and the output winding, the value of the latter being a constant one, and that of the valve being varied by the signal voltages. The

circuit is quite capable of dealing with considerable fluctuations in anode current, but it will be seen that in order to protect the apparatus it is not advisable to adjust the grid-bias plug whilst the filament of the valve is glowing. The working impedance of the valve is mainly dependent upon the grid-bias negative voltage applied to its grid, and if the grid-bias circuit is suddenly broken by the removal of one of the plugs the whole of the conditions under which the valve is working is altered. Its impedance will be suddenly reduced considerably, and an additional anode current of perhaps 25 milliamps will flow in the anode circuit.

An A.C. Warning.

If, however, the set in question employs an H.T. battery eliminator working from A.C. mains, it is advisable to switch on the filaments before switching on H.T. This is because if the H.T. is switched on when the filaments are "off" the condensers used in such an eliminator will become charged with the "peak" voltage of the A.C. unit, which is much greater than the nominal voltage of the supply. So with A.C. mains the usual plan is to switch on filaments first.

In conclusion, it must be admitted that neither the modern H.T. battery, the power valve, nor the output winding are unreasonably delicate, and it is not implied that sudden interruptions of the anode current are certain to ruin one or all of them. But on the contrary it should be realised that a multi-valver's output stage involves a degree of strain which does not exist in the smaller receivers. If it is desired to give proper consideration to the apparatus in use, the owner of a powerful set will not lightly alter either the grid-bias plugs or the H.T. plugs without bearing in mind the effect on circuit conditions.

THREE FAMOUS SETS.

- THE COSSOR MELODY MAKER—
- THE MULLARD MASTER THREE—
- THE EDISWAN R.C. THREESOME—

are shown in detail in the
FREE PICTORIAL BLUE PRINT
which is given away with every copy
of the March issue of

MODERN WIRELESS

Now on Sale. Usual Price 1/-

DOES BROADCASTING HARM THE THEATRE?

(Continued from previous page.)

to going through bad weather to see a show. In London the show is not the only attraction of an evening in town, there is also the supper and dance after, or the dinner beforehand. When one has nothing else to do, however, there is nothing better than turning on the loud speaker for an hour or two.



"June," of "Clowns in Clover."

Mr. Jack Hulbert.

There are some admirable things in the wireless programmes of to-day. They are so much different from the things one sees or hears in the theatre. It is sometimes a welcome change to be entertained at one's own fireside without having to brave the inclement weather and other disadvantages of an evening at the theatre. But the two can never be compared. The listener who will be satisfied with a little music and a light revuette, a little news and some informative chatter of an unusual nature, will have nothing to complain of.

"If Wireless Did Not Exist."

While accepting the fact that wireless does little harm to the theatre, I do not mind also admitting that if wireless did not exist the public might even be more ardent theatregoers. An imitation of the real thing, no matter how unsatisfactory the imitation, will always have its following. And as the imitation in this case is a highly

satisfactory one we should be very mean to envy the success that it must very necessarily have.

"Only the Best"—June.

I once heard a very bad broadcast of a good musical show. That is where wireless can do, in a roundabout way, a great deal of harm to the theatre. Broadcasting is such a powerful advertising



Miss Gertrude Lawrence.

medium, and in that alone it must be respected. I do know that the broadcast of a musical show has a great effect on the box office. It is up to the theatre to provide the best shows, and the B.B.C. to broadcast only the best shows.



The PROBLEM of TELEVISION

BY
SIR OLIVER LODGE F.R.S.

The first of two articles specially written for "Popular Wireless" by our Scientific Adviser-in-Chief. These articles should enable the non-technical reader to appreciate the real problem of television, and to understand why the policy of "P.W." on this topic has been dictated by a desire to tell our readers the plain unvarnished facts.

THE EDITOR.

I.—GENERAL CONSIDERATIONS.

THE transmission of pictures must be always much more difficult than the transmission of music or speech; for sound is essentially a sequence, the ear appreciates only one note at a time; whereas vision appreciates an immense number of impressions at the same time. Hearing is only a sequence, while vision is a simultaneity as well as a sequence.

Hearing and Sight.

It may and will be said that surely an ear appreciates a harmony of simultaneous sounds. So it does, but it does it by analysing one note—if we correctly use the word "note" to signify a definite mode of vibration however complex, whereas the word "tone" signifies a simple vibration of definite pitch. A note may be composed of any number of tones, and the inner ear has a construction which enables it to analyse a note into its constituent tones.

But it does not receive those tones separately; it receives only a single complex vibration, which could be transmitted

to it through a single rod, or through the contact of a single point on a diaphragm; as indeed we are familiar with in the gramophone, where the tones of a whole orchestra are transmitted as a single complex vibration through a needle point. The ear it is which sorts out that complex vibration and analyses it into the harmony of simultaneous tones.

There is thus no difficulty encountered or any problem to be overcome in the transmission of simultaneous impulses; they all travel together as a single group; and in that form they enter the mechanism of the outer ear; they are not analysed until they get inside.

With the eye it is different. Every point or small element of the retina is a separate receiving station, and they are all at work simultaneously; so that every patch of luminosity on an outside object produces its own impression independently of the rest; and thus a picture or a landscape can be appreciated as a simultaneity.

Birth of the Cinema.

If an object looked at moves, it can also be appreciated as a sequence, because when the stimulus ceases at any one place the nerves almost instantaneously, though not quite, cease to respond; so that if the illuminated patches are moving about outside, the corresponding images will be moving inside the eye, and different receiving stations will receive them one after the other.

That is not so with a photographic plate. There the impression one produces is persistent; and if the outer objects move, the result is mere confusion.

Consequently, though it is easy to project a moving scene or landscape upon a screen, as in the camera-obscura, just as it is done in the eye, it was not easy to photograph a moving scene so as to project it upon a screen; and about thirty years ago it could not be done. Strictly speaking, it is not done now. What is projected is a series or sequence of pictures, not quite alike, but following each other so closely that the illusion of continuous movement is produced from the series of jerks or intermittent

illuminations which are really supplied. Each impression on the eye lasts long enough to merge into the one that follows it, without any necessary flicker or variation in the intensity of average illumination.

The problem before television is how to



Sir Oliver Lodge, F.R.S.

transmit such a moving scene or picture to a distance. And, considering that the projection of moving pictures themselves is a recent invention, it is not surprising that the reproduction of them at a distance is a difficult problem.

Action of the Eye.

The outer part of the eye, the lens and chamber with the various adjustments, are very like a photographic camera; but the retina differs in innumerable ways from a photographic plate, for not only can it appreciate moving objects by reason of the small persistence of vision, but each point of the retina is a receiving station, capable of attunement to three different wave-

(Continued on next page.)



How a face "looks" when received by Wireless Television.

THE PROBLEM OF TELEVISION.

(Continued from previous page.)

lengths simultaneously—the red, the green, and the violet—and can thus appreciate a compound impression.

Unlike the ear, however, it does not analyse this impression into its constituents; it merges them into one, which may be quite different from either separately. It is quite capable of appreciating a single wavelength, like our ordinary wireless stations, if a pure or simple red or green or violet is incident upon it. But if it receives more than one it fuses them into another sensation altogether, so that if it receives red and green simultaneously it gives a sensation called yellow. While if it receives all three impressions simultaneously it gives us what we call white.

Telephotography.

By artifice even these devices can be imitated artificially, as we know in colour photography and the three-colour process. But the eye does everything so simply and easily that we fail to realise the wonder of it, until by long-continued experiment we find how difficult it is to transmit a clear impression of moving objects, even though we have eyes at the distant end to do most of the work and to give our crude experiments every chance.

The easiest thing to transmit telegraphically is a static picture or engraving, which may be built up by a number of dots, and these dots might be transmitted simultaneously and reproduced as a mosaic at the distant end by the use of a multiple cable with as many wires as there are dots. I do not say it is easy to do that, for I made attempts in this direction about fifty years ago with the use of selenium, and found it very difficult. Still, a more pertinacious experimenter might have succeeded. Transmission of a mosaic by multiple wires is imaginable.

But how are we to do it by a single wire, or, what comes to much the same thing, without a wire at all through the unlimited ether? We cannot hope to transmit the

dots simultaneously; we must transmit them as a sequence.

We can imagine a point travelling over the picture, taking one element at a time, and reproducing a patch of corresponding luminosity at the distant end. The moving



This picture of Capt. Hutchinson at the American end during the transatlantic "Television" experiment was sent across by radio. It probably took about ten minutes, and is, moreover, a "still" photo. One would have to speed up the process at least ten thousand times before crude but passable television was obtainable.

point need not travel quickly; the thing to be transmitted is steady and constant, and gradually a corresponding reproduction at the distant end can be built up. The process requires ingenuity and invention, but, as everyone knows, it has been done, both with a communicating wire and without, so that excellent portraits have been received at a distance. Well, that is one step towards television, though only a very early step.

Difficulties of Television.

Now let us consider how to transmit a moving picture, either an actual person or an image of such person, or a landscape projected on a screen. We have now not merely a simultaneity to be transmitted as a sequence; we have both a simultaneity and a sequence to be transmitted together; and, as that seems impossible, we must contrive to move our points so rapidly over the picture that the image of each point at the distant end will not have faded from the retina before all the others have been projected on it likewise. The time of persistence of vision depends partly on brightness, but it is comparable with from one-twelfth to one-sixteenth of a second.

Hence if in, say, one-twelfth of a second the tracing point can move all over the picture without missing any salient detail, then the images at the distant end successively produced may be perceived by an eye as if they were all simultaneous. In other words, an illusion of simultaneity may be produced.

And if the tracing point continues to repeat its motion over the picture continually, then any movements which have been projected there will naturally appear also on the distant screen. In imagination, therefore, the thing could be done if we had a sufficiently rapid moving point able to be affected by the illumination at one end, and if there were some device for reproducing that illumination synchronously at the distant end. To achieve that, however, immense ingenuity, research and skill, and indeed actual discovery, would be needed.

Searching the Object.

First, there is the moving point to be considered. Well, that would not be anything mechanical. It might be a small beam or pencil of light, which either by a rapidly vibrating mirror or by rapidly rotating lenses might be made to travel very quickly over any desired zigzag path. Then there is the transmitting instrument to be affected by the varying intensity of that light. This might be a photo-electric cell—that is to say, a contrivance which emits electrons, and thereby generates a current, varying in intensity with the amount of illumination. Having got such a current, however feeble, it is possible nowadays to magnify it by amplifying valves, so as to produce an effect at a distance.

And if this effect at a distance is the illumination of a screen, and if the receiving pencil of light can be made to move over that screen with the same rapidity and at the same time as the pencil at the sending end, then that screen would have reproduced upon it a succession of spots of illumination so rapidly succeeding one

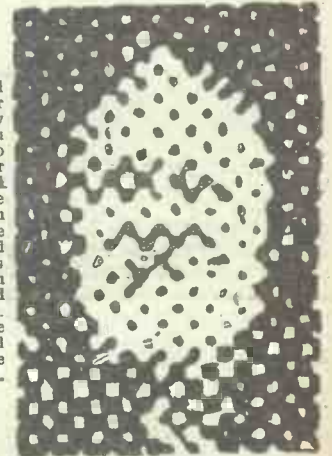

If you hold this picture far enough away from you, you will be able to discern a fair image of Lord Kelvin. The photos in "P.W." are fashioned more or less similarly from black and white dots. This example was televised by land-line 20 years ago.

another that to an eye they would seem to be simultaneous and give the required picture.

All this might seem fanciful and imaginative, for the intermediate stages which render such results possible have been here left out. But it is not so fanciful and imaginative as might at first sight appear, for up to a certain limit of imperfection the thing has been actually done. Human ingenuity has already been able to achieve something in the desired direction.

In next week's "Popular Wireless" Sir Oliver Lodge will conclude his examination of the Problem of Television as science regards it to-day. At the end of his article he gives a warning and a caution which every experimenter should read with interest.



Mr. Baird photographed at his London laboratory.

The POPULAR AMPLIFIER

PART 2

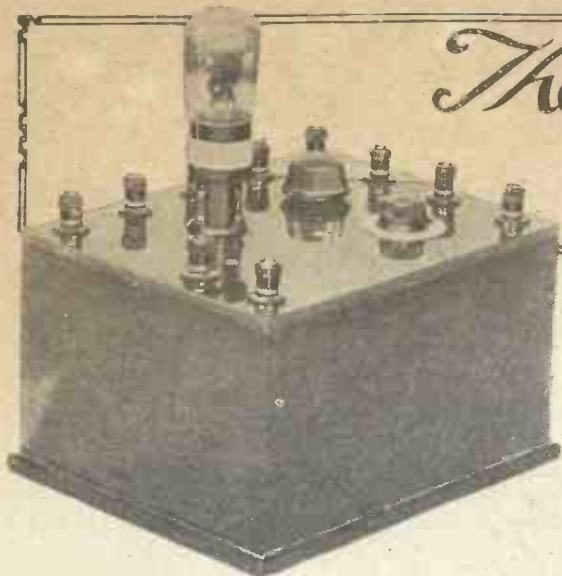

This handy little unit is the flat-topped version of the simple but efficient amplifier which appeared in our last issue.

Described by
A. JOHNSON-RANDALL.

Four components have to be mounted on the panel and, in addition, there are the various batteries, loud speaker, and input terminals. All the dimensions for drilling the panel are given on the drilling diagram on this page. This work is perfectly straightforward and the holes should be marked out on the back of the panel, and not on the front.

The holes for the valve holder may cause a certain amount of worry at first sight, but actually this operation is very

(Continued on next page.)

IN these days sets or units with "flat top" panels are not very common. There are, however, still a large number of two-year-old receivers of this type that are giving perfectly satisfactory results. The addition of an amplifying unit to these sets has hitherto been rather a problem, owing to the fact that practically all of the more modern lay-outs have made use of the American type of upright panel and baseboard.

Suitable For Any Set.

When the "P.W." Research Department was asked to produce a first-rate single-valve amplifier to suit any set it was decided that the best scheme would be to make up

are practically identical with those previously used. Of course, any good alternatives can be chosen. For example, there are a wide range of other rheostats available, including the Bowyer-Lowe, Burndept, G.E.C., Igranic-Pacent, Precision, etc. The L.F. transformer can obviously be chosen to suit the taste of the constructor as to price, etc., while in the case of the fixed condenser, such well-known makes as Clarke, Dubilier, Edison-Bell, Lissen, Mullard, T.C.C., etc., are suitable. The engraved terminals, again, might be of Belling & Lee or Eelex make if desired.

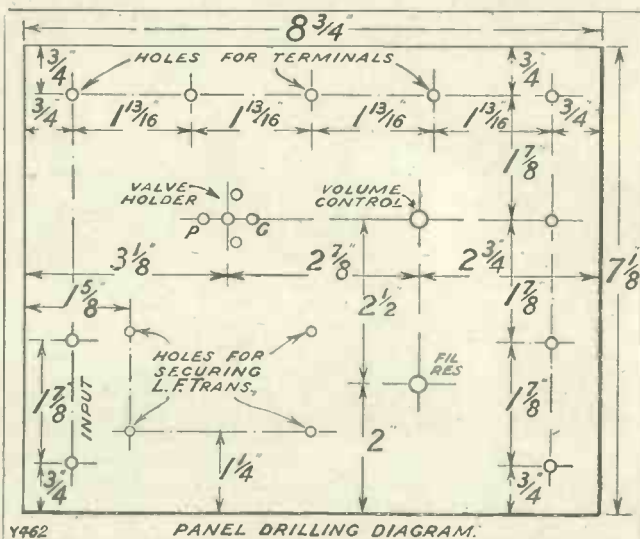
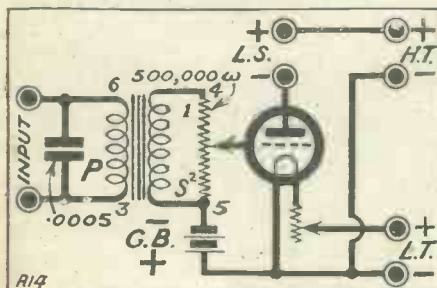

the unit in two different forms. One lay-out should be arranged to match up with the upright panel type of receiver, whilst the second was to have a horizontal panel so as to be suitable for use with the less recent set designs. The upright panel amplifier was described last week, and this—the second unit—is practically identical except for the fact that the whole of the components and terminals are arranged on a flat panel instead of a baseboard.

The amplifier can be employed with any set which does not already employ more than one stage of L.F. with transformer coupling. It is absolutely up-to-date in every way, and will give splendid reproduction. It is not critical, and the increase in signal strength obtainable by its use is extremely high. A glance at the photographs and back-of-panel diagrams will show how simple the lay-out is.

The components indicated in the list following are those actually in the amplifier, and in order to make the comparison with the American type as close as possible they

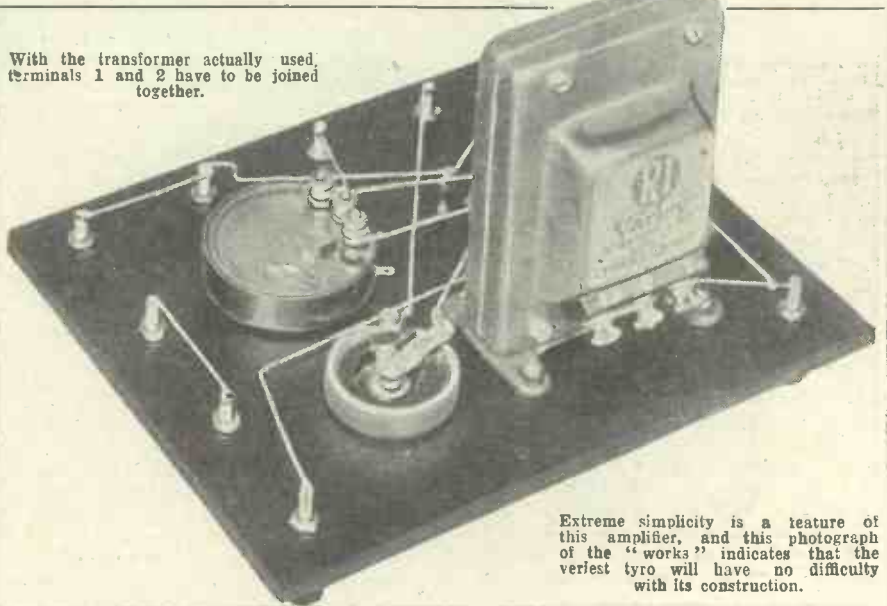

With the transformer actually used, terminals 1 and 2 have to be joined together.

Extreme simplicity is a feature of this amplifier, and this photograph of the "works" indicates that the veriest tyro will have no difficulty with its construction.

THE POPULAR AMPLIFIER. PART 2.

(Continued from previous page.)

simple. A standard valve socket is used and, in consequence, the holes which have to be drilled in the panel have only to be spaced so as to permit the four contact tongues to pass through.

In any case, with most of these valve holders a drilling template is supplied. The easiest method of wiring up the unit

COMPONENTS USED.

- 1 Ebonite panel, $8\frac{1}{2}$ in. \times $7\frac{1}{2}$ in. \times $\frac{1}{4}$ in
- 1 Containing box to suit (Peto-Scott).
- 1 500,000-ohm potentiometer ("Centralab," Rothermel Corporation of Great Britain).
- 1 Filament resistance (Lissen).
- 1 Super straight-line L.F. transformer (R.I.-Varley).
- 1 .0005 fixed condenser and mount (Igranic).
- 1 Valve holder (Lissen).
- 10 Terminals, marked L.T. +, L.T. -, G.B. +, G.B. -, H.T. +, H.T. -, L.S. +, L.S. -, and Input (Igranic).

is to use one of the insulated wires or, alternatively, bare tinned copper busbar, over which is slipped a length of Systoflex covering. Those who have tackled these jobs before can use bare wire without any insulation covering, if they wish, since this is perfectly safe provided careful attention is given to the spacing of the various leads. If bare wire is employed there should be a space of at least $\frac{1}{2}$ in. between the leads where they cross, otherwise there may be a danger of short-circuiting the batteries.

Let us now see how the unit can be joined up to an existing wireless receiver. The two "Input" terminals are joined to

the existing telephone terminals on the set. If the set already has a fixed condenser connected across these terminals, it should be disconnected because there is one joined across the L.F. transformer primary and the value is critical.

up the loud speaker and the unit is ready for use.

The amplifier can be used in conjunction with a crystal set by joining the telephone terminals on the receiver to the two "Input" terminals on the unit. The H.T.

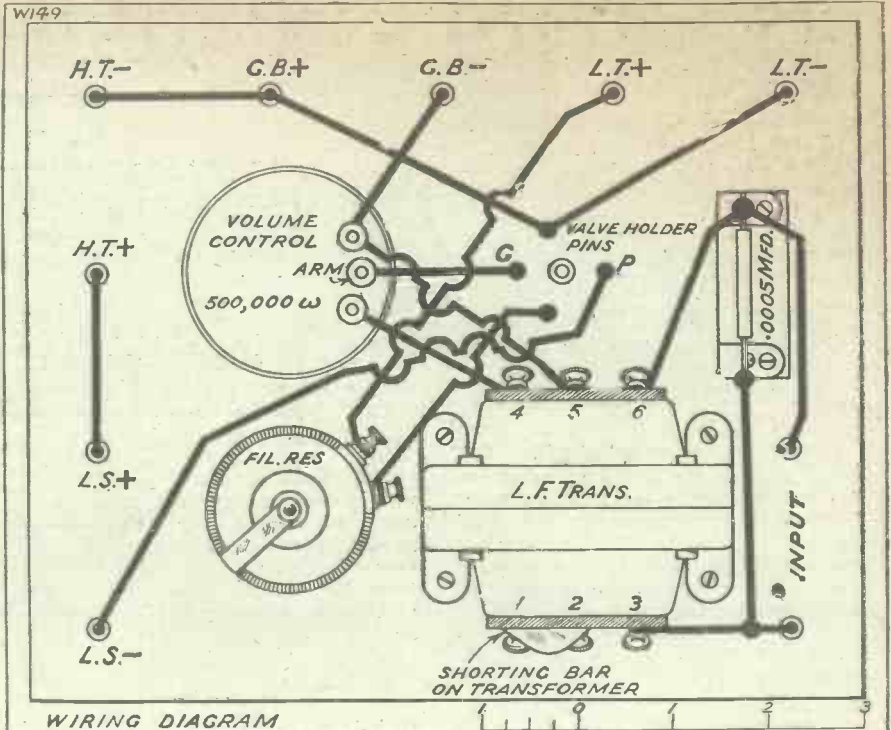

Connecting Up.

Next take two leads from the existing L.T. battery or from the L.T. terminals on the set to L.T. + and - on the unit. Join up a small grid-bias battery to G.B. + and G.B. -. Take a tapping from the H.T. battery to H.T. + on the unit and also connect up H.T. -. Do not connect the H.T. - terminal in the set to the unit or the H.T. battery, but leave the existing H.T. + connection undisturbed. Then join

and L.T. and G.B. batteries are then simply connected straight to their respective terminals on the unit.

With a crystal receiver it sometimes pays to join L.T. - to the earth terminal on the set. Do not forget to choose a filament resistance with a definite "off" position, because the rheostat has to fulfil the duties of an "on-off" switch. If there is no "off" position you will not be able to switch out the valve.

For most purposes a valve of the small power type will be found perfectly satisfactory. Suitable valves in the 6-volt class would be as follows: Marconi or Osram D.E.5, Mullard P.M.6, B.T.H. B.4, Cosmos S.P.55/R, Cossor 610L.F., etc. Valves in the 2-volt class having similar characteristics can also be employed.

If the signal strength is very great, such as might be the case if the set to which the unit is attached utilises three valves, one of the "super-power" valves can be used in the amplifier socket. In these circumstances a grid battery giving valves up to about 18 volts will be needed. For an ordinary small power valve a 9-volt grid-bias battery will be quite adequate.

A suitable H.T. value is 120 volts, and the grid bias should be adjusted in accordance with the makers' instructions, which will be found either marked on the box or on the small pamphlet which is usually supplied with the valve.

One of the special features of this amplifier is the efficient volume control which is incorporated. If the signals are very strong and tend to overload the loud speaker or valves, a slight turn of the knob will reduce them to a comfortable strength. This control will be found extremely useful when receiving from the local station,

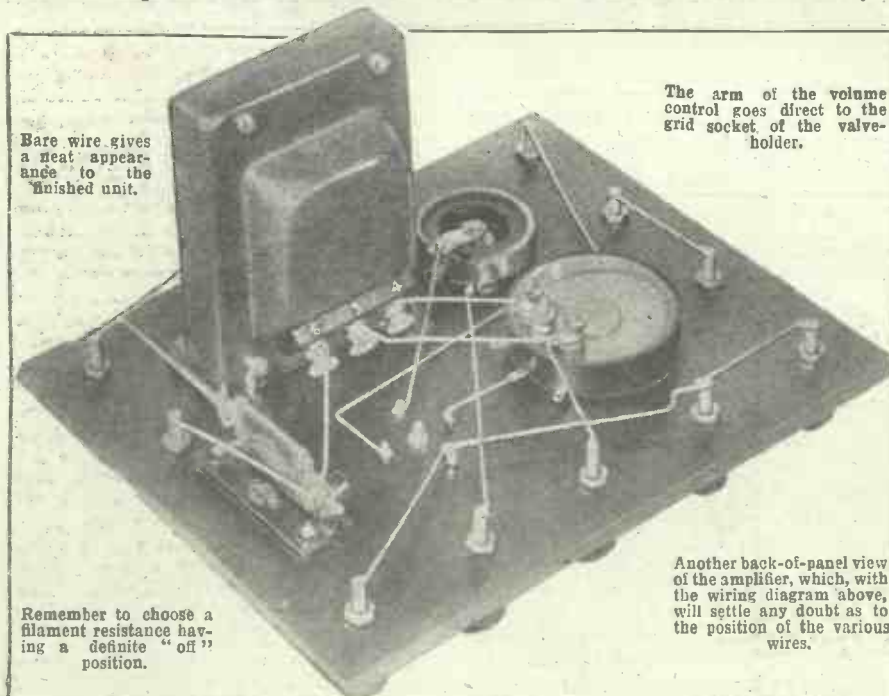

Bare wire gives a neat appearance to the finished unit.

The arm of the volume control goes direct to the grid socket of the valve-holder.

Remember to choose a filament resistance having a definite "off" position.

Another back-of-panel view of the amplifier, which, with the wiring diagram above, will settle any doubt as to the position of the various wires.



WIRELESS ON A WINDJAMMER

Did you hear the recent broadcast talk upon the above subject? Whether or no you listened-in, you will be interested in this article concerning an eventful voyage from Australia.

(FROM A SPECIAL CORRESPONDENT.)

THE wonders of short waves and their amazing possibilities were more than fully exhibited during the

epic voyage of the famous old windjammer "E. R. Sterling" from Adelaide, Australia, to London.

In an interview with a "P.W." representative, Mr. M. B. Anderson, the 20-year-old wireless operator of the battered ship, gave absorbingly interesting details of the use of his wireless during the vessel's eventful voyage.

A Well-known Amateur.

Mr. Anderson owned the amateur transmitting station A 5 M A in Adelaide, and having communicated with unseen friends in all parts of the world, he seized the opportunity of a job as wireless operator in order to visit some of them personally, and to conduct many valuable experiments.

When the ship was dismasted in a terrific gale in the South Atlantic he endeavoured for five days, without success, to get through to land, 340 miles away, by means of the commercial 1,000-watt spark transmitter on 600 metres. When he employed his 30-watt short-wave set, however, he managed to get a message through to Seattle, the ship's home, almost at once, with the assistance of an amateur in Michigan, U.S.A. ! This, said Mr. Anderson, was a good instance of the splendid results obtained throughout.



Mr. M. B. Anderson, wireless operator of the "E. R. Sterling," photographed on board that vessel before commencing the interesting and exciting voyage described above.

Communication was maintained with Adelaide and Seattle during most of the trip; and when the ship was still to the south of New Zealand, C 4 F Z in Winnipeg, Canada, was successfully worked on about 35 metres.

The reception of short-wave broadcasting stations proved an unspeakable boon while the ship was being tossed by a gale in the middle of an ice-field near Cape Horn. The American stations 2 X A D and K D K A came in well all the time, and Captain Sterling, the owner-master of the "E. R. Sterling," was able to pass many a weary watch on the poop deck with a concert from New York to Sydney to cheer him up.

Reception from the B.B.C. short-wave station, 5 S W, was not quite so good, but some fine results were obtained from this station, too. Mr. Marcuse's station, 2 N M, also came in well.

Equipped with a straightforward three-valve receiver, which could tune from 15 to 30,000 metres, Mr. Anderson received Press messages in Morse all through the voyage. The high-powered G.P.O. station at Rugby on 18,740 metres, he said, came in well off Australia, but later on he took his Press from New York on 40 metres, partly because the news was more interesting and partly because reception was more reliable.

Compact Radio Outfit.

In the island of St. Thomas, where the "E. R. Sterling" put in as the result of a storm, he was given a wonderful reception

by the only two amateurs on the island. Mr. Anderson wishes to take this opportunity of expressing, through the columns of POPULAR WIRELESS, his appreciation of the hospitality of his brother amateurs wherever he has met them. He intends to stay in England for a while before returning as passenger to his home in Australia.

As yet, he is not certain whether he will work his radio on the way home or not, although the whole set is very compact and easily adaptable to any conditions. The

receiver and transmitter are incorporated on one panel, only the H.T. supply to the transmitter valves being apart. This consists of a small motor-converter worked from six-volt accumulators and supplies a direct current at 500 volts to the transmitter, which employs a circuit known as the three-coil Meissner with the well-known choke-control system of modulation for telephony.

Interesting Experiments Tried.

Very little speech was emitted while the ship was at sea, as Mr. Anderson found certain "swinging" difficulties owing to the unusual nautical conditions on a sailing ship: with the same set, however, and working from Adelaide, he has succeeded in transmitting spoken messages to Texas and other distant latitudes. During the voyage he conducted a number of tests with different aerials, including the Hertz type, which he found unsuitable for use on a windjammer, where so many stays, sheets and sails are liable to interfere with its electrical properties.

When Mr. Anderson recently broadcast a short talk from the London studio, many listeners must have wished that he had more time at his disposal to enlarge upon his interesting account of the voyage. Mr. Marcuse—the amateur transmitter of Empire-broadcast fame—appears to have been one of these, for he telephoned Mr. Anderson after his talk and expressed a desire to see him and his apparatus. Perhaps we shall hear of some further useful experiments conducted between these two short-wave experts during Mr. Anderson's return passage.



WHERE THE WORK WAS DONE.

A photograph of the "E. R. Sterling's" wireless cabin, in which signals from all over the world were picked up whilst the vessel weathered her way round Cape Horn.

"P.W." AND MR. BAIRD.

£1,000 CHALLENGE.

By THE EDITOR.

IN this issue we make known the details of a challenge in connection with wireless television, and in particular with Mr. Baird, which we would ask our readers to study carefully.

Wireless television during the last few months has received an extraordinary amount of publicity, and there can be no question that the majority of people are under the impression that the television problem has at last been solved, and that before very long a wireless television service will be inaugurated.

Component parts for television models have, in fact, already been advertised, and Mr. Baird himself, at a recent luncheon given in his honour, has stated that amateurs with wireless television receivers may listen in after midnight to his station working at Long Acre, London, on a wavelength of 45 metres, and will hear a peculiar humming noise which, with the necessary apparatus, they may transform into pictorial images.

The question of what constitutes pictorial images is one which has not been clearly explained, and for that reason alone it is clear, from the correspondence we have received and from the remarks we have heard expressed by members of the general public, that there is a prevalent impression that with a wireless television receiving apparatus to-day it is possible to receive in one's home moving pictures by wireless. And although that is tempered by the belief that these pictures are crude, it is equally obvious that the public do not realise how crude these pictures are.

The Difference.

Furthermore, instructions have been published elsewhere regarding the construction of home television receiving sets, and, as we pointed out in a recent issue of this journal, advice has been offered to the effect that when working these machines a high-tension supply of six or seven hundred volts should be used.

Mr. Kendall, the chief of our Research and Construction Department, has rightly pointed out that the use of such a voltage by people unaccustomed to electrical work may prove serious in the extreme, for even six 100-volt H.T. batteries wired up in series may give a fatal shock.

In view of all this, and in particular in view of the optimism expressed in connection with the Baird Television System, we are making a friendly challenge to Mr. Baird to televise by radio, before a select and impartial investigatory committee, a series of objects, and if Mr. Baird can do this over a distance of twenty-five yards (using any power he likes providing the power at the receiving and at the transmitting ends is not taken from the same source) we will willingly accept the verdict of the committee, and, if favourable to Mr. Baird, pay him £1,000.

In our opinion, and in the opinion of Sir Oliver Lodge, our scientific adviser-in-chief, and in the opinion of one of our scientific

consultants, Dr. J. H. T. Roberts—and furthermore in the opinion of many other scientific men whom we have privately consulted—a strong public warning is necessary with regard to television. And we feel that some means should be adopted in order to demonstrate that, although wireless television is scientifically not an impossibility, it has not yet by any means reached a stage whereby it can be termed or regarded as a public utility service.

Nor, in the opinion of our scientific advisers, is it scientifically correct to assume that certain known systems are capable of development to an extent or likely to mature, in such a way as to provide a public television service in the near future.

There are other systems of wireless television, in particular a system which makes use of cathode rays, which suggest possibilities, but Mr. Baird, for example, still clings to a system which was demonstrated in this country some time ago; and an official of the Baird Wireless Television Development Co. has made statements, which have appeared in the daily Press, to the effect that further improvement as regards detail are in themselves details.

We invite our readers to send us their views concisely expressed, and for publication, on the Television Problem. We have also made arrangements to deal with any queries from experimental amateurs who wish to take up an intensive and practical study of Television, and need advice.

On scientific grounds we contest such statements and, as a result, make public this friendly challenge to Mr. Baird. We sincerely hope that Mr. Baird will accept this challenge, and nothing would give us greater pleasure than to be proved wrong in our belief that his system has definite limitations.

It would be a matter of great gratification to us to find that Mr. Baird, on accepting our challenge, could successfully carry out the details of the contest we suggest elsewhere in this issue, and thus win the £1,000. We ourselves should be the first to congratulate him.

Wireless television will undoubtedly become a practical proposition in the future. Whether it will be in the near future or whether many, many years will have to pass before the enormous difficulties which now confront the problem have been obviated, remains to be seen. In the words of our scientific adviser: "It is foolish these days to say that anything is impossible." And we at least claim that we have never taken up such an attitude with regard to wireless television as a whole.

But in the interests of our readers and in the interests of those who are inclined to

feel unduly optimistic because of certain recent experiments in television we have issued this challenge to Mr. Baird in the hope that it will help clearly to indicate what we consider to be, and what our scientific consultants consider to be, the exact position of television to-day; and that it will have the effect of dispelling many erroneous impressions which have been so current of late.

Mrs. Snowden and the B.B.C.

One thing is certain about the B.B.C., and that is that as long as Mrs. Snowden is a Governor it will always have someone in an official capacity who may be relied upon to say exactly what she thinks.

Her latest utterance is to the effect that critics among the listening public are fools whom the B.B.C. were able to suffer gladly. Added to this, she has expressed the opinion that the licence fee of 10s. a year ought to make the B.B.C. free from criticism.

"After all," she is reported to have stated, "what on earth do people expect for the money?"

"Ridiculous."

Obviously Mrs. Snowden was speaking for herself and not in accordance with the policy of the B.B.C., for in reply to a question a B.B.C. official stated:

"We have always welcomed criticism, and naturally do not expect that it will all be either constructive or in our favour. That we should be immune from criticism is, of course, ridiculous."

Mrs. Snowden may have been speaking in a light vein; but, on the other hand, she may have been deadly serious. If so, her reasoning is not very logical. It is not a question of what the public pays for its broadcast service, but it is, in fact, more a question of principle. The B.B.C. have set themselves certain standards, have even obtained a Royal Charter, and have propagated the belief that they are a public institution devoting their whole-time service to the public.

Putting it Bluntly.

It is not for the officials of the B.B.C. to serve the public in ratio to the individual amount paid by members of the public. The public to them should be not a mass of individuals out of whom they can pick one individual and judge the quality of their work by the fact that that individual pays 10s. a year, but as a community which, because of its size, is enabled by small individual contributions to provide what should be a very satisfactory and useful sum of money, out of which the B.B.C.'s share be devoted to the provision of a public utility service.

The A.A. could teach the B.B.C. a thing or two in the matter of organisation and in the matter of giving an unstinted and valuable service. And certainly we cannot imagine its popular secretary, Mr. Stenson Cooke, speaking in public to the effect that he and his colleagues should be immune from criticism on the grounds of the size of the payments made by individual members of the Association!

Mrs. Snowden seems to have an exalted idea of the Olympian importance of her duties and of the duties of the B.B.C. and, to put it bluntly, her suggestion that critics among the listening public are fools whom the Corporation were able to suffer gladly is entirely uncalled for.



CAN BE BUILT WITH LISSEN PARTS

*Congratulations to Messrs. Cossor
on an excellent set.*

It has been definitely proved that LISSEN parts can be used for this Set with eminently satisfactory results, as well as for every other type of Circuit which may be popular at a given time, and which requires Standard parts of recognised quality.

LISSEN parts are guaranteed to give satisfaction every time they are used. Test the LISSEN TRANSFORMER against any other, and if you are then willing to part with your LISSEN, and return it within seven days of purchase, your money will be willingly refunded.

Use the other LISSEN parts as well, resistances, condensers, rheostats, valveholders, batteries, etc.

Lissen Parts for the Cossor Melody Maker

- 1 Lissen L.F. Transformer (Price 8/6).
- 1 Lissen '001 Fixed Condenser (to be put across the primary of the L.F. Transformer) (Price 1/-).
- 1 Lissen Base-board Rheostat, 7 ohms (Price 1/6).
- 2 Lissen Key Switches or Lissen 2-way Switches (Price 1/6 each).
- 2 '0003 Lissen Mica Fixed Condensers (grid leak clips arc included) (Price 1/- each).
- 1 '0001 Lissen Mica Fixed Condenser (Price 1/-).
- 1 '001 Lissen Mica Fixed Condenser (Price 1/-).
- 1 '002 Lissen Mica Fixed Condenser (Price 1/6).
- 1 Lissen Mansbridge type Condenser, 2 mfd. (Price 3/6).
- 1 Lissen Grid Leak, 3 meg. (Price 1/-) and 1 Lissen Combinator (Price 6d.).
- 1 Lissen Grid Leak, .25 meg. (Price 1/-).
- 1 Lissen Grid Leak, 4 megs. (Price 1/-) and 1 Lissen Combinator (Price 6d.).
- 3 Lissen Valve Holders (Price 1/- each).
- 1 Lissen 9-volt Grid Bias Battery (Price 1/6 each).

Also use the Lissen H.T. Battery

All these Lissen parts for the Cossor Melody Maker are obtainable from 10,000 radio dealers throughout the country. Ask for Lissen parts in a way that shows you will take no other, and be sure of perfect results.

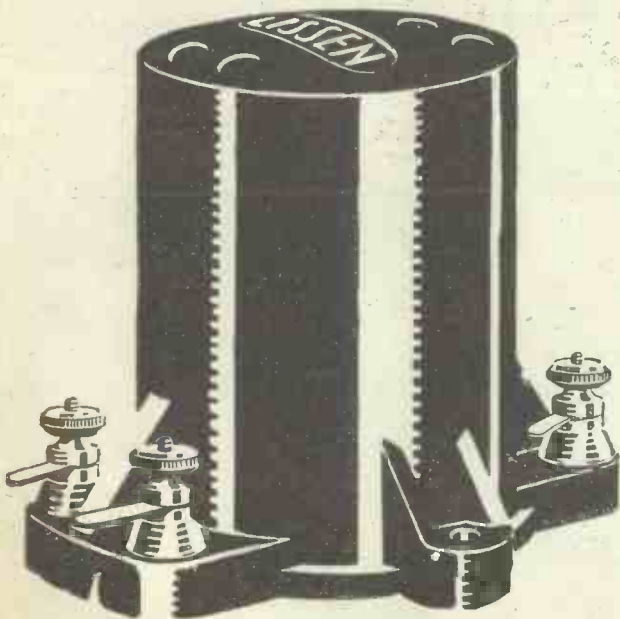

LISSEN GRID LEAK 1/-

LISSEN
COMBINATOR
6d.

LISSEN

LISSEN

LISSEN LIMITED,

8-16, Friars Lane, Richmond, Surrey

Managing Director: Thomas N. Cole.

HOW TO MAKE MICA DIAPHRAGMS.

By J. F. C.

QUITE a fascinating series of experiments on headphone reproduction may be carried out by substituting a mica diaphragm for the usual stalloo one. A diaphragm of mica is lighter than a diaphragm made of metal, and consequently it can be actuated by a smaller current in the headphone windings. Naturally, the whole of the diaphragm cannot be made of mica. A certain area of metal must be present in order to receive the pull of the magnets.

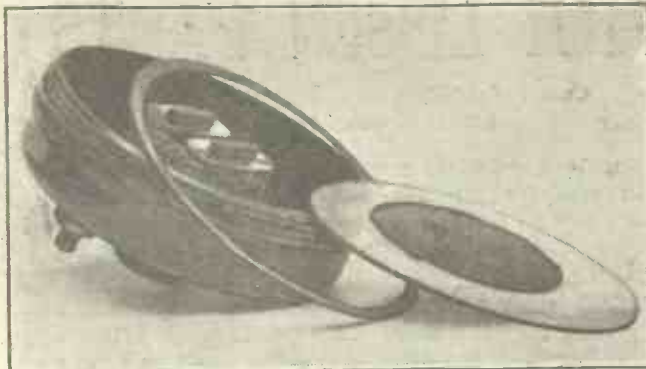

A mica diaphragm made up exactly in accordance with the accompanying simple instructions. Note the metal disc.

Quite a useful mica diaphragm for headphone use may be made by procuring a fair-sized piece of good thin mica, and by cutting out of it a circular piece just large enough to replace the metal diaphragm of the earpiece. In the centre of the mica

diaphragm is cemented a thin circular disc of sheet iron (obtained from an old diaphragm, or from some similar article) of a diameter just large enough to enable it to cover the poles of the phone magnets.

Easily Made.

Good shellac varnish makes an excellent cement for the above purpose. It should be thinly laid on the surface of the metal disc and also on the mica, and the two surfaces should be brought together after the shellac varnish has attained its "tacky" stage of drying. The metal disc and the mica diaphragm are now pressed together overnight by laying a heavy weight on top of them.

When adjusting the diaphragm on the 'phones, care should be taken to see that the metal disc on the under side of the diaphragm is just clear of the magnet poles when it is in its normal position. This, of course, can be effected by raising the diaphragm up with large metal washers if necessary.

Very Effective.

A mica diaphragm made as above will give very effective reproduction, especially on the high notes. At all frequencies, however, its behaviour is interesting, and much can be learned by having a pair of headphones, one earpiece of which is equipped with the usual metal diaphragm, and the other of which is fitted with a diaphragm of the mica type, and by carefully comparing the relative efficiencies of the two earpieces at different tonal frequencies, and under varying conditions of signal strength.

side of the filament, a streak appeared on the glass (see Fig. 1), and this amounted to a silhouette of that piece of filament.

The experiments of Professor Fleming, in which he shielded the negative leg of the filament with a plate, enabled him to prove conclusively that there was an actual stream of negatively electrified particles passing from the negative leg to the metal plate, an actual current flow being indicated in the sensitive meter M of Fig. 2.

The accompanying untouched photograph of a Royal Ediswan lamp, now in my possession, first installed in its bayonet socket for actual use in 1911, shows very clearly this phenomenon. The circular

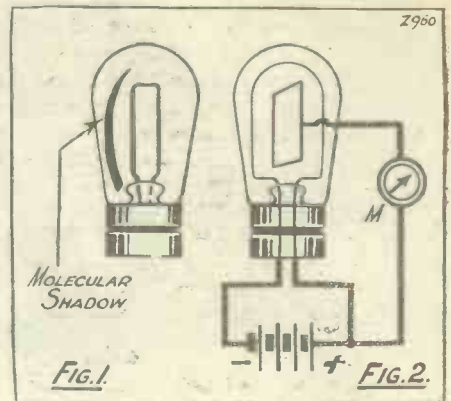

marking is the shadow referred to, the particular shape being due to the shape of the filament inside the bulb. Although older readers may have seen this effect themselves, many of the younger generation will have not, since with modern wire-drawn electric lamps such occurrences are very rare.



An untouched photograph of a 1911 electric lamp, which very clearly shows a "molecular shadow."

RADIO JOTTINGS.

When the telephone wires between London and Paris were out of action owing to a recent storm, the only quick means of communication was by wireless.

A series of international amateur tests was arranged by the American Radio Relay League, to take place between February 6th and February 20th, 1928. Prizes are to be awarded to the amateurs who received the greatest number of replies from abroad.

Canada, United States, Australia, New Zealand, Sumatra, Penang, South Africa and India have all reported the satisfactory reception of 5 S W, the Chelmsford short-wave station.

There are three stations operating under the Indian broadcasting company, namely, Calcutta, Bombay and Rangoon-Burma. The respective wave-lengths are 370, 357 and 350 metres.

The first horizontal directional aerial was patented by Marconi in 1905.

THAT "EDISON EFFECT."

By H. J. B. C.

THE term "Edison Effect" will be familiar to all readers of this journal who have studied the history of the growth of the thermionic valve, for it was the development of this phenomena, initially noticed by Edison in 1884 (hence the name), that enabled Professor Fleming to produce the first two-electrode valve.

A "Molecular Shadow."

In the early forms of carbon lamps the disintegration of the carbon particles from the lamp filament caused a blackening of the inside of the bulb. These particles were shot off in straight lines, and it was found that the filament disintegration generally took place at one particular portion of the filament more than at any other.

This was due to unevenness in the cross section, and thus at one point the filament had more resistance than at other points, with the result that more heat was developed there, and in the resultant highly incandescent state the particles of carbon were shot off in straight lines and darkened the bulb interior.

Owing to the shielding of the glass by one

For the music of a master

USE LISSEN BATTERY CURRENT

At the touch of a master there comes inspired music from mute strings. Hear this over the radio with a Lissen battery in your set and you will sit and listen with delight. For the pure D.C. current of this battery will bring every note of the music to you pure as it is played. Never again will you use any other form of current having once heard the music of a master violinist played as it should be played.

For the Lissen battery, due to its secret process and new chemical combination used only by Lissen, gives you purity as well as great power. The current it yields has no ripple in it, it has no trace of hum—it is smooth, noiseless, sustained all the time you use it. No matter how long the programme, and through months and months of use your reproduction will remain delightfully enjoyable always if you use the Lissen new process Battery.

You can buy it at 10,000 dealers throughout the country. Ask for it in a way that shows you will take nothing else.

60 volt. (reads 66)	7/11d.
100 " " 108	12/11d.
4½ v. Pocket Battery	5d.



A Musical Masterpiece

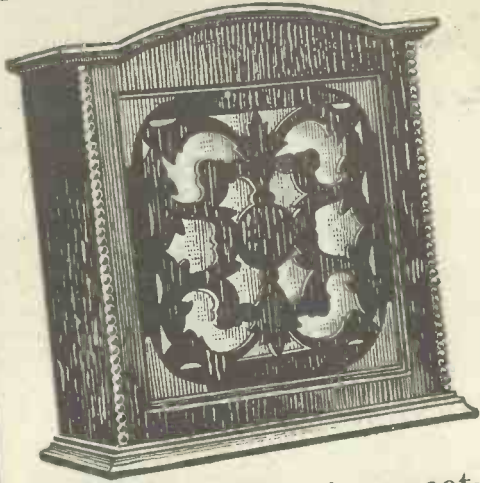

MELODY at its sweetest; beauty of tone that will enchant you. Radio reproduction that you never dreamed possible. That is Amplion Cone Speaker quality. Prices from

37/6

May we send you interesting list post free?

GRAHAM AMPLION LIMITED,
 Head Office & Showrooms:
 25, Savile Row, London, W.1.
 Demonstration and Service Depots:
 101, St. Vincent Street, Glasgow.
 10, Whitworth Street West, Manchester.

AMPLION

The World's Standard

Hear an **AMPLION** first

NO MORE JACK TROUBLES

NOW you can eliminate the old, messy soldering troubles when fixing Jacks and Switches. The famous Lotus Jacks and Switches are being made with terminals instead of soldering tags. The terminal makes as good a permanent connection as the most expert soldering job.

Lotus Jacks and Switches are made of finest bakelite, with nickel silver springs and pure silver contacts. To establish reliable connections in any set you make, choose Lotus Jacks and Switches. They occupy the minimum space—only 1 1/4 in. behind the panel.

The Lotus Coil Holder holds the heaviest coil in position. The moving block cannot fall. Prevents fading away of volume. Vernier movement reduces speed of moving coil block by eight times. For left or right hand.

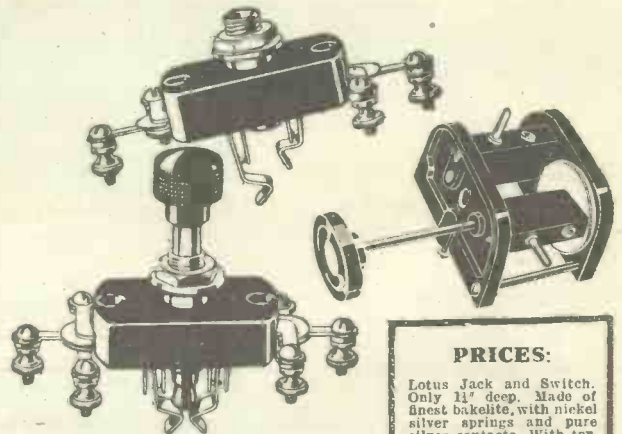

LOTUS JACKS SWITCHES PLUGS

Made by the Makers of the famous Lotus Remote Control and Lotus Buoyancy Valve Holder.

PRICES:

Lotus Jack and Switch. Only 1 1/2" deep. Made of finest bakelite, with nickel silver springs and pure silver contacts. With terminals. Jack No. 3, 2/6; others from 2/- to 3/-. Jack Switch No. 9, 4/-; others from 2/6.

Lotus Jack Plug. Spring sleeve fitting supplied. Can be used with any Jack. Bakelite mouldings, nickel-plated brass parts. Price 2/-.

Lotus Coil Holder. 2-way, for outside panel mounting, 7/-; 3-way, 10/6; for inside baseboard mounting, with 6-in. handle, 8/-; 3-way, 12/6.

GARNETT, WHITELEY & CO., LTD.,
 Broadgreen Road - LIVERPOOL.

REMOTE control is becoming very popular among wireless enthusiasts at the present time, and the fascination of being able to switch on and off one's set from any room, or from one's favourite armchair by the fireside, by merely pressing a button, is the result in store for any reader of this paper who makes up the simple control device here described.

In the first place, let it be noted that cheapness is one of its strong points. It is also very interesting to make up and effective when finished. The device here described is only suitable for sets with accumulators. It will not work off dry cells, as for such a small amperage as can be obtained from dry cells a much

An Easily Made REMOTE CONTROL

Make Your Own Press-the-Button Gadget.

For Fireside Radio.

By A. L. FENNEMORE

Now by magnetising the other coil B, the spindle arm is drawn away from contacts G₁ and G₂, thus breaking the circuit formerly created.

In making up this control, the first thing to prepare is a panel to hold the apparatus shown in Fig. 1. It is not essential that ebonite be used, as a small piece of wood will do equally as well. Now, our attention must be turned to the two coils A and B. (The coils used in the device described were removed from an old bell. In removing the coils from an old bell, care should be

taken that the wood bobbin is not broken.) It is as well to note here that these bobbins may be just riveted to the plate to which they are fixed, or they may be screwed on to the plate. If riveted, by removing the burr with a file, the coil can be driven out with a small punch. If the coils happen to be screwed in they will have to be removed with either a pair of pliers or a small hand vice.

Constructing the Carrier.

Having removed the bobbins, make up the two small angle brackets as shown in Fig. 2. To these brackets are affixed the two coils. The brackets, as will be noted, have elongated holes. This is to enable a fine adjustment to be made when the control is fitted up.

We now come to the carrier for spindle C. This is simply a piece of brass bent so as to form a channel, as shown also in Fig. 2. The spindle C here described is a piece of $\frac{1}{8}$ silver steel chosen chiefly for its smooth surface and lack of friction. This spindle C, as illustrated, is drilled at each end and plugged with a small piece of brass so as to prevent it sticking after becoming magnetised. This spindle is also drilled

(Continued on next page.)

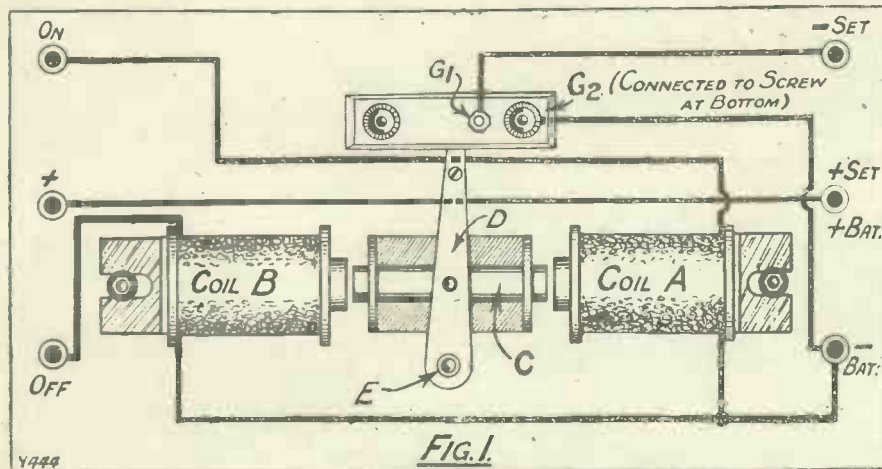

more delicately-wound coil would be required. Before describing the control in detail it is perhaps best for a word on the general principle on which it works, this being very simple.

How It Works.

Fig. 1 shows the general arrangement and wiring of the few parts used. The coil A, by having a current passed through its

windings magnetises its core. This in turn draws the spindle C towards it. Connected to spindle C is a control arm D, which, although allowed a free movement on the spindle, is anchored at point E. To the end of this control arm are fixed two small spring brass contact blades,

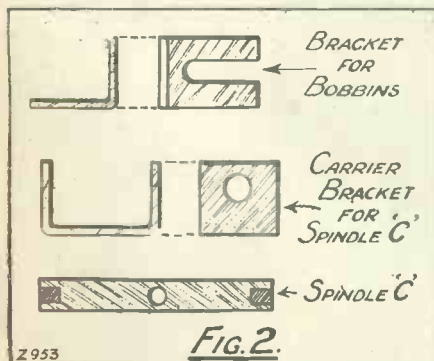

windings magnetises its core. This in turn draws the spindle C towards it. Connected to spindle C is a control arm D, which, although allowed a free movement on the spindle, is anchored at point E. To the end of this control arm are fixed two small spring brass contact blades,



A set can be switched on and off by depressing one or other of the two buttons. An old bright emitter was fixed to the control merely for demonstrating purposes.

AN EASILY-MADE REMOTE CONTROL.

(Continued from previous page.)

through its centre and tapped 6 B.A., so as to enable the control arm D to be connected to it.

The control arm D consists of a plain strip of brass drilled as shown, to which are fitted the two thin brass contact blades. These are fixed to the arm by means of a small 6 B.A. screw and nut.

Easily-made Contact Studs.

These blades, together with the two small strips of ebonite, now to be described, are the only parts which need special care, as undue friction at this point will greatly affect the working of the control.

These strips of ebonite are fitted with one contact stud each. The studs can be made from 4 B.A. cheese-headed screws, countersunk into the ebonite, the slots filed off level and the whole polished with a piece of smooth glass paper.

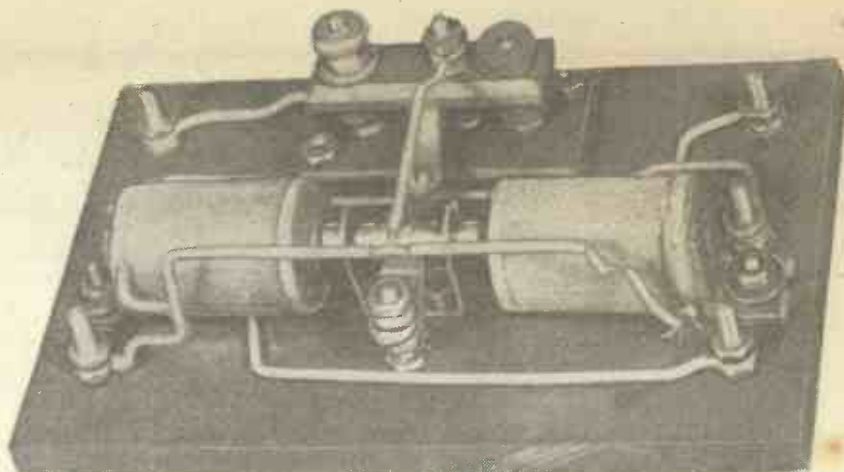

The action is that the "armature" is pulled to right or left by one or other of the magnets, according to whether the set is to be switched on or off.

Free Pictorial Blue Print of the Cossor Melody Maker, R.C. Threesome, and Mullard Master 3, with "Modern Wireless" on Sale everywhere.

On October 25th, 1906, Dr. Lee de Forest filed a patent in which a third electrode was added to the original two-electrode thermionic valve as patented by Dr. Fleming, of London.

The first wireless time signals were transmitted from the Eiffel Tower, Paris, in 1909.

Over 1,500 lives were lost in the "Titanic" disaster on April 15th, 1912, but more than 700 lives were saved by the wireless call from the stricken vessel.

As a result of the terrible disaster to the "Titanic," which was sunk in mid-Atlantic by an iceberg, wireless conferences were called by the chief maritime nations of the world and the fitting of ocean-going vessels with wireless apparatus was made compulsory.

In the Balkan War of 1913 a Marconi 1½-kw. wireless set was used in the siege of Adrianople, and enabled the beleaguered Turks to keep in touch with their Government at Constantinople.

The first transatlantic wireless telephony took place from the Arlington Station, Washington, to the Eiffel Tower, in 1915.

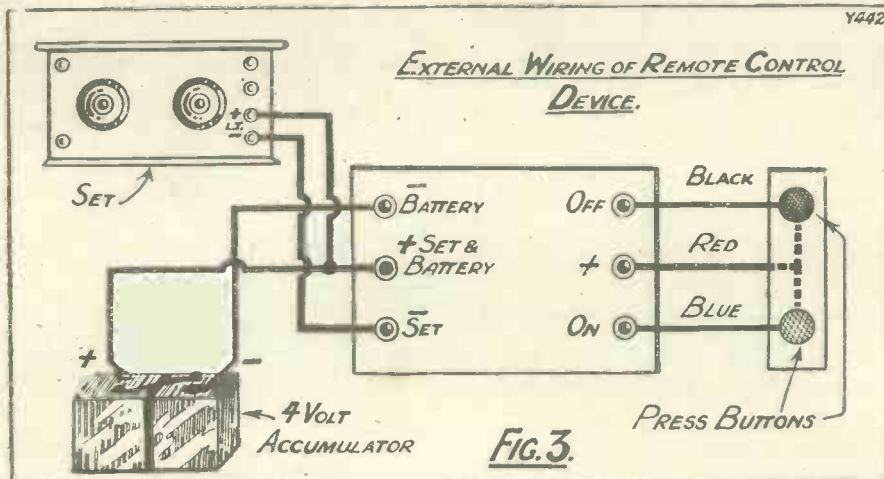

The parts may now be fitted to the panel, care being taken that the spindle C moves perfectly freely in its bracket.

The internal wiring of this control is very simple, and can easily be followed by reference to Fig. 1.

The external wiring also is easily followed as very little alteration has to be made to one's set, merely two short wires to connect the L.T. battery to the control, as shown in Fig. 3.

The Extension Wires.

Now, with regard to the 3-wire cable which is run to the different press buttons. As this is rather difficult to obtain, the writer used ordinary twin bell wire together with one strand of 24 D.C.C. wire. It will be noticed that in all twin bell wire two coloured wires are used so that no difficulty should arise either at the control end or at the press buttons.

The press buttons are very small bell pushes mounted on a piece of wood and fixed either to the wall or any other convenient place. To many enthusiasts, once the working of the control is understood, there will be many ways it can be made up, and other work to which it can be adapted.

* * * * * FROM FAR AND NEAR. * * * * *

There are now about 200 broadcasting stations in operation in Europe.

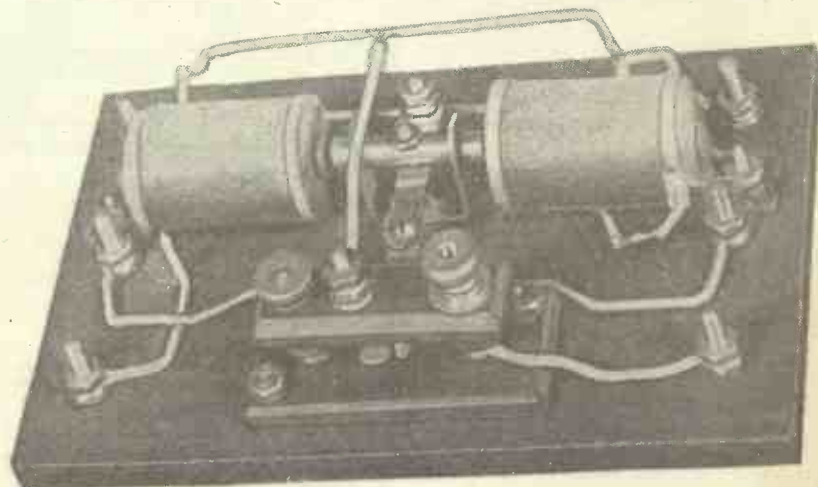

This original model of the control was carefully tested by the "P.W." Research Dept. and found to be perfectly reliable. A five-valve set was controlled at a distance of over 50 feet.

AN EVENING WITH THE COSSOR "MELODY MAKER"



Whether or not you are one of the many who are interested in this popular set you should find the following article of interest and value. In a future issue the author will deal with the Ediswan "R.C. Threesome"

By G. V. DOWDING, GRAD.I.E.E.
(Technical Editor)

ONE of these days a learned judge will convulse a Court of Law by asking, "What is a Cossor 'Melody Maker'?" The instrument will probably have nothing whatever to do with the case on trial, but the legal luminary will have raised his laugh. However, I am going to forestall the Eager Young Barrister and supply the answer now.

You see, Messrs. Cossor have told the world everything about their "Melody Maker"—except what it is! They have their reason for this, and it is a good one. In their own words it is that their design "is a receiver for the man who knows very little about wireless. To this end, therefore, we have shorn the instructions of every unnecessary technical detail. The expert will look in vain for the conventional circuit diagram."

So far so good. Messrs. Cossor will have achieved their aim when their Man-Who-Knows-Very-Little has successfully built the set and has tuned in his crop of stations. After this, I do not think he will be averse to learning something about his set so that he can at least pretend to a certain amount of technical knowledge concerning his "engine." And we mustn't forget the "expert"; he'll want some technical data before he decides to take the plunge at all. Taking all this into consideration, it is my belief that there should be many readers of "P.W." who would like to share with me an evening with the Cossor "Melody Maker." If you have one of these instruments, so much the better; draw your chair up to it and, in the words of a popular song, "follow me."

Circuit Details.

First of all, here is the "specification" of the Cossor "Melody Maker." It embodies a three-valve circuit; the leaky-grid detector is followed by a resistance-capacity-coupled L.F. stage of amplification, the second L.F. valve being transformer coupled. This is accepted as being the best practical arrangement of three valves for "all-purpose" loud-speaker reception. The aerial connection can be taken either to a .0001 mfd. or a .0003 mfd. series fixed condenser according to the degree of selectivity that is required. The former gives the greater selectivity.

The special coil unit is an arrangement peculiar to the "Melody Maker." The

aerial (grid) tuning coil is divided into two sections, both being wound on the same large-diameter cylindrical former. For "short wave" working, that is, for such stations as 2 L O and 5 G B, the larger of the two sections is shorted out of circuit by means of a simple switch on the front of the panel. Both sections of the coil are required for stations on the "Long Waves," such as 5 X X.

The reaction winding also takes its place on the same former, and it is placed so that it lies between the two grid-coil sections, and much nearer the larger one. This is a very cunning scheme and it enables perfect reaction to be obtained over both wave-length ranges. The values of the components employed in the resistance-capacity-coupling stage are such that the interests of both amplification and quality of reproduction are served.

Well-Designed Set.

The "lay-out" of the set is distinctly good. The components are so positioned that the wiring is straightforward, simple and efficient. And there is no possibility of "crowding" occurring as there is ample baseboard space for everything.

On the front panel is, left, the dial of the tuning condenser, and, right, the dial of the variable condenser which controls reaction. In the centre is the switch which enables the change over to be made at a moment's notice from long to short wave-lengths or, in other terms, from the medium broadcast band to 5 X X. Hilversum, and so on.

The "on-off" switch is at the back of the set, presumably, the idea being to eliminate from the front everything with which tiny and/or irresponsible fingers could do damage. At the back are also the various terminals.

There is only one H.T. plus terminal, and this is common to all three valves. But, in the circumstances, this is all that is required, and separate H.T.'s would be unnecessary complications. Room is allowed on the baseboard for the grid-bias battery and the three grid-bias plugs are easily accessible and come cleanly away from their points of connection.

Very Simple Assembly.

The coil unit is between the two variable condensers, but does not actually touch either (it must not be allowed to do this—it should be kept as far away as possible), although it is very near. Happily, the short-wave winding is adjacent to the tuning variable; had it been the reaction variable I would have given the set a black mark. But, as it happens, the designer could hardly have helped doing the right thing.

Well, that describes the "Melody Maker" as made up in accordance with the instructions. These instructions, by the way, are most detailed—and now that the coil unit can be purchased all ready wound at practically any store, the task is one of extremely simple assembly.

(Continued on next page.)

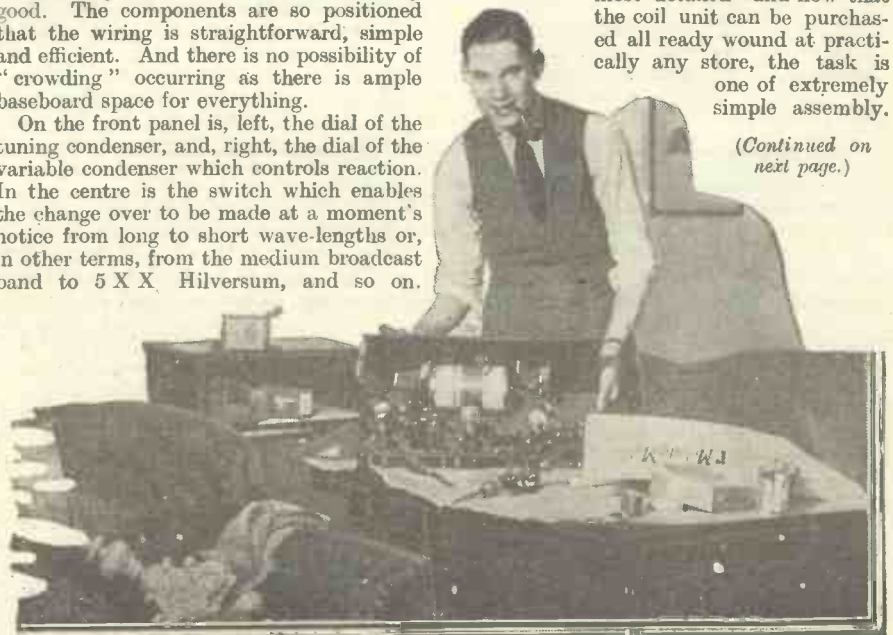

A "Melody Maker" enthusiast completes his receiver. Note the few simple tools with which he accomplished the task.

AN EVENING WITH THE COSSOR "MELODY MAKER."

(Continued from previous page.)

But it makes a handsome outfit, with its symmetrically disposed dials and is quite equal in appearance to the majority of manufactured sets.

Now, with your chair still drawn up to your own "Melody Maker," either in fancy or reality, let me recount to you my evening's experience with one built exactly as per instructions. I must assure you before we start that this is not an imaginary evening. I have actually had the set working at home exactly as described and I took notes at the time, the following being an exact record with additional and explanatory interpolations.

Prepared for Anything!

I started with quite an open mind; I was willing to believe the "Melody Maker" was a rattling fine set and all that Cossors claim, and I was just as equally prepared to find it most mediocre or even rather "dud." After about twenty years of radio one naturally develops this kind of mind.

First of all I connected an aerial lead from a fairly good outdoor aerial, consisting of a 75-ft. length of wire fairly high at both ends, to the A_2 terminal. To the earth terminal I joined a wire which runs to a main water pipe not very far distant. I then screwed the loud-speaker leads to their appropriate terminals. Before joining up the batteries I inserted three Cossor 2-volt valves, using those types recommended. I then carefully joined up the 2-volt accumulator to the L.T. terminals. There remained then only the H.T. battery and the grid-bias battery. The former, a 120-volt dry battery (actually two 66-volt batteries connected in series, the minus of one being joined to the 66-volt tapping of the other) was soon in position. For the time being I left the grid-bias plugs inserted in the 9 volt grid bias battery more or less at random. I did see, however, that the number 35 lead plug was in the positive grid-bias battery socket.

The "Q and A" Station!

My next step was to push in the switch at the back of the set (S_1), thus switching the receiver into an actual working condition. I then set the right hand dial at zero (V.C., had then all its moving vanes out of mesh with its fixed vanes) and rotated the left-hand dial (looking at front of panel) until I found 2 L O at 130. This station came in with a terrific roar but hopelessly distorted—distorted because the grid bias was not properly adjusted. I took the G.B.₂ plug up to 9 volts and G.B.₁ up to 3 volts. The volume was still there, but the reproduction became pleasingly mellow. I slightly readjusted the left-hand dial until the music was reduced to a comfortable volume.

The Brown loud speaker was functioning excellently, and for a few minutes I critically listened to the reproduction. And leaning back in my comfortable chair I must admit to a lapse of duty—I found myself criticising the MUSIC. But when one does this there is not much wrong

with the set! Dragging myself reluctantly away from a favourite Coleridge-Taylor item (A morceau of his Petite Suite De Concert which always reminds me of our "Radiatorial" columns—to wit "Demande et Réponse"), I set about hunting for distant stations. Not that they required much hunting for, for my practised hand was soon able to rope them in from all over the continent. I claim no credit for being able to do this, however; anyone could do the same after an evening or two's experience, providing they went the right way about it.

That "Sensitivity" Control.

You have only the two dials to manipulate, and the right-hand dial you should regard as a kind of volume or sensitivity control. Do not sweep about with this dial; operate it as you would the throttle of a motor-car or steam engine, gently putting in a few more degrees as required until you have just the volume you desire from a certain station. And keep it back from the point where you hear a whistling or howling noise.

My first rough run round the dial with the S_2 switch at "short waves" gave me eight stations, all worth listening to, on the loud speaker. I didn't stop to identify them, and I didn't use a wave-meter for the reason that I wanted to place myself in the position of the average user of the set. But note these dial readings, the pairs of numbers indicating the readings of the left and right-hand dials respectively 20-50, 60-70, 90-90, 120-120, 130-130, 135-135, 160-160, 164-164. Do you see their significance?



The author apparently emulated this Cossor "Melody Maker" builder as he says—"Stuttgart was very loud and clear and again I found myself pausing for purely programme purposes."

Let me point it out. As the readings of the left-hand variable condenser increase, so can one increase the dial readings on the right-hand variable condenser. That they move up equally from 90 in each case is a coincidence, it might not happen with every receiver. But you can see how one must go to work in order to tune in the stations very quickly. You regard the left-hand dial as the main tuning control, and gently run up and down over each little patch of degrees as you work upwards towards the top of the dial. All the time you follow up steadily with the right-hand dial readings, gentle moving this dial very slightly backwards and forwards as you come too near or too far away from the point of greatest sensitivity.

Stuttgart is Strong.

As I have said, 2 L O was tuned in at 130 degrees. At 135, with the right-hand dial showing similar figures, I came across Stuttgart. With the aerial lead on A_1 2 L O was cut out. Stuttgart was very loud and clear. He was practically as strong as I generally get him on a four-valver

using the same aerial, and he was entirely free from the background he generally accumulates when one uses a big set. I think I must make the admission that Stuttgart came in as well as I have ever heard this station on any set. And again I found myself pausing awhile for purely programme purposes. A catchy banjo solo was being played and it came through with silvery clearness. However, in due course I moved up to Langenberg at 160 degrees on both dials.

The volume was almost as great as 2 L O and the reproduction was most pleasing.

A Good "Bag!"

5 G B at 164 was every bit as good as 2 L O eight miles distant. A sweep further back I came across Frankfurt and further back still, Hamburg; both of these stations I recognised immediately. They came in with an ample reserve of strength. I had thus heard, so far, ten stations, any one of which I could have listened to with enjoyment. I had identified six, and could have discovered who the others were, too, had I so desired.

Getting really down to it, I had no difficulty in locating a further number of stations; indeed, they seemed to come chipping in at every other degree on the dial.

Pushing in the panel switch I eventually went over to the long waves. Here I was immediately rewarded with Hilversum and 5 X X, both, curiously enough, coming in

with almost equal strength but with little use of reaction. Truly that simple wave-band switch is a great asset to the set. With its use the veriest tyro must have at least eight stations at his finger-tips the very first evening he places the set in commission.

Well, the most interesting of evenings come to an end, so, in due course, I pushed in the switch at the back of the set and crept away to my bed—and it was late, too, as that rotten little Breslau station (I think it was Breslau) and the Cossor "Melody Maker" had lured me into listening—a fate at which all true experimenters shudder.

In conclusion, I suppose I am expected to sum up. I can do this in a very few words. In my opinion, the Cossor "Melody Maker" is as sensitive and as generally efficient as any three-valve set of its kind that I have ever handled. It appears to be a first-class receiver in every respect, and that it is simplicity itself to assemble is due to its clever design and the excellent instructions prepared; there appear to have been no sacrifices whatever made to gain this end.

No restrictions with Ormond sets

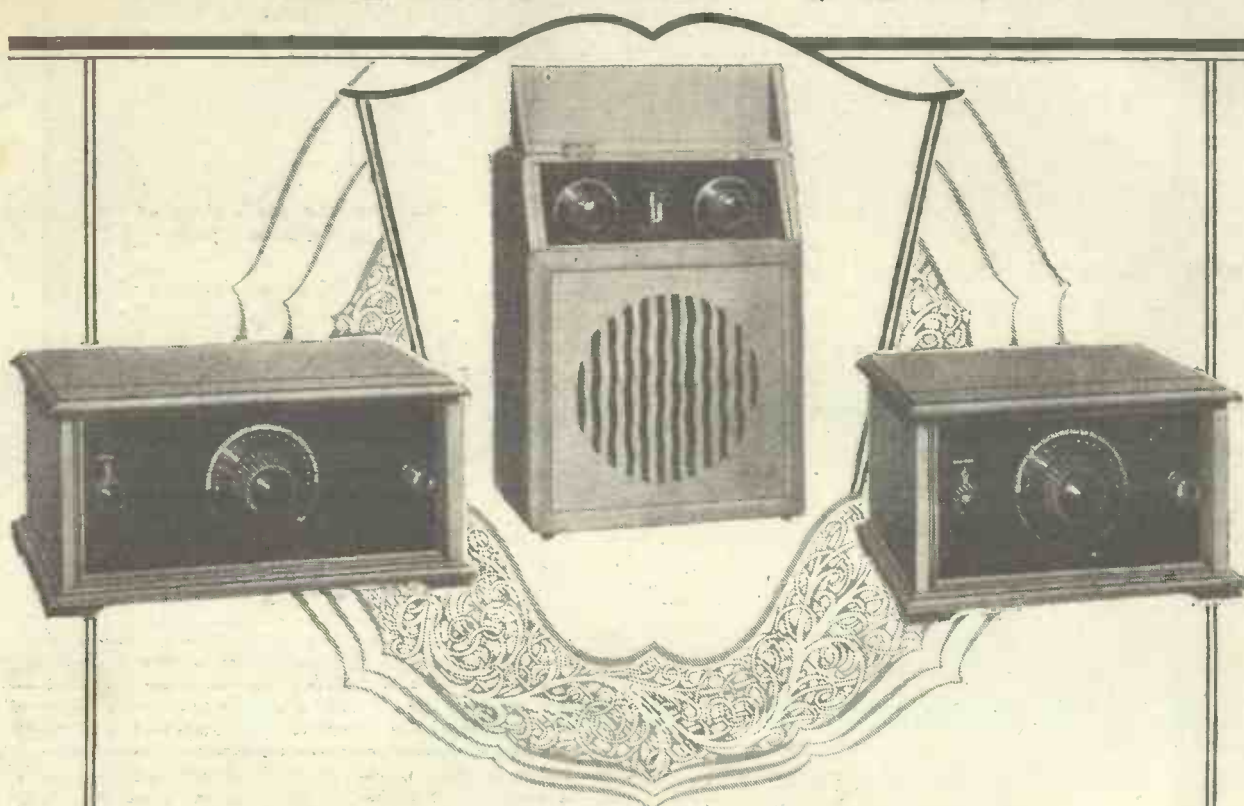

Simple to tune, yes. But that simplicity does not restrict experimenting. The circuits in each of the three Ormond sets are flexible—you can "stay at home" or reach out with equal facility and success. Make sure you buy more than good appearance—buy an Ormond Receiver.

The Ormond 2 Valve Set.

A very attractive design, capable of efficient Loud-Speaker reception on long and short wavebands. No moving coil system, a special Plug-in Unit being provided for each waveband. Smooth reaction control obtained by means of the Midget Condenser. Multiple Tracer fitted to simplify battery connections. Loud-speaker is plugged to set, the plug also acting as "on-off" switch. Complete with tuning coils (short and long wave). Retail Price £4 10s. Marconi Royalty £1 5s. Slow Motion Dual Indicator Dial 5s. extra.

The Ormond 5 Valve Portable.

Ideal for indoor and outdoor use. Contained in a Handsome Mahogany Cabinet. Extremely simple to control and renders perfect reproduction under average conditions from a main B.B.C. Station within about 30 to 40 miles and about 400 miles of Daventry. A simple switch gives choice of short and long wavebands. Entirely self-contained; fitted with Ideal Loud-Speaker. Complete with all accessories. Retail Price £24 10s. Marconi Royalty extra £3 2s. 6d.

The Ormond 3 Valve Set.

Very similar to the Ormond 2 Valve set. Provided with additional L.F. stage of Resistance Capacity type, the excellent quality being thus preserved, with the advantage of greater volume that is highly desirable when receiving distant stations. Filament control complications are completely eliminated by carefully calibrated resistors to suit the valves specified. Complete with long and short wave tuning coils. Retail Price £6 10s. Marconi Royalty £1 17s. 6d. Slow Motion Dual Indicator Dial 5s. extra.

ORMOND ENGINEERING Co., Ltd., 199-205, PENTONVILLE ROAD, KING'S CROSS, LONDON, N.1.
 Telephone: Clerkenwell 9344-5-6. Telegrams: "Ormondengl. Kinross."
 Factories: Whiskin Street and Hardwick Street, Clerkenwell, E.C.1.
 Continental Agents: Pettigrew & Merriman, Ltd., "Phonos House,"
 2 & 4, Bucknall Street, New Oxford Street, London, W.C.1.



SELFRIDGE'S

ENGLAND'S RADIO HEADQUARTERS

Selfridge's famous Radio Department can always be relied upon for the latest and most up-to-date productions, and now they are authorised to offer complete kits of components for

Circuits specially designed by Marconi

The outstanding feature of these splendid sets built from these Circuits is their super selectivity and range. Now, thanks to our

"NO DEPOSIT" SYSTEM

every Amateur Enthusiast is given the opportunity to enjoy the marvellous results obtained by these Sets, for the generous terms which give them within the reach of everyone. The complete set of components as specified by Marconi's, for their famous T1 Four Valve Receiver incorporating the

Famous Marconi Screened Grid Valve

S625, can be obtained through this convenient and sensible method of payment.

SPECIFICATION :

	Price		Price
Sterling Condenser .00025 mfd.	2 14/-	Sterling Mansbridge Condenser 2 mfd.	1 4/8
Marconiphone Astatic Coil Holder	1 6/6	Grid Leak Clips mounted	1 1/3
Astatic Aerial Coil (B.B.C.)	1 7/-	Ten-way Terminal Strip	1 9/-
Astatic Aerial Coil (5XX)	1 7/6	Grid Battery Clips (Baseboard Screen)	2 4d.
Reaction Unit Adapter	1 7/6	(Panel Screen) (Partition Screen)	1 Set 11/6
Anode Reaction Unit (B.B.C.)	1 12/6	Wander Plugs	3 4 1/2d.
Anode Reaction Unit (5XX)	1 12/6	Brackets for S625 Holder	2 6d.
S625 Valve Holder	1 5/6	Ebonite Panel 17 in. x 8 in. x 1/4 in.	1 11/4
Antiphonic Valve holders 4 to 1 "IDEAL" Transformer	3 2/9	Cabinet Baseboard 17 in. x 9 in. x 1/4 in.	1 35/6
Resistance Coupling Unit	1 8/-	Blocks for Terminal Strip	2
30 ohm Filament Rheostat	1 4/6	9 v. Grid Battery	1 2/-
H.T. and L.T. Switch	1 3/6	S625 Valve, Marconi	1 22/6
.00005 Fixed Condenser	1 2/-	D.E.H. 610 Valve, Marconi	1 10/6
.0001 " "	1 2/-	D.E.L. 610 " "	1 10/6
.00025 " "	2 2/-	D.E.P. 610 " "	1 12/6
.001 " "	1 2/6		
Sterling Mansbridge Condenser .25 mfd.	1 3/-		

CASH PRICE £14 : 5s. or in 12 monthly payments of **25/-**

or any of the above (to value of £3 or over) may be selected and obtained on the famous "NO DEPOSIT" System.

Full descriptive Booklet, including full size lay-out and wiring diagrams, price 3d. By post 4 1/2d.

The advent of the SCREENED GRID VALVE incorporated in the above Specification has opened up a new vista for the Constructor, and it has aroused very deep interest among all who follow the latest developments in Wireless. We are therefore confident that all Amateur Enthusiasts will deeply appreciate our announcement that during the famous *Birthday Week Celebrations*, MARCONI'S EXPERT ENGINEER will be present in our Radio and Television Department on the First Floor. He will be in attendance daily, from March 12th to 17th, between the hours of 10 a.m. and 6 p.m. (Saturdays, 10 a.m. to 1 p.m.), and he will be delighted to give expert advice and assistance in the instruction and building of circuits, embodying the Marconi Screened Grid Valve or any other Radio Problem. Why not take advantage of this unique opportunity?

SPECIAL BARGAIN

Polar Junior CONDENSERS, in Black Japanned Case. Complete with dial. Capacities: .0005, .0003, and .001 only. PRICE, each 1s. 6d. Postage 4d. extra.

SELFRIDGE & CO., LTD., OXFORD STREET, LONDON.
Phone: MAYFAIR 1234.

ARTISTIC EFFICIENCY!

TROLITE

THE RADIO PANEL DE LUXE

The distinctive Trolite panels can be bought in five beautiful finishes—Black polished, Mahogany polished, Walnut polished, Wavy design, Cube design. In each, high insulation and low surface leakage are guaranteed. Drilling, sawing and machining is easy, and permanent joints can be made with acetone.

Trolite does not fade, discolour or warp. Use Trolite panels for your set.

PRICES per sq. inch :

Polished Black.	Mahogany Walnut.	Cube Wavy.
3/16 in. - 5/8d.	3/16 in. - 3/4d.	3/16 in. - 3/4d.
1/4 in. - 7/8d.	1/4 in. - 1d.	1/4 in. - 1d.

Ask your Radio Dealer also for Trolite Dials, Coil Formers, Coil Mounts and other radio mouldings. In case of difficulty write direct to:

F. A. HUGHES & Co., Limited
204-206, Great Portland St., W.1
Telephone: Museum 8630 (3 lines).
Telegrams: "Distancing, Wesdo, London."
Manchester Office: 185, Princess Street.
Telephone: City 3329.

EFFICIENCY WITH EFFECT

A WONDERFUL 3-VALVE LOUD SPEAKER SET

The Saxon 3-Valve Loud-Speaker Set is the finest 3-valve set that money can buy. Very few 4-Valve Sets can equal the performance of the SAXON 3, either for purity, volume, range or selectivity. 48 stations at our Works (more than half at good loud-speaker strength), Daventry on loud speaker 1,200 miles away, 20 stations in Devonshire, 35 in Torquay, and over 20 stations on loud-speaker in the Orkney Islands have actually been received.

All latest improvements are incorporated—no coils are required, as the new SAXON all-wave tuner covers all wave-lengths from 200 to 2,000 metres by merely turning a knob.

Easily built by any beginner in two hours, all panels are drilled and most of the components assembled ready for wiring. No soldering required. 24 page instruction book and wiring diagram 3d. post free.

SAXON RADIOD CO. (Dept. P.W.), South Shore, BLACKPOOL



5/-

"1928" LOG CONDENSER
"00035 and "0005

SMALLEST

Span fully open 3 1/4 inches.
Behind Panel 2 inches.

LIGHTEST

4 1/2 OUNCES.

Write for literature

THE FORMO CO.,
22, CRICKLEWOOD LANE, N.W.2

A RADIO SCEPTIC.

The Editor, POPULAR WIRELESS.

Dear Sir—For the last four or five years I have been a regular reader of the various wireless papers you publish, and have absorbed during that time, and have made up during that time many of the circuits you publish.

These must amount to at least twenty or more, ranging from crystal sets to three-valvers, and in view of the very plain, clear and concise instructions you give, I have never had a failure. Every set has worked the instant the outside connections have been made.

During this period I have lived at several addresses, and therefore aerials and earths have varied from time to time.

Every set I have made has given me pleasure both in the construction and operation, and as I have but little knowledge of the theory of wireless, I have always strictly followed your lay-out, wiring and components.

Yet every set has left me disappointed, because a week or two after publishing the circuit I read letters from little boys, old men, etc., who hooked it up in about five minutes and roped in half the earth. Now I have never had even a quarter of the earth even with three valves.

Now do these enthusiastic writers omit to state they added a two-valve H.F. amplifier before and a three-valve L.F. after the set, am I a plain darn fool when building sets or, as I first ask "are wireless fans worse than fishermen"?

If you want one concrete example, I recently completed a well-known three-valver designed by one of the valve makers. It gives me excellent music on the L.S. from local and 5 X X, and will just put one German on the speaker. Twenty or more British and foreign on headphones, but tuning so flat, a wave trap is necessary to cut out local when on the long-wave coil.

Yet I read a testimonial from a gentleman who claims 30 stations on the L.S.

What about a "League of Candid Wireless Amateurs," you know, every member has to admit that when he made his one-valver—it got the local station fine, and that it was about all he could expect for his money?

Yours faithfully,

BERNARD ELSTON.

Stockport.

[Mr. Elston raises an interesting point—several interesting points, in fact, and it remains to be seen whether or not any others of our correspondents will feel impelled to champion the cause of DX on "Dets." and so on. For our part, we cannot help thinking that Mr. Elston has been beset by a run of bad local conditions or some other such limiting factors—we certainly should not think of rating him a "darned fool" any more than we can endorse his accusation concerning exaggerated reports. We

ITEMS OF INTEREST.

There are over 30,000 radio licence-holders in Japan.

* * *

Experiments have been made in the Bengal coal mines to ascertain the possibility of wireless communication underground, in case of emergency.

* * *

The United States Department of Agriculture now broadcasts daily informative talks from over a hundred different stations, thus making it the largest broadcaster of useful information in the world.

* * *

The sediment in an accumulator should never be shaken up so that it is disturbed and touches the plates? If this is done a form of local action will take place, which will result in considerable damage to the cells.

* * *

If your neutralising condenser will not go down low enough with the plates "all out," to neutralise properly, you can overcome the difficulty by adding a little external capacity to the grid and plate in the form of a short-insulated wire joined to each and twisted together.

CORRESPONDENCE.

A RADIO SCEPTIC

3 LO ON 32 METRES—WHAT IS WRONG WITH OUR LAND-LINES?

Letters from readers discussing interesting and topical wireless events, or recording unusual experiences, are always welcomed; but it must be clearly understood that the publication of such does in no way indicate that we associate ourselves with the views expressed by our correspondents, and we cannot accept any responsibility for information given.—EDITOR.

have no doubt whatever but that if Mr. Elston could hear a number of representative listeners' receivers in operation he would tend to change his opinion. On a good three-valve receiver, given average local conditions, there should be at least six stations available at really good loud-speaker strength. The "local," 5 G B and 5 X X are more or less a certain three, and there are dozens of powerful continentals now "on air."—Ed.]

THE "SYDNEY" TWO.

The Editor, POPULAR WIRELESS.

Dear Sir,—Between 11 and 12 p.m. last evening I was listening on the short waves of 20 metres and above, and the set I was using was assembled to the plan and lay-out which you published on November 12th, 1927, which was under the heading of "The 'Sydney' Two."

I very soon tuned in K D K A on 63 metres, and was surprised at the volume being received. If I had connected up the loud speaker, I am sure I should have woke up everybody in the house.

I should like to mention that I have constructed several short-wave sets during the last four or five years, and I have never received an American station like I did last evening. I have altered the lay-out of the receiver in one respect, viz., I have placed the potentiometer under the coil near the air condenser, which I find gives me shorter leads to same.

As regards oscillation, I find that instead of having to adjust the air condenser very carefully I can short it out all together, and find that the oscillation is constant over all the wave-lengths, and also by shorting out the air condenser I find increased signal strength. The set simply pulls in stations with ease.

Could you supply me with the correct time for picking up 2 F C Sydney, as I should like to hear what the set does with Australian broadcasting.

Thanking you for placing in your valuable journal such a splendid set, and wishing "P.W." every success.

Yours faithfully,

S. W. W.

P.S.—I am sure that if any radio-ite cares to assemble the "Sydney" Two they will be amply repaid for their trouble.—S.W.W.

Burnham-on-Sea,
Somerset.

3 LO ON 32 METRES.

The Editor, POPULAR WIRELESS.

Dear Sir,—I often see in your "Radio Notes and News" column in "P.W." reports of reception of 2 F C Sydney, Australia, on 28.5 metres. I don't remember seeing any mention of 3 LO, Melbourne, on 32 metres. I heard this station last night (Sunday, January 15th) between 19.00 and 19.30 G.M.T. Signal strength R5-R6 on three valves (Det., 2 L.F.) with no fading. Hoping to see more short-wave stuff than ever in "P.W.," which I have taken from its beginning.

Yours faithfully,

E. B.

Essex.

ANOTHER UNIDYNE ENTHUSIAST.

The Editor, POPULAR WIRELESS.

Dear Sir,—It was with great interest that I read "H.O.L.'s" letter in "P.W." (February 16th) concerning the high regard in which they hold the Unidyne. I am still using the old original Unidyne circuit which was published about the time that the transformer in the Unidyne 1-valver was dispensed with; the fundamental circuit, I say, remains exactly the same. I have merely replaced certain components from time to time with more up-to-date apparatus. I do wish we could hear more—much more of the Unidyne; what have our two old friends to say? My original valves were put up by the Bower Electric Co., and cost 17s. 6d. each (B.E.'s); the price of D.E.'s is still too high. Like "H.O.L.," I am very loathe to part with my Unidyne—at least, with the detector stage thereof. A great many enthusiasts, looking at my aerial—the only one possible—would say dud! Nevertheless, my list of identified stations is: Breslau, Petit Parisien, Barcelona, Stuttgart, Toulouse, Glasgow, Königsberg, Berne, Hamburg,

Rome (1 R O), Langenberg, Radio-Beigique, Radio-Wien, Milan (on 541 m.), Munich, all these without changing coils. With larger coils: Radio-Paris, Hilversum. Several of above at comfortable L.S. strength by switching in 2-valve amplifier. British stations (except Glasgow), conspicuous by their absence, do not know why.

Of course, 5 X X and 5 G B, as a matter of course. Must try the short waves.

Wishing "P.W." every success, especially Messrs. Dowding and Rogers.

Yours truly,
F. W. W.

Dalston, E.S.

WHAT IS WRONG WITH OUR LAND-LINES?

The Editor, POPULAR WIRELESS.

Dear Sir—This is what I want to know about land-lines. Oh, has only to listen to the local—in my case it is Sheffield (G F L)—giving out local news, or better still, a musical programme, and then be switched over "for the rest of the London programme." And if he has any ears at all it will be evident that there is something missing and, incidentally, something added.

Anyone accustomed to listening to relay stations will see my meaning at once.

I have spent a good deal of money this last six months or so in bringing my set up to date so that it would do justice to the quality of the transmissions we get nowadays. The only time I get the reward for my labours is when we have a "local night." The reproduction is well-nigh perfect, every instrument in the orchestra is heard as you would hear it if you were on the spot, including the drums, which are most realistic.

Now comes the snag. We are taken over to the London station; there may be an interval of about 30 seconds, during which we are entertained by a medley of strange noises, ranging from the high-pitched note of a generator to the sweet tone of a "hello" girl demanding—two pennies, please!

Of course, when the "mike" is switched on this trouble seems to have disappeared, but make no mistake, dear listeners, it is still there—as is painfully evident during a quiet passage in an orchestral item. But this is not all, for I find that most of the bass notes are very feeble or have disappeared altogether. In fact, there seems to be no "body" at all in the music.

If I wrote to the B.B.C. about it they would probably tell me to "look to my set," which seems to be their password nowadays.

Perhaps we shall have an end to our troubles in this direction when the regional scheme is complete, but my opinion is that it is useless spending money to obtain distortionless reproduction—or should I say, reception, when it simply is not there.

With best wishes to "P.W." and its excellent staff.

Yours faithfully,

"SEMLOH."

Sheffield.

RADIO ODDS AND ENDS.

A new type of transmitting valve, which is capable of oscillating at frequencies even below one metre, has recently been introduced on the American market.

* * *

A wireless transmitting set, automatically operated by the water level, keeps the city of Akron, Ohio, informed as to the level of the city's reserve supply of water, which is in a reservoir in the hills fourteen or fifteen miles away.

* * *

A piano reproducer, by means of which the sounding board of a piano is made to act as a loud speaker, is now being marketed in the United States.

* * *

German engineers, recording signals from Buenos Aires, have noticed that each dot is duplicated, one comparatively large impulse being received direct, followed by another one which has travelled right round the world again before reaching the receiving aerial!

* * *

Several European countries are interested in a project for linking them up by telephone with America, by means of the transatlantic telephony service operated at the Rugby station.

TECHNICAL NOTES

By Dr. J. H. T. ROBERTS, F.Inst.P.

AN IMPROVED ACCUMULATOR

NOVEL L.F. AMPLIFIER—D.E. FILAMENTS.

An Improved Accumulator.

WHEN an accumulator of the ordinary lead-acid type is being recharged and is "gassing," or when an electrolytic rectifier is in operation, water in the electrolyte is decomposed into its constituent gases, hydrogen and oxygen. These gases escape from the container and, of course, the electrolyte level gradually sinks, with the result that from time to time distilled water has to be added to make up for the loss.

Since the hydrogen and oxygen evolved in these circumstances are in exactly the right proportions (2 of hydrogen and 1 of oxygen) for the formation of water, it is clear that if some simple means could be found to cause them to recombine and again to form water, the necessity for "topping-up" would be avoided and the accumulator (or rectifier, as the case may be) would be self-contained.

Amongst the numerous and interesting inventions which I continually receive from readers is one which relates to the above-mentioned advantage. According to this invention, the accumulator or rectifier container is completely sealed (by means of a removable stopper) so that neither the vapour due to evaporation nor the mixed gases due to electrolysis can escape. A simple device is arranged inside the container by which an ignition spark is produced which re-ignites the mixed gases to form water again. The pressure due to the vapour is negligible, and if it were not for the gases generated by electrolysis the container could in any case be sealed up.

Re-forming Water.

Several methods for generating the ignition spark are explained. In one case the ignition spark is produced at regular intervals (when the device is in operation), and in another case the spark is produced every time the pressure of the gases reaches a definite figure.

An electrolytic rectifier made in this way would evidently have the advantages of a so-called "dry" rectifier, and perhaps other advantages as well, whilst in the case of an accumulator (particularly a motor-car battery, which is habitually overcharged in the summer, and which, owing to its inaccessibility, seldom receives any attention in the way of adding water) the advantage of this invention would be very great.

Of course, it is important that the ignition arrangement should operate with certainty, at definite and regular intervals, and that the accumulator case should be specially strengthened.

Novel L.F. Amplifier.

A curious and novel feature in a low-frequency amplifier is due to the well-known Société Française Radio Electrique, and consists in using a resistance of a special character interposed between one stage and

the next. The special property of this resistor is that its resistance value increases rapidly with the current passing through it; the resistance in actual practice may be a metal filament of an incandescent lamp.

In the low-frequency amplifier the first and second stages are transformer-coupled in more or less the usual way, but the output of the first transformer is connected to the input of the second through a resistance of the type just mentioned. By using a

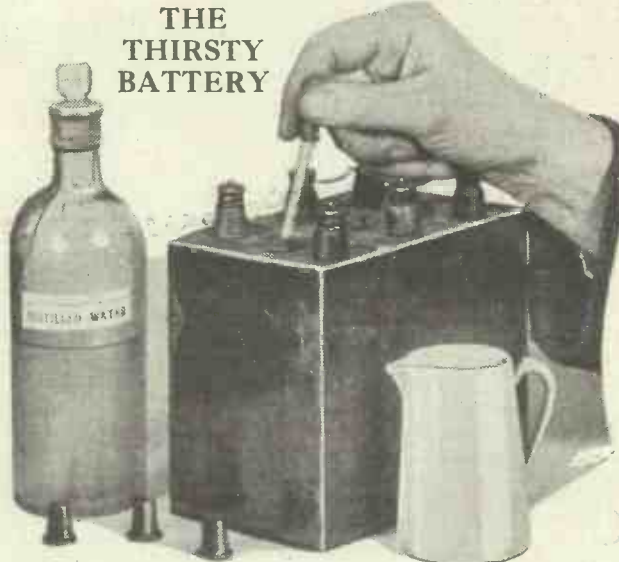
THE THIRSTY BATTERY

"The liquid should not be allowed to fall below the level of the plates," says the manufacturer. But remember that ordinary tap-water should not be used to replenish a battery, but DISTILLED water, which is obtainable at any chemists.

important feature which is common to most of them being the fact that the turntable runs on rollers at the periphery, instead of turning on a central axis. A locking-screw may be provided so as to fix the set in any given position.

D.E. Filaments.

Since the introduction of dull-emitter filaments (which have been defined as "cathodes having an efficiency of electronic emission considerably greater than that of pure tungsten") a great number of processes have been discovered for rendering metals thermionically active.

(Continued on page 83.)

NEWS FROM SAVOY HILL.**FROM OUR OWN CORRESPONDENTS.****BRIDGING A GAP**

SANDLER FOR LONDON—INTERESTING SPORTS TALKS.

Bridging a Gap.

AN attempt to bridge the gap which now exists between talks given specially for children and those for adults—that is, to provide for boys and girls between the ages of 14 and 18—will be made in a series of six experimental talks, which are to be given from the London studio on Wednesdays, April 11th, 18th and 25th, and June 6th, 13th and 20th. The scheme has received the enthusiastic support of such associations as the Juvenile Organisations Committee, the Y.M.C.A., the Scouts' Association, the Girl Guides' Association, the National Association of Boys' Clubs, and the National Council of Girls' Clubs, some of whom have passed resolutions

welcoming the experiment and urging its development. Indication of the interest that has been taken in the matter is evinced by the fact that the President of the Association for Jewish Youth has offered to defray privately the cost of installing wireless sets in all Jewish clubs and settlements in London, primarily for the reception of these talks. The series will include talks on "Football and Sportsmanship," by Charles Buchan, the famous Woolwich Arsenal forward; "That Job: How to Get It and How to Keep It," by Alexander Paterson; "The Adventure of Life," by Dame Katherine Furse, and talks on Camping Holidays and Foreign Travel by

(Continued on page 82.)

FERRANTI

TYPE A.F.3

Audio Frequency Transformer



PRICE

25/-

THIS famous Transformer is specified in the "Melody Maker."

All good sets are worthy of the best components, so do not risk disappointment but fit an A.F.3 and ensure the best possible results from your set.

Delivery of A.F. Transformers is being made in strict rotation. Hand your order to your Dealer to-day.

Also FERRANTI "Melody Maker" Coils

Silk covered 7/-

Enamel covered 5/6

The coils are wound on solid Bakelite Tubes, and have the FERRANTI finish.

Put a Ferranti Coil in *your* set. Your dealer can supply one.

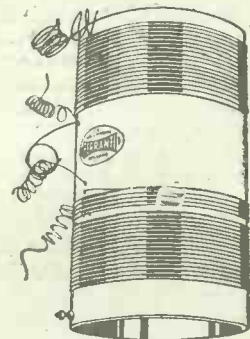

FERRANTI Ltd. HOLLINWOOD LANCASHIRE



APPARATUS TESTED

"HANDISOL" SOLDER—
"PIRTOID" TUBING—D.X.
SHORT-WAVE COILS—A
USEFUL HANDBOOK
—EDISWAN ACCU-
MULATOR, ETC.

* *

Traders and manufacturers are invited to submit wireless sets and components to the "P.W." Technical Department for test. All tests are carried out with strict impartiality in the "P.W." testing-room, under the supervision of the Technical Editor, and the general reader is asked to note that this weekly article is also intended to provide a reliable and unbiased guide as to what to buy and what to avoid.—EDITOR.

"HANDISOL" SOLDER.

THE Handisol Company, 25, Lawrence Street, York, recently sent us a bottle of their "Handisol" material. This is a solder put up in flake form and immersed in a liquid flux. It is a very convenient material to use, and we have found it useful in soldering jobs. The flaky granules of solder can be applied direct to the work and then heated, or a small quantity can be poured into a tin lid and the hot iron applied

in the usual manner. The solder always being coated with flux it runs easily, and it certainly saves time and trouble in the rather tricky art of soldering.

"PIRTOID" TUBING.

Constructors who find occasion to wind their own coils on tubular formers will be interested in the new form of "Pirtoid" being produced by Messrs. Clarke, Ltd., of Manchester. "Pirtoid" is one of the very

best materials we have come across for the purpose; it is sold in tubes of various sizes and diameters. It is excellent electrically, is cheap and easy to work. Although it is a thin, light material it is very strong and does not tend to distort when carrying tightly wound wire. The new "Pirtoid" is black in appearance similarly to polished ebonite, and makes handsome coils.

D.X. SHORT-WAVE COILS.

Some time ago Messrs. D. X. Coils, Ltd., sent us four of their "D.X." short-wave coils. These are built on ordinary plug-in coil bases which are, however, cut away to reduce losses. Heavy gauge nickelled wire is used, and this is well spaced and to all intents and purposes the windings are self-supporting. The coils were tested in quite an ordinary two-valve receiver not designed especially for short-wave reception, although, of course, the H.F. choke was suitable for this purpose; and the fact that one of the first stations tuned in was the well-known 3 L O of Australia is ample proof that the coils are efficient for the work for which they were designed.

A USEFUL HANDBOOK.

We have just received the 1928 edition of the "Practical Electricians' Pocket Book," published by S. Rentell & Co., Ltd. Costing only 2s. 6d. net, it embodies over 600 pages of the most useful information concerning all matters electrical. Notes on all phases of the work and hundreds of informative tables are included.

(Continued on page 81.)

MARCONIPHONE HIGH TENSION SUPPLY UNITS

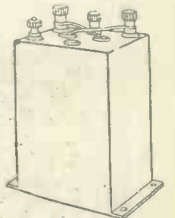

Marconiphone Model D.C.2 for D.C. Mains for 1 and 2-valve receivers only. For 100 to 125 or 200 to 250 volts. Its simple and sturdy construction ensures unfailing reliability. Two tapings are provided at 60 and 120 volts. 35/-.



Marconiphone Supply Unit Model D.C.2 for D.C. Mains

Marconiphone Model D.C.2 H.T. Supply Unit for Direct Current. The efficient design and robust construction ensures entire absence of hum under all ordinary conditions, whilst output is more than sufficient for all standard receivers. For 100-250 volts. 82/6.

Why not use power direct from your house electric supply and solve the problem of H.T. supply. Just plug the flexible cord of a Marconiphone H.T. Supply Unit into an ordinary lamp holder and you obtain continuous and steady H.T. Current requiring

THE MARCONIPHONE COMPANY LTD.,
(Dept. P), 210-212 TOTTENHAM COURT ROAD, W.1.

no attention or renewal and costing a negligible amount for upkeep. There is a complete range of Marconiphone H.T. Supply Units for all kinds of receivers, and for both A.C. and D.C. Current. Send now for full list No. 457, mentioning "Popular Wireless."



Marconiphone Model A.C.3 for A.C. Mains for 1 and 2-valve receivers only. For 100 to 125 or 200 to 250 volts. Two tapings at 60 and 120 volts (including valve and royalty) 73/-.

LISENIN PRE-SET RESISTOR

(Reg. Design.)

SPECIFIED BY THE DESIGNER OF THE

MELODY MAKER

OBTAINABLE OF ALL RADIO DEALERS.

1/9 each.

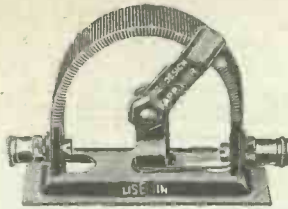

REFUSE TO BE PUT OFF WITH SUBSTITUTES.

1/9 each.

FIVE OHMS RESISTANCE IS THE VALUE REQUIRED FOR ALL COSSOR VALVES FOR THE MELODY MAKER. LISENIN PRE-SET RESISTORS ARE ALSO MADE WITH A MAXIMUM RESISTANCE OF 7, 10, 15, 20, 25, 30 and 50 ohms. ALL ONE PRICE 1/9 each. Obtainable of your Radio Dealer, but if he cannot supply, REFUSE SUBSTITUTES.



FABRIC LOUD SPEAKER CONES

Made in four colours, Gold, Silver, Oxydised Silver, Bronze and Oxydised Bronze Twelve inches diameter. Complete with reed adapter. 2/6 each. Without adapter 2/- each. Postage and packing 8d.



MELODY MAKER COILS wound to specification, with terminals and fixing brackets, as illustrated. Price 6/- each. Postage 4d.

Ask your dealer for them; if he cannot supply refuse to be put off with substitutes. Liberal discount to Trade.

THE LISENIN WIRELESS COMPANY,
1p, Edgware Road, London, W.2.

'Phone: Paddington 2734.

'Grams: "POSGRIP, PADD," London.

Your

COSSOR

Melody Maker

is incomplete without

a

SIEMENS

H.T. BATTERY



Two SIEMENS 60-volt Batteries connected together in series to give 120 volts will ensure CLEAR and POWERFUL reproduction of broadcast programmes for which the "Melody Maker" was designed.

SIEMENS Batteries are recommended exclusively, and we strongly advise our "POWER" Batteries.

SIEMENS 60 volts - - - 8s. 6d. each.

SIEMENS "POWER" 60 volts - 15s. 0d. each.



Do not overlook the

SIEMENS

GRID BIAS BATTERY

with special fixing flap
'G.2 size. 9 volts. 2s. each.

Obtainable from your Dealer.

SIEMENS BROTHERS & Co., Ltd., WOOLWICH, S.E.18.



A Perfect Combination!

—the Ericsson Family Two Loud Speaker Set and the Ericsson Super Tone. They combine to give the finest possible rendering of the "local" and 5 X X or 5 G B.

The set is beautifully made in a sturdy Oak cabinet. All parts enclosed. Price £8 - 15 - 0. Royalties 25/-. The Ericsson Super Tone costs 45/-.

On sale at all good dealers, or direct from:

ERICSSON TELEPHONES, LTD.,
67/73, Kingsway, London, W.C.2.

Ericsson
APPARATUS

Ericsson Ericsson Ericsson Ericsson Ericsson



All Editorial Communications to be addressed to The Editor, POPULAR WIRELESS, The Fleetway House, Farringdon Street, London, E.C.4.

The Editor will be pleased to consider articles and photographs, dealing with all subjects appertaining to wireless work. The Editor cannot accept responsibility for manuscripts and photos. Every care will be taken to return MSS. not accepted for publication. A stamped and addressed envelope must be sent with every article. All inquiries concerning advertising rates, etc., to be addressed to the Sole Agents, Messrs. John H. Lile, Ltd., 4, Ludgate Circus, London, E.C.4.

The constructional articles which appear from time to time in this journal are the outcome of research and experimental work, carried out with a view to improving the technique of wireless receivers. As much of the information given in the columns of this paper concerns the most recent developments in the radio world, some of the arrangements and specialities described may be the subject of Letters Patent, and the amateur and the trader would be well advised to obtain permission of the patentees to use the patents before doing so.

QUESTIONS AND ANSWERS.

LONG RANGE WITH A CRYSTAL.

"CRYSTAL" (Sandy Lane, Chorlton-cum-Hardy).—"A friend of mine living in the Midlands claims to have designed and built a crystal set, using only standard components, which appears to have remarkable long-range capabilities. He receives numerous stations such as London, Bournemouth, Birmingham, Newcastle, etc., by means of plug-in coils,

which seems to me a remarkable achievement. He is situated high up in open country, and consequently may be in an unusually favoured position for reception.

"Do you consider that this is an advance on what has been achieved before with plain crystal receivers?"

Ever since crystal sets became popular it has been found that under certain conditions these "freak" results are obtainable.

In most instances, such long-distance crystal-set reception is due to a combination of favourable circumstances, such as geographical position, efficient aerial and earth system, etc. Many crystal-set owners can tune in foreign stations night after night without much difficulty, even where re-radiation from a valve-set is not occurring. And the long range does not seem to be due to the set used so much as to these favourable "local conditions," under which any fairly good set will become a reacher-out.

If your friend's aerial is one of these favoured ones, it probably will not matter very much what kind of crystal set he uses provided it is an efficient one, able to deliver most of the energy put into it by the aerial. Almost any set will give good results in some cases.

But on the other hand even the best-situated set will respond to good treatment, and any little improvement that can be made to its efficiency will result in louder programmes.

THE WAY TO NEUTRALISE

T. M. (Jesmond-on-Tyne).—"The set is an H.F., Det., and L.F., with reaction, and I should be glad of some hints on neutralising."

The following method of neutralising is recommended.

Set the reaction control at minimum, and likewise the neutralising condenser. Now, on setting the tuning condensers so that the two tuned circuits are in step with each other it will probably be found that the set is oscillating.

Note: To test for oscillation touch with the finger one or other of the sets of plates of the tuning condensers (this may be either the fixed or moving, according to the particular set). Oscillation is indicated by very loud clicks corresponding to the finger-taps.

You will probably find that the set will only oscillate under the above conditions when the two
(Continued on page 74.)

BUYING ON EASY TERMS



THE universal popularity of the Deferred Payments plan of purchasing out of income has naturally created in many quarters a distorted impression of the methods employed by many firms of good intent. There are still many people who have not realised that goods can be acquired WITHOUT A DEPOSIT; that delivery is made immediately the first small instalment is paid; and that references are not required and no objectionable enquiries are made into their private affairs.

Yet this is the simple method by which you can obtain any of the famous BULLPHONE "NIGHTINGALE" Loud Speakers. On the assurance that you are the tenant of at least two rooms and that you own the furniture therein, the Loud Speaker is delivered to you immediately you pay the first instalment. We ask for this assurance simply to avoid applications from minors or others not wishing to use our loud speakers in their own homes. If you are not completely satisfied with the loud speaker, there is no obligation to complete the transaction.

THE NIGHTINGALE CABINET CONE LOUD SPEAKER

Gives Wonderful Results with the "MASTER THREE," COSSOR "MELODY MAKER," or any 3 to 7 Valve Sets

SEND DEPOSIT NOW!

SATISFACTION GUARANTEED OR MONEY REFUNDED.

6/-

is all you have to pay to secure immediate delivery of this handsome Cabinet Loud Speaker. This represents the first instalment, and the balance may be paid in 12 monthly instalments of 6/-, starting one month after you have received the Speaker.

BULLPHONE LTD.

38, HOLYWELL LANE, LONDON, E.C.2.

DO YOU KNOW ?



J.B. Solodyne Model.

DO YOU KNOW that the J.B. Condenser illustrated was specially designed and used by Mr. Kendall in the 1928 Solodyne ?

DO YOU KNOW that J.B. Models have been specified for practically every Star Set published since the commencement of the Season? This imposing list includes Mullard's masterpiece "The Master Three," and "Britain's Favourite Three," published by "Amateur Wireless."

YOU DO KNOW what this means. J.B. Condensers are considered by the leading Radio men of the day to be the best for inclusion in Receivers of any importance.

What further recommendation is necessary ?

JACKSON BROS.
8, POLAND ST.-OXFORD ST. Telephone:-
LONDON - W.1. GERRARD 7414

Transformer troubles banished by

BROWNIE WIRELESS

Brownie Transformers are guaranteed 100% British. Made from the very finest materials, the characteristics and performance are equal to those of transformers costing twice the price. Ensure perfect tone and quality by building a Brownie Popular Transformer into your set. See this wonderful transformer for yourself at your nearest Radio dealer.



THE BROWNIE POPULAR TRANSFORMER.— The magnetic field is composed of special laminations of the softest iron procurable, and the accuracy of the windings on their moulded bobbin guarantee distortionless reproduction, free from resonance. Totally enclosed in a moulded case . . .

9/6

Send for our new free booklet, "Wireless Without Worry," to:-

THE BROWNIE WIRELESS COMPANY (G.B.) LTD.,
Dept. 26, NELSON STREET WORKS, LONDON, N.W.1

Let these improve your set

In their respective positions each of these three components gives that faultless service which is characteristic of all Igranic Radio Devices, and so contributes towards the efficient trouble-free functioning of your set.

The complete illustrated Igranic catalogue, List No. R82, contains full particulars of a whole range of other components which will help you to obtain better radio reception. May we send it you?

Igranic Anti-Microphonic Valve Holder

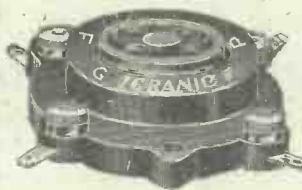

Possesses every feature essential for perfect valve suspension. The groove makes valve insertion easy in dark or awkward positions, while the sunk sockets make accidental burn-outs impossible. The springs effectively prevent microphonic noises and shield the valve from shocks. Price 2/- each.

Igranic Tapped Triple Honeycomb Coil

This Coil, possessing the high efficiency of the Standard Igranic Triple Honeycomb Coil, is provided with two tapings, one for aperiodic aerial coupling, and the other for centre-tapped circuits. Being mounted on a standard plug, it is particularly convenient for modernising old sets. Five sizes cover 180-3,350 metres.

Nos. 1 2 3 4 5
Prices. 3/9, 4/3, 4/9, 5/6, 6/3.

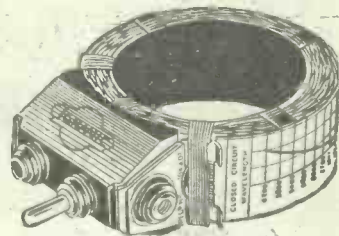

Igranic Radio Switch

A very neat and well-constructed battery switch which gives the finishing touch to a set. Snaps on and off with a positive click, making good contact when on. The part on the panel is heavily nickel-plated giving a very refined appearance. One-hole fixing is provided for. Price 2/6 each.

Works:
Bedford.



Branches: Birmingham, Bristol, Cardiff, Glasgow, Leeds, Manchester and Newcastle.

149, Queen Victoria Street,
London, E.C.4

RADIOTORIAL QUESTIONS AND ANSWERS

(Continued from page 72.)

circuits are in tune with each other, so this can be used as an indication. It is convenient to start neutralising at some point near the middle of the tuning range. Now, try the effect of increasing the capacity of the neutralising condenser (i.e. make the plates over-lap more).

Test at intervals for oscillation as this is being done, and you will presently find that the set has ceased to oscillate, and will not recommence even when the tuning dials are slightly readjusted.

Now increase the reaction a little, until the set once more oscillates, and again increase the neutralising condenser setting until oscillation ceases. Slightly readjust the tuning condensers again to make sure that the set is completely stable once more. Proceed in this way until it is found that the correct adjustment of the neutrodyne condenser has been over-shot. Once this point has been passed it will be observed that further increases of the neutrodyne condenser setting no longer stop oscillation, but cause it to become stronger.

The object is to find such an adjustment of the neutralising condenser as will permit the greatest setting of the reaction condenser to be used without producing oscillation. (It will be observed that if the two tuned circuits are in step, and the set is brought to the verge of oscillation a slight movement in either direction of the neutrodyne condenser will cause the receiver to break into oscillation.)

When properly neutralised as above, the set will be very sensitive, and will also be comparatively easy to handle.

USING THE STANDARD WAVE-TRAP.

"DISAPPOINTED" (Wanstead, London, E.).
—"I built the wave-trap just as given in 'P.W.', but as far as I can see I might have saved myself the trouble.

"I connected it between aerial and the set, and screwed the condenser right down, but it hasn't made a ha'porth of difference that I can see. What is wrong?"

You are, "DISAPPOINTED." The Standard Wave-trap is a good one, and like every good wave-trap it lets all the stations go by *except the one it is tuned*

to. You can't expect it to cut out 2 L O unless you adjust it to do so, can you?

The adjustments are very simple, and if you have not gone wrong in the constructional work you will find that the correct setting for the trap can be found in a moment. Try it, as follows:

Connect your aerial lead to the plug so that it can be plugged into one of the sockets on the wave-trap. Join the terminal on the wave-trap to the aerial terminal on your set.

First, tune in London (no reaction in use) until it fairly "shakes the speaker"—in other words, give the wave-trap the stiffest job that you can. Then leave the tuning condenser alone, and see what adjusting the trap will do.

"P.W." TECHNICAL QUERY DEPARTMENT

Is Your Set "Going Good"?

Perhaps some mysterious noise has appeared and is spoiling your radio reception?—Or one of the batteries seems to run down much faster than formerly?—Or you want a Blue Print?

Whatever your radio problem may be, remember that the Technical Query Department is thoroughly equipped to assist our readers and offer an *unrivalled* service.

Full details, including a complete scale of charges, can be obtained direct from the Technical Query Dept., "Popular Wireless," Fleetway House, Farringdon Street, London, E.C.4.

A postcard will do: On receipt of this an Application Form will be sent to you free and post free, immediately. This application will place you under no obligation whatever, but having the form you will know exactly what information we require to have before us in order to solve your problems.

To do this, simply turn the wave-trap's condenser *slowly*, and notice the effect upon 2 L O. Unless you have something wrong somewhere you will find that as you turn the condenser gently you will locate a place where the programme weakens. And if you turn the condenser carefully you will find there is one exact setting where 2 L O is weak.

By leaving the wave-trap set, you can make it "suck-out" 2 L O's signals, leaving other stations unaffected; and consequently your tuning is a different proposition altogether, and you should be able to pick up many programmes that were previously swamped out.

If at first you do not seem to be able to get rid of the London programme as completely as you hoped, try changing the aerial plug over to the other socket. On some aeriels it needs to be in the socket next to the terminal, and on other aeriels it is better in the far socket. In any case it is easy to compare results and decide which position suits you best.

By the way, don't forget to turn the wave-trap condenser *slowly*—probably when you "screwed it right down" you shot past the adjustment without noticing it.

H.F. FOR SELECTIVITY.

H. W. B. (West Hampstead, N W.6).—"In the cause of Radio truth and honesty you will say once and for all whether it is possible, on any valve receiver which has at least 1 L.F. and at most 1 H.F., to really tune out 2 L O, and at the same time receive at the full strength of which the receiver is capable any station whose wave-length is less than Langenberg?"

"Experience has taught me that (1) the statement 'I tune out' usually means that Langenberg drowns the detuned 2 L O, or (2) that tuning out 2 L O simply means putting the circuits out of resonance, in which case the wanted station is very weak, or cannot be tuned in. As soon as the set is resonant again, even at the 480-odd metres wave-length, in comes 2 L O at more or less strength.

"I speak above of loose-coupled circuits, but with tapped coils the result is much the same, for the tapping which decides the selectivity also decides the power, and MORE selectivity is LESS power on the wanted station.

(Continued on page 76.)

YOU GET MORE FROM MARCONIPHONE TRANSFORMERS AND CHOKES

In components, as in receivers, leadership falls naturally to Marconiphone. It is the vastness of this organisation, the continued research, that gives to Marconiphone components their technical advantage—and to you, finer, more finished *results* than you ever enjoyed before.

The Marconiphone "Ideal" Transformer is, to all intents and purposes, distortionless throughout the musical range. It is larger and heavier than any other transformer on account of the quantity of highest grade material used in its construction. Rigorously tested at every stage of manufacture, every "Ideal" is *guaranteed* to conform to the individual curve supplied with each instrument.

Supplied in four ratios, 2.7 to 1, 4 to 1, 6 to 1, 8 to 1, 25/- each.

THE MARCONIPHONE COMPANY, LIMITED

(Dept. P), 210-212, Tottenham Court Road, London, W.1.

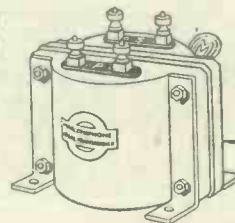

Marconiphone "Ideal" L.F. Transformer.

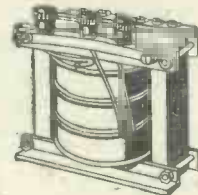

Marconiphone Power Transformers. Model "A" for use with the U.S. rectifying valve, 35/-; Models "C" and "D" for use with Marconi K.L.I. Valves, providing an "all-mains drive," 37/6.

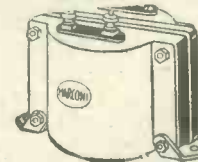

Marconiphone "Ideal" L.F. Choke. Design similar to "Ideal" Transformer. Suitable for choke-coupling, H.T. Supply Unit and filter circuit, 21/-.



Marconiphone "Ideal" Supersonic Transformer. Provides a happy blend of selectivity and good quality amplification. Designed for intermediate frequency stages of Super-Het receivers, and is tuned to 6,500 metres, 20/-.

There is a complete range of Marconiphone Transformers and Chokes for every purpose. Send now mentioning POPULAR WIRELESS, for publication No. 453.

Marconiphone H.F. Choke. Inductance 100,000 microhenries, resistance 700 ohms. Very efficient on wave-lengths up to 4,000 metres. 10/6.



The OLDHAM I.V.D. Accumulator is officially recommended for use with the Cossor "Melody Maker"



THE Oldham I.V.D. Clear Glass Accumulator gives superb results when used with the "Melody Maker." Charged ready for use when it leaves our factory, your dealer has only to add acid, and in 50 minutes you can connect it to your set. The Laminode Plates, made under the Oldham Special Activation Process, permit slow discharge, and their sturdy construction ensures long life. The I.V.D. is an accumulator of exceptional value, and is well named "The Faithful Service Accumulator."

Charged Ready for Use

Get an I.V.D. to-day from your Dealer.

9/- each

2 volts,
20 amp. hours



OLDHAM & SON LTD., Denton, Manchester.
London Office: 6, Eccleston Place, S.W.1.
Glasgow: 75, Robertson Street, C.2.

CA 2016

LOEWE RADIO

The Famous

LOEWE

LOEWE

High Vacuum Resistances and High Vacuum Block Condensers



Should be installed in every wireless receiving set.

They are

- Free from atmospheric influences.
- Moisture and dust proof.
- Free from losses.
- Fully guaranteed.

Delivery from stock.

Ask for illustrated leaflet.

LOEWE RADIO COMPANY LIMITED.,

4, Fountayne Road,
Tottenham, London, N.15.

Telephone: Tottenham 2076.



Worth £5.50
costs only
27/6
to build

STAND 6'6" EXTRA

Goodman's Loudspeaker Components have stood the test of time. That thousands have found it an easy matter to construct a Loudspeaker

capable of wonderfully faithful reproduction, for an exceptionally low cost, is proved by the large number of unsolicited testimonials received. The Goodman Seamless Moulded Cone has established itself as the finest Diaphragm at present obtainable. Our Double-Acting Reed Unit (27/6) is undoubtedly the most sensitive and powerful Unit on the market. The Goodman JUNIOR, a Unit of exceptionally good design, although only recently introduced, is now acknowledged to be far superior to any Unit at near its modest price (14/6); in fact, second only to our Double-Acting Reed type. It is housed in a strong brass case, finished bronze by electrolysis, every part interchangeable, with six screws provided at back, for fitting either to GOODMAN'S Backstays and Frames, or to those made by the constructor. Adjustable by heavily-plated knob at back. Cone bushes and strong leads (for set connections) are supplied with each Unit. Noteworthy features are the specially designed pole piece and bridge, built up from quantities of laminations—not solid. Three heavy magnets are incorporated in each unit. The ample proportions of all parts render this Unit capable of handling considerable volume without overloading or distortion. Its general appearance and finish is equal to that of the most expensive instruments.

It is much cheaper to build your own Speaker, with Goodman's parts. It will give you results equal to any on the market, irrespective of price, and will astonish you in its fidelity of reproduction. Avoid imitations. GOODMAN'S were the pioneers of Specialities for Home Constructed Loudspeakers. Experience counts!

SEAMLESS MOULDED CONES ARE BEST WITH ANY UNIT.
ANY CONE IS BETTER FITTED WITH A GOODMAN UNIT.

If you are interested in COIL-DRIVEN SPEAKERS, see our Lists (C.D.5) of COIL-SPEAKER UNITS, etc. Quality and finish are of the usual high GOODMAN standard, and prices as low as possible, consistent with perfect workmanship.

**EASY
TERMS
CAN BE
ARRANGED
IF
DESIRED**



The Goodman Junior.
A Reed Unit specially designed for the sole purpose of driving large diaphragms of the Cone, Pleated Disc, or similar type. NOT a converted Earpiece or Gramophone attachment.

**EASY
TERMS
CAN BE
ARRANGED
IF
DESIRED**

Illustrated descriptive leaflets on request.

Original unsolicited testimonials at our office:

From CIRENCESTER: "Accept my congratulations on having produced the perfect Cone Speaker, and that at a reasonable price."

From BRADFORD: "I am very satisfied with the Speaker, it is the best I've ever heard for tone."

From LIVERPOOL: "The GOODMAN UNIT handles volume equal to a Moving Coil Speaker without overloading. Startlingly efficient, and all you claim as far as volume, purity, and mechanical perfection is concerned."

From CARDIFF: "I must write and tell you how pleased I am with the instrument (27/6 Unit and Seamless Cone). The tone is excellent, superior to most, and equal to any other, irrespective of price. I am surprised at the splendid volume, and in this respect it is equal to a large and sensitive horn loud-speaker I have."

From GOOLE: "No praise can be too high. I was positively astounded... the roundness and fullness of tone, mellow, yet crisp speech, and the drums are all there, provided the set delivers them. This is quite unsolicited praise."

If you have any difficulty in obtaining locally, send direct to us, enclosing your dealer's name and address.

GOODMANS, 27, Farringdon St., E.C.4.

RADIOTORIAL QUESTIONS AND ANSWERS

(Continued from page 74.)

I write for "P.W."-ites who live in a two or three mile radius of 2 L.O., and more especially in my own district.

"With a wave-trap AND a loose-coupled circuit it is possible to perform wonders in absolutely silencing 2 L.O., and separating other stations from each other, but one is constantly hearing and reading of such claims of 'cutting out' at short distance that one wonders if all one's experience is at fault. When investigated I always find such claims break down if the above conditions as to set are observed.

Simpler Circuits Better?

"It is easy—no trouble at all—at this distance to cut out 2 L.O. on a crystal set, one-valve set or one-valve and crystal reflex if loose coupling is used, but add either H.F. or L.F. and the trouble begins. Will you please state as an answer to the letter whether you think that WITHOUT A WAVE-TRAP it is possible to fulfil the above conditions in this district?"

"It amounts to this, that if 2 L.O. cannot be cut out without serious loss of power on the wanted stations, then it is better to keep to the easier and simpler circuits and rely on the wave-trap which does NOT to any appreciable extent detract from the power of stations quite near to the 2 L.O. wave-length."

Your letter, H. W. B., raises some very interesting points. On the other hand, it also leaves a lot unsaid, and there are two unmentioned points in particular which have a very important bearing upon this question.

These points are, first, do you refer to specially-designed sets, or to the average set, such as is in the hands of the not-too-well-off-but-frightfully-keen-on-wireless enthusiast? And, secondly, the question of

adequate screening to prevent direct pick-up on coils, etc.

With reference to the first of these two points, we would point out that a set built by an expert and specially designed with H.F. circuits of extremely low damping, will, when handled by an expert, give results which seem absolutely phenomenal when compared with those of the ordinary set. And with regard to the second point, we would remind you that although the selectivity of an average set does not suffer because the coils or wiring is picking up energy

direct from the broadcasting station as distinct from the energy passed to it by its aerial, yet this factor of direct pick-up is a very important one with sets situated within a few miles of a powerful broadcasting station, such as 2 L.O.

Assuming that no special precautions with regard to screening have been taken and that your set is just an ordinary well-built one, we should say that if having one H.F. stage (even though loosely-coupled and working with reasonable efficiency) it is not of itself capable of giving sufficient selectivity to cut out the local station, and bring in distant stations on nearby wave-lengths at full volume.

It is common, nowadays, to talk of the addition of a high-frequency stage as an aid to selectivity, because practical experience has proved that this is one effect it has, in average cases. But it should not be forgotten that this extra selectivity is incidental, and that selectivity is not really the reason for adding an H.F. stage.

The real purpose of H.F. amplification is to increase the amplitude of the incoming signal to such a degree that it is capable of working the detector efficiently. Despite statements to the contrary, the addition of a stage of H.F. is not a sort of super-wave-trap that brings in the distant stations and silences the local one. As a matter of fact, it amplifies all signals in the aerial with absolute impartiality and, therefore, within its limits, it will magnify the signals from the local station as well as those from abroad.

A wave-trap, on the other hand, is a really selective device. When accurately tuned to the local station, it selects the signals in preference to all others, and it does, therefore, discriminate in favour of the foreign or distant stations. For this reason, situated as you are, we should prefer the wave-trap every time.

It is economical, it is easily made, it is efficient, it will really discriminate and take out the signals of the local station (or the one to which it is tuned) leaving all other signals comparatively unaffected. Considering also that it costs nothing to maintain, it will be seen that its advantages over a stage of high-frequency amplification are enormous, provided, of course, that it is really the elimination of the local station which is important. (No wave-trap, however efficiently it eliminates the local station, can possibly bring up the strength of distant stations to a degree sufficient to work a detector properly, so that for this purpose the stage of H.F. amplification is not merely preferable, it is absolutely essential.)

THE "PROGRESSIVE" THREE.

H. J. (Sheffield).—"I shall be much obliged if you can inform me if the 'Progressive'

(Continued on page 78.)

THE HALE ONE-VALVER.

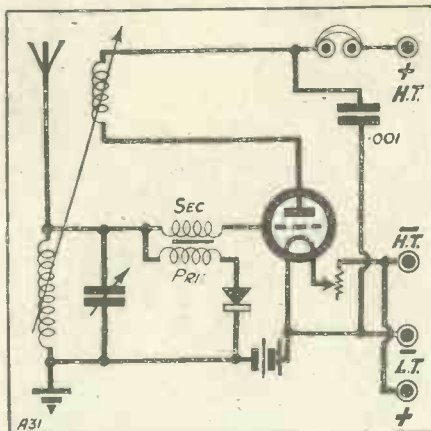

The correct connections for a Hale One-Valve set are shown above. In the "What is Wrong?" diagram last week, the grid-bias battery was reversed and was placed in the tuned circuit (between coil and condenser). L.T. was shorted, the rheostat was in parallel instead of in series with the filament, and the by-pass condenser was joined to the wrong side of the reaction coil.

LATEST IN CABINETS "ERECTO"

SUPREME SIMPLICITY

Amazing Strength

EXTREMELY HANDSOME

No Screws (21"x9"x7")

ASSEMBLED IN 3 MINUTES

Especially suitable for

THE COSSOR

MELODY MAKER

Panels supplied undrilled if required.

INTERLOCKED PARTS

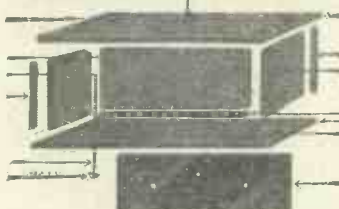

LUCIDON

12, Alderton Crescent, Hendon, N.W.4

Phone: Hendon 1862

INTERLOCKED PARTS

WONDERFUL VALUE

	s.	d.
Cabinet (unpolished)	8	0
Polished MAH., WAL., OAK	13	0
Insulated Panel	5	6
Insulated Strip	1	6
Tie Rods complete (4)	2	6
De Luxe set (polished)		
Tie Rods and Panels	£1	2 6

Postage 1/6.

AS SPECIFIED

OAK OR MAHOGANY CABINET SPEAKERS



Use also the Whiteley Boneham cabinet speakers, and make your reproduction do justice to a successful set.

Oak or Mahogany £3.0.0

All-bakelite cabinet cone £4.4.0

Junior model £2.10.0

THE W.B. ANTI-PHONIC VALVE HOLDER

Specified by Cossor to ensure perfect freedom of the "Melody Maker" from vibratory noises, valve shocks and losses. Insist on having the W.B. Valve Holder, because no substitute will give equal satisfaction.

Of all Wireless Dealers, each 1/9

Manufactured by:

WHITELEY BONEHAM & Co., Ltd.,
Nottingham Road, Mansfield,
NOTTS.

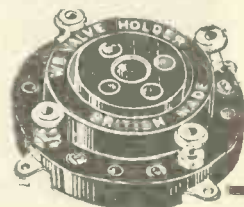

how many accumulators have you got?

ONE? TWO? OR NONE? If you have only one accumulator, we will lend you one of ours while we recharge yours to ensure a continuous service. We will collect, maintain, and deliver each alternately. If you have two accumulators we will give you the same service. If your accumulators are unserviceable we will keep you continuously supplied with ours.

And at the same time we will loan you, if you like, the famous C.A.V. H.T. Accumulators, which experts agree give far better results for less than the cost of unreliable dry batteries.

This Service is cheaper than seeing to accumulators yourself. It saves you the trouble and risk of unskilled recharging, never leaving you without current; eliminates accumulator trouble; looks after your accumulators properly.

Our elaborate plant, skilled operators, and fleet of delivery vans guarantee an efficient, punctual, and economical service. Deliveries are made weekly, fortnightly, or monthly. Send a p.c. right away, and we will post you full particulars.

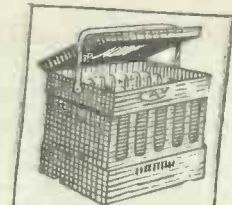

For H.T. Service we supply the famous C.A.V. make exclusively. Our experience has proved these to be the best. Any voltage.



RADIO SERVICE (LONDON) LTD., 105b, TORRIANO AVENUE, KENTISH TOWN, N.W.5.

Telephone: North 0623-4-5.

AND NOW THE "1930/FOUR" !!

Thousands have been amazed at the performance of the "1930 THREE" recently advertised. Add to this wonderful reception an unusually wired H.F. stage, and hear the stations roll in. One after another they come, all on the speaker. Space annihilated, half the world is yours. This wonder-circuit employs only ordinary parts, ordinary motionless basket coils made in a few minutes. No snag. No stunt. No trouble. Purchasers of RADIO-PLAN No 27 (which tells all about it) may receive as much free help as they desire. Nobody left guessing. Every set made a success. Send 3/- for blue prints and instructions. POINTS: STATIONS BY THE DOZEN. SHEER SIMPLICITY. FINE SELECTIVITY. MAXIMUM RANGE. LOW CONSTRUCTIONAL COST. VOLUME OF A BAND.

Ask for Radio-Plan No. 27. Price Three Shillings.

Send for Price List of "P.P.V." Circuits, Post Free.

PRESS EXCLUSIVES (Pioneers of Simple Wireless),
29, Paternoster Row, London, E.C.4.

"POPULAR WIRELESS" ADVERTISEMENT RATES

Whole Page £40 Quarter Page £10
Half Page £20 Eighth Page £5
Narrow Column Advt. (3 cols. to page) per inch 30/-
Minimum Space accepted - - - half inch 15/-

NO SERIES DISCOUNTS. ALL COPY AND BLOCKS MUST BE IN HAND 11 DAYS BEFORE DATE OF ISSUE TO ENSURE PROOFS. ADVERTISEMENT COPY SUBJECT TO EDITORIAL APPROVAL.

ALL communications respecting advertising must be made to: —
JOHN H. LILE, Ltd., 4, Ludgate Circus, London, E.C.4

Phone. CITY 7261

GOOD NEWS FOR SET BUILDERS

In response to the urgent demand for first-class sets for family use, Mr. PERCY W. HARRIS, M.I.R.E., has now prepared the

Wireless Constructor Envelopes

The first two of this series are Now on Sale, price 1/6 per envelope (by post 1/9).

Envelope No. 1.—THE RADIANO THREE. A famous loud speaker set which you can build in an hour or two—no soldering necessary and a wide range of components to choose from.

Envelope No. 2.—THE CONCERT FOUR. Made of standard parts, all easily obtainable, this is a highly-sensitive long-distance set, giving powerful reproduction of wonderful quality. Covering both long and short wave-lengths, with a switch for 3 or 4 valves, it is essentially a set to enjoy, both in building and operation.

In these envelopes you will find every detail of the set simply explained; photographic reproductions and diagrams are included, as well as a full-size Blue Print.

NOW ON SALE ————— **Price 1 / 6**

By post 1/9, from the Amalgamated Press, Ltd., Bear Alley, Farringdon Street, London, E.C.4.

17/6 BRINGS YOU

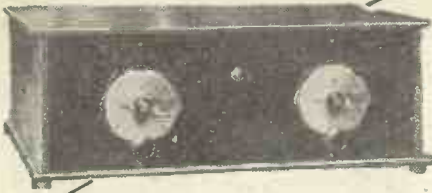

THE FAMOUS COSSOR MELODY MAKER

No set has created such a stir—in the Wireless Industry and out of it—as the Cosmor “Melody Maker.” It is the set for the man in the street. Even if you have never handled a receiver before, on the “Melody Maker” you will be able to get not only the new alternative B.B.C. programmes but also broadcasting from France, Holland, Germany, Italy and Spain. And now this wonderful set is yours for 17/6 down (Royalty paid) and 11 monthly payments of 17/6. For the first payment of 23/3 we will deliver the instrument complete with all valves and batteries. Balance in 11 monthly payments of 23/3.

If you would rather build the “Melody Maker,” we can supply Sets of Parts on Easy Payments. Write for details.

These Accessories on Easy Terms.

VALVES: 1 Cosmor 210D; 1 Cosmor 210R.C.; 1 Cosmor 220P; 2-volt Oldham Accumulator; 108-volt Ever-Ready H.T. Battery; 9-volt Grid Battery.

CONE LOUD SPEAKER. WE recommend M.P.A. PLAQUE. NOTE.—We supply everything Radio on Easy Payments. Write for list P.W.

FILL IN THIS ORDER FORM NOW.

Please send me as soon as possible.

I enclose

17 6 for the Cosmor Melody Maker Set only. Royalty paid.

£1 3 3 for the Cosmor Melody Maker Set, complete with valves and batteries.

£1 6 6 for the Cosmor Melody Maker Set, Accessories, and Loud Speaker.

Strike out lines not applicable. Fill in type required.

For which I agree to pay regularly the instalments as set out in this advertisement.

Please write in BLOCK LETTERS.

Name, Mr. or Mrs.

Address

Householder (Yes or No)

If not a householder insert name of person willing to guarantee instalments.

NEW Times SALES CO.
56, LUDGATE HILL,
LONDON, E.C.4.

RADIOTORIAL QUESTIONS AND ANSWERS

(Continued from page 76.)

Three, as published in ‘P.W.’ can be put on baseboard 12 in. by 8 in. and not lose efficiency. I have a cabinet taking this size panel, but by the diagrams I thought I might have to tighten the components up a bit, but did not wish to do this if it alters the function of the set. The reports in (this week’s ‘P.W.’ have made my wish to try this set stronger than ever.”

No, H. J., we are afraid 12 in. by 8 in. is too small if efficiency is to be retained. It is quite possible to get a three-valve set into this area, and to get results from it. But the “Progressive” Three is a long-distance set embodying H.F. amplification, and this type requires more “elbow room” than, for instance, a Det. and 2 L.F. No doubt a cramped “Progressive” Three would give results—possibly very good ones—but certainly not the results of which it is capable when provided with plenty of room.

THE “HANDYMAN” TWO.

P. G. (Lewisham, London, S.E.)—“How is the ‘Handyman’ Two’s air condenser made?”

This condenser is exactly the same as the one used in the “Sydney” Two. You will require a small piece of ebonite upon which to mount the

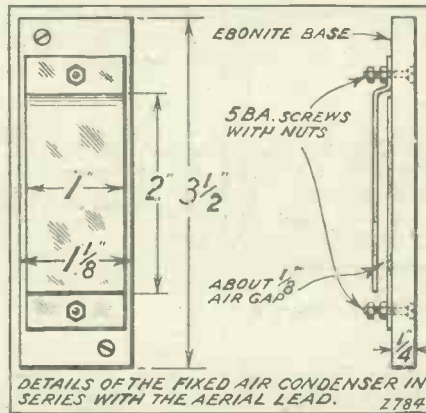

two copper strips, which form the two plates of the condenser. These are mounted so as to overlap for almost their whole length with a space between them of approximately one-eighth of an inch.

When you have got the set working upon the short waves you should not omit to try the effect of varying this space a little, by carefully bending the plates, thus securing a variation of the capacity in series with the aerial.

FOR GOODNESS’ SAKE!

E. F. (Berwick-on-Tweed).—“For goodness’ sake tell me which way a current flows. Is it from H.T. positive, through the loud speaker and valve to the H.T. negative, or is it from H.T. negative through the valve and loud speaker to H.T. positive?”

“I always understood that the positive-to-negative-through-the-valve idea was the old-fashioned way of looking at it, and that since the electron theory had been evolved it was taken for granted that actually the electrons leave the negative end of the H.T. battery, flow through the filament of the valve, across the space inside the valve to the plate, and then via the loud speaker to H.T. positive. But recently in one of the wireless papers I saw a statement to the effect that although the electron flow is from negative through the wire to positive, yet the current flows the opposite way. For goodness’ sake say which is right, as this appears to me to be all tosh!”

Actually the flow of current is nothing more than a steady movement of electrons. In the external circuit—in this case the valve, etc.—the flow or movement is from the negative end of the battery to the valve; here the actual wiring (the filament) terminates in a vacuum, but the electrons cross this vacuum, and find their way to the plate of the valve. From the plate they move via the loud-speaker winding to the H.T. + end of the battery.

THE GUARANTEE OF THE PERFECT TERMINAL

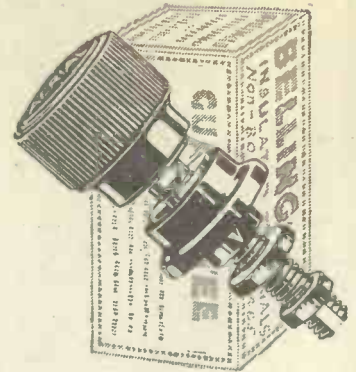

Every Belling-Lee terminal—the most perfect terminal in the world—is sold in an attractive Carton containing a year’s guarantee.

All discriminating Wireless enthusiasts choose Belling-Lee terminals. Are you numbered amongst them?

PRICES.

Type “B.” Bakelite insulated—9d. each.
Type “M.” As type “B” but smaller, and non-insulated—6d. each.

Both types made with 30 different engravings.

BELLING-LEE TERMINALS

BELLING & LEE, Ltd., Queensway Works, Ponders End, Middlesex.

“TROMBA” THE WET H.T. Components supplied. 90 v. for 2 valves 18/6d. NO EXTRAS Carr. Paid. All Voltages stocked. 14d. stamp brings booklet; 6d. a cell; 1/- full range of samples. TROMBA ELECTRICAL CO. (Dept. W.). Phone: Maida Vale 1669. 13, High Rd., Kilburn, N.W.5.

“RED DIAMOND” 2 WAY COIL HOLDER

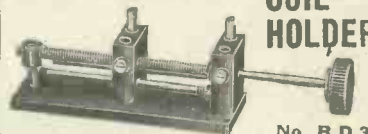

Parallel working. Fine adjustment. Worm driven. Coils cannot fall. Easy movement. Perfect finish. Of all high-class radio dealers or by insured post 4/6, from Sole Makers: **JEWEL PEN CO. LTD.,** Radio Dept. 46, 21/2, Gt. Sutton St., London, E.C.1

No. R.D.32.

4/- Each

TRADE MARK

RED DIAMOND

REGD

D-XELLENT!

D X IN-PLUG COILS

From 1/- D X COILS, LTD. London, E.8.

EVERYTHING RADIO ON

EASY TERMS

WOOLDRIDGE RADIO CO. LIMITED, 17 & 19 LISLE STREET, LEICESTER SQ. LONDON, W.C.

PLEASE MENTION ‘POPULAR WIRELESS’ WHEN REPLYING TO ADVERTISEMENTS

TWO of a kind

—each supreme in its class. Designed to meet varying needs, these two Loud Speakers are identical in the sheer value-for-money they represent. A factor which distinguishes every product bearing the name—



The Brown Q Loud Speaker. Made regardless of cost. 23 inches high - - - Price £15 15s.



The Brown H.4 Loud Speaker. 10 inches high. The smallest Loud Speaker made - - - Price 30/-

Brown

Advt. S. G. Brown, Ltd., Western Avenue, North Acton, London, W.3.

© 1979

MAGNAVOX Notice!

MAGNAVOX Dynamic Speaker Units (moving coil) are manufactured under the following patents—

BRITISH PATENTS.	AMERICAN PATENTS.
No. 197,836, May 24th, 1923.	No. 1,051,113, Jan 21st, 1913.
Others pending.	.. 1,088,283, Feb 24th, 1914.
	.. 1,266,988, May 21st, 1918.
	.. 1,444,524, Feb. 6th, 1923.
Foreign Patents issued and pending.	.. 1,448,279, Mar. 13th, 1923.
	.. 1,524,349, Jan. 13th, 1925.
	.. 1,579,392, Apl. 6th, 1926.
	.. 1,582,417, Apl. 27th, 1926.
	Others applied for and pending.

Purchasers of these units through our exclusive sales representatives

THE ROTHERMEL CORPORATION, LIMITED
24-26, Maddox Street, London, W.1

are advised that they will be fully protected against any infringement actions.

WARNING

The MAGNAVOX COMPANY serves notice that infringers of the above British patent—manufacturers of moving coil speakers assembled or unassembled embodying any exclusive MAGNAVOX features—will be vigorously prosecuted.

THE MAGNAVOX COMPANY
Oakland, California, U.S.A.



Terminal T2LC, Price 4/3d. each.
Terminal T2LN, with Plain Top, Price 3d. each.

Cossor "Melody Maker"



WIRELESS ACCESSORIES

are used and recommended for the Cossor "Melody Maker," also in all the best sets to-day.

Complete Set of EEXE Terminals and Wander Plugs for the "Melody Maker," 4s. 4d.

Write for List T32, which gives details of the EEXE Accessories.

J. J. EASTICK & SONS, 118, Bunhill Row, Chiswell Street, London, E.C.1.



RELIABLE CABINETS

MAKE your radio set as attractive as any sold in the shops by installing it in a Camco cabinet. Illustrated list of complete range sent FREE! Fill up and post coupon below.

CARRINGTON MANUFACTURING CO., LTD., Camco Works, Sanderstead Road, South Croydon.
Telephone: Croydon 0625 (2 lines)
Name.....
Address.....

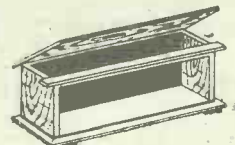

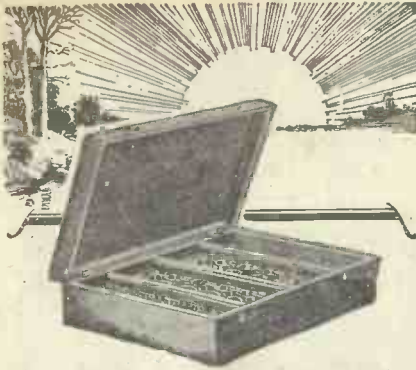

Fresh as the Dawn
every morning.

A permanent source of H.T. supply that re-charges itself while you sleep!

No matter how much you use it—night after night, week in and week out—the Standard self-generating Leclanche battery will provide your set with abundant H.T. supply. Enthusiasts everywhere are loud in its praise, and they have good cause to be! It brings constant, permanent, unflinching H.T. current at a price within the reach of all. The secret **IT RE-CHARGES ITSELF OVERNIGHT.**

GET THIS FREE BOOK!

Take the first step by sending for **FREE** Booklet describing every detail for installing and maintaining this super-efficient and money-saving battery.

2 valve sets, A. 4.50 volts	3.5 valve sets, D. 6.100	Super sets, F. 6.125 volts
25/1	37/3	69/6

Single units of 1½ volts from 4½d. each.

DEFERRED TERMS. NO DEPOSIT.

ORDERS OF 10/- OR OVER CARRIAGE PAID

See daily demonstrations, showing the Standard Battery in use with the Melody Maker, Master Three, and the latest Frame Aerial Set at:

(Dept. A), **WET H.T. BATTERY CO.**
12, Brownlow St., London, W.C.1.

STANDARD
SELF-GENERATING
PERMANENT
H.T.
SUPPLY

The Vital Power in Radio!

M. B. 54

REPAIRS

Any make of L.F. Transformer, Loudspeaker or headphones repaired and despatched within **48 HOURS—TWELVE MONTHS' GUARANTEE** with each repair. 4/- Post free.

Terms to Trade.

TRANSFORMER REPAIR CO.,
"Repairs" Dept.

214, High Street, Colliers Wood, London, S.W.19.

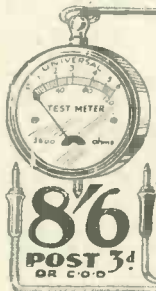

WATES
UNIVERSAL
TEST METER

Milliammeter, 0-30 Milliamps.
Voltmeter, 0-8 and 0-120 Volts.
Think of the advantage of this instrument. You can test your receiver for distortion. Find H.T. consumption. Test voltage of H.T. and L.T. Batteries. Accurate. Dependable. High Resistance.
WET H.T. BATTERY CO.,
12-13, Brownlow St., High Holborn,
LONDON, W.C.1.

8/6
POST 3d
OR C.O.D.

SHORT-WAVE NOTES.

By W. L. S.

THE day of the short-wave set that would, and was intended to, receive nothing but the shorter wave-lengths has practically gone. Nearly all the short-wave sets recently described in "P.W." have been capable of receiving broadcast as well as the short-wave signals.

In its way this is all to the good, since a set that will give a good account of itself on the shorter waves will undoubtedly be all the more healthy when used for less difficult tasks, for there is no doubt that broadcast reception is a far less difficult business.

Excellent Receiver Test.

There is nothing which is better calculated to show up the weak spots in a receiver than a test as a short-wave set. Just as months of testing on the road at ordinary speeds may be equivalent to one race at a really high speed in determining the vulnerable points of a car, so a few moments spent on improving a set at the really higher frequencies will show one as much as many weeks spent on the lower.

When the screened-grid valve has been developed to a greater stage of perfection for use as an amplifier in front of a short-wave set, it seems quite possible that the standard test of a broadcast receiver before it is passed as O.K. will be the substitution of short-wave coils and a short test for stability and sensitivity at, say, 30 metres.

A sure sign that spring is approaching is the way in which the European stations continue to come in right up to 11 p.m. or later, instead of fading out at 6 p.m. or so, as they have been doing all through the winter. In a way the spring and summer are the most interesting seasons of the year for short-wave work.

Many of the European amateurs whose work keeps them away from transmitters until late hours do not "see" one another over the ether from one week-end to the next throughout the winter. With the coming of the long light evenings, however, friendships in Europe can be renewed during the evening.

Low Aerial Best.

I spoke a little while back about my 6-ft. high aerial which was being used for short-wave reception. I have recently had on my bench a well-known make of broadcast receiver (commercial), and a home-made short-wave set, and have been indulging in some very interesting tests.

Changing the short-waver over from the high aerial (40 ft. high and 65 ft. long) to the low brought about an increase in signal-strength of about ten per cent, and a definite decrease in the amount of mush audible.

Changing over the broadcast receiver in the same way caused a decrease of signal strength of about 60 per cent (and on weak foreign stations 100 per cent!), and the "mush" did not change appreciably. It certainly seems that if one is keen on short-wave work only it is a good plan to dispense with masts and use an aerial not more than 6 ft. high.

FOR YOUR COSSOR MELODY MAKER

YOU will naturally prefer the Resiston panel. The even deep lustre of its brilliant surface is so beautiful. You will be impressed with the sense of fine finish that the Resiston panel will give to your Set.

Combined with fine appearance are those hidden qualities essential to efficient performance. Sheer strength under the drill—the Resiston does not split or break—low dielectric constant, perfect insulation—no surface leakage. These are seen only with the eye of experience. They are bought on trust.

Because it embodies every quality of appearance and performance, the Resiston Panel has proved itself worthy of confidence.

For your Cossor Melody Maker

INSIST ON

RESISTON
PANELS

Resiston Panels come in 13 stock sizes in black and Mahogany-grained. From 6 in. x 9 in. in black, 3/5 to 8 in. x 30 in. Mahogany-grained 19/-

"24 hours
Cut Panel Service"

American Hard Rubber Co. (Brit.) Ltd., 13a Fore St., London E.C.2

2007

APPARATUS TESTED.

(Continued from page 70.)

EDISWAN ACCUMULATOR.

The Ediswan X.W 22 type 6-volt accumulator has an actual capacity of 20 amp. hours, and retails at 30s. It conveniently comprises separate 2-volt cells. They have celluloid cases and large non-spill vent plugs. The terminals are large, and are brightly coloured red and black. We particularly like these large coloured terminals, for they enable the correct poles to be ascertained at a glance. The small red crosses and black lines which are the only indications available on some makes of accumulators tend to become erased in the course of time, and of little value.

The Ediswan accumulator appears to be particularly well designed and assembled. The Ediswan people, who we have never yet found to exaggerate in respect to their productions, claim special features in the construction of the plates which should make the battery capable of hard work and withstand ill-use, and, in general, give it a long and useful life. We have already had the battery in operation for a week or two, during which period it has been charged and discharged twice; and, as far as we can see, there is no reason why it should not be just as lively as it is now, and in practically as good a condition a year or two hence.

"THE MODERN BATTERY."

Messrs. C. A. Vandervell & Co., Ltd., of Acton, have issued an instructive brochure under the above title. This illustrates and describes in an ingeniously simple and non-technical manner the advance, progress, and improved design of C.A.V. accumulator batteries. Copies of this booklet are obtainable free upon application to the publicity department of the above-mentioned firm.

REMOTE CONTROL.

The well-known "Lotus" remote control, a speciality of Garnett, Whitely & Co., Ltd., of Liverpool, is now available in three different types. This makes the great convenience of remote receiver control applicable to any variety of receiving gear. Even if your receiver derives all its H.T. and L.T. from the mains, there is now a suitable "Lotus" remote control for it. We have examined and tested the model which permits the switching on and off at a distance of an L.T. accumulator and an H.T. eliminator, and find the device perfectly sound and reliable.

PRICE REDUCTIONS.

Messrs. Graham-Amplion, Ltd., announce the following price reductions. The Amplion cone model A.C.4, in oak, will in future sell at £3, instead of £4, and the model A.C.4M, in mahogany, will in future be, £3 3s., instead of £4 4s.

A RESISTOR CHART.

The Dubilier Condenser Co., Ltd., are issuing a chart, copies of which may be had free on application, which enables one to choose the correct value of resistor for valves of various voltages with any given voltage accumulator.



No secrets about BENJAMIN

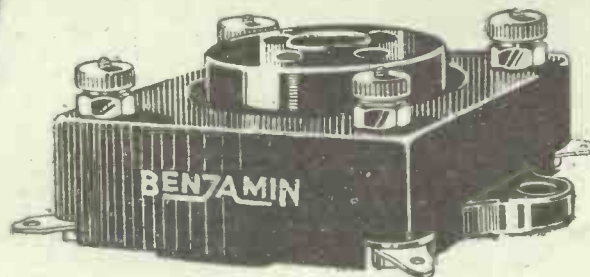

A STRAIGHTFORWARD ANTI-MICROPHONIC VALVE-HOLDER

In the Benjamin anti-microphonic valve-holder the valve is doubly sprung upon springs—one-piece springs that absorb every tremor of vibration, springs that protect your filaments from every shock, springs that will not let a sudden jar reach your valve from whatever direction, springs without joints or riveted connections. The Benjamin Valve-Holder is the simple, straightforward means of protecting a valve filament from shocks—as it was the first anti-microphonic valve-holder, it employs the obvious, and therefore, most practical, means to the end for which it was designed.

Every wireless expert, every radio manufacturer, every designer of sets knows that there is no valve holder so simple, so efficient, or so convenient as the Benjamin.

BENJAMIN

From all Radio Dealers—
price 2/- each

THE BENJAMIN ELECTRIC LTD.

Brantwood Works, Tariff
Road, Tottenham, N.17.

NEWS FROM SAVOY HILL.

(Continued from page 68.)

Clifford M. Collinson, as well as some interesting hints on "How to Keep Fit," by Commander B. T. Coote.

"Figaro" from Cologne.

It is now announced that the relay by land-line from Cologne, already referred to in these columns, which is to take place on Monday, March 12th, for broadcasting from British stations, will consist of Act II of Mozart's "Figaro."

As an indication of the cost of these long-distance relays the expense of the land-lines for the interchange of programmes between Liège and London on Sunday, March 11th, and between London and Cologne on the two following evenings, together with the necessary tests, will be of the order of £30, in addition to which there will, of course, be engineering expenses. It is understood, however, that the heavy expenses are the subject of negotiations between the B.B.C. and foreign broadcasting organisations, the outcome of which will be to share the cost on some equitable basis.

Moszkowski Again.

Another concert of Moszkowski's music, similar to that which Mr. Percy Pitt conducted from the London studio some months ago, is to be heard on Sunday evening, March 18th. It will include the seldom-heard Concerto, the equally unfamiliar Third Orchestral Suite, and other items from the opera, "Boabdil."

Sandler for London.

Now that Albert Sandler is leaving the Grand Hotel, Eastbourne, to take charge of the orchestra at the Park Lane Hotel in Piccadilly, tests are being made of the acoustics there with a view to this popular musician continuing to figure in the programmes. Meanwhile, it is good news to hear that concerts from Eastbourne will still be continued, and these, after the departure of Mr. Sandler, will be under the direction of Mr. Thomas Jones, who is director of Pattinson's Orchestra, Birmingham, and the Birmingham Pianoforte Quartet. Mr. Jones is a pupil of Rivarde, a member of the Queen's Hall Orchestra and the Royal Opera, Covent Garden. He was leader of the old Marconi House Orchestra when it first broadcast. The remarkable acoustic qualities of the auditorium of the Grand Hotel, Eastbourne, are put down to the shape and material of the glass dome, which seems to exercise a strange charm on the sound waves which it echoes through the microphone.

Another Hallé Concert for London.

The famous Hallé Orchestra is again visiting London to perform at the B.B.C.'s National Symphony Concert, which Sir Hamilton Harty is conducting at the Queen's Hall on Friday, March 23rd. The soloist will be the Polish pianist, Leopold Godowsky, who will be making his debut before the microphone in this country. Godowsky is regarded as one of the world's finest musicians, his piano transcriptions having become classics of their kind, and the ease with which he plays them, the envy of other pianists. He will play with the orchestra Beethoven's G Major Concerto.

NUGGETS!
that is what Hydra Condensers are— Think! Each is built to withstand a pressure of 500, 750 or 1000 volts.

HYDRA CONDENSER
The Zenith of Quality
H.F.

and yet they only cost:
1 mfd. - 2/6
2 mfd. - 3/6
4 mfd. - 5/3
Tested at 500 volts D.C. (Working voltage 240 D.C.)

All capacities made. Obtainable at all good dealers or direct from:—
LOUIS HOLZMAN
34, KINGSWAY, LONDON, W.C.2.
Telephone: Holborn 6209.

HEADPHONES REPAIRED. 4/-
Transformers 5/-. Loudspeakers 4 0. All repairs reimagined free. Tested, guaranteed and ready for delivery in 24 hours.
Discount for Trade. Clerkenwell 1795.
MASON & CO., 44, East Rd., City Rd., N.1.

EASY PAYMENTS
LOUD SPEAKERS, HEADPHONES, H.T. ACCUMULATORS. Anything Wireless
Send a list of the parts you are requiring, and we will send you a quotation on monthly payments.
H. W. HOLMES, 29, FOLEY STREET, Phone: Museum 4411, Gt. Portland St., W.1.

A PERFECT WET H.T.
Obtained with our Insulating Liner, which eliminates all "Local Action." Price 1d. doz. Self-Charging Cells. 3 Doz. 45 volts Minimum. packed in Special Divided Carton. Suitable as Contactor. Post Free 10/-. Double Capacity 13/-, with terminal top Sacs, 2/5 extra. Liners Included Free. Send 6d. for Complete Cell Instructions. Particulars. We stock Goodman's Cone Parts and Units. Cosmor Cabinets, Mahogany Finish. 17/6 only.
SPENCERS STORES LTD., 4-5, MASON'S AVENUE, COLEMAN ST., LONDON, E.C.2. Phone: London Wall 2292. (Near Bank of England.)

FREE A .0005 LOGARITHMIC CONDENSER OR A BEAUTIFUL NON-SLIP SLOW-MOTION DIAL.

To all purchasers of our "All-Wave" Ebonite Tuner, wave-length 180-2,000 metres. Combines a six-point switch with a variable reaction, wound with silk-covered wire, brass parts nickel-plated, size 4 1/2" x 3 1/2", two-hole fixing. The smallest, neatest and most efficient tuner on the market. Satisfaction guaranteed or money returned. Price only 15/-, post free. Cash with order, or O.O.D. Send now direct to the maker:—
S. W. SCOTT, 57, Camberwell New Road, LONDON, S.E.5.

PLEASE MENTION "POPULAR WIRELESS" WHEN REPLYING TO ADVERTISEMENTS.

COSSOR

"Melody Maker"

Immediate delivery of all parts, complete kit or any component.

2 Ormond S.L.F. Variable Condensers, 0005 mfd. @ 6/- each	12/-
2 Ormond Slow Motion Dia's @ 5/- each	10/-
1 T.C.C. Condenser, .0001 mfd.	1/10
1 T.C.C. Condenser, .002 mfd.	2/4
2 T.C.C. Condensers, .0003 mfd. @ 1, 10d.	3/8
1 T.C.C. Condenser, .001 mfd.	2/4
1 T.C.C. Condenser, 2 mfd.	3/10
2 Wearite Grid Leak Clips for baseboard mounting @ 6d. each	1/-
1 Dubilier Grid Leak, 4 megohms	2/6
1 Dubilier Grid Leak, 25 megohms	2/6
1 Dubilier Grid Leak, 3 megohms	2/6
3 W.B. Valve Holders @ 1/5 each	5/3
1 Ferranti type A.F.3 L.F. or R.I. Varley Straight Line Transformer	25/-
2 Bulgin Panel Switches @ 1/6 each	3/-
1 Wound Coil	each 5/6
1 Variable resistance for baseboard use. Peerless type	1/3
9 Eclax (T2 LC) terminals @ 4 1/2d. each	3/10 d.
1 Coil Glazite wire	10d.
1 Yard of Systoflex covering	4d.
9-volt Grid Bias Battery (Siemens)	2/-
3 Eclax 2 D.W. Plugs @ 2d. each	6d.
1 Ebonite Panel, 21 in. x 7 in. x 1/4 in. (Resiston), drilled to actual dimensions and cut to size	9/6
1 Ebonite Terminal Strip, 21 in. x 1 1/2 in. x 1/4 in. (Resiston), drilled to dimensions	2/6
1 Polished Oak Cabinet to fit above panel	30/-
Baseboard (if required)	2/-

Post orders despatched the same day as received. Orders by telephone delivered same day if received early. Write for Catalogue 52 H. of all parts we stock.

ARCHIBALD J. WRIGHT LIMITED,
26-28, Lamb Passage, Chiswell Street, London, E.C.1.
Telephone: Olerkenwell 4439.

RADIO REGISTERED PANELS

7 x 6, 1/3	9 x 6, 1-1/7
8 x 6, 1/4	11 x 8, 2/3
10 x 8, 2/1	12 x 8, 2/8
10 x 9, 2/4	12 x 9, 2/10
12 x 10, 3/-	14 x 10, 3/5
14 x 12, 4/-	16 x 9, 3/6
14 x 7, 2/7	21 x 7, 3/7
16 x 8, 3/2	24 x 7, 4/-
8 x 5, 1/2	in. thick.

Post Free.
Money back guarantee that each and all Panels are free from surface leakage. Megger test Infinity.
CROSSONIA CO., 10, South St., Moorgate, E.C.2
Phone: Clerkenwell 7853
Agents: John Henry Smith, 139, Anlaby Rd., Hull.
L. H. Helyar, 82, Chamberlin Rd., Norwich.
A. Stredwick & Co., 27, The Market, Chatham.
Boynton & Co., Ltd., 34, Bradford St., Birmingham.

TRADERS GET YOUR COMPONENTS AND CABINETS AT THE RIGHT PRICES.
Send for illustrated list.
Dept. P.W., PERSEUS RADIO, Burton-on-Trent.

The right place for the **WatMel**

I.F. CHOKE
Price 5/-

CROSS wound in four balanced sections, giving low self-capacity, constant impedance, small external field. Windings fully protected. Mounted on Bakelite base. Greatly improves the Cosmor "Melody Maker" when connected in place of wire No. 26. Also when used in "3.20 Express" and other circuits. Write for particulars, stating requirements for coil drive Loud Speakers.
THE WATMEL WIRELESS CO., LTD., Imperial Works, High St., EDGWARE, MIDDLEX.

ALL APPLICATIONS FOR ADVERTISING SPACE in "POPULAR WIRELESS" must be made to the Sole Advertising Agents, JOHN H. LILE, LTD., 4, LUDGATE CIRCUS, LONDON, E.C.4

TECHNICAL NOTES

(Continued from page 68.)

According to one of the latest, a platinum filament is mounted inside a bulb with the other electrodes, and after all oxygen has been carefully removed from the bulb the filament is raised, by means of a heating current, to a fairly high temperature, whilst barium vapour is generated in the region of the filament, a potential of 50 to 100 volts being applied between the filament and the other electrodes.

By this treatment, in the course of a very few minutes an active surface is produced on the filament, which has a high thermionic efficiency. It is probable that this specially activated surface consists of an alloy of platinum and barium.

Spreading Sound.

I suppose there are now only a small proportion of broadcast listeners who do not possess, or at any rate who have not tried, the cone type of loud speaker. This type of speaker has advanced enormously in popularity during the past year or two, largely owing to its artistic appearance (or to the fact that it can be more readily camouflaged than a horn speaker) and partly owing to its compactness.

But the question is continually cropping up as to the relative merits of the two types of speaker.

There seems to be no doubt that in general the horn type of speaker gives more volume in given conditions than the cone type, whilst on the other hand the supporters of the cone believe that the reproduction is more natural and that the sound is more uniformly distributed. A horn type of speaker certainly tends to throw the sound more or less in a definite direction with the result that there is a considerable difference in the volume as received by a person sitting opposite to the opening of the horn and one sitting somewhat to the side.

High or Low Pitch?

There is another point of a rather more technical character which is, perhaps, not so generally known: I refer to the range of audio-frequency to which each of these types of speaker is particularly adapted. It is now usually assumed that the horn type is better for higher pitched notes (being generally apt to be rather "tubby" on the lower notes), whilst the cone speaker is better adapted for the lower frequencies. For this reason manufacturers have begun to market instruments in which both the cone and the horn are incorporated, the object being, of course, to gain the advantages of both.

Microphones.

Microphones have changed greatly since the days of the old carbon transmitter. The greater and greater refinements of

(Continued on next page.)

THE LITTLE CELLS THAT SATISFY.

Eton Primary H.T. Battery P.I. Porous Pot Cells, S1 and S2 Sac Cells. All complete.

	1-cell	6-cell	12-cell	30-cell
P.I.	6d.	3/3	5/9	14/-
S.1	6d.	3/-	5/3	12/-
S.2	4d.	2/6	3/10	9/6

Send 1/4d. stamp for booklet giving full particulars to—

THE ETON GLASS BATTERY CO.
46, St. Mary's Road, LEYTON, E.10

COSSOR MELODY MAKER

Extract from "Modern Wireless"; report (by Mr. G. V. Dowding, the Technical Editor), issue dated March, 1928: "The circuit illustrates an almost ideal arrangement of 3 valves."

"A very important item is the specially designed coil, which must be wound with double silk-covered wire. Otherwise the results will be considerably impaired."

Be sure you keep your copy of "Modern Wireless," March, 1928, now on sale, as it has the blue print and much interesting information free, also read my full-page advert.

ALL COSSOR VALVES STOCKED.

FREE OF CHARGE with the Kit of Parts I present you with 1 High Grade Drilled Ebonite Panel 21 x 7; 1 Ditto Strip 21 x 1 1/2; 5-ply

MULLARD MASTER THREE KIT

Mr. Dowding dissects this wonderful set, and if you buy your components here you will be assured of the results. The most important parts which cannot be altered are the H.F. choke, R.C.C. unit, the L.F. transformer and the panel switch.

FREE OF CHARGE with Kit of Parts I present you with 18 x 7 Aluminium Panel (drilled) with specially prepared surface; 100 volt British H.T. battery (or 2 slow motion dials value 10/- instead of battery); 9 volt Grid Bias battery; set of A B C Junit wire.

ALL MULLARD VALVES STOCKED

A set demonstrated during broadcasting hours

COMPONENTS FOR SAME

Post £4.10.0 Kit Extra

2 Ormond '0005; 2 Do. S.M. Dials; 6 T.C.C. Condensers, '001, '002, two '0003, '0001, 2 mfd.; 2 Grid Lk. Clips, B.B.; 1 Var. B.B. Rheostat; 3 Dribbler Leaks, '25, 3, 4 meg.; 3 Lotus V.H.; 1 Ferranti L.F.; 2 Panel Switches; Highest quality Cossor Melody Coil ready to use (this as advised by Mr. Dowding); Terminals, Name Tabs, Glazite, 9v. Grid Bias (all as specified)

NOTE Drilled High-grade 21 x 7 Polished Panel, with Radion Strip, FREE with above kit. (Advt. of K. RAYMOND)

A set demonstrated during broadcasting hours

I present you with 1 High Grade Drilled Ebonite Panel, Baseboard; Screws, plugs, etc., etc. Carriage 1/-

2 Ebonite strips; Bulgin switch; 1 Coil base; 8 Wander plugs; Red and black flex; '0005 variable; '00035 variable (brass vanes); R.I. Varley L.F. Climax Choke; R.I. Varley R.C.C. unit; Master 3 coils; 4 marked terminals; Panel brackets; '0005 Condenser; 2-meg. grid leak; 3 anti-vibratory valve holders with terminals and 3 Mullard P.M. Valves (state voltage)

ABOVE KIT £6.17.6 Carriage 1/-

(Advt. of K. RAYMOND)

AMERICAN TYPE CABINETS, OAK, CAN BE PURCHASED WITH KITS OF MULLARD OR COSSOR PARTS (at same time) for 15/-, 18/11, 21/- according to quality. List prices are 5/- each more

EDISWAN NEW THREESOME

LIST OF COMPONENTS

Three Coupling Units, Tubular Fixed Condenser, Multi-hex Cable and Plug, '0003 Variable with S.M. Dial, 2-way Geared Coil Holder, Connecting Wire, Red & Black Flex.

The lot post free 42/- nett.

EBONITE PANEL 2/6 The two with 5 Ply Baseboard 2/6 above kit only. Ediswan Valves, 10/6 each; Power, 12/6.

PERSONAL SHOPPERS

WE ARE OPEN ALL DAY SATURDAY
TWO SHOPS ALL DAY THURSDAY
the other is open ALL DAY EVERYDAY
if one is closed hours 9 a.m. to 8 p.m.
Sat. 9 a.m. to 9 p.m.
Sunday morning 11-1

MARCONI, EDISWAN, OSRAM, B. T. H., COSMOS VALVES at USUAL PRICES.

UNITS AND PICK UPS, all makes. Amplion, Climax, Benjamin, Wearite, Colvern, Detex, Dubilier, Penton, Ediswan, Ormond, Ferranti, Harlie, Igranite, Lotus, Lissen, Ferron, Marconi, Mullard, Oldham, Watzmel, Polar, Exide, W. & B. Dubilier, McMichael, Utility, Hellesen, B.T.H., Siemens, Burndept, Ever-Ready, Lewcos, Belling-Lee, and all proprietary lines stocked.

BULLPHONE UNITS 15/- EACH

ORMOND '00035, 19/6. S.L.F. '0005, 12/-; '00035, 11/-.
S.L.F. CONDENSER FILAMENT - RHEO. '00025, 5/6. '00035, 5/9. STATS, Dual, 2/6; 6 ohms or 30 ohms, 4/-.
'0005, 6/-. With 4-in. Dial. Potentiometer, 400 ohms, 2/6. '0001, Reaction, 4/-; Air Dielectric, 2/-; Neutralising, 2/-; Neutrodyne, 2/-.
With Friction 55-1 4-in. Geared, '0005, 15/-; 32/-; Triple, 40/-; H.F. '0003, 14/6; '00025, 13/6. Choke, 7/6. Geared Straight Line Pre-Friction '0005, 14/-; '00035, 12/-; '0005, 20/-; 13/-; '00025, 12/-.

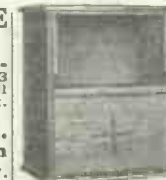

OAK CABINETS

American type, opens at back, compartment underneath for batteries, etc.

12 by 8 by 9 in. deep 18/11
16 by 8 by 9 in. 25/11

Reduction made if you buy your parts here. Carr. & Packing, 2/6.

IT IS IMPOSSIBLE TO ADVERTISE ALL THE WIRELESS PARTS NOW ON SALE, BUT IF YOU WANT THEM TRY RAYMOND'S FIRST! BE SURE YOU VISIT THE Bargain Window. New 100-page Catalogue. Profusely illustrated. Price 1/- POST FREE, allowed off first 10/- order.



CABINETS

Large stocks of really useful cabinets kept or made to order. Solid oak. American type, lined lid, baseboard.

12 x 8 x 9	11/6
14 x 7 x 9	13/11
16 x 8 x 9	16/11
18 x 8 x 9	19/11
20 x 8 x 9	22/6
21 x 7 x 9	25/-
24 x 7 x 9	27/6

Carr. & Packing 2/6 extra.

Reduction if you buy your parts here

LISSEN DARIO VALVES

(Genuine Radio Micro) Best in the World.

Valve-Holders, 1/-; Fixed Con. 1/-, 1/6; Leaks, 1/-; Switches, 1/6, 2/6; Latest 2-way Cam Varner, 4/6; Rheostats, 2/6; B.B. 1/6; Lissenols, 13/6; L.F. Transformers, 8/6; 100v. H.T., 12/11; 60-v. H.T., 7/11; Coils, 60 X, 6/4; 250 X, 9/9.

DON'T FORGET THAT WHEN YOU BUY YOUR ORDINARY GOODS HERE YOU CAN PURCHASE CABINETS, LOUD SPEAKERS, H.T. & L.T. BATTERIES, VOLTMETERS, ETC., AT A GREATLY REDUCED PRICE. CALL FOR LIST.

K. RAYMOND

27 & 28a, LISLE ST., LONDON, W.C.2

Come to LEICESTER SQUARE TUBE

This address is at the back of Daly's Theatre.

Phone: Gerrard 4637.

Why buy waste space?



when the **Columbia "Layerbilt"** is filled to capacity with layers of electricity



Ask your Dealer for:-
Columbia "Layerbilt"
 THE 100% BATTERY!
J. R. MORRIS
 15, KINGSWAY, LONDON, W.C.2
 Scotland: J. T. CARTWRIGHT,
 3, CADOGAN ST., GLASGOW.

ENGINEERS

£500 a year awaits you. Prof. A. M. Low shows HOW! in "ENGINEERING OPPORTUNITIES." This 70 pp. book shows the easiest way to pass the A.M.I.Mech.E., A.M.I.A.E., A.M.I.E.E., A.M.I.C.E., etc. Exams. We alone guarantee "NO PASS—NO FEE." Courses in all branches. Write now—state subject or Exam. **BRITISH INSTITUTE OF ENGINEERING TECHNOLOGY**, 101, Shakespeare House, Leicester Square, London.

Chosen by all the leading set designers

THE ALL BRITISH SIX
 RADIANT CIRCUITS
 THE MULLARD MASTER THREE
 SOLID DYNE
 THE 2 HF EVERYMAN FOUR
 THE COSSOR MELODY MAKER AND MANY OTHER CIRCUITS

BULGIN
 PUSH PULL SWITCHES
 Over Half a Million in use
A.F. BULGIN & CO.
 9-10-11, CURSITOR ST LONDON, E.C.4

PLEASE be sure to mention "POPULAR WIRELESS" when communicating with Advertisers. THANKS!

TECHNICAL NOTES.

(Continued from previous page.)

broadcasting apparatus and the consequently more exacting conditions have called for microphones of special types, and the present-day broadcasting microphone is really a highly specialised and extremely delicate instrument.

The carbon transmitter, of improved type, is still used in the ordinary Post Office telephone instruments, where it gives sufficiently good quality and has the great merit (essential in the conditions in which it is employed) of being sturdy and foolproof.

Capillary Type.

I notice that Monsieur Marius Latour, the well-known French inventor (who is reputed to have made fabulous sums from the sale of his radio patents in the United States and elsewhere), has invented a new type of electro-capillary microphone which was described recently by General Ferrié, head of the French Military Wireless Services, to the Academie des Sciences. Its essential element is a capillary tube which is bell-shaped at one end and contains a special electrolyte, the other end of the capillary dipping into mercury.

When sound waves are projected into the open end of the tube, using the arrangement in circuit as a microphone in the ordinary way, the voice is faithfully reproduced and the new microphone has the special advantage that its resistance is easily varied and it responds very readily to sound waves over a considerable range of frequency.

A Useful Volume.

Until recently the various researches upon the electrical conditions of the atmosphere had not been collected together, but I have before me an extremely interesting volume, by Dr. V. F. Hiss, entitled "The Electrical Conductivity of the Atmosphere and its Causes." The author is Professor of Experimental Physics at the University of Graz (Austria) and the work is translated from the German by L. W. Codd, M.A., and published by Constable. This book can be recommended to all serious students of the more recent developments in electricity: it includes chapters on the conductivity of the atmosphere, the causes of atmospheric ionisation, the processes which rob the atmosphere of its electrification and the factors which influence the atmospheric electrical balance.

BRITAIN'S BEAUTY SPOTS.

New Fortnightly Part Work.
 1,500 Photographs.

THERE are very few fortnightly part works which will appeal to all our readers so strongly as **WONDERFUL BRITAIN**, which is one of the finest pictorial records of the beauty spots in the British Isles yet produced. It is beautifully illustrated and is written in the most entertaining way—in all it will contain no fewer than 1,500 photographs, all of which will be reproduced by the new photo-tone process which gives to each photograph the full value of its varying light and shade, which brings out clearly even the smallest detail. **WONDERFUL BRITAIN** will be completed in about 24 fortnightly parts and will form a fascinating guide to where to go and what to see in the British Isles. The price of each part is 1/3.

ELECTRADIX SALE CATALOGUE

NOW ON!

72

Illustrated Pages and New Price Reductions

4d



WILL SAVE YOU POUNDS

218, Upper Thames Street, E.C.4

The Gambrell Neutrovernia

is a Condenser which can be used also as a Capacity Reaction Control, a Vernier Condenser or a Balancing Condenser.

It is perfectly constructed, is dustproof, and cannot short. On independent tests the breakdown voltage was in the neighbourhood of 2,000 volts. Capacity approx. 2/38 mmds. Suitable for either Panel or Baseboard mounting.

Price 5/6 each.

From all Dealers.

GAMBRELL BROS., LTD.,
 76, Victoria St., London, S.W.1.



TAYLEX WET H.T. BATTERIES.

New Prices: Jars, 1/3. Sacs, 1/2. Zincs, 11d. Sample doz. (18 volts), complete with bands and electrolyte, 4/3, post 9d. Sample unit, 6d. 16-page booklet free. Bargain list free. **AMPLIFIERS:** 1-valve 19/-; 2-valve, 30/-. 2-valve ALL-STATION SET, 24.—P. TAYLOR, 91, Studley Rd., Stockwell, London.

DIGBY'S CABINETS

Write for New 16-page Catalogue.

F. DIGBY, 9, The Oval, Hackney Road, E.2.
 Phone: Clissold 5458.

COMPLETE SETS, LOUD SPEAKERS, COMPONENTS, ETC., supplied for all circuits, including the Mullard Master 3, Cossor Melody Maker, also the new circuits featured in this issue.

EVERYTHING WIRELESS ON EASY PAYMENT TERMS

Send list of requirements, and best monthly terms will be quoted by return.

TELEVISION

Make your own Television. All parts supplied on cash or Easy Payment Terms. Send for detailed list of parts required.

The P.D.P. Co., Ltd.
 Dept. P.W.) 41, Great Tower Street, London, E.C.3

PATENTS, TRADE MARKS. Inventions Advice Handbook & Consultations FREE.—B. T. KING, C.I.M.E., Regd., Patent Agent (G.B., U.S. & Canada), 1468, Queen Victoria Street, London, E.C.4. 40 years' references. Phone: Cent. 0682.

UNIDYNE 4-ELECTRODE VALVES

We are now the sole suppliers of the genuine U.O. and Thorpe valves, as specially tested and recommended by the "Unidyne" inventors and "Popular Wireless." U.O.5 order and Thorpe K.4 (both 4-electrode 5-plate valves). Post free. Only direct from—**UNIDYNE VALVE CO.,** 1, CHARING CROSS, LONDON, S.W.1



T/R R/R D/B N/R

A New and Useful Work of Surpassing Beauty!

Wonderful Britain

Fortnightly Parts 1/3 each.

The glories of our own country from Land's End to John O' Groats brilliantly described and illustrated with 1,500 photographs in superb Phototones.

THIS richly printed and fascinating new work will show all that is beautiful, remarkable and historic in England, Scotland, Ireland and Wales. Highways, byways, historic places and beauty spots will be described by great travel writers and illustrated with a remarkable collection of photographs printed on delicately toned paper. There is not a corner of the British Isles that has been left unexplored in the preparation of **WONDERFUL BRITAIN**. It will help you to get the best out of your holidays. It will help you to plan a day's run or a long motor tour, and will lead you to visit the thousand and one places which, in the ordinary way, you might easily pass by. You will be able to turn to it both as a reminder of the places you have seen and as a guide to those you ought to see.

The following list of articles in Part 1 conveys a good idea of the interesting way in which the work has been arranged.

WINDSOR CASTLE AND ITS STORY. *By Rev. C. A. Alington, D.D.*

SHAKESPEARE'S ENGLAND. *By the Dean of Winchester.*

ROMANTIC EDINBURGH. *By Lewis Spence.*

HISTORIC SCENES ALONG THE BRIGHTON ROAD. *By C. G. Harper.*

THE GLORY OF THE CATHEDRALS. *By Rev. Percy Dearmer, D.D.*

THE FOLK DANCES OF OLD ENGLAND. *By Mary C.S. Neal.*

Buy
Part 1 **TODAY**
1/3^d

LARGE SCALE ROAD MAP
of Britain's Historic Places
FREE

printed in colours on stout card in 24 sections— one section free with each part of **WONDERFUL BRITAIN**. The complete map, unobtainable elsewhere, would cost at least 10/- in the ordinary way. This map will be invaluable to motorists, cyclists and tourists.

A special transparent fronted canvas case in which all the sections of this Free Map can be carried will be supplied to all regular subscribers at half-price, i.e., 2/6.

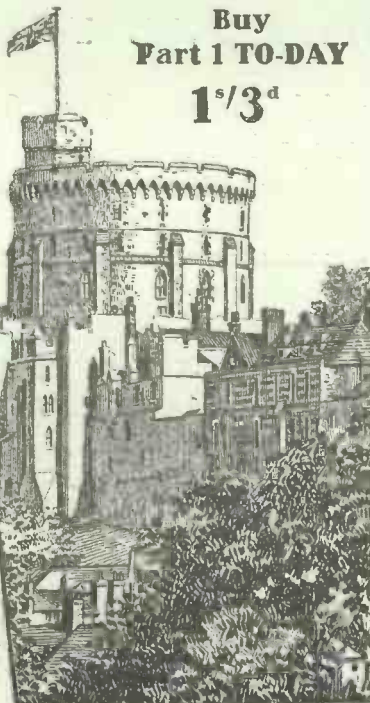

If you have any difficulty in obtaining a copy of Part 1 from your Newsagent or Bookstall, send 1/6 direct to the Publisher, The Amalgamated Press, Ltd., Fleetway House, London, E.C.4

POWER

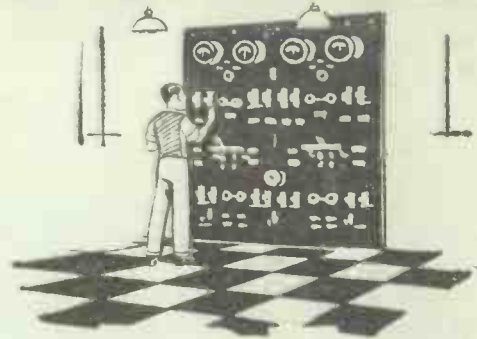

DIRECT

FOR YOUR COSSOR "MELODY MAKER"

CONSTANT—ECONOMICAL—SAFE

CONSTANT. Power from the mains is even, steady and silent. Entirely dispenses with run down battery annoyance and H.T. crackle.

ECONOMICAL. Power from the mains costs less than a penny per day. No more recharging expenses.

SAFE. An H.T. Eliminator built the T.C.C. way is a unit of proved reliability. Using T.C.C. 600 volt Condensers, it is safe.

The T.C.C. book "How to build your own H.T. Eliminator" will convince you how simple it is for you to build this efficient unit. It is free - of course.

Write for it to-day and—

GET YOUR POWER FROM THE SWITCH

T.C.C. CONDENSERS

I enclose 1d. stamp. Please send a copy of "How to build your High Tension Eliminator for A.C. or D.C." to:

Name

Address

P.W. Marj 10.

SEND COUPON TO-DAY

To Telegraph Condenser Co., Ltd., Wales Farm Rd., N. Acton, London, W.3.





Valves with the wonderful Mullard P.M. Filament

Powerful valves that fill any receiver with new life; lasting valves that maintain improved results long after a thousand hours' use; generous valves that give amazing volume and range due to the unequalled, tough, master filament they possess... the wonderful Mullard P.M. Filament; found **ONLY** in Mullard P.M. Valves.

Mullard

THE · MASTER · VALVE

BUILD THE "ALL-PROGRAMME" THREE!

Popular Wireless

Every Thursday
PRICE
3d.

No. 302. Vol. XIII.

INCORPORATING "WIRELESS"

March 17th, 1928.



Special Features In This Issue

Concerning the Counterpoise. Where Wireless Sets Wear
THE PROBLEM OF TELEVISION (Pt. 2). By SIR OLIVER LODGE, F.R.S.
 A New Short-Wave Circuit. Centre-Tapped Coil Circuits

A novel broadcast was recently arranged by a well-known snake expert in America. Two rattlesnakes were placed before the microphone and encouraged to "rattle" for the benefit of listeners. Our cover photograph shows the experiment taking place.

ON ALL POINTS

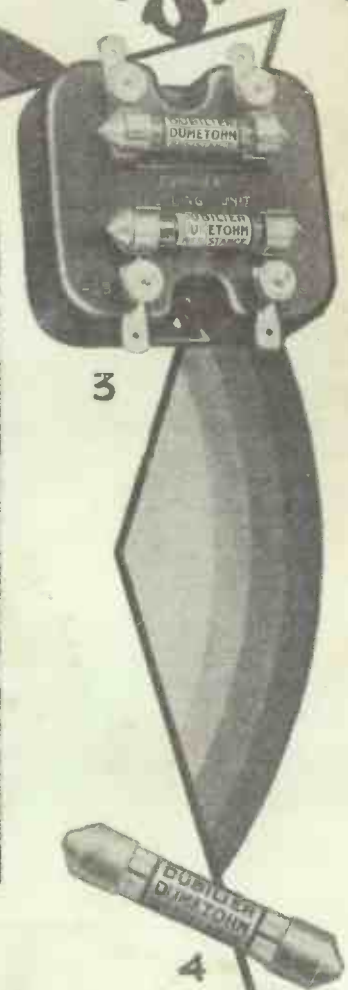
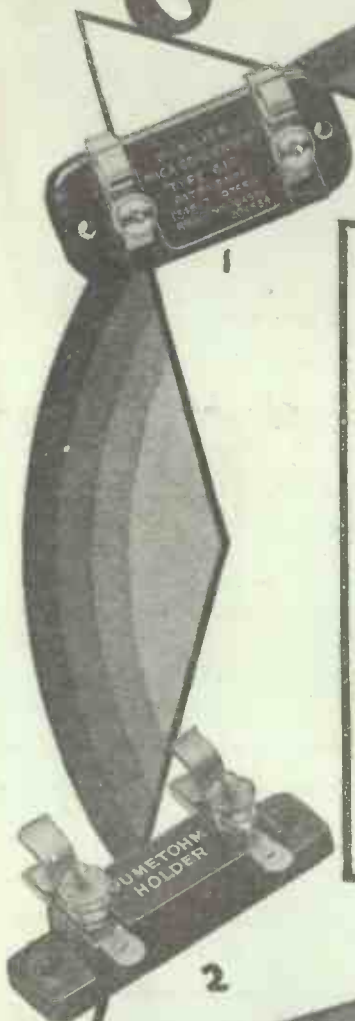

When you have built your Receiving Set, whatever the circuit you select, you will want to be proud of your achievement—you will want your friends to praise its performance.

By embodying the Dubilier components here featured, which are specified for circuits in this issue, you will ensure perfect functioning where they are concerned.

On all points of performance Dubilier products are the "stars" in every good circuit.

Write for our 1928 Catalogue showing complete range of Dubilier Components, sent post free.

- (1) Dubilier Mica Condenser, Type 610. .0003 2/6, .001 mfd. 3/- each.
- (2) Dumetohm Holder 1/- each.
- (3) Dubilier R.C. Coupling Unit (including 2 Dumetohms) 7/-.
- (4) Dumetohm 2 megohms 2/6 each.

If unobtainable from your dealer send direct to us.



THE "STARS" IN EVERY GOOD CIRCUIT



MARCONI Type H.L.210

General Purpose Valve



putting a stretch in its arm

Filament Volts - 2.0 max.
Filament Current - 0.1 amp.
Anode Volts - 150 max.
Amplification Factor 15
Impedance - 25,000 ohms.
Price 10/6 each

FREE ADVICE

Our Engineers will furnish free advice as to the best possible combination of valves for your set, if details of valves for your set, if details of the circuit and any valves at present in use are stated. Write to Dept. P, The Marconiphone Co. Ltd., 210/212, Tottenham Court Road, London, W.1.

Fill in the coupon below for full particulars of the new Marconi Valve.

Whatever the calibre of your set—one valve or five—you'll find its performance vastly improved if you fit the new Marconi Type H.L.210 G.P. Valve.

The H.L.210 is a wonderfully improved General Purpose Valve embodying the results of the latest research in the manufacture of thermionic valves. It is a valve which makes for greater efficiency, bigger volume, and more truth from the loud speaker. May be used for H.F. Amplification, as a Detector or as a L.F. Amplifier.

Like all Marconi Valves it is a worker—and it works throughout a very, very long life. Try one or more in your set.



MARCONI VALVES

-do everything that a valve should do

Dept. P, The Marconiphone Company Ltd.,
210/212, Tottenham Court Rd., London, W.1
Please send me Marconi Publication H3L
and other Marconi Valve literature.

Name.....
Address.....

PW.15.



LET ME BE YOUR FATHER.

I have acted as father and adviser to thousands of others. I give advice free, and when I do so I feel the responsibility of a father, either in advising a career or in guiding our students to success. Having been the self-constituted father and adviser to thousands of others, it is possible I may be able to help you and guide your footsteps so that you may make a success of your life.

Thousands of people think they are in a rut simply because they cannot see the way to progress. This applies particularly to Clerks, Book-keepers, Engineers, Electricians, Builders, Joiners, etc. They do not realise that in these particular departments the demand for the well trained exceeds the supply, also they do not realise that about 1s. per week will pay for all necessary books and tuition, and that by studying in spare time they can qualify for the higher and better paid positions. In Technical trades and in the professions employers are frequently asking us if we can put them in touch with well trained men. Of course, we never act as an employment agency, but it shows us where the shortage is. In nearly every trade or profession there is some qualifying examination, some hall-mark of efficiency. If you have any desire to make progress, to make a success of your career, my advice is free; simply tell me your age, your employment and what you are interested in, and I will advise you free of charge. If you do not wish to take that advice, you are under no obligation whatever. We teach all the professions and trades by post in all parts of the world, and specialise in preparation for the examinations. Our fees are payable monthly. Write to me privately at this address, The Bennett College, Dept. 106, Sheffield.

J. Bennett

F.R.S.A., M.I.Mar.E.,
A. I. Struct.E., M.B.I.P.S., etc.,

Governor of

THE BENNETT COLLEGE, Ltd., SHEFFIELD.

NOTE. We have special courses on all the following subjects, and we can combine courses to meet all requirements.

COMMERCIAL.

Accountancy
Advert. Writing
Salesmanship
Army Certif. Courses
Auctioneering and Estate Auditing [Agency]
Banking
Book-keeping
Civil Service
College of Preceptors
Commercial Arithmetic
Commercial Law
Company Law
Costing. Economics
English and French
Executourship Law
Foreign Exchange
General Education
Modern Business Methods
Police Entrance and Promotion Courses
Secretaryship
Workshop Organisation

INSURANCE.

Exams. for Agents and Officials F.C.I.I.

INSURANCE—Con.

Motor, Fire, Life, Marine.
Employers' Liability.

TECHNICAL.

Teacher of Handicrafts
Applied Mechanics
Architectural Drawing
Building Construction
Clerk of Works' Duties
Boiler Engineering
Boiler Making
Chemistry
Civil Engineering
Concrete and Steel
Draughtsmanship
Electrical Engineering
Practical Mechanical Engineering
Engineering Costing.
Quantities and Specifications
Foundry Work
Heat Engines
Internal Combustion Engines
Marine Eng. B.O.T.
Mathematics

TECHNICAL—Con.

Matriculation
Metallurgy
Motor Engineering
Naval Architecture
Pattern Making
Post Office Examinations
Quantity Surveying
Road Making
& Maintenance
Sanitation, Shipbuilding
Structural Engineering
Surveying and Levelling
Surveyors of Works, R.E.
Telegraphy & Telephony
Town Planning
Wireless Telegraphy
Works Managers' Course

MINING.

Fireman's Exam.
2nd Class Mine Manager
1st Class Mine Manager
H.M. Inspector
Mining Elect : Engineer
A.M.E.E.
Mining Mech : Engineer
Mine Surveyor

BEST on the MARKET P.R. ALL-STEEL SECTIONAL WIRELESS MASTS

Defy Competition SUPPLIED IN VARIOUS HEIGHTS

These Masts are made of British Tubular Steel, are supplied with every conceivable accessory, and fullest directions for erecting. No further outlay is necessary, and the Mast can be easily erected in half an hour, with just the assistance of another.

26 FT. HIGH ONLY 15/-

The 26 ft. Mast is in 3 sections of 1 1/4 in. Steel tube tapering to 1 in. Carriage costs, approximately, London and Suburbs, 1/6; Midlands, 2/6; other districts, 3/6. Nett weight 24 lbs. approximately. Two Masts for 28/6.

34 FT. HIGH ONLY 21/6

The 34 ft. Mast is in 4 sections of 1 1/2 in Steel tube tapering to 1 in. Carriage costs 2/- London and Suburbs, 3/- Midlands, 4/- elsewhere. Nett weight 34 lbs. Two Masts for 40/-

THE "SUPER" MAST.

42 FT. HIGH ONLY 29/6

The 42 ft. Mast is in 5 sections of heavy 1 1/2 in. Steel tube tapering to 1 in. A real bargain. Carriage costs 2/6 approximately for London and Suburbs, 3/6 Midlands, 4/6 elsewhere. Nett weight 46 lbs. Two Masts for 55/-.

Specification—All Masts are supplied with Massive Iron Bed Plate, Drilled Steel Ground Pegs, Stay Rings, Galvanized Standard Steel Flexible Wires for Stays, Pulleys, Bolts, etc., and everything down to the last item for erecting. Will stand any gale.

- (1) A High Aerial makes your set louder, and helps you to get away from your neighbours' oscillation.
- (2) A wonderful reception from a Crystal Set can be obtained with a tall Mast.
- (3) A 42 ft. Mast is as good as a Valve
- (4) Takes half an hour to erect.
- (5) A Steel Mast is a direct Earth, and saves your set from any electrical disturbances, such as lightning.
- (6) The Mast can be extended by purchasing another section, fullest particulars by request.

The Mast sent C.O.D. in London or Suburbs, or wherever Messrs. Pickford's or Carter Paterson have an Agency. Fullest guarantee with every Mast as to complete satisfaction, or money instantly returned without question. **ORDER TO-DAY OR CALL.**

P.R. MASTS (Dept. 100), 17, Paternoster Sq., LONDON, E.C.4.

NOW FINER WEATHER IS HERE, SCRAP THAT WOODEN POLE, INSTAL A STEEL MAST AND IMPROVE YOUR RECEPTION.

THE EASIEST MAST TO ERECT.

Fullest Instructions given

Guarantee of satisfaction or money back without

question.

'Phone your order Central 0181.

Pay C.O.D.

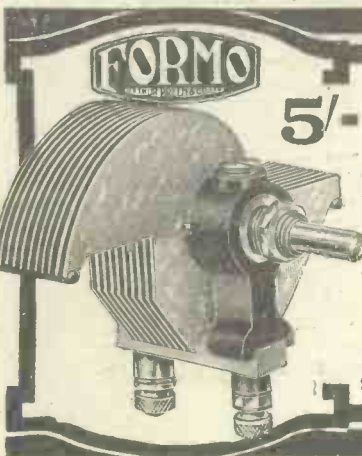
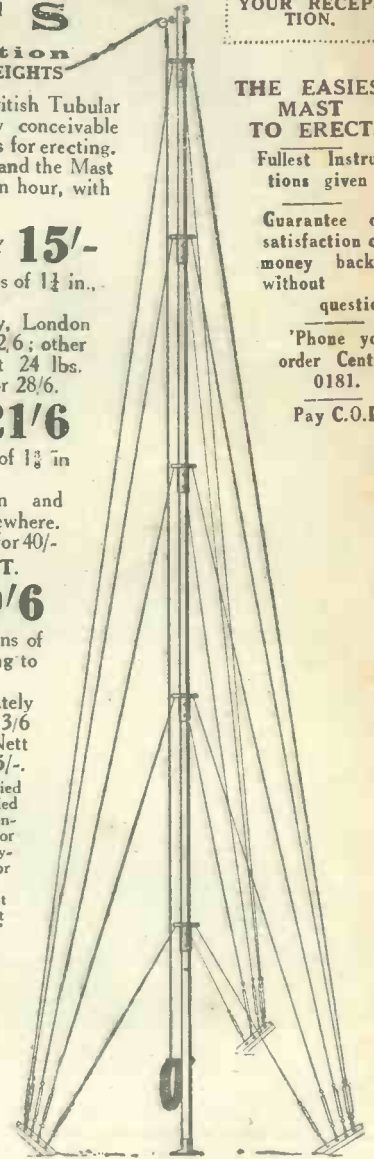

"1928" LOG CONDENSER

5/-

'00035 and '0005

SMALLEST

Span fully open 3 1/2 inches. Behind Panel 2 inches.

LIGHTEST

4 1/2 OUNCES.

Write for literature.

THE FORMO CO.,

22, CRICKLEWOOD LANE, N.W.2.

VALVE HEATING

from

Air depolarising "A.D." PRIMARY CELLS

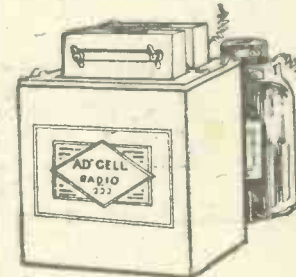

Operating EMF 1 volt or higher per cell, perfect simplicity; charged at home with sal-ammoniac. Most economical cell yet produced, as the following examples will show.

No.	Output Not to Exceed	Life per Zinc when used 3 hours daily	Price per complete cell, with salt.
222	1 amp. 3-5 hrs. daily	350 days with 5 valves (each 100 m/a.)	30/-
229	300 m/a 3-5 hrs. daily	330 days with 3 valves (each 100 m/a.)	15/-
240	120 m/a 5-5 hrs. daily	330 days with 1 valve (100 m/a.)	5/6

Pro rata life for other types of valves 1 volt. per cell, 2 volts 2 cells in series, etc.

PERFECT IN ALL RESPECTS For Country Sets or anywhere where attention to battery recharging is troublesome. Ask your dealer to give fullest particulars or apply to:

LE CARBONE
COVENTRY HOUSE,
SOUTH PLACE, LONDON, E.C.2
Works: Portlade, Sussex.

Met-Vick Components make the most of a Set

WHETHER you are building the Met-Vick three or four Valve Sets or any other set, you cannot fail to get successful and satisfactory results if your components are Met-Vick. Most of the lines shown here are already well known amongst enthusiastic constructors and listeners; yet for those who have not yet used "Cosmos" Components, here are some details:—

A.N.P. (Astatic - Non - Parasitic) Coils.—These new "Met-Vick" products provide a clever solution of a difficult problem. They overcome, simply and efficiently, the three difficulties associated with H.F. amplification, namely: Magnetic coupling between coils, Stabilisation, and Parasitic Oscillation. List 4117/8.

Resistance Coupling Units.—"Cosmos" ("Met-Vick") Resistance Coupling Units are well known to all wireless enthusiasts. The "V" type can now be obtained fitted with new "Met-Vick" A.C. Valve Holder. The latter is also supplied separately. List 7117/8.

Valves.—"Cosmos" ("Met-Vick") SHORTRPATH Valves for 2-v. and 6-v. battery working are available at most good radio dealers. The new "Cosmos" ("Met-Vick") A.C. Valves are also available. These make possible the operation of a set from the electric-light supply without any of the aggravating "mains noises." A special disc adaptor enables a "battery-set" to be easily converted without re-wiring. Lists 4117/3 and 7117/8.

Battery Eliminators.—"Met-Vick" Battery Eliminators are supplied in two models. The H.T.—G.B. Model can be used on various supply voltages of 40-100 periods. Grid Bias tapings are provided at 5, 10, 15, and 20 volts. A high voltage (up to 250 volts) can be applied to the last valve. The L.T. Model gives an output of 5 amperes at 4 volts without hum. List 7117/8.

Met-Vick Battery Eliminators

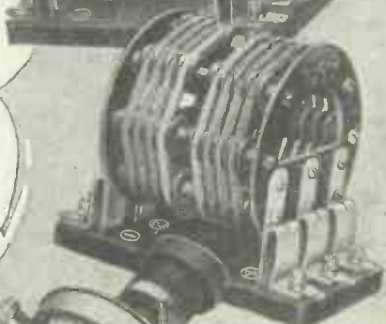
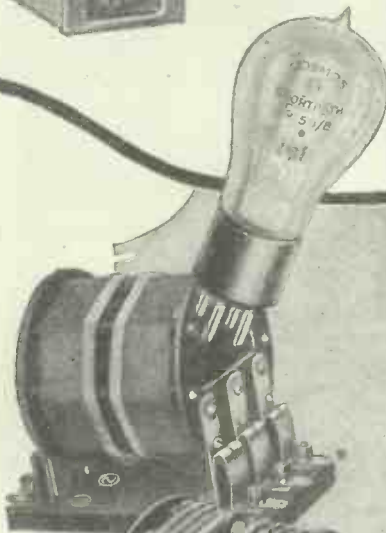

MET-VICK COMPONENTS, VALVES & SETS

For a complete description of the full range of Met-Vick (Cosmos) Components, ask your dealer for a copy of Booklet No. 4117/6.

Metro-Vick Supplies Ltd.
155, Charing Cross Road,
London, W.C.2.

R
F93

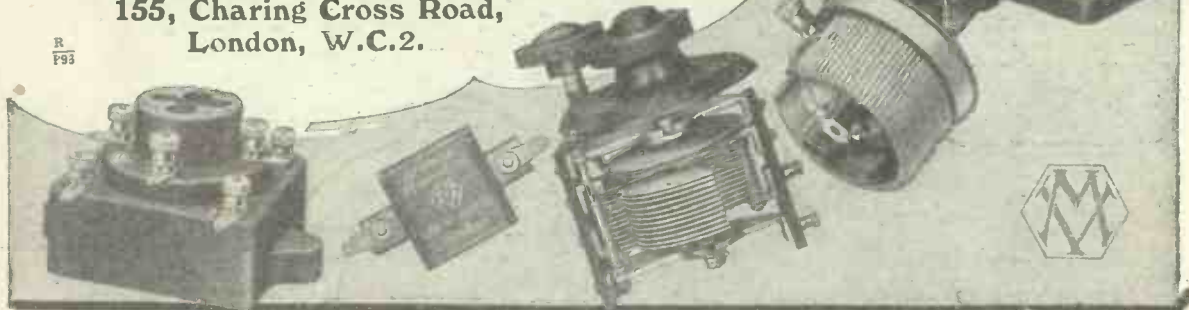

SEVEN COUNTRIES

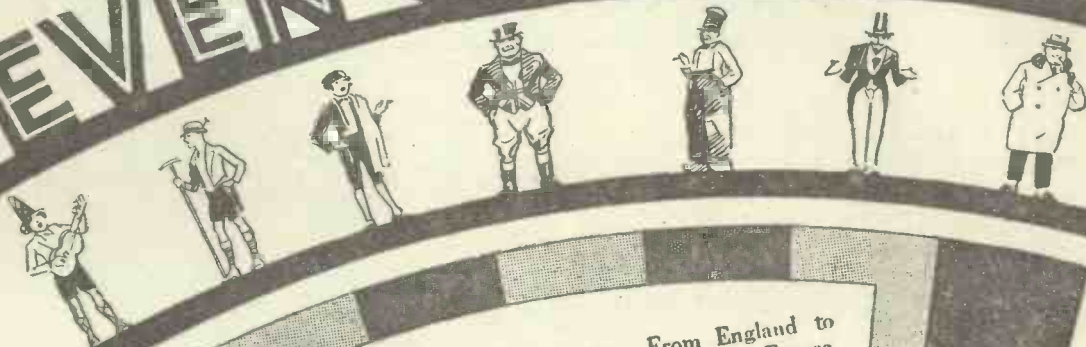

ROUND the dial we go. From England to Germany, and across to Spain; then France Italy and Holland, with Switzerland to wind up the evening. Distance eliminated at the turn of a wrist. That is what you can get on the wonderful Cossor "Melody Maker," the Set anyone can build. You need not know anything at all about Radio to be able to build this amazing Set. Thousands everywhere who know less than you do have already built it. Every step is made perfectly plain in the full-size plan your Dealer will give you. Just follow the instructions and in a few hours you'll have a better Set than many costing twice the price. It's as easy as your boy's Meccano. No blue print to puzzle you. No soldering to thwart you. Ask your Dealer for the Chart which will bring Europe to your fireside. It's free.



*As simple as
Meccano
- anyone can
build it*

ON YOUR WONDERFUL
COSSOR
"MELODY MAKER"

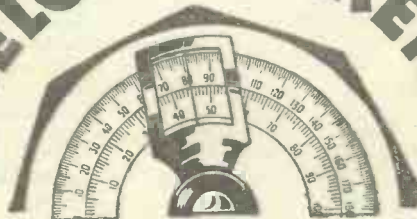

Popular Wireless

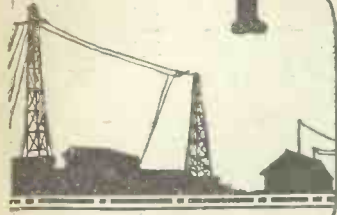

Scientific Adviser :
 Sir OLIVER LODGE, F.R.S.
 Editor :
 NORMAN EDWARDS, M.Inst.R.E., M.R.S.L., F.R.G.S.
 Technical Editor : G.V. DOWDING, Grad.I.E.E.
 Assistant Technical Editors : K. D. ROGERS, P. R. BIRD,
 G. P. KENDALL, B.Sc., A. JOHNSON RANDALL,

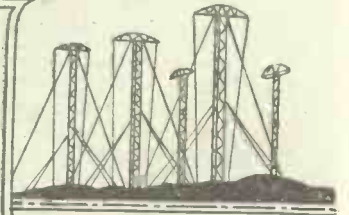

RADIO NOTES AND NEWS.

The Happy Hollander—But It Wasn't Television!—Our Pirate Story—More Sunday Wireless?—Marcuse Hits Siam—Programmes on 'Phones Only—The Last Word.

The Happy Hollander.

THE Netherlands Government has passed a Bill providing for the regulation of broadcasting. The hours of transmission are to be divided equally between the various broadcasting societies, which appear to be representative of various religious sects. There is to be no licence fee; hence the Dutchman may enjoy the B.B.C. programmes for 10s. per annum less than it costs us here.

But It Wasn't Television!

A CONVINCING foretaste of future business hustle is provided by the news that an eight million pounds prospectus of the issue of the Province of Buenos Aires 6 per cent Bonds was recently sent from New York to London by photo-radio-telegraphy for publication in French newspapers. I saw the reproduction of the prospectus in a Paris paper—nearly a page—and it was so clear that it did not need to be re-set in type, but was just photographed and printed—a saving of, say, a week's time. Marconi has predicted the abolition of Morse, and I certainly think that, for business purposes, he has the right idea.

Rumour or Forecast?

HOW did the rumour of Sir John Reith's impending flight—or triumphal progress—from Savoy Hill to the City begin? Was it born of mere gossip, repeated till it became a "fact"; was it a thought born of a wish, or was it really a well-founded anticipation? The translation of rumour into reality would not be surprising, for Sir John has handled a big thing in a big way. But does he not owe something to Broadcasting which might well bid him consider thrice before he forsake it?

Still They Come.

PARODYING the old adage, we may say that of the inventors of wireless there are "no end." Numbered amongst the celebrations of Edison's 81st birthday is an article in the "Telegraph and Telephone Age" which says, *inter alia*, that in 1875 Edison connected an electro-magnet with an interruptor to a gas-pipe and in another room he set up a spark-gap, one end of which was connected to the gas-pipe, the other end being free.

The First (?) Indoor Aerial.

THIS spark-gap was enclosed in a dark box and minute sparks were seen to occur between its points. So far as I can judge from this description, this was simply an instance of inductive sparking, and not radio at all, because, you will note, the spark gap was connected to the windings of the electro-magnet by the gas-pipe. What is of importance is, that, according to the article, he had a system of "induction" wireless which was actually used for communication between moving trains and between these and railway stations. And we all acknowledge that the "Edison effect" played its part in the invention of the valve.

Our Pirate Story.

THE little lyre-bird whispers that the listener in Andorra (kindly look at the map of Spain to find this independent municipality) has failed to pay his

licence fee for 1928, and as he still insists upon listening, because he is the mayor, has been fined a couple of goats or fourteen strings of onions, payable by instalments. Talking of "pirates," it is sad that India is in a bad way through lack of licence fees. But our Eric Dunstan is putting up a good fight. I am not a wet blanket, but I know a little of India and in these "Notes" I predicted wholesale piracy a long time ago.

Radio Arrives.

THE great Galli-Curci has at last sung before the microphone; she was the last of the die-hards in the top-notch singing line. When asked why she hung on so long, she said that she was waiting for radio to be perfected. Gentlemen, radio is now perfected, but what a pity some of them did not wait till the gramophone was—er—had reached its present degree of goodness.

(Continued on next page.)

SHIP AUTOMATICALLY LISTENS FOR THE S.O.S.



This Cunarder, trading between the West Indies and England, is equipped with the new automatic S.O.S. receiver. The instrument picks up distress calls within a distance of 300 miles, and immediately rings alarm bells to call the operator.

NOTES AND NEWS.

(Continued from previous page.)

Take Your Choice.

EXTRACT from article in an American magazine, "It is well-known that this (the microphone) is wholly and entirely Mr. Edison's invention." Extract from book advertisement in same magazine, "Emile Berliner, maker of the microphone." "Emile Berliner's story is the story of the microphone." I should not be surprised to hear that wireless, the microphone, and everything else, including the Tower of London, was invented by George Washington, Abe Lincoln, Big Bill of Chicago, Pussyfoot Johnson, Senator Borah, and Mr. Hoover.

More Sunday Wireless?

THERE is talk of extended Sunday programmes. Whether the B.B.C. is seriously considering this, I do not know, but I believe that if the afternoon programme were begun at 3 p.m., and the evening programme at 8 p.m., many listeners would welcome the change and would not then ask for any extra programmes at all.

A Few Questions.

WHERE, oh! where is the "Vicar of Mirth"—an infallible laughter-maker? When will the B.B.C. give us "Merrie England" again? Why is A. J. Alan such a rare bird? Does not the B.B.C. think that half an hour of Bert Hinkler would be more welcome than an hour of its Chief Engineer? And, finally, for the time being, when will the B.B.C. realise that the public wants more talks by men who have "done things" or "been somewhere," and not talks by book-students?

Marcuse Hits Siam.

MR. MARCUSE (2 N M), tells me that he has received a note from Mr. P. Pah, of the Radio Section, Post-Office, Bangkok, Siam, to the effect that 2 N M's signals (telephony) were received there in January. Mr. Marcuse certainly knows how to use the ether. "P.W." has not hitherto said much about amateur transmission, but when the Post Office grants transmitting licences more freely—well, then we shall have to institute an entirely new order of knighthood, and show you how to do it.

Colombo Radio.

J. P. W. (Bangalore) assures me that V P B is really a top-notch. He gets it over several hundred miles with great volume on his five-valve set. He gets also Bombay (500 miles) and Calcutta (1,000 miles). It is interesting to note that he can receive any evening from Moscow, Leningrad, Langenberg, and Stanhou.

Ceylon Calling.

FROM the "Ceylon Radio Times" I glean some facts. Ceylon was the first Colony, apart from the Dominions, to open a broadcasting service; it was the first service in the Empire to be worked as a public service under Government control; and V P B was the first station in the East, except, perhaps, in Japan, to give regular programmes. The service began in 1925

with 175 listeners and now has 900. Best wishes from "P.W." to Ceylon's radio fraternity. Stands the Galle Face Hotel where it did of yore? And does the coloured gent still do the mango trick on its garden path?

News from 3 L O.

HERE'S a batch of papers, programmes, etc., from Melbourne, Australia—where one flies to, if one flies. Great appreciation is expressed about letters from US who have picked up 3 L O. If you haven't written yet, why not send them a line? Apparently journalism—or, rather, newspaper distribution—is not yet up to the wonderful degree reached here, so 3 L O has begun a breakfast-time news programme. The same station is running a

SHORT WAVES.

John: "I certainly got a bargain when I bought my wireless set."

Frank: "Are you quite sure of that?"

John: "There's no doubt about it. After I had assembled the set I had sixty-seven parts left over."

The difference between a Scotsman and an electric battery is that you can overcharge an electric battery.—"Everybody's Weekly."

LEAP YEAR.

Pretty Saleswoman: "Don't you want a loud speaker in your home?"

He: "My dear, this is so sudden."

It is announced that television has been definitely established between England and America. Stop-at-home Americans are said to be very curious to see their friend, the British tax-payer.—"London Opinion."

A DRY NIGHT.

An American who conversed by wireless telephony to an Edinburgh business man the other day wound up with the announcement that he had heard a snatch of the B.B.C. "Burns' Night," but did not think it very realistic. "I heard no gurgles or fizzes," he explained.—"Bulletin and Scots Pictorial."

Bobby: "Papa, what is 'status quo'?"

Father: "Something that comes in over the radio, I think."

Wireless waves never die; they only fade away.

Oh, did you hear the wireless man
Pronounce the word mauso leum?
It seems to me that he should be
Enveloped in linoleum.

A subject grave indeed it is
To call the word mauso leum.
I think the listeners all should club
And burn him in petroleum.
"Glasgow Herald."

sort of ballot, the winners of which get a free rail trip across Australia and back. They haven't got much money but they spread what they have royally.

A Successful Appeal.

LORD KNUTSFORD'S appeal on behalf of the London Hospital on February 5th resulted in the receipt of no less than £20,000 from listeners. One subscription was received from Constantza on the Black Sea. An excellent proof of the enormous value of broadcasting, but one shivers to think of the possibilities of the art if it were used for propaganda.

Programme on 'Phones Only.

H. A. B.'s letter in our issue of February 18th has evoked much interest. H. B. G. (Derby) thinks that H. A. B. must have been touching some part of the set with one hand, whilst touching the

metallic part of the jack-plug with the other. Whatever the explanation, there can be no doubt that there was a connection between the set and the 'phones; let H. A. B. repeat the performance, standing on a cork mat, with his hands in his pockets. I am pleased to note that H. B. G. thinks our Enquiry Department "remarkably efficient."

Bartok and Charlot.

AN "Ariel" writes the wireless notes in the "Musical Times," and, of course, trounces the "ignorant" listener good and hard. According to him, people who don't like Bela Bartok's idea of music have "hermetically-sealed minds." And as to "Charlot's Hour," he was unable to smile even once. An hermetically-sealed sense of humour! I thought you would like to know what the other "Ariel's" views are, so that having paid your money you can take your pick.

Our "Daintree" Limerick.

ALATE-COMER to the competition submits the following line, which is not half bad "Where it's renamed (with other names) 'Faintry.'" This is the effort of C. B. (Belfast), who, sweeping aside the whole gamut of the "P.W." Peerage, has the nerve to apply for a Monarchy, on the strength of twenty-four stations brought in on a one-valve Reinartz, using a small indoor aerial. The Monarchy is reserved for the receiver of Mars at L.S. strength on a dud crystal. Take a Viscountcy and be thankful!

The Last Word.

FOR a downright, final, comprehensive testimonial to the excellence of our "General Purpose" Two we have to thank J. H. H. (Winscombe). He admits certain small virtues may reside in the "Sydney" Two; he thinks the "Simmonds" is efficient, and the "Hartley" ditto, but the "G.P." leaves him nothing to desire. Gosh! What a reader! The Editor can now sing his "Nunc Dimittis" and retire. So bucked is J. H. H. that he even creates himself a Valve Bart. I confirm it and will send the Letters Patent when—the Income Tax is ninepence.

Radio Rain.

SO far from blaming radio for causing rain, Dr. W. G. Murray, of Mossel Bay, South Africa, is reported to have expressed the wish that the Government would undertake experiments in rain-making by means of the Beam System. Evidently all the scientific arguments against the theory that radio makes rain do not cut any ice with Dr. Murray. To my mind, the fallacious radio rain notion springs from a belief, entirely belied by scientific records, that the annual rainfall in the British Isles is increasing.

Red Letter Items.

MARCH 21st: 2 L O and 5 X X. Speeches by the Prince of Wales and Mr. Baldwin. From 2 L O: A Sullivan concert—at last! March 22nd: 5 G B, Sir Oliver Lodge on "Scientists I Have Known." March 24th: 5 G B, "The Night Fighters," a play by Cecil Lewis. Mr. Lewis is the best producer of "effects" by radio ever employed by the B.B.C. (My pious opinion.)

ARIEL.

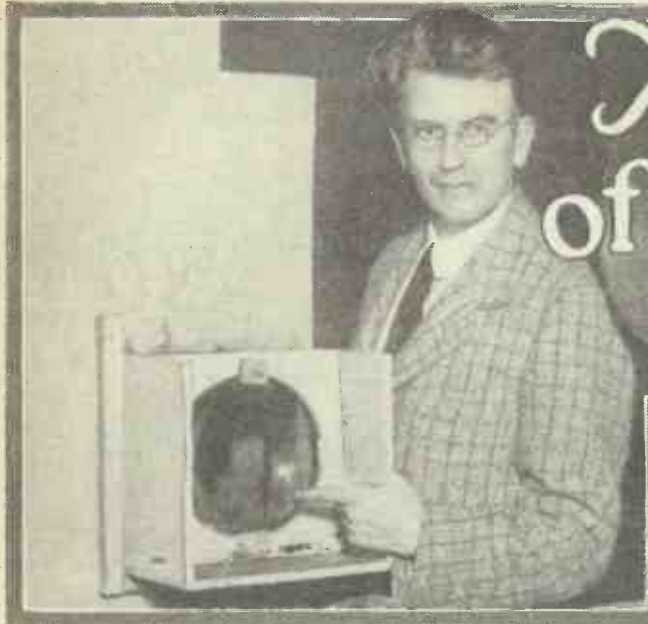

The PROBLEM of TELEVISION

BY
SIR OLIVER LODGE F.R.S.

The second of two articles specially written for "Popular Wireless" by our Scientific Adviser-in-Chief. These articles should enable the non-technical reader to appreciate the real problem of television, and to understand why the policy of "P.W." on this topic has been dictated by a desire to tell our readers the plain unvarnished facts.

THE EDITOR.

2.—FINAL CONCLUSIONS.

PLENTY of difficulties remain. Let us think for a moment what those difficulties are, and whether there is any chance of overcoming them. Let us assume that the illumination of each point of an object can be reproduced at a distant station if sufficient time is allowed.

Preliminary Difficulties.

In other words, let us assume, first, that an engraving can be transmitted, and, next, that with some suitable changes an illuminated point might be transmitted, or rather reproduced, as a luminous point.

The properties of selenium might be used for that purpose, for, as time is no object, its slowness of response or lag would not matter. It would transmit currents of varying strength according to the illumination, and those currents when magnified might produce the corresponding luminous spot at a distance, or might be used to regulate the intensity of a beam of light.

If, however, we want to work quickly, so as to send one spot rapidly after another, then, as far as we know, selenium would be too slow. And probably all material substances would be too slow. The only things quick enough would be either the ether or its electronic charges, for instance the electrons shot off from a surface when light of suitable frequency falls upon it.

Let us suppose then that a photo-electric cell can be made to respond instantaneously to a momentary illumination which is constantly varying, that it can be got to transmit a correspondingly varying current to a distance after suitable magnification, and that then from local batteries the corresponding illumination can be produced in corresponding positions upon a screen with great rapidity.

Question of Detail.

How many spots are required to the square inch in order to give a recognisable image, say, of a face? Can it be done with 100, that is with 10 to the linear inch? I think it can, at any rate as a beginning, and that something might even be attempted with less; though to get a

really good picture perhaps 40 or 50 dots to the linear inch are needed. Last week I showed a portrait of Lord Kelvin in which the dots are very few and far between. Looked at close to, or through a magnifier, there is nothing but a smudge; and yet, held at a reasonable distance, it is recognisable as a portrait of that great man.

The fact is that a familiar object like a face can be called up by very faint indications, as everyone knows by seeing faces in the fire, or in foliage, or in the markings on a wall when looked at for some time, or animals and other objects in clouds. No great detail is required to give a suggestive picture. Still, even to give 100 spots to every square inch within $\frac{1}{10}$ of a second is by no means easy. It involves very rapid movement on the part of the tracing point, and very rapid response throughout. And to give a picture of any reasonable size in this way, say four inches square, by means of vibrating mirrors or rotating lenses, would seem to be almost impossible.

If wire connection between the two

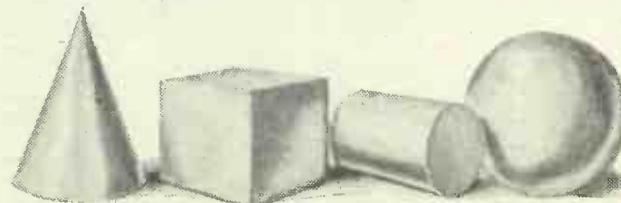

Simple solid geometrical models such as Mr. Baird is asked to televise in slow motion according to "P.W.'s" £1,000 challenge.

stations is permitted, then it might be possible to use a multiple wire, say of ten strands, and send the picture simultaneously in ten fragments, so that the difficulty of travelling over the surface in the fraction of a second would be reduced by ten. This, however, is only an evasion of the difficulty, and is not applicable to wireless transmission, about which otherwise there is no particular difficulty. It might, however, be politic for an experimentalist to work for some time between neighbouring rooms, and with wired connection, rather than

attack the ultimate problem with insufficient experience of subsidiary detail.

Evolutionary progress is generally slow and gradual. Many ideas, and indeed instruments, have to be scrapped on the way to ultimate success. There is wisdom in selecting conditions at first which enable these early stages to be overcome with fair rapidity, so as to give the more difficult attempt later the best chance.

The problem is to find a means of moving something equivalent to a beam of light with a rapidity above acoustic frequency; in other words, of vibrating it at a speed approaching radio frequency. Can this be done?

Mechanical Contrivances Fail.

The problem is to find something that can be made to traverse a picture with exceeding rapidity, of such a nature that it will make something respond to varying illumination at one end, and reproduce corresponding illumination at another.

Nothing mechanical is likely to work at the required rate, and a beam of light first suggests itself. But a beam of light is only tractable by mechanical contrivances. It can be made to move by moving lenses, as in a lighthouse, or by a rapidly moving mirror. Both these, however, involve mechanism, and no speed comparable to that of light is possible to any piece of ordinary matter. The only things able to move with speeds like that, except actual waves in the ether, are the positive or negative electric charges.

The stream of cathode rays fired off from a highly charged cathode into a vacuum has a very high speed; and Lenard found long ago that the rays could be got out into the open air by making them impinge on a thin aluminium or platinum window, which they were able to penetrate.

(Continued on next page.)

THE PROBLEM OF TELEVISION.

(Continued from previous page).

And recently Dr. Coolidge, of the General Electric Company in America, has succeeded in getting these cathode rays at exceptional high velocities and of prodigious power. That fact opens up possibilities at present unexplored, and makes us unwilling to decide that we are anywhere near the limit of exploration in such subjects. Otherwise we might have thought that the moving of a beam of light with sufficient rapidity was impossible.

Tractable Rays.

But consider these flying electric particles. They are not light, nor are they X-rays, which we know are waves in the ether. But when they impinge on matter they have the property of generating X-rays: and when the X-rays so generated again encounter matter they are able to precipitate electrons from it with a speed equal to that of the original electron which generated the waves. This is a remarkable fact, of which the full consequences have not yet been disinterred.

Again the whole nature of a flying electron is under discussion. Schrödinger has a theory that they are wave-like impulses, only differing from ordinary waves of light in the fact that they are limited in extent, and carry an electric charge—that they are, in fact, or might be considered, charged waves in the ether.

And still more recently, in the February "Proceedings of the Royal Society (1928)," Professor George Thomson, of Aberdeen, son of Sir J. J. Thomson, has demonstrated experimentally that cathode rays carry with them a wave-like structure, giving the phenomena of interference and diffraction, when passed on to a screen through certain crystals, the luminous patch on impact is ring-like or band-like in structure, a phenomenon demonstrative of waves.

It appears possible, therefore, that these cathode particles must have some of the properties of light (using the term "light" in a very general sense so as to include ether waves of every frequency); while at the same time, owing to their electric charge, they are amenable to influences to which light is inert. Light cannot be deflected by a magnet, but these charged waves can. The possession of an electric charge makes them tractable by electric and magnetic means.

More Research Essential.

It is therefore conceivable that by a great deal more research these cathode rays can be made to take the place of light, and at the same time be waved to and fro by alternating magnetic fields, even if those alternations are of radio frequency. The whole thing is vague in my mind at present, and is necessarily vague. Much more research is essential before any use can be made of these newly discovered properties.

But at any rate those concerned in the problem may take heart and realise that the laws of nature are not against them, and that there are unexplored methods still open to investigation.

I can imagine a magnetic coil-like the

coil of a transformer, conveying very high frequency currents, and thus generating an alternating magnetic field, able to influence and control a beam of charged waves, so as to make it move laterally with far more speed than can be inflicted on an ordinary beam of light; and yet, in some undiscovered way, that the beam can stimulate a receiving surface into activity, and thus do what is wanted for purposes of television.

"In Its Infancy."

It may be necessary to put a core into these magnetic coils, and here again recent research has disclosed magnetic substances of very peculiar properties. The difficulty which any magnetic substance feels in following rapid oscillations is caused by the waste of energy due to hysteresis on the one hand, and Foucault or eddy currents on the other. But the substance called stalloy has very little hysteresis; and a powdered substance would have very little Foucault currents.

There is another difficulty however, that most magnetic substances only develop their exceptional properties in a magnetic field of some strength. But the substance called "permalloy" has very great permeability, even for very weak magnetic forces. Accordingly, I can imagine that powdered permalloy, screened it may be from the earth's magnetic field so as to keep it

that question has been answered affirmatively. There may be theoretical reasons in favour of it; but if they are not final, such a substance would suggest all sorts of possibilities.

On the whole, therefore, we may conclude that whereas television is in its infancy, and the results obtained so far are very imperfect, yet enough has already been achieved to show that much more is possible. The progress of recent investigation, so far from shutting the door on further research and bringing us into conflict with the laws of nature, seems to open up further possibilities.

But until we are assured by long continued exploration, or, better, by theoretical proof, that any given problem is insoluble, it is wiser to hold that any problem clearly suggested will in time be solved. So may it be with television.

A Necessary Caution.

Finally, I think it advisable and perhaps necessary to issue a caution to the public, and incidentally to the Press, reiterating my assertion that the subject of television is quite in its infancy, that it is not as yet possible to purchase any apparatus likely to be successful, and that no amateur is likely to be able to adapt apparatus working in connection with a wireless receiver for the purpose of seeing moving objects at a distance.



Dr. Alfred Goldsmith, consulting engineer of the National Broadcasting Co., who has invented a simple home radio-photo receiving outfit. The problem of photo transmission is vastly simpler than that of television.

sensitive, might form the core of such magnets, and greatly increase their strength.

Nor is it to be supposed that research into the alloys of iron, nickel, and cobalt, and their congeners, is anywhere near completion. Fresh substances with desired properties may yet become available; for hitherto it has always seemed that when any peculiar property was really wanted, a substance with that property was likely to be forthcoming.

There have been a few exceptions, and in some cases we are up against the laws of nature in looking for them. For instance, a transparent conductor is a theoretical impossibility, unless it is merely an electrolytic conductor, as Maxwell showed. Any substance which conducts mechanically must be opaque. Opacity and conducting power go together. But is it impossible to find a transparent magnetic substance? Do magnetisability and opacity necessarily go together? I am not aware that

If television is in its infancy, home reception of its results by wireless aid is still more in the future, and in all probability in the somewhat distant future.

I would not say anything to dissuade amateurs from experimenting, but it seems only fair to issue this caution, in order to minimise over-enthusiastic rumours and prevent disappointment. If this attitude is considered over-conservative, then I must be content to plead guilty to that accusation, so far as my present knowledge extends.

No one can say that anything is finally impossible; but it is fairly safe to say that a given development has not yet been achieved. As far as I know about the attitude of other scientific men I think I am in agreement with them. I shall rejoice if the labours of Mr. Baird and other workers, in this country and in America, are able to falsify this caution within what remains of my own lifetime.

NOT many amateurs employ counterpoise earthing arrangements nowadays, although in times past this method of earthing a receiver was fairly common. Probably the amateur disuse of the counterpoise is due to the fact that the latter requires more care and precision in erecting than does an ordinary direct earth, and also on account of its inefficiency when used in conjunction with an ordinary one- or two-valve receiver.



CONCERNING THE COUNTERPOISE

Describing some interesting experiments which you can carry out.

By J. F. CORRIGAN, M.Sc., A.I.C.

However, any amateur possessing a really good three- or four-valver is in a position to conduct for himself many interesting experiments with counterpoise earths, and to determine the very great influence which their design and situation exercises on the reception derived from the set, and also upon its freedom from parasitic noises.

Like a Condenser.

A counterpoise earth, the text-books tell us, consists of "an insulated group of conductors forming part of an aerial system used instead of, or supplementary to, a direct continuity connection to earth." Which means to say that an ordinary

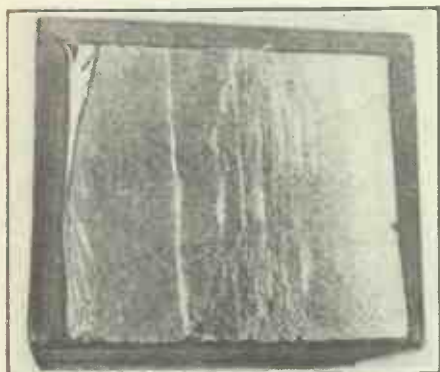

Fig. 1.—Tinfoil pasted on the base of a receiver to form a "capacity earth."

counterpoise earth consists of one or more wires which are elevated a short distance above the ground in an insulated manner, and which, in view of this fact, generally makes no direct electrical connection to earth.

An electro-magnetic field exists around a set of aerial wires in which current is flowing, and, owing to the fact that the aerial current is continually oscillating and changing in intensity, the electro-magnetic field is continually expanding and contracting in sympathy with the current. A similar sort of thing takes place at the earth connection of the set, and we may imagine the aerial and earth of a receiving set as constituting the two plates of a very large condenser, the air existing between them comprising the dielectric or insulating medium between the two.

A Simpler Form.

If, instead of a direct earth connection to the set, we employ a series of conductors stretched in an insulated manner a little distance above the ground, the same condition of affairs obtains. A field of influence exists between the aerial and the counterpoise earth.

The very simplest form of capacity earthing takes place in those instances in which the receiver is discovered to function fairly normally when the earth wire is removed from its terminal on the panel. Even some crystal receivers will operate under these conditions, the coils and connections within the set forming a miniature counterpoise arrangement.

Many a multi-valve set owner has found that he can effect a good earth "connection" by the simple process of gumming a sheet of tinfoil or silver paper on to the under side of the cabinet of the set, and by connecting the earth terminal of the receiver to a portion of the foil, as illustrated in Fig. 1. In such instances the "return" currents from the set flow into the metal foil.

Another simple—and often extraordinarily efficient—counterpoise earth is that illustrated in Fig. 2. It consists of an ordinary kitchen fender resting some two feet above the ground on two chairs.

Interesting Effects.

The earth wire from the set is soldered or clipped to this. Amateurs interested in the subject of counterpoises are strongly recommended to perform a few of these kitchen fender experiments. They will be successful when a good three- or four-valve receiver is used, and radio experimenters will find it greatly interesting to note the difference in reception derived by varying the position of the fender relative to the aerial, the best effect being obtained by having the fender directly under the aerial and parallel to it.

When considering the design of counterpoises it should be remembered that in order to get anything like the best effects the aerial should "electrically cover" the counterpoise system. That is to say, the counterpoise wires should be arranged symmetrically directly underneath the aerial system.

The entire conducting system of an ideal counterpoise earth should be well insulated from the surrounding objects. If, therefore, a counterpoise is constructed in a garden in such a manner that some portions of it are liable to come into contact

with plants, and so on, well-insulated wire should be used. The lead-in from the counterpoise should be insulated quite as carefully as the lead-in from the aerial.

At the same time, however, it may be pointed out that a counterpoise will work—and often with great effectiveness in certain directions—when one or more portions of it are directly connected to the earth. Thus the amateur has within his scope many interesting experiments

with one or more counterpoises which are totally insulated, or which, on the other hand, are connected to the earth by means of a buried ground-plate at one or more points.

Cutting Out Interferences.

Coming now to some of the effects accruing to the use of a counterpoise in place of an ordinary earth connection to the receiver. In the first place, the counterpoise will result in the cutting-out of much local interference. In fact the amateur sorely troubled with such interference will, more likely than not, find his radio salvation in the use of a counterpoise.

For receiving short waves a counterpoise is most useful, especially in cases in which the highly efficient direct earth connection which is demanded in this class of reception cannot be obtained. Again, a counterpoise earthing system adds to the directional properties of a receiver if it can be constructed in such a manner that the length of the counterpoise system points away from the station it is desired to receive.

A counterpoise affects the "natural wave-length" of the aerial—that is to say, the wave-length to which the aerial system would tune if inductances and condensers were not provided in the receiver—by lowering it to a considerable degree. Generally speaking, therefore, the reader who experiments with counterpoise working will find it necessary in some cases to employ coils of a larger size in order to obtain the best results from the use of the counterpoise system. On the other hand, it will be found that the counterpoise will result in considerably sharper tuning.



Fig. 2.—Simple "counterpoise" made by a kitchen fender supported on two chairs.



WHERE WIRELESS SETS WEAR

Some little suspected causes of gradual deterioration in radio sets.

By F. JACQUET.

ONE appreciates the fact that a radio set may gradually go off colour owing to a continual tendency to inefficiency on the part of its valves, batteries, headphones, or loud speaker. Again, any aerial which is erected in the neighbourhood of a manufacturing town quickly becomes covered with grime, which is, in the majority of instances, of a partially-conducting nature, and thus to causes such as these much of a set's decreasing inefficiency may be ascribed.

There are, however, a set of more deeply-rooted causes which sometimes work together to set up a gradual and insidious loss of efficiency in a wireless set. Such causes are all the more difficult to track down because they are ones which are the least suspected. Take, for instance, the soldered

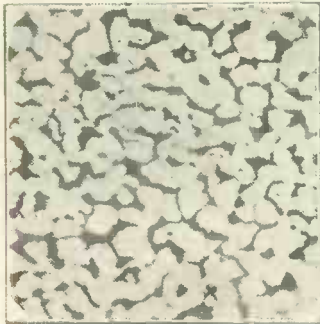

Fig. 1.—Surface of common solder (less in diameter than a pin's head) magnified to show its crystalline nature.

connections of a set. It may be a matter of surprise for the amateur to learn that at least some proportion of the growing inefficiency of a receiver may be ascribed to the soldered connections of his set. In the first place, the use of a flux which is in the least degree acid in nature—and how many fluxes do not give an acid reaction?—will, in time, and under favourable conditions, set up a corrosion of the joint, the corrosion being an inner one as well as an outer one.

Thus a soldered joint attacked by the corrosion fiend may to all intents and purposes hold together well enough, but yet, at the same time, quite a number of physical changes may be taking place within the mass of solder.

Re-Soldering.

Such changes, which may also be due to electro-chemical action taking place at the junction of the two dissimilar metals, to wit, the solder and the copper, will almost invariably increase the resistance of the area.

One would suggest, therefore, that it would be a good plan for an amateur confronted with a perplexing loss of inefficiency

in his set to heat up each soldered joint so that the solder just flows. By these means, the solder would be reconverted into its original condition, and any lack of inefficiency of the receiver due to the above causes would disappear. In a few instances with which the

writer is acquainted this plan has been put into practice, and it has been eminently successful in regaining lost efficiency. It has been stated already that much of the dust and grime which is present in the air of manufacturing and industrial cities is of a partially-conducting nature. For this reason, one is given the advice that it is at all times necessary to maintain the panel of a receiver in a dust-free condition. Such an end is difficult to attain, however, particularly in the case of matt ebonite panels.

Clearing Panel Faces.

Under the microscope, a matt piece of ebonite presents the appearance depicted in the photomicrograph, Fig. 2. The surface of the ebonite is sponge-like in nature, and the conducting particles of dirt become embedded in its pores, from which lodgments they are difficult to remove. Here, therefore, lies the cause of another mysterious growth of inefficiency.

The remedy in the case of matt ebonite panels is to go over the panel with a rag saturated with methylated spirit. An occasional treatment on these lines will maintain the matt panel in a dirt-free condition in a way which would be impossible of attainment by the ordinary process of dusting. Polished panels are, of course, free from this trouble.

A still more insidious cause of panel inefficiency in a wireless set is the gradual deterioration of the panel material under the influence of light. This deterioration is accompanied by a decrease in resistance, and accordingly the set is lowered gradually in efficiency as a result. The reasons underlying the action of light on insulating panel materials are quite unknown at the present day.

Gradual Degeneration.

However, most insulating materials of this nature undergo the deteriorating process to a greater or less degree. Fortunately, however, the degenerative influence only takes place on the surface of the panel, and thus the latter portion may be removed by rubbing the panel surface over with fine glass paper, and subsequently by polishing it again with a soft rag, very lightly moistened with a little sweet oil.

Ebonite panels undergo this light-deteriorating influence most of all, and the poorer the quality of the ebonite, the more susceptible it is to light action. Amateurs may have noticed, for instance, that a piece of scrap ebonite which has been exposed to air and sunlight for any length of time, loses its raven-black appearance, and acquires a greenish cast.

Naturally, a radio panel is seldom allowed to get into this state, but nevertheless it may lose some of its efficiency all the same.

Panels, of course, are not the only ebonite or ebonite-substitute articles which are liable to undergo these subtle changes. The process may take place in coil holders and bases, valve holders, and in many more of the numerous radio components which are moulded from insulating materials of not too good an efficiency.

Grid leaks and anode resistances may at times undergo degenerative changes. The continuous electron flow through the slightly-conducting path in these articles may cause the latter to become disintegrated, in which case, of course, the tendency will be for the resistance of the conducting path to become increased.

Further Degeneration.

In fact, this process of disintegration may give rise to minute gaps in the conducting path across which the trickle of current will pass in minute arcs. Such a state of affairs will inevitably give rise to parasitic noises in the reception which will be most difficult to trace.

The deterioration of a set's efficiency due to the presence of traces of moisture in the windings of its components is well-known. So also are the degenerative changes due to the partial breakdown of the poor insulating wrappings which used to be employed so greatly in the manufacture of cheap transformers. And, of course, the crystal enthusiast—if, from a purely technical standpoint, he still exists—will only too well be aware of the gradual and

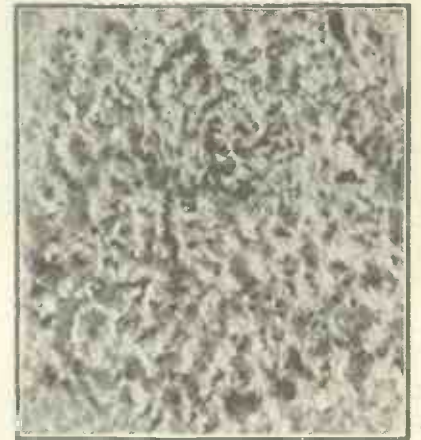

Fig. 2.—A Photomicrograph of the surface of an ebonite panel.

most mysterious degenerative changes which subtly take place within the very heart of the crystal and work havoc with its rectifying efficiency.

General Overhaul Advised.

It would, of course, be a very unlucky individual that was confronted with all the insidious effects noted in this article. Nevertheless, a consideration of such possible deteriorating effects which are not usually suspected will surely be of interest. A set which is functioning unsatisfactorily, and which has been gradually deteriorating in this respect for some time, despite the fact that it is in good "mechanical" condition, should be reflected upon along the lines set out in this article.

A NEW SHORT-WAVE CIRCUIT

It is very seldom these days that entirely new circuit-arrangements are met with, but here we have a distinctly original, and most interesting hook-up.

By J. ENGLISH.

I HAVE recently been carrying out some tests with experimental short-wave Filadyne receivers, and up to the present some very interesting results have been obtained.

I started off with the well-known standard Filadyne (see Fig. 1), as used for broadcast reception, changing the coils for S.W. ones. This circuit embodies potentiometer control

circuit, but it was pleasing to find no threshold howl unless the filament was run too high. (This should never be done with the Filadyne.)

The next step was to coax the receiver to oscillate at any setting of the tuning condenser, and further to improve the control of reaction so that it became absolutely smooth and even.

Oscillation Control Improved.

Now in a previous article I have touched upon the relation of the anode circuit to reaction control, anything in the nature of an impedance in the anode circuit being a hindrance to the development of oscillation in the input circuit. Therefore, there must be a clear path for H.F. currents from anode to filament and this would seem to be doubly important in the short-wave Filadyne. With this in mind, I tried the effect of connecting a small fixed condenser across anode and L.T. negative as shown in dotted lines in Fig. 2, thus providing a low-resistance shunt path for H.F. currents.

This proved a very effectual remedy in overcoming the receiver's reluctance to

oscillate; oscillation was now obtained whatever the setting of the tuning condenser. It was also noticed that the control of reaction had become very much smoother. The sensitive state prior to oscillation was easily obtainable, the set then being very stable without any threshold howl whatever. When aerial and earth were connected it was possible to slide out of oscillation very gradually and sweetly, thus

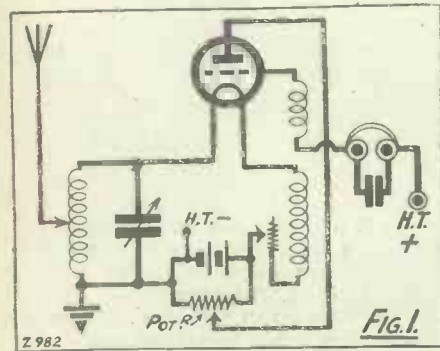

of reaction, which I prefer to capacity control for this circuit. A receiver was put together on the basis of the circuit of Fig. 2, with a transformer-coupled L.F. valve exactly as shown in the diagram. The inductance, L_1 , was a low-loss short-wave coil, L_2 and L_3 being both wound on another former. When everything was ready and the receiver switched on, nothing happened; the set was "as dead as mutton"! This absence of liveliness was obviously due to certain effects preventing the circuit oscillating on the very high frequencies to which it was tunable. This was a trifle surprising in view of the strong oscillation that could be obtained on normal wave-lengths. Doubtless this same difficulty has been observed by others.

Curing the Trouble.

Having eliminated possible causes of error due to incorrect reaction coupling and anode potential, it was found that a small fixed condenser connected across the L.T. supply and rheostat as shown in dotted lines in Fig. 2 was really essential for regeneration. On normal wave-lengths a condenser in this position makes hardly any difference to the operation of the set. However, even with this addition the short-wave set only oscillated over the lower readings of the condenser dial. Reaction control, moreover, was not as even as in the normal

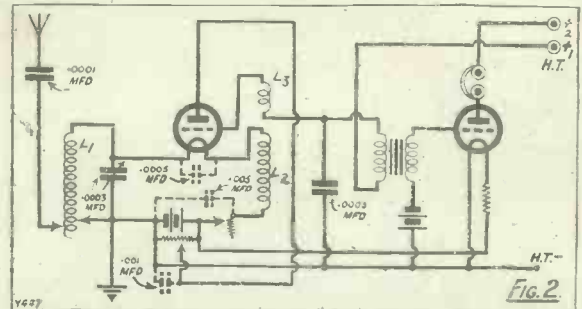

ensuring the maximum amplification of weak signals.

(Continued on next page.)

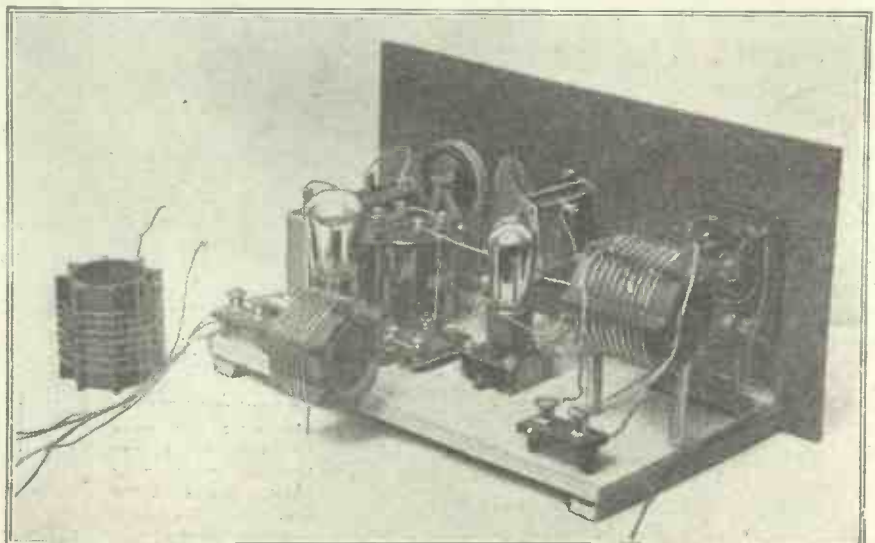

Only one variable condenser, no normal H.F. choke, and fixed coil-coupling are some of the advantages of Mr. English's short-wave receiver, a photo of which is shown above.

A NEW SHORT-WAVE CIRCUIT.

(Continued from previous page.)

To my mind, one of the most valuable features of this Filadyne circuit is that the control of reaction has hardly any effect whatever on tuning. This is a most important feature in a short-wave set. As many of you know, every adjustment of the reaction condenser in a capacity-controlled circuit requires a slight movement of the tuning condenser to keep in tune. Not so with the Filadyne. Once having tuned to the silent point of a carrier wave; reaction can be slackened off until oscillation ceases without losing the signal. It will be obvious that this constitutes a very simple means of tuning which is very valuable in a short-wave receiver.

A Further Refinement.

A further refinement of the circuit of Fig. 2 was to connect a small fixed condenser across the filament valve-holder terminals. This produced slightly better results as far as freer oscillation was concerned.

As regards adjustment for maximum rectification efficiency, this is done automatically to a certain extent by the potentiometer when using it as a reaction control. Apart from this there are no tedious adjustments required. The absence of the grid condenser-grid leak arrangement simplifies matters and this, as a source of damping of the tuned circuits, being absent, selectivity is better. As for H.T. values, these need never be high for the Filadyne detector, a maximum of 30 volts giving very excellent results. I have used as little as 12 volts H.T. at times when receiving weak signals. The most important adjustment is the filament current which, if too high, produces an unstable reaction control. If run at the normal value for the valve, no

signals at all result, as all Filadyne enthusiasts know. In the short-wave set the best adjustment was obtained by gradually

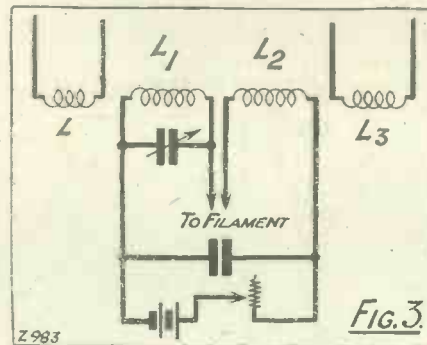

turning on the rheostat until oscillation commenced with the potentiometer set positive.

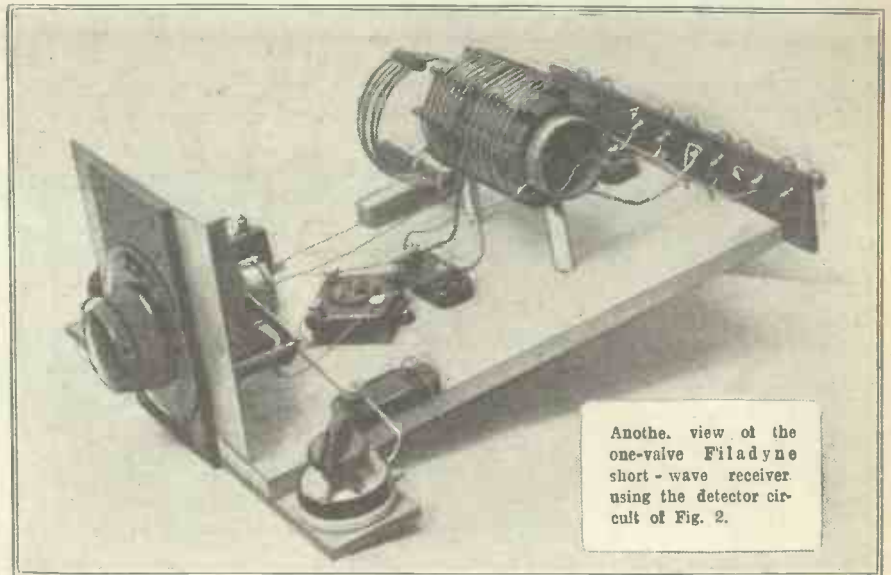

The short-wave Filadyne having been made to oscillate quite readily with and without aerial and earth connections, the particular requirements for the short-wave coils were next investigated. I had previously noticed that the lay-out of these coils in relation to the rest of the set was of importance, also the manner in which they were wound and mounted.

In one experimental set, a bare wire coil was used for L_1 (see Fig. 2), the reaction coil L_3 being wound on the same former, while the second coil, L_2 , was a simple solenoid of 20 D.C.C. space wound on separate former. This arrangement of inductances worked quite well, the coil L_1 being very convenient for varying the auto-coupled aerial tapping and the filament tap for wave-length variations. As regards the reaction coil, it was found that slightly better results were obtained with this coupled to the coil L_1 . This also was an advantage in that different coils could be used for L_2 without disturbing the reaction coupling.

Short-Wave Coil Windings.

The effect was next tried of winding both L_1 and L_2 on the same former. I had noticed previously with the Filadyne on broadcast wave-lengths that winding both filament coils on the same former and in opposite directions produced better results. A set of coils was wound for the short-wave set, as shown diagrammatically in Fig. 3, the two inner ends going to the valve filament terminals. Here both filament coils had the same number of turns, the reaction coil being coupled to L_2 and the aerial coil to L_1 . This arrangement of coils was found to be better than any I had previously tried for producing an easily oscillating circuit.

For the most interesting band of wave-lengths from about 20 to 60 metres, two coils would be required, one having double windings of 4 turns and the other of 8 turns. The reaction coil comprises 3 and 5 turns of fine wire respectively, the aerial coil being a fixed winding of 4 to 5 turns on a separate former arranged for variable coupling to the double coil. The coils L_1 and L_2 are best wound with 20 tinned wire on ribbed ebonite formers, or otherwise made of low-loss construction.

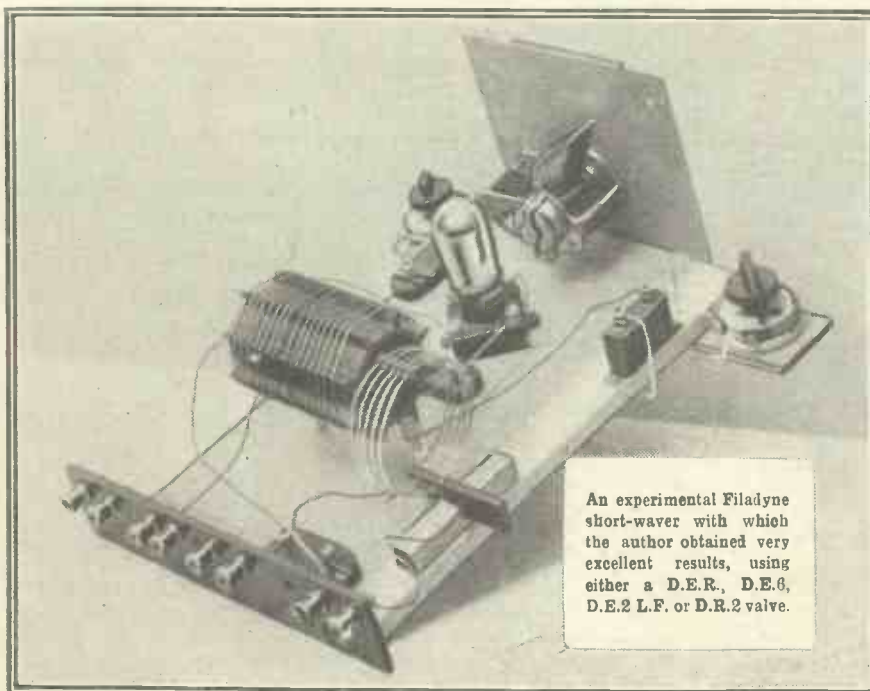

A CENTRE-TAPPED COIL may be regarded as a two-in-one or double-purpose coil, i.e. it may be used as an ordinary coil if the centre tapping is ignored, or as a centre-tapped coil or "auto-transformateur" as it is called in France.

If I require, say, a No. 50 coil, I usually ask for a No. 50 centre-tapped coil. If I want to use this coil as an ordinary non-tapped coil I simply leave the centre tapping point disconnected, and if the time should arrive when, trying out some form of neutrodyne circuit, I require 50 turns with a centre tapping, then the same coil still serves and it does not become necessary to rig up a makeshift or run out and purchase another coil. It would seem, therefore, that in the long run the experimenter gets better value for money by purchasing "C.T." coils.

This article is intended to be of a purely practical nature, the idea being to present a selection of diagrams showing a few practical uses for "C.T." coils, and from the examples the experimenter will be able to try out various different arrangements and form his own opinion as to the advantages or disadvantages of using them.

Useful Crystal Circuits.

Four suggested experiments for crystal-set enthusiasts are outlined in Fig. 1, where circuit A shows the well-known "crystal tap," an arrangement usually much more selective than the orthodox method of connecting the crystal to the top end of an ordinary coil. Circuits B and C are modifications of same, and circuit D is an "ultra selective" arrangement which will be found most effective in cutting out obstinate interference of almost any kind. This is one of the most efficient crystal circuits I have yet tried, and if the coils (which are placed very close together) are arranged on the plug-in principle, reception may be carried out on any wave-length. But it should be remembered that the small fixed condenser in series with the aerial lead-in should be short

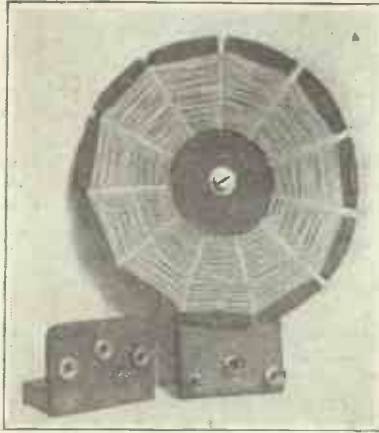

CENTRE TAPPED COIL CIRCUITS

By OSWALD J. RANKIN.

condenser in series with the plate of the detector valve and the filament, and coupling same to the secondary coil by the Reinartz method.

Tuned Secondary.

It should be noted that the tuning condenser is across the ordinary coil (secondary winding) and that the C.T. coil (split-primary winding) is untuned. The coils are placed very close together in order to obtain a tight (and fixed) coupling, so that in effect both coils are tuned by the single condenser. The circuit should be of interest to those who wish to convert

circuit when receiving on wave-lengths of from 1,000 metres upwards. This condenser sharpens the tuning of the aerial circuit and, therefore, adds to the selectivity of the system, but unfortunately it is only effective on the short to medium wave-lengths. The same remarks apply wherever

an ordinary tuned anode H.F. coupling to the more stable neutrodyne coupling, and it should be remembered that the aerial circuit can be made more selective by using a C.T. coil in place of the ordinary coil shown. Following the detector valve is a stage of R.C. low-frequency amplification,

and it will be found that the inclusion of the H.F. choke in the plate circuit of the detector valve is more or less essential. This prevents stray H.F. impulses from passing through to the L.F. valve, these impulses being effectively choked and passed through the .0001 mfd. fixed condenser to earth.

The two photographs, one in the heading and the other below in this column, show examples of home-made centre-tapped coils that have

been used by the author with great success.

The solenoid types are a little more efficient, perhaps, than those with basket coil windings, though the latter are undoubtedly easier to make and to mount, and they have the advantages of being easily coupled together and of taking up very little baseboard space.

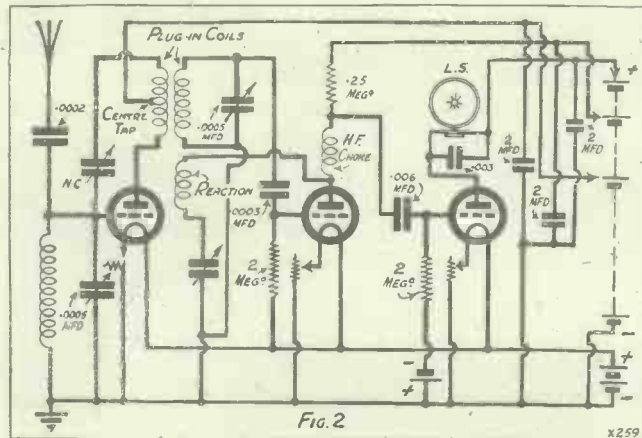

Fig. 2

this condenser is shown in almost any circuit.

A method of using C.T. coils to the best advantage in a three-valve circuit is indicated in Fig. 2. Here we have a really efficient stage of H.F. amplification followed by detector and L.F. valves, a combination suitable for long distance and loud-speaker reception. For the usual broadcast band of wave-lengths, coils Nos. 35 or 50 might be tried in the aerial circuit, and Nos. 50 and 70 in the H.F. transformer circuit.

Reinartz Reaction.

These numbers should, of course, indicate the total number of turns on the coils; for example, a No. 50 C.T. coil should have 50 turns with a tapping at the 25th turn.

Reaction may be easily employed (as shown) by connecting a small (ordinary) coil and

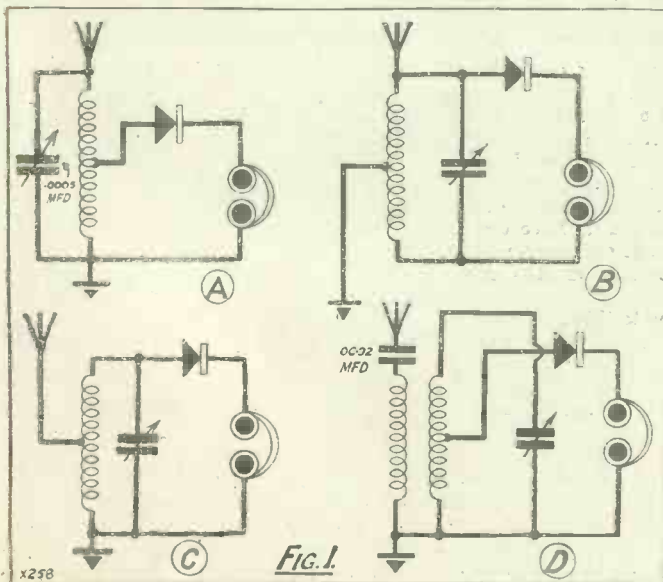
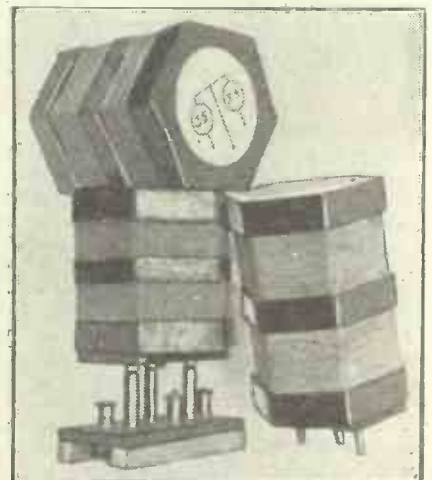

Fig. 1



Plug-in centre-tapped coils suitable for the purposes discussed by the author.

SPRING CLIPS.

A chat about some little gadgets the radio enthusiast will find of value.
By H. J. BARTON CHAPPLE.

DURING the course of a large amount of experimental work, receiver design, construction and tests, I have been struck by the multitudinous uses of spring clips, such as the little group illustrated in the accompanying photograph. Perhaps it has never occurred to the reader where they may be employed, and under these circumstances a few tips will not be out of place. Personally, I have a preference for the so-called "crocodile" pattern, with long jaws and a number of teeth, a screw terminal being provided at one end to enable wire connections to be made without trouble, but all the good makes are capable of giving firm and rigid connections and thus ensure an efficient electrical connection.

Temporary Hook-ups.

How often have we seen pieces of wire twisted round different positions in a wireless receiver when making tests, producing troublesome effects which are attributed to all sorts of causes but the right one, i.e. the inefficient temporary hook-up? Terminate these loose wire ends in spring clips, and once clipped into position they may be forgotten, for they can be relied upon always to do their task and cause no trouble.

With a few flexible connecting leads and spring clips circuits can be shorted out, wiring altered speedily and alternative connections tried out with ease, this being applicable specially before the final construction of a receiver is decided upon

when no fixed lay-out and wiring plan is being followed. Rapid alterations can be made and thus facilitate the making of comparative results, true comparisons only being possible in many cases if the operation eliminates to the fullest extent the time element.

Instead of twisting together the strands of two pieces of wire in order to make a junction, a process which frequently breaks off a number of the thin wires, grip the ends between the teeth and jaws of a spring clip. Several connections to one point may be made simply by the



A representative collection of spring clips of various sizes and types.

use of clips, this being safer than screwing a number of wires under a terminal head. To help connection and disconnection, the aerial lead-in and earth lead can each be provided with a clip at the end, and where a special earth device is not included in the system it is only necessary then to clip these two wires together when the set is not in use and the aerial is efficiently earthed.

Short-Wave Work.

For tapping on to coil turns the spring clip is really the only satisfactory method, unless each tapping is brought out to special sockets or terminals. On short-wave work, however, and using robust bare coils, the clip enables the position of the tapping to be very finely adjusted, and as readers know, in this class of reception the delicacy of the coil tapping position is a feature to which attention must be paid.

In addition, in many of the present-day ordinary receiving sets alternative connections are provided on the aerial side to meet the conditions imposed by the different types of aerials, and the spring clip dodge is then well worth while.

The writer also suggested in a recent article how rubber covers can be placed over the clips to give protection against undesired metallic contacts and any shocks which are liable to occur when circuits are broken, but enough has been said to emphasise the extreme utility of good spring clips.

WHEN the average radio enthusiast sallies forth with the intention of buying a valve, he can usually be relied upon to assure himself of the fact that it is suitably provided with a filament, a grid, and a plate, all efficiently connected to small pins in the base; but it frequently happens, that the amateur does not know all the pitfalls of component-buying, and it is hoped that the following hints may prevent a certain amount of acrimonious feeling on the part of "hams" who might be "done."

A Variable Condenser "Snag."

Let us consider, first of all, the variable condenser, as this is a component necessary to most receivers. Now, nearly everybody of any radio pretensions at all has been warned to "see that the vanes don't touch," but I wonder how many would trouble to examine the length of the fixing screw in a "one-hole fixing" component. The necessity for this examination was brought home to me in a rather unfortunate manner, as I bought a condenser made by a very well-known firm, and discovered, when I came to incorporate it in a set, that it could not be fixed to a 1/4-in. panel, owing to the shortness of its fixing screw.

Now let us consider the rheostat. With regard to this component, I would utter a very solemn warning—**BEWARE OF THE**

LOOK TWICE.

Words of Warning.
From A CORRESPONDENT.

CARBON COMPRESSION TYPE. It is true that they take up only about one square inch of panel room: it is true that they would almost enable you to work your D.E.'s off the mains; it is true that their terminals are easily accessible for soldering; but it is equally true that they are very much given to packing. Indeed, there are only two makes with which I have come into contact which did not suffer from this fault, and both of these acted on the "carbon disc" principle.

As rheostats cause one to think of valves, let us consider for a moment the valve holder.

In the panel-mounting type you cannot go far wrong, but it is when one comes to the baseboard-mounting holders that one "comes up against it." In the first place, if you are going to buy one, let it be a good instrument. That is to say, do not purchase a ring of ebonite (?), surmounted by four nickel plugs, the whole being referred to by the salesman, in a moment of enthusiasm, as a valve holder. If the pins do not become

loose during the soldering operations, they will come unscrewed afterwards. No! It is my opinion, founded on some years of experience, that one cannot pay too much for a valve holder. It is worth it in the end.

Coil-holder Pointers.

The instrument which, in my opinion, is most subject to faults of construction is the coil holder. When buying one of these components, the first thing to examine is the method of making connections to it. If these consist of two screws on each coil holder, see that the screws are long enough and can be reached by a screwdriver. If the contact screws are on the frame of the holder, see that they are efficiently connected to the plugs and sockets. Above all, see that the moving block retains its smoothness of action all the way round. The sides of these holders have been known to warp owing to faulty ebonite. As a last point, see that the arrangements for fixing the component to the baseboard are efficient, and that the control handles are straight and move without backlash.

Although the above hints by no means cover the whole field of radio buying, it is possible that they may be of some use in warning the inexperienced buyer of the more unusual faults in radio components,

Hear the rousing music of massed bands

— with a
**LISSEN
BATTERY**
in your Set

You can almost hear the stamping feet of marching soldiers as martial music floods your room— you get the spirit of the massed band festival as you listen with a Radio set whose power is supplied by Lissen Batteries. You hear the delightful blending of all the many instruments because the pure D.C. current of the Lissen Battery is noiseless, abundant and always smooth flowing, providing power for your valves such as you never had before and can never get in any other way, because the new process and chemical combination known only to Lissen is embodied only in the Lissen New Process Battery.

Buy this fine Battery at one of 10,000 Radio dealers, and show plainly by the way you ask for it that you mean to have a Lissen and no other.

60 volt
(reads 60 v.)

7/11

100 volt
(reads 108 v.)

12/11

60 volt
(Super Power)

13/6



TECHNICAL NOTES.

By Dr. J. H. T. ROBERTS, F.Inst.P.

ATMOSPHERIC ELECTRICITY

BATTERY CONNECTORS—PICK-UP TROUBLES, ETC.

IT is only in comparatively recent years that the importance of atmospheric electricity has been fully recognised. As a result of recent researches, however, the electrical actions taking place in the atmosphere are now understood to a much greater extent and it is found that they have their influence not only upon the natural conditions, weather and so on, but also upon the transmission of radio waves and even (to a lesser extent) upon telephone and cable communication. The electrification in the atmosphere is due mainly to the electrified particles now universally known as "ions" which are of two kinds, positive and negative and which, by accumulating in large numbers of either kind, may create enormous electrostatic charges; these give rise to all manner of discharge effects, of which lightning is the most familiar.

Atmospheric Electricity.

An electrified cloud of large extent, or a region or stratum of electrification in the upper atmosphere, may have an important influence in reflecting or refracting wireless waves. As readers are well aware, there is considerable evidence to support the theory of a reflecting or refracting layer in the upper atmosphere, known as the "Heaviside layer." This Heaviside layer is believed to be one of the controlling factors of long-distance transmission, more especially when short waves are used.

Battery Connectors.

In connecting the various battery leads to the terminals of the set, apart from the fact that the arrangement often becomes very untidy, there is the ever-present danger of wrong connections or accidental short-circuits.

Many "combined connectors" have been produced at different times, to enable all the battery-leads to be put together into a "power cable" and to permit of connection to be set in only one possible way.

The new "Harlie" seven-way connector is such a device, and strikes me as being a particularly neat and workmanlike job. The socket of this connector is provided with seven soldering tags, which are numbered. This socket is fitted to the panel by cutting a hole in the panel $1\frac{1}{4}$ in. in diameter and is then held in position by an ebonite ring, which screws tightly against the back of the panel.

The plug is in the form of a cylindrical moulding, into which the seven leads are connected. By means of a projection in the socket and a channel in the plug, it is impossible to insert the plug wrongly into the socket. In addition to this important advantage this simple device does away with terminals, and the usual unsightly array of battery connections.

Aluminium-Wood Panels.

The advantage of an aluminium panel, apart from the beautiful appearance and finish to the set which can be obtained by

means of a properly prepared panel of this kind, is that it helps to screen the set from extraneous interference.

If the panel is to be entirely of aluminium, the metal must obviously be of sufficient thickness to give the necessary mechanical strength to carry any components which may be mounted upon it and to prevent bending or sagging.

If, however, the aluminium panel is mounted upon a panel of some other material, such as three-ply wood, the metal sheet may be made quite thin. It still serves the dual purpose of giving a finish to the set and screening the components and yet the amount of aluminium used is much smaller.

Messrs. M. E. Hampshire, of Sydenham Road, now make a panel of this kind which

YOU CAN HEAR 3LO

and other far-distant broadcasters in Australia and elsewhere on practically any size or type of valve set if you use

THE ANTIPODES ADAPTOR

This remarkable instrument is easy-to-build and easy-to-operate, and you may have the parts for it in your "junk box." You can attach it to your set without the slightest trouble and without modifying or rewiring it.

SEE NEXT WEEK'S "P.W."

for full details of this intriguing "station catcher."

NEWS FROM SAVOY HILL.**FROM OUR OWN CORRESPONDENTS.****INTERESTING SPORTS TALKS****HENRICK IBSEN'S ANNIVERSARY—SYLVICULTURE FOR SCOTLAND.****Interesting Sports Talks.**

THE prospects of the Oxford and Cambridge Boat Race, on which, as already stated, a running commentary is to be broadcast from a launch following the crews when the race takes place on Saturday, March 31st, will be outlined in a talk to be given by Mr. G. O. Nickalls on Saturday evening, March 17th. Mr. Nickalls was one of the commentators on last year's race, and, as he has consented to perform these duties again this year, this preliminary chat on an event which holds a unique place for popularity, not only in England but throughout the Empire, is certain to be of particular interest. Another talk which should be interesting is that on Friday, March 16th, by Miss Eleanor E. Helme,

consists of a sheet of three-ply wood, to one face of which is secured a thin sheet of aluminium with an ordinary finish. These panels are available in the usual sizes and, in any case, can be cut in the usual way; in cutting, however, certain simple precautions are necessary to avoid damaging the thin aluminium sheet, or separating it from its ply-wood backing.

Voltmeter or Hydrometer ?

I might remark, as I have said previously in these "Notes," that although in certain circumstances the open-circuit voltage (or even, for that matter, the closed-circuit voltage) given by an accumulator may not be a very reliable indication of its condition, the hydrometer test of the acid is, in a large percentage of cases, an even more unreliable test.

We have not to consider the relative merits of these two tests if applied under laboratory conditions or by a skilled operator, but the relative merits as applied under ordinary operating conditions.

Unless the specific gravity of the acid is very carefully adjusted from time to time when the battery is fully-charged (which, unfortunately, is a precaution honoured, by most users, more in the breach than the observance) the hydrometer test may be altogether misleading. For the voltmeter test it can at least be said that where the accumulator is not half-empty of electrolyte and provided the specific gravity of the electrolyte is more or less within reasonable limits and that the plates have not been ill-treated out of recognition, the voltage test is not liable to lead you very far wrong.

Pick-up Troubles.

Referring to electric gramophone pick-ups which I mentioned recently, I do not know whether any of you who have used electrical gramophone pick-ups made abroad have noticed that in some cases they are not adapted to receive the ordinary type of gramophone needle which we use in this country. I have been using a pick-up

(Continued on page 124.)

who is to give an eye-witness account of the London Ladies' Golf Foursomes, which are being played on the three previous days.

Henrik Ibsen's Anniversary.

March 20th is the anniversary of the birth of the famous Norwegian dramatist, Henrik Ibsen, to mark which the London and Daventry Stations will give a performance of "The Master Builder," which many people consider to be his finest play. The work will also be broadcast from 5 G B on the previous night.

Belfast is also paying its tribute to the memory of the dramatist by giving a radio version of "Peer Gynt," in which Irene

(Continued on page 120.)

WEAR HEADPHONES WHILE THE KIDDIES ROMP!

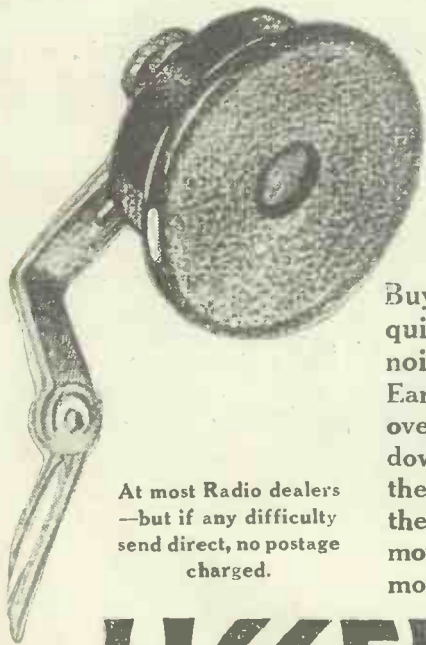
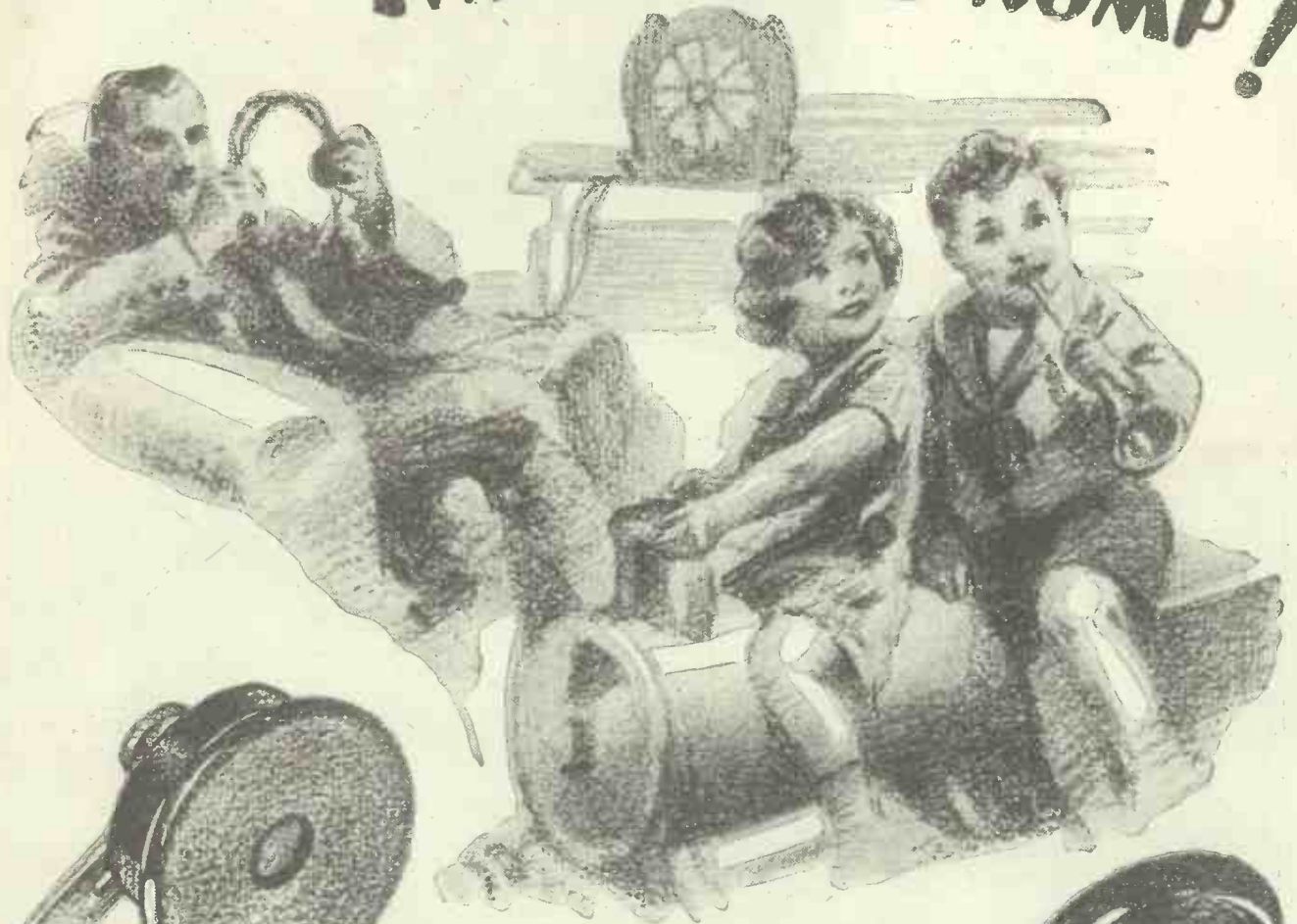

At most Radio dealers
—but if any difficulty
send direct, no postage
charged.

Buy a pair of Lissen Headphones and have quiet enjoyment of Radio despite all the noise and frolic of the children. Earpieces of the Lissen Phones fit comfortably over both ears. The cords hang always straight down, and no matter how the head may be turned they never twist or tangle. They are so light they may be worn for hours, and one single movement will always hold them without moving, and exactly where you want them.



LISSEN HEADPHONES

LISSEN LIMITED

(Managing Director: Thos. N. Cole)

8-16, FRIARS LANE, RICHMOND, SURREY

8'6

Pleasing
Player's

TOM NEWMAN



Player's
Please



RECEIVING MELBOURNE.

The Editor, POPULAR WIRELESS.
Dear Sir.—Your recent article on short-wave work made me get at my set and re-rig it up.

This is the ordinary short-wave circuit, three valves for strength, but mostly two for telephony. It is surprising how well 3 L O, the Melbourne Station, is received. On a recent Sunday night from 6.30 to 8.30 one could hear perfectly plain almost every word the announcer said.

The programme was as follows: News, mostly about Capt. Hinkler, what he had done, what he was doing, and what they proposed for him to do. In short, he must there be a national hero. This news was given not all at once but in between items, again and again.

Then music, some songs from "Carmen," and plenty of talk, and they did not forget to hand out plenty of bouquets to themselves on the quality of production, which they were justified in doing, to my opinion.

The wave-length is 32 metres, and it was announced that they would be doing this every Monday morning corresponding to our time 6.30 to 8.30 Sunday nights.

When closing down, he mentioned that they would be carrying on with the early morning broadcast on the usual wave-length, I think he said 7.30, and then with a good-night—the night for our benefit, and a "Cheerio" a very interesting time was brought to a close.

I find that by attaching some bare copper wire to the tuning-in wrist and then earthing this one can handle the tuning condenser without any hand-capacity.

Yours sincerely,
W. H. B.

Pembroke Dock.

DISTORTIONLESS RECEPTION.

The Editor, POPULAR WIRELESS.
Dear Sir.—If J. C., of Muswell Hill, will try a "power" (or, much better, a "super-power") valve in his detector socket he will find that the "parallel anode" rectifier is not quite so insensitive as he supposes.

I believe in this and allied circuits valve characteristics get somewhat inverted and the very low impedance type gives the "high mu" results.

Wishing you every success.
Yours truly,
G. M. P.

Woking, Surrey.

"SYDNEY" TWO AGAIN.

The Editor, POPULAR WIRELESS.
Dear Sirs.—While trying my luck on the dials of a short-wave set, viz., the "Sydney" Two, a product of POPULAR WIRELESS, on Sunday, January 19th, about 6.45 p.m., I came across a peculiar carrier-wave on about 32 metres, not unlike a high-pitched Morse transmission.

On resolving same, the words, "testing on" became audible. After this, an orchestral item was rendered, followed by the words, "Melbourne Time. This is 3 L O, Melbourne, Australia."

In writing this report, I thank you heartily for such a "wonder" set, and remain,
Yours truly,
A. E. B.

Wakefield, Yorkshire.

THE "SUPER-SCREEN" THREE.

The Editor, POPULAR WIRELESS.
Dear Sir.—I have constructed your "Super-Screen" Three, and it is the best three-valve circuit that I have ever tried.

I omitted the low-frequency stage, and coupled the set to the Note Magniplex given in the May issue of "Wireless Constructor," using one valve only. I

AN AMATEUR had wound a coil on a paxolin tube suitable for covering the ordinary broadcast band of wave-lengths, tested it on the local station, and found these signals tuned in at about half way round on the condenser dial of 100 degrees. He then added turns on either side of this coil so that a larger coil was obtained, and with the three coils in series the resultant inductance was just suitable for tuning the higher waves, Daventry being logged on test at about 70 degrees.

Tuning Entirely Wrong.

By referring to Fig. 1A it will be seen that the scheme was to cut out the top and bottom portions of the coil with a double-pole single-throw switch when tuning 250 to 550 metres, and normally the arrangement, quite a common one, should have proved satisfactory when wired up and incorporated in the set.

On test, however, while the long wave was quite O.K., on bringing the switch into commission the tuning range on the ordinary

CORRESPONDENCE.

RECEIVING MELBOURNE

A SIMPLE FUSE HOLDER—THE "UNIDYNE."

Letters from readers discussing interesting and topical wireless events, or recording unusual experiences, are always welcomed; but it must be clearly understood that the publication of such does in no way indicate that we associate ourselves with the views expressed by our correspondents, and we cannot accept any responsibility for information given.—EDITOR.

have already logged 60 stations on the loud speaker. These include Leningrad, Moscow, Warsaw, W G Y, and W B Z, and by plugging in short-wave coils I have got 2 X A F, 2 X A D—both on loud speaker—and K D K A, 26 and 62 metres, on 'phones. The set will oscillate readily down to 14 metres. Reaction is very smooth and, except for slight hand capacity, the set is ideal for short-wave work. I congratulate you on turning out such a good circuit.

I am yours truly,
J. D. ACLAND.

Somerscot.

A SIMPLE FUSE HOLDER

Dear Sir.—Now that the use of flash-lamp bulbs are being introduced as fuses in wireless sets, and as we may want to insert one in a set just for experiment, I give below a small holder which is simplicity itself to make and is very useful. All that is needed for its construction is a length of square section 16 S.W.G. thin wire and two screws.

The spiral is wound by holding the lamp in one hand and winding the wire in the groove.

I remain yours,
L. GINELLO.

Newport, Mon.

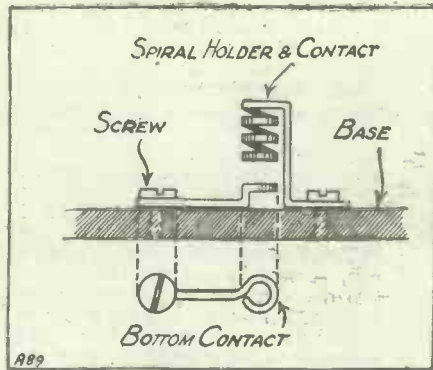

A COIL SWITCHING ERROR.

By H. J. B. C.

waves appeared to be entirely wrong, for signals from the local station only just now began to come through with the condenser

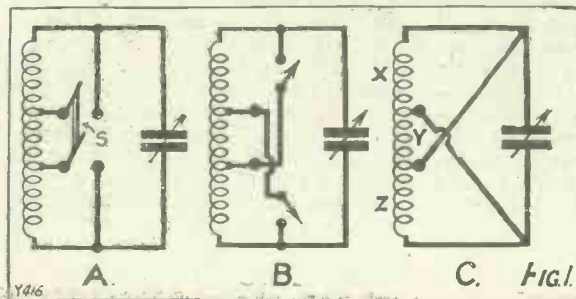

THE "PROGRESSIVE" ONE.

The Editor, POPULAR WIRELESS.
Sir,—H. H. P. (Penge, London, S.E.20) appears to be having trouble with his "Progressive" One. May I through your valuable columns give an account of my experiences with a similar set? I have only had it hooked up ten days, but am more than delighted with it. Stations received to date, verified by friends and "World Radio," are: Newcastle (local), Daventry (5 G B), Manchester, Langenberg, Aberdeen, Hamburg, London 2 L O (direct), Barcelona, Madrid, Glasgow, Leipzig, Frankfurt, Edinburgh, Oslo, Lyons, Radio Toulouse, and there are several still to verify. The British stations were not received, but were putting on local programmes. 5 G B comes in as clear as a bell with hardly any fading, and on the bottom tapping is practically as loud as the local.

And all this on one valve, a Mullard P.M.1 H.F., and only two joints soldered. I used a "Becol" low-loss former for coil, and an ebonite panel. I am proceeding next with a long-wave coil and then on to the high-frequency stage. So take heart, Penge, cut out that local, and you have what I consider is one of the finest circuits of the present moment. What it will do when it gets the other stages added—well, you'll hear all about it. My aerial is slung along the top of the roof between two chimneys, and I should say roughly is about 90 ft.

Congratulations to Mr. Dowding on producing such an A1 circuit and the best of luck to "P.W." They certainly produce the goods.

Yours, etc.,
W. S.

Darlington.

ANOTHER WORD WANTED?

The Editor, POPULAR WIRELESS.
Dear Sir.—I should like to enter a word of protest against the use of that wretched word "Eliminator" in reference to the apparatus which enables electric current from the mains to be used for the working of our wireless sets.

It was a long time before I grasped what the word really meant, as in itself it affords no clue. Was a clock ever called a sundial eliminator, or a motor-car a leg eliminator?

Perhaps your readers could suggest a more apt word to fit the occasion; at any rate, don't you agree that the term "eliminator" is unscientific and unworthy of the minds which are unfolding the wonders of wireless?

Yours faithfully,
BM/CPPH.

London, W.C.1.

THE "UNIDYNE."

The Editor, POPULAR WIRELESS.
Dear Sir,—I was glad to see, in your issue of February 11th, a letter from your correspondent H. O. L. (Bristol). I have felt for a long time, that the "Unidyne" is being left too much in the background. For the last three years, I have spent at least three hours every night with it, and have logged just on 100 stations. Many coming in as good or better than 2 L O at 50 miles. Of four attempts at Americans this winter, I have been successful on three occasions. Last week W G Y K G O, and W J L came in very well. I have tried to get down to the short waves, but without success.

Now I wonder if Mr. Dowding can give us a short-wave Unidyne? Also, may valve manufacturers soon give us an up-to-date valve for it?

Faithfully yours,
E. C. S.

Faversham, Kent.

plates wholly in mesh—i.e. at 100 degrees.

The trouble was soon brought to light, and an examination of Fig. 1B will show what had happened. The switches had been wired incorrectly, a simple trap for anyone to fall into unless the leads had been carefully labelled when brought out to terminals at the top of the former. Two sections of the coil had been shorted out by each switch, and a first glance would seem to show that this had resulted in cutting the coil completely out of circuit. Fig. 1C, however, makes the case a little clearer.

It was only the work of a few moments to rectify matters, but it serves to emphasise the importance of properly marking any tappings made on a large coil when the leads to these points are passed through the insulating tube and joined to terminals provided on a suitable mounting base.

LIFTING THE BAN.

OUR £1,000 CHALLENGE TO MR. BAIRD.

By THE EDITOR.

AT last the ban on broadcasting of controversial subjects is, within certain limitations, lifted. This welcome decision was made a few days ago by Mr. Baldwin in the House of Commons. Undoubtedly pressure of public opinion has had its effect upon the Government. Mr. Baldwin said the Government had reviewed the decision taken at the time of the constitution of the B.B.C. under which the Corporation had been prohibited from broadcasting:

1. An expression of opinion by the Corporation on matters of public policy; and
2. Statements involving matters of political, religious or industrial controversy.

Free Speech.

The Government had therefore decided that the first prohibition on the issue of editorial pronouncements must remain, but the second prohibition may be withdrawn.

"The Corporation," said Mr. Baldwin, "has been informed that the Government expect them to use the discretionary power thus experimentally entrusted to them in strict accordance with the spirit of the Crawford Committee's report, and it is their responsibility to see that this is done."

As a result of the Prime Minister's announcement, the B.B.C. stated that the removal of the restrictions will not involve any drastic changes in programmes. New material will be developed experimentally, and particular attention will be paid to safeguarding the policy of impartiality and also to the choice of subjects. But it is anticipated that broadcast debates should be more interesting now that these restrictive pledges will no longer have to be given by speakers who allow their debates to be broadcast.

As our readers know, there has been, during the last few months, a series of *débâcles* in connection with broadcast debates all due to the excessive restrictions which the B.B.C. have had to place upon broadcasters. More than one first-class debate has been cancelled because it has been necessary for the B.B.C. to ask debaters to guarantee that nothing controversial will creep into the debate. And, very naturally, this has roused the ire, to say nothing of amazing the artistic sensibilities, of many well-known people who have been invited to broadcast.

Mr. Shaw, Mr. Philip Guedalla, and many other well-known people have expressed their opinions very forcibly on this controversy ban; but it is a sign of the times that the Government have at last realised—and perhaps Mr. Winston Churchill's recent candid opinion has had a lot to do with this decision—that freedom of speech within reasonable limits is essential if the B.B.C. is to progress.

According to the newspapers, there seems to be a very general view that, when the next General Election comes along, broadcasting will play an important part,

and although the Prime Minister's statement indicates great caution and that restrictions will still be enforced in many cases, it is at any rate a move in the right direction towards that freedom which is so essential to the progress of broadcasting.

In last week's POPULAR WIRELESS we made known the details of a £1,000 challenge to Mr. J. L. Baird, the young Scotsman whose pioneer research work in television is well known to our readers. Perhaps we should have pointed out in last week's issue, in view of the fact that we gave Mr. Baird seven days in which for-

OUR £1,000 TELEVISION CHALLENGE.

As we go to press we have not yet received an official reply from Mr. Baird in connection with the thousand pound wireless television challenge which we published in last week's "Popular Wireless," but in reply to a question in connection with the challenge, an official of the Baird Company told a "Daily Express" representative: "This challenge is simply a continuation of mischievous attacks made on Mr. Baird. There is no need to answer criticism of that kind. Mr. Baird is above it."

We fail to understand why Mr. Baird seems to think that the impartial scientific criticisms we have published are mischievous. The public must be left to judge the value of this statement.

According to the "Daily Telegraph," the Secretary of the Baird Company said that Mr. Baird properly treated the challenge as nothing whatever to do with him, because he has "turned himself into a Company," which controls the rights of the patents and the policy of dealing with them in every way. And according to the "Daily Sketch" Mr. Baird said, when asked about our challenge:

"I shall probably ignore it."

However, we have not had time to hear from Mr. Baird officially, but we hope to be able to announce in next week's "Popular Wireless" that he has decided to accept our challenge. Such an acceptance would be a matter of great public interest.

mally to accept our challenge, that, owing to publication dates and to technical considerations in connection with printing POPULAR WIRELESS, it would not be possible to publish in this issue any statement regarding Mr. Baird's official acceptance, or otherwise, of our challenge.

This issue will be in the hands of the printers before the expiration of the seven days we allowed Mr. Baird in connection with the £1,000 challenge, but we hope that it will be possible next week to state whether we have received a reply from Mr. Baird and whether he intends to take up our challenge or not.

It will be remembered that Dr. Alexander arranged a big public television demonstration. This experiment cost thousands of pounds, and it was necessary to employ nearly a thousand people in connection with the experiment. A special report and technical paper of this experiment was recently published by the Bell Telephone Laboratories. In one part of the paper is the following paragraph:

"To proceed further with the discussion of multi-channel radio transmission is beyond the scope of the present paper. Whatever the system employed, however, one conclusion illustrated by these experiments may be pointed to with confidence: television by radio requires a discreet and fairly wide frequency band. Hence, the frequently predicted introduction of television as an adjunct to radio broadcasting without extensive changes in existing channel arrangements is extremely unlikely."

We wish it were possible to devote sufficient space in POPULAR WIRELESS to a full description of the technical details of the recent television experiment carried out by the Bell Telephone Laboratories in America. The Americans' passion for detail and spectacular results was given ample scope in this experiment, and although, admittedly, the experiment was very successful, when considered in the light of a practical basis for television in the home, the leading experts in connection with the experiment have had to admit that the expense and the technical difficulties are such that there is no hope at the time of television in the home becoming a practical possibility.

It may sound all very pessimistic to those readers who like persistent optimism in connection with radio developments, but we feel that in the long run we shall be serving our readers more faithfully and more sincerely if we do not, so to speak, butter the bread too thick in connection with television.

In the Melting Pot.

To raise foolish hopes in connection with television is unfair, and, on the other hand, to be unduly pessimistic is just as unfair. It has been suggested that nothing should stand in the way of the amateur who wishes to experiment with home television apparatus, and we quite agree. But, on the other hand, it must be pointed out that a home television set is no good unless regular television transmissions can be counted on.

So far, we are not aware of any official permission having been given of the inauguration of public television transmissions. We understand that no licence has been granted by the Post Office for television transmissions, and we further understand that the B.B.C. have no intention of conducting or participating in television transmissions.

Directly any such announcement is officially made, and we feel certain that our readers who wish to experiment in television will be able to count on transmissions, we shall be the first to give such a service every possible encouragement and to suggest various ways and means to our readers by which they may enjoy experimentally such transmissions.

But at the moment everything is in the melting-pot and, in any case, we again reiterate that the non-technical amateur should not at this juncture dabble in television home receiving outfits which require six or seven hundred volts high-tension supply until he is more *au fait* with the exact state of affairs in connection with television to-day.

"WHAT is the good of a long-range set, anyway? Hardly any of the distant stations are worth listening to." At one time such a remark would have been rank heresy, clearly showing the speaker to be lost to the higher side of radio, but times are changing, and nowadays something like it may be heard from quite experienced amateurs.

Not so long ago a man who built a simple short-range set and just listened to his local station was regarded as a very poor creature and treated with scant ceremony by the real highbrows, with their wondrous "DX" receivers covered with knobs and dials. Now, on the contrary, with improved loud speakers, better knowledge of distortionless circuits, better and larger valves, H.T. from the mains, and so on, we are finding that the reproduction of the local station at the highest possible quality is a very high branch of the art indeed, and well worthy of the attention of the most expert



This is the set you have been looking for. Without the bother of coil-changing you can pick up all the programmes that are musically worth while, and the quality of reproduction is really excellent.

By the TECHNICAL RESEARCH DEPARTMENT.

a strong local transmission! Station chasing is certainly a fascinating amusement, and it is well worth while to build sets capable of indulging one's taste for it, but this has not very much to do with radio as a source of entertainment consisting of almost perfectly reproduced music. This last is quite a separate, and, perhaps, even more absorbing branch of the art, and here we are concerned with a relatively small number of stations. Actually, it probably

comes down to a question of the local station, 5 G B, 5 X X, and a few of the more powerful Continental stations, although even these last cannot be expected to come quite up to the standard of the first three mentioned.

This, the reader will realise, is a frank statement of the present state of affairs, and represents the views of probably a very large proportion of the more experienced amateurs. It is given here because it is felt that if we all realised these things clearly there would be fewer disappointments, and a better chance of everyone getting the maximum of pleasure out of what is, after all, one of the finest hobbies of the century.

On Long Waves.

Now if we once realise that the number of stations really worth listening to for any length of time is decidedly limited, it obviously becomes very important to arrange our sets so that all of these specially good stations shall be easily picked up. This means in practice that we must take particular care to see that they shall tune easily and quickly over the wave-lengths on which these stations work, and it is to be noted that the effect of this point is to

fading, interference and atmospherics so spoil all but a relatively small number of stations that regarded strictly as entertainment they are rarely worth listening to for any length of time. Sometimes one still hears a die-hard enthusiast maintain a contrary view, but the reason is almost always that he has not kept up with progress, and does not know what very fine results can now be obtained on

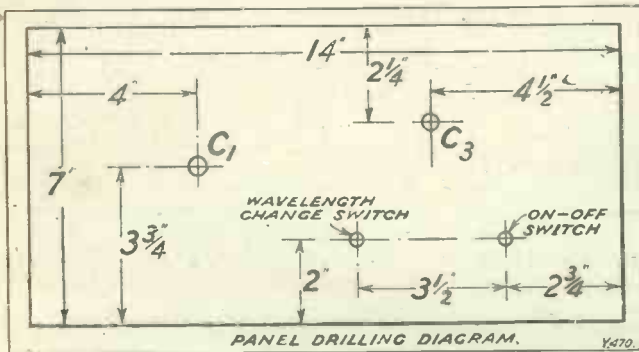

among us, and there is, in consequence, even a tendency to go to the other extreme and despise the "station-hunter."

What we need at the present time, it seems to me, is a little more perspective in our view of these things. There is unquestionably a real fascination in long-distance reception, and it cannot be denied that it is interesting to pick up the programme of some far-distant station and listen awhile, even though that programme may be far inferior as regards quality, freedom from interruption, and so on, to the transmission of the local station.

Thrills of Distance.

This is something quite distinct from the entertainment point of view, and relates rather to the genuine thrill of raking in some very distant station, a thrill which is generally greater the smaller the set, although that again means poorer quality almost inevitably (to bring it in with the best possible quality obviously means a big and powerful set using little or no reaction).

Experience soon teaches us that it is useless to build sets in the hope of being able to bring in large numbers of foreigners at such perfect strength and quality as to provide real alternative programmes. It simply cannot be done with any set, because

direct much greater attention to the longer wave-band.

(Continued on next page.)

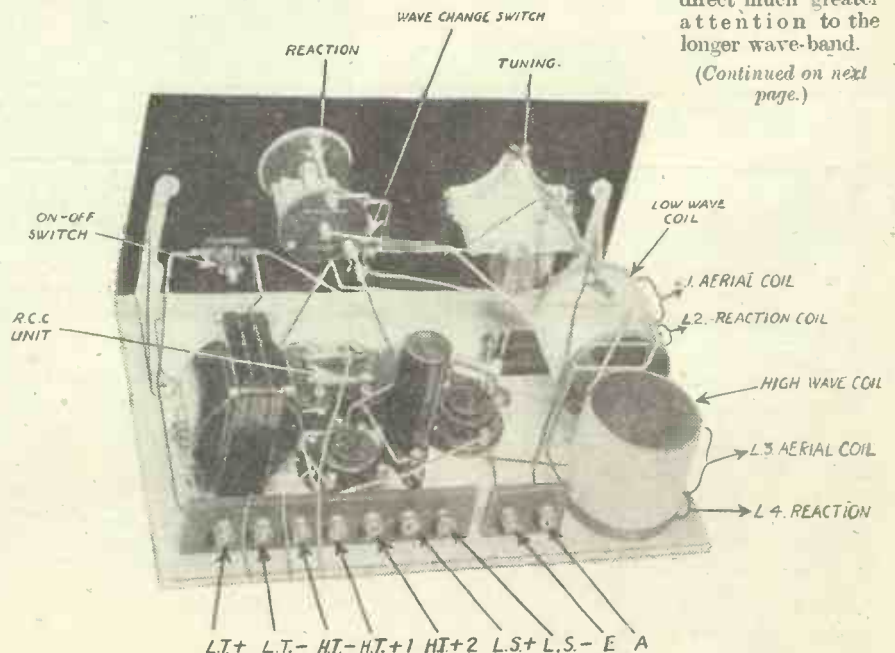

All the principal features of the set are marked in this illustration of the back of the panel of "The All-Programme" Three.



The **NEW WONDER
TRANSFORMER
WITH THE SILVER
WINDING AND THE
MULLARD
PERMACORE**

PRICE
25/-

THE new Mullard "Permacore" Transformer is absolutely revolutionary in design and construction. No transformer so compact and at the same time so efficient has ever been produced. It is a master product giving better results than the best of the big ones. The reasons are these:

- (1) The iron in the Mullard "Permacore" is a specially treated and scientifically prepared material, carefully handled in manufacture to preserve its high permeability.
- (2) This high permeability allows a high flux density to be used without any possibility of saturation in an iron circuit of exceedingly small dimensions.

- (3) The windings of the Mullard Transformer have been so selected that no resonant peak occurs at about 8,000—10,000 cycles as is usually the case. This eliminates all shrillness.

- (4) The primary is wound with silver, the secondary with nickel. Silver for the primary has the advantage of good conductivity and no deterioration. Nickel for the secondary has the advantage of high resistance and magnetic properties.

- (5) The amplification of the Mullard Transformer is high and uniform at all frequencies from 250 cycles upwards, below this limit, even at 50 cycles, giving a large percentage of its full amplification.

As pure in
reproduction as
the silver of its
winding

Mullard
MASTER · RADIO

No shrillness.
Resonant peaks
eliminated.

SELFRIDGE'S

England's Radio Headquarters

No development in the Radio business has proved of greater benefit or brought so much pleasure to the Radio Public than Selfridge's extension of their famous

"NO DEPOSIT" TERMS to WIRELESS COMPONENTS

Any combination of components can be supplied on this system, and the following are examples, delivery being made after the first small payment.

Sets of components, all exactly as specified by the designers, are supplied for the

CASH PRICE

"Marconi Screened Grid £ s. d.
T.1." 4-valve Receiver **11-6-1**

Or by 12 monthly payments of 19/9.

"Mullard Master Three" - **7-5-9**

Or by 12 monthly payments of 12/9.

"Cossor Melody Maker" - **6-15-8**

Or by 12 monthly payments of 11/10.

All the above include Valves.

"Britain's Favourite Two" **3-14-6**

Or by 6 monthly payments of 13/-.

"Britain's Favourite Three" **4-16-7**

Or by 6 monthly payments of 17/-.

SPECIAL OFFER

"Polar" Junior Condensers in Black Japan cases. Capacities .0005, .0003, and .001 mfd. only.

PRICE each **1/6**

Postage 4d. extra.

SELFRIDGE & CO., LTD., OXFORD STREET, LONDON.
Phone: MAYFAIR 1234.



Your house isn't effectively equipped with wireless unless you can *listen-in and switch on or off at will in any room.* A Lotus Remote Control outfit provides you with simultaneous reception and independent control in every room—you merely push in or pull out the plug at your elbow. Any number of rooms can listen-in at once without interference, and as the last plug withdrawn cuts off the filament circuit, you cannot leave your set on.

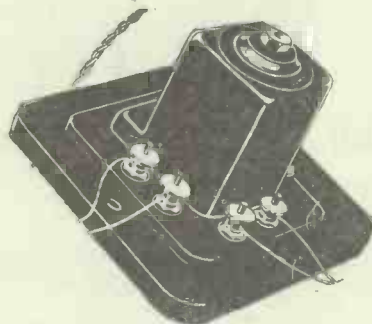

FREE

Send a postcard to the address below and we will send you FREE Blue-prints showing how YOU can wire two rooms in half an hour with Lotus Remote Control.

Your Set—any Set can use this Remote Control.

No matter what sort of set you use, there is a Remote Control to increase convenience.

If your set uses L.T. Accumulator and H.T. Battery, an outfit sufficient to wire two rooms, including Lotus Relay, 2 Filament Control Wall Jacks, 2 Jack Plugs and 21 yds. special 4-strand wire, costs **30/-**

If your set uses L.T. Accumulator and H.T. Eliminator, outfit for two rooms **45/-**

With an all-from-the-Mains set, it **47/6** costs . . .

In each case, each additional room, 7/6 extra.

LOTUS REMOTE CONTROLS

Made by the Makers of the Lotus Buoyancy Valve Holder, Lotus Vernier Coil Holder, Lotus Jacks, Switches and Plugs.

GARNETT, WHITELEY & Co., Ltd.,
Broadgreen Road, Liverpool

THE "ALL-PROGRAMME" THREE.

(Continued from page 106)

"All-Programme" Three are rather surprising, and you will find that all those stations capable of giving anything like a real programme are well within reach on anything like an efficient aerial. In addition,

by the skilful use of the controls, it is not difficult to bring in a really good string of the weaker distant transmissions, but here the operator must be warned that he ought to be careful how he sets about it, lest he makes an intolerable nuisance of himself to his neighbours by oscillating.

Always make sure of this point: When you have got a station tuned in, try varying the tuning adjustment just a shade either way. If you hear a suspicion of a squeal or howl you are oscillating, and should at once reduce the reaction condenser setting

until the transmission is properly cleared. This is not merely out of consideration for the neighbours, although that should really be a good enough motive, but because if so much reaction is used quality of reproduction is bound to suffer.

The part of the circuit following the detector is perfectly straightforward, consisting of the now almost standard arrangement of one resistance capacity L.F. stage, and one transformer-coupled stage.

(To be continued in our next issue.)

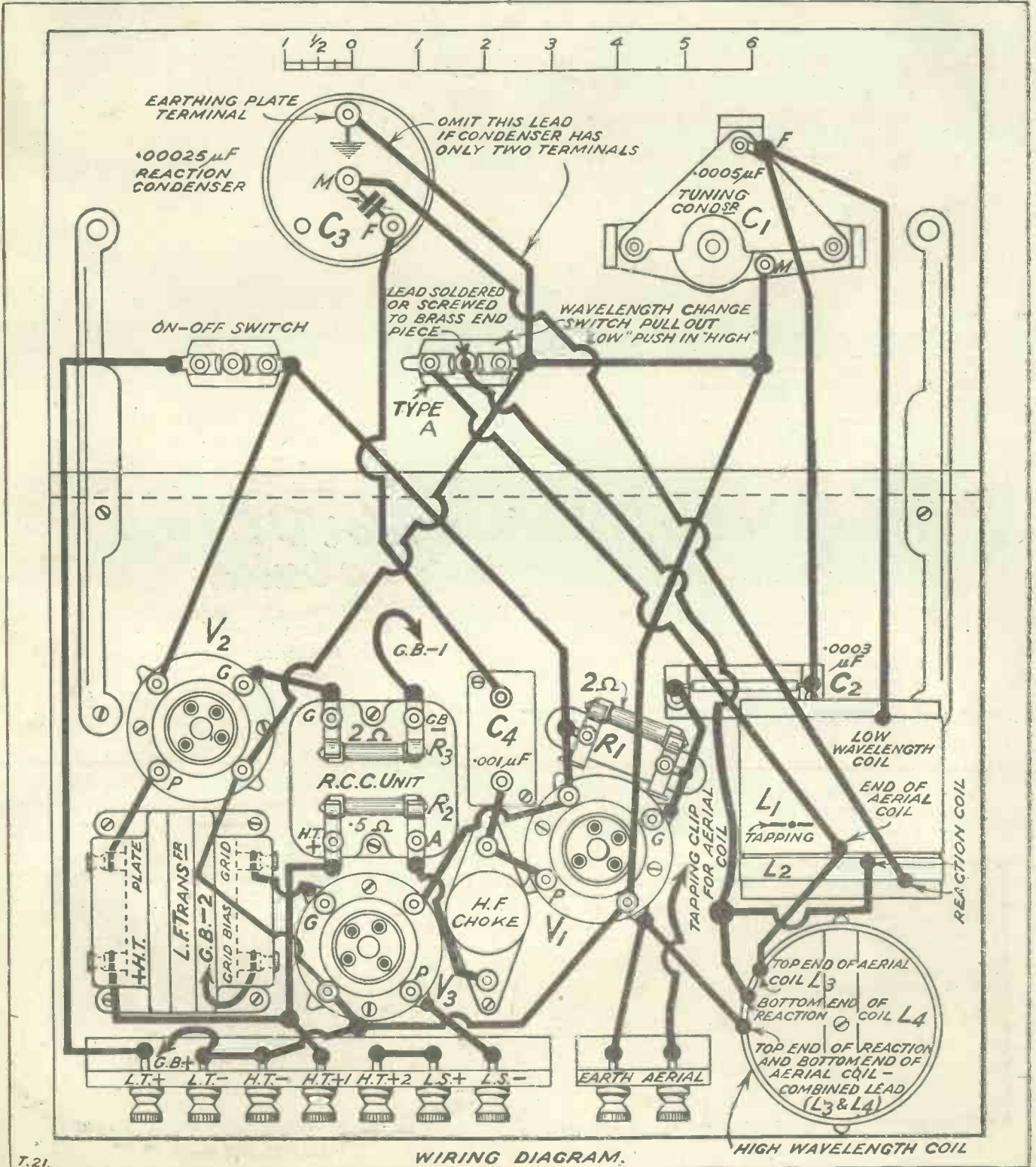

WIRING DIAGRAM.



APPARATUS TESTED

ORMOND JACKS—A BATTERY SWITCH—ALUMINIUM PANELS—THE "VIVAVOX" GRAMOPHONE PICK-UP.

Traders and manufacturers are invited to submit wireless sets and components to the "P.W." Technical Department for test. All tests are carried out with strict impartiality in the "P.W." testing-room, under the supervision of the Technical Editor, and the general reader is asked to note that this weekly article is also intended to provide a reliable and unbiased guide as to what to buy and what to avoid.—EDITOR.

ORMOND JACKS.

THE Ormond Engineering Co., Ltd., recently sent us a range of their new radio jacks. The range is very comprehensive and includes practically all the well-known varieties. Their designs are straightforward but have novel features. For instance, each has its soldering tags pierced and bent in such a manner that very solid soldered connections can be made. The contact points are widely separated and

make sound connections. The construction is solid.

The Ormond plug slides snugly into any of the jacks, and is in itself a distinctive and solid component. A large insulating cap can be unscrewed to reveal two screw terminals to which the flex leads can be attached. The eliminating of the necessity of fiddling about with small screws and so on in the connection of such a lead will commend itself to constructors who have

had experience of some makes of plugs and jacks.

Plugs and jacks make it very simple to carry out moderately complicated switching operations. Stages of amplification can be cut out in a receiver merely by removing the loud-speaker plug from one socket and inserting it in another. But unless the plugs and jacks are of sound design and good make they are liable to cause trouble. However, the constructor need have no hesitation in employing any of the new Ormond jacks, for they appear to us to be both efficient and robust.

A BATTERY SWITCH.

Messrs. Garnett, Whiteley & Co., Ltd., of Liverpool, have just placed on the market a battery switch which retails at 1s. 6d. It is of the conventional panel-mounting variety, and operates on the push-pull principle.

The movement is smooth, but crisply definite, and the contacts are large and efficient. Neat terminals are provided for connecting purposes. It is a soundly constructed component, and we have employed it in a receiver and found it in every way satisfactory.

ALUMINIUM PANELS.

S. M. Boyd, 17, Albert Street, London, N.W.1, is making a speciality of aluminium panels for radio receivers figured in various colours and patterns. His work is distinctive and original, and we found many of the samples submitted to us attractive in appearance. These range from a matt black carried through with a cellulose preparation of a hard and durable character to elaborate

(Continued on page 123.)

Heavy Duty H.T. Eliminator for D.C. Mains (200-240 volts) — cost to build £5

Incorporates these Burndept Components:—

No.	Description	£	s.	d.
1210	Filter Unit	4	0	0
1179	Heavy Duty Resistor, 3,500 ohms	7	6	
1185	Heavy Duty Resistor, 12,500 ohms	7	6	
718	Resistor Holders	1	0	
1148	Fixed Resistor, 600 ohms (or No. 1146, 400 ohms)	3	6	
Total		4	19	6
1175	Heavy Duty Resistor, 1,350 ohms (only for 240-volt mains)	6	0	
1212	40 Hy. Choke Coil (required only if "hum" is heard)	1	10	0

Full details of this circuit are given in the Burndept booklet on Battery Eliminators & Chargers

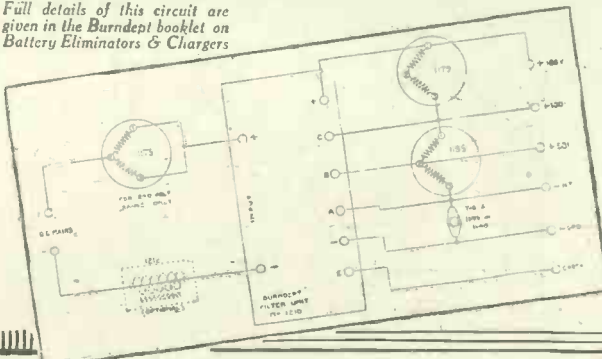

THIS eliminator will supply high-tension current to the largest sets (taking up to 25 milliamperes), and grid bias up to 25 volts. Its maximum output is 40 milliamperes.

The accessory can easily be constructed at a cost of about £5, full details being given in a special Burndept booklet on A.C. and D.C. Battery Eliminators, Chargers, and Power Amplifiers for home construction. Write for your copy of this interesting publication to-day. The Burndept components required are obtainable from your local radio dealer.

BURNDEPT

Offices: Blackheath, London, S.E.3.
London Showrooms: 15, Bedford Street, Strand, W.C.2.

EVERYTHING

The
G. E. C.
your guarantee

ELECTRICAL

To PORTABLE SET USERS!

A NEW AND BETTER VALVE



In neutralised and stabilised High Frequency Amplifiers the new H.L. 210 OSRAM VALVE gives a more sensitive response to weak signals from distant stations. The ideal valve for Portable Sets where only a small frame aerial is used. Gives maximum volume with minimum number of valves. Its characteristics allow it to be used as a grid detector for sensitivity, or as an anode bend detector for highest quality reproduction. Also used in the first stage of low frequency amplification, and ideal for choke coupled amplifiers. Write for full particulars.

Made in England

Characteristics

Filament volts 20
max.
Filament current 0.1
amps.
Amplification Fac.
tor 15.
Impedance 25,000
ohms.

**PRICE
10/6**

Osram Valves

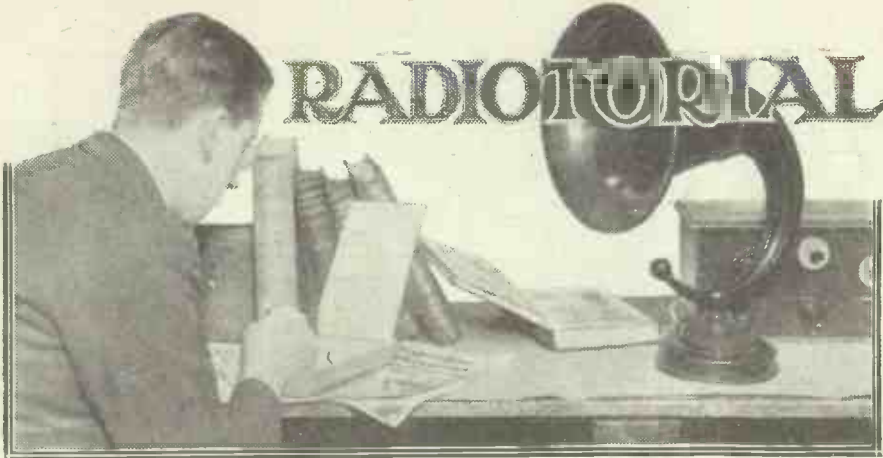

All Editorial Communications to be addressed to The Editor, POPULAR WIRELESS, The Fleetway House, Farringdon Street, London, E.C.4.

The Editor will be pleased to consider articles and photographs, dealing with all subjects appertaining to wireless work. The Editor cannot accept responsibility for manuscripts and photos. Every care will be taken to return MSS. not accepted for publication. A stamped and addressed envelope must be sent with every article. All inquiries concerning advertising rates, etc., to be addressed to the Sole Agents, Messrs. John H. Lile, Ltd., 4, Ludgate Circus, London, E.C.4.

The constructional articles which appear from time to time in this journal are the outcome of research and experimental work, carried out with a view to improving the technique of wireless receivers. As much of the information given in the columns of this paper concerns the most recent developments in the radio world, some of the arrangements and specialities described may be the subject of Letters Patent, and the amateur and the trader would be well advised to obtain permission of the patentees to use the patents before doing so.

QUESTIONS AND ANSWERS.

"HOW IT WORKS."

COLONEL W. (Hertfordshire).—"Until lately I was stationed in India, and heard practically nothing of wireless. But now I am settling down in England I am finding this subject one of great fascination. But, unfortunately, it seems so terribly technical! I made myself a "Master Three," and my pride in the results is only equalled by my shame at not under-

standing a thing about the works! What do the condensers do? What happens inside the coil? I don't suppose you can realise how strange it all seems to one like myself who had not really heard broadcasting until a few months ago. But if you can tell me where I can pick up some how-it-works hints, I shall be eternally grateful."

You will find a whole series dealing with the elementary theory and practice of wireless in "P.W." Numbers 280 to 285. This is just the sort of series you are looking for, and from the same pen—that of Mr. G. V. Dowding, "P.W.'s" Technical Editor—there appeared an article on the "Master Three" in "P.W." 297. Mr. Dowding has written also a further special article for the March number of "Modern Wireless," which deals with the "Melody Maker," the R.C. "Threesome," and the set you name in easy-to-understand language, and with operating notes, constructional details, how-it-works hints, etc.

FILAMENT VOLTAGE.

F. C. (Bellingdon, near Chesham, Bucks).—"I have just made a one-valve set from the diagram given in 'P.W.' November 19th, 1927, issue, but instead of putting in a filament rheostat I used a Lissen key-switch. I now find that when my accumulator is fully charged it reads 2.1 volts, and the valve I have should be used at the voltage of 1.8 to 2. Does this mean that I need a filament resistance, and, if so, what value would you advise?"

There is really no need for you to get a resistance as the voltage variation named is very small, and the modern valve filament is both robust and reliable. Although your accumulator reads 2.1 volts immediately it has been charged, the voltage rapidly drops down to 2 volts, and remains at that figure until the accumulator is almost discharged (when it falls rather rapidly).

Remembering that there is inevitably a small loss in the voltage, due to the leads (especially if they are long leads), and the fact that the maximum voltage of the accumulator is only about a quarter of a volt more than the valve should have for normal working, we consider you are absolutely safe in doing without a resistance of any kind and fitting up just a make-and-break switch for this particular valve.

(Continued on page 114.)

THE NEW "AUTOGRAM" DOUBLE ELECTRIC GRAMOPHONE

Fitted with two Tone Arms, two Celestion Pick-Ups, two 12-inch Turntables, Automatic Stopping Device for motors, two Universal Motors, suitable for any voltage from 110 to 240 volts A.C. or D.C., Speed Regulators, Pilot Lamps, &c., fitted in Substantial Leatherette Covered Mahogany Cabinet. Price, Complete £36. Quotations given for every type of design and outfit.

ONLY A FEW LEFT. AMPLIFEX LOOP AERIAL, the finest loop aerial yet devised, and the best for the reception of European Broadcasting. To clear 30/-.

OUR INTERNATIONAL RADIO CATALOGUE (3rd edition) will be sent to all enthusiasts sending 6d. to cover cost of postage and packing.

WILL DAY, LTD.

(The Best in the West)

19, Lisle Street, Leicester Square, London, W.C.2

Telephone (2 lines):
Regent 0921 and 0922.

Telegrams:
Titles, Westrand, London.

The little things that count.

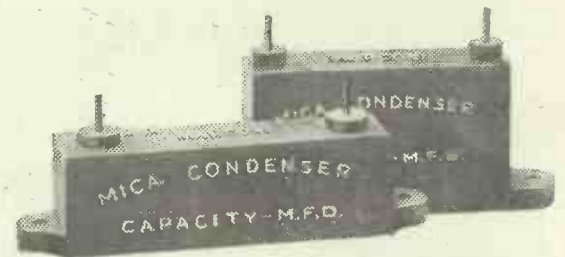

Fixed condensers—apt to be forgotten—but of vital importance in the performance of your receiver. Fit Marconiphone Condensers and definitely prevent current leakage.

In Marconiphone Fixed Condensers only the best mica is used, and the whole assembly is impregnated with wax under vacuum and then mounted into an insulating case. Each condenser is tested for insulation at 1,000 volts D.C.—a factor that ensures safety under all normal working conditions. From your dealer or send for full particulars direct.

.001 mfd. .002 mfd. .003 mfd. 2/6 each. .00005 mfd. .0001 mfd.
.0002 mfd. .00025 mfd. .0003 mfd. .0005 mfd. 2/- each.

MARCONIPHONE FIXED CONDENSERS

THE MARCONIPHONE COMPANY LTD.
(Dept. P.), 210-212, Tottenham Court Road, London, W.1.

Seven

vital points about the B.T.H. Transformer

- | | |
|---|--|
| <ol style="list-style-type: none"> 1. High and constant amplification, over wide range of frequencies. 2. Perfect reproduction, free from distortion, with maximum volume and absolute purity of tone. 3. Negligible Losses—the result of careful design and workmanship. 4. Uniform results ensured by the use of a single spool of moulded composition to contain all windings. | <ol style="list-style-type: none"> 5. Totally enclosed and thus protected from moisture, dirt and mechanical damage. 6. Large Core, perfectly jointed eliminates stray fields and renders screening unnecessary. 7. Guarantee. A definite guarantee is given to repair or replace, free of charge, any transformer which fails within a period of six months due to defects in the windings, providing these have not been subjected to improper treatment. |
|---|--|



B
T-H
TRANSFORMER

The British Thomson-Houston Co., Ltd.

2917

If you have built—or would like to build—

THE “MELODY MAKER,” THE “MASTER THREE,” or THE “R.C. THREESOME”

you ought to read the long illustrated article on these famous sets which appears in the March number of

MODERN WIRELESS

Here you will find, for the first time, operating details, constructional notes, helpful hints, and A FREE BLUE PRINT OF CIRCUIT CONNECTIONS of these famous receivers, telling you

HOW TO GET THE BEST FROM YOUR SET.

Packed with photographs, technical tips and practical wireless wrinkles, the March number of MODERN WIRELESS is not merely a magnificent magazine—it is a real radio investment.

Get your copy before it is too late.

MARCH ISSUE

NOW ON SALE

PRICE 7/-

RADIOTORIAL QUESTIONS AND ANSWERS

(Continued from page 112.)

A MYSTERIOUS FAULT.

G. WATSON (Henley-on-Thames).—"But this is what I cannot make out. After I switched the filaments out I disconnected the H.T. battery and let the H.T. negative and positive plugs hang in the air for a moment. Then I accidentally switched on the filament again, and to my surprise I could hear broadcasting for a moment. It was quite strong at first, but faded away quickly and died away to nothing. Several times I turned on the filament again but it did not happen, so I was going to give it up as a freak when I discovered the other night that, in exactly the same circumstances as the first time, the same thing happened again. Is it possible, that at certain times no high tension is necessary? Or do you think that inside the set there is somehow a sort of natural battery which can supply the H.T. for a few moments? I am very mystified, and it seems to me that there are great possibilities in the sudden bursts of music coming through without battery?"

How It Happens.

As Sherlock Holmes would say: "The explanation is a very simple one, my dear Watson." You do not mention the type of set you are using, but we have no doubt that in it you have incorporated some large fixed condensers connected between the H.T. negative and positive.

When the H.T. battery is connected up a charge flows into these condensers, so that if the H.T. plugs are taken from the battery and are not touched one upon the other, there is still a certain difference of potential between the H.T. positive wiring and the filament wiring. Consequently when the valves are alight, for just a moment there is a sort of false H.T. applied, sufficient to give momentary signals.

But this charge is strictly limited, and although it is sufficient to give perhaps a few words or a bar

of music, when the filaments are switched on again, it is very rapidly exhausted and the set ceases to function, until the battery is connected up again.

You will notice that you are only able to obtain signals in this way immediately after the battery has been disconnected, for once the condenser is discharged it requires the battery to be connected up again before the same sequence of events can happen.

A LOUD-SPEAKER PUZZLE.

T. J. B. (Coventry).—"As my little girl is ill I thought I would run a spare loud speaker up to the bedroom for her, and I decided to use No. 22 enamelled wire. I connected one end of this wire to the bedroom loud speaker, and then carried the other end of the wire through the hall and down to the main set.

"I connected this to one side of the loud-speaker terminal and went upstairs to proceed in the same way with the other wire, but to my surprise, when I got back into the bedroom, I found that the loud speaker was already playing, although there was only one wire from it connected to the set! Naturally I could hardly believe my ears, and then I discovered another funny thing.

"The loud speaker in the bedroom would not work if it was moved off the window-sill, but as soon as it was put back on the corner of the window-sill it worked almost as well as the one downstairs. In fact it works so well that I have not bothered to put on the other wire, and the set is a source of amusement and amazement to my neighbours. Why is it that I can work it in this way?"

Apparently what has happened is that you are standing the loud speaker on some metal object, possibly the window frame, which is in contact with the earth. The set also is connected to earth, and as the earth is a conductor there is, in fact, a connection between the loud speaker and the set, making a complete return circuit.

(This is the system employed by telegraph offices which are linked by a single wire overhead, and a return "wire" through the earth.) If you are using a filter output circuit in your receiver, there is no need why you should not continue to run the loud speaker as at present arranged; but if you are not employing a filter output, you had better send us a

sketch of your connections, as it is very easy in such cases to short the H.T. battery via the loud speaker, and thus incur the expense of a new battery before it should have been necessary.

USING THE BED AS AN AERIAL.

E. F. A. C. (Glasgow).—"Is it true that you can use a bed instead of an aerial? One of my friends insists it can be done, although I have tried and got, as I expected, nothing!

A SPECIAL

FREE BLUE PRINT

of

The "MELODY MAKER"

The "MASTER THREE"

and

The "THREESOME"

is given away with every copy of

THE MARCH

MODERN WIRELESS

On Sale Everywhere. Price 1/-.

GET YOUR COPY NOW

But this did not convince him, and he still insists that provided you know how to do it, you can use your bed as an aerial."

Within limits your friend is quite right. At short distances from a powerful broadcasting station there is no necessity to erect an aerial, as sufficient energy to work the receiver can be picked up on any large metal surface, even in some instances on a metal bedstead or fender; but such materials will only work at very short distances, and perhaps you are situated too far from a station for this to be successfully done in your case.

(Continued on page 116.)

Specially wound for use with screened grid valves

Encouraged by the success of LEWCOS Binocular Coils (ordinary type), we have now produced a specially wound astatic coil for use with screened grid valves. Together they form an ideal combination. Try this new LEWCOS success in your set.

Obtainable through all radio dealers.

Tuned Anode with Reaction.			
	Metres	Ref.	
B.B.C. Coil	250-550	BAR 5	10/-
Daventry Coil	1000-2000	BAR 20	12/-
Tuned Anode without Reaction.			
	Metres	Ref.	
B.B.C. Coil	250-550	BTA 5	10/-
Daventry Coil	1000-2000	BTA 20	12/-

The LONDON ELECTRIC WIRE CO. & SMITHS LTD.
Playhouse Yard, Golden Lane. London, E.C.1.



(Registered Trade Mark)
LEWCOS
Binocular Coils

Patent No. 277876

We are now making coils for the "MASTER THREE."

Details upon request.

SIEMENS RECHARGEABLE H. T. BATTERY

(Leclanché Type)

POSSESSES all the advantages of a DRY BATTERY—none of the disadvantages of the ordinary WET BATTERY.

1. Perfectly noiseless, clean and reliable.
2. Unspillable.
3. No attention required until exhausted.
4. Spring Connections, no soldering.
5. No "creeping" of salts.
6. Easily recharged, and maintains full energy throughout the longest programme.

The cells are made in the following three sizes:

- H.T.1 Small : 8d. each
- H.T.2 Large : 10d. each
- H.T.3 Extra Large : 1/- each

Guaranteed to give 1½ volts per cell.

Batteries can be made up from these cells with a minimum of trouble. We supply assembled Batteries complete in box.

Particulars on application.

SPECIFY

SIEMENS

—the Battery with 50 years' manufacturing experience behind it—
and you will be sure of satisfaction.

SIEMENS BROTHERS & Co., Ltd.,
Woolwich, S.E.18.



MAKE YOUR OWN CONE SPEAKER

The New Wonder
"Nightingale"

CONE UNIT

Exactly as fitted to our Cabinet Cone Speaker. Guaranteed to give results equal to the most expensive Loud Speakers yet made.

Full constructional details with each Unit.

GRAMOPHONE ATTACHMENT

Reduced from 32/6 to 15/- solely as an advertisement for the famous Bullphone Nightingale Loud Speakers. Cobalt Magnet guaranteed for all time.

With 4-inch Diaphragm.

Instantly converts your own Gramophone into a full power Loud Speaker, giving a wealth of pure undistorted volume which must be heard to be believed.

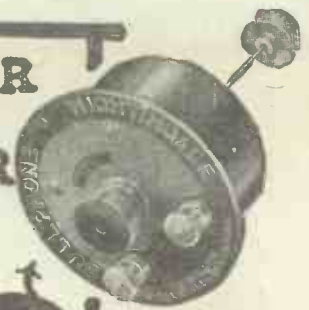

15/-

**SATISFACTION
GUARANTEED
or money
refunded!**



**AS FITTED
TO OUR £8
POST HORN.**

BUY ON EASY TERMS

**5/- Secures
this Speaker**

The Nightingale
"DE LUXE"

57/6 cash, or 5/- deposit
and 12 monthly pay-
ments of 5/-

21 ins. high, with
14-inch Bell.
Mahogany fin-
ished with plated
arm and stand.



**10/- Secures
this
Speaker**



BAKELITE
SOUND CONDUIT & TONE ARM

26" HIGH
BELL MOUTH 14" IN.
FINISHED IN
MAHOGANY

**NIGHTINGALE CONCERT
SUPREME
SUPER**

Guaranteed free from
metallic resonance.

63/- cash, or **EASY
TERMS**, 10/- deposit
and 12 monthly pay-
ments of 5/-

Send Deposit NOW!

Obtainable from your Local Dealer or direct from:—

BULLPHONE

LIMITED

**38. HOLYWELL LANE, LONDON
E. C. 2.**

NIGHTINGALE SPEAKERS

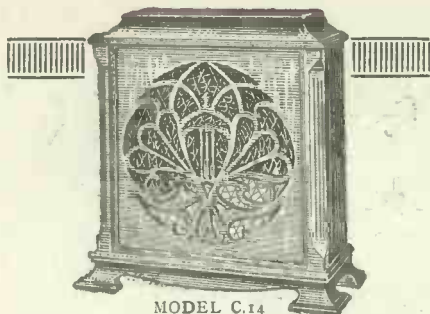

MODEL C.14

Reasons why dealers demonstrate "CELESTION" as their standard of comparison

"Celestion" possesses every characteristic of an excellent loudspeaker. It gives an even response to all frequencies, both in speech and in music.

Another feature of "Celestion" is its extreme sensitivity. It can handle both weak and very heavy signals without readjustment.

"Celestion" improves with age, and is unaffected by atmospheric conditions.

Further, the handsome appearance of "Celestion" breathes craftsmanship.

CELESTION

THE VERY SOUL OF MUSIC

Write for Illustrated Folder. Models range in oak or mahogany from £5-10-0 to £25.

THE CELESTION RADIO CO.,
Hampton Wick, Kingston-on-Thames.
Showrooms:
33/35, VILLIERS ST., STRAND, W.C.2
French Agents:
Constable & Co., Paris.

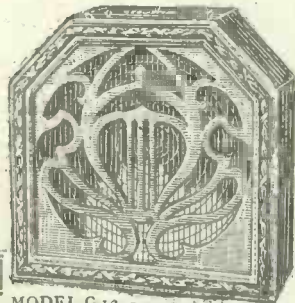

MODEL C.12

RADIOTORIAL QUESTIONS AND ANSWERS

(Continued from page 114.)

A FUNNY HUM.

S. J. (Walton-on-the-Naze).—"And there is another funny thing I should like to know about. Why is it that when London comes on I could always turn my condenser round and find a place where there is a funny humming sound on, not broadcasting, but just a sort of hum. It is a long way below London's wave-length, and yet it never comes on unless London is transmitting, and in some way it seems to be connected with 2 L.O.'s transmission. What is it?"

You are probably picking up one of the common wave-lengths shared by several of the relay stations. For instance, Hull, Dundee, Stoke and Swansea all work on 294.1 metres, and as several of these stations generally take the London programme, it is probable that the hum which puzzles you is a heterodyne effect caused by these different transmissions interacting upon one another.

LONG-WAVE COILS.

T. W. R. (Maidstone).—"My set is a three valver—Detector and two L.F.—the first being resistance coupled and the second transformer coupled. I get a whole pile of programmes and enjoy them well, but there is

WHAT IS WRONG ?

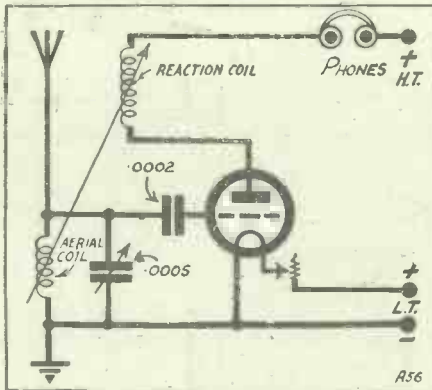

The above diagram is supposed to represent the connections of an ordinary one-valve receiver. But it is wrong, and would not work properly.

Next week the correct diagram will be given, and, to test your skill, we shall continue to publish, from time to time, a diagram in which a mistake (or mistakes) has been inserted. The correction will be published the following week.

No prizes are offered, but by trying to solve the problems the reader cannot fail to learn a lot about radio circuits.

one thing I should like to ask and that is, do you think the long-wave coils for this set would be worth while?

"On the short-wave coils which I have I can get at least twenty programmes, five or six of which come out on the loud speaker at good strength. How many equally excellent programmes do you think the long-wave coils would give me, and would they be regular ones?"

Situated as you are, in Kent, we should certainly invest in the long-wave coils. It is rather difficult to estimate how many extra programmes they will provide, but we should say about half a dozen regular ones of good loud-speaker strength would be available. Probably this number will be exceeded, but we think you could regard as certain Radio-Paris, Hilversum, Huizen, and one or two others, the three named being certain to be of good strength and probably quite as loud as any of the transmissions you are at present receiving. There have never been so many good transmissions on the long waves as now, and as your set is easily adaptable we should certainly invest in the long-wave coils.

EUROPE'S LOWEST WAVE-LENGTH.

"FREQUENCY" (Burnley, Staffs).—"Which of the European stations uses the lowest wave-length?"

This distinction belongs to Bezlers, France, which transmits on a wave-length of 158 metres and a power of half a kilowatt. The transmissions, however, are somewhat irregular.

WHAT CAUSES HOWLING ?

E. P. F. (Sutton, Surrey).—"What is it that actually causes the howl in a receiving set when the reaction is pushed too far? My own set will howl as piercingly and as strongly as a musical instrument or a violin played vigorously, yet apparently there is no particular instrument inside it causing this. Where does the howl come from?"

In order to understand where the howl comes from, you must remember that all noise is due to vibrations in the air. If these vibrations are perfectly regular, following one another at fixed frequency, the noise will have a characteristic note depending upon that frequency.

Low notes and tones, such as the bass notes of an organ are invariably caused by a comparatively slow movement of the air, i.e. by a low frequency, the particular part instrument which is causing the sound moving backwards and forwards at the rate of only a few hundred times per second. Very high notes, on the other hand, such as are played on the piccolo, only occur when the air is being moved at a very fast rate, that is to say the frequency at which the instrument is vibrating is many thousands of times per second. All musical sound is caused by a regular movement of the air.

The Beat Note.

The sound of the note varies from low to high according to whether the frequency at which the vibration is occurring is low or high. Having grasped the fact that a sound will be caused if the air is vibrated at the rate of several hundred or several thousand times per second, you will be able to appreciate the fact that the diaphragm of a loud speaker or a pair of telephones is quite capable of setting up an audible sound. This can either be a low growl or a piercing whistle, if electric currents cause it to move at the required frequency.

The howl which occurs in a receiving set due to too much reaction being used is generally caused by the interaction or "beat note" of two separate sets of electrical waves which, taken singly, are far too fast to affect the diaphragm. For instance, if the frequency of a broadcasting station's carrier-wave is one million times per second, and your receiving set is adjusted so that it has a frequency of about one million five hundred thousand times per second, the two different currents will fall into step five hundred times per second and consequently a beat note will be heard in the telephones at a frequency of five hundred times per second.

This would make an audible note, and if the frequency of your own tuned circuit were altered, and that of the station remains constant, the note would alter accordingly, and would go either up or down, according to whether the frequency was increased or decreased.

So you will see that the howl is caused by an (electrical) interaction between two non-audible frequencies which, beating together, form a third frequency. This falls within the range of audibility and therefore appears as a howl or shriek or growl from your telephones or loud speaker.

THE CHIME AND THE TIME.

R. T. (Cromer, Norfolk).—"Twice I have heard this station (on about 1,200 metres) which closes down its programme at 11 o'clock. On both occasions the clock was wrong, and it struck twelve instead of eleven. What station would it be, and why does it not keep the clock right?"

Probably you have been picking up the programme from the Danish station at Kalundborg. The wave-length of this station is 1,153 metres and the chimes with which it closes down are those from the Town Hall clock at Copenhagen. The reason that it chimes twelve instead of eleven is that Copenhagen observes Eastern European time which is one hour ahead of Greenwich time. Consequently it is 12 o'clock there when it is only 11 p.m. here.

POSITIVE INSTEAD OF NEGATIVE.

D. C. (Newcastle-on-Tyne).—"For about six weeks the quality of reproduction was bad, and then I remembered that I had not changed the grid-bias battery since the set had been installed twelve months ago, so I got a new 9-volt battery (a cheap one). But when I connected it up I found that with the usual 4½ volts grid bias I could hear nothing, whilst

(Continued on page 118.)

Full Band Strength

With the



WHAT a difference it makes! Your favourite dance tunes, just as they play them; violin, trumpet banjo, and saxophone, so natural, so tempting, you can't keep your feet still. Any music, every record, full band strength. You will never realise the real joy of your gramophone until you fit the BROWN electrical Pick-up. Such improvements! Volume—Purer Tone Volume control—no needle scratch—a wonderful instrument. Ask your dealer to demonstrate the BROWN Electrical Pick-Up. Price £4.

Brown

ELECTRICAL PICK-UP

S. G. BROWN, Western Avenue, North Acton, London, W.3.

CA 2039

Better reception with less trouble

The NEW "HOVEY" Patent

COLLAPSIBLE Spiral Aerial

Take Wireless with you Everywhere

The vagaries of the English climate will never interfere with your reception once you fit a HOVEY AERIAL. The sales of HOVEY Aerials are going up by tens of thousands through the recommendations of delighted users who had splendid TROUBLE-FREE RECEPTION throughout the recent storms.

YOU CAN FORGET GALES AND STORMS IF YOU FIT A HOVEY.

All good dealers sell HOVEY Aerials. If unable to obtain send direct to the manufacturers.

THE HOVEY AERIAL CO.,
10, Red Lion Passage,
LONDON, W.C.1.



2/6

OTHER POPULAR TYPES:

5/6

HOVEY Super Flat
Size,
12 ft. x
4 1/2 in.

2/6

HOVEY Standard Round

Indoor Size,
12 ft. x 2 1/2 in.
diameter.



SAVE MUCH SPENDING

BY TIMELY MENDING WITH



FLUXITE

it simplifies soldering

All Hardware and Ironmongery Stores sell FLUXITE in tins, price 5s., 1/4 and 2/8. Another use for Fluxite—Hardening tools and Case Hardening. Ask for leaflets on improved methods.

FLUXITE SOLDERING SET-complete

7/6

or LAMP only 2/6

FLUXITE LTD.
Dept. 324, Rotherhithe,
S.E.16



The Public, the Press—and "EKCO"

"Evening Chronicle,"
23th October, 1927.

Famous Eliminators. "Those manufacturing firms who have had the foresight to take up Mains Units some time ago are now reaping the benefit, and one firm which is particularly well established is the maker of the 'EKCO' Units."

"Hull Evening News,"
2nd January, 1928.

The Wireless Expert writes:—"An H.T. Eliminator I can confidently recommend is 'EKCO'. The slogan Safe! Silent! Sound! certainly applies to the '2F' Model which I have been using, as I could not detect the slightest trace of mains hum."

R. J. P., Brighton,
13th January, 1928.

"... I may say that I consider your Units far superior to the ordinary dry batteries and have recommended them to several of my friends."

H. H., Birmingham,
12th January, 1928.

"... The Unit is still working satisfactorily—now nearly two years—and at no cost."

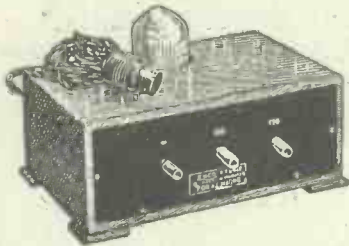

Model M2. A.C., as shown above, Two Tappings Suitable for 1 to 3 sets only. £4:12:6 complete.
Model C2. D.C. for H.T., L.T. and G.B. as shown below. Price £6:7:6 complete.

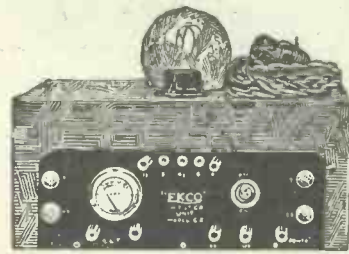

There is an "EKCO" model for every purse and for every voltage at prices from 17/6 D.C. and from £4:12:6 A.C.

EK.CO.LE LTD

Dept. A., "EKCO" WORKS,
LONDON ROAD, LEIGH-ON-SEA.

RADIOTORIAL QUESTIONS AND ANSWERS

(Continued from page 116.)

at 1½-grid-volts reception was very poor and distorted. Whilst trying to improve it, I took the grid bias out altogether and found that it went best that way, although it was still not at all satisfactory. Not being able to make out what was wrong, I happened, during my experiments to connect up the grid battery backwards, i.e. with the negative terminal towards the L.T., and with 4½ volts positive on the grid, and to my astonishment it went perfectly this way, in fact better than it has ever gone before, I think. Whatever can have made it do that?"

We are afraid that that "cheap" battery you bought was the whole cause of the trouble. If the circumstances are exactly as outlined by you, we have no doubt but that, through a manufacturer's error, the grid-bias battery has become marked with a positive at its negative end, and vice versa. It would thus appear that your previous poor reception was due to the fact that you had no grid bias except that given by a very inferior and run-down battery, and that when the new battery was connected up as marked, it was applying positive bias to the grid

GOOD NEWS FOR CONSTRUCTORS!

and all interested in

The "MELODY MAKER"
The "MASTER THREE"
and
The "THREESOME"

A special long illustrated article dealing with these three Popular Sets is one of the many features of

THE MARCH

MODERN WIRELESS

Now on Sale. Price 1/-.
OBTAINABLE EVERYWHERE

instead of negative. Your final lucky alteration put the right potential on the grid, i.e. 4½ volts negative, although according to the marking of the battery it would appear to be 4½ volts "positive."

SCREENED-GRID VALVE SET'S H.T. FROM THE MAINS.

S. W. A. (Corporation Street, Birmingham) — "The set I have in mind is one screened-valve H.F., Det. and 2 L.F. (resistance and transformer). It is called the "Super Screen" Four (described in "Modern Wireless" recently), and I want to get good quality on English and Continental stations, using the mains for H.T. Can this be done with a screened-valve set of this kind?"

Yes, provided the battery eliminator is a good one. You will get excellent quality with this set, and as many Continental stations as heart can desire.

THE GRID LEAK RETURN.

F. T. H. (Newcastle-on-Tyne).—"Should the leads of the grid leak go to the negative leg of the valve or to the positive?"

In most modern valves the grid return is taken to the positive side: but if you cannot find out which way the makers of your valve recommend for it, the best thing, of course, is to try both ways, and see which gives the better results.

"IT SOUNDS —"

S. W. E. (Atherstone, Warwickshire).—"It sounds like grumbling, I know, but the set does not sound half so good as before. It sounds "tinny," and not so strong. And it sounds held back somehow. Why?"

Frankly, S. W. E., it sounds to us like a run-down grid-bias battery!

Finest London Made Valves AT REDUCED PRICES

L.F., H.F., R.C. and DETECTOR in 2 and 4 VOLTS
The World's Best Valve The World's Best Valve
SELECTIVE PURE STRONG

P. R. VALVES are the latest product of one of the finest factories in London. Years of experiment and research are behind every one. It was only by the lucky discovery of new elements and new methods of manufacture that the P. R. VALVE at 3/6 became an established fact. Hitherto they had been sold at 8/6. The new price brings a good and reliable valve within the reach of everybody.



Trade Enquiries Invited
NOW ONLY 3/6

Post & Packing 4d

Phone your order: Central 0181
Pay the Postman
C.O.D. 4 Valves for 13/-
2 Valves for 8/9
Post & Packing 6d.
3 Valves for 10/-
Post & Packing 6d.
4 Valves for 13/-
Post & Packing 9d.

Type	Fil. Vts.	Fil. Amp.	Imp. Ohms.	Amp. Fac.	M/C	
PR 1	2	.06	35,000	15	.43	H.F.
PR 2	2	.06	25,000	12	.44	Det.
PR 3	2	.06	18,000	8	.44	L.F.
PR 4	2	.06	120,000	40	.33	R.C.
PR 5	2	.15	40,000	20	.5	H.F.
PR 6	2	.15	30,000	15	.5	Det.
PR 7	2	.15	12,000	6	.5	L.F.
PR 8	4	.06	23,000	15	.65	H.F.
PR 9	4	.06	19,000	9.5	.5	Det.
PR10	4	.06	11,000	6	.55	L.F.
PR11	4	.06	120,000	40	.33	R.C.

P. R. POWERVALVES are superb and challenge comparison with any other, no matter the make or price.

Power Valves	2V.	.20	6,000	5	.82	P.
	4V.	.15	4,000	4	1.0	P.

7/6 Each. Post and Packing 4d.

Tell us what your circuit is. We can help you to select the right valves. MATCHED VALVES for the intermediate stages of Super-hets specially selected for 1/- per set extra. All valves despatched by return of post under guarantee of Money Back in Full if not satisfied. All valves carefully packed and breakages replaced. Callers Invited.

P. R. VALVES Dept. 30 (Opp. Post Office Tube)
17, PATERNOSTER SQ.,
Newgate St., London, E.C.4

ENGINEERS

£500 a year awaits you. Prof. A. M. Low shows HOW! in "ENGINEERING OPPORTUNITIES." This 70 pp. book shows the easiest way to pass the A.M.I. Mech.E., A.M.I.A.E., A.M.I.E.E., A.M.I.C.E., etc. Exams. We alone guarantee "NO PASS—NO FEE." Courses in all branches. Write now—state subject or Exam. **BRITISH INSTITUTE OF ENGINEERING TECHNOLOGY**, 101, Shakespeare House, Leicester Square, London.



WET H.T. BATTERIES

Solve all H.T. Troubles.

SELF-CHARGING, SILENT, ECONOMICAL.

JARS (waxed) 2½" x 1½" sq. 1/3 doz.

ZINCS, new type 1½ doz. SACS 1/2 doz.

Sample doz. (18 volts), complete with bands and electrolyte, 4/3, post 9d.

Sample unit, 6d. 16-page booklet free.

Bargain list free.

AMPLIFIERS 1-VALVE 19/-, 2-VALVE 30/-.

2-VALVE ALL-STATION SET 6/-.

P. TAYLOR, 57, Studley Road, STOCKWELL, LONDON

PLEASE be sure to mention "POPULAR WIRELESS" when communicating with Advertisers. THANKS

EVERYTHING RADIO
EASY ON TERMS
WOOLDRIDGE
RADIO CO. LTD.
17 & 22 LISLE STREET,
LEICESTER SQ. LONDON, W.C.2



Style

In the wireless cabinets of V. C. Bond are combined all the knowledge of wireless experts with the craftsmanship of experienced workmen. They are stylish because of their careful design and efficient because of their sound construction.

If the cabinet you need is not illustrated in our free list we can make one to your special order.

& Service

This combined bedroom chair and trouser press, another V. C. Bond production, is the symbol of silent service. It is both an artistic piece of furniture and an unobtrusive servant.

For free illustrated particulars of cabinets and chairs write or 'phone to

Actual Manufacturers :

V.C. BOND & SONS

61, The Grove, Mare Street, HACKNEY, LONDON, E.8.

Phone 0115010483.
'Grams' VeeCeeBee, Hack. London.
Established 1900

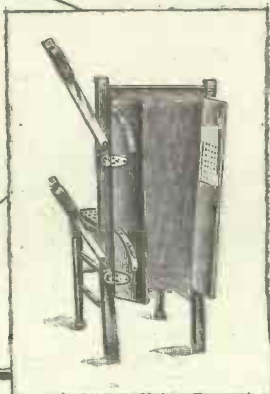

LOEWE RADIO

The Famous
LOEWE
LOEWE
High Vacuum Resistances and High Vacuum Block Condensers



Should be installed in every wireless receiving set.

They are

- Free from atmospheric influences.
- Moisture and dust proof.
- Free from losses.
- Fully guaranteed.

Delivery from stock.

Ask for illustrated leaflet.

LOEWE RADIO COMPANY LIMITED.,

4, Fountayne Road, TOTTENHAM, LONDON, N.15.

Telephone: Tottenham 2076.

GOOD NEWS FOR SET BUILDERS

In response to the urgent demand for first-class sets for family use, Mr. PERCY W. HARRIS, M.I.R.E., has now prepared the

Wireless Constructor Envelopes

The first two of this series are Now on Sale, price 1/6 per envelope (by post 1/9).

Envelope No. 1.—THE RADIANO THREE. A famous loud speaker set which you can build in an hour or two—no soldering necessary and a wide range of components to choose from.

Envelope No. 2.—THE CONCERT FOUR. Made of standard parts, all easily obtainable, this is a highly-sensitive long-distance set, giving powerful reproduction of wonderful quality. Covering both long and short wave-lengths, with a switch for 3 or 4 valves, it is essentially a set to enjoy, both in building and operation.

In these envelopes you will find every detail of the set simply explained; photographic reproductions and diagrams are included, as well as a full-size Blue Print.

NOW ON SALE Price 1/6

By post 1/9, from the Amalgamated Press, Ltd., Bear Alley, Farringdon Street, London, E.C.4.

Standing room only!

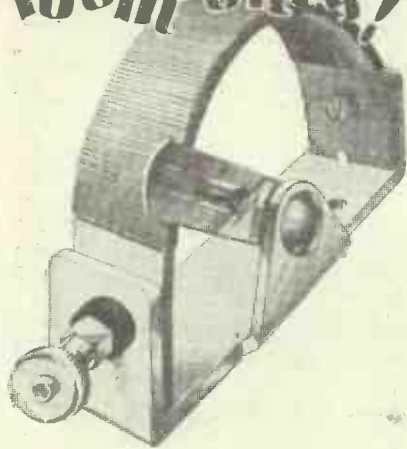

Your baseboard may be crowded. But there's room for the "Peerless Varistor." It stands up, prominent, easy to get at, but clear of complicated wiring.

Wound with finest quality resistance wire and fitted with a Phosphor-bronze adjustable arm that, once set to the resistance for your valves, stays set.

Terminals are fitted in convenient positions. Five different styles—3, 6, 10, 15 and 20 ohms.

From all good dealers or direct.

Then fit PEERLESS VARISTOR

1/3

THE BEDFORD ELECTRICAL & RADIO CO., LIMITED
22 Campbell Rd., Bedford.

LONDON: 21 Bartlett's Bldg., Holborn Circus, E.C.4.

GLASGOW: 113 St. Vincent Street, C.2.

NEWS FROM SAVOY HILL.

(Continued from page 100.)

Rooke and Robert Speaght will take the leading rôles. The work has been arranged for broadcasting by Edward P. Genn, and Ulster listeners will welcome this opportunity of hearing the work.

Sylviculture for Scotland.

A series of special talks on Sylviculture will be given from all Scottish stations during March, April, May, and June, by Sir John Stirling Maxwell, of Glasgow, and Dr. John Sutherland, of Edinburgh. The talks are designed to interest forestry workers in Scotland, and are of considerable importance in view of the co-operation between Government Departments and public associations to conserve our present stocks of timber and to provide new supplies in the future. The first talk by Sir John Stirling Maxwell, on Thursday, March 22nd. will deal with the historical aspects of forestry.

5 G B Features to Come.

5 G B keeps up its reputation for the best programmes yet radiated by the B.B.C. Good work, Percy Edgar!

The first performance of "Black-Eyed Susan," a delightful little scena, the music of which is by Alfred Reynolds, and is based on Leveridge's famous air originally heard in "Limehouse Nights," which had such a successful run in London, is being given by 5 G B on Friday, March 30th.

The characters will be sustained by Vivienne Chatterton, Harold Howes, Norman Archer, James Howell, Herbert Simmonds, and Geoffrey Dams. It will be followed by Offenbach's popular comical operetta, "The Blind Beggars." Other forthcoming programmes from the Daventry Experimental aerial which will undoubtedly interest music-lovers include a concert of chamber music on Wednesday, March 21st. during which songs will be sung by Harold Gladstone (baritone), and pianoforte solos by Arthur Ruddock; another Chamber Music programme on Saturday, March 24th, when the Virtuoso String Quartet will play some works by Eric Fogg, and in which the soloists are Dale Smith (baritone), Sidonie Goossens (harp), and Eric Fogg (pianoforte); and a Symphony Concert the same night by the Birmingham Studio Symphony Orchestra, in the course of which there will be pianoforte items by James Ching.

Community Singing Again?

A Community Song Festival of the Newcastle-upon-Tyne Y.M.C.A. Choral Society, which numbers three hundred voices, will be relayed from the Town Hall and broadcast from the local station on Wednesday evening, March 28th. The event is sure to be particularly popular if only because it has been arranged by Mr. and Mrs. Arthur Lambert—the ex-Lord Mayor and Lady Mayoress of the city—who will act as conductor and organist respectively on this occasion.

Mr. Lambert will also be heard in several songs during the evening, other soloists being Margaret-Magnay and Norman Curry. The portion which is to be broadcast ends at 9 p.m. with the singing of Parry's "Jerusalem." Incidentally, the "Daily Express" seems to have given up its sponsorship of community singing.

30% more electricity in Columbia "Layerbilt"



It is not generally known that any Dry Battery which is composed of cylindrical cells contains waste space amounting to 30 per cent of its total cubic area.

In the Columbia "Layerbilt" cylindrical cells are abolished altogether, and the electricity-producing material is built up in flat layers which comprise first a sheet of insulating paper, next a sheet of zinc, to which a sheet of Electrolyte is cemented by special process, and then a Carbon plate completing the construction of the first cell. This is repeated in two tiers in the battery, each tier containing 15 cells, the two tiers being separated by insulating material. Should any individual cell fail, the Columbia "Layerbilt" is not rendered useless, but will continue to function with only a proportionate drop in voltage.

Ask your dealer for Columbia "Layerbilt,"—the 100 per cent battery.

Price 25/-

J. R. MORRIS, 15, Kingsway, LONDON, W.C.2.

Scotland: J. T. CARTWRIGHT, 3, Cadogan Street, GLASGOW.

The WHITELINE VALVE HOLDER

"Mechanically and electrically perfect"



Bowyer-Lowe

2/3

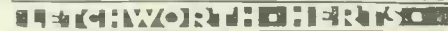

THE LITTLE CELLS THAT SATISFY.
Eton Primary H.T. Battery P.I. Porous Pot Cells, S1 and S2 Sac Cells. All complete.

	1-cell	6-cell	12-cell	30-cell
P.1	6½d. ..	3/3 ..	5/9 ..	14/-
S.1	6d. ..	3/- ..	5/3 ..	12/-
S.2	4½d. ..	2/6 ..	3/10 ..	9/6

Send 1½d. stamp for booklet giving full particulars to—
THE ETON GLASS BATTERY CO.
46, St. Mary's Road, LEYTON. E.10

CONDENSERS of QUALITY!

No mass production methods are employed in the manufacture of Camden Condensers. Every Condenser is stamped with a Serial No., and accompanied with a guarantee of 6 months' real service. Telegrams: KAMELCO. Telephone: Runcorn 109. Send for list and prices to Camden Electrical Co., Stanley Chambers, Runcorn.

REDUCED TO 10/6

Balanced Armature Cone Unit. This instrument is the finest value offered to the Radio public. Gives a greater output for a given input than any other cone unit. It is not a converted earpiece, but a unit designed for the manufacture of Cone Speakers. Our 136-page catalogue has all the latest and best in Radio and Electrical. Send to-day. FREE. Post free, 10/6, complete with Cone Washers and Cord.



ELECTRIC GRAFTON COMPANY
Dept. P.W., 54, Crafton St., Tottenham Court Road, W.1

how many accumulators have you got?

ONE? TWO? OR NONE? If you have only one accumulator, we will lend you one of ours while we recharge yours to ensure a continuous service. We will collect, maintain, and deliver each alternately. If you have two accumulators we will give you the same service. If your accumulators are unserviceable we will keep you continuously supplied with ours.

And at the same time we will loan you, if you like, the famous C.A.V. H.T. Accumulators, which experts agree give far better results for less than the cost of unreliable dry batteries.

This Service is cheaper than seeing to accumulators yourself. It saves you the trouble and risk of unskilled recharging, never leaving you without current; eliminates accumulator trouble; looks after your accumulators properly.

Our elaborate plant, skilled operators, and fleet of delivery vans guarantee an efficient, punctual, and economical service. Deliveries are made weekly, fortnightly, or monthly. Send a p.c. right away, and we will post you full particulars.

RADIO SERVICE (LONDON) LTD., 105b, TORRIANO AVENUE, KENTISH TOWN, N.W.5.

Telephone: North 0623-4-5.

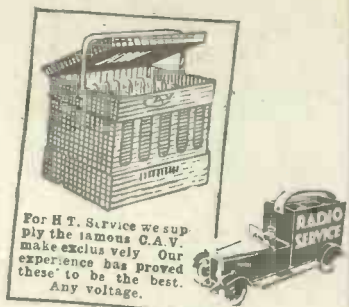

REFUSE IMITATIONS!



Standard Size panels supplied in three finishes, Black polished, Black Mat, and Grain polished, carefully packed in attractive cartons. Every panel and piece of ebonite guaranteed and made by British hands.

Apply for particulars of our new foot-proof 4 and 6 contact Former with buses ready for winding, directions and fully illustrated booklet, Price 6d.

ORIGINAL PRIZE - WINNING "BECOL" LOW LOSS FORMER, No. 5. 3 inch diam. overall.

Insist on a Becol Low Loss Former, the Former "with a reputation," incorporated in sets that have taken four first prizes and gold medal, a proof of their superiority. Supplied in cut lengths, 3 in., 4 in., 6 in., packed in cartons, and standard lengths of 3 ft.

Specify



Registered Trade Mark.

products



THE BRITISH EBONITE COMPANY LIMITED, HANWELL LONDON W.7

FOR PERFECT RECEPTION



Make a Cone Loud-speaker of wonderful tone and volume with this handsome ready-for-use FABRIC CONE at small cost. No cutting or sticking needed. The scientifically made HÖVEY RIDGED Cone is supplied ready for fitting. Gives equally good results on small and high powered sets. Handsome Metallic Finish, Gold, Silver or Bronze. Height of peak 4", Diam. 12 1/2". Unequaled for fidelity and volume. Do not accept worthless imitations. Get the genuine HÖVEY. Order TO-DAY from your dealer or direct from

"HÖVEY"

RIDGED FABRIC CONE
RIDGED CONE COMPANY, LTD.
10, Red Lion Passage, London, W.C.1

Patent Pending No. 31135/27.

Who is that? Breslau?

It might well be if you listen with the "F 5," for this latest Harris set has a dozen Continentals on its dials any night—at good loudspeaker strength at that. Full constructional details of this modern efficient, easy-to-build and cheap-to-assemble three valver are given in

THE APRIL 'WIRELESS CONSTRUCTOR'

One of the many special features of this "F 5" is that with a touch of the finger you can switch from any one station to any other. It incorporates a marvellously simple wave-change arrangement.

There are many other strong features in this issue of the "Wireless Constructor" which you will want to read.

Price 6d. Now On Sale Everywhere.

RECEIVE AND BE SATISFIED!



SUTRA TRANSFORMERS are supplied in ratios 3-1 and 5-1. Look at the Price! 5/-. Post free 5/3.

ALL RANGE TUNERS fitted to your set abolish all coils and worries. Price 14/-. Post free 14/6.

DOUBLE READING VOLTMETERS

Test your batteries before calling on your dealer. Finest value. 6/-. Post free 6/3.

SHIRLEY RADIO MFG. CO.,
Proprietors: Gibbs & White, Ltd.,
395, Shirley Rd., Southampton.

Reliability

WIRELESS COMPONENTS
GIVE UNEQUALLED SERVICE

Order from this List and save money.
Orders 5/6 value, carriage paid.
Under 5/6, 2d. per 1/- for packing, etc.

S.L.F. CONDENSER 	COIL FORMER 	'ZEION HAND' (15) DRILL 
Ebonite Ends and 4" Trolite die 0005 5/9 0003 5/6 Vernier dial extra 1/6	Send for Free Copy RELIABILITY WIRELESS GUIDE No. 999 with Electrical Supp.	Cases Drills up to 3-16 in. Only 3/6 Six Drills 1/-

HEADPHONES, B.T.H. 15/-; RELIABILITY ADJUST. 8 0 0	TANGENT L.F. TRANSFORMERS, 7/-; CROIX, 5/9 A1 5 0 0
NEW CLAYTON EBONITE CUTTINGS, Per lb. 1 3 0	R.I. & VARLEY GEN. PURPOSE L.F. TRANSFORMER 15 0 0
BRITISH STANDARD VALVES, ALL TYPES, EACH 5 0 0	FERRANTI TRANSFORMERS, AF4, 17/6; AF3, 25/-; AF30 3 0 0
LISSEN BATTERIES, 60 v., 7/11; 100 v., 12/11; 9 v. 1 6 6	R.A.F. TELEPHONE & MODULATION TRANSFORMERS HANDLED 46-PIN COIL FORMER & INSTRUCTIONS EXPERIMENTERS' PARCELS, CONTAIN 20/ VALUE OSSOR MELODY-DRIVER COIL, "GOLD DOME" . . . 3 9 9
VERNIER FRICTION-DRIVE CONDENSER DIAL . . . 3 9 9	EX-GVT. 120-OHM SULLIVAN'S HEADPHONES . . . 3 9 9
ERICSSON 0005 MFD. VARIABLE CONDENSERS . . . 3 9 9	LISSEN GRAMOPHONE PICK-UP 15/-; GRAM. UNIT 13 6 0
BULLPHONE WONDER CONE UNIT OF GRAM. UNIT 15 0 0	SIX-SOCKET COIL CASES, WITH TERMINALS . . . 1 6 6
DOUBLE-SCALE VOLTMETER . . . 1 6 6	BACK-OF-PANEL 2-WAY VERNIER COIL HOLDERS ANTI-PONG BASEBOARD HOLDER WITH TERMINALS EX-GOV'T. MULTI CONTACT DEWAR SWITCHES . . . 1 2 0 0
UTILITY 0002 SQUARE LAW CONDENSERS . . . 2 2 9	SET OF FIVE LEDION COILS 150/870 METRES . . . 1 3 6
SQUARE LAW CONDENSER 0005 MFD. AND DIAL FLASHLAMP BATTERIES 4-VOLTS, DOZEN LOTS . . . 3 10 6	HIGH-GRADE IRANIC H-TYPE VARIOMETERS . . . 4 6 6

J.H. TAYLOR & Co
4, RADIO HOUSE,
MACAULAY ST., HUDDERSFIELD
Macaulay St., Huddersfield

SHORT-WAVE NOTES.

By W. L. S.

THE "big noise" from P C J J, Holland, has once more started up on about 30 metres, and is putting a very lusty signal into most parts of the world by now. He is easily the strongest telephony station audible at the writer's location, barring none—not even 2 L O ! The engineers of P C J J certainly seem to be fully acquainted with short-wave operation!

There is a strong suspicion among the amateurs of the country that the new amateur wave-bands will be allotted for use on a date considerably in advance of December 31st. The new bands must be brought into use by the latter date, but it is, of course, left to the discretion of the respective Governments whether they are introduced before then.

It's An Ill Wind
Personally, I think that the 40-42-metre band will have far better carrying properties than the present 45-metre wave-length, and will have the extra advantage of being "nearer" to the 32-metre wave that is used by all the Australian and New Zealand stations as well as many of the South Americans.

After all, the transmitting amateur has gone through hard times and braved many difficulties before, with no one backing him but the R. S. G. B., and the introduction of other difficulties in the form of narrower wave-bands may have a beneficial effect in the long run. Perhaps an entirely new form of transmission may be the ultimate result of a search for methods of increasing selectivity!

The cone type of loud speaker gives some very peculiar results when used for the reception of short-wave Morse signals. I have for a long time been using a receiver with two stages of L.F., the 'phones always being inserted in the plate circuit of the second valve, with the option of plugging either 'phones or loud speaker in the last stage.

C.W. On Cones:
A horn loud speaker adjusted so that the diaphragm is just about to hit the pole-pieces will, of course, give remarkably strong signals which are very easy to copy, unless the wave-length of the transmitting station varies. With a cone, however, and its comparatively even response over a wide range of frequencies, the sharp shrill effect usually obtained on headphones or horn speakers is absent and C.W. signals take on an unfamiliar "smooth" or "mushy" effect.

Several of the British amateurs are now working quite regularly with the United States with inputs of 10 watts and under. By this I do not mean occasional, or even frequent, freak communications, but really reliable and regular work.

This low-power work done by the experimental section of the amateur fraternity will, in time, be reflected in the manners and modes of the commercial and broadcasting stations. Perhaps we shall live to hear of a 50-watt limit for the latter even yet!

PANEL PLATE TUNER

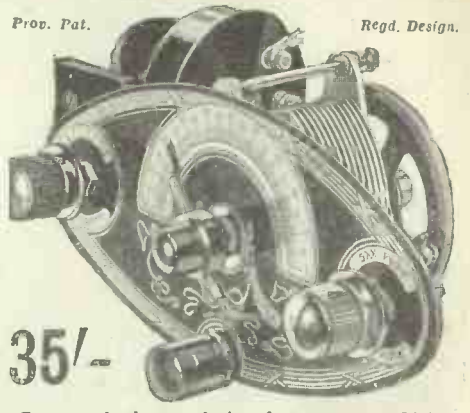

Great as is the popularity of our numerous high-grade Components and Receivers, the success achieved by this Unit has beaten all records. Amateur constructors in all parts of the country realize the immense assistance this unique assembly of parts affords them in the building of an efficient set which has the appearance of a professional product.

Above illustration clearly shows details of various parts mounted on richly engraved panel in black and gold or silver. No ebonite panel required, no coils to change and diagrams for building 2 or 3-valve supplied.

LAMPLUGH BRITAIN'S BEST RADIO

"LAMP-LOO"

S. A. LAMPLUGH, LTD.,
KING'S ROAD, TYSELEY, BIRMINGHAM.
Representatives for London and Southern Counties:—
G. C. Shore & Co., 28, Newnan St., Oxford St., W.1.

D-XELLENT!

DX-IN PLUG-IN COILS

From 1/- DX COILS, LTD. London, E.8.

TRADE MARK **RD40 . 2/-**

RED DIAMOND

REGD. A RADIO EXPERT writes:—

"I have now thoroughly tested your RD40 Detector, both on crystal and reflex sets. I have found it very satisfactory in every way, it is very efficient."

THE RECOGNISED DETECTOR FOR ALL CIRCUITS USING CRYSTAL RECTIFICATION. By Insured Post 2/3 or 2/9 with shield. Can be mounted on brackets or through panel. Once set always ready. Not affected by vibration. Each one is tested on broadcast before despatch, and is perfect. Of all high-class Radio Dealers or Sole Makers:—
JEWELL PEN CO., LTD.
(Radio Dept. 46),
21-22 St. Sutton St., LONDON, E.C.1.

Shield for same 6d.

"RED DIAMOND"

Make your loud speaker live

FIX A "TONER"

across the terminals and your loud speaker will reveal a clarity of reproduction equalled only in the broadcasting studio itself. This wonderful device removes all distortion and undesirable noises from any loud speaker or phones. The result of a long scientific research.

Trade applications invited
Send to-day to—
The JUNCTION ENGINEERING Co.
(Dept. 4) 149A, JUNCTION RD.
LONDON, N. 19

26 POST FREE

Solid Mahogany Cabinet

Hand french-polished, satin finish, hinged lids. Will take any set or panel up to 20" X 10", and battery compartment 20" long, 11" high, and 12" deep. The overall size is 34" high, 23" wide, 14" deep.

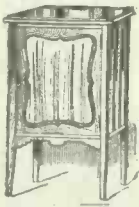

Delivered free England & Wales
56/-
Scotland 2/6 extra.
Crate 5/- extra, returnable.
F. DIGBY, 9, The Oval,
Hackney Road, E.2. Phone: Clissold 5458
Let us quote for your own design.

ELEX

TREBLE DUTY TERMINALS

Terminals T2LC 4d. ea. T2LN Plain top, 3d. ea.
The finest terminal designed for multiple uses and with 36 different indicating tops.

Write for List T33 of other parts, free on request.
J. J. EASTICK & SONS,
Elex House, 119, Bunhill Row,
Chiswell Street, London, E.C.1.
Hougham Service Advt.

APPARATUS TESTED.

(Continued from page 110.)

gold and silver figurings on grey backgrounds. We understand that Mr. Boyd undertakes the ornamenting of panels in this manner to any individual requirements in respect of design.

THE "VIVAVOX" GRAMOPHONE PICK-UP.

As Messrs. Graham-Amplion say, the "Vivavox forms only part of the apparatus necessary for reproducing records electrically. There is still also the receiver, or amplifier, and the loud speaker. These in themselves must be capable of reproducing without distortion and of sufficient volume. It is especially important that suitable valves are used with sufficient H.T. voltage and correct grid bias," and they go on to say that, "provided the radio receiver is such as to give really good loud-speaker reproduction, with plenty of volume, when used for reception of broadcasting at a reasonable distance from the transmitting station, it can be relied upon to give entire satisfaction when used with the Amplion 'Vivavox' type D.U.I."

This is a very straightforward statement, and one which we heartily endorse. As a matter of fact, the Amplion "Vivavox" is an exceptionally good pick-up. Its design is based on that of the well-known Graham-Amplion transmitter, which is a vital section of the Amplion public speech and band receiver equipment.

An Adaptable Device.

The "Vivavox" can be used with practically any two-valve amplifier or standard two- or three-valve set of modern design. In the case of a receiver, all that it is necessary to do to place the device into operation is to remove the detector valve and plug in the adaptor in its place. The valve takes its place in this latter. The set can then be brought into operation and the gramophone worked in the usual manner.

A feature of the "Vivavox" is that it is so designed that it can be fitted to any type of tone arm within wide limits of sizes, without the slightest trouble. Additionally to the adaptor there is also obtainable a very excellent volume control. This is provided with a heavy base and can be stood in any convenient position. The Amplion "Vivavox," complete with volume control, adaptor, and connecting lead, sells at the reasonable price of 50s.; the "Vivavox" with only the adaptor being sold at 35s.

On test we found this Amplion pick-up to be sensitive and stable. It does not seem to be hard on records in the manner of some, and it rides smoothly and with a minimum of chatter. With it, reproduction is distinctly bright and the high notes are not over-emphasised as with some pick-ups, while the low notes are delivered with full some roundness.

On a first-class outfit employing a moving-coil loud speaker, electrically recorded modern gramophone records are reproduced with uncanny naturalness. It is difficult when switching over from radio to the gramophone to distinguish which is the better, and it would be difficult for a listener not knowing which one was in operation to distinguish which was which.



About CELLS!

Your set can never do its best unless the Batteries are up-to-date—that is, unless the Batteries are SURE-A-LITE. The cells of SURE-A-LITE embody the last word in scientific construction, and we definitely assert that they are not only better designed and constructed, but actually larger than other makes.

SURE-A-LITE have unique recuperative powers, work with perfect smoothness and maintain their full voltage to an unprecedented degree.

SURE-A-LITE are supplied in deep, dust-proof covers—sealed.

That seal is your guarantee of perfect condition.

'SUPRA'

66 volts, 7/11.
100 volts, 14/3.

'GIANT'

66 volts, 10/6.
100 volts, 17/6.

Ask your Radio dealer; he knows.

Grid Bias tapped each 1½ volts up to 6 volts.

SURE-A-LITE

BRINGS MOST IN — GIVES MOST OUT
REGISTERED TRADE MARK

The better battery

THE BATTERY COMPANY,
92, HURST STREET, BIRMINGHAM.

WONDERFUL MONOTUNE 3

The Master Set of the year, designed by C. P. Allison, A.M.I.R.E., which gives 47 STATIONS ON LOUD SPEAKER. Complete Construction Book, 1/6. Refunded if set of parts purchased. Particulars Free.

RADIAX LTD., Palmer Place, London, N.7.

FREE 5-DAY TEST SEND NO MONEY

We will send you without obligation up to 3 Valves for test in your own set, to be paid for or returned at the end of trial.

OCTOPUS VALVES.

British Made. Fully Guaranteed. Low Consumption. Maximum Power and Distance.

Not to be confused with cheap valves of similar characteristics.

CONSTRUCTORS of the "MELODY MAKER" and "MASTER THREE" should take advantage of FREE TEST.

H.F., Det., L.F., R.C.	2 or 4 Volt.	Power 8/- Post Free.
5/6		
Post Free.		

Type	Imp.	Amp. Fac.
H.F. 206	35,000	15
Det. 206	25,000	12
L.F. 206	18,000	8
R.C. 206	120,000	40
H.F. 215	40,000	20
Det. 215	30,000	15
L.F. 215	12,000	6
H.F. 406	23,000	15
Det. 406	19,000	9.5
L.F. 406	11,000	6
R.O. 406	120,000	40
P. 220	6,000	5
P. 415	4,000	4

WENBANS, 74, New Oxford St., W.C.1.

RADIO REGISTERED PANELS

7x 6, 1/3	9x 6, 1/7
8x 6, 1/4	11x 8, 2/3
10x 8, 2/1	12x 8, 2/6
10x 9, 2/4	12x 9, 2/10
12x 10, 3/-	14x 10, 3/5
14x 12, 4/-	16x 9, 3/6
14x 7, 2/7	21x 7, 3/7
16x 8, 3/2	24x 7, 4/-
8x 5, 1/2	Pin. thick
	Post Free.

Money back guarantee that each and all Panels are free from surface leakage. Megger test infinity. CROKSONIA CO., 10, South St., Moorgate, E.C.2

Agents: John Henry Smith, 139, Anlaby Rd., Hull.
L. H. Helyar 82, Chamberlin Rd., Norwich.
A. Stredwick & Co., 27, The Market, Chatham.
Boynton & Co. Ltd., 34, Bradford St., Birmingham

HEADPHONES REPAIRED 4/-
Transformers 5/- Loudspeakers 4/- All repairs remagnetised free. Tested, guaranteed and ready for delivery in 24 hours.
Discount for Trade. Clerkenwell 1795.
MASON & CO., 44, East Rd., City Rd., N.1.

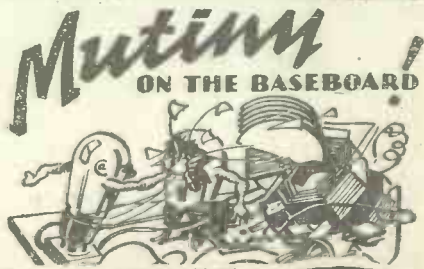

When your set gets out of hand, take the one vital step that ensures the perfect balance necessary to secure harmonious, distortionless reception—fit a Sifam Meter and tune with your eyes on the dial FREE leader "Distortion" from (Dept. P., S.I.P.A.M. 10a Page Street, Westminster, S.W.1.)

ALL APPLICATIONS FOR ADVERTISING SPACE IN "POPULAR WIRELESS" MUST BE MADE TO THE SOLE ADVERTISING AGENTS, JOHN H. LILE, LTD., 4, LUDGATE CIRCUS, LONDON, E.C.4.

The accepted Rolls-Royce of Radio is that great success the

DIX - ONEMETER

It is a Precision Instrument of universal use, with an ingenious system of multipliers which enable full-scale readings of any value to be made over a wide range. One millivolt to 2,000 v., 2 milliamperes to 20 amps., or 50 ohms to 50 megohms. Mirror double scale, jewelled, knife edge. A £10 De Luxe model for 55/-. Multipliers 6/6 each. New A.C. Model now ready.



The **ACONEMETER**. Model VAC.3. In Case. Is a new Model for measurement of volts on Alternating Current, a 3-range instrument reading 0-150 v., 0-300 v., and 0-600 v. Price, inclusive of case, 75/-. Extra for 1,500-volt Multiplier, 44/-.

TEST SETS. Cromptons, 600 v. and 500 amps., 10 ranges, £8 10s. Nalders, 1,200 amps and 600 volts., 10 ranges, £10. Fine 7-range Moving Coil in Case, B52, quite new, 55/-. worth double. Valve Characteristic Test Cabinet, 3 Moving Coil Meters on panel, 7 1/2 in. x 9 1/2 in. Socket for test valves, worth £10, Sale £4 10s. each. A. C. Tester's, 108/B21, 4 ranges, 120 v., 240 v., 20 amps., and 4 amps., for 40-100 cycle mains, cheap at 45/-. 4-Range Westons, 2 1/2 in. dial 0-6 a., 0-24 m.a., 0-120 m.a., 0-240 m/v. Cost £4. Sale 40/-. Ferranti Laboratory Sets, mov. coil, mirror scale, knife pointer, 5 ranges. - Millivolts to 240 volts, 1/10 milli-amperes to 25 amperes, and all between. Half-price, £5 10s.

ANODE METERS, panel type for showing H.T. output to Receivers, 7/-.
LABORATORY. Sullivan Standard Galvo., Scale and Shunt, £15; 3-range Tinsley Micro Ammeter, read to 1 micro., full scale 500, 60/-; Paul ditto, £5; Gambrell Onward, £4 10s.; Univ. Shunt Box, 35/-; Lab. Test Res. Box, plug, from 39/-; Capacity Bridge, 00001 to 10 mid., £8; Marconi B-T Direction Finder, £5 10s. For rapid readings use a Mesger 1,000 ohms to 10 megs., £15. Get the best out of your set by using a Dix-Onemeter and a Wavemeter. Paul's Bridge and Galvo., £9 10s. Res. Units, 2/6. Standard Mfd. Units, from 8/-. Wheatstone Bridges, £2 5s., £6 10s. and £10. Paul's Inductometer, £17.

VOLTMETERS. 500 volts, 50/-; 1,000 volts, £3; 1,500 volts, £5; 2,000 volts, £6; 2,500 volts, £6 10s.; 5,000 volts, £7 10s. Large stock of odd Voltmeter and Milliammeters at reduced prices.
ELECTRADIX TRANSFORMERS should be used for Best Results. Ironclad Screened Melody III or Melody V reduced to 40/-.
VIOLINAS. Do you realise that these are the Best Hornless Loud speakers ever put on the market and that these Five Guinea Cabinet Loud speakers are being sold at 25/- each. The famous Violina can be heard all day at Electradix, 218, Upper Thames Street.

MOLA REED CONE UNITS, 14/6. Western Electric Balanced Arm, 10/6. Brown's "A", 13/6. Special Hard Cone Paper, 15 in. x 15 in., 1/- Amplicones, Gold or Silver, 2/-. Cone Stand and Rim, 8/6, or with Cone, 10/-. Special Sk. Adjustable Unit, 8/-. Booklet, "Marvels of Microphone," 6d. post free. Skinderviken Buttons, 2/-. W.E., 1/- Micro. Transf., 100/1, 3/6.
BARGAIN RECEIVERS. Royalty paid. All first-class make. 2-Valve, No. 33 Marconi Lid Case, all waves, 50/-. 2-Valve Mark 32, 250 to 1,800 metres, £4. Western Electric 3-Valve, £6 5s. 3-Valve Aircraft, £4. Polar 4, Pol. Cab., £6 10s. 5-Valve R.A.F. with Valves, £5. 5-Valve Marconi De Luxe, £8. Sterling Surplus Anodian, £5 10s. Marconi R.B.10 Crystal and 1-Valve closed Cabinet. Complete with Valve, 22/6. Marconi Screened 6-Valve, £12; cost £50.
GRAMO. PICK-UPS. Magnetic Earpiece Units for making your own 40 - reproducer. Adapted with a little work. Only 1/2 each. In metal case, 1/6. Adapted Brown A Pick-ups, 21/-.
TABLE ELECTRIC PROJECTORS. For Photo Slide or Home Television experiments, 4 Magnif. and focus lenses, swivel stand. Socket cord and plug for supply mains or battery. Sale 25/-. Gun Telescopes, 17/6. 2 1/2 in. dia., 24 in. long, in case.
EX-ARMY OSRAM POWER AMPLIF. VALVES. Unused, in cartons. 50 to 500 volts. Not the type without valve legs offered by junk shops. Fully guaranteed, 7/6. Charging Valve Bargains. B.T.H., Cossor, etc., A.C. to D.C. 50 m/a at 200 volts to 1,200 volts, cost 35/-; Sale, 7/6, guaranteed. 6-volt B.E.
ANODE CONVERTERS. All sizes from 120 volts 20 m/a to 4,000 volts 500 m/a in stock. M.G. 30 volts to 400 volts 100 m/a, £4 10s.

72 Page Catalogue. Send 4d. stamps. Callers' sale now on at

ELECTRADIX RADIOS,
 218, Upper Thames St., E.C.4.

TECHNICAL NOTES.

(Continued from page 100.)

lately which, although it has many good qualities, will not (or would not, until it was suitably drilled) take ordinary loud-tone needles, or, in fact, even some of the medium-tone needles. This was because the needle channel was originally too small, evidently having been designed for what we would call very soft-tone needles.

In this instrument a lead is provided with a special contact to be slipped over the anode pin of the detector valve. The detector may be removed whilst this contact is attached to the anode pin, the valve being then replaced in its holder. When this pick-up is connected in the anode detector circuit and followed by two stages of low-frequency amplification quite good loud-speaker strength is obtained.

Need for Experiment.

Of course, there is always with these gramophone pick-up devices a tendency to amplify the "surface noise" from the record, and although special filter circuits cannot be arranged for the purpose of cutting down the surface noise without inevitably cutting down at the same time the volume of the reproduction, I believe there is considerable scope for the experimenter in the direction of reducing the record surface noise without seriously minimising the loudness of the reproduction proper.

Whether this may best be brought about by mechanical means (in connection with the design of the pick-up itself) or whether in the electrical circuit, after the vibrations have been transformed into electrical variations, it is impossible to predict. But there is no doubt that the gramophone electrical pick-up has come to stay.

Standard Coils.

All experimenters will be very pleased to note that at last standard British speci-

**BRITAIN'S
 BEAUTY SPOTS.**
 New Fortnightly Part Work.
 1,500 Photographs.

THERE are very few fortnightly part works which will appeal to all our readers so strongly as **WONDERFUL BRITAIN**, the first part of which appears to-day. This new publication is one of the finest pictorial records of the beauty spots in the British Isles yet produced. It is beautifully illustrated and is written in the most entertaining way; in all it will contain no fewer than 1,500 photographs, all of which will be reproduced by the new photo-tone process, which gives to each photograph the full value of its varying light and shade and which brings out clearly even the smallest detail.

Each part will contain a loose section of a very fine new road map of the British Isles, upon which every place of interest or historical importance is marked. On the back of each section there is a full list of places worth visiting in that section. This map is quite **FREE** and would cost at least ten or twelve shillings in the ordinary way.

WONDERFUL BRITAIN will be completed in about 24 fortnightly parts and will form a fascinating guide to where to go and what to see in the British Isles. The price of each part is 1/3.

fications have been arrived at for plug-in coils for radio reception. The specifications have been drawn up by a committee of representatives of various Government Departments and Research Associations, together with the Radio Manufacturers' Association, the Radio Society of Great Britain and the British Radio Valve Manufacturers' Association. The specification is described as the "British Standard Specification for Plug-in Coils for Radio Reception Purposes," and takes the form of a 12-page booklet (No. 289/1927) issued by the British Engineering Standards Association.

This specification is the third British Standard Specification which has been issued dealing with wireless apparatus. The features which are standardised are the dimensions of the plug portion and the tolerances which may be allowed so far as interchangeability is concerned, and a range of sizes based upon inductance values.

**ADANA AUTOMATIC SELF-INKING
 PRINTING MACHINE
 NEW ALL-STEEL SUPER-MODEL**

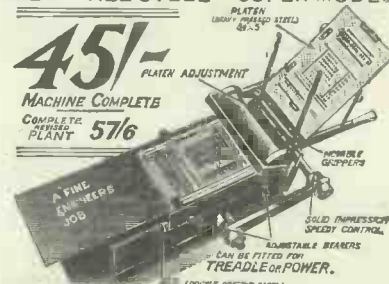

The Machine that is built from the experience of over 10,000 Users of the old Model.

Over 15,000 users of Adana Printing Plants, saving enormously in their own work, and hundreds making an excellent living. Government Departments, Large Printers and Big Stores are amongst the many successful owners. Will print any matter from **CHEMIST'S LABEL** to an **ILLUSTRATED MAGAZINE** at a really commercial speed, including Perforating and Creasing. Simplicity to the extreme, no special skill required. Hundreds of boys producing school magazines. Real Printers' metal type case, all complete accessories and fully illustrated instruction book included in plant. Two-coloured illustrated particulars and samples of work sent on receipt of stamp.

BUILT FOR COMMERCIAL USE.
 Machines can be shipped abroad C.O.D. cash against documents in London. Goods F.O.R. Twickenham.

THE ADANA AGENCY
 is a complete organisation for the supply of Printing Office Equipment of every description. Controlled by most highly skilled and long experienced men of the Printing World. (DEPT. PW/6), 17, CHURCH STREET, and 34, KING STREET, TWICKENHAM.

REPAIRS

Any make of L.F. Transformer, Loudspeaker or headphones repaired and despatched within **48 HOURS - TWELVE MONTHS' GUARANTEE** with each repair. 4/- Post free.

Terms to Trade.

TRANSFORMER REPAIR CO.,
 "Repairs" Dept.
 214, High Street, Colliers Wood, London, S.W.19.

COMPLETE SETS, LOUD SPEAKERS, COMPONENTS, Etc., supplied for all circuits, including the Mullard Master 3, Cossor Melody Maker, also the new circuits featured in this issue.

**EVERYTHING WIRELESS
 ON EASY PAYMENT TERMS**

Send list of requirements, and best monthly terms will be quoted by return.

The P.D.P. Company, Ltd.,
 41, GREAT TOWER ST. LONDON, E.C.3.

WHEN replying to advertisements please mention "Popular Wireless" to ensure prompt attention. **THANKS!**



In Mullard lies the secret
to perfect radio reception.

A good valve means good
reception—the best valve
means the best reception.

Mullard valves with the
wonderful Mullard P.M.
Filament are the keynote
to improvement in any
radio receiver.

Mullard
THE · MASTER · VALVE

Gramophone Electrical Reproduction

- essentially a Low Frequency Amplification Problem



The limitations of mechanical methods for the reproduction of sound are universally recognised to-day. It is not possible to obtain uniform amplification of all audible frequencies by purely mechanical means, with the result that science has turned to electrical methods to solve the problem.

The electrical apparatus required calls for the highest degree of experience and skill in design and manufacture. The greatest accuracy in detail is essential in a gramophone electrical pick-up, and the slightest defect, either in design or construction, will result in "blare." After months of extensive research we have discovered the secret of accurately converting mechanical to electrical vibrations, and the gramophone pick-up which we have perfected, and which we propose to market in the near future, will reveal a remarkable achievement in this new field.

Next we come to the amplifier proper. Our Manufacturers have built up a reputation for us as **SPECIALISTS IN ALL FORMS OF L.F. AMPLIFICATION**, and only those who have actual experience of the results that can be obtained by using R.I. & Varley L.F. Amplifier components can appreciate the real meaning of **TONAL QUALITY**.

**SPECIALISTS IN
L.F. AMPLIFICATION**



Varley

LTD



THE MARK OF BETTER RADIO

Kingsway House, 103, Kingsway, W.C.2. Phone, Holborn 5303.

Printed and published every Thursday by the Proprietors, The Annualgated Press, Ltd., The Fleetway House, Farringdon Street, London, E.C.4. Advertisement Offices: Messrs. John H. Lill, Ltd., 4, Ludgate Circus, London, E.C.4. Registered as a newspaper for transmission by Canadian Magazine Post. Subscription rates: Inland, 17/4 per annum; 8/8 for six months. Abroad, 19/6 per annum; 9/9 for six months. Sole Agents for South Africa: Central News Agency, Ltd. Sole Agent for Australia and New Zealand: Messrs. Gordon & Gotch, Ltd.; and for Canada: The Imperial News Co. (Canada), Ltd. Saturday, March 17th, 1923.

R R

MORE ABOUT OUR £1,000 TELEVISION CHALLENGE

Popular Wireless

Every Thursday
PRICE
3d.

No. 303. Vol. XIII.

INCORPORATING "WIRELESS"

March 24th, 1928.



Special Features

Notes on
The "R.C. Threesome"
An "Antipodes Adaptor"
Some Further H.F. Problems

A novel dance was recently held at the Royal Palace Hotel, London, the dancers wearing 'phones and picking up the music by means of a thin coil of wire round the shoulders.

ON ALL POINTS

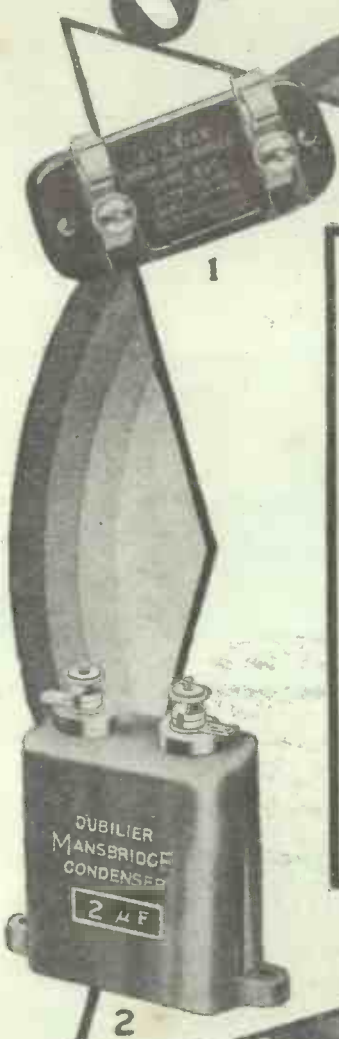

However good the circuit you select for the Receiving Set you intend to build, remember it will be no use at all unless you build it with efficient Components. And not only must they be efficient, but they must retain their efficiency. *By embodying Dubilier Components in your set you will ensure perfect functioning constantly maintained.*

On all points of performance Dubilier products are the "stars" in every good circuit.

Write for our 1928 Catalogue showing complete range of Dubilier Components, sent post free.

(1) *Dubilier Mica Condenser, Type 610, 1,003 mfd. 2/6 (specified for a "P.W." Circuit in this issue).*

(2) *Dubilier Mansbridge Condensers, Type BB, .5 mfd 2/6 each; 1 mfd, 2/6 each; 2 mfd. 3/6 each.*

(3) *"Dumetohm," Resistances, in 14 resistance values between 10,000 and 300,000 ohms inclusive, from 5/- to 11/6 each. Other values to order. "Dumetohm" Holder, 1/6.*

(4) *Dumetohm, 3 megohms 2/6 (specified for a "P.W." Circuit in this issue).*

If unobtainable from your dealer send direct to us.



THE "STARS" IN EVERY GOOD CIRCUIT

Battery Energy that costs less per radio hour

Marconiphone Long-Life H.T. Batteries give you more for your money . . . because of their remarkable *staying* power. It isn't the start of your battery that shows its value—it's the *finish*. When you discover that your Marconiphone H.T. Battery seems to be inexhaustible, that power and volume are sustained through hundreds of

programmes, you know that you have bought wisely.

Judge, therefore, the value of your battery by how many radio hours it will give, not only by its first cost, and start *now* to cut the cost of *good* radio reception by investing in a Marconiphone Long-Life Battery. Stocked everywhere by all good Radio Dealers.

THE MARCONIPHONE COMPANY, LTD. (Dept. P), 210-212, Tottenham Court Road, London, W.1

Marconiphone High Tension Batteries

No. B.	POPULAR"
66 volts 9/6
No. B.496	"POPULAR"
108 volts 15/6
No. B.510	STANDARD
TYPE 66 volts	.. 12/6
No. B.495	STANDARD
TYPE 81 volts	.. 15/6
No. B.1570	STANDARD
TYPE 108 volts	.. 21/-
No. B.1560	LARGE
CAPACITY	60 volts 20.-

Marconiphone Grid Bias Batteries

No. B.500
9 volts .. 2/-
No. B.251
16 volts .. 3/6



MARCONIPHONE

LONG LIFE

HIGH TENSION BATTERIES

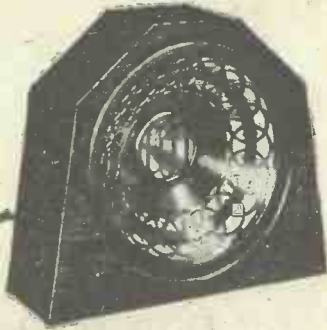

Something You Never Knew

Hearing the Brown Universal Loud Speaker* for the first time, you will be surprised at the sense of realism in broadcasting that it conveys.

Volume where there is volume, grandly impressive with no suspicion of clamour and where there is softness, a gentle, clear tone that woos your hearing for every perfect note.

"I never knew," you'll say, "that a loud speaker could reproduce like that."

And we would reply that until you hear the Brown Loud Speaker in the comfort of your home, you never will know the pleasure of Perfect Reception.

* The price of the Brown Universal Loud Speaker is £6. Your Dealer will be pleased to demonstrate it.



S. G. BROWN, LTD.,
Western Avenue, North Acton,
London, W. 3. Showrooms: 19,
Mortimer Street, W. 1; 15, Moor-
fields, Liverpool; 67, High Street,
Southampton. Wholesale Depots
throughout the Country.

2131

A New and Useful Work of Surpassing Beauty!

Wonderful Britain

Fortnightly Parts - 1/3 each.

The glories of our own country from Land's End to John O' Groats brilliantly described and illustrated with 1,500 photographs in superb Phototones.

THIS richly printed and fascinating new work will show all that is beautiful, remarkable and historic in England, Scotland, Ireland and Wales. Highways, byways, historic places and beauty spots will be described by great travel writers and illustrated with a remarkable collection of photographs printed on delicately toned paper. There is not a corner of the British Isles that has been left unexplored in the preparation of WONDERFUL BRITAIN. It will help you to get the best out of your holidays. It will help you to plan a day's run or a long motor tour, and will lead you to visit the thousand and one places which, in the ordinary way, you might easily pass by. You will be able to turn to it both as a reminder of the places you have seen and as a guide to those you ought to see.

The following list of articles in Part 2 conveys a good idea of the interesting way in which the work has been arranged.

LANDMARKS OF THE DRUIDS.

By T. D. Kendrick.

THE GREAT NORTH ROAD.

By Charles G. Harper.

SOME EARLY NORMAN CASTLES.

By J. E. Morris.

CURIOSITIES OF OLD TIME PUNISHMENTS.

By Veronica Scott-Gatty.

THE STORY OF THE MARTELLO TOWERS.

By Harold Van Tromp.

THE LITERARY SHRINES OF ENGLAND.

By Ernest H. Rann.

OVER 1,500 PHOTOGRAPHS

PARTS 1 & 2 NOW ON SALE

1/3^d

LARGE SCALE ROAD MAP of Britain's Historic Places

FREE

printed in colours on stout card in 24 sections— one section free with each part of WONDERFUL BRITAIN. The complete map, unobtainable elsewhere, would cost at least 10/- in the ordinary way. This map will be invaluable to motorists cyclists and tourists.

A special transparent fronted canvas case in which all the sections of this Free Map can be carried will be supplied to all regular subscribers at half-price, i.e., 2/6.

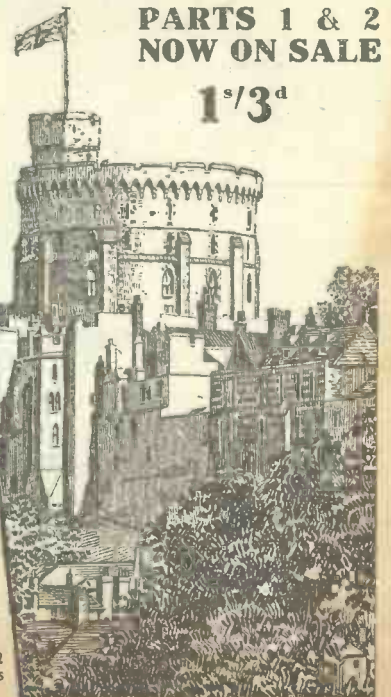

If you have any difficulty in obtaining a copy of Part 1 from your Newspaper or Bookstall, send 1/6 direct to the Publisher, The Amalgamated Press, Ltd., Fleetway House, London, E.C. 4

"THE VALVE OF THE FUTURE"

No Dry Batteries

No Accumulators



"Cosmos-Met-Vick" A.C. Valves, Green Spot and Red Spot, are the result of investigation and experiment by one of the finest Research organisations in this Country.

They provide the complete solution for, and, in conjunction with the use of Met-Vick Eliminators, overcome all the difficulties of direct operation from the Electric Light Supply.

"Met-Vick-Cosmos" A.C. Valves not only provide the solution of the complete operation of wireless sets for the Electric Light Mains, but they also provide great volume and extreme selectivity free from distortion. By their use you can switch on your set like electric light, and yet lose nothing in effect. In fact a mains operated set with Met-Vick-Cosmos A.C. Valves is a much better set.

See what Mr. A. P. Castellain says in the "Wireless World" for March 7th:—

"Remarkably High Mutual Conductance—
For the AC/G valve the mutual conductance is enormous when judged by ordinary valve standards—about 2 milliamperes per volt for an amplification factor of 36—and the heater current is only 1 ampere at 4 volts. The latter figures are quite comparable with valves of the 4½ volt 0·8 ampere L.S. class. For the AC/R valve the amplification factor is about 10, and the mutual conductance 4 milliamperes per volt, giving an A.C. resistance of about 2,500 ohms."

The writer continues by comparing the Cosmos AC/R Valve, very advantageously with other makes of valves for similar duties.

Note also what Mr. G. A. Exeter, the London Area Manager of the Radio Society of Great Britain says about the "Cosmos-Met-Vick" A.C. Valve:—

"..... in view of the results I have obtained upon trial, under decidedly adverse conditions, I now think you are indeed to be congratulated upon producing a great improvement in the technique of radio. Undoubtedly this is the valve of the future."

The power handling capacity of the AC/R Valve is as great as that necessary for Public Address Service and is sufficient for operating "moving coil" Loud Speakers to the greatest advantage

By using the ingenious "Cosmos" Disc Adaptors, these five-pin valves can be used in a set wired for accumulator valves, without altering the wiring.

MET-VICK

VALVES · COMPONENTS · & SETS

Metro-Vick Supplies, Ltd., 155 Charing Cross Road, London, W.C.2



TEAM WORK

The Valve that made possible the famous Cossor "Melody Maker"

Your nearest Wireless Dealer stocks Cossor Valves for every purpose, for 2, 4, and 6 volts. From 10/6.

ONE! Two! Three! Four! Deeper and deeper goes the stake. Four men acting together—with the precision of a machine. All in complete unison. Team Work.

Team work is as essential to success in Radio as it is to the work of a road gang. Choose a team of Cossor Valves* and, for the first time, know the full capabilities of your Wireless Set. Because every Cossor Valve is designed to function correctly with its neighbour—acting together as a team—your Set will take on a new lease of life. It will give you purer tone, far more life-like reproduction and greater volume—for less upkeep cost, too.

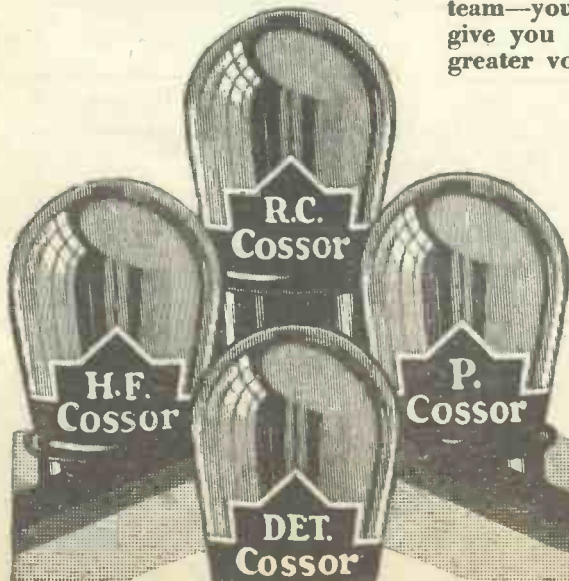

COSSOR VALVES

give you distance, clarity, volume.

Advt. A. C. Cossor, Ltd., Highbury Grove, N.5.

Popular Wireless



Scientific Adviser :
 Sir OLIVER LODGE, F.R.S.
 Editor :
 NORMAN EDWARDS, M.Inst.R.E., M.R.S.L., F.R.G.S.
 Technical Editor : G.V. DOWDING, Grad.I.E.E.
 Assistant Technical Editors : K. D. ROGERS, P. R. BIRD,
 G. P. KENDALL, B.Sc., A. JOHNSON RANDALL.



RADIO NOTES AND NEWS.

The Dare-Devil—A Wet Blanket—Via Radio and Dog-Team—The Sceptics Answered—
 Cost of Living Reduced—Imperial Broadcasts—Britannia and Short Waves.

Controversy.

SO the Government has lifted its ban on broadcast political, industrial and religious controversy. It is right that the B.B.C. should have freedom in this matter, and one hopes that they will use it wisely. Personally, I think the whole affair much less important than did most of the people who entered the lists, because I have noticed that controversy is but rarely of value. And I hope that the B.B.C. will ban religious controversy on their own account.

Peace.

IN my opinion, which in this instance I expect will be fairly popular, the B.B.C. would do well to think less of wordy warfare and more of national and international peace. There never was such a medium, so deadly when used for hostile propaganda, and yet so fraught with potential power for good, as radio-telephony. And, as for the Government, it could make Rugby pay for itself over and over again—not in hard cash—if it were used for peace propaganda as cleverly as the German stations were used during the war in the art of "telling the tale."

The Dare-devil.

I HAVE just seen it reported that at this year's Leipzig Fair the English radio trade is represented by one firm only. Honour to the brave unknown! But why do the others—the angels—"fear to tread"? Those that "rush in" sometimes come out with bulging pockets.

Transmitting Note.

IF you should hear BRS 131 on C.W. or telephony anywhere between 15 and 200 metres, you will know that you are on to Mr. R. L. Rowland, North View, Wivelsfield, Hayward's Heath, who will be glad to receive reports on his transmission.

Celestial News.

THE formation is announced of the China Broadcasting Association. The object is to provide an efficient foreign broadcasting service; a large commercial transmitter is to be hired during certain hours. Subscription, ten dollars per annum,

(or anything, I suppose from £1, according to what dollar they mean). My experience of China was that every town had a different dollar—and a different odour.

Echo Answers "No."

A. J. C. (Cupar) draws my attention to an interesting thing which he noticed whilst listening to KDKA on the "P. W. Ranger," a two-valver. He says, "When the announcer spoke I distinctly heard what appeared to be two voices exactly the same, saying the same words, only the second was a fraction of a second after the first. Was I receiving direct from America and also right round the world?" I'm afraid it was nothing so thrilling!

The Wet Blanket.

IT is contrary to my nature to flatten out romance with hard fact, but none the less I cannot support the "round the world" idea in this instance. If we were dealing with a Morse "dot" I would admit the possibility, but as we are dealing with speech, I am bound to say that in my view the fact that A. J. C. heard the voices distinctly—the italics are his own—proves that the second voice did not go round the world; had it done so it would have "jammed" the first. My theory is that there was an echo in the studio, which, of course, would be transmitted perfectly. Moreover, two valves would not be likely to tackle the "round the world" signals so well as A. J. C. represents. Sorry!

Bravo, the A.R.R.L.

IN compensation for the foregoing icy blast, here's a bit of real romance. About a year ago the [Editor arranged with a member of Dr. Grenfell's Labrador Mission for an article about radio as used on one of the expeditions to the frozen north. We have now received a message, relayed by Mr. E. Blodgett, of St. Albans, N.Y., U.S.A., from the Grenfell Expedition: office of origin being St. Anthony, Newfoundland.

Via Dog-Team.

THE message says, "Have sent your article entitled 'Radio with Grenfell in Labrador,' by dog-team mail today. Will probably take six weeks to arrive. Please acknowledge by mail to Mr. E. Blodgett, with whom we are in daily radio communication." So that by courtesy of Mr. Blodgett—to whom "P.W." sends its hearty thanks—our contributor, sitting on an ice-floe or heap of snow, has been enabled to reach Fleetway House long ahead of the dog-team mail. The article will be published in due course—thanks to the dogs and Mr. Dearlove, the writer. Again, bravo the American Radio Relay-League!

The Radio Sceptic.

MR. ELSTON'S letter in "P.W." No. 301—what a cry from the heart!—slightly touches these notes. My custom is to report nothing that seems to me wildly improbable, but the fact that

(Continued on next page.)

AN UNSINKABLE SHORT-WAVER.

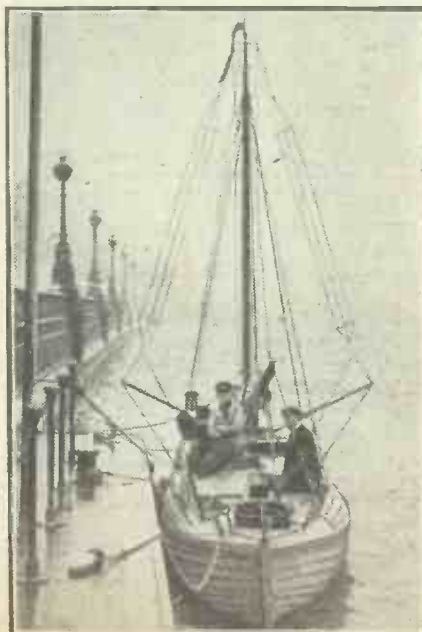

This is the "Schuttevaer," a twenty-foot unsinkable lifeboat, which recently arrived in London from Rotterdam. (It was to leave for America, which it was hoped to reach in forty days.) On the trip the programme included continuous short-wave experiments.

NOTES AND NEWS.

(Continued from previous page.)

I do report a "pick up" does not imply that "P.W." guarantees it. I know, however, what extraordinarily good results can be got with "P.W." sets, and am very cautious in doubting a result on the sole grounds that it is not my own. I suggest that Mr. Elston probably refuses to admit in his count stations which do not "come in" with the volume, clarity and stability of his nearest station. If that is correct, then he is not a true DX worker but a connoisseur.

The Sceptics Answered.

THERE is no doubt about C. P. A. (St. John's Wood, N.W.) having received WPG, the Municipal Station of Atlantic City, New Jersey, and WGY (Schenectady). From them he has received a gilt (paper) medal and a thing like an overgrown postage stamp, both verifying reception, and also a sort of cardboard certificate. In addition, he received a charming letter from the lady Publicity Director of WPG, enclosing booklets about the town and the station. Now, boys, all together for WPG and WGY!

Reception of Australia.

LETTERS reporting the reception of Australia have been so numerous that I have been somewhat embarrassed as to how to deal with them. I propose to devote a few paragraphs in next week's issue to the subject. I may say in advance that the "Sydney" Two is the most-mentioned set. The other side of the picture is shown by reports from 3LO (Melbourne). This station received news from the B.B.C. that a programme of more than two hours' duration, sent on January 29th, was 75 per cent intelligible. You might note that 3LO transmits on 32 metres, from 18.30 to 20.30 G.M.T. every Sunday.

Cost of Living Reduced!

SO the P.M.G. can now do transatlantic telephony at £9 for three minutes, a reduction of £6 on last season's prices. Of course, this fee is utterly fantastic and can be paid only by millionaires and newspapers. At a pound a time the service might find a few subscribers, but it will be the Beam system which will enable you to 'phone to America without creating an overdraft.

A Useful Tip.

A SUFFOLK reader kindly sends a description of the way in which he defeated the bad effects of rain on the aerial lead-in. He cut 3 inches from an old motor inner tube; from this he cut a wedge-shaped piece so that when the remainder was folded it formed a funnel-shaped tube. The funnel was put round the lead-in wire, so as to enclose the nut of the lead-in insulator with its wide end, and then tied to the wire round the narrow end. Smaller funnels of the same material were tied on the wire near the lead-in, with their wide ends upwards.

Imperial Broadcasts.

I AM indebted to the Editor of the "Sydney Morning Herald" for the news that the three firms organising Empire broadcasting in Sydney have informed the B.B.C. that they are ready to arrange for

programmes to be sent from Sydney, as and when required by the B.B.C., if the B.B.C. will reciprocate by sending programmes to Australia. They hope that some arrangement as to the defraying of the costs may be arrived at by the British Imperial Conference in London. Empire broadcasting is at present a name only. When will the Government awake to its paramount importance?

Remarkable Coincidence.

JUST to encourage you to listen to church services, I relate how J. T. D. (Birkenhead), who eavesdropped on Calvary Church, Pittsburg, for many Sabbaths, wrote to the Vicar and got an acknowledgment by radio. He received also a book from the deacon, who, it came out, is a Birkenhead man, and used to live opposite J. T. D. in that town. It's a rummy small place, the world! I remember meeting a girl in— Ah, well! Least said, easiest explained.

SHORT WAVES.

The B.B.C. have received many requests to permit controversial subjects to be broadcast. A much-married man timidly asks if there are any subjects which are not controversial.—"Humorist."

A: "Has that youngster of yours learned to let your watch alone yet?"

B: "Yes, I just caught him trying to take my radio set apart."

"Plentiful supply of gas from bore!" runs a headline in one of the newspapers. Which radio lecturer are they referring to now, we wonder.

TRIAL TRIP.

The attempt of the B.B.C. to broadcast parrots is believed to be a preliminary to the broadcasting of politicians' speeches.—"Birmingham Daily Mail."

SLIGHTLY IMPATIENT.

The wireless fan who was made to listen for two hours to his grandmother's musical box as a great treat.—"Sunday Pictorial."

"Wireless sets now made to suit all pockets," runs a headline in an evening paper. Good! This will do away with the question of where to instal the set in some of those overcrowded London flats.

THE MAGNETIC FIELD.

A Scotsman recently admitted into a London hospital had his head jammed down the horn of a loud speaker. It was afterwards ascertained that in the church from which the service was being broadcast the collection box was upset.

A fool there was with careless eyes
He failed to see high tension wires—
A fool there was

Limerick the Second.

"THERE was an old monk of Medina," etc. The first effort received was from sixteen-year-old R. B. (Cosham), namely, "He could not tune out his son's concertina." Touching, but the line does not "scan." Still, many of Shakespeare's didn't. I fear that the line reflects a precocious cynicism in regard to the conventional idea of a monk. R. B. runs a handy team of four sets, including the ubiquitous "Every Purpose" Two, the "Lo-loss Crystal," and the "Spanspace" Three. Sydney (Aus.) has fallen to his skill already. A beardless "P.W." knight!

Britannia and Short-Waves.

WITH the publication of the Navy Estimates came the interesting announcement that H.M. ships on distant stations are fitted with short-wave

apparatus, and that there is no ship which cannot be reached from the Admiralty at some time in the 24 hours. As a contrast, read the account of Anson's voyage round the world—it took him many weeks to round the Horn, and he was absent for two years. It's a thriller and true.

You Never Can Tell.

AT the recent annual meeting in New York of a technical association connected with the pulp and paper industry, the use of radio on paper-making machines was reported. The method was the result of a radio amateur's "fiddling about" with paper to de-tune his set; he had keen observation, and noticed that different qualities produced different results. So, you see, there may be more for you in "the game" than appears on the surface of things.

Radio-Regardless of Row.

YOU will have seen in the newspapers that there is a dispute between England and Norway touching the possession of that dot in the South Atlantic called Bouvet Island. While the dignified Notes pass between the two Governments, a wireless station is to be erected on the "precious" rock, for the purpose of giving important weather news to South Africa, South America and ships in the Antarctic.

"Canary Calling."

IN view of Miss Daisy Kennedy's success with nightingales, it is interesting to know that during the Christmas holidays Professor W. Rowan of the University of Alberta, Canada, induced some canaries to broadcast their little hearts out for the benefit of listeners to station CKUA. These birds were at the time living out-of-doors in a temperature—if you can call it temperature—of no less than 44 degrees (F.) below zero. B-r-r!

Post Office Perplexity.

I READ that a Yarmouth P.O. overseer—sounds like slavery!—conducting the prosecution in a wireless case, complained that it is difficult to tell whether a man is carrying his lunch or a wireless set. May I venture to remind the perplexed ex-"Male Learner" that it is no sin against the P.O. for a man to carry either and that he may, therefore, cease from troubling and rest his poor little head.

A Slight Relapse.

A LITTLE nonsense now and then, is relished by the wisest men. This is the lullaby handed out to the infant of an enthusiastic listener.

*Hushaby, Suddaby, on the top note,
Alan and Handley are playing the goat.
When the valve conks the programme will fail,
Mother must then do the cross-word in the "Mail."*

A Palpable Hit.

I AM partial to a good joke and here is a good one on me. I asked recently why the B.B.C. does not bottle Chamber Music and sell it as weed-killer. A reader, who I believe I should like, asks me whether that is not a little unfortunate, as C. Music evidently has a deleterious effect upon myself. It's a bull's-eye!

ARIEL.

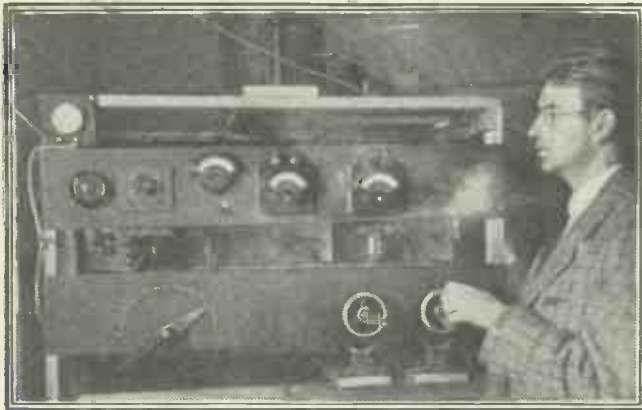

TELEVISION AND THE HOME CONSTRUCTOR

No one is in a better position to discuss the practical aspects of Television than Mr. P. W. Harris. He owns one of the best equipped experimental laboratories in the country and has wide facilities for research. He has taken a keen interest in the progress of Television, but has come to the conclusion that the home construction of the appropriate apparatus is, as yet, very impracticable.

By PERCY W. HARRIS, M.I.R.E.

FROM out of my recent correspondence I have just picked a letter which calls for a rather more lengthy reply than it is customary to send in the post, and as the subject matter of the reply will interest many people, other than the correspondent himself, I am availing myself of the kind invitation of the Editor to deal with the matter in the columns of "P.W."

The gist of the letter is just this: "Dear Mr. Harris,—When are we going to have an article from your pen on how to make a television set? I have seen a number of statements recently that suggests that television is now an accomplished fact and that the home constructor can make such a set for himself quite simply and cheaply."

In common with a large number of other experimenters I have closely watched the progress of television, both in this country and abroad, and I have not the slightest hesitation in stating that in my humble opinion we have not even measurably approached the time when the home constructor, as distinguished from the skilled experimenter, can try his hand at the game. The home constructor comes into his own when the fundamental problems have been solved and when the development of a particular art is a constructional one and a question of detail. The fundamental problems of genuine television have not been solved either in this country or abroad, nor can I see that they are likely to be along the lines which various inventors have so far pursued.

Why Not "Radiovision"?

This plain and blunt statement may give the impression that I am unaware of what has been done by such inventors as Mr. Baird in this country, the Bell Telephone Laboratories in the United States, and the numerous inventors on the Continent who have contributed a good deal to the elucidation of the problem, and the general clearing of the air. Such is by no means the case.

To understand the matter clearly we must be quite certain of the meaning of the terms we use, and I am rather sorry that the term "television" has come to be looked upon as embracing seeing-by-wireless as well as seeing-by-wire. It would be much better if we called the former "radiovision," and the latter television.

So far as all the experiments have gone, up to date, each portion of the picture to be transmitted has been "explored" separately and the whole picture has to be traversed in a short period of time. At the other end of the transmission system a spot

of light has been made to traverse a screen synchronously with the traversing of the original image by the exploring beam or focus, and as if we see a spot of light at a given point the image of that spot remains in the eye for a fraction of a second, the whole series of points of light remain in the eye of the observer long enough to give some kind of a persistence of vision effect.

The "Red-hot Stick."

The simplest way of understanding this point is by remembering the experiments of our boyhood days when the red-hot

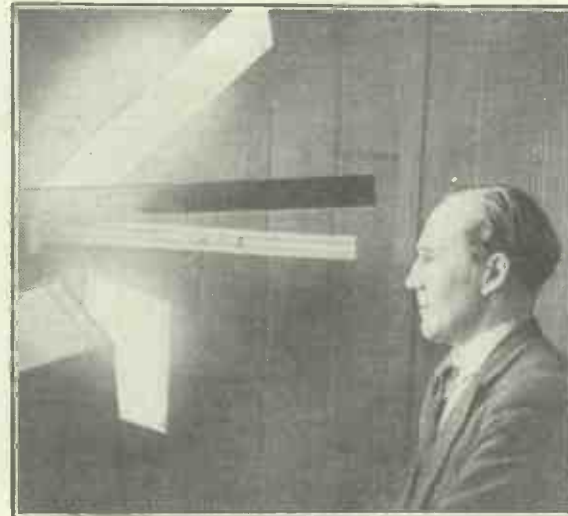

Mr. Fox being "televised" at Mr. Baird's London laboratory during the recent transatlantic experiment.

end of a stick, when spun round in a circle, seemed to give a ring of light.

The reason for this was, of course, that the image of the end of the stick at any given moment remained in our eye slightly longer than the time taken by the point to traverse the whole circle, so that we saw what appeared to us to be a continuous line of light.

Transmitting "Still" Pictures.

You will remember that it was possible, by skilfully handling the stick, to make a figure eight appear, and many other simple geometric signs. The quicker we "wiggled" the stick the more complex the geometric forms we could make appear in the air, but it was obvious even to the youngest child

that there was a limit to our activities in this direction.

The transmission of a simple image by wire or by wireless is not by any means a difficult matter. Provided we go slow enough quite elaborate and detailed pictures can be sent by these means, and the principle is daily utilised in the transmission of pictures across the Atlantic by the Marconi organisation. In this system the picture to be transmitted is wrapped around a rotating cylinder, and the variations of light and shade on the picture are made to vary the intensity of light at the other end of the transmission line.

Tele-photography.

In ten minutes or a quarter of an hour a very detailed photograph can be correctly transmitted. At this point it should be mentioned that once the apparatus used in tele-photography (that is the sending of photographs by wire or wireless) and that used in television (the seeing of objects by wire or wireless) can be made to function properly there is no great technical difficulty in sending the same thing by radio. Indeed, in general terms, it can be stated that anything that can be sent over a wire telegraph can be sent over a wireless telegraphic system,

and the distance traversed is merely a matter of increasing the power or the efficiency of the transmitting system. Now that we can speak by wireless telephone, and transmit all the infinitely complex sounds of the voice from one side of the world to the other, it will be realised that the means already exist for sending the variations of current necessary for tele-photography or television, if we can produce them at the sending end, and if we can reproduce them again at the receiving end! Two very big and important "ifs."

I hope no reader will think I am attempting to "crab" television experiments. I believe television will come, and I have a great admiration for those inventors who

(Continued on next page.)

TELEVISION AND THE HOME CONSTRUCTOR.

(Continued from previous page.)

have worked so persistently to overcome the difficulties, but I do strongly resent the wireless public being misled into believing that television has reached a stage when it becomes a practical proposition to instal television outfits in the home and for the home constructor to make his own outfits.

If the fundamental problems of television have been solved, then the far simpler problems of the rapid transmission of photographs by wire or wireless would have been solved previously. It is all a question of the time element, and the huge speeding up necessary to give practical television is not, as has been glibly stated in some papers, a "mere matter of detail." To give a reproduction of a moving picture at the receiving end in any way comparable with a crude cinematograph requires a speed of transmission and a general speeding up of all the apparatus and component parts of at least five thousand times that required for the successful transmission of photographs by wireless.

A Big Problem.

The cinematograph shows on the screen sixteen complete and separate pictures per second, any lower speed than this giving an irritating flicker in the eye. As the principles involved in the wireless transmission of photographs and television are very closely similar, there would be no need to take ten minutes for the transmission of a photograph across the Atlantic or for that matter from one side of London to the other (for the distance does not have any bearing on the speed) if a single picture could be sent for television purposes in a sixteenth or even an eighth of a second!

To give but a slight suggestion of other big problems facing the television experimenter, let us take the subject of light. Let us assume that one candle power is required to make a certain picture visible. In the television process a small spot of light has to traverse the whole of the screen sufficiently rapidly for that one spot to appear as a continuous light over the whole area of the picture. The clearest television image yet transmitted was that shown recently in the United States by the Bell Telephone Laboratories. In this case they had 2,500 "dots" successfully lighted up sufficiently speedily to give the appearance of simultaneous light all over the screen, and yet this image was very crude.

An Overlooked Point.

Assuming a total image illuminated at one candle power the dot of light would have to be of 2,500 candle power to give a one candle power effect all over the screen. Such a light, of course, can be obtained and controlled at a high speed but not by the home constructor. A multiple beam reduces the speed and light necessary but adds greatly to the complication of gear.

Then, again, the novelty and fascination of television has led many writers, particularly in the daily Press, to overlook

another point. Even with the most elaborate and most complicated gear handled by experts no one has succeeded in transmitting anything else than faces or objects which have been strongly illuminated close up to the television transmitter. It is not possible by any known system to place a television transmitter in front of a window and reproduce at the receiving end even the crudest suggestion of anything of any size that is seen outside that window, for the exploring of an image in ordinary daylight has not so far proved practical.

What Imagination Can Do.

A few of the problems facing the experimenter have already been dealt with in these pages, and space does not permit me to deal with these in detail, but possessing, as I do, more than ordinary facilities for experimental work I should say quite definitely that serious experimental work in television can only be done with expensive and complicated plant or else with new inventions entirely different from any that have so far been put forward.

Daytona beach at some 206 miles an hour. Perhaps before these lines are in print some other skilful motorist with another superb machine may reach 220 or 230 miles an hour, although those concerned with racing motors and motoring can fully appreciate the perfection of mechanism and the skill required to beat a record of this nature.

By speeding up Mr. Campbell's car ten times, he could do two thousand miles an hour, yet is there any reader of POPULAR WIRELESS who would insult Mr. Campbell by telling him that such a speeding up was merely a "matter of detail"? Before we can get practical television we want the speeding up of certain methods not merely ten times, but something like a thousand times at the very least, while at the same time our light sensitive cells and our luminous responding devices must be at least that many times as good as they are now.

Optical Limitations.

I wish all success to Mr. Baird and the many other television inventors who are working so hard to solve the problem. But



Several people participated, at the transmitting end, in Mr. Baird's transatlantic Television attempt. Here can be seen Miss Howe before the transmitting instrument.

It is so easy to suggest that progress in the transmission of a crude geometrical image or some sort of "blob" which with a stretch of imagination can be regarded as a face, to a proper image which has an entertainment value, is but a "matter of detail"! But a study of hard facts and the optical laws involved prove otherwise.

Malcolm Campbell, to the great credit of British motoring, recently sped along th

Have you purchased your copy of the March "MODERN WIRELESS" yet? You may not be able to secure a copy if you do not hurry up, as there has been an extraordinarily brisk demand for it. The comprehensive articles on the "Melody Maker," "Master Three," and "R.C. Threesome" may provide just the information YOU are looking for.

he and other ingenious workers do need protection from their new friends. It is seriously hampering their genuine work and arousing false hopes to suggest, as some of the less responsible and more excitable writers have done, that the problems of television have been solved and that we are within measurable distance of having practical television services.

What Mr. Baird has done in England a number of other inventors have done abroad and the progress each of them has made is remarkably similar, for they are all "up against" the difficulties and optical limitations of what I can call, for simplicity, the "red-hot-stick" method. Matters of principle and not of detail stand grimly in our path as we travel towards the goal of practical television.

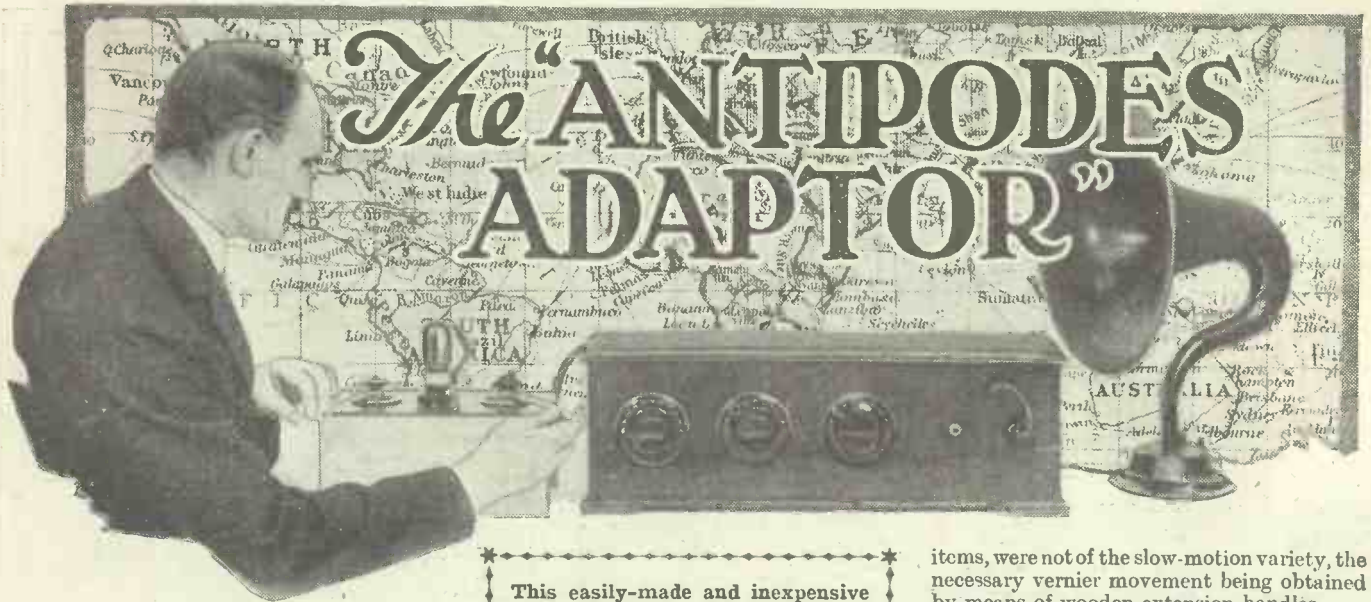

THE simple-looking unit described in this article has received the Australian station 3LO every Sunday evening for four consecutive weeks, despite the fact that it costs little more than £1 to build. No, there is no catch in it provided you are already in possession of a broadcast receiver with one or more stages of L.F. amplification, it is merely that the unit is designed to plug into any such set, thereby turning it into an efficient short-wave receiver.

This easily-made and inexpensive unit will enable YOU to pick up Australia (direct) on your present broadcast receiver.
 By G. T. KELSEY.

detector valve, replacing it with the plug, and to put the valve in the unit.

On paper no doubt it sounds remarkably simple, and that is just about what it amounts to in practice.

Small Cost.

As is the case with all short-wave receivers, the set requires a little more careful handling than a broadcast receiver, but, nevertheless, it is not difficult, and once the knack has been obtained—for such it undoubtedly is—everything should be simple.

So much for what it is and what it does, and now for a description of the construction of the unit.

There is a great variety of components from which to choose, and the total cost should not exceed about £1. In order to keep this cost as low as possible the two variable condensers, which are the biggest

items, were not of the slow-motion variety, the necessary vernier movement being obtained by means of wooden extension handles.

The total cost could have been kept still lower by mounting valve legs direct on to the panel to take the valve, but since it is very desirable to have some form of anti-microphonic device, it was decided to

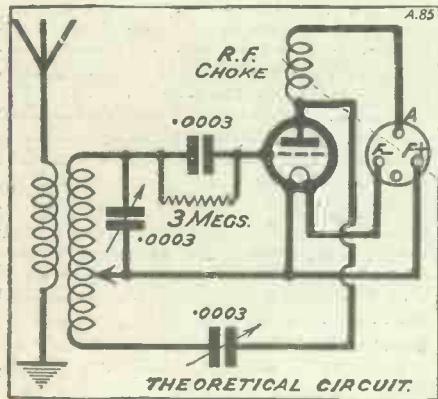

The circuit is simplicity itself.

From opinions expressed by friends it would seem that there are many people interested in short-wave reception, but who feel that to run two sets is an expensive item. In this connection it occurred to the writer that it would be a good idea to construct a single-valve detector unit which could be coupled to the amplifiers of an existing set.

Single Plug Connection.

The result is illustrated on this and following pages. It has several attractive features, not the least of which is the fact that there are no battery connections to fiddle about with, all the necessary links being obtained by a plug which is fitted into the detector valve socket.

Thus, all that it is necessary to do to receive American and Australian stations on the broadcast set is to change over the aerial and earth leads, take out the present

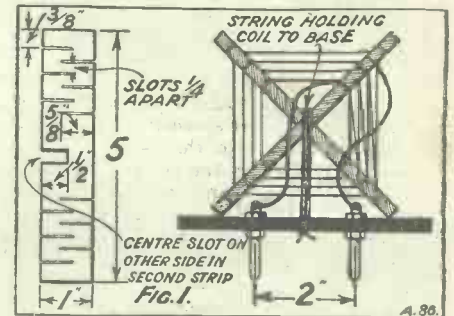

utilise a valve-holder of the type specially designed for this purpose.

With regard to the wooden supports, in the original unit nine-ply wood answered the purpose very well, but of course any suitable wood of the right dimensions will answer. Two pieces, 12 in. x 5 in. x 3/4 in.,

(Continued on next page.)



As shown, the panel is supported on two wooden sidepieces. Note the plug which goes into the detector valve's socket.

THE "ANTIPODES ADAPTOR."

(Continued from previous page.)

will be required, and centrally in one of these a hole should be cut 4 in. long by 3 in. wide. Behind this opening a small ebonite sub-panel is secured drilled to the dimensions given on the back-of-panel diagram. In this particular

YOUR SHOPPING LIST.

- 1 Ebonite panel, 12 in. x 7 in. x 1/8 in. (Radion or other good material).
- 2 Wooden side supports, 12 in. x 5 in. x 1/2 in.
- 1 Small ebonite panel, 4 1/2 in. x 3 1/2 in.
- 2 Variable condensers, .0003 each (Jackson).
- 1 Grid condenser, .0003, and leak, 3 megs. (Dublier, Lissen, Mullard, T.C.C., etc).
- 1 Anti-microphonic valve holder (Benjamin in original).
- 1 Panel-mounting coil socket and plug.
- 2 valve legs and 2 terminals.
- Glazite or square section tinned copper wire.
- Flex, screws, etc.

Cross Coil Requisites.

- 2 Strips of ebonite, 1 in. x 5 in. x 1/4 in. (or ready-made former).
- 1 lb. No. 22 enamelled wire.
- 1 Ebonite mounting strip, 4 in. x 1 in.
- 2 Valve pins.

support four small holes are also required, the use of which will be described later.

Detailed instructions for marking and drilling the main panel are given in the panel lay-out. When drilled the panel can be secured to the two side supports. The piece on which is mounted the sub-panel should be used for the back support.

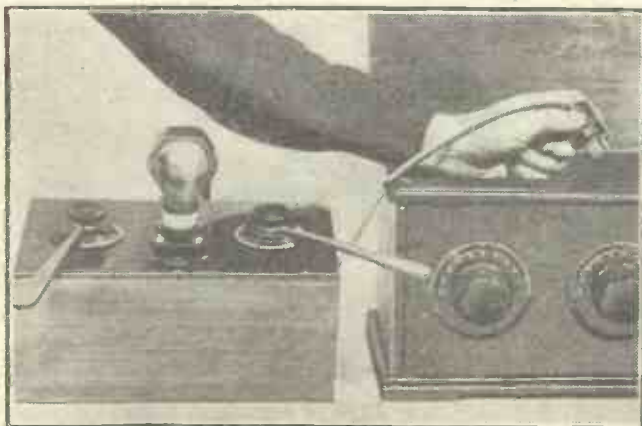

The necessary battery connections are made automatically when the plug is placed in position in the set.

All is now ready for the mounting of components, and accordingly this should be the next operation. I do not think there is any need to go into detailed instructions regarding this job, since any doubts which may arise can be cleared up by reference to the back-of-panel diagram.

Next then comes the wiring. Here again simplicity is the keynote and there is only one small point which perhaps requires elucidation. The flexible filament leads

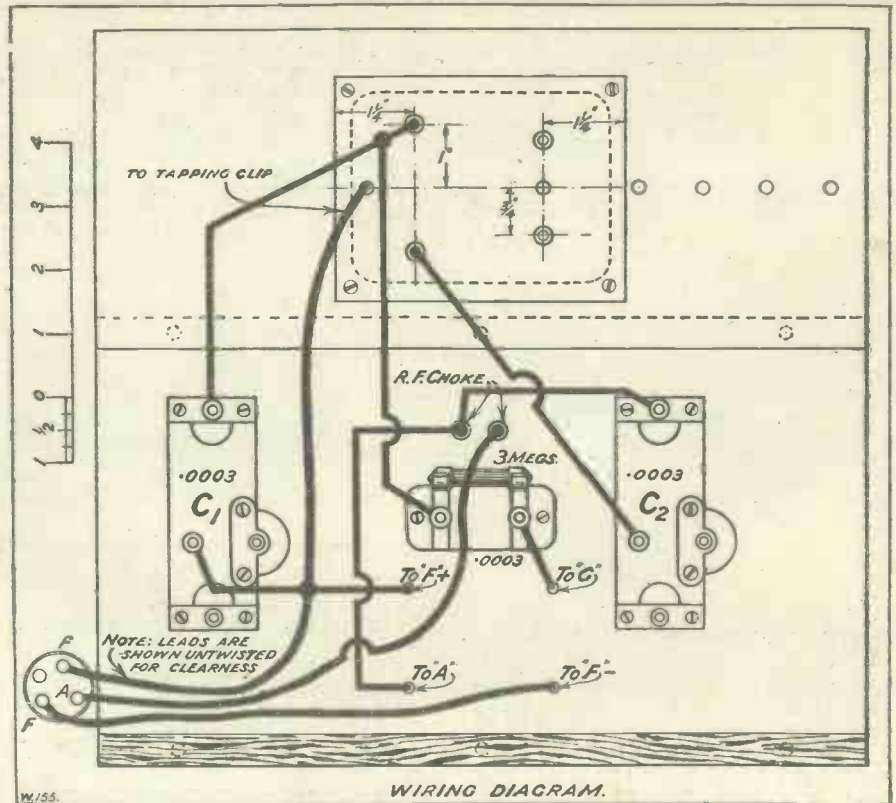

which are shown to the valve plug should be connected in such a manner that when the plug is inserted into the detector valve socket of the existing set, the lead from C₁, etc., is joined to L.T. positive. In other words the filament connections to the plug may in some cases be the reverse to those shown on the diagram.

The Adaptor Plug.

While on the subject, a few words about this plug will not be amiss. A suitable plug with terminals can be obtained all ready for use from Messrs. Lissen.

Alternatively the base of a burnt-out valve can be pressed into service, as was the case in the original set.

There now remain the coils to be made to complete the receiver. These can be entirely home-made, or readers preferring to buy the formers ready-made can do so from Messrs. Burne-Jones & Co., Ltd.

Join the two ebonite strips to form a cross, and after securing one end of the No. 22 enamelled wire to a hole at the junction of the cross, miss the first slot from the centre in each arm, and wind in the second three turns spaced 1/8 to 1/4 in.

Now cross the wire over to the next slot and wind on a further three turns. This point reached, a small part of the wire should be scraped for tapping purposes before the next six turns (three in each

slot as before) are wound. The twelve turns complete the coil and the remaining end should be held secure through a small hole in one of the arms.

The rather unconventional method of mounting shown in Fig. 1 is intentional from the points of view of simplicity and, what is of more importance, "low-loss."

It is not possible to say anything definite about the size of the aerial coupling coil since it is best determined by experiment; however, as a start it is suggested that six turns of No. 22 enamelled wire be wound to a diameter of about three inches. To keep the winding neat a jug or similar former should be used and cotton or thread will suffice to hold the coil together when removed from the former.

Coupling the Aerial.

It is now possible to go more fully into the purpose of the small holes in the back wooden support. First, a wooden rod should be prepared which will just fit tightly into one of these holes. To this should be tied the "milk-jug winding." By means of this rather crude plug and socket arrangement, it becomes a simple matter to vary the degree of aerial coupling.

(Continued on next page.)

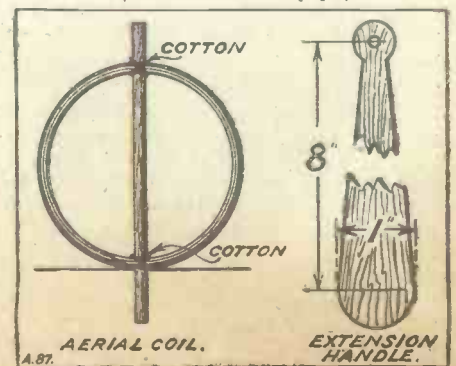

THE "ANTIPODES ADAPTOR."

(Continued from previous page.)

Up to the present I have not mentioned the method of fixing the extension handles. These are finished with a hole in one end (see Fig.), and it is this end which is clamped between the knob and dial. In cases where condensers are purchased with the dial and knob all in one, some other scheme will have to be devised for fixing the extension handles. In passing, let me just mention that these vernier handles are indispensable.

Preliminary Tests.

There is no need to use an aerial and earth lead for the first tests, and accordingly the unit should be coupled to the amplifiers of the set. The detector valve from the set proper should, of course, be transferred

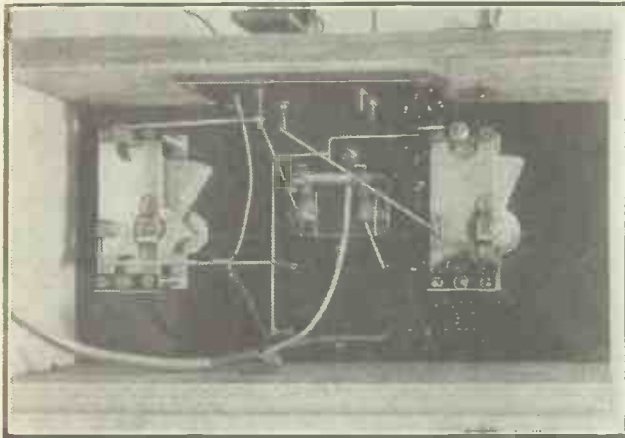

This view of the underside of the panel shows the aerial coil supports. The connections for this coil are external.

to the unit, and a No. 60 or 75 coil to act as a radio-frequency choke should be fitted in the appropriate place on the unit.

The tapping clip should next be joined to that part of the cross coil winding which is free from insulation, and all is then ready for testing.

WIRING IN WORDS.

Join fixed vanes of C_1 to one cross coil socket and to one side of grid condenser and leak.

Join other side of grid condenser and leak through the panel to "grid."

Join moving vanes of C_1 to a flex lead passing through the sub-panel and terminating in a tapping clip, to flex lead to one filament pin on valve plug and through the panel to one filament connection on valve holder.

Join remaining cross coil socket to moving vanes C_2 .

Join fixed vanes of C_2 to one side of R.F. choke holder and through the panel to "A" of valve holder.

Join remaining side of R.F. choke holder by a flexible lead to "A" pin of valve plug.

Join remaining filament pin on valve plug to remaining filament connection on valve holder.

With C_2 (the reaction condenser) at its maximum setting (plates all in), turn C_1 through its scale, making sure that the set will oscillate over the whole range. If any doubts exist as to whether the set is oscillating, touch with a moistened finger the "grid" socket of the cross coil, whereupon, if oscillation is present, two "clicks" will be heard, one upon touching and one when withdrawing the finger.

In the event of the set not oscillating—which condition can be recognised by only one "click" in the above test—the H.T. voltage on the detector valve should be increased.

Now for the aerial test. Join one side of the "milk-jug coil," together with the aerial lead, to one of the terminals on the sub-panel (it does not matter very much to which one), and to the other secure the remaining end of the coil and the earth lead. With the reaction condenser at such a position that the set is just oscillating, bring the aerial coil by means of the plug-and-socket system step by step towards the cross coil, until a position is found at which the unit ceases to oscillate. If increasing the capacity of C_2 fails to start it again, then place the aerial coil one socket further away from the cross coil.

As far as writing goes this, no doubt, reads rather complicated, but it is quite simple in practice.

With the set just oscillating and starting from minimum, the grid tuning condenser should be rotated very slowly by means of the extension handle until a carrier-wave, or, if you can read Morse, until a C.W. station, is heard. In the former case the carrier-wave must, of course, be resolved by decreasing slightly the capacity of the reaction condenser until the set just stops oscillating.

At the outset I mentioned that the unit would be found more difficult to handle than an ordinary broadcast set, and so if at the first test you are not very successful, do not be unduly alarmed. Just get the hang of short-wave operating and, under good conditions, stations will literally "pour" in!

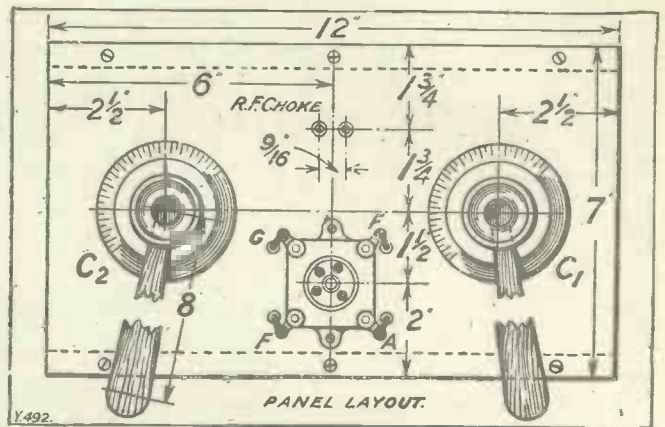

If it is desired to receive short-wave stations on higher wave-lengths than those covered by the 12-turn cross coil, it is quite a simple matter to make another coil for the purpose. The new coil should be made in exactly the same manner as the first, except that 20 turns of No. 22 enamelled wire should be wound on with the tapping as before at the centre. In making this coil it will probably be found necessary to put four turns in each slot, in order to get the full 20 turns on the former.

Short-Wave Stations.

As a rough indication of where to find two of the most important short-wave telephony stations, 3 LO (Melbourne, Australia) will probably be found at 22 degrees on the grid condenser, and 2 X A F (W G Y, Schenectady) slightly above this setting.

Finally, a few words about the best times to listen. Melbourne has for some time been making a regular transmission on 32 metres from 4.30 a.m. to 6.30 a.m. local time every Monday, which corresponds to 6.30 p.m. to 8.30 p.m. G.M.T. (Sunday).

The American stations can usually be heard from about 11.30 p.m. onwards on a Saturday evening. Sunday morning is the "Hams' happy hour," and many telephony stations are usually to be found at about 45 metres.



The method of adjusting the coupling of the aerial coil by means of a "plug-and-socket" system is clearly shown above.

THE RESULT OF THE WASHINGTON CONFERENCE.

FROM A SPECIAL CORRESPONDENT.

THE text of the recommendations arrived at by the delegates of the International Radio Conference which was held at Washington recently has now been published. These recommendations, the result of three months' intensive discussion at Washington among delegates from all nations of the world, deal very comprehensively with the questions of wireless transmission and reception, and incidentally affect very considerably—though, let it be added, generally favourably—the position of the wireless amateur.

These recommendations do not become law until they have been ratified by the various governments concerned, but it may be regarded as a foregone conclusion that, save for minor emendations, the recommendations made by the Conference will be officially adopted in about a year.

Not since 1912 has there been an International Wireless Conference, and consequently the work of the delegates was made vastly more difficult than that experienced by the delegates at the 1912 Conference; for in those days broadcasting was unheard-of, and waves below 300 metres were regarded as useless.

Wave Length Law.

Various conferences between broadcasting interests have, of course, been held from time to time in Europe, but this Conference in the United States was really a big affair, and it is worth while looking at the subject more closely and studying the recommendations in more detail; for, undoubtedly, wherever a wireless amateur exists, he will, sooner or later, feel the effect in connection with his hobby of the Washington Conference.

The most important recommendations made by the delegates are those which deal with waves to be used by the various services such as the Army, the Navy, commercial interests, broadcasting, etc. As our readers know, in Europe broadcasting has exclusive use of the band of waves between 200 and 545 metres, and between 1,550 and 1,875 metres, with the exception of the 220-metre wave which is used by ships. The use of waves in the band from 1,340 to 1,550 metres may also be used by ships, and by the Air services.

These wave-lengths will not be affected until the new Regional Scheme comes into force, for the Committee at Washington agreed upon them as being suitable, but below 50 metres another six bands of waves have been allocated to broadcasting services, and if Empire broadcasting develops to any great extent, transmissions will have to be fitted in below 50 metres.

It is quite possible that by the time the next Conference is held in Madrid, in five years' time, it will be found that short-wave broadcasting will have developed so extensively that the bands below 50 metres will be insufficient, and here is a possible danger to the interests of amateurs. Unfortunately, the Conference did not

decide to prohibit the use of shorter waves by ships—that is, the waves between 300 and 450 metres—for, as many of our readers know, they cause a great deal of interference, especially to broadcast receivers situated near the coast.

But this decisive recommendation could not be made, although the Conference does recommend the prohibition of the use of the 450-metre wave in any place where it might be calculated to interfere with broadcast listeners, and the use of 300-metre wave is prohibited between 6 p.m. and midnight. This prohibition, however, is only for the next twelve months; at the end of the year it is recommended that it be prohibited altogether.

It was found impossible to prohibit the use of spark sets, because, in view of the huge capital which has been sunk in such systems of signalling, especially in ships, it was considered an impossible ban. But there is a recommendation that at land stations no new spark sets shall be installed, and existing spark sets are to be converted to the continuous wave system, which causes much less interference with broadcast receivers, as soon as possible, and certainly not later than 1935. On ships, all powerful spark transmitters are to be converted to continuous-wave transmitters not later

than 1940, and no new ones are to be fitted up after next year.

The Amateurs Status.

The amateur experimenter has come out of the ordeal of the Conference very well indeed, and it is fitting that a tribute should be paid to Mr. K. B. Warner, of the American Radio Relay League, and especially to the American delegates who supported the claims of the amateur so solidly and fairly. Amateurs have six bands of waves below 200 metres, but whether our Government will ratify these recommendations as regards British amateurs remains to be seen. Certainly the attitude of the Post Office delegates at the Washington Conference was far from friendly; and, in fact, according to reports we have seen, our British delegates did everything in their power to reduce the status of the amateur to one almost of insignificance.

The recommendations, however, are distinctly an advance on the facilities enjoyed at present. The actual wave-bands allocated to amateurs are as follows:

150 to 175 metres.—Also to be shared with mobile and fixed services.

75 to 85 metres.—Also to be shared with mobile and fixed services.

41 to 42·8 and 20·8 to 21·4.—For amateurs only.

10 to 10·7 and 5 to 5·35.—To be shared with other experimental services.

We understand from the Post Office that no alterations regarding the regulations affecting amateurs in this country will be made for another year; that is, until the proposals and recommendations of the Washington Conference have been studied by the home services concerned, and until they have been ratified by the Government.

WIRELESS TELEVISION.

Our £1,000 Challenge To Mr. Baird Renewed.
By THE EDITOR.

ALTHOUGH we have not received any direct communication from Mr. Baird in connection with the £1,000 challenge we made to him in our issue of March 10th, we have noticed in the daily Press various answers to the challenge, attributed to Mr. Baird.

Which of these answers definitely expresses the real reason for our not hearing from Mr. Baird we do not know, but as one or two of the answers seem to indicate that as the challenge is personal to him, Mr. Baird cannot accept it, we hasten to amend the conditions in certain respects, and renew our challenge to him in the sincere hope that he will accept.

According to the "Daily Telegraph," the Secretary of the Baird Television Development Company is reported to have said: "Mr. Baird properly treats the challenge as nothing whatever to do with him, because he has turned himself into a Company, which controls the rights of the patents and the policy of dealing with them in every way."

In order to meet this objection, we formally challenge Mr. Baird and the Baird

Television Development Company, jointly or separately, as the Directors of the Company may think fit.

According to the "Daily Express," the Secretary of the Baird Television Development Company is reported to have said: "This challenge is simply a continuation of mischievous attacks made on Mr. Baird. There is no need to answer criticisms of that kind. Mr. Baird is above it."

For Charity.

We fail to see how our friendly challenge, made solely in the interests of television generally, can be regarded as a personal attack on Mr. Baird. However, it may be that Mr. Baird would be reluctant to embark upon a test, success in which would entail the winning of a large cash award. To remove entirely, therefore, any mercenary atmosphere, we amend the challenge in this way: "We will pay £1,000 to any charity Mr. Baird cares to nominate if he or the Baird Television Development Company carry out the conditions of the television test (as given in full in our issue for March 10th) to the satisfaction of the impartial Investigatory Committee."

In all other respects our challenge remains unaltered, and we hope that the emendations now made will enable Mr. Baird or the Baird Television Development Company to overcome any scruples they may have had in accepting it.

We consequently extend the period of time which Mr. Baird may, in a formal letter to the Editor, accept or decline this challenge, for another seven days.

THE symptoms indicative of many faults are now so well known that an immediate diagnosis is often possible with absolute accuracy, but very often after the fault has been correctly diagnosed and remedied, it returns in an inconceivably short period, or possibly another and more mystifying trouble will develop before one has had a chance to forget its predecessor.

Strangely enough, these things all seem to make themselves felt at this time of year, when wireless is in its greatest demand. As with everything else, an explanation is forthcoming. In this country especially, winter means rain, and rain, given the opportunity, makes a damp atmosphere which pervades town and country alike, and even in a house which has been built for a considerable time, leaves unmistakable traces of its presence.

A Faulty Four-Valve.

Wherever there is the slightest possibility of damp affecting a set, one must be continually prepared for trouble in some form or another, as damp will attack a set in many ways; condensation is naturally the most probable, and this in itself is sufficient to cause more trouble than one would ever expect from such a source.

A four-valve set was brought to my attention recently which absolutely refused to function. Inquiries as to the state of the batteries elicited the information that the accumulator was freshly charged, and the H.T. battery only six weeks old. On examination it was found that while the accumulator was in perfect order, the H.T. battery registered exactly nil.

Substituting a new battery certainly effected an improvement, but unfortunately the set was possessed of a terrible L.F. howl, a tendency to fade, regain full signal strength, burst into oscillation, and fade right away again, repeating the process every half-minute or so, and to cap all, a crackle sufficient to remind one of boards being smacked together.

A Bad Case.

On touching the loud-speaker terminal connected to H.T. positive one received quite a violent shock, and one almost as bad from the other terminal. Apart from these faults, the aerial tuning was very flat, and the anode tuning far from its usual setting.

It was next to impossible to control reaction, owing to the tendency above referred to, and no amount of adjustment affected the L.F. howl, which was absolutely earsplitting on four valves, and which necessitated



Queer faults can be caused if you do allow dampness to creep in or on your set.
By C. A. J. MEADOWS.

switching over to three to be able to get any idea of what was happening.

This set was standing in the corner of a room which lay exposed to the full force of the south-westerly gales which had been beating rain against the walls for weeks, almost, on end. The interior of the room had become so damp that after running a hand down the wall the moisture could be not only felt, but seen.

The set was removed and thoroughly dried, the cabinet receiving similar treatment, and when connected up a few days later, was up to its original standard of performance. A number of tests were made while the set was in the condition in which it was found, and proved that there was sufficient leakage to have run down the H.T. battery in less time than was actually the case; this is explained by the fact that fires were alight in the room several times during this period, and, naturally, had some effect on the moisture-covered terminal strip.

The L.F. howl owed its existence to the presence of moisture between the switches, etc., and the discrepancy in the tuning to the saturation of the cotton covering of the wire used on the coils, which was not treated in any way to resist damp. The grid leak, although probably damp-proof internally, was seriously affected, as were all the fixed condensers and coil holders.

The only components which did not appear to have suffered were the valve holders.

It will, therefore, be seen that the effect of continual damp on the different components may be responsible for a variety of widely different faults, which are easily mistakable for others having similar symptoms. The set is not the only thing which is likely to fall a victim to the all-pervading moisture. The loud speaker stands a chance, as do headphones, and, in fact, the latter are far more susceptible.

Effect of Heat.

A loud speaker seems to be better protected, and although it may deteriorate slightly, yet, in comparison with a pair of 'phones subjected to similar conditions, the loss of efficiency is not nearly so noticeable. It takes a good time for the covering on the wire to become saturated; it takes an equally long time for them to get dry.

The aerial and earth system will also suffer, but in different ways; the aerial insulators and lead-in tube may give trouble, as even the best ebonite will in time become saturated, and will allow the H.F. currents to leak through to earth, while if the insulation on the earth lead is affected it may give rise to variations in the resistance of the earth system.

The effect of heat on the components in the set, and on the general performance of the set as a whole, will be for the better, but it is the batteries that will be affected in this case. Heat will cause the jelly or paste inside the dry cells of an H.T. battery to dry up, and this, in turn, will be responsible for the loss of efficiency, which will be reflected in incessant crackling.

One can easily understand that the two opposite causes give rise to a similar effect in this particular, but with the difference that damp will probably work more rapidly and run a battery down in half the time taken by anything except intense heat.

So far, at least, I have not seen a battery thus exposed, the nearest to it being a battery on a shelf immediately above an oil cooking-stove, which would roast it down to less than half its rated voltage in a little over a month.

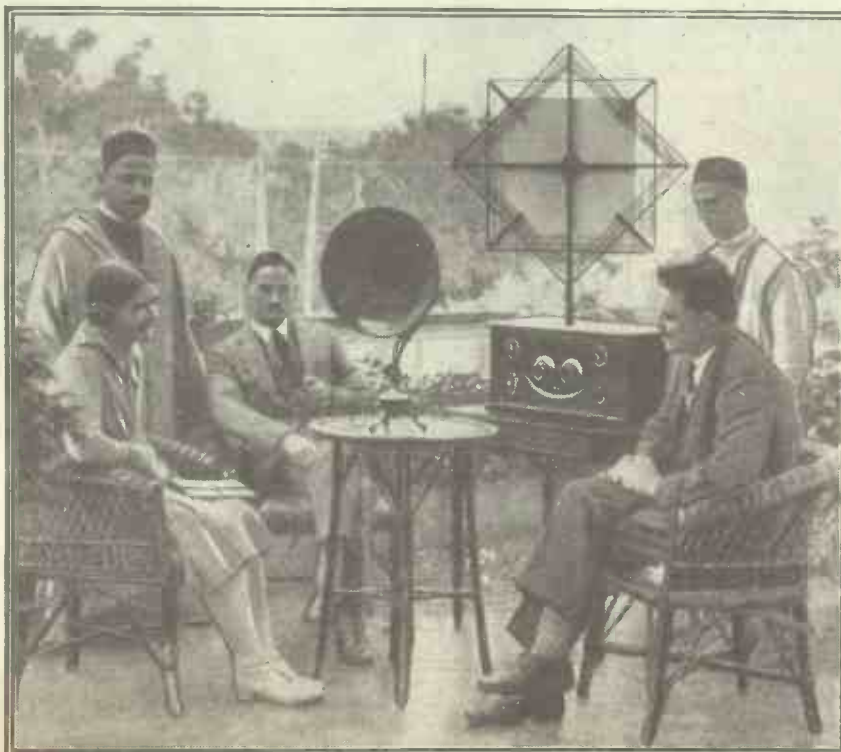

This is not an inappropriate photo to accompany the article on this page. It shows Miss Gleitze, the famous swimmer, listening-in on her receiver at Tangiers!



THE "All-Programme" Three Further Notes

This week the final constructional details are given together with operating hints.

By G. P. KENDALL, B.Sc.

THE special feature of the "All-Programme" Three is really the simple but efficient scheme for switching from short to long waves, and much experimental work was required before this was reduced to its present satisfactory form. Entirely separate tuning and reaction coils are provided for the long waves, and a very simple switching scheme shorts them out completely when working on the shorter wave-band. This is a very important detail, and it is here that so many change-over schemes fail, since they are liable to introduce heavy losses if they are not properly carried out. To reduce still further any chances of losses being produced by the shorted coils when not in use, they are placed at right angles to each other, and the result appears to be entirely satisfactory.

Which Switch?

It will be as well to explain exactly the kind of switch needed for this scheme. What is wanted is a switch in which one contact is joined to two others in the "on" position, while in the "off" it is separated from them. Further, in the "off" position these latter two contacts must be separated from each other, so that in effect the moving contact in the "on" position bridges together two other points, which are normally insulated from each other. Thus, if we call the moving contact "A," and the other two "B" and "C," then in the "off" position "A" will not touch either "B" or "C," and further, "B" and "C" will be insulated from each other.

This may sound a little complicated, but when we come down to practice a very simple solution is found in the fact that there are several ordinary on-and-off switches which meet the case quite well.

An Easy Job.

The actual building of the set is so simple that there is little which I can say which would help you in the process. The photos show exactly how the parts are laid out, and the wiring is quite easy if you follow the diagram and check off each connection on the "point-to-point" list. All that you really need, in addition, is the specification of the coils, and this follows in a conveniently summarised form.

Short-wave unit: L_1 , 60 turns of No. 24 D.C.C., with tapping at 15th turn (20th, if more than 12 miles from local station, and 10th if less than 7 miles). L_2 , 25 turns of

No. 34 D.S.C., in same direction as L_1 . Long-wave unit: L_3 , 150 turns of No. 34 D.S.C. L_4 , 80 turns No. 34 D.S.C., in same direction as L_3 .

Formers: Both are 3 in. in diameter and 3 in. long, and these just take the windings if only a very small space ($\frac{1}{8}$ in.) is left between L_1 and L_2 , L_3 and L_4 . Any good insulating material, such as the new "Super-Pirtoid" Radion, etc., can be used for the tubes.

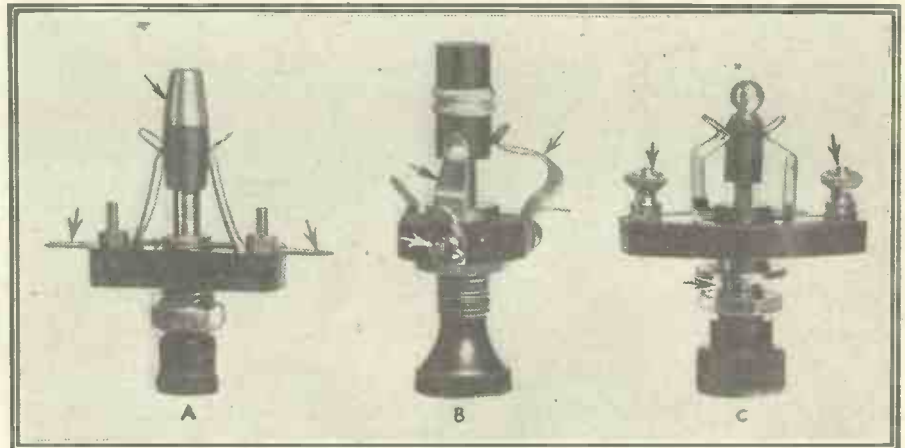

Three types of switch for the "All-Programme." "A" is that used in the original set; "B" is a simple Lissen S.P.D.T., with its long prong bent to make the desired contact; and "C" is a "Lotus" on-off switch. The arrows indicate the three points of connection in each case.

A HANDY TERMINAL MOUNT.

OCCASIONS often arise in receiver design or experimental work when it is desirable to mount a pair of terminals on a wooden baseboard. Obviously this cannot be done directly owing to leakage effects, and it is necessary to support the two terminals on a strip of insulating material. A piece of ebonite may be cut out to the appropriate size and holes drilled and recessed on the underside to take the securing nuts, but if time is a factor it is preferable to press into service a mount already to hand. When this is necessary, I find an excellent idea is to obtain one of the familiar Dumetohm grid-leak holders, remove the clips and turn it upside down. Ter-

Note: If you have any difficulty in cutting out 5 X X on the long-wave band, make a tapping near the centre of L_3 and put the aerial tapping clip here instead of on the tap on L_1 when working on long waves. This is not likely to be needed, but if necessary a tapping can be made by carefully prising up a suitable turn on L_3 after the set is finished.

Operating the "All-Programme" set is simple; it is merely a matter of turning the tuning condenser very slowly and carefully, and keeping the set all the while just below the oscillation point by means of the reaction condenser. Then, if the stations picked up are too strong, reduce the reaction a little and the quality will improve.

Choosing Valves.

Finally, as to valves: For the first and second sockets fairly high impedance, high amplification factor types (up to, say, 30,000 ohms) are advised, with $1\frac{1}{2}$ or 3 volts grid bias on the second (G.B.—1). For the last socket you should certainly use a power valve, and preferably a super power.

Both 2- and 6-volt types can be used, the 2-volt class if extreme economy is desired, and the others for super results. Above all, do not be too modest with the H.T. if you want real results; one hundred volts is really the lowest value which should be used if you want your set to show its merits properly, and even 120 or 140 will be better still.

minals and soldering tags can now be held easily on the end projections used normally for the holding screws, while wood screws pass through to the baseboard via the holes provided for the clips. The sketch shows the idea suggested, and it is very useful, having the additional advantage that the Dumetohm holder is in no way impaired for its primary function when its utility as a terminal mount has ceased to exist.

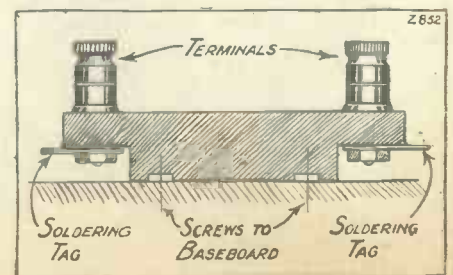

Now, then everybody—”

“D’YE KEN JOHN PEEL
WITH HIS COAT SO GAY?”

As the vast throng takes up the chorus, you catch the infectious thrill of the old Peel song coming to you from afar in fullest volume if your radio set enjoys the power that Lissen gives. For the pure D.C. current of the Lissen H.T. Battery brings a new pleasure to the listener—a new volume and purity of tone to the loud speaker which no other source of power can give.

Equip your set with Lissen Battery power, and know the full pleasure of radio: never again those irritating noises, never again that drop in volume towards the end of the programme. For Lissen power seems inexhaustible; through months and months or use the Lissen New Process Battery supplies smooth-flowing, silent power which lasts undiminished throughout the longest evening’s programme.

You can buy the Lissen New Process Battery from 10,000 radio dealers. Ask for it in a way that shows you will take no other.

you mean
LISSEN



60 VOLT (reads 66 v.) 7/11.

100 VOLTS (reads 108 v.) 12/11.

60 VOLT (Super Power) 13/6.

LISSEN LIMITED (Managing Director: THOS. N. COLE), 8-16, FRIARS LANE, RICHMOND, SURREY

TECHNICAL NOTES.

By Dr. J. H. T. ROBERTS, F.Inst.P.

POWER TRANSFORMERS

USEFUL TAPPINGS—PERIODICITY RANGE—SCREENING LOSSES.

Power Transformers.

IN these days of mains supply units, trickle chargers and electric mains valves, the necessity for small power transformers has brought quite a good number of these very useful appliances on the market. To be really of all round utility a power transformer of this kind should be adapted for use on at least two ranges of input voltage and should have a number of tappings from the output side, rated to give a fair range of voltage when actually on load. As those of you who experiment with power transformers will know full well, there is usually a considerable drop in the output voltage when a load is applied; in other words, the output voltage on closed circuit is usually decidedly lower than on open circuit.

Regulation in Transformers.

The ability of the transformer to maintain its output voltage unchanged even with considerable variations in the load is known as "regulation," and whilst regulation has been brought to a high pitch of perfection with large power transformers, as used in electrical undertakings, it is always a difficult matter to secure anything like the same degree of automatic regulation with very small transformers, such as those used for radio purposes.

It is therefore, as I remarked above, a matter of some importance that the stated output voltage should be the voltage developed at the output terminals when the instrument is actually delivering a current of the rated amount.

Useful Tappings.

It is also a great advantage if the secondary of the transformer is provided with a centre tapping and with a series of pairs of terminals giving equal numbers of turns on each side of the centre. This makes the transformer suitable for full-wave rectification with a single (3-electrode) rectifier in the case of battery charging arrangements and also for use in "eliminators." If there is no centre tapping, it is usually necessary either to employ single-wave rectification or to secure full-wave rectification by using what is known as the Gratz arrangement of three or four rectifiers.

I have been surprised at the meagre specifications and particulars given with some of the power transformers which are on the market. A number of terminals are provided, but it is a Chinese puzzle to know what voltage or current is supposed to be obtainable from them, and as the experimenter is seldom possessed of an alternating current voltmeter, still less of an A.C. ammeter, it is not a very easy matter for him to obtain the required information by direct test.

Periodicity Range.

In this connection, the new Gecophone power transformer designed specially for

use with the Osram-K.L.I. and K.H.I. valves has, amongst other things, the merit that it carries on the nameplate a diagram of connections giving exactly the information required. Incidentally, it is also adapted for use on periodicities of 40 to 100 cycles.

DISCONNECT THAT H.T. FIRST!

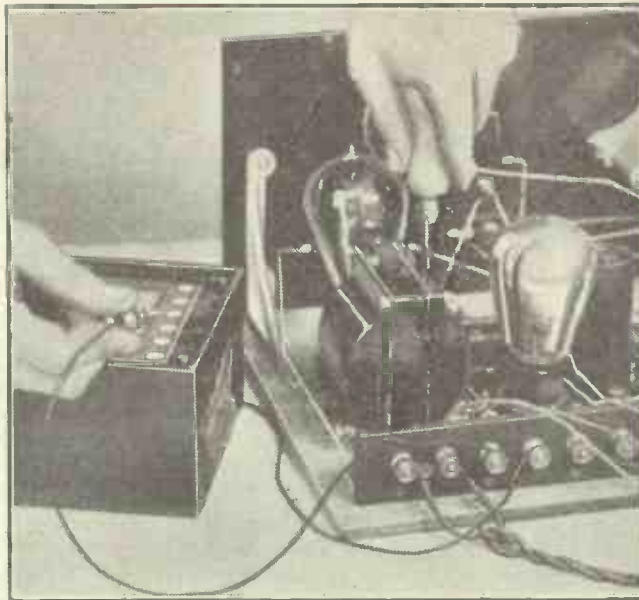

Always remove the negative wander plug from the H.T. battery before making any back-of-panel adjustment. If you fail to take this precaution before juggling about on the baseboard with a screwdriver, the metal part of this may short the H.T. current through the valves, with disastrous results.

NEWS FROM SAVOY HILL.

FROM OUR OWN CORRESPONDENTS.

ATTRACTIVE FEATURES

"SPEED"—CHARLOT'S SECOND SERIES.

Attractive Features.

BELFAST has some very attractive items in the programmes for the week beginning Monday, March 26th, on which day Mr. A. J. Cunningham, conductor of the Londonderry Philharmonic Society, is directing a programme by the Station Orchestra, and during which James McCafferty (baritone) will sing some popular operatic arias.

On the following day Leonard Hirsch, the well-known Manchester violinist, who, before forming that distinguished quartet which goes under his own name, was a member of the Hallé Orchestra, is giving a recital. Wednesday, 28th, brings a per-

Perhaps I should remark that if a transformer is correctly designed for any particular frequency, say 40 cycles, there is no harm in using it for a higher frequency; the danger is in using a transformer on a supply frequency much lower than that for which it is designed; if the supply frequency is much below the rated frequency there is a danger of the transformer being overheated or even of being burnt out.

Screening Losses.

I have often received comments on the system of using metal screening plates at the back of the panel of a radio receiver in order to avoid hand-capacity effects. As you might expect, the criticisms have generally been based upon the fact that eddy currents are set up in such metal

plates, and these currents represent energy losses. For similar reasons, objections have been made to the use of spade-tuning.

Although at first sight these objections seem to be valid ones, it has been found in practice that the losses due to high-frequency eddy currents are negligible provided the amplitude is small and provided the screening plate or the spade of the tuner, as the case may be, is constructed of metal of high conductivity, such as electrolytic copper. As a matter of fact, it is safe to say that were it not for the great developments made in the art of screening, the extraordinary

(Continued on page 164.)

formance of "Cavalleria Rusticana," the opera which has brought fame to Mascagni.

The cast includes Gwladys Naish, Appleton Moore, and Francis Russell. Listeners who prefer something of a lighter nature will look forward to a programme of dance music which is being relayed from a dance given by the Belfast Boat Club on Thursday evening, March 29th.

"Speed."

When one of our correspondents called at Savoy Hill one day this week he found the department over which Mr. R. E. Jeffrey holds sway, agog with preparations (Continued on page 163.)

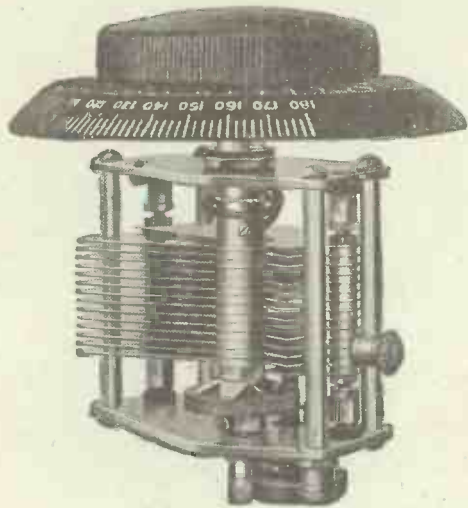

keen critical setting and more uniform separation

The Brandes Variable Condenser has been specially designed to provide a straight line frequency tuning characteristic and to bring in the B.B.C. Stations well spaced out over the major portion of the dial, at the same time retaining the compactness so essential in an instrument at the back of the panel.

VARIABLE CONDENSER

0003, 15/- 0005, 15/6



BIG BRANDES PRICE REDUCTION

The "Brandola" Horn-Type Loudspeaker

NOW 50/-

(Reduced from 57/6)

★ For further information apply to any Brandes Authorised Dealer or post coupon to us.

Brandes

RADIO REGISTERED TRADE MARK PRODUCTS

★ Brandes full range of fine quality instruments include receivers, loud-speakers, telephones and components.

Foreign and Colonial Representatives:

IRISH FREE STATE. Huet Bros., 106/7 Middle Abbey Street, Dublin.
NORTHERN IRELAND. J. C. Holland & Co., 27 Franklin Street, Belfast.
BELGIUM. La Radiophonie Belge, 23-25 rue Van Helmont, Brussels.
SOUTH AFRICA. African Broadcasting Co., Connaught Buildings, Johannesburg.

EGYPT. Eleövrä Radio, 30 Cherif Pacha Street, Alexandria.
DENMARK. Nordisk Elektrisk Apparatfabrik, Haraldsgade 6, Copenhagen.
NORWAY. AJS Diplomingenior Nicoll, Bogstadveien 5, Oslo.
SWEDEN. A. B. Stern & Stern, Regeringsgatan 9, Stockholm.
ITALY. J. B. Bignamy, Via dell'Orto 6, Bologna.

CZECHOSLOVAKIA. Radio Lucerna, Stepanska 57, Prague 11.
MALTA. Muscat's General Stores, 270 Strada Reale, Valletta.
INDIA. Bombay Radio Co., Ltd. 73-75 Queen's Road, Opp. Marine Lines Station, Bombay.
AUSTRALIA. International Radio Co., Ltd., 220 Castlereagh Street, Sydney, N.S.W.

NEW ZEALAND. International Radio Co., Ltd., 91 Courtenay Place, Wellington.
FRANCE. Cie. Nationale Radioelectrique, 5 Rue Tronchet, Paris.
HOLLAND. N. V. Technische Handel-Mij. "Delha," Damrak 62a, Amsterdam.



COUPON
BRANDES LIMITED, 2-3 Norfolk Street, W.C.2,
 Please send me your free illustrated catalogue.

NAME

ADDRESS

P.W. 11.

Brandes' Products are only obtainable where you see this sign.

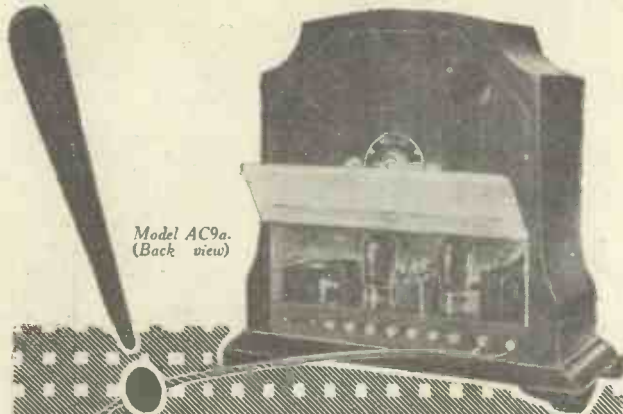

Model AC9a.
(Back view)

Buy or Build The AMPLION CONE AMPLIFIER

A master combination of the world-famous Amplion Loud Speaker with a soundly-designed two-valve amplifier. Prices are as follows: Amplion Cone Speakers with hinged backs ready for home-built amplifiers: Model A.C.7 H.C. (Jacobean Oak), £6:10:0; Model A.C.9 H.C. (Chippendale Mahogany), £7:0:0; or complete with Amplifier, Model A.C.7a, £10:0:0. Model A.C.9a, £10:10:0

Fully illustrated leaflet W.L.26'8, describing both the complete Cone Amplifier and the method of home construction, mailed free on request.

GRAHAM AMPLION LIMITED,
Head Office and Showrooms:
25, Savile Row, London, W.1.

**AMPLION
VIVAVOX**
Gramophone
Pick-up, Type
G.U.I., com-
plete with
volume con-
trol, £2:7:6
extra.

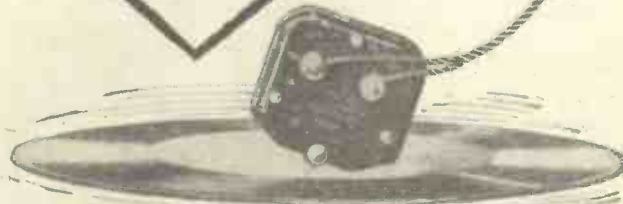

Gramophone Music at its Best

Components of Distinction & Quality

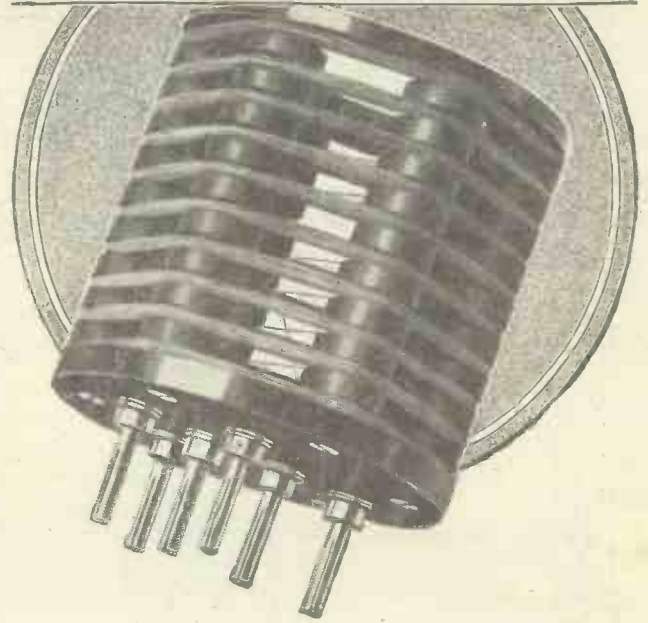

THE COIL for maximum MASTER THREE Efficiency



THE "POPULAR"
L.F. TRANSFORMER.

Suitable either for the
COSSOR MELODY
MAKER or the
MASTER THREE.

3-1 RATIO
297 £1:0:0

Master Three Constructors who have used this Bowyer-Lowe Coil are enthusiastic about the wonderful difference it makes. It enables them to obtain the greatest possible selectivity of this well-known circuit, and to ensure maximum volume of signal strength.

Ask your dealer to prove to you on his Master Three Demonstration Set the difference it makes.

304 Broadcast Coil - - - **7/6**
305 Long Wave Coil - - - **8/6**

306 COIL BASE - - 2/6

Write for the Bowyer-Lowe List of "Master Three" Components.

You can obtain Bowyer-Lowe Components through every good wireless dealer.

IMMEDIATE DELIVERIES



Quality Components

BOWYER-LOWE CO., LTD., Radio Works, SPRING ROAD,
LETCHEWORTH, HERTS.

THE original circuit, reproduced in Fig. 1, probably forms the basis of most existing Trinadyne sets. In the light of recent knowledge, a glance at the circuit reveals at once the obvious disadvantages of unselective tuning, and unsatisfactory control of reaction, besides other minor faults. The H.F. choke between transformer secondary and the grid is not too good as a high-frequency stopper. Another of the troubles of the earlier receiver was valve rectification, due to the valve acting partially as a detector instead of completely as an amplifier.

These defects, however, can be remedied by including just those improvements and gadgets which experience with other circuits has shown to be of particular use in overcoming similar troubles. This entails no drastic change in the circuit or in the construction of the receiver, as you will see

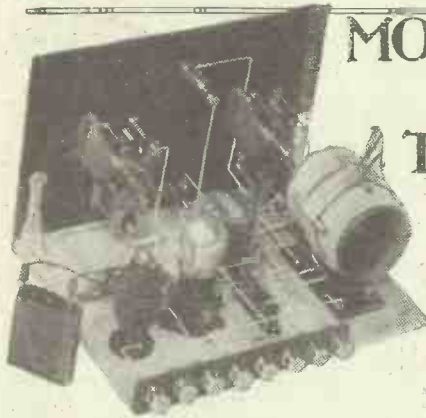

MODERNISING THE TRINADYNE

Simple but effective modifications described by the originator of this famous circuit.
By J. ENGLISH.

the wiring to conform to Fig. 2. The reaction condenser can be just an ordinary pattern, which may be purchased very cheaply. Even if the vanes were to touch at any time the H.T. battery would not be short-circuited, because of the extra feed condenser C1.

For the best results on local and DX work a fresh set of coils, as mentioned above, all wound on one former, are required. Suitable windings for two units to satisfy local and DX conditions on normal wavelengths are given in Fig. 3.

Such units can easily be fitted with plug-and-socket connections to be readily interchangeable. These coils are wound on formers 3 in. in diameter and 4 in. long. The aerial coil in the case of the DX unit is overwound on the secondary in the well-known manner, using pieces of 1/4 in. by 1/4 in. wood 1 1/2 in. long for supports.

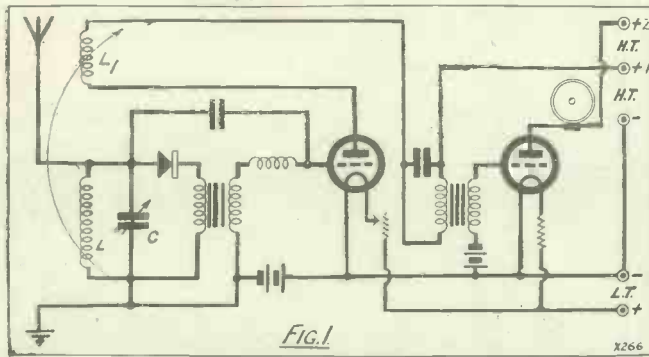

FIG. 1

small one in series, thus obtaining the desired capacity with more certainty of a very high degree of insulation resistance. The original first transformer will generally be satisfactory, for the earlier and cheaper components had small primaries coupling the crystal to the valve. In fact, the best type of transformer, of which there are several cheap types, is one having a fairly small primary with a step-up ratio of about 6 to 1. This gives a large voltage step-up without introducing distortion. The second transformer needs to be a first-class component, and if you are doubtful about the existing instrument buy a new one. It will certainly be worth while.

Coming to the actual constructional modifications of a Trinadyne receiver built to the original circuit of Fig. 1, the main alterations are on the input side of the first valve, the only changes on the output side being the insertion of an H.F. choke between anode and transformer primary, and connecting one side of the by-pass condenser C₂ to filament negative.

Reaction Changes.

The H.F. choke originally used in the grid lead can be placed in the new position, thus saving the expense of a new choke. The resistance replacing the H.F. choke in the grid lead should be of the grid-leak type, such as Dubilier, Ediswan, etc., mounted as near to the grid and transformer as possible.

The correct value is not critical, say 1 to 25 megohm.

The remaining changes are in the tuning and reaction circuits, for which I would recommend new home-wound solenoid coils, which can be quite cheaply constructed. If two plug-in coils were originally used, a third, one size smaller, can be arranged to couple closely to the tuned coil, the reaction coil being left where it is, slight modifications being made in

The Crystal Tappings.

Notice that the secondary of the DX unit is tapped at two points, to either of which the crystal can be connected to reduce damping. A low resistance crystal, such as galena, should be connected to the 25 tapping, and one such as zincite-bornite, or any of the "permanent types," to the 40 tapping, or even across all the coil. By

from Fig. 2, which is the Trinadyne circuit brought up to date. If you carefully compare Figs. 1 and 2 you will see that the changes are quite simple yet very effective.

More Selective.

The new circuit provides for more selective tuning by a suitable form of aerial coupling, while reaction control is much improved by incorporating the popular form of capacity control. The H.F. choke in the grid lead has been replaced by a high resistance R, which is more effective than any choke, while making very little, if any, difference to the strength of signals.

Precautions are also taken to avoid valve rectification apart from choosing the right valve. When rebuilding the set you can use the original by-pass condenser with another

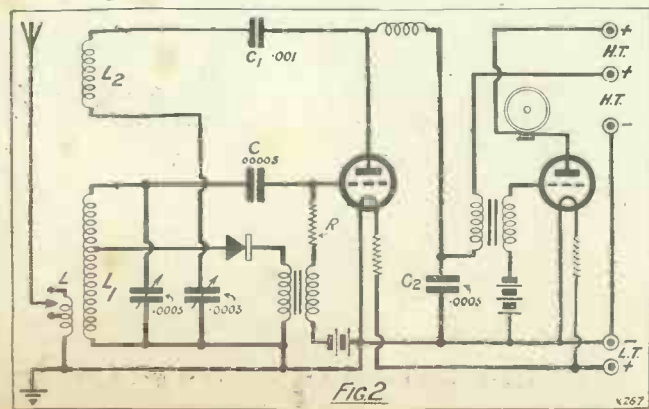

FIG. 2

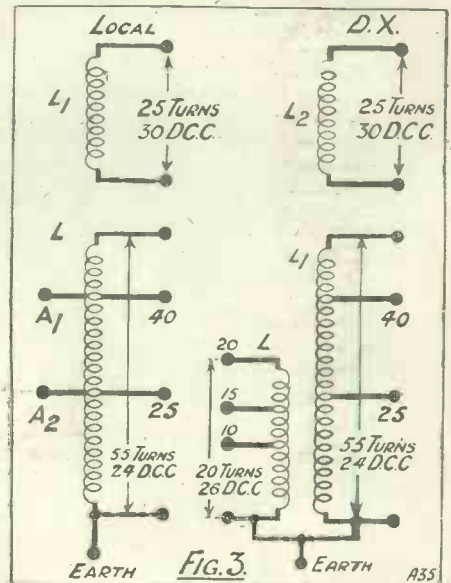

FIG. 3

bringing these tappings to sockets on a piece of ebonite it is easy enough to vary the crystal tap by taking a flexible lead terminating in a wander plug from the crystal.

Although the valves of two years ago gave such good results when used with the Trinadyne, it is astonishing what a difference the modern types make. I would recommend first stage L.F. valve for the Trinadyne position, say a valve with an A.C. resistance of 10,000 to 15,000 ohms, with liberal H.T. and proper grid bias.

If you can meet the resultant H.T. current demands a power, or better still a super-power valve, is the best type for the second stage when using the receiver for local station work.



H.T. BATTERY FAULTS

* ————— *

Some useful hints particularly applicable to the wet Leclanché type.

By J. R. WHEATLEY.

* ————— *

IF carelessly handled, wet H.T. batteries, although efficient and cheap to run, may be sources of endless worry and trouble. Fortunately, the cures for most of their faults are simple. Incorrect electrolyte, poor quality electrodes, corrosion, or containing jars of insufficient size, are the main sources of trouble.

With perfectly new cells, the electrolyte should consist of 3 oz. of sal-ammoniac to one pint of water. Sometimes a peculiar smell not unlike that of bleaching powder is detected. This is due to free chlorine gas, and is generally caused by the use of impure sal-ammoniac. If this should be noticed, thoroughly clean out the cells and rinse with water before recharging with fresh electrolyte.

Cure for Corrosion.

If, after a considerable period, the cells begin to become noisy in use, empty out the electrolyte and fill with a weak solution of spirits of salt and leave for some hours, then clean out and fill with new electrolyte.

Sometimes the zincs become encrusted with a dirty white deposit. This is an oxide of zinc, and is a sure sign that too weak a solution is in use. Also the electrolyte may turn milky, giving forth a very strong smell of ammonia, and this is apt to become intensely disagreeable. The remedy is thoroughly to wash the cells in warm water, and refill with a fairly strong solution of sal-ammoniac.

Owing to the chemical action which takes place, all brass and metal parts of the battery are liable to become corroded. To prevent this, each exposed joint and metal part should be covered with a thin layer of vaseline. Heat a small quantity in a tin and apply it with a brush. A thin layer of paraffin oil, or thin lubricating oil, on the electrolyte of each cell will prevent, to a great extent, this destructive action.

"Amalgamating" the Zincs.

The "amalgamation" of the zincs often advised in text books is really not a difficult problem, but it is surprising how seldom this is correctly carried out. It may not *always* be necessary to amalgamate the zinc electrode, as in some cases the metal has already been treated in this way. A solution of ten parts of water to one of sulphuric acid should be obtained, and a piece of the zinc placed in this weak acid. Excessive fizzing indicates that the metal requires amalgamation.

The rods or plates should first be thor-

oughly cleaned by scrubbing them with a warm solution of ordinary washing soda, afterwards thoroughly rinsing them in cold water. Pour into a saucer a small quantity of mercury, to which should be added sulphuric acid and water, in the proportion of one to four. Holding the zinc in one

Prevents "Local Action."

Do not allow surplus mercury to remain, but gently remove such by means of a brush or a soft rag. This necessity for amalgamation would not exist if it were possible to obtain perfectly pure zinc entirely free from impurities; but, unfortunately, this is practically impossible, as the cost of such a substance would be enormous.

The alternative is, therefore, to amalgamate the zinc element. If this is not done, an effect known as "local action" is set up. This is in reality the formation of minute electrolytic cells on the face of the zinc electrode, between the foreign bodies present in the metal. Such an action may result in the production of miniature atmospherics in the headphones, especially after the cells have been in use for some time.

Batteries should be placed in a dry, cool place (in a cupboard, if possible), well away from metal objects. Perfectly pure chemicals and electrodes would result in a really highly efficient cell, but unfortunately such elements are difficult to obtain. For this reason every possible precaution should be taken in assembling such a cell, each stage being carried out correctly and with care.

PARALLELING VALVES.

THE effect of placing two valves in parallel in the last amplifying stage of a receiver is not to enable that stage of amplification to handle a greater input. And a valve's "grid swing" limitation, by

the way, is a serious factor, and is one of the greatest causes of distortion. There is a very considerable "build-up" in a three-valve (Det., 2 L.F.) receiver. The detector may be able to handle its input, but the second valve may, when the receiver is working on the local station, have to be of a stalwart nature. A so-called general-purpose valve may be of little use here. A robust L.F. or a small power valve may be the type required.

Avoiding Overcrowding.

The magnified input to the third valve needs to be handled by a super-power valve properly used, if overloading is to be avoided, and this is where the majority of 2-volters fail, for in this class there are few whose grid-swing factors are up to the task. Paralleling another valve in the last stage is no solution, for it does not enable that stage to handle any greater input.

This paralleling becomes only of value when any one of the two valves in parallel can handle the input without overloading, but even then one must not forget the limitations of the other accessories employed. Two valves in parallel means double the anode current, and this might mean saturation of an anode choke and a cancelling of the gain. Two L.F. valves of exactly the same type in parallel can be looked upon, for practical purposes at least, as one valve



An H.T. battery of the wet Leclanché type is capable of giving useful orders of currents.

of the same type, having half the impedance. That is to say, two valves of 3,000 ohms impedance, and a magnification factor of four, in parallel, can be regarded as one valve of 1,500 ohms impedance with a similar amplification factor.

There is a Gain.

The retention of the amplification factor and the halving of the impedance is a gain in that the ratio of the voltages across the output and the valve increases. Regarded from another point of view, we can say the "M/I" or "slope" is increased. In effect, the result is a greater current charge in the anode circuit for the given but divided input.

In some circumstances, this may provide noticeably louder signals, although increased magnification where power valves are used is not always the factor looked for. Even so, this paralleling of valves is a little value to the owner of the smaller type of set, and owing to the limitations of most output chokes, rarely of great value to the possessor of the average multi-valver.

NOTES ON THE "R.C. THREESOME"



This design, due to the "Ediswan" people, was one of the very first of the "valve-maker" receivers. It has achieved considerable popularity for its simplicity, compactness, and general efficiency.

By G. V. DOWDING, Grad.I.E.E.
(Technical Editor.)

I SUPPOSE there are quite a lot of people who think of wireless sets only in terms of numbers of valves. And to them one three-valve receiver must be very much like any other set which uses three valves. Actually, as many readers will know, this is far from being the case. One can no more judge the merits or otherwise of a radio receiver by the number of glass bulbs it sports, than one can the speed of a motor-car by its tally of seats.

But the above-mentioned people must not search for the difference in outward appearances or in dimensions. One three-valve set can be as different from another as a mouse-trap can be from a match-box, without revealing it to the unpractised eye. In one way or another, I expect I, or any other experienced technician for that matter, could ring the changes with three valves and produce a hundred different designs without having to think too hard about it. And every one of these would distinctly vary from its fellows in some way or another. Further, I would challenge anyone to say which one was the best.

Factors Which Vary.

There is no such thing as the perfect set. For one thing, the individual requirements of listeners vary enormously; and so do their pockets. And local reception conditions are as variable as either of these factors.

All this is by way of an introduction to a consideration of the "R.C. Threesome"; a three-valve set designed by the Ediswan people and one which has achieved considerable popularity. I want you to steer clear of the idea that it is a standard three-valve set. The term "three-valver" indicates a category, a rough-and-ready means of classification. Don't make your choice of a set primarily by valve numbers. It is possible a two-valver of a certain kind will fulfil your requirements just as well as any three-valver, although again, it is possible for a two-valve set to be more expensive to build and to run than a three-valve set.

Very Compact Three-Valver.

Practically every set will have virtues, but in cases these might be obtained by very serious sacrifices. And in every receiver, save perhaps one designed and built to the individual requirements of a millionaire, there will be compromises. Bearing all this in mind, let us examine

this Ediswan "R.C. Threesome." I have before me as I write all the literature issued in connection with it as well as two representative models which I have had on test on my home aerial.

The first thing that strikes me is that it is one of the smallest three-valve sets I have seen. The front panel measures but 12 in. by 6 in., while the depth of the cabinet is only about 9 in. This smallness will probably have a wide appeal, because there is not too much room in most people's houses for anything that isn't "furniture." And for a radio set to deserve this description means a Jacobean or Queen Anne style cabinet—an expensive kind of article.

Only Two Panel Controls.

There are only two items on the front panel. One is the variable condenser dial for wave-length tuning, and the other is a small knob which operates the reaction adjustment.

There are no terminals on the outside of the set. A multi-wire cable is a feature of the assembly, and this includes all the H.T. and L.T. battery leads. Another

battery, the grid-bias battery, has to be used, but this is accommodated within the cabinet.

In effect this Ediswan "R.C. Threesome" is a small box having two adjustment devices on its front, and a bunch of plainly marked leads flowing from a hole in its side which have to be connected to an accumulator and a fairly large dry battery. The aerial and earth leads and the loud-speaker leads are taken through three other small holes in the cabinet.

"Masterpiece of Simplicity."

The receiver has "innards" unique for their compactness and simplicity. Apart from the grid-bias battery, there are only three items, namely, a coil holder, a variable condenser, and a bunch of three "coupling units" each with a valve holder embodied in it. There is no real construction about this set, and I hope no one who "makes" it will air himself as a "constructor." The Ediswan people have originated a design which is a masterpiece of simplicity. Practically the whole of the

(Continued on next page.)

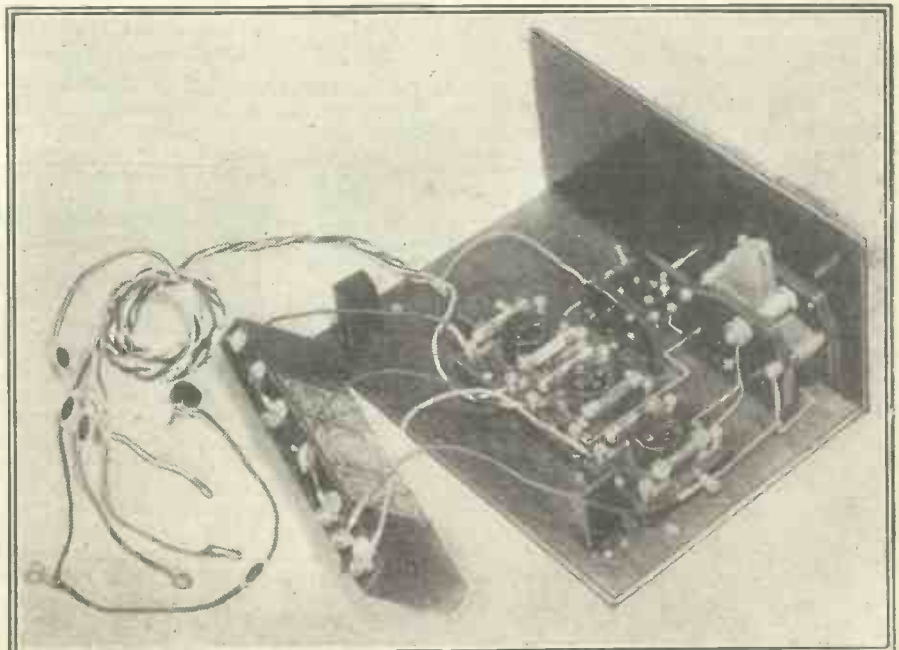

This is the Ediswan "R.C. Threesome" all complete and ready for use. The simple nature of its assembly can be seen from this back-of-panel view.

NOTES ON THE "R.C. THREESOME."

(Continued from previous page.)

circuit relative to the coupling of the three-valves is automatically "wired up" when the three Ediswan "Universal" Coupling Units are plugged together by means of their plugs and sockets before being screwed down on the baseboard.

And, after fixing the variable condenser and the coil-holder in position, there remains but five connections to make (and this can be done without reference to soldering), and the set is ready for use! With the instructions and blue print which are given one would have to have no previous experience whatever to assemble the outfit. The cost is something between two and three pounds excluding the batteries and valves and the loud speaker.

Therefore you will see that the Ediswan "R.C. Threesome" has the following initial merits. It is cheap, and it is extremely simple to assemble. It is compact, and battery connections are facilitated by the provision of plainly labelled leads which issue direct from the interior of the set. There are only two controls.

The Set in Action.

But before we can say sacrifices have been made in order to achieve these virtues, we must consider the question of individual requirements. Here we have a set having certain highly attractive features and, in my opinion, it would be impossible to duplicate these and obtain a better radio performance than that given by the "Threesome." Regarded in this light, it is in many ways one of the best propositions that one could hope to encounter. One might be able to do more with three valves, using them regardless of cost or of any of the above-mentioned points, but many might not think that "more" would be enough to warrant the additional expense and complications. But let us see what the Ediswan "R.C. Threesome" is like in action.

Some time ago I had sent me a complete set of parts. I hooked these up and the results of my tests with the outfit were, in due course, published in "P.W."

Recently I have had both this "hook-up" and a complete "Threesome" made up by the Ediswan people on further tests. I was particularly interested to note that, although a different set of batteries and valves (of similar types) were used, both sets gave results identical to a "dot." It is very seldom that two apparently similar sets will do this, so we must also credit the "Threesome" with consistency, a virtue which also implies reliability!

You will probably remember that the Ediswan people claim for their set that it is "essentially a receiver for the reception of the local and high-power station transmissions; but since reaction and leaky grid rectification are incorporated, many distant stations (at home and abroad) are well within the receiver's range. Just how many home and foreign stations are received at good loud-speaker strength on the individual 'R.C. Threesome' depends on the conditions under which the set ordinarily functions; location, time of day, aerial, earth, etc."

It does not take long to connect it up to the batteries; within a minute or two one has it all ready for action. One rather misses a battery "on-off" switch, but having the labelled leads makes up for this omission. All that one has to do to switch the set on or off is to connect or disconnect one of the L.T. leads, making sure, however, that this lead does not tend to stray in the direction of the H.T. battery. (The other batteries go out of action immediately when the L.T. is disconnected.)

One must keep very close to the specified battery voltages and must use the valves recommended, otherwise the set will not function at its best. With all the batteries joined up, and the aerial, earth, and loud-speaker leads taken to their correct points, one can commence tuning in stations.

The Reaction Adjustment.

The coils plugged in one of my particular sets were those which are shown in the book of instructions as being capable of covering 330 to 500 metres; an extremely useful range. The dial on the left of the panel (variable condenser) does the actual wavelength tuning, and the central knob by operating the moving coil-holder controls

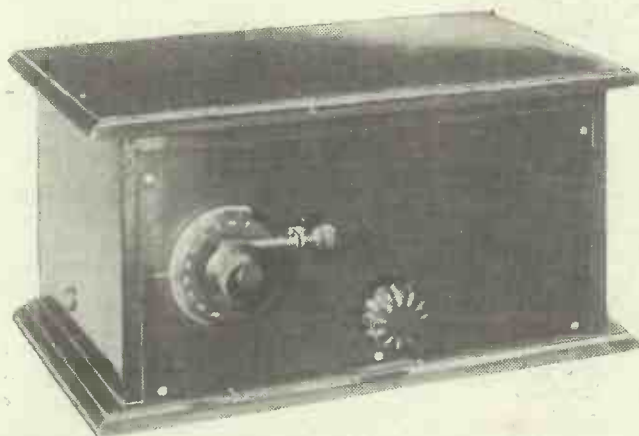

Only two items figure on the front panel of the "R.C. Threesome," viz., a reaction and a tuning condenser control.

the reaction or sensitivity of the receiver. The closer the coils are brought together by the coil holder the more sensitive the set should become. But they must not be brought so close together that variations of the tuning dial cause a whistling or howling. Keep back from this point, or you will interfere with the reception of your neighbours.

Several Stations Available.

To get back to my test. I easily found 2 L O and 5 G B. Both of these stations came through extraordinarily well. The loud speaker in use was a fairly large cone, and the reproduction was everything that one could desire for real programme enjoyment. Speech was clear cut and the music was round and mellow. There was ample volume for the rather large room; as a matter of fact, it was necessary slightly to detune 2 L O at eight miles distant in order to reduce the volume to a comfortable degree.

With moderately careful use of reaction I was able to bring in Langenberg with a trace of 5 G B in the background. Hamburg came through very clearly a few degrees further down the dial. The "R.C. Threesome" has a fairly useful degree of selectivity, and

if serious interference had been experienced I could very easily have increased its selectivity.

Right at the very bottom of the dial, at practically zero, I found Breslau, and this station was received quite as clearly as Langenberg. With large coils in, 5 X X came through practically as well as 2 L O. One or two other stations were audible, but not loud enough to make them useful as programme providers,

For Further Details—

That makes, however, a round half dozen stations that were well worth listening to, three of them coming through with ample reserves of power and with excellent purity. And in passing it is well worth noting that, owing to the type of circuit and valves employed, the H.T. consumption is abnormally low.

So in conclusion you will see that the Ediswan "R.C. Threesome" is a proposition very well worth serious consideration. It gives the impression that within its admitted limitations it is the very best thing of its kind in existence. Whether you think so, too, depends entirely upon your present radio requirements.

The many little points in its construction that I have noted, and ways in which it can be made more selective and so on, together with technical circuit details, appear in an article I have written for the March issue of "Modern Wireless." If you are interested in this Ediswan "R.C. Threesome" receiver or the Corsor "MelodyMaker" or Mullard "Master Three," I would advise you to get that "M. W." I have spent a considerable amount of time with these sets, and have garnered some very useful notes concerning them.

ITEMS OF INTEREST.

A counterpoise earth requires the same careful insulation as an aerial.

A rubber covered wire attached to the fence and running along underneath the aerial makes a good counterpoise earth.

The use of a counterpoise instead of a direct connection is often very successful in eliminating hum due to electric light and power mains.

There are some very helpful hints on handling a set in the B.B.C. oscillation pamphlet, which is obtainable free on application to 2, Savoy Hill, London, W.C.2, or to any British Broadcasting Station.

When a potentiometer is used for H.F. or detector circuits, a small fixed condenser should be used as a bypass between the slider of the potentiometer and that end of it which is connected direct to the filament of the valve.

HOW TO USE YOUR GRAMOPHONE

AS AN ORCHESTRA FOR REAL DANCING!



Use the Lissen Electrical Pick-up on your gramophone and you can amplify the music, adjusting the volume with the round milled nut provided until it fills the largest room or hall. You can dispense with an expensive orchestra and yet enjoy real dancing to the finest bands.

The Lissen Electrical Pick-up helps your gramophone to reproduce the low notes of the music more perfectly than ever you have heard them — it takes the needle scratch from old records and makes new records last longer.

LISSEN ELECTRICAL PICK-UP 15'

INSTRUCTIONS:

Replace your sound box with the Pick-up, connect from Pick-up to Grid Terminal of the Lissen Pick-up Adaptor and to one filament terminal of the Adaptor. Plug the Adaptor with valve fitted in it into the Detector Valve Socket of a two or three valve set.

Full particulars included in every Adaptor Carton. Obtainable at most dealers, but if any difficulty send direct to factory (post free or C.O.D.).

LISSEN LTD., 8-16, FRIARS LANE, RICHMOND, SURREY

(Managing Director: Thomas N. Cole.)



H.T. SUPPLY at your finger tips

Right in your own home is current waiting to be used? Just plug the flexible cord of a Marconiphone H.T. Supply Unit into the lamp-holder, switch on, and you obtain continuous and steady H.T. current requiring no attention and no renewal, and costing a negligible amount for upkeep.

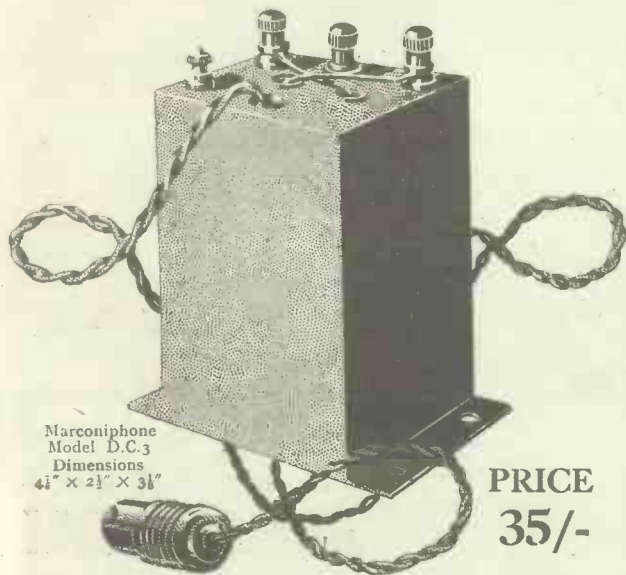

Marconiphone
Model D.C.3
Dimensions
4 1/2" x 2 1/2" x 3 1/2"

PRICE
35/-

*Marconiphone
Model D.C.3*

Price 35/-

for D.C. Mains for 1 and 2-valve receivers only. For 100 to 125 or 200 to 250 volts. Two tapplings.

There are also models, both A.C. and D.C. for receivers with three or more valves. Full particulars on request.

MARCONIPHONE H.T. SUPPLY UNITS

THE MARCONIPHONE COMPANY LIMITED,
(Dept. P) 210-212, TOTTENHAM COURT ROAD, LONDON, W.1



BRAINS!

RADIO Valves are the brains of your Wireless Receiver.

When you buy a new set look to the Valves. In nine cases out of ten you will find that they are Six-Sixty Valves—first-class Valves that are fitted as standard by Britain's leading set manufacturers.

Fit a new set of Six-Sixty's in your existing set. We need not tell you to notice the difference; it will be obvious at once.

Six-Sixty Valves are non-microphonic, are matched valve with valve, and give perfect electrical balance.

There is no Radio Valve like Six-Sixty, and no other Radio Valve is as good.

We publish a booklet that will plainly tell you why. Ask for a copy at the nearest radio shop, or write direct to us

**All types and voltages,
from 10/6.**

USE ONLY



THE ELECTRON CO., LTD.,
122-124, Charing Cross Road, London, W.C.2.

Telephone: Regent 5336.



SOME FURTHER H.F. PROBLEMS

Mr. Allinson has spent a considerable amount of time on research in this direction, and the accompanying article describes some of his latest interesting results.

By C. P. ALLINSON, A.M.I.R.E.



A friend rang me up and complained that a receiver which he had just made (using the split-primary circuit), which neutralised perfectly with 6-volt valves would not neutralise with 4-volt ones, and I therefore decided to investigate this, since I was at the time working on the split-primary circuit, and see if I could find out to what this was due.

I therefore took out the 6-volt valves which I was using in a 2 H.F. amplifier and put in 4-volt valves. Sure enough I found that I could not obtain a zero signal point with the H.F. valve turned out.

It was therefore clear that the trouble my friend was experiencing was not due to any peculiarity in his own receiver, but was due to some other cause.

The first thing that occurred to me was that possibly the primary of one of my H.F. transformers might be reversed, and even if it were not I thought that I might just as well try the effect of reversing the connections to this coil.

Different Settings.

Now, in both cases I found that the setting of the neutralising condenser, which gave the zero signal point with the valve cold, was not the setting at which the set was stable. This, I found, depended on the direction of the primary and neutralising windings. With the standard connections the set, when neutralised with the valve cold, was under-neutralised when the valve was hot. This is what we should expect, since the effective grid to plate capacity of the valve is greater hot than cold. With the primary and neutralising windings reversed, however, I found that the reverse occurred, that was, that when the valve

was neutralised cold it was over-neutralised when hot.

I found, further, that with the primary and neutralising windings reversed I could obtain a definite neutralising position with the valve cold when using 4-volt valves, whereas I could not do so with the standard connections. This applied, however, only to the H.F. stages not adjacent to the detector valve.

The H.T. Test.

In the case of the H.F. stage which preceded the detector valve I found that if the standard connection were used for the primary and neutralising winding of the H.F. transformer coupling this valve to the detector, the minimum value of the neutralising condenser was too large to obtain true neutralisation, whereas with the windings reversed the maximum value of this condenser was too small. Since all these preliminary experiments were carried out with the old type of screen, which covers the coil only, some of my findings which will be described in later paragraphs, will be of particular interest to those who have had any difficulty with regard to stability in a 2 H.F. amplifier using the split-primary circuit. The chief trouble which I experienced with this H.F. amplifier was instability when more than a certain value of H.T. was employed.

Now, to my mind, the true test of an H.F. amplifier is that it should be capable of standing 100 to 120 volts H.T. without instability occurring, since otherwise the full amplification is not obtainable from the valves.

That this is the case will be realised from a brief examination of valve characteristics. These show that with an increase in plate voltage the mutual conductance of a valve increases so that the efficiency, which is a function of the amplification factor of the valve (which is constant) and the mutual conductance, which is variable, would

increase with an increase in plate voltage. This increase, as a matter of fact, is very marked, and I was anxious to be able to use at least 100 volts on the H.F. amplifier in order to get the maximum amplification on very low inputs.

Now, I found that one of the difficulties to be experienced with the primary circuit was that if the receiver were correctly neutralised, say on the lower wave-band, it would not be found to be correctly neutralised at the top and vice versa, and I therefore determined to investigate this point. Notwithstanding the fact that the neutralisation position when cold was not the same as when hot, I concluded that if all the readings were taken with the valve cold, they would give a definite indication as to what was occurring when the valve was hot.

Effect of Screening.

One of the H.F. valves was accordingly neutralised in the cold state at the bottom of the condenser scale in the neighbourhood of 250 metres, the necessary signal being provided by a local modulated oscillator. The greatest care was taken in obtaining the setting, and the wave-length of the local oscillator was then shifted up to about 500 metres. With the standard winding it was found that the receiver was now over-neutralised, whereas when the reversed winding was used, the neutralising was found to hold over the whole scale and, further, it was found possible under these circumstances to use a larger value of H.T. than with the standard connections.

The effect was next tried of removing one or two of the screens to see what would result as regards stability, and also the signal strength given. With a screen removed it was found that the value of the neutralising condenser had to be increased for the neutralising setting to be obtained when standard connections were used. With the primary reversed, however, less neutralising condenser was required when the screen was removed.

Removing the screen from one of the H.F. transformers was found to result in an increase of signal strength from 104 to 108. Two screens could not, however, be removed without instability occurring.

(Continued on next page.)



Some of the H.F. transformers which the author used in connection with the interesting experiments and tests described in the accompanying article.

SOME FURTHER H.F. PROBLEMS.

(Continued from previous page.)

In the case of the detector, when removing the screen, a marked increase in signal strength was noticed, and it would appear from the readings I obtained then, as well as from conclusions I had previously reached during the course of my experimental work, that the use of a screen which fits closely round a coil has a greater detrimental effect on the performance of the detector valve than on the H.F. valve. I have found, indeed, that the use of an ordinary screened coil in a detector and L.F. receiver results in a very marked loss in signal strength, and cannot always be made up by the use of reaction. I do not think that I am alone in having reached this conclusion.

Reversing Transformer Windings.

As the result of the experiments I had carried out up to this point, I had found quite definitely that by reversing the

primary and neutralising windings, but as far as I could tell from such measurements as I did make, and from the use of the receiver under practical conditions, an improvement was obtained by the use of the reversed primary winding, the improvement being in the neighbourhood of 5 per cent to 10 per cent.

A Further Test.

It is also very difficult to say whether this improvement was only due to the reversal of the windings, since the apparently simple reversal of two connections may bring about far more complex variations in the circuit concerned. Thus it may change the capacity coupling existing between the anode of the H.F. valve and the grid of the following one. It may further alter the damping introduced into the anode circuit from the succeeding grid circuit, while the leakage inductance between the two windings is also affected.

Under these circumstances I can only say that I found an improvement, but I could not definitely determine to what it was due. The final test as to the stability of the reversed windings was obtained by using 100 volts H.T. and seeing how far down I could get without instability occurring.

valves would now neutralise correctly where they would not do so before. I still found certainly that when the valve was neutralised in the cold state it was not stable when hot, but the same results were found as before, namely, that the valve was under-neutralised.

No difficulty was experienced in stabilising the two stages of H.F. when working under practical conditions, either by the "click" method or by the "maximum reaction demand" method which has been described by Mr. Kendall.

It was certainly impossible to obtain quantitative measurements with a view to obtaining the amplification obtained with the screening boxes as compared with the amplification given when the screened coils only were used, but in practice it was certainly found that distant stations came in at greater strength, while an improvement in selectivity was observed owing to the coils not being so heavily damped as before.

Parasitic Oscillations.

The damping introduced by the old screens can be quite considerable, as was shown when I reversed the primary and neutralising windings when using the coils in the screening boxes instead of the old screens. Whereas before complete stability was obtained by reversing these windings in the boxes it was not found possible to stabilise the H.F. valves with the reversed windings with some transformers. Others still remained stable, and some experiments with transformers I wound up myself enabled me to find out why these different results were obtained.

The oscillations which were produced were not at the fundamental frequency of the coil, but at some parasitic frequency, and were definitely due to the much lighter damping resulting from the use of the "copper cubes."

I found, however, with the long-wave coils that I still obtained parasitic oscillations when the reaction on the detector valve was increased, and I was inclined to suspect the H.F. reaction choke.

I had had trouble with H.F. chokes giving rise to parasitic oscillations before, and it occurred to me that this was happening again. I finally came to the conclusion, however, that I was maligning this component, and an examination of the actual construction of the H.F. transformers soon laid bare the secret of the source of these parasitic oscillations.

Why Reaction Was Poor.

It was much to my surprise that I found on stripping down the coil that the reaction winding was carried on the same former as the primary winding. Now, the circuit into which we actually desire to react is the grid circuit of the detector valve, and it is therefore to the grid winding that our reaction winding should be coupled. It does not matter whether we are using ordinary magnetic reaction or whether we are using capacity reaction, the H.F. impulses are fed back through the reaction control and should be fed into the grid circuit of the detector valve.

Now, with the form of construction employed the result is that we are feeding not directly back into the grid circuit. The reaction winding is coupled to the anode winding and neutralising winding of the preceding H.F. valve as well.

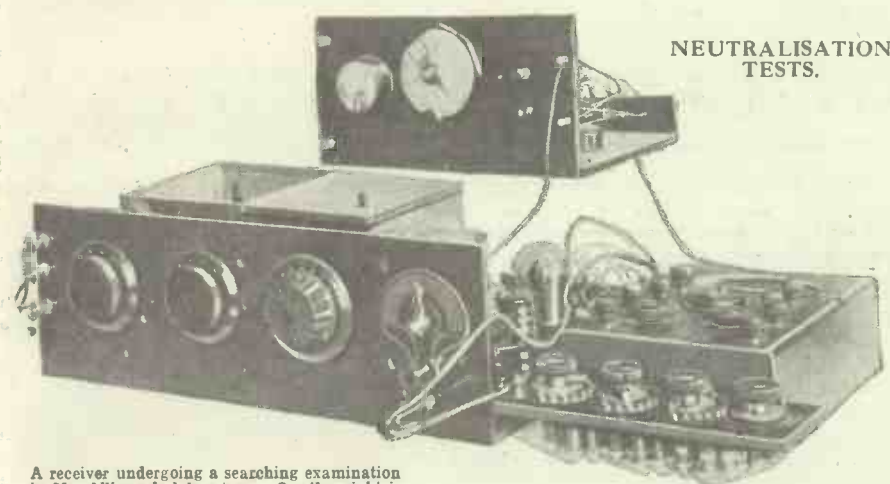

A receiver undergoing a searching examination in Mr. Allinson's laboratory. On the right is the sensitive large-scale meter and "resistance box," while in the background is the precision H.F. measuring device. Mr. Allinson discusses the results of some of his experiments in this article.

primary and neutralising windings it was possible to obtain stability over the whole range covered by the tuning condensers with greater ease than in the case of standard connections, while I could also use a higher value of H.T. on the anode of the H.F. valve without the receiver.

These experiments were carried out with several different makes of split-primary H.F. transformers, as I was anxious not to have the issue confused by any peculiarities of individual makes.

Ten Per Cent Better.

In order still further to make certain, I used 4-volt valves throughout these tests, since these had shown themselves, with the standard connected primaries, to be more liable to instability than 6-volt valves.

In view of the fact that the stable position was not necessarily that at which the valve neutralised when cold, it was very difficult to make any quantitative measurement with regard to the amplification given with the two different connections of the

I found that with reversed windings I could get down almost to 180 metres (that is London's first harmonic) without oscillation occurring, but in the case of the normal connections to the primary and neutralising windings it was not found possible to do this with even as low as 45 volts H.T., H.T. accumulators being used.

Having determined this much by the experiments carried out with the old-fashioned screened coil, I now determined to strip down the H.F. amplifier and try it out with the new copper boxes which have been evolved by Mr. G. P. Kendall for use in H.F. amplifiers.

The two stages of H.F. were accordingly rebuilt, using these screening boxes, and it was immediately found that the set was now working under very different conditions from those obtaining previously.

With the standard connection to the primary windings it was found that complete stability was obtained over the whole range covered by the tuning condenser with 100 volts H.T., and that the 4-volt

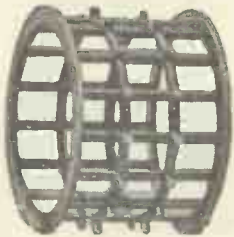

Coil Former.



Secondary Coil.



Primary.



The Fixed Condenser.

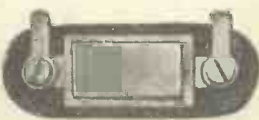

Internal View of Fixed Condenser.

FERRANTI

AUDIO-FREQUENCY

TRANSFORMERS

The true measure of a Transformer's merit is its Primary Impedance. FERRANTI has the highest impedance of any Audio Frequency Transformer made—*anywhere*. Therefore it reproduces the low notes better than any other. For over 40 years FERRANTI have designed and built Transformers of every type, and the high quality of the Audio-Frequency Transformers was to be expected from that unequalled experience. The core metal is the best obtainable. The joint of each lamination is almost perfect and the air space is so small as to be immeasurable. This feature alone has won high praise from Engineers. There are miles of coiled Wire thinner than fine hair, enamelled and tested every foot of its length. The coil winding is done by unique machines specially designed by FERRANTI Engineers. FERRANTI craftsmen concentrate their experience upon every minute detail of construction. The tests carried out at each stage of the manufacture and on the finished product are so complete that it is very nearly impossible for any Transformer sold to depart appreciably from the high standard set up. That is one reason why FERRANTI products are famed the world over.

The finished Transformer is totally encased in a metal shroud, stove enamelled, with damp-proof joints. Markings gold and black. Three views above indicate the adaptability of movable feet—detachable for placing in any position.

Coil Formers are of special Ferranti design to ensure low self-capacity. Note the great sub-division of the windings.

Secondary Coil. Notice this typical Ferranti Construction, using an insulated spider with windings sub-divided.

Primary. Wound on two coil formers respectively interior and exterior to the Secondary, it helps inductance, raises impedance and reduces magnetic leakage and self-capacity.

Fixed Condenser. It is of correct capacity required, .0003 mfd. This mica insulated condenser is especially moulded into the terminal block, immune from moisture, and ensuring highest insulation. Incidentally it saves money. No separate condenser required as with other transformers.

It's good if it's made by FERRANTI

FERRANTI LTD., HOLLINWOOD, LANCASHIRE.
BUSH HOUSE, LONDON.

Write for the Ferranti Catalogue.
Delivery of A.F. Transformers is
being made in strict rotation.

Each the best at its price

It is the Igranic policy to cater for every need—for the man who wants the best at any price and for the man who wants the best at a popular price. These two low frequency chokes are the result of this policy. At their respective prices, they represent the finest value in chokes on the market.

Igranic L.F. Choke, Type "G"



This choke is outstanding as having the exceptionally high maximum inductance of 370 henries. This makes it the ideal choke for intervalve coupling. Provision is made for connecting the sections in parallel when it makes an excellent output filter choke with an inductance of 40 henries at 15 milliamps. The iron circuit is so massive that saturation is impossible under ordinary working conditions.

Price 27/-.

Igranic L.F. Choke, Type "F"



A choke giving really remarkable value. Its popular price brings a really efficient choke within the reach of everybody. The sections may be connected in series or parallel, making it suitable for either intervalve coupling or as an output choke. The maximum inductance is 73 henries in series, and 21 henries in parallel.

Price 15/-.



Send for List No. R83 which gives full particulars of these and the many other Igranic Radio Devices.

149, Queen Victoria Street, LONDON, E.C.4.

Works: Bedford.

Branches: Manchester, Birmingham, Newcastle, Leeds, Glasgow, Bristol, Cardiff.

A SPECIAL FREE BLUE PRINT

of
THE "MELODY MAKER"
THE "R.C. THREESOME"
and
THE "MASTER THREE"

is given away with the March issue of

MODERN WIRELESS

A long article containing constructional and operating details of these three popular receivers is also included, and should be read by all home constructors.

Obtainable Everywhere.

Price 1/-

GET YOUR COPY NOW.

Make your "Standard" H.T. Battery from 6^D UNITS

OBTAINABLE FROM WOOLWORTHS STORES

Now you can call at the nearest Woolworth's Stores and inspect these wonderfully efficient Standard Wet H.T. Battery units. At only 6d. each these 1½ volt No. 2 cells (completely assembled) have scored another triumph of value for the famous "Nothing over 6d. stores."

The "Standard" cells can be connected in series with your present dry battery or accumulator until you have built up the voltage you want. Simple instructions given free. Standard Electrolyte chemical in 6d. bottles.

Banish all your battery troubles by installing this permanent battery now. Make sure the name "Standard" is on every bottle.

Write for interesting free booklet to Wet H.T. Battery Co. (Dept. A.), 12-13, Brownlow Street, High Holborn, W.C.1.

All types of Standard batteries are also obtainable from Halford's Cycle Stores and Wireless dealers.



STANDARD
Permanent H.T. Supply

OUR TELEVISION ARTICLES.

The Editor, POPULAR WIRELESS.

Dear Sir,—After reading your articles in "P.W." and "M.W." on Television, one comes to the conclusion that Mr. Baird has been, and is, on the eve of Television! To-day I found the enclosed cutting and decided to bring it to your notice. It is signed as "Candide."

New Discovery.

"I understand that Mr. John L. Baird, the Scottish inventor of television, is on the eve of another astounding discovery. It will, it is claimed, revolutionise telegraphy. Messages will be sent at such great speed over any distance that reception and transmission will be practically instantaneous. Details are not yet available, but the development of the television principles ensures its ultimate success."

Here we are told that Mr. Baird is on the eve of another "astounding discovery." If his idea can supersede a 250-words-per-minute method of telegraphy, it must be water-cooled, or else does not actually work as telegraphic transmission. The principle on which it works must be to increase the speed of wave propagation. At least, that is how I read it!

Anyway, I for one agree with your articles on Television, and, further, I do seriously hope our inventor will have an early dawn to a few of his "eves," because he is straining the public rather hard, as, I fear, he will soon find out.

Yours faithfully,

J. A. KAYE.

Bramley, Leeds.

ACID AND THE CARPET.

The Editor, POPULAR WIRELESS.

Dear Sir,—I was very interested, as a carpet expert, to see your illustration and description of how to remove acid from a carpet when spilt, and it led me seriously to think, because all carpet houses are to-day receiving letters from their customers something in this strain:

"Some time ago we purchased a carpet from you, and beg to inform you that it is going into holes, showing that the carpet must be made of rotten material. It has had very little wear—only two in family, and house shut up for more than three months in the year, etc., etc. We are surprised at a firm of your repute supplying such poor materials."

A representative is sent and, if cute, before entering the house, sees if there is an aerial; also takes a book of litmus-paper and proves on the spot that acid has been spilt, and the carpet firm is not to blame. Sulphuric acid penetrates very quickly any material, and immediately starts to eat away all fibre goods, such as jute, cotton, hemp, etc., of which all carpet backs are usually made; and the wool tufts on the face of the carpet are held by the same material, so that the back may have been completely rotted away without the face showing anything unusual, until it is swept or a vacuum-cleaner used. Then a hole appears and starts trouble. Even then the acid is still in the back fibres, creeping further and further each way.

The method described in your paper would, to a great extent, nullify the acid, but the colour would be spoilt with the wetting and rubbing as advised, and the carpet would always show the mark, "NOTHING" can really be done if sulphuric acid is spilt on a carpet to guarantee no damage resulting.

R. GEORGE.

"AMATEUR RADIO."

The Editor, POPULAR WIRELESS.

Dear Sir,—I have been following the letters and articles on "Amateur Radio" published lately in "P.W." with great interest.

SIMPLIFIED GRID BIAS.

YOU would not give an order for a quart pot if you only wanted to drink a pint. It would be wasteful. Similarly, when a valve needs only a volt or two of grid bias, it is clumsy and wasteful to tap off the required voltage from a 9-volt battery, or even from one of 4½ volts. Screened grid H.F. valves, for example, need about 1½ volts on the main grid. Sometimes, too, you want to add a few volts

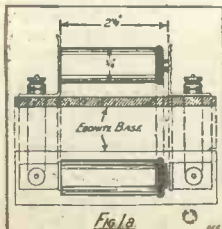

Fig. 1a

bias to the detector grid, when the L.T. battery cannot apply enough through the medium of a potentiometer.

CORRESPONDENCE.

OUR TELEVISION ARTICLES

ACID AND THE CARPET—AMATEUR RADIO.

Letters from readers discussing interesting and topical wireless events, or recording unusual experiences, are always welcomed; but it must be clearly understood that the publication of such does in no way indicate that we associate ourselves with the views expressed by our correspondents, and we cannot accept any responsibility for information given.—EDITOR.

I am sure that the new Amateur Association formed by the Manchester radio societies will lead to great things.

I feel sure that all amateurs will agree with me when I say that we want a society "over here" to equal the A.R.R.L. I have already written to the secretary of the new association for particulars regarding membership of same.

I shall be glad to see a special amateur section in "P.W.," if this is possible.

I am, sir, yours faithfully,

JAMES N. ROE.

Operator 2 BUW

(Member of Guildford and District Wireless Society.) Farnham, Surrey.

CONDENSER CONNECTIONS.

The Editor, POPULAR WIRELESS.

Dear Sir,—In his interesting article on condenser connections in a recent "P.W." Mr. O. J. Rankin seems to imply that the desirable connections cannot

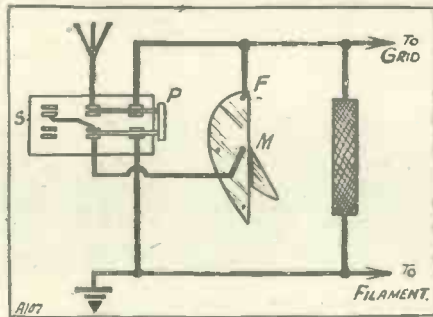

be obtained when using a D.P.D.T. switch for series-parallel-switching. I enclose a rough sketch showing my method of connecting this type of switch for this purpose, and it will be seen that the fixed plates go to grid in either position of the switch.

Hoping this may be of interest.

Yours truly,

J. D. STUART MARTIN.

Lasswade, Midlothian.

NATURAL REPRODUCTION.

The Editor, POPULAR WIRELESS.

Dear Sir,—May I encroach on the hospitality of your correspondence columns in reference to a letter by the Rev. N. Bonavia Hunt, in your issue of February 25th, on the subject of natural reproduction? I decided to accept Mr. Hunt's invitation to a visit, which fully justified his letter published in your columns.

The quality-seeker knows, or should know, that expensive apparatus is required, and a voltage that really means using the mains, so it is idiotic to decry the expense involved in getting quality. Rather is it better to compare similar apparatus and, after hearing the ideal in the Science Museum, and allowing for the acoustic coloration due to the building, and then hearing Mr. Hunt's apparatus, I must confess he has attained a reality little short of marvellous.

Admitting that Mr. Hunt's knowledge of both music and the science of wireless is of a very high standard indeed, I consider his letter in your column the essence of common-sense, and the sooner we have available a musician of standing, preferably with technical knowledge of the wireless science, the sooner will that eagerly awaited dawn of reality appear to all.

Believe me to be, yours faithfully,

S.E.7.

F. M.

TAKES ALL THE BISCUITS!

The Editor, POPULAR WIRELESS.

Dear Sir,—You will be pleased to hear that I have received confirmation from 2 P.C. Sydney, 28.5 metres, of a report I sent last October of a direct pick-up from that station, using the Simmond's panel and one-valve amplifier connected in (three valves). Reception was not strong, but very pure and steady for the distance, which was also heard on 'phones by my wife and daughter. Truly wonderful, I think. They have sent a photograph of their articles and say, "We greatly appreciate your kindness in sending details of reception." I have reported to you before on the working of this panel, but this takes ALL the biscuits. The added amplifier was supplied by your technical department, and is quite O.K.

Yours faithfully,

CHARLES MEUR.

East Finchley, N.2.

THE "SUPER-SCREEN" THREE.

The Editor, POPULAR WIRELESS.

Dear Sir,—Re the "Super-Screen" Three set, it is far and away the finest three-valve set I have ever tried. I have taken your papers from the start and tried many circuits, but this one beats the lot, and my station is situated in a valley with hills 1,000 ft. and over all round, except to the west, where there are only American ones. I have had fifteen stations on long waves and well over fifty on broadcast band, all on loud speaker; also two American stations on loud speaker, WBZ and WPG on L.S., and eight others on 'phones.

On the short waves I get 2 XAF, 2 XAD, KDKA (both waves on loud speaker), and many amateur stations, French and German and Spanish.

PCJJ roars in on an indoor aerial; in fact, is doing so now as I write. The last three Sundays I have had 3 LO (Melbourne), last Sunday being very good. The set is absolutely stable on short waves and easy to tune.

Good luck to your paper, and many thanks for such a good circuit.

I am yours truly,

JOHN DYKE ACLAND.

Somerset.

AROUND THE STATIONS.

The Klagenfurt Station has just celebrated its first birthday.

At the time of writing Canada's first high-power station, CKGW (Toronto), is so near to completion that it may be on the air the time these lines appear.

The South African broadcasting authorities are importing a short-wave transmitter as being the best means of overcoming the long distances separating listeners in that country.

The mysterious telephony which has been troubling Surrey listeners recently was the testing of the Government Mitcham transmitting station (1,400 metres).



All Editorial Communications to be addressed to The Editor, POPULAR WIRELESS, The Fleetway House, Farringdon Street, London, E.C.4.

The Editor will be pleased to consider articles and photographs dealing with all subjects appertaining to wireless work. The Editor cannot accept responsibility for manuscripts and photos. Every care will be taken to return MSS. not accepted for publication. A stamped and addressed envelope must be sent with every article. All inquiries concerning advertising rates, etc., to be addressed to the Sole Agents, Messrs. John H. Lile, Ltd., 4, Ludgate Circus, London, E.C.4.

The constructional articles which appear from time to time in this Journal are the outcome of research and experimental work, carried out with a view to improving the technique of wireless receivers. As much of the information given in the columns of this paper concerns the most recent developments in the radio world, some of the arrangements and specialities described may be the subject of Letters Patent, and the amateur and the trader would be well advised to obtain permission of the patentees to use the patents before doing so.

QUESTIONS AND ANSWERS.

"A FRIGHTFUL FAILURE."

M. A. (Retford, Notts).—"I built the set exactly like the 'P.W.' blue print, but it gives forth no sound. I turn the dial and nothing happens—it is, in fact, a frightful failure, and I am very upset about it. What am I to do, for good parts are used in the set, and I cannot afford another?"

First of all you must not be downcast about it. For, nowadays, there are no "frightful failures," and you certainly won't have to buy another set just because at present nothing happens when you turn the dial.

The probability is that you have overlooked one of the small connections, or else that you are using a "dud" lead. Any such fault would easily be discovered by anyone with a little experience of wireless apparatus, so we should get a wireless friend to look over the set for you. Failing this, ignore the wiring diagram, and instead check the wiring from the scheme of connections given in the blue print's pictorial diagram, which thus gives a valuable check, independent of the position of actual wires. As each lead is checked—airial terminal to one end of coil and .0005 condenser, etc.—cross it off, and proceed slowly until every line is crossed out. If all appears O.K., and you are sure that the components are good ones, you will find that one of the leads is broken inside its covering, and when this is replaced the set will be O.K.

THAT BURNT-OUT TRANSFORMER.

E. G. (Manchester).—"I know the L.F. transformer was a cheap one, but it went all right for two and a half years. When I got my H.T. from the mains, the set certainly became much more powerful, but there was a constant hum that spoilt it a bit, and now the L.F. transformer has burnt out."

"If I get a good new transformer will results be still better, or will that burn out? Because, if the latter, I shall buy another cheap one, as I find the mains cheaper than H.T. batteries."

You need not fear that using the mains will "burn out" the transformer. Get the best one you can afford, and you will find it improves results tremendously. And if there is still a trace of that humming noise, don't throw your old "burnt-out" transformer away, but connect its good winding in the H.T. lead from your eliminator to the detector valve. It may cure the trouble completely.

PICKING UP AUSTRALIA ON 2 VALVES.

E. G. A. (Bury).—"A friend tells me that some time ago in POPULAR WIRELESS you gave a description of how to make a set that got Sydney, New South Wales. In what issue did these particulars appear, and what components are required to build the set, as I should very much like to try my hand at it?"

The set was described in POPULAR WIRELESS No. 284, November 12th, 1927. It was a 2-valver in a cabinet and, apart from the usual accessories, the following components were needed to make the set:

- 1 panel, 14 in. x 7 in.
- 1 .0003 mfd. special short-wave variable condenser, or alternatively a good low-loss square law or S.L.F. condenser of .0003 mfd. capacity.
- 1 Vernier dial.
- 1 .00025 mfd. miniature reaction variable condenser.
- 1 On-off switch.
- 2 baseboard-mounting rheostats to suit valves to be employed.
- 2 Valve holders.
- 1 Grid leak and holder.
- 2 megohms.
- 1 .0002 mfd. fixed condenser and one .0005 mfd.
- 1 potentiometer of about 400 ohms resistance.
- 1 L.F. transformer.
- 2 tubes, to wind the coils on.

Wire, and 10 in. baseboard. Angle brackets (for supporting the panel). Odd pieces of wood and copper, etc.
(A blue print (No. 39) of this set which was called the "Sydney" Two, was given away with POPULAR WIRELESS, No. 295, for January 28th, 1928.)

THE "CHITOS" ONE-VALVER.

"CHITOS" (Paisley, Scotland).—"I should like to build the 'Chitos' One-Valve Set which was described in POPULAR WIRELESS February the 4th issue, but I want to know if you would advise a .0003 mfd. variable condenser instead of a .0005 mfd. which is mentioned. I have a .0003 mfd. on hand, and I do not want to purchase a .0005 unless it is really necessary?"

The .0003 mfd. variable condenser can be used instead of the .0005 mfd. in the "Chitos" One-Valve set. On account of its lower capacity it will not, however, tune over such a wide band of wave-lengths as the condenser which was specified, namely, the .0005 mfd. The use of a lower capacity will not, however, affect the working of the set, and if you have a good selection of plug-in coils on hand, this should not be a serious drawback, as the variation in coils will serve the same purpose as an increase in the capacity of the condenser.

THE USE OF A MILLIAMMETER.

V. B. (Chigwell, Essex).—"I am making the set for a friend who lives near Newbury Park, and he is going to get his high tension from the mains (D.C.). The set is a four-valver, and in order to get the correct potentials upon the plates of the different valves, variable resistances will be employed in the eliminator. He wishes to buy voltmeters to measure this voltage, but I am in favour of inserting a milliammeter in the plate circuits of the valve to detect how much current the valve is taking. Is this latter a satisfactory way of measuring the supply to the valve, or would it be better to employ voltmeters as he desires? (The question of cost is immaterial, as he, lucky chap, has plenty of money.)"

We like your plan of using a milliammeter in the plates of the valves. At the most two of these would be required, one reading up to, say, five milliamps for the H.F. and detector valve supply, and one of higher reading which would be used to measure the larger current taken by the power valve. Or alternatively a multi-scale single instrument could be used with shunt resistances which would enable it to measure either the small or the larger current as desired. It is quite easy to arrange a pair of sockets in the plate leads of each valve, and to short these when the milliammeter is not in use.

To adjust the voltage to the required degree, obtain the valve curve as supplied by the makers, and note the plate current in milliamps at the required voltage, say 120, when no grid bias is applied. Disconnect the grid-bias plug, and then adjust the resistance in the eliminator until the correct current for that H.T. voltage is flowing. Repeat this operation for each of the valves, making sure that the grid-bias plug is taken out each time, and in this way you can quickly adjust the resistances to give the required voltages.

ZEESEN'S WAVE-LENGTH.

G. V. C. (Ipswich).—"Since winding the long-wave coil I have been absolutely delighted

WHAT IS WRONG?

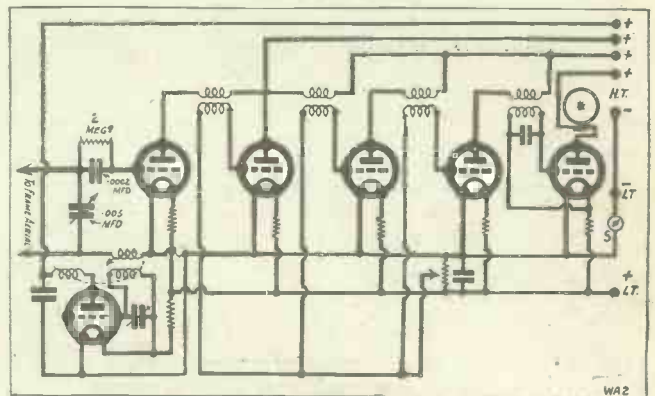

The above diagram is supposed to represent the connections of a six-valve super-heterodyne receiver. But it is wrong, and would not work properly.

Next week the correct diagram will be given, and, to test your skill, we shall continue to publish, from time to time, a diagram in which a mistake (or mistakes) has been inserted. The correction will be published the following week.

No prizes are offered, but by trying to solve the problems the reader cannot fail to learn a lot about radio circuits.

with the strength of the Zeesen station; in fact, I can receive Berlin just as well as Daventry 5 X X. But I hear that this station is to alter its wave-length. Is this correct?"

According to recent announcements made officially by the German broadcasting authorities, the Zeesen
(Continued on page 160.)

**YOU GET MORE FROM
MARCONIPHONE
WHATEVER THE
COMPONENT**

Whether your requirements be large or small; for circuit complicated or simple, Marconiphone components "give you more." Even in the smallest component the practical experience and technical advantages of Marconiphone are apparent. Take no chances with your next receiver, use Marconiphone components throughout, and be certain of unerring accuracy and unfailing reliability at every point.

There is a complete range of Marconiphone Components. Write now, mentioning "Popular Wireless," for List No. 453, fully describing them.

Marconiphone "Ideal" Transformer

The Marconiphone "Ideal" Transformer is to all intents and purposes distortionless throughout the musical range. Rigorously tested at every stage of manufacture, every "Ideal" is guaranteed to conform to the individual curve supplied with each instrument, and, moreover, it is guaranteed against mechanical and electrical defects for 12 months. Supplied in four ratios. 27 to 1, 4 to 1, 6 to 1, 8 to 1. 25/- each.



Marconiphone "Ideal" L.F. Choke

In design, it is similar to the "Ideal" Transformer, having a number of spaced sections, individually impregnated under pressure with "Marconite" and undergoing the same rigid tests that are imposed on the transformer windings. Inductance 110 henries, D.C. resistance 2,000 ohms. Eminently suitable for choke coupling, for H.T. Supply Units, and for use in filter circuit. Price 21/-.

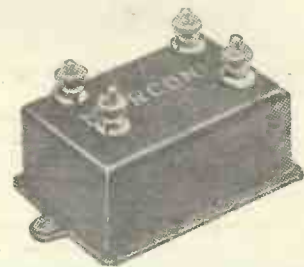

Marconiphone Resistance Coupling Units

Constant and compact. The special type of resistance used is absolutely silent and maintains its stated value under all working conditions. There are two types, "A" for medium impedance valves 8/-, "B" for high impedance valves 7/3.



Sterling Mansbridge Type Condensers

Unquestionable quality and reliability at an extremely low price. The dielectric is protected against breakdown. For trouble free condenser efficiency specify "Sterling." All sizes and capacities from .01 mfd. 1/9, to 10 mfd. 18/-.

THE MARCONIPHONE COMPANY, LTD.,
(Dept. P), 210-212, Tottenham Court Road, London, W.1.

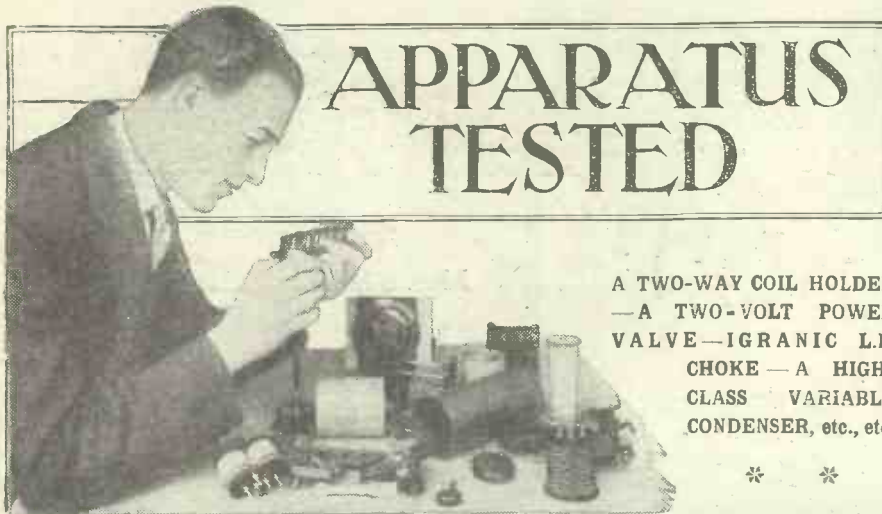

Traders and manufacturers are invited to submit wireless sets and components to the "P.W." Technical Department for test. All tests are carried out with strict impartiality in the "P.W." testing-room, under the supervision of the Technical Editor, and the general reader is asked to note that this weekly article is also intended to provide a reliable and unbiased guide as to what to buy and what to avoid.—EDITOR.

A TWO-WAY COIL HOLDER.

THE Jewel Pen Co., Ltd., of 21-22, Great Sutton Street, London, E.C.1, recently sent us a sample of their R.D.32 two-way coil holder which has been advertised frequently in "P.W." The moving block of this coil holder is carried on two parallel guides, and is moved along these by the rotation of the control knob and a stout threaded rod which passes through the holder.

The movement is very fine and smooth,

and the moving block cannot shift the smallest fraction of an inch until the control is operated. There cannot be backlash, and there is no harshness or looseness throughout the whole range of movement. The coil holder is for baseboard mounting, and seems to be in every respect quite a sound production.

A TWO-VOLT POWER VALVE.

The inevitable doom of the 4-volter, which we have already forecast, is made

the more certain by the continual improvements in 2-volters. Now, that little Ediswan power-valve, the P.V.2, was a very excellent little tube, and one which always appealed to us as not being far behind a 4-volter of a similar type. But the new type P.V.2 has a considerably longer filament of V form, and is even better still.

At 12s. 6d., its initial cost is low; its running costs are also low, while it will handle all the power available in the average listener's loud-speaker receiver. Its filament current is 15 amps., and anything up to 120 volts H.T. can be usefully applied to it. It has an impedance of 6,700 ohms and an amplification factor of 5. But it has the creditable M/I or "slope" of .75.

IGRANIC L.F. CHOKE

We recently received an L.F. choke, type F, from Messrs. Igranic for test. It is wound in two sections, and these can be connected either in series or parallel. The ohmic resistances are commendably low, being only 240 ohms when the two windings are in parallel and 960 ohms when they are in series.

When the choke is asked to handle only a low current of the order of one milliamperes or so, it provides an inductance of 73 henries. When the comparatively high current of 27 milliamperes is passed through it, the windings being in parallel, the still fairly useful inductance of 8 henries is available. It makes a very excellent choke for inclusion in a loud-speaker output circuit.

Even when a super-power valve is used, taking some 15 milliamperes anode current,

(Continued on page 158.)

BUYING ON EASY TERMS



THE universal popularity of the Deferred Payments plan of purchasing out of income has naturally created in many quarters a distorted impression of the methods employed by many firms of good intent. There are still many people who have not realised that goods can be acquired WITHOUT A DEPOSIT; that delivery is made immediately the first small instalment is paid; and that references are not required and no objectionable enquiries are made into their private affairs.

Yet this is the simple method by which you can obtain any of the famous BULLPHONE "NIGHTINGALE" Loud Speakers. On the assurance that you are the tenant of at least two rooms and that you own the furniture therein, the Loud Speaker is delivered to you immediately you pay the first instalment. We ask for this assurance simply to avoid applications from minors or others not wishing to use our loud speakers in their own homes. If you are not completely satisfied with the loud speaker, there is no obligation to complete the transaction.

NIGHTINGALE CABINET CONE LOUD SPEAKER

Gives Wonderful Results with the "MASTER THREE," COSSOR "MELODY MAKER," or any 3 to 7 Valve Sets

SEND NOW!

SATISFACTION GUARANTEED
OR MONEY REFUNDED.

6/-

is all you have to pay to secure immediate delivery of this handsome Cabinet Loud Speaker. This represents the first instalment, and the balance may be paid in 12 monthly instalments of 6/-, starting one month after you have received the Speaker.

BULLPHONE LTD.

38, HOLYWELL LANE, LONDON, E.C.2.

Which is the

CLEAREST

VALVE?

"I have been an experimenter now for nearly four years, and only last week I discovered that the valves for crystal clear reproduction, which I had been in search of all this time, were Ediswan. They have absolutely transformed my set. I can assure you for the future, Ediswan!"

EDISWAN

R. W., Newport, Mon.

Which is the

STRONGEST

VALVE?

"... I am able to receive KDKA and two other American broadcasting stations daily and at very good strength. We are living on the equator—the home of atmospheric, and America is about 10,000 miles from here. Yet I enjoy American broadcasting regularly... signals are much stronger on your valves."

EDISWAN

A.R., Nairobi.

Which valves

LAST THE

"... one has been in use for over four years, and the other three years and a half, and they are working as well now as on the day I bought them. It works out at nearly 6,000 hours use from one, and 5,000 hours from the other—a most marvellous performance."

H.H.A., Durham.

LONGEST

Why—

EDISWAN VALVES - of course!

A type for every purpose

The EDISON SWAN ELECTRIC CO., LTD.
123-5, Queen Victoria Street, London, E.C.4.

LOEWE RADIO

The Famous
LOEWE
LOEWE

High Vacuum Resistances and High Vacuum Block Condensers



Should be installed in every wireless receiving set.

They are

- Free from atmospheric influences.
- Moisture and dust proof.
- Free from losses.
- Fully guaranteed.

Stocked by all reputable dealers.
Ask for illustrated leaflet.

LOEWE RADIO COMPANY LIMITED,
4, Fountayne Road,
Tottenham, London, N.15.
Telephone: Tottenham 2076.

THE EVER POPULAR L.F. TRANSFORMERS

that are incorporated in the world's most famous Radio Receivers.



Radio's Choice

For finest value.
For maximum volume.
For perfect reproduction.
For use in any circuit.
For better Radio reception.

"ACE" 8/6

Ratios 5-1 and 3-1

Specially designed for Portable sets and where space and light weight are desired.



"RADIOGRAND" 12/6 RATIOS 5-1 & 3-1

The above illustrates our standard model for which we have been experiencing an extraordinary demand. The high degree of efficiency renders this component worthy of inclusion in the finest sets where pure distortionless reproduction is the aim. Receiver manufacturers and home constructors alike can utilise Telsens L.F. Transformers with the greatest confidence. They are entirely British made by specialists:

YOUR DEALER WILL BE PLEASED TO SUPPLY ON 14 DAYS' FREE TRIAL.

Every Instrument guaranteed 12 months.

IF UNABLE TO OBTAIN WRITE:—
TELSEN ELECTRIC Co., Ltd.,

Head Office and Works:
207, ASTON ROAD, BIRMINGHAM.
Phone: Central 5265. Grams: Escort, B'ham.

APPARATUS TESTED

(Continued from page 156.)

the inductance of 34 henries is present, and this is ample for practically all purposes. The component is eminently suitable for use in intervalve coupling. It is of the completely shielded variety and is well made. We particularly like the ingenious manner in which the terminals are arranged. These, which are supplemented by soldering tags, are mounted in an insulating moulding consisting of four staggered sections. The result is both a convenient and efficient arrangement. This choke is reasonably priced at 15s., and we have no hesitation in recommending it to the attention of our readers.

ADAPTING A SHORT-WAVER.

In the letter from the Managing Director of the Bombay Radio Co., which appeared in our March 3rd issue, the statement was made that the Two-Valve Bowyer-Lowe Short-Wave receiver is not designed for medium wave-length reception. Messrs. Bowyer-Lowe inform us that recently they have solved the problem of making their set efficient on the broadcast band without impairing its short-wave efficiency. They offer to send full particulars to any interested reader.

A HIGH-CLASS VARIABLE CONDENSER.

For a long while the name "Polar" was associated with rather a queer pattern of variable condenser. Although quite

efficient and very well made, it was possibly viewed with suspicion by many amateurs owing to its unorthodox structure. The latest "Polar" variable, a sample of which was sent to us recently by Messrs. Wingrove & Rogers, of Strand, W.C.2, is quite orthodox and very up-to-date in design.

It is known as the All-Brass No. 3 type, and is a clean, attractive production. It is constructed throughout of hard brass and the insulating material has been reduced to a minimum. It has two ball bearings which operate smoothly but positively. It is very strongly made, although it is not heavy, and is compact.

The vanes are shaped in accordance with the "mid-line law," which means that compensation is provided for external capacity effects in order to preserve straight-line frequency tuning. There are six

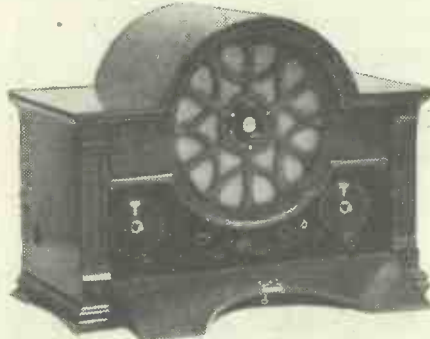

This four-valve set due to the Avon Radio Manufacturing Co., embodies an Amplion Senior Cone Speaker. The design, as will be seen, is both novel and effective.

capacities available, the .0005 mfd. costing 8s. 6d. No knob or dial is supplied, but if a "Polar" slow-motion dial is purchased together with a No. 3 condenser, a special reduction of 6d. is made.

NEW TWO-VOLT VALVE.

We have received samples of the Marconi and Osram type H.L.210 valve. This is of the general-purpose type and has the following characteristics. Filament volts, 2; filament current, 1; amplification factor, 15; impedance, 25,000 ohms; price 10s. 6d.

This H.L.210 does fill a definite gap which lies between the D.E.H.210 with an impedance of 75,000 ohms and an amplification factor of 35, and the D.E.L.210 with its 17,000 ohms impedance and amplification factor of 9. Its usefulness is particularly emphasised in the case of certain L.F. stages, where the input is moderate. And on test we found that it makes an excellent detector and that it could be successfully employed in the majority of H.F. stages. It is a very excellent little valve and we can only hope that there will be a clearance in the 4-volt direction to give it more room. At present we can only regard the arrival of a new valve type as a mixed blessing!

USEFUL VALVE BOOK.

Under the title of "Five Hundred Marconi Valve Combinations," the Marconiphone Company has issued a useful book showing how their valves can be used in all types of receivers and amplifiers employing from one to five valves. The book is free to applicants.

"INDISPENSO" CHARGER
Improved 1928 Model.
Unsurpassed for charging High and Low Tension Accumulators from Direct Current Circuits.
Thousands in use, giving every satisfaction.
Price complete **6/-** Each.

"ALTERNO" CHARGER
The ideal efficient and economical appliance for home charging H.T. Accumulators from A.C. Lighting Mains.
Complete, ready for use... **21/-**
With Ammeter (as illustrated) 12/6 extra.
Full particulars on request.

"SELECTA" (WAVE TRAP)
You can cut out 2LO if within 2 miles of station and bring in far distant stations hitherto unobtainable.
Fitted in a moment—no alteration to set. Price, complete with instructions... **30/-**

"GOLSTONE" COILS FOR COSSOR MELODY MAKER.
Accurately wound to specification with best D.S.C. Wire. Price, each **5/-**
"GOLSTONE" L.F. TRANSFORMER for Purity and Volume, ideal for "MELODY MAKER." Price **17/6**
Every Cossor Melody Maker will give far better results with "NEGROLAC" Aerial. Send for Sample and Pamphlet. From all First-class Radio Stores—or Direct. REFUSE SUBSTITUTES.

Ward & Goldstone
PENDLETON MANCHESTER

FORMO

5/- "1928" LOG CONDENSER
.00035 and .0005
SMALLEST
Span fully open 3 1/2 inches.
Behind Panel 2 inches.
LIGHTEST
4 1/2 OUNCES.
Write for literature.
THE FORMO CO.,
22, CRICKLEWOOD LANE, N.W.2

WORLD'S SHORT WAVES ON YOUR ORDINARY RECEIVER

J.B.S. SHORT WAVE UNIT.

No need to make a special short-wave receiver to get American and other short-wave stations on your speaker. You just connect up the J.B.S. Adapter in the place of your plug-in coils and tune in right away.

The J. B. S. Adapter
Puts the World on Your Set
Price **22/6** (No. 21948) P.P.
(Not suitable for receivers using H.F. stages).

Send for a descriptive leaflet.

Sole Manufacturers:
J. BRIDGE & SONS, Warrior Square, Southend-on-Sea.

how many accumulators have you got?

ONE? TWO? OR NONE? If you have only one accumulator, we will lend you one of ours while we recharge yours to ensure a continuous service. We will collect, maintain, and deliver each alternately. If you have two accumulators we will give you the same service. If your accumulators are unserviceable we will keep you continuously supplied with ours.

And at the same time we will loan you, if you like, the famous C.A.V. H.T. Accumulators, which experts agree give far better results for less than the cost of unreliable dry batteries.

This Service is cheaper than seeing to accumulators yourself. It saves you the trouble and risk of unskilled recharging, never leaving you without current; eliminates accumulator trouble; looks after your accumulators properly.

Our elaborate plant, skilled operators, and fleet of delivery vans guarantee an efficient, punctual, and economical service. Deliveries are made weekly, fortnightly, or monthly. Send a p.c. right away, and we will post you full particulars.

RADIO SERVICE (LONDON) LTD., 105b, TORRIANO AVENUE, KENTISH TOWN, N.W.5. Telephone: North 0623-4-5.



For H.T. Service we supply the famous C.A.V. make exclusively. Our experience has proved these to be the best. Any voltage.



GOOD NEWS FOR SET BUILDERS

In response to the urgent demand for first-class sets for family use, Mr. PERCY W. HARRIS, M.I.R.E., has now prepared the

Wireless Constructor Envelopes

The first two of this series are Now on Sale, price 1/6 per envelope (by post 1/9).

Envelope No. 1.—THE RADIANO THREE. A famous loud speaker set which you can build in an hour or two—no soldering necessary and a wide range of components to choose from.

Envelope No. 2.—THE CONCERT FOUR. Made of standard parts, all easily obtainable, this is a highly-sensitive long-distance set, giving powerful reproduction of wonderful quality. Covering both long and short wave-lengths, with a switch for 3 or 4 valves, it is essentially a set to enjoy, both in building and operation.

In these envelopes you will find every detail of the set simply explained; photographic reproductions and diagrams are included, as well as a full-size Blue Print.

NOW ON SALE — Price 1 / 6

By post 1/9, from the Amalgamated Press, Ltd., Bear Alley, Farringdon Street, London, E.C.4.

“K.N.”

“Goes Round Corners”



Electric Soldering Iron GUARANTEED FOR ONE YEAR

ASK YOUR DEALER—If any difficulty, write enclosing cheque or P.O. value 12/6, stating voltage, to sole manufacturers and patentees, **KNOWLES & SON**, 87, Wardour Street, London, W.1 Agents wanted throughout the world

PRICE **12/6** British made. 14 points of superiority. Complete with 2 bits (straight and angle) and sit. flex and Patent Lamp Socket Adaptor

CUT THIS OUT FOR CABINETS



and post to us for **FREE** list illustrating Cabinets as shown in “Popular Wireless,” etc., etc.

NAME
ADDRESS



(Write in block letters, please.)
CARRINGTON Mfg. Co., Ltd.,
CAMCO WORKS, SANDERSTEAD ROAD,
SOUTH CROYDON.
Telephone: Croydon 0623 (2 lines).
Trade enquiries especially invited.

PERFECT TERMINALS



The unique advantages of the Belling-Lee patented terminal:—

- Insulated, Non-rotating, engraved top.
- Highly finished screw-action, insulated head.
- Non-threaded stem and cross-hole.
- Specially made to grip spade or pin terminal or flex.
- Shielded metal clamping faces.
- Highly finished insulated collar.
- Metal parts nickelled.
- Transverse slot with clamping nut eliminating soldering.
- Guaranteed.

PRICES. Type "B"—Standard large, insulated model. Polished black bakelite, 9d. each.

Type "M"—As type "B" but smaller, and with only the engraved top insulated, rest nickel-plated brass, 6d. each.

Made with 30 different engravings.

BELLING-LEE TERMINALS

Belling & Lee, Ltd., Queensway Works, Ponders End, Middlesex.

"RED DIAMOND" 2 WAY COIL HOLDER



No. R.D.32.

4/- Each

Parallel working. Fine adjustment. Worm driven. Coils cannot fall. Easy movement. Perfect finish. Of all high-class radio dealers or by insured post 4/6, from Sole Makers:

JEWEL PEN CO. LTD., Radio Dept. 46, 21/2, Ct. Sutton St., London, E.C.1



TRADERS GET YOUR COMPONENTS AND CABINETS AT THE RIGHT PRICES. Send for illustrated list. Dept. P.W., PERSEUS RADIO, Burton-on-Trent.

BEAUTIFUL TRANSFERS. PERFECT REPRODUCTION BEST INLAY. LIST ILLUSTRATING 800 DESIGNS AND SAMPLES, 2/6. "P.W.", AXON, JERSEY, C.I.

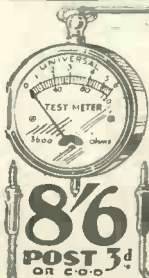

WATES UNIVERSAL TEST METER

Milliammeter, 0-36 Milliamps. Voltmeter, 0-6 and 0-120 Volts. Think of the advantage of this instrument. You can test your receiver for distortion. Find H.T. consumption. Test voltage of H.T. and L.T. Batteries. Accurate. Dependable. High Resistance. **WET H.T. BATTERY CO.,** 12-13, Erownlow St., High Holborn, LONDON, W.C.1

8/6 POST 3d OR C.O.D.

PLEASE MENTION "POPULAR WIRELESS" WHEN REPLYING TO ADVERTISEMENTS.

RADIOTORIAL QUESTIONS AND ANSWERS

(Continued from page 154.)

station will continue to use the wave-length of 1,250 metres formerly employed by Kcenigswusterhausen, but this will eventually be altered in accordance with a decision taken at the Washington Conference. (The modified wave-length will be higher than that at present used, but in all probability it will not be greater than 1,875 metres.)

AVOIDING JAMMING.

T. J. E. (Eastbourne).—"To celebrate their silver wedding I am giving my parents a three-valve set, as they are both very fond of broadcasting. The trouble in this part of the country is interference from ships, and for that reason I have been advised to use a long-wave set instead of one that will receive the ordinary broadcasting stations. Do you think this would be a better thing than picking up London direct?"

We think you have been well advised, for as a matter of fact you would be constantly getting interference if you tried to pick up the London direct, whereas you can receive it via Daventry 5 X X on

"P.W." TECHNICAL QUERY DEPARTMENT

Is Your Set "Going Good"?

Perhaps some mysterious noise has appeared and is spoiling your radio reception?—Or one of the batteries seems to run down much faster than formerly?—Or you want a Blue Print?

Whatever your radio problem may be, remember that the Technical Query Department is thoroughly equipped to assist our readers, and offers an unrivalled service.

Full details, including a revised scale of charges, can be obtained direct from the Technical Query Dept., "Popular Wireless," Fleetway House, Farringdon Street, London, E.C.4.

A postcard will do: On receipt of this an Application Form will be sent to you free and post free, immediately. This application will place you under no obligation whatever, but having the form you will know exactly what information we require to have before us in order to solve your problems.

the long waves at about the same strength and without this difficulty. In addition, you should get several alternative programmes at good loud-speaker strength on the long waves, so that we think there is no doubt in the circumstances that this is the best wave-band for your purpose.

LOUDER LOUD SPEAKERS.

R. J. (St. Mary Cray, Kent).—"It was over two years ago that we built the set from one of your early blue prints, and I must say that the pleasure we have had out of it since is simply incalculable. But just lately it has been very unsatisfactory one way and another, and although it is hard to put a name to it I can best express it by saying that the set seems to lack life.

"At one time the news bulletin, seemed to fairly ring round the room, but nowadays one has to get close up to the loud speaker to hear what is happening, and even then it is very soft. The batteries are all right, and I am sure that the aerial is O.K., because it has not been altered in any way. I suppose wireless sets do wear out, so I am wondering whether I ought to build a new one altogether, or else add the Popular One-Valve Amplifier which was described by you in POPULAR WIRELESS a week or two ago? (I very much

(Continued on next page)

RADIO REGISTERED PANELS

7x 6, 1/3	9x 6, 1/7
8x 6, 1/4	11x 8, 2/3
10x 8, 2/1	12x 8, 2/6
10x 9, 2/4	12x 9, 2/10
12x 10, 3/1	14x 10, 3/5
14x 12, 4/1	16x 9, 3/6
14x 7, 2/7	21x 7, 3/7
16x 8, 3/2	24x 7, 4/1
8x 5, 1/2	1/4 in. thick

Post Free.

Money back guarantee that each and all Panels are free from surface leakage. Megger test infinity. **CROSSONIA CO.,** 10, South St., Moorgate, E.C.2
Phone: Clerkenwell 7853
Agents: John Henry Smith, 139, Anlaby Rd., Hull.
L. H. Helyar, 82, Chamberlin Rd., Norwich.
A. Stredwick & Co., 27, The Market, Chatham.
Boytoun & Co. Ltd., 34, Bradford St., Birmingham

REPAIRS

Any make of L.F. Transformer, Loudspeaker or headphones repaired and despatched within 48 HOURS—TWELVE MONTHS' GUARANTEE with each repair. 4/- Post free.

Terms to Trade. **TRANSFORMER REPAIR CO.,** "Repairs" Dept. 214, High Street, Colliers Wood, London, S.W.19.

D-XELLENT!

DX IN PLUG-IN COILS

From No. 25 1/- to No. 500 4/-

DX SHORT-WAVE SET 4 Coils Nos. 3, 5, 7, 9 .. 7/6

"P.W." Test Report, March 10:—"The fact that one of the first stations tuned in was 3 L O of Australia is ample proof that the coils are efficient."

If unable to obtain send P.O. 7/6. **DX COILS LTD LONDON E 8**

A PERFECT WET H.T. Obtained with our Insulating Liner, which eliminates all "Local Action." Price 1d. doz. Self-Charging Cells. 3 Doz. 45 volts Miniam., packed in Special Divided Carton, Suitable as Container, Post Free 10/-. Double Capacity 13/-, with terminal top Sacs, 2/3 extra. Liners included Free. Send 6d. for Complete Cell, Instructions, Particulars. We stock Goodman's Cone Parts and Units. Cossor Cabinets, Mahogany Finish, 17/8 only. **SPENCERS STORES LTD.,** 4-5, MASON'S AVENUE, COLEMAN ST., LONDON, E.C.2. Phone: London Wall 2292. (Near Bank of England.)

KAY'S CABINETS This Cabinet, 36" x 15" for panels 18", 19", or 20" x 9" can be adapted to other sizes at slightly extra cost, or supplied with shelf to house your set. Strongly made of Oak and polished rich 45/- Jacobean 45/- Quotations for Specials by return. **H. KAY, Cabinet Manufacturer,** Mount Pleasant Road, London, N.15 Phone: Walthamstow 1626.

PLEASE be sure to mention "POPULAR WIRELESS" when communicating with Advertisers. THANKS!

"TROMBA" THE WET H.T. 72 volt., 15/2 Components supplied. NO EXTRAS CHARGED. All Voltages stocked. Send 1d. stamp for booklet; ed. a cell; or 1/- for full range of samples. **TROMBA ELECTRICAL CO. (Dept. W.),** 13, High Rd., Kilburn, N.W.6. Phone: Maida Vale 1669.

EVERYTHING RADIO ON EASY TERMS **WOOLDRIDGE RADIO CO. LTD.** 17, LISLE ST., LEICESTER SQUARE LONDON, W.C.2.

RADIOTORIAL QUESTIONS AND ANSWERS

(Continued from previous page.)

prefer not to have too much expense, as I want to keep cost down to the very minimum, but I simply cannot do without broadcasting.)"

From your description we rather think it will not be necessary either to buy a new set or even a new amplifier, for your symptoms point to the fact that in all probability the trouble is nothing worse than a worn-out valve (or valves). In a general sense, radio sets do not, as you suppose, wear out, even after several years' constant use. Apparently your set has had this, so it is quite likely that one or more of the valves is losing emission. This would give rise to a general falling off in reception of the kind of which you complain, and we should certainly try the effect of one or more new valves if you have not replaced these for such a considerable period (say a year or more).

SUPER-REGENERATION ON SHORT WAVES.

"EXPERIMENTER" (Accrington).—"I have always been very keen on hooking-up stunt circuits, especially one-valvers, and I was particularly interested in the Armstrong regenerative receiver when this was in favour a year or two ago. I always had a feeling there was more in this circuit than was generally

"STRAIGHT" SINGLE-VALVE SET.

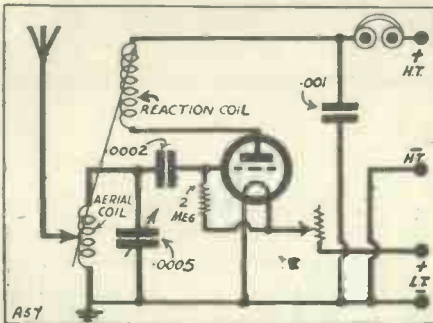

The correct connections for the single-valve set are shown above; in the "What is Wrong?" diagram last week the H.T. negative terminal and the grid leak were omitted.

Apart from actual faults two circuit improvements are shown above, the aerial coil being centre tapped (to improve selectivity), and a .001 by-pass condenser being shunted across the 'phones and batteries to assist smooth oscillation.

realised, and I wonder why it has not been applied to short-wave work. Now that short-wave stations are putting strong signals into our aerials, why cannot we try the Armstrong super on high frequencies, and get loud-speaker reception on one valve?"

There is undoubtedly an interesting field for experiment in the direction you name, and provided one is willing to give plenty of patience to the task there should be some excellent results obtainable in this way. As a matter of fact, the subject seems to be coming into a good deal of attention lately, and it is quite possible that super-regenerative receivers will regain at least a measure of their former popularity.

(An interesting article upon this subject, dealing in detail with the construction of a super short-waver, appears in the March issue of "Modern Wireless," now on sale, price 1/-.)

If you are interested in
THE "MELODY MAKER,"
THE "MASTER THREE,"
OR THE "R. C. THREESOME,"
 You ought to get the March issue of
"MODERN WIRELESS," and see the
FREE BLUE PRINT and long article
 about these famous sets.

NOW ON SALE - - Price 1/-

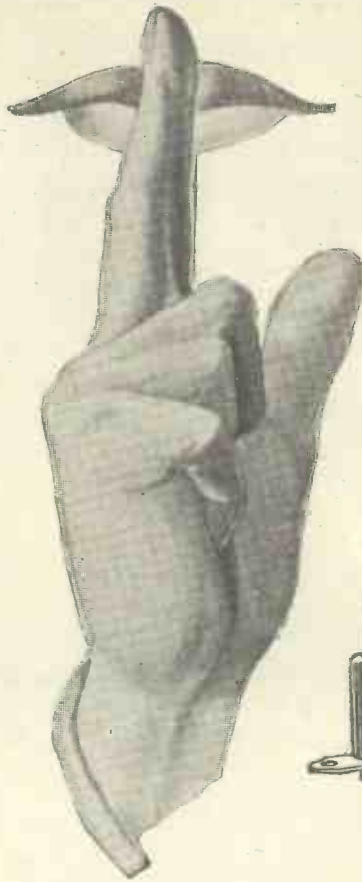

No secrets about BENJAMIN

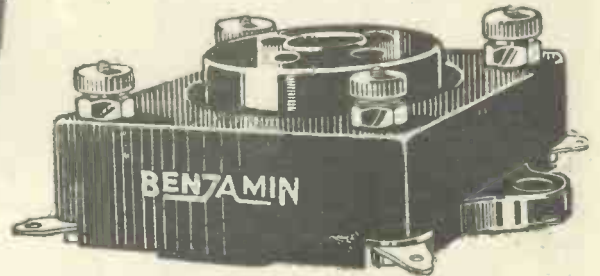

A STRAIGHTFORWARD ANTI-MICROPHONIC VALVE-HOLDER

In the Benjamin anti-microphonic valve-holder the valve is doubly sprung upon springs—one-piece springs that absorb every tremor of vibration, springs that protect your filaments from every shock, springs that will not let a sudden jar reach your valve from whatever direction, springs without joints or riveted connections. The Benjamin Valve-Holder is the simple, straightforward means of protecting a valve filament from shocks—as it was the first anti-microphonic valve-holder, it employs the obvious and therefore most practical, means to the end for which it was designed.

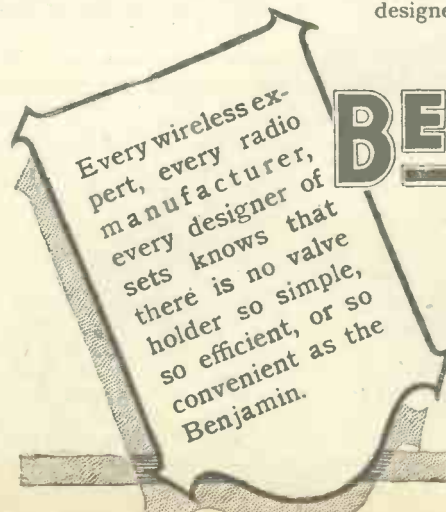

BENJAMIN

From all Radio Dealers—
price 2/- each

THE BENJAMIN ELECTRIC LTD.

Brantwood Works, Tarriff
Road, Tottenham, N.17.

Looking for Trouble



You may look for the trouble that mars reception, but if it is due to a faulty panel, it is most difficult to locate. Buy a panel of proved efficiency, everything a panel should be—always. If your panel's right—you start right. Insist on—



Resiston Panels come in 13 stock sizes in black and Mahogany-grained. From 6 in. X 9 in. in black, 3/5, to 8 in. X 30 in. Mahogany-grained, 19/-.

"24 HOURS CUT PANEL SERVICE."

Adot. American Hard Rubber Co. Ltd. Fore St., E.C.

2166

The Gambrell Neutrovernia

is a Condenser which can be used either as a Capacity Reaction Control, a Vernier Condenser, or a Balancing Condenser. It is perfectly constructed, is dustproof, and cannot short. On independent tests the breakdown voltage was in the neighbourhood of 2,000 volts. Capacity approx. 2/38 mfd. Suitable for either Panel or Baseboard mounting.

Price 5/6 each.
From all Dealers.

GAMBRELL BROS., LTD.,
76, Victoria St., London, S.W.1.



TAYLEX WET H.T. BATTERIES.

New Prices: Jars, 1/3. Sacs, 1/2. Zincs, 11d. Sample doz. (18 volts), complete with bands and electrolyte, 4/3, post 9d. Sample unit, 6d. 16-page booklet free. Bargain list free. **AMPLIFIERS:** 1-valve, 19/-; 2-valve, 30/-. 2-valve **ALL-STATION SET.** £4.-P. TAYLOR, 77, Studley Rd., Stockwell, London

Make your loud speaker live

FIX A "TONER"

across the terminals and your loud speaker will reveal a clarity of reproduction, equalled only in the broadcasting studio itself. This wonderful device removes all distortion and undesirable noises from many loud speaker or phones. The result of a long scientific research.

Trade applications invited
Send to-day to—

The JUNCTION ENGINEERING Co.
(Dept. 6) 149a, JUNCTION RD., LONDON, N.19

2/6 POST FREE

PLEASE MENTION "POPULAR WIRELESS" WHEN REPLYING TO ADVERTISEMENTS

SHORT-WAVE NOTES.

By W. L. S.

ONE sometimes notices in connection with short-wave work that conditions occasionally seem to be extraordinarily good over a fairly small area, and for a fairly short time. Observers outside the area usually notice that conditions are good, but not to the point of freakishness, this extreme being well confined. There is no known explanation of this effect, although it has been very pronounced of late.

A very good example occurred some three days before the time of writing, when one station in South London logged a huge number of 5th district American amateurs in the space of half an hour or so (some of them being as far west as Texas), while other neighbouring receivers had not heard a sound of one of them.

Effect of Locality.

The following day three others logged several 9th district stations, while the first station mentioned also logged quite a large number of "nines," but an entirely different set of them. Only about two stations had been heard by all the observers, while most of them had only been heard by one of the observers!

All this goes to show that local conditions may have a far greater effect than is ever realised. When two receiving stations a mere hundred yards apart listen on a given wave-length for a given time and hear entirely different sets of stations, there is bound to be some way of explaining the matter, but no one has found it as yet!

The strange part of it is that DX stations using high-powered transmitters, such as 2 X A D and 2 X A F and the other "International" broadcasting stations, although they are sometimes no stronger than the amateurs using small fractions of their power, seem to be universally received, local conditions apparently having no effect whatever upon them. One never hears of 2 X A D's signals being good at one receiving station and indifferent at another, say, a quarter of a mile distant.

Low Power Freaks.

Probably it will be acknowledged later that all the "freakishness" attributed to short-wave work when it was first commenced by the amateur transmitters was due to the comparatively low powers which they employed.

The American stations, by the way, often come in exceptionally well at about 7.30 a.m. or thereabouts. I have, as a matter of fact, heard them as late as 9.45 a.m., but that was certainly on an extremely good morning. These remarks, of course, apply to the 45-metre band. 23-metre work is gradually getting later, but cannot be done with any great success after about 11 p.m. This, however, is quite late compared with the time at which distant stations were fading out on this wave-length about three weeks ago.

It will probably be found that at no time during the summer do the Americans, for instance, come in on 20 metres up to a later time than during April.

FREE 5-DAY TEST SEND NO MONEY

We will send you without obligation up to 3 Valves for test in your own set, to be paid for or returned at the end of trial.

OCTOPUS VALVES.

British Made. Fully Guaranteed. Low Consumption. Maximum Power and Distance. Not to be confused with cheap valves of similar characteristics.

CONSTRUCTORS of the "MELODY MAKER" and "MASTER THREE" should take advantage of FREE TEST.

H.F., Det., L.F., R.C. 5/6 Post Free.

2 or 4 Volt.

Power 3/- Post Free.

Type	Imp.	Amp. Fac.
H.F. 206	35,000	15
Det. 206	25,000	12
L.F. 206	18,000	8
R.O. 206	120,000	40
H.F. 215	40,000	20
Det. 215	30,000	15
L.F. 215	19,000	6
H.F. 406	23,000	15
Det. 406	19,000	9-5
L.F. 406	11,000	6
R.O. 406	120,000	40
F. 220	6,000	5
F. 415	4,000	4

WENBANS, 74, New Oxford St., W.C.1.

HEADPHONES REPAIRED 4/-

Transformers 5/-. Loudspeakers 4/-. All repairs remanaged free. Tested, guaranteed and ready for delivery in 24 hours.

Discount for Trade. Clerkwell 1795. MASON & CO., 44, East Rd., City Rd., N.1.

The LITTLE CELLS that SATISFY

are now obtainable made up in 66 volts, e.g., 48 cells in a neat box. The Eton Primary Wet H.T. Battery is yours for 7/6, and 1/6 weekly to complete purchase price, 25/-. Cash price, 22/6. This is a special offer you shouldn't miss. Send 1/3d. stamp for booklet giving full particulars to—

THE ETON GLASS BATTERY CO.,
46, St. Mary's Road, Leyton, E.10.

The right place for the **WatMel**

H.F. CHOKE
Price 5/-

Cross wound in four balanced sections, giving low self-capacity, constant impedance, small external field. Windings fully protected. Mounted on Bakelite base. Greatly improves the "Cossor" Melody Maker when connected in place of wire No. 26. Also when used in "3.20 Express" and other circuits. Write for particulars, stating requirements for coil drive Loud Speakers.

THE WATMEL WIRELESS CO., LTD., Imperial Works, High St., EDGWARE, MIDDLEX.

ADVERTISEMENTS

As far as possible all advertisements appearing in "P.W." are subjected to careful scrutiny before publication, but should any reader experience delay or difficulty in getting orders fulfilled, or should the goods supplied not be as advertised, information should be sent to the Advertisement Manager, "Popular Wireless," 4, Ludgate Circus, London, E.C.4.

NEWS FROM SAVOY HILL.

(Continued from page 140.)

for a new radio play, of which, it surmises be correct, we shall hear quite a lot in the days to come. The title of the play is "Speed." Its most significant characteristic is that it differs, both as regards material and technique, from any radio play we have yet heard, so that we must regard it in the nature of an experiment.

Following so closely on other original ideas which, comparatively recently, have been introduced by Mr. Cecil Lewis, the play keeps alive the great interest in the development of radio drama, perhaps the most progressive side of all broadcasting activities at the present time.

Peculiar Theme.

Because of the peculiar action of the play no fewer than five studios will be required simultaneously for its production. "Speed" is the work of an author whose pseudonym, Charles Croker, hides the identity of a playwright with a string of London and provincial successes to his credit. He has been interested in the possibilities of radio work for some time and has sent in the play only after making a deep study of the subject.

"Speed" is described as a tragi-comic fantasy, based on the ceaseless war between the gods on high Olympus and mortals of the Earth. It is the old story with up-to-date illustrations through the craze for speed of man's puny efforts to attempt those things that seem grotesque to the gods, efforts so hopeless of accomplishment that the gods smile, and smiling coerce the mortals to tragedy and catastrophe that bring violent deaths.

It is a theme abounding in scope and opportunities, that almost cry aloud for masterly treatment. The important thing yet to be told about the play is that it will be broadcasted from London, Daventry and other stations on Monday evening, April 2nd.

Charlot's Second Series.

The second series of radio entertainments arranged by André Charlot, which are being given every Thursday evening until the end of May are likely to provide a more intimate link between listeners and the actual business of programme building than the B.B.C. has been able to establish since the very early days of broadcasting.

Time was when the B.B.C. mildly boasted that the composition of the programmes was an accurate reflection of the wishes of listeners as expressed in the thousands of letters of appreciation or criticism received every week.

This was, in fact, one of the chief points in an interview given by Charlot a day or two ago, when he was discussing the character his new series should take. Having received many thousands of letters of appreciation, on his first six efforts, he planned the next twelve shows on identical lines, though at the same time he says he will alter the style of any item to suit the wishes of listeners if they will only take the trouble to write and say what they want.

It is the intimate touch that he desires to cultivate, and who can blame him! The B.B.C. have apparently given him a free hand, and Charlot is sufficiently cute to exploit the privilege for all it is worth. It is the same with the Limerick competition that is a part of his entertainment.

WE ARE OPEN

ALL DAY SATURDAY
ALL DAY THURSDAY
ALL DAY EVERY DAY
Hours : 9 a.m. to 8 p.m.
Sat. : 9 a.m. to 9 p.m.
Sunday morning : 11-1.

EDISWAN NEW THREESOME

List of Components.
Three Coupling Units,
Tubular Fixed Condenser,
Multiflex Cable and Plug,
0003 Variable with S.M.
Dial, 2-way Geared Holder
Wire, Red and Black Flex.
The lot post 42/- nett.
free
EBONITE PANEL, 2/6
5-ply Baseboard . . . 2/6
(These two with above kit
only. Post 6d.)

Ediswan Valves, 10/6 each.
Power, 12/6.

MULLARD MIKADO

Component Parts :
Ormond Logarithmic
0005, Ditto 00035, Two
4 in. Dials, One Igranic
"Type G" L.F. 3-6 to 1,
Four Engraved Terminals,
One on-and-off Switch,
Two strips, 2 by 1 1/2 in.
Connecting Wire, Six-pin
Base, Mullard 0003,
Mullard 2 meg, Two
Lotus valve holders, Red
and Black Flex, Two
Spade Terminals, Five
Plugs (2 B, 3 R).

£3 : 14 : 0
MULLARD VALVES,
P.M. 1, 10/6; P.M. 2, 12/6.
MASTER 3-COILS B.B.C.,
7/6; LONG WAVE, 8/6.
* When purchasing above
you can buy 100 volt
H.T. for 5/-, L.T.
2 volt 45 amp. for 3/11.
(Both Best British Make)
POST 1/6 for Batteries.

BURNE-JONES

(MAGNUM)
H.F. Choke, 7/6. H.T.
Auto Fuse, 0.5 bulb, 1/6.
Standard Wavetrap, 15/-.
Screening Box for same,
5/-.
1928 Solodyne Coils
(3), 45/- (including Bases).
Ditto for Long Wave (no
Bases), 45/-.
Calibrated
Rheostats, 6 or 30 ohms,
3/-.
000025 Neutralising,
5/-.
Coil Plug on Base,
4 Terminal, 1/9.
Split
Primary H.F. Trans-
formers, S.S. Ditto, Aerial
Coils (6-pin), for short and
long wave, stocked.

LISSEN

Valve-Holders, 1/-; Fixed
Con., 1/-; 1/6; Leaks, 1/-;
Switches, 1/6, 2/6; Lenses,
2-way Cam Vernier, 4/6;
Rheostats, 2/6; B.B., 1/6;
Lisena, 13/6; L.F.
Transformers, 8/6; 100-V.
H.T., 12/11; 60-V. H.T.,
7/11; Coils, 60 X, 8/4;
250 X, 9/9.

ORMOND COMPONENTS YOU CAN ALWAYS GET THEM HERE! LONDON'S LEADING DISTRIBUTORS!

IMPORTANT

We stock Igranic, Climax,
Ever - Ready, Hellesen,
Siemens, Formo, Ferranti,
Weirite, Ormond, J.B.
Benjamin, Lotus, Mullard,
Dubilier, Lissen, Lewcos,
Utility, Magnum, Peto-
Scott, Peerless, Burndept,
Pye, Marconi, McMichael,
Cosmos, Carburandum,
R.I. Varley, Gambrell,
Brown's Sterling, Am-
plions-In fact, every-
thing it is possible to stock.

MULLARD MASTER THREE

No solder—only 20 wires to connect. COMPLETE
SET OF COMPONENTS. 2 Term strips 2 1/2 x 2, Lewcos
Base, 2 J.B. condensers, Climax H.F. choke, Master
Three Coil, 3 Pye Valve Holders, Magnum Brackets,
4 Terminals, Spade Terminals, Wander Plugs, Bulgin
Switch R.I. Unit, R.I. L.F. Transformer, Mullard
0003, 2 meg. Leak, Flex, Screws, &c.
AND THREE MULLARD P.M. VALVES
ABOVE KIT £6 : 17 : 6

MULLARD TOREADOR 3

0005 and 00035 S.L.F.; 2 Ormond S.M. Dials,
1 bush; 1 Six-pin Base; 3 Valve holders; P.M.
R.C.C. Unit; 1 L.F., 2.5-1 (Pye); 2 2-mfd. Mans-
bridge; 0003 and 2-meg. Leak; Climax H.F. Choke;
9 Marked Terminals; L & P On-and-off Switch;
Brackets, 3 Plugs, Flex; Unit Wire.
List Price £4 : 18 : 3
FOR YOU CAN BUY with above parts : Aluminium
2/6 Panel, drilled, best quality; Baseboard, 18 x 10;
Ebonite Washers.

MASTER 3 COILS B.B.C. 7/6

Long Wave, for Toreador 8/6
L.T., 2 volts, 45 amps, 6/8 (with parts only).
H.T., 108 volts, British, 10/- (with parts only).
Mullard Valves, 10/6 & 12/6 (Power) (Super Power, 20/-)

The Corsor "Melody Maker"



COMPONENTS FOR SAME.

Post £4 : 10 : 0 Kit Extra.
2 Ormond 0005; 2 Do. S.M. Dial; 6 T.C.C. Con-
densers, .001, .002, two .0003, .0001, 2 mfd.; 2 Grid
Lk. Clips, B.B.; 1 Var. B.B. Rheostat; 3 Grid Leaks,
.25, 3, 4 meg.; 3 Lotus V.H.; 1 Ferranti A.F.3; 2
Panel Switches; 1 Corsor Melody Wound Coil;
Terminals, Name Tabs, Glazite, 9-v. Grid Bias (all
as specified).

NOTE

Drilled High-grade 21 x 7 Polished Panel,
with Radion Strip, FREE with above kit.
COSSOR VALVES FOR ABOVE
210 D 410 HF 610 HF 10/6 EACH
210 RC 410 RC 610 RC 10/6 EACH
210 P 410 P 610 P 12/6 EACH
COSSOR MELODY MAKER CABINET, 21 x 7, as
shown above, in oak, with baseboard, can be pur-
chased for 12/6 with above. Carriage 2/-.

RADIANO THREE

Mr. Percy Harris has issued a new Envelope and Blueprint,
price 1/6 (deduct if buying parts). All parts with Terminals.
ORIGINAL COMPONENTS.
2 Ormond S.L. Variables,
with Friction Gear; 3
Coil Sockets; T.C.C.
0003 and Clips and 2-meg.
Leak; 3 Benjamin Valve-
holders; 3 Fixed Resis-
tances and Bases; On-
and-off Switch; Geco-
phone 1st Stage L.F.;
Igranic 2nd Stage L.F.;
Engraved Strip, with
Terminals and Nuts; 2
B.L. Terminals for Front
Panel; 1 Gross Pinch-on
Spades; Rubber Flex.
NETT CASH 84/-
(Usually 98/6.)

A GOOD CABINET, oak, American type, hinged lid,
16 x 8, with baseboard for 11 to callers only at this
price. IF BY POST CABINET IS 12/6.

BRITAIN'S FAVOURITE THREE

ORIGINAL COMPONENTS.
Ormond 0005 and 00025 Log
Mid-line Condensers, 12/- and
13/- each. 7-ohm Panel Rheo-
stats, 2/-; 3 B.R. Valve-holders
at 1/9. 2 Single Coil-holders.
0003 Fixed and Series Clip and
Dubilier 2-meg. Leak 5/-. H.F.
Choke 8/-. R.C. Dubilier Unit
H.T. Transformer, 25/-.
7 Terminals at 9d. (5/3). 2
Strips 4 by 2. TOTAL 81/6.
Sent post free for 74/6 nett.
16 by 8 PANELS, GRADE "A" 3/11 nett, with parts. 16 by 8
by 10 ins. AMERICAN CABINETS (OAK), HINGED LID AND
BASEBOARD. SPECIAL PRICE WITH ABOVE KIT OF PARTS
ONLY. 15/- NETT. Post 1/- for Cabinet.

K. RAYMOND,

27 & 28a, LISLE STREET, LONDON, W.C.2
Come to Leicester Square Tube.
IMPORTANT.—This address is at the back of Daly's Theatre
Be sure it is RAYMOND'S. 'Phone: Gerrard 4637.

Callers bring your lists.

Special quote for sets of
parts over 25/-.

BE SURE TO COME TO RAYMOND'S SPECIAL OFFERS

Special Indoor
Aerials, phosphor bronze
wire, ebonite separators,
12 ft. x 8, making total
100 feet, 4/11. Post 3d.

BE SURE YOU READ
"Wireless Constructor",
and "Modern Wireless"
for latest sets. (See my
advertisements in same.)

Bulgin Short-Wave
Chokes, 8-80 metres, 3/-
each. Post 6d.

Weirite H.F. Chokes,
6/6. Short-wave do., 4/6.
Post 3d.

Dr. Nesper Bronze
Finish Horn Type
Speaker, worth 35/-.
Now selling at 21/-
Post free.

Dr. Nesper 35/- Cone
Type Loud Speaker.
Special price, fine 25/-
value. Post free.

Radio Micro (Darlow)
R.C.C. Unit, 4 ter-
minals, all enclosed 5/6

Double Reading (O-6,
0-120) Voltmeters for
H.T. and L.T. A
very special offer. . . . 5/11
Post 6d.

Dr. Nesper De-Luxe
Headphones, 7/11
4,000 ohms. . . . Post 6d.

N. & K. Pattern Light-
weight Gram and
value, 4,000 ohms. . . . 5/6
Post 6d.

Dr. Nesper Loud
Speaker Unit, 9/11
Latest model. . . .

"Hegra" Goni Units,
with fitting at back
for Cabinet. . . . 9/6
Post 9d.

Ormond Latest On- &
Off Switch, a
beautiful job. . . . 1/3
Post 3d.

S.L.F. Variable Con-
densers, ebonite ends,
0005, 00035, a really won-
derful offer. Each
Post 8d. . . . 2/11

Lissen Electrical Pick-
up, the finest at the price.
Without adapter,
15/- with adapter. 16/6
Post free.

Triotron Valves (latest).
Power 6/3. G.P. 4/3.
Detector 4/6. Post 6d. ca.
(20/- worth free).

CABINETS (s)

SPECIAL LINES
FOR CALLERS ONLY
(as supplies limited)

16 by 8 by 9 in. Oak 8/11
(Radiano Three)

18 by 7 by 10 in. Oak 12/8
(Mullard)

21 by 7 by 9 Oak 12/6
(Cossor)

Complete with baseboard.
These for Callers ONLY.

BRITAIN'S "FAVOURITE 2"

Ebonite Panel 14 by 7 in.,
0005 Ormond S.L.F. and
S.M. Dial, Igranic 6 ohms,
Lissen 2-way, 2 Lotus
Valve Holders, 0003 and
series clip, 2 meg. Leak,
B.T.H. or R.I. and Varley
L.F. Transformer, 0005
Fixed, Strip 4 by 2, Eight
marked Terminals, G.B.
Clips, Two Wander Plugs,
Square Wire.
THE ABOVE LOT
nett cash, post free 45/-
with Lissen or
Telsen Acp L.F. 37/6

DARIO VALVES

(Genuine Radio Micro)
Best in the World.
BIVOLT 2-v. .05, 7/6;
Loud Speaker Valve, 10/9;
R.O. 1-8 7/6; 3-5
.05, 7/6; Loud Speaker
Valve, 10/9; 3-5 R.O. .07,
7/6.

ELECTRADIX BARGAINS THE DIX-ONEMETER.

THE RECOGNISED RADIO STANDARD.
HIGHEST GRADE. LOWEST PRICE.

The DIX-ONEMETER will measure signals on a Crystal Set, Grid Valve Current or a large Battery Current with equal ease and accuracy. E.M.F. from a millivolt to 2,000 volts or the values of Resistances between 50 ohms and 50 megohms can easily be read on the clear scale with fine knife-edge pointer and reflecting mirror. The resistance of the 100-volt range is 50,000 ohms, as nearly electrostatic as a moving-coil instrument can be. The ingenious system of Multipliers at 6/6 enables full scale readings of any value to be made over an enormous range.

Write for
Particulars
and Free
Booklet.

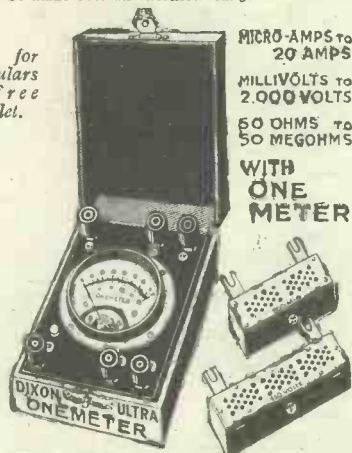

THE DIX-ONEMETER is
The Rolls-Royce of Radio!

PRICES: "DIX-ONEMETER," in case, reading 0.2 m/a, 40 microamps. per div., 55/-.
PRICES FOR MULTIPLIERS: Current, all ranges Milliampers to 20 amps., each 6/6. Voltage, all ranges to 100, 6/6; to 150, 7/6; to 200, 9/-; to 250, 10/6; to 300, 11/-; to 500, 16/6; to 750, 27/-; to 1,000, 36/-; to 1,500, 57/-; to 2,000, 74/-; Cases, with base, for 4 multipliers, 4/- New A.C. Model now ready to 600 v.

TELEVISION PARTS.

Focussing Arc Lamps, as used in America, 60/- Powerful Projectors with lenses and fitted 100-watt gas-filled focus lamp, 39/6. 24 x 2 1/2 in. Telescope Tubes with lenses, 17/6. Torpedo Type Spring-driven Gyroscopes 15/- Neon Tubes, 2/6. Holders, 8d. Osram B.E. Power Valves, 8/6. Selenium Cells up to 200 v., ratio 30-1, 15/-. Double Scale Taylor-Hobson Protractors for marking discs, 5/6. 3-valve Amplifiers, 50/- A.C. or D.C. Motors for Disc Drive, 35/- Wonderful 200-watt Alternators, Watford A.C. self-exciting. Cost £30. Great bargain, £3. As used by Baird.

THE LATEST BARGAIN.

A.C. to D.C. BATTERY CHARGERS.

Work off a lampholder and charge a 2-, 4-, or 6-watt battery up to 6 amps. max. Sale at Half Price, £2 10s. Larger type for 12-volt Car Cells, £4. Both fitted plug, cord and C.Z. Ammeter. There are only a few of these surplus

stock sets available and all are brand new.
Send us your enquiries for Dynamos and Alternators, Recorders, Relays and Special Apparatus.
Now ready, New Edition of 72-page illustrated Catalogue, 4d.

ELECTRADIX RADIOS,
218, UPPER THAMES ST., LONDON, E.C.4

PLEASE be sure to mention
"POPULAR WIRELESS"
when communicating with
Advertisers. THANKS!

UNIDYNE 4-ELECTRODE VALVES



We are now the sole suppliers of the genuine U.O. and Thorpe valves, as specially tested and recommended by the "Unidyne" inventors and "Popular Wireless," U.O.5 Cash with order.
and Thorpe K.4 (both 4-electrode 5-plate valves). Post free. Only direct from
UNIDYNE VALVE CO.,
1, CHARING CROSS, LONDON, S.W.1

TECHNICAL NOTES.

(Continued from page 140.)

degrees of high-frequency amplification which are to-day obtainable would not have been possible.

Combined H.T. Charger.

The new H.T. accumulator recently introduced claims to be the first combined H.T. accumulator and charger for A.C. mains. Combined H.T. accumulators and chargers of this kind have been popular in the United States for some time past, and one had the impression that similar outfits were on the market over here. I cannot just call one to mind, however; and if the makers state that this is the first combined charger of the sort referred to, it is probable that is correct.

I had one of these H.T. accumulator batteries sent to me by the makers some time ago, and have had it not only in constant use, but also pressed into service for all kinds of rather drastic experimental purposes. I may say that it has stood all these trials in a wonderful way and looks like giving the same excellent service for many years to come. I have not actually had a very long experience of the A.C. charger which is now combined with the battery, but so far its performance has been quite satisfactory.

Iron-core Chokes.

One of the advantages of using an iron-core choke is that the anode current from the last valve is prevented from traversing the loud-speaker windings, so that much stronger signals can be handled by the loud speaker without the danger of the latter being overloaded. An output filter used in this way is a very useful arrangement, the advantages of which are becoming increasingly recognised.

For one thing, the resistance of the filter may be made much lower than that of the loud speaker. A well-known company have recently placed on the market an iron-core choke which is very well designed and has a sufficiently generous allowance of iron to prevent the saturation which often occurs in smaller chokes if of very low D.C. resistance. This choke is obtainable in several inductance values, an all-round useful value being about 30 henries.

Gramophone Pick-ups.

Gramophone pick-ups are often arranged so that the low-frequency amplifying stages of the radio receiver may be called into service for amplifying the electrical impulses, received from the pick-up and delivering amplified signals via the loud speaker.

This is on the assumption that the loudness of the reproduction from the gramophone in the ordinary way is insufficient and that the loud speaker is capable of handling effectively a larger volume of sound than is ordinarily obtained from the gramophone directly.

I mention this because many people overlook the fact that frequently quite a robust volume of tone is already obtained from the gramophone itself without the aid of any extra amplifying devices. In such a case there is probably little to be gained from the valve amplification of the sound, except perhaps a certain degree of filtering out of "surface noise."

Saving Space.

On the other hand, the loud-speaker reproducer unit is sometimes made in such a form that it may be attached to the tone-arm of the gramophone in place of the ordinary gramophone sound-box. Such an arrangement, of course, does not involve any question of special amplification, but is designed merely to permit the use of the trumpet of the gramophone instead of having to employ a separate trumpet, as in an ordinary horn-type loud speaker. The advantage of this lies chiefly in the direction of combined gramophone-and-radio sets within a single cabinet, duplication of the loud-speaker horn or its equivalent being thereby avoided.

I have heard loud speakers, and no doubt you have, too, supplied with the output from a three-stage low-frequency amplifier connected to the gramophone pick-up, in which the production was incomparably inferior (if I may use the phrase) to the reproduction from the gramophone itself. These are evidently cases in which it is much better to leave well alone.

A Useful System.

Talking about gramophone pick-up devices to be connected to the low-frequency amplifier of the radio set, it is, of course, sometimes inconvenient to use the L.F. valves of the set and more convenient to have a separate amplifier between the pick-up and the loud speaker. A set of this kind is now marketed by an English concern and includes a gramophone pick-up, a three-stage low-frequency amplifier, and a cone loud speaker. Between the pick-up and the L.F. amplifier is a special transformer, the output of which is controlled by a high-resistance potentiometer. This gramophone amplifying equipment gives excellent tone and volume, and is specially adapted to be used with the gramophone irrespective of a radio set altogether.

H.T. Accumulator Design.

Something rather new in the way of H.T. accumulators is to be found in a late pattern which employs an acid-proof container, each individual cell being provided with a porcelain screwed stopper: the design and casing are, therefore, practically identical with those of low-tension accumulators.

The average high-tension accumulator consists of a collection of more or less fragile glass containers which are loosely held in position, and from which the acid is liable to escape either by evaporation or by being shaken out. The whole affair, as a rule, is far from being the sound and workmanlike job to which we are accustomed in the case of low-tension accumulators. Owing to this and to its usually rather high cost, it is a source of no little anxiety to its owner, who always has a kind of half-fear that unless it is continually overhauled and generally attended to, it will depreciate very rapidly in value.

This new H.T. battery may well be described as being in effect a collection, within a specially moulded case, of small but otherwise sound and business-like accumulators. I have not had an opportunity of testing or using one of these batteries for any extended time, but I should imagine that it would have considerable advantages in use over the flimsy collections of open glass tubes, etc., often masquerading as high-tension accumulator batteries.

SWITCH ON

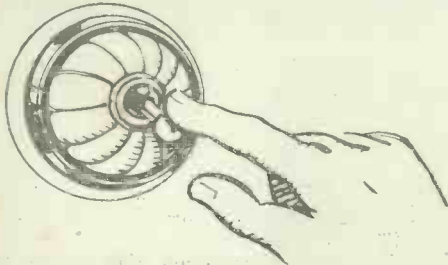

FOR POWER

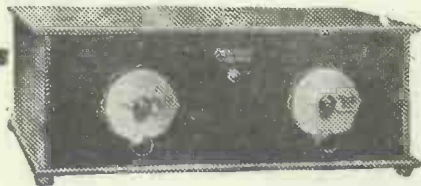

FOR YOUR COSSOR "MELODY MAKER"

CONSTANT—ECONOMICAL—SAFE

CONSTANT. Power from the mains is even, steady and silent. Entirely dispenses with run down battery, annoyance and H.T. crackle.

ECONOMICAL. Power from the mains costs less than a penny per day. No more recharging expenses.

SAFE. An H.T. Eliminator built the T.C.C. way is a unit of proved reliability. Using T.C.C. 600 volt Condensers, it is absolutely safe.

The T.C.C. book "How to build your own H.T. Eliminator" will convince you how simple it is for you to build this efficient unit. It is free—of course—and will be sent to you on receipt of penny stamp for postage. Write for it to-day and—

GET YOUR POWER FROM THE SWITCH

T.C.C. CONDENSERS



WRITE
FOR
THIS

FREE
BOOK
TODAY

THE NEW IDEA— WIRELESS ALL OVER THE HOUSE

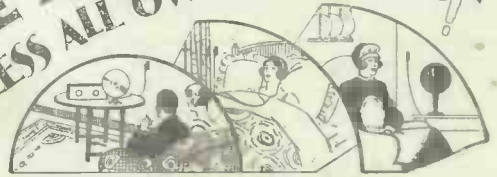

Your house isn't effectively equipped with wireless unless you can *listen-in and switch on or off at will in any room.* A Lotus Remote Control outfit provides you with simultaneous reception and independent control in every room—you merely push in or pull out the plug at your elbow. Any number of rooms can listen-in at once without interference, and as the last plug withdrawn cuts off the filament circuit, you cannot leave your set on.

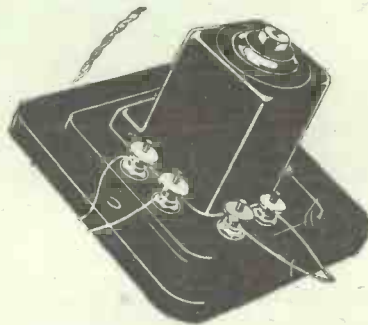

FREE

Send a postcard to the address below and we will send you FREE Blue-prints showing how YOU can wire two rooms in half an hour with Lotus Remote Control.

Your Set—any Set can use this Remote Control.

No matter what sort of set you use, there is a Remote Control to increased convenience.

If your set uses L.T. Accumulator and H.T. Battery, an outfit sufficient to wire two rooms, including Lotus Relay, 2 Filament Control Wall Jacks, 2 Jack Plugs and 21 yds. special 4-strand-wire, costs **30/-**

If your set uses L.T. Accumulator and H.T. Eliminator, outfit for two rooms **45/-**

With an all-from-the-Mains set, it costs **47/6**

In each case, each additional room, 7/6 extra.

LOTUS REMOTE CONTROLS

Made by the Makers of the Lotus Buoyancy Valve Holder, Lotus Vernier Coil Holder, Lotus Jacks, Switches and Plugs.

GARNETT, WHITELEY & Co., Ltd.,
Broadgreen Road, Liverpool



Always the valve with the wonderful Mullard P.M. Filament— that consumes only 0.075 ampere filament current and that for length of life and purity of reception is unequalled, Always then, the valve for improved radio reception in any receiver. Always Mullard.

Mullard

THE MASTER VALVE

ADVT. THE MULLARD WIRELESS SERVICE CO., LTD., MULLARD HOUSE, DENMARK ST., LONDON, W.C.2.

Printed and published every Thursday by the Proprietors, The Amalgamated Press, Ltd., The Fleetway House, Farringdon Street, London, E.C.4. Advertisement Offices: Messrs. John H. Lile, Ltd., 4, Ludgate Circus, London, E.C.4. Registered as a newspaper for transmission by Canadian Magazine Post. Subscription rates: Inland, 17/4 per annum; 8/3 for six months. Abroad, 19/8 per annum; 9/9 for six months. Sole Agents for South Africa: Central News Agency, Ltd. Sole Agents for Australia and New Zealand: Messrs. Gordon & Gotch, Ltd.; and for Canada: The Imperial News Co. (Canada), Ltd. Saturday, March 24th, 1923.

BUILD THE "POCKET MONEY" AMPLIFIER

Popular Wireless

Every Thursday
PRICE
3d.

No. 304. Vol. VIII.

INCORPORATING "WIRELESS"

March 31st, 1928.

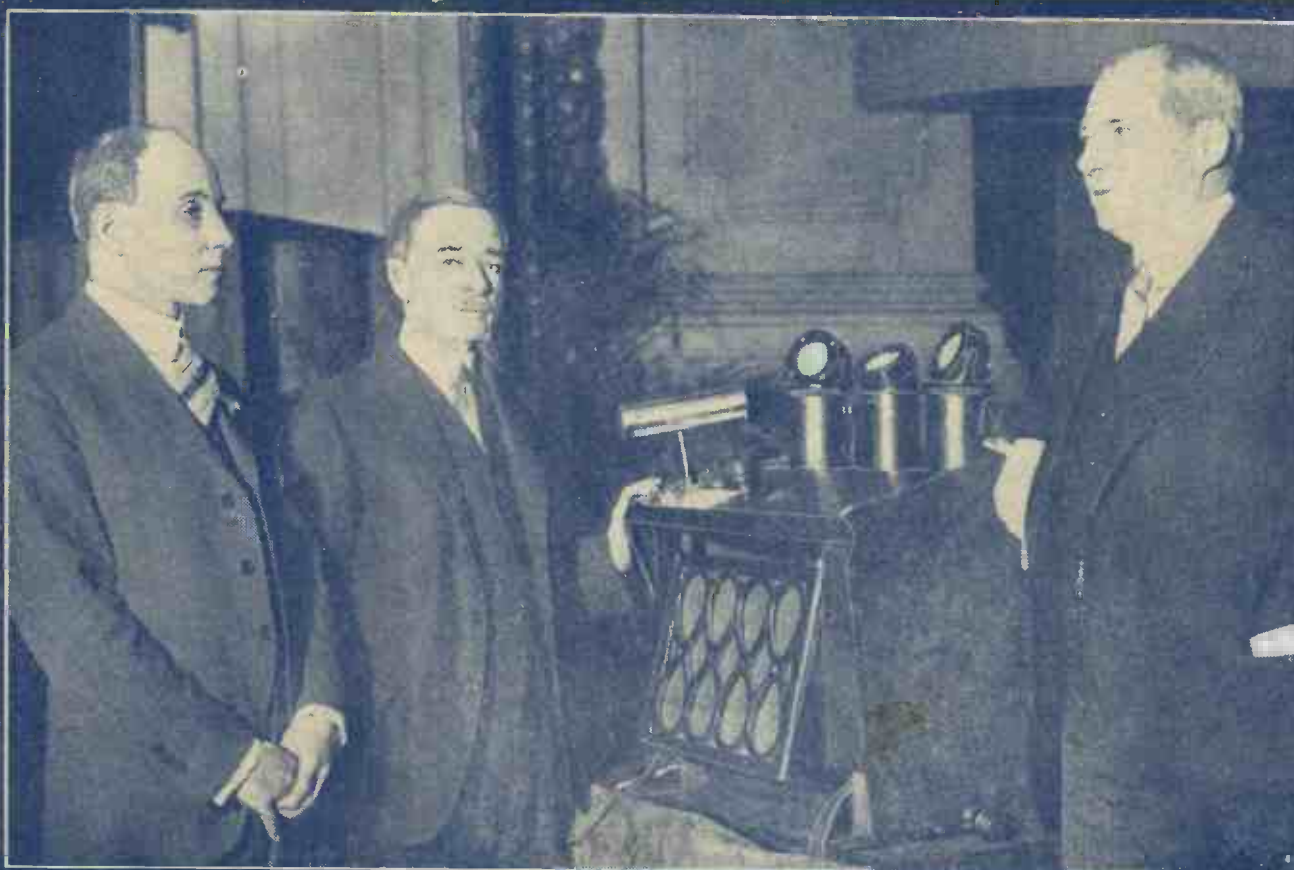

SPECIAL FEATURES IN THIS ISSUE

**Ganging Your Own Condensers. "Pick-Up" Programmes
A Disturbing Fault. "Secret Forces" and Television.
THE "HARTLEY" ONE-VALVER
Frame Aerial Reception. Is Selectivity Worth While?
Hints for the Handy Man, etc., etc.,**

Radio-telephony linked the two sections of a recent meeting of electrical engineers in such a way that speakers in either section—one in London and the other in New York—could address the whole meeting by means of microphones and loud speakers. The above photograph shows some of the speakers at the American end.

THE WINNER!



New construction—
new prices—but still
EVER READY.
The new "WIN-
NER" gives splen-
did service at the
lowest possible cost
per hour. Look for
the Ever Ready
"WINNER" in its
improved red con-
tainer.

60 VOLTS 7/-
66 VOLTS 7/6

Obtainable from all
Wireless Stores and
Electricians.

WRITE for com-
plete Battery Cata-
logue, free and post
free, from THE
EVER READY
CO. (Gt. Britain)
LTD., Hercules
Place, Holloway,
N.7.

99 VOLTS 11/6
9 V. GRID 1/3

EVER READY BATTERIES

BRITAIN'S BEST

"Elementary, dear Watson"

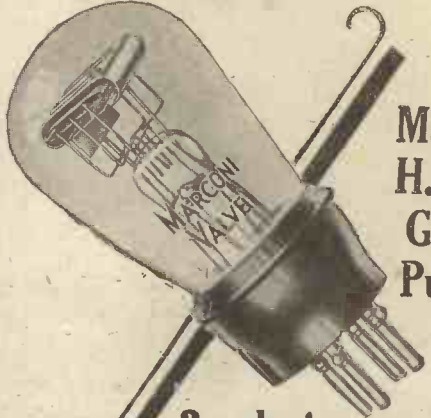

**Marconi
H.L.210
General
Purpose
Valve
for
2-volt Accumulators.**

As a detector, the Marconi Valve Type H.L.210 is a regular Sherlock Holmes. The faintest of signals are clapped heartily upon the shoulder and persuaded to say their piece with surety and volume.

And the H.L.210 makes no comments of its own. It detects without distortion and adds no adenoids to what the announcer has to say.

If your accumulator is a 2-volt one, and if you believe in making the amps. give as many hours as possible, try out the H.L.210 as a high frequency amplifier, as a detector, or in any L.F. stage except the last, then see how much more you get out for what you put in.

If you fill up the coupon below, we will send you a copy free and post free, of a helpful book, "500 Marconi Valve Combinations."

Suitable for the following purposes:—
(1) For High Frequency Amplifiers in circuits where some form of stabilising or damping is employed.
(2) As a Detector Valve.
(3) In Transformer or Choke-coupled Low Frequency Amplifiers, except in the last stage where a D.E.P. 215 or D.E.P. 240 power valve should be used.

Filament Volts - 2.0 max.
Filament Current 0.1 amp.
Anode Volts - 150 max.
Amplification Factor - 15
Impedance - 25,000 ohms.
Price 10/6 each

FREE ADVICE

Our Engineers will furnish free advice as to the best possible combination of valves for your set, if details of the circuit and any valves at present in use are stated. Write to the following "P.W." to The Marconiphone Co. Ltd., 210/212, Tottenham Court Road, London, W.1.



MARCONI VALVES
-do everything that a valve should do

Name.....

Address.....

Round the World
with the
Brown

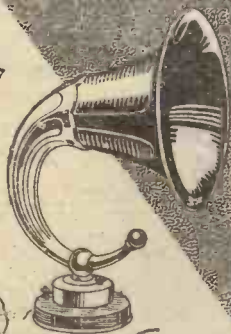

The "Brown"
HQ Loud Speaker
Price . . . £6



In the City of Waterways (VENICE)

SHEER from the waters of the canal, stately palaces raise spire and turret into the waning sunlight. Smoothly the gondola glides and through the stillness comes the sound of music, ringing true and clear across the waters. It is the "Brown" Loud speaker, reproducing with its own inimitable realism.

All over the world, the perfect realism of the "Brown" Loud Speaker is enjoyed by those who enjoy good reception. All over the world the standard of Loud Speaker reproduction is set and maintained by the "Brown."

they listen to the

Brown

The Loud Speaker on which the sun
never sets!

Advt. S. G. Brown, Ltd., Western Ave., N. Acton, W. 3.

2240

What ever kind of set you have, or hope to have, you must not miss the April issue of

MODERN WIRELESS

It is a wonderful double number, covering every fascinating phase of radio. For instance, if you have a

"MELODY MAKER"

a

"MASTER THREE"

or an

"R.C. THREESOME"

you will be delighted with the details of how to make your gramophone work the loud speaker, with wonderful clarity and volume.

Or perhaps you want to "reach-out" further? Details are given on an easily-made H.F. Amplifier to work in conjunction with your present receiver.

And finally there is a

SPECIAL SOLODYNE SUPPLEMENT

containing full details of a

THREE-VALVE SOLODYNE

(of which three versions are given) to enable you to use your own components. This special supplement also tells "How to Modernise the 1926 Solodyne," "Notes on the 1928 Model," etc., etc.

Be Sure to Order Your Copy Now.

MODERN WIRELESS

APRIL DOUBLE NUMBER

Price 1/6 - - On Sale MARCH 30th

"THE VALVE OF THE FUTURE"

No Dry Batteries

No Accumulators



"Cosmos-Met-Vick" A.C. Valves, Green Spot and Red Spot, are the result of investigation and experiment by one of the finest Research organisations in this Country.

They provide the complete solution for, and, in conjunction with the use of Met-Vick Eliminators, overcome all the difficulties of direct operation from the Electric Light Supply.

"Met-Vick-Cosmos" A.C. Valves not only provide the solution of the complete operation of wireless sets for the Electric Light Mains, but they also provide great volume and extreme selectivity free from distortion. By their use you can switch on your set like electric light, and yet lose nothing in effect. In fact a mains operated set with Met-Vick-Cosmos A.C. Valves is a much better set.

See what Mr. A. P. Castellain says in the "Wireless World" for March 7th:—

"Remarkably High Mutual Conductance—
For the AC/G valve the mutual conductance is enormous when judged by ordinary valve standards—about 2 milliamperes per volt for an amplification factor of 36—and the heater current is only 1 ampere at 4 volts. The latter figures are quite comparable with valves of the 4½ volt 0.8 ampere L.S. class. For the AC/R valve the amplification factor is about 10, and the mutual conductance 4 milliamperes per volt, giving an A.C. resistance of about 2,500 ohms."

The writer continues by comparing the Cosmos AC/R Valve, very advantageously with other makes of valves for similar duties.

Note also what Mr. G. A. Exeter, the London Area Manager of the Radio Society of Great Britain says about the "Cosmos-Met-Vick" A.C. Valve:—

"..... in view of the results I have obtained upon trial, under decidedly adverse conditions, I now think you are indeed to be congratulated upon producing a great improvement in the technique of radio. Undoubtedly this is the valve of the future."

The power handling capacity of the AC/R Valve is as great as that necessary for Public Address Service and is sufficient for operating "moving coil" Loud Speakers to the greatest advantage

By using the ingenious "Cosmos" Disc Adaptors, these five-pin valves can be used in a set wired for accumulator valves, without altering the wiring.

MET-VICK

VALVES · COMPONENTS · & SETS

Metro-Vick Supplies, Ltd., 155 Charing Cross Road, London, W.C.2



TYPE No. 372.

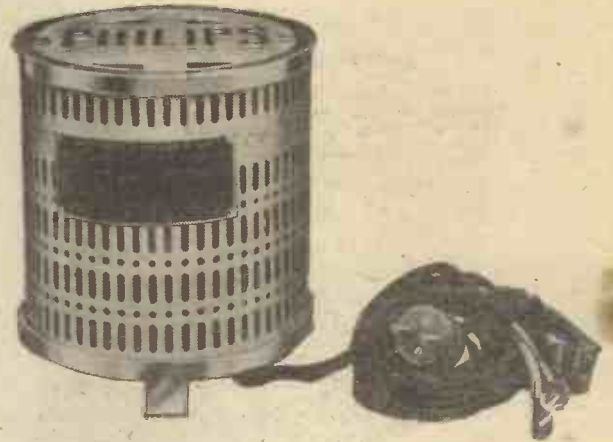

TYPE No. 1009.

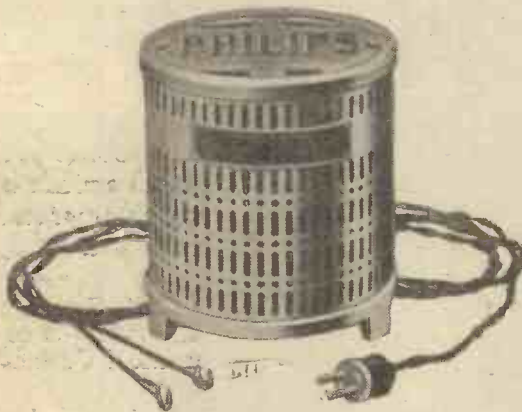

TYPE No. 327.



TYPE No. 450.

Beautifully designed and faultlessly constructed, these Units uphold Philips reputation for excellency. They are completely reliable.

Type No. 372.—A High Tension Supply Unit A.C. Mains.

Price complete, £7 10s. 0d.

Type No. 508.—A High Tension Supply Unit for D.C. Mains.

Price complete, £3 17s. 6d.

Type No. 1009.—The Dual Battery Charger for charging High and Low Tension Batteries from A.C. Mains.

Price complete, £6 10s. 0d.

Type No. 1001.—A High Tension Accumulator Charger for A.C. Mains.

Price complete, £4 0s. 0d.

Type No. 450.—A Battery Charger for Low Tension Accumulators from A.C. Mains, charging 2-6 volts at 1.3 amps.

Price complete, £4 0s. 0d.

Type No. 327.—Is a Low Tension Battery Charger similar to Type No. 450, but charging 2-12 volts.

Price complete, £4 15s. 0d.



TYPE No. 503.



TYPE No. 1001.

Follow Philips—developments are coming rapidly. Watch for future announcements, keep Philips in your mind and remember always



TYPE No. 366.

PHILIPS

for Radio

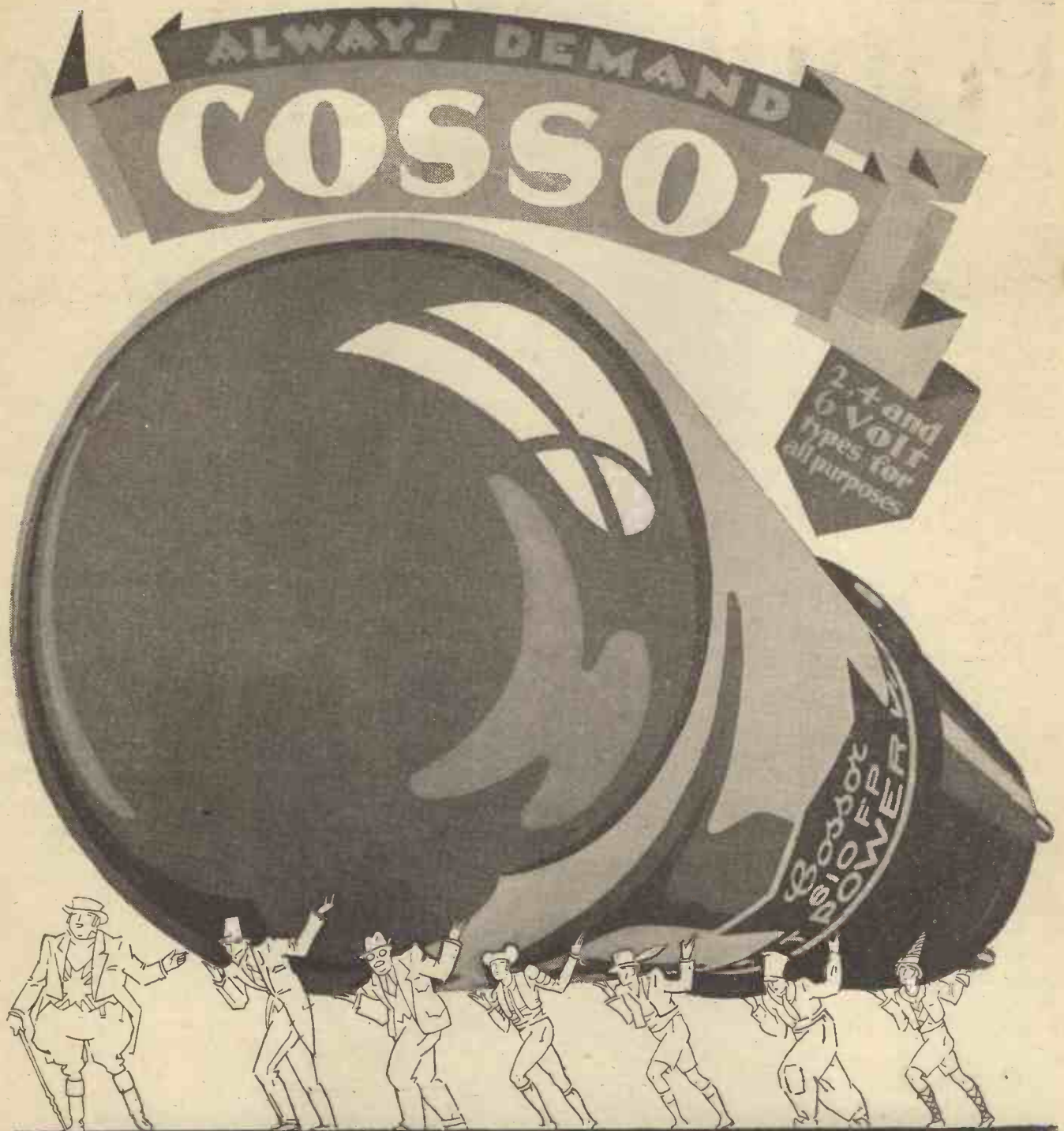

**The Valves which made possible
Radio Concerts from Seven Countries
through the wonderful Cossor "MelodyMaker"
USE THEM IN YOUR SET**

Popular Wireless

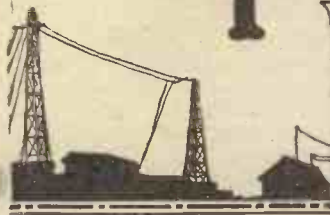

Scientific Adviser :
 Sir OLIVER LODGE, F.R.S.
 Editor :
 NORMAN EDWARDS, M.Inst.R.E., M.R.S.L., F.R.G.S.
 Technical Editor : G. V. DOWDING, Grad.I.E.E.
 Assistant Technical Editors : K. D. ROGERS, P. R. BIRD,
 G. P. KENDALL, B.Sc., A. JOHNSON RANDALL.



RADIO NOTES AND NEWS.

The Continental Relays—Regional Wireless—Have You Heard Harbin?—Eiffel Tower's Wave-length—Opportunity Knocks—The "Progressive" Four—A New Idea.

The World in A.D. 2000.

THE issue of the "Daily Mail" for January 1st, 2000, which I have obtained from the "Ideal Home" Exhibition, presents a somewhat nerve-racking picture of what the life and times of the human race may be then. Aircraft, radio and television bulk largely in the letterpress, which includes a "fill-up" to the effect that a crystal set dated 1923 has been placed in the British Museum, and an account of the murder by a woman of her husband, whom she shot at Tiflis "by a beam fired from some place unknown."

Our Chemical Lesson.

THE fact that a man was injured recently by the explosion of an accumulator, near which he had held a naked flame, renders it worth while to remind readers that a "gassing" accumulator is evolving an explosive mixture of gases. The "Manchester Evening News," I observe, informs the public that, when on charge, a battery develops sulphur dioxide gas, which is highly combustible. Except that it is not sulphur dioxide and that sulphur dioxide is not combustible in air, but will, in fact, put a light out, the "M.E.N.'s" chemistry is correct.

What "Gassing" Is.

WHEN an accumulator is fully charged, the chemical reactions between the electrolyte and "the plates" are completed. If the charging current is maintained after this stage is reached, it splits up the water of the electrolyte, so that the cell discharges a mixture of hydrogen and oxygen. Hydrogen by itself will burn but not explode; but when mixed with air, as it would be at the vent-holes of the battery, it will explode violently if a flame be applied to it. Moreover, a mixture of H and O also is explosive. But there is no danger at all unless a naked light or glowing body is very near the battery.

The Continental Relays.

THE line relays from Liège and Cologne were a great success, especially the Cologne job, and it looks as though for this particular work the line and submarine cable are more reliable and effective than the wireless relay. As a radio man, I

am chilled to the marrow at this, but as a "listener" I rejoice to think that the road seems clear to the extension of the B.B.C.'s programmes to the genius of capitals of Europe. Barcelona has one of the finest opera-houses in Europe. What about it, B.B.C.?

Tragedy of Imagination.

THERE was a young sailor of Bristol, Who thought he heard Mars on a crystal. But his friends wouldn't "bite," So he shot himself right Through the head with a loud-speaking pistol.

More Listeners—or More Payers?

THE latest figures I have seen in regard to P.O. licences are little short of amazing. At the end of February the number of licence-holders in Great Britain was 2,451,051, an increase of about 33,000 over the January total. I read that the B.B.C. attributes this to the founding of new homes by marriages and the improvement of its programmes. But I am wondering whether it may not be partially

due to the prosecution by the P.O. of listeners who have sets without licences. Anyway, it looks as though the B.B.C. finances are on velvet.—which is good for all of us. Or ought to be.

Radio and Employment.

LOOKING at that total of licence-holders, I cannot help smiling when I recollect that in 1922 a newspaper telephoned to me and asked whether I thought that the (then) proposed wireless telephone broadcasts would affect the unemployment problem. I said that I thought it would not affect it noticeably (which has proved correct), but that it would require the services of "hundreds of people." Well, I suppose I ought to have said hundreds of thousands. But at that time neither Sir J. Reith nor Captain P. P. Eckersley was appointed; in fact, there was no B.B.C.

More Sceptics.

MR. ELSTON'S letter in our number of March 10th, has caused a lot more sceptics to bob up. In a very piquant letter, T. M. (Tylorstown) suggests that the alleged loud-speaker results reported in respect of distant and numerous stations are nothing more than noises, because of distortion and "threshold" effect. I am afraid I must agree that there is a tendency to over strain reaction and amplification in order to get distant stations in the log, but so long as the signals are fairly recognisable I think reception may be claimed.

Limits of O-v-2.

T. M. says that with O-v-2 it is impossible to get pure full loud-speaker volume at more than 100 miles from Daventry or 25 miles from a local station, using a full P.M.G. aerial. I have not tried that, and will wait to learn readers' opinions. I will, however, say that my last set was a

(Continued on next page.)

THEREMIN IN NEW YORK.



Prof. Theremin, whose "music from the air" recently created much amusement, some speculation, and a fair amount of controversy in this country, is now in New York, where he is busy endeavouring to mystify the Americans with his "magic box" (seen above). It is, of course, in essentials, an oscillating radio set, the "music" being controlled by a sort of hand-capacity effect.

NOTES AND NEWS.

(Continued from previous page.)

straight det. with reaction and one L.F. stage, and on this 5 X X always came in at comfortable loud-speaker strength and only a little weaker than 2 L O; also, it was sufficiently pure in tone for domestic listening. Distance to 2 L O about 12 miles and to 5 X X about 90 miles.

Regional Wireless.

I UNDERSTAND that there is to be a grouping of the northern English stations and that a choice will be given to the listeners of a "national" or a "regional" programme. The B.B.C. is no doubt working out its problems as well as it can, and I do not wish to obtrude premature criticism, but frankly I do not see the necessity for either of those kinds of programme. The average person, I am convinced, wants just a good programme, let it be as cosmopolitan as you please.

The Right Idea.

TALKING of programmes, I recall that I have often said that the entertainment side of broadcasting ought to be run by people who have had successful experience in public entertainment. Hence, I note with subdued pleasure that this fact has been recognised and acted upon in America, where a Radio Programme Corporation was formed three years ago, run by men who have been brought up to cater for popular amusement. Cables and wireless are gradually joining forces! Why not broadcasting, music halls and theatres?

Have You Heard Harbin?

REPORT says that C O H B (Harbin, China) has been broadcasting since January 1st on 445 metres. Has anyone here heard it? A pretty far cry, I admit, for such a long wave, but it is not an impossible performance. No doubt it can be recognised by the words "Chu Chin Chow," or by jokes about bobbed pigtails.

Eiffel Tower's Wave-length.

DUE to the decision of the Washington Conference that the band for long-wave stations shall be 1,340 to 1,875 metres, the wave-length of the Eiffel Tower station, now 2,650 metres, is to be altered to 1,400 metres this year. It is probable that the power will be raised to 100 kw.

Meat for Sceptics.

SINCE commenting upon Mr. Elston's letter, I have seen a report about Mr. W. R. Pierce, Junr., of Rhode Island, U.S.A. This gentleman is 17 years old, and claims to have logged 694 stations in 41 different countries, on a two-valve set. He says that the loudest European station is E A J 22, Salamanca. Yes, it would be. Well, gentlemen, let us pull up our socks and listen some more. Maybe we have missed one or two stations.

Radio in America.

THE STOCK EXCHANGE gambling in shares of the Radio Corporation of America has attracted so much notice in the English Press that I have had a look at the R.C.A. balance sheet for 1927; it is sensational. Net income, \$11,799,659. After reserving for amortisation of patents,

income tax, foreign investments, pension fund and general reserve, the surplus is \$8,478,319. Machinery and tools are written down to \$1, and the patent account by \$1,000,000. After paying dividends of 7 per cent on Preferred Stock and placing \$4,500,000 to reserve for plant, the surplus is \$7,029,621, or something over £1,400,000. Wow!

Opportunity Knocks.

KEEN radio amateurs are wanted by the Royal Corps of Signals, Territorial Army. You understand, no doubt, a good deal about radio in general, but here is a chance for you to get free instruction in its theory and practice and to be paid for it. Why not turn yourself from an amateur into a competent radio man.

SHORT WAVES.

A loud speaker, with a radius of over four miles, has been constructed. This should give an added impetus to attempts to establish a new high-flying record.—"Humorist."

The only difference between electricity and wireless is that an electric installation often fuses and a radio refuses.

Many are grateful for the B.B.C.'s S.O.S.—pity.—"Daily Mirror."

Teacher: Can you name to me something that talks, sings and plays that wasn't in existence a hundred years ago?
Bright Pupil: Yes, me.—"News of the World."

In Athens there is a monument to Adam.
But in every place where there is a loud speaker there is a monument to Eve.

PERSONAL.

Young man with one pair headphones, five valves, two condensers, two tuning coils wishes to meet a young lady with some H.T. and L.T. batteries, two transformers, some busbar wire and a panel. Object: matrimony and a complete set.—"Radio News."

Uneasy lies the head that wears a crown.
But uneasier lies the head that has fallen asleep with the headphones on.

Some critics of the B.B.C.
Don't want these serious talks at all;
They think the programmes ought to be Quite frivolous, or musical.

Time thus devoted is just rot,
They say with frank hostility;
And for the present they are not Devoted to the B.B.C.!
—"Bulletin and Scots Pictorial."

You never know when you may be glad of your knowledge and skill.

Answer the Knock!

YOUR obligations are simply that you agree to present yourself for instruction for a certain number of hours per year; you can put in as much extra time as you like. You will receive expert instruction in radio and knowledge of the latest Army equipment, and a free fortnight's holiday at the annual camp in the summer, being, in addition, paid for every day at the camp. Call any day, 10 a.m. to 2 p.m. at 56th (1st London) Divisional Signals Headquarters, 51, Calthorpe St., London, W.C.1.

A Real Beginner.

MR. J. R. ARMSTRONG KELLY, Donnybrook Estate, Box 180, Salisbury, S. Rhodesia, who is growing baccy and amusing himself with chess and one newspaper a week, got hold of a copy of "P.W.," the first radio paper he had

ever seen, and is now filled with a divine discontent. He wants to build a set, and wonders whether a "P.W." reader will advise him how to go about it. As this may be the nucleus of a "P.W." colony, I propose to spend another paragraph on Mr. Kelly.

Which Shall He Build?

OUR friend wants to be able to receive J B, 500 miles away, besides England, America and Continentals, if possible. Moreover, situated as he is, he requires data as to all the necessary parts and their prices, delivery free by parcel post via Beira, for cash with order. Here's a chance for some kindly reader, or a club, to use experience in the cause of radio and work out a complete specification; but for the learner's sake I recommend that a set be chosen for which a "P.W." back number can be supplied.

The "Progressive" Four.

I MENTION that because there is no doubt that "P.W.," "M.W." and "Constructor" articles have made construction as simple as A B C. As proof of this witness a letter from E. B. (Barnham) to Mr. P. W. Harris. E. B. says that he has no less than 25 youngsters making up the "Progressive" Four, only one of whom has made an error. Our Mr. Dowding, designer of the set in question, is having his hats made to measure now. E. B. hopes that Mr. Harris is keeping in the best of spirits, and Mr. Harris, authorises me to say that he is very "well preserved" indeed.

Transmitting Note.

WILL all who are interested in observing amateur transmissions note that Mr. C. A. Webb, 38, Oakhill Road, Putney, S.W.15, has been allotted the call sign 5 W B, and transmits on 90 metres and 150-200 metres. He would be glad to have reports about the signals from all and sundry, either in this country or any other.

Readers' Results.

AN analysis of the letters on hand shows that the most popular "P.W." circuit published this year is the "Sydney" Two, and the results obtained with it prove that it can do what was claimed for it. Most of the writers succeeded in getting Australia, though the rest got a number of American stations and are no less enthusiastic in their comments.

A New Idea.

A THREE-MILE swim in the river Yarra was the cause, earlier this month, of a lot of public interest in Australia, and 3 L O broadcast an account of the race from start to finish. Now why not apply the same idea to Channel-swimming, so that there shall be no more dubious hoaxes. We could go to bed knowing that the swimmer was half-way across and catching buns as cleverly as a seal catches fish, and wake to learn that he or she is in sight of Dover Harbour but involved in a school of mackerel which is tickling him or her and impeding progress with laughter, etc., etc.

ARIEL.

IF you possess a two or three-valve set using a detector valve and one or two low-frequency stages (in all probability you do, because this is the most popular type of set in this country), and if you have an old gramophone or some apology for a gramophone, you can very simply arrange your own programmes, just how and when you want them, and with very little expense.

You have all heard of the gramophone pick-up, that little device which is fitted on the tone-arm of a gramophone in place of the usual sound-box, and which when connected up to an amplifier, enables you to reproduce the record placed on the gramophone *via your loud speaker*, the reproduction being, in most cases, very much better than that obtainable with an ordinary gramophone.

Not Expensive.

When you are using a pick-up, you do not use the gramophone at all, the only portion of the instrument that you employ is the tone-arm and the turn-table, which of course means the motor as well. So you see you may have a hopeless gramophone, when considered from a gramophone point of view, but as long as the turn-table and motor are all right and capable of running at constant speed, and as long as there is a tone-arm (which by the way you can purchase for about five or six shillings if the one you have is badly battered), you have all the elements of a gramophone as required for pick-up work.

If you have not such a gramophone, have no motor or turn-table, you can very easily buy one for about thirty shillings, a really reliable one, and this, mounted on a box with a suitable tone-arm and a pick-up, will provide you with all the pleasure you could get from a thirty or forty guinea gramophone, provided, of course, that your set is reasonably pure in reproduction, and that you have a reasonably good loud speaker. A pick-up, such as the Lissen, can be obtained for 15s. only.

No Set Alterations.

Now what do you have to do to make that pick-up work with your set? As I said before, all that has to be done is to fit it on to your gramophone tone-arm and then set the motor going with the record, place a needle in the pick-up, and lay it on to the record, and that is that end of the business. The other end consists in connecting the two ends of the pick-up, which by the way should be of the high resistance variety, to your valve receiver.

No alteration in this latter is necessary. All you need is a little adaptor which you can plug into the detector valve holder of the set, the valve being placed on the top of the adaptor, which has special sockets for it. The adaptor is connected to the two ends of the pick-up.

Suitable plug-in adaptors are available for practically any pick-up at varying prices from about 3s. 6d. upwards. There

"PICK-UP" PROGRAMMES



So all you have to watch for is that the adaptor on your pick-up plugs into your valve detector sockets in such a way that the filament pin which is connected on the adaptor to the pick-up, plugs into the filament socket on the valve holder which is connected to low-tension negative. Whether it goes to L.T. negative through a rheostat

or not does not matter.

The plate pin, of course, will go into the plate socket and the grid pin is already cut off, so that the grid of the adaptor only makes contact with your pick-up and the valve, and does not plug into the grid socket of the original valve holder in the set.

Why not "broadcast" your own musical items? This is easily done, as this article shows.

By K. D. ROGERS.

may be slight alterations necessary in the set if you use a four-pin adaptor, because the original grid circuit of the set should really be broken.

But if you use an adaptor that only has three pins, or if you are supplied with an adaptor with four pins and you cut off the grid pin of the adaptor, leaving the socket,

Simple Volume Control.

The valve is inserted in the adaptor, which itself is inserted into the valve holder on the set. The set is switched on, the pick-up laid on the record, and there you are. The music comes out of the loud speaker. Nothing in the set has to be altered at all, neither H.T. nor grid bias.

It is useful in pick-ups to have a volume control. This usually consists of a 500,000-ohm potentiometer, which is connected right across the pick-up, and the slider of the potentiometer is then taken to the grid socket of the adaptor, instead of the end of the pick-up being taken there, so that you have the pick-up across the volume control, the slider of the volume control going to the grid socket of the adaptor, and then the filament pin and the volume control going to the other end of the pick-up.

I hope I have made this reasonably clear. It is rather difficult to make it quite clear in a short article, but the few points you have to watch when fitting a pick-up to a set are just those mentioned, and the rest entails no alteration or particular care whatsoever.

Further Details.

A detector with one stage of note magnification is quite enough for most records, but if you have two stages of note magnification so much the better. Should you have an H.F. valve in front of the detector, it should be switched off. It need not be disconnected, just the filament turned off, or the valve removed while the pick-up is in action. For pick-up work you use just the detector and the note magnifying stages.

For those who are more interested in pick-ups and gramophone work in conjunction with their sets I would draw their attention to the special gramophone section in "Modern Wireless" every month. This section goes into the matter far more deeply and gives details concerning the use of pick-ups with various sets, discusses records suitable for pick-up work, different types of pick-ups, hints and tips and so on. You will find it worth while to try your set as a gramophone reproducer and once tried I do not think you will regret the initial outlay and trouble.



A neat little pick-up that is marketed for the modest sum of 15s.

then your set will be absolutely fool-proof as regards the pick-up. All you have to do is to connect the pick-up between the grid socket of your adaptor, which will of course, have a little terminal, and one filament pin, the filament pin, making contact with its socket.

Collecting the "Pick-up."

Now you must choose that filament pin so that it plugs into the filament socket of your detector valve holder in the set which goes to L.T. negative. If you connect it to the one which plugs into L.T. positive you will find that you get distortion, because the valve will be operating at the wrong end of its curve, and you will be running into grid current.

"SECRET FORCES" & TELEVISION.

By THE EDITOR.

WHAT is the secret behind all the conflicting statements about television? is a question Mr. William J. Brittain asked during his lecture on "My Television Journey" to the Hull Literary and Philosophical Society. Mr. Brittain pointed out that Mr. Baird has been able to announce that he has flashed a face across the Atlantic and enabled a sweetheart in London and her lover in mid-ocean to meet.

The Bell Telephone Company in America has achieved a demonstration of television in the home, and television sets are now on sale in London, and books and periodicals concerning television seem to be taking up the subject with great gusto.

"But," said Mr. Brittain, "against these amazing evidences of progress have been put up a series of statements by eminent scientists suggesting that television is years away, and culminating in a £1,000 challenge to Mr. Baird to give a television demonstration of five simple objects."

"Ducks and Drakes."

Mr. Brittain suggested that there was a secret behind these two "opposing tornadoes" which nullified each other, and left the ordinary man wondering what way, if any, the television wind was blowing.

Mr. Brittain then proceeded to make a statement which calls for explanation. "It is necessary," he said, "for the public to know of these two secret and powerful groups which are playing ducks and drakes with the fortunes of television."

Exactly what Mr. Brittain means by that statement we are at a loss to know. But in the course of his lecture he went on to say that television has been achieved by Baird and by two large Companies in America, and other workers such as Jenkins in America, Dieckman and Mihaly in Germany and Belin and Holweck in Paris, all of whom are doing excellent work.

"Crude Toys."

"It must be realised, however," continued Mr. Brittain, "that only a face and shoulders of a person have been televised. It must be remembered, too, that television across the Atlantic is an achievement of little more difficulty than televising from one room to another. A scene at a theatre or a horse race cannot be attempted. And the sets now on sale are but crude toys which would not receive television if it were being broadcast. Machines equally advanced were made last century.

"In trying to realise what is the exact position of television," said Mr. Brittain, "the public must know of the two opposed forces, take the statements of both sides, and find the truth between the two."

In making statements like this, Mr. Brittain—no doubt quite legitimately in his rôle of popular lecturer—suggests that there is some "secret force" at work, and the innuendo is undoubtedly that POPULAR WIRELESS is one of these forces. But we would again point out that there is nothing secret in our desire to clarify the position with regard to television, and there is certainly nothing secret in our attempt to

warn amateurs that they must take a very large pinch of salt when they read in the daily newspapers the exaggerated and sensational statements in connection with television.

Make sure of your copy of the
April double number of

MODERN WIRELESS

which contains a

SPECIAL SOLODYNE SUPPLEMENT

showing several versions of the incomparable "Solodyne" set. With these details you can make a Solodyne using components already on hand.

Don't miss this magnificent radio magazine.

APRIL DOUBLE NUMBER

MODERN WIRELESS

ON SALE MARCH 30th. Price 1/6

Adverse criticism of a new branch of wireless science like television is undoubtedly not going to be popular. We have risked earning unpopularity among a large section of our readers in being so



A novel test for a tuning coil is to make it light a Neon lamp by power picked up from a local oscillator.

candid with regard to television, but we have done so because we feel that in the long run if we were to follow in the footsteps of those hysterical people who, on the strength of certain crude experiments which eminent scientists regard as the limit certain systems are capable of achieving, and attempt to convince the public that television in the home is very nearly an

accomplished fact, and that before very long a real television service will be started, we should be far more unpopular!

We have yet to find, as we have already stated, any scientist of repute who will substantiate fantastic television theories; just as we have yet to find a scientist of repute who will be so dogmatic as to state that true television will never be possible.

We again reiterate that our views, concisely expressed, are these: That by the known systems of television, especially the mechanical systems, the optimistic forecasts of television critics will never be realised. And we again reiterate that not until System X (which is the unknown system) has been discovered will it be possible for moving pictures, in any reasonable detail, to be televised by wireless.

Mr. Brittain, we suggest, should carefully read the articles we have published in connection with television in this journal and in "Modern Wireless," and in particular we would draw his attention to the details of the challenge which we issued to Mr. Baird, which, by the way, he has not yet accepted.

Mr. Brittain is undoubtedly a journalist who has devoted considerable time and attention to the various television systems being experimented with in various parts of the world and, with certain limitations, we have a respect for his opinions. But when he suggests that there are secrets behind television, and when he talks about two opposing forces, he is allowing his journalistic imagination to run away with him.

As far as we are concerned, our challenge to Mr. Baird was made in all friendliness, and only because Mr. Baird has so many good friends that they are inclined to put him on a pedestal and to acclaim his pioneer work as the final achievement of a genius who has solved the television problem and made it possible for amateurs to build their own sets at home, and so ultimately receive moving pictures by wireless from broadcast television stations.

P.M.G. and Television.

That such a contingency is not likely at the moment, and indeed, not until some really reliable system has been invented, is borne out by the fact that the Postmaster-General stated recently in the House of Commons that wireless licences covering experiments in television have been issued to a number of persons, and he understood that tests had been carried out; but his technical advisers considered that the matter had not yet advanced beyond the experimental stage.

We can only repeat that we thoroughly agree with the scientists whom we have consulted on the problem of television and whose general attitude may be summed up in the concluding words written by Sir Oliver Lodge in our issue for March 17th. We venture to close this article by repeating the conclusion to Sir Oliver Lodge's article on "The Problem of Television":

"No one can say that anything is finally impossible; but it is fairly safe to say that a given development has not yet been achieved. As far as I know about the attitude of other scientific men I think I am in agreement with them. I shall rejoice if the labours of Mr. Baird and other workers in this country, and in America, are able to falsify this caution within what remains of my own life-time."

THIS little unit has been designed to meet the demand for an amplifier that is capable of giving a consistently good degree of amplification without distortion, whatever the set used in conjunction with it, and provided one does not try to work off a super-regenerative or a really fierce reflex set, it fulfils this condition admirably.

It has other advantages in its compactness, simplicity, and low cost; and provision is made for the use of a gramophone pick-up without interfering in any way with the receiver in general use.

The circuit employed is shown on another page and it will be seen that the first valve is coupled to the set with which it is to be used by means of an L.F. transformer, the coupling between the first and second valves being through a standard R.C. unit. The transformer stage is placed first to render the amplifier more adaptable, as it would be impossible to use a resistance-capacity coupled stage immediately after a reflex set such as the Hale or Trinadyne, for which a valve having a low amplification factor is essential.

Connecting a Pick-up.

The jack which breaks the connections between the secondary of the L.F. transformer and the grid-grid-bias circuit is to

LIST OF COMPONENTS.

- Panel, 8 in. x 6 in. x 1/4 in. (any good branded material, Becol, Ebonart, Radion, Red Seal, etc.).
- Cabinet to fit, 6 1/2 in. deep (original is by Peto-Scott).
- L.F. transformer (Lissen in original amplifier).
- R.C. Unit (Dubilier in original. Any good make, Lissen, etc.).
- 2 Sprung valve holders (Benjamin, Bowyer-Lowe, B.T.H., Burndep, Burne-Jones, I granio Lotus, Marconiphone, Pye, W.B., etc.).
- 2 Fixed resistors (Burne-Jones in original. Any similar type, such as Cyldon, Dubilier, etc.).
- L.T. switch.
- Double circuit jack and plug (Lotus in original. Any good make, Bowyer-Lowe, Igranio, etc.).
- Terminal strip, 5 in. x 2 in. x 1/4 in.
- 8 Terminals.
- Wire, screws, etc.

facilitate the connection of a gramophone pick-up of the high resistance magnetic type. It is not always possible to plug an adapter into the detector valve holder, as it may happen that there is no detector valve; the amplifier may be intended for use with a crystal set, or with a set employing a crystal detector, and in this case the pick-up is connected to the plug, which, when inserted in the jack, cuts out the

The "Pocket Money" Amplifier

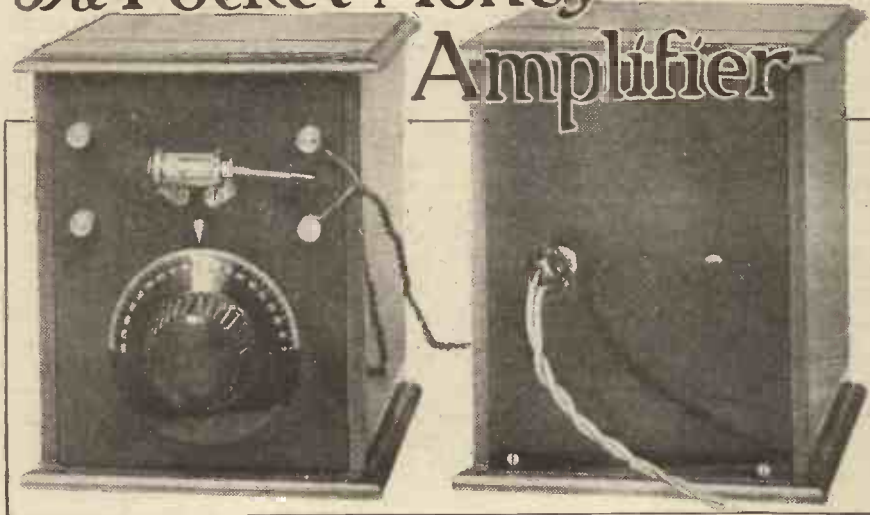

* * * * *

You can use this instrument with practically any set or with a gramophone pick-up. It gives extraordinarily good results although it is, as its name suggests, inexpensive and easy to build.

By the "P.W." Technical Staff.

* * * * *

secondary of the transformer and brings the pick-up into circuit instead.

The instructions given by the makers of the various pick-ups on the market state that the leads on the adapter should be changed over to find which connection gives the better results. This is to ensure that the pick-up is connected across the grid and grid return leads; with the amplifier this is unnecessary, as the jack contacts are already connected in the correct manner.

Very Simple.

Can see at a glance the simplicity of the lay-out, and the few holes which have to be drilled, the largest of which is 3/8 in. in diameter, and which is to accommodate the double-circuit jack. The hole for the L.T. switch is only 1/8 in. diameter, and those for the wood screws 1/4 in. counter-sunk to take the heads of 3/8 in. No. 3 wood screws.

The terminal strip should then be drilled according to the diagram provided, and the panel and strip may be fitted to the

base board. When fitting the terminals to the strip it is as well to cut off the projecting shanks and fit soldering tags under the nuts.

This will be found of great assistance when wiring, as the bottom row of terminals will be rather difficult to reach otherwise. The other components may now be secured to the baseboard as shown in the wiring diagram, and here are one or two points worthy of consideration.

The L.F. transformer and R.C. unit should be kept as close to the panel as possible, to allow the valve holders to be

kept away from the terminal strip, and before fitting the fixed resistors to the baseboard, turn the soldering tags round so that instead of being at right angles to the resistor, they are in line with it. They may then be placed quite close together, and the wiring will be simplified.

The Wiring.

This latter operation needs a little more care than is usually required, and it is essential that insulated wire should be used. The original amplifier was wired with Glazite

(Continued on next page.)

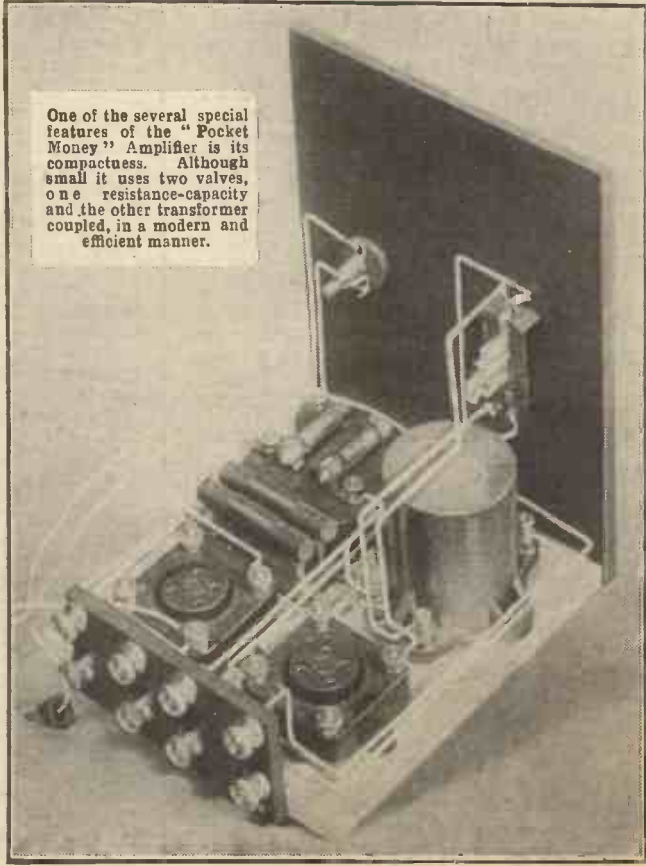

One of the several special features of the "Pocket Money" Amplifier is its compactness. Although small it uses two valves, one resistance-capacity and the other transformer coupled, in a modern and efficient manner.

THE "POCKET MONEY" AMPLIFIER.
 (Continued from previous page.)

which, besides giving a neat appearance, is a perfect safeguard against short-circuits.

The query which always seems to crop up with this sort of wire concerns the best means of removing the insulation, at the same time leaving a clean end. The most satisfactory method, I find, is to cut it off with a sharp penknife by making a cut round the wire, and sliding the end off. Naturally, the cut must be right through the

tags a lot of bother will be avoided, and this part of the work greatly facilitated.

The only flex leads in the assembly are those to the grid-bias battery, which is fitted in the back of the cabinet. The battery actually used was one made by Siemens, and this is provided with a cardboard flap which can be fixed to the cabinet by drawing pins. This, of course, is the 9-volt type, which is quite sufficient in the ordinary way, but should it be desired to use a super-power valve in the second stage, or at least, one which requires more than 9 volts grid bias, the battery will have to be placed outside the cabinet, and the leads extended.

Operating the Amplifier.

A few notes on the operation will not be out of place, and it may be mentioned that with standard R.C. and power valves the results obtained were really most satisfactory. Using a P.M.1 in the first stage and a P.M.2 in the second, the amplifier was tested in conjunction with a crystal set, a straight single-valver, and a single-valve reflex.

A B.T.H. B4 was used in the two single-valvers, and

with each of them a most satisfactory degree of amplification was obtained. A gramophone pick-up was tested at the same time, and the volume delivered from the loud speaker was more than sufficient for any ordinary room. With the crystal sets the results were equally gratifying, but it was, of course, necessary to earth the L.T. negative terminal. This should also be done if a pick-up only is connected to the amplifier.

With Super-Power Valve.

To ascertain the performance of the amplifier under really strenuous conditions, it was again connected to the straight single-valve set, and the P.M.2 replaced by a P.M.252. The pick-up was refitted to the

(Continued on next page.)

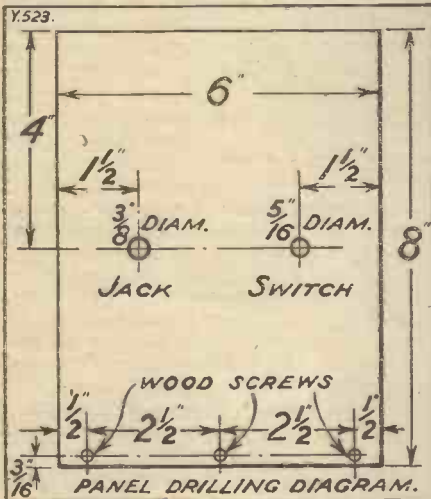

insulation, and must go right round the wire, but after a few attempts one acquires the knack of peeling it off as neatly as could be wished.

As the valve holders and, in fact, all the components except the resistors, switch, and jack have both terminals and soldering tags, one can carry out the wiring—which is not complicated—in the manner to which one is most accustomed.

Grid Bias.

The wiring itself, although needing care, is quite simple and there should be no difficulty experienced in carrying out this operation quite satisfactorily; the leads to the terminal strip being those which may prove a little tricky. To try to use a very

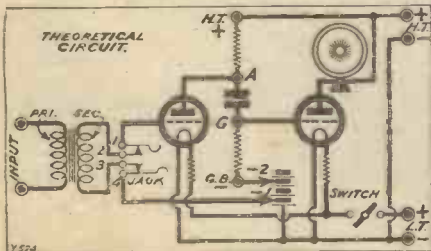

large soldering iron for these joints is hopeless, as there is not a great deal of room between the valve holders and the terminal strip, and to accomplish the soldering of the various leads to the terminals with any degree of success, a half-pound iron will be found essential. By cutting off the surplus terminal shanks, as suggested at the beginning of this article, and fitting soldering

POINT-TO-POINT CONNECTIONS.

Input terminals to OP and IP terminals of L.F. transformer. L.T.—terminal to H.T.—terminal, G.B. positive, and to one filament terminal of each valve holder. L.T. positive to one side of L.T. switch; other side of switch to one side of each fixed resistor; other side of each resistor to remaining filament terminal of corresponding valve holder.

Grid terminal of 1st valve holder to No. 1 contact of jack.

No. 2 contact to OS terminal of L.F. transformer.

No. 3 contact to IS terminal of L.F. transformer.

No. 4 contact to G.B.—1.

NOTE.—Nos. 1 and 4 contacts are the two longest, and are the outer spring contacts.

Plate terminal of 1st valve holder to "A" terminal of R.C. unit.

"H.T." terminal of unit to H.T. positive terminal, and to one L.S. terminal.

"G" terminal of unit to grid terminal of 2nd valve holder.

"G.B.—" terminal of unit to G.B.—2.

Plate terminal of 2nd valve holder to remaining L.S. terminal.

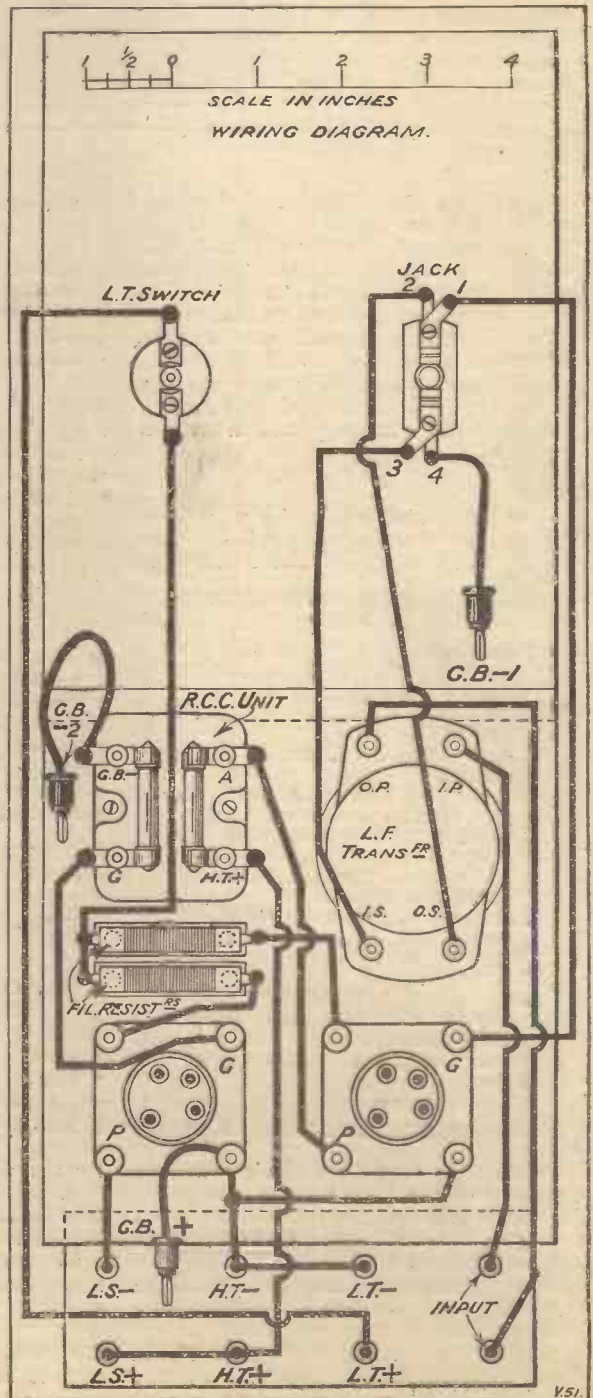

SOME PRACTICAL POINTS.

Generally speaking, the *higher* the aerial the better. * * *

The use of a large shell insulator instead of a metal pulley will avoid the jamming of halyards at the mast head. * * *

It is unsafe to use rope as a stay for masts, but the seven-strand galvanised wire sold for clothes lines is both cheap and effective. * * *

If your earth is a buried one it is a good plan to drive a length of metal piping in the ground, and occasionally to pour water down this so as to moisten the soil around the earth plate. * * *

If two equal resistances are connected *in series* with each other the total resistance is *twice* that of the resistance.

If two equal resistances are connected *in parallel* with each other the total resistance in the arrangement is *half* that of one of the resistances. * * *

The permanent magnets of telephones or loud speakers are injured by mechanical shocks, so that the efficiency is lowered every time they are dropped or knocked over.

THE "POCKET MONEY" AMPLIFIER.

(Continued from previous page.)

4-pin adapter, and plugged into the valve holder of the single-valver; the detector valve was replaced. Unfortunately a large loud speaker was not available, and the one in use began to chatter when a fairly loud record was played, but on broadcasting the results were excellent.

The whole amplifier may be constructed for less than £2.

SOME HINTS FOR THE CONSTRUCTOR.

How wireless receivers should be built.

By W. W. D.

WIRELESS-SET building these days has become more or less of a strenuous business, the amateur being so filled with all sorts of designs, blue prints, etc., gratis, that he finds that he really does not know exactly which type of set to build.

Not knowing much, and perhaps nothing about wireless, he looks at all and sundry and decides upon a particular set which appears so very simple to build. So off he goes, and this is where the advice part of this article comes in.

First of all, if you have decided upon the set you intend to build, **BUILD IT**. That is to say, get on with it and do not attempt to alter it half way through just because Jack Jones has another type that works so well, etc.

Follow the Directions.

Yours will work equally as well, perhaps better, so do not be misled. Remember the people who have written up the article on the set you are going to build **KNOW** something about it; and perhaps Jack Jones doesn't, and he may be the means of making your set a failure.

Immediately you begin you will find heaps of pals who have built sets galore, and rest assured you will **NEVER** build the **RIGHT** set; they all know better what you **SHOULD** have done.

Carry on is the advice, and be careful to carry out the instructions, and you may then rest assured you will get a **SET** all right.

Another piece of advice is this, that when you get going nicely **DO NOT** experiment with it. Remember that the people who wrote the article have already done all the experimenting necessary, but leave the set alone; and if you are then enthusiastic, try and get some more parts and do your experimenting. Then, when you feel that you want a change, try to make a deal with the first set.

Buy British.

The great point is this, that if you bought a piano or a gramophone you would never dream of tampering with it, so why tamper with a wireless design?

Don't be in a hurry; do all the work **WELL** and do not buy the very cheapest goods you can; it will not pay, and if you really take care and do as suggested by the article you will assuredly get a set that will be a pleasure and not a source of trouble.

Remember this and, if you like, call it a maxim. **ANYTHING** will **NOT** do for wireless, and that there is **NOTHING TOO GOOD** for wireless. Get the best you can afford, and by doing this you will save yourself no end of trouble later on, if not at the start.

As a last word, do not buy unknown valves, etc.; be British and **BUY** British goods. **THEY ARE THE BEST.**

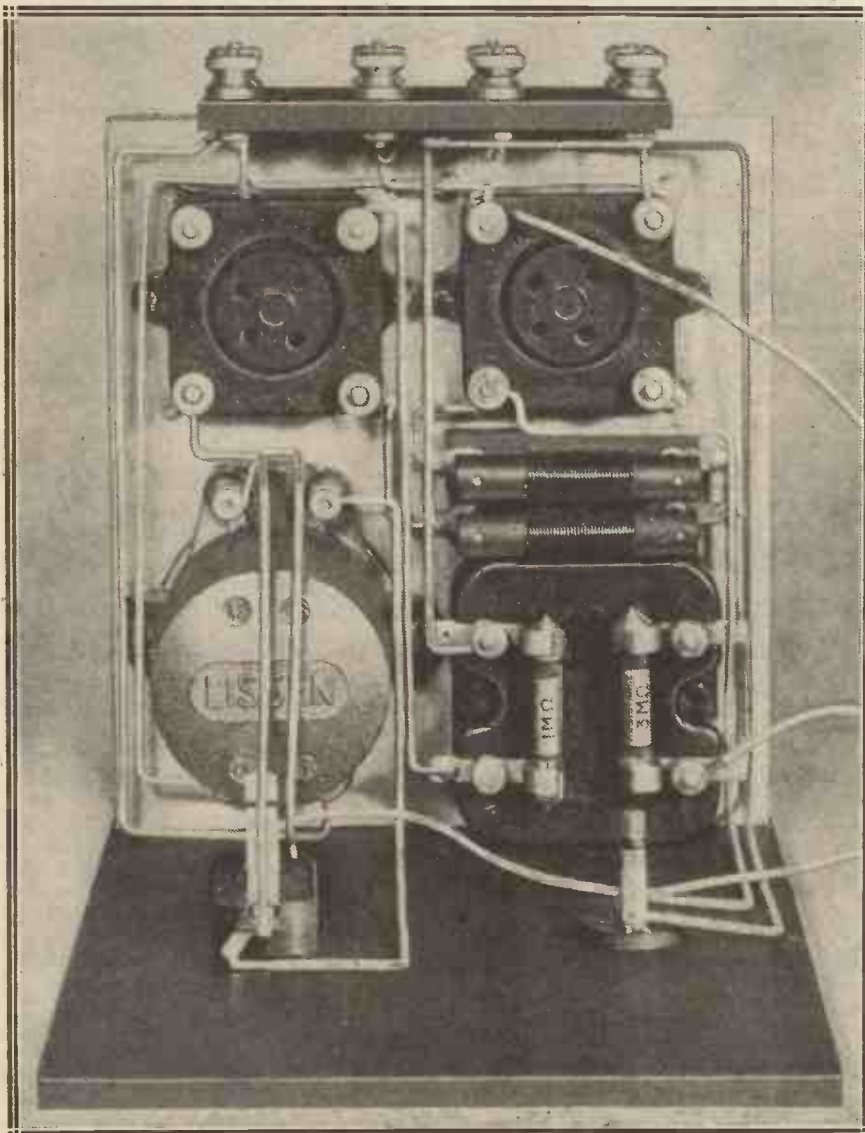

On the left can be seen the connections to the jack of the amplifier, while on the right is the L.T. switch. Note the symmetrical and compactly grouped lay-out of components. The wiring is quite straightforward and is facilitated by this design.

TECHNICAL NOTES.

By Dr. J. H. T. ROBERTS, F.Inst.P.

A NOVEL ACCUMULATOR

Kw. AS MEASURE OF POPULARITY—AN INTERESTING LECTURE.

A Novel Accumulator.

READERS will remember that I mentioned, a short time back, an invention which had been sent to me in connection with accumulators and liquid rectifiers. This invention being for the purpose of igniting the mixed hydrogen and oxygen evolved during the working of the cell and converting back to water so as to avoid the necessity for topping up.

Several readers have written to me to point out that the ignition of these gases would probably fracture the containing vessel.

This, of course, is the first thing that occurs to one's mind, but you will remember that I remarked, at the time, that the case of the accumulator or rectifier should be made stronger than usual. At the same time those who have written to me may have perhaps an exaggerated idea of the instantaneous pressure developed when the mixed gases are ignited. If the ignition spark occurs sufficiently frequently the pressure developed may be comparatively small. In any case I understand that this invention has been fully tried out and that it is about to be adopted in the United States, so I suppose any possible snags of the kind which immediately suggest themselves have either proved to be of no serious account or else have been overcome.

Kw. as Measure of Popularity.

It has often been suggested that a useful addition to the multitude of meters and indicating systems employed by a broadcast transmitting station would be one which indicated the popularity of the programme or particular item which was being transmitted at the moment. Such a meter would, for instance, "go up" when any of the various types of popular item was being broadcast, but would certainly "go down" wherever a talk came on. Its indication would be equivalent to a sort of instantaneous referendum from the listening public as to the acceptability or otherwise of the item in question. Suggestions have, in fact, been seriously put forward that a kind of "absorption meter" might be provided, indicating the amount of the radiation from the transmitting station which was being absorbed by wireless aerials.

The above-mentioned idea forms excellent material for the humorist and the wag but, curiously enough, a meter has been found which, in a sense, gives an indication of the amount of listening-in. It proves to be none other than the load meter (or set of such meters) at the New York Edison Company's power station, and it might be said that the kilowatt hour has provided a "measuring stick" to determine the relative popularity of broadcast features. According to Mr. Arthur Williams, the Vice-President of the New York Edison Company, there was about 6,000 dollars' worth

of extra electricity consumed on the night of the Tunney-Dempsey fight, which was attributed to people staying up late to listen to the description of the fight and to read the newspaper accounts that appeared in special editions shortly afterwards. The extra load carried by the company's generators did not fall off until about three o'clock in the morning.

An Interesting Lecture.

Those of you who are interested in the development of short-wave work and particularly of the Beam system, will find a very valuable paper in a recent issue of the Proceedings of the Institute of Radio Engineers (Volume 16, No. 1). The paper in question is by Senatore Marconi, and is very long and comprehensive, covering over 40 pages. It is a most useful and interesting history of the development of radio communication in general and, of course, deals specially with the experiments leading to the Beam system with which Senatore Marconi has been particularly associated. The paper is one which, in any case, cannot fail to prove extremely interesting to all wireless experimenters whether they specialise in short-waves or not.

(Continued on page 208.)

TRACKING THIEVES TELEGRAPHICALLY.



By means of the latest apparatus for transmitting photos, it is now possible to send very full descriptions of suspected or "wanted" malefactors either by radio or by land-line. Above is a "warrant," complete with finger print, received by the Berlin police by the Lorenz-Korn system. It is not television, for the process demands some minutes to "set over" just the one picture, but the result is remarkably successful.

NEWS FROM SAVOY HILL.

FROM OUR OWN CORRESPONDENTS.

PROGRAMME PLANS FOR EASTER

NEWCASTLE'S SCANDINAVIAN PROGRAMME—LIVERPOOL FEATURES.

Programme Plans for Easter

IN accordance with the practice of the B.B.C., the programmes on Good Friday, April 6th, will be in keeping with the solemnity of the occasion, the hours of transmission being restricted to those of an ordinary Sunday, except that there will be no break between the afternoon and evening programmes. The afternoon concert from London will be given by the Casano Octet, following which, at 5.15 p.m., a Children's Service, conducted by the Rev. A. R. Brown Wilkinson, M.C., of St. Christopher's College, will be relayed from Bournemouth. At 6 o'clock Masefield's play "Good Friday" will be taken from Glasgow, and at 7 o'clock a service will be heard from St. Anne's Church, Manchester. The evening concert will take the form of a National Symphony Concert, conducted by Sir Henry Wood, and relayed from the Queen's Hall, the music from which will consist of excerpts from Wagner's "Parsifal." The interval

will be made between 8.50 and 9.10 p.m. for the news bulletin and local announcements.

The programmes from 5 G B consist of a performance of the St. Matthew Passion by Bach, the great sacred music drama which was first performed at Leipzig on Good Friday, 1729, since when it has become firmly established as one of the finest sacred musical works of all time. Later there will be a concert of chamber music followed by a religious service from Manchester, and then a concert of vocal and instrumental works provided from London.

Easter Sunday will be marked by the broadcasting at 10.30 a.m. of Matins from York Minister with an address by the Archbishop of York. This service will be heard from London and 5 G B, as well as other stations. The afternoon programme from London is to be provided by the Wireless Military Band, while the evening service

(Continued on page 205.)

A VERY popular receiver has three valves. The first is a detector, that also provides reaction, which is resistance-capacity coupled to the second valve. The second valve is transformer-coupled to the third or output valve.

Such a receiver may be connected as in Fig. 1. Here R_1 is the anode resistance joined to the detector valve, C the coupling condenser, and R_2 the grid leak; T is the transformer that is used to couple the second and third valves. You will notice that a common high tension is applied to all three anode circuits, and that a bypass condenser, C_1 , of 2 microfarads is connected across the high-tension battery.

"Common" Batteries.

A common grid-bias battery is also used, but only a small part of it is applied to the grid of valve V_2 through the grid leak R_2 . The point we wish to bring out is that the receiver has one battery for the high-tension circuits, one for the filaments, and one for the grid circuits. It therefore follows that if either of these batteries have resistance the valves have a common coupling. This is undesirable.

We can ignore the filament circuit and for the moment the grid circuit. We will confine ourselves to the high-tension supply.

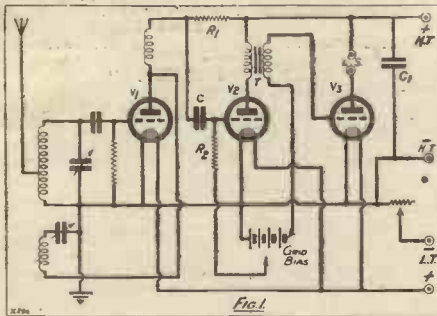

and the anode circuits of the valves. The internal resistance of a new battery is generally negligibly small, but after it has been used for a length of time, depending on its capacity and the construction of the battery, its resistance increases to such a value that the behaviour of the circuit is modified.

When the high-tension circuit has a negligibly low resistance it is quite fair to assume that the amplification-frequency characteristics of the receiver are exactly what one would expect them to be from a knowledge of the characteristics of the individual stages. We can, in fact, look upon the circuit as though it had separate high-tension batteries for each valve. But when the high-tension supply has an appreciable resistance the individual anode circuits are no longer isolated. They are united through a resistance common to them all.

Cause of "Howling."

This greatly modifies the performance of the receiver. Distortion may be produced, "motor-boating" may occur, and, in some cases, a howl may be emitted by the loud speaker.

You will see, that the behaviour of the

MAKING YOUR SET STABLE

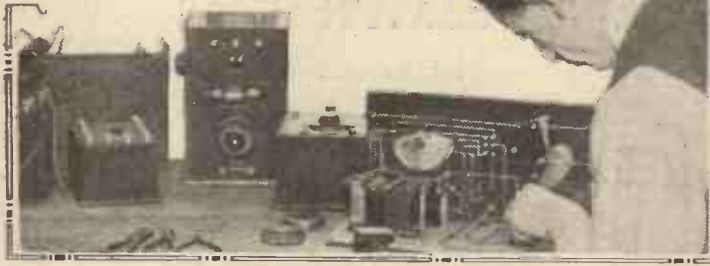

* How, in an inexpensive and simple manner, you can eliminate howls and other noises due to battery coupling and, incidentally, make your H.T. batteries last longer. *
 | By W. JAMES. |

receiver must change when resistance is present in the high-tension supply, if you consider what happens when a signal is applied to the last valve. The anode current of this valve rises and falls according to the signal voltage applied to the grid. This varying current flows through the loud speaker, and, of course, actuates it, but it also flows through the high-tension supply. Voltages corresponding to the signal are, therefore, produced across the high-tension supply. But the same high tension is applied to all three valves. Therefore, the varying voltage is applied to all the valves. This is passed through the amplifier and tends to increase or decrease the fluctuating currents.

Preventing the Trouble.

In bad cases the coupling produces a howl which shows that self oscillation has set in. The problem is, therefore, how best can one arrange the circuit that the evil effects of the resistance of the high-tension supply are minimised.

The first thing to be done is to reverse the primary or the secondary winding of the intervalve transformer T. Notice that only one of the windings has to be reversed, and it does not matter much whether it is the primary or the secondary.

As a rule it is the OP terminal of the primary that goes to the anode of the valve, and the OS terminal of the secondary that goes to the grid. The effect should be tried of joining the IP terminal to the plate, or the IS terminal to the grid.

The effect of changing over one of the windings as suggested is to help stabilise the receiver. The effect produced on the quality of reproduction is as a rule quite negligible.

The next change that should be made to the circuit will be understood by referring to Fig. 2. In this drawing we show the first and second valves only of the receiver, but we have modified the anode circuit of the detector. We have added a further resistance, R_3 , to the anode circuit and a bypass condenser, C_2 .

The value of R_3 may be approximately the same as that of R_1 , and condenser C_2 should be of 2 microfarads.

I have found that a receiver having the

transformer arranged as described, and with this additional anode resistance and bypass condenser, gives very good quality and does not howl or "motor-boat." For this reason it would be a good thing to include the stabilising device R_3 , C_2 in a receiver.

Dry batteries soon develop a high internal resistance. This does not mean that their terminal voltage is much less than their rated voltage, and, in fact, the harmful effects of the battery's resistance may be very noticeable long before the battery is discharged. The expense of the stabilising resistance and condenser is saved because a battery can be used for a longer period. It is a common experience that the battery may develop such a resistance that the receiver "motor-boats" long before its voltage has fallen to a point which would warrant it being replaced. The stabiliser helps prevent this.

The "Stabiliser" in Use.

If the stabiliser is added to an existing receiver the working of the reaction circuit may be altered. A little more capacity will have to be put in to make the circuit oscillate, or if the circuit was one which only oscillated when reaction condenser was all in it will be necessary to add a few more turns

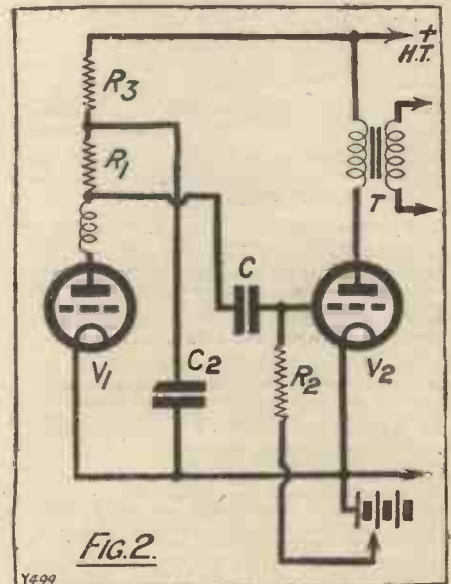

to the reaction coil. The correct number can soon be found by trial. Even when a battery eliminator is used there is an advantage in modifying the receiver as described. Certain high-tension eliminators have a circuit for the detector which includes a high resistance and a bypass condenser, but even so, the extra filtering provided by the resistance and condenser is worth having.

If you are already having trouble with your receiver, and it is exhibiting any of the above-mentioned symptoms, it is very probable that "battery-coupling" is the cause, as it is a frequent source of such faults. But it may happen that an error in design or connections is at the bottom of it—the "stabiliser" is not a "cure-all"!

FROM SIR OLIVER LODGE.

The Editor, POPULAR WIRELESS.
Dear Sir—Near the end of my last article on "Television" I made reference to the use of cathode rays, or moving electrons, as the only things likely to be sufficiently docile and controllable to be used as the agents for television. No material things are likely to be able to move quick enough; but electrons respond so instantaneously that if devices can be invented for utilising them, the theoretical difficulties connected with the required rapidity of motion would begin to disappear, both from the sender and receiver, especially as photo-electric response is almost infinitely rapid.

When I wrote my article I had entirely forgotten that a suggestion to the same effect was made long ago by Mr. A. A. Campbell Swinton, F.R.S. on several occasions, and I think it will be a convenience to your readers if I give references to his utterances, so that they may look them up. They are as follows:

A letter to "Nature," June 18th, 1908 p. 151, entitled "Distant Electric Vision."
Presidential Address to the Röntgen Society, on November 7th, 1911, reported in "Nature" of December 7th, 1911, p. 191, "Scientific Progress and Prospects."

A Paper read before the Radio Society of Great Britain on March 26th, 1924, on "The Possibilities of Television."
I am, Sir,
Yours faithfully,
OLIVER LODGE.

OUR £1,000 TELEVISION CHALLENGE.

The Editor, POPULAR WIRELESS.
Dear Sir,—I would just like to say that I am heartily in accordance with your challenge to Mr. Baird, and I also think that your terms set down in the challenge are extremely lenient, especially if the present television claims are true.

If you will permit me, I would like to suggest that in the event of Mr. Baird declining your challenge, you still keep the offer of £1,000 open to any inventor who can come forward and perform the feat according to your terms.*

A prize of £1,000 would greatly stimulate invention in this direction and may bring forth many valuable discoveries. I, for one, would perfect my own ideas, which I think will greatly improve the present apparatus. Of course, less than £1,000 could be offered, that is your part of the business. I just suggest offering a prize.

Yours truly,
LONDON, E.C.1. RONALD L. MANSE.
[*This suggestion is under consideration.—The Editor.]

The Editor, POPULAR WIRELESS.

Dear Sir,—I have read with interest your article and that of Sir Oliver Lodge on Television. I gather that in your view Mr. Baird has encountered a cul-de-sac, as it were, in his line of television experimenting, and his refusal to accept your challenge and the opportunity indicate that he is conscious of his limitations.

What I am curious to know is—assuming the Press account of the "Berengaria" incident is true—how is it he cannot accept your challenge?

Yours,
New Malden, Surrey. THOS. J. COE.

The Editor, POPULAR WIRELESS.

Dear Sir,—The attitude adopted by "P.W." with regard to Television rather surprised me. But having read the issue for March 10th, 1928, and the challenge to Mr. Baird, I have been convinced that "P.W." is in earnest, and have therefore changed my opinion.

Every new thing seems to be deprecated—it was always so. From telescopes to the Atlantic cable, from gunpowder to aeroplanes—all have been deprecated. Why do not the "velvet-edged" pessimists learn a lesson, with all the preceding failures of pessimists to make pessimistic predictions before them?

If the science of electricity had had as much publicity two or three hundred years ago, as television and ordinary wireless are having to-day both infancy a hundred years ago. Present systems of television seem to lead to dead ends. So did the first methods employed in wireless, until Marconi showed the way. The difficulties always get solved.

The chief difficulty with regard to television seems to be the light-sensitive device.

Probably the television sets of the future will not employ a large screen, but two small ones, viewed through eyepieces—like the stereoscope. This, to some extent, will solve the problem of bright light at the receiving end. The variation of intensity of the light is another problem. A clue might be found to this in experiments relating to the Interference of Light, and Fresnel's Mirror Experiment.

The challenge made to Mr. Baird interests me very much. The conditions seem to be very reasonable, all things considered, and I am sure all readers of "P.W." and others as well will follow developments with interest.
P. S. ROBSON.
Barras Bridge, Newcastle-upon-Tyne.

The Editor, POPULAR WIRELESS.

Dear Sir,—Your challenge to Mr. Baird, as published in your issue of March 10th, is distinctly interesting, and because progress in this intriguing quest is much to be desired, I hope to hear that Mr. Baird has accepted it.

It might not be necessary to jump to the conclusion that no progress has been made in the Baird system, even if Mr. Baird should not take up the challenge,

CORRESPONDENCE.

OUR £1,000 TELEVISION CHALLENGE

**"REGIONAL" TWO ON SHORT WAVES
—"THAT RADIO SCEPTIC."**

Letters from readers discussing interesting and topical wireless events, or recording unusual experiences, are always welcomed; but it must be clearly understood that the publication of such does in no way indicate that we associate ourselves with the views expressed by our correspondents, and we cannot accept any responsibility for information given.—EDITOR.

but if he is really ready to demonstrate in the positive way you have suggested, the demonstration would immensely quicken the practical interest and give direction to the research of many who already believe in the possibility of television, but are in doubt as to the line of experiment by which it may most hopefully be sought.

Yours faithfully,
J. S. MOULD
(Sales Manager),
Igranic Electric Co., Ltd.,
147, Queen Victoria Street, London.

The Editor, POPULAR WIRELESS.

Dear Sir,—The controversy regarding Television has undoubtedly reached the stage when it becomes highly desirable to raise the veil of mystery surrounding its possibilities and limitations. If, as we understand, the £1,000 challenge is designed to prove whether or no television in its present state of development can fulfil the expectations which have been aroused in the public mind, then we congratulate you in performing a public service. In the interest of all concerned, including the inventors, we sincerely hope that the challenge will be accepted, and the present possibilities and limitations of Television made widely known.—Yours faithfully,

D. BURNE-JONES
(Managing Director),
Burne-Jones & Co., Ltd.
288, Borough High Street, S.E.1.

**"TELEVISION," "PHOTO-RADIO," AND
"FACSIMILE."**

The Editor, POPULAR WIRELESS.

Dear Sir,—In a paragraph which recently appeared in a number of newspapers dealing with an advertisement—concerning the Province of Buenos Aires Loan—transmitted by wireless from New York to London, the process by which this advertisement was transmitted was described as Television, and the heading put up "Advertisements by Television." This is not correct.

Seeing that Television is now frequently mentioned in the newspapers, we think it might not be out of place if we draw your attention to the fact that there is a distinct difference between Television and Photo-radio or Facsimile transmission. Television is essentially the reproduction at a distance of things that

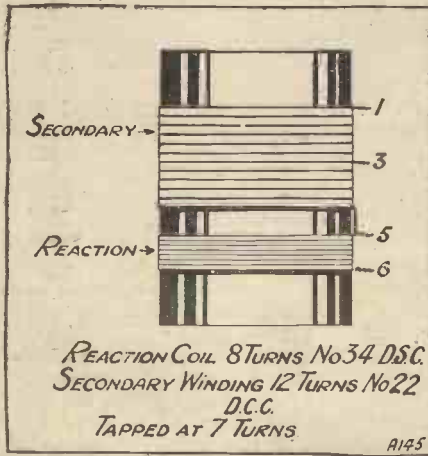

are actually happening at the moment. This has not yet been put into practice commercially.

Photo-radio or Facsimile transmission is, on the other hand, the transmission by electrical means of still pictures and of documents and diagrams of various kinds which are received in the exact form in which they are transmitted. This system has been in commercial use between the Radio Corporation of America's station in New York and the Marconi Company's station in London, since May, 1926.

As references to these different processes are likely to be frequent in the near future, you might find it useful to draw the attention of your sub-editors to this fundamental distinction between these methods.
Yours faithfully,

W. G. RICHARDS,
Chief of Publicity Department,
Marconi's Wireless Telegraph Co., Ltd.
[NOTE.—The confusion referred to above chiefly concerns the daily Press. We have not noticed errors of this nature in "P.W." or in our technical contemporaries.—Editor.]

"REGIONAL" TWO ON SHORT WAVES.

The Editor, POPULAR WIRELESS.

Dear Sir,—I recently built the "Regional" Two, as described in "P.W." No. 286. It gave excellent results on the medium and long waves, bringing in 44 stations on the 'phones and several at loud-speaker strength. I decided to wind a coil and try for K D K A on 62.5 metres. This station came through at excellent strength from 11.15 p.m. ('phones). Quality was good and a very slight, quick fading was experienced, but this gave no trouble. I give a diagram of the coil in case any reader should be interested. A small condenser, such as that used in the "Sydney" Two, must be connected in series with the aerial lead. I am going to build a smaller coil and try for 2 X A F and P C J J in the near future.

Yours sincerely,
Hornchurch, Essex. K. D. H. SELF.

THE "VARIATOR."

The Editor, POPULAR WIRELESS.

Dear Sir,—Re the "Variator Two," published in your issue of January 7th, I made up the one-valve part from a collection of odds and ends, and, with two small alterations, I find it the handiest and best one-valve I have ever tried. With little trouble I can get from ten to twelve stations including Madrid, Toulouse and the big German stations. I found that with the loading coil at back of baseboard sufficient reaction could not be obtained. Arguing that if the variometer reached to one side it ought equally to reach to the other, I placed the loading coil to opposite side of variometer and was surprised at the improvement. Then, to save pulling out big coil when altering a broadcast wave-length, I fitted a home-made two-way switch, so that I could cut out large coil completely. This, with two separate aerial terminals, makes the handiest set anyone could wish for. I have tried it on four different aerials including an indoor aerial, and with a P.M.1 for detector—it is the goods! Thanking you for such circuits as this.

Yours truly,
Great Yarmouth. W. SMITH.

"THAT RADIO SCEPTIC !"

The Editor, POPULAR WIRELESS.

Dear Sir,—After reading Mr. Elston's letter in to-day's "P.W.," I feel I must reply to it. I have been a reader of "P.W." practically from the first issue, and have got a great deal of useful information from it. I constructed a three-valve receiver (Det. and 2 L.F.) from details given in "P.W." which will tune from 60 to 3,000 metres, using home-made honeycomb coils, and will bring in fifteen stations on the loud speaker and a great number on the 'phones, which I think speaks very well for "P.W." circuits. I might add that my aerial is rather badly screened by buildings, and is not very high, being eighteen feet at the lead-in end, and thirty-five feet the other.

Wishing your paper every success.
Yours faithfully,
Ware, Herts. E. J. WALKER.

The Editor, POPULAR WIRELESS.

Dear Sir,—I should like to say a few candid words to Mr. B. Elston. On the nights of March 2nd and 3rd, I received 49 low-wave European stations (details enclosed for Editor's perusal) on a cone speaker. In the early morning of March 4th I logged 18 U.S.A. stations on headphones (I await confirmation from "World Radio"). On March 5th I picked up W G Y at 11.25 p.m. At 12.15 a.m. I transferred him to loud speaker, which he worked at weak strength. While reception conditions may have been exceptional, I rarely have any trouble in picking up plenty of stations. A passage from Mr. Dowding's excellent article reads: "My practised hand was soon able to rope them in from all over the continent." Here is the crux of the whole matter. Other essentials I find are good layout, components, and detector valve. These results were obtained with a modified 0-v-2 placed on the market by a popular valve maker.

Yours faithfully,
Cornwall. W. A. E. ROWETT.

THOSE "ROLLING-IN" STATIONS.

The Editor, POPULAR WIRELESS.

Dear Sir,—I greatly enjoyed reading the letter of "A Radio Sceptic," as I think some of the performances of the amateurs must make even Mr. Marconi gasp. Witness E.C.'s letter from Co. Wicklow, on February 18th last, describing his "Q. and A." Set, a straight two. I will quote his words: "The stations rolled in one after another, altogether between 35 and 40."

Now, I have made quite a few in the last three years, but if this reader can do this on two, I shall give my three away, and buy a gramophone.

Yours sincerely,
"OLD TIMER,"

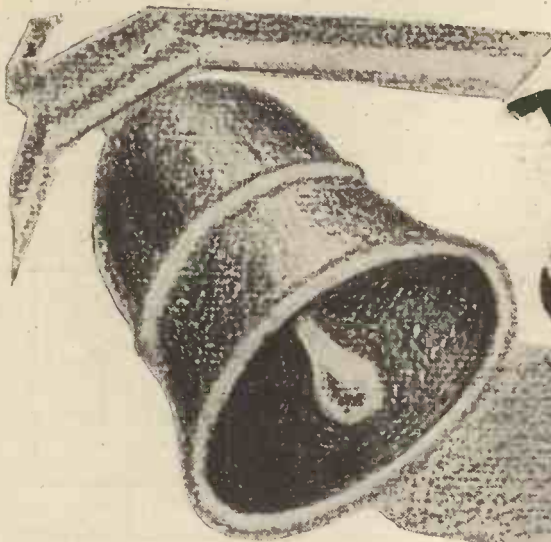

THE BOOM OF BIG BEN

Through a background
of utter silence you
hear it with startling
clarity to its last
reverberation

AS THE LAST notes of the Savoy Bands die away Big Ben's giant gong strikes out the midnight hour, and if you have a LISSEN Transformer in your set the notes sound so clear and true that you might be standing upon the silent forecourt of the Abbey. For the LISSEN Transformer fully amplifies every note, every tone, every harmonic, every overtone in a background of silence.

TEST IT FREE FOR 7 DAYS!

No matter what other Transformer may be specified, buy LISSEN L.F. Transformers when set building; test them in your chosen circuit for seven days—then if you are not satisfied take them back to the shop where you bought them and the dealer will refund your money.

This is a guarantee which only LISSEN gives—for the LISSEN Transformer may be used in every set and every circuit, no matter what else may be specified, and 10,000 radio dealers sell it under the unconditional guarantee given above.

LISSEN L.F. TRANSFORMER

LISSEN LIMITED, 8-16, FRIARS LANE,
RICHMOND, SURREY.

Managing Director: Thomas N. Cole.

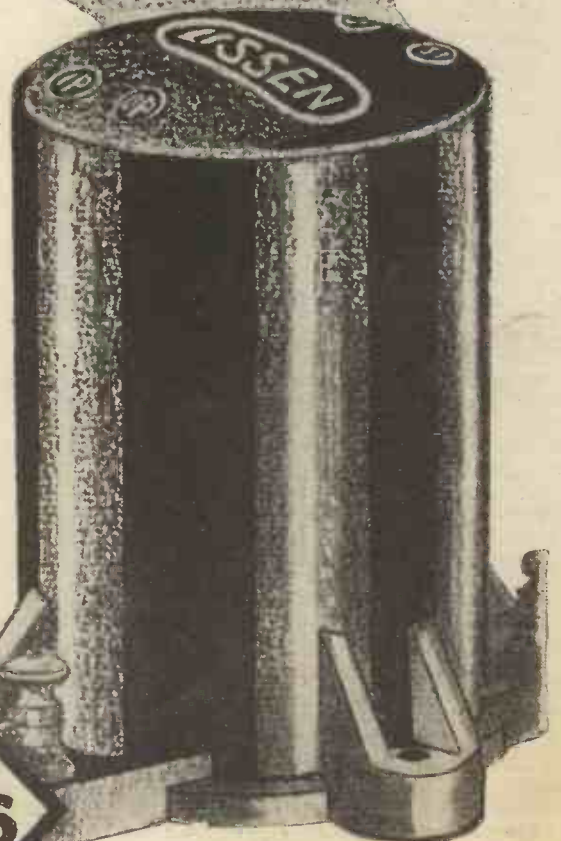

A DISTURBING FAULT.

Possibly your set might not have developed this trouble,
but you never know—

By H. J. B. C.

METAL panels for use in wireless receiving sets are no doubt proving very popular in many quarters, and deservedly so, for not only are they cheap and of pleasing appearance, but in a set designed specially for employing a metal panel the amount of wiring can be reduced by taking advantage of the metallic connection provided by the panel itself.

A Recent Experience.

Particular care must be exercised, however, to ensure that the incorporation of this particular arrangement does not lead to a personification of the phrase concerning "a good servant but a bad master." This was brought home to me very forcibly just recently through the location of rather

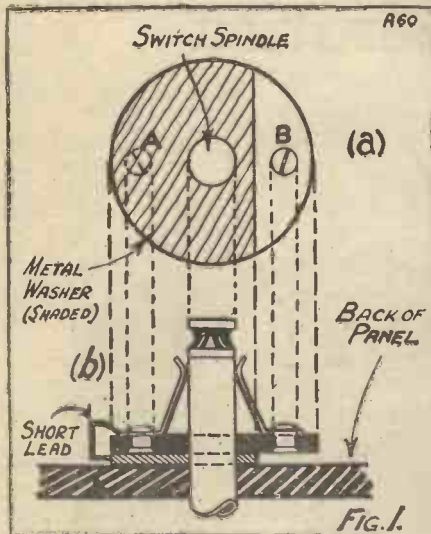

an unusual fault in a two-valve receiver I had cause to examine.

The set was situated in one room of the house, with a loud-speaker jack in the drawing-room, and it appears that the procedure always adopted was to switch on the set, then retire to the drawing-room and insert the loud-speaker plug into the jack for the evening's entertainment. When the programme was finished the plug was withdrawn and then one of the family was deputed to go and switch off the set.

Always "On."

It transpired that the accumulators (two being kept in alternate use to prevent any break in the use of the set) only lasted for about a sixth of their expected time, while the H.T. battery ran down in a relatively short period. Further questioning elicited the information that the average nightly use was for four hours—i.e. one sixth of a day.

The similarity between these two proportions caused me to suggest that the set had not been properly switched off, and in consequence the valves were consuming current day and night.

The set was accordingly taken from its cabinet, the L.T. switch examined, and the fault at once revealed. A metal panel was in use, and the switch had been packed at the back with washers and one side of the switch was joined to the top washer by a short lead, see Fig. 1 (b).

This particular washer had a segment cut away to prevent it touching the other switch contact, but, unfortunately, during the process of mounting, or as the result of a loose nut, it had slipped from the position shown in Fig. 1 (a).

Now the screw holding contact B in place projected slightly at the back, with the result that the washer was shorting contacts A and B, and hence the valve filaments were switched on all the time irrespective of the position of the push-pull switch.

OVERCOMING RESISTANCE.

THE picnic party was forced to remain on one side of the river owing to the sudden rising of the floods. Galvan Ometer, a huge Pole, volunteered to swim for aid, but they knew that the resistance of the swift current would amperé him.

"We shall have to get ohm by the bridge," said one gentleman with a large joule. But when they reached this, they found that it was sagging in the middle. "I am positive I can volt that gap," said Galvan Ometer. There were cries in the negative, but "Watts that to me!" he cried, determined to risk it and cell his life for his friends. He laid his switch down, and bundled himself up into a coil. After a series of swings, he let go, and describing an arc, landed safely on the other side. Examining the broken part, he exclaimed: "It's only these two ions which have snapped—that's the key to the whole thing. I'll soon fix them so that you can come across on these two parallel beams."

They cheered; and Mr. A. M. Meter said: "Anode 'e could do it, lad, yet I would have been filled with re-Morse if he had perished. Yes, he is a brave fellow." E. W. H.

FLEXIBILITY WITH THE "HARTLEY."

THE increase in selectivity of the Hartley over the more common circuits of a detector valve is due to two causes: (a) the reduction of damping caused by the valve itself, and (b) the reduction of damping caused by the aerial.

The Hartley circuit is indicated in Fig. 1, where A.C. is the combined tuning and

reaction coil. The coil is generally tapped at the mid-point B—the part A B is in series with the aerial, and also connected across grid and filament of the valve; the other part of the coil is used for reaction.

If our coil is not centre-tapped, but tapped say at one-quarter way down from one end, in Figs. 2 and 3 we can alter the selectivity

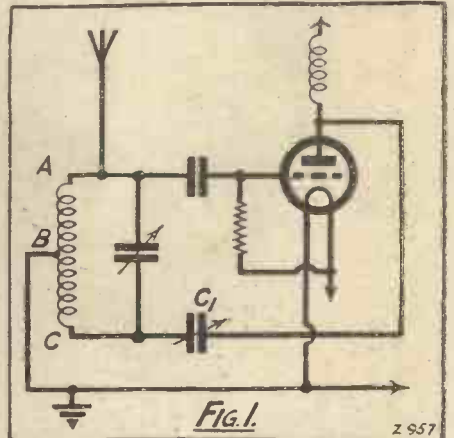

by interchanging the connections at A and C. To change from Fig. 2 to Fig. 3 it is only necessary to reverse the coil in its holder, which can easily be arranged for in any home-made coil.

If a multi-tapped coil is available the selectivity may be varied in steps. Simply by altering the position of the tap B, and

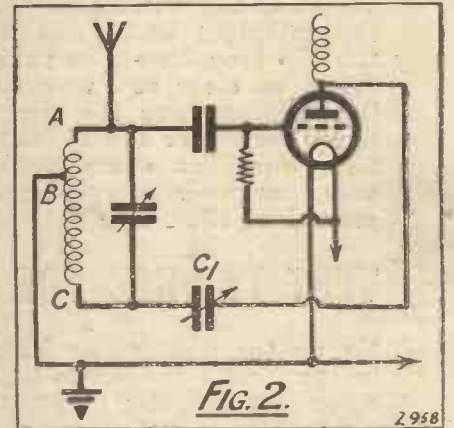

no dead ends are formed at any tapping. Incidentally, variation of the tapping point gives a rough control over reaction which may be very useful, particularly if a small capacity is used at C₁, and the set is required to cover a large range of wavelength.

P. G. B.

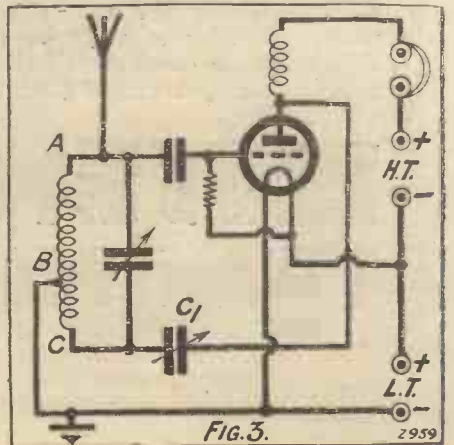

Get this feast of real music

with a **LISSEN BATTERY** in your set



You need the pure power of the Lissen Battery in your set if you want to hear glorious opera at its best. Not only is there long life in the Lissen Battery but it gives a sustained power through many hundreds of programmes. With its large cells, low internal resistance, with a new combination of chemicals embodied in a new process known only to Lissen the cells of the Lissen Battery generate abundant energy and the current flows always so noiselessly, so smoothly, that every instrument of an orchestra and every note of music, every word of song, is clear and distinct.

If you want your loud speaker utterance to remain natural and true throughout the longest programme, use only the Lissen Battery.

Obtainable at 10,000 radio dealers. Ask for it in a way that shows you mean to have a Lissen and will take no other.

60 volt (reads 66 v.) - - **7/11**
100 volt (reads 108 v.) **12/11**
60 volt Super Power **13/6**

KILOCYCLE TUNING for greater selectivity!

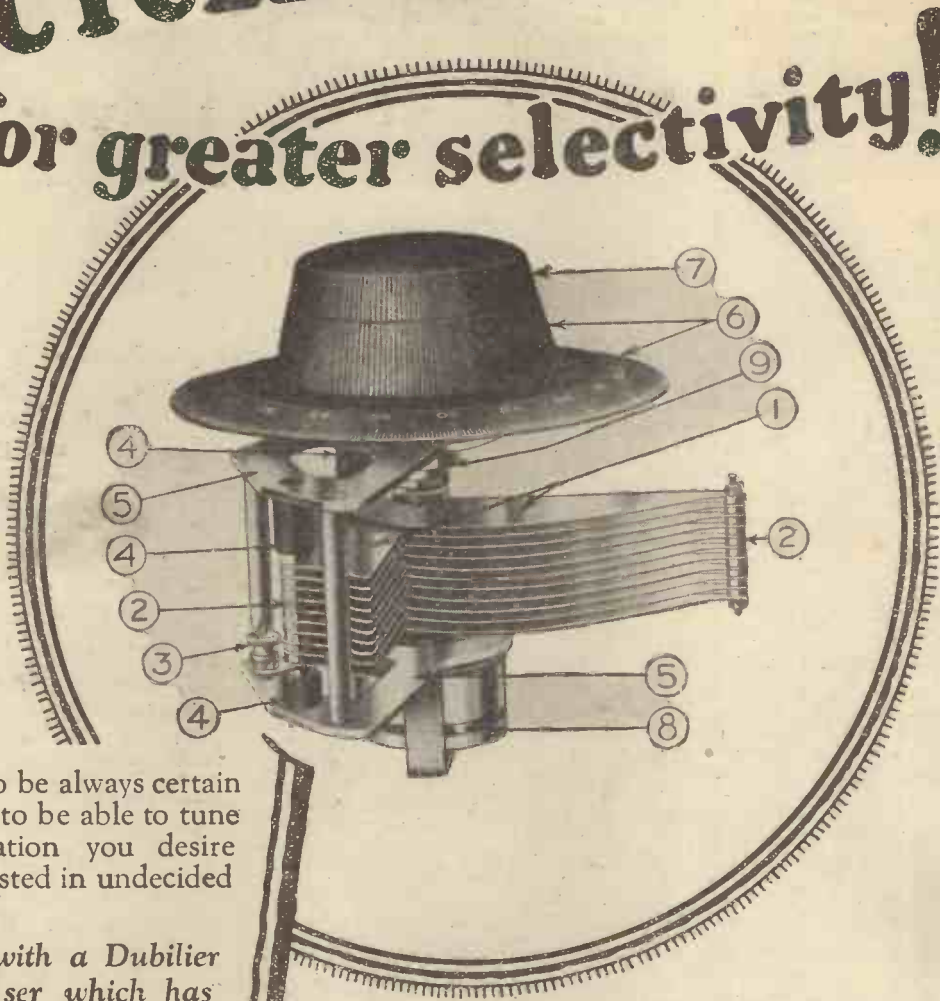

How delightful to be always certain of your station—to be able to tune in whatever station you desire with no time wasted in undecided searching.

Fit your set with a Dubilier K. C. Condenser which has been specially designed to render true kilocycle tuning. With no other type of condenser are the stations so adequately distributed round the dial.

In design and workmanship, the Dubilier K.C. Condenser maintains the recognised standard of Dubilier efficiency and, like all Dubilier products, is unsurpassed in performance.

1. VANES of stout brass sheet. 2. SPACERS, between which vanes are firmly clamped, ensuring rigidity and eliminating possible resistance through loose connections. Consistent spacing assured by the extreme accuracy to which spacers are turned. 3. TERMINALS—one giving direct connection with the frame and rotary vanes and the other with the fixed vanes. 4. INSULATORS of high quality moulding material under compression, forming an effective insulation of the stator slates, and eliminating dielectric losses. 5. END PLATES of the skeleton type, ensuring rigidity and lightness. 6. KNOB AND DIAL of finest finish and engraved in 180 single degrees. Diameter 4 ins. Main knob rotates moving vanes direct. 7. SMALL KNOB. This moves independently of the main knob and works a slow-motion drive. 8. SLOW-MOTION DRIVE. Approximate reduction ratio of 200:1 enabling precise tuning adjustments to be easily secured. 9. BALL RACE, giving a velvet-smooth movement whether the direct or slow-motion drive is used, and with entire absence of backlash in either case. One Hole Fixing— $\frac{1}{8}$ in. clearance. A large nut is provided for mounting on panel. Maximum Capacity '0005. Price (including knob and dial), 12/-.



©139

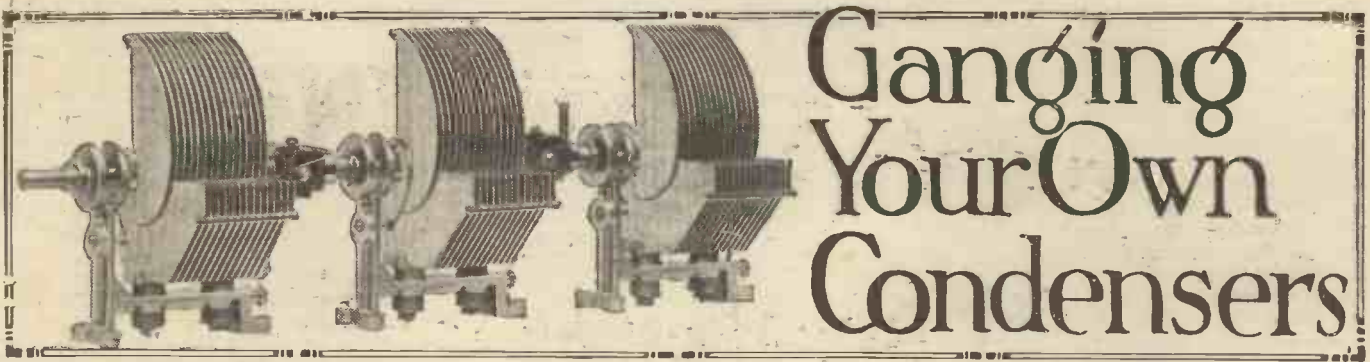

Ganging Your Own Condensers

THE tuning of a receiver which has one or more tuned H.F. stages is greatly simplified by the use of gang-controlled condensers. The tuning coils must, of course, be matched, or nearly so, and it is then vastly simpler to rotate the variable condensers together, with one knob, than to adjust separate dials to the correct readings. The condensers now obtainable in ganged form are coupled together by means of their spindles. This method of coupling is not easy with existing single condensers, and it is a job which is hardly possible in most amateur workshops. There is one type

 Details of a simple method of making your own "gang" condensers.
 By A. V. D. Hort, B.A.

easy to construct, but it does not permit of much adjustment of one of the condensers independently of the other. A slight difference in the settings of the vanes can be obtained by slacking the nuts at one end of the coupling, turning the ebonite strip

of the coupling, sliding the bolt along the slot in the required direction and tightening the terminal head again. If you need a wider range of adjustment, make the slotted ebonite strip and the strip opposite to it longer. The slot should be wide enough to allow free play for the 4 B.A. bolt, as the latter has to move through an arc of a circle in making the adjustment.

The Friction Adjustments.

The friction adjustment of the condensers is important. The front one should be normal. Slack the spindle of the rear one until the vanes will fall back of themselves when they are lifted. There will then be no risk of straining the coupling or the vanes. The front condenser is mounted on the panel in the usual way. The rear one is supported by a metal bracket standing on an ebonite base, or on a vertical strip of ebonite fixed to the baseboard with brackets or against a block of wood as in the photograph. Be specially careful to align the condensers as exactly as possible. If they are out of line, they will not turn smoothly.

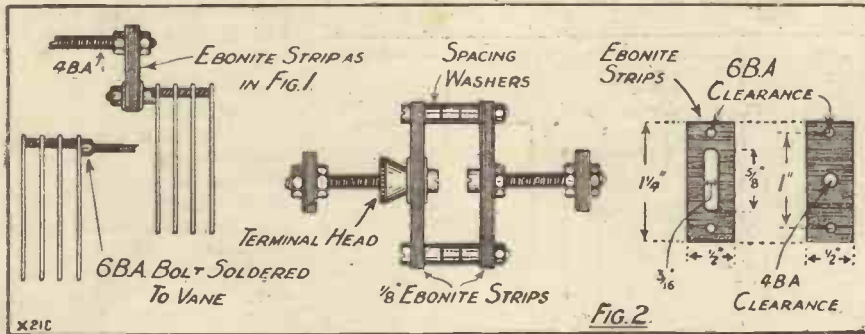

of condenser, however, which lends itself to ganging by another method. An example of a two-gang condenser constructed in this way is shown in one of the diagrams. The components to use are S.L.F. condensers with long moving vanes held together at their outer ends with some form of clip or bolt.

Easy to Construct.

The coupling shown in Fig. 1 is the simplest. Here the moving vanes are held at their ends by a bolt. To make the coupling, take out this bolt and put in a slightly longer one. Clamp on this an ebonite strip

through a small angle and tightening up. More Satisfactory Type.

This, of course, throws the 4 B.A. rod out of line and tends to twist the moving vanes, but provided that the difference between the two condensers is not too great, no harm will be done.

In Fig. 2 are given details of a much more satisfactory type of coupling. It is a bit more troublesome to make, but it gives a fine adjustment without throwing the coupling out of line. A pair of condensers fitted with this coupling are, shown in the photograph, which illustrates also the method of mounting them. In these condensers a bolt through the ends of the vanes would cause a short-circuit with the fixed vanes, since the moving vanes do not overhang the fixed ones. A fibre strip is, therefore, fitted to the ends of the moving vanes. The coupling is fixed to the condensers by means of cheeseheaded 6 B.A. bolts soldered to the outside moving vanes.

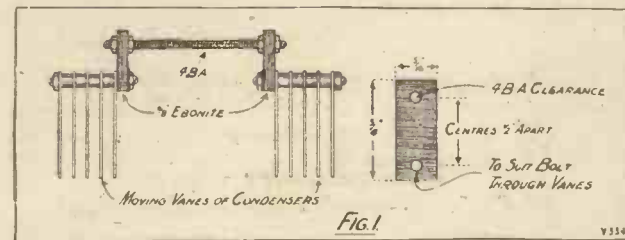

of the dimensions given, and fix a 4 B.A. rod of the required length at the other end of the strip. The second condenser is fastened to the other end of the rod in a similar manner. This form of coupling is

Independent adjustment of one condenser relative to the other is effected by slackening the terminal head on one side

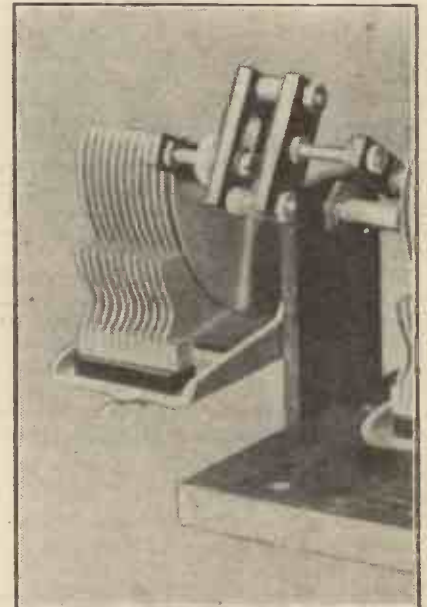

The two condensers connected together by the method explained above.

You will not have the vernier balancing adjustments provided on commercial models, but it is very easy to employ what is known as a "trimming condenser." This is a small "vernier" condenser of say .0001 mfd. connected across one of the sections of your home-made gang for balancing.

THE frame aerial is perhaps one of the most neglected of wireless devices. Presumably everybody knows what a frame aerial is, but most amateurs fight shy of using one. It is quite a common belief that a frame aerial is very inefficient, and apart from self-contained portable sets one rarely sees a frame aerial in use unless it is with a super-heterodyne receiver.

This general belief that frame aerials are too inefficient to be worth while probably arises from using too small a frame and using it incorrectly. Frame aerials for successful use with a modest receiver require careful consideration; properly used they are then far from inefficient and possess important advantages over the outside aerial.

Ignoring for the moment the degree of efficiency, the case for the frame aerial is quite a strong one. It is compact and easily transportable, it is cheaply and easily constructed, it is free from the dangers of lightning and minimises atmospheric and interference. Above all it increases selectivity, and has the well-known property of directional reception. A long list of merits you may say, but useless without some degree of efficiency as an aerial. This I hope to show is far higher than is generally believed. A modest receiver, such as a detector and one or two L.F. stages is ample for DX work.

Constructional Details.

The frame aerial should have a side of at least 3 ft.; but more than 3 ft. 6 in. is unnecessary. The construction of the form upon which the frame is wound should be rigid, using the least material possible. The frame winding must be well insulated, space wound, using for preference stranded wire, of which there are several kinds specially manufactured for this purpose. For a wave-length range of approximately 200 to 550 metres using a .0003 mfd. tuning condenser, 14 turns are required. Three of these comprise the reaction winding as described below.

The receiver attached to the frame aerial requires to be simple, straightforward and efficient. A regenerative detector must be used for fullest sensitivity and upon the manner of applying and controlling reaction hinges the whole success of frame aerial reception. Maximum signal strength depends upon delicate tuning at the stage prior to oscillation.

Smooth Reaction Control.

Undoubtedly the best method is to react straight into the frame, as shown in the theoretical diagram on this page. The usual form of capacity control is used and, with proper adjustments of H.T. and filament voltages, a very smooth reaction control is possible. Given this super-smooth control, plus a slow-motion tuning condenser, it is surprising how far one can reach out with a receiver like this. Careful tuning is necessary for the best results, but modern condensers simplify the operation greatly. Of course, the receiver will not give loud-speaker results on any station other than



FRAME AERIAL RECEPTION

Some practical notes on the subject.

By J. ENGLISH.

being in a state of gentle oscillation. Reaction is then carefully slackened off until the receiver is in the pre-oscillation state, the tuning condenser being moved at the same time to keep in tune. A final adjustment of this condenser then produces maximum signal strength.

The peculiar effect is noticed of a sudden jump in signal strength when the tuning condenser is exactly in tune, with the set just off oscillation. Although signals may be coming in well and the set appear to be in tune, there is just one critical setting where maximum signals are heard. Without the modern slow-motion devices it is difficult to obtain this fine tuning. Hand capacity effects, however, although they can be troublesome, can be largely avoided by careful design and construction.

the local, but during both summer and winter months, I have toured Europe on the phones on many evenings, stations a thousand miles away coming in with extraordinary clarity. Atmospherics have always been considerably less than with outside aerial and fading not so marked.

When searching for distant signals the frame is rotated until one position gives the strongest heterodyne note, the receiver

Short-Wave Possibilities.

It is well known that the efficiency of the frame aerial increases as the wave-length decreases. This opens up possibilities for short-wave reception where the efficiency of the frame may approach that of the ordinary small aerial. As a basis of experiment the frame should have 3 to 4 turns, with a variable tapping for the filament lead. Alternatively a modified Hartley circuit can be used.

One of the essentials for satisfactory results on all wave-lengths is the elimination of receiver noises. When there is a perfectly quiet "background" weak signals are naturally more easily readable.

The desired state of affairs can be secured by using reasonably fresh H.T. and grid-bias batteries, a reliable grid leak and condenser, and a transformer free from leakage.

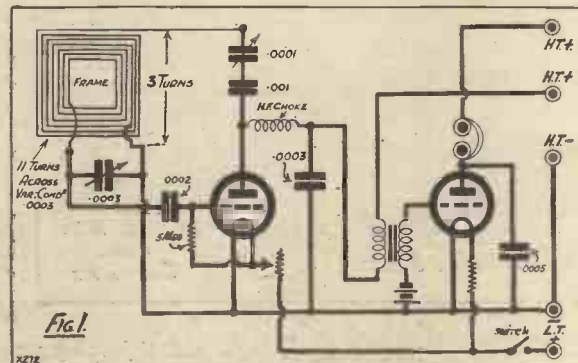

A simple but efficient frame aerial circuit.

RADIO JOTTINGS.

A record for amateur telephony in daylight was recently established by G 5 H S, of London, and U 6 Z A T, of Los Angeles, California.

The musical instruments used by one of the bands whose dance music is broadcast regularly by W J Z, New York, are valued at over £2,000.

Radio on railway trains is becoming increasingly popular on the Continent, and successful experiments have recently been carried out on the Warsaw railway.

An enterprising New York newspaper, "The Evening Telegram," has announced that its radio department is investigating the possibilities of transmission on a wave-length of only three-quarters of a metre.

Owing to the interruptions caused by storm and floods to the ordinary tele-

graphic and telephonic communication, the Government of Ceylon have been experimenting with a portable wireless receiving and transmitting set capable of communicating over a range of 300 miles.

It has been officially computed that the world contains no less than 18,000,000 radio receiving sets.

The first direct wireless messages between England and Australia were transmitted from Carnarvon on September 22nd, 1918, and were picked up in Sydney, New South Wales.

Four thousand metres is the longest wave-length used in Europe for broadcasting, this being one of the wave-lengths of the Berlin Koenigswusterhausen station.

The Belfast Station was opened on November 4th, 1923.

The crystal as a wireless detector was discovered by an American, General Dunwoody, in 1906.

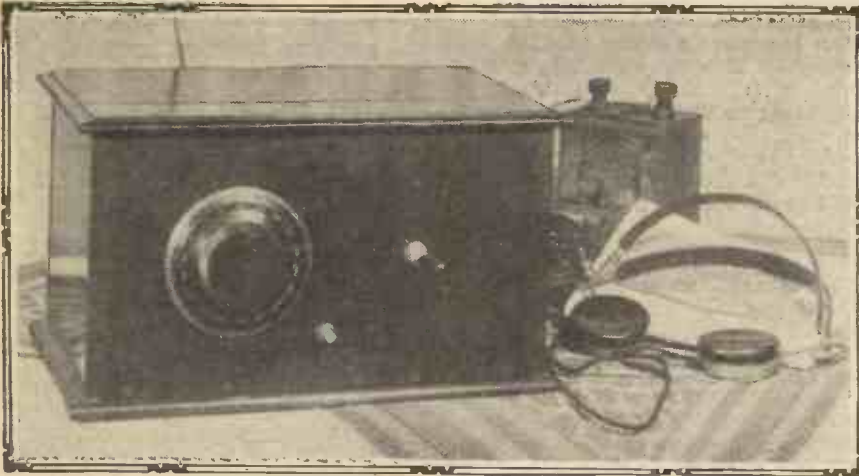

The "HARTLEY" ONE- VALVER

Here is a fascinatingly simple and efficient little set—just the one to give you real DX results. It is a special design of the "P.W." Research Department, and has been given exhaustive tests.

Described by
G. P. KENDALL, B.Sc.

It always seems to me rather a curious thing that one of the most efficient and fascinating forms of the single-valve reaction circuit, namely the Hartley, should also be one of the most neglected. Probably this is due to some extent to the fact that one form or another of the popular

of cost, and it must not be forgotten that the Reinartz requires two variable condensers, although one of these may be of the relatively cheap type of .0001 mfd. developed for reaction purposes. Again it must not be assumed that the Reinartz necessarily gives the loudest possible signals that can be obtained with a detector valve.

Tricky Circuits.

As a matter of fact, there are a number of special circuits which, when working at their best, will beat the average Reinartz for signal strength, although, of course, it does not follow that they have quite all the other advantages of the Reinartz. Many of these circuits are admittedly a little difficult to operate, troublesome to adjust so that reaction is smooth, and so

on. Many of them possess some slight drawback or other which is not present in the Reinartz, but nevertheless they form a very fascinating field for those who have acquired a little skill in handling wireless receivers, and can appreciate the very good results obtainable by the expenditure of just a little time in practising their operation.

The Hartley forms a very good example of a circuit of this kind, giving the possibility, as it does, of particularly good

(Continued on next page.)

COMPONENTS REQUIRED.

- 1 Panel, 12 in. × 7 in. × ½ in. or ⅜ in. (any good branded material).
- 1 Cabinet to fit, with baseboard 9 in. deep (Artercraft, Bond, Camco, Makerimport, Pickett, Raymond, etc.).
- 1 .0005 mfd. variable condenser with slow-motion or vernier dial (Ripault in original. Any good make).
- 1 On-and-off switch (Benjamin, Bowyer-Lowe, Igranic, Lissen, Lotus, etc.).
- 1 Panel-mounting neodyne condenser (Peto-Scott in original. Any standard make).
- 2 Board-mounting coil sockets (L. & P., Lotus, Magnum, Peto-Scott, etc.).
- 1 .0003 mfd. fixed condenser (Clarke, Dubilier, Goltone, Lissen, Mullard, T.C.C., etc.).
- 1 2-megohm grid leak with holder or other mounting (Dubilier, Igranic, Lissen, Mullard, etc.).
- 1 Sprung valve socket (Benjamin, Burne-Jones, B.T.H., Cosmos, Igranic, Lotus, Marconiphone, Precision, Pye, W.B., etc.).
- 1 Baseboard filament rheostat (Igranic, Lissen, or similar type).
- 1 H.F. choke (Bowyer-Lowe, Burne-Jones, Cosmos, Lissen, Igranic, R.I. & Varley, etc.).
- 1 Terminal strip, 8 in. × 1½ in. × ½ in.
- 8 Terminals (plain type, or engraved, such as Belling & Lee, Eelex, Igranic, etc.).
- Wire, screws, short piece of flex, etc.

Reinartz has now become almost standard practice for the detector circuit, and so experimenters are ceasing to pay much attention to other arrangements.

Why the Reinartz?

No doubt the Reinartz circuit has a number of very solid advantages, such as the possibility of obtaining beautifully smooth reaction control, reasonably good selectivity, ease of control, and so on, but it does not follow necessarily that it is the best possible arrangement for a detector valve. For example, there is the question

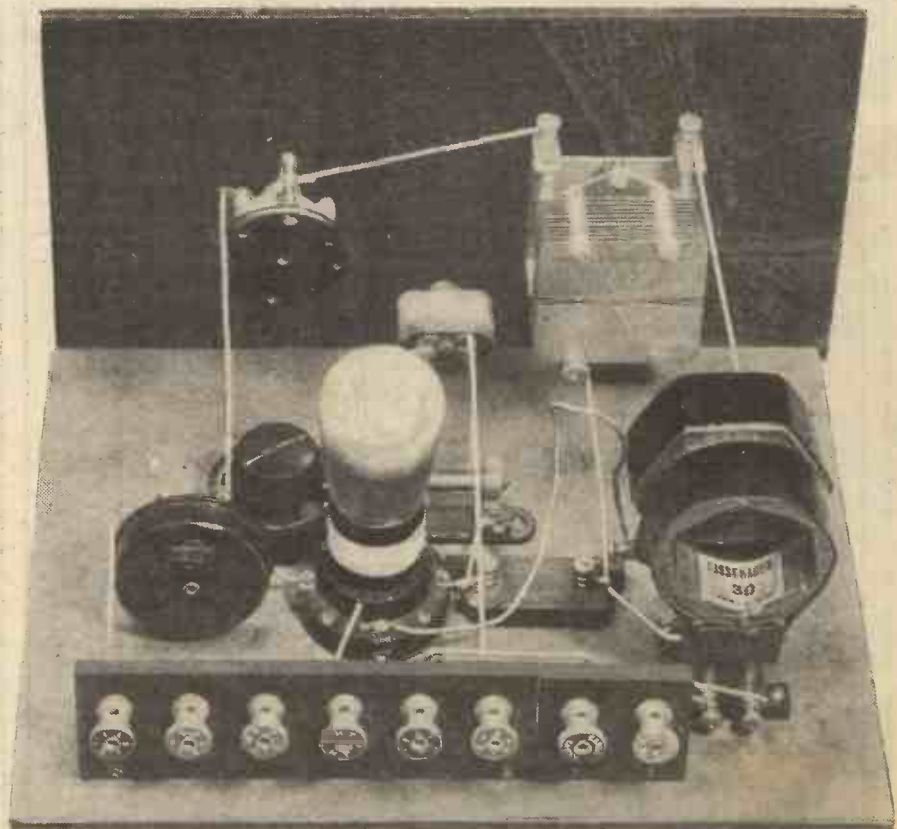

You will gain a good idea of the simplicity of the receiver from this back-of-panel photograph. Note the two plug-in coils which are used and the small reaction control condenser.

THE "HARTLEY" ONE-VALVER.

(Continued from previous page.)

signals, coupled with smooth reaction control with very few of the disadvantages associated with so many of these special circuits. Its particular advantages are relative cheapness, in that only one full size tuning condenser is needed, the reaction control being obtained by what is usually called a neutrodyne condenser and, further, high sensitivity and selectivity. When properly designed and well-built, the only real drawback which can be regarded as inherent in the circuit is that of a slight difficulty in tuning which results from the fact that neither side of the variable condenser can be connected to earth, so that there may be some slight trouble with hand-capacity effects. This difficulty, however, can usually be got over almost completely by the use of a good vernier dial with an operating knob which is separated from the main body of the condenser so that one's hand does not approach very closely while tuning in.

When this is done a well-designed Hartley receiver can prove a most fascinating set to operate and can be strongly recommended to those who have tried ordinary single-valve reaction circuits, and feel that they would like something a little more specialised and capable of giving finer results in the hands of an operator prepared to cultivate just a little delicacy of touch.

Cheap But Good.

It has seemed to me such a pity that the merits of this very excellent little circuit should be neglected that a special design has been prepared by the "P.W." Research Department, to enable those readers who are interested in this sort of thing to try it out for themselves. The set has been carefully designed so as to be very simple, and, of course, as cheap as possible as consistent with really good results.

The set has been built on the American plan of a vertical front panel carrying the tuning and reaction controls and the on-and-off switch, with all the rest of the components neatly arranged on the base-board inside the cabinet, and although this, maybe, is slightly more expensive than the flat-topped cabinet, it is perhaps the only extravagance which has been com-

POINT-TO-POINT CONNECTIONS.

One filament socket of the valve holder to one end of the grid-leak holder, and to one side of the filament resistance.

Other side of resistance to one side of the L.T. switch.

Remaining side of switch to the L.T. + terminal.

L.T. - to H.T. - terminal, to the remaining filament socket of the valve holder, to the centre tap on the aerial secondary coil via a flexible lead, to the earth terminal and to the socket of the aerial primary coil holder.

Aerial terminal to the plug of the aerial primary coil holder.

Grid of valve holder to one side of the .0003 mfd. fixed grid condenser, and to the remaining end of the grid-leak holder.

Other side of the .0003 mfd. grid condenser to the socket of the secondary aerial coil holder and to the fixed vanes of the .0005 mfd. secondary tuning condenser.

Plug of secondary aerial coil holder to one moving vanes terminal on the .0005 mfd. secondary tuning condenser.

Remaining moving vanes terminal on the tuning condenser to one side of the reaction condenser. (With other makes of condensers used for the secondary tuning this lead will be joined to the moving vanes terminal which is also joined to the plug of the secondary coil holder.)

Plate of valve holder to one side of the H.F. choke and to the remaining side of the reaction condenser.

Remaining side of the H.F. choke to the 'phones - terminal.

'Phones + terminal to the H.T. + terminal.

This completes the wiring.

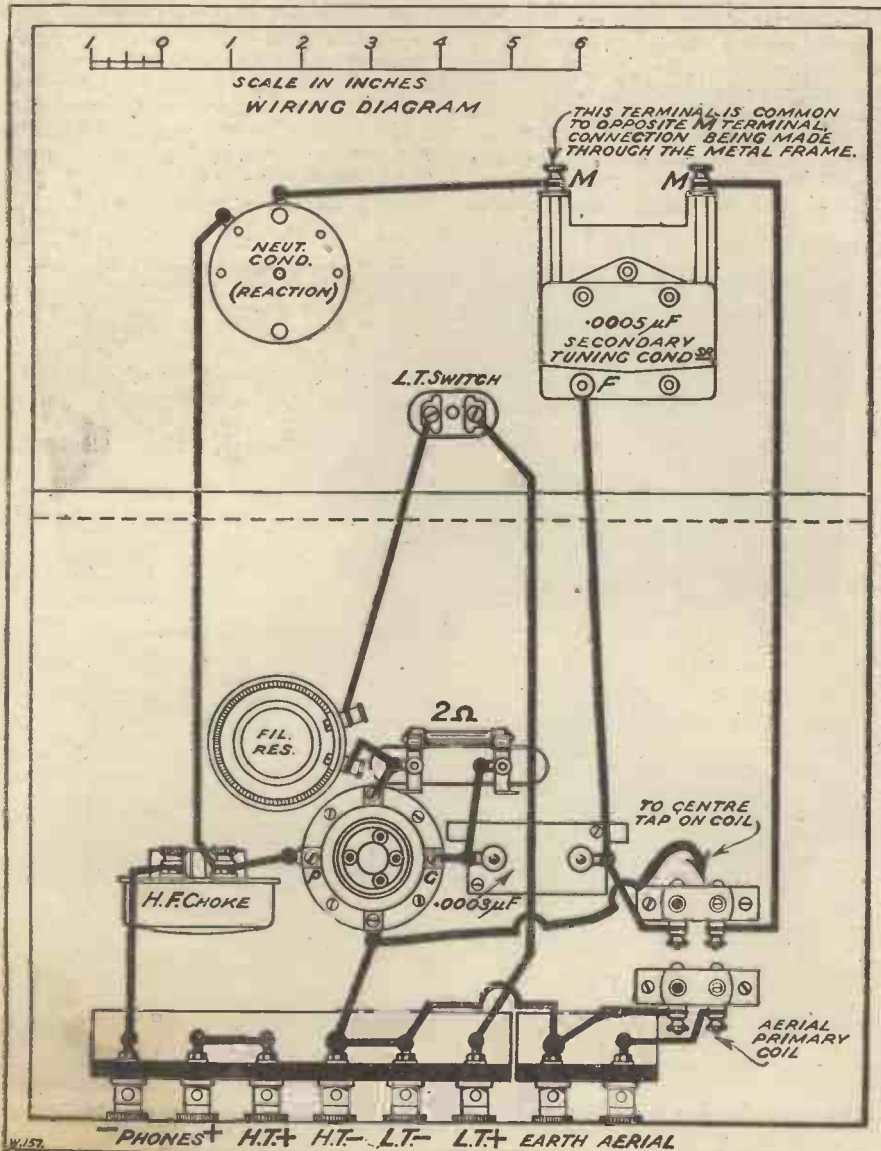

mitted, and it is still possible to build the set for about two pounds, even if quite a good cabinet is purchased ready-made, instead of being made at home.

The circuit is reproduced on these pages, and those who are skilled in reading circuit diagrams will perhaps be interested to take a look at it at this point. A separate coupled aerial circuit is provided of the semi-aperiodic type, and this is one of the special features of this particular design. This feature is, as a matter of fact, particularly helpful in these days, when most people value highly the power to cut out their local station and receive foreigners and 5 GB when desired, and this is easily achieved in most places by the choice of a suitable size of coil for the aerial. For the ordinary broadcast band of 250 to 550 metres, the coil will usually be about a 35, although a smaller coil may sometimes be necessary to increase selectivity.

Selectivity.

You will find that the larger this coil within limits, that is to say, up to about No. 40, the stronger the signals for any given station, but if the coil is made too big you may find that selectivity will suffer seriously. Thus, you should aim at using as large a coil as you can without getting into trouble with your local station. With small, and indoor, aerials, you will naturally use the larger size of coil. On the longer band of waves (5 X X, etc.) a No. 100 will usually be correct for the aerial circuit.

(Continued on page 191.)

YOU GET MORE FROM MARCONIPHONE L.T. ACCUMULATORS



Why are Marconiphone Accumulators so extraordinarily long-lived? What is the secret behind their marked superiority? It lies in the plates—the heart of every accumulator. For only in Marconiphone can you obtain plates built from the new formulæ especially to resist acid attack. Remember, too, that all parts of Marconiphone Accumulators are protected against sulphuric acid fumes; the separators are made from the finest ebonite; the substantial celluloid container allows easy inspection of acid level, and a host of other features ensure unfailing service under all conditions.

Write now for full particulars. Marconiphone Accumulators are sold by most Wireless Dealers.

	Without crates.	Complete with crates.
	£ s. d.	£ s. d.
2 volt, 20 amp. hours	11 3	15 3
2 volt, 30 amp. hours	13 6	18 6
2 volt, 40 amp. hours	16 0	1 1 0
4 volt, 20 amp. hours	1 2 6	1 7 0
4 volt, 30 amp. hours	1 7 0	1 13 0
4 volt, 40 amp. hours	1 12 0	1 18 0
6 volt, 20 amp. hours	1 13 9	1 19 3
6 volt, 30 amp. hours	2 0 6	2 7 0
6 volt, 40 amp. hours	2 8 0	2 14 6

THE MARCONIPHONE COMPANY LTD. (Dept. P.), 210-212, Tottenham Court Road, LONDON, W.1.

Pleasing
Player's

TOM NEWMAN

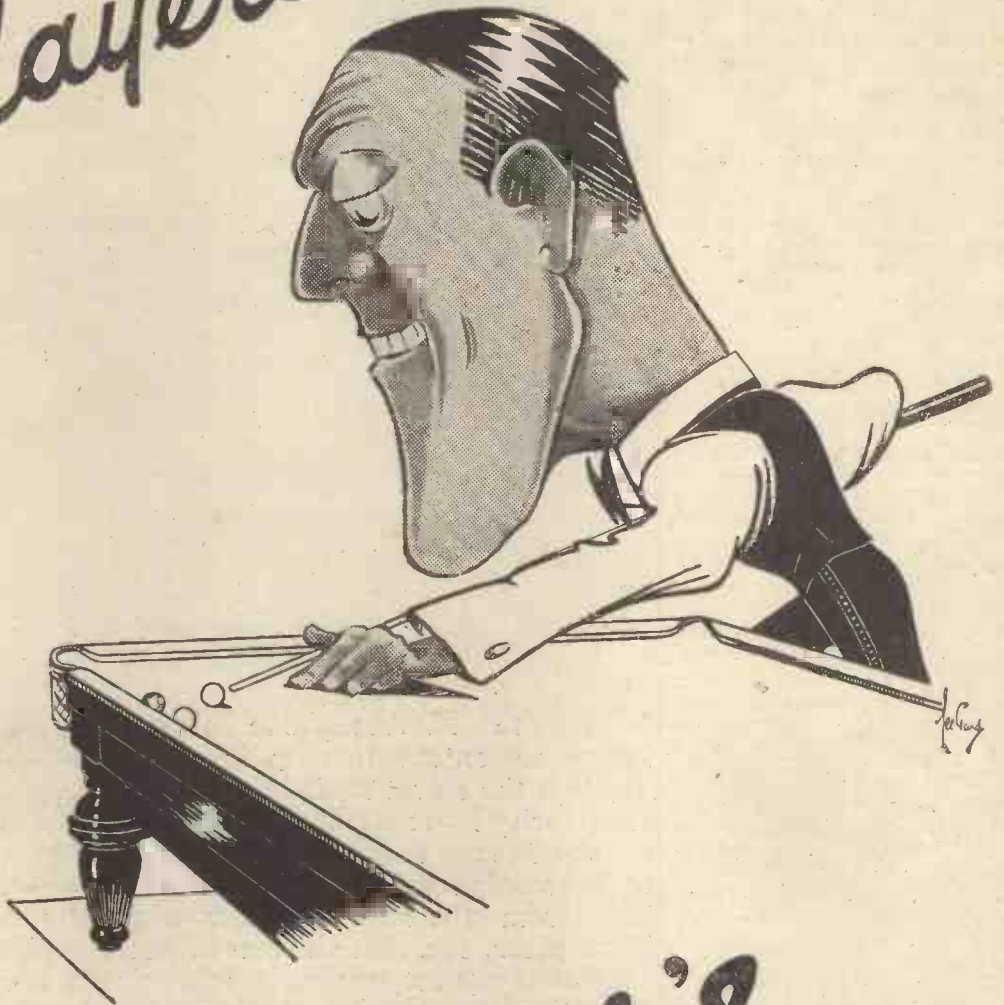

Player's
Please



THE "HARTLEY" ONE-VALVER.

(Continued from page 188.)

Coupled to this aerial coil is a secondary which is tuned by a variable condenser connected across its two ends in the ordinary manner, and this will be a No. 60 for the ordinary broadcast band, or a No. 250 for the 5 X X range. This coil, it will be noted, is of the centre-tapped variety, and in the circuit diagram you will see that this

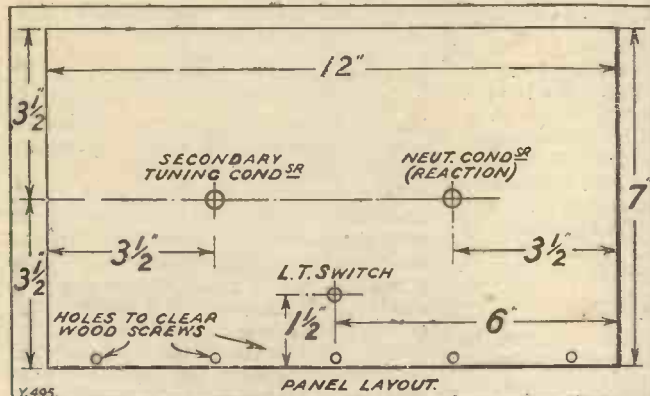

you will find that the wiring automatically becomes very simple and there is little need to take any great pains in spacing out.

You will see in the photographs that the original wiring was done on the straight point-to-point system, running wires by practically the shortest paths possible from one terminal or soldering tag to the next. This makes quite an efficient arrangement but, of course, you can if you like try the right angle method, which no doubt looks very much neater although there may be some slight theoretical sacrifice of efficiency (probably not measurable with so simple a set). The wiring can naturally be carried out with practically any material the constructor chooses, such as bare wire covered with Systoflex, bare wire without covering, covered wire such as Glazite, a special material such as Junit, and so on.

One final point before leaving the details of construction. The particular variable condenser used in this set was the Ripault, which has two terminals connected to the moving plates. You will see that three wires go to the variable

condenser, although two of these are both connected to the moving plates by the two terminals just referred to, and if you choose some other make of condenser these two wires will naturally be placed under the same terminal, namely that for the moving plates.

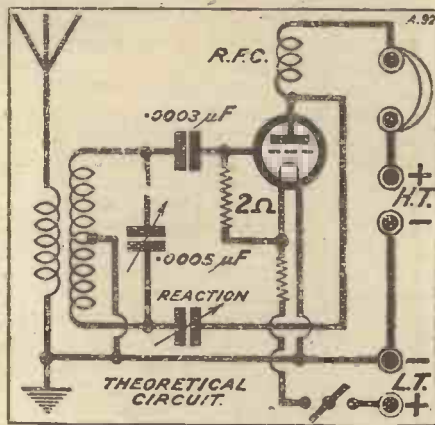

On the original set we did not actually fit a slow-motion dial, because the set would naturally be handled for its tests by skilled operators, but I would strongly advise that a very good vernier dial, with a knob placed at some little distance from the main body of the condenser, should be chosen by any constructor who desires to follow out this design.

Turning to operating details, the first important point to be considered is that of the kind of valve to use. Very good results have been obtained on test with a valve of the H.F. type, or even the R.C.C. type, namely, high impedance, high amplification factor, and good results will be obtained if either 2- or 6-volt types are used. Naturally, you will expect to obtain slightly better results with a 6-volt valve in most cases but, of course, the economy of the 2-volter is a very attractive feature.

(Continued on page 207.)

centre tap is connected to the filament and to earth.

One side of the tuned circuit goes to the grid of the detector valve via the grid condenser, and the other end is taken to one side of the little reaction condenser, and through this to the anode of the valve. The anode circuit, of course, contains the usual H.F. choke and the telephones. At this point you will see what is meant by saying that neither side of the tuning condenser is at earth potential in this circuit.

Efficient on Short Waves.

It is interesting to note in passing that one of the advantages of this circuit is that it is also quite useful on the short waves, and one can pick up the short-wave transmissions such as K D K A, 2 X A F, A F C, and so on, with the use of suitable short-wave coils, sets of which can now be obtained from a number of manufacturers, among others Messrs. Clarke and Igranic.

When using these coils, of course, the lead from the filament which normally goes to the centre tap of the coil (a terminal on the broadcast and long-wave sizes) will need to be furnished with a tapping clip, so that you can make connection on one of the turns of the bare wire coils used for the shorter waves.

Easy to Build.

The construction of this little set is really so simple that little can be said about it, since if you use single-hole fixing components there are only three holes to be drilled in the panel, and you will merely have to screw the panel to the baseboard, mount the coil sockets, grid condenser, leak, valve socket, rheostat and H.F. choke upon the baseboard with the terminal strip, and you can then carry out the wiring-up operation.

Wiring again is extremely simple, as you will see from the photographs and wiring diagram, and there is nothing critical about it. If you follow the lay-out fairly closely,

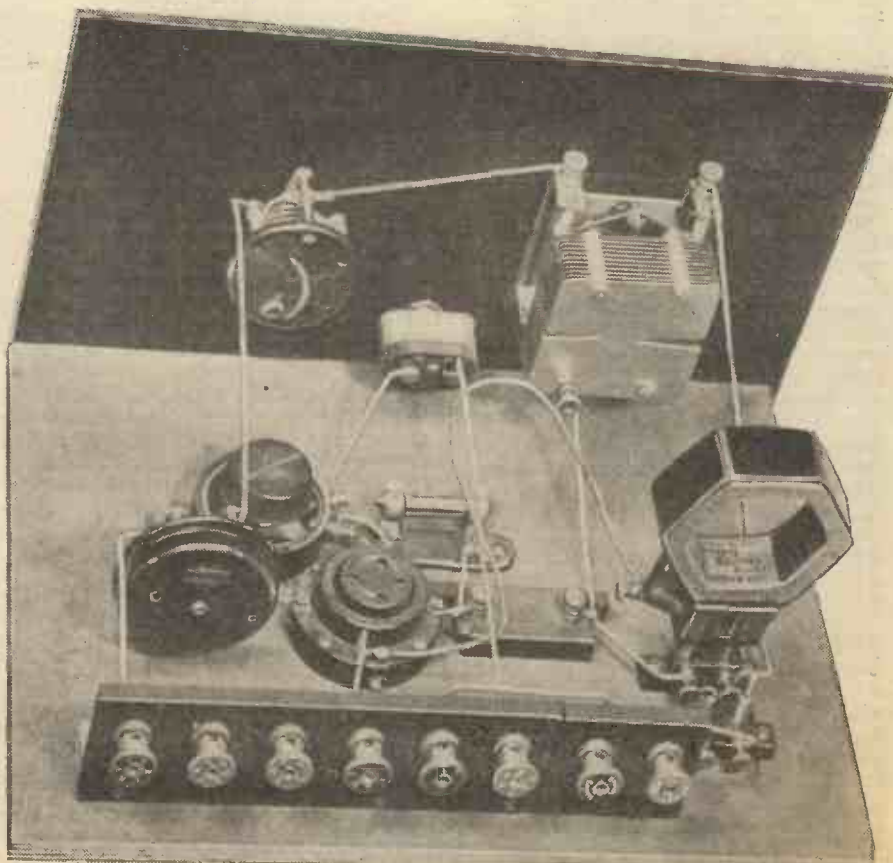

The terminals from left to right are : 'Phones minus, 'Phones plus, H.T. plus, H.T. minus, L.T. minus, L.T. plus, Earth and Aerial.

A Magnet Detector.

A CRYSTAL detector constructed on the principle of the article depicted in the photo, can prove to be a very useful device for the crystal enthusiast. The illustration is self-explanatory, and therefore little need be said about the actual construction of the detector. It will be seen, however, that the magnet holding the pin which makes contact with the crystal is attached by means of two metal staples to an upright post which is screwed down to a baseboard. The latter screw should not be too tightly driven home, nor should the staples holding the magnet be too firmly driven into the wood. The magnet will then be free to be pushed slightly backwards and forwards through the staples, and also slightly from side to side by rotating the wooden post on its supporting screw.

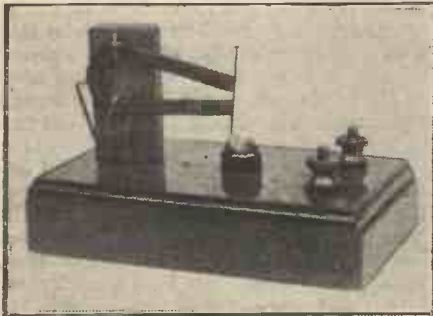

Quite a simple idea, but it works well.

The great advantage of a detector of this nature, which, of course, can be constructed in many different patterns, is that the pin contact to the crystal is held securely and firmly, and also that it is entirely vibration-proof. By moving the magnet backwards or forwards, or from side to side slightly, almost the whole area of the crystal will be capable of being explored for sensitive spots.

Connections are taken from the underside of the crystal cup to a suitable terminal, and also from the magnet itself to another terminal.

Care should be taken to solder the wire connection to the magnet with the absolute minimum of heat. For this purpose, Wood's metal is best used. A little of the red enamel should be scraped off the end of the magnet, and the end of the wire, previously cleaned and tinned with ordinary solder, should be secured as rapidly as possible to the bared end of the magnet with the aid of a few blobs of Wood's metal. As there will be no strain on this joint, its actual strength is a matter of little consequence.

Finally, when the detector is not in use, the pin should always be allowed to adhere to the poles of the magnet in order to act as a "keeper," and thus to conserve the strength of the magnet.

Aerial and Earth Leads.

Here is a good idea for aerial and earth leads. Equip the end of each lead with a spade terminal in the usual manner. To the spade terminal of each lead secure a Clix plug also, by simply placing the spade between the insulated bush and the nut of the plug. The idea is simple enough, but its advantages lie in its many useful adaptations.

For instance, when connecting the lines to a set equipped with terminals, the spade

HINTS FOR THE HANDY MAN.

A selection of short and practical articles from various contributors.

ends are used. Connecting to a set equipped with sockets, the plugs are used. Finally, to earth the aerial, one socket is just plugged into the other. The plugs are easily attached to or taken off the spade terminals with the fingers.

Dusty Panels.

It does not seem to be realised by some wireless enthusiasts that a dusty panel is by no means desirable. In sets of the old type, where panels are arranged in a sloping position with external valve holders, the dust is in the habit of getting round the legs, etc., thus causing faulty insulation. In any case, it cannot be over emphasised that dust is an undesirable commodity. Panels should therefore be periodically dusted with a camel-hair brush and kept scrupulously clean.

Leatherette Radio Cabinets.

American cloth or leatherette may be put to a number of uses by the wireless constructor, especially by those who are accustomed to making their own cabinets. Where the constructor is not particularly good at cabinet work, or has no time to give such work a first-class finish, a rough cabinet may be knocked up from even unplaned deal and an extremely pleasing finish applied by giving it a complete covering of American cloth or leatherette of any desired tint, black usually presenting the neatest appearance. Owing to the cheapness of this material a considerable amount of expenditure may be saved in the direction of cabinets.

Wood Filling.

Where cabinets are put together by amateur constructors with screws, a good wood filling is essential. All screw heads should be countersunk below the surface of the wood. When the work has been sandpapered the dust obtained in this operation should be carefully collected. If this is mixed with secotone, or pure gum arabic and water, an excellent natural wood filling may be obtained.

This is carefully worked into all cracks and crevices, and screw head or nail punch recesses, and left till hard and dry. A final sandpaper will render all defects absolutely invisible, the filling used being the actual colour of the wood from which the cabinet is constructed.

Sheet Fibre.

There are numerous uses to which sheet fibre can be put. This material may be obtained in two colours, black and brick red, and in varying thicknesses. The thin fibre lends itself admirably to such purposes as shaped loud-speaker flares, where the sides are of flat-shaped pieces of wood, the fibre being used for the curved sections.

Washers of any size or description can be quickly made from this material, and spacers also. Cone loud speakers of extremely rigid and good tone-producing types are easy to construct. Templates which are often extremely useful things to

have, such as valve or panel-drilling templates of any kind, if made from fibre, will stand a considerable amount of wear and tear, in addition to acting as extremely true guides for work of this nature.

Old panels may be utilised over again by placing over them a sheet of fibre, the panel terminals, etc., acting as ample security. Where wood panels are used an ebonite appearance may be given in a similar manner.

Retaining Accurate Coil Adjustment.

In some forms of coil-holders, and particularly after such articles have been subjected to a good deal of wear, it often becomes rather a tricky task to retain a fine degree of close coupling between the two coils, the larger and weightier of the coils tending, under these conditions, to fall back slightly.

Naturally, the true remedy for a trouble like this is to disassemble the coil holder, and to take up any wear by means of washers of one form or another.

In times of emergency, however, the trouble may be cured by adopting the very simple mode of procedure illustrated in the accompanying photograph. Procure a not too tightly fitting rubber band, and slip this over the coil sockets in the manner shown. Of course, if the tension of the rubber band is too great, both coils will be pulled together. On the other hand, provided a rubber band which is not too tight has been employed, it will not influence the limited movements of the coils, but will merely serve to check any slight falling-back movement of the heavier coil. In most cases an accurate and stable coupling will thus readily be obtained.

Interesting Facts.

Continuous fiddling with the adjustment of a crystal receiver is not only unnecessary, but is often responsible for corresponding clicks in the receivers of your neighbours.

Reaction is a good servant but a bad master.

If you are nervous of lightning use an outdoor earth arrester, which is very cheap and can easily be fitted.



The rubber band is shown here slipped over a coil holder.

EVERYTHING

The
G. E. C.
your guarantee

ELECTRICAL

To PORTABLE SET USERS!

A NEW AND BETTER VALVE

In neutralised and stabilised High Frequency Amplifiers the new H.L. 210 OSRAM VALVE gives a more sensitive response to weak signals from distant stations. The ideal valve for Portable Sets where only a small frame aerial is used. Gives maximum volume with minimum number of valves. Its characteristics allow it to be used as a grid detector for sensitivity, or as an anode bend detector for highest quality reproduction.

Also used in the first stage of low frequency amplification, and ideal for choke coupled amplifiers. Write for full particulars.

Made in England



Characteristics

Filament volts 20
max.
Filament current 0.1
amps.
Amplification Fac-
tor 15.
Impedance 25,000
ohms.

PRICE
10/6

Osram Valves



APPARATUS TESTED

EFFICIENT DETECTORS—
THE "BROWN BUDGET"—
A "CELESTION" LOUD
SPEAKER—AN EX-
CELLENT L.F.
TRANSFORMER.

* *

Traders and manufacturers are invited to submit wireless sets and components to the "P.W." Technical Department for test. All tests are carried out with strict impartiality in the "P.W." testing-room, under the supervision of the Technical Editor, and the general reader is asked to note that this weekly article is also intended to provide a reliable and unbiased guide as to what to buy and what to avoid.—EDITOR.

EFFICIENT DETECTORS.

MESSRS. N. M. C. DETECTORS, of Princes Parade, Finchley, London, N.3, recently sent us a range of their new crystal detectors. There are three varieties which sell at 6d., 1s., and 1s. 6d. They can be obtained, post free, at these prices. The detectors are of the semi-permanent variety and can be used with good effects in such circuits as the Hale, and other reflexes. Iron Pyrites is the crystal employed, and the specimens sent us are the best that we

have come across. The 1s. 6d. detector, which is known as the Azure label, comprises a practically perfect piece of the crystal.

THE "BROWN BUDGET."

This is the name of Messrs. S. G. Brown's monthly journal. It is mainly concerned with the activities of this go-ahead and interesting firm, but it makes absorbing reading, and we would like to take this opportunity of extending our appreciation and thanks for the copies regularly sent us.

A "CELESTION" LOUD SPEAKER.

No doubt a very large number of our readers would consider £7 5s. too much to pay for a loud speaker; this is the price of the "Celestion" model C.12 in oak. In mahogany it is £7 10s. It is admittedly a lot of money, but we think that if efficiency and appearance are taken into consideration it is very well worth it. It is always worth while buying the best of anything that one can afford, and nowadays, in radio, like in most other things, price is a pretty fair guide to quality. We know of one or two exceptions, but the rule is a fairly safe one.

To obtain a better speaker than this model C.12 Celestion one would have to pay very much more money. As a matter of fact a move up into the moving-coil class would, in our opinion, be necessary. The C.12 is a cabinet cone and its construction and finish are so good that one stamps it "de luxe" at a glance. A point in its favour is that it is not particularly large, being only 6 in. in depth, and 14 in. x 14 in.

It has a splendid projection, every vibration coming cleanly away from the cone, and we know of but one or two other cones which have less coloration. Speech is decidedly of moving-coil quality. There is no appreciable resonance and both bass and high notes are faithfully dealt with. The speaker is rather more sensitive than the majority, but it is capable of handling heavy inputs. We found it perfectly satisfactory on each of the several sets with which it was tested, ranging from two valves to a multi-valver of the super kind.

(Continued on page 196.)

Recognised leaders in the design of

FOR THE 1928 SOLODYNE



B.B.C. Coils:

Aerial Circuit	1 Ref. LAA 5	} £2-5-0 Per Set including bases:
H.F. Transformer	2 Ref. LAT 5	
5-pin Bases	3 Ref. LB	

Daventry Coils: (No. 285,723)

Aerial Circuit	1 Ref. LAA 20	} £2-5-0 Per Set without bases
H.F. Transformer	2 Ref. LAT 20	
Additional Bases	Ref. LB.	



1 Lewcos Wavetrapp 13/6

Solodyne Coils

As manufacturers of the special coils used in the original 1926 Solodyne, Lewcos established a leadership which is still unchallenged. New developments necessitate many alterations in the design of coils for the 1928 Solodyne. But again LEWCOS will give you that extra selectivity and efficiency that constructors have learnt to expect from all Lewcos Coils.

The demand for these new coils and wave-trap will be heavy; place your order now and ensure early delivery. Obtainable through all good radio dealers.

The LONDON ELECTRIC WIRE CO. & SMITHS Ltd.,
Playhouse Yard, Golden Lane, London, E.C.1.

LEWCOS

(Regd. Trade Mark)

COILS and WAVETRAPP for the 1928 SOLODYNE

MAKE YOUR OWN CONE SPEAKER

The New Wonder "Nightingale"

CONE UNIT

Exactly as fitted to our Cabinet Cone Speaker. Guaranteed to give results equal to the most expensive Loud Speakers yet made.

Full constructional details with each Unit.

GRAMOPHONE ATTACHMENT

Reduced from 32/6 to 15/- solely as an advertisement for the famous Bullphone Nightingale Loud Speakers. Cobalt Magnet guaranteed for all time.

With 4-inch Diaphragm.

Instantly converts your own Gramophone into a full power Loud Speaker, giving a wealth of pure undistorted volume which must be heard to be believed.



15/-

SATISFACTION GUARANTEED or money refunded!



BUY ON EASY TERMS

10/- Secures this Speaker

5/- Secures this Speaker

The Nightingale "DE LUXE" 57/6 cash, or 5/- deposit and 12 monthly payments of 5/-.



BAKELITE SOUND CONDUIT & TONE ARM
26" HIGH BELL MOUTH 14" FINISHED IN MAHOGANY

NIGHTINGALE CONCERT SUPREME SUPER

Guaranteed free from metallic resonance. 63/- cash, or EASY TERMS, 10/- deposit and 12 monthly payments of 5/-.

Send Deposit NOW!

For LONG LIFE

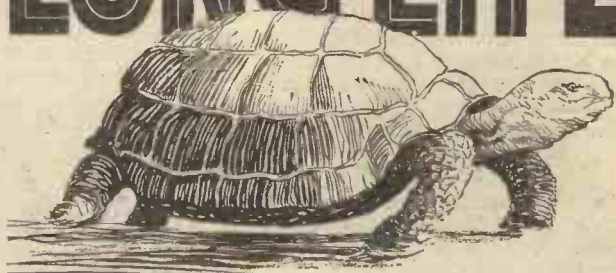

USE

SIEMENS RADIO BATTERIES

NOT only do they enjoy a reputation for exceptionally LONG LIFE, but in addition possess all those qualities which are essential for the clear and powerful reproduction of Broadcast Programmes. Only in a SIEMENS Battery will you find all these good qualities. Insist on Siemens.

For all sets employing a Power Valve we recommend our

LARGE CAPACITY (POWER) TYPE

SIEMENS "POWER 60" volts 15/- (as illustrated)

SIEMENS "POWER 100" volts 25/-

At your Dealers.

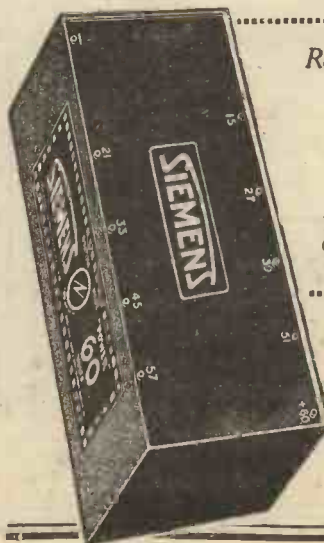

Recommended exclusively by the designers of the COSSOR MELODY MAKER

For 120 volts connect two 60-volt batteries in series.

BRITISH MADE THROUGHOUT
SIEMENS BROTHERS & Co., Ltd.,
WOOLWICH, S.E.18.

Obtainable from your Local Dealer or direct from:—
BULLPHONE LIMITED
38, HOLYWELL LANE, LONDON E.C.2.
NIGHTINGALE SPEAKERS

APPARATUS TESTED

(Continued from page 194.)

It is some time since we have experienced so much pleasure during a loud-speaker test, and we have no hesitation in saying that we consider this "Celestion" a long way ahead of its class. Those of our readers who have the opportunity should endeavour to hear it in operation. We are sure they will agree with us when we say it is a revelation in what sound design and construction mean to such an instrument.

A CORRECTION.

An advertisement concerning the well-known H.T. Eliminators produced by Messrs. E. K. Cole, Ltd., appeared in page 118 of our March 17th issue. Unfortunately, in connection with the address of that firm, the word "EKCO" was incorrectly spelt. The correct and full address is as follows: E. K. Cole, Ltd., Dept. A, "EKCO" Works, London Road, Leigh-on-Sea.

AN EXCELLENT L.F. TRANSFORMER.

In the usual way the size and weight of an L.F. transformer are, to a certain extent, indications of its efficiency. They may mean that either there is a large amount of iron in the magnetic circuit or that there are ample windings, or both. And in the past we have advised constructors to be wary of transformers of very light construction for these reasons.

But it seems that we shall now have to

revise our ideas in this connection, for the new Mullard L.F. Transformer is both small and light, and yet it is extremely efficient. It is not much larger or heavier than the average R.C.C. coupler.

Of course, its internal structure is far from conventional, new things must be done to achieve such a revolutionary design. The transformer is called the "Permacore," because it incorporates a special iron having this name. This special metal has an exceedingly high permeability so that it allows a high flux density to be used in an iron circuit of very small dimensions. It can

therefore handle heavy currents without reaching "saturation."

The primary is wound with silver and the secondary with nickel wire. The former provides the advantages of good conductivity and capability of resisting deterioration, and the latter introduces excellent magnetic properties and a high resistance just where they are required. And as the makers claim, the use of these special windings provides permanent and robust construction apart from decidedly improved electrical characteristics. We also agree with their claim that "The amplification

of the Mullard transformer is large, smooth and uniform from 250 cycles upward, and below this limit gives a large percentage of its amplification even at 50 cycles. All the bass notes that are wanted are given and there is no shrillness whatever."

In short, it is a very excellent transformer, indeed, and having the additional advantage of extreme compactness and lightness it is certain to achieve wide popularity among discriminating constructors. And as a transformer for portable sets it is absolutely ideal and has no rivals.

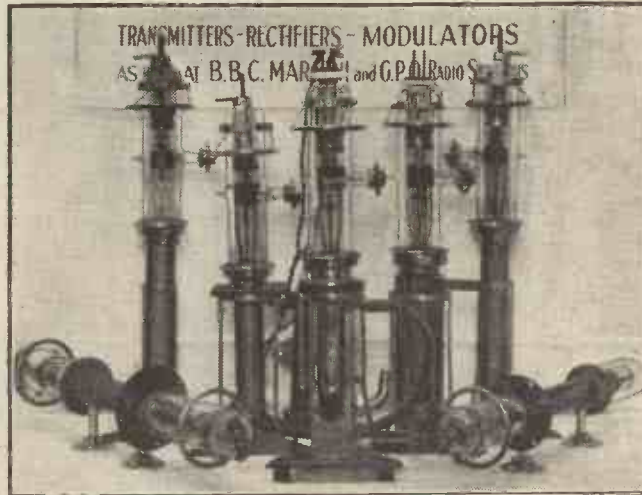

"At a recent London exhibition the M.O. Valve Co. displayed a range of water-cooled "Osram" transmitting valves. One, as can be seen above, has its anode cut away to show the glowing filament, a glass water-jacket being substituted for the usual metal casing to reveal the circulating water.

THE NEW "AUTOGRAM" DOUBLE ELECTRIC GRAMOPHONE

Fitted with two Tone Arms, two Celestion Pick-Ups, two 12-inch Turntables, Automatic Stopping Device for Motors, two Universal Motors, suitable for any voltage from 110 to 240 volts A.C. or D.C., Speed Regulators, Pilot Lamps, &c., fitted in Substantial Leatherette Covered Mahogany Cabinet. Price, Complete £36. Quotations given for every type of design and outfit.

Send For Full Particulars.

MOVING COIL LOUD SPEAKER.—Send now for List of Parts and Special Reference Work by C. P. Allinson, A.M.I.R.E., at the specially REDUCED PRICE of 1/6.

OUR INTERNATIONAL RADIO CATALOGUE (3rd edition) will be sent to all enthusiasts sending 6d. to cover cost of postage and packing

WILL DAY, LTD.

(The Best in the West)

19, Lisle Street, Leicester Square, London, W.C. 2

Telephone (2 lines):
Regent 0921 and 0922.

Telegrams:
Titles, Westrand, London.

LOEWE RADIO

The Famous

LOEWE
LOEWE

High Vacuum
Resistances
and
High Vacuum
Block Condensers



Should be installed in every wireless receiving set.

They are

Free from atmospheric influences.
Moisture and dust proof.
Free from losses.
Fully guaranteed.

Stocked by all reputable dealers.
Ask for illustrated leaflet.

LOEWE RADIO COMPANY
LIMITED,

4, Fountayne Road,
Tottenham, London, N.15.

Telephone: Tottenham 2076.



HOBBIES THREE

The Set.

The layout is neat and straightforward. The base-board plan shows component positions and tabulated wires (ready turned with loops) are supplied for the numbered circuit chart.

The Cabinet.

Can be made by any amateur from the planed boards supplied cut ready for fitting. In good quality mahogany, with moulding and illustrated instructions, for 9/- complete.

The Speaker.

A handsome cone cabinet complete for 23/1. Can be cut with a fretsaw from planed mahogany boards supplied. Gives results equal to any ordinary instrument.

As simple as falling out of bed

Those who have never previously built a set will be able to undertake the Hobbies Three. It is a splendid circuit yielding wonderful results. Easy to build and simple to operate. Specially planned for the novice.

Get your copy of this week's Hobbies to-day from any newsagent or Hobbies' branch—2d.

If your newsagent has sold out send three penny stamps to Hobbies (Dept. 69), Dereham, Norfolk, for one.

DIFFERENT

SOMETHING different from all the others because any amateur constructor can make the whole outfit for himself—set, cabinet and cone speaker—quite cheaply and in two or three evenings. The three valve set covers a range from 250 to 2,000 metres on a single tuner. No soldering, no technicalities. The cost is reasonable, and the results startling. An amateur who handled one for the first time logged 32 stations in one evening.

FREE

WITH THIS WEEK'S HOBBIES IS GIVEN FREE A LARGE SHEET SHOWING COMPONENTS, POSITION, AND WIRING OF THIS SET. WITH AN ILLUSTRATED WRITE-UP ON HOW TO CONSTRUCT IT. INTERESTING TO ALL WIRELESS ENTHUSIASTS. MANY OTHER SUBJECTS OF GENERAL USEFULNESS IN THE SAME ISSUE.

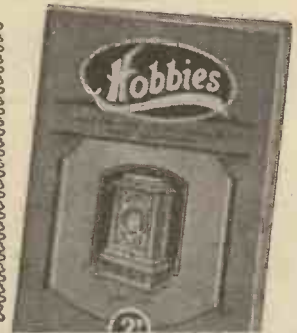

MURDER! MURDER!!

Build the "SWEENEY TODD THREE" and MURDER that interfering Local Station.

Sweeney Todd, the Demon Barber of Fleet Street, trapped and murdered his victims ere robbing them. YOU CAN "SWEENEY TODD" YOUR LOCAL station that has been "kyboshing" your DX work and get all stations within range at FULL LOUD SPEAKER STRENGTH. Note the surging power of stations 500 miles away. Note the round melodious tone of music from stations you have never heard before. Note how your "local" can be cut dead out with no "messing about." Simple inexpensive parts. Simple "no soldering" wiring system. Your own "Baby" coils. No stunts. An entirely new and unconventional circuit described fully with full-size blue print in P.P.V. RADIO PLAN No. 30. PRICE 3/- POST FREE.

FREE with each circuit, the P.P.V. 25/- low-wave circuit receiving Sydney (Australia) direct. Also 20 pages of wireless information, some other circuits according to stock and wireless literature. If you cannot send for SWEENEY TODD (price 3/-) send for price lists of P.P.V. circuits.

PRESS EXCLUSIVES, Wireless Publishers, 29, Paternoster Row, London, E.C.4.

NOW ON SALE

WIRELESS CONSTRUCTOR ENVELOPES

Envelope No. 1.—THE "RADIANO" THREE. A famous loud-speaker set which you can build in an hour or two—no soldering and a wide range of components to choose from.

Envelope No. 2.—THE "CONCERT" FOUR. Made of standard parts, all easily obtainable, this is a highly-sensitive long-distance set, giving powerful reproduction of wonderful quality on 3 or 4 valves.

In these envelopes you will find every detail of the set simply explained, photographic reproductions and diagrams are included, as well as a full-size Blue Print.

AT ALL BOOKSTALLS Price 1/6

By post, 1/9, from the Amalgamated Press, Ltd., Bear Alley, Farringdon Street, London, E.C.4.

FORMO
A MONUMENT IN THE MARCH OF PROGRESS.
The Formo Shrouded Transformer is the universal favourite.

10/6 Ratios 1-3 and 1-5
Send for Catalogue.

THE FORMO COMPANY,
CROWN WORKS, CRICKLEWOOD
N.W.2. Phone: Hamp. 1797.



All Editorial Communications to be addressed to The Editor, POPULAR WIRELESS, The Fleetway House, Farringdon Street, London, E.C.4.

The Editor will be pleased to consider articles and photographs dealing with all subjects appertaining to wireless work. The Editor cannot accept responsibility for manuscripts and photos. Every care will be taken to return MSS. not accepted for publication. A stamped and addressed envelope must be sent with every article. All inquiries concerning advertising rates, etc., to be addressed to the Sole Agents, Messrs. John H. Lile, Ltd., 4, Ludgate Circus, London, E.C.4.

The constructional articles which appear from time to time in this journal are the outcome of research and experimental work, carried out with a view to improving the technique of wireless receivers. As much of the information given in the columns of this paper concerns the most recent developments in the radio world, some of the arrangements and specialities described may be the subject of Letters Patent, and the amateur and the trader would be well advised to obtain permission of the patentees to use the patents before doing so.

QUESTIONS AND ANSWERS.

MAKING THE FILADYNE OSCILLATE.

F. E. L. (Motherwell, Scotland).—"I have got a Filadyne going and, although I can pick up Glasgow very well, I feel I am not getting the best out of the set, because it will not oscillate properly. Perhaps it is my own fault, because I am using a cheap foreign valve, but as a matter of fact a friend of mine has used one of the same kind in a rather different circuit

and got excellent results; and it was this which persuaded me to try it. Is there anything I can do to make the set oscillate properly? If it will do this I feel sure I shall be able to get plenty of foreign stations on it like my friend."

With such an unusual circuit as the Filadyne it is customary to find that certain changes in the lay-out or components have a great effect upon the operation of the circuit. If, for instance, you have omitted to place a condenser across the telephones this would be quite sufficient to prevent the set from oscillating, and slight variations of coupling or of tapping points will very often overcome the difficulty.

One ingenious Scottish reader has hit upon a method of making the set oscillate which you might like to try, as it is very simple. He simply connects a 35-turn coil in series with the lead which goes from plate to potentiometer and couples this lead to that to which the aerial is connected. He found when using a cheap foreign valve that this made all the difference between faulty operation and good easy oscillation, so that we should certainly try the method, particularly as it is an interesting circuit to experiment with, the results frequently being phenomenal for one valve.

VOLUME CONTROL WITHOUT DISTORTION.

W. P. (Newbury, Berks).—"In order to get distortionless reception the set must have resistance coupling throughout, but I am a bit puzzled about the volume control.

"The loud speaker is of the moving-coil type, and I understand it will not be very easy to overload this, but all the same I do not want to keep the neighbours awake at night when I am listening in, and I should like to have some method of cutting down the volume if necessary. But the important point is that it is essential that this must not interfere with the quality of reception. Quality is everything, in my opinion. What can you recommend as being the least likely to introduce distortion?"

We think that the most satisfactory method in your case would be to use a high-resistance potentiometer operating on the grid of the first low-frequency valve. Suitable resistances are now being marketed,

(Continued on page 200.)

REFUSE IMITATIONS!



Standard Size panels supplied in three finishes, Black polished, Black Mat, and Grain polished, carefully packed in attractive cartons. Every panel and piece of ebonite guaranteed and made by British hands.

Apply for particulars of our new fool-proof 4 and 6 contact Former with bases ready for winding, directions and fully illustrated booklet, Price 6d.

ORIGINAL PRIZE - WINNING "BECOL" LOW LOSS FORMER, No. 5. 3 inch diam. overall.

Insist on a Becol Low Loss Former, the Former "with a reputation," incorporated in sets that have taken four first prizes and gold medal, a proof of their superiority. Supplied in cut lengths, 3 in., 4 in., 6 in., packed in cartons, and standard lengths of 3 ft.

Specify



Registered Trade Mark.

products



THE BRITISH EBONITE COMPANY LIMITED, HANWELL LONDON W.7

Without Accumulators or Valves. Earth and Aerial Connections only are needed. Tunable to all wave-lengths.

The **CRYSTO-BAR** Wireless Receiver — an epoch-making New Wilson achievement—is an up-to-date Crystal Set combined with the Microphone Bar Amplifier.

50/- POST FREE



It will make wireless cheaper and better for you. Only one or two inexpensive dry cells of 1½ required to give loud speaker results equal to a two-valve set.

Write for our fully descriptive and illustrated list POST FREE.

Sole Manufacturers and Patentees: **NEW WILSON ELECTRICAL MANUFACTURING Co. Ltd.** 18, Fitzroy Street, Euston Road, W.1. Phone: Museum 8974.



For
Natural Tone the Ethovox

Test the Ethovox Loud Speaker in *any* way you please and it will please you in *every* way! Its natural tone is full and mellow and it gives life to broadcast speech and music. The Ethovox is capable of considerable volume without any trace of distortion. Many thousands of this famous make have been sold and it has never been found necessary to modify the design in principle—because the Ethovox has *always* given good results. Hear this speaker—try one on your set.

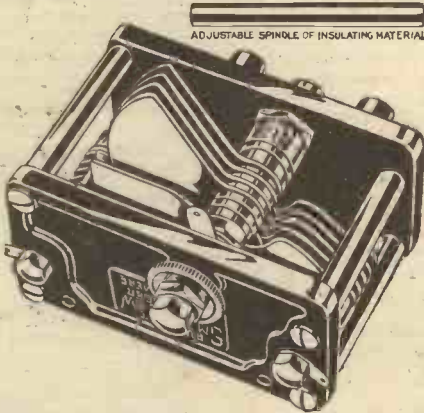

Burndept
Condensers for easier Tuning

Having a spindle and end-plates of insulating material and a metal earth shield, the new Burndept Condenser is absolutely free from hand-capacity and gives increased signal strength. Experts acknowledge this Burndept product to be an important improvement in condenser design. There are two types: LOG-LAW (for H.F. circuits), .0003 mfd., 15/-; .0005 mfd., 15/6. SQUARE-LAW (for capacity reaction and short-wave circuits), .00007 or .0001 mfd., 13/6. The Log-Law Condensers are easily ganged and are supplied with printed scales for 150-3,000 metres (1/6 per set). Use these Condensers on your next set.

BURNDEPT

Offices: Blackheath, London, S.E.3.
London Showrooms - 15, Bedford St., Strand, W.C.2.



GOOD -
'for good'

B.T.H. Nickel Filament Valves have a higher emission than other 2 volt valves of corresponding types, and they retain this emission for a longer period. In other words they give better reception and have longer useful lives.

You want to have and to maintain the best results of which your set is capable. B.T.H. Nickel Filament Valves alone will enable you to do this. Get some today and enjoy better radio from now on.

B. 210H	B. 210L	B. 215P
R.C. and H.F.	General Purpose	Power
Fil. Volts . . . 2	Fil. Volts . . . 2	Fil. Volts . . . 2
Fil. Amps. . . 0.10	Fil. Amps. . . 0.10	Fil. Amps. . . 0.15
Max. H.T. V. . 150	Max. H.T.V. . 120	Max. H.T.V. . 120
10s. 6d.	10s. 6d.	12s. 6d.

The above prices are applicable in Great Britain and Northern Ireland only.

B.T.H. NICKEL FILAMENT VALVES

VALVES

NICKEL FILAMENT

Made in the Mazda Lamp Works, Rugby.

The British Thomson Houston Co. Ltd.

B.T.H. NICKEL FILAMENT

RADIOTORIAL QUESTIONS AND ANSWERS

(Continued from page 198.)

and the ends of the resistance are connected between the coupling condenser and the negative grid-bias tapping just like a grid leak; but instead of the coupling condenser being connected also to the grid, this latter is joined to the slider on the potentiometer, and thus one can apply to the grid of the valve either the full voltage developed across the resistance, or some lower value according as the slider is moved down towards negative G.B. This is an efficient and distortionless method.

BY-PASS CONDENSERS.

S. W. (Chipping Norton, Oxon).—"The set I am building is a detector and two L.F. amplifiers, and I notice that connected to the plate of the second amplifier is a .0005 mfd. fixed condenser, the other side of which goes to the L.T. negative lead. I cannot understand the function of this condenser, especially as it is connected right across the valve so as to join up the filament with the plate. What is its purpose?"

The condenser is placed in this position with the idea of improving the quality of reception. Despite the precautions taken in coupling the valve to the preceding one, it often happens that a trace of high frequency gets into the low-frequency stage of the set, due to stray H.F. impulses reaching the grid of the valve.

If this happens corresponding currents at high frequency will tend to flow in this circuit and will result in a certain slight distortion occurring. In order to prevent this a .0005 mfd. fixed condenser is connected between the filament and plate so that any impulses of high frequency which tend to flow in the valve can pass across this fixed condenser instead of choosing the alternative route via the L.F. transformer or resistance, and so spoiling the purity of reception.

THE "PROGRESSIVE" THREE.

S. R. P. (Streatham, London, S.W.16).—"Please accept my congratulations in your having evolved such an interesting set as the

above. My last set was the Two-Valve Reinartz, built from POPULAR WIRELESS free blue print, and I thought this was pretty good; but the 'Progressive' Three is indeed an eye-opener.

"My aerial, a single, is about 20 ft. high and 50 ft. long, earth of heavy stranded cable about 5 ft. long. My reaction condenser is not first class and I am changing this, and at the moment I am using low-cost valves of the 2-volt, '06 type. Continentals, station after station, come in well, but I am unable to resolve other British stations when 2 L.O. and 5 G.B. are working.

"Such results are of course quite ordinary, but I venture to say that it was not predicted that K D K A would have been received without an aerial under the following conditions:

"I wound a coil with 20-gauge bare copper wire, 14 turns on a 3 in. diameter former, and connected the 9th turn to the base pin, leaving 5 turns for reaction.

With the flex lead from the .0003 variable to the 14th turn (that is the top), centre-tapped coil removed from set, and flex from fixed condenser disconnected and hanging loose, K D K A came in at fair headphone strength, and with flex from the fixed condenser joined to the aerial lead itself

free from the set connections I got very good headphone strength, sufficient, in fact, to operate a Lissen loud-speaker unit. There was very little interference and hardly any atmo-

A SIX-VALVE SUPER-HET.

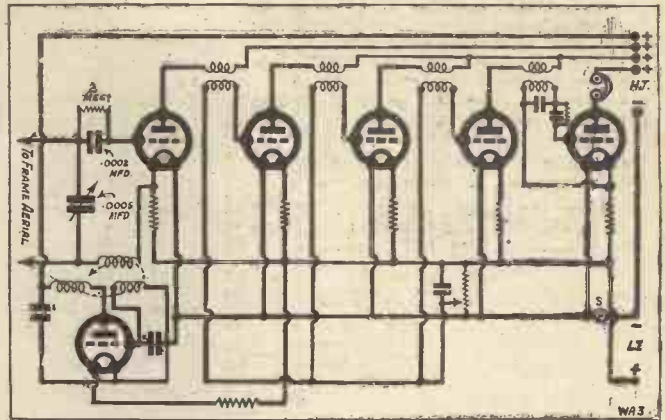

The correct connections for a six-valve super-het. are shown above. In last week's "What is Wrong?" diagram, part of the H.T. battery was shorted, there was no "2nd detector," the tuning condenser was ten times too large, and the by-pass condenser should have been connected to the slider of the potentiometer. Also a loud speaker was shown, though no L.F. amplification was provided, and it is usual (though not essential) in such circuits to allow for reaction on to the frame aerial.

spheric effects, every word being clear and distinct. This was, I believe, on Thursday night, February 2nd, time about 12.45. The strange part of it to me was that I could get no results whatever if I placed a centre-tapped (Continued on page 202.)

"INDISPENSO" CHARGER

Improved 1928 Model. With polarity indicator. For charging High and Low Tension Accumulators from Direct Current Mains. Thousands in use, giving every satisfaction.



"ALTERNO" CHARGER

The ideal efficient and economical appliance for charging H.T. Accumulators from A.C. Mains. Complete, ready for use .. 21/- With Ammeter (as illustrated), 12/6 extra. Full particulars on request.

MAKE YOUR OWN H.T. BATTERY ELIMINATOR with the "GOLTONE" CONSTRUCTIONAL KIT

To operate successfully from Direct or A.C. Circuits.

For full particulars see List sent on request.

Ward & Goldstone
PENDLETON MANCHESTER



"GOLTONE" L.F. TRANSFORMER Unsurpassed for volume and purity of reproduction. Fit this "Goltone" product in your "MAKER" or MULLARD MASTER 3" your results will be infinitely better. Send for particulars of the wonderful "NEGROLAC" Aerial.

SPRING BOOKS NUMBER



The issue of T.P.'s Weekly, now on sale, is a special number in which all the newest novels are reviewed. It will help you to choose the best books to put on your library list and the most suitable books as gifts. If you read T.P.'s Weekly regularly you will be as well informed in literature and of the important happenings of the day as anyone need be.

T.P.'s Weekly

Edited by the Rt. Hon. T. P. O'Connor, M.P.

At all Newsagents.

Every Saturday 2d.

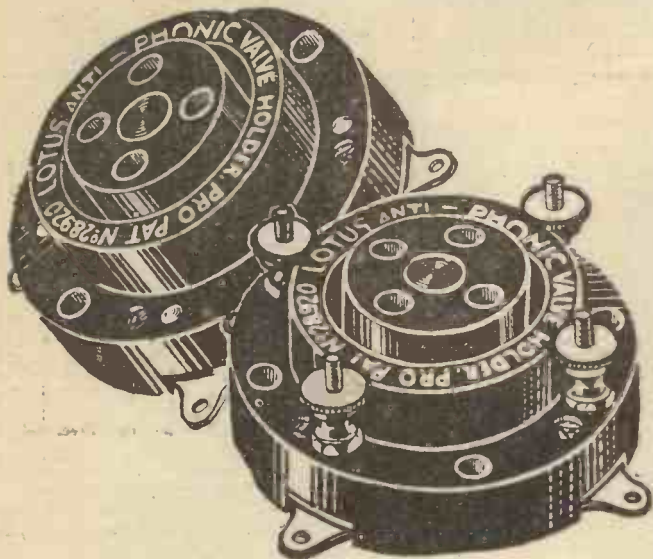

CUT OUT MICROPHONIC NOISES!

Lotus Valve Holders cut out all microphonic noises. They produce pure, clear reception, absorb shocks and protect the valves.

* If your set is prone to microphonic noises, look to your valve holders. A cheap, shoddy valve holder quickly spoils reception. Change to Lotus and you will get best possible results.

Without terminals - 1/6
 With terminals - 1/9

From all radio dealers



Made by the makers of the famous Lotus Remote Controls, Lotus Vernier Coil Holder, and Lotus Jacks, Switches and Plugs.

Garnett, Whiteley and Company, Limited,
 Lotus Works, Broadgreen Road, Liverpool.



BRAINS!

RADIO Valves are the brains of your Wireless Receiver.

When you buy a new set look to the Valves. In nine cases out of ten you will find that they are Six-Sixty Valves—first-class Valves that are fitted as standard by Britain's leading set manufacturers.

Fit a new set of Six-Sixty's in your existing set. We need not tell you to notice the difference; it will be obvious at once.

Six-Sixty Valves are non-microphonic, are matched valve with valve, and give perfect electrical balance.

There is no Radio Valve like Six-Sixty, and no other Radio Valve is as good.

We publish a booklet that will plainly tell you why. Ask for a copy at the nearest radio shop, or write direct to us

All types and voltages,
 from 10/6.

USE ONLY



THE ELECTRON CO., LTD.,
 122-124, Charing Cross Road, London, W.C. 2

Telephone: Regent 5336.

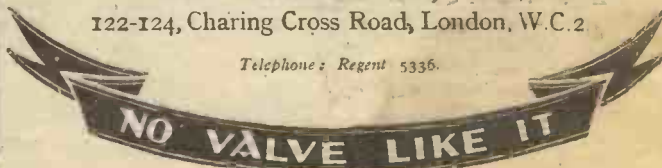

Economise in floor space

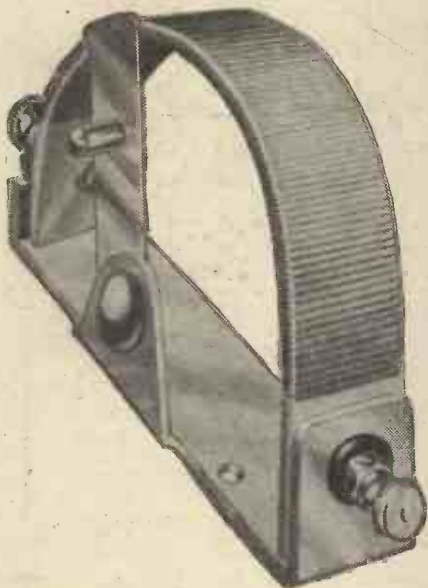

The "PEERLESS" VARISTOR stands up on the baseboard, taking only a fraction of the usual space. It can be fitted on an already crowded panel. The adjustable phosphor-bronze arm is easily accessible. The windings are of best-quality resistance wire, wound tightly on insulating fibre. Terminals are fitted in the most convenient position. You can buy 5 types—3, 6, 10, 15 and 20 ohms. *The "Peerless" Varistor is fine for the Cossor "Melody Maker."*

From all good dealers or direct:—

PEERLESS VARISTOR

BEDFORD ELECTRICAL & RADIO CO., LTD.
22, Campbell Road, Bedford.
LONDON: 21, Bartlett's Bldgs., Holborn
Circus, E.C.1
GLASGOW: 115, St. Vincent St. 2, 2

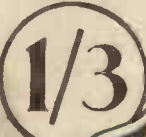

RADIOTORIAL QUESTIONS AND ANSWERS

(Continued from page 200.)

aerial coil of any value in the position allocated to one in the original lay-out."

"The reason of this achievement under these strange conditions may be quite simple to an expert, but I have a lot to learn about wireless, and I wondered whether I had in my experimenting unconsciously stumbled across something which may be interesting?"

What was happening in this case was that you were in effect cutting out the first valve and receiving the short waves directly on the detector portion of the set. It is a peculiarity of short-wave signals that they hop across space in a most amazing way, so that even if the aerial lead is only brought quite close to the coil they pass across the intervening space, which forms a kind of natural condenser, and find their way to the grid circuit. As your 9-turn coil was tuned to K D K A, the signals were impressed upon the grid of the detector valve and thus operated your telephones in the ordinary way.

When the leads from the aerial were joined to the .0022 mfd. fixed condenser at the point where this is tapped to the grid coil you were in effect switching out the H.F. valve, but when you plugged the coil in the centre-tapped aerial holder the aerial was connected through this coil to earth and most of the signals choose this path instead of the alternative path via the short-wave coil in the detector.

"P.W." TECHNICAL QUERY DEPARTMENT

Is Your Set "Going Good" ?

Perhaps some mysterious noise has appeared and is spoiling your radio reception?—Or one of the batteries seems to run down much faster than formerly?—Or you want a Blue Print ?

Whatever your radio problem may be, remember that the Technical Query Department is thoroughly equipped to assist our readers, and offers an unrivalled service.

Full details, including a revised scale of charges, can be obtained direct from the Technical Query Dept., "Popular Wireless," Fleetway House, Farringdon Street, London, E.C.4.

A postcard will do: On receipt of this an Application Form will be sent to you free and post free, immediately. This application will place you under no obligation whatever, but having the form you will know exactly what information we require to have before us in order to solve your problems.

Your experience constitutes an interesting instance of how powerful is the penetration of the short wave, even where the aerial system is anything but conventional, and similar instances of short-wave peculiarities are coming to light daily. As this is your first three-valve set we should like to take this opportunity of congratulating you

THE POSITION OF THE LOUD SPEAKER.

"OLD STAGER," (Merstham, Surrey).—"We have been happily married for more years than I care to remember, but now we are falling out about the position of the loud speaker! Both my wife and myself are musical enthusiasts, and there is not much played at 2 L O that one of us does not listen to, one way or another. But whereas I like the loud speaker placed on the table in the middle of the room (loudest), my wife insists that it sounds better when it is placed near the window. I cannot convince her that the position of the loud speaker has no effect upon the reproduction. (Possibly you know what women are?) So that if you would write to me I can assure her that her idea is all nonsense, and I should be able to have the

(Continued on page 204.)

FREE 5-DAY TEST SEND NO MONEY

We will send you without obligation up to 3 Valves for test in your own set, to be paid for or returned at the end of trial.

OCTOPUS VALVES.

British Made. Fully Guaranteed.
Low Consumption.
Maximum Power and Distance.

Not to be confused with cheap valves of similar characteristics.

HOME CONSTRUCTORS of any make of set should take advantage of FREE TEST.

H.F., Det., L.F., R.C.	2 or 4 Volt.	Power 3/- Post Free.
5/6		

Type	Imp.	Amp. Fac.
H.F. 206	35,000	15
Det. 206	25,000	12
L.F. 206	18,000	8
R.C. 206	120,000	40
H.F. 215	40,000	20
Det. 215	30,000	15
L.F. 215	12,000	6
H.F. 406	23,000	15
Det. 406	19,000	9.5
L.F. 406	11,000	6
R.C. 406	120,000	40
P. 220	6,000	6
P. 415	4,000	4

WENBANS, 74, New Oxford St., W.C.1.

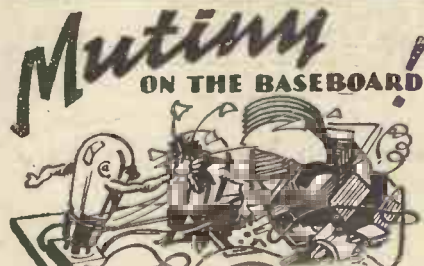

When your set gets out of hand take the one step that ensures the perfect balance necessary to secure harmonious, distortionless reception—fit a SIFAM Meter and tune with your eyes on the dial FREE leader "Distortion" from (Dept. P), S.I.F.A.M., 10a, Page Street, Westminster, S.W.1

PLEASE be sure to mention
"POPULAR WIRELESS"
when communicating with
Advertisers. THANKS!

MOVING COIL SPEAKERS AND GRAMOPHONE PICK-UPS. Demonstrations Daily.

Call and Listen! It is worth your while.
Blue Spot Balanced Armature Cone Unit, 25/-
Magnavox Ditto, 63/-
Balanced Armature Type Cone Unit, 10/6.
Moving Coil Milliameters, 17/- and 17/6.

Telephone: Museum 0241. Send or call for our 136-Page Catalogue FREE
ELECTRIC (GRAFTON) COMPANY
Dept. P.W.
24, Grafton Street, Tottenham Court Road, W.1.

ADVERTISEMENTS

As far as possible all advertisements appearing in "P.W." are subjected to careful scrutiny before publication, but should any reader experience delay or difficulty in getting orders fulfilled or should the goods supplied not be as advertised, information should be sent to the Advertisement Manager, "Popular Wireless," 4, Ludgate Circus, London, E.C.4.

Satisfaction
Guaranteed
or money
refunded

RIDLEY for RADIO

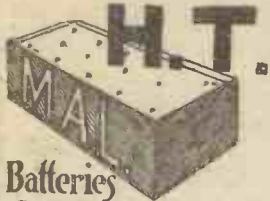

Batteries
for your Wireless!
RIDLEY'S
price **4/11**
60 volts

The finest value in H.T. Batteries, having long life and giving constant output. 100-volt size, 8/6. Add 6d. postage.

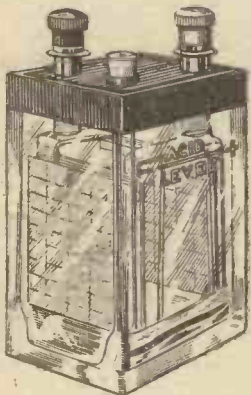

2-volt Accumulators, 20 amps. hour capacity, well made, good large plates well insulated, in glass case, each **3/6** Carriage 6d. extra.



Ridley Head-phones, finest value on the market, guaranteed.

Per pair, **4/11**
Add 4d. postage.

CABINETS SPECIAL OFFER

21 x 7 Cabinet Oak **16/-**
18 x 7 Cabinet Oak **16/-**

ILLUSTRATED CATALOGUE POST FREE ON REQUEST

CECIL RIDLEY

"RADIO HOUSE," MIDDLESBROUGH

Phone 1368.

Here is a fine list of Radio Bargains you will be interested in. I purchased for quick clearance and offer at bargain prices.

- 72-yd. COILS RED AND BLACK FLEX, usually 10/6. My Price, 6/9.
- Devicon Variable Condensers, .001, 2/- each.
- Miniature Ebonite Switches, 9d. each.
- 4½-volt Flash Lamp Batteries, 3/6 per doz.
- Neutron Crystals, 11d. each.
- Hertzite Crystals, 6d. each.
- .0002 Devicon Variable Condensers, 3/6.
- 4-volt Frelat Valves, 3/- each.
- 4-volt Frelat Power Valves, 3/- each.
- Murray Valve-holders, 6d. each.
- Valve-holders, 1/- each. Baseboard type.
- Antimicrophonic Valve-holders, 10d. each.

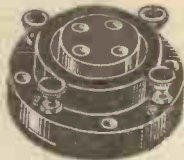

Ebony Anti-microphonic VALVE-HOLDER, cheapest on the market, considering quality. Base-board mounting, 1/9

- Single Circuit Plugs and Jacks combined, 2/6.
- H.T. Voltmeters, 0-130, 4/3 each.
- 2- and 4-volt Electra Valves, 2/6.
- 30-ohm Rheostats, 9d. each.
- Mans. Fixed Condensers, .5, 6d. each.
- Mans. Fixed Condensers, .25, 6d. each.

JACKS AND PLUGS

- Single Circuit Jack, open, 1/3
- Double Circuit Jack, closed, 1/6.
- Filament Jack, Single, 1/9.
- Filament Jack, Double, 2/3
- Plugs, 1/6, 2/-, and 2/9 each
- S.P.D.T. Switches, 6d.
- D.P.D.T. Switches, 9d.
- .0005 S.L.F. Condensers, 3/6
- Push-pull Switches, 9d.
- Baseboard Rheostats, 11d.
- 6-in. Panel Brackets, 6d.



- 2-way Coil-holder, geared, 2/6 each.
- Valve Windows, 6d. each.
- Transfers, per packet, 3d.
- 9-volt Grid Bias Batteries 1/- each.
- Hydrometers, 2/- each.
- Grid Leaks, 6d. each.
- "Sovereign" Coil-holders, 9d. each.
- Basket Coil-holders, 9d. each.
- Porcelain Valve-holders, 3d. each.
- .0003 Condenser and Grid Leak, 2/- each.
- Scrap Ebonite, 8 square inches a 1d. (in 5/- parcels only).
- .001 Finstone Condensers, 6d. each.
- Croix Transformers, 3/6 each.
- Forward Transformers 3/- each.
- Dundas Loud Speakers, full-size horn, 25/-.
- 6-pin Coils, 3/6 each.
- Brass Vaned Var. Condensers, .0005, 3/10 each.
- 2-mfd. Condensers, 2/3 each.
- 2-volt Power Valves, 3/- each.
- Complete Parts for Cossor Melody Maker, £5.
- Complete Parts for Mullard Master Three, £5 15s. 0d.

(Write for details.)

The KABINET-KONE-KIT!



This beautiful
**CABINET
SPEAKER**

is only **52/6** complete
in oak or 55/- mahogany

INCOMPARABLE RESULTS!

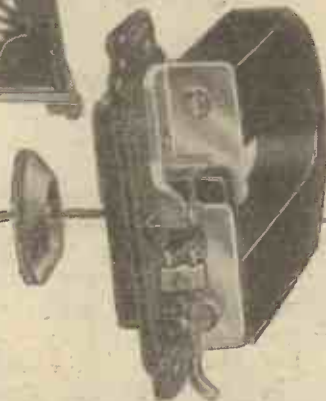

Incorporating the famous
BLUE SPOT
Four-pole, Balanced Armature
CONE UNIT

(as illustrated)

and the scientifically produced "Six-Sixty" Cone. Sold as a complete constructional outfit you can put it together in a few minutes by the aid of our illustrated booklet issued with each kit.

ASK YOUR DEALER TO DEMONSTRATE IT AGAINST THE MOST EXPENSIVE MODELS AVAILABLE. THE RESULTS WILL ASTOUND YOU!

If unable to obtain from your dealer, write direct to either:—
F. A. HUGHES & Co., Ltd. **WALKER BROS. (Guildford) Ltd.**
204/6, Gt. Portland Street, W.1 or St. Joseph's Works, Bramley, Guildford



**SAVE
MUCH
SPENDING**

**BY
TIMELY
MENDING
WITH**



FLUXITE

it simplifies soldering

All Hardware and Ironmongery Stores sell **FLUXITE** in tins, price 6d., 1/4 and 2/8. Another use for Fluxite—Hardening tools and Case Hardening. Ask for leaflets on improved methods.

**FLUXITE
SOLDERING
SET—complete**

7/6

or LAMP only **7/6**

FLUXITE LTD.
Dept. 324, Rotherhithe, S.E.16

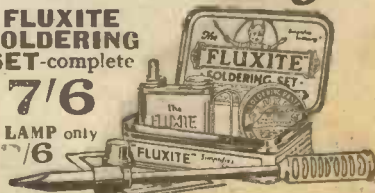



What constitutes an excellent Loud-Speaker ?



MODEL C12.

- Even response.**
Not only on the low, but on the middle and the high frequencies.
- Extreme sensitivity.**
Sensitive to the output from the weakest set.
- Adjustment.**
Ability to produce weak as well as very heavy signals without readjustment.
- Improves with age.**
Improves and *not deteriorates* with the passing of the years.
- Distinctive appearance.**
An excellent loud speaker breathes craftsmanship in appearance, so careful and capable is the workmanship wrought upon it. And it must be British.

Let your dealer convince you that "CELESTION," most excellent of loud speakers, passes all these tests readily.

Write now to Dept. B for the "Celestion" illustrated folder and also for our new Gramophone Pick-up leaflet.

CELESTION

THE VERY SOUL OF MUSIC

Write to Dept. B,
THE CELESTION RADIO CO.,
Hampton Wick, Kingston-on-Thames.

Showrooms : 33/35, VILLIERS ST., W.C.2.
French Agents : CONSTABLE & CO. PARIS.

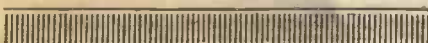

RADIOTORIAL QUESTIONS AND ANSWERS

(Continued from page 202.)

loud speaker as near to me as she has it to her, and peace will thus be restored in our once happy home."

In a great many instances the position of the loud speaker *does* alter the "tone" of the reproduction. This is on account of the fact that the sound waves set up by the loud speaker are reflected by neighbouring surfaces. And the character of this reflected wave will obviously be different if the sounds reflect from a perfectly flat surface, such as a wall, than when the surface is a broken one such as perhaps a heavy curtain or other soft furnishing material. It is therefore quite probable that in your case there is a scientific explanation for the difference noted by your wife.

(We do not go so far as to say, however, that there is any need to draw your wife's attention to this fact. We do know what women are !)

THE BARGAIN HUNTER.

E. K. (Canonbury, London, N.).—"The boy is very keen on wireless, but the other Saturday he spent a shilling on a big choke (apparently ex-Government) which he picked up on a stall in the Farringdon Road. The man who sold it to him said he could 'protect his loud speaker with it,' whatever that means, but although he told the boy some story about connecting it in the place of the loud speaker we have not so far succeeded in making any use of it. It is marked 50H, and it appears to be O.K. because you can hear clicks from it when a battery is connected across it with the telephones. Is there any use to which we could put it on the set ?"

Apparently you have got a bargain, for if it is a good choke it is certainly exceedingly cheap at a shilling, and it *can* be used to protect the loud-speaker windings as stated. In a great many sets the H.T. current passes from the battery through the loud-speaker windings to the plate of the valve. This main current does not operate the loud speaker, but is, from the loud speaker's point of view, so much waste.

Output Filter Connections.

What causes the sound is the *variation* in this current, and by means of the L.F. choke we have a method of operating the loud speaker by the variations without the necessity to pass a heavy, steady current through the windings. Thus the loud speaker is relieved of a comparatively heavy load, and if long leads are used the danger of leakage across these leads is entirely obviated. In fact, there are several distinct advantages about the method, which is called "filtering" the loud-speaker output.

In addition to the choke, however, you require a large fixed condenser of one or two, or more, mfd.s., and then all you have to do to get the advantages of the filter is to connect up as follows :

Disconnect the loud speaker from its terminals and join the choke across these. Now join one side of the large fixed condenser to that side of the choke which is connected to the plate of the last valve. Join the remaining terminal of the large condenser to one side of the loud speaker. The remaining side of the loud speaker is now joined to any point of the set connected to the filament of the last valve, probably H.T. negative or L.T. plus, or earth.

If you draw a sketch of this arrangement you will find that the steady H.T. current now passes through the windings of the choke direct to the plate of the valve. There is an alternative path to the plate from H.T. negative via the fixed condenser and the loud speaker, but the fixed condenser is an effective barrier to any direct current getting through this way. Steady current passes easily through the choke, but the varying current caused by the speech frequencies has great difficulty in overcoming the impedance of the choke, and therefore such variations in current find a much easier path through the alternative route consisting of the fixed condenser and the loud speaker. In this journey they operate the loud speaker just as well as if it were connected in the plate circuit of the valve. If you try the method we feel convinced that you will be delighted with the results.

BACK NUMBERS OF "P.W."

J. W. F. (Hounslow).—"Where can I get back numbers of POPULAR WIRELESS ?"

Application for back numbers should be made to
The Amalgamated Press, Ltd.
(Back Number Dept.)
Bear Alley,

Farringdon Street, E.C.4,
Price 4d. per copy.

It will pay you to insist on Columbia



Columbia

No. 4780, 60 volts type, 22/6.

Figures speak louder than words, and figures prove conclusively that Columbia High Capacity Batteries combine Efficiency with Economy to a far greater degree than any other H.T. Battery obtainable. The greater the weight of an H.T. Battery the greater its recuperative powers, and as the Columbia 60-volts type weighs 13 lb., as compared with 5 lb. of other batteries, the inference is obvious. In fact, the Columbia Battery commences its life containing nearly three times the amount of electricity-producing material contained in the smaller batteries. And every Columbia Battery sold carries the full guarantee of the manufacturers, The National Carbon Company, the world's largest battery manufacturers Economise by using Columbia. Price of 60-volts type—22/6.

Ask your dealer for descriptive literature.

J. R. MORRIS,
15, Kingsway, London, W.C.2
Scotland: J. T. CARTWRIGHT,
5, Cadogan Street, Glasgow.

CONDENSERS of QUALITY !

No mass production methods are employed in the manufacture of Camden Condensers. Every Condenser is stamped with a Serial No., and accompanied with a guarantee of 6 months' real service. Telegrams: KAMELCO, Telephone: Runcorn 109.

Send for list and prices to
Camden Electrical Co., Stanley Chambers, Runcorn.



WET H.T. BATTERIES

Solve all H.T. Troubles.

SELF-CHARGING, SILENT, ECONOMICAL.
JARS (waxed) 2 1/2" x 1 1/2" sq. 1/3 doz.
ZINCS, new type 1 1/2 doz. SACS 1/2 doz.
Sample doz. (18 volts), complete with
bands and electrolyte, 4/5, post 9d.
Sample unit 6d. 16-page booklet free.

Bargain list free.
AMPLIFIERS 1-VALVE 19/-, 2-VALVE 30/-,
2-VALVE ALL-STATION SETS 4.
P. TAYLOR, 57, Studley Road,
STOCKWELL LONDON

PLEASE be sure to mention
"POPULAR WIRELESS"
when communicating with
Advertisers. THANKS !

Make your loud speaker live

THE TONER

FIX A "TONER"

across the terminals and your loud speaker will reveal a clarity of reproduction equalled only in the broadcasting studio itself. This wonderful device removes all distortion and undesirable noises from any loud speaker or phones. The result of a long scientific research trade applications invited

Send to day to
The JUNCTION ENGINEERING CO.
(Dept. 18) 149a, JUNCTION RD.
LONDON, N.19

26
POST FREE

NEWS FROM SAVOY HILL.

(Continued from page 178.)

at 8 p.m. will be relayed from Carlisle Cathedral. 5 G B listeners will hear a symphony concert during the afternoon, and Bach's Cantata for Easter Day, followed at 6.30 by a service from Birmingham Cathedral. The evening concert will consist of music by the Wireless String Orchestra for London, and a programme by the Birmingham Police Band for 5 G B.

An attraction from London on Bank Holiday, Easter Monday, will be a burlesque pantomime by Mabel Constanduros filling the first part of the evening programme, after which the Wireless Military Band, under Mr. Walton O'Donnell, will give a programme of popular music, and there will, of course, be dance music until midnight. The alternative from 5 G B consists of a concert of chamber music and a play until 10 p.m., when there will be dance music until 11.15.

Newcastle's Scandinavian Programme.

The many Scandinavian interests on Tyneside have induced the Newcastle station to arrange a special Scandinavian Programme on Tuesday, April 10th. Mr. Edgar L. Bainton, of the Conservatoire of Music, Newcastle, is to be the conductor, and the artistes include the distinguished Norwegian pianist, Madame Johanne Stockmarr, and Miss Gundrun Nordraak, both of whom will be making their first appearance in the local studio. Madame Stockmarr will include among her items Grieg's Concerto and pieces by Sibelius. Svendsen, Sinding and other Scandinavian composers.

Liverpool Features.

Merseyside listeners have their own special programme from the Liverpool Station in the last part of the evening transmission on Monday, April 16th, when a pianoforte recital will be given by Norman Henderson, the brilliant young Liverpool pianist, who has already achieved fame both in this country and on the Continent. There will also be two short plays, "The Family Group," a farcical comedy, the scene of which is set in a photographer's studio, and "Witch-Wife," which is a play of terror, the action taking place in a Devonshire farm-house in the year 1697.

The first of these plays is by Mabel Constanduros, while the other play was written by her in collaboration with Michael Hogan. Songs will also be sung by Constance Astington (soprano), and some violin solos played by John P. Sheridan, who will be using an instrument made by Stradivarius.

Music from Leamington.

The first concert of the season from Jephson Gardens, Leamington Spa, will be broadcast from 5 G B on Tuesday, April 10th, when a programme of music will be given by the Band of H.M. Royal Artillery (Mounted), conducted by Mr. T. J. Hillier. Their items will include a suite of Three Light Pieces (Fletcher), the Overture to "The Sicilian Vespers," and a selection of "Songs of the Fair" (Easthope Martin). Songs will also be sung by Walter Glynne (tenor), and other items given by Myra B. Johnson (entertainer). A permanent line has been installed between the Birmingham studio and Leamington Spa.

*As pure in reproduction as
the Silver of its winding*



THE new Mullard "Permacore" Transformer is based upon absolutely revolutionary principles which give these outstanding features.

Small in size; great in amplification. High flux density without saturation. No resonant peaks to give unnatural reproduction.

All shrillness eliminated.

Gives all the bass notes required.

Silver primary, nickel secondary; windings that will not deteriorate.

Silver for the primary has the advantage of good conductivity and no deterioration. Nickel for the secondary has the advantage of high resistance and magnetic properties.

The iron in the Mullard Transformer is a specially treated and scientifically prepared material with a high permeability that allows the use of a high flux density in an iron circuit of exceedingly small dimensions.

This new wonder Mullard Transformer opens new possibilities for the constructor. It is the finest L.F. Transformer ever produced.

Obtainable from all radio dealers.

25/-

Mullard
MASTER · RADIO

KEYSTONE COMPONENTS

MEAN CARE-FREE RADIO

KEYSTONE "MIDGET" REACTION CONDENSER

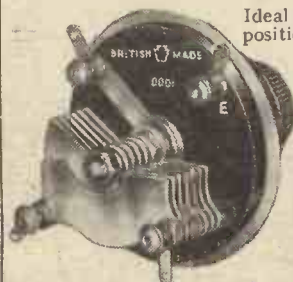

Ideal for the many positions where a small capacity condenser is required. An aluminium shield prevents hand-capacity effects, and a special taper bearing gives a beautifully

smooth movement. Accurately designed and rigidly constructed, this Keystone condenser is backed by the usual Keystone guarantee of efficiency. Capacity .0001 mfd. Price 5/6. '00005 5/-.

KEYSTONE ALUMINIUM BRACKETS

Keystone Brackets are made from high-grade aluminium. The slots are a special Keystone feature, and the finish is of that standard which has made Keystone components the choice of thousands of radio enthusiasts.

NOTE THE SLOTS—A KEYSTONE FEATURE

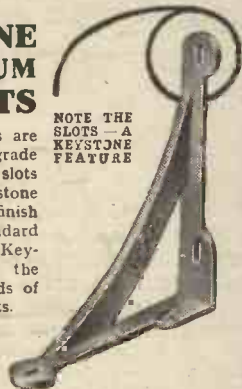

2/- PER PAIR



WAVE-TRAP Standard Model

15/-

SIX-PIN COIL BASE

Standard spacing with terminals arranged for easy accessibility. For use where the standard 6-pin coils are utilised without the actual screen. Price 2/9



PETTO-SCOTT Co., Ltd.,
77, City Road, and
62, High Holborn, London
Also 4, Manchester Street, Liverpool.

SHORT-WAVE NOTES.

By W. L. S.

THE use of H.F. amplification for short-wave receivers seems to be achieving a considerable measure of popularity among those who are enthusiastic enough to take the necessary trouble.

True, it necessitates one or more extra tuning controls, which make really quick searching rather difficult, but there is a great deal of "certainty" in the performance which such a set will put up.

One may always argue that all the signals which are available will make themselves heard on an ordinary oscillating detector, but with a set incorporating H.F. stages greater selectivity can be obtained, and signals which would be smothered in mush on the average two-valver may be cleared of all such noise and received intelligibly. The short-waver with one or two stages of H.F. is the ideal set for those who wish to receive short-wave broadcast with something more than ordinary regularity.

It is surprising now to reflect that it is only a matter of about a year since it was believed impracticable to obtain any high-frequency amplification of signals below about 150 metres! This is the more surprising in view of the fact that perfectly ordinary circuits will now do the work; as a matter of fact, the straight circuit has been found considerably more successful for this purpose than any of the freak or unusual circuits that have yet been tried.

Effect of Locality.

Different localities have greater effects upon short-wave work than upon ordinary broadcast reception. I have recently moved from a rather low and screened situation to a locality which, while not particularly high, is at the same time comparatively open and free from screening. The difference in reception is amazing.

On the whole, distant stations do not seem to be received at better strengths than before, but quite a different set of stations is heard. Several of the old familiars are now inaudible, and stations that were often eagerly listened for, but never heard, at the old station now come through with great vigour.

Transmission, strangely enough, does not seem to have been affected to such a great extent. The same directional properties seem to persist; the aerial still runs due east and west. Strong reports are still received from the same stations as before.

However, as the apparatus has only been installed for a matter of three weeks, it is probably somewhat premature to try to sum up the conditions.

I am of the general opinion that a good earth is preferable to a counterpoise for short-wave work. By a good earth is meant a large, buried plate or mat, not a water-pipe connection, and a short lead is certainly desirable.

For those who are not in a position to instal this arrangement, I certainly recommend a counterpoise, but it is well worth one's while to try an earth in comparison with the other before making a final decision.

PANEL PLATE TUNER

Prov. Pat.

Regd. Design

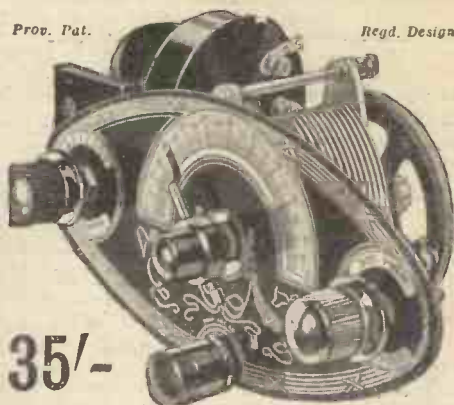

35/-

Great as is the popularity of our numerous high-grade Components and Receivers, the success achieved by this Unit has beaten all records. Amateur constructors in all parts of the country realize the immense assistance this unique assembly of parts affords them in the building of an efficient set which has the appearance of a professional product.

Above illustration clearly shows details of various parts mounted on richly engraved panel in black and gold or silver. No ebonite panel required, no coils to change, and diagrams for building 2 or 3-valver supplied.

LAMPLUGH

BRITAIN'S BEST RADIO

"LAMP-LOO"
S. A. LAMPLUGH, LTD.,
KING'S ROAD, TYSELEY, BIRMINGHAM.
Representatives for London and Southern Counties:—
G. O. Shore & Co., 28, Newman St., Oxford St., W.1.

TRADE MARK RD40 .2/-

RED DIAMOND

REGD. A RADIO EXPERT writes:—

Shield for same 6d.

"RED DIAMOND"

THE RECOGNISED DETECTOR FOR ALL CIRCUITS USING CRYSTAL RECTIFICATION. By Insured Post 2/3 or 2/9 with shield. Can be mounted on brackets or through panel. Once set always ready. Not affected by vibration. Each one is tested on broadcast before despatch, and is perfect. Of all high-class Radio Dealers or Sole Makers:—

JEWELL PEN CO., LTD. (Radio Dept. 46).
21-22 Gt. Sutton St., LONDON, E.C.1.

THE RELIABILITY GUIDE No. 999

FREE UPON REQUEST

0-6 VOLT METER Reliable Instrument 3/6

Double Scale Type 0-6 v., and 0-120 v., 5/6

S.O.S. BATTERY TESTER 3-Beam Type

Tells immediately full or empty. Only 3/6. Vent

J. H. TAYLOR & CO. 4, RADIO HOUSE, MACAULAY ST., HUDDERSFIELD. Plug Type, 1/6

THE LITTLE CELLS THAT SATISFY.

Eton Primary H.T. Battery P.I. Porous Pot Cells, S1 and S2 Sac Cells. All complete.

	1-cell	6-cell	12-cell	30-cell
P.1	6d.	3/3	5/9	14/-
S.1	6d.	3/-	5/3	12/-
S.2	4d.	2/6	3/10	9/6

Send 1d. stamp for booklet giving full particulars to:—
THE ETON GLASS BATTERY CO.
46, St. Mary's Road, LEYTON, E.10

PLEASE be sure to mention 'POPULAR WIRELESS' when communicating with Advertisers. THANKS!

THE "HARTLEY" ONE-VALVER.

(Continued from page 191.)

The success of a little circuit like this depends very largely upon proper adjustment of the valve, and you must be prepared to spend a little time securing just the right combination of high-tension voltage and filament current for the best signals and smoothest reaction control. You are likely to find with most valves that a somewhat higher value of H.T. will be necessary than is usually the case with reaction circuits, smooth control being usually obtained with something like 60 to 65 volts on the average.

Tuning Without Interfering.

Searching with a set of this type requires just a little practice to get the hang of running over the scale of the tuning condenser without actually oscillating, yet keeping the set on the very edge of oscillation, so that it is in its most sensitive condition. It is worth while to obtain this knack, and once acquired you will find that there is considerable satisfaction in feeling that you have learnt the method employed by all skilful operators, and one moreover which ensures your picking up any station within the limits of the set, yet causing no possible interference with anybody.

Finally, just a word as to the results which you will get. On test, this little set proved to be very good and noticeably above the average of single-valve reaction circuits, and quite a long string of foreign stations were logged with it.

Regarding Results Reports.

Now, I always think that it is very misleading to give a string like this without comment, and to leave the constructor to imagine that he will be able to duplicate these results immediately. It must be remembered that on test the set is handled by a very skilled operator, who usually has at his disposal a highly accurate wave-meter for identifying stations quickly so that in a very short time he can make a really wonderful "catch."

As a matter of fact, to give such a report without a really definite warning is rather misleading, and I propose to try and give the reader some idea of what he is likely to do under his own conditions and without too great a degree of skill in operation.

Well, with a reasonably efficient outdoor aerial, it should be quite easy to hear at least a dozen foreign stations at clear 'phone strength provided that you do not live in a particularly bad locality, either with regard to reception conditions or with regard to had jamming from a very nearby local station. On the longer wavelengths there should be something like a further six stations which will come in at good and clear headphone strength, so that you may quite well expect something like twenty stations in the course of time as you gain skill in manipulating the controls.

NEXT WEEK.

Full details will be given of

THE "INDUCTO-CRYS,"

something new and highly efficient in the way of crystal sets.

ORDER YOUR COPY NOW.

LONG LIFE

The Battery that lasts longest is the SURE-A-LITE—a fact your radio dealer will confirm.

No other battery can claim such recuperative powers or give such smooth and silent service, because no other battery is made just like a SURE-A-LITE. The cells in a SURE-A-LITE are larger than any other and, we definitely state, better designed and constructed. Each SURE-A-LITE is supplied in a sealed, dust-proof cover. That seal is your guarantee of perfect condition.

GRID BIAS. Each 66 volt battery tapped every 1½ volts up to 6 volts. Each 109 volt battery tapped every 1½ volts up to 9 volts.

SURE-A-LITE

BRINGS MOST IN — GIVES MOST OUT
REGISTERED TRADE MARK

"Supra"
66 volts
7/11
108 volts
14/3

"Giant"
66 volts
10/6
108 volts
17/6

THE BATTERY COMPANY,
92, Hurst Street, Birmingham.



THE BETTER BATTERY

STARTLING REDUCTION IN WIRELESS VALVES

BEST BRITISH MADE VALVES FOR 3/6 OLD PRICE 8/6

L.F. H.F. R.C. AND DETECTOR IN 2, and 4 VOLTS. P.R. SUPER VALVES are the latest product of one of the finest equipped Wireless Research Factories in Great Britain. They must not be confused with Bankrupt or Foreign stocks of old and rubbishy valves. The P.R. SUPER VALVE FILLS EVERY WIRELESS NEED, and has enormous TONAL STRENGTH, PURITY, and SELECTIVITY.

Type	Fil. Vts.	Fil. Amp.	Imp. Ohms.	Amp. Fac.	M/C	
PR 1	2	-05	35,000	15	-4	H.F.
PR 2	2	-06	25,000	12	-43	Det.
PR 3	2	-06	18,000	8	-44	L.F.
PR 4	2	-06	120,000	40	-33	R.C. MATCHED
PR 5	2	-15	40,000	20	-5	H.F. VALVES for the intermediate stages
PR 6	2	-15	30,000	15	-5	Det. of Super-hets specially selected for 1/- per set ex.
PR 7	2	-15	12,000	6	-5	L.F.
PR 8	4	-06	23,000	15	-65	H.F.
PR 9	4	-06	19,000	9-5	-5	Det.
PR10	4	-06	11,000	6	-55	L.F.
PR11	4	-06	120,000	40	-33	R.C.
Power Valves	2V.	.20	6,000	5	.82	P.
	4V.	.15	4,000	4	1.0	P.

Tell us what your circuit is. We can help you select the right valves; the intermediate stages of Super-hets specially selected for 1/- per set ex.



Phone-order: City 3788. Buy the Postman C.O.D.

Sets of Valves made up to any requirements.

NOW ONLY

3/6

Post 4d.

- 2 Valves for 6/3 Post 6d.
- 3 Valves for 10/- Post 6d.
- 4 Valves for 13/- Post 9d.

All valves despatched by return of post under guarantee of Money Back in Full if not satisfied. All valves are carefully packed and breakages replaced. Cutlers invited.

P.R. VALVES

"TROMBA" 72 volt, 15/2. NO EXTRAS, CARR. PAID. All Voltages stocked. 6d. a cell; or 1/- for full range of samples. TROMBA ELECTRICAL CO. (Dept. W.), 13, High Rd., Kilburn, N.W.8. Phone: Maida Vale 1669

THE

WET H.T. Components supplied. Postage extra.

TRADERS GET YOUR COMPONENTS AND CABINETS AT THE RIGHT PRICES. Send for illustrated list. Dept. P.W., PERSEUS RADIO, Burton-on-Trent

REPAIRS

Any make of L.F. Transformer, Loudspeaker or headphones repaired and despatched within 48 HOURS—TWELVE MONTHS' GUARANTEE with each repair. 4/- Post free.

Terms to Trade.

TRANSFORMER REPAIR CO.

"Repairs" Dept.

214, High Street, Colliers Wood, London, S.W.19.

EVERYTHING RADIO ON

EASY TERMS

WOOLDRIDGE RADIO CO. LIMITED. 17, 19 & 21, LISLE STREET, LEICESTER SQ. LONDON, W.C.

ALL APPLICATIONS FOR ADVERTISING SPACE IN "POPULAR WIRELESS" MUST BE MADE TO THE SOLE ADVERTISING AGENTS, JOHN H. LILE, LTD., 4, LUDGATE CIRCUS, LONDON, E.C.4.

**THE ROLLS-ROYCE OF RADIO
IS THE
DIX-ONEMETER**

THE HIGH GRADE RADIO TESTER.

Low price. High Value. Worth £10.

INSTRUMENT, 55/-. MULTIPLIERS, 6/6 each.
Radio Test Booklet. All Radio Users need one.



The ACONEMETER. Model VAC.3. In Case.
Is a new Model measuring Alternating Current, a 3-range instrument reading 0-150 v., 0-300 v. and 0-600 v. Price, inclusive of case, 75/-, 1,500 volt Multipliers, 44/- extra.

Capacity Meters, £8. Wheatstone Recorders, £12. Multi-Micro Galvos, 60/-. Res. Boxes, 17/6. Hydrometers, 1/6. Relays, 6/6, and Remote Switches, 15/-. Transmitting Sets and Wave-meters, from £2. Loewe Triple Valves, 38/-. Cabinet Violina Speakers, 25/. Hear Easy Phone Pads, 3d. pair. Skinder. Micro Buttons, 2/-.
GRAMO PICK-UPS. Magnetic Earpiece Units for making your own 40/- reproducer. Adapted with a little work, 1/2 each. Sullivans are the smallest and have aluminium case, 1/6 each. Adapted Brown A Pick-ups, 17/6. Electradix 25/-. Complete outfit, £5 10s.

TABLE ELECTRIC PROJECTORS. For Photo Slide or Home Television experiments. 4 Magnif. and focus lenses, swivel stand. Socket cord and plug for supply mains or battery. Sale 25/-. Gun Telescopes, as used on Warships. 21 x 24 in. long, 12/6, 15/-. & 17/6, in case. Selenium Cells, 10/-. A.C./D.C. Chargers for 2, 4 or 6 volt Batteries up to 6 amps. at half List Price, 50/-.
Get our New 72-Page Catalogue.

ELECTRADIX RADIOS,
218, Upper Thames St., E.C.4
St. Paul's and Blackfriars Stations. Phone City 0191

FREE A 0005 LOGARITHMIC CONDENSER.



To all purchasers of our "All-Wave" Ebonite Tuner, wave-length 180-2,000 metres. Combines a six-point switch with a variable reaction wound with silk-covered wire, brass parts nickel-plated, size 4 1/2" x 3 1/2", two-hole fixing. The smallest, neatest and most efficient tuner on the market. Satisfaction guaranteed or money returned. Price only 15/-. post free. Cash with order, or C.O.D. Send now direct to the maker:—
S. W. SCOTT, 57, Camberwell New Road, LONDON, S.E.5.

ALL APPLICATIONS for ADVERTISING SPACE in "POPULAR WIRELESS" must be made to the Sole Advertising Agents, JOHN H. LILE LTD., 4 LUDGATE CIRCUS LONDON, E.C.4.

TECHNICAL NOTES.

(Continued from page 178.)

Aerial Overhaul.

After a receiver has been in operation for some time it will generally be found that reception can be much improved by overhauling the aerial system. This is specially true in the winter when, owing to the usually damp conditions and the prevalence of fogs, the insulators are liable to be covered with a more or less conducting film of soot and other dirt. In most cases, it will be found that merely wiping the insulators with a dry cloth will bring about a noticeable improvement in reception. Various cleaners may be used for the insulators, the commonly recommended ones being alcohol (methylated spirit), benzene, and carbon tetra-chloride (separately, of course—not mixed together). When the aerial is lowered for the cleaning of the insulators, the aerial wire itself should be carefully examined to make sure that it has not become rotten at any part, otherwise there may be a breakage when it is again hoisted, and it may be inconvenient to get certain parts down again. Most listeners are apt to neglect their aerials, imagining that once installed an aerial should last and function efficiently for ever. As a matter of fact, the aerial ought to have more attention than some of the other parts of the set, as it is exposed to all kinds of destructive influences. An aerial overhaul is a job which is commonly shirked and put off till some other day, but as a matter of fact, it is well worth while, not only for the improvement in the loudness of local stations which may thereby be obtained, but for the great increase in sensitivity if you go in for distant reception.

Winding Wire.

Talking about wire, you know how annoying it is when winding a coil, or one of the windings of a transformer, to come across an awkward joint in the wire which upsets the evenness of the layers (in the case of a transformer winding) and leaves you with a horrible suspicion that the covering may be chafed and that trouble may be in store.

It would certainly be a great advantage to be able to obtain an absolutely continuous length on a reel without any joint and also, in the case of enamelled wire, to be sure that the enamel was really pliable and not liable to crack.

The "KEW" enamel copper wire made by Kent Bros. Electric Wire Company and E. H. Phillips, Ltd., is guaranteed to be in continuous lengths per reel without any joints and the copper wire to be absolutely dead-to-gauge.

The enamel covering is claimed to be entirely free from liability to crack or peel and the thickness of the covering does not vary throughout the entire length of a reel of wire. Moreover—and this is a very important point—the enamel covering is free from pinholes: you will appreciate the value of this when using enamel wire for fairly high voltages.

A Useful Dodge.

A reader in the Isle of Wight, referring to my recent note about holding short lengths of busbar by means of a pair of pliers, has kindly sent me a draughtsman's ruling pen which he says he finds very

useful in place of the pliers. When you want to solder a short piece of busbar in position in some more or less inaccessible place, you simply insert the length of wire at a suitable angle in the jaws of the draughtsman's pen, tightening up the screw and then holding in position whilst the soldering is done.

My correspondent states that the idea is not new, but that he has himself found it very useful. As a matter of fact, I believe I mentioned this idea in this journal some considerable time ago, and I know that the dodge is one which is often used by experimenters and constructors. At the same time I am, of course, very much obliged to my correspondent for his letter and to all the numerous readers who, from week to week, send me useful suggestions. In fact, many of the most useful ideas which I am able to pass on this way come originally from readers who are kind enough to write and send them to me.

Sound and Sight.

One of the most remarkable things about radio is the immense stimulus which it has given to developments in all kinds of related sciences. I am thinking particularly, at the moment, of the developments in the recording of sound by means of light and the simultaneous reproduction of cinematograph pictures and sound.

The recording of the sound is done by means of a "light" process on a part of the film and the reproduction is effected by means of a beam of light projected through the film and varying in intensity as the different parts of the film pass through the machine. The light, of course, falls upon a photo-electric device by means of which variations in an electric current are set up these being amplified in the usual way.

PANELS REGISTERED RADIO

7 x 6, 1/3	9 x 6, 1/7
8 x 6, 1/4	11 x 8, 2/3
10 x 8, 2/1	12 x 8, 2/6
10 x 9, 2/4	12 x 9, 2/13
12 x 10, 3/-	14 x 10, 3/5
14 x 12, 4/-	16 x 9, 3/6
14 x 7, 2/7	21 x 7, 3/7
16 x 8, 3/2	24 x 7, 4/-
8 x 5, 1/2	1 in. thick

Post Free.
Money back guarantee that each and all Panels are free from surface leakage. Megger test infinity.
CROXSONIA CO., 10, South St., Moorgate, E.C.2
Phone: Clerkenwell 7853
Agents: John Henry Smith, 139, Anlaby Rd., Hull.
L. H. Helyar, 82, Chamberlin Rd., Norwich.
A. Stredwick & Co., 27, The Market, Chatham.
Boynston & Co. Ltd., 34, Bradford St., Birmingham

HEADPHONES REPAIRED 4/-
Transformers 5/-. Loudspeakers 4/-. All repairs remagnetised free. Tested, guaranteed and ready for delivery in 24 hours.
Discount for Trade. Clerkenwell 1795.
MASON & CO., 44, East Rd., City Ed., N.1.

D-XELLENT!

DX IN PLUG-IN COILS

From No. 25 1/- to No. 500 4/-

DX SHORT-WAVE SET
4 Coils Nos. 3, 5, 7, 9 .. 7/6

"P.W." Test Report, March 10:—"The fact that one of the first stations tuned in was 3 L O of Australia is ample proof that the coils are efficient."

If unable to obtain send P.O. 7/6.
DX COILS LTD LONDON E 8

The MASTER VALVE



The valve with the wonderful Mullard P.M. Filament, which is so essential to consistent service, length of life and purity of radio reproduction.

You buy Master products when you buy Mullard P.M. Valves.

Obtainable from all Radio Dealers.

Mullard

THE · MASTER · VALVE

New Eliminator Components



SMOOTHING CHOKE.

The problem of producing efficient smoothing chokes to carry a heavy load without an appreciable fall of inductance has occupied the close attention of our Research Department for some considerable time.

We have now solved this problem to an extent hitherto even unapproached. The new Smoothing Chokes which we have just marketed can carry the enormous current of 100 milliamperes without saturation, whilst the size, and therefore the price, has been kept within reasonable limits.

The extensive use of high power output valves calls for an eliminator capable of dealing with the necessary heavy anode current. Such current needs to be adequately smoothed, and the public have now available for the first time smoothing chokes which fulfil the necessary requirements, and which, owing to the special manner in which they are made, are procurable at a very reasonable price.

Price 21.-



SUPER POWER RESISTANCE.

The series resistance method of adjusting the voltage in eliminators has proved so popular that we have specially designed a new form of resistance for this particular purpose.

These resistances are able to carry a heavy anode current without overheating, special care having been taken in their design to deal adequately with any slight heat generated.

There are many other uses for these super power resistances which will appeal to the discerning amateur and professional radio engineer.

These resistances are made up as follows: 500 ohms to carry 50 milliamperes; 1,000, 1,500, 2,000, 2,500 and 3,000 ohms each to carry 30 milliamperes.

Price 12/9 each.

SPECIALISTS IN
LE AMPLIFICATION

R
AND
Varley
LTD.

THE MARK OF BETTER RADIO

Kingsway House, 103, Kingsway, London, W.C.2

Telephone: Holborn 5303.