

The Lodge "N" Set: Exclusive Constructional Details

Popular Wireless

Every Thursday
PRICE
3d.

No. 224. Vol. X.

and Wireless Review

September 18th, 1926.

Scientific Adviser: SIR OLIVER LODGE, F.R.S., D.Sc.

60

Pages

Price 3d.

as

Usual

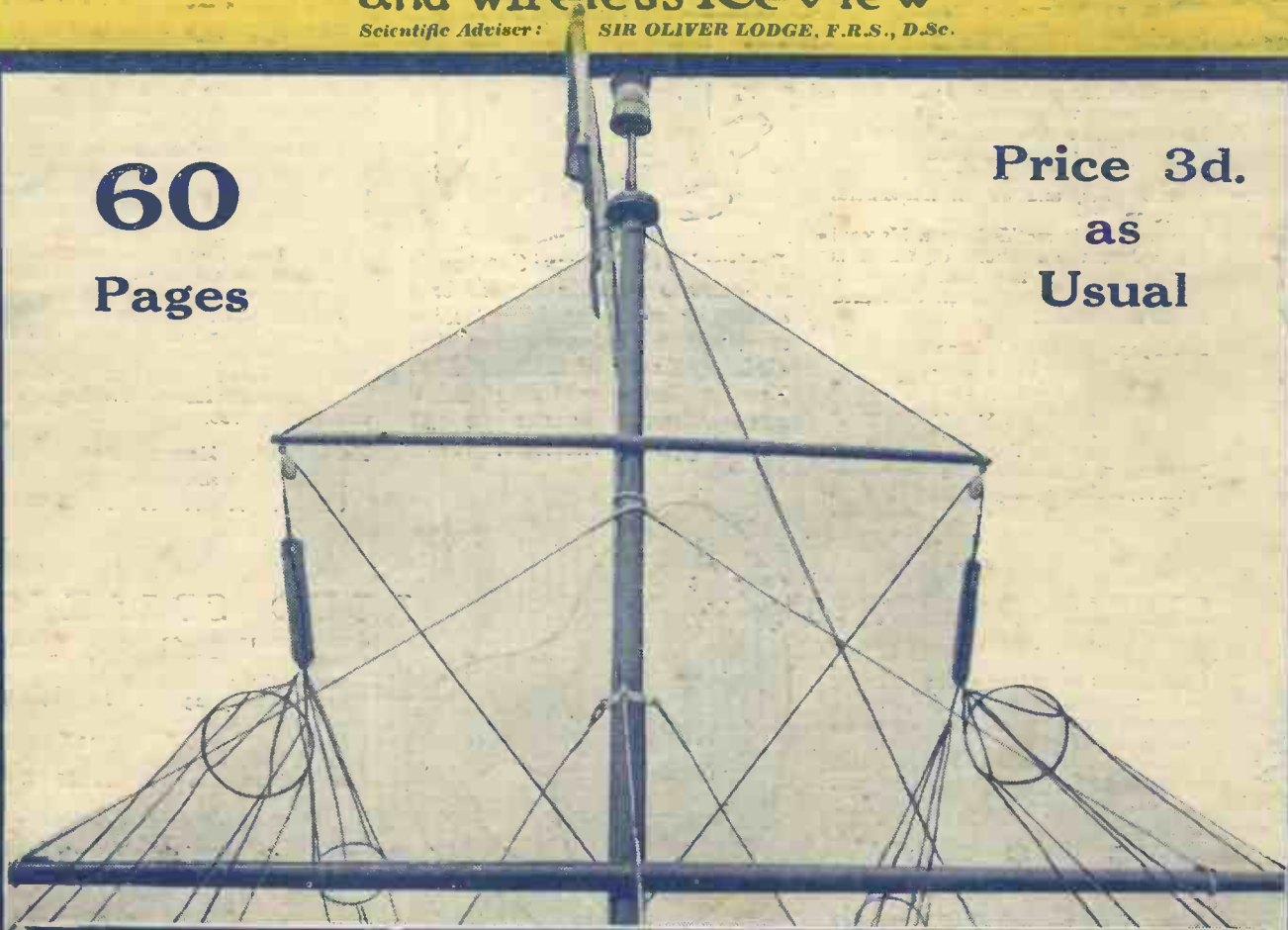

THIRD SPECIAL EXHIBITION NUMBER.

CONTENTS.

Features at the Exhibition.

BY THE "P.W." CRITIC.

A "P.W." Harkness Reflex Receiver.

Making a Loud Speaker for 13/-.

Exclusive Article on the Lodge "N" Set: First published details for building an Experimental Model.

MARCONIPHONE

HIGH TENSION

MARCONIPHONE H.T. SUPPLY UNIT FOR ALTERNATING CURRENT

This instrument works without "hum" on any supply. The output, which can be taken in three pressures, viz., 42, 84 and 126 volts, is sufficient to operate any set on the market, and permits the use of power valves on full load.

By using alternative terminals provided on the unit, it can be utilised on mains of different pressures varying from 95 to 240 volts, and on all frequencies above 32.

The current is rectified by a Marconi U₅ valve, the filament of which is heated through the medium of a specially wound transformer contained in the instrument.

No. B925. Marconiphone	
A.C. High Tension Supply Unit	£9 5 0
Royalty	0 12 6
Marconi U ₅ Rectifying Valve . .	1 10 0
Instrument complete with valve, including Royalty..	<u>£11 7 6</u>



Designed by the Marconi Company's engineers to meet the demand for a device for obtaining high tension current from the house mains, thus obviating the use of the usual High Tension Battery with its attendant disadvantages. Suitable for all types of Receivers.

SUPPLY UNITS

MARCONIPHONE H.T. SUPPLY UNIT FOR DIRECT CURRENT

Similar in appearance to the A.C. Unit, but as its purpose is to smooth out direct current, no valve is necessary. Different types of D.C. Supply Mains, however, require different smoothing circuits, and this has been surmounted by providing adjustable connecting links to enable the unit to be connected up by the user in a way most suitable to the supply system—full instructions are furnished with the unit. Output tappings at 42, 84 and 100/120 volts are provided. Can be used on mains of 100/120 or 200/240 volts. In the latter case a pair of ordinary metal filament lamps are inserted in the instrument. A variety of output voltages can be obtained by the use of different lamps. This instrument can be used for charging H.T. accumulators of voltages not exceeding 90/100.

No. B926. Marconiphone	
D.C. High Tension Supply Unit	£6 0 0

STERLING "TYPE 33"

A new Loud Speaker of great volume capacity.

Designed to reproduce melody faithful to the original by retaining the tones and over-tones which give music its beauty and charm.

The horn channel offers no impediment whatever to the passage of sound, and



LOUD SPEAKER

does not reproduce any particular frequency at the expense of others.

Exceedingly pleasing in appearance. Height overall, 23 ins. Diameter of Flare, 14½ ins.

No. 1286. Sterling "Type 33"	
Loud Speaker, Mahogany or Walnut finish	£5 5 0

* * *

* * *

Visitors to the National Radio Exhibition, Olympia, will find much of interest in the Marconiphone and Sterling exhibits. Stand Nos. 121, 122, 123, 124 and 125.

Write for a copy of Publication 364G containing the most up-to-date information concerning the complete range of Marconiphone and Sterling Radio Receivers and Components, also new lines and revised prices.

THE MARCONIPHONE COMPANY, LIMITED,

Registered Office :

Head Office :

Marconi House, Strand, London, W.C.2

210-212, Tottenham Court Rd., London, W.1



A NEW AMPLION Model

The SENIOR "DRAGON"

Model AR.65

65/-

A new member of the famous "Dragon" Series. All metal, of patent **non-resonant** design and finished in a pleasing chocolate shade. A new and improved light-weight unit is fitted.

Height 17". Diameter of Flare 12".

AMPLION

The World's Standard Wireless Loud Speaker

*Look out for
Announcements
regarding the new
AMPLION
Loud Speaker
Value*

20th - 25th
 Exide Sept week

A week of opportunity

READ

the advertisements devoted to Exide Batteries this week.

MARK

the premises of the Exide Agents and reputable dealers making special displays.

LEARN

by examination of the extensive range of batteries for every car and wireless purpose, and by conversation with those who display them, the facts that have made Exide famous as the long-life battery.

AND INWARDLY DIGEST

these reasons and the further fact that no matter what the make of your car, what size or type of wireless set you use, there is an Exide Battery specially designed which will completely satisfy your particular need.

Exide

THE LONG-LIFE BATTERY

Advertisement of the Chloride Electrical Storage Co. Ltd., Clifton Junction, Near Manchester.



**B
T-H**

TWO VALVE L.F. RECEIVER

The Ideal
Loud Speaker Set
Price £5.0.0.
Royalty £1.5.0. extra
(exclusive of Valves & Batteries)

2644

Sold by all good Radio Dealers

The British Thomson-Houston Co. Ltd.

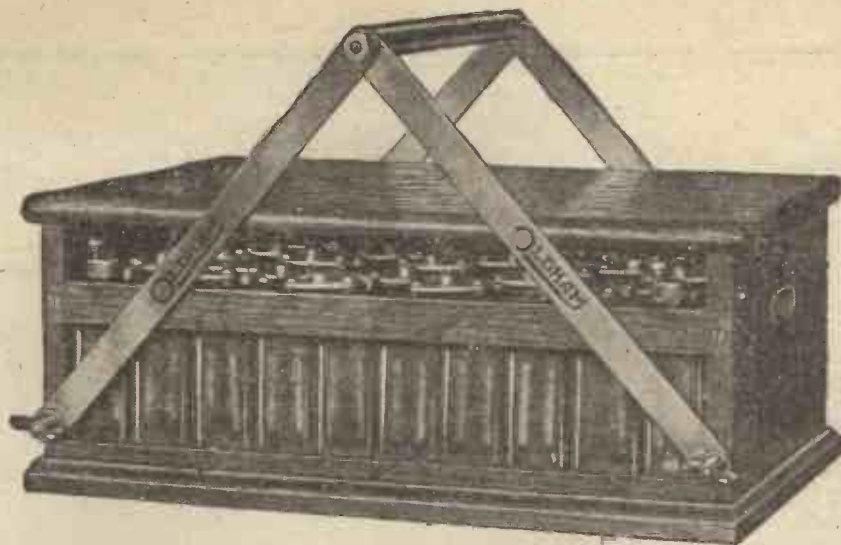

The Only High-Tension Accumulator built in units like an expanding bookcase

THE H.T. Accumulator is now added to the ever-increasing list of commodities to which the expanding system has been successfully applied. Just as the unit principle revolutionised the bookcase, so, we predict, will the new Oldham H.T. Accumulator change the whole trend of battery design.

The principle underlying this new Oldham is just this: a single unit is made up of ten 2-volt cells complete in a wooden holder; thus if a 60-volt Accumulator is wanted, three of these units are supplied clamped together, complete with carrying handle. Other units can be added at will (as illustrated on this page) to make up accumulators of 80, 100, or 120 volts.

The unit principle is, however, by no means the only advantage of this new accumulator. The fact that it bears the proven name of "Oldham" is sufficient to commend it to thousands of accumulator users whose experience tells them that the Special Activation Process, under which it is made, is responsible for a far greater efficiency,



(20 volts)

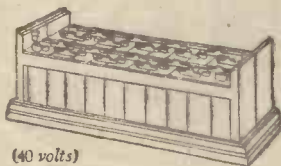

(40 volts)

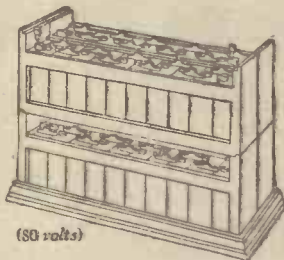

(80 volts)

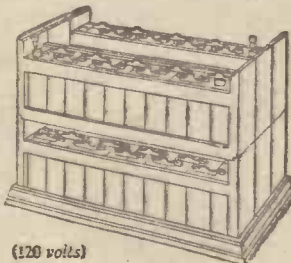

(120 volts)

immense resistance against all accumulator ills, and therefore a much longer life.

The Oldham H.T. Accumulator is not only more efficient, but is cheaper than the dry battery. Constant cost of renewals of H.T. Batteries has been a big deterrent against radio; the initial cost of this accumulator is covered in the amount saved in renewals after a few months' use. An additional feature that must not be ignored is that, each cell being tapped, the accumulator can be used for grid bias.

Finally, you should note that every Oldham Accumulator is soundly constructed to give several years' service. Each cell is a real miniature accumulator, using real plates and contained within a stout glass box, sealed at the top against evaporation. There are no cheap flimsy test tubes to break—no thin plates to buckle—no connections to corrode and cause trouble. Ask your Dealer to show you one—you'll be amazed at the moderate price of such a beautifully constructed accumulator.

10d. per volt

60 volts, £2-10-0 100 volts, £4-3-4

80 volts, £3-6-8 120 volts, £5-0-0

Complete with lid and polished aluminium handles

Solid Oak Base, 3/6 extra

Special Activation Process Batteries

OLDHAM

OLDHAM & Son, Ltd.

Denton, Manchester

LONDON: Hazlitt House,
Southampton Edges., W.C.2

Service Depot: 6, Eccleston Place,
S.W.1

Phone: Victoria 0286

Gilbert Ad 585x.

VISIT STAND
No. 162
RADIO EXHIBITION
OLYMPIA, SEPT. 4-18

The Cosmos Resistance Coupling Unit



Type "O" The Unit alone.
Price 8/6



Type "V" a similar unit incorporating
the "Cosmos" Spring Valve Holder.
Price 10/6



Illustration
shows a
Type "V"
Unit with
a valve
inserted.

Real purity of reproduction

Even the advertisements of the best Transformers plead guilty to imperfect amplification over the whole musical range. Real purity of reproduction can only be obtained with resistance capacity coupling. The Cosmos coupling unit with a suitable valve can be as effective as a transformer-coupled stage. Avoids all distortion and effects considerable economies in first and operating cost.

Designed primarily for use with the "Cosmos" S.P. Blue Spot Valves, it can be used successfully with any valve having an amplification factor of 30 or more.

Additional Advantages:—

1. Maximum possible amplification per stage.
2. Economy in filament consumption. Cosmos S.P. Blue Spot Valves consume 0.09 amps.
3. Economy in H.T. battery consumption. Less than 1/20th of normal.
4. Immunity from breakdown caused by complete or partial failure of the windings of transformers or chokes.
5. Small space and light weight.

A high-tension battery of 120 volts is adequate with this unit and "Cosmos" Short-path Blue Spot Valves.

METRO-VICK SUPPLIES LTD.

Metro-Vick House,
145, Charing Cross
Rd., London, W.C.2

Suitable Valves are:
for 2-volt, "Cosmos" S.P.18/B at 14/-
for 6-volt, "Cosmos" S.P.55/B at 18/6

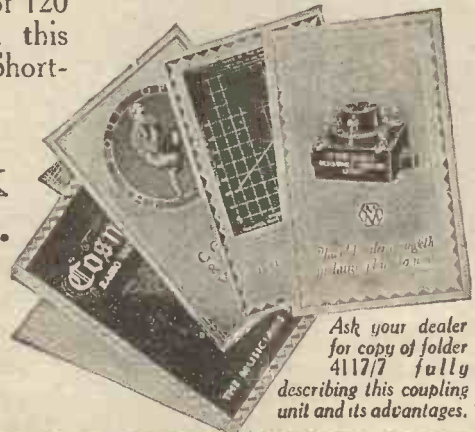

Ask your dealer
for copy of folder
4117/7 fully
describing this coupling
unit and its advantages. P51



IT is difficult to believe one's ears. Every tone and subtle variation in the singer's voice is repeated with uncanny accuracy. The very individuality which has made her a great artiste is minutely reproduced. With the introduction of the amazing Cossor Point One, broadcast reception enters a new phase. Co-axial Mounting—a new method of construction evolved by Cossor and employed for the first time in these valves—at last permits a standard of reproduction comparable only to the flesh-and-blood artistes themselves. Don't be satisfied any longer with mediocrity. Let the new Cossor Point One Valve bring you music—rich colourful music you can enjoy—untrammelled by yesterday's mechanical limitations.

In three types :

Red Band

For H.F. use.
Consumption '1 amp.

14/-

Black Band

For Detector or
L.F. use.
Consumption '1 amp.

14/-

Stentor Two

The power valve
Consumption '15 amp.

18/6

N.B.—All operate at
from 12 volts to
2 volts.

Popular Wireless

Scientific Adviser :
Sir OLIVER LODGE, F.R.S.
 Technical Editor :
G. V. DOWDING,
 Grad.I.E.E.
 Assistant Technical
 Editors :
K. D. ROGERS,
P. R. BIRD.



Editor : **NORMAN EDWARDS, M.Inst.R.E., F.R.S.A., F.R.G.S.**

Consultants :
Dr. J. H. T. ROBERTS,
 F.Inst.P.
J. F. CORRIGAN, M.Sc.,
 A.I.O.
C. E. FIELD, B.Sc.
E. J. SIMMONDS,
 M.I.R.E., F.R.S.A.

RADIO NOTES AND NEWS.

Sir Oliver Lodge to Broadcast Again—"Serving" a Summons by Radio—The Wireless Exchange—Who is the "Southern King"?—Daventry's New Aerial—America in Daylight—Albert Hall for B.B.C.

Reaction ?

LATE one evening, as I came out of the Wireless Show at Olympia, I saw two disreputable revellers "seeing one another home." They had been puzzling out the great placard "RADIO EXHIBITION," and then one of them gravely explained to me:

"Wireless. That'sh what it is. London Calling."

The other pointed derisively to his companion and announced:

"He's a reg'lar Eckerlesley, he is! Haw! Haw!"

In an endeavour to live up to the part, his friend looked contemptuously at him for a moment and then, knocking off his pal's hat, said, with a distinctness that must have cost him a great effort:

"Don't do it!"

The Week's Great Thought.

PITY poor Uncle Husky! He is the Bed-time Story Man at the North Pole Broadcasting Station.

What makes him "husky" is the fact that up there the sun doesn't set for nearly six months, so he's got to keep on telling his tale in the dusk of the Northern nights, until next Equinox!

All on Two Valves!

YOU'VE heard all the talk about long-distance multi-valve sets? Well, here is what a "P.W." reader is doing with a 2-valve set, built from "P.W." Blue Print No. 9.

"I receive the local station (5IT), 5XX, Königswusterhausen, and two local amateurs, loud enough to be heard comfortably all over the room. All B.B.C. main stations are at excellent 'phone strength, and of the relays, Stoke, Nottingham, Sheffield, and Liverpool are all 'good.' Here is a list of foreigners, all of which I have received at R-5, or stronger. Hilversum, Königswusterhausen, Hamburg, Dublin, Radio-Toulouse, Rome, San Sebastian, Dortmund, Hanover, Prague, Toulouse (Rdo du Midi), Frankfurt-on-Main, Petit Parisien, Stuttgart, and Barcelona. Not one is at what you can call poor strength, and any reader living in my district is invited to confirm for himself the truth of the above statements." The address is Mr. D. Baker, 54, Harrow Road, Bournbrook, Birmingham.

Music and the Ordinary Listener.

SIR HENRY WALFORD DAVIES, Mus.Doc., who is to resume his popular series of talks on "Music and the Ordinary Listener," on September 21st, was Director of Music in the Royal Air Force during the last year of the war.



Captain Eckerlesley at the 5 WA Sunshine Carnival, Weston-super-Mare, with Mr. Henry Butt, J.P., and other members of the Carnival Committee.

As a boy he was a soloist at St. George's Chapel, Windsor.

"Uncle" Makes Good Hubby.

"SIR, I would like to marry your daughter."

"What is your occupation?"

"Radio announcer."

"Take her. You're the first man who ever said 'Good-night' and meant it!"—
 "Oldham Evening Chronicle."

Poor Poppa ?

"I BOUGHT it second-hand, and the man said it was a P.P. set—but so far I haven't tuned-in anything," says a

troubled reader, in a letter to the Query Department.

Probably the P.P. stands for a "Poor Poppa" set.—("He's gets nuthin' at all!")

6 W K.

MR. W. WICKS informs me that the above call-sign has been allotted to him, at 11, Rigby Cottages, Dawley, Hayes. The licensed wave-lengths are 45/90 metres, and 150/200 metres. All reports on transmissions will be answered.

Training in Radio.

COURSES in Wireless and High Frequency Engineering will commence at the Polytechnic, 307-311, Regent Street, London, on September 27th. The fee for the full course is thirty shillings. A new transmission laboratory is available with a complete commercial installation for telegraphy and telephony (6 R A).

Particulars are obtainable from the Secretary, at the above address.

Wireless Watch on the Whirling World.

IN an address before the French Academy of Sciences, M. Bigourdan recently explained a method by which wireless could be utilised to regulate all the observatory clocks of the world.

It would thus be possible to check the regularity of the rotation of the earth—in other words to keep a watch on the whirl of the world! The accuracy claimed for the method is of the order of one-thousandth part of a second.

Women Who Mustn't Look.

THERE are four women on the staff of WLWL, a famous American broadcasting station. But under no circumstances will any of them ever be allowed to set eyes on the transmitting apparatus that sends their voices over the ether. The reason is—just because they are women!

This station is owned by the Paulist League, and its studio is in an ordinary house, but the transmitter is in the monastery next door. No woman is allowed to set foot across the threshold.

(Continued on next page.)

NOTES AND NEWS.

(Continued from previous page.)

Sir Oliver Lodge to Broadcast.

THE B.B.C. has arranged a first-class series of talks, for the session ending December 31st.

Sir Oliver Lodge, F.R.S., D.Sc., has promised to give a weekly Wednesday-evening series, commencing on October 6th, at 9.30 p.m., and continuing on 13th, 20th, and 27th of October, and 3rd and 10th of November.

Sir Oliver's subject is "Atoms and Worlds;" and the B.B.C. is to be congratulated upon securing the services of the one man living who can handle such a vast and vital topic in a manner to grip the imagination and interest of every listener.

No, No, Nanette.

A FAREWELL broadcast of the great theatrical success, "No No, Nanette" has been arranged by the B.B.C. The date fixed is Saturday next, September 18th.

No Light Music?

A HARD task was given to the judges of the B.B.C.'s musical competition, for in all classes there were heavy entries. The word "heavy" is literally true, for I hear that the entries weighed approximately half a ton!

Serving a Summons by Radio.

CAN a summons be served by radio? According to a decision recently announced by a Supreme Court Justice in America, this form of "service" is lawful! The method was invoked for the first time in history by the attorney of a lady, who despaired of finding her husband through the ordinary legal channels, and was so anxious for a divorce that she enlisted the aid of the ether!

The Wireless Exchange.

READERS who remember my remarks upon the subject a few weeks ago will be interested to hear the end of the "Wireless Exchange" case. It concerned the right of Mr. W. Maton, of Southampton, to erect a wireless exchange and supply broadcasting from his own set to twenty neighbours, for a fee of 1s. 6d. per week, per subscriber. Mr. Maton has now received official permission to carry on.

21 Licences for One Set!

IN a letter from headquarters he is told that the Postmaster-General has no objection to the scheme, provided that he has a wireless licence himself, and that all his "subscribers" have one. The stipulation is made that if, at any time, new subscribers are added, the Postmaster-General must be informed of their names and addresses.

The Southern King.

WHO is the Southern King? A Battersea reader tells me that he picked up this station on Saturday, Sept. 4th, about 12.30 a.m.. He was using a two-valve set (detector and L.F.), and overheard the King plaintively inquiring for his Queen (by telephony), as follows:

"Southern King testing, and calling Southern Queen, on 400 metres. Can you hear me?"

Apparently his royal consort did not, for after disconsolately inquiring, he eventually gave it up as a bad job. Have other readers picked up either station sufficiently well to establish its identity?

Daventry's New Aerial.

IF you haven't already done so, you should take a tip from 5XX, and overhaul your aerial in preparation for winter weather. Daventry, it will be remembered, came a cropper last December, the weight of snow and ice bringing down the 10-wire sausage aerial, with a run. The new aerial is of the single-wire type.

A Broadcasting Romance.

AN interesting wireless wedding—at which a whole company of B.B.C. personalities were present—was recently celebrated at Redditch. The bridegroom, Mr. Stanford Robinson, is a well-liked member of the B.B.C. musical staff, and his bride was Miss Mavis Bennett, the popular soprano.

Wesley's Chapel Broadcast.

WHEN the service from Wesley's Chapel, City Road, E.C., was broadcast recently, it was heard at the Wesley Mission in Hastings Old Town, upon a set built by the minister there. An aerial was erected over the roof of the church (that 100 years ago was the only theatre in Hastings), and the 4-valve set enabled an attentive congregation to worship with the London congregation, kneeling, and singing, in unison.

More Than 2,000,000 Licences.

THE latest official figures issued by the Postmaster-General show that new licences are being issued at the rate of

SHORT WAVES.

There was an Archdeacon of Bristol,
Who murdered his niece with a pistol,
He said "I can't bear
Your absurdly cropped hair
And your listening-in with a crystal."

M. Paul Painlevé, French Minister of War, predicts that in the future the weather will be controlled by radio. Heaven help the sailor's on a night like that! (Judge, New York). To say nothing of the morning after!

Sir Eric Geddes, in a message to the organisers of the National Radio Exhibition at Olympia, says: "I can see the nerve doctor of the future saying to the man with a nagging wife, or to the woman who is worried because her husband will not stay at home, 'Give them a radio set. No other medicine is required.'"
A case of 2 L O—VE or not 2 L O—VE.

In a letter to his publisher, Mr. George Bernard Shaw writes that he is a declared enemy of radio.
The C.O. at 2, Savoy Hill is stated to be calm and confident and no signs of panic are noticed among the staff.

A plague of earwigs has been experienced in parts of Surrey. Many nervous people have been sleeping in their headphones.
(Humorist).
Wouldn't the earwigs be preferable?

Mr. David Sarnoff, the Vice President of the Radio Corporation of America, says that radio has been responsible for adding nearly two thousand words to the English dictionary.
We suppose these are *not* for publication!

Dr. J. A. Fleming writes in the "Evening News": "It is commonly said that a nation has the Government it deserves, and this probably will be true also of its broadcasting programmes." I wonder what Britain did to deserve "The Sea Affair and Harry Binns."?

about 25,000 per month. At the beginning of last month the total had reached 2,100,000.

And the beauty of it is that if another two—or another twenty—million come along, there will be plenty of programmes for them all. There is "seating accommodation" for the whole human race upon the ether!

Complete American Programme Received.

I SHOULD hate to have it on my conscience that I kept you out of your little warm bed when you ought to have been tucked in and snoring. But if you really want to pick up the U.S.A. broadcasting, there's no need to wait till there's a Christmas in the month, for it can be done right now.

One POPULAR WIRELESS reader up in Hull didn't believe me recently when I said DX conditions were good, so he sat up late one night just to have the pleasure of being able to write me and call me an untruth. But instead of that he heard an entire American programme right through. 'Sfact!

Coming Through in Daylight.

HE says, "From 1 a.m. till 5 a.m. strength was for the most part 'small loud speaker,' using 1-v-2. I have forwarded to WPG a detailed log of the transmission, which took four sheets of paper, so you can guess I didn't miss much. It was light at 5 a.m. when WPG switched off, but after that I could hear two other American stations!"

Albert Hall for B.B.C.

IN arranging for a series of twelve "National Concerts" at the Albert Hall, the B.B.C. has embarked upon one of the most important musical enterprises ever attempted in this country. Instrumentalists from famous orchestras all over Britain will be drawn upon to form a "National Orchestra," supported by a special chorus of 250 specially-trained voices.

All the concerts will be simultaneously broadcast, and the public will be admitted to the Albert Hall at really popular prices, ranging from 1s. 2d. (Gallery and Orchestra) to 4s. 9d. (Amphitheatre and Stalls).

National Concerts.

THE first of these great concerts has been arranged to commence at 8 p.m. on September 30th, when the conductor will be Sir Hamilton Harty, and Mme. Maria Olczewska will sing.

The list of musical celebrities already engaged for the remaining National Concerts during 1926 is a most impressive one. Four additional dates have been arranged, the concerts to be conducted respectively as follows: October 21st, Mr. Albert Coates; November 9th, Herr Richard Strauss; November 25th, Sir Edward Elgar; and December 16th, Herr Otto Klemperer.

The Radio Manufacturers' Association.

AN agreement has been reached between the National Association of Radio Manufacturers and Traders (N.A.R.M.A.T.) and the Society of Radio Manufacturers, and in future the two bodies will be amalgamated, and known as the Radio Manufacturers' Association.

ARIEL

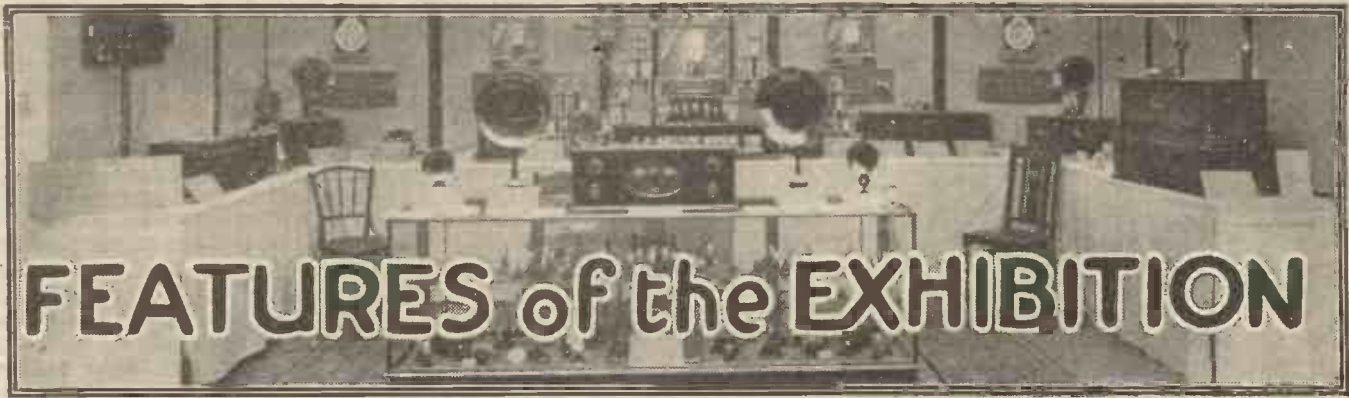

FEATURES of the EXHIBITION

FOR sheer liveliness, punch, pep, and "What-d'you-want?-Here-it-is!" all in one breath, Britain's first National Radio Exhibition beats all records. Optimism overflowed Olympia. Just as I was setting out from the "P.W." offices to pay my first visit to the show, I was handed a telegram, which I hastily tore open, thinking it might be something to prevent my going to Olympia. All it said was, "When visiting Exhibition, please be sure to examine Kathanode patent batteries (Stand 104)."

* * * * *

**A SPECIAL ARTICLE
ON THE WIRELESS
EXHIBITION.**

By THE "P.W." CRITIC.

* * * * *

Fortunately, the stalls were conspicuously numbered, so in order to miss nothing I started at No. 1 and worked my way round by arithmetical progression. The stall-numbering was done upon a gyratory system, not unlike the Piccadilly Circus one-way traffic, and one eventually "fetched up" in the centre of the hall, at Stand No. 164, tired out! This, however, was merely a half-way house, for in addition to the main hall there were the 60 or 70 exhibits in the gallery.

Looking over the busy scene, I could not help feeling proud of the radio progress shown—it was a show of which any industry might have been proud.

The first half-dozen stalls set up a very tempting standard. At Stand No. 6 (London and Provincial Radio Co.) one of the ordinary L. & P. 2-coil holders was displayed, with huge wooden "coils" plugged in, which demonstrated convincingly the steadiness of the holder.

The "Yelling Peril."

The imitation coils were made of solid oak, and measured nearly a foot across, but they would "stay put" at any desired angle without a trace of slip.

How great is the interest in "H.T. from the mains" was well illustrated at Stand No. 9 (E. K. Cole), where quite a crowd collected from the first. There was general regret, shared on every side, that it was impossible to demonstrate loud speakers

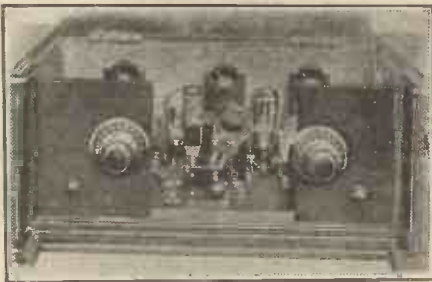

The "Majestic" 4-valve Set, showing interior and arrangement of controls (J. E. Hough, Ltd.).

The manufacturer who sent me that wire from Bakewell, Derbyshire, had struck the note to which the whole exhibition is keyed. Right from the start there was a keenness and confidence displayed by the British business-getters that ensured success.

When I walked through the doors of the New Hall, Olympia, armed with a sixpenny catalogue, I was somewhat staggered by the scene. The whole of the great hall and the gallery were tastefully draped in blue, and literally hundreds of salesmen were on the scene before a single member of the public had been admitted. Right from the kick-off this show was obviously going to make all the previous radio exhibitions "look like ten cents."

Setting a Standard.

One glance round convinced me of two things. First, it was patently impossible to linger at every exhibit, unless one was prepared to spend several days on the job. And, secondly, the catalogue—with its concise list of Olympia's contents, and its neat little margin for memos and notes—was going to prove invaluable in reminding its owner of what he had seen! With every exhibit trying to out-do its neighbours, and hundreds of red-hot enthusiasts believing in their own goods (and trying to make you do the same), I found that the only way to recall your impressions was to pencil them in the margin of the catalogue and ponder over them quietly at home.



The "Symphony Seven," an attractive Bureau-Receiver (A. J. Stevens & Co., Ltd.).



The new Burndept 7-valve Super-heterodyne.

from complete sets, or batteries and battery eliminators.

Obviously it was impracticable, for the battery of loud speakers assembled would have blown the roof nearly off, if in full blast. The only way to avoid "the Yelling Peril" was to enjoin silence upon all the sets; but I noticed that many of the manufacturers were announcing addresses in the vicinity where the sets could be heard by intending purchasers before reaching a decision. This was obviously the best way out of a rather difficult position.

Novelties and Nymphs.

The note of novelty was early in evidence, and the Pictorial loud speakers on Stand 11 (J. W. See & Sons) tickled the public, and especially the ladies very much indeed. Hung upon the wall, they look exactly like ordinary pictures, the subjects ranging from a portrait of H.M. the King to nymphs who hadn't a care in the world. (The upkeep of a nymph's wardrobe must cost the lady very little anxiety, I should imagine.)

(Continued on next page.)

FEATURES OF THE EXHIBITION.

(Continued from previous page.)

Stand No. 14 (C.A.C. Valve Distributing Co.) showed that the public are interested in the small valve makers, as well as in those whose names are household words. I got "stung" at this stall by a "Directory of Valve Manufacturers (who make better valves than ours)." Inside, of course, it was blank—but it showed that self-confidence in their own products which



A compact "Cosmos" resistance-coupling unit (Metro-Vick).

animated all the exhibitors, and that was a feature of this exhibition!

Stand No. 24 (Felcourt Products, Ltd.) was featuring "Press-the-Button" sets that simplify wireless to the level of falling off a log! And near here (Stand No. 28) Celestion Radio Co. were showing an attractive range of loud speakers that included a model with a diaphragm 28 inches across!

Ormesby & Co., Ltd. (Stand No. 35), were displaying cardboard models for the constructor that attracted a good deal of attention; and a dinkum little complete tuning unit, which delighted the seekers for compact components.

The "P.W." Premier Set.

The popularity of resistance-coupling today was shown by a crowd at Stand 36 (Varley Magnet Co.), and by the nearby display of resistances, grid leaks, etc., by the Watmel Wireless Co., Ltd. (Stand No. 50). A little further round the British Electrical Sales Organisation (Stand 58) were showing a Rosebowl loud speaker, that solved the problem of loud speaker disguise and enabled the instrument to be used as an ornament, complete with flowers in water!

As by this time I had made a complete circuit of the main hall, I was not sorry to notice that the ubiquitous J. Lyons and Co. had established a depot (*à la carte service*) near the main entrance, whither I wended my way for "Nippy" attention.

Here I had leisure to examine my catalogue more fully, and I was intrigued to find that it contained a message from the Rt. Hon. J. Ramsay MacDonald, P.C., LL.D., saying, "My wireless set is a source of daily delight to me." (Readers will remember that the set in question is the "P.W." Premier Set, that was fully described in "P.W." No. 185.)

Further inspection of the official handbook of the show, with its programme of band music, broadcasting attractions, etc., whetted my appetite for the pleasures to

come, and after hastily taking a bearing of the main hall, and calculating the time at my disposal, I started again upon my travels round the stands.

One very attractive feature of the show, that up till now I haven't mentioned, is the variety of the complete sets available. At Stand 59, for instance (Halcyon Wireless Supply Co., Ltd.), there was a portable set requiring neither aerial nor earth, complete with an 8-day clock inside the lid, and volt-meter control of the filament current.

Many exhibitors specialised in sets with loud speakers and batteries enclosed in a compact case, and the external appearance of these sets fitted in with every conceivable furnishing scheme.

The General Electric Co. "stood" three times (at Nos. 61, 63, and G214), and then hardly had room, what with Gecophone sets, Gecophone loud speakers, condensers, eliminators, etc., and an array of Osram valves! The latter was a particularly interesting exhibit, showing stages in the manufacture of the Osram D.E.2, D.E.8, and D.E.6 valves.

The Lodge "N" Circuit.

At Stand 70 the Ormond Engineering Co. had engineered a fine show, including a whale of a condenser with a silky movement that fairly asked to be adjusted, just to show how easily it could be done. Farther along, Wilkins & Wright (Stand 70) were showing their well-known "Utility" lines, and Igranic Electric Co., Ltd., had a "double" (Stands Nos. 72 and 73). Visitors who imagined that Igranics were coil-people only must have had an eye-opener at the array of super-hets, tuners, frame aeriels, coil holders, variometers, condensers, dials, potentiometers, and all the rest of it, with which these latter two stands were piled!

"Atlas" coils were on show at Stand No. 80 (H. Clarke & Co., Ltd.)—these, also, were backed up by transformers, eliminators, etc.—whilst Stand 84 was "holding" its own with Lotus coil holders, Lotus valve holders, etc. (Garnett, Whiteley & Co., Ltd.).

A. C. Cossor, Ltd., had a double stall all to themselves (Nos. 86 and 87), and here were to be found valves helmeted like the London Fire Brigade, and capable, like them, of standing up to a right good hard knock!

At Stand 91, W. G. Pye & Co. were displaying a complete range of sets (1 to 5 valves), including a beautiful corner-cabinet set, complete with loud speaker, that was fetching £60! After contemplating this, it was quite a relief for non-millionaires

to turn to Stand 93 and to find that one could still obtain a Bretwood grid leak for 3s. 6d.

The bombshell of the exhibition was the Sir Oliver Lodge N Circuit Receiver, complete in cabinet form, for the cash price of £15 15s. (Cleartron Wireless Sets, Ltd.; Stand 102). This was an "all-in" price that included dull-emitter valves, L.T., H.T., and G.B. batteries, and a full-sized loud speaker, the price to include installation (except the erection of aerial).

Sale and Service.

Incidentally, it may be mentioned that this plan of "service sale" (by which the sellers instal the set and get it working for the purchaser) is one of the best signs in the trade to-day. Many firms actually prefer to instal the set for the buyer, so that they may be sure it will give satisfaction.

Marconi valves and the Marconiphone-Sterling group occupied two "islands"

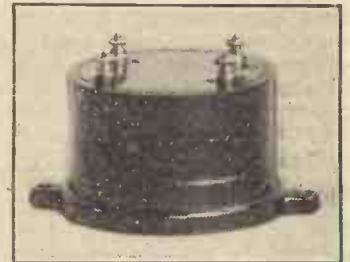

Another compact audio coupling device—the Bretwood Auto-Audio Amplifier.

of five stands (Nos. 121-2-3-4-5), as well as a gallery stall (No. 220). They appeared to be showing everything! This part of the floor space was the hub of the exhibition, and there were many fine displays adjacent, including Bowyer-Lowe Co., Ltd. (Stand 126), B.T.H. Co., Ltd. (Stands 127 and 130), and S. G. Brown, Ltd. (Stands 128 and 129).

(Continued on next page.)

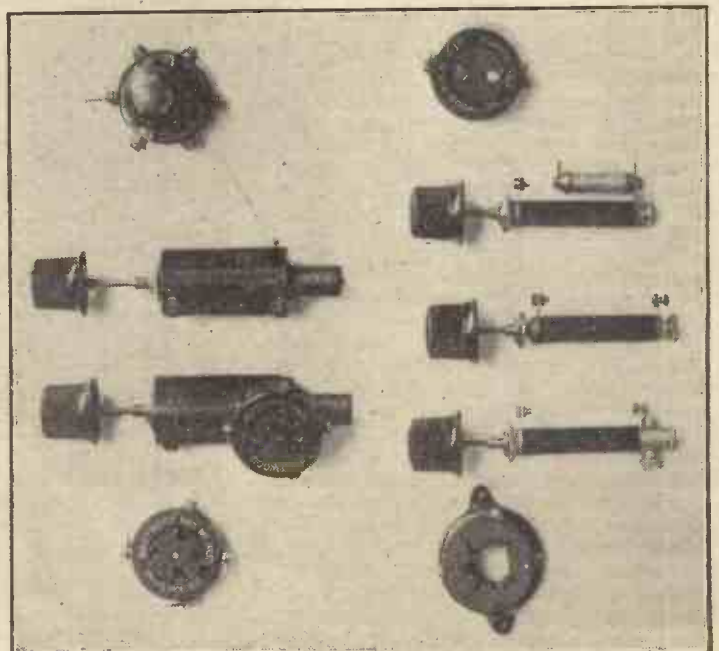

A selection of Bretwood components for the home-constructor.

FEATURES OF THE EXHIBITION.

(Continued from previous page.)

The range of B.T.H. products included a six-valve super-het. with enclosed loud speaker, and a combined table lamp and loud speaker.

The keen interest in the S. G. Brown exhibit centred round the firm's new disc loud speaker, introduced in response to the demand for a hornless "Brown."

Forecasting Filament Life.

Centred near this point, too, were the displays of Alfred Graham & Co. (Nos. 131 and 132), The Edison Swan Electric Co. (Nos. 134 and 3), the Mullard Radio

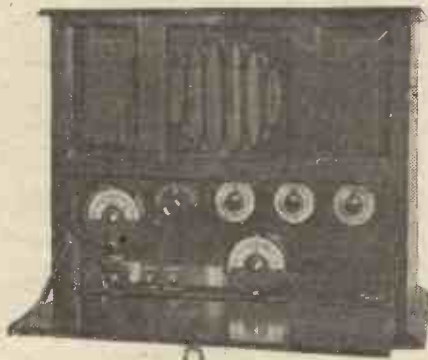

The Standard "Retrosonic" model, opened to show the controls.

Valve Co. (Nos. 136 and 138), and L. McMichael, Ltd. Mullards were running a prize competition in connection with the life of valve filaments, and, in general, the displays at this part of the exhibition were of outstanding interest.

Radio Instruments (Nos. 145 and 147) had divided their display into three sections, comprising complete sets, transformers and chokes, and other components. Nearby was another dual display (Stands Nos. 150 and 152) by the Tungstone Accumulator Co., which was attracting more than usual interest.

The New "Televisor."

At Stand 154, Dubilier Condenser Co., Ltd., showed a complete range of condensers, and also a model of the proposed new "Televisor," fitted with a glass screen about a foot square upon which the owner will be able to "look in" and see whoever is being "broadcast" by television!

Other famous firms that had secured situations right at the hub of the exhibition were Chloride Electrical Storage Co., Ltd. (Nos. 158 and G233), Lissen, Ltd. (No. 160), The Peto-Scott Co. (Nos. 161 and G259), and Metro-Vick Supplies (No. 162). Of these Peto-Scott's were claiming to "put the lid on interference" by their Copex coil screen (a sort of copper hat that fits over the coil), whilst Lissen's had some expensive scientific instruments showing the wide ramifications of the modern radio business equipment.

My travels had now brought me to the gallery, and up I went to see the "overflow," and the various other attractions that could not be housed upon the main floor. A crowd was pressing round the

"aquarium," through the glass windows of which the jolly old B.B.C. could be seen pushing out the broadcasting! Interesting as this was to the general public, it held no attractions for me, so I wandered along to Rectalloy, Ltd. (No. G202), and to a display by A. Hinderlich (No. G203), who was showing quartz-crystal control, with specimens oscillating between 2,400 metres and 45 metres.

Great interest was taken in this display, but the star turn upon the gallery (apart, perhaps, from the B.B.C. display) was the Marconi historic exhibit at Stand G262. Here was shown some of the original apparatus used in the first reception of wireless signals across the Atlantic on December 9th, 1901.

Better still, the man who stood beside Mr. Marconi at that historic moment, Mr. G. S. Kemp, was at Olympia to demonstrate the instruments. The story that Mr. Kemp told me is far too engrossing to fit into the tail of any article, but visitors who saw him have the satisfaction of knowing that they have seen one of the two men who made radio history on Signal Hill, Newfoundland, less than twenty-five years ago.

Britain's Best Show.

After a final look round the gallery, I leaned over and looked at the swarming floor beneath, trying to come to a sort of general conclusion about the first national radio exhibition. Without a doubt, it was the best and biggest boost ever planned for broadcasting; but the chief impression in my mind was not of the marvellous progress shown in every branch of the business, nor the lower prices, the simplified sets, nor the keen competition, but a sort of aching astonishment that some people can still do without wireless! Mercifully, they haven't the faintest idea of all the pleasure they're missing!



The B.S.A. seven-valve "Universal" receiver, the "panel" of which is of sheet metal, to avoid hand-capacity troubles.

BOOK REVIEW.

A SIMPLE GUIDE TO WIRELESS. By Admiral Sir Reginald Bacon, K.C.B., K.C.V.O., D.S.O. (Mills & Boon, 3/6).

The difficulty of explaining wireless simply and clearly is well-known. Yet there are many persons, untrained in electrical matters, who would like to know a little about how wireless works.

Admiral Sir Reginald Bacon's book is certainly a readable one, with not only a complete absence of dry terms, but a good deal of quiet fun in its pages. A characteristic passage is the following:

"If you bump down on to a sofa (which you are not supposed to do) you will compress the springs more than you would have done if you had sat down like a well-behaved child. The springs, of course, do not put up with that sort of treatment meekly, and as soon as you are right down they bounce you up again and lift you once more a little above the sofa. Then down you fall again, this time not quite so far as before, and gradually you come to rest in your proper place. You will probably be scolded, but you will have the satisfaction of telling your mother that you were merely behaving like an electric current in an oscillatory circuit. You were, in fact, oscillating up and down."

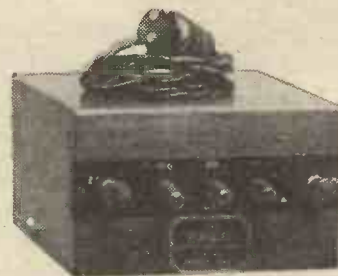

The "Ekco" high tension unit for obtaining H.T. from direct current mains.

DRILLING PANELS.

MANY home constructors when drilling a panel for a new set spend a good deal of time re-drilling holes which are not sufficiently large. This, although a common error, is quite unnecessary, as most one-hole fixing components have a bush of standard size which passes comfortably through the hole made by a $\frac{3}{8}$ in. drill.

The exceptions to this rule are jacks, for which in most cases a $\frac{1}{2}$ in. drill is necessary, and the smaller types of variable grid leak, which only require a hole $\frac{1}{8}$ in. in diameter. The foregoing applies to the components which are fixed by means of a nut screwed down on the bush which takes the central shaft, such as variable condensers, rheostats, potentiometers, and push-pull switches.

Components which are fixed to the panel by means of one or more screws do not require holes of such a large diameter.

The screws used in this case are either 4 B.A. or 6 B.A., clearance drills for these sizes being $\frac{3}{32}$ in. and $\frac{1}{8}$ in. A "rose" bit for countersinking holes is best, but if one is not available a twist drill may be used. To countersink a 6 B.A. hole use a $\frac{1}{16}$ in. drill, and for 4 B.A. use one not above $\frac{1}{8}$ in.



A useful detector which, when once set, will remain in efficient operation over prolonged periods of use in a crystal receiver.

AN EFFICIENT PERMANENT DETECTOR

before you finally decide upon the particular specimens you are going to use.

A zincite crystal which looks like a black mass of coke streaked over with reddish colourations is of no use whatever for the purpose. The zincite *must* have a deep ruby red glassy appearance. Artificial zincite can also be used with success equal to zincite. Cement the zincite or artificial

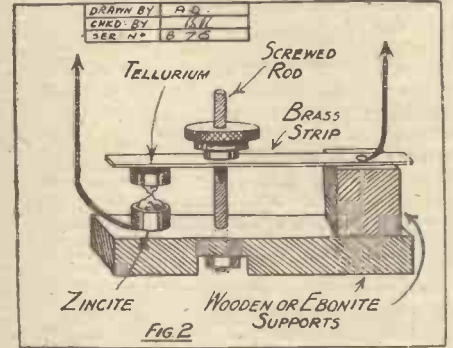

zincite crystal to its cup by means of ordinary solder. The degree of heat required for that operation will not harm the crystal.

The tellurium element of the detector may be used either in the form of small crystals or in the stick form. The latter is more convenient to use, but care should be taken not to sandpaper or grind the end of the stick down. A tiny stick of tellurium, freshly broken, gives the most satisfactory results. Embed the tellurium in Wood's metal in the upper cup. The use of ordinary solder for this purpose might cause the tellurium to melt.

Stable Rectifier.

Having provided the crystalline elements for the detector; the next thing to do is to adjust the instrument. This operation should be done with care, exploring every part of the zincite crystal with the tellurium before finally deciding upon the most sensitive spot.

When once the most sensitive contact has been found, increase the contact pressure. These crystals will stand up to a contact pressure of a pound or two without undergoing any change in sensitivity. So, therefore, attain a heavy contact pressure, and then keep the detector under observation for a day or two.

Finally, if the detector is required for under-panel mounting, carry out the job, and your permanent rectifier will be an established fact.

The advantages of under-panel mounting for either of these types of detectors are that the instrument is excluded from dirt and dust, that it is freed from the inquisitive fiddling of other people during the absence of its owner, and, finally, that the setting is much less liable to become inadvertently disturbed than when the detector is mounted above the panel.

Of course, the crystal set containing the under-panel detector must not be banged about in a rough manner. Any amount of reasonable carrying about of the set from room to room will not affect the setting of the detector in the slightest degree, and therefore, given this ordinary thoughtful usage, the detector will continue to function satisfactorily for an indefinite period.

THAT the detector, two forms of which are described on this page, will, if carefully made, prove to be a really permanent crystal rectifier, is amply proved, I think, by my own experiences with these simple instruments. I have had a number of these detectors under close observation for the last eight months. Eight months ago the detectors were constructed and carefully adjusted. They have not received any adjustment whatever since, and to-day they function as excellently as ever they did.

What is the secret, you ask? There is no secret. The success of the detectors consists entirely in the choice of suitable

Apart from the crystals employed, these detectors can be made at a total cost of a copper or two, and if they are neatly constructed in a miniature form they may be mounted *underneath* the panel of the set, thus doing away with the conventional mounting of the detector "above-panel-wise."

The diagrams, Figs. 1 and 2, indicate the general construction of the detectors for the requirements of under-panel mounting. The actual size of the detectors is purely a matter of personal choice. So also is the finish of workmanship which is put into them. For under-panel mounting, however, the base board or ebonite block should not exceed about three inches square. A strip of springy brass is fastened down at one end to the wooden or ebonite base by means of a screw, a wire lead being soldered on to this end of the strip.

Choice of Crystals.

To the other end of the brass strip is attached either a small crystal cup or a small piece of brass or copper tubing of about $\frac{3}{8}$ -in. diameter, this latter, of course, being firmly soldered to the strip. A similar crystal cup may comprise the mounting for the lower crystal.

In the instrument, Fig. 1, the pressure of contact is adjusted by manipulating the curved end of the brass strip, whilst in the detector, Fig. 2, this adjustment of pressure is attained by means of the upright screw.

Now we come to the most vital and important part of the construction of these detectors, viz., the choice of the crystals.

The best crystals to use are zincite and tellurium—zincite in the bottom cup, tellurium in the upper. The whole success of the detector as a really permanent rectifier depends almost entirely upon the careful selection of these crystals. Spend, therefore, some considerable time in making comparative tests of the sensitivity of various samples of zincite and tellurium

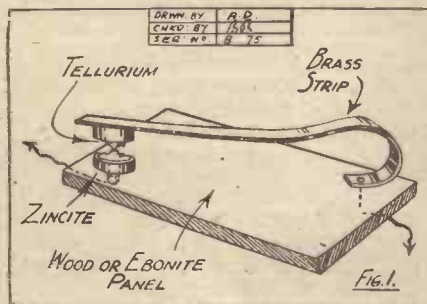

crystals for the rectifying contact. Of course, such detectors could not be commercially marketed, for the simple reason that, in transit, goods are always liable to get banged about more or less, and this sort of thing would inevitably cause the sensitive adjustment of the detector to be lost.

For the amateur, however, who wishes to attain complete freedom from crystal tickling with the cat's-whisker, I would certainly advise the use of one of these little permanent rectifiers, that is, provided, of course, that the crystal-set owner resides within "perikon distance" of a broadcasting station—a distance of approximately six miles for loud and effective reception.

A "PW" HARKNESS REFLEX RECEIVER

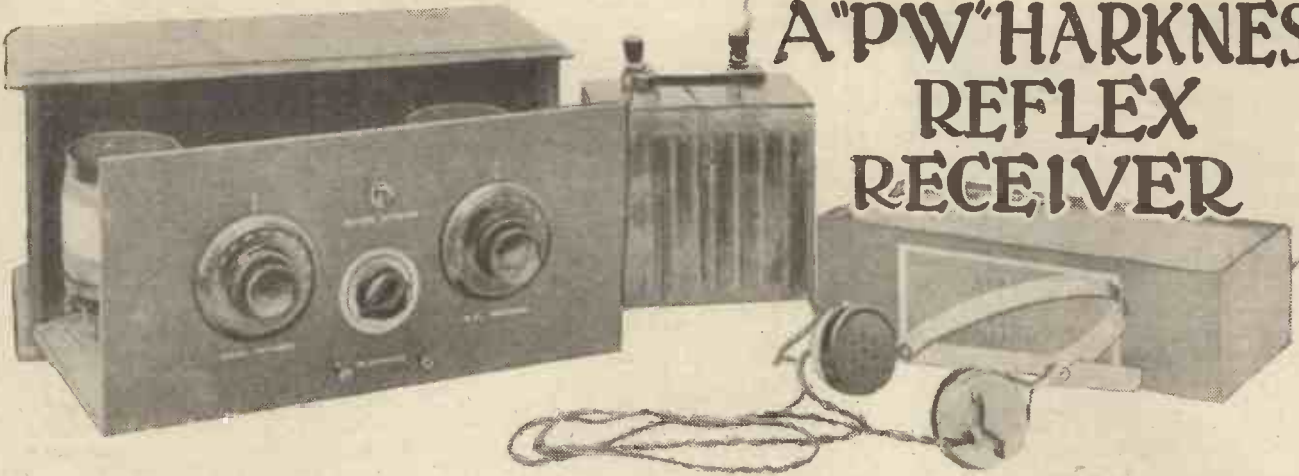

AMONGST the many good one-valve receivers that are popular in America, but have never "caught on" properly in this country, is the famous Harkness set. In view of the exceptionally good results that are obtainable with this circuit, the wonder is that it has not been tried by every experimenter in the country.

Probably there is no better all-round one-valver which will give such excellent long-distance results, combined with the ability to reproduce the programme of the local

The Set Designed and Described by
P. R. BIRD
(Assistant Technical Editor).
Constructional Work by
G. V. COLLE
(Technical Staff).

The handling of the set is quite a simple affair, the main adjustments being the two tuning condensers that control the tuning. The setting of the crystal detector and of the filament resistance will, of course, affect results, but once a correct position has been found these can be left set whilst the tuning adjustments are being made.

The H.F. Transformers.

In view of the economy in space and the simplicity of the wiring consequent upon the fact that there are no swinging coils in the set, the receiver was constructed in a totally enclosed cabinet, with upright panel, as shown in the photographs. The

first step in construction is to make the two H.F. transformers, the first one of which is to act as the aperiodic coupler between the aerial and secondary circuit (tuned grid circuit).

The cardboard tube should measure 2 3/4 in. external diameter, and should be of well-dried cardboard or ebonite. The secondary is wound on the tube first, and this consists of 60 turns of No. 22 D.C.C. wire. The beginning of the wire is secured to the former in the usual way, by threading a short length of it through two or three holes made for the purpose near the end of the former. When all the 60 turns have

been laid on side by side, the end of the winding is finished off in the same manner, leaving 6 or 8 ins. of wire for connecting up.

The primary winding of this first "aerial" H.F. transformer is wound over the secondary, so that when completed it will be

LIST OF COMPONENTS.

	£	s.	d.
1 Red Triangle panel 13 in. x 6 1/2 in. x 1/2 in., with cabinet and baseboard (Peto-Scott)	1	6	0
1 Ormond .0005 variable condenser	15	0	
1 Ormond .0003 variable condenser	13	6	
1 L.F. transformer (Eastern Wireless Co.)	8	0	
1 Igranic-Pacnet Rheostat	2	6	
1 Lotus valve holder	2	8	
2 Burwood valve holders	2	6	
1 R.I. crystal detector	6	0	
2 coil formers, 2 1/4 in. diameter, 3 in. long	2	0	
1/2 lb. 22 S.W.G. D.C.C. wire	2	3	
1 six-terminal strip (complete) (Peto-Scott)	2	6	
Valve pins, screws, transfers, etc.	2	6	

exactly over the centre of the secondary winding. It consists of 20 turns of the No. 22 D.C.C. wire, and there should be a tapping point at the centre (tenth) turn.

(Continued on next page.)

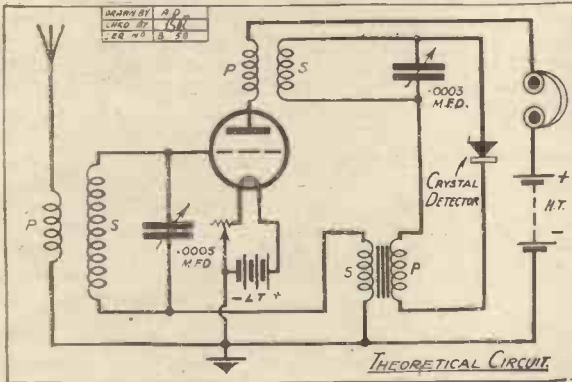

station at very good strength. In principle the set is akin to the ordinary one-valve reflex receiver, but an inspection of the theoretical circuit shows that there are several notable differences.

No Moving Coils.

It will be seen that no variably-coupled coils are employed. Instead, the anode tuning is carried out by means of a high-frequency transformer, and a very similar H.F. transformer is employed to couple the aperiodic aerial circuit to the tuned grid circuit. This means that the usual juggling with the two-coil holder is entirely obviated, as all the "coils" are of the plug-in transformer type.

From the back of panel photographs it will be seen that the H.F. transformers employed are of the solenoid type, wound on cardboard or ebonite tubes. These are very easily made at home, and their construction will be dealt with later. The rest of the components are more or less standard, and any ordinary valve, crystal, and L.F. transformer will give good results.



The back of the receiver, showing the valve and special H.F. transformers in position.

A "P.W." HARKNESS REFLEX RECEIVER.

(Continued from previous page.)

The two windings (primary and secondary) should be laid on in the same direction, separated by a layer of waxed paper or Empire cloth.

Two ends of the primary winding of this transformer will eventually be taken out to the aerial and earth terminals. The purpose of the tapping at the tenth turn is to provide an alternative aerial connection, as when using this set as a long-distance receiver it is sometimes advisable to employ only 10 turns of the aerial and earth coil, instead of the 20 which constitute the whole of the primary winding. In many cases, where long-distance reception will not be attempted, this refinement will be unnecessary, and the aerial will be connected always to one end of the primary winding, with the earth connected to the opposite end.

The Transformer Connections.

Where, however, long distance is to be tried for and selectivity is required, the tapping point should be connected to a separate terminal mounted upon the cardboard former itself. Then, if interference is bad during DX reception, the aerial lead can be disconnected from its external terminal, and connected instead to the aerial tapping terminal on the cardboard former.

The second H.F. transformer is used in the anode circuit in the manner of an ordinary H.F. transformer (secondary

tuned). It is made in the same way as the first (aerial) H.F. transformer, but instead of the primary having 20 turns and the secondary 60 turns as before, the secondary now has 70 turns and the primary 30 turns.

An ebonite disc is fitted over the end of each former, and on this are mounted four valve pins to plug into an ordinary valveholder, like the usual plug-in H.F. transformer.

Of the four valve pins on each former, the primary windings are connected to the two filament pins, and the secondary windings to "plate" and "grid." That end of each secondary winding which is nearer to the ebonite disc is connected to its respective "grid" pin. The corresponding end of the primary is joined to the right-hand filament pin (looking down inside the tube, with the "plate" pin held nearest to the observer).

As very much of the success of the receiver will depend upon these H.F. transformers, it may be as well to emphasise at this stage that the ordinary commercially-made H.F. transformer is unsuitable for the Harkness receiver. The experimenter who is keen to get the last ounce out of the set may even find it an advantage to vary the number of turns on primary or secondary of the above-described specially made transformers, so that they may exactly suit his other components used in the set. Such a variation will be very slight, and it is very unlikely, therefore, that any old H.F. transformer that happens to be on hand will be found good enough for the Harkness.

Baseboard Lay-out.

The list of components to make the set gives the necessary size of the panel and case. The latter should be marked in accordance with the panel layout that accompanies this article, on which all the essential measurements are given. The panel itself is fixed to the baseboard by means of three wood screws, countersunk into the face of the panel. At the back of the baseboard is fitted a terminal strip carrying half a dozen terminals, and this also is fixed to the baseboard by three wood screws. It is a good plan to mount the terminals upon the strip, and to file their ends ready for soldering before the strip is attached to the baseboard.

The relative position of the components on the baseboard is clearly shown by the various back of panel photographs. There

(Continued on next page.)

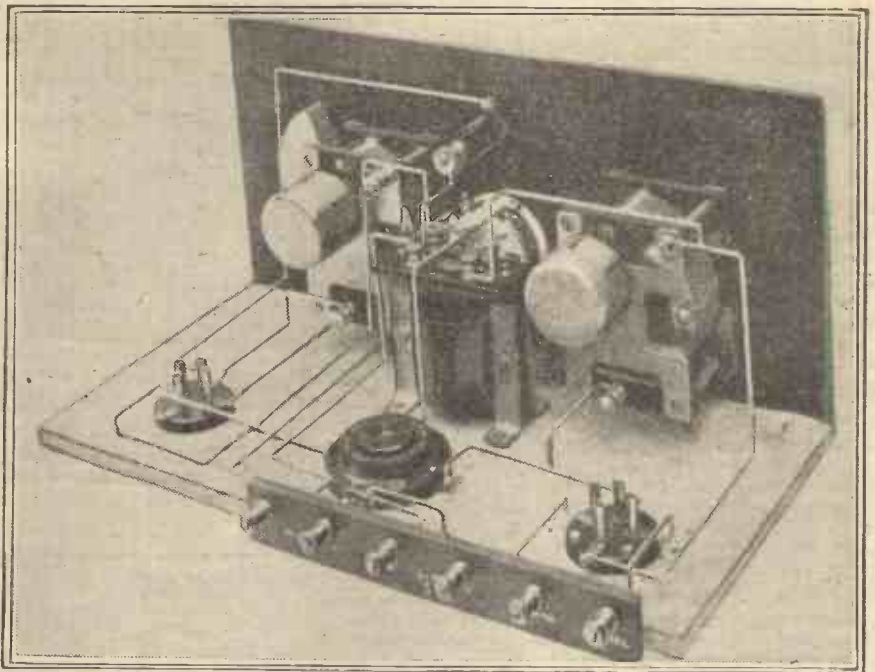

In this photograph the H.F. transformers and valve have been removed to show the simple nature of the wiring.

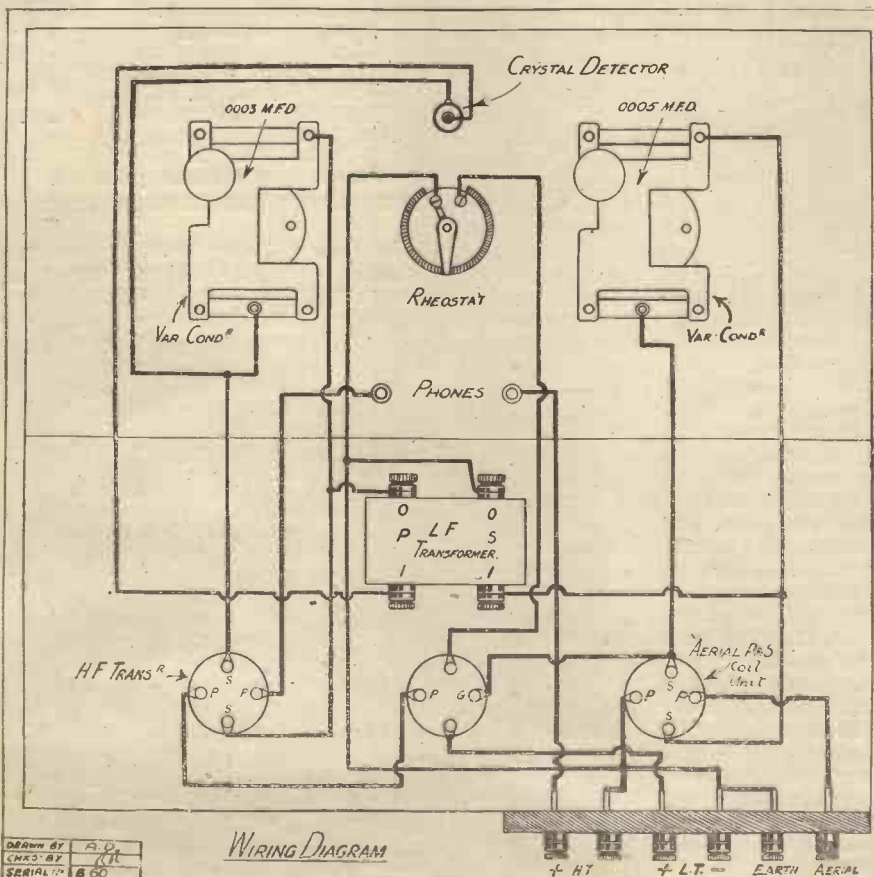

A "P.W." HARKNESS REFLEX RECEIVER.

(Continued from previous page.)

is plenty of room for all the components, so that even in the event of the use of a large L.F. transformer the space at the back of the panel will not be found too limited.

When mounting the "outside" valve holders, into which the H.F. transformers will be plugged, care should be taken to arrange the "plate" sockets nearest to the back of the baseboard—i.e. that side opposite to which the panel is fixed.

The Wiring and Wave-length Range.

The crystal detector employed is a well-known commercial one, but any other crystal detector may be used instead if desired. An anti-microphonic valve holder was chosen for the central one of the three valve holders shown, as this is the one that actually holds the valve. The other two are for the H.F. transformers, as shown in the photograph—the one on the right (looking at the back of the set over the terminal strip) being the "aerial H.F. transformer."

The mounting of the components is quite a straightforward operation, and after this the panel is fixed to the baseboard



This photograph of the panel and baseboard, withdrawn from the case, shows how the few controls are arranged.

and wiring is commenced. Any form of stiff wire will do for the latter, that shown in the photographs being No. 18 square

tinned copper wire. Spacing troubles are not likely to arise if ordinary care is taken to keep the wiring of the plate and grid circuits separated as far as possible. After each joint has been soldered it is essential that the warm metal should be wiped over with a clean duster in order to remove superfluous flux, which will cause leakage.

When the wiring is finished it should be checked over from the accompanying list of the point-to-point connections, and if found in order the set is ready for test.

The H.T. and L.T. requirements of the receiver will, of course, depend upon the valves chosen; and the specifications of the valve maker, as given upon the valve itself (or upon its container), should be carefully noted and adhered to.

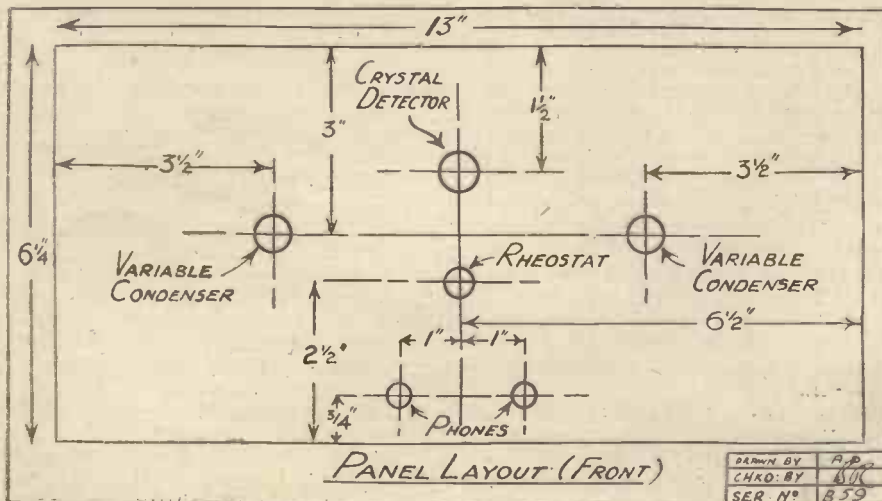

DESIGNED BY R.P.
CHECKED BY B.K.
SER. NO. 859

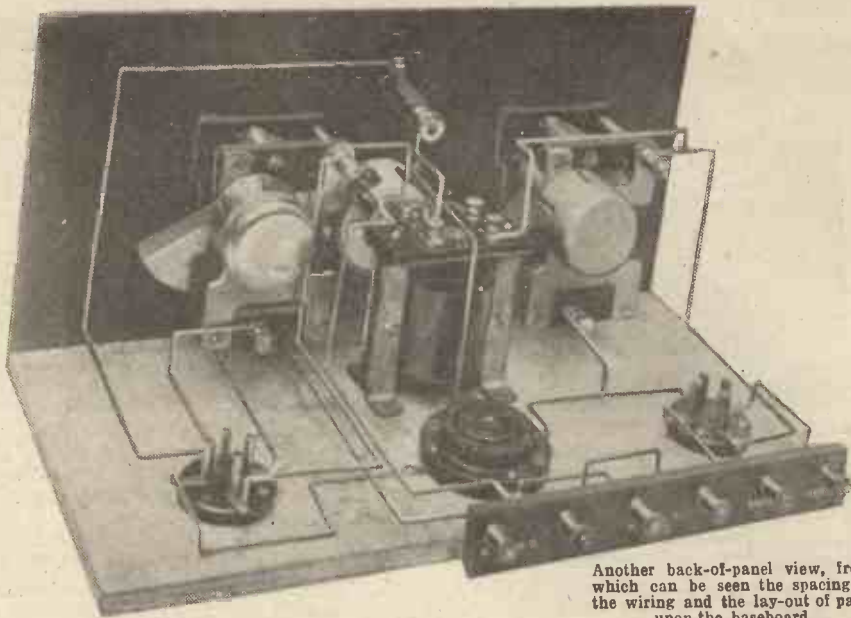

Another back-of-panel view, from which can be seen the spacing of the wiring and the lay-out of parts upon the baseboard.

Like all the specialised one-valve circuits that give exceptional selectivity and sensitivity (e.g. "Chitos," "Hopwood," etc.), the Harkness circuit does not function on 1,600 metres (or thereabouts) in the same way that it does upon short waves. It is essentially a low-wave-length receiver, and though it may be possible to receive 5 X X if other specially-made H.F. transformers are experimented with, the absence of ordinary reaction effects places the set

POINT-TO-POINT CONNECTIONS.

Aerial terminal to one primary socket of aerial tuner holder; earth terminal to other primary socket of tuner, O.S. of L.F. transformer, H.T. negative, L.T. negative, and to one side of rheostat; other side of rheostat to one filament socket of valve holder. Other filament socket to L.T. positive.

I.S. of L.F. transformer to moving plates of .0005 variable condenser and one secondary (plate) socket of aerial tuner holder. Other secondary (grid) socket to fixed plates of .0005 variable condenser and grid socket of valve holder.

Plate socket of valve holder to one primary socket of H.F. transformer holder; other primary socket to one 'phone terminal, other 'phone terminal to H.T. positive.

One secondary (grid) socket of 2nd transformer holder to fixed plates of .0003 variable condenser and to one side of crystal detector; other side of crystal detector to I.P. of L.F. transformer. O.P. of L.F. transformer to moving plates of .0003 variable condenser and to remaining secondary socket of H.F. transformer holder,

at a great disadvantage. It is not, therefore, recommended as a long-wave-length receiver, but is intended essentially for stations working on the wave band between 250-550 metres.

As the set is very stable in operation, it is quite easy to add a stage of L.F. amplification in the ordinary way. Like most one-valvers, much of the set's success is dependent upon the aerial used, and with a good one of the outdoor type many foreign stations can be heard at good strength.



Conducted by our Staff Consultant, J. H. T. ROBERTS, D.Sc., F.Inst.P.

AN addition to the many existing types of aerial has lately been made by two British inventors, and consists essentially of a number of circular metal plates strung or threaded upon an insulating rod. The plates are spaced equally apart, and are separated by insulating distance-pieces.

They are, however, connected metallically together at their edges, the connecting wires being placed alternately at opposite edges. It might seem at first that the same result would be achieved by stringing the circular sheets upon a conducting rod or wire, which would have the effect of connecting them together electrically. This is not so, according to the inventors, who find that a much better result is obtained by the arrangement described.

It would seem to me that the arrangement, in any case, is not very different from that of the spiral aerial, and the latter is probably much cheaper to produce and easier to erect.

Soldering Steel.

In cases where it is desired to solder iron or steel, it is sometimes difficult to get the solder to "wet" the surface of the work, in spite of the use of flux. A useful hint in such cases is first to clean the iron or steel thoroughly at the part to be tinned and then to wet it and rub it with a crystal of copper-sulphate (or "blue vitriol"). This has the effect of producing instantly a slight deposit of copper and it will be found that the soldering is rendered much easier.

An Excellent Battery.

Readers will no doubt have noticed the remarkable figures given in the National Physical Laboratory tests of the Tungstone accumulator, as much as 96 per cent efficiency being recorded. The essential feature of this accumulator is the employment of pure lead, although, of course, there are innumerable other features connected with the design and construction of the plates and the batteries which call for attention. I have recently had some of these batteries for test, both H.T. and L.T., and so far they have put up an astonishing performance. The tests are not yet complete, but later on I hope to have space to give a much fuller description of these batteries, which bid fair to revolutionise the manufacture of lead accumulators. For the interest of readers who happen also to be motorists, I may mention that I have had one of these batteries fitted to my car, and have deliberately made the most exorbitant demands

upon the self-starter; but the more the starter is used, the more the battery seems to like it.

Testing Crystals.

An arrangement for testing crystals to determine their general sensitivity as detectors, and also to locate the most



Mr. David Sarnoff, America's first wireless uncle, is now on a visit to London. He is Vice-President of the Radio Corporation of America, one of the largest wireless concerns in the U.S.A.

sensitive spots, has been devised by a well-known London amateur, and is briefly as follows. A source of alternating current at fairly high voltage is provided, and this current passes through a pair of 'phones and through the crystal in series, the contact being made with the crystal by means of a movable electrode, which is used to explore the surface of the former. The source of A.C. may be a small buzzer, worked from a couple of 2-volt cells, in series with the cells being a coil which forms one part of a loose coupler. The other part of the loose coupling is preferably of considerably more turns, in order to gain the necessary step-up effect, and this is the coil which is placed in series with the headphones and the crystal. The crystal is laid or mounted upon a metal sheet, contact being made to the latter.

H.F. Chokes.

A reader has asked me certain questions as to the use of H.F. chokes for amplification and for detector purposes. The questions really revolve around the con-

sideration of the efficiency of the choke and it should be pointed out that, although the efficiency of the choke is of little importance (generally speaking) when the latter is used in the anode circuit of the detector valve, as, for example, in the Reinartz circuit, it is of considerable importance where the choke is used for H.F. amplification. Of course, it is incorrect to say that the efficiency of the choke is of no importance, even when used in connection with the detector, for here it is required for the purpose of producing reaction or feedback effects. But for H.F. amplification purposes, the higher the efficiency of the choke the better.

It might be as well to mention, in passing, that the efficiency of a choke is greater the smaller the self-capacity. The ideal choke should possess a negligible self-capacity. For H.F. amplification purposes, it is desirable to have an inductive value of, say, half a henry, and the self-capacity should not exceed perhaps 0.00001 mfd. The reason for

this is that it is desired to offer a high impedance to the high-frequency currents; for this purpose a high inductance is of little value if it is accompanied by a high capacity.

The choke for use in a Reinartz may be of the inductance value of 0.05 henry, but this, as will be seen from the foregoing remarks, is much too small for efficient working in H.F. amplification.

Valve Efficiency.

In this connection it is interesting to note that largely owing to the presence of some form of choke in the plate circuit of a valve, the performance of the valve under actual working conditions may be very different from that indicated by the so-called "characteristic curve" obtained under static conditions. Probably every reader knows that the usual way in which to obtain the characteristic curve of a valve is to connect a milliammeter in series with the plate of the valve, applying various

(Continued on page 171.)

BRANDES LIMITED : 296 REGENT STREET : LONDON : W.1



The Brandola
75/-



The Table-Talker
30/-



Audio Transformers
17/6

1-5 (black case); 1-3 (brown case)



Matched Tone Headphones
20/-



NEW PRODUCTS BY "OLD HANDS"

The penalty of early achievement is that reputation must be maintained at all costs. In the new Brandes range will be found the same guaranteed excellence. Seventeen years' experience bears fruit in perfect performance and finished workmanship. Though Brandes are in the front rank prices are kept within reasonable limits; there is nothing to prevent you having the satisfaction of a best quality instrument.

Brandes

From any reputable Dealer.

THE AUDIO TRANSFORMER.
Ratio 1 to 5. High amplification of applied voltage, together with straight line amplification frequency curve. Also 2nd stage 1 to 3.

THE BRANDOLA.
Greater volume with minimum current input. Large diaphragm gives fullness to upper and lower registers. Walnut plinth, electro-plated fittings.

THE TABLE-TALKER.
Material used in the construction of goose-neck horn eliminates metallic harshness. Adjustable. Height 18", neutral brown finish, padded base.

MATCHED TONE HEADPHONES.
The synchronised effort of both receivers discovers greater sensitivity and volume and truer tone. Light, comfortable and sturdy.

THE BRANDESET II.
Excellent for long-range loud-speaker work. Straight line frequency Condenser tuning. Reaction and grid-bias. Fixed coils and "throw-over" switch for long and short waves.

THE BRANDESET III.
The same ingenious characteristics as the 2-valve receiver. Employs an extra stage of audio frequency. All battery connections plaited into one lead.

THE ELLIPTICON.
Driving unit of special design. No diaphragm but a small armature which reacts to the faintest impulse. Special sound producing cabinet.

THE TABLE CONE.
Attractive Cabinet. Circular diaphragm with sensitive driving unit and large magnet. Superior to any similar loud-speaker at the price.



The Brandeset III
£8 - 10 - 0
(Exclusive of Marconi Royalties and Accessories)



The Brandeset II
£6 - 10 - 0
(Exclusive of Marconi Royalties and Accessories)



The Ellipticon
£5 - 10 - 0



The Table Cone
£2 - 15 - 0

EXPERTS IN RADIO ACOUSTICS SINCE 1908

THE LESSON OF THE SHOW

The Public's Demand for

GECOPHONE

New Season's Radio Equipment

The new season's GECOPHONE equipment has created a profound impression at the National Radio Exhibition. If you have been unable to visit the GECOPHONE stand write for the new illustrated, descriptive literature, giving particulars of the GECOPHONE equipment in which you are interested.

WIRELESS SETS. The new season's 2-, 3- and 4-valve GECOPHONE Receiving Sets embodying novel tuning devices for greater selectivity and higher efficiency. The new "L & D" 3-valve set which is simpler to operate than a gramophone.

LOUD SPEAKERS. The new GECOPHONE Cabinet Type Loud Speakers—remarkable constructional advances.

HIGH TENSION UNITS. The new GECOPHONE H.T. Units dispense with the necessity for High Tension batteries with their heavy cost of renewals. Upkeep costs are now negligible.

COMPONENTS. New to the GECOPHONE range are the Low-Loss, Slow-Motion Square Law and Straight Line Frequency Condensers, Slow Motion Condenser device; L.F. Transformer, Tapped Transformers, H.T. Unit Components, L.F. Choke and Choke units, Frame Aerials—and also the newly-designed GECOPHONE Headphones.

GECOPHONE

(Registered Trade Mark)

BRITAIN'S BEST BROADCASTING SETS
COMPONENTS & ACCESSORIES

The G.E.C.—your guarantee



An unsuitable household receiver. Too many controls and awkward layout spoil the appearance of the panel and render operation difficult.

THE "IDEAL" GENERAL PURPOSE SET.

A brief article discussing those qualities which go for good results and satisfactory operation of a receiver, together with minimum of expense and maximum of adaptability.

By K. D. ROGERS (Assistant Technical Editor).

To try to describe a receiver answering to the above title is not an easy task, for one can only approximate to that ideal, however much care is taken in planning and building the set. Wireless is as inconstant as, I was going to say, the weather, but perhaps it is not quite so variable as that, but the set that is to be the one and only, as it were, must be, above all things, reliable enough to counteract to a large extent the vagaries of radio that are beyond the control of the listener.

Weather changes, geographical and astronomical conditions, etc., all play their parts in making the reception of broadcasting an unsure undertaking. Certain stations can be heard on a certain set during one evening, and on the next, perhaps, half of these will be well-nigh silent, and a totally different receiving arrangement will be required to bring in any but near transmissions.

Economy Essential.

The ideal receiver has to cater for these variations in reception conditions, and not only must it do all that, but it must be arranged so that economy is practised as far as is possible, no matter what programme is being received.

It is useless to have a multi-valve set if the number of valves cannot be reduced in order to make the set suitable for the reception of the local broadcasting. As the writer once remarked in a previous article, the best arrangement of all is to have a separate set for each purpose—one for local reception, another for DX work, and so on—but this is not economical, and so the real ideal, if it is to be attempted at all, must combine the various good points of the separate receivers in one set and leave out as many of the bad points as possible.

This is no easy task, for it at once precludes the use of such receivers as the average super-het., which has to use at least 6 valves whatever station is being received. This is very nice in its way, but it is not economical, and we must set economy as one of the standards to be attained in the operation of the "ideal" set.

Adaptability.

The set capable of getting nearly everything has not yet been devised, and I think it will be a long time before radio will even approach that happy state of affairs. So, at the present, the listener who wishes for an ideal general purpose or "household" receiver must content himself with a few programmes well received, and at the same time a moderate cost both in construction and upkeep.

it must have a heavy plate or H.T. consumption; this necessitating the use of either an H.T. accumulator or H.T. from the mains, neither being always convenient to the average listener. Apart from this the constructional cost of multi-valve receivers is high, and such sets as the super-hets. and neutrodyne are not easily adaptable for "local or 5 X X"—a refinement that is almost essential.

A Suitable Circuit.

Taking everything into consideration, the writer considers that the circuit shown on this page, while perhaps not the ideal of some enthusiastic amateurs and experimenters, will come somewhere near the standards of efficiency, adaptability, simplicity and economy that must be set by the listener if he is to have a receiver that can be truly termed a household set.

In the first place, it must have as few controls as possible (its panel face should not look like the one shown in the illustration); separate rheostats for each valve can be employed, but an on and off switch is advisable, so that the rheostats and even the tuning can be left set, and the receiver put into or out of action by one single

Purity of reception can be obtained without the trouble and expense of fitting tone controls, special chokes, etc., and the consequent time spent in experimenting first with one valve and then another. That is the writer's opinion, although the tone "fiends" may not be absolutely satisfied that all the deep notes as well as the overtones are being faithfully reproduced, but to the average ear the results of such a circuit are very pleasing—provided a good loud speaker is used.

One stage of transformer-coupled L.F. amplification is often quite enough to give good loud-speaker results, especially when a power valve is employed and suitable grid bias and H.T. are used, but for extra strength a further stage of L.F.—resistance-capacity coupled—is incorporated in the circuit shown, and this enables full volume on several stations to be obtained, while the maximum purity of reception is also maintained.

Concerning Lay-out.

The actual layout of the set can be left to the individual constructor—should anyone wish to incorporate the circuit given into his receiver—but it should be pointed out that the switches must be of reliable type, with definite rubbing contacts (not merely pressure contacts), or trouble may arise as soon as these contacts have had time to become tarnished.

In a receiver of the type being discussed

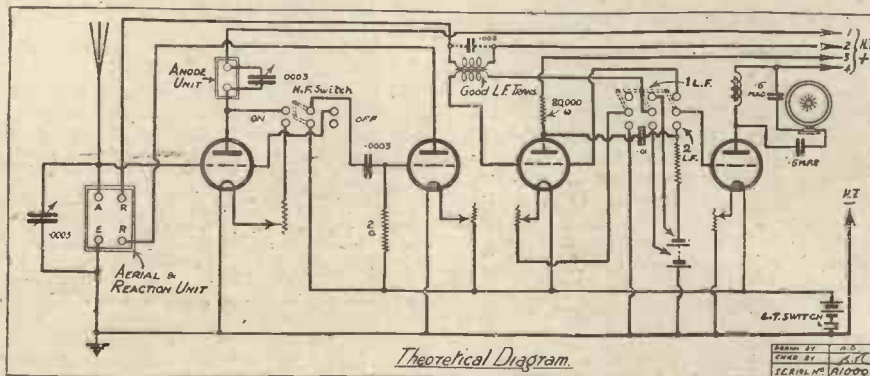

movement. Tapped inductances such as those supplied by Messrs. R.I., Ltd., should be employed, as these enable a wide band of wave-lengths to be covered without the necessity of plug-in coils and the consequent trouble incurred every time the band of wave-lengths is to be altered.

Slow-motion variable condensers simplify the tuning, and so with the tapped tuning units—which can be set on any band required—the whole control of the set can be carried out on the two condensers and reaction. In short, the set is rendered really "foolproof" and as such can safely be recommended for use as a "household" receiver in the broadest sense of that term.

it pays to use good components and to space them out carefully, and still more so does it pay to have good and suitable valves. These should be chosen for the tasks they have to perform, an H.F. in the 1st position, then one recommended as a detector, followed by either a good resistance L.F. and then a power valve, or else two power valves, one being suitable for resistance-capacity coupling.

A Minimum of Valves.

The number of valves used will depend on whether a loud speaker (as shown in diagram) or 'phones be required, and also (Continued on next page.)

CONCERNING LOUD SPEAKERS.

A few things that should be remembered when, after having built the set, a loud speaker has to be purchased.

By DUDLEY KEITH.

IT is an unfortunate fact that many amateur constructors, after having made quite a good job of a set, will go and spoil the whole thing by using an unsuitable loud speaker. It has been the writer's lot, on more than a few occasions, to be asked for advice upon various receivers, especially if they suffer from distortion, only to find that the whole trouble is due to the loud speaker. This state of things is found whether the set be home-made, or from a well-known manufacturer's store.

The main trouble is usually due to the fact that the set, quite good if properly treated, is installed in a corner "out of the way," and is fitted with a small loud speaker—mainly so as not to attract attention, or to give a small volume.

Overloading Troubles.

This is all right as long as a small output from the set is all that the loud speaker is required to carry, but if the set is capable of giving a large output, and the loud speaker is being "pushed," distortion is bound to follow. The same occurs if a small loud speaker is expected to fill a large room, or to provide sufficient volume for occasional dancing.

The safest way to ensure satisfaction, unless small volume and a small room are to be coupled together, is to use a medium-sized loud speaker, whether loud or small volume is required. A medium loud speaker will give good round tone on both loud and weak speech and music, and if less volume is required the set can be detuned or a valve cut out.

There are, of course, many types of loud speaker, and it is best for the listener buying one for the first time to have a demonstration—a comparative demonstration—before he completes the purchase. He should hear various types and makes of loud speaker under the same conditions—if at all possible, on his own set—before he finally makes his choice. He will probably be surprised at the difference between the various tones that the different loud speakers produce.

Demonstration Advisable.

Whatever he does he should not buy his loud speaker upon recommendation alone. If he is advised to get a "so-and-so," he should insist on hearing it before he places his order—and after hearing it, it would not be a bad plan to hear some others before finally choosing. Many and varied are the tastes of listeners as regards the tonal quality of broadcast music. Some prefer the higher frequencies to be predominant, others don't mind what they have so long as they get volume, while still more are dissatisfied if the low notes of the bassoon and organ are in any way cut off, and do not mind losing a few of the higher harmonics. A very few, in the writer's experience, really study the problem and demand real tonal purity and these have to get it themselves, as a rule, by suiting the set to the loud speaker and vice-versa.

Another point that may escape the listener is that concerning the impedance or resistance of the loud speaker. This may seem a small matter, but if tonal purity is to be obtained it is really essential that the resistance of the loud speaker be suited to the impedance of the output from the set, which latter depends upon several factors, such as the anode impedance of the valve used, and so on. Roughly speaking, if the resistance of the loud speaker is about a quarter of that of the impedance of the output, the set should be capable of giving reasonably pure results. The resistance of a loud speaker is usually somewhere about a quarter of its impedance, so that a "2,000 ohm" loud speaker has an impedance of about 6,000 or 8,000 ohms. This is a very rough calculation and is only very approximately correct, but for the average power valve having about 5,000 ohms impedance, the 2,000 ohm loud speaker should be most suitable.

The Hornless Type.

Loud speakers having only 120 ohms resistance will necessitate the use of a telephone transformer, that is, a transformer with a ratio of 10-1, or thereabouts, will have to be inserted between the output of the set and the input of the loud speaker in such a way that a step down in voltage (and corresponding step up in current) is obtained. This is often useful where the loud speaker is to be used on extension leads, though it is not necessary, as the well-known choke system of feeding the loud speaker, and thereby isolating it for all except the required L.F. impulses, is quite efficient and enables long leads to be employed without danger of H.T. leakage or howling due to capacity leaks between the plate circuit of the last valve and earth.

THE "IDEAL" GENERAL PURPOSE SET.

(Continued from previous page.)

on the distance from the station it is desired to receive. The constructor will have to decide this point for himself. In any case, however, it will be found that the circuit is an excellent "all round hook-up," and once the handling has become familiar and the battery plugs (both H.T. and grid bias) have been set for "best results," it will be possible to switch valves in and out as desired, or the whole set on or off without the need for readjustment, except in the case of reaction, when the H.F. valve is brought in or cut out.

Automatic Bias Adjustment.

The use of an aerial-reaction unit precludes the necessity for a reaction reversing switch, as such units as the R.I. have a rotor reaction that is automatically reversed by rotation of the reaction control knob.

Finally, the intending purchaser should remember that the hornless loud speaker, as a rule, appears to give less volume than its earlier brother with the sound conduit, and this is often due not to insensitivity but to the fact that the sound is dispensed in all directions and not led out in one definite direction. The golden rule for success in choosing a loud speaker is to insist on a demonstration and not to choose before hearing, not only the one you fancy, but also several others.

More care should be exercised in the choice of a hornless loud speaker, especially if it is of the cone type, because blemishes



An example of the hornless type of loud speaker—the C.A.V. Musicola

in the way of high or low note suppression due to the set itself may be seriously pronounced when the loud speaker is coupled to the set.

Extreme care should therefore be taken by the purchaser whatever loud speaker he "has his eye on," and it cannot be too much emphasised that he should insist on a demonstration under conditions as nearly like his own as possible and not choose a loud speaker solely for its beauty of line or because the firm that advertises it is "sure to turn out a good one."

As valve No. 3 is cut out when the extra I.F. stage is not required, this valve can be one suitable for resistance coupling (such as the D.E.3 B., D.E.5 B., D.F.A.4, etc.), and it is only used when this resistance stage is required. The arrangement of the switches automatically provides for the breaking of the filament circuit of the valve not in use, and also for the provision of correct H.T. and grid bias on all the valves. No alterations have therefore to be carried out with regard to valve adjustment, whatever number of valves is in use.

A last word to those who build the set. The writer would like to emphasise the fact that the circuit that has been discussed is only the writer's conception of a household set that shall answer as many purposes as is possible and consistent with good results—economy, and simplicity of construction and operation. It may not be the "ideal" in other respects, but as a general purpose "hack" receiver, if I may put it that way, it seems to incorporate those qualities which go for good results and satisfactory operation with the minimum of expense and the maximum of adaptability.

WERE I a Jules Verne, or did I possess the more balanced prophetic propensities of Mr. H. G. Wells, I should probably fill the whole of this page with a description of a wonderful sort of crystal receiver which would not only get America and Australia at will, but which would also be sufficiently sensitive in properties to penetrate far beyond the confines of our little earth and to pick up any stray messages which were flying from non-terrestrial sources about the area of the earth's orbit.

Such might conceivably be the properties of the crystal set of the far-distant future. For the word "impossible" is a term

THE CRYSTAL SET OF THE FUTURE.

By "CRYSTOGRAPH."

Will the Crystal Set ever receive Australia? Here is a "dream of the future" which will make many readers gaze wistfully at their cat's-whiskers.

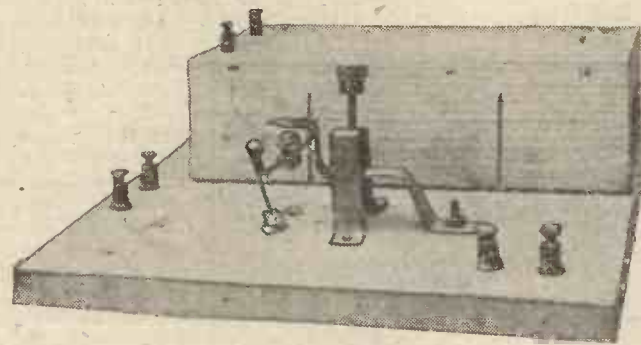

A very early type of crystal set, which, despite its crude appearance, gave excellent results.

which is not, or at any rate should not be, admitted to the vocabulary of modern science. But, nevertheless, an ideal no-trouble super-super-sensitive receiver of the above description is not within our life's ken, and therefore I leave a description of its properties and possibilities to Mr. Wells and to the other literary adepts in the art of scientific and socialistic forecasting.

Despite the above matter, however, it does not appear to be a wholly impossible task to give a reasoned outline of the form which the crystal set of, say, twenty-five years hence, may be expected to take. The crystal set, in one form or another, has come to stay. Of that there is no doubt. In fact, it has lasting properties akin to the income tax in that respect!

Come to Stay.

Now, just why has the crystal receiver come to stay? Such a question is not difficult to find an answer to. In the first place, we have got to remember that quite a number of listeners-in exist, and always will exist, who do not take the slightest scrap of interest in the technical aspects and possibilities of radio science. These individuals form a very large portion of the total number of radio listeners, and therefore it is quite natural that a receiver designed to suit their needs must always be forthcoming. What these good people want is a radio receiver which will give constantly good and trouble-free reception. Batteries and accumulators, and the various operations attendant upon the process of tuning-in, are a curse to them. The ideal radio set, therefore, for a large proportion of the country's population is

one which will always be ready for use, one which will never go out of action, and, of course, one which will give loud and clear reception of the neighbouring station.

And does not the average well-made crystal set of the present day, within certain limits, approximate more than any other receiver to these requirements? For simplicity and straightforwardness of operation there is nothing like a crystal set.

For purity of reception, also, the crystal set is not to be beaten, and this despite statements which are often made to the contrary. Well may we say, therefore, that the crystal set of the present day, even if we regard it only as a primitive type of instrument, contains the essence of longevity in its fundamental properties, and that, unlike the "hob" and the "shingle,"

or the latest creation from Paris, it has no ephemeral existence.

Naturally, it is far from my intention to imply here that the crystal set will always remain in its present form. The crystal receiver is an instrument which is capable of development. But exactly what nature that process of development will take is very difficult to predict.

Recent Research.

The crystal receiver is a product of applied crystallography, or mineralogy. Now, a quarter of a century ago, mineralogy and crystallography were very dry sciences indeed. Followers of those twin sciences spent their days in weighing up crystals and minerals, making notes of their colours and forms, and of the localities in which they occurred. Victorian scientists measured the sizes and angles of crystals with a methodical accuracy worthy of the most exclusive of Bond Street tailors. But that is pretty much as far as they went. Now, however, a new science has been "invented." It is the science of what I may call "electro-crystallography." And it deals with the study of the remarkable electrical

functions which the crystal is capable of undertaking.

This recent branch of crystallographical science is a fascinating one indeed. It becomes a matter for astonishment when one considers the many-sided electrical properties of the average sensitive

crystal. Crystals can act as rectifiers and amplifiers of radio-frequency current. They can also produce various current transformations. Besides which, many crystals seem to possess the property of converting light rays into electrical currents. Crystals also can convert mechanical strains and stresses into electrical currents. They can control current modulation, and they can perform other numerous functions, which were undreamt of by the earlier crystallographers.

Synthetic Crystals.

The latent power of the crystal has only within the last few years been discovered. The science, then, of "electro-crystallography" is in its infancy. It is difficult, therefore, accurately to forecast the sequence of developments and applications which will undoubtedly be made in this recent electro-technical science.

Without a doubt, however, the crystal set of twenty-five years hence will employ crystals of very greatly enhanced sensitivity.

Probably no naturally occurring crystals will be employed in the receiver at all. They will all be carefully prepared synthetic products. Loose and delicately adjustable crystal
(Continued on next page.)

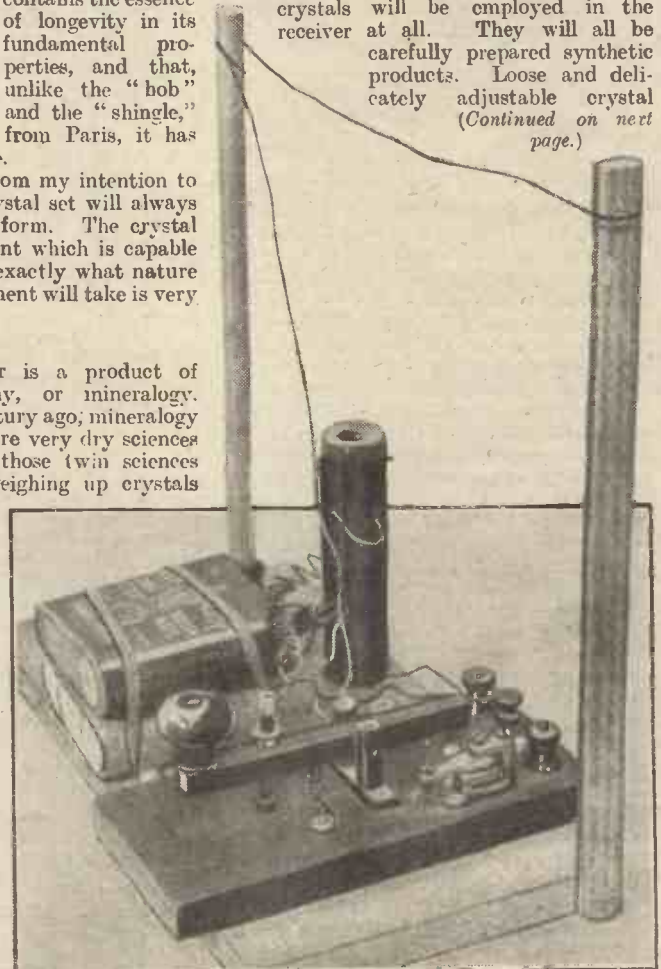

An equally early example of a miniature transmitter used for testing the crystal set when no "sigs" were on—a frequent state of affairs.

THE CRYSTAL SET OF THE FUTURE

(Continued from previous page.)

contacts will at that time have long ago become things of the past. There will be no "cat's-whisker" curse. The rectifying element of the set will work under a contact pressure of many pounds. Already the beginnings of such a rectifying device are at hand, it having been recently shown that agate and similar crystals will, under certain conditions, rectify high-frequency currents in heavy contact with a flat metal plate.

Crystal Amplification.

But I am assuming, of course, that the future crystal set will employ a separate rectifier, just as it does at the present. In all probability, however, the crystal, or whatever synthetic substance is used in place of the crystal, will combine several functions. The crystal as an amplifier is well known even at the present day. And it has been proved, also, that in addition to rectifying, many crystal contacts possess some inherent property of actually producing sounds when they are attached to a delicate diaphragm. So therefore, I think we may reasonably expect, if the present rapid rate of progress in science is at least maintained, the detector element of the future crystal set to combine the functions of rectifier and amplifier, if not, also, that of an actual sound producer.

The future synthetic crystal will undoubtedly possess a greatly improved sensitivity over the product of the present day. By that, I do not mean to imply that the sensitive range of the crystal itself will extend over a thousand miles, or anything like that, but it is possible that the crystal receiver of twenty-five years hence may be able to pick up messages from such distances, owing to the dual rectifying and amplifying rôle of the crystal itself.

Whilst a good deal of development in the crystal receiver will take place as regards the crystal itself, it must not be forgotten that the actual circuits which are employed nowadays in crystal sets will also come in for their share of advancement and improvement. The conventional crystal circuit of the present day is nothing like final.

Advance in Set Design.

And, even assuming that no advance at all was made in the science of crystal technics, we may have every assurance that the not far distant future will bring some important modification and improvement in the present-day crystal circuit, which invention will, of course, increase the effectiveness of crystal reception accordingly.

The crystal set of 1910 was a cumbersome affair, with its massive solenoid loose-coupled tuning coils, its bulky condensers, and the other incidental devices which were attendant upon it in those days. Nowadays, instead of occupying a goodly portion of a large-sized table, a crystal set, quite as effective and generally more so than the old type of crystal receiver, may conveniently be constructed within the confines of a reasonably small box or cabinet, in which form the instrument takes up no more room than a cigar box or a large volume.

What bulk will the twenty-five years hence crystal outfit occupy? To my mind, the radical improvement which will at that time have taken place in the crystal receiver will externally manifest itself in the still further compression of the instrument's size. There will probably exist two forms of the receiver. One will be comparable with the present "cabinet" type of instrument.

Permanent Fixture.

That is to say, the various components will be built up within a small portable box. The other type of crystal receiver will, however, form an intrinsic portion of the household fittings. It will be contained in a small box attached to some convenient part of the wall in very much the same manner as a gas-meter or household electric meter is fixed at the present day. From this instrument, wire leads will be taken to various rooms of the house to terminals placed on wall pattresses.

The crystal set will contain a perfectly trouble-free, permanent, and non-adjust-

The "broadcast on tap" system, which, I think, we may look for in the near future, will obviate all this disappointment, for, whilst not interfering in the least with other aspects of radio-technical work and experiment, it will provide the modern household with an ever-present, non-failing method of listening to the outside world. Such a system is, of course, a possibility at the present time, but in view of the present admitted shortcomings of the crystal set, it has not found any wide sphere of application.

Promising Future.

There is a future crammed full of promise for the crystal set. The men who even now have brought the instrument to its present stage of usefulness have benefited mankind probably much more than ever they thought. And with the combined efforts of the mineral and crystal physicist and the radio circuit inventor it is not only probable, but it is indeed very likely that the present-day crystal receiving instrument will develop along the general lines I have suggested.

When people tell you that the invention of the valve killed the crystal, it would be well to take their well-meant assertions with the customary sprinkling of saline matter. For a time, the valve certainly did annihilate the crystal, especially for commercial purposes. But the radio-sensitive crystal is gradually coming back into its own. Already specially prepared crystals are being used in America for the purpose of governing modulation effects. Valve improvements or no valve improvements, the crystal has come to stay.

As I remarked before the crystal will

change again and again in form and composition, but the one essential and that it is a crystal—will remain. The valve has been a great success in many ways but it is not unlikely that the crystal will be able to do all that the valve set does at present.

And if we peer into the distant future, is it quite impossible that we may dimly discern a period when the crystal, improved enormously in sensitive properties, has completely outrivalled the valve? Who knows? Nothing is really impossible. "You never can tell!"



A "P.W." Simplicitus 3-valve set, as made by one of our readers, Mr. F. W. Smallridge, 27, Ormerod Road, Burnley, Lancs.

able detecting and amplifying device. The sets will be manufactured in a roughly tuned condition, the final accurate degree of tuning being imparted by the householder after the set has been installed as part of the household fittings. Once tuned, no further adjustments will be required, except, of course, on the occasion of a change of wave-length. Naturally, such a household set will only suffice for the reception of the local station, but, generally speaking, most listeners are usually content with that. The installation will, in a word, supply radio broadcast "on tap" from an ordinary aerial. There will be no trouble, no worry, and no annoyance.

Music "On Tap."

Such an arrangement will benefit the technical man and the experimenter also. We all have experienced times at which we have desired to receive some particular broadcast item, and it has so happened on that occasion that our experimental apparatus or "stunt" circuit has failed to function.

NEXT WEEK

Mr. K. D. Rogers will describe the construction of

A **A.C. MAINS H.T. UNIT**, a simple-to-construct instrument which provides 10 H.T. plus tappings.

ORDER YOUR COPY NOW.

S.P. 18 RED.

A real two volt power valve. Designed specially for low frequency amplification. Should always be used in last stage of operating loud speaker. It is also suitable as a detector.

Fil. Volts: 1'6.
Amps.: '3.

PRICE 14/-

S.P. 18 GREEN.

A high amplification valve having a moderate impedance. Designed as a high frequency amplifier and as a detector. Also suitable for resistance, choke and transformer coupling (except last stage, where an S.P. 18 Red should always be used.)

Fil. Volts: 1'6.
Amps.: '3.

PRICE 14/-

S.P. 18 BLUE.

Extra high amplification valve. Designed for resistance capacity, choke and early stages of transformer coupling. Excellent as a detector or tuned anode H.F. amplifier.

Fil. Volts: 1'6.
Amps.: '09.

PRICE 14/-



STAND No. 105
at the
NATIONAL RADIO
EXHIBITION.

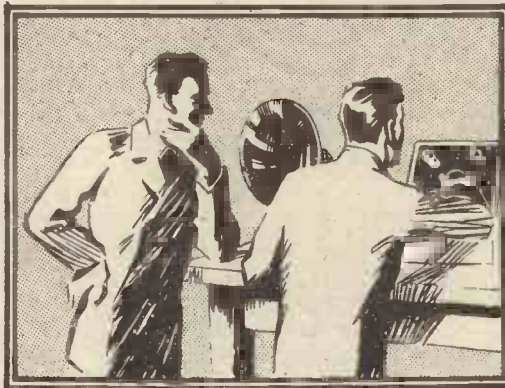

Smith asked for the circuit

SMITH, curious to know if Brown's 3-valve set equalled his own 3-valve neutrodyne, paid him a visit. A surprise awaited him. Not only did Brown's set bring in many more stations than his; it also reproduced everything clearer and louder.

Smith asked what freak circuit was being used. He had another surprise. It was an absolutely straightforward H.F. and L.F. Circuit. Puzzled, he asked what made Brown's reception so perfect. He was told in four words—

BENJAMIN

SHORTPATH

RADIO VALVES

Greater amplification, greater output, less distortion, exceptionally good rectification, and extremely low filament consumption are among the more important features of BENJAMIN VALVES. Better results can be obtained from any receiving set if they are fitted.

Ask your dealer about them—or send to us for leaflet giving full particulars.

THE BENJAMIN ELECTRIC LTD.,
Brantwood Works, Tottenham, N. 17.

D.E. 55.

A very economical general purpose valve. For high frequency, detector and low frequency (except last stage when the S.P. 55 Red should always be used.)

Fil. Volts: 5'5.
Amps.: '09.

PRICE 18/6

S.P. 55 BLUE.

Extra high amplification valve. Designed for resistance capacity, choke and early stage transformer coupling. Also excellent as a rectifier or high frequency amplifier.

Fil. Volts: 5'5.
Amps.: '09.

PRICE 18/6

S.P. 55 RED.

Super power valve specially designed as a last stage power amplifier. Will give great power without distortion. Also suitable for detector or H.F. amplifier.

Fil. Volts: 5'5.
Amps.: '25.

PRICE 18/6



STAND No. 105
at the
NATIONAL RADIO
EXHIBITION.



BY APPOINTMENT

*A Name to Conjure
with in the world
of Broadcasting*

HART BATTERIES

ENSURE

*A marked increase in Volume
of tone & freedom from distortion*

says- **DE GROOT**

THE FAMOUS VIOLINIST OF THE
PICCADILLY HOTEL



There are models of "HART"
BATTERIES for all wireless cir-
cuits. Write to-day to Department
P.W.2. for illustrated leaflets and
full particulars, and call at our
STAND No. 56, National Radio
Exhibition, Olympia, Sept. 4th
to 18th.

THE PICCADILLY HOTEL
PICCADILLY AND REGENT STREET,
LONDON. W. 1.

Messrs. Hart Accumulator Co. Ltd.,
Stratford, E.15.

Dear Sirs,

I have been immensely pleased with the very excellent results of substituting a "HART" High Tension Accumulator for the dry battery previously in use with my wireless set. The reception generally has been tremendously improved, whilst I have also noticed a marked increase of volume of tone and freedom from distortion, which, in the case particularly of delicately phrased musical items, is, of course, a pronounced asset to critical listeners.

I am happy to recommend "HART" High Tension Accumulators as infinitely superior to dry batteries, the relatively short life of which, in my opinion, constitutes not the least of their many disadvantages.

Yours sincerely,

July 21st. 1926.

HART

THE BATTERY OF QUALITY

HART ACCUMULATOR CO.LTD. STRATFORD LONDON E.15

HOW TO MAKE A COMPLETE LOUD SPEAKER FOR THIRTEEN SHILLINGS.

By F. H. NEWRICK.

The instructions given by our correspondent should enable an experienced constructor to make for himself a really efficient loud speaker for the small sum stated above.

THE instrument described has a lovely mellow tone, and can be quite easily made by the merest novice without special tools, and all the materials can be purchased without difficulty at any wireless emporium.

The whole of the components should be

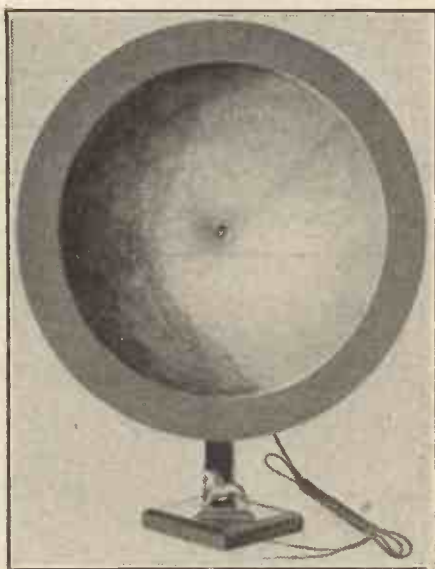

A well-known model of hornless loud speaker.

obtained before a start is made with the construction of the instrument.

A list of parts is given on this page, together with their approximate costs, the same being exactly as paid by the writer.

The first stage of the work should consist of the conversion of the Bakelite earphone cap to carry the reed mechanism.

The cap must be placed upside-down on a sheet of coarse glasspaper and rubbed with a circular motion until the face of the cap has a level face formed upon it to form a true and tight joint with the wood adapter mentioned later. The removal of one-sixteenth of an inch off the cap will suffice.

Preparing the Earpiece.

The existing circular hole in the cap is now enlarged to 1 inch in diameter with the aid of an old knife-blade and a half-round file.

When this has been done, the cap must be placed flat on the bench with the screwed portion uppermost, and carefully marked for drilling as shown in Fig. 1.

Care must be exercised during the drilling of the holes (which are all 4 B.A. clearance) to prevent flaking away from

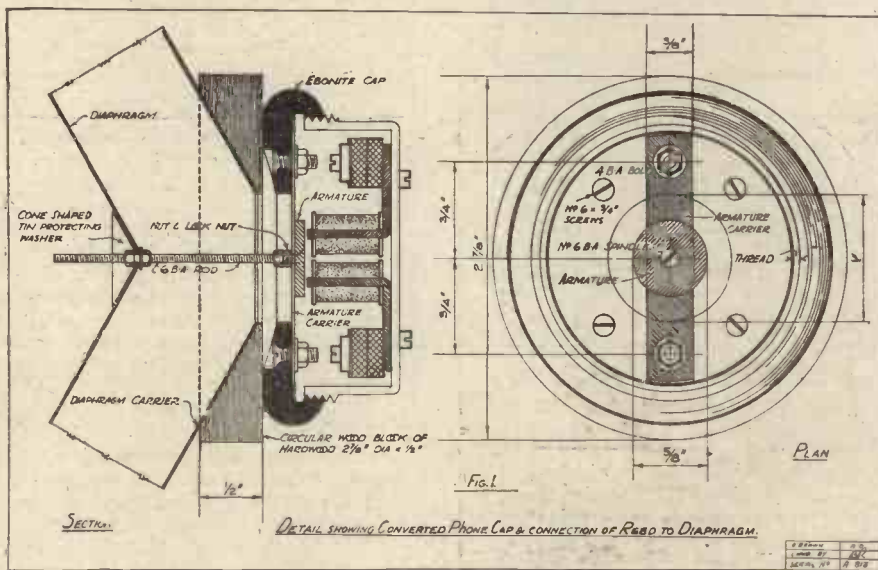

the under-side, as the compound is much more brittle than ebonite, and must not be unduly weakened in any manner.

Keeping the cap in the same position, the four holes for the wood screws are now countersunk as necessary. Reverse the cap and countersink the two holes for the bolts securing the bronze armature carrier.

The cap is now ready to receive the armature and connecting rod, the making of which is the next lap. Carefully trim up the piece of 22 S.W.G. phosphor bronze to exactly $2 \times \frac{3}{8}$ in., and mark off the holes to exactly coincide with those drilled in the cap.

The two end holes are 4 B.A. clearance, and the other hole—which must be precisely in the centre—is 6 B.A. clearance. The armature consists of a circular disc of soft iron $\frac{3}{8}$ in. in diameter, $\frac{1}{16}$ in. thick, and perfectly flat, with a 6 B.A. clearance hole—exactly in the centre—countersunk to suit the head of connecting rod.

The Armature Carrier.

If no charcoal iron is available, the disc may be cut from $\frac{1}{16}$ in. mild steel plate which has been softened previously.

To do this, take a piece of the sheet as required and heat it red-hot, keeping it so for about ten minutes, and then drop it into a tin of sawdust and leave it until cold. If not then perfectly soft, repeat the process.

The armature carrier, armature, and 6 B.A. connecting rod must now be assembled together, to do which take the 6 B.A. screw in the fingers with the screwed shank pointing upwards, place upon it the circular armature with the countersunk side downwards, and over this place the $2 \times \frac{3}{8}$ in. phosphor bronze armature carrier, threading the centre hole over the screw.

If the parts now lie snugly together, slip a 6 B.A. washer over the screw and

(Continued on next page.)

COMPONENTS REQUIRED.

	s.	d.
1 French Thomson-Houston ear-piece, with clip (2,000 ohms.)	7	6
One 6 B.A. x 2 in. C.S. head-screw with 4 nuts and 2 washers	2	
1 piece of phosphor bronze sheet, 22 S.W.G., $2 \times \frac{3}{8}$ in.	3	
1 piece of circular soft iron sheet, $\frac{3}{8}$ in. diameter x $\frac{1}{16}$ in. thick	3	
1 circular tin washer, $\frac{3}{8}$ in. diameter	1	
4 No. 6 x $\frac{3}{8}$ in. C.S. head wood screws	1	
2 4 B.A. x $\frac{3}{8}$ in. C.S. head screws, with 1 washer and 1 nut each	2	
1 circular block of hardwood, $2\frac{1}{2}$ in. diam. x $\frac{1}{2}$ in. thick	4	
1 hardwood base, $5 \times 5 \times 1$ in.	8	
1 hardwood standard, $1\frac{1}{2} \times 1\frac{1}{2} \times 10$ in.	6	
1 small tube of "Croide" liquid glue	6	
2 sheets of "Five Sheet" ivory board	6	
1 loud-speaker cord, 6 ft. long	2	6
Total	13	0

A COMPLETE LOUD SPEAKER FOR 13/-.

(Continued from previous page.)

put on the first nut, and tighten it down on the assembly until the whole is firmly clamped together.

The lock-nut is then fixed in position and firmly tightened, but care must be taken not to strip the fine threads, which are quite easily damaged.

Now take the previously prepared Bakelite cap and, holding it with the threaded part upwards, place upon it the armature



assembly so that the connecting rod projects downwards through the enlarged hole, and then inset the 4 B.A. $\times \frac{1}{2}$ in. screws from the under-side through the cap and bronze strip, and fix each one with a washer and nut, which should only be tightened sufficiently to hold firmly, as if too much strain is placed on the screws the cap may be fractured.

The nuts should be fairly thin, and any screw projecting should be trimmed off level with the nut, so that no fouling of the magnets will occur when the cap is placed on the earphone. This completes the conversion of the earpiece, and attention must now be given to the paper diaphragm and its carrier.

Constructing the Diaphragm.

The making of these is an extremely simple matter, and if the directions are closely followed no fear of even one failure need be anticipated.

Two sheets of what is known in the printing trade as "Five Sheet" ivory board are required, one for the diaphragm and the other for the carrier. From each sheet cut one perfect circle, 15 in. in diameter. For the diaphragm take one of the paper discs and, using the same centre as before, describe a circle on it of 6 in. radius, which is shown in Fig. 2 as "Incised Line."

This line must be evenly and firmly indented into the paper to facilitate the bending over of the edges without "kinks." For the carrier, take the second disc and indent upon it a similar line at a 7-in. radius,

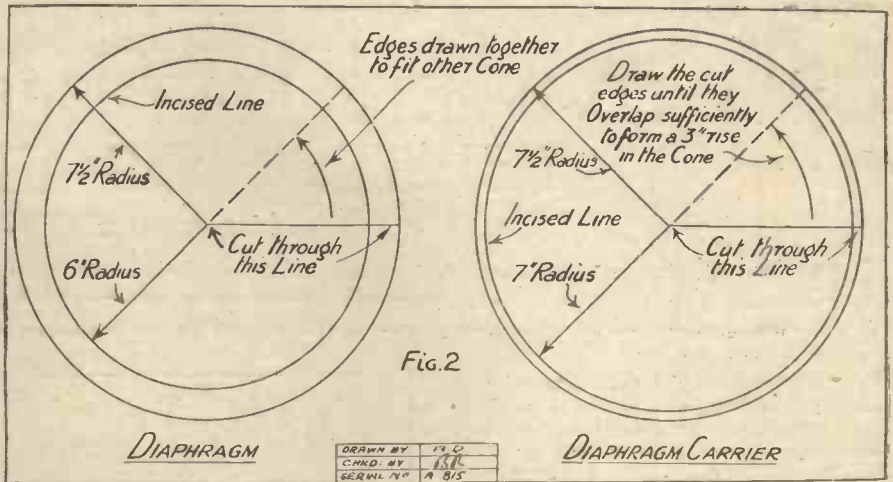

It is absolutely essential that the indenting should be evenly done or the bending will be uneven and the appearance of the instrument spoiled.

By inserting a "bodkin" needle into the pencil holder of the compass used and using it as a pencil point the inscribing of the line will be found simple, although a trial on thick brown paper just to "get the hang of it" would, no doubt, be an advantage.

An Important Point.

Having successfully proceeded so far, take a sharp pocket knife and from centre to circumference of each disc cut a clean, straight line right through the paper, taking care not to overstep the centre pop by even a fraction of an inch.

The edges of the cut can now be drawn together, and the portion of the disc outside the indented line will be found to automatically turn down to the correct angle as the overlap is made greater and a perfectly symmetrical cone with a turned-up border $1\frac{1}{2}$ in. wide will result.

The V-shaped portion of the overlap must be cut away, leaving only $\frac{3}{8}$ in. for glued overlapped joint. The joint must have both edges sparingly smeared with liquid glue and left a few moments until the surfaces

are "tacky," when they may be pressed together with the fingers and will adhere firmly in a very few minutes.

Assembling the Loud Speaker.

The same procedure follows with the second disc which forms the larger cone or diaphragm carrier. The two cones are now glued together at the circumference in the same manner as at the overlapped seams.

The wood block shown in Fig. 2A is now carefully glued on to the diaphragm carrier

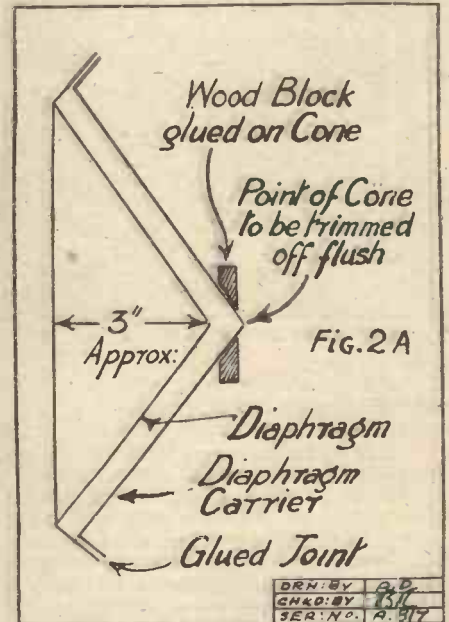

—as indicated by the diagrams—before the point of the cone is cut off.

When the cones and wood adaptor are properly set the projecting end of the paper is trimmed off flush with the plane face of the cone and a small hole punctured in the exact centre of the diaphragm to take the connecting rod.

The earcap with its levelled face is now to be placed on the adaptor, as shown in Fig. 1, with the connecting-rod projecting through the diaphragm—the nut and washer securing rear of diaphragm having first been placed in position—and secured by means of the four small screws shown.

The tin washer is now bent to fit the front cone and placed over the projecting

(Continued on next page.)

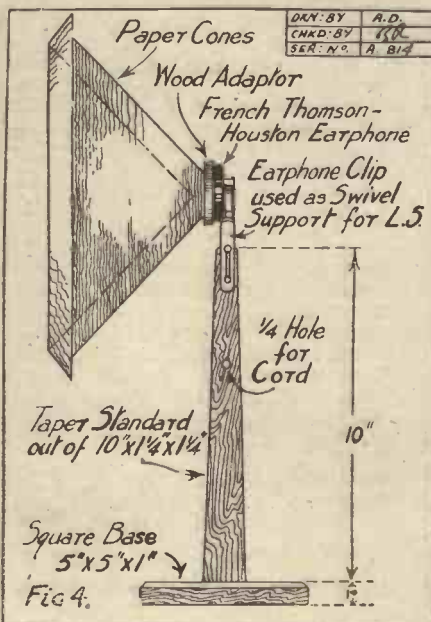

THE "UBIQUÉ" UNIDYNE.

By "GIDEON."

AFTER narrating Unidyne experiences to the Irish owner of a four-valve H.T. set, the comment was, "I can't do that on my set—but, of course, the Unidyne circuit is super-selective." This opinion is rapidly becoming general in Ulster—a great change of attitude from just over a year ago, when I met with remarks such as, "It is only a stunt," and "They've forgotten all about the Unidyne in England, long ago!"

I have proved to some who were dissatisfied with the amount of volume from local stations that all they needed for louder local signals was a reserve of power in the aerial. With two flexible copper wires plaited along an insulated wire up to the commencement of lead-in, loud-speaker results are A1.

Daventry is somewhat of a disappointment on all circuits; in Belfast, receptive strength varies so much with weather conditions and interference. Using a 250 and a 300 coil, I have found that improved results accrue from inserting a No. 75 coil between the aerial lead-in and aerial terminal, for some reason, doubtless, to do with the aerial in use.

Filament Control.

Tuning-in to distant stations is facilitated greatly by attention to the control of first valve. Touching the condenser dial with two fingers sometimes doubles the volume—but that is only a sign of incorrect tuning. Occasionally the set suddenly jumps into oscillation, and then it is only necessary to turn back the aerial coil and bring it forward again. If that does not get the transmission without renewed oscillation, the filament control will right matters. Tuning-in to distant stations on the Unidyne is not the exasperating task it is on some circuits. A friend of the writer recently constructed a four-valve H.T. set that possesses more loud-speaker power than any four-valve set I've previously heard. All parts of it were the best of those made by well-known firms. On a Sunday evening, prior to the start of 2 B E, he was juggling with coils, vainly trying to link up with Glasgow.

"This is tantalising," he said, "after your Unidyne, only two coils to adjust, and those two covering almost all the 'musical' wave-lengths."

Reaction Refinements.

The valves I have used are the Thorpe K.4. I doubt if any pair of valves in the British Isles have been in use a greater number of hours during the period since first installed. Six-volt Exides have provided the current (whether one or two valves were lit). Occasionally the position of valves has been interchanged. An "Elwell" valve-window, inserted to the left of 'phone terminals, proved to be an appreciable refinement, and pointers on the coil-holder knobs are essential to "Pelmanising" the positions for Continental stations.

I have used both Atlas and Lissenagon coils, mixed or in pairs.

An acquaintance, who declared that he

"could not afford one of the Unidynes" last year, obtained a one-valve amplifier and a crystal set.

Since then his apparatus has "eaten" nine half-guinea H.T. batteries—an excess of cost perhaps due to defective storage (heat, dampness, etc.)—but there it is. He now regrets not installing the Unidyne two-valver to start with.

No "Hand Capacity."

Were I in charge of an advertising campaign designed to popularise the Unidyne, my chief point stressed would be the fact that in very many homes the womenfolk repress their desire to "start the wireless" when their husbands or sons are elsewhere, because they fear mishaps to valves due to errors with H.T. connections. With the Unidyne L.T. can be left attached O.K., and there remains nothing to do but turn the valve controls.

A COMPLETE LOUD SPEAKER FOR 13/-.

(Continued from previous page.)

connecting-rod and the front and back nuts adjusted so that the diaphragm is not strained either to back or front.

When the earpiece is screwed on to the

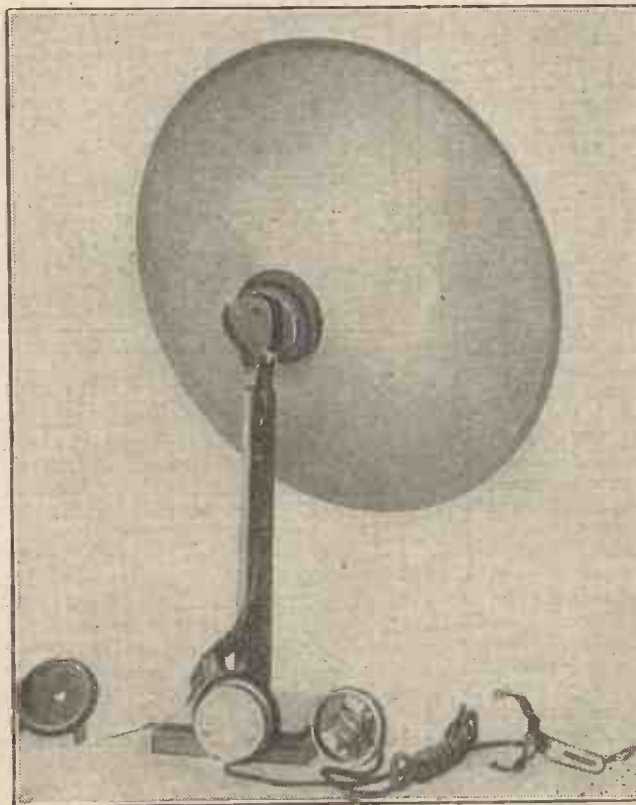

A view of the rear of the completed loud speaker, with a pair of telephones (similar to those from which the speaker was made), at the base.

The most appreciable change in the "1926" Unidyne was the "elimination of hand capacity effects."

With former lay-outs, one's fingers seemed sometimes to become miniature transmitting aeriars.

Good DX Districts.

When the Wireless Exhibition was held in the Ulster Hall, Belfast, many visitors from the Free State were disappointed at not seeing the Unidyne in demonstration kiosks. Dublin and Cork are much better situated for DX experimenting than is Belfast, and long-distance selective sets are specially favoured in Southern Ireland, where enthusiasts, "heart-sick with hope deferred," patiently await the inauguration of local transmissions from Marlborough Barracks—the building from whence, in pre-Treaty days, wireless messages were sent to Curragh and Gormanston Camps—broadcasting that brought anxious moments to Irishmen "on the run."

Wireless listeners at Dundalk and Drogheda, with selective, easily tuned Unidynes, will have the choice of Belfast or Dublin programmes, engaged in a friendly rivalry that will prove interesting in both contrast and co-operation.

earcap and cones the speaker is complete, the adjustment of the distance between the poles of the magnets and the armature being accomplished by rotating the paper cones.

There is only one point liable to trap the inexperienced, and that is that when the armature is connected to the diaphragm it may appear that nothing short of a steam hammer will produce the slightest vibration in it, so if the constructor should feel inclined to file the armature carrier down nice and thin and springy, take to heart the advice of Captain Eekersley—"Don't DO IT!"

As to the mounting of the speaker, the diagram—Fig. 4—and photograph will no doubt serve to spur the ambitious to better efforts as far as the decorative scheme is concerned.

It must be made clear that this type of speaker is the subject of various letters patent, and if constructed for other than solely experimental purposes it is up to the maker to apply for the necessary permission from the patentees concerned.

The specification of the particular 'phone mentioned has only been decided on after finding that results have been markedly superior to those obtained with several other makes at a corresponding price.

THE flare-up over the Sitwell incident calls attention again to the precariousness of the relations between the stage and broadcasting in this country. One can readily understand an astute theatre manager turning the Sitwell interview to account for much-needed publicity. But to attempt to hold up the B.B.C. programmes because of an outside private quarrel was going too far. The B.B.C. are to be congratulated on refusing to give way. Sensible people on the stage will know how to deal with the A.B.C.—“Anti-Broadcasting Company.”

An interesting legal point is raised in connection with the forthcoming stage tour of Mr. James Lester's “Radio Radiance” Revue, which was formed and developed by the B.B.C. under the direction of Mr. Lester. This revue is now quite separate from the B.B.C.; but I gather that the Savoy Hill people will expect to share in the profits on the tour because of the “goodwill background.”

The “Mikado” Broadcasts.

The broadcasting, on September 20th, of two half-hour excerpts of the new “Mikado” production marks an epoch in broadcasting progress. The Gilbert and Sullivan people have hitherto been most obstinate opponents of broadcasting. Although I note that the affair is not to be taken as a “precedent,” everyone knows that it will be in practice. Thus a new and popular field of musical material is opened for listeners.

Apparently the B.B.C. have come to the conclusion that there is little real likelihood of securing parliamentary action that will release more licence money than the Treasury are at present contemplating. Anyway, facing up to this possibility, the management at Savoy Hill have initiated a strict examination of the chances of staff reduction in all departments of the work.

Reduction of Staff?

Many broadcasters will get their notices on September 29th. I am not sure of the wisdom of this drastic policy. First of all, the service is not overstaffed, or anything like it. The management has seen to it that on the staff side the principles of competitive business management have been applied.

The result is that many first-class men are working for the B.B.C. If these people are to be weeded out, the new Corporation will have to re-engage them or secure substitutes at considerably bigger cost.

Some months ago we were hearing of a campaign for British goods projected by the B.B.C. The idea appears to have retreated into the background. I hope it will be dug up again soon, because it is high time that the microphone made a sustained effort to help British manufacturers and traders.

On this subject there is just the suspicion of timidity at Savoy Hill. Because a certain talk by the President of the Board of Trade attracted criticism in Free Trade circles, the talks censors at the B.B.C. have been reluctant to consider British goods pro-

BROADCAST NOTES.

By O. H. M.

The Sitwell Incident—The “Mikado” Broadcasts—No More Money—The British Goods Campaign—Wave-length Changes—A Policy of “Uplift.”

paganda. But the time has come when objections of this kind must be over-ruled. The effort to recover after the coal dispute will be difficult enough at best, and it is unthinkable that the B.B.C. will stand by with folded arms because of the objections of a few discredited theorists who belong to a generation long forgotten by the majority of people.

A Special Programme.

Great interest attaches to the programme on Sunday afternoon, October 3rd. As exclusively announced in POPULAR WIRELESS, Mr. Chesterton has this in hand. He has framed the programme to commemorate the 700th anniversary of St. Francis of Assisi. Details are being reserved.

A forthcoming programme feature will be a series of programmes drawn up by people eminent in all walks of life, including in

as to future receiving-set requirements. It is of extreme importance, therefore, that the trials should not be delayed longer than is absolutely necessary.

It looks as if the exigencies of the international position, and the consequent new wave-length scheme will rule out the proposal for alternative programmes. The latter had involved the duplication of both Daventry and London, which cannot be carried out. The only hope now is that the overlap of the new regional stations is so great that nearly every listener will be within the service area of two regional stations.

Even then it will be hard to guarantee that the programme of the neighbouring region will offer a reasonable contrast to that of one's own region. If, therefore, it is necessary to go on with one main set of programmes for another period, there will have to be a good deal of change in programme

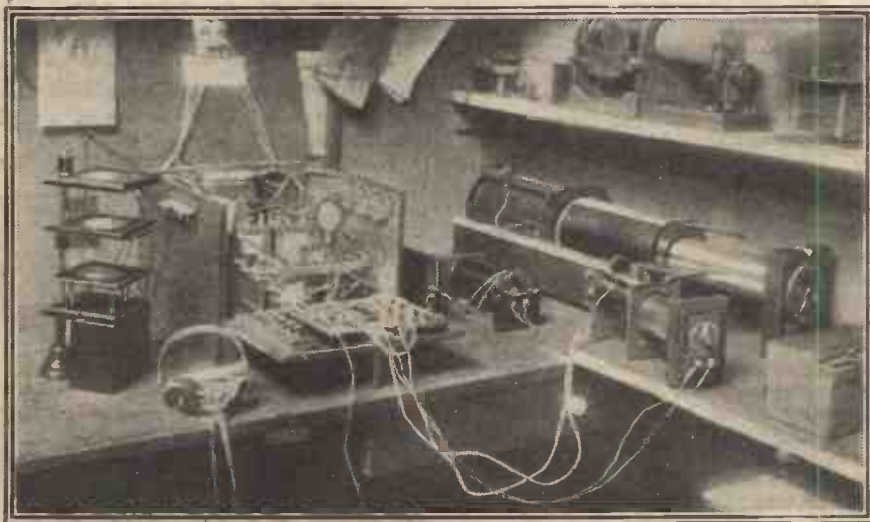

Part of the experimental station erected by Mr. F. Catherly, of Parkstone, Dorset.

particular those public men inclined to be critical of the B.B.C. I understand that the following names have been suggested: Lord Beaverbrook, Sir Oswald Stoll, Commander Kenworthy, Mr. Lionel Powell, Mr. Gulliver, Col. Harry Day, and Sir Eric Geddes.

I gather Savoy Hill is alive to the popular discontent with variety of the kind provided this summer. Considerable revision of forthcoming programmes is being made, and I should think there will be a good deal less of the offending material. Rather than engage such indifferent artistes, the B.B.C. would be well-advised to build up another good concert-party which listeners would get to know and appreciate.

The Wave-length Hold-up.

Procrastination on the Continent threatens to hold up the new wave-length changes for

policy, if licence revenue is to be maintained. For one thing, a great deal of the education will have to go. This could only have been carried on if alternative wave-lengths were to be available.

Of course, the new Corporation may flout public opinion and try to make listeners swallow the uplift stuff; but there will soon be no licence money. The B.B.C. policy of education and uplift is excellent for other people—that is, if it is on an alternative wave-length.

In this connection I heard the other day that it was reported of the Director of Education of the B.B.C. that his talks had to be dull in order to secure the recognition of education authorities and public bodies. I should think he was “leg-pulling,” but some of the stuff that is broadcast in talk-periods would lead one to believe that he might have been serious.

The Lodge "N" Receiver



An exclusive article dealing with an experimental form of the "N" circuit invented by SIR OLIVER LODGE, F.R.S.
Described by G. V. DOWDING, Grad. I.E.E., and K. D. ROGERS.

THE original "N" 2-valve receiver, in which one valve is used as a detector and the other as a transformer-coupled L.F. amplifier, is ideal for local loud-speaker work. It provides excellent volume and a purity of tone of an unsurpassable quality. It is quite useful for DX work, too, as it is extremely selective and sensitive. Only two controls figure on the panel of the particular "N" we are going to describe constructionally. One is a variable condenser for wave-length tuning adjustment, and the other the filament resistance by which the set is turned on and off.

As well as providing excellent reproduction, one knob tuning control and selectivity and sensitivity above the average, this "N" receiver cannot cause interference with neighbouring receivers. Admittedly, this last is a virtue that will appeal more to other listeners than to the actual owner, but the other advantages are so great that on their consideration only it must be admitted that the "N" is an outstanding proposition.

Easy to Handle.

It is a receiver that is very easy to handle, no undue capacity effects exist, and the control is not critical; in fact, it is much simpler to operate than an ordinary "straight" set with reaction. But it requires careful assembly, and it is essential that the components specified be used and the layout as described strictly adhered to. A single diversion in either direction can cause, if not complete failure, considerable losses in efficiency.

The interim report published in our issue of May 1st dealt with two valve "N"

The first published news concerning the "N" circuit appeared exclusively in P.W. many months ago; later we exclusively published the first authorised report on the capabilities of the circuit, and in this issue we publish exclusively the first of a series of constructional articles on the "N" set. This, the first article, deals with an experimental type of "N" circuit; we shall publish in a subsequent issue, further articles on other forms of "N" circuit—THE EDITOR.



A recent photograph of our Scientific Adviser, Sir Oliver Lodge, F.R.S.

been discovered, however, that A.J.S. coils are uniquely suitable, although Goswell's "Quality" types have been used with very good results. But more of this anon.

We do not propose to discuss the theory of the circuit in this article—that has been dealt with by Sir Oliver Lodge himself—we intend to confine ourselves to construction and operation details, further details of any advance in design being published at a later date if possible.

Types of Components Important.

A list of the components and materials needed is given on page 147. The "Silvertown" transformer is a particularly essential item; other types and makes are usually quite hopeless in this circuit. It may be as well to point out that unless the constructor obtains a "Silvertown" he might as well give up the task. It is peculiar that the L.F. transformer should make all this difference, but it is, nevertheless, a fact. Another critical item is the grid leak, although in this case and in the case of the other components it is straightforward electrical efficiency that is required and not special characteristics.

There is very little panel drilling to do—merely two holes for components and three or four for the baseboard. Everything in the matter of layout has been done for a specific purpose, and no attempt should be made to vary it in any way. Particularly does this apply to the coil holders, aerial and earth terminals, and the first valve holder. Constructors should carefully study the back-of-panel photographs at this point.

The three-plate variable condenser, which, by the way, *must have ebonite endplates*, should be mounted, and the filament rheostat fixed on the panel. The other components should be mounted as shown. The variable grid leak should be fixed directly on to the grid terminal of the valve holder. This can be accomplished by means of a small brass plate of about 3/4 in. in length. At one end of this a hole should be drilled to take the bottom end screw of the grid leak, and at the other a slot provided so that it can slip under the valve holder terminal screw. A rigid structure should result, the grid leak standing firmly vertically. Its other connection will contribute strength to the fixture. Then the ebonite terminal strips can be fashioned.

(Continued on next page.)

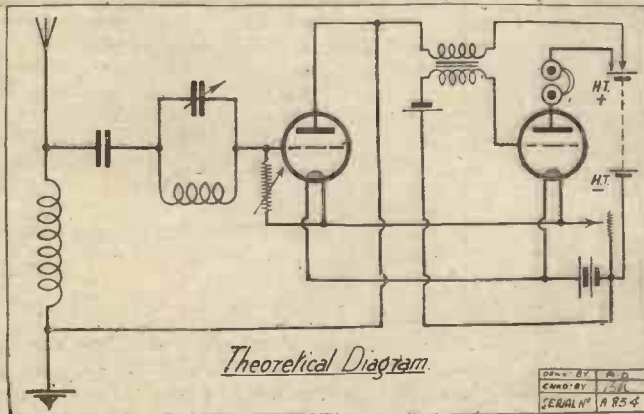

receivers of exactly similar nature to the one discussed in this article, so that readers will, by studying that report, gain a very complete idea of the capabilities of the set.

It will be noted that its aerial and earth requirements are normal, and that all wave-length ranges can be covered. This latter is accomplished by means of plug-in coils in the usual manner. It has

THE LODGE "N" RECEIVER

(Continued from previous page.)

One measuring 3 in. by 2 in. will be required to carry the aerial and earth terminal, and another 3 in. by 2 in. the batteries and 'phone terminals.

These should be fixed at the back of the baseboard as shown in the photographs. The wiring can then be commenced.

Now, it will not suffice merely to wire according to the wiring diagram and point-to-point list, for the wiring of the "N" is a very important detail. Square-section tinned wire should be used, and soldering wherever possible is essential. But the most important thing in connection with the wiring is the route of the leads. The wires must be run as direct as possible, with ample spacing and minus close "jump overs." Again, the back-of-panel photographs should be consulted, for they show more clearly than can words exactly what is meant.

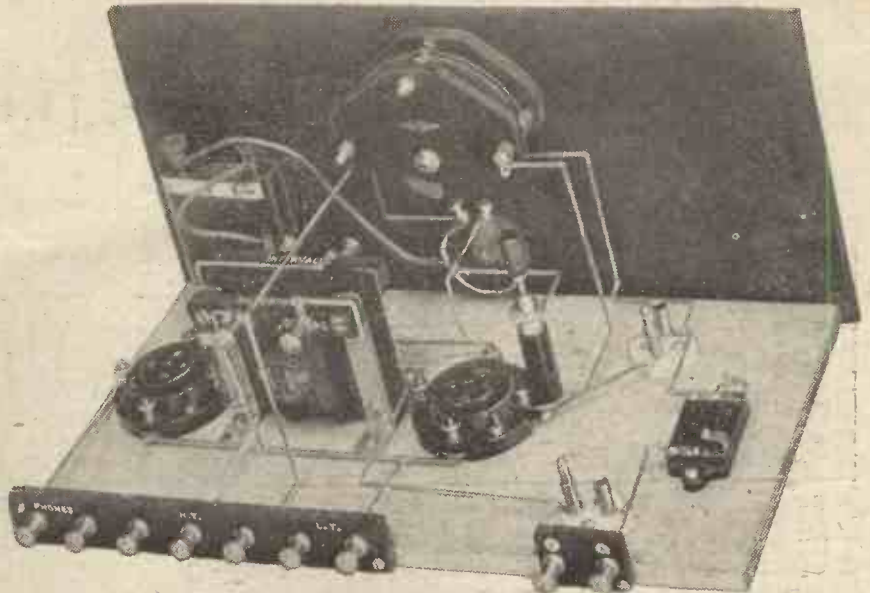

Note the direct wiring especially on the H.F. side of the receiver. The grid leak is fixed directly to the tag of the grid socket of the valve holder.

After the wiring has been carefully overhauled and checked, and all traces of fluxite and loose beads of solder removed, the set can be connected up to its batteries and tested out.

in the coil holder nearer the panel, which, with the three plate condenser, forms the "N" circuit, and for wave-lengths below 360 and down to about 320 metres a 125-turn coil should be used. We are given to understand that special coils having 125 turns are being made for this circuit, so that constructors should have no trouble in obtaining them.

On Test.

On test the receiver photographed worked well with either A.J.S. plug-in coils or "Quality" coils—the latter being of the double-wound basket type. The illustrations show the A.J.S. coil in position, and as the type of coil used has a direct bearing on the results obtained, we advise constructors to use the types mentioned.

The aerial coil should have about 45 turns to cover the broadcast band. The aerial is aperiodic or nearly so, and consequently this coil does not have to be changed on the 300-500 metre band unless ultra DX results are required.

Oscillation is controlled by the filament, the leak being set so that the receiver is just off oscillation point when the filament is a little "down." Then, on increasing the filament slowly the set can be brought up and over the point, so that distant carriers can be picked up.

Sharp Tuning

Tuning is sharp, but not unduly so, and the handling resembles that of a standard two-valve set with the difference that there is no "reaction" to worry about. The station is simply tuned-in with the variable condenser and strength is controlled by the filament rheostat, and that is all there is to it.

For local reception, the set can be left "set" and just turned on by the filament rheostat when required. It is extremely stable and the setting does not require readjustment every time the set is used, as is the wont of some receivers. As a household receiver, the "N" circuit 2-valver is difficult to beat, while it possesses all the requirements of the standard 2-valver, as well as easier control and more stability when it comes to DX reception.

For the reception of Daventry a 500-turn coil is needed in the "N" circuit and 150 in the aerial, though in this case, as in the case of the lower range, a variation of the aerial coil may improve results—depending upon the material properties of the aerial on which the set is used.

Suitable Valves.

Ordinary general-purpose valves can be used quite well, and this part of the set is

(Continued on page 149.)

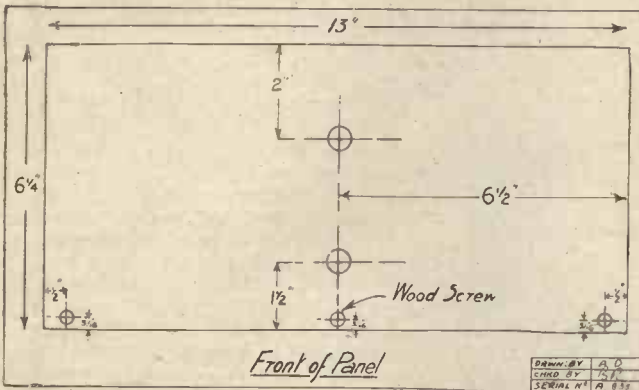

Two short, flexible leads with wander plugs should be provided for the grid bias battery connections.

For all wave-lengths between 360 and 500 metres a coil of 150 turns is necessary

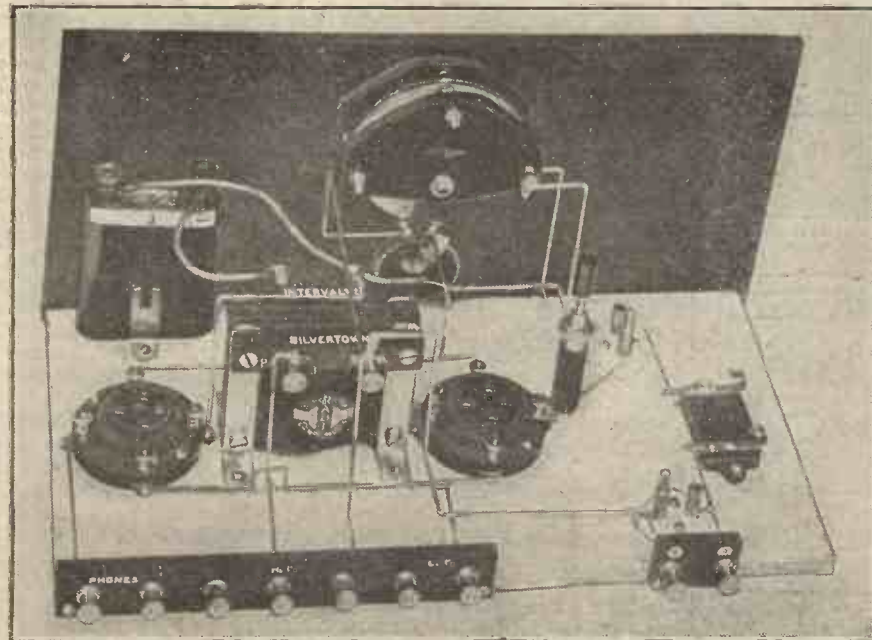

In conjunction with the other back-of-panel photographs, this illustration should be used as an aid to the wiring of the receiver.



ART and Science go hand in hand in the **Brown Cabinet Loud Speaker**. Beautifully finished in rich Mahogany or Oak, it will harmonise with the setting of any room, while in purity of tone and adequacy of volume it stands alone among Loud Speakers of this type. In resistances of 2,000 or 4,000 ohms. **£6.6.0**

Conscientiously made—for you

The careful, conscientious workmanship—the almost loving care with which **Brown** workers tend the instruments they make is almost akin to the pride with which the Craftsmen of old fashioned their work. This pride of work is distinctly reflected in the finished product—it will be obvious to you the moment you see a **Brown Loud Speaker or Headphone**.

Each **Brown Instrument** is conscientiously made; we, its sponsors, know that in it we have designed

a Loud Speaker which will give the most faithful rendering of the Broadcast it is possible to imagine; one that, in purity of tone and adequacy of volume, sets a standard in reproduction unequalled throughout the World. Because we want to pass this on to you, we are determined that not by the slightest deviation from the high standard of workmanship, nor by a moment's relaxing in the discernment with which only the finest quality materials are chosen, shall the astounding fidelity of **Brown** reproduction be prejudiced.

Brown

S. G. BROWN, LTD., Western Avenue, North Acton, W.3.

Retail Showrooms: 19, Mortimer Street, W.1; 15, Moorfields, Liverpool; 67, High Street, Southampton.

Wholesale Depots:—2, Lansdown Place West, Bath; Cross House, Westgate Road, Newcastle; 120, Wellington St., Glasgow; 5-7, Godwin St., Bradford; Howard S. Cooke & Co., 59, Caroline St., Birmingham. N. Ireland: Robert Garmany, Union Chambers, 1, Union St., Belfast.

Q

In addition to the Cabinet, there are eight other **Brown Loud Speakers**—a type for everyone from 30/ to £15.15 0.

Choose your Valves carefully —

For —
ONE-CELL ACCUMULATORS

For —
THREE-CELL ACCUMULATORS

"Cosmos" DE.11



The 1.1-Volt Valve that works well off a Dry Battery
Filament Current 0.25 Amp.
Amplification Factor 6.5

14/-

"Cosmos" SP.18/R SHORTPATH RED SPOT



The real 2-Volt Power Valve
Filament Current 0.3 Amp.
Amplification Factor 7

14/-

"Cosmos" SP.18/G SHORTPATH GREEN SPOT



A 2-Volt High Amplification Valve
Filament Current 0.3 Amp.
Amplification Factor 15

14/-

"Cosmos" SP.18/B SHORTPATH BLUE SPOT



The 2-Volt Resistance Capacity Valve
Filament Current 0.09 Amp.
Amplification Factor 35

14/-

A CAREFUL choice of the valves for use in the various positions of a receiving set will often make a wonderful improvement, and the time spent in making the choice is well worth while. The comprehensive range of "Cosmos" Valves shown on this page are shown for convenience under the general heading of the L.T. Supply—2-Volt and 6-Volt respectively—and some brief particulars are given to indicate their chief characteristics.

Particular attention is drawn to the S.P. 18/B and the S.P. 55/B (Blue Spot) Valves which are specially effective when used with the modern method of Resistance Capacity coupling, equaling the amplification obtained with L.F. Transformers and general purpose valves, with all the recognised advantages of resistance coupling.

Complete details of every valve cannot be given in the space at our disposal, so, in order to assist you in making a careful and satisfactory choice of a valve for each position in your set, the booklet illustrated below has been produced. It gives all the characteristics and features of the entire range of "Cosmos" Valves, and includes an easily understood table showing the best types of valves for use in the different positions or stages in various kinds of circuit.

Your dealer has a supply of these booklets, "The Soul of Music," and would be very pleased to give you a copy.

If by any chance you should have any difficulty in obtaining it write to:—

METRO-VICK SUPPLIES LTD.
Metro-Vick House,
145, Charing Cross Road,
LONDON, W.C.2.

VISIT STAND
No. 162,
Radio Exhibition, Olympia,
September 4th
to 18th, 1926.

A.45 "Cosmos"

A Bright Filament Valve for general purposes for 4.5 Volts
Filament Current 0.65 Amp.
Amplification Factor 9



8/-

DE.55 "Cosmos"

A 6-Volt Dull Emitter General Purposes Valve
Filament Current 0.09 Amp.
Amplification Factor 9



18/6

SP.55/R "Cosmos" SHORTPATH RED SPOT

The Loud Speaker Valve supreme for 6 Volts
Filament Current 0.25 Amp.
Amplification Factor 6



18/6

SP.55/B "Cosmos" SHORTPATH BLUE SPOT

The 6-Volt Resistance Capacity Valve
Filament Current 0.09 Amp.
Amplification Factor 35



18/6



A COSMOS VALVE FOR EVERY POSITION

THE LODGE "N" RECEIVER

(Continued from page 146.)

not critical. Good results have been obtained with two B5's, a B5 and B6 together, two B4's, Cossor bright and dull

POINT-TO-POINT CONNECTIONS OF THE "P.W." 2-VALVE "N" SET.

Aerial parallel terminal to socket of aerial coil holder and to one side of .0001 fixed condenser, other side of which goes to socket of "N" coil holder, and to moving plate of variable condenser. Plug of "N" coil holder and fixed plates of variable condenser to grid socket of first valve holder, and one side of variable grid leak. L.T. negative is joined to H.T. negative, grid bias positive, and one side of the rheostat. Other side of rheostat to one filament socket of each valve holder and to other side of variable grid leak. The two remaining filament sockets are joined together and to L.T. positive. Earth terminal to plug of aerial coil, plate socket of first valve holder and O.P. of L.F. transformer, I.P. of which goes to H.T. positive 1. O.S. of L.F. transformer to grid socket of second valve holder; I.S. to grid bias negative.

Plate socket of 2nd valve holder to one 'phone terminal, other 'phone terminal to H.T. positive 2.

emitters, Cleartron 2-volt valves, and several other makes. A valve that is a good detector in the ordinary sets will be O.K. in the "N" circuit, while the L.F. side is, of course, purely an L.F., and an L.F. or power valve should be used there if maximum volume is required.

H.T. and Grid Bias.

As regards H.T., this is also not at all critical and any voltage up to 120 can be used on both valves, depending upon the individual requirements of the valves themselves. A higher voltage will mean a louder volume—other things being equal—but as a rule 90 volts on the detector, and 100-120 on the L.F. will be all that is required.

Grid bias is advisable on the L.F. valve, and a battery of 4½ or 6 volts—tapped every 1½—should be used. This allows a higher H.T. voltage to be used on the last valve, and enables loud loud-speaker signals to be received without distortion—one of the most marked properties of the "N" circuit.

Such then are all the details necessary for the construction and operation of what must be the most interesting receiver of the year. It is sometimes helpful to fit

LIST OF COMPONENTS

1 Panel, 13" x 6½" x 1", with cabinet and baseboard	1	6	0
1 Peto-Scott 3-plate variable condenser	3	6	
1 Silvertown L.F. transformer	1	1	0
2 "Tiger" single-coil holders	5	0	
2 Lotus valve holders	2	9	
1 Peto-Scott rheostat (10 ohms)	3	0	
1 .0001 fixed condenser (.0001)	2	6	
1 Lissen variable grid leak	1	6	
1 4½ v. grid bias battery	2	0	
2 Terminal strips and 9 terminals	2	0	
Wire, transfers, etc.	2	0	

an extension handle on the spindle of the variable condenser, though the need for this will depend upon the depth of the condenser and the skill of the constructor in avoiding of head capacity effects due to badly spaced wiring.

It will take a little time for the constructor

The grid leak is a useful "vernier" control for reaction but often can be left set and all the control necessary for the bringing in of distant stations by filament rheostat.

We quote the statement made in report of May 1st, namely, that "we are of the opinion that the Lodge-Meliasky "N"

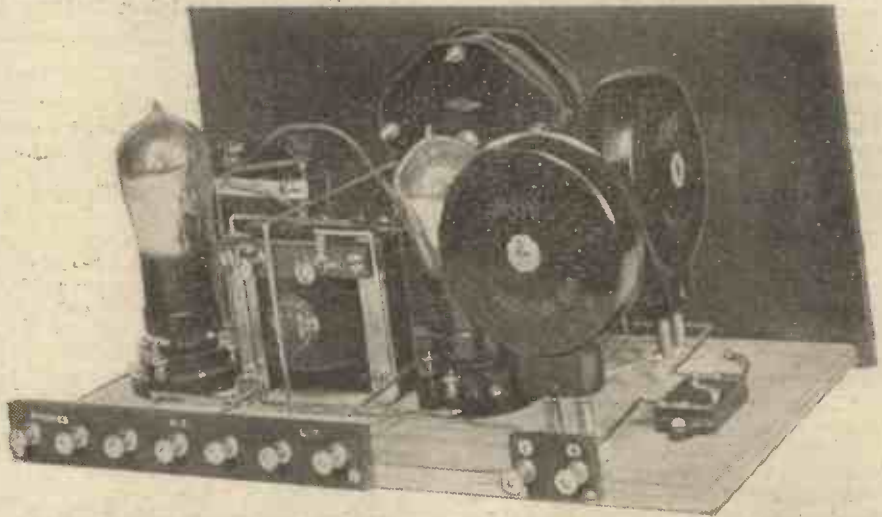

The 2-valve N. receiver with valves and coils in position. Two Cleartron valves are shown, while the A.J.S. coils are of 150 and 45 turns, the 150 being the "N" coil and nearest the panel. It is essential that the coils be at right angles to one another.

to get used to the handling of the set and the peculiarly sharp tuning and reaction control, but he will find that he will be able to pick up stations more rapidly with the "N" receiver than is possible with the average 2-valve employing loose coupled coils and magnetic reaction.

circuit is meritorious and constitutes a development in the improvement of wireless receivers, inasmuch as it simplifies control, eliminates magnetically coupled reaction, and greatly reduces the possibility of the set interfering to any appreciable extent with a neighbouring receiver.

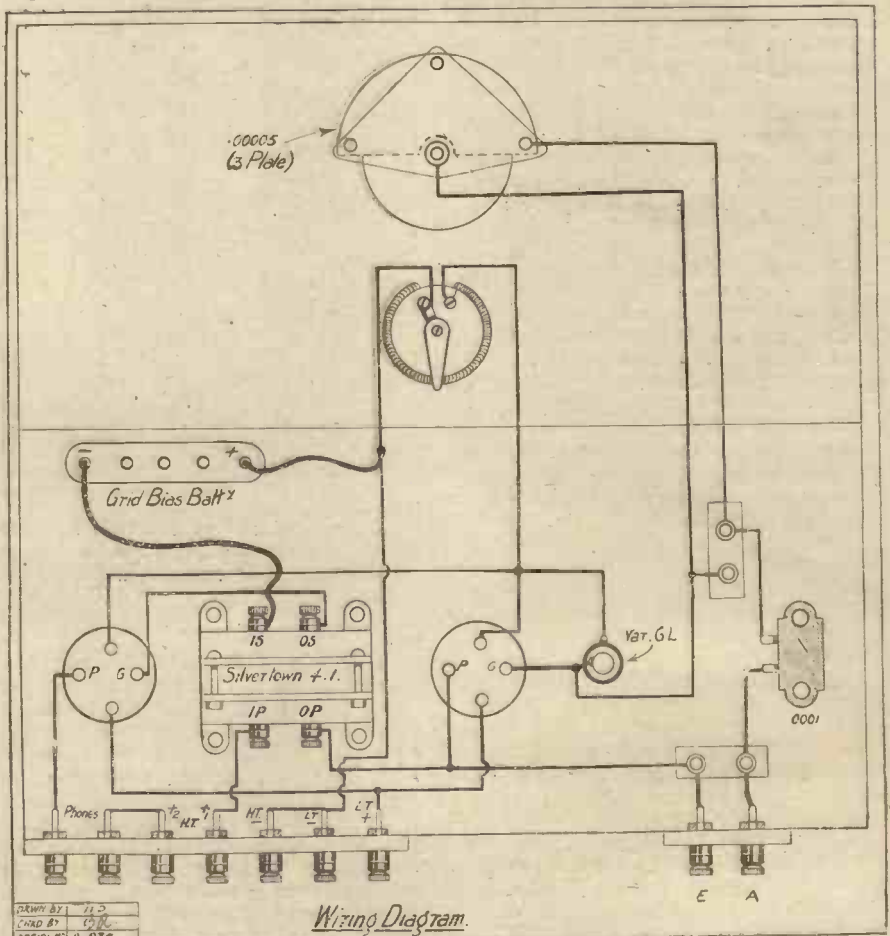

THE Radio Society of Great Britain and the Wireless League have, through a joint committee, recently launched a comprehensive scheme for the registration of wireless traders and repairers. The scheme—which we understand, is the result of many months of careful investigation and consideration of the various interests involved—is primarily concerned with the object of offering reasonable protection to listeners and with the raising of the status of the wireless industry.

Two Sections.

In a statement issued by the joint committee the organisers say that it is common knowledge that efficient wireless traders and repairers have had a difficult task in gaining the confidence of the public owing to the number of incompetent people claiming to be experts; and with this latter paragraph we are in complete agreement, for there are undoubtedly many inexperienced, not to say incompetent, "experts" who have been attracted by the popularity of wireless broadcasting and have set themselves up as efficient repairers of wireless apparatus, much to the detriment of the listeners.

A register is being compiled by the joint committee in order to eliminate this undesirable element in the industry, and to provide the public with trustworthy information as to the capabilities and bona fides, etc., of wireless traders and repairers. The committee has ample evidence of the manner in which accessories and apparatus have been damaged and even lost after removal from the owner's premises for purposes of repair, and their object is a praiseworthy one in attempting to prevent the repetition of such scandals.

The scheme provides for registration under either of the two following sections: (a) Approved Wireless Trader; (b) Approved Wireless Trader and Repairer. Section A includes those traders who can be depended upon to sell reliable goods and to give satisfactory service to the public. Section B, in addition to the above, includes those traders who are competent to undertake repairs and maintenance of wireless apparatus and accessories.

A Word of Warning.

Applicants for appointment as approved traders and repairers must satisfy the joint committee of their bona fides and will be required to furnish detailed information as to their premises, technical staff, machinery, &c. The premises of those appointed under the scheme will be periodically visited by accredited representatives of the joint committee, and these representatives will be independent of all trade influence.

Each registered trader will be allowed to exhibit a sign in a prominent position on his premises, and will be supplied with a certificate denoting his appointment. The joint committee hope that this scheme, promoted as it is by the two most important wireless organisations in the country, will receive the support of all concerned. Further particulars can be obtained from the offices of the joint committee of the Radio Society of Great Britain and the Wireless League, Chandos House, Palmer Street, S.W.1.

CURRENT TOPICS.

By THE EDITOR.

Registering Traders and Repairers—A New and Useful Scheme—The "P.W." Policy—Components and Constructional Articles.

We hope that the efforts of the joint committee will meet with every success, for there is no doubt that their objects are laudable and deserving of every support.

We must utter one word of warning, however, and that is: Listeners must not be influenced by this organisation until it has been proved that it has attained a satisfactory membership. It will be obviously unfair if a reader, on immediate knowledge of the above, were to sever business relations with some firm which has been giving him good service in the past.

In due course we shall know whether the efforts of the joint committee have been

WIRELESS, we do not concern ourselves with the selection of certain components because those components happen to be advertised in POPULAR WIRELESS.

For the Reader's Benefit.

The various members of our technical staff, when designing and constructing receivers for the purpose of ultimately describing them in this journal, select their apparatus according to their needs and to the needs of the sets which they are constructing. We are entirely uninfluenced as to whether such components have been or may be advertised in POPULAR WIRELESS.

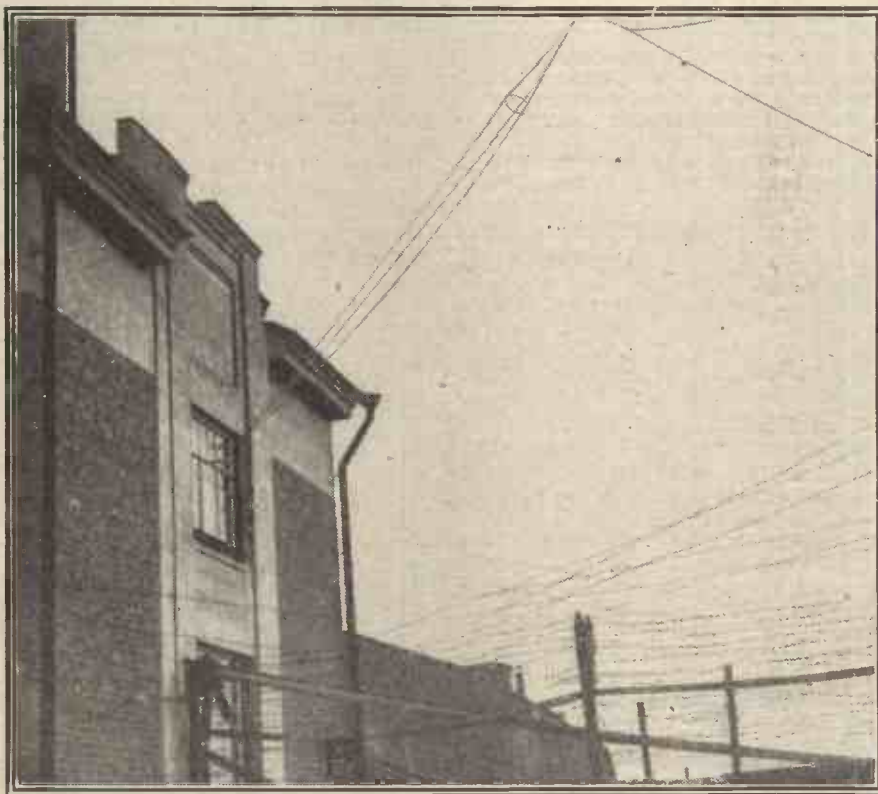

The lead-in and counterpoise of the Helsingfors station in Finland.

successful, and, if they are, then we would certainly advise readers only to deal, as regards repairs, at any rate, with members of that association.

The "P.W." Policy.

As certain of our contemporaries have issued statements regarding their policy in connection with components to be used in constructional articles, details of which they publish from time to time, we feel that we should make a brief statement regarding our own policy.

We have noticed in certain cases that it has been made clear that certain sets described in certain journals are to include only such components as may be advertised in the journals in question. We wish to make it quite clear to our readers that this policy

We, however, reserve the right to announce to manufacturers in advance the details of publication of our constructional articles, and to inform them of the components which will be used in various sets. This is a courtesy which we extend to advertisers in order that they may, for the benefit of their own advertising, take note of what type of set, etc., we shall be dealing with week by week for the benefit of our readers.

However, we would point out that we endeavour to use as much apparatus of a varied nature as possible in order that our selections may be as impartial as possible, and that will explain to the reader why so many various components are used from time to time in the constructional articles of POPULAR WIRELESS.]

is not the policy of POPULAR WIRELESS.

When publishing a constructional article in this journal we have in mind one thing only, and that is the needs of our readers. Whatever article of a constructional nature we publish in POPULAR

Osram Valves

for Broadcasting
and the NATIONAL RADIO EXHIBITION

DURING THE SHOW

The Show revealed that the same types of OSRAM VALVES that have been the favourites since the earliest days of broadcasting are still the accepted standard of excellence in design.

AFTER THE SHOW

Resolve NOW to cheapen your wireless, improve your wireless; *make it more reliable and pleasurable in every way;* by using OSRAM VALVES.

Dependable, sound and satisfying service, day in and day out—week after week—is then guaranteed.

The G.E.C.—your guarantee

EFESCA

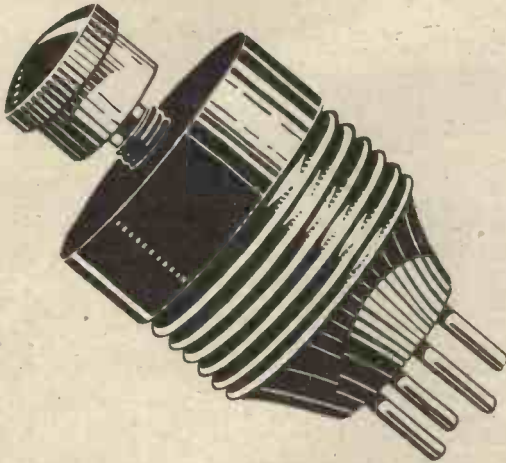

MAXITANCE

for greatest High Frequency Amplification

TRY this in place of your existing plug-in High Frequency Transformer; it will increase signal strength appreciably. Not only that, but where more than one H.F. stage is used you can match them yourself with absolute accuracy.

A single EFESCA "MAXITANCE" will cover the whole B.B.C. band from 275 to 500 metres. Interchangeable with all standard makes of H.F. Plug-in Transformers. The Efesca "Maxitance" is adjustable to the optimum value of wave-length covered by means of a frequency adjuster. No tapping switch or condenser necessary.

For 275 to 500 metres, 10/6 each.

Ask your Wireless Dealer or write for Catalogue No. 573/6. Wholesale only.

FALK, STADELMANN & Co., Ltd.,
83/93, Farringdon Road, London, E.C.1
And at Glasgow, Manchester, Birmingham, Newcastle & Dublin.



Use Efesca batteries

"Silvertown"

WIRELESS ACCESSORIES

Quality guaranteed by over 50 years' electrical manufacturing experience.



The SILVERVOX

The "Silvervox" Loud Speaker will reproduce both speech and music without the loss of its original tone and quality. Coils wound to either 120 or 2,000 ohms. The tone arm is a heavy aluminium casting. Total height 20 inches. Size of trumpet 12 1/4 inches diameter.

Price £3 : 0 : 0 each.

B.599. SILVERTOWN FILAMENT RHEOSTAT. ONE-HOLE FIXING.

Circular pattern, on ebonite former, complete with knob, pointer, black celluloid scale engraved in white, and two terminals for connections. The resistance wire is wound on an insulating rod, thereby giving a perfectly smooth adjustment. B.599 — Wound to approximately 5 ohms resistance. Price 3/- each. B. 600 — Wound to approximately 30 ohms resistance. Price 3/6 each.



B.570. 10-WAY INDUCTANCE OR CAPACITY SWITCH. (Patent 226215).

This switch is of the under panel mounting type, and is fitted to the panel by means of the two countersunk head screws supplied. It enables the experimenter to build up large capacities, and is an invaluable addition to any set. Price 5/6 each.



AN AID TO ENTHUSIASTS.

We have prepared a logging chart for recording wavelengths, condenser settings, etc., of those stations which require careful calibration to tune in. A copy of this chart, printed on stiff card, with hanger, can be obtained free of charge at any of our Branches or from any high-class dealer.

Makers:

THE SILVERTOWN COMPANY,
106, Cannon St., London, E.C.4. Works: Silvertown, E.16

BELFAST.
BIRMINGHAM.
BRISTOL.
CARDIFF.

DUBLIN.
GLASGOW.
LEEDS.
LIVERPOOL.

LONDON.
MANCHESTER.
NEWCASTLE-ON-TYNE.
PORTSMOUTH.
SHEFFIELD.



More Experiments with the Crystal Telephone

 * By J. F. CORRIGAN, M.Sc., A.I.C. *
 * (Staff Consultant.) *

THE interest created by the recent articles in POPULAR WIRELESS on the subject of the Miller crystal telephone was such that it is hoped that the present article—a sort of sequel to the former ones—may be of some practical and theoretical assistance to those experimenter readers of this journal who, being interested in matters pertaining to the practical application of the many-sided properties of the radio-sensitive crystal, may be thinking of carrying out further and more advanced experiments with the crystal telephone.

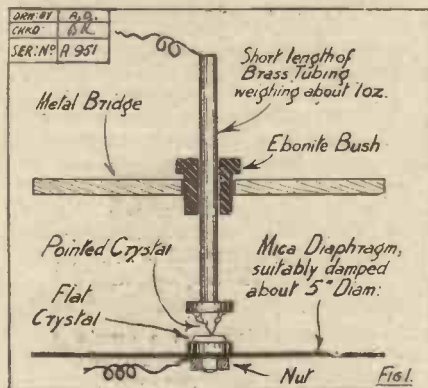

In the present article I do not propose to repeat the instructions regarding the actual making of the crystal telephone, such constructional details being given in POPULAR WIRELESS Nos. 195 and 196, to which the reader is referred also for a general description of the instrument, its properties, and the possibilities of its application. There are, however, many directions in which the crystal telephone can be experimented with, and also improved, and as such experiments are ones which require the minimum of apparatus to carry out, they will no doubt appeal in particular to the "small" radio experimenter.

Constructional Details.

So far, a satisfactory crystal telephone loud speaker has not been constructed, although a reasonable approach to such an ideal can be constructed by any interested amateur. In point of fact, this latter instrument is really the best and loudest form of the crystal telephone, its only disadvantage being its non-portability.

Fig. 1 shows in detail the construction of the large form of crystal telephone. It consists of a large round mica disc of about 4 to 5 inches in diameter, and about $\frac{1}{30}$ th of an inch in thickness. It is held in a metal or wooden frame which is fixed to a suitable wooden baseboard. A small, flat disc of galena is fixed in a small cup which is attached

to the exact centre of the mica disc or diaphragm by means of a brass nut.

Resting on the flat disc of galena is another galena crystal which has been sharpened down to a dull point, and which is contained in a suitable cup attached to the end of a hollow brass or copper rod. The brass or copper rod or tube passes at its upper end through an ebonite bushing placed in a metal bridge, this latter arrangement acting as a vertical support for the tube.

The tube itself, complete with crystal and cup, should not weigh more than one or two ounces, for the contact between the crystals under these conditions is made by gravity, and if the contact is too heavy the instrument will not function. The current, of course, is brought to both the electrodes of the instrument by means of stranded copper wire or flex.

Possible Improvements.

The above arrangement acts both as a crystal telephone and a crystal oscillator. In the latter case, the lower crystal on the mica diaphragm should be replaced by a small flat steel disc, and the upper crystal by a sharpened fragment of zincite. Used as a crystal oscillator in any suitable circuit for this purpose, the oscillation hum can be heard several yards away from the instrument. Such a device is not difficult to construct, and many detail modifications of its design may be effected if desired.

In general, there are two lines of experiment in the way of improving the efficiency of the crystal telephone. The first is to increase the efficiency of the necessary crystal contact. This is perhaps a difficult proposition, mainly because it has been found that the crystals which give the best results with the crystal telephone are also the ones which show the maximum efficiency when used as ordinary rectifiers. So that such a line

of experiment would necessitate the discovery of an entirely new variety of crystal, possessing better rectifying powers than any crystal or mineral known at present. Such a feat would, of course, be eminently desirable, but nevertheless it is not likely to be easily achieved.

Applied Potential.

The other line of experiment connected with the crystal telephone is the better one for the average amateur. It is to endeavour to increase the efficiency of the instrument by means of some radical modification of the circuit or circuits in which it is employed, or by devising some

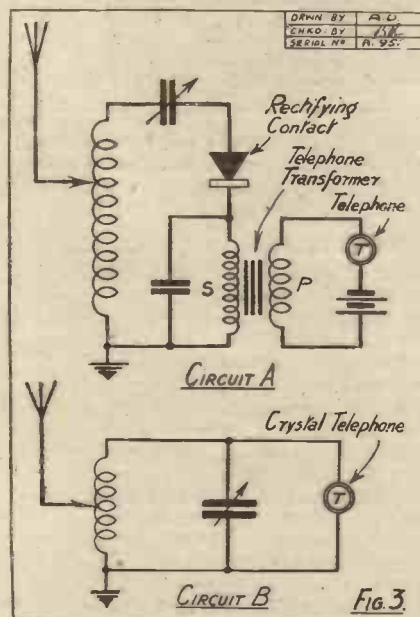

means of combining the well-known oscillating properties of many crystal contacts with their function of sound producing as is taken advantage of in the crystal telephone as it stands at present.

Now, it is not at all evident why the use of a local current should increase the efficiency of the crystal telephone. The instrument will act without the employment of any local current, and, under these conditions, the signals are quite as clear and distinct as they are when a local current is passing through the contact. However, they are very much fainter. Thus it seems that whilst the crystal contact does the sound producing work, the local current acts in some way as a sound amplifier.

Exactly how and why does the local current act as an amplifier in this direction? Again, we come up against a problem which has not been solved, and which presents much scope for further experiment. The crystal telephone functions by virtue of rapid expansions and contractions of the

(Continued on next page.)

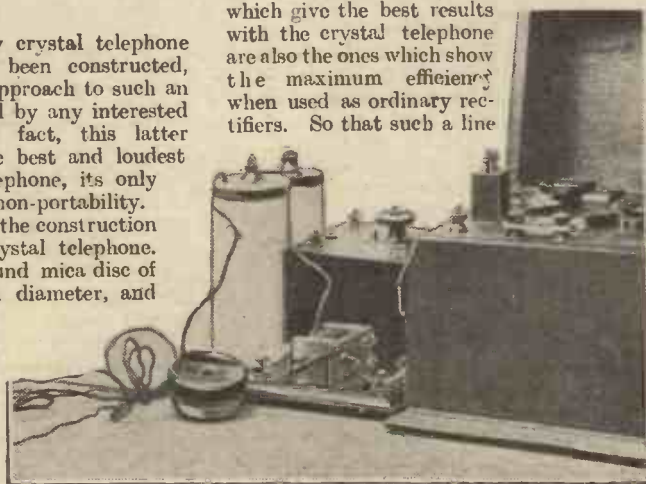
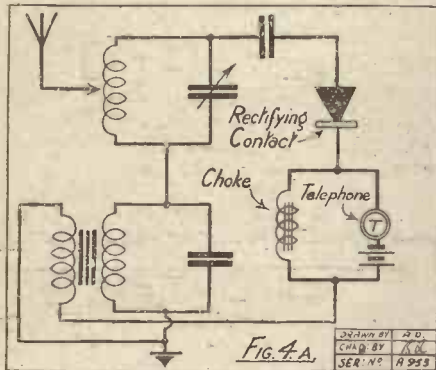

Fig. 2. Part of the apparatus used by Mr. Corrigan for testing a crystal telephone.

MORE EXPERIMENTS WITH THE CRYSTAL TELEPHONE.

(Continued from previous page.)

crystal contact under the influence of the imposed current pulsations from the tuner of the set, such movements being directly communicated to the diaphragm of the instrument. When an impulse of current comes along, it heats up the crystal contact. The expanding movement is then communicated to the diaphragm. But, before



the next current impulse can have any real effect, the contact must have had time to cool. Thus, quite as much depends upon the cooling of the contact as on its heating.

Increase of Volume.

Now, if we apply a local current across the contact, we increase its temperature. Things at a higher temperature cool more rapidly than things at a lower one. Thus, it is probable that when a local current is applied across the contact in a crystal telephone, the cooling of the contacts after each current impulse is more effective than is the case when the telephone is used without the local current, and, being more effective, a relatively greater push is given to the diaphragm with each pulsation of current, a greater volume of sound being thus produced.

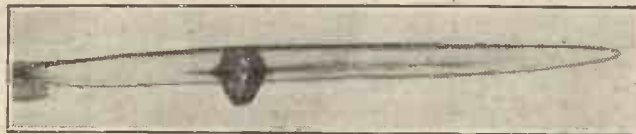
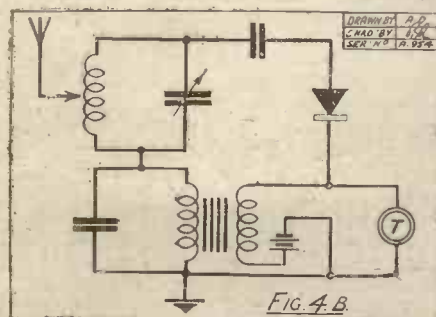

Fig. 5. An enlarged photograph of the contact crystal, showing the pointed shapes.



Again, the resistance of the crystals in the telephone is to a very great extent (the greater the better) confined to their actual point of contact. The resistance of the contact is always decreased with increase of local D.C. current, this alteration in resistance being, of course, quite independent of the changes incurred by the successive expansions and contractions of the contact

caused by the imposed current from the aerial circuit of the receiver.

To take an example. If a signal comes along which adds, say, one tenth of a volt to the battery volts, it will cause a much greater decrease in the resistance of the crystal contact if the battery E.M.F. is 4 volts than if it is 1 volt only. Thus, a more intense thermal effect will be set up at the crystal contact, the diaphragm of the 'phone will be more strongly actuated, and the all-round efficiency of the instrument will increase in consequence.

Some Interesting Circuits.

Here it is that careful experiments are needed in order to get the best results from the crystal telephone. What is the relationship between the physical condition of the crystal contact, the strength of the local current, and the resultant amplification of the sound-producing thermal changes at the point of crystal contact?

Fig. 3 shows two interesting circuits in which the crystal telephone can be employed. In circuit A it will be noticed that the telephone deals only with currents which have been rectified previously by means of an ordinary crystal rectifying contact. But circuit B indicates a mode of making the crystal telephone act as its own rectifier, thus combining the functions of rectifier and sound-producer.

It is an undoubted fact that the crystal telephone will act in this manner, albeit but feebly. Still the effect is there quite definitely, as any amateur can prove for himself, and the further study of this remarkable effect may quite possibly lead to the total elimination of the ordinary crystal rectifying contact from wireless

receivers. Such a possibility is an important one.

Another interesting line of experiment in connection with the crystal telephone would consist in an attempted reflexing of the current which passes through the local battery circuit by sending it through the primary of a transformer, the secondary of which is connected in series with an ordinary rectifying crystal contact.

Possible Reflex Arrangement.

The reader will, no doubt, immediately raise the objection that there is no alternating current in the battery circuit, and, on this account, the transformer would be unable to exercise its usual function. However, a little consideration will show that under the influence of the incoming current from the aerial circuit, the crystal contact in the telephone is always varying in resistance, and that, therefore, the battery will be passing a varying current all the time.

Two probable crystal reflex circuits for the purpose of the above experiments are given at Fig. 4 (A and B). These circuits are, of course, purely suggested ones, but nevertheless an experimental investigation of their properties would be of interest, and they could naturally be modified or elaborated as desired.

Although the crystal contacts for the telephone described in these articles have been composed of galena, it must not be imagined that this is the only mineral which will give practical results. Crystals, such as carborundum, ferro-silicon, silicon, and graphite all yield desirable results. And, in fact, they have perhaps one advantage over galena, in that the use of too much local sensitising current does not cause the contact to burn off as it does in the case of a pure galena contact.

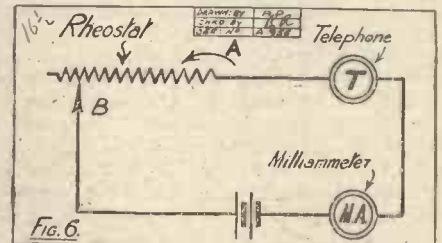

The adequate functioning of the telephone is largely dependent upon the physical nature of the contact and its correct adjustment. As a general rule, one crystal should have a perfectly flat surface. The other crystal fragment should have a blunt point. If the point is too sharp, the contact becomes almost impossible to adjust. On the other hand, if this crystal has too blunt a point, much sensitivity is lost. Fig. 5, which is a photograph on an enlarged scale, shows the approximate shape of the pointed fragment of crystal for successful use. In the photograph the pointed fragment of crystal is attached by means of solder to the diaphragm.

Testing Efficiency.

Testing the efficiency of a crystal telephone is an interesting job. The telephone is connected up in series with a milliamperemeter, variable resistance and a local battery, as indicated in the circuit diagram, Fig. 6. An ordinary tubular rheostat provides a suitable resistance for the above purpose. In the diagram, B represents the sliding-arm of the rheostat for the purpose of governing the current supply, whilst A indicates a small piece of wire, the purpose of which is to make and break a contact on a few turns of the rheostat.

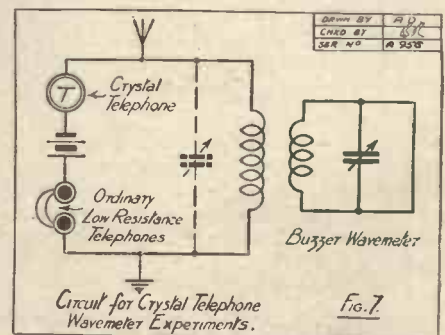

In order to test the sensitivity of the crystal telephone, the circuit—Fig. 6—is rigged up and a current of a few milliamps. is allowed to pass through the contact in the telephone.

This current being allowed to remain steady, a few turns, say two or three, of the resistance wire at A in the diagram are short circuited by means of a short length of wire. Under these conditions, if the crystal telephone is in sensitive condition,

(Continued on page 157.)



EXPLORERS!

Explorers have their eyes on Mount Everest. But Listeners have their ears thrilled by the perfection of the New EDISWAN $\frac{1}{4}$ -WATT VALVES.

Peaks of perfection they are! Snowy summits symbolize their low temperature, with consequent low current consumption. Ediswan Valves reach altitudes of sheer efficiency by avoidance of eccentric construction, AND BY CONCENTRATION ON THE PERFECTION OF EVERY PART; and they last, and last, and last!

Ask for Booklet, "The Ediswan Range" at your Dealer's or at the National Radio Exhibition.

NEW $\frac{1}{4}$ -WATT VALVES

Ediswan 2-Volt $\frac{1}{4}$ -Watt Valves				
H.F.	Detector	1st L.F.	2nd L.F.	
G.P. 2	D.K. 2	G.P. 2	P.V. 2	P.V. 6 (1-Watt)
	G.P. 2	P.V. 2	P.V. 6 (1-Watt)	
Resistance Combinations				
		*R.C. 2	P.V. 6 (1-Watt)	
*The anode resistance used should not be less than 1-5 megohms.				
PRICES: G.P. 2, D.R. 2, and R.C. 2, 1s/- each; P.V. 2 and P.V. 6, 18/6 each.				
RECOMMENDED EDISWAN COMBINATIONS				
Receiving	Accumtr. or Battery	Prices	Power	Prices
*A.R.D.E.	1.8-2	14/-	P.V. 6	18/0
†R.C. 2	1.8-2	14/-	P.V. 6	18/6
†R.C. 2	1.8-2	14/-	P.V. 2	18/6
G.P. 2	1.8-2	14/-	P.V. 2	18/6
D.R. 2	1.8-2	14/-	P.V. 2	18/6
*A.R. 06	3	14/-	P.V. 8	18/6
G.P. 4	4	14/-	P.V. 4	18/3
*A.R.	4	8/-	P.V. 4	18/6
A.R.	4	8/-	P.V. 4	18/6
*A.R.	6	8/-	P.V. 5	18/6
R.	6	8/-	P.V. 5	18/6

*Made in L.F. and H.F. Types.
 † When R.C. 2 is used as detector, anode bend rectification should be employed.
 All DULL EMITTERS-except A.R. & R.



NURSE YOUR SET.

THE EDISON SWAN ELECTRIC CO., LTD., 123-5, Queen Victoria St., LONDON, E.C.4

Invaluable to EVERY Amateur and Constructor.

The "POPULAR WIRELESS"

BLUE PRINTS of TESTED CIRCUITS

Every wireless amateur and every wireless constructor will find these "POPULAR WIRELESS" Blue Prints absolutely reliable. They have been most accurately drawn, and every circuit has been tested under normal broadcasting conditions by the technical staff of "Popular Wireless." It will be seen from the complete list given below that the series covers a very wide field. The veriest tyro will find each print most straightforward to follow and the receivers most easy to construct.

P.W. BLUE PRINT Number

1. DETECTOR VALVE WITH REACTION.
2. UNIDYNE DETECTOR VALVE WITH REACTION.
3. 1-VALVE L.F. AMPLIFIER.
4. CRYSTAL DETECTOR WITH L.F. AMPLIFIER.
5. H.F. (Tuned Anode) AND CRYSTAL, WITH REACTION.
6. H.F. AND CRYSTAL. (Transformer Coupled; without Reaction).
7. 1-VALVE REFLEX WITH CRYSTAL DETECTOR (Tuned Anode).
8. 1-VALVE REFLEX AND CRYSTAL DETECTOR (Employing H.F. Transformer, without Reaction).
9. H.F. AND DETECTOR (Tuned Anode Coupling, with Reaction on Anode).
10. H.F. AND DETECTOR. (Transformer Coupled, with Reaction).
11. DETECTOR AND L.F. (With Switch to Cut Out L.F. Valve).
12. DETECTOR AND L.F. UNIDYNE (With Switch to Cut Out L.F. Valve).
13. 2-VALVE REFLEX (Employing Valve Detector).
14. 2-VALVE L.F. AMPLIFIER (Transformer Coupled with Switch to Cut Out Last Valve).
15. 2-VALVE L.F. AMPLIFIER (Transformer-Resistance Coupled with Switch for Cutting Out Last Valve).
16. H.F. (Tuned Anode), CRYSTAL DETECTOR AND L.F. (with Switch for Last Valve).
17. CRYSTAL DETECTOR WITH TWO L.F. AMPLIFIERS (with Switching).
18. 1-VALVE REFLEX AND CRYSTAL DETECTOR, with 1-VALVE L.F. AMPLIFIER, Controlled by Switch.
19. H.F. DETECTOR AND L.F. (with Switch to Cut Out the Last Valve).
20. DETECTOR AND 2 L.F. AMPLIFIERS (with Switches for 1, 2, or 3 Valves).

ALL "POPULAR WIRELESS"
BLUE PRINTS—6d. EACH

All orders for these Blue Prints should be sent direct to the "Popular Wireless" Queries Department, Fleetway House, Farringdon Street, London, E.C.4, enclosing a stamped addressed envelope and a postal order for 6d. for each Blue Print Ordered.

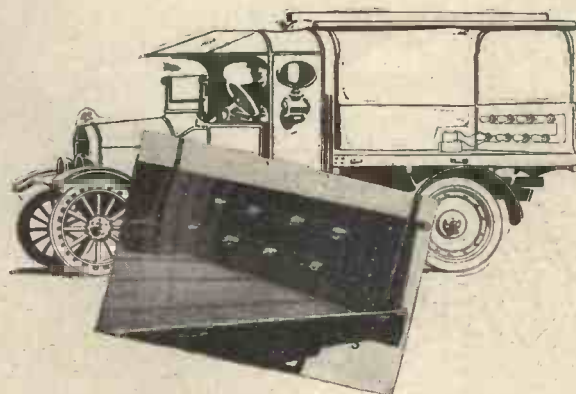

Here's Proof that
the 'LOTUS' Survives
Shock and is
anti-microphonic!

EIGHT Lotus Valve Holders fitted with large power valves and fixed to tailboard of a Ford motor lorry, driven over rough roads for 30 miles survived the test.

At the finish each spring was as it started—perfect. No damage or looseness at the connection of leg socket and spring—no valve became loose from the holder. Both were electrically perfect all the way.

That is why we guarantee the security of Lotus Valve Holders against shocks and vibration.

Fit the Lotus to *your* set and protect your valves

From all Radio Dealers

LOTUS
BUOYANCY
VALVE HOLDER
ANTI-MICROPHONIC

Pat. No. 256833.

Made from best bakelite moulding with springs of nickel silver and phosphor bronze valve sockets.

GARNETT, WHITELEY & CO., LTD.,
Lotus Works, Broadgreen Rd., Liverpool.
Makers of the famous "Lotus" Vernier Coil Holder

Prices :
Combination
GRIDLEAK
and VALVE
HOLDER
3/9
VALVE
HOLDER
With
Terminals
2/6
VALVE
HOLDER
Without
Terminals
2/3

A HANDY PLUG-IN CRYSTAL DETECTOR.

By C. C. PRIOR.

ONE of the advantages of the crystal detector is that it neither runs down like a battery nor burns out like a valve, and it is very useful to have at hand a crystal detector which may be plugged into the sockets of the valve should the latter suddenly give out. Such a stand-by detector is here described. For its construction are required two valve pins, a piece of ebonite tube $1\frac{1}{2}$ in. long, $\frac{3}{8}$ in. diameter, and with a bore of 4 B.A. clearance, two small angle brackets which may be made of strip brass (or may be purchased for a penny), three odd bits of 2 B.A. screwed rod, three 2 B.A. nuts, and a small strip of ebonite $1\frac{1}{4}$ by $\frac{3}{8}$ by $\frac{3}{16}$ in.

First drill out the ebonite tube in three-parts of its length to 2 B.A. clearance, and tap the remaining one-quarter 2 B.A. Next drill the ebonite strip to take the valve pins, the drilling centres being $16\frac{1}{2}$ millimetres apart. The angle brackets

perikon combinations (in the detector illustrated they are tellurium and arsenite) are dropped into the open end of the tube, a short piece of 2 B.A. rod about $\frac{1}{4}$ in. long is dropped into the tube on top of them, and the remaining bracket fixed to the ebonite strip by the remaining valve pin. A longer piece of 2 B.A. rod (about $1\frac{1}{2}$ in.),

fitted with a knob (made of a shorter length of the ebonite tube), is screwed through the nut on the bracket into the tube till the crystals are brought into contact. It will be observed that the small, loose piece of rod is inserted between the crystals and the adjusting rod, in order that the turning of the rod may not grind up the crystals. A small spring may be interposed, if necessary, in addition.

The drawing makes the construction clear. When once set, the crystal detector may be left indefinitely. Readjustment can, however, be effected by slightly withdrawing the adjusting rod and shaking or tapping the ebonite tube, afterwards screwing up the adjusting rod again.

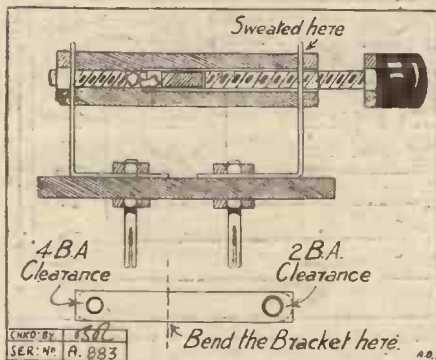

are made of two lengths of strip brass, each $1\frac{1}{2}$ in. long by $\frac{1}{4}$ in. wide. Bend each to a right angle at $\frac{3}{8}$ in. from one end. Drill a 2 B.A. clearance hole $\frac{3}{8}$ in. from the end of the longer arm of each bracket, and a 4 B.A. clearance hole $\frac{1}{4}$ in. from the end of each shorter arm.

A Stable Arrangement.

A 2 B.A. nut must be sweated centrally over the 2 B.A. clearance hole in one of the brackets. This must be done accurately, and the best method is as follows: First tin round the hole on the bracket and one surface of a 2 B.A. nut. Screw the nut on to a length of 2 B.A. rod, and pass the rod through the hole in the bracket, locking it on the other side with another nut, so that the tinned faces of the nut and bracket (after having been touched with flux) are clamped together. Then apply a hot soldering iron for some seconds to the nut to be sweated. Remove the iron and leave the bracket to cool. The locking nut and the rod may then be removed.

Screw a short length—say $\frac{3}{8}$ in.—of 2 B.A. rod into the tapped end of the tube, leaving about $\frac{1}{8}$ in. outside. The plain bracket can now be secured to this end by a nut, and fixed to the ebonite strip by one of the valve pins.

Two pieces of crystal of any of the



Members of the Golders Green and Hendon Radio Society carrying out tests during a recent field-day at Berkhamstead.

MORE EXPERIMENTS WITH THE CRYSTAL TELEPHONE.

(Continued from page 154.)

no alteration of the milliamperemeter reading will result from the local short circuiting; but, nevertheless, the make and break of the local short circuit at A will be very distinctly heard in the 'phone.

Microphonic Effects.

The current supply may now be varied by means of the sliding arm of the rheostat, until a point is reached at which the local short circuiting at A produces the loudest sound in the 'phone; but, at the same time, does not affect the milliamp. reading. The general sensitivity of the telephone may be estimated in this manner, the greater the number of turns of resistance wire on the rheostat which may be locally short circuited without affecting the milliampere-

meter reading, but, at the same time, giving rise to a sound in the 'phone, the greater the sensitivity of that instrument.

Connect up the circuit shown in Fig. 7. As will be seen from the diagram, it merely consists of a pair of low resistance telephones, a local battery, a crystal telephone and a milliamperemeter (90 ohm resistance approx.) connected in series across an aerial tuning inductance. A buzzer wave-meter of any ordinary type is situated in the immediate vicinity.

Now, on operating the wave-meter, the tuning-in point will be heard in both the ordinary 'phones and the crystal telephone. Capacity effects, such as the approach of the hand to the tuner, can be more readily detected in the crystal telephone, the effect being very critical.

Place, now, a watch on the bench near the inductance. The tick of the watch will be plainly heard in the crystal telephone, provided the contact is in sensitive adjustment. This is an interesting microphonic effect, and it is apparently governed to some extent by the intensity of the current flowing across the crystal telephone contact.

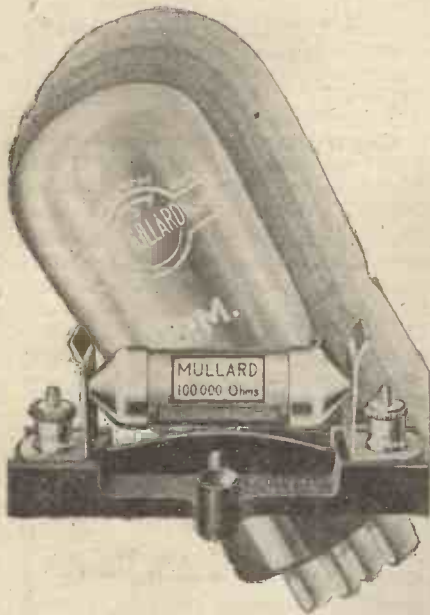

The Research behind the finest Valve behind a wire wound Anode Resistance

When one research organization controls several products, it follows that the same standard of efficiency must be applicable to each product marketed. The costly patient research which has resulted in the finest valve, lies behind THE MULLARD WIRE WOUND ANODE RESISTANCE, and it is placed on the market with the certain knowledge that its efficiency is the efficiency of the finest valve.

A resistance wound on a textile fibre core perfectly covered, and interlaced with the same material, ensuring the elimination of all self-capacity, and also that the fine metallic wire is rendered absolutely free from every particle of mechanical shock.

The temperature co-efficient is negligible, since the resistance is not set in wax but only covered with a thin layer of wax to allow a perfect dissipation of heat.

Mullard EVER-REST Wire Wound Anode Resistance (80,000 and 100,000 ohms) - 5/-
Complete with Holder 6/6

Also supplied in any intermediate values.

- Mullard Grid Leaks and Condensers.
- Type Grid B 0.5 to 5.0 megohms 2/6
- Type Grid B combined with .0003 mfd. Condenser Type MA 5/-
- Type MA Condenser .0001 to .0009 mfd. 2/6
- Type MB Condenser .001 to .01 mfd. 3/-

Leaflet P.W. free on request.

VISIT STANDS 136, 138, OLYMPIA, Sept. 4-18.



WIRE WOUND ANODE RESISTANCE

The MULLARD WIRELESS SERVICE Co., Ltd.
 Mullard House, Denmark St., London, W.C.2.

USEFUL SWITCHING ARRANGEMENTS.

By T. DOUGLAS BAKER.

"SIMPLICITY in operation" is the aim of most constructors nowadays. We have succeeded in cutting down the controls to a minimum, but unfortu-

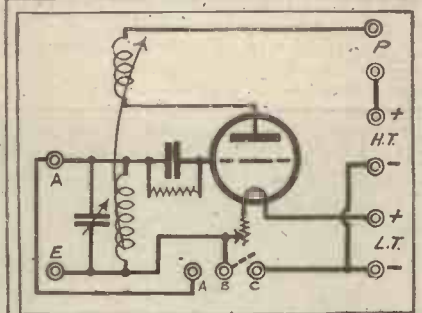

FIG. 1.

Drawn by A.D.
 Checked by J.C.B.
 Serial No. B 116

nately there is in most sets a certain amount of adjusting and connecting before the "music" comes. The condensers, coils and rheostats, etc., may be left untouched from night to night as they need little attention, but the trouble arises chiefly over connecting batteries, aerial and earth. To the constructor of the set this, although inconvenient, is not a difficult task; but for the inexperienced will prove confusing. For instance, in nine cases out of ten they will connect the red leads to negative and the black to positive, or, with more disastrous effects, the H.T. battery may serve to light the filaments (for a moment). Simple "Battery-Earth" Switch.

In view of this I have involved a switch that will cut out both H.T. and L.T. batteries and also short the aerial and earth terminals with one movement. The switch is an S.P.D.T., the pattern of course, being immaterial to the working. The connections from the switch are as follows: The moving arm is connected to earth; one pole of the switch is connected to the common battery negatives (the H.T. and L.T. terminals having been disconnected

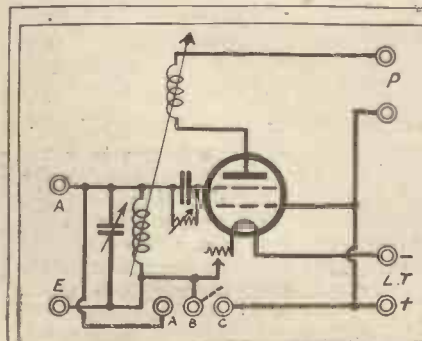

FIG. 2

Drawn by A.D.
 Checked by J.C.B.
 Serial No. A. 117

from the earth and rheostats, etc.), and the other switch pole is connected to the aerial terminal. A glance at Fig. 1 will explain a little better, perhaps. This is a straight one-valve circuit. When the switch A B C is in the B C position, the set is in working order, and when in the B A position the batteries are satisfactorily disconnected and the aerial "earthed." Fig. 2 is a one-valve "Undyne" circuit, with switch. In this case, there being no H.T., the use of the switch is two-fold.

There is no fear of leakage even between two H.T. positives when two are employed, as in Fig. 3. Readers who adopt this arrangement will find it entirely satisfactory and useful, as well as a bit of a novelty, but more than this, perhaps, it will be found a boon to other members of the family as well as the constructor himself, when he arrives home at night in a state of "discharge."

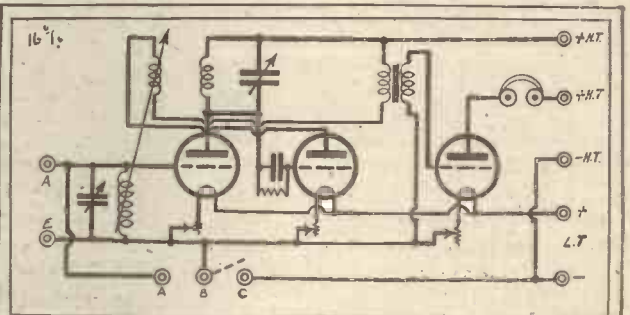
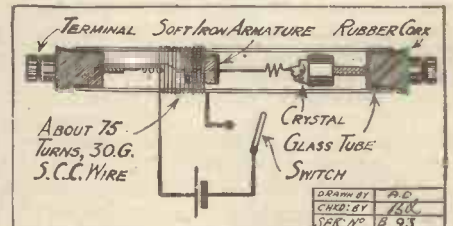

FIG. 3.

Drawn by A.D.
 Checked by J.C.B.
 Serial No. B. 118

A MAGNETIC CRYSTAL DETECTOR

A VERY interesting and effective crystal detector, which will give excellent results in all types of receiving sets, may be constructed in the manner shown in the diagram. A thin glass cylinder about 5 inches in length forms the body of the



detector. Two rubber stoppers, just large enough to fit tightly in the two ends of the glass tube, are needed. Terminal posts are mounted on these stoppers, one being connected with the cat's-whisker and the other to the crystal cup. The cat's-whisker is formed of two separate spirals joined by a small iron armature. A solenoid is then wound round the cylinder, as shown, and connected to a battery and switch. The readjustment of the detector is effected by closing and reopening the battery switch.

Drawn by A.D.
 Checked by J.C.B.
 Serial No. B. 93

Consistently perfect reception



Duo-triangular filament suspension

A COMPARISON between the principles applied in different branches of engineering science is always interesting. Here, for instance, on the one hand, we have the Warren Girder—typical of some of the world's big engineering feats—built up triangle after triangle, each adding stability to the structure as a whole, and on the other, intriguingly similar, the Six-Sixty method of filament suspension in which a corresponding degree of stability is ensured by a dual system of triangles.

But in addition to the inherent stability of the Duo-Triangular system of suspension, this construction renders it unnecessary to assemble the filament in tension, and enables equal and relatively short supports to be employed, with the result that the filament is in perfect alignment, and all possibility of displacement in any direction is eliminated. In the usual type of valve with one long and two short supports, the same degree of stability is not possible owing to the greater tendency to bend on the part of the longer support.

We have, then, a perfectly designed construction in which the relative positions of filament, grid, and anode are absolutely fixed, thereby ensuring uniformity of results, and consistently perfect reception.

And remember, Duo-Triangular Filament Suspension means increased electronic emission, since the length of filament is almost twice that in the usual type. And what a filament! Absolutely no sign of "glow" when operating at the rated voltage, and a current consumption of only .1 amp.

After exacting and exhaustive tests, Messrs. A. J. Stevens (1914) Ltd. have decided to standardise SIX-SIXTY Valves in their famous "Symphony" Range of Receivers.

Descriptive Leaflet S.S. 9-26 giving full particulars of complete range, free on application.



S.S. 2A. H.F. and L.F.

D.E. 1.8 volts, .1 amp., H.F., L.F. & Detector 14/-

S.S. 10.

D.E. 2 volts, .15 amp., Power Amplifier .. 18/6

S.S. 7.

D.E. 3.7 volts, .1 amp., Power Amplifier .. 18/6

S.S. 8.

D.E. 3-4 volts, .1 amp., General Purpose .. 14/-

These prices do not apply in the Irish Free State.

SIX-SIXTY VALVES
Better by Six times Sixty.

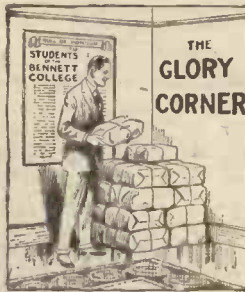

This is the Glory Corner at The Bennett College. We give it that name because it contains in bundles about One Hundredweight of letters which we have received from Grateful and Successful Students. We keep all these thousands of unsolicited testimonials as a fountain of inspiration and because we are really proud of them. Having helped thousands of others to achieve success and advancement, it may be possible that we can help YOU.

I am assisted by a large and expert staff and the advice we give is sound. If we cannot help you we will say so; if we can we will tell you how.

We have FREE booklets setting out the possibilities in connection with each of the subjects shown in the lists; send for the one in which you are interested, or ask for MY PRIVATE ADVICE, which also is free. You incur no obligation.

COMMERCIAL

- Accountancy
- Advert. Writing
- Salesmanship
- Army Certif. Courses
- Auctioneering and Estate Agency
- Auditing
- Banking
- Book-keeping
- Commercial Arithmetic
- Commercial Law
- Company Law
- Costing
- Economics
- English and French
- Executorship Law
- Foreign Exchange
- General Education
- Modern Business Methods
- Police Entrance and Promotion Courses
- Secretaryship
- Workshop Organisation

TECHNICAL

- Applied Mechanics
- Architectural Drawing
- Building Construction
- Clerk of Works' Duties
- Boiler Engineering
- Boiler Making
- Chemistry
- Civil Engineering
- Concrete and Steel
- Draughtsmanship
- Electricity
- Engineering
- Engineering Costing, Quantities and Specifications
- Foundry Work

GOOD REASONS

why you should join The Bennett College.

1. We give a written guarantee of success.

2. We supply all the necessary books FREE.

3. We have expert tutors for every department.

4. We teach by post—you study in your spare time.



Yours sincerely,
J. Bennett

Have You ANY Ambition?

Most moderate charges, payable monthly. No extra fees.

TECHNICAL (contd.)

- Heat Engines
- Internal Combustion Engines
- Marine Eng. B.O.T.
- Mathematics
- Matriculation
- Metallurgy
- Mining
- Mine Surveying
- Motor Engineering
- Naval Architecture
- Pattern Making
- Quantity Surveying
- Sanitation

TECHNICAL (contd.)

- Shipbuilding
- Structural Engineering
- Surveying and Levelling
- Telegraphy & Telephony
- Town Planning
- Wireless Telegraphy
- Works Managers Course

WE SPECIALISE IN PREPARATION FOR ALL EXAMINATIONS IN CONNECTION WITH THE ABOVE SUBJECTS.

Note Address: The Bennett College, Dept. 106, Sheffield.



ULTRA LOW-LOSS

Straight Line Frequency Condenser Conc Bearings. Braced Vanes, Positive Collector. A real precision job.

Condenser only, .0003uF., .0005uF. .. 9/-
Condenser with plain Dial. Standard 1/2 watt .. 10/6

Send for Catalogue and Descriptive Literature of complete Formo Range THE FORMO COMPANY Crown Works, Cricklewood, N.W.2

Manchester: Phone: Hampstead 1787.
Mr. J. B. Leves, 23, Hartley St., Levenshime
Phone: Heaton Moor 475
(See page 160 for Formo Transformers)





Traders and manufacturers are invited to submit wireless sets and components to the "P.W." Technical Dept. for test. All tests are carried out with strict impartiality in the "P.W." Test room under the supervision of the Technical Editor, and the general reader is asked to note that this weekly article is also intended to provide a reliable and unbiassed guide as to what to buy and what to avoid.—EDITOR.

BURNDIPT VALVES.

WE have recently had an opportunity of testing some more of the valves manufactured by the Burndept Wireless Co., Ltd.—namely, the types HL 425 and LL525.

TYPE HL 425.—H and L indicate, respectively, that the valve is suitable for high and low amplification; in other words, it is designed for general purposes. The 425 is also perfectly self-explanatory to those acquainted with the Burndept method of designation, and denotes the valve requires 4 volts and consumes .25 filament amps. Its amplification factor is 8.5, and its impedance 10,000 ohms. Different manufacturers have different ideas as to what constitutes ideal characteristics for a general purpose valve, for the solution to the rather difficult problem of attaining such an ideal is one of compromise. In the HL 425 Messrs. Burndept have given a bias to the L.F.

properties of the valve without unduly prejudicing its H.F. capabilities. The result is that it can be used for medium power work on the L.F. side, and is capable of handling pretty heavy inputs. Its makers curves indicate that it can deal with a grid swing of 16 volts when 9 volts grid bias and 170 volts H.T. are used. At 120 volts with 6 volts grid bias it can still handle a swing of over 10 grid volts, and this represents sufficient volume for quite a fair-sized room. In the circumstances, it was not surprising that we found the HL 425 to be a better rectifier and L.F. amplifier than an H.F. amplifier, although it functioned with commendable efficiency in this capacity. The HL 425 is one of the most interesting four volters we have tested, and if, in conclusion, we state that in our opinion its H.F. performances were far superior to those anticipated, perhaps some idea of its all-round efficiency will be given.

TYPE LL 525.—This valve is even more interesting than the HL 425, as the following description will show. Taking .25 amps at 5 volts its impedance is but 3,000 ohms. Nevertheless its amplification factor is 3.3. Capable of handling grid swings of 30 volts with only 120 volts on the plate (15 volts grid bias), it is essentially a power valve able to deal with heavy inputs and to deliver a volume sufficient for really large rooms. It was designed to operate with 750 ohms loud speakers of the Kone and new Burndept types. A point well worth bearing in mind is that a valve of the LL 525 type does not provide greater magnification than an ordinary power valve; in fact, in the case of small inputs, it will probably give less, but it is an efficient alternative to paralleled valves in the last stage of a powerful receiver. For instance, amateurs possessing super-hets. followed by three or so stages of resistance-coupled L.F. amplifiers built for out-of-doors loud-speaker work or for concert hall or ballroom reception, will realise the difficulty of efficiently handling the resultant energy. In the LL 525 Burndept valve, providing that it is employed with a suitable speaker, they now have an economical "last stager" which, in our opinion, is as good as, if not better, than anything in its class.

THE NEW LISSSEN L.F. TRANSFORMER.

Owing, no doubt, to their new method of trading, details of which were recently given in these pages, Messrs. Lissen are able to place an efficient L.F. transformer on the market at the definitely competitive price of 8s. 6d. Amateurs with short

(Continued on page 162.)

An INTERNATIONAL RADIO EXHIBITION

When you have visited the RADIO EXHIBITION at Olympia, you will still wish to see the best Radio Productions from all other parts of the world.

DO NOT FAIL TO PAY A VISIT TO STAND No. 48 at the MODEL ENGINEERING EXHIBITION Horticultural Hall, from September 17th to 25th,

where we shall be showing the best of the world's productions in Radio Apparatus.

CATALOGUE FREE at Stand, or send 6d. to cover cost of postage and packing. The world's finest international radio guide.

WILL DAY, LTD.,

19, Lisle St., Leicester Sq., London, W.C.2
Telephones: Regent 4577. Telegrams: Titles, Westrand, London.



REDUCED PRICES FOR 1927.

'001	7/-
'00075	6/-
'0005	5/3
'0003	4/3
'0002	4/-

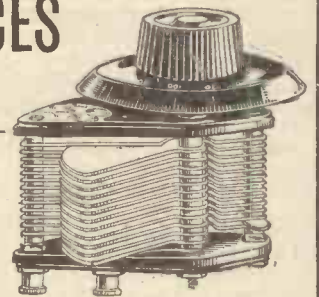
Bakelite End Plates. Positive Contact.
Dely. Ex-Stock. Goods sent C.O.D. Carriage Paid.



H. E. ASHDOWN (BIRMINGHAM) LTD., PERRY BARR, BIRMINGHAM.

A MONUMENT IN THE MARCH OF PROGRESS

The Formo Shrouded Transformer is the universal favourite
Made in Ratios 1-1, 1-2, 1-3, 1-4 and 1-5
10/6 1-3 and 1-5 for 1st and 2nd stages

Send for Catalogue and Descriptive Literature of Complete Formo Ranges

THE FORMO COMPANY
Crown Works, Cricklewood, N.W.2
Phone: Hampstead 1787.
Manchester: Mr. J. B. Leree, 23, Hartley St., Levenshulme.
Phone: Heaton Moor 475.
(See page 159 for Formo S.L.F. Condensers.)

*A New
Dubilier
Product*

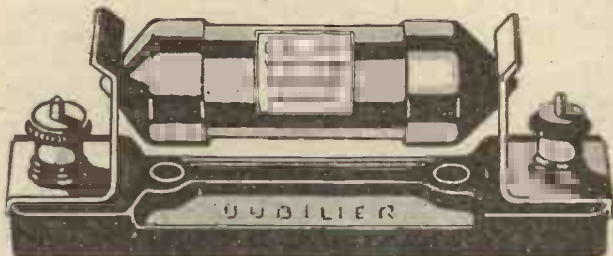

The Dubilier wire-wound resistance

No new Dubilier Product is placed on the market until it has undergone prolonged tests under working conditions.

In this manner you can always be assured of the perfect reliability of any product bearing the Dubilier name.

The new Dubilier Wire Wound Anode Resistances will be found to be ideal for resistance capacity circuits.

Self induction and self capacity effects are virtually non-existent, and the resistance values remain constant throughout all variations of climatic conditions.

20, 30, 40, 50, 60, 70, 80, 90 and 100 thousand ohms. 5/- each.
200 thousand ohms. 8/- each.
HOLDERS (as shown, extra) 1/6 each.

Specify Dubilier.



ADVT. OF THE DUBILIER CONDENSER CO. (1925), LTD., DUCON WORKS, VICTORIA ROAD, N. ACTON, LONDON, W.3. Tel. Chiswick 2241-2-3. E.P.S. 212.



Here is
a New
Super
Valve

BURNDEFT

NEW materials and improved methods of manufacture enable us to produce valves whose filaments are mechanically stronger than any other of similar type, and they will stand excessive current to an astonishing degree. Thus breakages of valves in transit are avoided, and accidents due to a valve being over-run do not result in the emission being destroyed. Another safety feature is the absence of the little pointed "pip" at top of valve, a Burndeft innovation that also prevents breakage, there being nothing to catch wires, etc.

Long life and absence of microphonic noises are special features of the New Season's Range.

Type L.L. 525 is a Super Power Valve, designed for the last stage of an amplifier where great volume is required. Its high emission and good characteristics ensure perfect reproduction.

Type L.L. 525. Super Power Valve, 5 volts, 0.25 amp. Emission 35, ma., μ 3.3. Impedance 3,000 ohms. H.T.: -120 v. 22 1/6 (grid-15 v.); 150 v. (grid-20 v.)



Head Office & Factory: Blackheath, London, S.E.3
Telephone: Lee Green 2100. Telegrams: Burnacoil, Phone, London.
London Office & Showrooms: Bedford St., Strand, W.C.
Telephone: Gerrard 9072. Telegrams: Burndeft, Westrand, London.
Agents and Branches Everywhere.

APPARATUS TESTED.

(Continued from page 160.)

pockets will appreciate this British alternative to cheap foreign productions, for it must be pointed out that this new Lissen component replaces all their previous models. It is a Lissen L.F. transformer and not merely the cheapest one of a range. And having all the backing of this firm's well-earned reputation for careful design and masterly construction as well, who would not buy British?

An L.F. transformer is a very important component in a set, and can do much more towards making or marring results than say a coil or even a variable condenser. In fact, a really bad L.F. transformer will do more to render loud-speaker work unpopular than a bad loud speaker. "Tinniness," "woolliness," "harshness," and what not are more often due to frequency distortion arising "behind" the L.S. terminals than is realised by many listeners. The choice of an L.F. transformer requires discrimination—it is much more than a mere hank of wire wound on a lump of iron—or, at least, should be if it is to deserve the name.

Messrs. Lissen's new product is well up to Lissen standard. It is well made and nicely finished, and gave very creditable results on test. It is excellent value for money, and we do not think that there is another up to at least double the price that can beat it.

"SIX-SIXTY" VALVES.

The Electron Co., Ltd., have revised their range of "Six-Sixty" valves, and have made several important additions to it. A sample of each of their six latest types was recently submitted to us, and we append full details of these, accompanied by our comments subsequent to a careful series of tests.

S.S. 2a H.F.—Price 14s.—Filament voltage, 1.8 volts; filament current, .1 amps; anode voltage, 50–100 volts; mutual conductance, .50 ma. volt; anode impedance, 27,000 ohms; amplification factor, 13–14; total electron emission, 8 ma.

This economical little valve gave very satisfactory results indeed, more especially in a straightforward detector position. Using 60 volts H.T. rectification was efficiently carried out, with a sensitivity of almost "soft valve" order accompanied by perfect stability. In an H.F. position it also proved quite stable, but had just that "liveliness" necessary to give it "DX" qualities.

S.S. 2a L.F. Price 14s.—Filament voltage, 1.8 volts; filament current, .1 amps; anode voltage, 50–100 volts; mutual conductance, .46 ma. volt; anode impedance, 18,000 ohms; amplification factor, 8.5; total electron emission, 8 ma.

Tested in a first stage L.F. position the S.S.2a operated well in conjunction with the S.S. 2a H.F. as a detector.

S.S. 8. Price 14s.—Flament voltage, 3–4 volts; filament current, .1 amps; anode voltage, 50–125 volts; anode impedance, 18,500 ohms; amplification factor, 13; total electron emission, 15 ma.

Here we have a very useful general purpose valve for use with a four-volt

accumulator of small capacity. It gave satisfaction in all three positions.

S.S. 10. Price 18s. 6d.—Filament voltage, 1.8 volts; filament current, .15 amps; Anode voltage, 50–100 volts; mutual conductance, .61 ma. volt; anode impedance, 7,700 ohms; amplification factor, 5; total electron emission, 20 ma.

We were considerably impressed by the performance of this little power valve. It handled considerable volume with the freedom from wave distortion usually only associated with six-volters. Its mutual conductance, as per its makers, is not exciting, and its amplification factor is not particularly high, and the same applies to its emission, but the fact remains that it gives what is an almost abnormal "punch" in the circumstances. This is a valve which will appeal strongly to the economical-minded amateur, to the "purity fan," as well as to the "noise ham."

S.S. 11. Price 18s. 6d.—Filament voltage, 5.5–6 volts; filament current, .1 amps; anode voltage, 50–100 volts; mutual conductance, 1.22 ma. volt; anode impedance, 6,000 ohms; amplification factor, 7.2; total emission, 30 ma.

A very versatile six-volter, capable of creditable performances in H.F., Det., and L.F. positions.

S.S.9. Price 18s. 6d.—Filament voltage, 5–6 volts; filament current, 0.1 amps; anode voltage, 50–125 volts; mutual conductance, 1.0 ma. volt; anode impedance, 20,000 ohms; amplification factor, 20; total electron emission, 25 ma.

A very excellent six-volter of the power type, and one that provides excellent magnification with a freedom from distortion when handling considerable inputs.



**MÉTAL
RADIO VALVES**

If you are not getting the results you expect, fit "Métal" Valves. A change of valves may make all the difference. "Métal" Valves are made by one of the largest and oldest makers on record. They are used by the French Government, and are the most popular valves abroad, and in U.S.A. Try a set of "Métal" Valves and note the purer tone and increased volume you get.

Type.	Fil. Volls.	Amps.	Price.
C.L.62	2	0.06	10/6
C.L.202	2	0.2	8/-
6/100	4	0.06	9/6
Power.			
C.L.502	2	0.5	12/-
C.L.104	4	0.10	15/-

Your dealer stocks them. Write for list showing all sizes.

Sole Distributors:
JOHN RAE, LTD., 60, BLACKFRIARS RD., LONDON, S.E. I.

MODERNISE YOUR SET



Modernise your set by fitting Igranic-Pacent Jacks and Plugs for all switching operations. By fitting Igranic-Pacent Jacks you can carry out simple or complicated switching operations, simply by inserting or withdrawing a plug. Igranic-Pacent Jacks are made in ten different patterns specially for radio work. Prices from 2/- each. Igranic-Pacent Plugs are made in four different patterns at prices from 1/6 each.

Send for new Igranic Publication "Jack Switching Diagrams." (List No. R.24)

IGRANIC ELECTRIC CO. LTD
149, QUEEN VICTORIA ST., LONDON.
Works: BEDFORD.

EDISON BELL RADIO

The new Edison Bell Bijou 2-valve set is a vastly improved model. Size 12x10x10 inches deep, moulded panel engraved with white lettering, it is an efficient and trustworthy set in every respect, it having one Detector and one Low Frequency Stage, and in addition a Grid Bias Battery and Filament Rheostat is provided. The whole circuit is built into an elaborate cabinet with a transparent oval front, enabling it to be closed when desired. Reaction is controlled by a novel lever movement, which is both simple and efficient. Supplied complete with Coils from 280-500 metres. Coils for high power stations supplied at additional cost.

Price £3 15s.

(Valves, Batteries and Marconi Licence extra.)



This and many other attractive and efficient Valve Sets, Components, etc., all guaranteed British manufacture, were exhibited at our Stand No. 75 at the National Radio Exhibition, which took place at Olympia from September 4-18. Ask your dealer for fully illustrated catalogue, or write direct to the company, when same will be willingly forwarded, post free.

EDISON BELL LIMITED,
LONDON, S.E.15.
AND AT HUNTINGDON.

TESTED 500 VOLTS
FLAT TYPE



THE NEW "BIJOU" 2-VALVE SET.

TESTED 500 VOLTS
UPRIGHT TYPE



INSIST ON EDISON BELL CONDENSERS

THEY ARE BRITISH MADE AND GUARANTEED BY A NAME WITH 30 YEARS REPUTATION BEHIND IT

CAXTON 4-VALVE CABINET

Made for Sets, "As good as money can buy,"
"Harmony Four Receiver," "The Melody Three"

Special Cabinets made to Customer's measurements. Prices quoted.

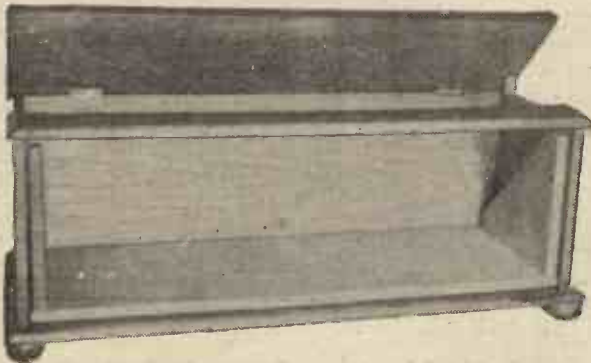

Cash with Order. Fumed Oak	...	£1 5 0
Dark or Jacobean Oak	...	£1 10 0
Real Mahogany	...	£1 14 0

Detachable 7" deep Base Board to mount 21" by 7" panel to slide out of Cabinet front.
Also supplied at 10/- extra with two beaded front doors placed 2 ins. in front of the enclosed panel.

Ebonite or Radion Panels Supplied and perfectly Fitted at low extra cost.

All Polished with the new enamel that gives a glass-hard surface that cannot be soiled or scratched. **SENT FREE.**—Catalogue of standard Wireless Cabinets in various sizes and woods.

Packed and delivered free in U.K. No. C3

CAXTON WOOD TURNERY CO., Market Harborough

7/6 solves your soldering problems for ever

No Home-Constructor can afford to be without the Fluxite Soldering Set, for not only does it make soldering simpler and neater, but the joints will always provide perfect contact with consequent better reception.

The Fluxite Soldering Set is exceptionally suited for Wireless: it is simple and compact, and will last for ever. It contains a special "small-space" soldering iron with non-heating metal handle, a really efficient pocket blow-lamp, Fluxite, solder and full instructions.

All Hardware and Ironmongery Stores sell the Fluxite Soldering Set, 7/6 complete. Fluxite can also be had in tins price 8d., 1/4 and 2/6
FLUXITE LTD.,
(Dept. 324),
Rotherhithe
S.E.18.

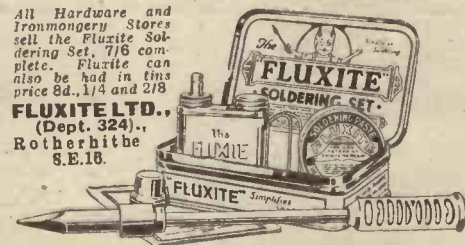

FLUXITE

RADIOTORIAL

All Editorial Communications to be addressed to The Editor, POPULAR WIRELESS, The Fleetway House, Farringdon Street, London, E.C.4.

Editor :
NORMAN EDWARDS, M.Inst.R.E., F.R.S.A.,
F.R.G.S.

Technical Editor :
G. V. DOWDING, Grad.I.E.E.

Assistant Technical Editors :
K. D. ROGERS. P. R. BIRD.

Scientific Adviser :
Sir OLIVER LODGE, F.R.S.

Staff Consultants :
Dr. J. H. T. ROBERTS, F.Inst.P.; J. F. CORRIGAN, M.Sc., A.I.C.; C. E. FIELD, B.Sc.,
E. J. SIMMONDS, M.I.R.E., F.R.S.A.

Foreign Correspondents :
F. M. DELANO, Paris; Dr. ALFRED GRADENWITZ, Berlin; L. W. CORBETT, New York; P. F. MARTIN, Italy; W. PEETERS, Holland.

The Editor will be pleased to consider articles and photographs dealing with all subjects appertaining to wireless work. The Editor cannot accept responsibility for manuscripts and photos. Every care will be taken to return MSS. not accepted for publication. A stamped and addressed envelope must be sent with every article. All inquiries concerning advertising rates, etc., to be addressed to the Sole Agents, Messrs. John H. Lile, Ltd., 4, Ludgate Circus, London. E.C.4.

As much of the information given in the columns of this paper concerns the most recent developments in the Radio world, some of the arrangements and specialities described may be the subject of Letters Patent, and the amateur and the trader would be well advised to obtain permission of the patentees to use the patents before doing so.

Readers' letters dealing with patent questions, if sent to the Editor, will be forwarded to our own patent advisers, where every facility and help will be afforded to readers. The envelope should be clearly marked "Patent Advice."

TECHNICAL QUERIES.

Letters should be addressed to: Technical Query Dept., "Popular Wireless," The Fleetway House, Farringdon Street, London, E.C.4.

They should be written on one side of the paper only, and **MUST** be accompanied by a stamped addressed envelope.

Queries should be asked in the form of the numbered questions: (1), (2), (3), etc., but may be accompanied by a short letter giving any necessary additional particulars as briefly as possible.

For every question asked a fee of 6d. should be enclosed. A copy of the numbered questions should be kept, so that the replies may be given under the numbers. (It is not possible to reproduce the question in the answer.)

BLUE PRINTS. A series of 20 Blue Prints can be obtained from the Query Dept., price 6d. per Blue Print.

Only a limited number of circuits are covered by this series, and full details of the circuit arrangements available in Blue-Print form are published fortnightly in the advertisement columns of this journal.

All other back-of-panel diagrams are specially drawn up to suit the requirements of individual readers at the following rates: Crystal Sets, 6d.; One-Valve Sets, 6d. One-Valve and Crystal (Reflex), 1s. Two-Valve and Crystal (Reflex), 1s. Two-Valve Sets, 1s. Three-Valve Sets, 1s. Three-Valve and Crystal (Reflex), 1s. 6d. Four-Valve Sets, 1s. 6d. Multi-Valve Sets (straight circuits), 1s. 6d. Except **SUPER-HETERODYNE DIAGRAMS**, all of which, irrespective of number of Valves used, are 2s. 6d.

If a panel lay-out or list of point-to-point connections is required an additional fee of 1s. must be enclosed.

Wiring diagrams of commercial apparatus, such as sets of any particular manufacture, etc., cannot be supplied. (Such particulars can only be obtained from the makers.)

Readers may submit their own diagrams, etc., for correction or for criticism. The fee is 1s. per diagram, and these should be large, and as clear as possible.

No questions can be answered by phone. Remittances should be in the form of Postal Orders.

Questions and Answers

INDOOR AERIAL.

C. R. J. (London, W.1).—I am anxious to receive the broadcasting programmes using a crystal or one-valve set. Owing to an objection by my landlady I am absolutely prevented from using an ordinary aerial of any kind. What is the best alternative in the circumstances?

As you are quite close to the broadcasting station there should not be much difficulty in receiving good signals from 2 L O, even without the use of any form

(Continued on page 166.)

TESTED PANEL GUARANTEED FREE FROM SURFACE LEAKAGE.

Ready for use

Your Panel Size 14.9 x 7.5 Price 6/6



RADIO BECOL PANELS

BRITISH **EBONITE** MADE

THE BRITISH EBONITE CO. LTD. HANWELL LONDON W.7.

STANDARD SIZE PANELS.

We are exhibiting at Olympia, Sept. 4-18, Stand 81.

→ "EKCO" H.T. UNITS ←

SCRAP DRY BATTERIES

by obtaining H.T. current from electric supply mains (D.C. and A.C.) by just attaching adaptor to electric light lampholder.

SAFE! SILENT! SOUND!

Units to Suit } from **42/6**
all Sets }

AN OUTSTANDING EXHIBIT
at the
NATIONAL RADIO EXHIBITION,
OLYMPIA, SEPT. 4TH-18TH.

Illustrated Catalogue FREE.
E. K. COLE, WESTCLIFF-ON-SEA.



Trade Mark "Nightingale." Copyright.

A PERFECT DETECTOR AT LAST! THE WONDERFUL

"Nightingale" Master Crystal Detector

TRADE MARK.

PATENT APPLIED FOR.

EMPLOYING phosphor bronze in firm contact with "Goldite," which has been a difficult and expensive wireless crystal to produce, the N.M.C. Detector has effected a very important advance in radio rectification. Unlike cat's-whisker and perikon arrangements, etc., "Goldite," an extremely hard crystal, is engaged with a considerable amount of pressure between two phosphor bronze contacts which cannot shift, and is not only a perfectly stable and exceptionally efficient rectifier of radio signals, but it also affords a higher degree of tonal purity than any other detector whatsoever, which alone will contribute an improvement to the reception of any wireless receiver employing any other kind of detection. In addition, the N.M.C. Detector has considerable distance sensitivity, definitely providing in all thoroughly reliable, and trouble-free detection of a powerful and particularly pleasing nature, hitherto impossible by any other means to obtain.

Apart from possessing such sterling qualities as a rectifier, "Goldite" tenaciously retains its sensitivity even under the most adverse conditions, and can be handled or exposed to any atmosphere without injuring it in the least. Moreover, you can procure this wonderful detector, which has no equal at any price.

COMPLETE FOR EASY PANEL MOUNTING AT 2/6. GUARANTEED FOR FIVE YEARS.

From your dealer, or post free from N. M. C. DETECTORS, 30, Princes Parade, London, N.3.

To the trade.—If you have not already obtained supplies, please write for particulars.

UTMOST TONAL PURITY—STABILITY—VOLUME. THE MOST PERFECT DETECTOR POSSIBLE TO PRODUCE

"All through the night, until the hour before the dawn, that marvellous voice shall hold the woodland spellbound."

RADIOTORIAL QUESTIONS & ANSWERS.

(Continued from page 164.)

of aerial to which objection could be taken. If the house is fitted with electric light we suggest you might try the "Ducon" aerial, which takes the form of a plug on a flexible lead. This is manufactured by the Dubilier Condenser Co., and utilizes the electric mains as an "aerial."

Alternatively, you could get results from a frame aerial wound in the form of a square with 2 ft. or 4 ft. sides. The former should have about 11 turns, and the 4 ft. type 5 turns, tuned with a '0005 variable condenser. Of the two the latter is better, but probably no frame aerial would give such good results as an indoor aerial of insulated wire wound round and round the picture-rail, or arranged criss-cross on to the ceiling, or in the same form as an outdoor aerial.

As you happen to live quite close to a powerful broadcasting station, you are fortunate in the fact that almost any aerial will do. At greater distances the importance of the aerial increases, until at distances of 25 miles or more the form and type of the aerial is one of the most important factors in the success obtainable with a one-valve or crystal set.

FITTING SEPARATE H.T. AND GRID BIAS.

E. G. R. (Camberley, Surrey).—"I have constructed your straight three-valve set that was described in POPULAR WIRELESS No. 183 (Nov. 28th, 1925). I should like to know how to:

(1) Add separate H.T. supply to the last valve, and (2) Add grid bias.

Please describe the necessary alterations.

SEPARATE H.T. TO THE LAST VALVE.

Disconnect the top H.T. 'phone terminal from H.T. +, and provide this terminal with a separate H.T. + connection via a flexible lead (and red plug), or by means of a separate terminal (H.T. + 2).

GRID BIAS:

Disconnect the lead from I.S. to the L.T. - earth lead. Two new terminals can now be fitted on the panel, at any convenient spot, one to be marked

"grid bias plus," and the other "grid bias neg." The former is connected internally to any point on the lead which joins earth to the filaments and L.T. and H.T. -.

The G.B. - terminal is joined internally to I.S. of the L.F. transformer. The grid bias battery is then connected to the two terminals as marked. As not more than 4½ volts, will be required, the battery should be of a type which is tapped at every 1½ volts.

FILADYNE DIAGRAM.

D. A. (Kirkcaldy).—I started to couple up your 2-valve "Filadyne" set, as illustrated on page 779 of August 7th issue, but notice that the H.T. battery has a "dead short" on it

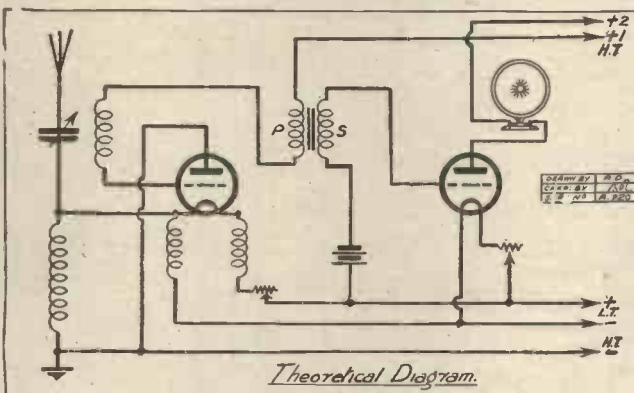

through series tuning coil, chokes, filaments, etc. As this is of general interest I hope you will publish correction.

Apparently you misread the diagram (which is reproduced herewith).

The two H.T. + leads are those marked respectively +1 and +2 at the top of the diagram.

It will be seen that they do not connect in any way with H.T. negative.

AERIAL LOCATION.

A. T. (Bradford).—My aerial, when fitted up, will be partly surrounded by tall trees. What effect will this have upon reception?

The trees will partly screen the aerial, and this will result in a slight loss in signal strength and a considerable loss in range. The effect will be chiefly noticeable in summer when the trees are leafy, and full of sap. A screened aerial is often responsible for "flat" tuning.

HUMMING NOISES.

A. S. M. (Bournemouth).—I own an ordinary two-valve set (Detector and L.F.) which, while giving good results, gives rise to an unpleasant humming noise which I cannot trace. I have no electric light mains near my house nor, as far as I can discover, any power station or dynamo. The noise persists on all wave-lengths and when I remove the aerial coil on the set it becomes a "roar." Has it anything to do with my earth lead?

The hum may be due to the earth lead, or to a long aerial leading-in wire. If this latter is run round walls and picture rails or is of considerable length it will sometimes cause such a noise. Removing the aerial coil has the effect of causing it to become more audible, and in some cases the set will burst into oscillation.

In other cases great difficulty is experienced in making the set oscillate, however large a reaction coil be employed.

The trouble can generally be overcome by shortening the leading-in wire, but if this is not possible, we advise an indoor aerial, as possibly this will give results better than the aerial in use.

(Continued on page 168.)

The choice of coils

for your set can only be decided by you. We offer you two designs, each good value, and both reliable.

FINSTON LO-LOSS COILS are designed to give maximum air spacing. Special thumb grips on base enable coils to be plugged-in or removed without fear of damage to the windings.

Efficient in action, Strong in construction.

Prices:—No. 25, 1/3; 35, 1/6; 50, 1/9; 75, 2/-; 100, 2/6; 150, 2/9; 175, 3/3; 200, 3/6; 250, 3/9; 300, 4/-.

FINSTON SUPER COILS have been so constructed that the centres are always in alignment when two or more are used, thereby securing maximum results from their magnetic field. All connections are soldered, so as to give constant electrical continuity throughout. A loose plug is provided so that the winding of the coils can be reversed if so desired.

They are totally enclosed in moulded Bakelite cases, giving great mechanical strength without impairing their efficiency.

Prices:—25, 35, 40, 2/6 each; 50, 60, 3/- each; 75, 100, 150, 3/6 each; 175, 200, 4/- each; 250, 300, 4/6 each.

Write for complete list of all Finston Components.

FINSTON MANUFACTURING Co. Ltd.
45, Horseferry Rd., London, S.W.1

OUR latest production, the C.E. PRECISION FLOATING VALVE HOLDER, shows great improvements upon others. By its use, the distortion due to vibrations transmitted to valve filaments is entirely eliminated and a receiver fitted with it acquires a perfectly clear background which facilitates the reception of distant stations. Of very low capacity and entirely non-microphonic, the C.E. PRECISION FLOATING VALVE HOLDER is ideal for its purpose. Made from Bakelite and fitted with soldering tags and terminals.

2/3 each.

C.E. PRECISION RHEOSTATS AND POTENTIOMETERS have so frequently been specified by the Wireless Press that they need little description. The special care taken in their production ensures a perfectly smooth and silent action. Bakelite formers; silvered dials; fitted with soldering tags and terminals.

7 and 15 ohms - 2/9 each
30 and 50 ohms - 3/- each
Dual Rheostats & Potentiometers - 3/9 each

FOR UTMOST EFFICIENCY

C. EDE & CO., LTD., BYFLEET, SURREY
Telephone: Byfleet 226; Telegrams: "Ceprecise, Byfleet."

Visit Stand No. 206 OLYMPIA.

Parrys Ad.

THE BURNT OFFERING!

Maybe the valve just "died of old age"—burnt away in hours of pleasure-giving service. Perhaps it fell foul of the H.T. Battery and went in a flash.

Whether burnt out or smashed up—send us your old valve and for a ridiculously small sum we will guarantee to return it as good as new.

No matter what the make of valve or the nature of the damage we can restore it to useful life, perfect in tone-reproducing qualities.

—and just note Lustrulux Repair Prices:—Bright Emitters, 4/6; Double-Grid and Dull Emitter Valves, 7/—; Power Valves repaired at half the original cost of the valve—maximum charge, 8/6. SPECIAL VALVES — SPECIAL PRICES.

Send for Catalogue "A.R." of

LUSTROLUX

All British Valves to

LUSTROLUX LTD.;

West Bollington, Nr. Macclesfield.

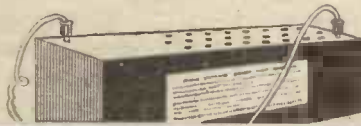

THE BEST AMPLIFIER and the CHEAPEST both to fix and operate IS THE NEW NON-VALVE MAGNETIC MICROPHONE BAR AMPLIFIER

(Patent No. 248591/25).

Complete Amplifier PRICE

38/-

Post Free.

Dry Cells Extra.

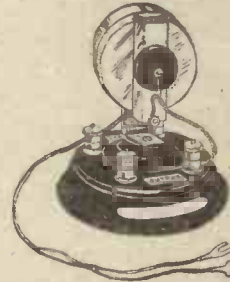

Microphone and other parts of Amplifier also supplied separately.

Illustrated lists free.

REALLY GOOD LOUD-SPEAKER RESULTS from CRYSTAL RECEPTION of average strength. WEAK CRYSTAL or VALVE RECEPTION made STRONG AND CLEAR. ENABLES even very DEAF PERSONS TO HEAR from Crystal Sets.

Not a Microphone Button. Entirely free from distortion and micro-phonous noises. No valves, accumulators or H.T. Batteries. No fragile parts. Nothing to get out of order. A child can adjust it. Operates on one or two Dry Cells lasting over 3 months.

EQUALLY EFFICIENT ON VALVE SETS.

Order from your dealer or from Sole Manufacturers and Patentees:

NEW WILSON ELECTRICAL MANUFACTURING CO., LTD.,

18, Fitzroy Street, Euston Road, London, W.1.

Phone: Museum 2703.

See us at

STAND No. 50

At the National Radio Exhibition!

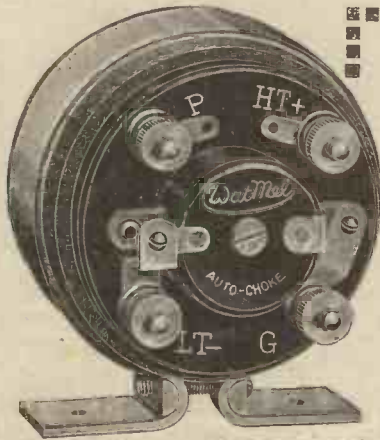

WatMel

The Watmel exhibits at Stand No. 50 comprise the Watmel Auto-Choke (as illustrated), the Watmel Variable Grid Leak, and the Combined Fixed Condenser and Fixed Grid Leak. All three of these ingenious components are being used with great success by constructors and are now widely known for good results. If interested in the Auto-Choke please send for the N.P.L. CURVE 103/1, and Booklet (or ask for it at Stand 50 if at the Exhibition).

THE WATMEL WIRELESS CO. LTD.,
332a, Goswell Road, London, E.C.1. Telephone: Clerkenwell 7990.

Lancashire and Cheshire Representative:
Mr. J. B. LEVEE, 23, Hartley Street, Levenshulme, MANCHESTER
Telephone: 475 Heaton Moor.

The OCTOBER LONDON MAGAZINE 1/-

Now on Sale

contains

A Complete New Detective Novel by Agatha Christie

Complete stories by F. Britten Austin, Robert W. Chambers, Gladys St. John Loe, Douglas Newton, Selwyn Jepson and others

An account of a thrilling episode when alone in the desert among Arabs,

by ROSITA FORBES

and other articles

BUY A COPY TO-DAY!

RADIOTORIAL QUESTIONS AND ANSWERS.

(Continued from page 166.)

CRYSTAL ON INDOOR AERIAL.

T. O. (Sheffield).—Why is it that I am unable to get my signals with my crystal set, using an indoor aerial, although I am only seven miles from the Sheffield relay station.

The range of the Sheffield relay station for a crystal is only a few miles (probably even less than seven) with an outdoor aerial; on account of the low power employed: so you cannot expect signals under the conditions in which you are working.

THREE-VALVE SET.

A. J. N. (Wolverton, Bucks).—Can you please tell me in which of your papers I shall find a diagram and lay-out of a good 3-valve model, 2 L.F. amplifiers with grid bias?

Sets of this type were described in "P.W." No. 200 ("My 3-Valver," by "Ariel"), and in No. 195. (The latter is the flat panel type, and is obtainable in Gd. Blue-Print form, Blue Print No. 20.)

For the Constructor

No. 8.—WORKING EBONITE.

- (a) Don't use pencil to mark a panel. Unless thoroughly cleaned off with a slightly oily cloth, there is a tendency for leaks to occur along the pencil-marks.
- (b) When the marking has been done, a light tap with a centre-punch will ensure that the drill starts properly.
- (c) Ebonite can be cut perfectly square if a tenon saw is employed.
- (d) If a hacksaw or (for big panels) a rip-saw is used, the "cut" should not be along the line marked, but just outside it. Otherwise the panel will be too small.
- (e) Use a coarse file to trim panel edges. Fine files become choked.
- (f) "Metal-working" drills should be chosen, and only a light pressure employed.
- (g) Keep the bench clear whilst working, or the panel will be disfigured by scratches.
- (h) When "breaking through" with the drill, relax the pressure, or the panel surface may chip.
- (i) When withdrawing the drill, do not reverse, but continue turning slowly.
- (j) Ebonite melts under heat, so terminals will need tightening after they have been soldered.

PICTURE LOUD SPEAKER.

"INTERESTED" (London).—Can you give me the name and address of the firm that manufacture a loud speaker that is camouflaged as a picture to be hung on the wall. I believe this firm was represented at the Olympia exhibition.

The loud speaker in question is manufactured by J. W. Lee & Son, Earl Street, Maidstone.

BACK NUMBERS OF "P.W."

F. R. (Co. Down).—I am a new reader and would like to try some of the sets which have been described previously in "P.W." Where can I get the back numbers?

Back numbers of "P.W." are obtainable from the Amalgamated Press (1922), Ltd. (Back No. Dept.), Bear Alley, Farringdon Street, E.C.4. Price 4d. each, post free.

"PRESS-A-BUTTON" SET.

E. L. (Birmingham).—I understand that a set is now obtainable that is capable of receiving the local station or 5 X X, merely pressing a button.

Can you oblige me with particulars of the firm who make this, and how many valves are employed.

We believe the set you refer to is made by Felcourt Products, Ltd., East Grinstead, Sussex. This receiver makes use of three valves, and as two are L.F. amplifiers it is capable of operating a large size of loud speaker from 5 I T and 5 X X.

A second socket is provided on the set for using two valves in the event of the operator wishing to use 'phones for reception, or in cases where the local station is too loud on three valves, to cut down the volume on the loud speaker.



Less work for Set Builders

Time spent in wiring up Valve Holder, Grid-Leak and Condensers separately can now be saved by using the new BENJAMIN Anti-Microphonic Valve Holder Units. Less space required, wiring dispensed with, mounting simplified and troubles arising from faulty connections and spacing avoided. Cost of Grid-Leak clips and mounting screws saved too.

Remember, also, that the BENJAMIN Anti-Microphonic Valve Holder is not only infinitely superior to all its imitators in design and finish, but in actual performance too.

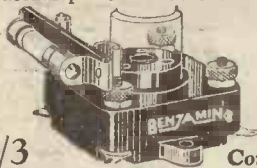

5/3 Complete

VALVE HOLDER & GRID-LEAK
A Dubilier Dumetohm 2 meg. Grid-Leak is fixed on to a rigid insulating bar by means of nickel-plated copper clips.

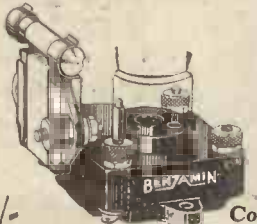

7/- Complete

VALVE HOLDER, GRID-LEAK & CONDENSER

Nickel-plated copper clips carry a Dubilier fixed Condenser (.0003) in addition to the Grid-Leak. Series or parallel.

BENJAMIN VALVE HOLDER
without Leak or Condenser **Price 2/9**

From all good Dealers

BENJAMIN

BRITISH MADE

**Clearer-Tone, Anti-Microphonic
VALVE HOLDER**

THE BENJAMIN ELECTRIC LIMITED
Tottenham, London, N.17.



USE

DRY CELLS INSTEAD OF ACCUMULATORS

COLUMBIA Dry Batteries are much safer, cleaner and convenient to handle besides eliminating trouble and expense occasioned by the frequent recharging needed by the ordinary accumulator. You can eliminate the inconvenience of storage batteries entirely—there is a Columbia Dry Battery for every radio battery need.



Send for our useful and informative battery instruction books "How to get the most out of your radio batteries" and "Choosing and using the right radio batteries." They are sent post free on request.

Columbia Dry Batteries

Ask your Dealer for full particulars concerning the complete range of Columbia Batteries or send direct to us.

J. R. MORRIS,

15-19, KINGSWAY, LONDON, W.C.2.

Telegrams: Colcarprod, London.

Phone: Gerrard 3038.

Scottish Representative: John T. Cartwright,
7, Cadogan Street, GLASGOW.

Orphean

The Specialists' Masterpiece

The Finest Loud-speaker in the World for purity and Volume

Each instrument is subjected to rigorous tests during the process of manufacture, and it is finally tested and adjusted under actual broadcasting conditions before leaving the London factory. No Loudspeakers can compare to an Orphean for purity, volume, ease of adjustment and beautiful finish. You may pay more but you cannot get a better Loudspeaker.



Orphean de Luxe
Height 24 ins.
Diam. of Flare 14 ins.
PRICE 90/-

Also Orphean No. 12
Height 21 ins. Diam. of Flare 12 ins. PRICE 50/-

Test either Model in your home for seven days—FREE
If you would like to test either model at home any dealer, even if he has not one in stock, can obtain one quickly on seven days' free trial without any obligation to purchase.

LONDON RADIO MANUFACTURERS LTD.,
61, Borough Road, S.E.1.

CORRESPONDENCE.

(Continued from previous page.)

single filament really means constructing a new 3-valve set, or buying three new valves; I am loth to suggest that such an ingeniously designed valve is a piffal to be avoided by wireless fans, but it does strike me that the scant information published conveys little to imbue the constructor with confidence.

Yours faithfully,
F. JOWETT.
Rostellon,
Prospect Road,
Woodford Green,
Essex.

SUMMER DX WORK.

To the EDITOR, POPULAR WIRELESS.
Dear Sir,—Enclosed you will find a list of U.S.A. amateurs received by me from 2nd July to 31st July, 1926. I would like to have cards from as many of the following stations as possible so as I could let them have individual reports if desired. The following have all been received by me on 0-V-1 Reinartz receiver Q.R.K. varying between R4 and R6 between 24'00 and 03'00 B.S.T.

- | | | | |
|-----------|-----------|-----------|-----------|
| U-3 P L | U-1 C I B | U-3 A H L | U-1 A X |
| U-2 A C B | U-2 C U F | U-2 C V J | U-2 H A |
| U-6 M L | U-2 V B O | U-1 A O F | U-1 K F |
| U-2 R S | U-2 A W Q | U-2 B A A | U-3 Z O C |
| U-1 K O F | U-3 B C E | U-2 A N X | U-2 L D |
| U-1 A D E | U-1 V A | U-1 A A Y | U-1 K A |
| U-1 C C Z | U-1 A A P | U-1 B E Z | U-2 C C Q |
| U-1 A Y G | U-1 A L R | U-2 T Y | U-2 A I B |
| U-4 H X | U-2 A R X | U-1 A H C | U-2 F F |
| U-1 A X A | U-1 A R U | U-2 A S Q | U-2 A H K |
| U-1 A L M | U-1 A M S | U-1 C I | U-2 A O F |
| U-2 H S U | U-2 C X L | U-8 A O L | U-1 B U S |
| U-2 G X | U-2 A H G | U-2 M D | U-1 X V K |
| U-2 C Z R | U-2 P P | U-3 C D K | U-4 P U |
| U-1 A W B | U-2 A Q W | U-5 A J P | U-1 Q M |
| U-3 Z O | U-2 X B B | U-8 A D C | U-1 B V B |
| U-4 J K | U-4 D D | U-5 M I | U-8 R Y |
| U-4 Q I | U-1 C M F | U-8 D B B | U-2 A X |
| U-2 A W | U-2 C Y X | U-2 W O | U-8 A P M |
| U-2 C C | U-8 A U D | U-2 A Y V | U-2 N F |
| U-1 X V | U-4 H X | U-2 A B | U-3 B T Q |
| U-3 Z O A | U-3 B U V | U-1 N V | U-1 E J O |
| U-1 A O | U-1 F L | U-4 H B | U-4 V S |
| U-8 C C | U-8 E Q | U-2 A U X | U-8 D M E |
| U-4 A A | U-2 P F | U-2 N D | U-1 A L L |
| U-4 J Z | U-2 A Y Q | U-1 B T F | U-9 D S C |
| U-1 A O H | U-2 C A O | U-1 A H S | U-4 E A |
| U-2 B G I | U-1 M V | | |

Total . . . 110 stations.
I shall be pleased to hear from any of above. I am always Q.R.V.
Yours faithfully,
JOHN W. HIGGINS.
c/o Young, 23, White St., Govan, Glasgow, S.W.

A SUCCESSFUL THREE-VALVER.

To the Editor, POPULAR WIRELESS.
Dear Sir,—I wish to take this opportunity of thanking "Ariel" for the 0-V-2 set described in "P.W." March 27th, 1926, which set I am using with the best of results and tonal purity of reproduction. Although only half a mile from the 2 L S aerial I can get Manchester, Newcastle, Daventry and two Germans on the Lissenola unit at good strength any night, and with the 'phones I have bagged all B.B.C. stations (of course, some of the relays are not great, but most stations are good). After darkness has set in the dial of my '0005 A.T.C. Jackson Bros. geared is alive with stations, and some of the foreigners are at tremendous strength. Although I cannot tell what they are saying and where they are all coming from, still I recorded 15 different stations in one night, from 11 p.m. to 2 a.m.
Wishing "P.W." every success and still looking for its next issue, I am
Indebtedly yours,
I. H. ELIOTT.
44, Earl St., Manchester Rd., Bradford, Yorks.

ANOTHER THREE-VALVER.

The Editor POPULAR WIRELESS.
Dear Sir,—As a reader of POPULAR WIRELESS for the past twelve months, I should like to express my appreciation of your paper, which has been of real assistance to me. I especially like the clear, concise manner in which constructional articles are presented and the up-to-date news.
I recently constructed a 3-valve loud-speaker set (Det. 2 L.F.) from the free blue print presented with your paper several months ago, and the results obtainable are certainly all that you claim. Using Corsor "Wancells" and with a 120 ft. aerial, 65 ft. high, I can get Rome, Madrid, Radio Paris, Hamburg, Hilversum, and Dublin on the loud speaker, and, of course, Daventry, London, and Bourne-mouth come in very strongly.
That POPULAR WIRELESS has been of great use to me can be judged from the fact that I have made five crystal sets embodying various circuits of yours. I have constructed a loud speaker with the aid of an article appearing in your paper, and recently successfully "rejuvenated" two D.E. valves which had been over-run, by the method described in a recent issue.
Wishing your paper every success.
Yours truly,
ERIC W. CHATFIELD.
60, Shortbridge,
Near Uckfield Sussex

: Instruments :

ONEMETERS
are the finest Multi Range Sets. No. B 52 T has 7 ranges: 120 v., 6 v. and 300 m/v.; 6 amps, 120 m/a, 12 m/a and 3 m/a. 55/-

THE ULTRA ONEMETER
is an entirely new production of wonderful precision and delicacy from microamps to 20 amps, millivolts to 2,000 volts. Measures 50 ohms to 50 megohms.

Instrument only ... 55/- Multipliers each ... 6/6

ELECTRADIX RADIOS
Instrument Dept. P,
218, Upper Thames Street, London, E.C.4

PHONE REPAIR SERVICE
Phones rewound and remagnetised, 4/6 per pair. Remagnetised only, 2/- Loud Speakers and Transformers rewound. Glass Jars for making up wet H.T. units, waxed, 1/3 doz.; plain, 1/-. Post extra.
The H.R.P. Co., 1, Cottrill Road, nr. Hackney Downs Station, E.8.

EXCEPTIONAL OPPORTUNITY
FADA 5-Valve Neodyne Receiver, latest model, wave-lengths 200 to 3,000, highly selective. All main British and Continental Stations received on loud speaker. Three spare P.M.6 valves, 50-foot sectional mast, five-guinea Allison 18-inch loud speaker, Exide accumulator, H.T. batteries, etc. Complete set cost owner over £80. Sacrifice £37 cash. Owner going abroad.
HARDIE, 3, Blenheim Street, New Bond Street, W.1
Phone: Mayfair 6558

S.L.I.C. LTD.

SPECIAL OFFER.
Wireless Accumulators by the best Manufacturers.
BIG REDUCTIONS.

Volts.	Amps.	Price.
2	40	8/-
4	40	15/-
6	40	23/-
2	100	13/6
4	100	26/-
6	100	38/-

60 ampere hrs. units, pro rata price.
Add 1/6 for carriage and packing.
Each Battery Guaranteed.
Approval against cash, 7 days.
SOUTHERN LIGHTING & IGNITION COY., LTD.,
156, Great Titchfield Street, W.1.
Museum 3005. Private Exchange.

COIL REPAIRS
Headphones & Loud Speakers re-wound & remagnetised. H.F. & L.F. Transformers re-wound & repaired. All work tested at our experimental station.
B. KIMBER & SON, 39, Bargey Rd., Cattford, S.E.6. Phone: Lee Green 2995.

TRIUMPH

2-COIL STAND
Ref. No. C.169
Price 5/9

THE LATEST SUCCESS
VELVET VERNIER ACTION. FULLY GUARANTEED. ON VIEW
TRIUMPH STAND No. 238
NATIONAL RADIO EXHIBITION
Ask your dealer for illustrated lists or send p.c. mentioning "Popular Wireless" to
A.H. CLACKSON LTD. WHITE HART WORKS, LONDON, N.22

TECHNICAL NOTES.

(Continued from page 132.)

values of bias to the grid, to note the corresponding values of plate current. In this way the curve showing the relation of grid-bias to anode current is readily obtained, and this is one of the curves most usually given.

More Grid Bias Required.

Owing to the fact that the actual working conditions in the valve differ, however, from these static conditions, as already mentioned, the characteristic curve is apt to be considerably "flattened out," the practical result of which is that, to obtain a given effect, a larger value of grid-bias must be employed than that indicated by the static characteristic curve. In the case of a very high impedance detector valve, for example, this effect may be very marked.

The Lodge "N" Circuit.

The Lodge 2-valve set, now on view at Olympia, is an interesting exhibit, and as compared with an ordinary 2-valve set, gives wonderful volume and purity of reproduction. The 3-valve set is designed (detector and two low-frequency amplifiers) for situations too far from a broadcast station for the 2-valve set to give the necessary volume.

The set requires an aerial and earth in the usual way, although in many cases it works well without an aerial, using only the earth. A portable or semi-portable set is stated to be in preparation. As everyone now knows, one of the principal claims in connection with the Lodge circuit is its freedom from re-radiation, in other words, its inability to cause interference in neighbouring sets.

A word of explanation, however, is necessary here. Sir Oliver has pointed out in his articles that true radiation does not commence until a quarter wave-length has been traversed; within that distance there is inevitably, with any kind of circuit, a certain amount of what Sir Oliver calls "inductive pumping" effect. If deliberately abused, the "N" circuit may be made to cause a little effect in an adjacent set, but even if deliberately abused, it does not cause the effect in a set a short distance away. For all practical purposes, therefore, it is incapable of causing "howling" in neighbouring receivers. I think my readers will agree that to secure this condition with a circuit consisting of a detector and one L.F. amplifier (that is to say, without any H.F. amplifiers) is a remarkable achievement.

A New Valve.

Many readers have written to ask for further details of a new type of valve in connection with which my name was mentioned in an interview published in an evening newspaper recently. Briefly this valve contains a "filament" consisting of a tiny "neon tube," or equivalent, this tube being coated on its outer surface with a substance capable, under the stimulus of the radiation from within the tube, of emitting a sufficient supply of electrons for the purposes of the ordinary working of the valve. In another form, the "filament" consists of a tiny disc of metal, which may be similarly coated, and upon which radiation is focused from without the valve.

(Continued on next page.)

Tungstone Accumulator
makes another
World's Record
Unequivocally Proved
by the
Impartial and Independent
Tests made at the
National Physical Laboratory
Official Testing Station of the
British Government
Extra-ordinary convincing results
96% Amp. hour Efficiency
88% Watt hour Efficiency
Confirms Tungstone's
Exclusive Claim to use only
Pure Lead
For plate Grids and Paste

Sent post free. Copy of the Original British Government's Test Certificate with "Unique Booklet of the Battery Trade" Inaugurating Revolutionary Methods favourable to Users. For the first time in the World's History of Accumulator Manufacture Tungstone as the result of its Original Design and manufacture on Standardised, Interchangeable and Accessible principles can issue a definite Priced Parts List of all its component parts and Plates for fitting in any Tungstone Battery by unskilled labour. No other Accumulator maker in the World has ever issued a complete Parts List for Battery Owners.

TUNGSTONE ACCUMULATOR CO. LTD., St. Bride's House, Salisbury Square London E.C.4

REPAIRS SETS, PHONES, TRANSFORMERS
 Officially Approved by Radio Association.
 ALL WORK GUARANTEED LOWEST RATES 24 HOUR SERVICE
 Cash on Delivery if Desired.
JOHN W. MILLER, 68, Farringdon St., E.C.4.
 Phone: Central 1950.

EASY PAYMENTS Finest 2-valve amplifier set, including loud speaker, 120 H.T., D.E. valves, £7 10s. 1 or 18/9 down and 11 instalments of 15/-.
CASH BARGAINS.
 Good Crystal Sets, 8/3 and 9/3. Amplifiers, 17/6 and 21/-. Phones, Telefunken type, 7/9; Fr. T. Houston, 11/-; U.S. Baldwins, 17/9. Valves, Radio Micro, 5/6; or power, 8/9. Good H.T., 60-v., 5/9; or 4-v. (laboratory test), 3/9 doz. Accumulators, with 12 months' guarantee, 2v. 40 ignition. 8/3; 4v. 40, 15/-; 5v. 50, 29/-. Polished Cabinets, Ebonite, Variometers, Condensers, Coil Holders, and everything in Wireless, reliable and cheap. Satisfaction or cash refunded.
MUSIC ROLL EXCHANGE,
 29, High Street, Clapham, London, S.W.4.

SAVE YOUR VALVES
 PRICE complete 2/-
 New Bulbs 6d. each

HUNTS "SAVE IT"
 SAFETY FUSE COSTS PENCE WANDER PLUG SAVES POUNDS
 A. H. HUNT, LTD., (Dept. 12), Croydon, Surrey

ALL APPLICATIONS FOR ADVERTISING SPACE IN "POPULAR WIRELESS" MUST BE MADE TO THE SOLE ADVERTISING AGENTS JOHN H. LILE, LTD., 4, LUDGATE CIRCUS, LONDON, E.C.4.

The latest in Jacks & Plugs

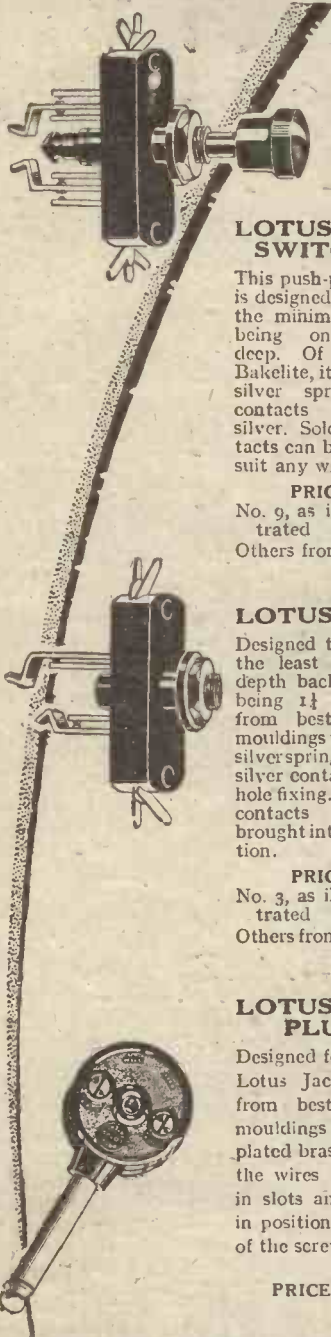

LOTUS JACK SWITCHES

This push-pull switch is designed to occupy the minimum space, being only 1 1/2 in. deep. Of the finest Bakelite, it has nickel silver springs and contacts of pure silver. Soldering contacts can be made to suit any wiring.

PRICES:
No. 9, as illustrated .. 4/-
Others from .. 2/9

LOTUS JACK

Designed to take up the least space, the depth back of panel being 1 1/2 in. Made from best Bakelite mouldings with nickel silver springs and pure silver contacts. One-hole fixing. Soldering contacts can be brought into any position.

PRICES:
No. 3, as illustrated .. 2/6
Others from 2/- to 3/-

LOTUS JACK PLUGS

Designed for use with Lotus Jacks. Made from best Bakelite mouldings and nickel-plated brass. To fix, the wires are placed in slots and gripped in position by a turn of the screw cams.

PRICE 2/-

LOTUS JACKS · SWITCHES · PLUGS

Garnett, Whiteley & Co., Ltd.

LOTUS Works, Broadgreen Road, Liverpool.

TECHNICAL NOTES.

(Continued from page 171.)

Experimental Stage.

In order to avoid any misapprehension, I ought to point out that these valves are only in the laboratory stage; they are not by any means ready for the market, nor is it absolutely certain that they ever will be. If, however, the inventor's experiments should prove successful, there should be, in my opinion, a big field for such a valve, for the energy consumption is small and, moreover, the energy is provided from a source that is not restricted in the same way as the present usual source of filament energy. The battery eliminator problem would be much simplified, for both the filament and the H.T. supply would be of the "small-current high-voltage" kind, for which it is much easier to provide a mains supply unit.

H.T. from the Mains.

Many readers have asked me to advise them as to the desirability of investing in a device for obtaining their current, more particularly the H.T. current, from the electric-lighting mains, and in quite a number of cases they have quoted extraordinary voltages or periodicities. One usually has the impression that electric-light voltages are either 100-110 or 200-250 and, in the case of A.C., periodicity 50. This, however, is far from being the case in this country, although in the United States the majority of electric-supply is A.C. 110 volt, 60 cycle. I took the trouble to enquire as to the different types of supply in this country and was informed that if an electrical manufacturer were to make any device with a separate model for every kind of electric supply, he would need to stock close upon a hundred different models. Where fresh installations are made, however, they are now usually A.C. of 50 cycles and about 230-240 volts.

The Four Electrode Valve.

The tetrode, more popularly known as the 4-electrode valve, is not so widely used by experimenters as it deserves to be. Undoubtedly the greatest use to which this kind of valve has ever been put is in the Unidyne circuit, invented by two members of the technical staff of this Journal about a couple of years ago. The immense popularity of the Unidyne gave a great stimulus to the manufacture and sale of 4-electrode valves.

But the tetrode may be used in many other kinds of circuit and lends itself to a greater variety of interesting experiments. It is not necessary, as a rule, to interfere either with the circuit or with the wiring. The auxiliary grid may be connected to a positive H.T. tapping of a few volts, say 10 volts, and it will then be found, in general, that the H.T. voltage required on the plate is much less than would ordinarily be required in similar circumstances with a triode or 3-electrode valve. As a detector, used in this way, the sensitiveness of the 4-electrode valve usually greatly exceeds that of the ordinary valve, and as an amplifier it sometimes gives the same result in a single stage as may be obtained with ordinary valves in two stages. The 4-electrode valve is apt to be neglected by the experimenter; it still has great unexplored possibilities.

TRIUMPH

**RHEOSTAT.
STRIP WOUND.**



**AIR COOLED.
SMOOTH ACTION.**

Highly praised by all users.

8 ohms 2/3 Ref. R200
30 " 2/6 " R201

ON VIEW AT
TRIUMPH STAND No. 238

NATIONAL RADIO EXHIBITION

Ask your dealer for illustrated lists, or send p.c. mentioning "Popular Wireless" to

A. H. CLACKSON LTD. WHITE HART WORKS, LONDON, N. 22

Valves Repaired

AS GOOD AS NEW!!

HALF PRICE

(Except Weeco, S.P.'s, and low capacity types). Minimum D.E. Current 0.15 amps when repaired. ALL BRIGHT & DULL EMITTERS listed at less than 10/-. Minimum charge - 5/-

VALCO LTD., Dept. P.W., Tabor Grove, Wimbledon, S.W.

HEADPHONES REPAIRED

Re-wound & re-magnetised 5/- per pair. Loud Speakers repaired 5/-. Transformers re-wound 5/- each. All work guaranteed and tested before delivery. Write for Trade Prices. Phone: Clerk. 1795. MASON & CO., 44, East Road, City Road, N.1.

LITTLE WIRELESS GADGETS

MAP

SMALL PARTS TO THE TRADE.

MADE BY ALL IN ALLES

MAP Co., 21, Gt. Lister St., Birmingham.

ACTIVE AGENTS WANTED (either sex) to sell Private Christmas Cards. Up-to-date designs. Latest Novelties. Best Paying Spare Time Agency Ever Offered. Free Book Highest Com. Valuable prizes. Apply Firth Graham Co. (Dept. F112), Accrington.

VALVES REPAIRED

WHY WASTE MONEY?

Let us RE-MAKE your old ones as good or BETTER than NEW D.E. 4/8 ea. Power 8/- ea. All work thoroughly TESTED, GUARANTEED and promptly dispatched by Post C.O.D.

NaVal Mfg. Co., 64, Mill Hill Rd., ACTON, W.3

WHEN replying to advertisements please mention "Popular Wireless and Wireless Review" to ensure prompt attention. THANKS!

REPAIRS

By specialists skilled in every form of accurate and intricate coil windings.

Headphones, Loud Speakers & Transformers re-wound, re-magnetised and reconditioned.

EQUAL TO NEW

and returned the same day on C.O.D. system. The unsolicited opinion of one of our many satisfied clients—"all I can say is, they are better than when new."

VARLEY Magnet Co.
Repairs Dept.,
Woolwich,
S. E. 18



VARLEY

Proprietors:
Oliver Pell
Control Ltd.

400 P.M. filaments will lift a man!



CONSIDER THE FACTS

The life of a valve is not one minute longer than the life of its filament.

Therefore, for real value, see that your valves have **STRONG FILAMENTS.**

The wonderful P.M. Filament offers you three times more for your money. It is so tough that even after 1,000 hours' life it can be tied in knots and cannot be broken except by the very roughest handling—result, *safety against accidents.*

There is more than strength in the P.M. Filament. It has up to 3 times greater length and up to 5½ times greater emission than an ordinary filament. This is where the P.M. Filament gives you real value.

Another big point, the P.M. Filament requires only one-tenth ampere giving 7 times the life to each of your accumulator charges.

For great economy, great life and great results secure the valves with

THE WONDERFUL P.M. FILAMENT

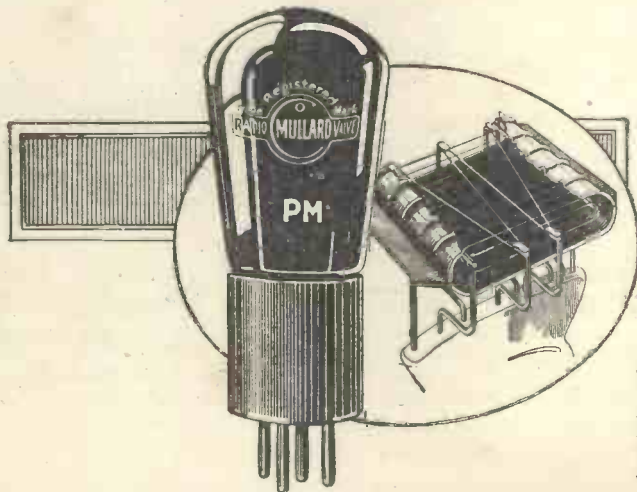

Sectional view of the P.M.5 showing the great length of the P.M. Filament and its resilient hook suspension.

NEW REDUCED PRICES

For 4-volt accumulator or 3 dry cells
THE P.M.3 (General Purpose) 0.1 amp. 14/-

THE P.M.4 (Power) 0.1 amp. 18/6

For 6-volt accumulator or 4 dry cells
THE P.M.5 (General Purpose) 0.1 amp. 18/6

THE P.M.6 (Power) 0.1 amp. 18/6

For 2-volt accumulator

THE P.M.1 H.F. 0.1 amp. 14/-

THE P.M.1 L.F. 0.1 amp. 14/-

THE P.M.2 (Power) 0.15 amp. 18/6

These prices do not apply in Irish Free State.

ASK YOUR DEALER FOR P.M. VALVES

Mullard

THE · MASTER · VALVE

British Made
in a
British Factory

*I get them
all now*

I MADE tuning easy on my 4-valve set when I fitted the R.I. Retroactive Tuner. Now I get any station I want between 175 and 4,000 metres quicker than it takes to reach for a plug-in coil, while over the whole range of wavelengths I get correct aerial reaction—always the difficulty with coils, which, by the way, including the holder cost appreciably more than the R.I. Retroactive Tuner. Take my tip—make sure of clean, easy tuning right from the start—fit the R.I. Retroactive Tuner to your set.

Price **39/6**

Write for the new R.I. Catalogue.

The **R.I.**
RETROACTIVE
TUNER

 **BRITISH**

THE MARK OF BETTER LTD RADIO

Advt. R.I. Ltd., 12, Hyde Street, New Oxford Street, London, W.C.1

Printed and published every Thursday by the Proprietors, The Amalgamated Press (1022), Ltd., The Fleetway House, Farringdon Street, London, E.C.4. Advertisement Offices, Messrs. J. H. Lile, Ltd., 4, Ludgate Circus, London, E.C.4. Registered as a newspaper and for transmission by Canadian Magazine Post. Subscription rates: Inland 17/4 per annum, 8/8 for six months; Abroad, 19/6 per annum, 9/9 for six months. Sole Agents for South Africa: Central News Agency, Ltd. Sole Agents for Australia and New Zealand: Messrs. Gordon & Gotch, Ltd.; and for Canada: The Imperial News Co. (Canada), Ltd. Saturday, September 18th, 1926.

R/R