

HOW TO MAKE A FILADYNE TWO-VALVER.

Popular Wireless

Every Thursday
PRICE
3d.

No. 218. Vol. IX.

and Wireless Review
Scientific Adviser: SIR OLIVER LODGE, F.R.S., D.Sc.

August 7th, 1926.



Features in this Issue.

Loud-speaker Horns.

H.F. Stability.

America Calling!

The New B.B.C.

By Sir Robert Donald, G.B.E.

What Valves Shall I Use?

Wireless Weather Reports.

When broadcast speeches and music are to be reproduced for the entertainment of large crowds in the open, special large loud speakers mounted on towers are generally used. Our cover photograph shows one of these wireless "kiosks" being erected at Hendon.

"BEST WAY"

GUIDES FOR WIRELESS CONSTRUCTORS

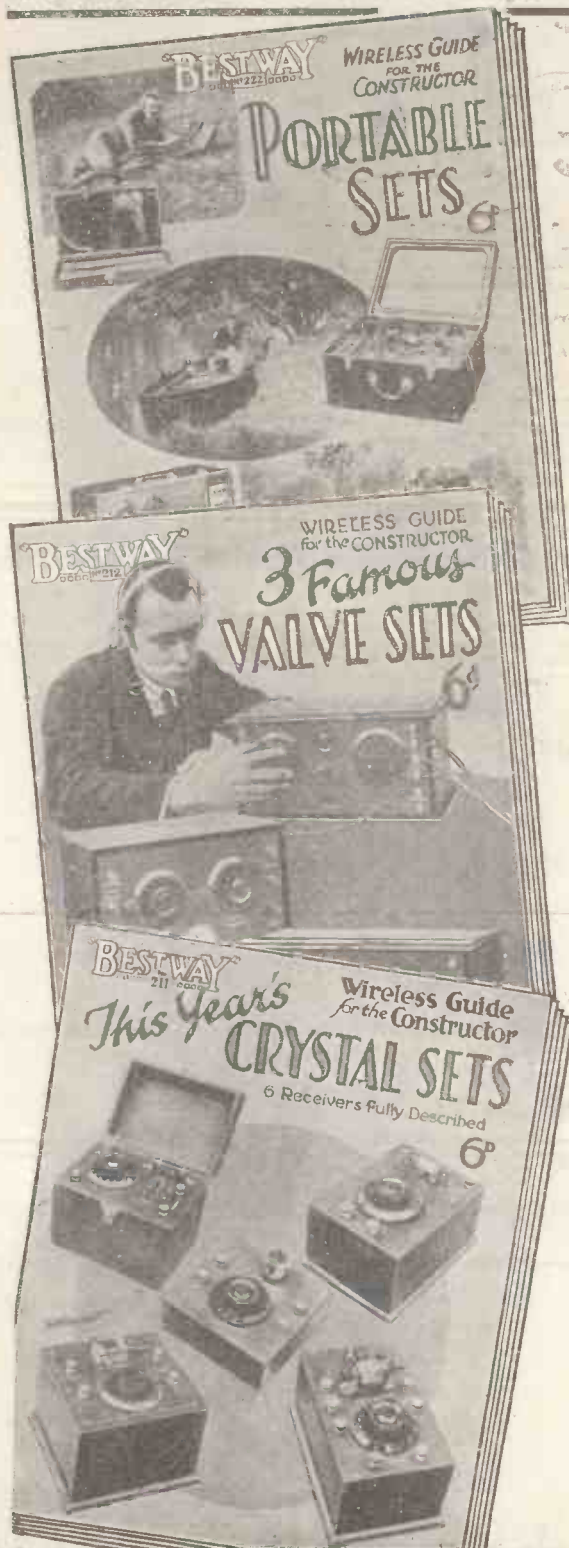

The Latest Numbers—now
on Sale Everywhere

PORTABLE SETS

The book is amply illustrated with photographs and diagrams, and constructors will find the wiring directions most lucid and straightforward. The sets described are: The All-Station Loudspeaker Portable. A remarkably compact six-valve Super-Het. Three-Valve Portable. Several stations on the loudspeaker and many more on Telephones can be obtained with this receiver. Baby Portable. A two-valve receiver contained in a very small attaché case.

THREE FAMOUS VALVE SETS

This book describes and illustrates in photographic detail three absolutely reliable circuits. All have been tested under normal broadcasting conditions. The sets are "A Trinaryne Two-Valver," "The 'Chitos' One-Valve Set," and "The One-Valve Unidyne Receiver." The directions given make the assembling of each set exceedingly straightforward.

THIS YEAR'S CRYSTAL SETS

This new addition to the popular "Best Way" series of Guides for the Wireless Constructor contains the latest and most authentic information on the best Crystal Sets of the Year. A special feature of the book is the clear constructional photographs. All the receivers described have been carefully tested. The sets described are as follows: A One-Control All-Range Set; Building a "D" Coil Receiver; The Universal Crystal Set; A Quick-Change 2 L O—5 X X Receiver; A Main Stations Ultra and The Half-Crown Crystal Set.

Price **6^d** Each.

At all Newsagents and Bookstalls

**CONSTRUCTORS USING THESE BOOKS
CANNOT GO WRONG.**

The World's Standard

STANDARD
**DRAGON
AMPLION**

Type A.R. 19.

*Wireless
Loud Speaker*

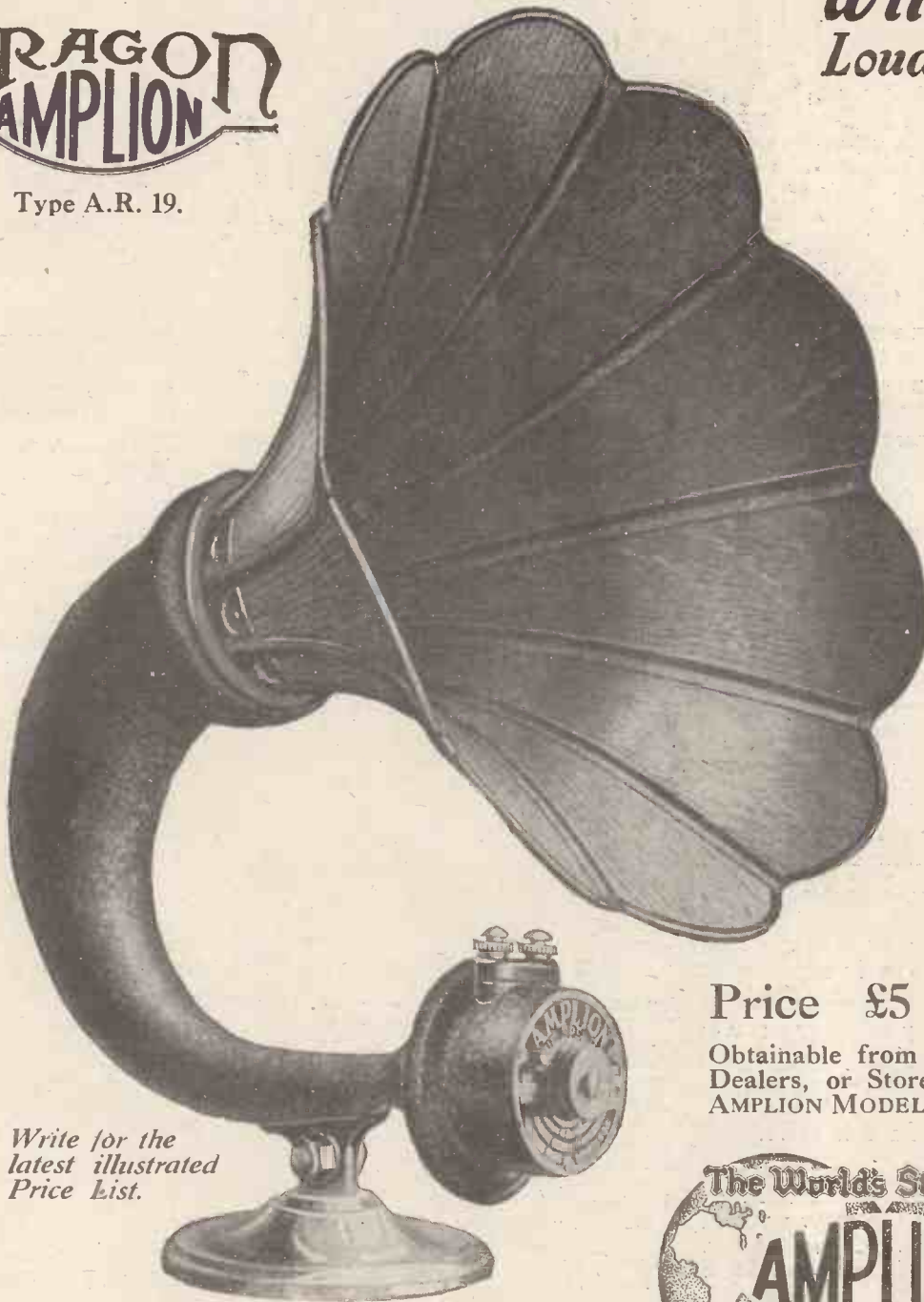

*Write for the
latest illustrated
Price List.*

Price £5 : 5 : 0

Obtainable from all Radio
Dealers, or Stores. Other
AMPLION MODELS from 38/-



There is no substitute for a genuine AMPLION

Announcement of ALFRED GRAHAM & CO. (M. Graham), St. Andrew's Works, Crofton Park, London, S.E.4

A

According to Homer, Stentor was the name of a Greek herald in the Trojan War whose voice was as loud as that of 50 other men combined. As the name for a new Cossor Power Valve it is, therefore, peculiarly appropriate.

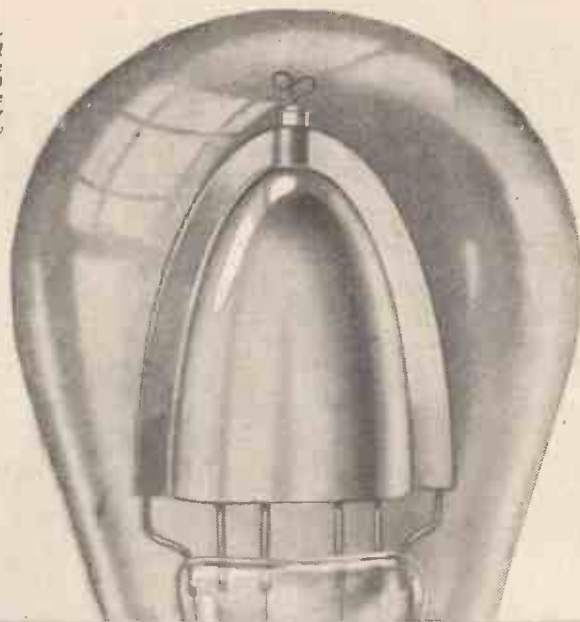

Already a sensational success

ALREADY technical experts and radio journalists are enthusing over the new series of Cossor "Point One" Valves. "The best Valves Cossor has ever made," said one, whose name is a household word among home constructors. "These new Cossor Point One valves have quite converted me to the 2-volt idea," writes another prominent radio journalist. "Your new Valves prove that this country has nothing to learn from other nations in valve design," is an extract from a letter recently received from a third expert.

We could quote numerous other letters in similar strain and it is significant that many of those who have taken the trouble to write to us during the past two or three weeks are men who have grown up in the wireless industry.

Men whose seasoned judgment in radio technique is invaluable—men who are not easily roused to enthusiasm by the introduction of a new valve.

They are the men who are the pace-makers of the whole Radio industry—their opinions are the straws which show which way the wind is blowing. And there is unmistakable evidence that the new Cossor Point One has been given warmth of welcome accor-



The wonderful new Cossor "Point One" Dull Emitters

Plain Top:		
For Detector or L.F. ...	15/6	(Consumption 1 amp.)
Red Top:		
For H.F. use ...	15/6	(Consumption 1 amp.)
Green Top:		
For Power use ...	18/6	(Consumption 1.5 amp.)

All operate at a voltage of from 1.2 volts to 2 volts

ded to no other valve. Wireless enthusiasts have been quick to realise the importance of the wonderful new system of Coaxial Mounting, which ensures perfect uniformity of characteristic between all valves of the same class. An exclusive Cossor feature. The broadcast listener tired of frequent replacements, has appreciated the tremendous advantage of a shock-proof filament system which ensures an incredibly long life. While its exceptional economy in current consumption (the new Cossor Point One consumes only .1 of an ampere at 1.8 volts) proves that there is now available a valve capable of giving superb results from ordinary dry batteries.

When your present valves become useless, choose the new Cossor Point One Series—the only valves in the world to utilise Coaxial Mounting. We can promise you a new pleasure in Radio—greater volume—improved stability—a fidelity of reproduction that will astound you—an increased sensitiveness that will add miles and miles to the range of your Set. And remember, finally, the prestige enjoyed by Cossor—the good name that stands squarely at the back of every Cossor Point One and Stentor Two.

Cossor Point One

Popular Wireless

Scientific Adviser
 Sir OLIVER LODGE, F.R.S.
 Technical Editor:
 G. V. DOWDING,
 Grad. I.E.E.
 Assistant Technical
 Editors:
 K. D. ROGERS,
 P. R. BIRD.

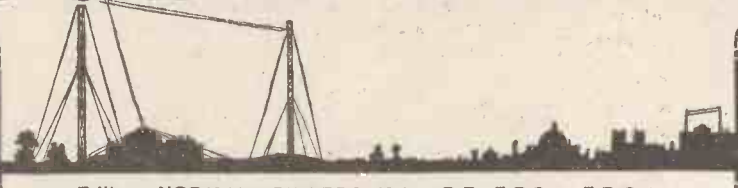

Editor NORMAN EDWARDS, M.Inst.R.E., F.R.S.A., F.R.G.S.

Consultants:
 Dr. J. H. T. ROBERTS,
 F.Inst.P.
 J. F. CORRIGAN, M.Sc.,
 A.I.C.
 C. E. FIELD, B.Sc.
 E. J. SIMMONDS,
 M.I.R.E., F.R.S.A.

RADIO NOTES AND NEWS.

More High-Power Stations—Across the World on One Valve—Daventry a Back Number?—Valve Pioneer Retires—Germany's Giant Station.

More High-Power Stations.

"HAS Hilversum increased its power?" asks a Liverpool reader, who picked up this station at excellent strength recently. I believe the Dutch station is now testing upon the same power as 5 X X, and incidentally it will soon be joined by two other equally powerful neighbours on the long waves. One of these is the new Swedish high-power station at Motala, and the other is the Chablovka broadcasting station, near Moscow.

news, without having to wait for the papers hours afterwards.

"My valve is an Ediswan A.R.06, and the two I½ v. dry cells that have already had six months still survive. The aerial is a standard 100-ft. single wire, of 7-22 enamelled wire."

This is easily the best claim I have read for a week or two. Can any other Australian or New Zealander beat it?

goes on to state that sixteen new broadcasting stations had been licensed in Canada recently. Most of them use low power only.

Duke of York's Camp Broadcast.

A SING-SONG from the Duke of York's camp at New Romney is one of the items on the August 6th programme. This will be broadcast from 2 L O and 5 X X and will consist of the good old shanties usually sung around the camp fire.

The New Romney camp is a fifty-fifty mixture of public school boys and factory hands, who camp out together for their summer holidays, and their vocal efforts ought to be worth hearing.

The Torchlight Tattoo.

THE B.B.C. announce that the Torchlight Tattoo from the Royal Marine Depot at Deal will be broadcast from London at 11 p.m. on August 6th. Music will be provided by the Royal Marines band, which accompanied the Prince of Wales on his recent tour of South Africa and South America.



"Birds of a Feather" broadcasting from the London studio.

"Is Rugby a Failure?"

DO you remember all that fuss recently about "Is the Rugby Station a Failure?" Some disgruntled Jeremiah has been saying Australia is now listening in vain for the great British station, and what is GBR good for, and a lot more here-we-suffer-grief-and-pain sob stuff of the same kind.

But whilst he was writing to the papers, and grouching and grumbling generally, one "P.W." reader who lives at Kew, Melbourne, made up a one-valve set that reaches out and picks up Rugby every morning before breakfast. Here is what he says about it:

Across the World on One Valve.

I USE home-made coils, and I can tune in Rugby any morning at all at 6 a.m. It certainly is great to have the Test scores laid on, and all the official British

Sid Firman Signs on Again.

I HEAR that Sid Firman has signed a six months' contract with the B.B.C. His engagement was due to expire this month, but this ensures him a continuous broadcasting run of twelve months or more.

Sixteen Stations for Canada.

NOT long ago I referred in these Notes to the fact that the ether had been "soggy" for a long time, all the world over. Confirmation of this is now forthcoming in a report from the High Commissioner of Canada, which says, "Unusually poor radio reception conditions prevailed on the North American Continent during the winter 1925-26." This report

It is to be erected at Freiburg, and will be backed up by three other high-power German stations, at Königswusterhausen (Berlin), Hamburg, and Langenberg (Cologne). The former is an 18 kw. station, whilst Hamburg will employ a power of 10 kilowatts.

Germany's Giant Station.

THE Langenberg station is now being erected, and this will be more than twice as powerful as Daventry. Instead of the latter's 25 kw., 60 kw. will be utilised, and the station will provide crystal reception over the area formerly covered by Dortmund and Elberfeld.

(Continued on next page.)

Daventry a Back Number?

DAVENTRY, at one time Europe's super-station, will soon be quite a back number as far as the power employed is concerned. Only twelve months ago the 25 kilowatts at 5 X X were thought to be marvellous, but now Germany contemplates a station with four times this power.

NOTES AND NEWS.

(Continued from previous page.)

"The White Château."

THAT stirring radio play, "The White Château," is to be broadcast again from London on August 16th. That date is the twelfth anniversary of the official landing of the British Expeditionary Force in France.

In those days we used to sing, "It's a Long Way to Tipperary," but now we make a song if we can't pick up Hamburg, or Dortmund, or one of our whilom foes! It's a topsy-turvy world, my masters!

Radio for Mountaineers.

THE Radio Club de France has decided to fit up some of the famous refuge huts for mountaineers with radio. Telephone communication has proved unsatisfactory in the past, so transmitting and receiving gear is to be installed at La Charmette, Wardon-Oredon in the Pyrenees, and other danger points.

The whole of the apparatus must be light and compact, for transport must perforce be on the backs of men, no animals being able to scale the heights where the refuges are situated.

Radio Valve Inventor Retires.

WHEN Dr. John Ambrose Fleming, professor of electrical engineering in the University of London since 1910, retired on August 1st, he severed a forty-one years' connection with the university.

Professor Fleming is now seventy-seven years of age, and he can look back to the day when from crude laboratory apparatus he made the first wireless valve. His were the first cars to hear wireless through a thermionic detector, and the whole science of radio-telephony is based upon the model that he made.

Honoured universally and loved by the university, Professor Fleming has the good wishes of every listener in the land.

Another Arctic Venture.

ONCE again a radio-equipped Arctic expedition is on its travels, and once again radio experimenters the world over are asked to co-operate with the explorers. The expedition has embarked upon the schooner "Morrissey" (call sign VOQ), and will work upon 33, 20 and 18 metres. VOQ will be on the air until the vessel returns to civilisation in October.

Better Conditions Coming.

HAVE you noticed how the tuning dials are getting crowded with stations, now that the sun stops transmitting earlier in the day?

About 9.30 one evening recently I got quite a shock to find my straight three-valver was full of foreigners; without any trouble at all, five or six came through on the loud speaker, and plenty of others seemed to be hanging about just outside the grid condenser, so to speak. All the signs point to this coming one being a real red-hot season for long-distance results.

Too Much 2 L O.

THE Reading Town Council has become so heartily sick of braying loud speakers that a by-law has been passed to protect the public from too much

2 L O. Under the new by-law it is an offence for anyone to operate a loud speaker in or adjoining any street or public place in such a manner as to cause annoyance to residents or passengers.

Apparently the agitation against the loud speakers started with people who live near wireless shops that insisted upon letting their goods speak for themselves. In future, the salesman must do the talking!

A Radio Trust?

I HEAR that the famous American broadcasting station W E A F has been bought by the Radio Corporation of America. This is said to be part of a move to acquire monopoly of the air on the part of the Radio Corporation, the Westinghouse Co., and the G. E. C.

This group is believed to already control fourteen important stations, so that it looks

SHORT WAVES.

"Our own view is that in attempting to get 'idyll' pronounced 'idle' the B.B.C. are simply iddling their time."—*Sporting Times.*

"In America they have been trying to discover a new word for long-distance broadcasting. A competition was run and a prize offered for the best effort. 'Orbraying' carried off the prize, suggesting as it does a combination of 'orb' and 'ray'.

"Uncle thinks it is an unfortunate choice. How is he to know whether he is broadcasting orbraying? We are far too polite to suggest which it might be."—*South African Wireless Weekly.*

"A Yorkshire miner claims to be able to play ten musical instruments at once. Strainous efforts are being made to keep the B.B.C. in the dark about this."—*Humorist.*

as though America may have unified broadcasting after all—under trust, instead of public-control.

Those Q S L Cards.

I AM glad to be able to announce that "P.W.L." has come to an arrangement with "Popular Radio," the famous American radio journal, to assist the ready exchange of QSL cards between this country and America. British amateurs who desire to send QSL cards to America may now address them care of this office, and they will be forwarded to "Popular Radio" to be mailed to the addressees.

Similar arrangements are being made at the other end, and by this means we hope to speed up and improve the delivery of the cards on both sides of the Atlantic.

Germany's New Wireless Link.

IT is announced from Berlin that it will no longer be necessary for South American telegrams to be sent via British cables, for a wireless service is to start next month. This will be open to the general public, the stations concerned being Rio de Janeiro and Nauen.

For Services Rendered.

A PROPOS of the retirement of Professor Fleming, to which I have already referred on this page, I hear that there is a movement on foot to commemorate his distinguished services.

The proposal is to have two portraits painted, one to be placed in University College, and one to be given to Professor Fleming, who wishes to offer it to the Institute of Electrical Engineers.

Any gift for the fund, however small, will be welcomed, and subscriptions should be sent to Professor W. C. Clinton, University College, Gower Street, London, W.C.1.

Green Diamond Lost.

A WEEK or two ago I referred to the only clear green diamond in existence, which had been lost by Mrs. S. G. Brown (of S. G. Brown, Ltd.). I was interested to learn that this diamond obtained its colour after ten years' experimenting by Mr. S. G. Brown, and the only rival it ever had was a milky-green diamond, which had been coloured by the late Sir Wm. Crookes.

The lost stone therefore had great scientific as well as pecuniary value.

Radio and the Invalid.

DO you—like the rest of us—get a trifle fed up with wireless, sometimes? If so, try to think of another hobby that could take its place. Here's a poignant extract from a letter to the Query Dept.:

"I am unfortunately an invalid with little hope of being otherwise, but through the medium of 'P.W.' I have been able to gain sufficient knowledge of wireless construction to enable me to possess an instrument that has brought much joy into an otherwise intolerable existence."

That's only one case out of thousands. Makes you realise what a fine, friendly old fellow the ether is, doesn't it?

National Radio Exhibitions.

THIS year the National Radio Exhibition in London will run concurrently with the German Wireless Exhibition. The former extends from September 4th to the 18th, whilst the latter opens on September 3rd and closes on the 12th.

O—A 4 Z.

MR. J. B. STREETER, of Cape Town—known on the air as O—A 4 Z—has asked me to inform readers of that station's change of address. Instead of Observatory, Cape Town, the Q R A is now J. S. Streeter, Esq., "Wood Green," Liesbeck Road, Rosebank, Cape Town.

A Drastic Remedy.

REMARKING that to some extent he sympathised with her, the magistrate at Tower Bridge police court recently fined a woman one shilling, for wilfully damaging a wireless set. It was stated that the set suddenly fell from the table, and when the police were called the defendant admitted that she broke the aerial, to stop the noise from the loud speaker! The damages amounted to forty shillings.

More New Stations.

AMONGST the new converts to broadcasting announced since last week are Nova Scotia and the Dutch East Indies.

The station for the former country is to be erected at Halifax.

ARIEL.



THE NEW B.B.C.

UNDER the British Broadcasting Company, which comes to an end as a corporate entity at the end of the year, Radio had made well-ordered progress. The company has shown enterprise to the limit of its resources, and has established an organisation which is certainly equal to the best in existence.

The company has been owned by radio manufacturers, and controlled by a Board consisting mainly of their representatives. It may have been a coincidence that the regime of the B.B.C. has seen a remarkable development in the manufacture of wireless equipment of all kinds. A successful radio industry, with a considerable export trade, has been established, which has held its own in the home market, even after the safeguarding protective duties were abolished.

Vital Questions.

The Government policy is not to set up a new authority constituted on the lines recommended by the Crawford Committee. A Commission of five or seven members will take the place of the present Board. It will be known as the British Broadcasting Commission, a semi-Governmental body, with the Post Office in a position to exercise control and regulate finance. The Postmaster-General has not given details of the new organisation or indicated the type of Commissioner to be appointed.

The future progress of Radio will be influenced largely by these factors. Will the Commissioners be independent business men, with or without some expert knowledge, or retired civil servants or political place hunters? Will the Commission be incorporated in the Civil Service? Government Commissioners—when highly paid, as in this case—usually go by favour to political friends of the party in office.

Radio Fund Raids?

Will the Government of the day use this new medium of vast potentialities which science has put in its hands for partisan purposes? In Italy radio is used frankly for Government propaganda, and an attempt, which was strongly resented, was made during the general strike by Mr. Churchill, or whoever was responsible, to include radio editorials in the news service.

Will the Commission under the new conditions, and in normal times, be more amenable to official pressure? Not until the Commissioners are appointed, and the

An Exclusive Article by
SIR ROBERT DONALD,
G.B.E., LL.D.
(Chairman of the Imperial Wireless
Telegraphy Committee, 1924.)

conditions under which they will function are known, will we be able to express definite opinions on these points.

The main interest of the readers of POPULAR WIRELESS is in the effect which the change is likely to have on development. There is a danger that the Commission may come under Treasury control.

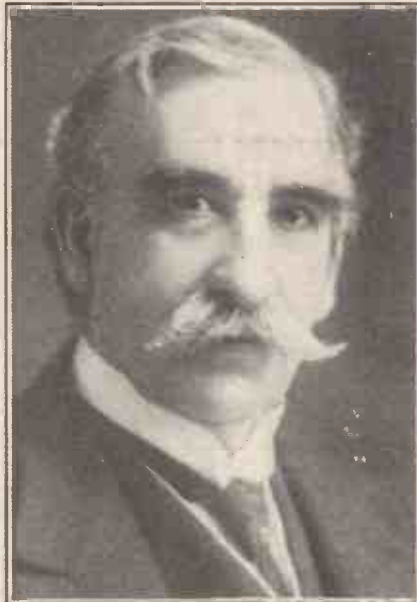

Sir Robert Donald.

The Post Office is a branch of the Treasury: it cannot incur capital expenditure or dispose of its profits without the sanction of the Treasury.

At present the Post Office does not give broadcasting a square deal. The arrangement was that out of every 10/- subscribed 7/6 should go to the Broadcasting Company while the Post Office retained 2/6. But the Post Office has upset this percentage by limiting the amount granted to the Company to half a million a year, and has accumulated a big surplus by retaining more than its

fair share. There is nothing to prevent Mr. Churchill from raiding the Radio Fund as he did the Road Fund.

The view of listeners is that while the industry is developing ample funds are required for research and improvement, as well as for providing better programmes.

There is also a risk that under Commission rule the control will fall into the hands of an oligarchy, which on questions of policy may have no direct representative in Parliament. Both the Postmaster-General and the Chancellor of the Exchequer can say that they do not interfere with the Commissioners, to whom large powers have been delegated, or they may interfere just when it suits the Government's policy.

International Possibilities.

The last four years have only seen the first stage in the progress of Radio. We are mastering the national problem, but the international possibilities of Radio have not yet been developed. We are still in the experimental stage. The new B.B.C. should be in a position to carry on the work of experiment on bold lines in the international sphere.

Unless a thoroughly businesslike policy is adopted we will not keep our place in the Radio world. The Germans have devised a system which gives more encouragement to initiative and enterprise. The nine Radio centres in Germany are allotted to independent companies—under licence from the Post Office. They are responsible for the equipment of the stations and for arranging the programmes. The nine companies are associated with a central corporation which deals with questions of common interest and policy. The system combines an element of competition without waste.

American Methods.

We must look out for progress also in the United States, where broadcasting has been left to private enterprise. It is customary to regard the American method as chaotic, but the force of circumstances is bringing about unity and a national organisation. There are 540 broadcasting stations in the United States, and 20,000,000 listeners.

There have been some advantages from the American free market in Radio. It makes for experiment and development. It secures the help of amateurs who run their own stations and carry out a great

(Continued on last page.)

WIRELESS WEATHER REPORTS



THE International Meteorological Conference at present control in Germany an hourly wireless weather service both for general and aeronautical purposes. The former is taken charge of by Königswusterhausen, while the latter has been entrusted to the Aeronautical Observatory at Lindenberg, one of the most remarkable meteorological institutions in the world, which once per hour, on 1,680 metres, sends out a wireless bulletin.

In addition to this international weather service there is a similar service on 1,525 metres between Lindenberg and the various German aerodromes, while 1,400 metres is set apart for communication between aerodromes and 900 metres between aeroplanes and the ground.

As a wireless service, of course, is indispensable for safeguarding aviation, the large German airplanes are being fitted not only with wireless receivers, but with duplex radio telephones, while communication between aerodromes is required for the giving out of starting and landing bulletins as well as for urgent service reports. Weather reports, in accordance with the above, are broadcast both within Germany and in connection with the international meteorological service.

Meteorological observations, comprising accurate information on pressure, temperature, moisture, and visibility, on the condition and altitude of clouds, are continually being made at about forty meteorological stations. This data, which is transmitted in code, enables the meteorological expert of each aerodrome to form an idea of actual atmospheric conditions. Altitude, wind, and temperature conditions in the upper atmosphere are, of course, explored by

means of small pilot balloons, as well as with big captive balloons, kites, and aeroplanes. Full bulletins are broadcast at 7, 8, 11 a.m., and 2, 7, and 8 p.m., whereas at the remaining hours between 9 and 4 o'clock provisional data is given out. Observations at the actual meteorological stations are supplemented by those made at many post-offices throughout the country and telegraphed to the nearest aerodrome.

Certain special phenomena, such as fog centres, storm fronts, etc., which are of particular importance to aviators, are signalled from an even larger number of post-offices, comprising the so-called danger signalling stations.

The meteorologist in charge of each aerodrome observatory is entrusted with a most responsible task, that of combining his per-

bulletins, entails the use of fifteen wireless transmitters and about thirty-five receivers. The 1 kw. transmitter installed at Lindenberg has also recently been replaced by a 5 kw. transmitter.



Preparing a "Meteorograph" weather chart.

Another branch of the subject is also receiving considerable attention, and this might almost be termed "Wireless AND Weather Reports." Careful observations are being taken of wireless conditions contemporary with, preceding and subsequent, to varying atmospheric conditions. The result is that the effect of the weather on wireless communication is being placed on a scientific basis.

From the mass of information which is becoming available it may also be possible to determine how seriously wireless may be regarded as a weather prophet.

Every amateur and every listener will know that loud atmospheric noises can be heard while a thunderstorm is in progress, and that these make themselves evident some time before the storm actually commences. It is possible that by analysing the nature of these "X's," which on powerful sets and on long wave-lengths can nearly always be heard, that an accurate system of weather forecasting can be evolved.

The idea is a very old one, comparatively speaking, but it is only recently that it has received close scientific attention. It forms a subject that all amateurs possessing valve sets can, to some extent, study with the possibility of making important discoveries.

An exclusive article by our Berlin Correspondent,
DR. ALFRED GRADENWITZ.

sonal observations with data received from other meteorological stations.

The forty-odd meteorological stations working in conjunction with the Lindenberg Observatory send out about 2,000 words daily in the form of weather telegrams. To this should be added 300 wireless telegrams daily received from 120 post-office stations, and those sent out from about 100 danger signalling stations. This service, in connection with the starting and landing

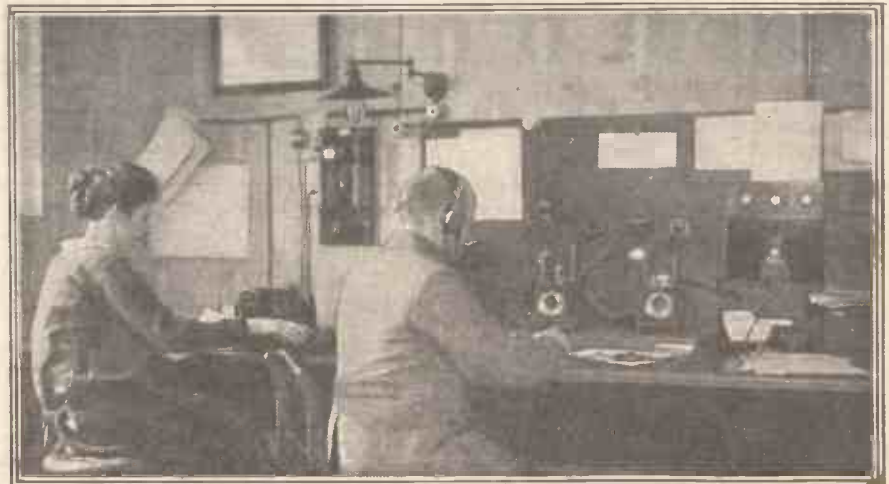

The receiving apparatus at the Lindenberg Meteorological Observatory wireless station.

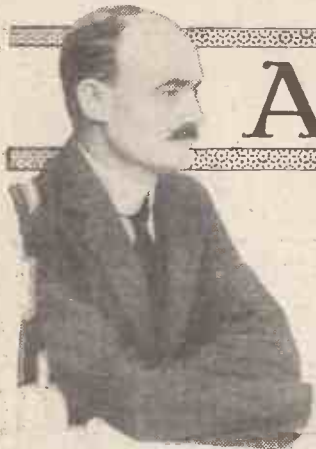

A Filadyne Two Valver

Full constructional details of a two-valver built on the new principle devised by Mr. Dowding.

The Set Described and Constructed by G. V. DOWDING, Grad.I.E.E. (Technical Editor).

BEFORE dealing with this two-valve Filadyne receiver we must take the opportunity of thanking the many readers who have sent us information concerning experiments carried out with the one-valve Filadyne. Quite apart from the usual complimentary letters received from constructors obtaining good results, we have received dozens of letters from amateurs containing invaluable data obtained obviously from most intelligent observation. We have been unable to reply to every one in detail, but we are carefully collecting all this useful matter and will embody the gist of it in a further general article.

Some of the points raised by our corre-

LIST OF COMPONENTS.

	£	s.	d.
1 Panel, 16 in. by 8 in. by 1/2 in., with cabinet (Peto-Scott) ..	1	15	6
1 .0005 var. condenser with vernier (Peto-Scott) ..	10	6	
1 Ferranti A.F.3 L.F. transformer	1	5	0
1 Lotus 2-way coil holder ..	8	0	
2 Lotus valve holders ..	5	0	
2 Lamplugh rheostats (30 ohm) ..	7	0	
2 terminal strips complete (as shown) ..	3	6	
1/2 lb. 22 or 24 gauge D.C.C. wire (approx.) ..	2	6	
Wire, screws, transfers, etc. ..	2	6	

normal. Separate H.T. positive connections and grid bias are included, and it will be noticed that the one H.T. battery and the one L.T. battery serve both sections of the receiver. This is important in view of the fact that many readers doubted whether it would be possible to add a stage of L.F. to the Filadyne detecting circuit without using separate batteries.

No Complications.

It is interesting to note that the L.F. side is in no way affected by the fact that a complete reversal of valve electrodes takes place. This, of course, similarly applies to the detector. It is a curious circuit on paper—in fact, it looks much more curious than it really is. Actually, nothing could be much more straightforward. Possibly it is a note of unconventionality that is emphasised by comparison with the conventional in the form of a stage of "straight" L.F. in close proximity.

From the point of view of aerial and earth and accessory requirements, the Filadyne is quite normal with but one or two exceptions, which will be dealt with in detail at the end of this article.

It is quite a straightforward set to construct and there are no complications to be faced. Ordinary components are employed throughout.

It should be noted that, as described, this Filadyne two-valver is suitable for reception of stations with wave-lengths below 1,000 metres, although it can be adapted to receive on the higher wave-band without difficulty.

A list of parts required is given separately, and particular attention is drawn to the filament rheostats. These must have a

(Continued on next page.)



For such a selective, sensitive receiver the Filadyne employs very few controls, as this photograph of the complete set shows.

spondents are of vital importance, and tend further to emphasise the unusual nature of the operation of a valve when used in a filament input manner.

What Filadyne Means.

For the benefit of new readers it will perhaps be advisable to summarise the theory underlying the operation of a Filadyne set before proceeding with the constructional details of the two-valver described in this article. Filadyne is a "synthetic" word intended to indicate "filament force." In an ordinary valve set the signal energy from the aerial or from the anode circuit of a preceding valve is passed on to the grid of a valve in order to influence the stream of electrons passing from the filament to the plate. By this means rectification and/or amplification is carried out.

In the Filadyne circuit the signal energy is fed on to the filament of the valve in order to influence the electron stream at

its source. The grid is connected to H.T. plus, and is therefore enabled to disperse the space charge, a cloud of free electrons which normally tends to congregate thickly around the filament.

One of the results of this is that lower H.T. voltages can be used, although this is more by way of being an incidental advantage. Loud, clear signals and distance sensitivity are the more important claims made for the Filadyne. The two-valver will, of

course, operate a loud speaker most satisfactorily over very good ranges. Tone and volume can both be described as exceptional.

A theoretical diagram of the circuit appears on this page, and this clearly shows how the filament input is affected. The filament of the detecting valve is isolated from the batteries and filament rheostat by two H.F. chokes. The ohmic resistance of these is low and they do not impede the flow of heating current from the L.T. battery. But they do prevent H.F. charges spreading through the L.T. system and confine them to the filament of the valve.

The L.F. side of the circuit is perfectly

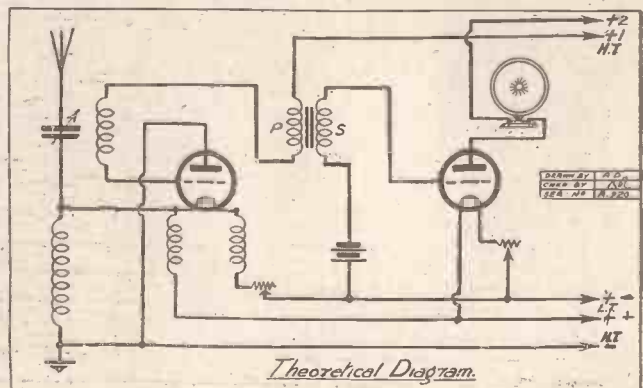

Theoretical Diagram.

A FILADYNE TWO-VALVER.

(Continued from previous page.)

maximum of 30 ohms. In filadyne circuits the valve functions best with its filament under-run. Over-running the filament even to the smallest degree will prevent the circuit operating. Not that filament adjustment is really critical, but just as in an ordinary set if the valve filament is not hot enough the receiver refuses to work, so in the filadyne anything above a certain temperature cuts out signals. It will be agreed that this is something of a further advantage, especially in the case of dull emitters whose lives are shortened by over-running. Indeed, it is impossible to over-run a dull emitter in a Filadyne receiver owing to this topsy-turvy state of affairs.

The Two H.F. Chokes.

As will be seen, this Filadyne 2-valver is designed on American lines, a practice which is becoming more regular owing to its popularity among constructors. The panel is screwed to a wooden baseboard, and these, which hold all the components, terminals and wiring, slide into an oblong case. Thus every part of the set is always immediately accessible without necessitating the removal of a single screw.

A panel drilling diagram is given, and this indicates clearly exactly where the various holes should be drilled for the panel mounted components and for the coil holder

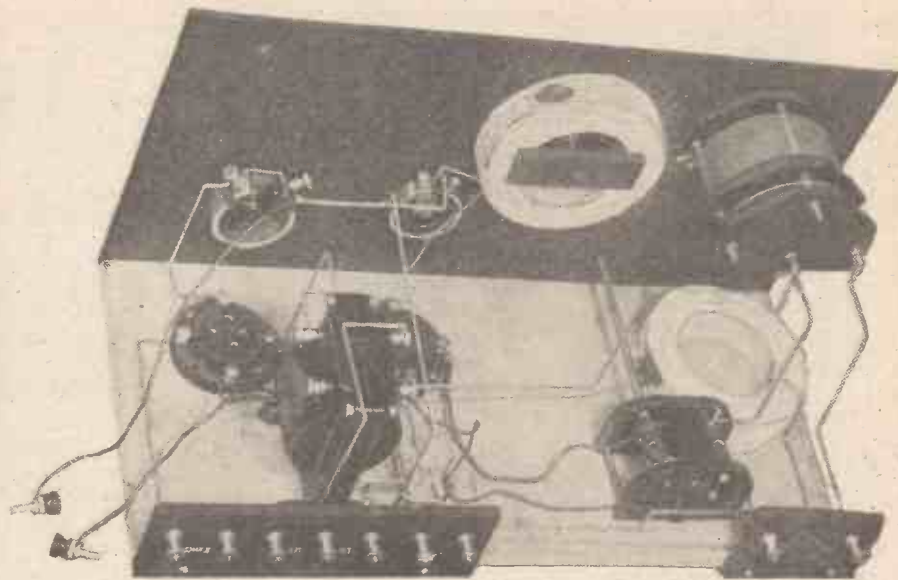

A back-of-panel photograph of the Filadyne two-valver, clearly showing the positions of the two filament chokes and other components.

handle. If the constructor is not well versed in the working of ebonite he should refer to "For the Constructor" series which appears weekly under the "Radiotorial" heading in our end columns. This series also includes valuable hints on soldering and the things useful to assemblers of wireless sets, and is well worth while retaining in book form for reference purposes.

When the panel has been drilled it can be screwed to the baseboard and the mounting

of components commenced. The lay-out of these is clearly shown in the various photographs which appear with this article.

The nine terminals are mounted on two ebonite strips situated at the back of the baseboard. One strip holds the aerial and earth terminals and the other the battery and loud-speaker terminals.

POINT-TO-POINT CONNECTIONS

Aerial terminal to fixed plates of variable condenser. Moving plates of condenser to socket of fixed coil holder, one filament socket of first valve holder, and to one side of one 250-turn H.F. choke; other side of choke to L.T. positive. L.T. positive also goes to one filament socket of the second valve holder. L.T. negative goes to one contact of each of the rheostats, the other contact of the first rheostat is taken to one side of the remaining choke, other side of choke to remaining filament socket of first valve holder.

Earth terminal to plug of fixed coil holder, H.T. negative, and plate socket of first valve holder.

Grid socket of first valve holder to plug of moving coil holder, socket of which goes to H.T. positive terminal of L.F. transformer; plate terminal of transformer to H.T. positive 1.

Grid terminal of transformer to grid socket of second valve holder, grid bias terminal to negative grid bias.

Positive grid bias to L.T. positive lead. Plate socket of second valve holder to one 'phone terminal, other 'phone terminal to H.T. positive 2.

Remaining side of second rheostat is joined to remaining filament socket of second valve holder.

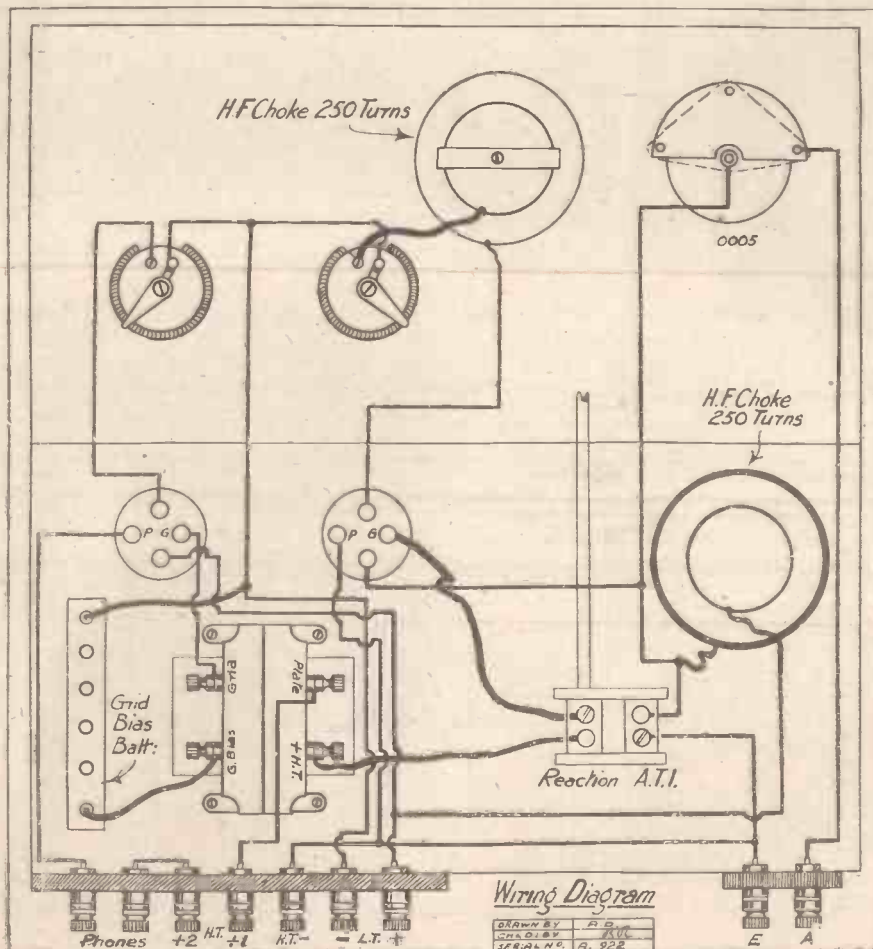

The two H.F. chokes should each consist of 250 turns of cotton-covered 22 or 24 gauge wire wound honeycomb coil fashion. Actually 250 turn coils of any type could be used, but the wire must be of fairly stout gauge in order to keep their ohmic resistance down. For wave-lengths above 1,000 metres 500 turn chokes would be needed, or for sake of compactness, two 250-turn choke coils in series in each case.

(Continued on next page.)

A FILADYNE TWO-VALVER.

(Continued from previous page.)

One choke coil should be mounted behind the panel. It can be held by a strip of ebonite and one nut and screw, as shown in the back of panel photographs. The other choke can be held down on the baseboard by means of a little Chatterton's compound or a strip of fibre.

Suitable Accessories.

The wiring of the set should be carried out carefully with tinned copper wire of the square section variety, soldering being done wherever possible. All leads should be well separated, especially those which go to the choke coils. Flexible wire will be

fixed to the terminal strips and to the panel, and the set is ready for test.

Now a few words in respect of accessories. Ordinary coils of any of the usual types can be used. As series condenser tuning is employed the aerial coil will need to be of about 75 turns. The reaction will vary with valves used and may be anything from 50 to 100. The grid bias battery should be at least $4\frac{1}{2}$ volts tapped like an H.T. battery but at every $\frac{1}{2}$. About 45 or less volts H.T. will be needed for the first valve and 60 upwards for the second, ac-



The complete set with grid bias battery, coils and valves in position.

This is a very important point, and readers will save themselves much time and trouble if they bear it in mind. Remember, some valves fail to operate altogether in the filadyne stage—dead silence results.

Besides too much L.T., too much H.T. can cause a weakening if not a total loss of signals, and so can a reversal of L.T. connections.

Tuning in the Filadyne is very sharp, and a high order of selectivity is evinced.

Naturally, the L.F. side is quite normal in behaviour and the above observations in respect of H.T. and L.T. do not apply. If a B.5 is used in the first position a B.6 can be used in this stage and a Cossor Stentor goes well with a D.E.R.

Finally, we are confident that constructors will agree with us that the set is exceptional in point of selectivity, sensitivity and tone, but, nevertheless, we will be grateful to every reader who writes to us and lets us know what he thinks of this receiver. Any data in respect of peculiarities noted or types of valves used will be doubly welcome. Such information will materially assist us in our further investigations concerning the development of this principle.

Since writing the above article (these words are being penned as we go to press with this issue of "P.W."), a further mass of data has been collected. Among other things, careful observation has shown that the most suitable valve for Filadyne circuits, above all others, is the Marconi or Osram D.E.R. Therefore, to obtain optimum efficiency, a D.E.R. should be used in the first stage of this two-valver, and a D.E. 6 or Cossor Stentor in the second. Owing to the resistance of the chokes a four-volt accumulator will be necessary, but the resultant volume and sensitivity fully justifies its employment.

The D.E.R. seems to operate in a different manner to the B 5, and demands its full filament current, but as it gives three or four times the volume this fact is of little moment. Using the D.E.R., and providing the circuit is functioning properly, an enormous volume results in the case of the two-valver. But despite this signals are notably pure and mellow.

Although the Ferranti transformer embodies a condenser across its primary winding, an additional .001 mfd. in the form of a fixed condenser sometimes improves results, and the addition of a .005 mfd. fixed condenser across the telephone terminals is to be recommended in the case of some loud speakers.

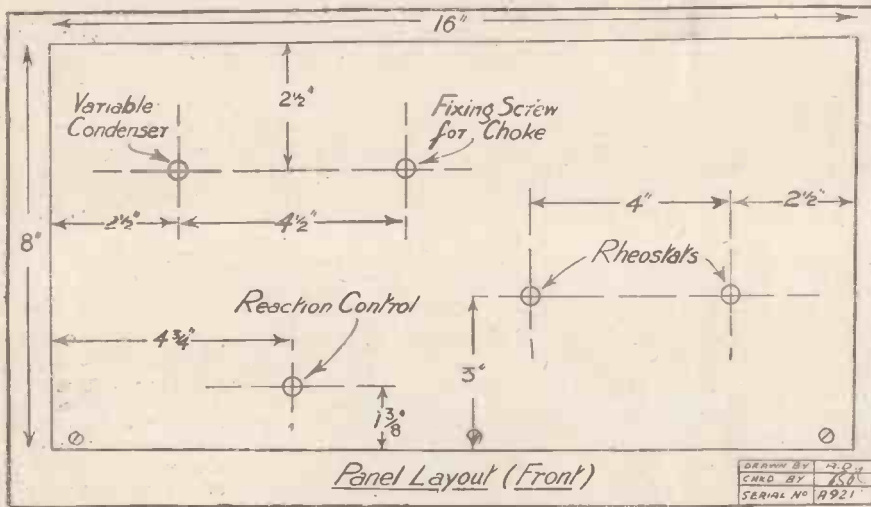

needed for connecting the moving block of the coil holder and for making the grid bias battery leads. The wiring should be carefully checked by the list of point-to-point connections given separately.

After a general clean up to remove dust and traces of surplus flux, transfers can be

corded to what types are used. Now not all valves will suit the Filadyne—very few do, in fact, but it is worth while trying out any that may be on hand.

A B.T.H. B.5. is quite O.K., and so is a D.E.R. In the L.F. position of the set any valve suited to L.F. work can be employed.

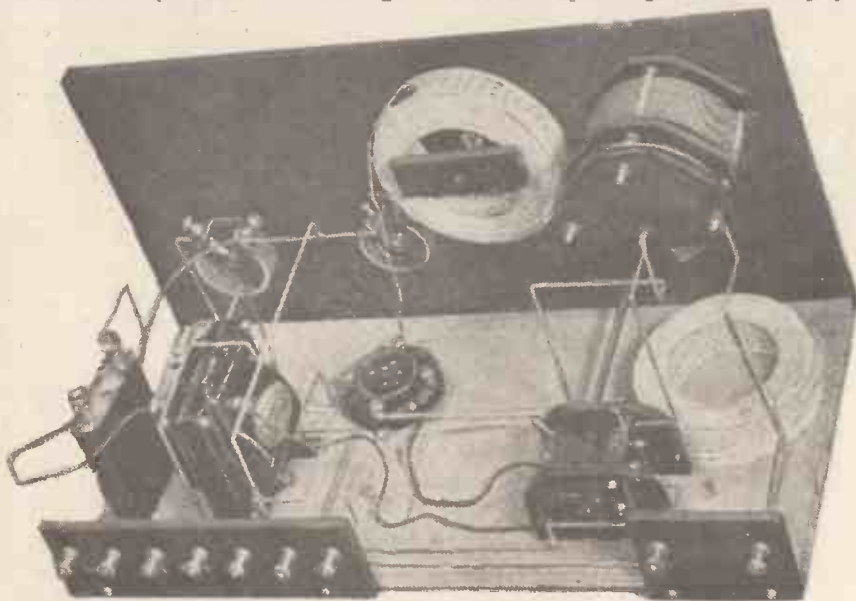

Another back-of-panel view with valves and coils removed to show the wiring more clearly.



Technical Notes

Conducted by our Staff Consultant, J. H. T. ROBERTS, D.Sc., F.Inst.P.

Dealing with L.F. "Howls."

A COMMON trouble which still appears to present a difficulty, especially to beginners, is the howling which occasionally arises in the L.F. amplifying part of the set. This is sometimes very difficult to cure, and as it may proceed from a variety of causes, it is desirable to know what those causes may be in order that the howling may be properly traced back to its source.

One of the commonest causes and the easiest to overcome is sound coupling between the loud speaker and the valves of the set, particularly the detector valve. It is evident that when the sound from the loud speaker falls upon the valves, the latter are set into corresponding vibration, and by their ordinary microphonic action they may tend to amplify the vibrations so received. Whether amplification of the vibrations will occur or not depends upon a number of conditions into which we need not for the present moment enter.

An important fact where coupling of this kind arises is that the valves should be adequately protected from the oncoming sound-waves (by properly enclosing them within the receiver cabinet) and the loud speaker should be turned in such a direction that the sound-waves do not fall directly upon the set. Usually this type of L.F. howl is entirely overcome by the simple expedient of turning the loud speaker in a different direction, but sometimes with a particularly sensitive set it is rather troublesome and the loud speaker has to be removed to a little distance from the set.

A Simple Remedy.

Another type of coupling may, of course, be brought about due to the resistance in the H.T. circuit which is common to all the valves. It is probably well known that in cases where a high-resistance is introduced into the H.T. circuit for the purpose of preventing accidental burning out of the valve filaments in the case of short circuit, this resistance has the effect in some cases of setting up an L.F. howl due precisely to the cause just indicated. This type of howl may, however, be overcome completely by shunting across the resistance (if a resistance be employed) a fixed condenser of sufficiently large capacity; this capacity may be up to one or two microfarads, although half a microfarad will usually be quite sufficient. Where no such resistance is specially introduced into the H.T. circuit, but where howling is caused by the resistance which already exists in that circuit, this may be over-

come by shunting a condenser of a similar capacity to the one just mentioned across from the H.T. negative terminal to each of the H.T. positiveappings. With an H.T. battery which is getting on in years, so to speak, the trouble may be caused by the drying-up of some of the cells in the battery and the consequent great increase in the internal resistance of the battery as a whole.

A New Loud Speaker.

There are, of course, other causes of L.F. howl which are not quite so common. One is magnetic coupling between two L.F. transformers, but this is readily overcome by placing the transformers with their axes at right angles to one another, or spacing them farther apart. Capacity-coupling between the busbar wires is also responsible in some cases for howling, and if the trouble cannot be traced to any other cause, the set may be dismantled and laid out afresh.

A new type of loud speaker was recently brought to my notice, which appears to me to embrace a more or less

novel principle. The essential part of the new device is a long tapered trumpet which can best be described, both as regards size and shape, as being like an elephant's trunk. Moreover, it still further resembles the member referred to in that it is entirely flexible; this is one of its essential features. The trumpet is made of a spiral of rattan cane, the convolutions being spaced about $\frac{1}{4}$ in. apart and the whole being covered over with a sort of linen fabric. The reproducer unit is fitted to the small end of the horn. Owing to its very flexible and snake-like character, the trumpet can be coiled up in a small cabinet practically of any shape. It lends itself to coiling into corners in a remarkably simple way, whilst at the same time the gradual and regular increase in diameter, without change of shape, from the narrow end to the open end is secured.

A Novel H.T. Accumulator.

In order to prevent the "creeping" of acid in an H.T. accumulator, and also to reduce the rate of evaporation, it is a common practice to pour a small drop of paraffin oil or some such-like mineral oil upon the surface. This has a very good effect, and to a large extent prevents corrosion of the exposed metal parts and the terminals.

A well-known firm of accumulator manufacturers are now marketing a type of H.T. accumulator in which the plates are almost completely submerged in oil. In this way, it is possible to make up the battery in units of, say, 10-cells in a unit, with partitions between separate 2-volt compartments. It is claimed that a battery of this type, other things being equal, will outlast very considerably a battery of the ordinary kind.

I have not personally used this new battery as yet, but I have experimented a good deal with other types of H.T. battery, using special means to prevent evaporation and "creeping," and from my experience I should say it is quite likely that claims made for this new battery may well be substantiated.

An Interesting Book.

Those who had any experience during the War of sound-signalling, either under-water signalling or ordinary "sound ranging," will find much that is of interest in a new book entitled "The Principles of Sound Signaling," by Hart & Smith, published by Constable, price 12s. 6d. This book deals, amongst many other things, with the methods which were adopted for the locating of enemy artillery. Many of the problems
(Continued on page 800.)

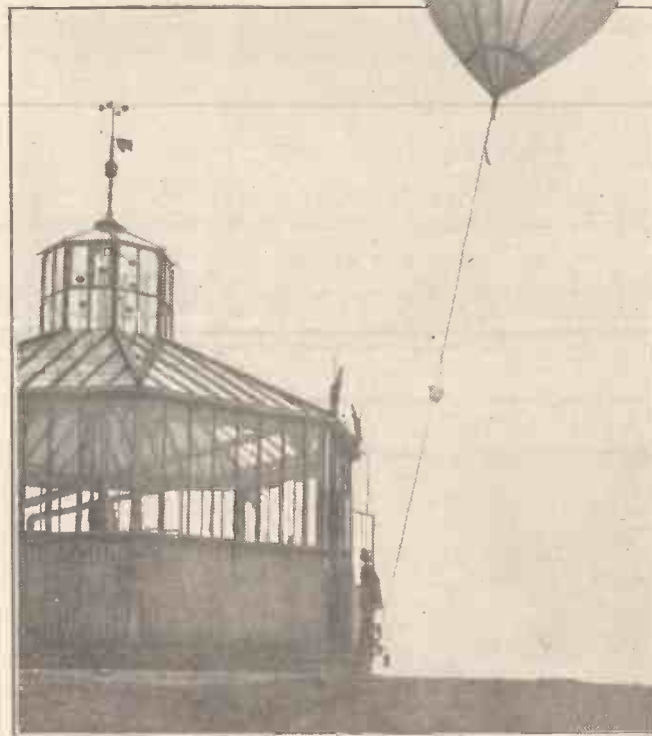

The captive balloon used at the Lindenberg Meteorological Observatory to prepare "Meteorographs" for broadcasting.

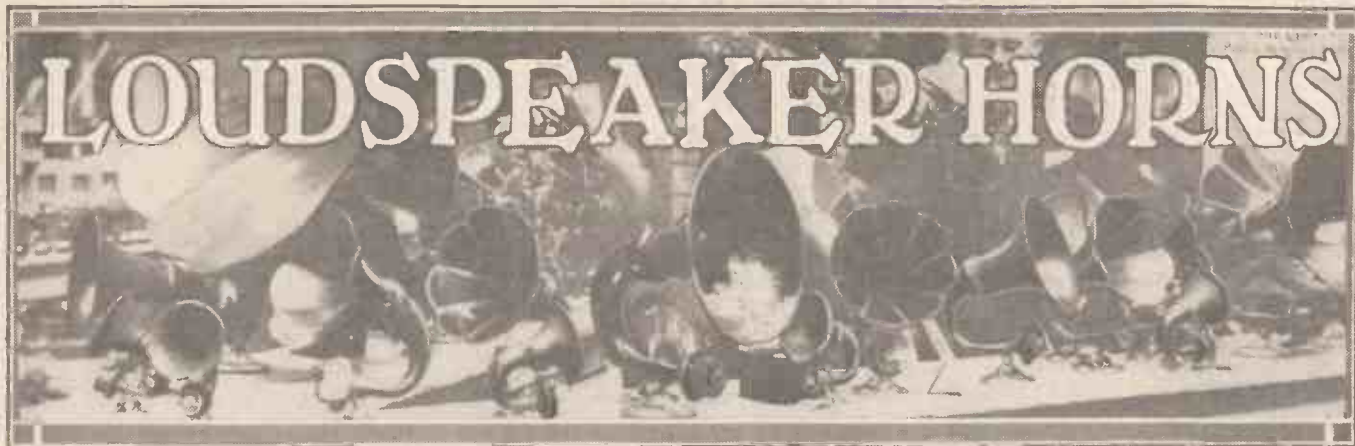

IT may be taken as an axiom that it is the ambition of every wireless enthusiast to own a loud-speaker set of really good tone, and whilst reliable components for set construction are now to be had at reasonable prices, the loud-speaker equipment often proves a stumbling block because of cost. Where a gramophone is available an attachment may be purchased for a moderate sum and fitted thereto, which enables the horn to function in place of the

A practical and informative article for those interested in first-class loud-speaker reproduction.

By CHARLES BAXTER, F.R.M.S.,
A.M.I.Mech.E., A.M.I.Min.E.,
A.M.I.A.E., etc.

to put upon the market two classes of bulb motor horn. One was cheap and constructed of thin metal and gave a terrific ear-piercing blast, and sold readily to taxi proprietors, whilst the better variety, made of thicker material was a total failure, as whatever period of reed was

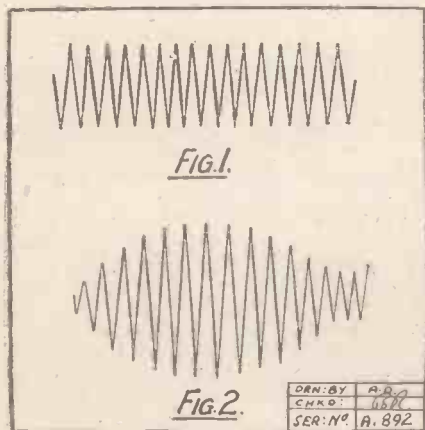

to interpolate here that horns are simply used to magnify the sound as it were, and cannot improve the tone, but can, of course, greatly mar it, by imposing upon the loud-



The result of many years' research in loud-speaker horn design.

undesirable natural period effect in horns, such as by heavily coating them with some substance, or making them in separate pieces coupled together by means of a special rubber joint ring.

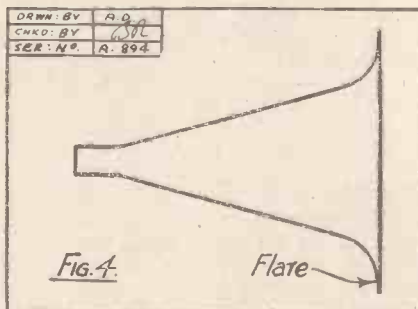

To show what an important bearing this sort of thing has upon the matter, the case can be cited of a certain firm who wished

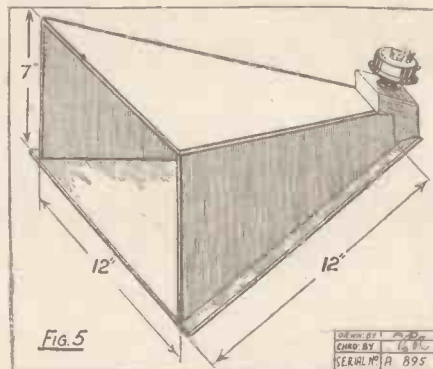

tried, no decent hoot could be coaxed from it. In the latter instance the horn did not vibrate at any period produced by the usual reed fitting, and so the reed wave was little influenced, and although magnified, was useless for the purpose in question. Fig. 1 shows a diagram taken from this unsuccessful horn, and Fig. 2 from the successful type, and it will be noticed that in the latter the period of the reed so coincided with the natural period of the horn as to produce the desired amplitude. Now, this is an extreme case, but indicates just the sort of thing we wish to avoid in loud-speaker trumpets.



A recent example of the hornless type of loud-speaker.

Those who have outfits that resonate at certain pitches can improve matters by binding them with ordinary string, or giving them a few coats of thick paint or varnish

(Continued on next page.)

speaker trumpet, the resulting assembly providing a speaker with a tone and loudness depending in some measure upon the acoustical properties of the gramophone tone arm and horn.

Magnifying Properties.

Where the sounding arrangements are of the metal horn variety the tone may be disappointing, as horns have natural frequencies of their own, both as regards the contained air column and the material from which they are constructed. It is as well

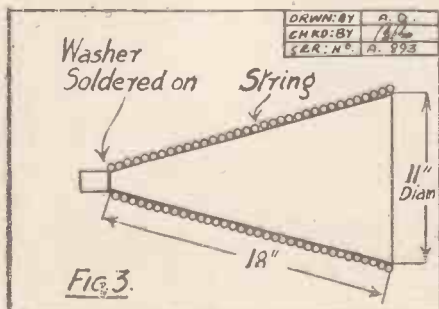

WHAT VALVES SHALL I USE?

By K. D. ROGERS.

THERE still appears to be a good deal of doubt among listeners as to the types of valves they should use in their various receivers. As the advancement of valve design has increased, more and more valves have been put on the market, until now there are well over 300 different valves—all British made—from which the bewildered amateur has to make his choice.

These can be divided into three classes, according to the L.T. voltage they require, namely, 2, 4, and 6 volts, and so it behoves the listener to decide on his L.T. voltage first if he is just commencing wireless. Otherwise he must choose his valves to suit his present L.T. supply, taking into consideration the charging capabilities that he has at his disposal.

Filament Consumption.

Among the valves, then, we have the two-volters; those that take 4 volts (including the 3 volt .06 amp. types) and those that require a 6-volt battery to operate them. It must not be forgotten, however, that the voltage is a minor consideration, and this is a point that should be made absolutely clear to listeners—it is the *current consumption* that matters, and that is one of the main factors that the listener must consider when choosing valves for his set.

The total ampere consumption of all the valves in use should never be allowed to exceed one-tenth of the actual ampere-hour capacity of the L.T. battery from which the valves are being operated. If this is likely to take place the listener must either get a larger accumulator or else substitute his valves by those having a less filament consumption.

If the consumption does exceed one-tenth of the capacity of the accumulator it will run this down too quickly and the battery will soon deteriorate.

The next and most important consideration is the type of valve to be used, for this must be chosen according to the task it has to perform. For instance, if it has to operate as an H.F. amplifier the valve should be one designed for that purpose if the best results are to be obtained. It is no good using a "good" L.F. amplifier (one specially designed for power work) and expecting the same results as if an H.F. valve had been used.

Choosing H.F. Valves.

The results *may* be quite satisfactory under normal working conditions, but this will be rather the result of luck than proper judgment in the arrangement of the valves. For good H.F. amplification valves having a high impedance should be employed, dependent, of course, to a large extent on the exact circuit being used.

If resistance coupling, or even choke coupling, is being employed, it is very often advantageous to use a valve with an impedance of anything between 30,000 and 60,000 ohms, but if transformer coupling is incorporated, so high an impedance often causes instability, and I do not advise valves having an impedance of, say, more than 35,000 as a general rule.

Suiting valves to one or more stages of tuned-anode coupling is a rather difficult business owing to the inherent stability of such circuits. Here, again, too high an impedance will make the set prone to self-oscillation and may make neutrodyne a difficult matter.

In any case, if too high an impedance is used in such a circuit it will often be found that the result in amplification is much less than that obtainable when a more moderate valve impedance is employed.

In the case of the detector it is rather more a matter of experiment as to whether a high or low impedance valve is better. Usually the former will be more satisfactory, but unless a very tricky circuit is being used, such as a super-het. or a Neutrodyne, no trouble should be experienced in the finding of a rectifier which will give good results. Very often makers advocate special use of either their H.F. or L.F. valves for rectification purposes, and, in such instances, it is usually safe to take their advice.

L.F. amplification needs a little more judgment and care than either of the two stages mentioned. As a rule, any moderate L.F. valve can be used in a first-stage unless

LOUD-SPEAKER HORNS.

(Continued from previous page.)

the idea, of course, being to deaden any tendency to ring or vibrate, which is easily tested by tapping the rim with a lead pencil.

For those who do not possess the necessary gramophone, or who object to having to remove and replace the speaker unit, a very efficient horn may be made from wood. Other materials may be used, of course, as for instance, a plain cone of sheet tin, 26 S.W.G., as shown in Fig. 3, bound with string, or coated, as previously mentioned, or the same thing may be made from cardboard, and both will prove useful, the relative results, including that of the wooden variety, being as follows:

Tin or Brass.—This will be loud but liable to resonance, as stated.

Cardboard.—Will not resonate at all, but is very weak, due to wave absorption.

Wood.—Not so loud as metal, but very free from tone disturbances.

Wooden Horns.

The last mentioned, although most efficient from an all-round point of view, appears to have been somewhat neglected by constructors. On the other hand, wood is not a critical substance, as although it is supposed to be bad practice to allow the sound waves to proceed round right-angle bends, travel a duct containing

that stage is followed by resistance-capacity coupling. If this latter is the case, the valve should have an impedance of between 20 and 50 thousand ohms in order to obtain sufficient amplification and clear results.

Transformer stages require valves with a lower impedance, while, as stage after stage is added, it is a general rule for the impedance of the valve to decrease and its grid to become more open.

Resistance-Capacity Coupling.

Take a case in point where an efficient type of amplifier using one transformer and two resistance coupled stages is being employed. The first valve, following the transformer and preceding a resistance stage should have a high impedance such as D.E.5b, D.F.A.4 or D.E.3b. Following this, although another resistance capacity coupled stage comes after it, a valve having a less impedance and capable of carrying more volume must be used. Suitable valves will be the D.E.5, D.F.A.1, etc., while, in the last stage, where the valve has only the loud speaker in its plate circuit, a wide-mesh power amplifier, such as the D.E.5a, can be used with success.

The foregoing remarks should be sufficient to show how important it is to use the correct valves in the various positions, and those readers who do not feel clear about the choice of their valves will do well to study the various valve lists that have been published from time to time, or write to the valve manufacturers before deciding what valves they will use in their sets.

corners, and emerge into the outer atmosphere suddenly—i.e. without a flare to the trumpet, as shown in Fig. 4—these effects are, in the case of wood, very slight.

As in the case of good musical instruments the wood is an important factor and must be of the right grain and properly seasoned, and knowing this the writer utilised the horn portion of a cabinet set, shown in Fig. 5, obtainable from Messrs. Sames, Ltd., the piano makers of Ombersley Road, Birmingham, who make them in quantities, the price being 4/3 each. This with the

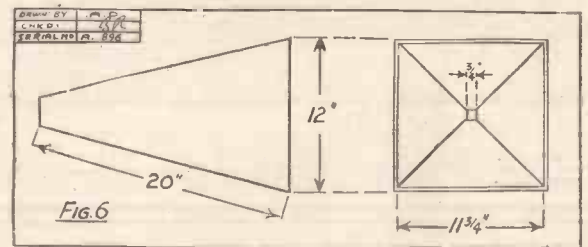

Lissen attachment shown, forms a good loud speaker and conveniently rests on a table or cabinet.

For those who wish to construct their own horn three-ply wood can be used and fastened together by pinning and glueing, but if the jointing is not thoroughly done, or the wood not properly seasoned, the results are apt to be disappointing. A convenient size for this is shown in Fig. 6, and it should be noted that if it is desired to keep the horn a perfect square, allowance must be made for the thickness of the wood, as shown in the end view, which assumes the wood to be one-eighth of an inch.

AMERICA CALLING!

News of Progress and Events of Radio Interest in the United States.

By LAWRENCE W. CORBETT.

A WORD or two about the cone loud speaker. First of all, though, let it be known that the remarks below respecting the comparative popularity of the cone and horn type speakers are based upon personal observations; actual statistics are not available. As far as the writer is aware, there is only one cone loud speaker on the market in England. It is, admittedly, an excellent reproducer, but way above the average man's purse. In America, on the other hand, the market is gradually becoming flooded with cones of every type and description, some licensed by the patentee of the cone patent, and others—well, manufactured by those unprincipled firms who are out to "cash in" quickly.

These latter unscrupulous concerns are out to make money "while the going's good." When approached by the people whose patents they have been infringing, maybe they'll be willing to compromise. "Let us sell the goods we have on hand," they say, "and we'll stop infringing your patent." The patentee, more or less on the horns of a dilemma, is as often as not willing to accept the terms proposed. Or, of course, he may resort to expensive litigation, but what a chance he has with the American Courts in their present poor state!

A Monster Cone Loud Speaker.

We have only to cite the Armstrong-De Forest case as a typical example of the "speedy" action one may now expect to get in a patent dispute. The cone speaker, then, we may surmise, is quickly ousting the horn type in America. Yes, indeed, probably two or three cones are sold to every horn, and that may even be a conservative estimate.

Whence this sudden popularity you may well ask. And why has it not spread abroad? Well, to begin with, we readily admit that the cone is usually a better reproducer than the horn. Especially does this apply to the bass notes. As far as the high notes are concerned, the writer prefers a good horn and, as a matter of fact, believes that a certain British horn type speaker is better than many cones for the low notes, too. However, the American public has been informed in incalculable advertisements that the cone is better than any horn, with the result that they now believe that to be the case.

No discredit to our American cousins that they should fall for such advertising (which, this time, is approximately accurate), for in England we too would fall just as quickly should we be given the opportunity. No matter where you are, the public, generally, is as gullible as are the advertisements colourful in its journals. Let us not forget the "Daily Mail's" show-up some two years ago of a certain medicinal product which we all took to cure our coughs, colds, influenza, and what not!

However, this is not a treatise on advertising. We were talking of the popularity of the cone in the States. While in England

the would-be cone owner has no choice but to purchase the one rather expensive cone now on the British market, in New York he has the option of purchasing perhaps one of a hundred different makes. He may pay as little as thirty-five shillings for one (he'll get rather a poor one at this price, though), or he may pay seven pounds for one of the new 36-in. diameter diaphragm ones, which would constitute a good "buy"—a good "bargain," we would say in England—for they are very efficient.

Probably he would get about a third off list prices in New York by taking the subway (underground) down to the cut-price district, and buying his cone at a "gyp"

frequency scale, and this is very noticeable when (and this is very often the case) there is a slight background hiss. This hiss is usually of a fairly low frequency, and does not as a rule interfere with the music being received with a horn. The cone will often give this hiss enough prominence to make it uncomfortably annoying when music of a higher frequency is being received.

Old Valves for New.

Irrespective of the fact that it is possible to buy tubes (valves) for as little as fifty cents (about two shillings) in the "gyp store" district of most American cities, the retailer will always give you his word that the aforesaid tubes are brand new—not



A self-contained wireless set fitted in the bedroom of a typical American house.

store. Or probably he would prefer to get his instrument from a reliable dealer who will be willing to change it should it prove to be defective, and pay the full list price. Ten pounds a week is a common wage for a labourer in the United States; he can afford to buy the best that radio has to offer. In the writer's opinion, the American working man spends much more on luxuries than on home and garden.

The Pleated Type.

While the cone loud speaker continues to gain in popularity, it is interesting to note that the pleated type speaker is very little used. The "Victor" people (His Master's Voice) are the licensed manufacturers of this speaker in the United States, but the sales have not been very great.

One thing the writer does not like about the cone speaker is that it is apt to emphasize too greatly the lower end of the

rejuvenated. Who, then, gets all the second-hand valves taken in exchange for new ones? Many New York dealers advertise the fact that they will accept fifty cents and a worn-out tube for a brand new dollar one. It is obvious to the most ignorant of us that the base alone is not worth the fifty cents the dealer subtracts from the list price of the so-called new tube.

Some dealers rather give the game away by saying they will accept only old tubes in which the filament has not been broken. One dealer makes so bold as to advertise the fact that he will give one and a half dollars for all old tubes, regardless of their condition, towards the purchase of a new two-dollar tube.

Incidentally, the new two-dollar tube referred to in this blatant announcement may be purchased for one dollar, but that is beside the point.

(Continued on next page.)

VARIATIONS IN TUNING.

FROM A CORRESPONDENT.

THEORETICALLY, perhaps, one should be able to tune in the "household" receiver and leave it permanently set on the local station, leaving only an "on-off" battery switch to be operated. In some cases this is possible, but it frequently happens that the necessity for re-adjusting the tuning controls arises at more or less regular intervals.

This is generally due to variations occurring in the voltages of the batteries. When the H.T. commences to run down it becomes necessary to tighten the reaction coupling and this affects the wave-length tuning, too, in most sets. The reverse might happen after the set has been out of use for a day or two and the H.T. has to some extent recuperated. The greater liveliness of this element calls for less reaction coupling and, again, the tuning controls will need a slight readjustment. More or less similar variations in the L.T. supply will have similar effects, but not to such a marked degree.

Caused by Neighbours.

But variations in tuning may be necessitated by "outside" influences as well. Not that the wave-lengths of the broadcasting stations vary much, although it must be mentioned that Capt. Eckersley does push most of the stations about within a metre or so now and then. This will have no effect on any but the most ultra-selective of sets. When, however, there are a large number of receiving aerials situated closely to one another, the tuning of one may have a considerable effect on the tuning of others.

Thus, when No. 157 Suburban Road, London, is twisting his dials, both Nos. 155 and 159, and even other neighbours farther away, may experience that fading feeling and have to rush over to the set to re-adjust. On the other hand, considerable increases of volume might be broadcast by No. 157 and this no one would mind. Again, he might oscillate, and this violent form of variations in tuning can be given no compensation by the sufferers from it.

When the Aerial Sways.

Variations in atmospheric conditions will cause very slight variations in the inductance and capacity of an aerial system and variations in the earth connections will sometimes necessitate moving station "X" from 30 on the condenser dial to a considerably higher or lower figure. When a water-pipe connection goes "dud" all the stations will move up on the dials. A buried earth is sometimes prone to cause similar trouble in changeable seasons.

A loose aerial swaying in the wind will play havoc with an ultra-sensitive DX receiver, but will leave a "household" set supplied with a reasonable "margin of safety," quite unmoved.

Shifting the position of a receiver or the larger objects of furniture near it sometimes makes a little difference to dial readings, while the lengthening or shortening of either the aerial or earth lead invariably does.

Filling up Panel Holes.

The two materials most commonly used for filling up holes in ebonite are Chatterton's Compound and cobbler's heel-ball. Both may be used successfully for holes up to about $\frac{3}{8}$ in. Chatterton's has the disadvantage of being rather sticky and difficult to rub down so as to leave a neat repair, and it is not easy to buy, although it is cheap enough when it can be obtained. The best way to use it is to make a pellet by rolling a scrap of warmed compound between moistened fingers and press the pellet into the hole until this is rather more than filled. The pellet should then be lighted and allowed to burn for a second or two. As it melts it will spread. It should be left for about half an hour to set, after which time any

surplus may be removed with a sharp knife and the panel finished off with sandpaper.

Heel-ball presents its own difficulties in that, when melted and dropped into a hole, it usually drips through. This may be prevented by screwing a bolt half-way into the hole from the under-side, so that the wax cannot drip. When the wax has set (in a few seconds) the middle of the blob will sink, and it will be necessary to add another drop on top of that already partly filling the hole. Any surplus should be removed carefully with a knife, as the wax has a tendency to chip.

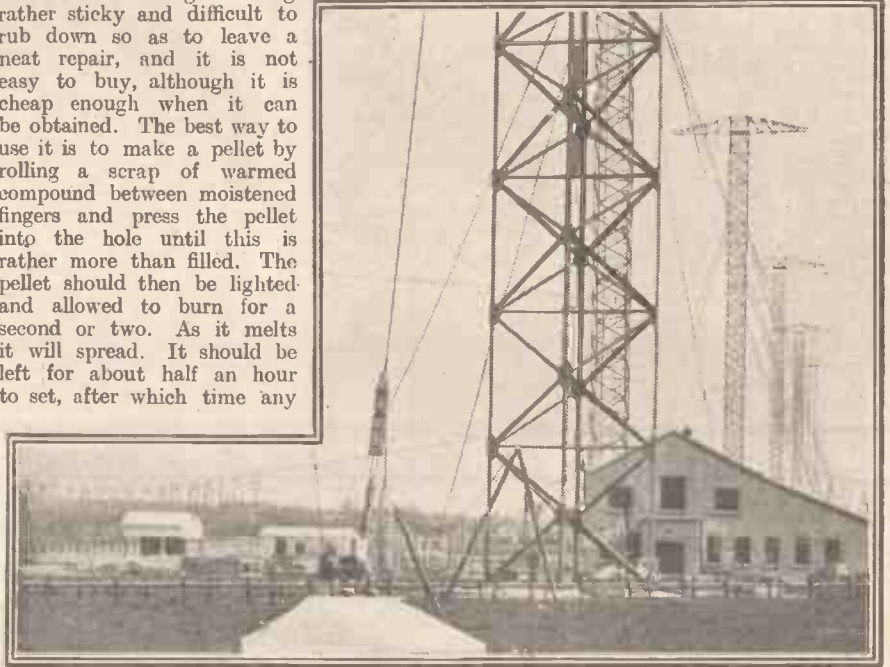

A view of the new Marconi beam station at Bodmin, showing the foot of one of the masts.

AMERICA CALLING.

(Continued from previous page.)

An expedition is being organised to carry members of the American Museum, of New York, to within 700 miles of the North Pole. The call signal of the transmitter, which is aboard the "Morrissey," is V O Q.

In addition to seeking new and finer specimens of the narwhal, walrus, seal, muskox, and other Arctic denizens, the expedition will undertake to solve some of the mysteries pertaining to short-wave radio communication in Polar regions. The short-wave transmitter employs one 250-watt tube, and will be heard during the months of July, August, September, and October on 20 and 33 metres. Then in the neighbourhood of Etah, Greenland, waves below 18 metres will be employed to transmit from the "Morrissey." The following hours will be kept free for CQ calls: 20 metres, 5-30 to 6 p.m., G.M.T., and 11-30 to midnight: 33 metres, 1-30 to 2 a.m., G.M.T., and 5 to 5-30 a.m. Most of the ordinary work will be done on 20 metres.

Those short-wave amateurs who have listened to 2 N M working Canadian 1 A R will be interested to know that V O Q will endeavour to maintain this definite

schedule with the Canadian: 20 metres, 3-30 to 4-30 p.m., G.M.T., and (33 metres) 4 to 5 a.m., G.M.T. The operator of V O Q will keep a log of the stations he makes contact with, and a prize, probably in the form of a Polar bear skin or a set of walrus tusks, will be awarded to the amateur who scores highest in this log.

Concerning Wireless Patents.

The United States Patent Office has published the fact that there are 3,053 radio patents listed. Of these, 650 have expired. The above figures do not take into consideration pending patents applications, the total of which is kept secret. Of the approximate 2,400 patents still in force, nearly 1,000 are controlled by the Radio Corporation of America and the companies under whose licenses the Radio Corporation manufactures. These companies are, of course, the General Electric Company, the Westinghouse Company, the American Telephone and Telegraph Company, and the Wireless Speciality Apparatus Company. The vacuum tube patents listed in the U.S. Patent Office number 268, eleven of which are expired. Of these 268, 167 are owned by the above cross-licensing companies. These figures are extremely interesting in view of the findings of the Federal Trade Commission, who charged the Radio Corporation with creating a monopoly in the radio business.

H.F. Stability



Some of the Difficulties of H.F. Amplification are lucidly Discussed in this Article by a well-known "P.W." Contributor.
By SEXTON O'CONNOR.

THE chief difficulty when using one or more stages of H.F. amplification for distant reception, is to prevent the set from oscillating—or "spilling over," as the Americans say. This problem has already been tackled with considerable success (a) by the neutrodyne method of

there comes a point when a "plop" is heard and the set spills over. This will happen even if the reaction coil is short-circuited, and is due simply and solely to the electrostatic coupling between the input and output circuits across the valve electrodes.

city) and C_1 and C_2 the respective capacities of the tuning condensers.

Controlling the Coupling.

Accordingly, when C_1 and C_2 are low in value, the co-efficient of coupling increases,

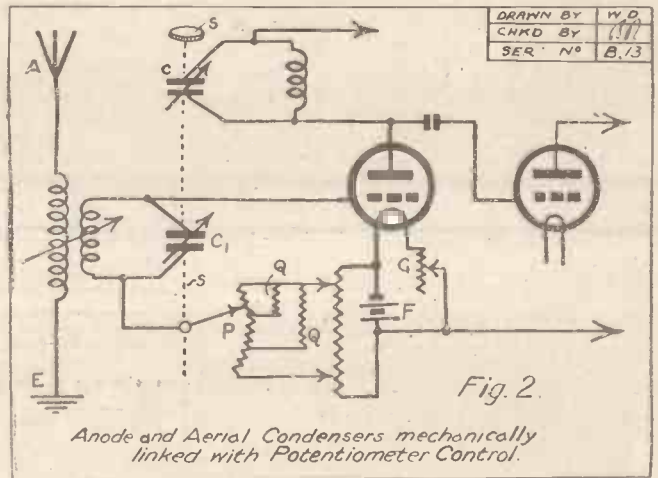
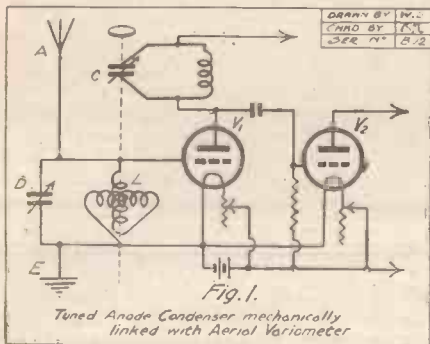

"balancing" the stray capacity effects, and (b) in the superheterodyne receiver where the amplifying process is carried out on a converted or intermediate wavelength.

At the present time most of the local disturbance caused by re-radiating receivers is probably due to the standard type of 3 or 4 valve set using only one stage of H.F. amplification, to which the neutrodyne stabiliser is not particularly suited. In spite of the efforts made by the B.B.C. and the various wireless clubs to educate listeners in the proper use of their sets, the "howling" nuisance is still rampant, and will probably remain so until some really effective method is found of automatically stabilising all standard sets so as to render them incapable of oscillating even in unskilful hands.

The "N" Circuit.

The Lodge "N" circuit is one of the simplest and most effective non-radiators at present available, though its capabilities as an H.F. amplifier have still to be determined. It may, therefore, be of interest to consider one or two other stabilising methods particularly suitable for use with a standard circuit of the tuned-anode type.

It is by no means a simple matter to avoid self-oscillation in such a circuit at all settings of the anode and aerial condensers. So long as the condensers are at high dial readings (for any particular set of plug-in coils), there is usually very little tendency to oscillate, provided the reaction coupling is kept reasonably loose; but as the condensers are turned towards the lower part of the dial (for the shorter wave-lengths)

Just as the co-efficient of magnetic coupling between any two circuits is M divided by $\sqrt{L_1 L_2}$, where M is the mutual inductance and L_1 and L_2 the respective inductances of the two circuits, so the co-efficient of capacity coupling between two similarly-tuned circuits is measured by dividing C by $\sqrt{C_1 C_2}$, where C is the coupling capacity (the inter-electrode capacity) and C_1 and C_2 the respective capacities of the tuning condensers.

because C (the inter-electrode capacity) is quite unaffected by the process of tuning; and the result of dividing a constant quantity C by a variable quantity such as

(Continued on next page.)

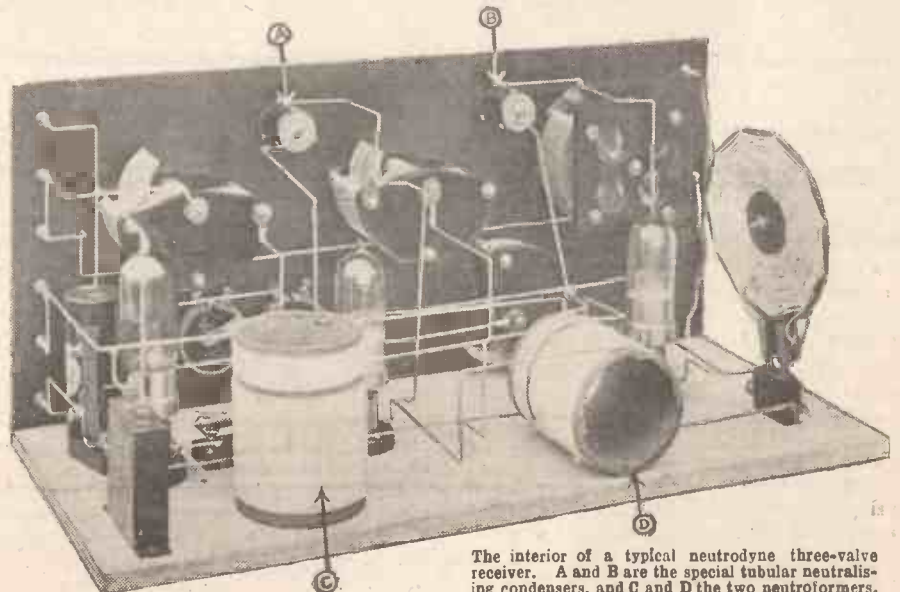

The interior of a typical neutrodyne three-valve receiver. A and B are the special tubular neutralising condensers, and C and D the two neutroformers.

SOME WORKSHOP HINTS.

FROM A CORRESPONDENT.

SOLDERING fluxes, of one description or another, are substances which every radio constructor uses. Yet it is strange that so very few constructors think of preparing their own fluxes and soldering pastes at home.

One of the best fluxes for ordinary soft soldering work is prepared according to the following recipe:

Tallow 4 parts.
Powdered resin 2 "
Powdered sal-ammoniac .. 1 "

The sal-ammoniac should be dissolved in the least possible quantity of water. It should be then added to the other ingredients, the whole then being thoroughly stirred up into a paste after the addition of a few drops of olive oil or glycerine.

Another soldering paste is prepared as follows:

Dissolve 3 parts of pure zinc chloride and 1 part of sal-ammoniac in 4 or 5 parts of water. To this solution add 1 part of powdered starch, the starch being stirred into the liquid until it attains a creamy appearance. Boiling water is now added to the mixture until the mass begins to thicken. The soldering paste will now be ready.

The Best Flux.

Of course, the best flux for very fine and delicate radio work is pure resin only. Such a flux is not a popular one, however, on account of the difficulty which some constructors find in working with it. This difficulty, however, may be somewhat lessened by dissolving a quantity of finely powdered resin in methylated spirit until a dark-coloured solution results.

This resin solution is painted over the portions of the wire to be soldered. Thus the method provides a mode of placing just the right quantity of resin on the parts to be soldered, not too much and not too little. The resin, by this method, is coated evenly and tightly over the part, and further soldering proceedings are very much facilitated by this means.

Do not be too economical in the matter of tools. One pair of pliers cannot successfully do the work of three pairs. A light pair is desirable for bending and holding wires during soldering; the jaws of this pair should be lined to ensure a good grip. A pair of round-nosed parallel pliers is desirable for making loops and for holding nuts when locking them. A fairly heavy pair of electrician's pliers is necessary for cutting wire and for general use.

Trimming and Drilling.

When wiring up a set, there will be a saving of both time and gas if two soldering irons are used. One should be of a fairly heavy type; the other may be smaller, for getting into awkward corners.

An adequate supply of several grades of sandpaper is indispensable. Coarse grades are wanted for trimming the edges of wood and ebonite panels, medium and fine grades for cleaning the soldering bit, and for

removing the insulation from wire covered with cotton, silk, enamel, or rubber. Very fine grades are required for finishing the surface of wood and ebonite.

When a drill of the size required is not available, a slightly smaller hole may easily

be enlarged by means of the end of a file, or a gimlet. A small hole may be made by means of an awl.

A small twist drill is useful for marking out the points on the panel through which larger holes are to be drilled; if a small hole is drilled in wood before a nail or screw is inserted, the wood will be less likely to split. A watchmaker's screw-driver is useful to deal with bolts of 6 B.A., or smaller sizes.

When a hacksaw is used for cutting ebonite, the blade is liable to snap. For cutting small pieces, in the absence of a tenon saw, a hack-saw blade gripped in the fingers (without a frame) is quite effective,

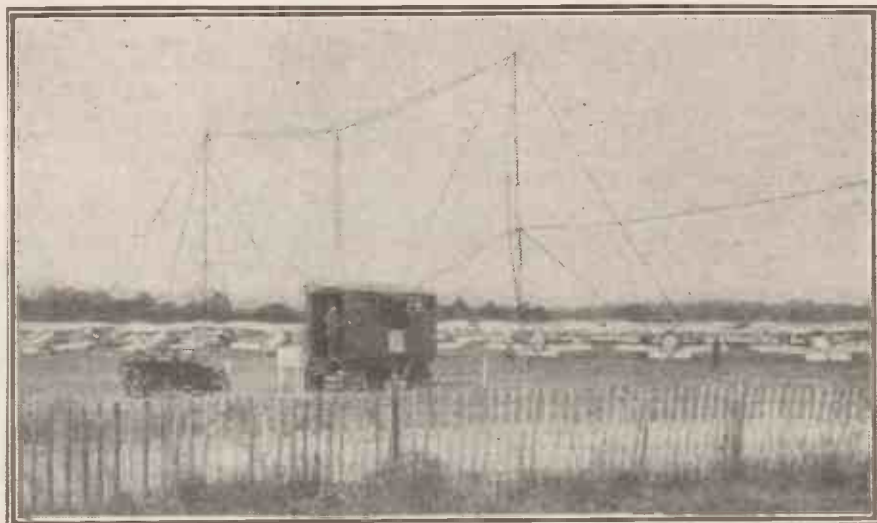

An R.A.F. mobile short-wave wireless station at work on the Hendon aerodrome (Marconiphone Co.)

H.F. STABILITY.

(Continued from previous page.)

$\sqrt{C_1 C_2}$, increases as the value of $C_1 C_2$ diminishes. An increased co-efficient of coupling implies a greater transfer of energy from the plate to the grid circuits, until at a certain point self-oscillation sets in as stated above.

The circuit shown in Fig. 1 illustrates an ingenious system invented by Mr. Carpenter for counterbalancing this inherent tendency to self-oscillation. The underlying principle consists in mechanically linking the tuning-condenser to some other control element which automatically reduces reaction as the condenser approaches the zero point.

For instance, the condenser C of the tuned-anode circuit is linked through a common spindle S (shown in dotted lines) to a variable inductance or variometer L in the aerial circuit. The variometer is so arranged that its inductance decreases as the value of the capacity C decreases, so that normally after the setting of the condenser C has been reduced it will be necessary to increase the reading of the aerial condenser D, connected across the variometer, in order to bring the aerial again into tune.

Another combined tuning and reaction control has been developed on somewhat different lines by an American investigator, Mr. Lovejoy, and is illustrated in Figs. 2 and 3.

As shown in Fig. 2, one or more of the tuning condensers C, C₁ are linked by a common control spindle S (shown in dotted lines) to a special potentiometer P, connected across the filament battery. The potentiometer is arranged to add positive bias to the grid automatically as the condenser readings decrease. In order to permit accurate adjustment of the potentials at the ends of the resistance P, these ends are connected to adjustable sliders on a second resistance R, also shunted across the battery terminals.

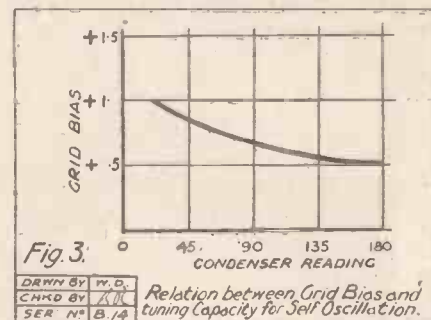

It is to be observed that the curve of Fig. 3 is not linear but is slightly bent. If the relationship were linear, the resistance P could be uniformly wound. To compensate for the non-linear nature of the relationship, the potentiometer resistance may either be wound in a non-uniform layer, or additional resistances Q may be connected at intervals as shown in Fig. 2.

TH**E**re is real danger that listeners will be lulled into a sense of false security because of the promise of the Postmaster-General in the House of Commons that there would be ample opportunity to discuss the proposals for the future of broadcasting before they become law. It is common knowledge that under existing conditions the administrative machine—in other words, the Civil Service—enjoys quite disproportionate power. I was not surprised, therefore, to be told on the very evening of the P.M.G.'s statement in the House, that the Treasury had already decided on the proportion of licence money it would appropriate up till the end of 1926.

I was unable to find out what the proportion was, but my informant indicated that it was something quite substantial, more than 33½ per cent. This is according to plan. The intention is, of course, quite laudable. It is the job of the Treasury to make the already intolerable burden of the taxpayer a little easier if possible. But the method is all wrong, and if put into force, will have a "boomerang" effect. Already the uncertainties and equivocations about the future regime are reflected in a falling off in the rate of increase of licences.

If the attempt of the Treasury succeeds, broadcasting will decline, and there will be no licence money either for the broadcasting service or for public funds. Once broadcasting is stabilised at a reasonable saturation point of organisation, distribution, and efficiency, then it should yield a permanent satisfactory surplus for public funds.

Civil Service Influences.

Already the P.M.G. has indicated that on several important points the Government have departed from the recommendations of the Broadcasting Committee. I understand that they will do so on still another point, and one of even greater importance. As things stand at present, there is apparently no intention of inviting Mr. Reith to join the new board, or of inscribing his name in the charter. Here, again, the Civil Service conception is dominating the drafting.

The present head of the service is to be given a position analogous to that of the permanent secretary of a government department. This, in effect, represents a "demotion," and I would not be at all surprised to hear that, if this course is sanctioned by Parliament, there will be a change in the direction of the service. For blundering madmen it would be difficult to surpass a piece of "red tape" which would deprive British broadcasting of the man who has made it. I am not without hope that Parliament will see that this does not occur.

Future Entertainment Policy.

As I prophesied some time ago, the change-over in control might well be attended by an unjustifiable extension of the educational and "uplift" parts of the programmes. The B.B.C. had acted wisely in readjusting its own balance to the undoubted satisfaction of the majority. Now it appears that the nucleus of the new corporation, which has already met several times under the new chairman, has turned its attention in the direction suggested.

BROADCAST NOTES.

By O. H. M.

False Security—A Radio Fund Raid—Civil Service Influences—Future Entertainment Policy—"Serious Talk"—The Musicians' Union—Forthcoming Attractions.

I hear, on unimpeachable authority, that the idea seriously contemplated is to reduce the main entertainment period of the evening programme in order to introduce an additional hour of serious talk at a time when most people are listening. This sort of thing will have to be watched. There is also talk of abolishing the publicity activities of the B.B.C.

Those members of the corporation who advocate the demobilisation of B.B.C. publicity point out that by so doing they can save enough money to meet part of the additional financial burden created by the appointment of paid commissioners. They add that as their tenure of life is practically permanent, they will not need to care about

NEXT WEEK.

"BUILDING UP A SUPER-HET."

By Captain H. J. ROUND.

In next week's issue we shall publish the first of a series of special articles by the chief of the Research Department of the Marconi Company, Captain Round's article will be certain to excite widespread interest among amateurs, so make sure of your copy of "P.W." by ordering it now.

publicity anyway. The idea is to dispose of the "Radio Times" and "World Radio" to outside publishers, and to stop the issue of programmes and programme information to the press.

A B.B.C. lecturer concluded his broadcast address the other night with "Good-night, Perce and Mabel." This, taken in conjunction with some other similar breaches of microphone etiquette, has led to the imposition of a rule under which those speakers who depart from their properly edited manuscripts, either by addition or by alteration, will have their fee cancelled.

A New Musical Talk.

Starting on September 20th, a new weekly musical talk will be given from 6.30 to 7 on weekdays. The talk will be illustrated

with musical extracts in the form so popular since the experiments introduced by Sir Walford Davies in his series, "Music and the Ordinary Listener." The idea is to give a simple outline of the music arranged for the week that follows, so that listeners may

choose those pieces which are most likely to give them real enjoyment.

A Musical Novelty.

I confess to a belief that novelties are a bit overdone when the B.B.C. is reduced to serious consideration of playing gramophone records backwards. Anyway, we are to have this, and I hope it will not be so grotesque as it sounds.

More Seaside Nights.

The attack on the B.B.C. for the seaside programmes which began with Brighton has failed ignominiously. The other arrangements are going full steam ahead. Blackpool is down for September 2nd, Margate on September 10th, and Eastbourne on September 24th.

A Chinese Programme.

Captain C. A. Lewis is building a special Chinese programme which he will "compere" on September 29th. Captain Lewis was in China, flying, before he took up broadcasting, and has an intimate knowledge of the customs and art of that ancient civilisation. I look forward to an extremely interesting and enjoyable evening on September 29th.

The Musicians' Union.

There is trouble between the musicians and the B.B.C. again at Manchester. The last time there was trouble of this kind at Manchester the result was the cancellation by the B.B.C. of the Hallé Concert broadcasts for next season. Now the choir of Manchester Cathedral has virtually gone on strike because the B.B.C. was to take excerpts from musical services once in two months without extra payment to the choir. No extra labour was entailed by these broadcasts. The hold-up has failed again. The attitude of the Musicians' Union is leading to cumulative trouble for them.

The result of the attempted hold-up of the Hallé Orchestra broadcasting is that the orchestra is to be reduced in number. The result of the general attitude of hostility and unreasonableness is that, in self-protection, the B.B.C. will be forced to take steps which will increase unemployment among musicians all over the country.

There is still time to prevent organised reprisals on a big scale, and I hope that the M.U. leaders will see sense before it is too late. If they are reasonable now, they will get more money when the Post Office has disgorged its secret hoard of licence money. The musicians would be much better employed if they joined hands with the B.N.O.C. in its endeavour to secure the liberation of licence money.

Variety in August.

Vaudeville and variety generally will be conspicuous in the August programmes. I am glad to learn that Newell and Most, the two artistes doing so well at the Holborn Empire, will broadcast on August 25th.

CURRENT TOPICS.

By THE EDITOR.

The P.M.G.'s Promise—Appropriation of Licence Money—Sapping the Vitality of Broadcasting—Bad Effect on the Radio Industry—The Loud-speaker Problem—Trouble Brewing in Back Gardens—A Tragedy in the Offing—A Word of Warning.

OUR correspondent, O. H. M., points out in this week's "Broadcast Notes" that there is a real danger that listeners will be lulled into a sense of false security because of the promise of the P.M.G., in the House of Commons, that there would be ample opportunity to discuss proposals for the future of broadcasting before they became law.

This promise is by no means what it seems, and we have it on good authority that discussions have already taken place with regard to what proportion of the licence money should be appropriated by the Treasury up to the end of 1926. We have no definite knowledge as to the exact amount the Treasury are likely to appropriate, but our correspondent, O. H. M., understands that it is likely to be more than 33½ per cent. In one sense the Treasury's intention is quite correct, because it is the business of the Treasury to adopt every possible method of reducing the burden of taxation. The Road Fund raid is an example, and now it seems certain that there will be a Radio Fund raid.

The Surplus.

Theoretically, then, we will grant that the Treasury is correct in this procedure; but radio, we venture to suggest, is an exception to the general rule, for, as O. H. M. points out, the application of such a principle will have a "boomerang" effect. This effect cannot but be deleterious to the progress and prosperity of the radio trade.

We are not in absolute agreement with our correspondent, O. H. M., when he suggests that it will have the effect of reducing the rate of licences taken out, but we are certain that if the Treasury raids the surplus radio licence money held by the P.M.G., it will have a bad effect on the radio trade.

The time is not yet ripe for broadcasting to yield a surplus which can be satisfactorily and safely appropriated for public funds. Broadcasting has not yet reached maturity, and it will be a great pity if its energy is sapped by inopportune raids on its vitality. We hope, therefore, that the new broadcasting commission will very seriously consider its decision, and that no raid will be made upon surplus licence money this year.

It is all the more unfortunate that these decisions should have been made just prior to the holding of the biggest wireless exhibition in this country. Radio manufacturers are already very much perturbed by the lack of information granted them regarding the future of broadcasting. Their business for the coming season depends a great deal upon a straightforward statement of policy, a

statement which they are entitled to, and which we hope they will be given at the very earliest possible moment.

Sidcup's Trouble.

An order has been passed in Vienna that during certain hours of the evening people playing gramophones and pianos and operating loud speakers must keep their windows and doors closed. It would seem that there is too much music in Vienna. And in this country we now find that the Sidcup Council, moved by a complaint from Councillor R. Ellison regarding the use of wireless loud speakers by many residents in the district, has instructed the Clerk of the Council to make inquiries about this complaint and report to them at the next meeting. Councillor Ellison has stated that if "this cheap



The amplifier room at the Berlin Opera House which is frequently "on the air."

and unnecessary entertainment" went on people would have to leave the district and go where they could get a few hours' peace.

It has been stated that people inside the four walls of their houses are entitled to make what noise they like, but it is quite true that some limit should be put upon the amount of noise in people's back-gardens, which undoubtedly does cause a certain amount of friction in suburbs. It will be a pity if the loud speaker is responsible for an outbreak of a kind of semi-guerrilla warfare in Sidcup; in fact, it would be a pity if the loud speaker became a *causus belli* in any suburb.

Wireless has been blamed for many things. It has been blamed for the bad weather; it has been blamed for its effect upon bird life and for its effect upon certain agricultural pursuits, and surely its character has been blackened enough without it being maligned as the cause of unpleasant disturbances in suburbs.

It is a curious thing that before broadcasting began we seldom heard of complaints of residents in suburbs about the use of gramophones in back-gardens. Whether it is that suburban listeners are very partial to excessive L.F. amplification, and that they delight in forcing their loud speakers to bray with excessive loudness, we cannot say; but we certainly have noticed many times in the Press the recurrence of complaints about the annoyance caused by loud speakers in gardens. We do not think that such drastic measures as those adopted in Vienna will be given force in this country, but it is a sign of the times that loud speakers are earning the unenviable reputation of being peace shatters in some parts of the country.

It may be that people's nerves are a little frayed these days, and that, perhaps, when the economic situation is a little easier, the loud speaker will be regarded more tolerantly; but at the moment it seems quite likely that a loud speaker, if operated to excess in one's back-garden, will cause an outbreak of hostilities which may have far-reaching effects.

Danger Ahead.

We include this little homily in this week's Editorial for what it is worth, because a timely word of warning may yet help to avoid many a dark and gory tragedy. That great philosopher, Hegel, has stated that a real tragedy is caused, not by the opposition of right and wrong, but the opposition of right against right, or good against good.

The householder feels that he is right in amusing himself by taking the loud speaker on to the lawn on a fine evening, and his next-door neighbour, feeling that he is also right in attempting to alleviate the sufferings of his shattered nerves by protesting, perhaps forcibly, against the atmosphere being sprayed with acoustic cacophony, will undoubtedly feel the significance of the royal motto, "Dieu et mon droit." And when two householders, both convinced in their own minds that they are perfectly right, get at loggerheads, there is bound to be trouble; and none of us want to open our daily newspapers one morning and find splashed across the headlines these awful words: "Tragedy in Sidcup; Loud-Speaker Owner Foully Murdered." To be forewarned is to be forearmed. Loud-speaker users in Sidcup should take heed, lest worse befall them than the complaints of Councillor Ellison.

PHOTOGRAPHS. Readers are invited to submit photographs of wireless interest for publication in "Popular Wireless." Every photograph accepted and published will be paid for at the rate of 10/6 per copy.

THE modern tendency is towards the use of shorter and shorter wave-lengths.

Fig. 9 shows a short-wave aerial of the Hertzian oscillator type without an earth connection. It consists of two short rods 1, 2, mounted vertically upon a supporting mast C as shown, the lower rod being adjustably connected to a tuning inductance L. A cross-wire 3 is mounted on separate insulators at the base. When H.F. currents

AERIAL DEVELOPMENTS

From the Earliest Types of Antennae to the Most Modern.

By **SEXTON O'CONNOR.**

PART II.—(Conclusion).

inside the limits of radiation. This effect is produced by using a vertical antenna comprising two or more conductors loaded by a series of condensers inserted at equal intervals as shown.

The result is that the radiated energy has a greater horizontal

but less vertical spread as indicated in Fig. 11A, where the unshaded curve corresponds to the normal high-angle or space-wave radiation, and the shaded area shows by comparison the distribution of energy from the loaded aerial.

The aerial proper is shown as a second ring A closely surrounding the first, and terminating in two horns or antennae A1. The whole of the apparatus, except the parts A1, is screened by a casing. If the horns are placed in close proximity to a conducting line, the H.F. energy will be transferred into the line, and can then be used as a carrier wave for wired-wireless signalling; or the waves may be radiated directly into space.

In short-wave systems using wave-lengths of the order of 100 metres or under, it is well-known that the bulk of the energy radiated from the aerial is projected upwards at an angle to the horizon. Such radiation is, in fact, a true "space" wave as distinct from those longer waves which are practically "earth-bound." The latter travel along the ground in much the same way as an H.F. current flows along an ordinary conductor, and in consequence suffer considerable attenuation owing to earth resistance losses.

High-Angle Radiation.

The fact that it is free from such absorption losses largely explains why space-wave radiation is so effective in covering long distances. At the same time, the high-angle path taken by the wave means that a receiver located, say, within thirty or forty miles of the transmitting station, may remain unaffected; although a second receiver some three or four hundred miles away may be getting good signal strength, because the space-wave has, by then, been deflected earthwards from the Heaviside layer.

A Flat-Angle Aerial.

The aerial shown in Fig. 11 is designed to avoid this disadvantage and to enable short-wave signals to be heard at all points

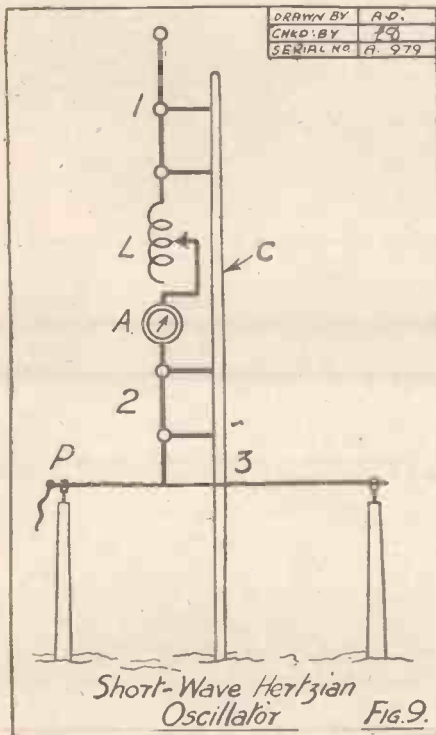

are fed into such an aerial, a standing or stationary wave system is set up with nodes and loops of current, and potential located at definite points along the wires. The H.F. supply is made at the point P, which is a current node; whilst a hot-wire ammeter A inserted at a current loop (or point of maximum flow) indicates when the aerial is in tune and absorbing maximum power.

Ultra Short-Wave Radiators.

For generating still higher frequencies, the arrangement shown in Fig. 10 has been used. Here the main oscillatory circuit consists of a circular conductor B of copper tubing 12 m.m. in diameter, split in the centre by a condenser C. One half of the tube is connected directly between the plate of the generator valve and the condenser, whilst the other half circle connects the grid to the condenser.

The high tension is applied across the condenser from a D.C. generator as shown, whilst a grid-filament circuit is completed by a lead taken from the grid side of the condenser direct to the filament. Chokes S protect the H.T. and L.T. sources from the H.F. oscillations.

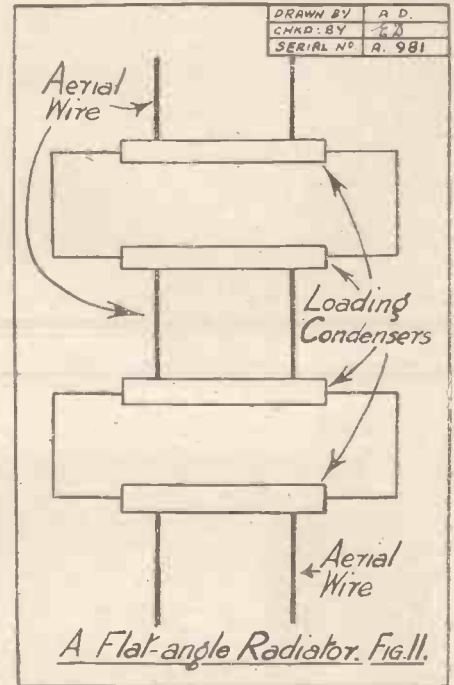
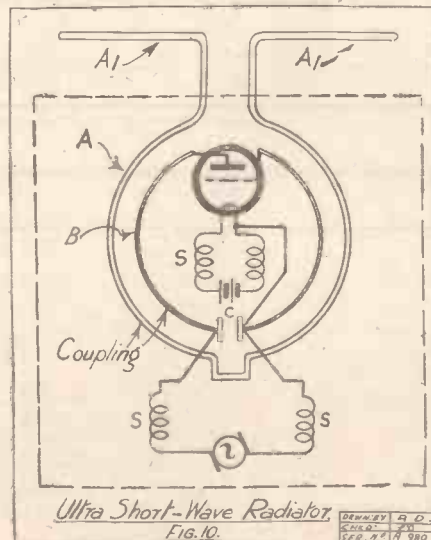

Another development of recent date is the so-called beam system, in which a combination of aerials and reflectors is used to produce a well-defined directional effect. In the earliest form of Marconi beam-transmitter a single Hertzian or rod oscillator was placed at the focal point of a curved network of reflecting wires.

The Beam System.

The action is very similar to that of a source of light placed at the focus of a parabolic mirror. After reflection from such a mirror, the rays of light, originally divergent, are converted into a parallel beam. Similarly with the rod oscillator. The normal radiation outwards is reinforced by a stream of parallel waves reflected back from the curved network of radiators, so that a strong directional effect is secured.

Later the curved network of reflectors was replaced by a flat vertical bank of wires, which can either be separately energised from the same source as the primary aerials, or purely by induction from the latter. In either case the net effect is to produce a definite directional beam of waves instead of the scattered radiation characteristic of the ordinary rod oscillator.

(Continued on next page.)

AERIAL DEVELOPMENTS

(Continued from previous page.)

Fig. 12 shows a further development of the same idea. Here the aerial system comprises a series of separate banks of short-wave oscillators. Each bank consists

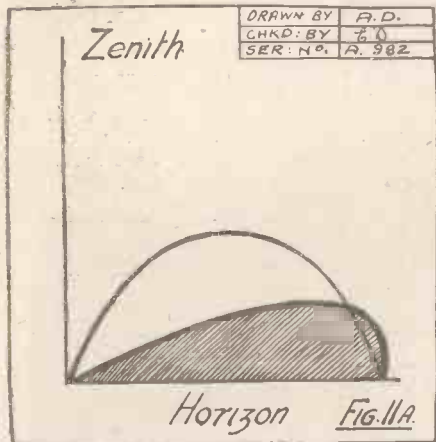

of a number of vertical oscillators A strung from horizontal supporting wires and adjustably connected to a central tuning inductance.

Beam Experiments.

The whole system is energised from an alternator O or other source of supply, which may, however, be coupled to one bank only, the adjacent bank being energised simply by inductive action from the first. The supply currents are fed simultaneously to each of the vertical oscillators forming the bank, by the horizontal transmission line M which comprises series condensers to compensate for any phase displacement.

The separate banks are arranged in parallel and spaced apart by a distance equal to an odd multiple of a quarter wavelength, the resultant radiation being a concentrated beam in a direction at right angles to the plane of the aerial network.

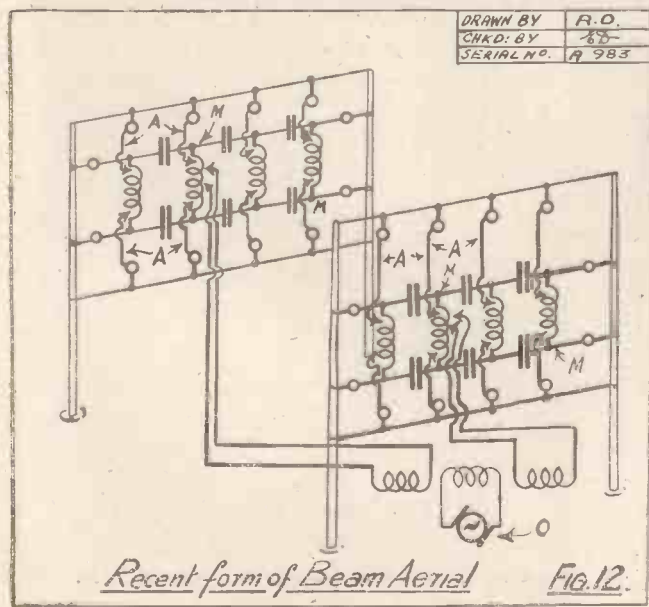

Elevated Type of Aerial.

Fig. 13 shows a beam-transmitter on which both the Hertzian oscillator or rod aerial A and the curved network of reflecting wires B are mounted at a considerable height above the ground. The radiation from such an aerial is not only directional, but is also practically entirely composed of true "space" waves. It is specially designed for long-range working on low power.

Polarised Wave Radiators.

It has for some time been suspected that the peculiar susceptibility of short-wave transmission to "fading" is due to reflection effects at the Heaviside layer. Quite recently considerable interest has been aroused by the discovery that such losses can be avoided by the use of horizontally polarised waves.

Ordinary earth-bound waves radiated by a vertical aerial become automatically polarised after they have travelled a certain distance. That is to say, the electrostatic component is then vertical and the electro-magnetic component horizontal, or parallel to the earth's surface. This is an automatic process, because any vertical magnetic

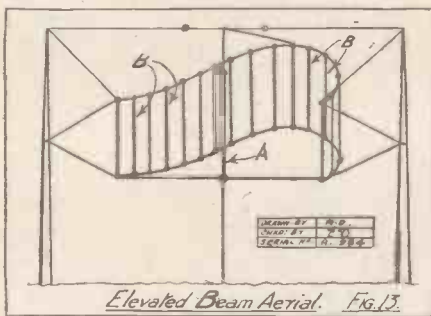

component originally present will cut into the earth's surface, and in course of time is wiped out or converted into eddy currents, the ground acting like any other conductor in this respect.

In order to produce horizontally polarised waves an aerial system of the kind shown in Fig. 14 may be employed, consisting of a network of horizontal wires supported a considerable distance above the ground, and energised at a central point by two vertical feeders coupled to a H.F. source.

The currents in the vertical feeders flow in opposite directions at any instant, so that no vertically polarised radiation is emitted from this part of the system. A standing wave is set up in the "flat top" network, from which ether waves are radiated into space having a horizontal electrostatic and a vertical electro-magnetic component. Such waves are stated to be practically free from "fading" because they are reflected from the Heaviside layer with minimum energy loss.

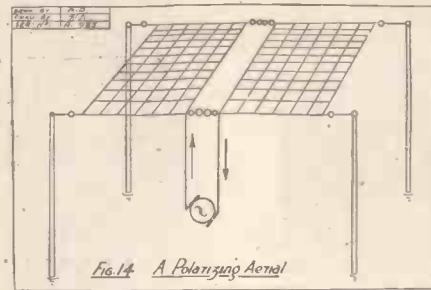

FIG. 14 A Polarising Aerial

A SUMMERTIME WIRELESS PEST.

NO, this time it is not the oscillator. That individual, to a greater or less extent, is always with us. Quite an unsuspected cause of reception inefficiency during the summertime, and especially during the month of August and early September, may crop up owing to the activities of a well-known being—the common garden spider.

Mr. Spider (or is it Mrs. Spider?) very often would appear to take a delight in constructing webs around the aerial lead-in, especially in those cases in which the lead-in enters the room through a window frame which is surrounded by climbing plants, trees, and similar growths.

Of course, this sort of thing does no harm in dry weather, because the spider's web, being composed of the purest silk, makes an excellent insulator. But when the rain comes along, or during the late evenings when heavy dew begins to collect, the condensed moisture on the webs provides a leak for the aerial current, and thus the set decreases in efficiency, often in a most mysterious manner.



A cause of aerial leaks: the garden spider.

This is, of course, quite a trivial matter and one which is easily remedied. Nevertheless, it is one which is worth bearing in mind, especially if during the late summer evenings your set refuses to give of its best, and you are unable to find any internal cause for the decrease in efficiency.

NEXT WEEK

HOW TO MAKE THE "P.W." "OLD WORLD" TWO

a receiver incorporating a novel crystal-valve circuit
ORDER YOUR COPY NOW!

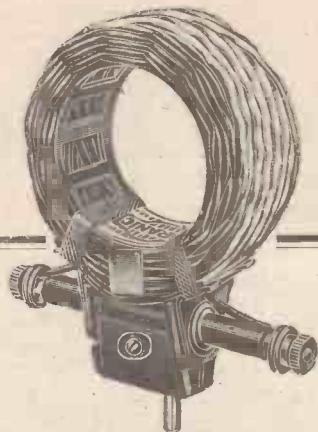

Regd.
Design
No. 708263.

De Forest Pat.
No. 141344.
Pat. No.
238318.

SIMPLIFIED SELECTIVITY

The most simple means of increasing the selectivity of a receiver is to fit the **Unitune Aperiodic Fixed Coupler**. Just take out your usual aerial coil and insert the **Unitune** in its place, connecting the aerial and earth wires to the terminals on the extension arms. That is all you have to do—no additional parts, no alterations to wiring. Give yourself the choice of alternative programmes—with a **Unitune**.

Range 250 to 500 metres, PRICE 4/6
SEND FOR NEW IGRANIC CATALOGUE No. R 18.

IGRANIC ELECTRIC CO., LTD.,
149, Queen Victoria St., LONDON, E.C. Works: BEDFORD

CHANGE of ADDRESS

THE rapidly growing demand for the Ormsby Extra Selective Long-Range Receiver and Components has necessitated the removal of our works to larger premises.

Our new registered offices and works, from the 1st of August, will be:—

**ORMSBY WORKS,
LOWER RICHMOND ROAD,
RICHMOND, SURREY.**

All communications and orders should be sent to this new address, where they will receive more than the usual prompt attention.

IMPORTANT

Our showrooms will remain at 10, New Oxford Street, W.C.1.

ORMSBY & Co. Ltd.,
Wireless Designers and Manufacturers,
**ORMSBY WORKS,
Lower Richmond Rd.,
RICHMOND, Surrey.**

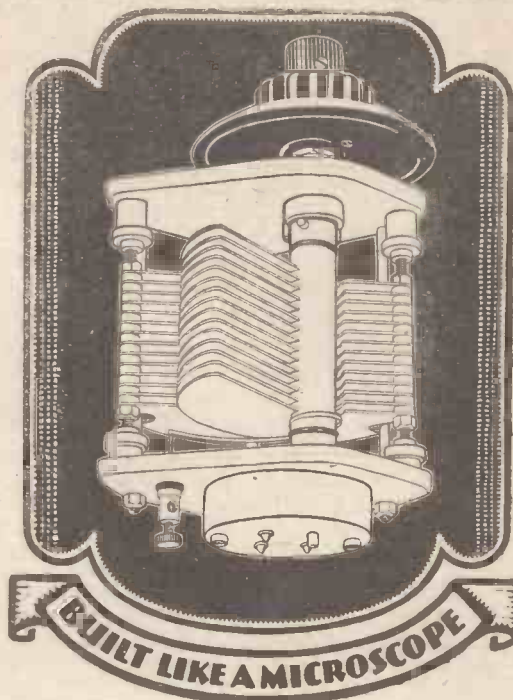

HERE IS the last word in Variable Condensers. Geared movement combined with low-loss design—made by a famous firm of scientific and radio instrument makers, built with the precision and finesse that only makers of scientific instruments know how to impart.

A TYPICAL FEATURE is the unique smoothness of the 200-1 ratio geared vernier control that enables the minutest adjustment to be made. There is not the slightest trace of backlash. The condenser is solidly built of brass with porcelain insulation. A dust-proof case is provided for the gear mechanism, and the stout stamped endplates are entirely insulated from the rotor vanes by ebonite and from the fixed vanes by porcelain, making hand capacity negligible. Connection to the rotor vanes, which are of decrement shape, is made by a soldered pig-tail to the spindle. Definite stops are provided. Fixing is by the one-hole method.

CAPACITIES.	.0001 m.f.d.	.0003 m.f.d.	} £1 2s. 6d.
	.0002 "	.0005 "	
	.00075 "		

Obtainable at all radio dealers or direct

**W. G. PYE & CO., GRANTA WORKS,
MONTAGUE ROAD, CAMBRIDGE**
Manufacturers of Scientific Instruments and Radio Apparatus



H.T. and L.T.— charge them both yourself



DON'T go on carrying your heavy Low Tension and High Tension Accumulators continually to the charging station whenever they run down, and risk having them ruined by inexperienced assistants. Just instal one of these Rectalloy Chargers and leave it to do its work—satisfactorily and well.

Model:
A.C. 1. 100-110 volts.
A.C. 2. 200-250 volts.
Pre-eminently the safest and
cheapest charger for H.T. accu-
mulators up to 90 volts.
Price complete 47/6

Model:
A. 100-110 volts.
B. 200-250 volts.
The most efficient charger
for Low Tension 2-6 volt
Accumulators.
Price complete 65/-

Can you afford to continue paying regularly for charging, with its consequent trouble, when at a minute cost, you can solve your Accumulator problems definitely and permanently? Write for full particulars (P.S.) now to:

RECTALLOY
The ideal Battery charger Ltd.,

Vulcan House, Ludgate Hill, E.C.4

G.A. 5580.



Ask your
Dealer
for the

BECOL
FORMER

THE FORMER OF THE FUTURE.

Low Loss. Size 3 ins. diameter to outside of wings.
Made from the famous BECOL EBONITE.
Specially designed for low loss. Large air
space between wings. Easy winding. Thoroughly
dependable and British made.

From all dealers, in
6 inch lengths, 3/-

THE BRITISH EBONITE CO., LTD., HANWELL, LONDON, W.7.
Rods, Tubes, Sheets, Panels, Mouldings, etc.

FORMO

**A MONUMENT IN THE
MARCH OF PROGRESS**

The Formo Shrouded Transformer
is the universal favourite

Made in Ratios 1-1, 1-2, 1-3, 1-4 and 1-5
1-3 and 1-5 for
1st and 2nd stages

Send for Catalogue and Descriptive
Literature of Complete Formo Range

THE FORMO COMPANY
Crown Works, Cricklewood, N.W.2

Phone: Hampstead 1787.
Manchester: Mr. J. B. Leve, 23,
Hartley St., Levenshulme.

Phone: Heaton Moor 475.
(See page 797 for Formo S.L.F. Condenser.)

APPOSITE ADAGES.—No. 4

*An ounce of practice
is worth a pound
of theory.*

Specify

DUBILIER
PRODUCTS



Have you entered for the
Dubilicon Competition
yet?

If not, write to us now for
full particulars.

Cash Prize £200.

REGISTERED **DUBILIER** TRADE MARK

DUBILIER
CONDENSER CO (1925) LTD

ADVT. OF THE DUBILIER CONDENSER CO. (1925) LTD., DECON WORKS,
VICTORIA ROAD, N. ACTON, LONDON, W.3. Tel. Chiswick 2241 2-3.

E.P.S. 214.

RADIO TUTORIAL

All Editorial Communications to be addressed to The Editor, POPULAR WIRELESS, The Fleetway House, Farringdon Street, London, E.C.4.

Editor:
NORMAN EDWARDS, M.Inst.R.E., F.R.S.A.,
F.R.G.S.

Technical Editor:
G. V. DOWDING, Grad.I.E.E.

Assistant Technical Editors:
K. D. ROGERS, P. R. BIRD.

Scientific Adviser:
Sir OLIVER LODGE, F.R.S.

Staff Consultants:
Dr. J. H. T. ROBERTS, F.Inst.P.; J. F. CORRIGAN, M.Sc., A.I.C.; C. E. FIELD, B.Sc.; E. J. SIMMONDS, M.I.R.E., F.R.S.A.

Foreign Correspondents:
F. M. DELANO, Paris; Dr. ALFRED GRADENWITZ, Berlin; L. W. CORBETT, New York; P. F. MARTIN, Italy; W. PEETERS, Holland.

The Editor will be pleased to consider articles and photographs dealing with all subjects appertaining to wireless work. The Editor cannot accept responsibility for manuscripts and photos. Every care will be taken to return MSS. not accepted for publication. A stamped and addressed envelope must be sent with every article. All inquiries concerning advertising rates, etc., to be addressed to the Sole Agents, Messrs. John H. Lile, Ltd., 4, Ludgate Circus, London, E.C.4.

As much of the information given in the columns of this paper concerns the most recent developments in the Radio world, some of the arrangements and specialities described may be the subject of Letters Patent, and the amateur and the trader would be well advised to obtain permission of the patentees to use the patents before doing so.

Readers' letters dealing with patent questions, if sent to the Editor, will be forwarded to our own patent advisers, where every facility and help will be afforded to readers. The envelope should be clearly marked "Patent Advice."

TECHNICAL QUERIES.

Letters should be addressed to: Technical Query Dept., "Popular Wireless," The Fleetway House, Farringdon Street, London, E.C.4.

They should be written on one side of the paper only, and MUST be accompanied by a stamped addressed envelope.

Queries should be asked in the form of the numbered questions: (1), (2), (3), etc., but may be accompanied by a short letter giving any necessary additional particulars as briefly as possible.

For every question asked a fee of 6d. should be enclosed. A copy of the numbered questions should be kept, so that the replies may be given under the numbers. (It is not possible to reproduce the question in the answer.)

BLUE PRINTS. A series of 20 Blue Prints can be obtained from the Query Dept., price 6d. per Blue Print.

Only a limited number of circuits are covered by this series, and full details of the circuit arrangements available in Blue-Print form are published fortnightly in the advertisement columns of this journal.

All other back-of-panel diagrams are specially drawn up to suit the requirements of individual readers at the following rates: Crystal Sets, 6d. One-Valve Sets, 6d. One-Valve and Crystal (Reflex), 1s. Two-Valve Sets, 1s. Three-Valve Sets, 1s. Three-Valve and Crystal (Reflex), 1s. 6d. Four-Valve Sets, 1s. 6d. Multi-Valve Sets (straight circuits), 1s. 6d. Except SUPER-HETERODYNE DIAGRAMS, all of which, irrespective of number of Valves used, are 2s. 6d.

If a panel lay-out or list of point-to-point connections is required, an additional fee of 1s. must be enclosed.

Wiring diagrams of commercial apparatus, such as sets of any particular manufacture, etc., cannot be supplied. (Such particulars can only be obtained from the makers.)

Readers may submit their own diagrams, etc., for correction or for criticism. The fee is 1s. per diagram, and these should be large, and as clear as possible.

No questions can be answered by phone. Remittances should be in the form of Postal Orders.

Questions and Answers

CAN I WORK A LOUD-SPEAKER?

J. F. A. (Petersham).—I wish to work a loud speaker, and at present my signals are too loud to be comfortable with 'phones on. Would a one-valve L.F. amplifier be sufficient to work a small loud speaker of the "junior" or "baby" type?

It is difficult to know what you mean by "too loud to be comfortable," as some people can enjoy signals which are deafening to other people. The usual rule as to whether a loud speaker will work when an L.F. stage is added, is to place the 'phones upon a table in the centre of the room. If the speech is then audible all over the room a loud speaker will nicely fill it, or if music only can be distinguished clearly a small loud speaker will give good results.

Where the signals are not loud enough to be heard in this way results with a loud speaker will be disappointing, as the input is not sufficient for satisfactory working.

COIL WINDING.

What is the easiest method of winding aerial and reaction coils, and what wire should be used?

The easiest coils to make are "spider-web" coils, wound on a flat cardboard former. (See accompanying photograph.)

No. 24 or 26 S.W.G. D.C.C. wire is suitable, and the winding is carried out by merely passing the wire through alternate slots. The photograph shows how the coil appears when the end of the wire has been fixed to the former, and wound through the first six or seven slots.

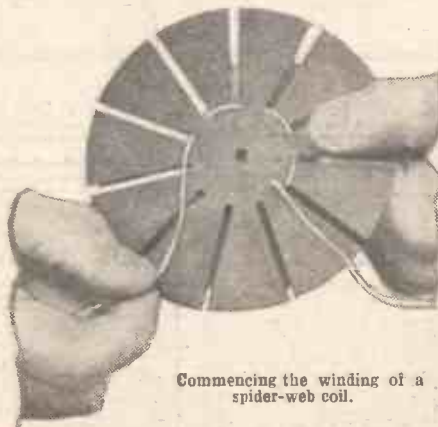

Commencing the winding of a spider-web coil.

F. G. E. (Four Oaks).—Please forward your address to the "P.W." Queries Dept., so that your query can be answered by post.

THE BEST AERIAL.

T. B. (London).—What is the best aerial that I can erect for all-round good reception? Do you advise a single or twin aerial?

You will probably find a single wire aerial, 70 to 80 feet long, including the lead-in wire, will give the best results on B.B.C. wave-lengths. See that it is well insulated at both ends, and, if possible, that it is not too badly screened. The lead-in wire should, for preference, be taken from one end of the aerial (the end nearest the house), and can be a continuation of the horizontal portion, the wire simply being twisted round the insulator so as to prevent it slipping.

Any good aerial wire such as 7.22 enamelled copper will give satisfactory results. The wire should be kept well away from trees, and the down-lead must not be run parallel with walls, but should be run at an angle to them, with the end leading to the lead-in tube at nearly 90 degrees to the walls. This will avoid undesirable capacity effects and increase the sharpness in tuning.

Needless to say, get your aerial as high as possible, as, owing to the great amount of screening in London, this is an all-important factor in the reception of distant stations. The aerial should not be less than 30 feet from the ground, and if it can be raised 40 or 50 feet so much the better.

DIAGRAMS.

E. F. (Finchley, Church End).—Having had no wireless training, I am very puzzled by the different diagrams used.

Sometimes two or three quite different arrangements of the components are given, and in one of these diagrams a condenser

For the Constructor					
NO. 2.—DRILLING & TAPPING SIZES.					
B.A.			WHITWORTH.		
Size.	For Tapping	For Clearance	Size in.	For Tapping	For Clearance
0	11	6	$\frac{1}{16}$	$\frac{1}{16}$	52
1	17	10	$\frac{3}{32}$	$\frac{1}{16}$	41
2	25	12	$\frac{1}{8}$	$\frac{3}{32}$	30
3	29	20	$\frac{5}{32}$	$\frac{1}{8}$	4m/m
4	33	27	$\frac{3}{16}$	$\frac{1}{8}$	12
5	39	30	$\frac{7}{32}$	$\frac{1}{4}$	6½m/m
6	43	34	$\frac{1}{2}$	$\frac{1}{4}$	8m/m
7	47	39	$\frac{5}{16}$	$\frac{3}{8}$	10m/m
8	50	44	$\frac{3}{8}$	$\frac{7}{16}$	11½m/m

may be shown as a box, whilst in others it is given as short parallel lines. Why are they drawn differently, and what is the purpose of several signs to mean the same component? When several arrangements for components are given, I suppose the wiring diagram is the one to follow?

There are three different forms of diagram in general use, called the "theoretical," "pictorial," and "wiring" diagram.

The theoretical diagram uses the symbols to indicate the different components. Its purpose is to show at a glance the path of the current, and it is arranged without regard to practical lay-out and spacing, except that coils which are coupled are shown close together, with an arrow through them to indicate the coupling. This class of diagram is read very easily with practice, and, being clear, compact and easily drawn, is invaluable in the study of involved circuit connections.

The pictorial diagram is intended for the novice who is uncertain of the appearance of instruments or of their respective symbols. It is very useful for beginners, but is not so easy to follow as a theoretical diagram which, with practice, shows the path of the current at a glance.

The wiring diagram is simply a plan of the practical connections, showing how the components are arranged on the panel, and the method of taking the wires from point to point.

HOWLING.

S. R. (Kensington).—I own a three-valve set (Det. and 2 L.F.) which previous to my going away for my summer holidays gave excellent results.

Since returning, however, I find the set's behaviour has altered, although it has not

(Continued on page 800.)



Apparatus Tested

Traders and manufacturers are invited to submit wireless sets and components to the "P.W." Technical Dept. for test. All tests are carried out with strict impartiality in the "P.W." Test room under the supervision of the Technical Editor, and the general reader is asked to note that this weekly article is also intended to provide a reliable and unbiassed guide as to what to buy and what to avoid.—EDITOR.

THE WATMEL AUTO-CHOKE.

THE Watmel Wireless Co., Ltd., of 332a, Goswell Road, London, E.C.1, recently sent us a Watmel Auto-Choke to test. The component consists of a choke coil wound on a special form of core which is provided with balanced tappings to give a step-up effect, a fixed condenser and a resistance. These are contained in a neat frosted black casing, on the back of which are situated four terminals with soldering tags corresponding to those on an L.F. transformer. Two brackets are fitted for mounting purposes.

It is stated that over a mile of wire is used in winding one of these chokes. Naturally a high impedance results and the compactness of the article is obtained by machine winding, a sufficiently stout gauge of wire being used to ensure that the choke will not "burn out" when high values of

H.T. are applied—or misapplied! The Watmel Auto-Choke can take the place of any ordinary L.F. transformer and has the advantage that no more H.T. is needed, as is the case when resistance-capacity coupling is employed.

We tested the component in several circuits and in both first and second stages it functioned very satisfactorily. There was negligible frequency distortion, and amplification equalled that given by a standard transformer. Tone was excellent—well up to that of a carefully arranged resistance stage. It is necessary, of course, to employ

a more or less suitable valve with appropriate grid bias and H.T. values as with any form of L.F. coupling. Provided this is done, the results given by the Watmel Auto-Choke are such that it merits the attention of all who desire to combine volume with purity.

With its bright nickelled fittings and attractive frosted black round casing, it is a handsome little component in appearance and gives ample visual evidence of the care bestowed on its construction and finish. It retails at the reasonable price of 18s. 6d.

FERRANTI L.F. TRANSFORMERS.

On page 729 of our July 24th issue we refer to the Ferranti L.F. transformer as having a ratio of 4-1. Messrs. Ferranti have asked us to point out that all their transformers have the ratio of 3½-1.

A NEW SOLDERING FLUX.

A sample of a "De Luxe" soldering fluid was handed in to our testing laboratory for examination by Mr. G. Bull, of 38,

(Continued on page 798.)



Assembling the new Igranic triple honeycomb coils at the Bedford Factory.



Where there's a child there should be cocoa

CHILDREN are brain-workers and manual workers too, and many overgrow their strength at school and play. Now Cocoa is food, and gives the children extra strength to keep pace with their growing bodies. It is the children's idea of a really delicious drink for breakfast and supper.

"Keep fit on cocoa"

BOURNVILLE

By test the best

See the name "Cadbury" on every piece of chocolate

Superior to any Transformer

both in Volume and Tone

ON account of its patent core and specially balanced windings it may safely be claimed for the **WATMEL AUTO-CHOKE**

Complete with condenser and fixed resistance. Bright parts heavily nickelled.

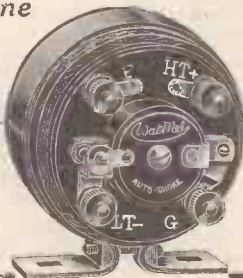

PRICE 8/6

that it gives an amplification even greater than that of any transformer, yet with all the natural purity of tone associated with Choke coupling. This wonderful little component is fully described in a booklet entitled "Straight as a Die." May we post you a copy?

THE **WATMEL WIRELESS Co. Ltd.**
332a, GOSWELL ROAD, LONDON, E.C.1.
Telephone: Clerkenwell 7990.
Lancashire & Cheshire Representative:
Mr. J. B. LEVÉE 23, Hartley Street, LEVENSHINE, MANCHESTER.
Telephone: 475 Heaton Moor.

SCRAP H.T. BATTERIES!

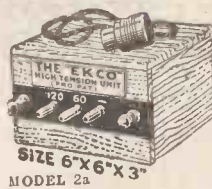

Derives H.T. from the mains (D.C. and A.C.) by just attaching adaptor to electric light lamp-holder!

SAFE! SILENT! SOUND!

Model	Voltage Tappings	D.C. Price	A.C.
1A	One	£2: 2:6	—
2A	Two	£2:15:0	£6:10:0
3	Three	£3: 7:6	£7: 5:0
V2A	1 Variable, 1 Fixed	£4: 5:0	£7:15:0
V3	2 Variable, 1 Fixed	£5:10:0	£9: 0:0
V3A	3 Variable	£6: 2:6	—
3A	Special "Marconi Straight 8" Model	£6: 6:0	£9:10:0

A.C. MODELS NOW OBTAINABLE!

ILLUSTRATED CATALOGUE FREE!

E. K. COLE

(Dept. A), 513, London Road, WESTCLIFF-ON-SEA.

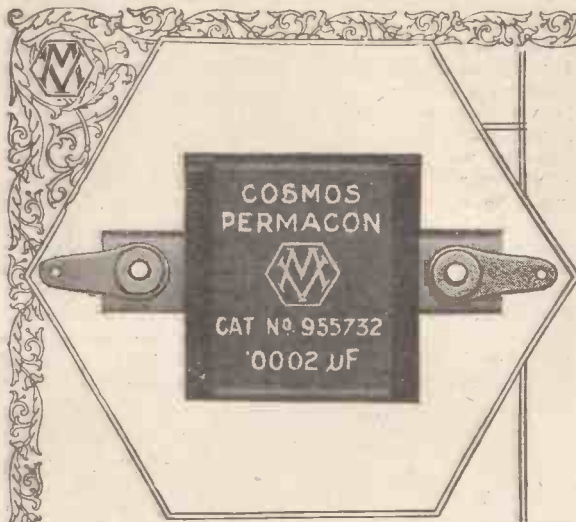

"the best English fixed condenser in the Country"

Such is the opinion of a London Wireless firm after subjecting the "Cosmos" Permacon to a rigid test for insulation and capacity.

The "Cosmos" Permacon is an ideal fixed condenser, being light in weight, of guaranteed accurate capacity, and having the lowest possible losses.

The dielectric is mica and each condenser is tested at 500 volts during inspection. Nickel plated cases give them a particularly neat appearance.

Prices are given below.

Ask for copy of the "Cosmos" Components Brochure.

METRO-VICK SUPPLIES, LTD.

(Proprietors: Metropolitan-Vickers Electrical Co., Ltd.)

Metro-Vick House, 145, Charing Cross Rd., London, W.C.2

.0001 mfd.	...	1/6
.0002 "	...	1/6
.0005 "	...	1/6
.0003 (with clips for grid leak)...	...	1/8
.001 "	...	1/8
.002 "	...	1/10
.005 "	...	2/8
.01 "	...	3/9

"COSMOS" GRID LEAKS are uniform and permanent
1, 1.2, and 3 megohms, ... each 1/6.

Cosmos
RADIO COMPONENTS

C.E. PRECISION RHEOSTATS 7 & 15 ohms 2/9, 30 ohms 3/...
C.E. PRECISION POTENTIOMETERS, essential for efficient H.F. control, 3/9.



Used in such famous Circuits as: The 1926 Unidyne 2-Valver; The Marcuse Short-Wave Receiver; The Household 3-Valver; The Trindyne 1-Valver, &c.

WHY PAY MORE?

You may pay more, but you certainly will never require a better rheostat than the C.E. Precision. They are perfectly finished, and the neat silvered dial which mounts flush with the panel, lends an air of distinction to any set. Call in and see one; you will buy it. C. EDE & CO., LTD., High Road, Byfleet, Surrey.



ULTRA LOW-LOSS Straight Line Frequency Condenser

Cone Bearings, Braced Vanes, Positive Collector. A real precision job.

Condenser only, .0003uF., .0005uF. ... 9/-
Condenser, with plain Dial, Standard 1/8" dia. shaft ... 10/6

Send for Catalogue and Descriptive Literature of complete Formo Range
THE FORMO COMPANY
Crown Works, Cricklewood, N.W.2
Phone: Hampstead 1787.

Manchester: Mr. J. B. Levee, 23, Hartley St., Lovenshulme. Phone: Heaton Moor 475.
(See page 791 for Formo Transformer.)

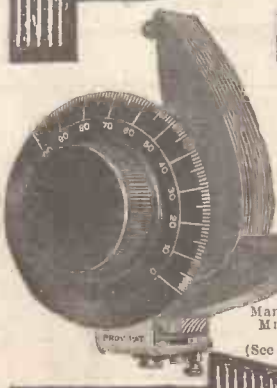

7/6 solves your soldering problems for ever

No Home-Constructor can afford to be without the Fluxite Soldering Set, for not only does it make soldering simpler and neater, but the joints will always provide perfect contact with consequent better reception.

The Fluxite Soldering Set is exceptionally suited for Wireless; it is simple and compact, and will last for ever. It contains a special "small-space" soldering iron with non-heating metal handle, a really efficient pocket blow-lamp, Fluxite, solder and full instructions.

All Hardware and Ironmongery Stores sell the Fluxite Soldering Set, 7/6 complete. Fluxite can also be had in tins price 6d., 1/4 and 2/8
FLUXITE LTD.,
(Dept. 324), Rotherhithe, S.E.16.

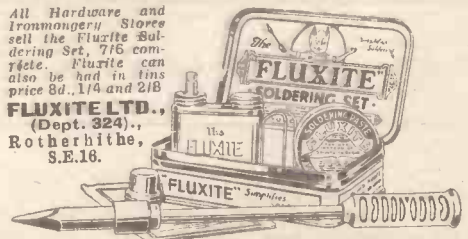

FLUXITE

APPARATUS TESTED.

(Continued from page 796.)

Walham Green, S.W.6. It is a pink-coloured fluid, and is intended, we imagine, to be used in a similar manner to "killed" spirits. Quite alkaline by nature, it does not tend to cause corrosion, but we cannot say we consider it a particularly efficient flux. Our mechanics tested it very carefully in several different ways, but were unanimous in considering that it failed to equal other well-known fluxes. The work had to be more than unusually clean before satisfactory joints could be made with its assistance. Perhaps Mr. Bull will be able to effect an improvement by varying his formula a little; we hope so, for his fluid is certainly more pleasant and less dangerous to handle than are "killed" spirits.

"RANGE" LECLANCHÉ H.T. BATTERIES.

We recently received a "Range" H.T. battery for test from C. O. Birtles, of 177, West Street, Sheffield. It consists of a number of small Leclanché cells embedded fairly deeply in wax and contained in a wooden case which is provided with a lid. The 60-volt type measures some 10 in. by 6 in. by 4 in., so that it will be seen that it is quite compact. Each little glass jar is waxed around its rim to prevent "creeping," and connections can be made to sockets outside the case by means of ordinary wander plugs. There are three sockets, two being connected to the extreme ends of the battery and the third to a flexible lead and clip which can be used to obtain intermediate

voltages by tapping on to the connecting wires between the cells.

The battery is supplied complete with a quantity of sal ammoniac and filler for topping up, in all voltages, at the reasonable price of 3½d. per volt. Replacements are available at equally low prices, viz., sacs at 1s. 6d. per doz., glass jars (waxed), 1s. 6d. per doz., and zincs with connecting wires at 1s. per dozen. This method of obtaining H.T. is, therefore, one that must be considered by all listeners and amateurs as a proposition worth serious attention. Initial cost, and cost of upkeep are low and the life of such a battery so long, as everything is replaceable, that it can almost be termed everlasting.

On test the "Range" gave excellent results, providing steady, noiseless outputs of between 15 and 25 m/a over lengthy periods. For listeners requiring a reliable alternative to dry batteries, "eliminators" and main units, for sets in frequent use, this battery can be thoroughly recommended.

SARBOLT AERIAL INSULATOR.

Readers will probably have noticed that telephone poles are equipped with inverted cup-shape insulators which very satisfactorily prevent rain and dust causing surface

leakage. This efficient design has been incorporated in a modified form in the Sarbolt aerial insulator, a product of the Hatton Supply Co., Hatton, Middlesex. Additionally the Sarbolt incorporates a lightning arrester, so that using one of these insulators at each end of the aerial, ample protection against lightning is provided.

The materials used in its construction are vitreous porcelain and galvanised wrought iron. Thus the article is able to resist rust and other corrosive influences.

It is very solidly constructed and capable of standing far greater strains than those imposed by an ordinary receiving aerial.

The price of the Sarbolt aerial insulator is 3s. It should appeal to the amateur transmitter even more than to the listener, but could be employed with equal advantage by both.



An R.A.F. Aeroplane equipped with short wave radio apparatus.

(Marconiphone Co. photo.)

EDISON BELL RADIO

THE FINEST FIXED CONDENSERS MONEY CAN BUY OR SCIENCE PRODUCE. FIT THEM TO YOUR SET AND BE SATISFIED.

CAT. No. 139/327. E.B. FLAT TYPE fitted with GRID LEAK IN SERIES.

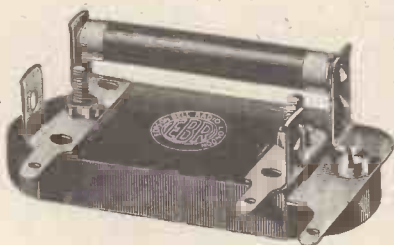

Ask your Dealer for Catalogues & List R/E. 144. If unable to obtain write direct to Manufacturers—**EDISON BELL Ltd., Edison Bell Works, LONDON, S.E.15, and at Huntingdon.**



CAT. No. 139/328. E.B. UPRIGHT TYPE fitted with GRID LEAK IN PARALLEL.

In these condensers the two clips used when the grid leak is in parallel are fitted under the terminals. The third clip is supplied loose and should be held in position by the screw which holds the condenser to the panel. The exact position of the third clip is clearly indicated in the above illustrations, and full directions are supplied with each condenser.

The parallel connection is usual in valve detectors, and the series arrangement is used in tuned anode and resistance couplings, etc.

The above can be supplied with or without grid leaks fitted.

TESTED 500 VOLTS FLAT TYPE



TESTED 500 VOLTS UPRIGHT TYPE



INSIST ON EDISON BELL CONDENSERS

THEY ARE BRITISH MADE AND GUARANTEED BY A NAME WITH 30 YEARS REPUTATION BEHIND IT

Holds the loudest spot at once—and always!

One adjustment at the most is all that's needed to reassure you upon having found the loudest spot. When you are satisfied with the clear reception so easily and quickly obtained, you can leave it to the Brownie Wireless "PERMATECTOR" to hold this for you for all times. No more fiddling about with catswhiskers, and no more expense. Three shillings is the only cost your crystal detector will be to you. But in case of accidents—severe ones on your part—you can obtain refills at 1/6 per pair.



The **Brownie Wireless** "PERMATECTOR"
The always "ever-set"
CRYSTAL DETECTOR.

3/-
IN CARTON.

Neither vibration nor shocks will cause the crystal detector to lose the extraordinarily loud reception you secure. The secret lies in the unique spring construction which safeguards the connection of the two super-sensitive elements. The "Permator" is a handsome addition to your set. Built to fit any "Brownie Wireless" Receiver instantly, it has also brackets, screws and nuts provided to allow it to be fitted to any make of crystal set in a few minutes. The outer case is turned out of solid brass rod and heavily nickel-plated.

The "Permator" is manufactured by the makers of the world-famous "Brownie Wireless" (No. 2) Crystal Receiver. Your dealer will show you this—its cost is only **10/6**

Also get your dealer to show you the "Brownie Wireless" Distribution Board, which accommodates 4 pairs of Headphones or Loud Speaker anywhere without moving your set or losing in reception strength. This only costs **3/-**

FROM ALL DEALERS OR DIRECT

The Brownie Wireless Co. (Of Great Britain) Ltd.,
310a-312a, EUSTON ROAD, LONDON, N.W.1.
Telephone: Museum 3747.

On Guard!

There is no leakage with a "Lotus" Buoyancy Valve Holder on guard.

Immediate and lasting connection made when valve pins enter valve sockets. The leg socket expands and automatically locks.

Absorbs shock, protects the valves and eliminates all microphonic noises.

Without
Terminals
2/3

With
Terminals
2/6

LOTUS
BUOYANCY
VALVE HOLDER
ANTI-MICROPHONIC

Made from best bakelite mouldings with springs of nickel silver and phosphor bronze valve sockets.

Garnett, Whiteley & Co., Ltd.

Lotus Works, Broadgreen Road,
LIVERPOOL

Makers of the famous "Lotus" Vernier Coil Holder.

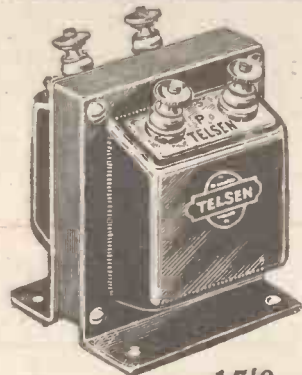

L.F. TRANSFORMER
TELSEN
ELECTRIC CO.

BRITISH MADE.
The L.F. TRANSFORMERS that give maximum volume without distortion.

Ratios 5-1 and 3-1.

Other types:—
Standard Open - - - 14/-
TELSEN "ACE" - - - 9/6

Guaranteed (all models) for 12 months.

TELSEN ELECTRIC CO.,
207, Aston Road, Birmingham

Shrouded Popular **15/6**

"POPULAR WIRELESS" Advertisement Rates

WHOLE PAGE **£40** QUARTER PAGE **£10**
HALF PAGE **£20** EIGHTH PAGE **£5**

Narrow Column Advts. (3 cols. to page) per inch **30/-**
Minimum Space accepted half inch **15/-**

NO SERIES DISCOUNTS. ALL ADVERTISEMENT COPY SUBJECT TO EDITORIAL APPROVAL

COPY AND BLOCKS MUST BE IN HAND 11 DAYS BEFORE DATE OF ISSUE TO ENSURE PROOFS

ALL Communications respecting advertising must be made to

JOHN H. LILE LTD., 4 Ludgate Circus London E.C.4.
Phone: City 7261

Non-Microphonic

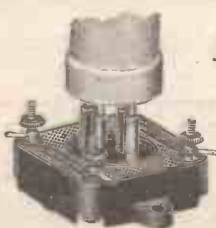

The Etherplus + "Anti-Vibro" Valve Holder prevents damage to the delicate valve filaments. It has low capacity legs mounted on a soft rubber base suspended on four phosphor bronze springs enclosed in a high quality moulding.

PRICE **2/6**

From dealers or from

MANDAW 9-15, Whitecross St., London, E.C.1

ETHERPLUS

RADIO ACCESSORIES
= ENSURE PERFECT RECEPTION

Don't forget to use

GLAZITE
BRITISH MADE REGD.

COLOURED CONNECTING WIRE

[RED YELLOW BLUE BLACK WHITE and GREEN]

Write for descriptive leaflet to
The LONDON ELECTRIC WIRE CO & SMITHS LTD
Playhouse Yard, Golden Lane, London, E.C.1.

Makers of Electric Wire for over 40 years



Have You?

A very large number of readers of "Popular Wireless" wrote for and received a copy of our revised Catalogue. Many have since bought one or more of the thousand Radio Bargains listed.

Have You?

Send 4d. stamps for a copy by return post.

ELECTRADIX RADIOS

218, Upper Thames Street, London, E.C.4

Parr's Ad.

HEADPHONES REPAIRED

Re-wound & remagnetised 5/- per pair. Loud Speakers repaired 5/-, Transformers re-wound 5/- each. All work guaranteed and tested before delivery.

Write for Trade Prices. Phone: Clerk, 1795. MASON & CO., 44, East Road, City Road, N.1.

Give Your Set a Treat

by fitting the only perfect Coil Holder. Fading away and backlash definitely banished and the moving block can be locked immovably.

The Penton GEARED COIL HOLDER Patent No. 193150

Gear Ratio 9:1

6/- The Only Perfect Coil Holder From all good Radio Dealers, or post free direct from

THE PENTON ENGINEERING CO., 15, Cromer St., Gray's Inn Road, London, W.C.1.

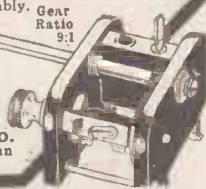

'PHONE REPAIR SERVICE

Phones rewound and remagnetised, 4/6 per pair. Remagnetised only, 2/-. Loud Speakers and Transformers rewound. Glass Jars for making up wet H.T. units, waxed, 1/3 doz.; plain, 1/-. Post extra. The H.R.F. Co., 1, Cotterill Rd., Dalston Lane, E.8.

Do you want a better Set?

There is no need to postpone having a better set because the initial cost is too large. We supply complete Receivers, guaranteed Components and Accessories on the Easy Payment System. It will pay you to write at once for our comprehensive Catalogue P, and let us know your requirements.

SALES CO., VULCAN HO., LUDGATE HILL, E.C.4. 5585

MAKE WIRELESS PAY!

French Exporter seeks agents in every town for sale of Sets and Components. Liberal commission. Write: EXPORTER, 9, Avenue Robert Bain, Bois-Colombes, Seine, France.

Valves Repaired

AS GOOD AS NEW!!

(Except Weeco, S.P.'s, and low capacity types). Minimum D.E. Current 0-15 amps when repaired.

ALL BRIGHT & DULL EMITTERS

Listed at less than 10/-

Minimum charge 5/-

VALCO LTD., Dept. P.W., Tabor Grove, Wimbledon, S.W.

REPAIRS SETS, PHONES, TRANSFORMERS

Officially Approved by Radio Association. ALL WORK GUARANTEED. LOWEST RATES. 24 HOUR SERVICE. Cash on Delivery if Desired. JOHN W. MILLER, 68, Farringdon St., E.C.4. Phone: Central 1950.

LITTLE WIRELESS COGGETS.

MAP

SMALL PARTS TO THE TRADE.

MAP Co. 246, Gt. Lister St. Birmingham.

TECHNICAL NOTES.

(Continued from page 782.)

dealt with are directly connected with those of present-day broadcast reception, and for that reason, no doubt, many readers of these columns would find the book of considerable interest.

Improved Valve-Pins.

One would hardly think that there was much room for invention in connection with so simple an object as a valve-pin or a wander-plug. The new hollow valve pins, however, have some very important advantages over the old split-pin type. Quite apart from the fact that they are much easier to insert into the valve sockets, and that a much better contact is obtained, they have other advantages in connection with the manufacture of the valves. In case the exact character of these pins may not be known to all my readers, perhaps I ought to explain that the new type of pin, which I understand is being adopted by the leading valve manufacturers in the coming season, is drilled along its axis so that it is, in effect, a hollow tube whilst the cylindrical wall of the tube is longitudinally slotted at four positions.

In assembling a valve, the four leading-out wires from the electrodes (when using an ordinary type of pin) are brought out from the valve cap and are twisted around the valve pins close up to the base, where they are then soldered in position. This operation of soldering in very close proximity to the base is objectionable, as the base is liable to be overheated and distorted, and any flux used for the soldering operation is distributed upon the base and must be very carefully cleaned away.

New Wander-Plug.

With the hollow pin, however, the leading-out wires from the electrodes are threaded down through the hollow pins and emerge at the tips, where they are bent over and clipped off. When the four wires are arranged in this way, it is only necessary to place the tips of the four valve-pins against a hot plate covered with molten solder, and the four leading-out wires are simultaneously soldered to the pin tips. Not only is this a very simple and labour-saving feature, but the heat is kept entirely away from the base, and there is very little possibility of any flux being deposited upon the base, as with the old-fashioned method.

The Clix wander-plug, to which I have briefly referred, is also a hollow type of pin, but instead of being longitudinally slotted it is spirally slotted so that the two prongs have a degree of "spring" which would correspond to a much greater length than the length of the pin if the prongs were straight instead of being spiral.

THE NEW B.B.C.

(Continued from page 777.)

deal of research work. Radio in America has also the co-operation of the Press—programmes are published in every newspaper, and much more attention is given to broadcasting than in the English Press.

The fear is that the new Broadcasting Commission will be more cramped than the present Company, and that policy will become stereotyped, especially if it is subject to financial control by the Treasury.

RADIOTORIAL QUESTIONS & ANSWERS.

(Continued from page 795.)

been touched in any way. Previously I was able to use 60 volts on the detector, 90 volts on the first L.F., and 108 volts on the last stage L.F. Now I cannot plug-in more than 30 volts on the detector, nor more than 60 volts on the amplifiers without the set breaking into violent howling. What is the cause of this?

There is little doubt that the trouble is due to the H.T. battery, which we assume is of the "dry" type.

Apparently it is deteriorating, and as its resistance increases it becomes impossible to use more than a small part of the battery. The trouble is particularly liable to occur during the hot months, as the difficulty of storing dry "cells" in a cool place is greatly increased in the summer.

In your case the only remedy will be a new battery, and as you employ three valves, we suggest you obtain one of the triple capacity type (dry battery), or an accumulator H.T., the latter being preferable.

MASTER RHEOSTAT.

L. P. (Willesden).—Having a multi-valve set I find that it is quite a tedious task adjusting each filament rheostat every time I wish to use the receiver. To obviate this trouble I fitted a switch which lights all the valves simultaneously.

I have been told, however, that this method throws a strain on the filaments. Is there another method without this disadvantage?

Yes. We recommend a master filament rheostat for your purpose. This rheostat is usually wound with a fairly heavy gauge of Eureka or Nicrochrome resistance wire of 4 to 6 ohms, and is connected in series with the positive L.T. lead of the accumulator.

When adjusting the filament of the valves, it should be turned about half-way on, the other adjustments being made with the rheostats to each valve.

It is then possible, by turning this master rheostat to its "off" position, to cut off the L.T. to all the valves without the necessity for readjusting each rheostat or, when again switching on, without throwing any strain on the filaments of the valves.

IS THE AERIAL SYSTEM O.K.?

F. W. A. (Maidenhead).—I have an idea that some bad crackling I am experiencing is due directly to my aerial leading-in wire half breaking through from swaying about in the wind.

As I do not want to bring down the aerial without being certain that this is the cause of the trouble, how can I prove it conclusively?

We advise you to connect up the aerial in question to your usual set, and tune in a powerful B.B.C. station (probably the local one). Then see if the volume varies or if crackling still occurs. If so, disconnect the aerial wire and listen for several minutes on the set to see if the noises continue. Should the crackling have ceased it will be safe to assume that the aerial is faulty.

On the other hand, if the crackling continues, the trouble can be due to the set itself or to the earth wire.

We therefore suggest you disconnect the latter wire also, and test the set without aerial or earth.

A silent background in this instance will denote a faulty earth.

ADVERTISEMENTS

As far as possible all advertisements appearing in "P.W." are subjected to careful scrutiny before publication, but should any reader experience delay or difficulty in getting orders fulfilled, or should the goods supplied not be as advertised, information should be sent to the Advertisement Manager, "Popular Wireless," 4, Ludgate Circus, London, E.C.4

Judge a valve by its filament

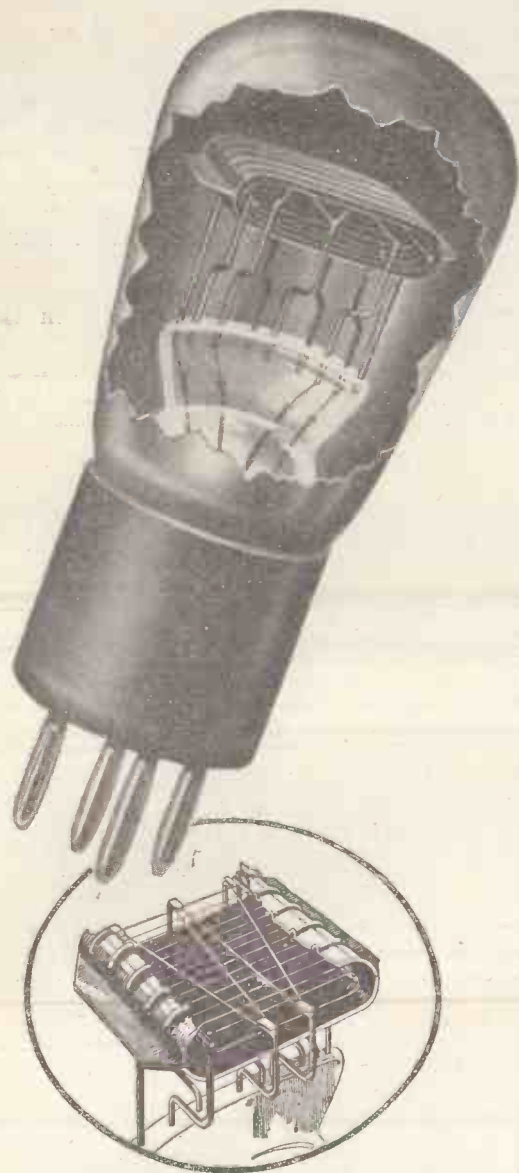

If you have ever been disappointed by a valve that has expired with premature old age or been cheated by the weakening results due to lost emission from a valve or cursed by a valve's insatiable appetite for current that made your accumulator recharging an incessant annoyance,

You will agree that when it comes to purchasing radio valves all the anodes, grids and features in the world cannot alter the trenchant fact that

It is the filament that counts Whether you have learnt by sad experience or not you will eventually make a point of finding out all about the filament of a valve before you buy it.

Look at the P.M. Filament

Its core of a special rare metal is so thick and tough that it can be tied in knots after 1,000 hours' life and its length is up to 3 times greater than any other filament on the market. This greatly increased length is set around 5 strong resilient hooks by an ingenious device that completely eliminates all tension and possibility of displacement, thereby ensuring consistent characteristics throughout its life.

Its emission as a result of these larger dimensions and the multi-layers of high emitting alloy of precious metals, is up to 5½ times greater than that of any ordinary filament, and this emission continues for a proportionally increased life.

The operating temperature is so low that no sign of glow can be discerned and the current consumption being only one-tenth ampere, your accumulator charges will last seven times as long. In other words, you will reduce your accumulator recharging journeys and costs to one-seventh.

The P.M. filament is completely within the field of the grid and anode, and is so tough and well designed that it cannot be broken except by the very roughest handling.

You can be sure that the manufacturers of a masterpiece like the P.M. filament will supply it with fitting grid and anode of equally masterly design. The sectional illustration will tell you all their best features.

You will only find the P.M. Filament in P.M. Valves.

For 4-volt accumulator or
3 dry cells

THE P.M.3. (General Purpose)
0.1 amp. 16/6

THE P.M.4 (Power) 0.1 amp. 22/6

For 6-volt accumulator or
4 dry cells

THE P.M.5 (General Purpose)
0.1 amp. 22/6

THE P.M.6 (Power) 0.1 amp. 22/6

For 2-volt accumulator

THE P.M.1 H.F. 0.1 amp. 15/6

THE P.M.1 L.F. 0.1 amp. 15/6

THE P.M.2 (Power) 0.15 amp. 18/6

These prices do not apply in Irish Free State

Mullard

THE MASTER VALVE

4 Steps to Better Radio

R.I. Components will do more than any others to help you with your set building. They not only make the actual construction easier, but they go a long way towards ensuring the most satisfactory results.

There is a reliable R.I. Product ready for each successive stage of your set, ready to give perfect results in the capacity in which it can be used.

Let us commence with The R.I. Duostat, a filament rheostat unsurpassed for silence and surety of control. Its special construction allows it to be used for either bright or dull emitter valves, a black scale showing the correct position for each type.

PRICE 7/6.

The R.I. Reactive Anode Unit. Built to tune those distant signals to good strength. Has five tappings covering all wavelengths from 200—4000 metres, three of them serving to cover the broadcast band and giving excellent adjustment. Owing to the special winding the impedance of each tapping keeps the reactance values approximately uniform for all wavelengths.

PRICE 25/-.

The R.I. Retroactive Tuner provides more efficient tuning over the range of wavelengths from 175 to 4,000 metres, and costs less than a set of coils with coil-holder to cover the same range. It is wound on the single layer method proved by eminent technicians to be more efficient than the multi-layer method.

PRICE 39/6.

The R.I. Permanent Mineral Detector. Here we have a crystal detector absolutely permanent and unaffected by vibration. No catwhisker is employed, a spring plunger maintains the correct pressure on the crystal, which is sensitive throughout its area, making it unnecessary to search for special sensitive spots.

Manufactured in two different forms. Standard pattern, with supporting clips for mounting either above or below the panel, and one-hole fixing pattern with detachable ebonite cover which protects the adjusting knob when in position.

PRICES : Standard Pattern, 6/- . One-hole Fixing Type, 7/6.

Write for the R.I. Blue and Gold Catalogue.

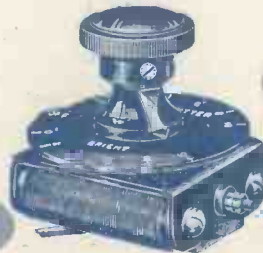

THE MARK OF BETTER RADIO

Advt. R.I. Ltd., 12, Hyde Street, New Oxford Street, London, W.C.1.

P.C. 35

All applications for Advertisement. Space in POPULAR WIRELESS to be made to JOHN H. LILE, LTD. (Sole Agents), 4, Ludgate Circus, London, E.C.4. Phone : City 7261.

FACTS ABOUT THE NEUTRODYNE

Popular Wireless

Every Thursday
PRICE
3d.

No. 219. Vol. IX.

and Wireless Review
Scientific Adviser: SIR OLIVER LODGE, F.R.S., D.Sc.

August 14th, 1926.



SPECIAL FEATURES

That Aerial and Earth.

Home-made Valves.

THE "P.W."
"OLD WORLD" TWO.

British Broadcasting To-day.

Building Up a Super-Het.

Our cover photograph this week shows the short-wave super-heterodyne set installed at the Keston receiving station which is used by the B.B.C. for picking up American stations for relaying purposes.

MARCONI
Type D.E.R.
 (General Purpose Valve)
 for 2-Volt Accumulator **14/-**



Look for this Signature



when purchasing a valve—it is your guarantee of sound design.

For brilliant quality and abundant volume try these recommended combinations of

MARCONI VALVES

Type.	Position.	Fil. Volts.	Grid Bias.	H.T. Volts.
For Two-Valve Set.				
D.E.R	Det.	1'8	+2	40
D.E.6	L.F.	1'8	-9	120
For Three-Valve Sets.				
D.E.R	Det.	1'8	+2	40
D.E.R	1 L.F.	1'8	-4'5	120
D.E.6	2 L.F.	1'8	-9	120
D.E.R	Det.	1'8	+2	40
D.E.6	1 L.F.	1'8	-9	120
D.E.6	2 L.F.	1'8	-9	120
For Four-Valve Sets.				
D.E.R	H.F.	1'8	0	40
D.E.R	Det.	1'8	+2	40
D.E.R	1 L.F.	1'8	-4'5	120
D.E.6	2 L.F.	1'8	-9	120
D.E.R	H.F.	1'8	0	40
D.E.R	Det.	1'8	+2	40
D.E.6	1 L.F.	1'8	-9	120
D.E.6	2 L.F.	1'8	-9	120

MARCONI
Type D.E.6
 (Power Valve)
 for 2-Volt Accumulator **18/6**



Valve Publication No. 443a sent on request.

The MARCONIPHONE COMPANY, LTD.

Head Office :
 210-212, Tottenham Court Road, London, W.1

Regd. Office :
 Marconi House, Strand, W.C.2

THE VALVE IN THE PURPLE BOX

The NEW "BEST WAY" Guide for Wireless Constructors



Details of the three splendid sets described in this "Best Way" Wireless Guide are given below. The book is amply illustrated with photographs and diagrams, and constructors will find the wiring directions most lucid and straightforward.

The All-Station Loudspeaker Portable

A remarkably compact six valve SUPER-HET. Aerial, batteries and loudspeaker all completely enclosed and permanently connected. This receiver will appeal strongly to Motorists, Caravanners, River Parties, and Seaside Bungalow inhabitants.

A Three-Valve Portable

Several stations on the loudspeaker and many on the Telephone receivers can be obtained with this receiver. It employs a frame aerial which is built into the lid of its neat carrying case. It will prove popular among Motor Cyclists and other Road and River Tourists.

The Baby Portable

A two-valve receiver contained in a very small attaché case. Batteries and telephone receivers are enclosed and a reel of wire and earth pin for erecting temporary aerials are provided. This is the set for the Cyclist Holiday Tourer.

Now on Sale Everywhere. Buy a Copy To-day 6d.

The Australians —

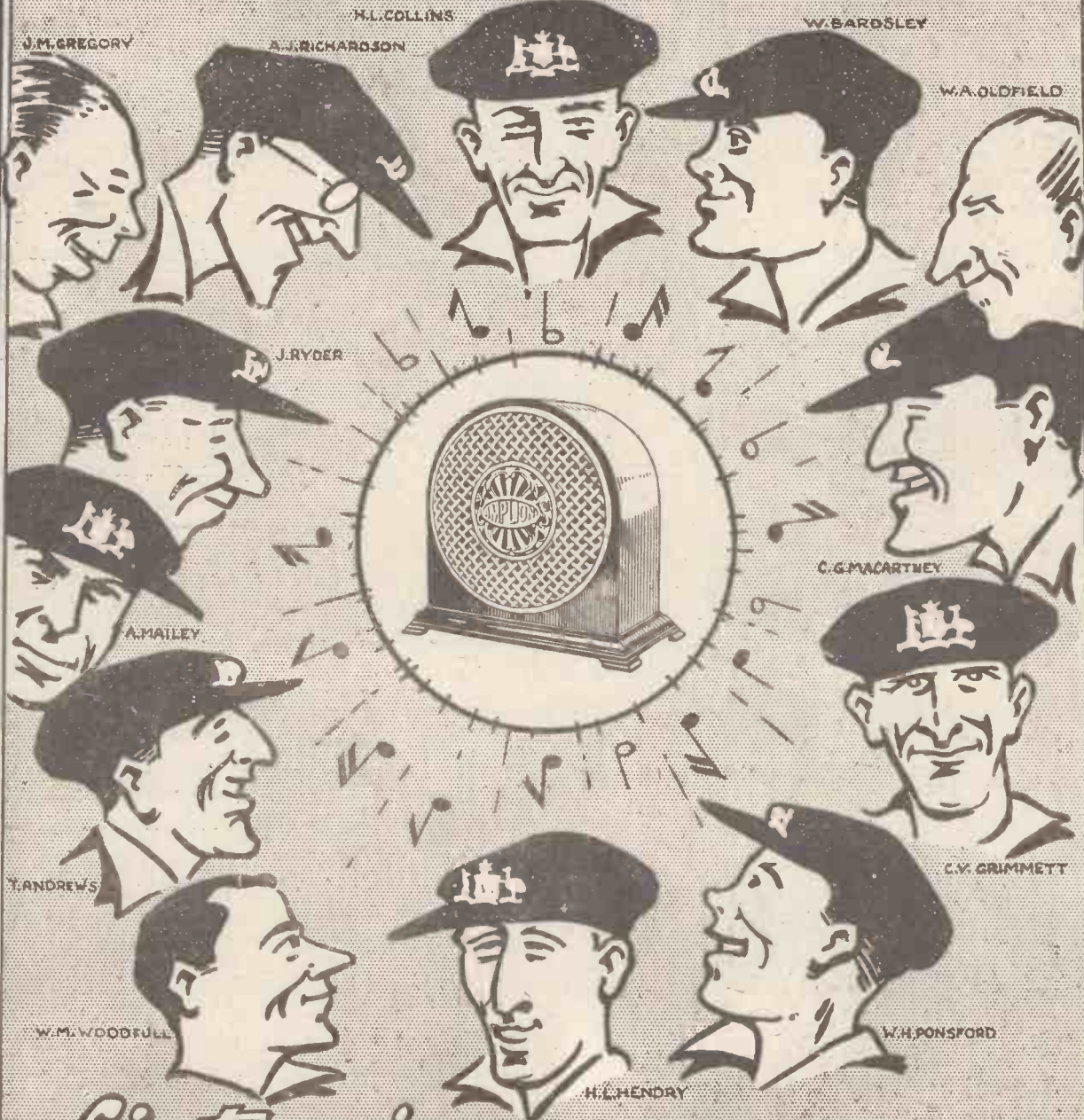

Listen in on a —

Radiolu I AMPLION

Stands Nos.
131 & 132

OLYMPIA
Sept. 4-18

Patents and manufacturers:

ALFRED GRAHAM & CO. (M. GRAHAM), St. Andrew's Works, Crofton Park, London, S.E.4

Demonstrations gladly given during business hours at the AMPLION Showrooms:
 25, Savile Row, London, W.1. 10, Whitworth Street West, Manchester.
 70, High Street, Clapham, S.W.4. 101, St. Vincent Street, Glasgow.

Cosmos

COMPONENTS



THOSE constructors who desire smooth working, reliable and neat-looking sets, use "Cosmos Precision Components.

RHEOSTAT AND POTENTIOMETER.

The "Cosmos" Rheostat is strongly constructed to give a smooth, reliable and continuous contact. The contact arm moves round the inner side of the winding, and is thus protected from accidental damage. It takes up little space, and is one-hole fixed.

PRICES: Each	"Cosmos" Filament Rheostat.			Potentiometer.
	6 ohms. 1 amp.	20 ohms. 4 amp.	34 ohms. 2 amps.	300 ohms. —
	4/6	5/-	5/-	6/-

ANTI-VIBRATION SPRING VALVE HOLDER.

The shock-absorbing element in the "Cosmos" Valve Holder is not a stiff flat spring or sponge rubber which absorbs moisture, but a separate spiral spring for each leg. This construction gives maximum elasticity.

Price for Panel or Baseboard Mounting: **2/9**
each

MICROMETER TWO-COIL HOLDER.

This is a high-grade precision component of robust construction. It cannot develop backlash, and is always smooth in motion. It gives rapid swinging or fine adjustment as required.

Prices of "Cosmos" Micrometer Two-coil Holder:

As shown for Panel Mounting	6/6	Complete with base	7/6
-----------------------------------	------------	--------------------	------------

Ask for a copy of the "Cosmos" Components List.

METRO-VICK SUPPLIES, LTD.

(Proprietors: Metropolitan-Vickers Electrical Co., Ltd.)

METRO-VICK HOUSE, 145, CHARING CROSS ROAD, W.C.2.

Popular Wireless

Scientific Adviser:
Sir OLIVER LODGE, F.R.S.
 Technical Editor:
G. V. DOWDING,
 Grad.I.E.E.
 Assistant Technical
 Editors:
K. D. ROGERS,
P. R. BIRD.



Editor: **NORMAN EDWARDS, M.Inst.R.E., F.R.S.A., F.R.Q.S.**

Consultants:
Dr. J. H. T. ROBERTS,
 F.Inst.P.
J. F. CORRIGAN, M.Sc.,
 A.I.C.
C. E. FIELD, B.Sc.
E. J. SIMMONDS,
 M.I.R.E., F.R.S.A.

RADIO NOTES AND NEWS.

The Prince and Sir Oliver Lodge—Wireless Worship—University of the Ether—A Wireless Exchange—The German Giant

Cardiff Goes Holiday-making.

HOLIDAY-MAKERS at Weston-super-Mare next week will have an opportunity of seeing how programmes are broadcast from the Cardiff station. The whole of the 5 WA programme on August 19th is to be relayed from Clarence Park, Weston-super-Mare, in connection with the Radio Sunbeam Carnival.

Captain Eckersley, chief engineer of the B.B.C., will open the carnival, and amongst the stars that will twinkle in the good cause are the Two Bobs and Tommy Handley.

There will be plenty of side-shows and side-splitters!

Hearing Hilversum?

DID you know that Hilversum's new transmitter, which, by the way, is in excellent voice at the time of writing—has been designed and erected by an Englishman? He is Mr. G. W. White, formerly an engineer in the employ of Marconi's Wireless Telegraph Co., Ltd., and now chief of the laboratory of the large Dutch firm that operates the Hilversum station.

Mr. White is always pleased to hear reports upon transmissions, and a good many English listeners are already co-operating with him in this respect.

Trying for American Broadcasting.

HAVING seen your recent remarks in POPULAR WIRELESS that conditions were becoming better," writes a Bideford reader, "I determined to try American broadcasting. On Friday, July 23rd, I received WPG, Atlantic City, playing dance music. The call was distinctly heard several times.

"At 4.20 a carrier and faint dance music was heard; this, I think, was WJZ. At 4.30 another carrier was heard, which turned out to be WGY. Fading was bad."

A Good Time Ahead?

MOST of us would have been content with a haul like that in midsummer, but this enthusiast carried on, and at 4.45 a.m. he had another bite. This

The Wireless Novel.

IS there a big future for the radio serial? I don't know what you thought about "At the Villa Rose," if you listened, but, personally, I thought that the innovation was a great success.

The fact that I don't find sufficient time for reading has for years been one of the little crosses that I try to bear cheerfully. Consequently, I enjoy a boiled-down,

peptonised, tabloid, thrilling novel which can be absorbed and enjoyed without effort. There are plenty of first-class novels that are insufficiently known, so my vote goes for the broadcast story every time. What do you think about it?

BROADCASTING IN COMFORT.



Miss Margaret Bannerman broadcasting from her dressing-room at the Globe Theatre. Note the small portable microphone, in use.

time it was WGBU, of Fulford-Florida, relaying a dance band from the Fulford Palais-de-Danse. The wave-length was 275 metres and fading was bad.

Considering that this reader uses a straight three-valve set (H.F., Det., and L.F.), his success bears out what I said a week or two ago about improving conditions. There is every indication that the coming one will be a splendid DX (long-distance), season and I cannot remember an August when conditions have been more promising than at present.

church has just been installed in due form at Portland, Maine. All his parishioners are broadcast listeners who have no church edifice, and whose place of worship is before their receivers.

The minister's livelihood depends entirely upon subscriptions received from his unseen "congregation," and he has no work outside his radio activities. The call sign of the station is WCSH, and it works on 256 metres, with a power of 500 watts.

(Continued on next page.)

New Radio Revue.

THE newest radio revue is by Peter Haddon, who has produced some good stuff at the Winter Garden Theatre. London will not hear it until September 4th, but it will be broadcast from Belfast, Bournemouth, and Aberdeen on the 21st of this month.

Wireless Worship.

THE first radio minister of the first radio parish

NOTES AND NEWS.

(Continued from previous page.)

An Edward German Programme.

EDWARD GERMAN is himself conducting the wireless orchestra on August 13th, when a programme of his works is being broadcast from Daventry and London. The composer intends to include some of his less-known works, amongst them the incidental music to "The Tempest."

High Up.

DROITWICH and district readers will have to try a bit of rubber-neck drill to-day, looking upward to the skies. For a number of small gas-filled balloons will be released from the Droitwich Agricultural Show, and the finder of the winner gets a wireless prize.

A complete set of "Mellowtone" Couplers for aerial tuning (value 24s.) will be presented by the manufacturers to the person finding the balloon which has travelled a greater distance than any other returned to them. Full particulars will be announced locally to-day.

Some Odd Items.

IN Germany the postman collects the licence fees, which are payable once a month.

There are just about as many wireless direction-finding stations round the U.S. coast-line as around all the coasts of all other countries in the world.

The Dutch station P C G G is coming on the ether again regularly, on 1,150 metres.

Beating the World.

THE English and Australian amateur experimenters who set up the wonderful low-power long-distance records by working across the world on about half a candle-power will have to look to their laurels. A competition has been organised by the Radio World's Fair people in New York, and every "ham" in America is out to bust the radio records of creation. The closing date is Sunday next August 15th, and the prizes go for greatest distance covered on lowest power in shortest time.

The German Giant.

IT is expected that the new German super-station at Langenburg, to which I referred last week, will be in operation next month. It will at first work upon two or three times the power of Daventry, I hear, and the wave-length will probably be in the vicinity of 2,000 metres.

When this station gets into its swing, a set of long-wave coils will be a sound investment, covering as they should three easily-received first-class stations (and several prospective programme suppliers upon similar wave-lengths). Between them, Daventry, Radio-Paris, and Langenburg will fill a large proportion of the twenty-four hours with entertainment.

The Prince and Sir Oliver Lodge.

HIS Royal Highness the Prince of Wales paid a very graceful compliment to Sir Oliver Lodge, F.R.S.—"P.W.'s"

scientific adviser—at the annual meeting of the British Association. In concluding his Presidential address, the Prince referred to the first public demonstration of wireless, given by Sir Oliver thirty-two years ago at Oxford.

The assembled scientists clapped as one man; for, though it's just possible there may be one of them not keen on wireless, they are absolutely unanimous about Sir Oliver Lodge!

5 G Z.

I AM informed that the call sign 5 G Z has now been allotted to Mr. Jim Geary, of Landore, Swansea. He will be pleased to arrange tests with other experimenters.

A University of the Ether.

NOVEMBER is likely to see a French radio university. The Council of the University of Paris have decided to set up a scheme of broadcast lectures, and possibly diplomas will be granted to

SHORT WAVES.

THE VACANT CHAIR

Daughter: "Mother, how long ago did daddy die?"

Mother: "He didn't die, darling; he just joined a radio-club."—"RADIO."

"The B.B.C. . . feels that however great has been the development of broadcasting in the past three and a half years, it is still in its comparatively early stages."—AN OFFICIAL STATEMENT.

"Daddy, the wireless set's on fire! Look at the smoke."—"Oh, keep quiet, my boy. It's all right. I've just got Sheffield."—"NEWS OF THE WORLD."

those successful with the courses. Eminent savants of the Sorbonne will thus be able to lecture on art, history, or literature, and they will be heard not only "in class," but in the homes of the people.

Polar Expeditions.

ACHESHIRE listener has picked up signals from two different Polar expeditions which are now en route for the Arctic regions. One was W N P (the call sign of our old friend, the s.s. "Bowdoin"), which did some excellent radio and Polar work last year. The other was V O Q, a Newfoundland fishing schooner called the "Morrissey," upon which are embarked scientists representing the American Museum of Natural History.

Where the Money Goes.

IN a snappy little memorandum circulated recently amongst Members of Parliament, the B.B.C. made known some interesting radio facts. The total broadcasting revenue retained by the Postmaster General since broadcasting began is given as £481,000—and we shall never see that money again, I'm afraid!

Pleading for more funds for developing the service, the broadcasting memorandum goes on to say "when an adequate service

has been assured, but not till then, it is expedient that the surplus be retained by the State." If the P.O. already collars nearly half a million of licence-money, whilst the service is in its infancy, what chance of development will there be in a year or two's time?

A Wireless Message.

AN interesting situation has arisen at Hythe, near Southampton, over a man's wireless exchange. He has a five-valve set (homo-made), and organised a one-and-six a week scheme to supply neighbours with loud-speaker music. The broadcasting is carried over telephone wires, to houses about half a mile away, and now the question is whether this is breaking the law? All the recipients had apparently taken out licences, and a ruling on this unusual case is being awaited with interest.

Honolulu Calling China.

A GOOD example of the way in which amateur experimenters toss messages about from continent to continent is afforded by the case of 6 D B L. This gentleman hangs out his aerial in Honolulu (where the ukeleles come from!) and he had a message one day for China. Unable to link up with the Orient, 6 D B L asked a New Yorker to take it, and pass it on. The New York station called up the East, but could only get the message as far as Minneapolis, so it went to 9 Z T in that city.

The Long, Long Trail.

THE "ham" in Minneapolis called up the wide, wide world, asking somebody to take a message for China. The only people who seemed keen on the job were the U.S. Navy, so the message went to headquarters at Washington, and from there, in one glorious jump, the boys in blue pushed it through to a station in New Zealand. The next station to receive it was a French one, which passed it on to South Africa. The South African couldn't raise China, but he picked up the Philippines, and they eventually got it through, after it had travelled about 45,000 miles!

Australia's Beam Ready.

THE arrival in England of photographs of the Australian "beam" stations, show that the buildings at Ballan, Victoria, were completed in June. The receiving station is not at Ballan, but at Rockbank, near Melbourne, and between them the stations will link up Australia with Britain and Canada. The system will be operated over landlines from the central telegraph office in Melbourne.

Shakespeare and Broadcasting.

BECAUSE I omitted their own favourites numbers of readers have hauled me over the coals about the recent article on "Shakespeare and Broadcasting." In response to their requests, and in view of its absolute accuracy, I must quote the following prophetic speech from Henry IV. "Those musicians that shall play to you Hang in the air a thousand leagues from hence, And straight they shall be here: sit and attend."

ARIEL

BRITISH BROADCASTING TO-DAY.

An Unsatisfactory Position.

By THE EDITOR.

The Shadow of the Civil Service—The History of the B.B.C.'s Licence—That £500,000—Post Office "Savings"—Sapping the B.B.C.'s Vitality—The Possibility of a "Decline and Fall"—The Contemplated Treasury Raid.

THE position of broadcasting in this country at the present time can only be summed up in one word, and that is "unsatisfactory." As everybody knows, the B.B.C.'s licence expires at the end of this year, and broadcasting will then be carried on under a Civil Service régime. The time is ripe for a short survey of the affairs of the British Broadcasting Company, and for an inquiry into the reason why the Post Office still refuses to part with a good deal of money which the listener has paid in the form of licence fees for broadcast entertainment and which, because it has been withheld, has resulted in a broadcasting service which is not as good as it might be.

No Government Profit.

The present B.B.C. obtained its licence in January, 1923, and it was supposed to expire in December, 1924. In that licence it was stipulated that the B.B.C. should establish eight transmitting stations, but having adopted a progressive policy, and the recommendations of the Sykes' Committee of 1923 having resulted in an extension of the B.B.C.'s licence to 1926, extra stations in the shape of eleven relay stations, a main station at Belfast, and a high-power station at Daventry, were constructed. Since that date the B.B.C. have

also undertaken the construction of an experimental station at Daventry.

According to an interesting pamphlet on the broadcasting service which we have recently received, we are reminded that the initial capital required to start the company—that is, to purchase plant, equipment, etc.—was in the neighbourhood of £60,000. This sum of money was subscribed by wireless manufacturers, and to-day members of the B.B.C. number 1,715. The total capital subscribed was approximately £70,000, while the dividend was limited to 7½ per cent.

It is interesting to note that one of the recommendations of the Sykes' Committee was "that no part of the cost of broadcasting should fall on the tax-payer, but that the Government should not endeavour to make a profit on the administration of the service."

The P.M.G.'s Chance.

According to the terms of the original licence, 50 per cent of the licence income is payable to the B.B.C., the other 50 per cent being retained by the Post Office in order that the actual cost incurred by the Post Office in the matter of collection of licences should be well covered. Later on the Sykes Committee realised that 75 per cent of the revenue could be handed over to the broadcasting service, and as licences increased it was expected that a substantial additional percentage of the income could also be handed over.

In view of this the financial terms of the B.B.C.'s licence were altered by an addition of a supplementary agreement, and the provision for money payable to the company was this: Up to and including December 31st, 1924, 75 per cent of the total licence fees, and after that, and up to and including December 31st, 1926, "such proportion as the P.M.G., in consultation with the Company, should consider reasonably adequate to enable the Company to provide a broadcasting service to his reasonable satisfaction."

It was this clause that gave the P.M.G. the opportunity (and he had

the figures before him at that time) to limit the Company's income to £500,000 for the year ending March 31st, 1926. This decision, it would seem, was also endorsed by the views of the Broadcasting Enquiry Committee, and as a result of this decision, whereby the P.M.G. withheld large amounts of money from the licence fees, the progress of the B.B.C. has undoubtedly been retarded; improvements have been hindered and expenditure on first-class programmes curtailed.

Total Revenue.

The B.B.C. do not deny that although they have agreed that the expenditure incurred in connection with licence forms, collection of fees, and other expenses incurred by the Post Office, should be paid for out of the licence money. But they have also had in mind that in order to give the licensees the finest possible service in return for this licence money, all of the balance should be available for this purpose—that is, all of the balance after the Post Office expenses had been paid.

The following table will give the reader a clear idea of the total revenue from broadcast licences, and the proportions of the moneys collected which have been handed over to the B.B.C., and also the amounts which have been retained by the Post Office during the past three years.

Date	Amt. rec. for licences	Licences unexpired at end of periods	Paid to B.B.C.	Balance retained by Post Office
31/3/24	£ 556,000	297,000	£ 177,000	5 82,000
31/3/25	689,000	382,000	489,000	115,000
31/3/26	982,000	580,000	500,000	234,000

The increase in licences from the date of the inception of the B.B.C. can be quickly realised by a glance at the following table:

Date	Total Licences
30/9/23	158,871
31/3/24	720,895
31/3/25	1,348,840
31/3/26	1,964,912
31/5/26	2,049,549

The B.B.C. have also given us some interesting figures with regard to the population included in the urban areas served by their stations. The figure for the latter is 21,943,000, while it has been calculated that in the urban districts throughout the country there is a wireless set in every third or fourth house.

The population in rural areas, to a total of about 21 millions, cannot be classified as being served by any one particular station, but the B.B.C. estimate that a

(Continued on next page.)

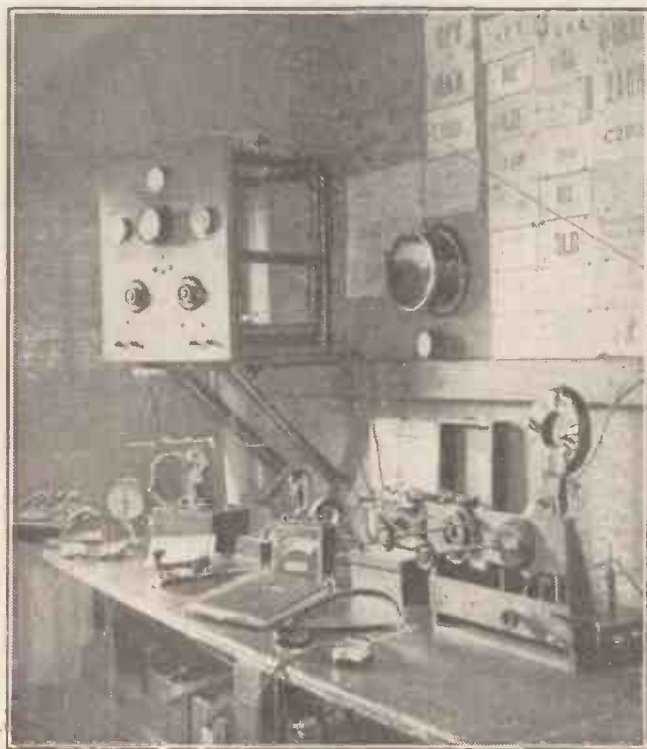

A well-known amateur transmitting station: 6YD of Birmingham.

BRITISH BROADCASTING TO-DAY

Continued from previous page.)

large proportion of the 25 millions of people within the service area of Daventry are regular listeners, while the new regional scheme of high-power stations, which was originally proposed by the B.B.C. will, it is estimated, bring the whole of the population of the United Kingdom and Ireland within an area of British distribution, allowing listeners to select at least two simultaneous programmes.

Another interesting sidelight on the scale of broadcasting is that in 1923 the average number of letters received from listeners by the B.B.C. did not exceed 300 a week, but to-day in London alone an average of 3,600 letters are received, while in the provinces about 3,500 is the weekly average. The B.B.C. deal with about 730,000 letters every year. The total number of the staff of the B.B.C., excluding orchestras, is 725; this figure includes 250 engineers.

A Wrong Idea.

It has always been the idea of the B.B.C., during what may be termed its stewardship of the service, to create a public corporation as the permanent broadcasting authority, and it is pleasing to note that as regards the work of the personnel of the B.B.C., the affairs of the Company have been so managed that its revenue earning capacity for the future has been greatly increased, and that by the end of this year, when the licence terminates, the B.B.C. will be able to pay its shareholders in part, and hand over its organisation with all its assets in the highest state of efficiency with no cost whatever to the new authority.

All things considered, the B.B.C. may congratulate themselves that during the past three and a half years the rapidity of the progress has been remarkable; but, gratifying as all this is, it only enhances the feeling of disappointment that all students of broadcasting must feel when

they realise that the growth of what may be termed a national institution has been atrophied by the action of the authorities in restricting its scope and, in particular, in withholding funds which are its legitimate due.

In the circular we have above referred to, the B.B.C. point out that there appears to be a tendency in some quarters to assess the future requirements of the Company on the basis of past accounts; the idea being, we suppose, that programmes can be stabilised at their present standard. We feel that every listener who has made a study of broadcasting will agree that this attitude is hopelessly illogical and wrong. Never mind how great has been the progress of broadcasting in the past three years; never mind how rapid has been the progress, the fact still remains that there is a very long road to travel yet before broadcasting can be said to have reached maturity.

Encourage Progress.

There is still a very important work to be done, especially in connection with the substitution of the present stations for new high-power stations which will enable every listener in the United Kingdom to have a choice of at least two programmes—programmes which can be received simultaneously on the simplest and cheapest of apparatus.

The engineering side of this work will be extensive, and undoubtedly on the programme side provision will have to be made for a more highly specialised and more varied and interesting series of programmes. Needless to say this scheme will cost money.

Every member of the B.B.C. personnel believes that the service must go forward, that it must not be allowed to stagnate or rest upon its laurels. If it is prevented from doing this, like the Roman Empire, it will "decline and fall." If progress is encouraged there is no reason why at an early date broadcasting should not provide a permanent supplementary source of revenue; but if its vitality is sapped by the appropriation of its funds at the present moment, if these funds are taken away from it before

the service is more robust and more fully developed, then its energies will be seriously impaired.

Lord Crawford's Committee made this quite clear in the broadcasting report which it issued. It stated that "when an adequate service had been assured, but not until then, it is expedient that the surplus should be taken by the State."

If the Treasury make a raid on this surplus licence money, which is being withheld by the Post Office, then the British broadcasting service will receive a setback which will at least retard its development for some years to come.

AERIAL PULLEYS.

WITH the approach of the time when the back garden plots will be recognisable once again, our minds turn to that outdoor aerial which we had decided to erect.

A source of annoyance in connection with this operation is the aptitude of pulleys to allow the wire (or rope) to slip off the wheel and jam, so that the wire cannot be moved

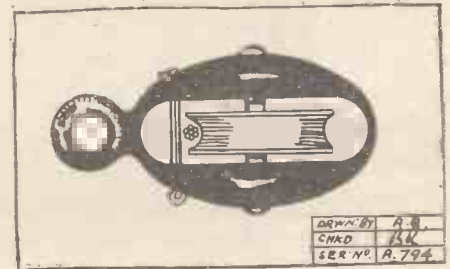

one way or the other. A simple way of avoiding this bother is to drill a hole in each side of the pulley block and insert a split pin, as shown in the sketch. If care is taken to see that the pin is close up to the wheel the aerial may be run up or down without fear of jamming, even though there should be undue clearance between the wheel and the sides of the pulley block.

ANALYSIS OF B.B.C. PROGRAMMES.

We publish below an interesting analysis of programmes which has been worked out by the B.B.C. Early in 1923 the average programme time was 20 hours per station per week. This has now been increased to more than 60 hours per station per week. The following table illustrates the range of subjects covered, with the approximate percentage of programme time allotted in a typical winter month.

MUSIC.					DRAMA.	SPECIAL FEATURES	TALKS.			RELIGIOUS SERVICES.		CHILDREN'S CORNER	MISCELLANEOUS [(from outside sources.)]		
Classical.	Light.	Popular.	Dance.	Gramophone.	Straight Plays.	Radio Revels.	News Bulletins.	Instructional Talks.	Poetry and General Literature Reading	Studio Services.	Relays from Cathedrals and Churches		After Dinner Speeches	Ceremonies.	Theatre Excerpts
Opera.	Light Opera.	Military Bands.	Dance Bands in Studios.	All types of New Gramophone Records.	Drama.	Round the Continent.	Twice Daily.	Lectures, School Transmissions.		Sacred Music.			Pilgrims' Banquet to Lord Reading	Trooping the Colour.	
Orchestral.	Comic Opera.	Musical Comedy.	Outside Dance Bands.		Farce.	Nightingales.		Topical Talks.		Organ Recitals.					
Symphonic	Light Orchestral.	Revue.	Synco-pated Symphony.		Comedy, etc.	Music from Aeroplanes.									
Chamber, Vocal and Instrumental Recitals.		Entertainers.	Ballads.			Divers and Miners at work, etc.									
		Cinema and Restaurant Relays.													
10.02%	11.85%	26.53%	12.5%	1.27%			5.38%	14.5%	.95%						
62.17%					1.69%	1.67%	20.83%			4.18%	7.4%	2.06%			

THE issue by the B.B.C. of a statistical leaflet to members of both Houses of Parliament has already had an excellent effect. I wonder why the B.B.C. has delayed so long in going straight to Parliament? I presume that there was some diffidence in view of the peculiar relations with the Post Office. I hope that the dignified and informative document now circulated will be followed by others when the House resumes. There is a good deal of educative work to be done in a very short time.

I have only one fault to find with the first effort. Its main statistical and factual features were exactly right; but it was unnecessary to pile on the agony about the sincerity of the staff and their dedication to high ideals. If we hear much more of this sort of thing in B.B.C. writings I for one shall be disposed to wonder whether, after all, the staffs are themselves quite convinced on the point.

Post Office "Novelties."

Possibly with a view to future work, certain officials at the Post Office have been working out programme novelties. I heard of one of these the other day. The idea is that an interesting "Outside Broadcast" can be done from a mail train picking up letters "on the run," with a gentle background of an official voice describing the process in blank verse. I have not been able to discover if the B.B.C. has accepted the suggestion. I think it would be a good plan to try it out, as the precursor of future possibilities.

August 24th and 26th will be big variety and vaudeville dates in British broadcasting. There are to be formidable aggregations of "stars" before the microphone on both evenings. Arrangements are still being made, but the following artistes are on the tapis: Jack Buchanan, Beatrice Lillie, Gertrude Lawrence, Will Rogers, W. H. Berry, Jack Hulbert, and Cicely Courtneidge.

"I Love You."

This feature, down for August 31st, forecast exclusively in this page, is developing very well. There will be a number of surprises, and I can confidently predict an excellent programme. Other specialist programmes of the kind will follow at suitable intervals. These will include programmes built up round the following sentimental themes: "The Moon," "Mother," "Good-Night, My Baby," and "Roses." This is a line of country the B.B.C. has neglected up to the present. It is bound to be popular, even if the highbrows "shout the odds."

Radio Physical Jerks.

The newspaper attempt to try to put physical jerks across the B.B.C. does not look like succeeding. The idea seems attractive on the surface, but there are serious snags. First of all is the psychological fallacy. It is contrary to British ideas to fall in with American ideas like this. If broadcasting were just starting and therefore in need of artificial stimulus, there might be something to say for it as a "curiosity raiser."

BROADCAST NOTES.

By O. H. M.

Facts for Parliament—Post Office "Novelties"—Radio Physical Jerks—A Bombshell in the West—Dominion Premiers to Broadcast—Forthcoming Attractions.

The second snag is that no such step could be taken without the consent of the Ministry of Health through Sir George Newman, who advises the B.B.C. on all

as well as the Welsh in Wales. A strong movement has sprung up in Bristol to secure the transference of the headquarters of the West Region there. Bristol can claim more artistic and cultured traditions than Cardiff, and has strong arguments on accessibility and superior prestige. Curiously enough there is a considerable body of opinion throughout Wales that would welcome the Bristol idea. They look with alarm on the attempt of a minority of cranks to make Welsh broadcasting purely provincial. They argue with some show of reason that the Welsh people will get better programmes from Bristol than from any place inside Wales. But there will be a lot of fur flying before the dispute is settled. Meanwhile I hear the B.B.C. will broadcast excerpts from the 1927 Eisteddfod at Holyhead.

NEXT WEEK.

THE GENEVA WAVE PLAN.

An exclusive article about the proposed revision of broadcasting wave-lengths.

By **ARTHUR BURROWS**

ORDER YOUR COPY NOW!



The diver who recently broadcast his experiences from the bottom of the Thames via 2 L O.

matters affecting public health. Now I happen to know that Sir George Newman is rather against the idea, chiefly because it is bad practice professionally to offer standardised physical exercises to people without examining them beforehand. The third snag, of course, is poverty. Even if the money were released, there are many more urgent purposes to which it would have to be put.

Mr. Ansell has succeeded Mr. Godfrey as conductor at the London Station.

A Bombshell in the West.

A new bombshell has been thrown into the already troubled waters of broadcasting in Wales and the West of England. While the enthusiasts of North and South Wales were getting to grips over the placing of the studios in the new scheme of distribution, they forgot or ignored the fact that the new regional transmitter for that area will have to serve a large English population

A change has been made in the feature programme arranged for September 1st. This was to have been a special Musical Comedy programme, but it has now been decided to give, instead, a selection of the old musical burlesques in vogue before the time of musical comedies.

By September 3rd listeners will have had about enough of "seasonable" summer stuff, and will welcome the Wagner programme down for that night. Either Albert Coates or Sir Hamilton Harty will conduct.

Dominion Premiers to Broadcast.

All the Dominion Premiers will probably broadcast from London during their meeting here in October. Arrangements are already under way. I understand that the B.B.C. will help a good deal in the publicity of the Imperial Conference, and Economic Conference. This is all very well as long as it is confined to the obviously non-party political, but I heard a disturbing rumour in the Lobby the other day about the extent to which a B.B.C. official had pledged his organisation to support Imperial Preference.

This has to do with a sub-committee of the Empire Marketing Board, which was set up after the last Imperial Conference. When the Conservatives failed to carry their Preference proposals at the General Election of 1923, they fell back on the policy of encouraging voluntary preference, and decided to spend public money on a big campaign of advertisement for British overseas products.

This purpose is laudable, but I have grave doubts if the Opposition parties in the House would regard the procedure as either correct or non-party political. And the B.B.C. is officially represented on the committee. There will be trouble about this.

Forthcoming Attractions.

A special programme bearing this title is being organised and will be given in October, the three Hales doing "Yesterday," the Astaires "To-Day," and the Sitwells "To-Morrow." Another big programme feature promised for October is John Masefield reading his own work.

Listeners will have a rare treat early in the autumn, when Sir Frank Benson gives a special broadcast of his Memories.



Conducted by our Staff Consultant, J. H. T. ROBERTS, D.Sc., F.Inst.P.

SINCE I frequently receive inquiries from readers with regard to various troubles which arise in their sets, it may be useful to summarise shortly a number of the most common troubles and the means which should be taken to correct the same.

A comparatively common trouble is due either to a defective or to a burnt-out L.F. transformer. To test out the winding of a transformer we may utilise a dry cell and a pair of telephones, connected in series, which are connected first across one winding of the transformer and then across the other winding.

On making contact, a distinct click should be obtained and another click on breaking contact. If this is not obtained, it is evident that there is a break in the winding. The click which is heard when the secondary winding is tested will, as a rule, not be so pronounced as with the primary winding, because the former has a much higher resistance.

Connecting Variable Condensers.

Another trouble is sometimes due to the variable condensers being connected improperly. If we are using a set with low loss variable condenser across the coil this should be connected with the movable plates to filament. If, however, we are using a circuit with the ordinary type variable condenser between the aerial terminal and the tuner, the movable plates should be connected to the aerial.

A New Crystal Detector.

The suggestion is often made that the crystal detector should be capable of acting as a rectifier of oscillating potentials, as distinct from its usual function of rectifying oscillatory currents. As a matter of fact, the use of a crystal in this way is attributed to Dr. de Forest, the famous inventor of the three-electrode valve. The crystal may be used with quite a simple circuit to act in conjunction with a valve, and in this way makes an efficient and practically distortionless amplifier under proper working conditions. A suitable circuit consists of the usual aerial coil shunted by a variable condenser, the aerial connection to the grid having interposed in it the crystal rectifier and a fixed condenser, these latter components being in series with one another.

The grid leak runs from the grid to earth in the usual way. The rectifying potentials are thus applied directly to the grid through the fixed condenser. It will be noted that in this system there will be practically no current flowing in the crystal output

circuit. The grid condenser will need to be very well insulated, and for this the type of condenser may be used which is commonly employed in resistance capacity intervalve coupling.

A.C. Interference.

Much is said of the trouble experienced from alternating current power lines, but, so far as my experience goes, this trouble

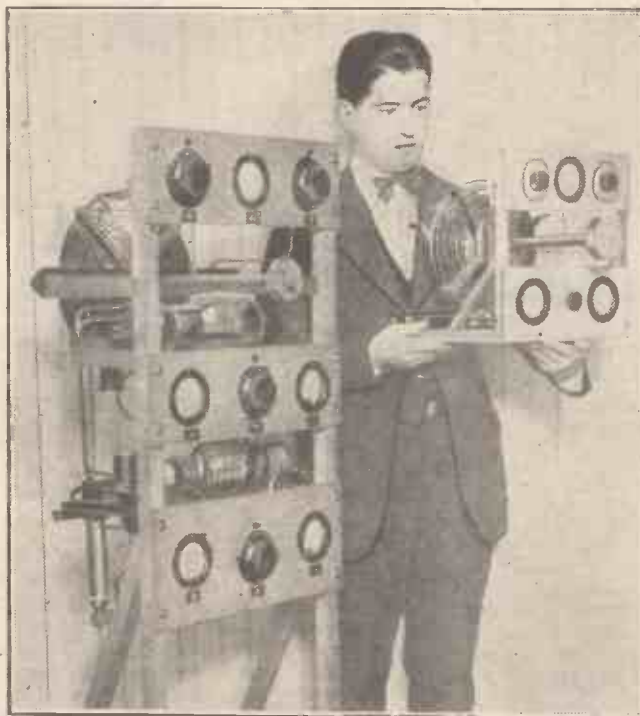

A successful American transmitting station which utilises wood instead of ebonite for all H.F. insulation.

is not so common as one might be led to think. However, there are cases in which it occurs very definitely, and the simplest way to avoid it is to arrange the aerial as nearly as possible at right angles to the offending power line. An aerial which has an unduly long lead-in wire running parallel to the lighting circuit of the house is liable to cause trouble.

When the set is located close to a powerful broadcasting station a wave-trap is often very useful in order to cut out signals of the local station and enable a distant station to be received. A simple wave-trap may be constructed by winding, say, 75 turns of

No. 22 double cotton covered wire on a $3\frac{1}{2}$ in. cardboard tube former. Directly over and in the centre of this coil should be wound five turns of the same type of wire. The five-turn coil may be used as the primary and connected in series between the aerial and the aerial terminal. The 75-turn coil should be shunted by a small variable condenser, say, 00025.

The Tuner.

With regard to the tuner, it is impossible to state exactly how many turns should be used, as this depends upon the wave-length to be received. The number of turns should be such that the entire range of the tuning condenser is used in getting stations from the lowest to the highest wave-lengths. If all the desired stations can be received whilst using only a portion of the range of the condenser it shows that there are too many turns on the secondary winding, assuming the circuit is of the loose-coupled variety.

The G.B. Battery.

I think I have already mentioned previously in these Notes the importance of using the grid bias battery. This not only improves the quality of reproduction, but its influence is noticed in a much more marked degree in the cutting down of the anode current drawn from the H.T. battery. Every user of a valve set knows only too well the comparatively short life of an H.T. battery, and therefore anything which has the effect of lengthening the life is a valuable asset.

L.F. Connections.

The grid return wire from the L.F. transformer should be connected to the negative terminal of the L.T. battery. It is, of course, permissible, and may be desirable, as mentioned above, to insert a grid bias battery in the grid return. If the connection be made the wrong way round, the amplification obtained will probably be seriously interfered with. Therefore, if the L.F. amplifier does not appear to be functioning properly, it is

a good plan to ascertain that the grid return connection is correctly made.

Finally, a large capacity fixed condenser say of $\frac{1}{2}$ microfarad or more, may be shunted across the H.T. battery or, in the case of tapplings being taken for different valves from the H.T. battery, separate condensers may be used connected from the negative end of the battery, one to each of the positive tapplings.

The question has been raised whether the convenience of using a fixed resistor with several valves or a single rheostat for all the valves is worth the loss of

(Continued on page 832.)

HOME MADE VALVES

THERE are quite a number of radio experimenters who sometimes wish to attempt their own valve repairs, but are unable to do so owing to the difficulty of securing the necessary high degree of vacuum within the bulb of the valve after the repair has been made. Serious amateurs, also,

frequently desire to attempt the entire construction of an experimental type of valve, but here again, to most of these individuals, the same difficulty invariably crops up. Given a simple means of exhausting glass bulbs and other vessels, a far greater number of enthusiastic amateurs would undertake experiments dealing with valve construction than is at present the case.

By the use of the pump described in these columns, quite a reasonably high vacuum may readily be produced. The pump itself is really a simplified type of the well-known Sprengel mercury vacuum pump, and, when properly constructed and used, it is quite capable of producing a degree of vacuum in a glass container or bulb sufficient to permit of the reasonably efficient functioning of an experimentally constructed valve, Geissler tube, or similar evacuated electrical device.

Simple Apparatus.

The apparatus has the great advantage of not being very costly to construct, and, apart from the mercury itself, the pump can be made by an outlay of two or three shillings. The mercury itself, however, is the one expensive item, this metal costing about five shillings a pound, and about three or four pounds of the material being necessary for the adequate working of the pump.

The illustration depicts the general principle and construction of the pump. Essentially, it consists of a mercury container, D, which is secured to the end of a short length of tubing, C. Attached to the end of this latter tubing is a glass T-piece, one limb of which should be provided with a glass tap opening into a tube, the internal diameter of which is not more than $\frac{1}{8}$ ths of an inch.

At the lower limb of the T-piece is fixed a long glass tube, whose internal diameter must be only a third of that of the arm of the T-piece to which it is attached. That is to say, this latter tube should consist of a length of glass "capillary tubing." It should be about three feet long (not less), and the lower end of it must dip into a trough containing mercury in order to act as an air seal.

The whole apparatus should be attached to a suitable wooden stand by means of metal bands, as indicated in the illustration, and, after a few adjustments have been made, it will be ready for use.

It is of the very greatest importance that



completely ruin its capabilities. For this reason it is by far the best plan to fuse the various glass tubes together. This can easily be done, after a little practice, by the use of a blow-pipe. If this device is not handy, there can usually be found in most towns some individual or firm of laboratory outfitters who will

undertake the work for a moderate sum. The joints between the tubes may, of course, be effected by means of stout "pressure tubing," which must be very firmly wired on to the tubes and afterwards thickly covered with some adhesive substance such as Chatterton's compound.

Action of the Pump.

The action of the pump is simple to understand. A small amount of mercury above the tap, X, is maintained at a constant level by manipulating the tap of the main mercury container, D. The tap, X, is then adjusted to such a degree that a slow but steady stream of mercury descends into the long tube until it eventually reaches the trough at the bottom.

Before the stream of mercury is turned on, the apparatus, valve bulb, or other vessel, which it is desired to exhaust is attached to the arm of the T-piece, B, and the tap, Y, is fully opened. It is, of course, almost unnecessary to state that the joint by which the apparatus to be exhausted of air is attached to the arm of the T-piece must be very efficiently made by means of a short length of rubber "pressure tubing" so that the joint is perfectly air-tight.

As has been stated, the action of the pump is simple. When each globule of mercury passes the junction of the T-piece, and falls into the constricted bore of the long tube, A, it breaks up into a number of smaller globules, each of which, in descending the tube, acts like a miniature piston, and drives the air in front of it out of the tube. More air, of course, from the vessel which is being exhausted immediately replaces that which has been driven out by the descending mercury, and this is in its turn expelled from the tube.

Estimating Degree of Vacuum.

After a little time, the pressure in the vessel which is being exhausted becomes very low, and, as the degree of vacuum increases, the mercury rises in the tube, A, under the influence of the external atmospheric pressure. After some experience with the pump, the operator will be able to estimate the degree of vacuum which has been attained in the exhausted vessel by noting the height of the mercury in the tube.

It may also be pointed out that, as the vacuum in the apparatus increases, the

(Continued on next page.)

Most amateurs jib at making or repairing their own valves, but Mr. Corrigan shows in this article that, given certain apparatus, the amateur can do the job.
By J. F. CORRIGAN, M.Sc., A.I.C.
(Staff Consultant.)

all the joints in the apparatus should be perfectly air-tight, for the degree of vacuum eventually obtained after the pump has been working for some time is high, and the slightest air leak in the instrument will

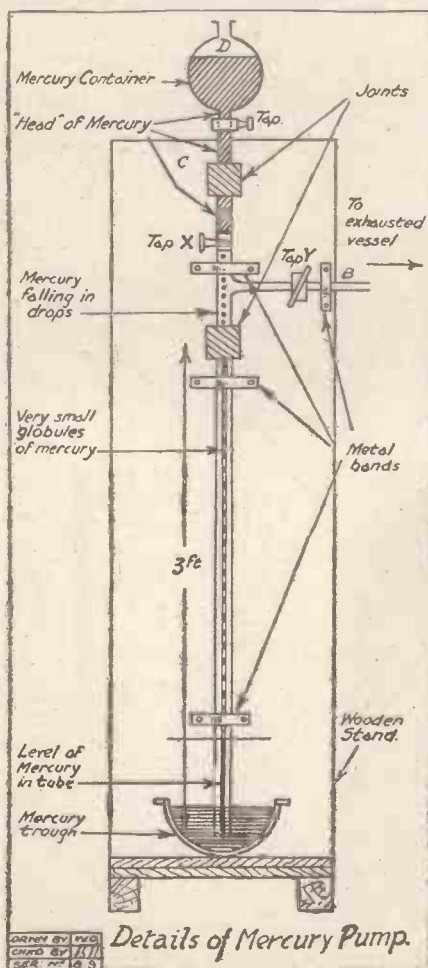

Details of Mercury Pump.

HOME-MADE VALVES.

(Continued from previous page.)

descent of the particles of mercury in the long tube is accompanied by a peculiar thudding noise, very different from the sound which the falling metal makes at a low degree of vacuum.

The mercury should be allowed to continue falling for two or three hours, the exact time, of course, depending upon the size of the vessel which is being exhausted, and the degree of vacuum which it is desired to attain in it.

The one vital precaution to observe when working the pump is to see that the supply of mercury in the top container does not completely run out, otherwise air would be immediately admitted into the apparatus, and thus the whole pumping procedure would have to be recommenced. Thus, the top mercury container will have to be continually replenished with the metal from the lower trough, and in doing this, care must be taken not to let air enter into the lower tube at the point where it dips below the level of the mercury in the trough.

If, for any reason, the experimenter wishes to discontinue the working of the pump before the necessary degree of vacuum has been attained in the exhausted vessel, all that it is necessary to do is to turn off all the taps, thus preventing the admittance of air to the tubes. The taps should be lubricated by smearing their inner surfaces with just a trace of the purest vaseline.

Clean Mercury Essential.

Finally, it is necessary to add that the mercury should be quite clean and free from dirt or greasy substances. In order to ensure this condition, all the mercury passed through the apparatus should previously have been cleaned by forcing it through a piece of chamois leather in which has been pierced one or two pin holes.

Carefully made, and carefully used, this pump will give a really good degree of vacuum, much higher than that attainable by a water pump. Its one defect is, of course, that it is not automatic in action, and that the top mercury container has constantly to be replenished with the metal. The mercury, however, is not used up or wasted in any way by the pump, and thus after an initial three or four pounds of it have been obtained, it can be used repeatedly for an infinite time. For the serious valve experimenter, therefore, this simple pump will prove a most useful adjunct to the experimental equipment of the laboratory or workroom.

PHOTOGRAPHS.

Readers are invited to submit photographs of wireless interest for publication in "Popular Wireless." Every photograph published will be paid for at the rate of 10¢ per insertion.

A SIMPLE DEVICE FOR "REMOTE CONTROL."

FROM A CORRESPONDENT.

It is often convenient to keep the wireless set in an attic, and to run twin flex or bell wire to the rooms where the loud speaker or 'phones are required. In such cases it is necessary to visit the set for the purpose of switching it on and off. By the

ordinary way when required. A good quality "tumbler" switch is suitable for use downstairs. The diagram gives the connections of the writer's installation. When the S.P.D.T. switch is to the right the extension is in use, and the downstairs

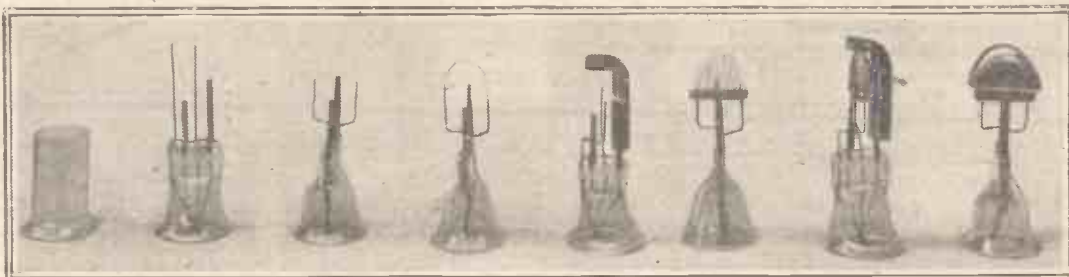

The growth of a well-known type of valve showing how the various elements are constructed and sealed into position.

following simple arrangement this becomes unnecessary, and the set kept in the upper room and tuned to a certain station may be switched on and off at will like the electric light. The wireless set itself and its batteries are also out of sight and out of harm's way. The writer has used the device himself with success for a year or more.

The method depends upon the fact that, if the L.T. current is switched off, the valve filaments become cold, the valves themselves become non conductors, and so switch off the H.T. current. The L.T. switch may be placed downstairs in a convenient place, and its battery can be switched off from there, thereby turning off the whole set.

A single-pole-double-throw up-stairs will enable the set to be worked there

switch controls the set. When the S.P.D.T. switch is to the left the downstairs extension is out of action, and the set is on.

Certain precautions are desirable. It is best to make sure that the H.T. battery is giving no current when joined up to the set with the L.T. switched off. This can be tested by putting a milliammeter in the H.T. lead, as shown.

There should be no reading until the L.T. is switched on. If there is a reading it indicates faulty insulation in the set, which should in any case be eliminated.

With bright valves and a 6-volt accumulator, or with 3 volt .06 amp. type valves and a 4-volt accumulator, a slight voltage drop in the extension leads does not matter, as the filament temperatures can be adjusted by the rheostats.

The Voltage Drop.

With bright valves and a 4-volt accumulator, or with 2-volt valves of the .3 amp type and a 2-volt accumulator; it is important that the extension leads should be low resistance wire, as there is little voltage to spare. In these cases good quality electric lighting flex should be used, and the leads should be as short as possible.

On the other hand, any kind of flex or twin bell wire will do for the loud-speaker extension. The wire may be run where it will be out of sight. It can be conveniently terminated in each room by a wall plug simply made out of a small strip of ebonite with a couple of valve sockets. The loud speaker can be connected to this by a length of flex, to one end of which is attached another strip of ebonite and two valve legs, spaced to fit into the sockets on the wall plug.

As there is a long length of wire attached to the negative L.T. terminal of the set, it will be found that the set can be operated without an earth connection, the extension lead acting as a counterpoise of a sort. In fact, it is possible to lengthen the wire, which goes direct to the set, to make the earth lead to the water-pipe in the cellar. The writer has worked his set this way, using an indoor aerial in the attic and a counterpoise in the cellar.

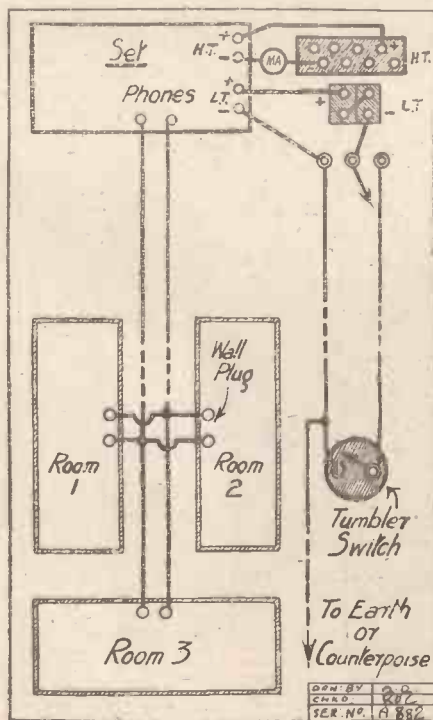

OWN BY
CHAS
SER. No. 1882

The "P.W." "OLD WORLD" TWO

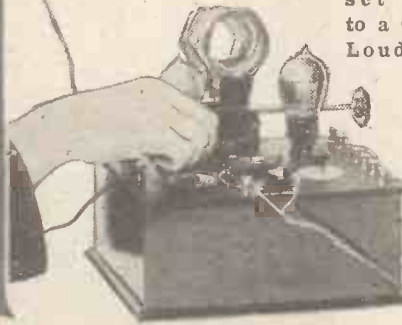

The completed set wired to a Celestion Loudspeaker.



THE absolute perfection of reproduction obtainable with a crystal detector has lately led to the inclusion of this component into many one- and two-valve circuits. One of the most interesting lines of experiment in this direction has been that known as the Sharman circuit, in which a crystal detector is connected to the grid of a valve, and is used in conjunction with a fixed condenser, to give a "floating grid" arrangement.

With such a receiver the quality of tone and reproduction is generally far in excess of that obtainable by the home constructor, unless he is using specially-chosen components, valves, etc. The insertion of the crystal under such conditions does not in any way impair the volume obtainable from the valve or valves in the floating grid circuit, and the arrangement possesses the advantage of great simplicity. The only extra component as compared with the valve circuit is the crystal detector, and this is offset by the fact that no grid leak is required with the Sharman arrangement.

One or Two Valves Possible.

The photograph that is given on this page shows the receiver constructed on these lines. Because of the increased simplicity and cheapness of a flat panel, this form of design is used, in conjunction with a shallow wooden case, which can easily be made at home, if desired.

To the left of the instrument are the

The Set Designed and Described by
P. R. BIRD.
(Assistant Technical Editor.)
Constructional Work by
G. V. COLLE.
(Technical Staff.)

LIST OF COMPONENTS.

	s.	d.
1 Panel 10 in. by 8 in. and cabinet to fit (Peto Scott)	11	0
1 Two-way coil holder (Penton) . .	6	0
1 .0005 variable condenser (Peto Scott)	10	6
2 Rheostats (Precision)	6	0
2 Valve sockets (Security)	2	0
1 Crystal detector (Gripco)	3	6
1 S.P.D.T. switch (Nesthill)	1	6
1 .0003 fixed condenser (Lissen) . .	2	0
2 .002 fixed condensers (Lissen) . .	5	0
1 L.F. transformer (Eureka Baby Grand)	15	0
12 terminals	1	6
Wire, screws, transfers, etc.	2	0

aerial and earth terminals. The well-known system of two-aerial-terminal tuning is employed, by which the aerial tuning condenser is placed either in series or in parallel with the aerial coil. This is an efficient and economical method, better than the usual switch, and details of how

frequency amplifier. Reaction from the plate circuit of the first valve to the aerial coil is obtained by coupling the two coils in a two-way coil holder.

By means of a single-pole double-throw switch the receiver can be used as a one- or two-valver. In the one-valve position the reaction coil is connected through the telephones to H.T. plus. When the switch is in the opposite position, the H.T. supply to the first valve is via the primary of a low-frequency transformer.

The Panel Lay-out.

The secondary of this component is led to the grid and filament circuit of the second valve, this valve functioning in the usual way as a low-frequency amplifier, with the telephones connected in its plate circuit.

Referring now to the actual receiver illustrated on this page, it will be seen that the coil holder is arranged centrally to the rear of the panel, with the valves symmetrically disposed on either side. In front of each valve is the rheostat controlling it.

The loud-speaker leads are taken from a pair of terminals in the front of the panel, and immediately behind these is the variable condenser which controls the tuning.

Between the variable condenser and the coil holder is the single-pole double-throw switch, for one or two valves.

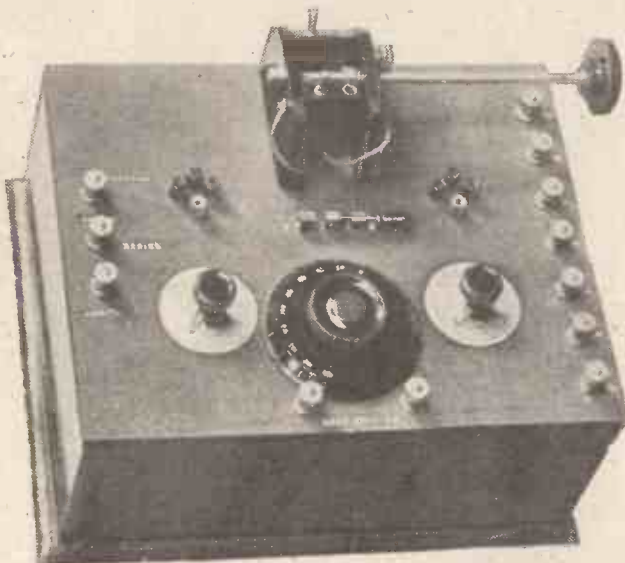

The simplicity of control is well illustrated by this photograph of the set.

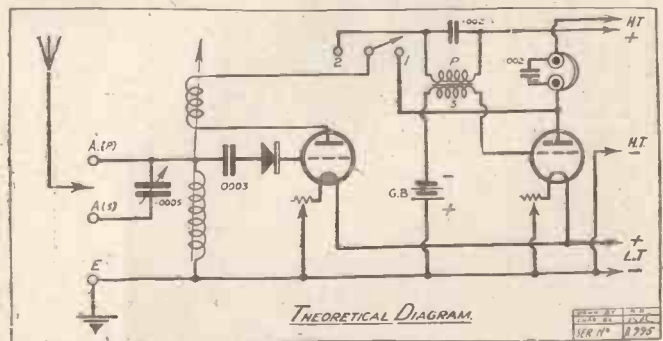

to change from series to parallel tuning are given at the end of this article.

The theoretical diagram, which is reproduced above, shows that the circuit is very similar to the straightforward detector and low-fre-

All the battery terminals are on the right, and their order from front to back of receiver is as follows:

H.T. + 2, H.T. + 1, H.T. -, L.T. +, grid bias +, grid bias -.

A point that will occur to many prospective constructors is the fact that although a crystal detector is used, no provision is

(Continued on next page.)

THE "P.W."
"OLD WORLD" TWO.
(Continued from previous page.)

made for this upon the panel. The reason for this is that one of the permanent detectors was used, and as this requires no readjustment it is quite satisfactory if this component is enclosed in the case.

Any of the well-known fixed crystal detectors can be used with success, the particular ones shown in the photographs being the Gripico.

Construction is commenced by the preparation of the panel, which is drilled as shown by the panel drilling diagram, and there is plenty of room for components, so that no trouble should be experienced in the mounting, even if rather larger parts are employed.

Self-Supporting Wiring.

It is a good plan when the terminals have been mounted, to prepare these for soldering by filing the ends before the rest of the components are mounted. This obviates the risk of specks of brass dust adhering to the vanes of the condenser, valve sockets, or other places where they would cause noisy reception.

The valve sockets employed were of the countersunk type, let into holes in the panel. The crystal detector is mounted, at one end, direct on to the grid socket of the first valve holder, its other end being connected to and supporting the small grid condenser.

This small fixed condenser is attached to the near aerial terminal by its other connection, and thus neither the crystal detector nor the fixed condenser need to be mounted direct upon the panel, as they

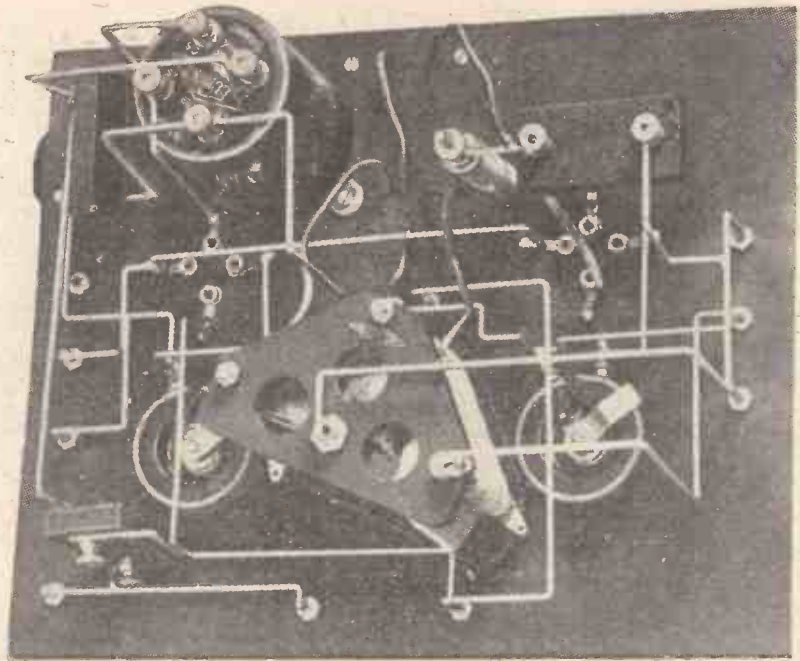

When connecting up the components this illustration should be used in conjunction with the wiring diagram.

are sufficiently supported by their own wiring.

The full system of connections is shown by the wiring diagram that is given upon the next page. Incidentally, it may be mentioned at this point that neither of the .002 fixed condensers need be mounted direct upon the panel.

When the wiring of the L.F. transformer primary and of the telephones has been completed, their respective condensers may easily be attached across these two points. The leads to the reaction (moving) must, of course, be flexible connections, and as a matter of fact all four coil leads

were connected by this means on the set shown.

The whole of the wiring is very straightforward and simple, so that if the wiring diagram is followed carefully this part of the construction will present no difficulties. When completed the wiring should be checked with the list of point-to-point connections given on the next page.

It has been stated that the receiver is capable of either series or parallel tuning. As is well known, the former is used chiefly for short wave-lengths round about 300 metres, whilst the parallel arrangement is generally better for 400 metres or more, and for Daventry. For "Series" tuning connect aerial lead to "Series" terminal, leading "Parallel" terminal without external connection. For "Parallel" tuning connect aerial lead to "Parallel" terminal and join "Series" terminal to the "Earth" terminal externally.

Reaction Connections.

Most constructors are familiar with the fact that in order to strengthen signals the connections of the aerial and reaction coils must be placed in the correct relative positions. If, therefore, the effect of reaction appears to weaken signals instead of causing the set to oscillate, the flexible connections to the reaction coil should be reversed.

Readers who are interested in the remarks on coupling crystal detectors to valves which appeared in "P. W." No. 211, will remember that Lieut.-Commander H. W. Shove, D.S.O., R.N., refers to the fact that when the crystal acts as a one-way conductor for voltages—as distinct from currents—the circuit is more selective than usual. Experience with this receiver proves the truth of this contention, and unusually good selectivity for single circuit-tuning was found to be obtainable.

This advantage of increased selectivity enables the set to be used for long-distance reception upon telephones with one valve switched out. For ordinary local loud-speaker work the usual two-valve results

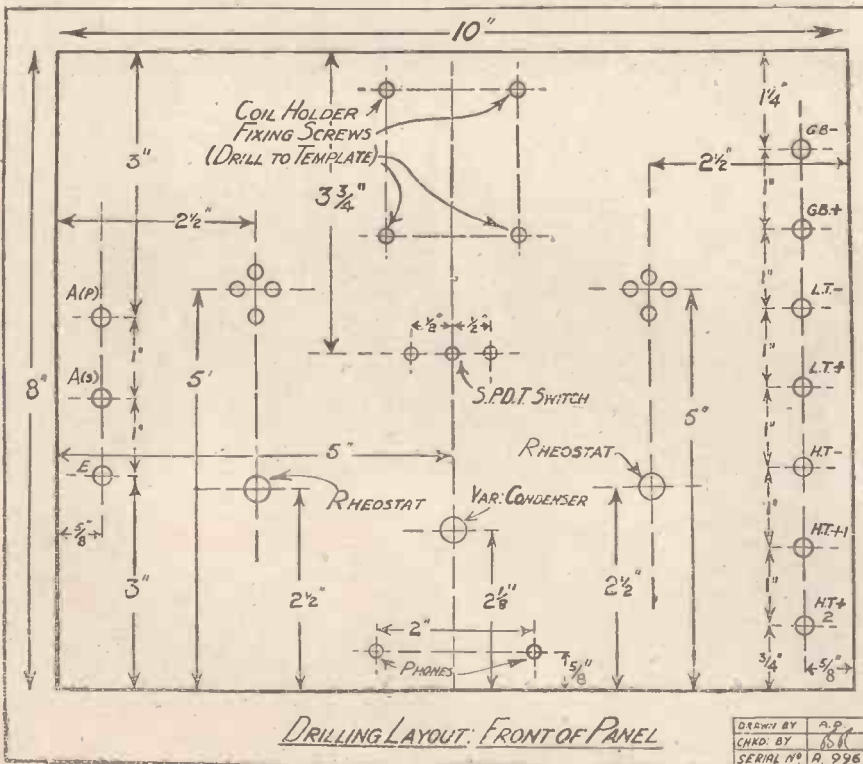

(Continued on next page.)

THE
"P.W." "OLD WORLD" TWO.

(Continued from previous page.)

are obtainable, working a loud speaker up to ten or twelve miles, at a volume depending upon local conditions, the efficiency of the aerial, and the valves employed.

Particularly good results are obtainable with the B.T.H. B.4 valves, but almost any valve suitable for general purpose and low-frequency amplification will be found satisfactory. Needless to say, the H.T., L.T. and grid-bias batteries should be chosen in accordance with the valve makers' specifications.

It has already been stated that no grid leak need be employed in this receiver. Nevertheless, constructors who have a grid leak on hand which is

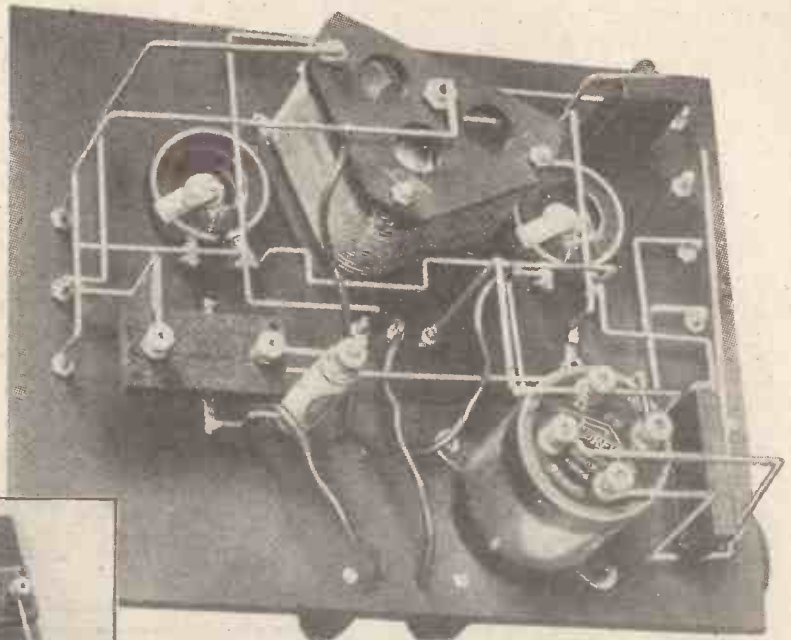

This illustration should be used in conjunction with the wiring diagram when connecting up the components.

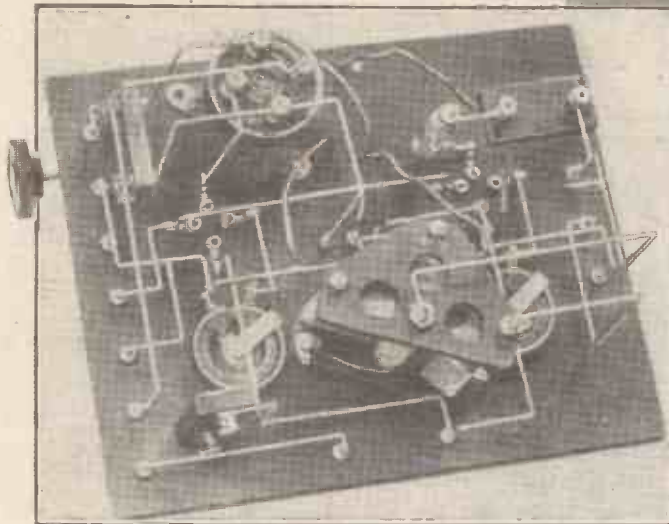

The layout of the components is clearly seen in this under-panel photograph.

not in use can try the effect of connecting this in circuit. Either a fixed leak of 2 megohms or so, or one of the variable type, can be used. And it can be connected in either of the usual positions, i.e. across the grid condenser, or between grid and one of the L.T. or filament leads.

Occasionally it will be found that a slight improvement results, but generally the leak is quite unnecessary, and therefore constructors who have no leak on hand are not recommended to purchase one specially for the set.

The plug-in coils required are the usual broadcasting sizes. For short waves a

POINT-TO-POINT CONNECTIONS.

Aerial parallel terminal to one side of A.T.I., .0003 fixed condenser, and .0005 variable condenser. Aerial series terminal to remaining side of .0005 variable condenser. Remaining side of .0003 to one side of crystal detector.

Other side of crystal detector to grid of first valve.

Other side of A.T.I. to earth, to one side of each rheostat, L.T. negative, G.B. +, and H.T. -.

Remaining sides of rheostats to their respective filament sockets. Other filament sockets to L.T. +.

Plate of first valve to one side of reaction. Other side of reaction to centre contact of S.P.D.T. switch.

Left-hand contact of this switch to I.P. of L.F. transformer.

Right-hand contact of switch to plate of last valve and one side of 'phones.

Remaining side of 'phones to H.T. +2. Across the 'phones is connected a .002 fixed condenser.

O.P. of L.F. transformer to H.T. +1.

Across O.P. and I.P. is connected a .002 fixed condenser.

O.S. of L.F. transformer to G.B. -.

I.S. of L.F. transformer to grid of second valve.

75 and a 50 will be O.K., though if parallel tuning is used the aerial coil may be as small as 35 turns.

For 5 X X and parallel tuning, a 150 reaction and a 200 or 250 aerial coil are required. The set is quite a good one for use on small aerials; but, of course, the full results can only be obtained when a good outdoor aerial is employed.

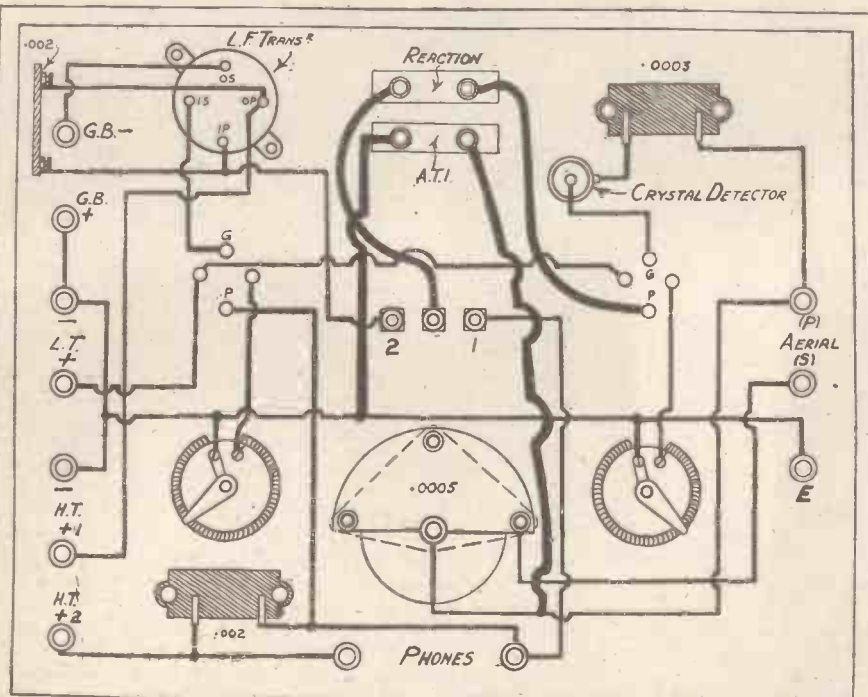

WIRING DIAGRAM.

DRAWN BY	A. D.
CHECKED BY	J. H.
SER. NO.	997

CONTACT.

ITS IMPORTANCE IN WIRELESS.

By J. ENGLISH.

AN often discussed point in the construction of radio receivers is whether connections should or not be soldered. At one time the ardent experimenter would have regarded with horror any set wherein all the connections were not neatly soldered, but of late there have been attempts to discontinue the use of soldered joints.

For the purpose of avoiding what is, after all, rather a tedious operation, there have been placed on the market many "gadgets," most of which consist of some means of bringing connections into close and forcible contact. The makers claim all the advantages of soldering without any of its disadvantages.

It may be easier to wire up a receiver when connections have not to be soldered, but what counts more than any saving of time and labour is whether such a set would be more efficient if these connections were soldered. This brings us to the consideration of metallic contact, an interesting subject from the wireless point of view, as the nature of the contact between any two metallic conductors has an influence upon the operation of the circuit of which they form part.

Insulating Film.

If the ends of two pieces of wire are cleaned and polished until the metal gleams brilliantly and then twisted tightly together the contact between the two wires will not be perfect. That is because however much the wire may be scraped and polished an infinitely thin layer of oxide will form immediately upon the surface. This layer will increase in thickness with the passage of time, due to further formation of oxide and possibly sulphide of the metal. This layer prevents the molecules of metal from coming into as close a contact as they are in the metal itself, so that clean pieces of metal, however tightly pressed together, will never make a perfectly homogeneous joint.

Some metals oxidise more quickly than others, the precious metals, platinum, gold and silver, very slowly, while metals such as lead and aluminium oxidise rapidly, a freshly cut surface becoming covered with a relatively appreciable film of oxide in a few minutes.

Action of Flux.

When a joint is soldered by applying flux and melted solder, the heat causes the flux to dissolve the film of oxide and the solder "takes" to the wires, which are then joined metallically by a film of solder. In a well-soldered connection there is perfect metallic continuity through the whole of the joint, for the molecules of both metals are in the closest contact. If the flux does not dissolve the film of oxide, the solder will not unite with the metal and this is known as a "dry" joint, which is useless for our purpose. Such a joint is no better, and often worse than mere mechanical contact.

Now in a twisted connection such as described above, the film of oxide, however thin, offers a resistance to any current flowing across the contact, the resistance being greater as the area of contact is reduced. In filament circuits this resistance is of little importance. A pressure of a volt or two will break down the resistance of this film so that it does not matter where there is plenty of power. But if weak radio-frequency currents are flowing across the contact, the situation is quite different.

Soldered Joints Preferable.

Suppose, for example, that we cut the aerial lead-in wire, and after cleaning, twist both ends tightly together to join up the break in the wire. The voltages induced in the aerial by some distant transmission are so minute, perhaps a few micro volts, that the oxide film now presents quite an appreciable resistance to the formation of radio-frequency currents. Were this twisted contact left for any length of time it is possible that the increasing thickness of



A recent photo of Dr. J. Rogers with some of his latest apparatus for underground radio signalling.

the film would introduce so much resistance that distant transmissions could no longer be received. The obvious cure is to solder up the joint, thus re-establishing a continuous metallic path in the aerial circuit.

It will now be evident that well-soldered connections are almost imperative where weak H.F. currents are expected to flow, and this covers the whole of the aerial-earth system and the tuning circuits. After the first valve there is usually sufficient power to overcome the resistance of any thin film of oxide, but as this film tends to increase in thickness, it is important, except in the case of temporary receivers, to solder all connections in circuits carrying H.F. currents. Other connections such as those in filament and audio-frequency circuits do not of necessity require to be soldered. It may be argued that reaction effects could be used to counteract the resistance introduced into a circuit by contact films. But where the initial signal impulses are extremely weak they will have no chance to build up owing to this contact resistance,

and the latter may be so appreciable that the valve will not regenerate at all. It is a fact that a receiver with connections soldered generally works better for D X than a similar set unsoldered, reaction being used in each case.

Variable Condenser Faults.

Of course, it is debatable whether a receiver with all its connections soldered is more pleasing to the eye. Personally, I prefer to solder as many contacts as possible, but it matters little as regards efficiency, provided the exceptions noted above are observed. If a joint is not soldered due care must be taken that the contact is so tight that it will not work loose when subjected to vibration. In a poorly made unsoldered joint the area of contact may be so small that the resistance effect of the contact film is considerably increased, but soldering ensures a larger area of contact and is preferable for this reason.

There are some connections that cannot be soldered, such as the contact between aerial and earth wires and their respective terminals on the set, so that these should always be kept bright and clean.

Variable condensers often make use of a rubbing contact for connection to the moving vanes. Although such a contact does tend to clean off the oxide film, it is not above suspicion, and condensers with "pigtail" connections to the moving vanes are to be preferred. I have known a case where, after much use, a condenser of the rubbing contact type completely upset the proper functioning of a sensitive receiver.

Keep Valve Legs Clean.

This was found to be due to the high contact resistance produced at the junction of the spindle and its socket by minute particles of oxide and sulphide rubbed off by the continual rotation of the condenser. When this dust was removed the receiver worked as well as formerly. Recent improvements in the mechanical design of this type of condenser would probably prevent a failure of this nature.

Valves should not be left long in their holders as the prongs tend to oxidise and they should be removed periodically and the prongs brightened with emery paper. Similar remarks apply to plug-in coils and their holders. In fact, as we have seen above, any unsoldered contact in an H.F. circuit is not above suspicion. Instances have frequently occurred where, for some reason or other, the grid pins of a detector reacting valve have become tarnished with oxide and sulphide formation. This film has been sufficient to prevent the set working at all.



Likely Switch Troubles.

Another instance of the necessity of reducing contact resistance is the use of switches in H.F. circuits. However well such switches may be designed there is always the danger of unwanted resistance being added to the circuit. Apart from troubles of self-capacity for which they can be responsible, switches are best left out of H.F. circuits altogether.

Before commencing the construction of his next receiver, the experimenter may save himself much future trouble by due consideration to the points briefly outlined above, and by ensuring perfect contact wherever possible his receiver will certainly function with a greater degree of efficiency.



IMPROVED AERIAL TUNING

 A description
 of a new
 method of
 aerial tuning.
 By
H. H. WARWICK

THERE is an old saying to the effect that the obvious is always missed.

In general, to what extent this is true it is difficult to estimate, but in radio one need not look far before being convinced that there is foundation for such a statement.

Take, as an instance, the variable condenser. It can be readily understood that in the first place an instrument was produced to give a varying capacity and having a certain electrical efficiency, but without any attempt to make its effect uniform for any given movement of the vanes. Then the straight-line wave-length or square-law condenser was evolved to incorporate the latter, and this is a definite improvement.

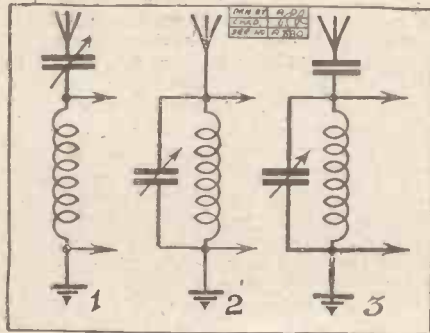

But why has such a condenser arrived in such quantities when it is obvious that in the vast majority of cases it is the straight-line frequency condenser that is best?

In this article it is desired to point out a further and similar idiosyncrasy in connection with that same instrument—the variable condenser.

Two Valuable Advantages.

With the growing tendency towards the simplification of receivers has come the reduction in the number of controls, and in the number of alterations necessary for the covering of a given frequency range. If the lower belt be considered it will be found that stations are in operation within the limits of 200 and 550 metres, and to cover this range with the movement of one control has provided some difficulty, as the two arrangements in general use are either a coil tuned by a condenser or a variometer. Of these, only the second has been used to cover so large a range, but the efficiency

of a variometer is not high and tuning is flat; also it is difficult to apply reaction or insert a secondary circuit.

The alternative has so far been to use a tapped coil or a number of coils tuned by a condenser; a number of coils since an excessively large condenser is necessary if only one coil be used. This is based on the assumption that the maximum allowable capacity for the shorter wave-lengths of the aerial tuning condenser, in accordance with the dictate of modern practice, is .0005 mfd.

Now, there are three well-known arrangements of the aerial tuning circuit, series tuning, parallel tuning, and constant aerial tuning (Figs. 1, 2, and 3), all of which are in general use, although constant aerial tuning has substantial advantages over the other two. A fourth arrangement (Fig. 4) that has a lesser degree of popularity is a combination of the first two circuits, and this has much to be said for it; it has, however, the disadvantage of an additional control.

The really astonishing point about the whole thing is that no one appears to have observed the advantages accruing from an arrangement in which two condensers are coupled together (Fig. 5), after the manner of the now quite common twin condenser.

There are two advantages of considerable value, and the first is that the ranges covered by the systems of Figs. 1 and 2 are added together, thus giving without

difficulty a range in excess of 200-500 metres in conjunction with a suitable inductance, this being an advance on Fig. 4, inasmuch as one control performs both operations simultaneously, and is an advance on a series-parallel arrangement incorporating 1 and 2, since there is no gap in the range due to minimum and maximum capacities of the condenser.

The second advantage is not quite so obvious, and it affects general stability of operation and reaction control.

A reaction coil in the course of its operation has to overcome damping, and if it is reacting on the aerial coil, as is most generally the case, it has to overcome the damping due to two distinct sources, that due to the aerial coil and that due to the aerial system external to the receiver, the extent to which each is operative depending very largely upon the position of the tuning condenser, and to a considerable extent on the respective designs of aerial system and inductance. Bearing in mind the easily proved fact that the reactances of coils and condensers oppose one another, again examine Fig. 5.

How It Affects Reaction.

As the capacity of the twin condenser is increased, the capacities of the two parts are increased, but one part is in series with the aerial system, so that damping from that source will be gradually increased, whilst the other part being in parallel with the aerial coil reactance, is decreased. Thus damping from the two sources tend to neutralise one another, and consequently the damping factor varies between considerably narrower limits, so that the reaction coil is not called upon to overcome such extremes of damping, thereby ensuring that, although a larger range is covered, no change in reaction coil need be made. Several points worthy of mention arise from this system of tuning.

(Continued on next page.)

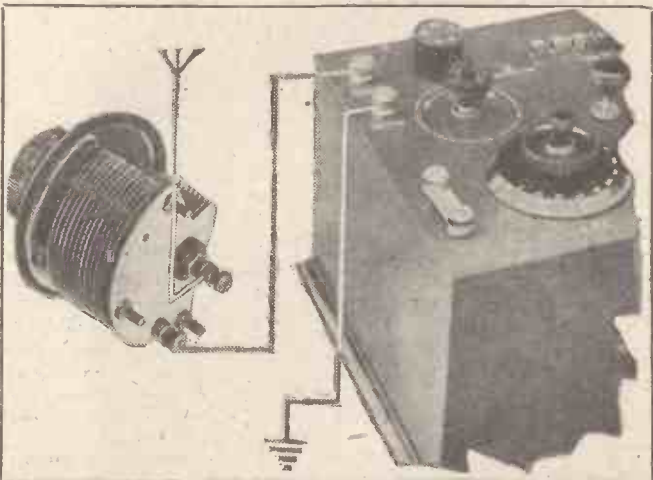

The effect of the system is to place another variable condenser in series with the aerial as shown in the above photo.

CORRESPONDENCE.

Letters from readers discussing interesting and topical wireless events or recording unusual experiences are always welcomed, but it must be clearly understood that the publication of such does in no way indicate that we associate ourselves with the views expressed by our correspondents, and we cannot accept any responsibility for information given.—Editor.

REMOTE CONTROL.

The Editor, POPULAR WIRELESS.

Dear Sir,—I was looking through the back numbers of papers, and in my "P.W.'s," in No. 125, I found an article on remote filament control by Sexton O'Connor, which seemed to be rather elaborate, and fairly difficult to construct.

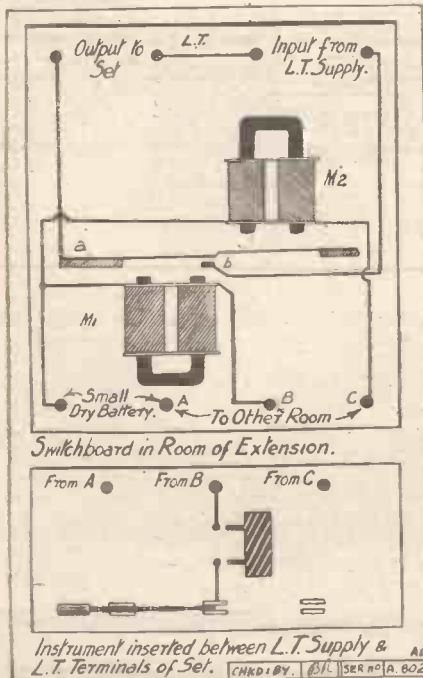

As I am in need of an arrangement for remote control, I thought a little on the matter, and enclose the results. The diagram is, I think, fairly self-explanatory; by means of the switch either of the magnets "M1," "M2" can be operated, thus making or breaking contact between "a" and "b," and the small dry battery used for operating the magnets can immediately be cut out of circuit, so that it lasts a long time. The ratchet "c" serves to keep the contact between "a" and "b," but may be rather tricky to adjust.

Trusting this arrangement may be easier to construct and much cheaper than the other one, I am, yours faithfully,

J. R. STAFFORD-WATERS.

35, Upper Park Fields,
Putney, S.W.15.

BLIND SPOTS.

The Editor, POPULAR WIRELESS.

Dear Sir,—With reference to London blind spots, one of the worst of such spots in London is the immediate vicinity of the Central Hall, Westminster.

A friend of mine lives in the shadow of this, with the building between him and 2 L.O. A five-valve set is required to receive 2 L.O. at poor L.S. strength, although only a mile away. In fact, an eight-valve super-heterodyne receiver is rendered practically useless by the great copper dome of that building.

Yours faithfully,

W. W. WOODMAN.

61, Hanover Road,
Willesden, N.W.10.

TELEPHONY FROM RUGBY.

The Editor, POPULAR WIRELESS.

Dear Sir,—Having noticed in your Correspondence columns readers' reception of Rugby, I thought it might be of some interest to you to know of my experience in crystal reception of this station.

A few weeks before the coal stoppage I happened one Sunday morning to connect up three cylindrical coils in series, and shunted them by a variable condenser, judging the wave-length range to be about 4,000-6,000 metres. Immediately I heard a very muffled voice saying: "Hallo, New York."

I was unable to understand anything but short answers, such as: "Was that all right?" which was usually said after several long Morse "dashes" of a faint humming noise (which I took to be a C.W. note), and sometimes a call sign G B (T?). I might also mention here that I have done some DX work during my three years' crystal experience, having only taken up valves lately.

The only reception I had on the short waves last winter was a spark time signal daily at 7.55 p.m., and similar to that radiated from P O Z (3,100 metres) at noon and midnight, but each group of letters separated by six-dot seconds instead of three dashes. At 8.0 p.m. the seconds were "tapped" out for five minutes. Owing to fading, I could only get parts of the message, but I think the call sign was D B I. I have searched the long waves at the same time to find out if this was a harmonic, but heard nothing. I can only give the wave-length as somewhere between 100 and 200 metres, possibly a little below 100 metres. Perhaps some of my fellow-readers would be able to solve this mystery for me.

Wishing your excellent paper every success,
I am, yours sincerely,

Huish,
Radstock,
Near Bath.

H. R. KENNE.

too easy. It is not made any more simple by the practice of the various valve concerns in publishing their valve curves without any kind of standard.

What I mean is this. The average listener can, with care, understand the meaning of a valve curve pretty well, but when he comes to compare the properties of various valves he is usually rather at a loss because he finds he must work out their characteristics from the tables before he can adequately compare the valves. He cannot see at a glance whether one valve has more amplification powers than another of similar type but different make. The steepness of valve curves as published is wholly misleading because this is only apparent—no standard is taken and the slope can be varied to suit the makers' purpose, size of page, etc., by the simple expedient of varying the scale of one or other of the components plotted. I contend that valve curves should be a graphical indication for comparison purposes, and not merely a convenient way of arranging a number of laboratory readings in picturesque form.

Cannot the makers do something regarding the standardisation of these curves so that we can see at a glance how the various valves stand?

Yours faithfully,

DUDDLEY KEITH.

Hfracombe,
N. Devon.

CONCERNING VALVE CURVES.

The Editor, POPULAR WIRELESS.

Dear Sir,—We are repeatedly told—in the various technical articles—to use valves "suitable for the tasks they have to perform," and with the large number of valves on the market this choice is not

If there is anything in this or any other issue of "Popular Wireless" that you DO NOT LIKE, please let us know what it is when you write.

IMPROVED AERIAL TUNING.

(Continued from previous page.)

When the condenser is placed at, and near to, minimum, reactance due to the series portion of the condenser is excessive, and

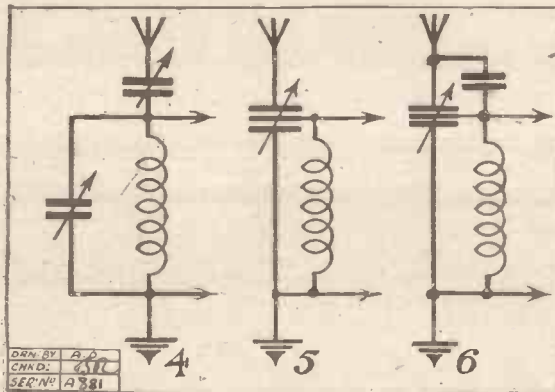

the only way to overcome this is to have a minimum capacity of some .0001 mfd., which can easily be arranged by connecting a fixed condenser in parallel with the series condenser permanently. (Fig. 6). A suitable value twin condenser to use is one in which each part has a capacity of .0005 mfd. It is necessary to point out that these values are not suitable for reception on wave-lengths outside the belt of about 150-900 metres, the arrangement to use below this being C. A. T. or series tuning, and that above, parallel tuning.

Fixed Reaction Possible.

An effect of this arrangement is that a straight-line wave-length or frequency condenser gives a result less like a straight line than it does in a closed circuit, but either of these types of condensers can be used with advantage, as the increase of wave-length or decrease of frequency for a given movement of the condenser near maximum capacity will not be vastly greater than

that near minimum capacity. Ease of tuning, therefore, will be as good as any of the other arrangements, since they are all affected by the aerial system in varying degrees.

A theoretical point to notice is that, if damping could be kept constant over the whole range by such means, a fixed reaction adjustment could be utilised with every satisfaction. This, at present, appears impossible, but it should be borne in mind that when the coil is small damping is less than that due to an aerial system of the usual type, so that it is here that damping should be reduced as far as possible.

In order to determine exactly what ranges could be covered with such a circuit, standard coils of well-known makes were taken and used with an aerial of slightly over average dimensions and slightly above the average natural wave-length. Nos. 25, 35, 50, 75 coils were of one make, and of somewhat low overall efficiency, while No. 40 was more efficient and of different make. The value of the fixed condenser was .0001 mfd.,

and the variable condenser .0005 each section.

No. of Coll.	In Metres.		
	Series-Parl. Arrangt.		Parl. Arrgt.
	Max. λ	Min. λ	Min. λ
25	360	132	243
35	511	185	301
50	735	278	386
75	1145	432	527
(40)	567	208	356

This table definitely shows that it is possible with one coil and one control to cover a wave-length band between 200-550 metres.

The simplicity of the arrangement is in itself commendable, but the fact that it is only necessary to replace the aerial tuning condenser, add a fixed condenser, and alter several wires, is more important, since no change in panel or apparatus layout is required.

Building up a Super-Het

I THINK one learns very much more about a receiver such as a super heterodyne if one builds it up bit by bit with more or less ordinary components, making up the parts which cannot be purchased.

I do not mean to decry those sets of components which are being sold complete, but with them it is not necessary to know the whys and wherefores of each section and operation, and in fact if the component set is a reliable one and the instructions given with it are good, you have really been given a finished set. You will, therefore, not learn very much and the real reason for any faults will not be so evident.

I propose in this series of articles to describe how I would put together a super-het, but I am going to leave a lot of the detail for you to do. Step by step I will give the reason for my choice of arrangement and you can alter it if you do not like it. You will probably have troubles, but



 The first of a special and exclusive
 series of articles for the amateur.
 By Captain H. J. ROUND, M.C.
 (Chief Research Engineer of the
 Marconi Co.)

of the wire will reduce the tuning range of the condenser.

I suggest you put about 10 turns of bell wire on the frame, but I will leave it to you to adjust these turns. About this number will tune up on the maximum of a .0005 mfd. condenser to 550 metres. An even number of turns is useful because I propose to earth the centre (see Fig. 1), and an even number brings the earth position to the same end of the frame as the two end positions. When cutting down or adding turns take or add one, or part of one, to each end so as to keep the earth centre symmetrical.

Fig. 1 shows a frame as I suggest it could be made, and the cost should be quite small. You will afterwards want another frame for Daventry, no doubt, and if you put up the number of turns in proportion to the wave-length you will not go far wrong; but make another frame and do not try to tap off one made for Daventry to get the

local station. The two ends of the frame winding and the centre can be brought to the three terminals or to three flex leads.

A plank of wood about 9 in. wide and 4 ft. long is an excellent base to work on. Two under battens at the ends keep any underneath wiring off the table, and it is preferable to cover the top of this plank from end to end with a sheet of thin copper—or zinc for cheapness—tacked well down. Zinc is a bit more troublesome to solder, so that the copper is preferable. The length seems rather great, but it is a distinct advantage to start with plenty of room; it is easy to cut down afterwards.

I propose to introduce one high-frequency stage into the super, as it has several advantages, one being that it relieves one of the necessity of forcing the magnification on the intermediate frequencies, and for another it removes a lot of jamming trouble. Fig. 2 shows the arrangements I suggest at the left-hand end of our plank of wood, and Fig. 3 is the theoretical diagram of the arrangement.

H.F. Valve Neutrodyne.

The crosses mark the positions where the connections are soldered on to the metal base; the terminal Z solidly connected to this base will do for your battery negatives. Care must be taken, of course, to insulate the different parts from the metal base; both sets of plates of all condensers will have to be free from earth.

The two tuning condensers can be .0005 mfd. The cheap non-square law type will do for the experiments, and if you like, afterwards, to replace these by straight-line frequency condensers, it will be an additional refinement.

If the coil is wound of 80 turns of No. 28 D.C.C. on a cardboard cylinder 1.8 inches in diameter, with a .0005 mfd. condenser, it will give a maximum wave of

(Continued on next page.)

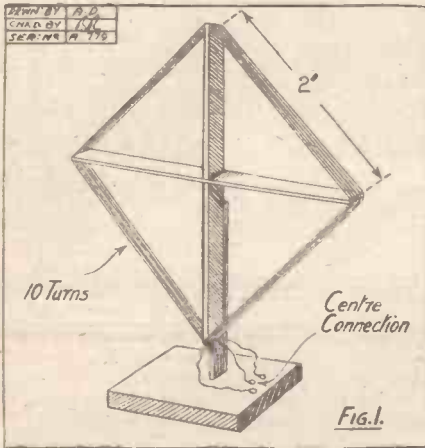

in overcoming them you will find a new pleasure and also you will be able to try out a large variety of arrangements.

We will only consider the making up of what I call the plank model. This will be a rough but neatly arrayed model which you can afterwards, if you like, carefully rearrange and fit into a cabinet, and I shall most certainly leave that part to you.

The Experimental Model.

I never attempt to make the first model of a circuit up in the final commercial form. For one thing the circuits are difficult to get at to make alterations, and one would undoubtedly want to re-design the panel at the end of the experiments.

The first thing to consider is the frame aerial. Please do not use a super set on an outside aerial. For one thing it is not necessary, and also during the testing you will be sure to cause trouble to your neighbours.

A convenient frame is one about 2 feet square made with two pieces of wood, at right angles, and the wires wound cylindrically and not radially. Slight spacing of the wires is necessary, otherwise the self-capacity

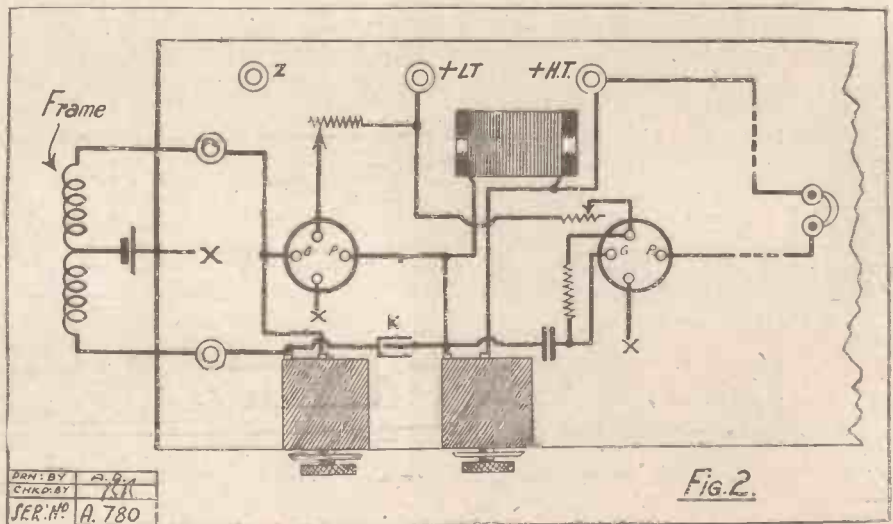

DESIGNED BY A.S.D.
 CHECKED BY J.S.A.
 SER. NO. A. 780

Fig. 2.

BUILDING UP A SUPER-HET.

(Continued from previous page.)

about 550 metres. The little condenser, K, which is a neutralising condenser, is very easily made up, as shown in Fig. 4. Where A is a bit of copper wire, B is a bit of sistoflex tubing wound round with some bare copper wire bound on with thread. The sistoflex should slip moderately easily. The whole arrangement which I show

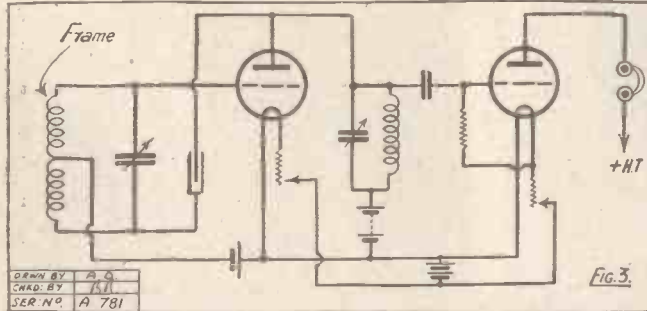

diagrammatically in Fig. 3 is a neutralised tuned circuit with a grid leak and condenser rectifier. In the first tests the bottom of this grid leak is brought to the positive end of the filament, but later I shall alter this and put grid bias on.

The Unidyne System.

Now, if you put telephones on, as shown, using any valves you have by you, you should easily get the local station up to distances of ten miles. Use a 42-volt H.T. battery, but if you can get valves such as the D.E. 5 B. or the D.E. 8 H.F., a higher voltage battery with these valves will get stronger signals, but stability will not be

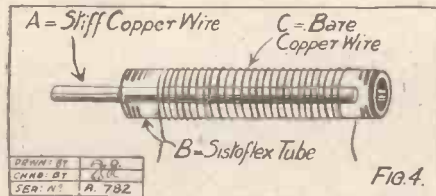

so easily obtained. Those of you with four-electrode valves might try the Unidyne scheme for these two valves, but I am not certain how the rectifier will take the oscillator.

You may adjust the neutralising condenser by guessing a position (it does not want to be very far in with .06 or R type valves), and testing the set for no oscillation, but a wiser plan is to break the

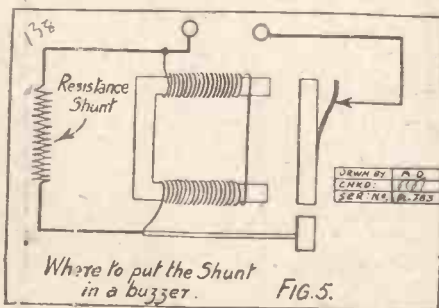

filament circuit of the high-frequency valve (do not remove the valve), and when listening to strong signals set the condenser until you hear nothing.

It is not always easy to get strong enough signals for this purpose, so that, unless you have a buzzer wave-meter to make strong signals for you, you will have to set the condenser in the way I first stated.

A Simple Wavemeter.

A buzzer wave-meter can be made very cheaply from an old electric bell, a condenser, and a standard plug-in coil. The coil of the buzzer must be shunted with a piece of resistance wire, as low a resistance as will just not stop it buzzing easily; from five to ten ohms of thin resistance wire wound on a match-stick works well (Fig. 5), connect up the buzzer coil and

condenser as shown in Fig. 6.

To use this buzzer for neutralising, wrap one turn round the middle of your frame (see Fig. 7), and carry the two ends to a coil of, say, ten or twenty turns of wire about 2 in. in diameter. If you place this latter coil near the wave-meter coil you will get loud signals from the buzzer in the 'phones, and now you can break the filament circuit-

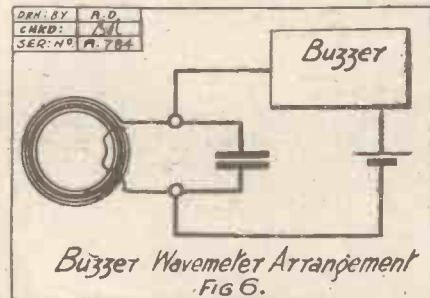

of the high-frequency valve, and adjust for minimum buzzer signals. Of course, have the condensers tuned well in. Any change

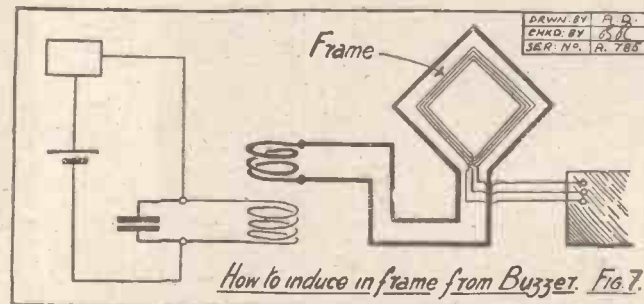

of valve will necessitate a different position of neutralising condenser. When you are using the buzzer wave-meter afterwards for

calibration, this strong coupling will not be necessary.

The high-frequency circuit will not only be very stable, but will be practically non-radiating, as the energy cannot get back to the aerial from the oscillator when the latter is working.

Your wave-meter, if made up with a bought coil, such as the Igranic, will be roughly calibrated, as there is a chart on the coil; and thus you will be able to check exactly on your local station, and afterwards with other B.B.C. stations.

It will be wise at this point to build up your note magnifier, and I am going to suggest a double-valve one; but if the expense is too much, go for one valve first, leaving room for another. For this super receiver I recommend two transformers, and buy good ones with a guaranteed curve. The other end of your plank will look like Fig. 8.

With regard to the transformers, the first one will be a 6 to 1, with a 250,000-ohm leak across its secondary. This choice of

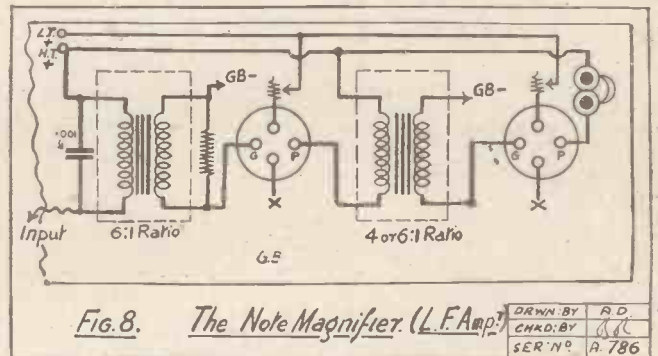

transformer is to enable us to put a fairly big bypass condenser across the primary. The second transformer can be a 4 or 6 to 1 ratio.

Finding Correct Bias.

The two valves had better be of the power type—say, D.E.5 or B.4—and grid bias should be arranged for on the basis $\frac{H.T.}{2M}$ where M is the magnification constant given by the valve manufacturer for that valve. Supposing we put 120 volts on these valves, then, with a D.E.5, the M value is 8, and

$$\frac{H.T.}{2M} = \frac{120}{16} = 8 \text{ volts, about.}$$

The input of the first transformer can now be temporarily connected to the rectifier; a .001 mfd. blocking condenser

across the two leads will be useful and necessary later on. You have now a complete four-valve frame set which should give good quality and fair strength up to reasonable distances from the local station.

If you do not want to spend money on the second valve and transformer, leave them off; but allow enough space for them, because you will want them later, I am sure.

(Continued on page 832.)

TAKE THE SHORTPATH TO BETTER RECEPTION

Cosmos

SHORTPATH WIRELESS VALVES

THE precise construction of the electrodes in these valves has enabled the distance between the electrodes to be greatly reduced, so that the electron stream has only to traverse a short path. This results in **GREATER AMPLIFICATION, GREATER OUTPUT, NO DISTORTION, EXCEPTIONAL RECTIFICATION, LOW CURRENT.** Made in three types marked with **RED, GREEN, and BLUE SPOTS** having the following characteristics:—

**“COSMOS” SHORTPATH S.P.18/R
RED SPOT VALVE**

A Real Two-Volt Power Valve

Suitable for supplying a powerful loud speaker without distortion. Equal to an average 6-volt power valve.
 Filament voltage 1.6—1.8 volts
 Filament current 0.3 amps
 Anode voltage—for detector 20 to 60 volts
 “ —for amplifier up to 120 volts
 Grid bias up to 9 volts
 Voltage amplification factor 7.0
 Mutual Conductance (slope of characteristic) approx. 0.90—1.00 mA per volt
 Anode impedance, approx. 7000 to 8000 ohms

Price 12/6 each

**“COSMOS” SHORTPATH S.P.18/G
GREEN SPOT VALVE**

A High Amplification H.F. Valve

Its high voltage amplification factor (15) is combined with a steep characteristic slope and an impedance very much lower than is usual with this type of valve. Exceptionally efficient as H.F. Amplifier, or as detector.

Filament voltage 1.6—1.8 volts
 Filament current 0.3 amps
 Anode voltage—for detector 30 to 80 volts
 “ —for amplifier up to 120 volts
 Grid bias up to 3 volts
 Voltage amplification factor 15.0
 Mutual conductance (slope of characteristic) approx. 0.85 mA per volt
 Anode impedance, approx. 17,000 ohms

Price 12/6 each

**“COSMOS” SHORTPATH S.P.18/B
BLUE SPOT VALVE**

A “Resistance-Capacity” Valve

This valve has a much higher voltage-amplification factor than any other receiving valve on the market. It is intended for use with 80—120 volts H.T., thus avoiding the use of two H.T. supplies. It consumes very little H.T. current, and only 0.09 amp. for the filament. Can be used with excellent results in many positions, but is particularly recommended in combination with resistance capacity coupling, where it gives as much amplification as the usual L.F. Transformer, but with the added freedom from distortion and breakdown.

Filament voltage 1.6—1.8 volts
 Filament current 0.09 amps
 Anode voltage (for detector or amplifier) 80-120 volts
 Grid bias Nil
 Voltage amplification factor 35
 Mutual conductance (slope of characteristic) approx. 0.45—0.5 mA per volt
 Anode impedance, approx. 70,000 ohms

Price 12/6 each



RECOMMENDED S.P.18 VALVES for ALTERNATIVE H.T. VALUES.			
		H.T. 20-80 v.	H.T. 80-120 v.
H.F. Amplifier	Tuned Anode (stabilised, by neutrodyne or otherwise)	Green	Blue
	Tuned Anode (non-stabilised)	Green	—
	Transformer, loose coupling	Red	—
	“ tight	Green	—
Dual or Reflex Stage	Resistance coupling (for long waves above 2000 metres)	Green	Blue
	L.F. Transformer or Choke Coupling	Red	Red
Detector (Grid Leak)	Resistance Coupling	—	Red
	Resistance Coupling	—	Blue
Detector (Anode Bend)	L.F. Transformer or Choke Coupling	Green	Blue
	Resistance, L.F. Transformer or Choke Coupling	Green	Blue
L.F. Stages (except last)	Resistance	Green	Blue
	Transformer or Choke	Green	Green
Last stage Loud Speaker	All couplings	Red	Red

CHOOSE YOUR S.P.18 VALVES FROM THIS TABLE

THE COMBINATION RECOMMENDED FOR BEST RESULTS IN EACH CASE IS SHOWN IN HEAVY TYPE

Ask your Dealer for a copy of Leaflet 4117/3 “The Soul of Music.”

METRO-VICK SUPPLIES LTD.

(Proprietors : Metropolitan Vickers Electrical Co., Ltd.)

Metro-Vick House, 145, Charing Cross Road, London, W.C.2

? CHOKE COUPLING ?



AUDIO FREQUENCY TRANSFORMERS TYPE AF3

Give all the advantages claimed for Choke Coupling PLUS a step-up of 3½ to 1.

25/-

Ask your Dealer for Leaflet W-401.

Send us the diagram of your set, and refer to this advertisement and we will suggest improvements.



FERRANTI LTD. HOLLINWOOD, LANCASHIRE

Come and See the best Coil Holders!

At Stand No. 84 at the National Radio Exhibition you are invited to inspect for yourself the Coil Holders that are used in fully half the sets that are made—the "Lotus" Coil Holders. Their popularity with constructors everywhere is due to their unvarying good performance and the following unique features:—

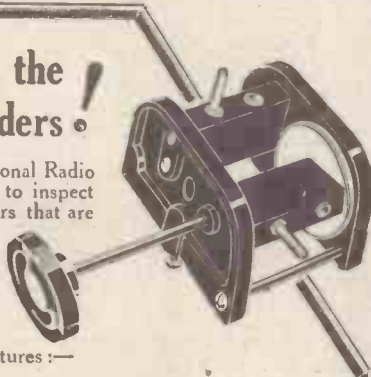

Moving Block cannot fall

Moves in same direction as knob, thus preventing confusion. Holds heaviest coil securely in any position. Dead accurate tuning possible because encased precision cut gears reduce speed by 8 to 1.

From all Radio Dealers

LOTUS

VERNIER COIL HOLDERS

GARNETT, WHITELEY & CO., Ltd.,
Lotus Works, Broadgreen Road,
LIVERPOOL.

Makers of the new Lotus Buoyancy Valve Holder.

Two Types:
For outside panel mounting:
Two-way - 7/-
Three-way 10/6
For inside base-board mounting, with 6-in. handle:
Two-way - 8/-
Three-way 12/6

Bakelite mouldings for the side plates, coil blocks and knobs; heavy nickel plating for the metal parts.



DESCRIBING THE TWO NEW DULL EMITTERS FOR 4VOLT ACCUMULATOR

Ask at your Dealer's for a copy

Take the first opportunity of obtaining particulars of G.P.4 and P.V.4—the new combination in the Ediswan range. They bring you lower current consumption, clearer reception, louder volume, extreme purity of tone, and the very minimum of microphonic effects. G.P.4 is 16/6, and P.V.4 22/6

Fit EDISWAN VALVES

and Nurse your set.

The Edison Swan Electric Co. Ltd

S.V.4
123.5
Queen Victoria St
London, E.C.4

That Aerial & Earth

By K. D. ROGERS, Assistant Technical Editor.



PROBABLY there is no part of the average listener's wireless installation that receives less consideration than the aerial-earth system. Not that it really needs a great deal of attention, but it

is a very vital part of the whole receiving station, and as such it should not be definitely left alone after it has been erected.

The erection of a new aerial naturally calls for a certain amount of thought and care, consideration of type, size, height being weighed up, the final erection being determined by the space, etc., at the disposal of the listener. Usually, however, having gone so far with the job the owner of the aerial promptly proceeds to forget all about it—possibly until some disaster overtakes it, and he wonders why it has fallen down, why his pole has collapsed, or why signals are not quite what they used to be.

Renewing Halyards.

True enough, the overhaul of an apparently healthy aerial seems to be a serious waste of time, but it must not be forgotten that though the aerial may appear to be perfectly in order, it may be found far from "correct" when careful examination is carried out. Therefore, it is advisable, to say the least of it, to overhaul the whole of the outside equipment—i.e. aerial and earth—at least once a year, and the summer being the most advantageous time for this examination listeners should make a point of overhauling their aerials, poles and all, during the next few months.

The first thing to look at is the pole or other means of supporting the aerial. Any signs of rotting should be noted and, if necessary, the support should be removed and the pole taken down and thoroughly examined. If it is concreted into position it will probably be quite in order, but if merely sunk a few feet into the ground, it may be rotten at the base and want trimming up and re-tarring. The base should be thoroughly saturated with tar before replacing the pole.

Guy ropes and the aerial halyards should be examined and replaced if any signs of rotting or fraying are apparent. Remember that although

the present state of affairs may be "quite good enough" for summer "wear," when the winter comes the first real storm will probably bring the whole lot down; halyards will slip through the pulleys and the owner will have the bother of re-erecting the aerial, possibly of demounting and re-mounting the pole in order to get at the pulley.

The Earth System.

All soldered joints and connections should be examined and any connections at present relying upon twisted wire should be thoroughly cleaned and soldered. Such connections should not be wrapped round with insulating tape, as this latter contains sulphur and is liable to cause corrosion of the surrounding wire. Insulators should be well cleaned and examined for cracks and weak places, especially the lead-in insulator.

It is a good plan if a lightning switch is fitted to dismantle the whole switch and thoroughly clean it, afterwards re-assembling and re-fitting. If it is not protected from the weather in any way it is not a difficult task to make a small wooden "roof" over it, or even a wooden case, in order to keep rain, snow, etc., from forming partial "shorts" of the contacts.

When the aerial has been overhauled to the listener's satisfaction he should turn his attention to the earth. Here still more care should be exercised for more troubles are due to faulty earths than many people imagine.

In the first place, before tackling the job of overhauling the earthing system, the listener should ask himself the question: "Is my earth the best I can obtain under the present circumstances?" If not, he should consider the other types available and decide upon what he considers the best. If he is thoroughly satisfied with the results he has been obtaining I would advise him not to tamper with his earth other than to overhaul it and see that all is in order.

In case he is doubtful as to the efficiency of the present arrangement he should consider the various other means of earthing at his disposal. It should be remembered that a direct earth to an earthing plate or pin is best only if well buried with a short earth lead, and if kept well watered. Otherwise I would advise the use of a main water-pipe.

This latter must be "main," however, it is only asking for trouble to hitch the set to a hot-water pipe or another which may wander all over the place before finding "ground." I do not say that such an "earth" would not work, but the chances are that it would be very inefficient. The same applies to the gas-pipe earth, which has been used by the writer on more than one occasion with more or less success; but, it seems to act more as a counterpoise than anything else. It cannot be advised as an "earth," and should not be used unless alternative arrangements fail.

A Frequent Pitfall.

Above all, the listener should be careful not to mistake a waste-pipe for a water-pipe. These waste-pipes rarely make good contact with earth, very often going into china conduits or else stopping short just after entering the ground. A counter-poise erected under the aerial would be far preferable.

Contact between the earth lead and the earth pin, water-pipe, etc., should be soldered, if possible, or, failing this, it should be soldered to a metal clip well screwed on to the pipe or pin. This latter should be perfectly cleaned first and the whole joint wrapped round with tin or copper foil, and soldered to give the joint a perfect protection against weather. Finally, a covering of empire cloth or oiled silk should be used, insulation tape being avoided.

Direct earths should be well watered and when first made should be surrounded with coke, well beaten in and filled up with soil. The length of the earth lead should determine whether a direct or water pipe be used.

A thorough overhaul of the aerial-earth system, replacing badly corroded wire, etc., will well repay the trouble taken and will ensure immunity from defects or disaster in the coming winter.

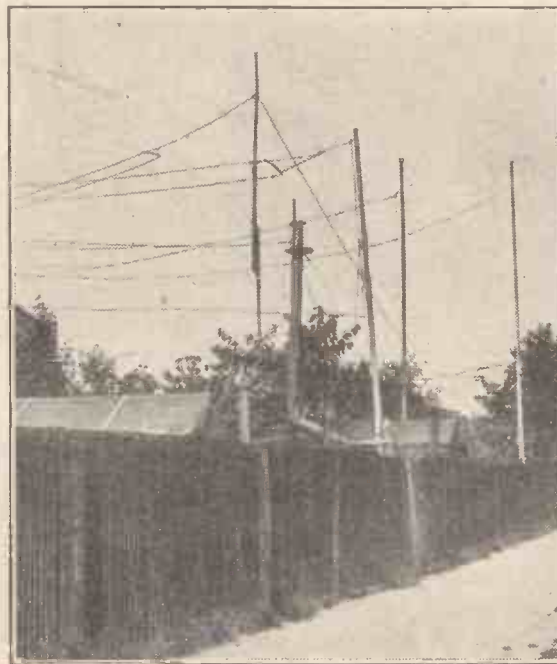

The difficulty of erecting an efficient aerial in the average suburban garden is well illustrated above. In such cases of overcrowding the aerials should be as high as possible and of the single wire type.

STATEMENTS have recently appeared in one of our contemporaries in connection with what is undoubtedly a very useful invention. I refer to the well-known method of stabilising a high-frequency amplifier by the use of a neutralising condenser, which counteracts the inherent coupling between the grid and plate circuits across the internal electrodes of the tube.

This method is usually referred to as Neutrodyne. Although the word Neutrodyne is now the registered property of the Hazeltine Corporation, it does not necessarily follow that all methods of stabilising an H.F. amplifier by means of a balancing condenser fall within the patent rights of that company.

An Early Patent.

As long ago as January 2nd, 1918, a British patent, No. 119,365, was granted to the British Thomson-Houston Company for avoiding the production of undesired oscillatory currents in a valve amplifier due to the coupling which is always present between the grid and plate circuits, partly arising from stray electro-magnetic coupling between the external inductance coils,

FACTS ABOUT THE NEUTRODYNE AND OTHER CIRCUITS.

BY THE EDITOR.

In view of the publicity recently given to the question as to who invented the Neutrodyne, the following article is placed before our readers as being of general interest.

and partly due to the electrostatic coupling between the electrodes inside the glass bulb.

According to this early invention, which is usually referred to as the Rice patent, the coupling due to stray magnetic fields is prevented by enclosing the various inductance coils inside metallic screening coils.

Further, in order to compensate for the capacity coupling inside the tube, a specially derived electromotive force is impressed upon the grid circuit from the plate and is made equal and opposite to that existing between these two circuits owing to the internal capacity coupling across the electrodes. This is accomplished by connecting the filament to a central tapping on the grid inductance coil, and inserting a balancing condenser between the lower end of that coil and the plate of the valve. A similar centre tapping is made from the anode to the H.T. battery.

It seems clear that the fundamental idea of using a balancing condenser in order to

plate circuits and means for compensating for the capacity coupling between said circuits and thereby preventing the generation of oscillatory currents which interfere with the reception of desired signals."

Recent Developments.

On January 2nd, 1923—five years later to the day—a patent No. 217,971 was issued to Mr. Scott Taggart and the Radio Communication Company. In this patent, it is admitted that the idea of counteracting the tendency to self-oscillation of a single-valve amplifier by the use of a condenser connected so as to produce a reverse reaction effect is already known, and the patentees add that they are aware of patent No. 119,365, and do not claim anything contained therein.

They do, however, claim the use of a similar balancing method when applied to a plurality of tuned circuits.

If one inventor has already described a certain method of stabilising a single valve, there may or may not be merit in another inventor extending this system to the case where several valve stages are connected in series, but, at the best, it can hardly lay claim to be considered as an inventive step of the first importance.

The Hazeltine Patents.

The two first Hazeltine patents referred to in our contemporary's article are 223,181, 222,895, both dated April 5th, 1923. In one of these the attention of the public is officially directed to the previously mentioned Rice patent No. 119,365.

It is also an interesting fact that the corresponding American patents of the Hazeltine Company were first filed in that country on August 7th, 1919, and December 28th, 1920, or more than two years before the date of Mr. Scott Taggart's patent in this country.

The question as to what are the exact rights of the various parties involved in this story, is one which only a Court of Law can decide, but meanwhile it seems to me that the wireless public should at least be given the true facts in their proper sequence.

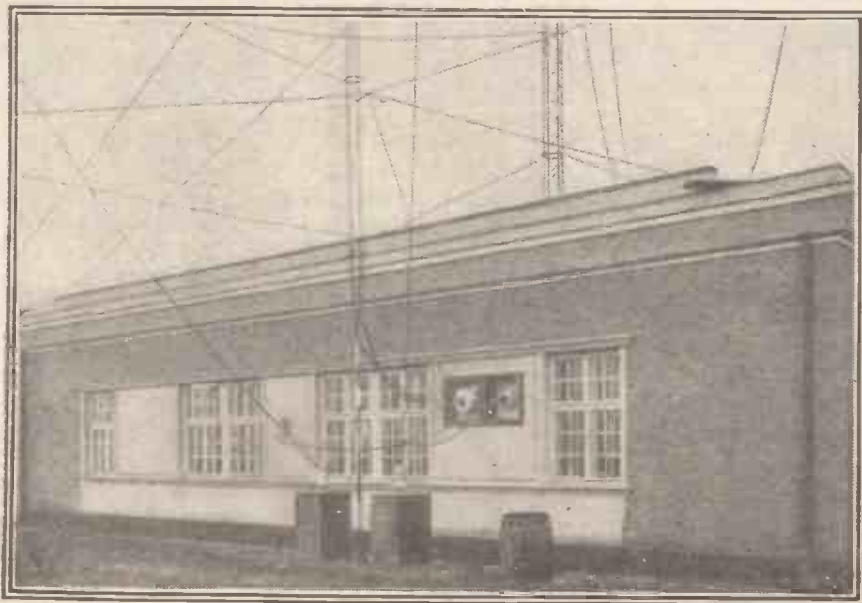

Part of the aerial arrangement of one of the recently completed German broadcasting station.

TO OUR READERS.

WE are constantly receiving requests from readers for information regarding various circuits, and we would again draw attention to the fact that a special series of 20 Blue Prints can be obtained (price 6d. each) from the Technical Queries Department.

WE also supply a comprehensive series of constructional books at the same price—the famous "Best Way" wireless guides for constructors.

THESE books—of which considerably more than half a million have already been sold—constitute a wireless library which no amateur should be without.

DETAILS concerning Blue Prints and the "Best Way" Wireless books appear periodically in "Popular Wireless" advertisement pages.

1925

CLEARTRON'S POLICY—
"POPULAR PRICES
FOR QUALITY VALVES"

1926

CLEARTRON STANDARD VALVES—C.T.08, C.T.15, C.T.25 and C.T.25B, at 12/6 and 15/- have made CLEARTRON'S name in the Wireless Trade.

CLEARTRON'S new 1926/27 models with NEW filaments, INCREASED electronic emission, HIGHER vacuum and LONGER life.

Give "Last word" satisfaction and are always backed by CLEARTRON'S IRONCLAD GUARANTEE.

Send for new season's catalogue with full technical data, etc.

CLEARTRON RADIO LIMITED

ONE CHARING CROSS, LONDON, S.W.1.

(Works: Birmingham.)

Telephone: Regent 2231-2.

Telegrams: "Cleartron, Westrand, London."

See us at Stands 135, 102, 46



National Radio Exhibition.

CT/34

SCRAP H.T. BATTERIES!

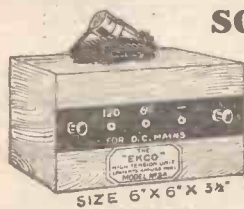

Derives H.T. from the mains (D.C. and A.C.) by just attaching adaptor to electric light lamp-holder!

SAFE! SILENT! SOUND!

Model	Voltage Tappings	D.C. Price	A.C.
1A	One	£2: 2:6	—
2A	Two	£2:15:0	£6:10:0
3	Three	£3: 7:6	£7: 5:0
V2A	1 Variable, 1 Fixed	£4: 5:0	£7:15:0
V3	2 Variable, 1 Fixed	£5:10:0	£9: 0:0
V3A	3 Variable	£6: 2:0	—
3A	Special 'Merconi Straight 8' Model	£6: 6:0	£9:10:0

ILLUSTRATED CATALOGUE FREE!

(Dept. A), 513, London Road, WESTCLIFF-ON-SEA.



E. K. COLE

Utility

GUARANTEED COMPONENTS

Reduced Prices

—the same quality
—the same 'Utility' Guarantee.

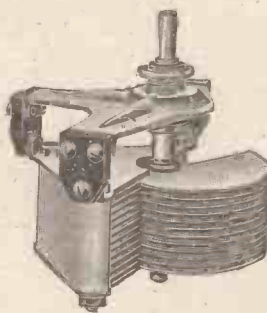

Every Wireless Amateur who takes his hobby seriously knows the value of accuracy and finish in the Components he uses—that is why so many choose 'Utility' Components. New Reduced Prices—made possible by greatly increased demand—now bring 'Utility' Components within reach of every wireless enthusiast. Better reception, longer life and a guarantee that any 'Utility' goods that develop faults with reasonable care will be repaired or replaced—all these are ensured if you demand 'Utility' Components. All good dealers stock them.

New Prices.

'Utility' Low Loss Condensers without Vernier from 12/- for '001 capacity. With Vernier, fitted with slow motion dial, from 17/6.

'Utility' No-capacity Change-over Switches. Knob pattern from 3/-. Lever pattern from 3/6.

Two windings

Made specially for both dull or bright emitter valves. One winding has resistance of 6 ohms with continuation on to a 30-ohm strip winding. Resistance wire wound on hard fibre strip under great tension and immune from damage. One-hole fixing, terminals conveniently placed. Contact arm has smooth silky action. All metal parts nickel-plated. Complete with Ebonite Knob and Dial 3/9.

From all dealers or direct from

The Bedford Electrical & Radio Co. Ltd.,
22, Campbell Road, Bedford.



3/9
"PEERLESS"
DUAL
RHEOSTAT

WILKINS & WRIGHT LTD
KENYON ST. *Utility* BIRMINGHAM

THE LIGHTER SIDE.

No. 1. Jazz and Broadcasting.

Being an Interview with Peter Blackman, the famous American Band Leader.
By "EARTH."

ON entering the principal entrance of the palatial Plaza Hotel in the Strand I was met by one of Mr. Blackman's secretaries. He beckoned to me and, after a quick scrutiny of my card, passport and car licence, finally convinced that I really was myself, he bade me follow him. After travelling a few miles of the thickly-carpeted corridors, he halted outside No. 4362. I shall always remember that number, as seven happens to be my favourite lucky number.

A Million-Dollar Contract.

Before tapping on the door, the secretary, who, by the by, wore a spring suit and a black moustache, drew me aside and whispered:

"Don't make any noise as you go in. Mr. Blackman hates noise—he hates sound. One day a man coughed while Mr. Blackman was playing on his saxophone. Without losing a moment, Mr. Blackman threw away his saxophone (he has several, I might mention) and strode across to the man and beat him to death with his umbrella. So hush!"

A moment later I found myself in the most distinguished presence of Mr. Peter Blackman—the man who started Jazz and whose life is insured for three million pounds.

He is a handsome man built on generous lines. Both his chins are determined, whilst his hands are those of a man. This is neither here or there, but the Editor says that if I don't fill in the picturesque stuff he will get Mr. Wells or Mr. Shaw to write it.

Mr. Blackman is a charming personality of a man. His mastery of the English language, despite the fact that he is an American, is perfect.

He shook hands.
"Glad to have you know me socially, Earth," he said genially. "I know your brother, Ariel."

Mr. Peter Blackman was wearing his beautiful dressing-gown of elephant skin with buttons made of young tusks.

"I understand, Mr. Blackman," said I, graciously accepting the stick of chewing-gum he tendered, "that you have broadcast in America."

"Sure. I gave the proposition a quick look over and informed my manager that we were willing to radio for three minutes for one million dollars! We signed that there contract right away. We played for three minutes without an interval and included by special request Gershwin's 'Rhapsody in Blue,' which we played as a funeral march. Another item which was extremely popular was 'Valencia,' taken from Gilbert & Sullivan's famous musical comedy, 'H.M.S. Pinafore.'

"If there were no listeners."

"We also gave a six-minutes' entertainment with two automatic pianos whilst the boys went out to have one."

Mr. Blackman then went to say that the New York studio made them extremely welcome.

"I guess we were right royally treated," said Mr. Blackman, drinking a little iced

water. "One of my men (we are now 180 strong, you know!) broke one of his teeth on the trombone, and they treated him in a special hospital ward they have at the station. I might mention that the operation was broadcast, and everyone thought it was Schubert's 'Moment Musical' for piccolo. Before leaving we were all given a Turkish bath and a bar of chocolate."

Mr. Blackman likes wireless. He thinks there is nothing radically wrong with wireless unless it is broadcasting.

"Of course," said Mr. Blackman, drinking more iced water, "if there were no listeners, broadcasting would be more popular. As an entertainment it is much more popular than Tiddley-Winks. Anyway, it is far less strenuous and much less exciting!"

"Broadcasting is old-fashioned."

Mr. Blackman is of the opinion that broadcasting will not last.

"It is like the revolutions in Mexico. They are all flashes in the pan. Broadcasting is a flash in the pan. I cannot imagine why it ever became popular. Now, when you have a band like my own—in the dead season we are making eleven thousand pounds a week—I consider broadcasting unnecessary."

Mr. Blackman said he does not like broadcasting because he thinks it's too noisy.

"We must be modern," said Mr. Blackman, in conclusion; "broadcasting is old-fashioned. It makes one stay at home. It is not the fashion to stay at home these days."

"What could be more enjoyable than living at an hotel with one of my bands playing all night and in the morning for breakfast, going to lunch at a restaurant where another of my bands is playing, to a thé dansant, a souper dansant, and finally to a Night Club, at which places my Bands would be playing. I ask you—Is that not better than broadcasting? What, my sunny Seville, could be more enjoyable?"

"Anything," I murmured, and crying bitterly, I left.

THERE has been a great deal of discussion on the subject of loud-speaker strength signals on a single valve from the local station, and many have been the attempts to evolve a practical circuit capable of giving such results. Whatever the success experiments in this direction have attained, two valves (0-v-1) or their equivalent are generally considered the necessary minimum for satisfactory volume up to within a mile or two of the station. A good word, however, must be said for some specialised forms of Flewelling circuits and the Chitos.

No Grid Leak Used.

It was while experimenting with these one-valve arrangements, with the object of minimising rather than increasing their complication, that the present circuit was "hooked up." As will be seen, the conventional grid leak and condenser have been entirely eliminated. There cannot fail to be those who will be struck at its radical difference from most other grid-leakless circuits, but its simplicity will easily allow the dubious to convince themselves as to its efficiency.

The circuit is shown in its essential form and, while it may be extended, no

A NOVEL ONE-VALVE LOUD SPEAKER CIRCUIT.

By JAMES NOXON.

attempt to contract it is advised. The tuning of the reaction coil is a necessary

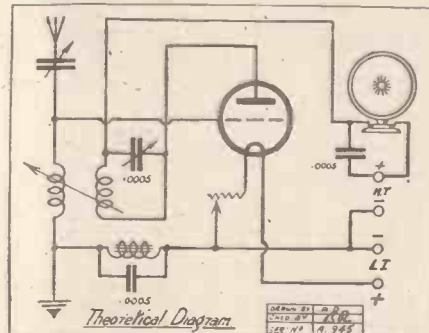

refinement, as is the condenser across the loud speaker, the theoretical function of which is not that of an ordinary tone

condenser. Capacity values should be approximate, and when a 35 aerial coil is used the aerial condenser should have that of .001 microfarad. The reaction coil may be anything from a 25 to 100. The choke coil is the ordinary iron-core choke used in low-frequency coupling, or may conveniently be the secondary of a good transformer.

Some Results Obtained.

No other instructions are necessary, the circuit being easily handled and controlled. No difficulty will be experienced in picking up the local station, although until the operator becomes acquainted with its vagaries the maximum strength will not be obtained.

At nine miles from 2 L O, with very poor aerial and earth systems, it gives sufficient volume on a Brown H1 to fill a large room, and when adjusted properly is of excellent purity. An ordinary R valve with 50 volts on the plate was used. No DX results other than those of an ordinary one-valve set are claimed.

The writer would be very glad to hear from readers as to their experiences in its operation, and of any improvements which they may effect.



MODERNISE YOUR RECEIVER

LOOK through the leading radio journals and you will notice that most modern receivers are fitted with Jacks and Plugs. Why not modernise your receiver?

By fitting Igranic-Pacent Jacks you can switch your whole receiver "on" or "off" merely by inserting or withdrawing a plug. You can carry out complicated inter-stage switching operations just as easily.

Igranic-Pacent Jacks and Plugs are made specially for radio work. Springs are of German silver with silver contacts riveted on. Nickel-plated, non-magnetic frames and high-grade insulating material only is used.



IGRANIC-PACENT JACK No. P69



IGRANIC-PACENT UNIVERSAL PLUG



IGRANIC-PACENT JACKSET

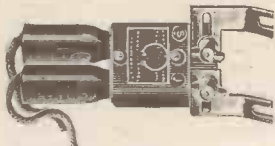

IGRANIC-PACENT DUOJACK

Igranic-Pacent Jacks are made in ten different patterns and meet every switching requirement. Prices from 2/- each.

Igranic-Pacent Plugs are made in four different patterns at prices from 1/6 each.

The Igranic-Pacent Twin-adaptor enables two plugs to be connected in series to one jack.

The Igranic-Pacent Duojack serves a similar purpose, but enables plugs to be used with a receiver fitted with output terminals.

The Igranic-Pacent Jackset and Multi-Jack enables three plugs to be connected in series, the withdrawal of any one not interfering with the others.

Send for interesting leaflet of "Jack Switching Diagrams" and for new Igranic Catalogue No. R19.

Exclusive Manufacturing Licensees of Pacent Radio Essentials.



149, Queen Victoria St., LONDON.

Works: BEDFORD.

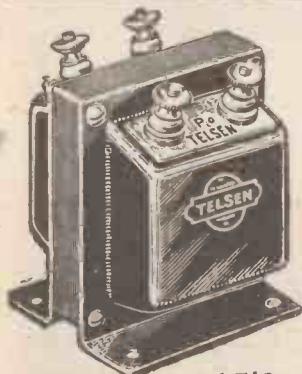

Shrouded Popular 15/6

TELSEN
L.F. TRANSFORMERS
Radio's Choice

British Made
The L.F. TRANSFORMERS that give maximum volume without distortion.

Other types:—
Standard Open " " " 14/-
TELSEN " ACE " " 9/6
All models in ratios 5-1, 3-1, and
Guaranteed for 12 months.

TELSEN ELECTRIC CO.,
207, Aston Road, Birmingham



Ask your Dealer for the



THE FORMER OF THE FUTURE.

Low Loss. Size 3 ins. diameter to outside of wings. Made from the famous BECOL EBONITE. Specially designed for low loss. Large air space between wings. Easy winding. Thoroughly dependable and British made.

From all dealers, in 6 inch lengths, 3/6
THE BRITISH EBONITE CO., LTD., HANWELL, LONDON, W.7.
Rods, Tubes, Sheets, Panels, Mouldings, etc.



Apparatus Tested

Traders and manufacturers are invited to submit wireless sets and components to the "P.W." Technical Dept. for test. All tests are carried out with strict impartiality in the "P.W." Test room under the supervision of the Technical Editor, and the general reader is asked to note that this weekly article is also intended to provide a reliable and unbiased guide as to what to buy and what to avoid.—EDITOR.

LEW COS MULTI-WAY BATTERY LEADS.

THE London Electric Wire Co. & Smiths Ltd., makers of Glazite, Lewcos coils, etc., are placing a series of multi-way battery leads on the market. These are complete with wander plugs and spade tags. Four types will shortly be available at the following prices: 4-way 5s. 6d.; 5-way, 6s. 6d.; 6-way, 7s. 6d., and 7-way, 8s. 6d. each.

The use of a multi-way connecting cord obviates the employment of a number of untidily straggling leads, and when it is of Lewcos quality, it is an efficient as well as a tidy method.

OF INTEREST TO TRADERS.

Messrs. Rockliff Brothers, Ltd., 44, Castle Street, Liverpool, have sent us a sample linen postal bag which they have designed

especially for the wireless trade. They inform us that they are producing large quantities at reduced prices, and that they can supply this line in any size and fitted with either a linen or manilla label or with an envelope attachment. Judging by the sample, strong, first-grade material is used, and traders should find them very useful indeed.

IGRANIC SHORT-WAVE COILS.

In order to meet a growing demand for such items, the Igranic Electric Co., Ltd., have produced a range of plug-in coils specially designed for short-wave work. They are provided with standard plug and socket bases, and can there-

fore be used with any ordinary type of coil holder.

They are wound in a solenoid manner with a very stout gauge of bare copper wire, which is threaded through a light supporting material. The turns are well separated, although the over-all size of each complete coil does not exceed that of a normal broadcast band plug-in coil.

Despite its compactness, the new Igranic short-wave coil was found to be remarkably efficient. Undoubtedly, it is a great advance over the huge short-waver of the helix pattern, from both these points of view. They were tested in a "Simmonds" two-valver, and gave very satisfactory results.

There are four sizes in the range, viz., 2, 4, 6, and 9 turns, suitable for ranges (closed circuit) of 15 to 45, 22 to 70, 30 to

(Continued on page 828.)



A Mullard Radio Demonstration Van which is touring the western counties.



for the 7 Valve SUPER-HETERODYNE SET

Owing to the excellent design and workmanship of the Bowyer-Lowe Super-Heterodyne Transformers, thousands of amateurs have built super-hot. sets, using these components with perfect success.

Follow their example. Each set of Transformers is complete with instruction booklet illustrating how to construct a 7-valve set. Every assistance will be given by us to those who are making a set to these instructions.

Set of 4 Transformers	£ s: d
Interchangeable Oscillator	4 0 0
Couplers, 300-600 metres	1 0 0
550-2000 "	1 0 0
Base for same	4 0

Constructor's Kit, containing principle components for building a 7-valve set, £10. Send for full particulars.



ANNOUNCEMENT BY THE BOWYER-LOWE CO LTD LETCHWORTH HERTS

...lower H.F. resistance than any other commercial plug in coil!

Made by the manufacturers of Glazite.



TESTS carried out by the National Physical Laboratory show that the LEWCOS COIL has a lower H.F. Resistance than any other coil on the market. Its low H.F. resistance combined with great selectivity and mechanical strength make the LEWCOS Coil the finest you can buy.

Try a LEWCOS Coil in your set—it makes all

the difference! Descriptive leaflet sent free on request to:

THE LONDON ELECTRIC WIRE COMPANY & SMITHS LTD. Playhouse Yard, Golden Lane, London, E.C.1.

No.	25	35	40	50	60	75	100	150	200	250	300
Price	4/6	4/6	4/6	5/-	5/6	5/6	6/9	7/6	8/6	9/-	10/-

LEWCOS Inductance COIL



Unexcelled in purity and richness of tone

ONE has heard Loud Speakers likened to the early gramophone with its harsh, metallic tone; one has, however, never heard the Brown spoken of in this manner. The name Brown is synonymous with all that is best in radio reproduction—its pure unadulterated tone and its faithful, accurate rendering of every phase of the broadcast is a byword among those who know this, the first Wireless Loud Speaker.

If you do not know the Brown, you have yet to hear true radio interpretation. See the Brown at your nearest Dealer's. You will at once appreciate the unusual beauty of its outline; but hear it and you will know that such rich volume and purity of tone is available in no other instrument.

Brown LOUDSPEAKERS

Type H.1. 21 ins. high. 120 ohms £5 5 0 2,000 ohms £5 8 0 4,000 ohms £5 10 0	Type H.2. Height 12 ins. 120 ohms £2 5 0 2,000 ohms £2 8 0 4,000 ohms £2 10 0	Type H.3. 15 ins. in height and in resistance of 2,000 ohms. £3 0 0	Type H.4. The smallest Brown Loud Speaker. Only 10 ins. high. 2,000 ohms £1 10 0
Type H.Q. 20 ins. high. Resistance: 2,000 or 4,000 ohms. £6 0 0	Type Q. 23 ins. high. In resistances of 120, 2,000 or 4,000 ohms £15 15 0	Cabinet Type. In Mahogany or Oak Cabi- net, 2,000 or 4,000 ohms £6 6 0	Crystavox. The only Loud Speak- er which works from a Crystal Set £6 0 0

Brown HEADPHONES

Type A. As used by the Admiralty 120, 2,000 or 4,000 ohms £2 10 0 8,000 ohms £3 0 0	Type F. Popular Broadcast type. Weight only 6 ozs. 2,000 ohms £1 0 0	Type A.2. The New reed-type unequaled for sensitive- ness. 2,000 ohms £1 10 0
---	---	---

S. G. BROWN, Ltd.
Western Avenue, N. Acton, W.3

Retail Showrooms—19, Mortimer Street, W.1; 15, Moorfields, Liverpool;
67, High Street, Southampton.
Wholesale Depots—2, Lansdown Place West, Bath; Cross House,
Westgate Rd., Newcastle; 120, Wellington Street, Glasgow;
5-7, Godwin St., Bradford. N. Ireland Agent: Robert Garmany,
Union Chambers, 2, Union St., Belfast. G.A.5613

Figures to Remember



The Innkeeper

To the weary traveller this one-time familiar figure stood for real comfort and the best of good things. To the wireless enthusiast to-day Six-Sixty Valves stand for the best in radio reception. They enable you to command unequalled volume and yet retain that wonderful purity of tone for which they have already become famous. And it's good to know that our new range contains just the valve you want for your particular set or circuit.



S.S. 7

Voltage - 3.7 volts.

Consumption .1 amps.

PRICE 22/6

These prices do not apply in the Irish Free State.

Take for instance the S.S. 7—a real Power Valve which has been recommended by all the leading Wireless Journals to-day. This valve is absolutely non-microphonic, and consumes only .1 amps. filament current. Hundreds of satisfied users have expressed their appreciation of this perfect valve emphasising in the main its wonderful purity of tone and remarkable economy. We can confidently state that there is no valve on the market to-day which can boast of a longer life, because there is no valve that operates at a lower temperature.

Then there's the S.S. 3 L.F. (green disc) for small or medium sized Loud Speakers. The S.S. 3 (red disc) gives excellent results both as an H.F. amplifier and as a detector. Owing to the low current consumption of both types dry cells may be used.

**FOR PERFECTION OF QUALITY
insist on SIX-SIXTY VALVES.**

Leaflet S.S. 1.7 gives full particulars. Your Dealer will be pleased to order Six-Sixty Valves for you if he is out of stock.



SIX-SIXTY VALVES
Better by Six times Sixty

The Electron Co., Ltd., Triumph House, 189, Regent Street, London, W.1. 11.

APPARATUS TESTED.

(Continued from page 826.)

90, and 40 to 130 metres respectively. This is with '0002 and '0005 mfd. variables. Thus the 10 to 100 metre band can be very completely covered. The prices of the four coils in the above order are 2s. 6d., 2s. 7d., 2s. 8d., and 2s. 9d., or 10s. for the complete set of four. Messrs. Igranic are to be congratulated on having turned their attention to short waves with such an admirable effect.



The new Cossor "Point One" and—

IGRANIC TRIPLE-HONEYCOMB COILS.

Some time ago we gave it as our opinion in these columns that the Igranic Electric Co. is one of the most progressive of all wireless manufacturing concerns in this country. We have now before us further evidence that this is indeed the case. Very few firms handling such a "best seller" as the Igranic coil would have had the courage or imagination to embody very considerable alterations in design in order to provide increased efficiency, and at the same time announce

greatly reduced prices. But the Igranic people have done both these things with their world-famous coil.

It is known now as the Igranic Triple-Honeycomb Inductance Coil. Instead of one solid duolateral winding, the coil is wound in three distinct and well-separated sections. This has the effect of still further reducing its self-capacity to a very marked degree. Igranic coils always had low self-capacities, but the new ones, in some cases, have only a quarter of the previous quite low values. A further feature of the new coil is that it also has a decreased high-frequency resistance.

On test practical evidence of these improvements was given in the form of still sharper tuning, even better coupling, and really "low loss" sensitivity.

The prices of these new Igranic coils are most reasonable, and range in the seventeen sizes from 2s. 9d. for the 25, 30, 40, and 50 up to 16s. for the No. 1,500. They can be supplied with gimbal mountings, instead of the usual plug pattern, at the same prices.

We are glad to note that a different method of holding the coils on their plugs has been adopted. Earlier types of Igranic coils were apt to come adrift unless handled with care, especially the larger ones, such as the 1,250 and 1,500. The new Igranics are very rigidly assembled, and should give long service in the most industrious experimenter's workshop.

ANOTHER LECLANCHÉ H.T. BATTERY.

The wet Leclanché battery as a solution to the H.T. problem is receiving more and

more attention of late, and is deservedly gaining considerable popularity. A battery built up on this principle was recently sent us for examination and test by Mr. D. Muir, of 59, Badlis Road, Walthamstow, E.17. The little cells are constructed on rather more robust lines than is usual practice; the glass jars are stout and of more conventional Leclanché pattern, and the sacs are a good deal larger than those employed in flash-lamp batteries. Cole and Vincent zincs and connectors, which were recently reviewed in these columns, are employed, and a special pitching material is used as a substitute for wax to prevent creeping.

On test the battery delivered a steady and vigorous current and was in every way perfectly satisfactory. It should give lengthy service per charge, even in the case of large, multi-valve sets. Mr. Muir can supply these batteries in any voltages at the rate of 6s. 6d. per dozen cells (carriage and packing extra) and trays to hold same from 1s.

The patent pitching paint which is quick drying and easy to handle, is available separately at 1s. 3d. per bottle, post paid.



—the same valve shown with its elements in section to reveal the patent co-axial mounting.

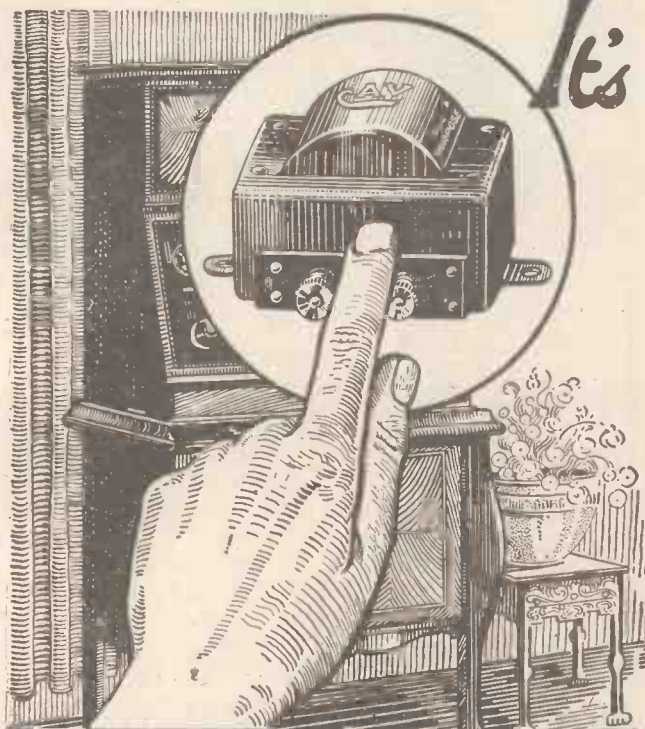

It's the components that count

Undoubtedly a beautiful wireless cabinet provides a very desirable addition to the home, but do not let this consideration outweigh a more important factor in the selection of your radio equipment. Remember "It's the components that matter" if true tone reception is expected.

If they are C.A.V., you are assured of the best. That is why the unchallenged reputation for reliability which the name of C.A.V. has held among motorists for over a quarter of a century, now exists with the radio public.



"ALL PURPOSE" L.F. TRANSFORMER has achieved pre-eminence by its scientific design and gives a marked improvement in reception. It will work equally well in a first or second stage amplifier

Price **15/-**

Write for C.A.V. Radio Catalogue. each

C.A.V. andervell & Co. Ltd.
ACTON, LONDON, W. 3.

Also obtainable at the following Depots:—
BIRMINGHAM (Lucas): Gt. Hampton Street. BRISTOL (Rotax): 7, Temple Street. COVENTRY (Lucas): Priory Street. GLASGOW (Lucas): 227/229, St. George's Road. MANCHESTER (Lucas): 277 Deansgate. MANCHESTER (Lucas): Chester Road, Streteford. NEWCASTLE-ON-TYNE (Lucas): 68, St. Mary's Place. LEEDS (Rotax): 117, Park Lane.

HOME ACCUMULATOR CHARGERS

CLEAN, ECONOMICAL & CONVENIENT.

NO TECHNICAL KNOWLEDGE OR ATTENTION REQUIRED.



The "ALTERNO."

(Alternating Current.) As Illustrated.

Charges the High Tension Accumulator at slight cost by simply plugging in to any convenient lampholder. Complete with full instructions, Flexible Cords and Adaptor.

Price 21/-.

The "INDISPENSO."

(Direct Current.)

For High Tension Accumulators. Charges at no cost when light is in use. Plug into any convenient lampholder. Complete with Polarity Indicator, Flexible Cord, Adaptor and Full Instructions.

Price 6/-.

The "PENDELTON."

(Alternating Current.) Patent App.

Charges the Low Tension 2, 4 or 6 volt Accumulator economically and effectively. No valves or replacements. Simply connect to the most convenient lampholder. Charging rate approx. 2 Amps. Please state voltage when ordering. Price £2-12-6.

Write direct for name of nearest stockist.



Large, fully illustrated 48-page Radio Catalogue free on request. Dealers should enclose Business Card for Trade Terms.



If you use a Valve Set you need Neutron Valves.

If you use a Crystal Set you need Neutron Crystal.

Remarkable Results achieved with Neutron Valves and Crystals.

The extraordinary success of Neutron Crystals has been repeated in the recently-introduced British-made Neutron Dull Emitters. Each is a scientifically sound product which does all that is claimed for it, and proves its low cost in long and good service.

The Red Spot Neutron Valve (H.F. and Detector) can now be obtained in two types: 4-volt, '06 amp., and 2-volt, '2 amp. Both are special-purpose valves for H.F. Detector Stages. The Green Spot Neutron Valve (L.F.)—also procurable in the same two types—is adequate for the operation of loud speaker sets with surprising volume and purity. All these valves are one price, all are of

the same superlative quality, fully guaranteed and therefore absolutely dependable.

Neutron Crystals are already famous for long-distance records. Every spot is sensitive, there is no unnecessary "tickling," and the volume achieved will astonish those who have wasted time and money on inferior crystals. You will come to Neutron in the end.



Trade Mark.

Your Assurance of Finest Results

Neutron H.T. Batteries
60-volt (British made), each 9/6

Neutron 4.5-volt Batteries
5d. each. Fully guaranteed.

Neutron Crystal
Packed in airtight tin with silver Catswhisker. Insist on Neutron in the black and yellow tin. From all dealers, 1/6

Neutron H. 406 Red Spot.
4-volt, '06 amp. (H.F. and Detector) 12/6

Neutron H. 220 Red Spot.
2-volt, '2 amp. (H.F. and Detector) 12/6

Neutron L. 406 Green Spot.
4-volt, '06 amp. (L.F.) .. 12/6

Neutron L. 220 Green Spot.
2-volt, '2 amp. (L.F.) .. 12/6

Advt. of Neutron, Ltd., London.

NEUTRON DISTRIBUTORS, 144, Theobald's Road, London, W.C.1
'Phone: Museum 4901, 4902.

Visit our Stand No. 82 at the Radio Exhibition.

THE BEST AMPLIFIER and the CHEAPEST both to fix and operate IS THE NEW NON-VALVE MAGNETIC MICROPHONE BAR AMPLIFIER

(Patent No. 248581/25).

Complete Amplifier
PRICE
38/-
Post Free.

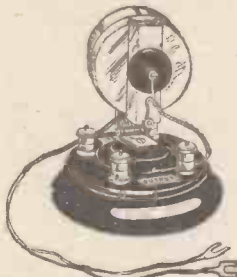

Microphone and other parts of Amplifier also supplied separately.

Illustrated lists free.

Dry Cells Extra.

REALLY GOOD LOUD-SPEAKER RESULTS from CRYSTAL RECEPTION of average strength. **WEAK CRYSTAL or VALVE RECEPTION** made **STRONG AND CLEAR.** **ENABLES even very DEAF PERSONS TO HEAR** from Crystal Sets.

Not a Microphone Button. Entirely free from distortion and microphonic noises. No valves, accumulators or H.T. Batteries. No fragile parts. Nothing to get out of order. A child can adjust it. Operates on one or two Dry Cells lasting over 3 months.

EQUALLY EFFICIENT ON VALVE SETS.

Order from your dealer or from Sole Manufacturers and Patentees:
NEW WILSON ELECTRICAL MANUFACTURING CO., LTD.,

18, Fitzroy Street, Euston Road, London, W.1.

'Phone: Museum 2703.

What is an anti-microphonic Valve holder

AN ANTI-MICROPHONIC valve holder is more than a valve holder mounted on springs. It is specially designed to smooth out vibration so that no shock reaches the filament. The BENJAMIN CLEARER TONE VALVE HOLDER is anti-microphonic in the full sense of the word. It "floats" the valve on springs and cushions it against vibration in every direction. Valve legs cannot touch the baseboard and the springs cannot be damaged by the tightest valve. The metal work is in one solid piece—no soldered tags to create noise. Terminals are provided in addition to the tags.

Benjamin Clearer Tone Valve Holders can be obtained at all good dealers. Do not be persuaded to buy imitations—you can always obtain Benjamin direct from the sole manufacturers.

2/9

EACH

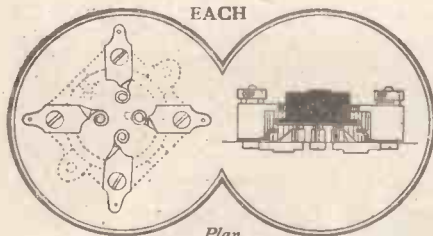

Plan and elevation of the

BRITISH **BENJAMIN** MADE
CLEARER TONE VALVE HOLDER
(ANTI-MICROPHONIC)

THE BENJAMIN ELECTRIC Ltd.
Brantwood Works, Tariff Road,
Tottenham, N.17.

Patent Nos.
222086-1923
250471-1925

Regd. Design
No. 71484

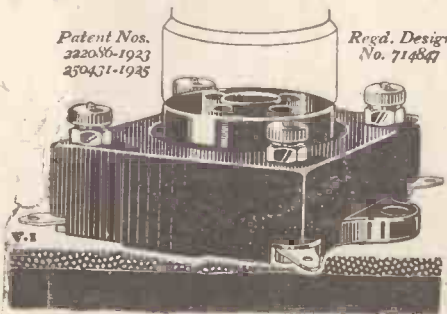

RADIO TUTORIAL

All Editorial Communications to be addressed to The Editor, POPULAR WIRELESS, The Fleetway House, Farringdon Street, London, E.C.4.

Editor:
NORMAN EDWARDS, M.Inst.R.E., F.R.S.A.,
F.R.G.S.

Technical Editor:
G. V. DOWDING, Grad.I.E.E.

Assistant Technical Editors:
K. D. ROGERS. P. R. BIRD.

Scientific Adviser:
Sir OLIVER LODGE, F.R.S.

Staff Consultants:
Dr. J. H. T. ROBERTS, F.Inst.P.; J. F. CORRIGAN, M.Sc., A.I.C.; C. E. FIELD, B.Sc.;
E. J. SIMMONDS, M.I.R.E., F.R.S.A.

Foreign Correspondents:
F. M. DELANO, Paris; Dr. ALFRED GRADENWITZ, Berlin; L. W. CORBETT, New York; P. F. MARTIN, Italy; W. PEETERS, Holland.

The Editor will be pleased to consider articles and photographs dealing with all subjects appertaining to wireless work. The Editor cannot accept responsibility for manuscripts and photos. Every care will be taken to return MSS. not accepted for publication. A stamped and addressed envelope must be sent with every article. All inquiries concerning advertising rates, etc., to be addressed to the Sole Agents, Messrs. John H. Lile, Ltd., 4, Ludgate Circus, London, E.C.4. As much of the information given in the columns of this paper concerns the most recent developments in the Radio world, some of the arrangements and specialities described may be the subject of Letters Patent, and the amateur and the trader would be well advised to obtain permission of the patentees to use the patents before doing so.

Readers' letters dealing with patent questions, if sent to the Editor, will be forwarded to our own patent advisers, where every facility and help will be afforded to readers. The envelope should be clearly marked "Patent Advice."

Questions and Answers

FAULTY L.F. TRANSFORMER.

A. S. (Preston).—My 4-valve set (H.F., Det. and 2 L.F. transformer coupled) has, until a week ago, given full satisfaction.

Since that date I have been troubled with a loud crackling noise which sounds, to all accounts, like bad "atmospherics."

Someone suggested that I had a broken connection, either inside my set or else in my aerial lead.

These, however, I have carefully examined, but they are all O.K. The earth lead I have also examined, and while its connections appear sound, I have wondered if it has gone "dry," and so causing the crackling. Can you suggest what is wrong? It cannot be the batteries, as these were tested at the time of inspecting the set.

The loud crackling is not caused by a faulty earth wire but probably by an L.F. transformer primary burning out. We advise you to replace each primary in turn by the 'phone tags to see if steady signals come through. First disconnect the two wires going to the primary of the first L.F. transformer, and join them to the two 'phone leads. Signals will then be received on the H.F. and Det. valves only. If

TECHNICAL QUERIES.

Letters should be addressed to: Technical Query Dept., "Popular Wireless," The Fleetway House, Farringdon Street, London, E.C.4.

They should be written on one side of the paper only, and MUST be accompanied by a stamped addressed envelope.

Queries should be asked in the form of the numbered questions. (1), (2), (3), etc., but may be accompanied by a short letter giving any necessary additional particulars as briefly as possible.

For every question asked a fee of 6d. should be enclosed. A copy of the numbered questions should be kept, so that the replies may be given under the numbers. (It is not possible to reproduce the question in the answer.)

BLUE PRINTS. A series of 20 Blue Prints can be obtained from the Query Dept., price 6d. per Blue Print.

Only a limited number of circuits are covered by this series, and full details of the circuit arrangements available in Blue-Print form are published fortnightly in the advertisement columns of this journal.

All other back-of-panel diagrams are specially drawn up to suit the requirements of individual readers at the following rates: Crystal Sets, 6d. One-Valve Sets, 6d. One-Valve and Crystal (Reflex), 1s. Two-Valve and Crystal (Reflex), 1s. Two-Valve Sets, 1s. Three-Valve Sets, 1s. Three-Valve and Crystal (Reflex), 1s. 6d. Four-Valve Sets, 1s. 6d. Multi-Valve Sets (straight circuits), 1s. 6d. Except SUPER-HETERODYNE DIAGRAMS, all of which, irrespective of number of Valves used, are 2s. 6d.

If a panel lay-out or list of point-to-point connections is required, an additional fee of 1s. must be enclosed.

Wiring diagrams of commercial apparatus, such as sets of any particular manufacture, etc., cannot be supplied. (Such particulars can only be obtained from the makers.)

Readers may submit their own diagrams, etc., for correction or for criticism. The fee is 1s. per diagram, and these should be large, and as clear as possible.

No questions can be answered by 'phone. Remittances should be in the form of Postal Orders.

O.K., disconnect the 'phones, connect up the primary, and repeat the process for the second L.F. transformer primary.

Should no signals be received when the 'phones are connected to the plate of the first L.F. valve, the first stage L.F. transformer is the cause of the trouble, but if otherwise it will be safe to assume the second stage transformer is faulty.

FIRST STAGE L.F.

C. M. (Weymouth).—Is it necessary to employ a power valve in the L.F. stage on a 2-valve set (Det. and L.F.)?

No; but it is an advantage where a separate H.T. tapping and grid bias are provided.

L.F. TRANSFORMERS.

R. P. (Brighton).—I have a Ferranti A.F.3, and wish to use it in a "P.W." set which shows a fixed condenser across the primary of the L.F. transformer. Will this condenser be necessary with this particular transformer?

No, as a fixed condenser is already incorporated in the case of the A.F.3.

LANDLADY AND THE LEAD-IN.

"P.W." Reader.—Can our landlady stop us from having a lead-in through the bedroom window? She asks us to pay 18/- per year to fasten it on the chimney, and she won't take less than this price.

Unless you are the tenant of the whole of the house you cannot safely fix up an outdoor aerial without the consent of your landlady. Her claim appears to be exorbitant, it should be sufficient if you undertake to repair any damage you do to the window frame, and pay any additional insurance premium she may be called upon to pay.

(Continued on next page.)

RADIOTORIAL QUESTIONS & ANSWERS.

(Continued from previous page.)

CALCULATING WAVE-LENGTH.

G. N. H. (Swiss Cottage).—What is the easiest way of calculating the wave-length of a coil and aerial system ?

There is really no *easy* way of calculating the wave-length of a coil and aerial system, but the following will probably be the quickest.

First calculate the coil's inductance in microhenries and add this to the inductance of the aerial, taking the capacity of the aerial in microfarads and applying the formula :

Wave-length = $1,885 \sqrt{K \text{ (mfd.)} \times L \text{ (mhys.)}}$.
As the result will only be approximate the capacity of the average aerial used for broadcast reception can be taken as .0002 mfd., while the inductance will be about 15 mhys. This latter can be checked roughly by multiplying the length of the aerial in feet (plus lead-in) by 1.5, the result being in metres wave-length. Then, if we call this W and apply the formula below we shall have the inductance in mhys.

$$\frac{W}{(1,885)^2} \div K \text{ (note, } K = .0002) = L.$$

This then gives us K and L for the aerial as nearly accurate as is necessary, and we have found the inductance of the coil alone by means of the formula

$L = \frac{0.8 D^2 N^2}{1,000} k$, mhys., where D = diameter of coil in cms.; N = number of turns per cm.; l = length of coil in cms.; k = correction factor, based on the ratio of the length of coil to the diameter. This can be found from coil tables, or else roughly calculated for the following data. The

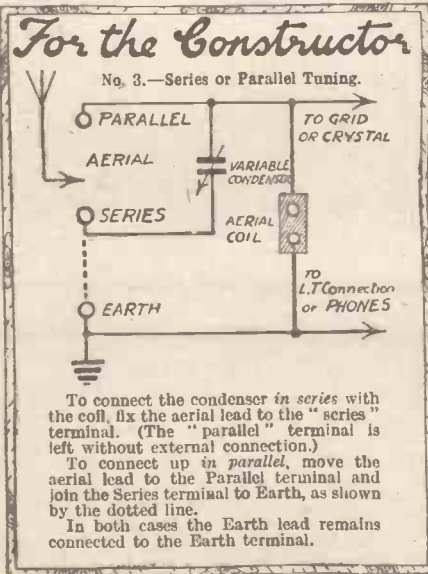

factor varies from .96 (where the diameter is .7 of the length) to .2 (where the length is .1 of the diameter). If diameter = length the factor is .69. If l = 2D, k = .82, and if l = 5D, k = .92.

The answer in mhys. from the above is then added to the inductance of the aerial, and the capacity of the latter is taken and the first formula is applied—i.e. $1,885 \sqrt{KL}$, which gives the total wave-length of coil and aerial. Any parallel capacity across the coil can be added before the final equation is worked out.

AVOIDING FREQUENT RECHARGING.

G. K. D. (Forest Gate, London, E.).—How many hours should a 6-volt 40 amp. accumulator last when used for a 3-valve set ?

This can be easily calculated when the current taken by each valve is known. (It is always stated by the makers.) If the consumption averages .7 each, the three valves will take 2.1 amps, and this figure divided into the "ampere-hour" capacity will give the number of hours—in this case

$$\frac{40}{2.1} = 19 \text{ hours (approx.)}$$

It will be seen that for three valves a 60 ampere-hour battery is preferable to avoid the necessity for constant re-charging.

Air Spaced for sharp tuning

ASK your dealer to show you one of these new Eureka Low Loss Coils. You won't need to hold it up to the light to realise how each turn of the wire is well spaced from its neighbour. You'll see the advantages of its unique method of winding at a glance. Right from the time you began to be interested in Wireless you'll remember always reading how coils should possess a low self-capacity. Here is the coil with the lowest self-capacity on the market—a glance at the illustration will show you how well-spaced are its turns. Low self-capacity means sharp tuning and greater selectivity—you need it to-day with so many stations crowding the ether.

Great Mechanical Strength

But don't think that because the new Eureka looks a perfect network of spaced wiring that it is weak. Actually it is probably the strongest coil ever made, because it is wound on a solid ebonite former. Further it is reinforced just at the base where the most strain comes. It can be removed from its socket and roughly handled without the possibility of any harm being done. The Eureka method of mounting is another improvement. The ends of the coil are brought through the centre of the mount and soldered to the sockets. Electrical losses are reduced to a minimum. With its handsome green silk wire the Eureka Low Loss Coil will add distinctiveness to any set—you would certainly expect to pay more for such a beautifully made coil. And, finally, bear in mind the fine reputation enjoyed by all Eureka guaranteed Radio Products.

Reasonable Prices:

E20	40-150 metres	4/3	E100	285-1000 metres	6/3
E25	55-250 metres	4/3	E150	360-1500 metres	7/-
E35	80-375 metres	4/3	E200	470-1375 metres	8/-
E50	120-560 metres	4/6	E250	530-2725 metres	8/6
E75	185-760 metres	4/10			

All the above wave-lengths are obtained with a .0005 mfd. variable condenser in parallel.

EUREKA

Low Loss Coils

[Apt. of
Portable Utilities Co., Ltd.
(Eureka Radio Products),
Fisher St., London, W.C. 2.]

TECHNICAL NOTES.

(Continued from page 808.)

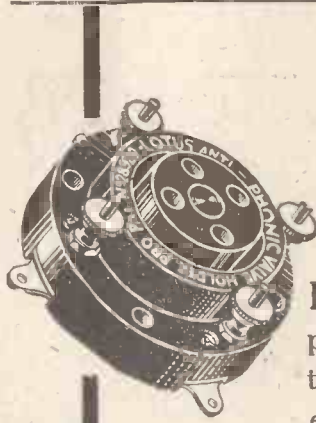

It will pay you to see this exhibit!

Visit Stand No. 84 at the National Radio Exhibition—see the "Lotus" Valve Holders and learn just how and why they excel in absorbing shock, protecting the valves and eliminating all microphonic noises.

Rigorous tests at the factory ensure that "Lotus" Valve Holders will give entire satisfaction under any conditions. That is why you should insist on them for your set.

Valve sockets and springs locked together by a mechanical process, making a definite and permanent connection. Bakelite mouldings, nickel silver springs and phosphor bronze valve sockets, nickel plated.

2/6 With terminals
2/3 Without terminals



Made by the makers of the famous Lotus-Vernier Coil Holder.
GARNETT WHITELEY & CO., LTD.,
Lotus Works, Broadgreen Road, Liverpool.

efficiency which results from the inability to control the valve separately. Personally, I am always in favour of a separate rheostat control for each valve. In spite of the fact that the valves, even of the best makers, are intended to be of standard characteristics, it is impossible in manufacture to avoid slight variations, and, unfortunately, in the case of some of the less reliable makes the variations are very considerable.

New Type of Cone.

One of the most ingenious patents in connection with loud-speaker cone diaphragms is one which covers the making of a rigid cone by means which I will explain presently. It is probably well known that one of the difficulties in the making of a cone for a loud speaker of this type is to make the cone sufficiently rigid, so that it vibrates more or less as a whole, whilst at the same time keeping its mass very small. Various methods of corrugating the material have been tried, as well as the application of "rigid" varnishes, such as shellac and celluloid.

But by the method covered in the patent mentioned above, the rigidity of the diaphragm is secured by making it of two cones instead of one, these two cones being of very slightly different angles. The result is that when the cone of larger angle is placed within the cone of smaller angle the apex of the one cone is about $\frac{1}{2}$ in distant from the apex of the other, and the centre pin, by which the double cone is secured to the reproducer armature, passes through the apex of each cone and by means of a small nut draw the two closer together. Since the two cones are adhesively sealed at their rim, the drawing together by means of the mounting pin has the effect of tensioning the inner cone and compressing the outer one, the result, in any case, being a composite conical diaphragm very light in weight and at the same time of considerable rigidity. A cone made in this way is found in practice to work extremely well.

BUILDING UP A SUPER-HET.

(Continued from page 818).

So far, this set is quite suitable for aerial working, and you can use it with an aerial by earthing the copper base and tapping the aerial on to the frame about four turns from the central tapping. Try for the best place with a pin. Reaction can be introduced by adjusting on the neutrodyne condenser, but do not lose the balance position, otherwise you will have all the trouble of finding it again.

This aerial working is merely a sideline, and you should concentrate on making the receiver as a frame set function quite nicely and smoothly. The frame itself, on rotating with the local station, should give two zeros and two equal strength maxima. You can earth the copper sheet, if you like, but it should not require it in any stage of the building up.

The next step is to introduce an oscillator, and I will discuss this question, and that of addition of the intermediate frequency stage, next week. But even if you go no further with the job, you have a good four-valve receiver which, with the aerial on, will give very fair results.

Have You?

A very large number of readers of "Popular Wireless" wrote for and received a copy of our revised Catalogue. Many have since bought one or more of the thousand Radio Bargains listed.

Have You?

Send 4d. stamps for a copy by return post.

ELECTRADIX RADIOS

218, Upper Thames Street, London, E.C.4

Parr's Ad.

HEADPHONES REPAIRED

Re-wound & remagnetised 5/- per pair. Loud Speakers repaired 5/-. Transformers re-wound 5/- each. All work guaranteed and tested before delivery.

Write for Trade Prices. Phone: Clerk 1795. MASON & CO., 44, East Road, City Road, N.1.

Valves Repaired

AS GOOD AS NEW!!

(Except Weco, S.P.'s, and low capacity types). Minimum D.E. Current 0.15 amps when repaired. ALL BRIGHT & DULL EMITTERS Listed at less than 10/- Minimum charge - 5/- VALCO LTD; Dept. P.W., Tabor Grove Wimbledon, S.W.

PATENTS, TRADE MARKS. Inventions Advice Handbook & Consultations FREE.—B. T. KING, C.I.M.E., Regd. Patent Agent (G.B., U.S. & Canada), 146a, Queen Victoria Street, London, E.C.4. 40 years' references. Phone: Cent. 682

Pay while you Listen!

Don't deny yourself the joys of Radio because of the initial cost of a complete Receiver. We can supply many "P.W." and other well known sets, guaranteed Components and Accessories on the Easy Payment System. It will pay you to write at once for our comprehensive Catalogue "P", and let us know your requirements. New Times SALES CO., VULCAN RD LUDGATE HILL E.C.4 5221

WET H.T. BATTERIES British made round or square Leclanche Glass Jars, 21 x 14 x 11, for wet H.T. Units, Waxed, 1/3 doz.; plain, 1/- doz. Carriage and packing extra. Phones and Loud Speakers reconditioned, 8/6 & 5/-. The H.E.P. Co., 1, Cottrill Road, nr. Hackney Downs Station, E.8.

PICKETTS CABINETS

:: For every Wireless Constructor :: Send for Cabinet Designs and Lists Free

CABINET WORKS, BEXLEY HEATH (nr. London)

REPAIRS S.E.T.S. PHONES, TRANSFORMERS

Officially Approved by Radio Association. ALL WORK GUARANTEED. LOWEST RATES 74 HOUR SERVICE. Cash on Delivery if Desired. JOHN W. MILLER, 68, Farringdon St., E.C.4. Phone: Central 1950.

4-ELECTRODE VALVES

We are the suppliers of the genuine U.C. and Thorpe valves, as specially tested and recommended by the "Unidyne" inventors and "Popular Wireless" U.C.5 and Thorpe K.4 (both 4-electrode 5-pin valves), each, post free..... 10/6

Order direct from— LUDGATE RADIO CO., 56, LUDGATE HILL, LONDON, E.C.4.

PLEASE be sure to mention "POPULAR WIRELESS" when communicating with Advertisers. THANKS!

ACCUMULATORS ON EASY PAYMENTS

50-volt High-Tension Accumulator complete in varnished case, built up in 20-volt sections. Tapping arranged every 10 volts, 45/- CASH, or 12/6 DOWN and 6 monthly payments of 5/-. Carriage Paid. Satisfaction or money back. Write for Lists to DEPT. 11 COVENTRY DIRECT SUPPLIES Ltd., Coventry. Any Wireless Goods supplied on easy payments.

PLAYER'S MEDIUM NAVY CUT CIGARETTES, PLAIN OR CORK TIPS

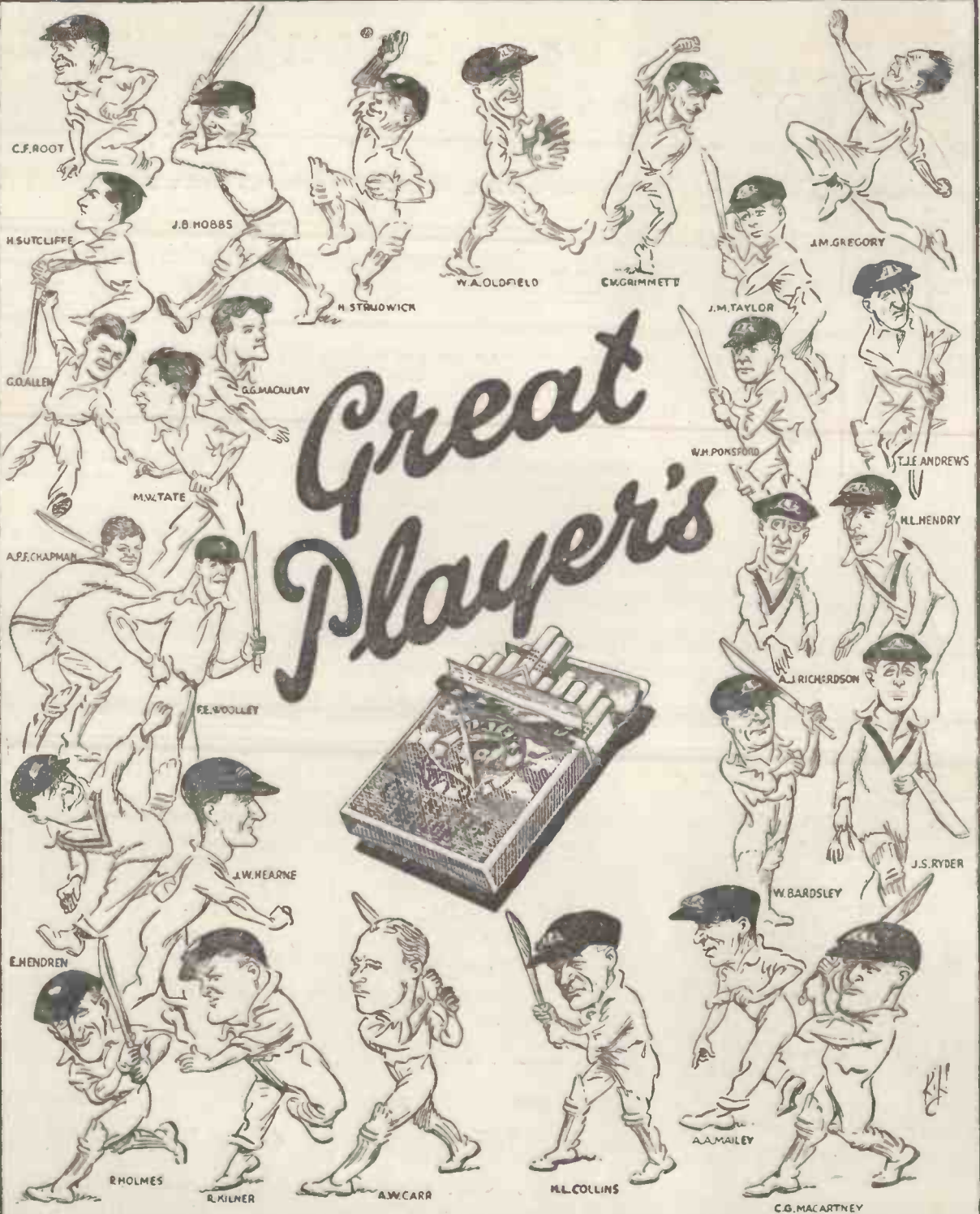

Great Player's

A Coloured Reproduction of one of these "Rip" Caricatures will be found in every Packet of PLAYER'S NAVY CUT CIGARETTES

A Filament

that is tough enough
to support four valves
without breaking



Every feature of the wonderful P.M. Filament has a superiority all its own.

In this case you can judge the high mechanical strength of the P.M. Filament, particularly when you realise that an ordinary filament will barely support a single valve compared to the four possible with the P.M. filament.

This great difference in the strength is due to the special core of rare metal in the P.M. Filament, which is so tough that it can be tied in knots after 1,000 hours' life, and cannot be broken except by the very roughest handling. The P.M. Filament is set around 5 strong resilient hooks in such a way that it is free from tension or sag and cannot become displaced during the long life of the valve.

The multi-coating on the P.M. Filament core is prepared from an alloy of precious metals that secures a copious and powerful stream of electrons at a temperature so low that no sign of glow can be discerned.

The low current consumption of the P.M. Filament, only one-tenth ampere, will make your accumulator charges last seven times as long, reducing your recharging costs and journeys to one-seventh. The emission of the P.M. Filament is completely within the field of the grid and anode, despite the fact that this emission is up to 5½ times greater than that of an ordinary filament.

Finally, this vastly increased emission gives a wide range of power free from microphonic disturbances, and the P.M. Filament is so conservatively rated that it will stand a reasonable overload without fear of damage.

You will never really be satisfied until you have secured the valves with the P.M. Filament. There are many attempts to imitate its individual features, but all the advantages of the P.M. Filament can only be found in P.M. Valves.

ASK YOUR DEALER FOR P.M. VALVES. HE SELLS THEM BECAUSE THEY SATISFY.

Mullard

THE MASTER VALVE

ADVT. THE MULLARD WIRELESS SERVICE CO., LTD., MULLARD HOUSE, DENMARK STREET, LONDON, W.C.2.

Printed and published every Thursday by the Proprietors, The Amalgamated Press (1922), Ltd., The Fleetway House, Farringdon Street, London, E.C.4. Advertisement offices, Messrs. J. H. Lile, Ltd., 4, Ludgate Circus, London, E.C.4. Registered as a newspaper and for transmission by Canadian Magazine Post. Subscription rates; Inland 17/4 per annum, 8/8 for six months; Abroad, 19/6 per annum, 9/9 for six months. Sole Agents for South Africa: Central News Agency, Ltd.; Sole Agents for Australia and New Zealand: Messrs. Gordon & Gotch, Ltd.; and for Canada: The Imperial Co. (Canada), Ltd. Saturday, August 14th, 1926.

R/P

All applications for Advertisement Space in POPULAR WIRELESS to be made to JOHN H. LILE, LTD., (Sole Agents), 4, Ludgate Circus, London, E.C.4. Phone: City 7261.

For 4-volt accumulator or
3 dry cells
THE P.M.3 (General Purpose) 0.1 amp. 16/6
THE P.M.4 (Power) 0.1 amp. 22/6
For 6-volt accumulator or
4 dry cells
THE P.M.5 (General Purpose) 0.1 amp. 22/6
THE P.M.6 (Power) 0.1 amp. 22/6
For 2-volt accumulator
THE P.M.1 H.F. 0.1 amp. 15/6
THE P.M.1 L.F. 0.1 amp. 15/6
THE P.M.2 (Power) 0.15 amp. 18/6
These prices do not apply in Irish Free State

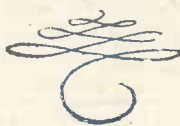

THE GENEVA WAVE PLAN: By ARTHUR BURROWS

Popular Wireless

Every Thursday
PRICE
3d.

No. 220. Vol. IX.

and Wireless Review
Scientific Adviser: SIR OLIVER LODGE, F.R.S., D.Sc.

August 21st, 1926.

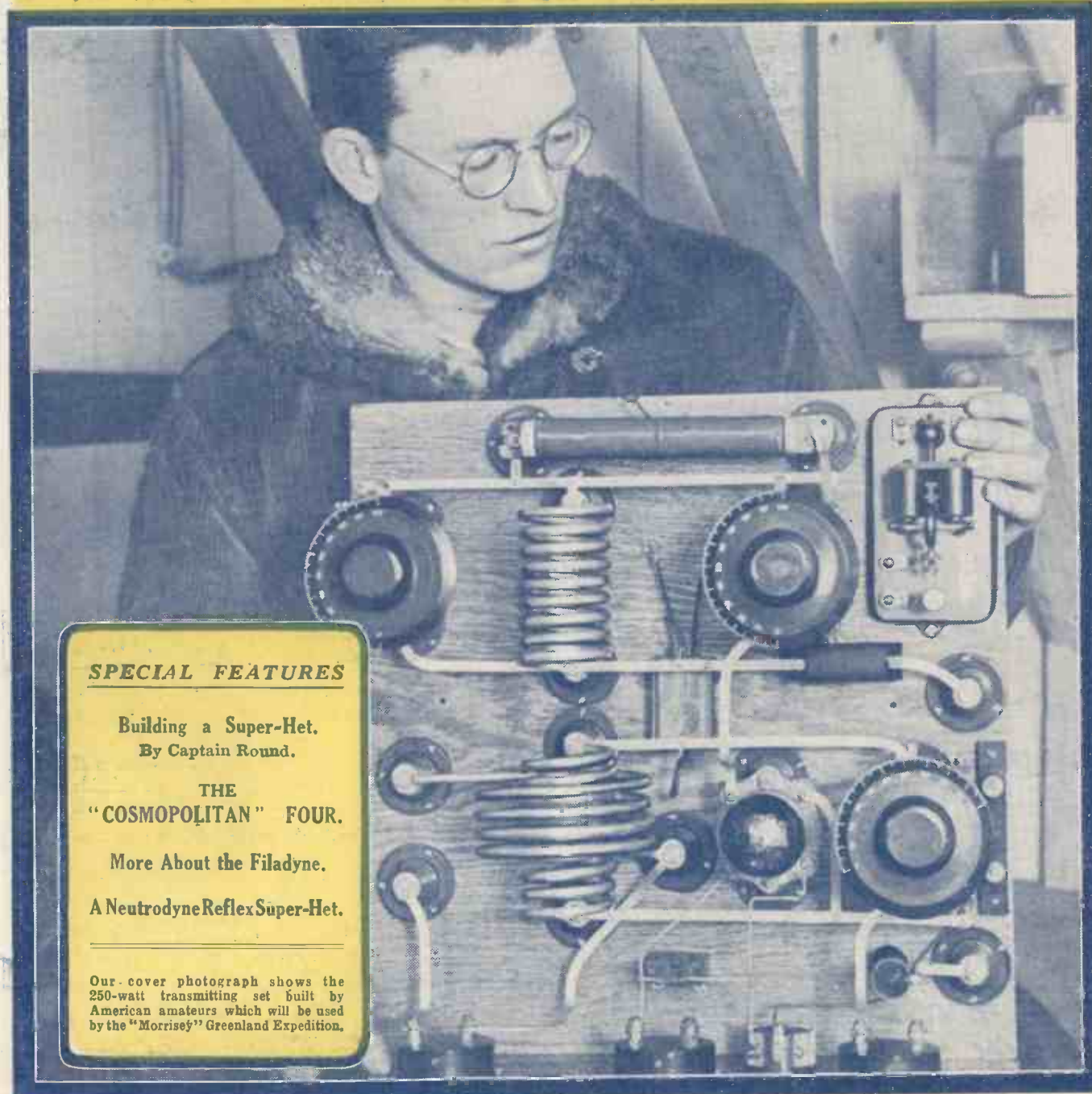

SPECIAL FEATURES

Building a Super-Het.
By Captain Round.

THE
"COSMOPOLITAN" FOUR.

More About the Filadyne.

A Neutrodyne Reflex Super-Het.

Our cover photograph shows the 250-watt transmitting set built by American amateurs which will be used by the "Morrisey" Greenland Expedition.

Cosmos

COMPONENTS

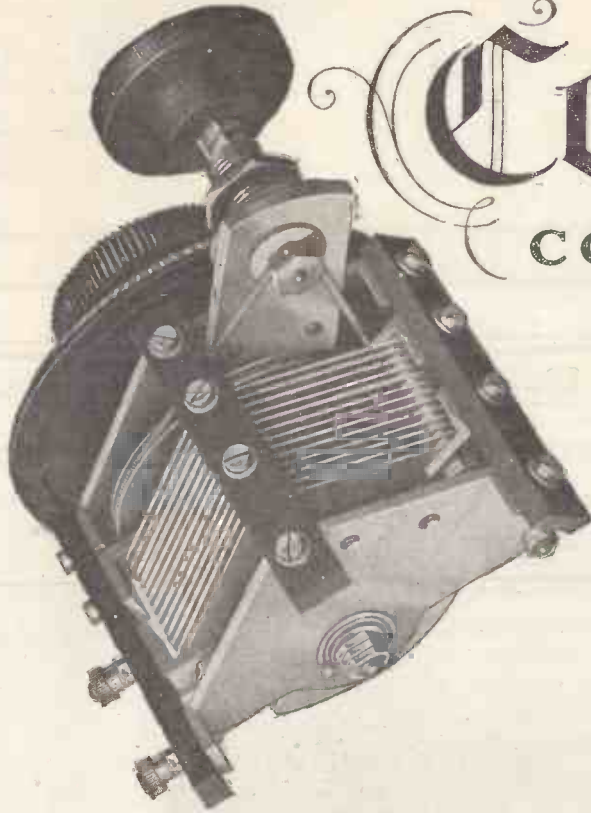

THOSE constructors who desire smooth working, reliable and neat-looking sets, use "Cosmos" Precision Components.

"COSMOS" LOW LOSS SQUARE LAW SLOW MOTION CONDENSER

The "Cosmos" Condenser is a slow motion condenser with absolutely no backlash either when new or after use. This desirable feature is accomplished by the use of a spring belt held in tension which permits coarse tuning with the large knob, and a 10:1 slow motion with the small knob. Cone bearings allow for adjustment and the slow motion bracket can be mounted for remote control.

The Condenser for fine tuning.

Slow Motion '00025 mfd.	14/9	Ordinary Motion '00025 mfd.	12/-
" " '0005 "	15/6	" " '0005 "	13/-

"COSMOS" PERMACON

The "Cosmos" Permacon is an ideal fixed condenser, being light in weight, of guaranteed accurate capacity, and having the lowest possible losses.

The dielectric is mica, and each condenser is tested at 500 volts during inspection. Nickel-plated cases give them a particularly neat appearance.

'0001 mfd.	1/6	'001 mfd.	1/8
'0002 "	1/6	'002 "	1/10
'0005 "	1/6	'005 "	2/8
'0003 " (with clip for grid leak)	1/8	'01 "	3/9

"COSMOS" GRID LEAKS

are uniform and permanent. $\frac{1}{2}$, 1, 2, and 3 megohms, each 1/6.

"COSMOS" High Frequency CHOKE COIL

Suitable for use in reflex circuits or in circuits similar to the Reinartz. The sectionalised windings have the lowest possible self capacity (5.5 mmfd.) and an inductance of 55,000 microhenries.

Owing to its small inductive field, which lessens the chance of stray capacity or inductive coupling, it is far more suitable for use as high frequency choke than large inductance coil.

Price for "Cosmos" H.F. Choke Coil 6/6 each.

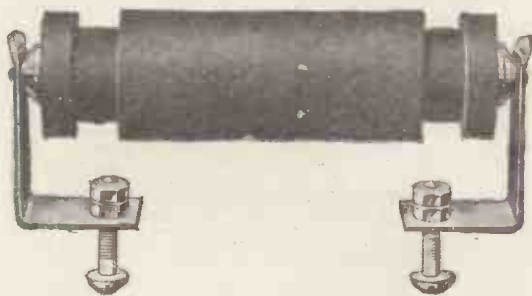

Ask for copy of "Cosmos" Components List.

METRO-VICK SUPPLIES, LTD.

(Proprietors: Metropolitan-Vickers Electrical Co., Ltd.)

METRO-VICK HOUSE, 145, CHARING CROSS ROAD, W.C.2.

The

NATURAL TONE

Loud Speaker



THE
RADIOLUX AMPLION

Prices £4:15:0 to £13:13:0

Other Amplion Models from 38/-

Write for Latest
Illustrated Lists.

There is no substitute for a genuine AMPLION

Here is absolute uniformity—
longer life—increased sensitivity
—incredible economy of opera-
tion—a shockproof filament—Co-
axial mounting system—the same
Cossor unblemished standard of
excellence.



COSSOR POINT ONE
[Red Top]

For H.F. Amplification and Re-
sistance Capacity Coupling
Normal filament voltage 1'8
Filament current 1 amp.
Maximum anode voltage 120 volts.
Impedance 42,000 ohms.
Amplification factor 13.

14/-

[Plain Top]

For Detector and L.F. use.
Normal filament voltage 1'8
Filament current 1 amp.
Maximum anode voltage 120 volts.
Impedance 22,000 ohms.
Amplification factor 9.

14/-

PERIODICALLY Cossor has inaugurated improve-
ments in valve design so far reaching in effect as to
be hailed as milestones in the progress of the industry.
The first self-supporting unsprung filament was in the
Cossor P1—still regarded as the standard British bright
emitter. The first triple-coated filament to work at a
really low temperature was to be found in the Wuncell
Dull Emitter.

And now Cossor has aroused universal interest among
all radio enthusiasts with the wonderful new Cossor
Point One—the first Valve ever to utilise successfully
Co-axial Mounting.

Already eager thousands have discovered in this new Dull
Emitter a standard of performance which has never be-
fore been available in any valve. They have revelled in
a super sensitivity which has enabled them to smash
with ease their own records for long distance reception,
and with the Stentor Two in the power stage they have
been dumbfounded at the superb fulness of tone from the
Loud Speaker.

Yet sensitivity and tonal purity are but two of the outstanding features
of this new valve. Co-axial mounting permits the use of a shockproof
filament suspension system which assures an abnormally long life. A
new method of filament manufacture cuts current consumption to one
tenth of an ampere. A new grid of exceptional rigidity banished for
ever the bugbear of microphonic noises.

Obtain some of these wonderful new Cossor Valves without delay—
they will set you a-tingling with enthusiasm and awake your admira-
tion for the British research workers who have made such remarkable
results possible.



STENTOR TWO
POWER VALVE.

Normal filament voltage 1'8.
Filament current 1'5 amp.
Maximum anode voltage 150 volts.
Impedance 8,000 ohms.
Amplification factor 8.

18/6

Q Ask your Dealer for the new
Cossor Folder which fully ex-
plains the new system of Co-
axial mounting.

The new and amazing
Cossor Point One

Popular Wireless

Scientific Adviser:
Sir OLIVER LODGE, F.R.S.
Technical Editor:
G. V. DOWDING,
Grad. I.E.E.
Assistant Technical
Editors:
K. D. ROGERS,
P. R. BIRD.



Editor: NORMAN EDWARDS, M.Inst.R.E., F.R.S.A., F.R.G.S.

Consultants:
Dr. J. H. T. ROBERTS,
F.Inst.P.
J. F. CORRIGAN, M.Sc.,
A.I.C.
C. E. FIELD, B.Sc.
E. J. SIMMONDS,
M.I.R.E., F.R.S.A.

RADIO NOTES AND NEWS.

Classical Music Wins—A Wild Man of Borneo—Daventry versus 2 L O—More Morning Music?—Broadcasting from Olympia—Channel Swim Radio—Wireless Faces.

Zachary Tan.

CAN you play a rubber balloon? Zachary Tan can! He will play this and a number of other peculiar instruments on August 20th, so if you want to experience the latest musical thrill, listen in for Zachary Tan to-morrow.

Classical Music Wins.

THE recent debate between Sir Landon Ronald and Mr. Jack Hylton, on Classical Music versus Jazz, brought the B.B.C. 828 letters on the subject—172 of these correspondents came down for jazz, 88 were neither heads nor tails, and the vast majority, 568, were out-and-out supporters of classical music every time.

I will readily confess that the result of the ballot surprises me, for Jack Hylton seemed to be making out a good case! Perhaps his adherents are so enthusiastic about jazz that they all went out jazzing instead of writing to the B.B.C. about it!

A Wild Man of Borneo.

MR. J. A. PARTRIDGE, of Wimbledon, has been talking to Borneo. An Englishman out there had only had his station on the ether six weeks, when he got through to Blighty, in Morse, and talked with Mr. Partridge for half an hour.

Brazil kept chipping in, but greetings were exchanged every time the Brazilian nuts kept quiet enough. More messages were started, but more interference from Brazil blotted them out! Eventually Mr. Partridge had to say "Good-bye." What the Wild Man of Borneo said about Brazil nobody knows!

Broadcasting for India.

THE prospectus of the new Indian Broadcasting Co., Ltd., has now been issued. The authorised capital is fifteen lakhs of rupees. (It doesn't sound much, but it represents about £112,000. Having been in India I know all about a lack of rupees!)

The company intends to establish powerful broadcasting stations in Bengal and Bombay, and if these are successful, more stations will follow in other populous centres.

Daventry versus 2 L O.

WHEN the Daventry station was opened last summer there was some talk of the B.B.C. staff playing the town cricket team, and sure enough the Mayor

of Daventry received a challenge last month, the outcome of which was a fine game between Daventry and the B.B.C. Daventry won by an innings and four runs. Captain Eckersley scored one glorious run before the umpire unhesitatingly gave him "out," owing to a kind of technical difficulty developing at his wicket!

Beginnings of Broadcasting.

SIR OLIVER LODGE contributed some interesting reminiscences of the beginnings of wireless to the special number of "Discovery," published in

Exchanging Dud Valves.

IF you can find room for a few words of comment on the prompt and satisfactory manner in which Messrs. _____ have dealt with the exchange of a defective valve, I shall be greatly obliged," says an extract from the letter of a Lincoln reader (Mr. E. Strawson, 19, Milton St.). I know of hundreds of similar instances of considerate treatment from the big British wireless firms; and I'm glad to be able to compliment them upon their courteous attitude to customers nowadays.

More Morning Music?

IAM glad to see that the proposal for more morning broadcasting is being taken up enthusiastically by listeners. The German stations manage to get on the ether as early as 6.30 and 7 a.m., long before the dew is off the aerial! There is a lot to commend this plan, and some time it will have to be put in force here, so why not immediately?

Night-workers and invalids would benefit straight away, and the trade would welcome it, as such programmes would enable demonstrations of a receiver's efficiency to be given at all hours.

Broadcasting from Olympia.

IHEAR that one end of the gallery at the Olympia Radio Exhibition, in September, is to be a broadcasting station at work. A studio will be erected, exactly on the lines of that at 2 L O, and through glass windows visitors to the exhibition will see the uncles being avuncular. There's a possibility of a revue being presented, so you really must "look in" at Olympia next month.

A True Story.

INTRODUCING Gardner T. Smith.—New York Lawyer.—Started Europe holiday. Received radio—"Partner met accident." Sent radio—"Book return passage."

Arrived Plymouth.—Stayed 16 hours.—Caught return boat!

Mr. Smith's "holiday" appears to have been rather like one of those H.F. changes, (with slight damping), that one reads about!

"On the Toes—Rise!"

IT is proposed that the B.B.C. should broadcast a series of physical jerks, every morning, at shaving time. My own feelings about this are well expressed (Continued on next page.)



THE LAST WORD IN WIRELESS SETS.

A cone loud speaker is worked from this 6-valve set, and the baby-grand frame and sounding-board give realistic tone to the music.

connection with the British Association meeting in Oxford. Thirty-two years had passed since the association met in that city, when Sir Oliver gave the first public demonstration of wireless.

In praising the skill, enterprise, and energy of Senatore Marconi and his co-workers, Sir Oliver Lodge disclosed the fact that he himself had been urged by the famous Lord Rayleigh to develop the new invention, but was unable at the time to follow the great man's advice.

NOTES AND NEWS.

(Continued from previous page.)

by the following, culled from the "Daily Herald."

No man with any sense denies
The need for Healthy Exercise.

It's not for me to criticise

This novel proposition.

Let every listener-in who will
Forsake his bed when Dawn is chill,
And do his daily "broadcast drill,"

'Twill keep him in condition.

Yet I, for one, shall not obey
Those brusque commands at break of day.

Upon my virtuous couch I'll stay,

Sunk in a sleep seraphic.

A sedentary life I lead,

But, where the buses swerve and speed

I get what exercise I need—

Dodging the "one-way traffic."

Europe Plays General Post.

NEXT month, about this time, we shall have the European broadcasting stations playing a sort of ethereal "General Post." Nine exclusive wave-lengths (apart from 1,600 metres) have been allotted to Britain, and most of our stations will have to make only minor tuning readjustments, necessitating but slight retuning on the part of listeners.

Of the main stations, only Newcastle, Bournemouth, and Belfast will make comparatively large wave-length shifts, and even these will be covered by practically any ordinary receiver.

"All Together" at the Relay Stations.

THE B.B.C. has decided to put all the relay stations, with the exception of Leeds and Bradford, on a common wave-length of 288.5 metres. Leeds will go to 297 metres, a wave-length which has been allotted also to Hanover, and four other foreign stations. Bradford will share 294.1 metres with Dresden, Bilbao, Liege, Valencia, Onnsbruck, and Trollhatten (Sweden). Cardiff and Daventry remain absolutely unaffected at their former wave-lengths.

The Climax!

WHEN Mr. Ernest Wright, the manager of a Holloway wireless shop, was married in London recently, his assistants and friends formed a wireless guard of honour. The bride and bridegroom walked from the church under an arch of drawn—no, not *swords*, but wireless earth-tubes! I hope that now they have passed the "Climax," the young couple will find this is a very good earth—to live on.

Channel Swim Radio.

WHEN Miss Ederle so gallantly swam the Channel, readers of American newspapers were kept abreast of her progress by wireless reports despatched at regular intervals during the swim.

The tug "Alsace," which accompanied the young champion, was fitted with a quenched spark transmitter, and from this the reporters kept in touch with land. The Press messages were then transferred to the regular Marconi transatlantic service, and special editions of the papers were coming out in America during the whole time that Miss Ederle was in the water.

Talking Tanks.

WE have already had demonstrations of the use of wireless in aeroplanes.

The Hendon display showed how the squadron-leader could swing all the machines about by one wireless order, and that a whole flock of them would then operate as one cohesive unit. Now the same principle has been applied to tanks, and very successful tests have been made. Not only can one tank talk to another whilst out "on the job," but they can communicate with headquarters or even co-operate with aeroplanes!

Up a Tree.

A VERY, very unkind South London reader has sent me the following news cutting, taken from the "Daily Chronicle":

"Ariel," the woman parachutist, who is making a series of descents at the Crystal Palace, last night landed on the top of a tall tree and was kept there for a long time.

SHORT WAVES.

"The man who can eliminate the atmospheric in a simple way will—if he handles his patent rightly—become a millionaire."—Captain Eckersley, writing in "Reynold's News."

"The B.B.C. goes out of business at the end of the year, but it will depart with considerable glory if it can make the Government disgorge, or, at least, explain why they are clinging to money that was not collected for them. They have no right to turn radio into a taxable entity."—Edinburgh Evening News."

"A correspondent suggests that listeners-in would rejoice if more attention were given to the question of purity and correctness in vowel sounds. People are more than tired of hearing that the 'Wahrliiss Orkistrer' is going to play."—Daily Chronicle."

"It was found impossible to climb the tree owing to the brittle nature of the branches, and the woman was finally rescued by means of a fire escape."

He wants to know what I was "up to" at the time! Only a balloonatic would ask such a question!

Aeroplane Wireless.

IT is announced from America that the Sikorsky bi-plane, entered for the New York-Paris flight of 3,600 miles, has been allotted the wireless call-sign W O P. The intention is that when the wireless apparatus is out of touch with the American stations, it will be able to pick up European weather reports, etc., and will be able to talk to liners on the ocean below.

"Better Conditions Coming."

HAVING been incautious enough to mention that readers were already picking up America on simple receivers, I suppose I have only myself to blame for the shoals of reports that have come in since. Amongst them is one from Mr. E. Tarplee, of Gloucester, who has often been in the news for remarkable long-distance reception.

He quite agrees with my diagnosis that this is going to be a wonderful season for reaching out. And he tells me that nearly a month ago he had the World's Playground station (W P G, Atlantic City), as well as a lot of American carrier-waves that he couldn't identify properly. This was using

a Det. and 2 L.F., so the straight circuits still hold their own for long-range work,

"By the Way."

BY the way, I hear that "By the Way" will shortly be returning to London.

Judging by the way the provinces have enjoyed it, the broadcast performance which has been arranged provisionally for August 19th should be a great success.

The Automatic Policeman.

ONE of the exhibits at the National Radio Exhibition, to be held at Olympia, London, next month, is to be a piece of quartz, as used for wave-length control. It looks like a piece of glass, but as a matter of fact it acts more like an automatic policeman than anything else. Placed in circuit under the right conditions, it will keep a broadcasting station absolutely, accurately on its allotted wave-length, without wobbling half a metre, one way or the other. Probably the use of quartz will become general in time, and before long we shall be wondering however we managed without it.

Exhibition for Ireland.

THE radio manufacturers and wholesalers of the Irish Free State have now banded themselves into an association for the purpose of promoting and protecting trade interests.

The first step to this end is to be a Wireless Exhibition, and it is expected that this will be held in the early autumn.

Wireless Faces.

THE Post Office have now granted the first two licences for Television, and experimental "sights" are on the ether. Faces of the operators and other unexpected "views" are being sent out on 200 metres, but, of course, it needs proper televiso. apparatus to see them. In the ordinary set they can only be received as a noise, rather like that made by an aeroplane in the distance.

"Looking-in" on 200 Metres.

THE actual stations which are engaged in this pioneer television work, are under the control of Mr. J. L. Baird, the inventor. One is situated at Motograph House, Upper St. Martin's Lane, London, and is now in operation. The other station is under construction at Green Cables, Harrow-on-the-Hill. The call signs are 2 T V and 2 T W; respectively.

The power employed at 2 T V is the same as that of one of the B.B.C. relay stations (i.e. 250 watts), and almost nightly pictures are being sent out from London to Harrow. I am sure that readers will join with me in wishing this British venture the success it deserves.

Radio for the Blind.

IN their annual report, the National Institute for the Blind announce that up to the present 158 wireless sets and 282 pairs of headphones have been presented, 117 licences have been provided, and 26 aeriels have been erected. Those having discarded headphones are asked to send them to the Secretary-General of the Institute.

ARIEL.

THE Geneva wave-plan, as it is generally termed (actually the details have been worked out in Brussels), will be put into effect shortly, probably before the end of September. The actual date is not yet fixed. It is mainly dependent upon the ability of the laboratory producing the controlling gear for each station to complete its task by the beginning of September.

The principles underlying the plan are already well known, for that reason the briefest summary will be sufficient for present needs. The stations of Europe are divided into two classes—those considered

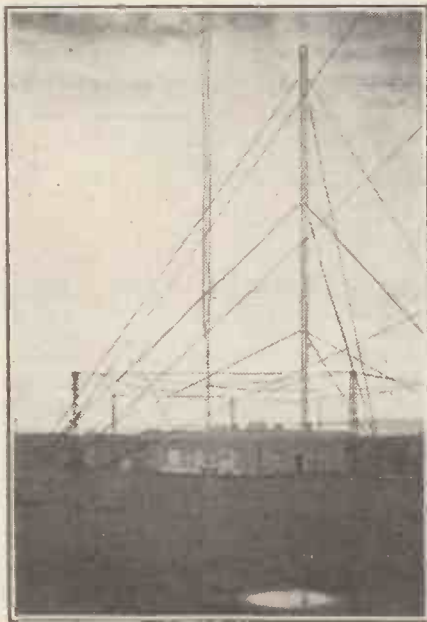

The aerial masts at the new Vienna station.

to be of such importance as to require an absolutely exclusive position in the European ether, and those of more local importance, which, while deserving freedom from interruption in the area for which they were originally designed, cannot hope to be heard clearly at extraordinary distances.

Sharing the Ether.

These latter stations will not have exclusive positions in the ether, but will share a wave-length with other stations remotely placed. The stations enjoying exclusive wave-lengths will be separated from their neighbours by at least ten kilocycles, a margin which, by experience, is found to give absolute freedom from mutual interference. In order, however, to make doubly sure of the success of this system of allotment, the choice of wave-lengths has been made according to a "polygonal" method, which means, in practice, that the neighbouring stations, whether in the "exclusive," or "commune" classifications, are separated by some hundreds of miles.

The plan requires from all the European stations three leading characteristics—

THE GENEVA WAVE-PLAN.

LATEST DETAILS ABOUT THE WORK OF THE INTERNATIONAL RADIOPHONE BUREAU.

BY ARTHUR BURROWS

(Manager of the International Radiophone Bureau.)

[EXCLUSIVE TO "POPULAR WIRELESS."]

a very definite understanding regarding the wave-length assigned to it; an ability to adhere strictly to this wave-length; a freedom from harmonics. While the stations are preparing to serve these conditions, listeners can also make important contributions to this scheme for better broadcasting by overhauling their receivers.

In this overhaul two points should be aimed at—greater selectivity, and freedom from ability to oscillate. Good reception is impossible when a receiving set is re-radiating.

"Toeing the Line."

As has already been indicated, the transmitting stations are having prepared for them certain controlling—or, more correctly speaking—checking apparatus. Each station is being assigned a wave-length which must not only conform to a common standard, but must be rigidly adhered to. Unfortunately, for various reasons, quite a number of stations need careful watching on this point.

Some are used in the daytime for aerodrome or other purposes, and, therefore, have to make readjustments each night, and as there are few countries where broadcasting is yet in a sufficiently flourishing state to admit of the purchase of duplicate transmitters (or new ones guaranteed to possess absolute stability), it has been considered as an essential part of the Geneva plan that each station should have a means of assisting the engineers in their task of keeping their "toe to the line."

The Wave-length Lamp.

The apparatus in question is a wave-meter, specially constructed for each station, according to the wave-length assigned to the station. This wave-meter is very sensitive and is provided with a "tell-tale" lamp, which burns brightly when the station is transmitting on the correct wave-length. This means that one of the duties in future for a station engineer, like that of an engine driver, will be to keep his eye on the signal—the little lamp of his wave-meter.

It is true that in the search for a checking device one method employing the much-talked-of quartz crystal was examined. About its precision there is no question, but quartz crystal control presents certain difficulties which would delay the general application of the new plan. The Brussels wave-meter with its little lamp, gives to the engineer not only a precise indication of what is the correct wave-length, but also, by varying degrees of luminosity, some guide in the approach to the correct wave-length. In other words, it avoids a process which might be compared to hunting for a needle in a haystack.

So much for principles and processes.

Shakespeare employed Jacques in "As You Like It" to remind us that "All the world's a stage." Europe will certainly be a stage when the curtain is rung up on the new wave-plan. There will, however, be this difference between a new play in a compact little theatre, and the

"spectacle"—we have yet to coin a really suitable word—now under production by the European broadcasters; the professional producer can rehearse his new piece for days and weeks, behind closed doors, during which he can drill his actors, stage carpenters, and sceneshifters—all close at hand—into a clockwork-like routine. He closes his theatre for this purpose.

"When the Curtain Rises."

There is no close season for broadcasters, and so, when our curtain rises it will be on something of the nature of a rehearsal and first-night performance thrown into one. We shall be hunting for weak spots and will undoubtedly find some, but it is only fair to those who will be engaged in this unusual task—the first in the world of its kind and magnitude—that all should know the conditions governing its completion.

Directly the night for the application of the new plan has been definitely fixed, the broadcasting engineers of the several European countries will be left more or less to their own resources to ensure its success.

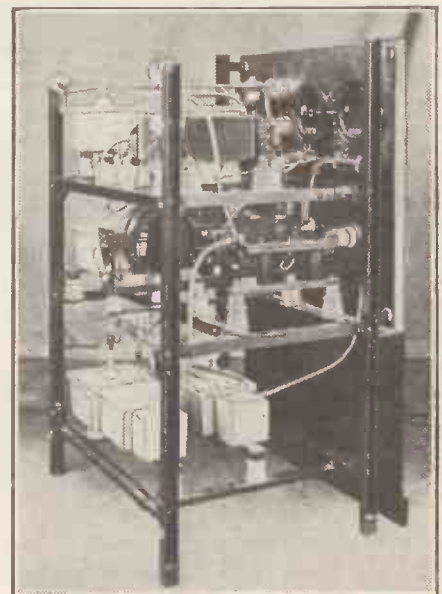

Rear view of transmitting panel at the Vienna station.

For this reason we heartily recommend to readers of POPULAR WIRELESS to watch carefully for advice given by the British Broadcasting Company, and to follow closely any suggestions or instructions which they may offer to listeners.

A point to be remembered is that the new plan has been prepared for the benefit of the millions who now listen nightly to the

(Continued on next page.)

SOME NOTES ON GRID BIAS.

FROM A CORRESPONDENT.

IN spite of the fact that grid bias is now known to be practically essential where sets with more than one stage of L.F. amplification are concerned, many readers still use receivers having L.F. valves without this provision.

Although their results may on occasion be free from distortion, they cannot appreciate the fact that the H.T. current consumption will be considerably reduced when the above battery is introduced. They may also be ignorant of the fact that the volume will be improved.

Values for Various Stages.

While it is assumed above that clear telephony can be obtained without grid bias on two L.F. valves, in actual practice this is not often possible, the results of such an attempt in most instances resembling those obtained on a cheap and scratchy gramophone.

No grid bias need be used on a set having one stage of L.F. amplification, but if a separate H.T. tapping is employed on the L.F. valve, $1\frac{1}{2}$ to $4\frac{1}{2}$ volts grid bias will often effect a noticeable improvement.

If grid bias is used on a set having only one L.F. valve, it is advisable to employ a

grid bias battery that is tapped every $1\frac{1}{2}$ volts, as the voltage is usually critical.

Suitable grid bias voltages for various sets are as follows:

Resistance-capacity coupled L.F. amplifiers.

First stages, $1\frac{1}{2}$ to $4\frac{1}{2}$ volts.

Second stages, 3 to 6 volts.

Third stages, 6 to 12 volts.

Subsequent stages, from 12 volts upwards.

Transformer-coupled L.F. amplifiers.

First stages, $1\frac{1}{2}$ to $4\frac{1}{2}$ volts.

Second stages, $4\frac{1}{2}$ to 9 volts.

Third stages, 9 volts upwards.

Choke coupled L.F. amplifiers will take grid bias voltages between those suitable for transformer coupled amplifiers and those used for resistance coupling.

The tables are based on the assumption that suitable H.T. voltages are given to individual valves, and that a power valve is used for the last L.T. stage with first and second stage L.F. valves in the preceding positions. The voltages on the grids may vary with the type of valves used, but the above tables give a rough indication of suitable potentials.

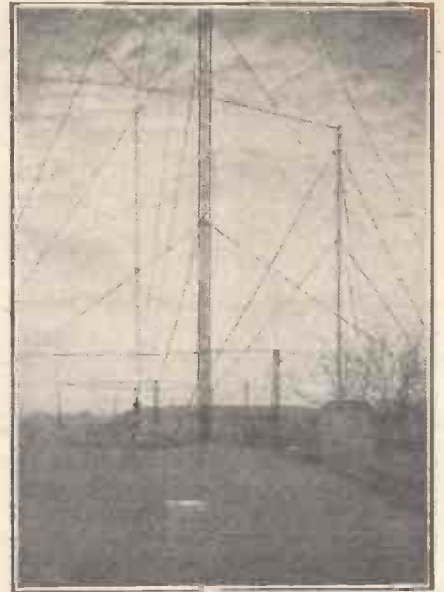

Another view of the Aerial at the new Vienna station

THE GENEVA WAVE-PLAN.

(Continued from previous page.)

broadcast programmes of Europe, and is not some experiment being undertaken regardless of the consequences to those outside the transmitting stations. It is a serious effort to give to Europe a state of affairs not enjoyed even in America, where broadcasting has been in practice for over five years. In this, as in all processes of development, some sacrifices have to be made, but a close examination of the plan, when its details are published, will show that any small inconveniences which it may offer to a limited number of listeners will be easily outweighed by the advantages.

Great Gain to Listeners.

In order that there may be no misunderstanding upon the meaning of this remark, let us take an illustration. A listener to a British relay station, which, in future, may be working on a commune wave-length, may have made a hobby in the past of searching-out with his multi-valve set for some small-power station in a distant part of Europe, for which he has a sentimental interest.

He may find that this particular station has, by sheer coincidence, been given the very wave-length of his local station, and that, therefore, his old search is no longer possible of success. Against this he should in future find more than eighty of the principal stations of Europe, the majority of which have not until now been receivable with any real pleasure, standing out clearly like the lighthouses on a length of rocky coastline.

Some, perhaps, may suffer at a distance from slight interferences outside the control of the broadcasting organisations, but of the eighty odd exclusive wave-lengths, the majority should be heard clearly over the maximum distance which their power, situation and radiating characteristics make possible.

A NEW SLOW-MOTION DIAL.

FROM A CORRESPONDENT.

THE sketch illustrates the fundamental idea embodied in a new type of precision condenser dial recently placed on the French radio market. The usual expensive cut-gear movement is entirely eliminated, and in general appearance the device resembles an ordinary dial with small vernier knob. In France it can be purchased at a cost approximating to one

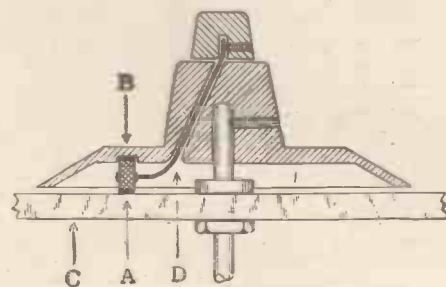

fifth of the cost of the more complicated geared dial, and being equally effective it is naturally becoming very popular. It may be described as an elaborate modification of the ordinary home-made friction gear, where a small typewriter eraser is made to engage the edge of the dial, and rotated in order to obtain the desired slow movement of the latter which then acts as a frictional pinion-operated gear.

In the present example the small rubber pinion, A, engages a small recess in the internal face of the dial at B, and also the top face of the receiver panel, C. The pinion is attached to the small vernier knob by means of a flexible shaft, D, which passes through a special channel moulded in the main knob. A turn of the small knob rotates the pinion which in turn slowly revolves the dial, the effective ratio being approximately 15 to 1.

It would appear that the unavoidable torsional play of the flexible shaft might have an unbalancing effect on the fine setting of the condenser plates, but in practice this is not the case.

No "Transmission" Troubles.

When commencing or finishing an adjustment one experiences, by nothing more pronounced than a mere sense of touch, a very slight "taking up" or "letting out" of the flexible shaft, but this is no drawback, and as the writer has proved by a practical test it can be totally ignored.

The device works smoothly and efficiently and certainly deserves to be known on this side of the Channel.

One other advantage of this type of friction drive is the fact that, as very little metal is employed in its construction, undesirable coupling effects are reduced to a minimum, and consequently no extra hand-capacity troubles are introduced.

A Neutrodyned Reflex Super Het:

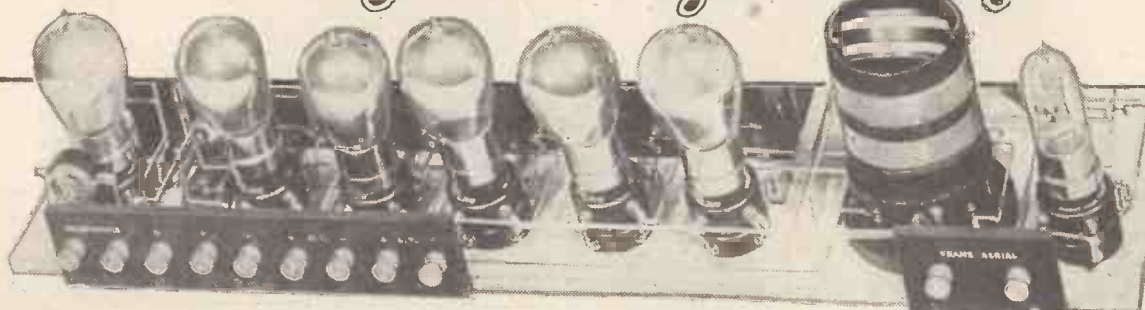

By
J. MacINTOSH

THE circuit shown in Fig. 1 was the result of experiments to combine an "Autodyne" unit with a 4-valve receiver so as to form a complete super-heterodyne receiver. The 4-valve set employed two H.F. valves—V2 and V3—a detector valve V4, and one power valve V5. Valve 3 acted as a "reflex" valve amplifying the low frequency output from the anode circuit of the rectifier. The two H.F. valves were neutrodyned, the method adopted being the original and the easiest, incidentally; but, let it be said, not the most efficient method. Loose coupled aerial circuit could be used and complete control exercised over oscillation.

In Fig. 1, V1 acts as both detector and oscillator—the circuit used being similar to the "Tropadyne" type. It is not proposed to deal with the theory of the super-heterodyne, as this has already been dealt with exhaustively by this journal. Coils L4

and L5 are an addition to the usual "Autodyne" circuit, and their purpose will be explained later.

whole range of the oscillator tuning condenser C1. Coils L1, L2, and L3 may be mounted in a 3-way coil holder, with L3 as the centre coil. Actually, the writer used L3 as one of the outside coils. If the positions of L1 and L2 are moved relative to each other the tuning of the oscillator will be altered—a variometer effect taking place. L1 and L2 should be coupled close together and left in that position, the movement of L3 alone being variable. Of course, the three coils could be coupled together and fixed so, although it is preferable to have L3 variable.

Improving Selectivity.

Condensers C and C1 should be .0005 mfd. and it is essential that C1 be of the slow motion pattern as the tuning of the oscillator circuit is very sharp.

During experiments, the writer discovered that the tuning of the frame circuit

balance of potential is obtained between the two points at which the frame circuit is connected. The oscillations in the circuit L1, L2, C1 are thus prevented from entering the frame and being radiated. It should be possible to set C2 and C3 (large type neutrodyning condensers will do) so that no radiation will be experienced by neighbouring sets.

The coupling together of L4 and L5 does interfere slightly with the tuning of C and C1, so, once a reasonable position of coupling was ascertained it could be left thus. I am not prepared to state whether or not the circuit radiates just before the valve V1 chokes owing to excessive coupling between L4 and L5. It is possible it does not, as I imagine the valve-chokes immediately the coupling between L4 and L5 is close enough to cause oscillation. Possibly the choking action is due to the valve attempting to oscillate at both the transmission frequency and the oscillator frequency.

Suitable Valves.

The circuit, as given in Fig. 1, works excellently with L5 removed as in the orthodox arrangement—all the tuning being done on C and C1. L7 is the aerial coil of the 4-valve receiver and it serves as one of the transfer coils—the other coil being L6. These two coils could be Nos. 750—the two high-frequency transformers T1 and T2 being tuned to the wave-length of the "filter" L6, L7, C5. The coupling between L6 and L7 should not be too tight, and it was found advantageous to connect a fixed condenser of .0003 or .0005 mfd. across L6 as shown at C4. Oscillation of the intermediate frequency amplifier is obtained by virtue of L8 being coupled to L7. It is essential to have a grid bias on V3 of at least 1½ volts negative, otherwise distortion is certain.

The 2-volt type of valve works well in this set; a D.E.R. D.E. 2.L.F., or Cossor Wuncell plain or red top functioning excellently as the "detector-oscillator." The D.E.6 also acts well in position V1. V3 should be suited for both H.F. and L.F. amplification—but especially the latter—here the D.E.2 L.F. Cossor (both types) and D.E.R. work well.

The long wave side of the set is not out of the ordinary—by-pass H.T. condensers being omitted for clarity. The values of the various fixed condensers in connection with the "reflex" part of set, etc., are normal, and not in any way critical.

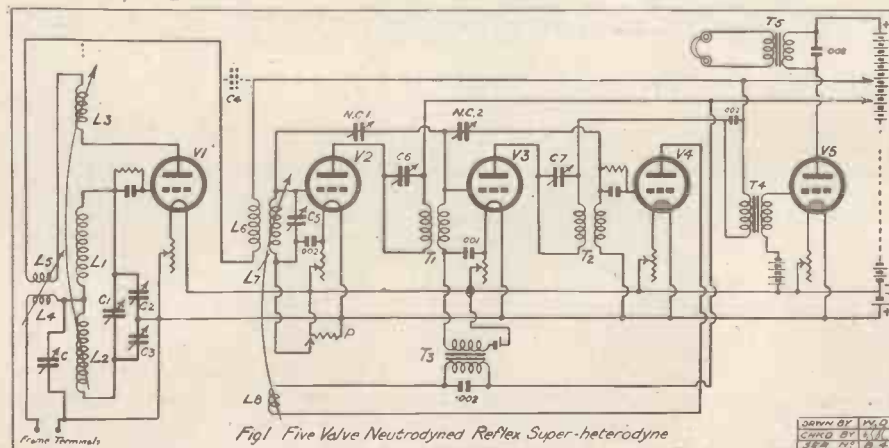

and L5 are an addition to the usual "Autodyne" circuit, and their purpose will be explained later.

A Variometer Effect.

Coils L1 and L2 can be either two No. 40 or two No. 50 Lissen coils, joined in series, and placed side by side. If the plug connection of L1 is joined to the grid condenser of V1 then the socket connection of L1 should be connected to the plug connection of L2. This is to ensure the two coils do not oppose each other. L3 is the reaction coil and its size may be a No. 35, 40, or 50. It should be no larger than is necessary to give oscillation over the

was not at all critical, and a method of increasing the sharpness of tuning was sought. L4 was in use as a loading coil—the frame aerial having an insufficient number of turns for normal use—and the effect of connecting L5 in series with L3 in the anode circuit of V1, and coupling it to L4 was noted. Signal strength was increased, and the tuning of C was considerably sharpened, consequently improving selectivity slightly. If the coupling between L4 and L5 was too tight, the valve simply "choked" and signals disappeared. With L4 and L5 separated (or L5 shorted out) it should not be possible to radiate, provided C2 and C3 are so adjusted that a perfect



Conducted by our Staff Consultant, J. H. T. ROBERTS, D.Sc., F.Inst.P.

REFERRING to the question of L.F. howl, with which I dealt in these Notes recently, I have had several letters from readers describing their experiences in this direction and the various means by which they have overcome their troubles. It is curious that in this, as in so many other matters in wireless, each one seems to have his own particular theory as to the cause, and also the cure, for difficulties. Of course, I think I omitted to mention that the best value of the by-pass condenser, the function of which is to provide a path for the H.F. currents around the resistance of the H.T. battery (or any other resistance that may be in the circuit) depends upon the frequency of the currents. If this is really high, a comparatively low value of condenser will be sufficient, but if it is not particularly high, a larger condenser will be necessary. It is, however, a very simple matter to add further condensers in parallel with the existing ones, the total capacity being then equal to the sum of the capacities of the individual condensers. It may be mentioned that it is usual to employ the large "paper" condensers for such purposes as the above.

Improvements in Tone.

In this connection it should be mentioned that the improvement in the tone and general reproduction by the judicious use of fixed condensers in this and suchlike ways is very real, and if you do not at present employ any condensers in this way, it is well worth while to make a few trials.

Those of my readers who employ the H.T. accumulators instead of ordinary H.T. dry batteries will, no doubt, be enthusiastic as to the marked improvement both in tone and volume that is thus obtainable: this in itself is due to the very low internal resistance of the H.T. accumulator as compared with the H.T. dry battery.

Even when fresh, the dry battery has quite an appreciable resistance, and after a short life its internal resistance increases considerably. Incidentally, it may be noted that it is quite unnecessary to shunt an H.T. accumulator by a condenser.

Amplification Factor in Practice.

Another matter which seems to interest a considerable number of readers is the question of the amplification obtainable from a valve of given amplification-factor under various conditions. When using choke or resistance coupling, it is important to remember that it is impossible to obtain an amplification equal to the factor

of the valve unless the choke or the impedance be infinite in its impedance value. This is obviously impossible, and in practice it is usual to employ a value between five and ten times the impedance of the valve in the case of the anode resistance, or perhaps twice the value of the valve in the case of the choke, in which case the actual amplification will probably be between

of the valve is reduced by the transformer primary to perhaps 60 or 70 per cent of its theoretical value before the value is arrived at which may be multiplied by the transformer ratio, and even then there are certain further allowances to be made.

An interesting little component is the new Philips safety fuse, for the protection of the filament of the valve against burnouts due to wrong connection of the H.T. battery or making wrong contacts of the valve pins with the sockets. This fuse consists of a short length of fine wire (filament wire) enclosed in a short glass tube and connected with two metal caps forced on to the ends of the glass tube. The fuse is held between two metal springy clips after the fashion of a grid-leak, and it fuses at a current of about 150 milliamps.

Safety Fuses for Valves.

This is evidently sufficient to protect any filament, even of the 0.06 type, from H.T., since the latter, although operating at 0.06, will withstand considerably more than that current without actually burning out, and the momentary subjection to a much higher temperature than its rated working temperature will not harm it.

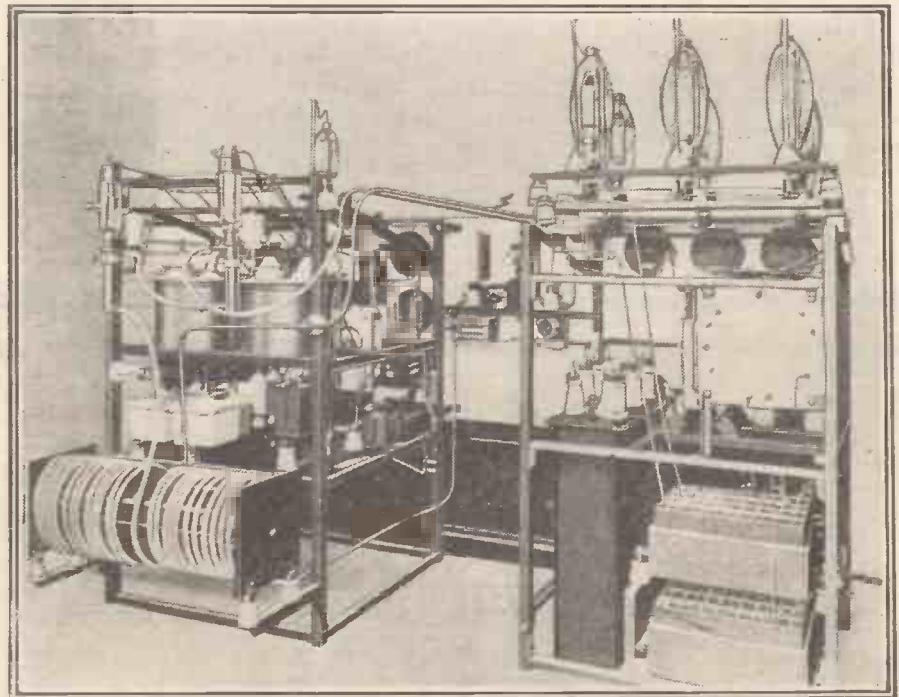

A view of the transmitter at the New Vienna Station.

60 per cent and 80 per cent of the amplification factor of the valve, lower values being obtained with the resistance than with the choke:

In passing, it is desirable, when using resistance, or choke coupling, to employ a valve of high amplification factor.

In this connection the transformer ratio is also involved, and it is common to assume that the product of the amplification factor of the valve and the transformer ratio gives the amplification actually obtained. But this is not correct, in so far as the transformer primary acts as a choke and, being of insufficient impedance value (as a rule), it does not bring out (so to speak) the maximum amplification from the valve. In general the effective amplification factor

Of course, notwithstanding what is said of burnouts due to the H.T. battery, the usual cause of a burnout is the L.T. battery, not the H.T. at all. And here what is required is a fuse that will protect the valve filament against excessive filament-battery voltage.

This is a much more difficult problem, since such a fuse would be working normally at a current which was in the region of its fusing current. Hitherto, it does not seem to have been found possible to provide a fuse that will "go" at, say, 0.09 amp. and yet will carry 0.06 amp. indefinitely and that, furthermore, will have a resistance small in comparison with that of the usual

(Continued on page 868.)

HAVING obtained stability and nice working conditions on our four-valve or three-valve set, as the case may be, the next step to take is to put on the oscillator; but first of all let us see what operation we want to perform.

The principle used in the super-heterodyne is like this. Normally our one high-frequency valve delivers high-frequency currents to the detector valve; these are rectified and deliver low-frequency currents, similar to the modulation of the transmitter, directly to the low-frequency amplifier. We require, however, to get more sensitiveness—more high-frequency magnification, much more, in fact—and if we try to add this with more H.F. stages we run into considerable trouble through instability, and an expert will have to be called in.

BUILDING UP A SUPER-HETERODYNE RECEIVER.

The second instalment of an article describing a novel method of constructing an efficient super-het. step by step.

By Captain H. J. ROUND, M.C.
(Chief Research Engineer, Marconi Co.)

H.F. is a distance-getter and L.F. a volume-getter, and this I.F. is definitely a distance-getter.

So much for theory. Let us put our oscillator on the set and try some simple tests to see if it is working O.K. The best oscillating circuit to use is the Hartley circuit—a coil of 80-100 turns on a 1.8-in. diameter cardboard tube, with a split in the middle of the coil, the split being

joined with a .01 mfd. fixed condenser; and this coil system is joined up as in Fig. 1.

Again, you will have to adjust your turns, and they should be arranged so that the longest wave on the oscillator is about 700 metres if the longest wave on your frame and tuned anode coil is 550 metres. You will see the reason for this later on, and we will also go a little bit more into the question of calibrating them, as for an amateur these calibrations are distinctly troublesome to do. This coil wants to be set on your baseboard two or three inches away from your tuned anode coil. The coils can

When the note is in the audible condition it is not much use to us; speech and music are horribly distorted; but if we carry the beats to an inaudible frequency, put this inaudible frequency into a tuned circuit, tuned to the new or intermediate frequency, and then rectify it again with a non-magnifying rectifier, we shall recover the speech and music undistorted.

"Definitely a Distance-Getter."

Of course, such an operation would waste energy if only carried so far—we should only gain in tuning. So we connect a valve

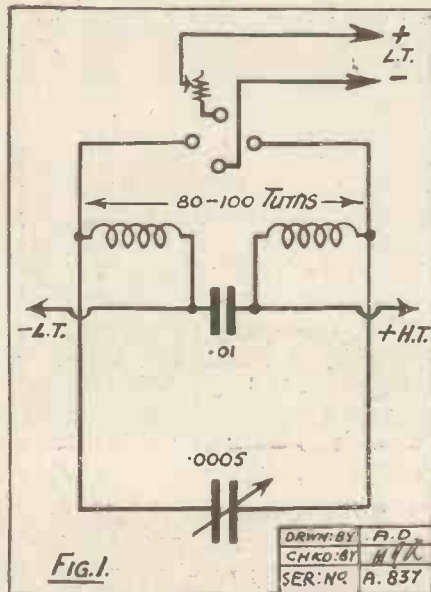

There is another way which, in some respects, is simpler. We induce into our rectifier a continuous oscillation, from a local oscillator. It will give a note with a carrier wave which can be carried to inaudibility by making the difference between the inducting oscillator and the station's carrier wave sufficiently great.

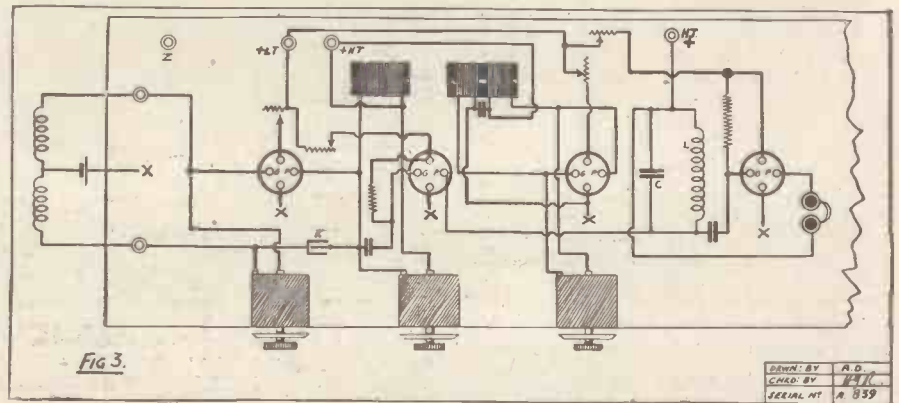

to this inter-frequency (I.F.) circuit, and magnify up the signal, and then perhaps again. Thus, when we rectify we shall have the benefit of two more high-frequency stages, and good ones, too, because it is much easier to get good magnification on this longer intermediate frequency with stability than on the short H.F. waves.

This I.F. gives a type of magnification which is similar to high-frequency and not to low-frequency magnification. In general,

be put on the board as in Fig. 2. Means should be arranged to move the oscillator coil nearer to, or further from, the rectifier coil.

Now listen-in first to your local station, then start the oscillator up. You will hear the usual heterodyne sound as you move the oscillator condenser, with the note going very low, then possibly a click, and the note going high again. This clicking would be a nuisance if we were after an audible heterodyne note; but if you set the coils so that the click just occurs and at a slightly greater distance it is not occurring, the position will do to start with.

Perhaps you do not get a click with your particular valves; but don't worry if you get your high heterodyne notes clearly—adjustment of distance can be made afterwards.

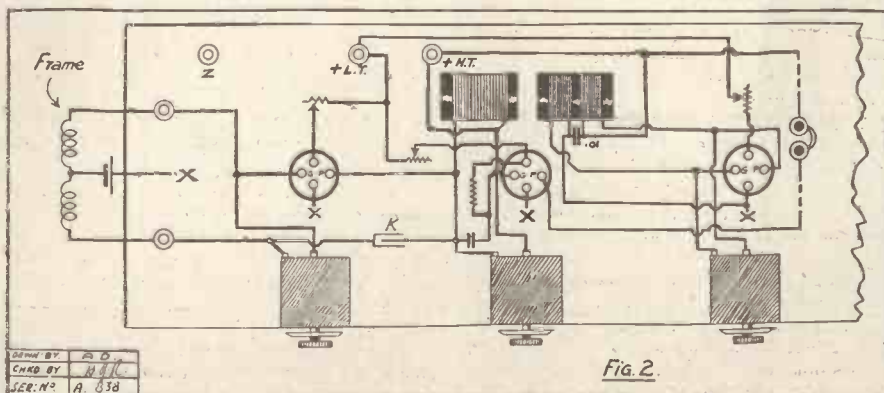
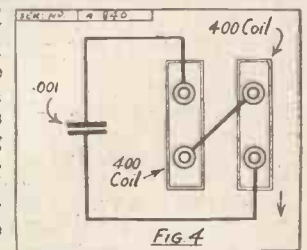

(Continued on next page.)

BUILDING UP A SUPER-HET.

(Continued from previous page.)

Now the first intermediate stage has got to be arranged for. I am assuming that the rectifier is a valve such as an R, D.E.R., D.E. 5B, or a D.E. 8 H.F., and not a power valve of low impedance. For a home-made set the simplest scheme for the I.F. system is a tuned choke-coil system.

A Simple Adjustment.

In Fig. 3 the detector valve is connected to the circuit L-C, which not only has to be tuned to the supersonic beat

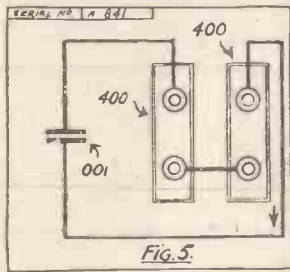

FIG. 5

tone, but has to be arranged to give just so much tuning that it gives a maximum selectivity without muffling of signals. Its wave-length should also be kept fairly long, as there is less trouble in getting magnification with long waves.

I think somewhere between six and eight thousand metres is a nice range, but you can work from three to four thousand metres with economy of wire. Five to six thousand metres should be avoided on account of Rugby long-distance telephony.

As the circuit needs to be adjustable in a simple way without too much expense, one of the three following methods may be used.

A suitable value for K will be about .001 mfd., and a variometer can be made up of two 400-turn coils sliding side by side.

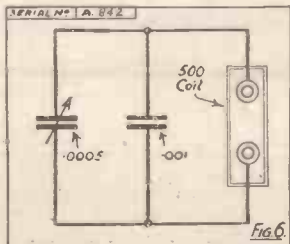

FIG. 6

If connected as in Fig. 4 the wave-length is longest. As you slide one of them in the direction of the arrow the wave-length gets shorter. Then if you reverse the connec-

tions as in Fig. 5 the wave-length will be shortest and will get longer as you slide the coil. Another way would be to take one 500 coil, put a .001 mfd. condenser across it, and then a cheap variable .0005 mfd. across that as in Fig. 6. Or a third method with a 500 coil, with a piece of copper sheet arranged to slide near the coil (Fig. 7).

If you increase your condenser much beyond .001 mfd. and decrease the coil accordingly to keep to the same intermediate frequency, you will get too sharp a tuning, and vice versa.

All these are suggestions, so that with a little thought you may be able to use what you have in stock for trying the experiments with. I will assume for the article that you are using the sliding-coil method, as in Fig. 4.

Obtain or make two coils of about 400 turns each, standard size. These can be layer-wound, but each layer should be spaced from the next one, otherwise self-capacity will cause some trouble. Also, get two .001-mfd. mica condensers and a 250,000-ohm. grid leak, and another valve of the same type as the rectifier. Now connect up as shown in Fig. 8. Where I show the two coils connected in series, place side by side. We have now a one-stage I.F. magnification which it would be better to thoroughly understand before going any further.

One I.F. Stage Working.

I find it an improvement to put grid bias on the first rectifier (the one you heterodyne) when you are oscillating, the value of this grid bias being best found by trial. This is only a minor point, but is worth paying attention to.

Now you can get to work and see what improvement has been made to the sensitivity of the set, and all the peculiar points about super-heterodyne working, for now you have a super with one stage of intermediate frequency.

Set your aerial condenser and tuned anode condenser to the local station tune—which points you should know from previous experience—and run the oscillator condenser round. The local station should come in at two points on the condenser. If it is too strong to play about with, mistune your aerial condenser a bit.

Now, we have seen that the coils of the intermediate frequency, if arranged side by side, one way oppose each other and the other way add to each other. That is to say, the wave-length of the I.F. circuit

will be long one way and short the other, and intermediate positions can be found by sliding the coils over one another. You will be able to fix up some gadget to do this sliding.

An Interesting Calculation.

Try the local station with various arrangements of the coils, and you will find the two receiving points are nearer together when the coils are adding than when they are in opposition.

When you are listening to your local station you will get two adjustments on the oscillator, and half-way between them a weak heterodyne note. Now, if your oscillator is calibrated you have a means of measuring your intermediate frequency circuit wave-length. Supposing you get the three positions as

1 2 3,
convert these into frequencies (freq. x λ) = 3×10 metres,

then $n_1 - n_2$ should equal $n_3 - n_2$, and this $n_1 - n_2$ is the frequency of the intermediate frequency circuit. This point is only one of interest, but it is always wise to know what you are doing.

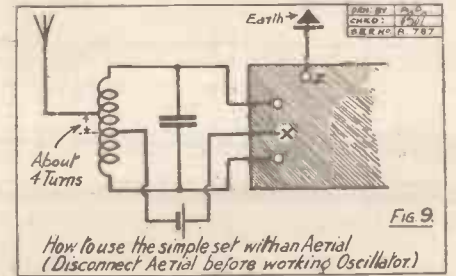

FIG. 9

How to use the simple set with an Aerial (Disconnect Aerial before working Oscillator.)

You will see now why your oscillator condenser should go up to a longer wave-length than the wave you wish to receive: it is so that you can get both of these active points of reception.

The actual frequency of the I.F. circuit is not of much importance with one stage, (Continued on next page.)

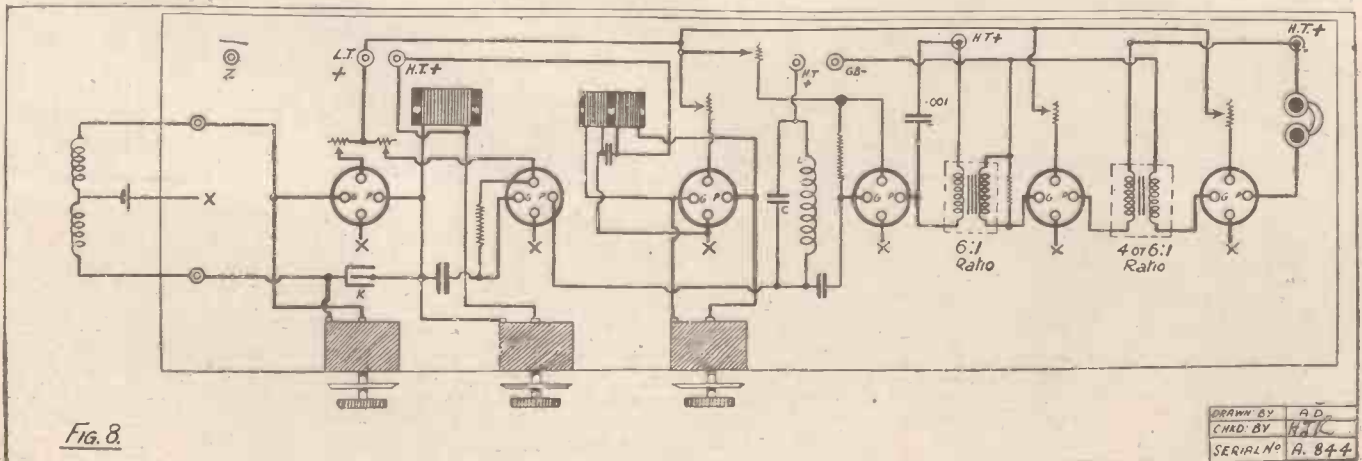

FIG. 8

DRAWN BY A.D.
CHKD BY R.A.C.
SERIAL NO. A. 844

POINTS WORTH NOTING.

FROM A CORRESPONDENT.

IN many cases small power valves make excellently stable detectors, and give results far superior to those given by other types, both in point of tone and sensitivity.

Nowadays permanent and semi-permanent crystal detectors are very popular, and, consequently, many are in use. They are liable to lose their sensitivity if subjected to heavy inputs, and should therefore be disconnected when the set is not in use. Atmospherics are heavy during most summer nights, and it is these which may cause the trouble. If an aerial earthing switch is employed, as it should be, this will assist, but not a lightning arrester, as such is a protection against only very heavy statics indeed.

It is advisable to employ an aerial earthing switch which isolates the set from the aerial altogether when the latter is earthed. This is if complete protection is desired.

Leads and Batteries.

All leads should be removed from the set every now and then and the ends of them cleaned up. Terminals, too, should be cleaned at fairly frequent intervals. Oxidation can take place on the two surfaces of pieces of metal apparently in the closest and tightest of contact.

Copper wire is apt to get brittle with, and without, undue exposure to the air, so that if flexibility and mechanical strength are to be retained, leads should be changed every six or so months and new wire used. Leads should not be kept in use until they fall to pieces and cause shorts.

Old H.T. batteries of the dry cell type sometimes recuperate to a remarkable extent if left in a cool place for a week or two. At the same time once an H.T. battery develops faults it is risky to leave it in commission. It is apt to give trouble in the middle of important transmissions.

If the valves in use are microphonic, noises can be caused by vibrations transmitted from the loud speaker through the wood and ebonite of the set if the loud speaker is standing on the top of the receiver.

Interference has been known to develop from electricity generated by a geyser working at high water temperatures. In a more marked manner the steam escaping from steam engines can cause similar trouble. Only very sensitive valve-sets would pick up such "atmospherics."

The positions of batteries sometimes affect the sensitivity of a receiver, more especially in the case of a set whose batteries are contained in its cabinet.

The Care of 'Phones.

Telephone receivers can be seriously damaged by either damp or heat, and this

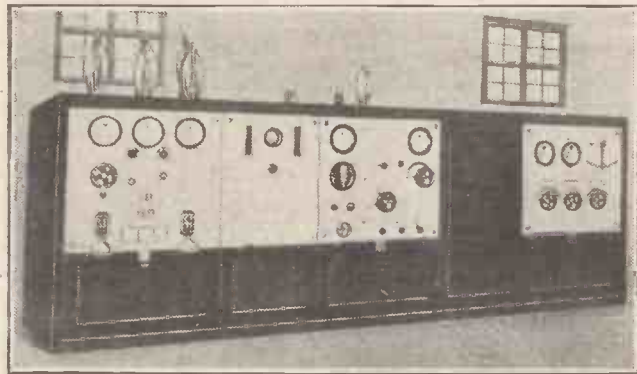

The transmitting panel at the new Vienna broadcasting station.

applies to loud speakers as well. Neither components should be placed near damp walls or too close to fireplaces.

Acid creeps and destroys fabrics in a very insidious manner. It is always advisable to stand an accumulator on a piece of wood or on an old magazine, even if the battery is contained in a box. This latter can pick up acid at charging stations quite apart from any creeping.

Concerning Components.

Components are constantly being improved in design, so constructors should ascertain that the wireless gear they purchase is of the latest type. Even first-

class manufacturers are apt to improve their components without changing the type names of them.

It is not essential that a uniformity should be retained in the make of valve used in a multi-valve set. Frequently it is advantageous to pick valves carefully from different sources.

Some makes of coils are wound in a different direction from others, and may not couple in a two-coil holder for reaction purposes unless connections to one or other are reversed.

Preventing "Burn-Outs."

When a new receiver is tested for the first time precautions against valve burn-outs should be taken. Unless a safety fuse is incorporated in the set somewhere there is always a risk that an undetected short between H.T. and L.T. will make itself felt for the first time when expensive valves are destroyed.

An easy method of detecting such a leak is to connect the L.T. battery to the H.T. battery terminals, leaving the H.T. battery itself quite unconnected. If the valves light up, when turning on the filament rheostats, then something serious is wrong. If not, everything is O.K. so far. But, after this, leaving the filament rheostats on, the effect of joining the L.T. terminals together should be noted. The L.T. battery is still, of course, connected to the H.T.

terminals. Again, if the valves light up, even ever so dimly, there is a short somewhere.

Still leaving the receiver connected up in the above unorthodox manner, all the controls and moving parts should be briskly handled, and if no shorts are evinced, all is ready for the more conventional test. As a further precaution, after the receiver has been properly connected up, with everything in position except the valves, the filament rheostats can be turned on and a flashlamp bulb held across each successive pair of filament pins. If in any one case it goes "west" with a flash, then—well, a valve has been saved at its expense.

BUILDING UP A SUPER-HET.

(Continued from previous page.)

but is a very important factor with another stage of I.F., as all I.F. circuits require to be the same tune; whereas with one I.F. transformer alone you automatically set the oscillator to give the I.F. wave in tune with the I.F. circuit.

You should now test the best position for the oscillator coil with regard to the tuned anode coil. Don't overdo it in nearness. Pull it away until signals begin to weaken noticeably, and take care to

adjust the oscillator for best signals each time you move the oscillator coil. Then push it back a bit and leave it there. The shorter I.F. wave-length will probably need the oscillator coil a bit nearer the tuned anode coil.

Making a Calibration Chart.

If your new valve is a high-magnification one such as the D.E. 8 H.F. or D.E. 5B, you should have a good chance with telephones of finding other stations. Get on to your local station and then go up or down, as the case may be, on the aerial condenser, the tuned anode condenser (the tuning of which will always be flat), and the heterodyne condenser.

If you have made up the tuning buzzer and have calibrated from that with a preliminary calibration, this will give you a

rough indication of where to look for, say, Hamburg on 395, Radio-Toulouse 435, Birmingham 475, London 365, and, of course, your local station. Once you have one or two stations, given straight-line condensers, you can make out an accurate calibration chart for the aerial and the tuned anode. You need not trouble to calibrate the oscillator condenser.

The set should still be very stable and easy to handle, but do not use it with an aerial, although if made to these instructions it is as safe as a set can be because of the neutralising arrangement preventing serious radiation from the frame or from the aerial. Your oscillator coil itself may be a slight nuisance to the man next door, but we will take account of that later. Next week we will add further I.F. stages and carry the set to its limits.

BROADCAST NOTES.

By O. H. M.

The New Wave-lengths—The Broadcasting Position in Wales—The Corporation Stakes—B.B.C. and the Albert Hall—Nora Bayes and Noel Coward.

THE verdict on the new wave-lengths in well-informed quarters is one of unanimous approval. There is a general feeling of relief, and a feeling also that Admiral Carpendale and Captain Eckersley have done well for Britain. Naturally, Birmingham is not overjoyed at the prospect of sharing a wave-length. But then, Birmingham's importance as a station has considerably declined since the advent and success of Daventry.

I should not be surprised to see Birmingham's transmitter disappear entirely under the new regime. The studio would remain, of course, as a collecting centre of programme material and local colour. As for Aberdeen, not much interest has been taken in the announcement of the joint wave with Birmingham.

There would appear to be a curious decline in broadcasting in Scotland during the past year. There will hardly be justification for more than one transmitter north of the Tweed under the regional scheme. Aberdeen, Dundee and Edinburgh have never established themselves in the broadcasting firmament. I should not be surprised also to see the Belfast wave washed out in favour of a second Daventry wave.

The Broadcasting Position in Wales.

The broadcasting position in Wales remains acute. Certain nationalist organisations have been agitating for some time with a view to securing the establishment of what would be a separate broadcasting service for the Principality devolved from the British Broadcasting Corporation. They had succeeded in impressing their views on Government circles to such purpose that their point was almost conceded, when suddenly a counter-move intervened.

A strong group of Welsh newspapers and a formidable proportion of the population have adhered to the counter move, the object of which is to defeat the proposals for a separate Welsh broadcasting service devolved from the British Broadcasting Corporation. The argument is that the extreme nationalism of the separatists is not reflected in public opinion, and is largely sponsored by cranks and axe-grinders.

They are disturbed at the possibility of the elimination of English from Welsh broadcasting, and they are not enthusiastic about the prospect of hearing no music or singing that has its origin outside the Principality.

The effect of the counter-move has been to delay final decision until the Corporation is constituted. My own belief is that, ultimately, under the regional scheme, there will be a West Britain transmitter capable of reaching most of Wales as well as the Bristol area. This will be fed by collecting studios at Cardiff, Bristol, Aberystwith, and possibly Wrexham. There will be a proportion of Welsh programme material.

Speculation on the Corporation Stakes continues, and there is brisk advance bet-

ting. The odds are fluctuating rapidly, but the stronger candidates are gradually forcing their way to the front. Lord Reading and Lord Eustace Percy are definitely scratched.

A good deal of new money is being placed on Sir A. Steel-Maitland, Lord Salisbury, Sir P. Cunliffe-Lister, Lord Clarendon, and Sir S. Hoare. Most of the big layers will give thirties against each individual; but it is significant that they will only allow evens on this bunch as a whole. Meanwhile the only dead certainty for the Corporation itself is Lord Gainford; but not as chairman. Backers can save money by easing off on Dame Henrietta Barnett.

B.B.C. and the Albert Hall.

Nora Bayes and Noel Coward will be heard from London at nine o'clock on September 4th. Arrangements are now being completed to broadcast the Three Choir Festival from Worcester on September 8th.

So the B.B.C. concerts at the Albert Hall throughout the autumn and winter are to be known as "national" and not as "international" affairs as originally announced.



Sir George MacLaren Brown broadcasting a special talk on Canada on the occasion of Dominion Day.

I hear that the concert industry went on bended knees to the B.B.C. and asked them to make this change. I wonder what the B.B.C. got out of it. I hardly credit the rumour that they gave way without any *quid pro quo*.

If this were done it would savour of dereliction of duty and bad business. The war to the knife between the concert industry and broadcasting has been declared, and the next twelve months will see some of the hardest blows dealt on both sides.

The big series at the Albert Hall is really the reply of the B.B.C. to the mad boycott by the concert industry. The new policy should be pursued relentlessly to the end. The B.B.C. owes it to ten million listeners to smash the trust that deprives the microphone of so many great artistes.

A Special Choral Programme.

Sir Henry Coward will probably give a special choral programme from London early in October. Mr. Julius Harrison is preparing to present for listeners a new version of that delightful old opera "Venus and Adonis." A forthcoming talk feature

of interest at the London station will be a series of broadcasts by representative eminent people on their conception of Utopia. Mr. Donald Calthrop has returned from his American tour, and his reappearance at the microphone should not be long delayed. It would be an excellent plan to employ Mr. Calthrop as a builder of special programmes at intervals.

Drastic Alterations.

The physical jerks stunt by radio did not come off. Apparently the orthodox medical fraternity are dead against physical jerks anyway. The B.B.C. has to be guided in these matters by the Ministry of Health officials, who will not hear of any kind of physical exercises by radio.

I am sure, however, that the matter will come up again under the new regime, which probably will be in a position to decide this for itself. With at least one alternative wave-length and the new regional stations



functioning, there might be a chance to gratify the desire of those who want to be guided in physical contortions every day.

I hear on good authority that the Children's Hour is to disappear under the Corporation. I can well imagine a desire to strengthen and change it, but the abolition of this standing item will not be popular.

One regrettable effect of the new agreement about the wave-lengths is that it will not be possible for each station to work on a double wave. Thus the simultaneous alternatives can be arranged only by overlapping and by Daventry. It follows, therefore, that there will have to be drastic revision of the programme plans for next year. One effect will be a considerable reduction of staff, particularly in the provinces.

At least six stations will be practically demobilised. Headquarters staff will be cut down. The publicity department (or is it Information now) will disappear. I should think, therefore, that the total staff of the B.B.C. will be cut down by a third next year. This will release much-needed money for programmes.

MORE ABOUT THE FILADYNE

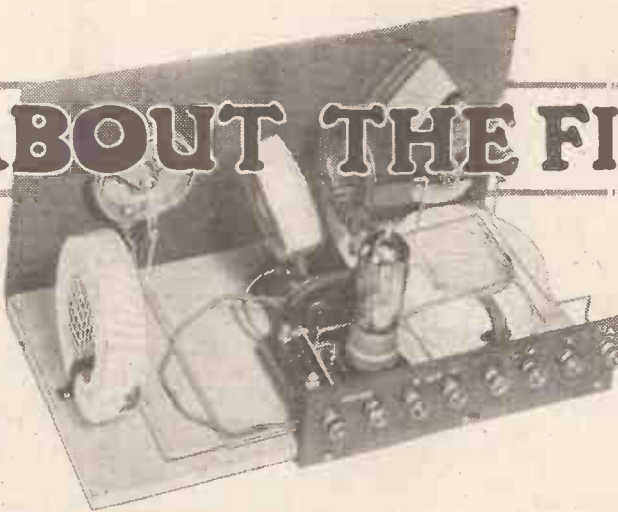

THE Filadyne circuit achieved almost immediate popularity notwithstanding its very unostentatious introduction to "P.W." readers, and while this is very gratifying we cannot say that we were surprised. Filament input is fascinatingly mysterious in operation, besides which it is so logical. We don't wait till the water is flowing from a tap before we start regulating the dimensions of the H₂O stream, so why should we stand some distance away from the filament in a valve and regulate the electron stream after it has started its journey? Obviously, the best plan is to control it at its source. There will be less loss and a greater advantage can be taken of controlling potentials.

New Theory Required.

We have only a small amount of energy in the aerial and we want this to have the greatest possible effect. There is no real saturation point for trigger action. A man can press a button and release sufficient energy to pull a railway train along. The potential energy in a 1-valve receiving system is limited only by the batteries employed, and sufficient exists in a normal L.T. and H.T. supply to operate one

* * * * *

By G. V. DOWDING, Grad. I.E.E.
(Technical Editor.)

The Filadyne has jumped into immediate public favour and amateurs will welcome the further details about this novel circuit which the inventor gives in the following article.

* * * * *

hundred loud speakers. What about the valve, grid currents, anode current, grid swing limits, saturation points, etc?

Well, these are limitations imposed by the method in which the valve is used in conventional circuits. A different state of affairs altogether exists in the Filadyne.

Here the anode is no longer the plate and grid currents ascend to milli-amp. heights! In fact, we cannot regard the valve from an ordinary "fil-grid-plate" standpoint at all, when we are dealing with a Filadyne circuit, so that it is necessary to frame a new theory to suit the new conditions. Of course, we still have an electron stream, so we have a sound starting point, but ordinary valve characteristics won't be of much use to us.

Concerning Curves.

And talking about characteristics, it must be remembered that ordinary valve work characteristic curves are merely graphical representations of what happens to a valve under static conditions. In a radio receiving set conditions are anything but static, and while experience has taught us that many valuable inferences may be drawn from such graphical representations, this fact must not be forgotten or arguments may base themselves on an insecure foundation. It would be foolish to wave a nice little curve in the air and shout "This thing cannot be

for it is written that—" And it would be worse than useless to refer to conventional bends and straights and mus in the case of the Filadyne as in due course I will clearly show.

By plotting a graph in which "input" and "output" form the two essential components, we obtain something of an insight into the functioning of a valve, for static and kinetic energy have something in common. We know that a valve is a potential operated device, and that its action depends upon the effects of a fluctuating potential between grid and filament on the electron stream bridging the gap in the anode circuit. This, of course, is in an ordinary valve circuit.

Increased Anode Current.

By means of a small battery and a potentiometer connected across grid and filament a series of "grid volt" values of either minus or plus sign can be applied. The corresponding variations in anode current registered by a milli-ammeter can be noted, and a curve plotted in the form of a simple graph. From such a characteristic curve much valuable information can be gained, as Mr. Field showed in his recent articles on "How To Use Valve Curves,"

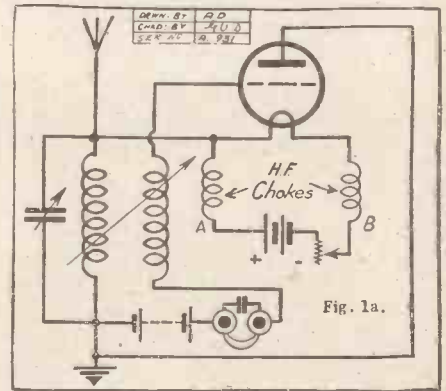
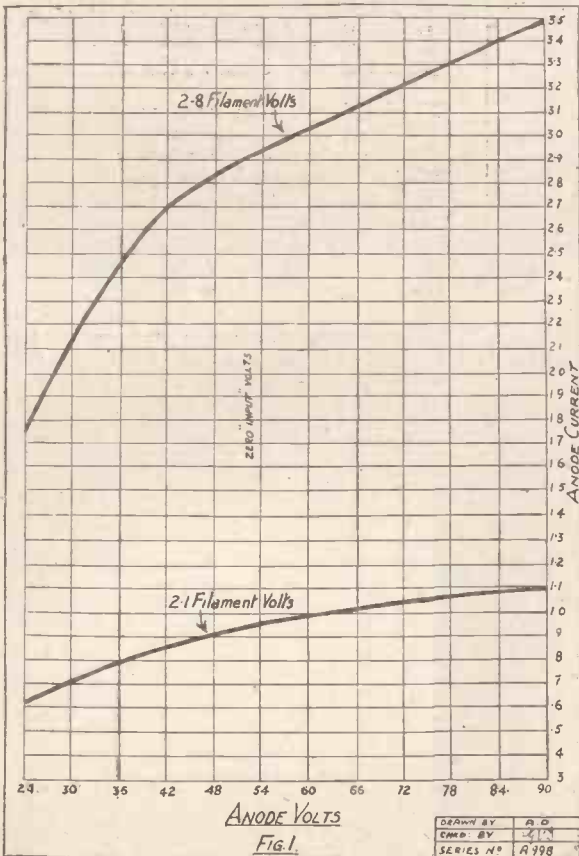

The standard Filadyne detector circuit with reaction.

but, as previously mentioned, such are of little use in the case of the Filadyne. Of course, there is a possibility that conventional characteristics march in parallel with Filadyne characteristics, but, so far, we have not obtained much evidence that this is the case.

One of the first points that strikes us when we begin to introduce measuring instruments to the Filadyne is the greatly increased anode current that obtains in the case of most valves. Of course, this is only to be expected in view of the fact that the conductance of the valve is increased by the dispersal of the space charge resulting from a highly positive grid, which is situated in close proximity to the source of the electron stream. In effect, very many

(Continued on next page.)

MORE ABOUT THE FILADYNE.

(Continued from previous page.)

more electrons complete their journey from the filament to the anode, as the grid now becomes, and naturally plate current must primarily depend upon the dimensions of the electron stream.

It would be wasteful to increase anode current without increasing the intensity of its signal fluctuations, but this we do in the Filadyne to a very marked degree.

The B.T.H. B.5 was considered particularly suitable for the Filadyne for some time, but it has now been discovered that the Osram D.E.R. is very much superior for the purpose. The B.5 cannot be run at its correct filament temperature, and while it operates at a surprisingly low voltage, and thus effects a saving in filament current, it will be agreed that this economy is of little importance if it demands a loss in signal strength. Actually, of course, this is quite comparative, as there is no real loss, for signals with a B.5 are excellent. The point we wish to stress, however, is that it appears that best Filadyne results are obtained when a valve is allowed to run normally, if we can draw such a conclusion from the behaviour of but two types!

This means a greater consumption of H.T. current, but a signal strength out of proportion to the increase. The foregoing statements contradict some of those made in our previous articles, but it must be remembered that a new valve comes into the field; in connection with the B.5 they still hold good. Fig. 1 shows graphically the relation between anode volts and anode current, when a B.5 is employed in a Filadyne one-valver (1) at normal filament temperature; and (2) at the most suitable filament temperature. The figures were obtained in quite a simple manner. The set was "hooked up" in the usual way, and the reaction coil removed, and in its place a milli-ammeter was inserted. A voltmeter was connected across the filament sockets of the valve holder.

What the Curves Prove.

Maximum sensitivity resulted when the filament voltage recorded was 2.1 volts, and this is a figure noted during previous experiments. As will be seen, anode current rose from .55 milli-amps at 24 volts H.T., more or less evenly up to 1 milli-amp at 90. Signal strength varied fairly uniformly.

When the filament voltage was increased to 2.8 volts, a normal figure for the B.5, which is rated by its makers at 2.8-3, anode current jumped up to 1.75 milli-amps

at 24 volts H.T., or nearly double that at 90 volts H.T. on the lower curve, and reached 3.5 milli-amps at 90, a really surprising increase in view of the fact that it was accompanied not by an increase in signal strength, but in a total loss of signals.

But the curves are of no great value except in that they prove the unusual nature of the Filadyne and the possibility that variations in actual filament emission take place. It is in the plotting of curves representing input-output variations that we come to more vital stages in our investigations.

An Astounding Result.

In order to do this the aerial coil was removed from the receiver, and across its sockets was placed a battery and potentiometer system, shunted by a voltmeter. The milliammeter remained in the anode circuit. A D.E.R. valve was plugged in, as by this time we had come to regard the

In Fig. 2 we reproduce on a similar scale and in similar proportions a section of the maker's curve for the D.E.R. If we were writing this article in the form of a modern novel we would pause here and insert a series of asterisks! Readers will not need us to point out the astounding increase in "steepness" when the D.E.R. is used in a Filadyne receiver. Actually, the Filadyne curves are nearly seven times as steep. Four times as much H.T. current is used, but "judged on form" we obtain seven times the amplification!

Again we must remind readers that these are static characteristics, although we do not think they exaggerate the efficiency of the Filadyne. The severe straightness of the Filadyne curves will cause astonishment, no doubt, and there will be speculation as to whether rectification takes place at the bends or in some original manner. We will have more to say about this, however, on some future occasion.

Questions Requiring Answers.

According to Fig. 2 the Filadyne should be capable of useful work in the DX capacity, but according to existing theories would hardly be able to handle loud signals without very considerable distortion. Why is it, then, that the one-valver, using the same D.E.R., operates a large loud speaker on the local station with an unsurpassable quality of tone? This and other questions remain yet to be answered, and there are many other points that have yet to be brought forward. Our investigations are really only just commencing, and what developments the future holds in store for us—well; we are as optimistic as the majority of our correspondents appear to be.

SOME USEFUL LOUD-SPEAKER HINTS.

WHEN extension leads are run from a set to another room, it is sometimes puzzling to tell whether the loud speaker is connected correctly with respect to its polarity. This is an easy method of determining polarity:

Switch on the loud speaker, and, while it is working, turn the adjusting screw until the diaphragm just grates. Then reverse the connections. If now the grating sound becomes louder, or the signals almost inaudible, the former connection was wrong. Adjust the screw again until signals are normal.

On the other hand, if signals become almost or entirely free from grating, the former connection was correct. Reverse connections again and adjust the screw for maximum tone and purity.

If you have just finished constructing a loud-speaker set, and are experimenting to obtain maximum tonal purity, do not forget to try changing over the valves. Some valves, no matter how carefully grid bias is applied, will not act as distortionless L.F. amplifiers, but serve satisfactorily as rectifiers. Others, acting well enough as detectors, really show up well when given a grid bias and placed in L.F. positions.

Also try combinations of accumulator and grid battery connections, reversing each battery in turn, and then both together.

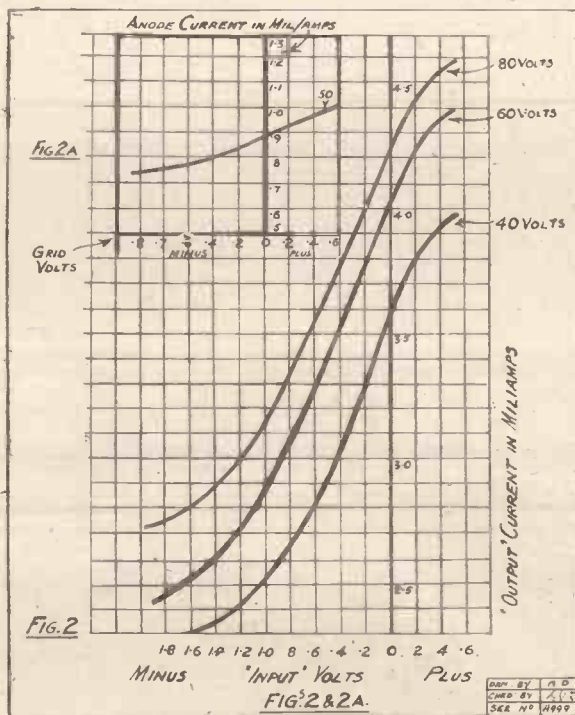

D.E.R. as the most suitable for the circuit. It was run at its normal filament temperature, at which it functions excellently in Filadyne sets. It was necessary to employ a four-volt L.T. battery, owing to the low resistance of the D.E.R.'s filament (about 5 ohms). Even although the H.F. chokes are of quite low ohmic resistance they made their presence felt when a valve of such a low resistance is used.

A matter of 11 ohms or so in circuit with a four-volt accumulator limits current to a D.E.R.'s .35 amps, and as the valve itself accounts for five, and the various leads, etc., for two or three, it will be observed that even if the chokes have a resistance, together, of but three ohms, little margin is left for filament rheostat control.

Anyway, plotting input volts against anode current for those values of H.T., viz. 40, 60, and 80 volts, the curves shown in Fig. 2 were produced. It should be mentioned in passing that 60 volts H.T. seems to suit the D.E.R. best in a Filadyne receiver.

TAKE THE SHORTPATH TO BETTER RECEPTION

Cosmos

SHORTPATH WIRELESS VALVES

THE precise construction of the electrodes in these valves has enabled the distance between the electrodes to be greatly reduced, so that the electron stream has only to traverse a short path. This results in **GREATER AMPLIFICATION, GREATER OUTPUT, NO DISTORTION, EXCEPTIONAL RECTIFICATION, LOW CURRENT.** Made in three types marked with **RED, GREEN, and BLUE SPOTS**, having the following characteristics:—

**“COSMOS” SHORTPATH S.P.18/R
RED SPOT VALVE**
A Real Two-Volt Power Valve

Suitable for supplying a powerful loud speaker without distortion. Equal to an average 6-volt power valve.
Filament voltage 1.6—1.8 volts
Filament current 0.3 amps.
Anode voltage—for detector 20 to 60 volts
” —for amplifier up to 20 volts
Grid bias up to 9 volts
Voltage amplification factor 7.0
Mutual conductance (slope of characteristic) approx.
0.90—1.00 mA per volt
Anode impedance, approx.
7000 to 8000 ohms

Price 14/- each

**“COSMOS” SHORTPATH S.P.18/G
GREEN SPOT VALVE**
A High Amplification H.F. Valve

Its high voltage amplification factor (15) is combined with a steep characteristic slope and an impedance very much lower than is usual with this type of valve. Exceptionally efficient as H.F. Amplifier, or as detector.
Filament voltage 1.6—1.8 volts
Filament current 0.3 amps.
Anode voltage—for detector 30 to 80 volts
” —for amplifier up to 120 volts
Grid bias up to 3 volts
Voltage amplification factor 15.0
Mutual conductance (slope of characteristic) approx. 0.85 mA per volt
Anode impedance, approx. 17,000 ohms

Price 14/- each

**“COSMOS” SHORTPATH S.P.18/B
BLUE SPOT VALVE**
A “Resistance-Capacity” Valve

This valve has a much higher voltage-amplification factor than any other receiving valve on the market. It is intended for use with 80—120 volts H.T., thus avoiding the use of two H.T. supplies. It consumes very little H.T. current, and only 0.09 amp. for the filament. Can be used with excellent results in many positions, but is particularly recommended in combination with resistance-capacity coupling, where it gives as much amplification as the usual L.F. Transformer, but with the added freedom from distortion and breakdown.
Filament voltage 1.6—1.8 volts
Filament current 0.09 amps.
Anode voltage (for detector or amplifier) 80—120 volts
Grid bias Nil
Voltage amplification factor 35
Mutual conductance (slope of characteristic) approx. 0.45—0.5 mA per volt
Anode impedance, approx. 70,000 ohms

Price 14/- each



RECOMMENDED S.P.18 VALVES for ALTERNATIVE H.T. VALUES.

		H.T. 20-80 v.	H.T. 80-120 v.
H.F. Amplifier	Tuned Anode (stabilised, by neutrodyne or otherwise)	Green	Blue
	Tuned Anode (non-stabilised)	Green	—
	Transformer, loose coupling	Red	—
	” tight	Green	—
Dual or Reflex Stage	Resistance coupling (for long waves above 2000 metres)	Green	Blue
	L.F. Transformer or Choke Coupling	Red	Red
Detector (Grid Leak)	Resistance Coupling	—	Blue
	L.F. Transformer or Choke Coupling	Green	Blue
Detector (Anode Bend)	Resistance, L.F. Transformer or Choke Coupling	Green	Blue
	Resistance	Green	Blue
L.F. Stages (except last)	Transformer or Choke	Green	Green
	Resistance	Green	Green
Last stage Loud Speaker	All couplings	Red	Red

CHOOSE YOUR S.P.18 VALVES FROM THIS TABLE

THE COMBINATION RECOMMENDED FOR BEST RESULTS IN EACH CASE IS SHOWN IN HEAVY TYPE

Ask your Dealer for a copy of Leaflet 4117/3 “The Soul of Music.”

METRO-VICK SUPPLIES LTD.

(Proprietors: Metropolitan Vickers Electrical Co., Ltd.)

Metro-Vick House, 145, Charing Cross Road, London, W.C.2

In order to popularise
DULL EMITTER VALVES
PRICES WERE REDUCED

as and from
AUGUST 16th, 1926
of the following OSRAM VALVES

	OLD PRICES	REDUCED PRICES
<u>For 2-Volt Accumulators.</u>		
D.E.2 H.F. & L.F. ...	15/6	14/-
<u>For 4-Volt Accumulators.</u>		
D.E.3	16/6	14/-
D.E.3B. }		
D.E.4	22/6	18/6
<u>For 6-Volt Accumulators.</u>		
D.E.8 H.F. & L.F. }	22/6	18/6
D.E.5 }		
D.E.5B.	26/-	22/6
D.E.5A.		

Osram
Valves
for Broadcasting

The G.E.C. - your guarantee.

THE work of the International Radiophone

Bureau, with headquarters at Geneva, has always interested the student of broadcasting, and its endeavours to solve the problem of the congested ether have had the sympathy and good wishes of amateurs all over the world. After many experiments and much hard work, the Bureau has now evolved a plan which, we think, is deserving of praise.

Until the plan is put into practice, no man can say whether it will work smoothly and efficiently; but this may be said for it at this stage, that on paper it "looks good."

Let us hope that its bright promise will be fulfilled and that the scheme will in actuality provide a really efficient means of reducing interference between broadcasting stations.

Those 200 Stations.

As our readers know, there are at least two hundred stations working, or about to start working, in Europe alone; and the DX amateur knows what a difficult task it is to cut out some of these stations when only one particular station is wanted.

Although some of these continental stations are considerable distances apart, and although many of them are as much as a thousand miles from this country, the restricted wave-length band for broadcasting has made mutual interference

CURRENT TOPICS.

By THE EDITOR.

Solving the Ether Problem—Reducing Interference—Exclusive and Common Waves—The Future for Low Power Stations.

between stations one of the greatest drawbacks to the progress of the technique of broadcasting.

Consequently, to stop—or, at any rate, to reduce, this interference, all broadcasting stations should work on wave-lengths differing from each other by so many kilocycles, or, where the range of the station is a limited one, on exactly the same wave-length.

The Solution.

Within the broadcasting wave-band (200-600 metres) there are approximately 99 available wave-lengths if one wave-length is separated from another by a frequency of 10,000 a second.

The problem set the Geneva Bureau was to make room for 200 stations in a wave-band where, by rights, there is only room for 99, providing every station used a different wave-length.

The solution to the problem, as presented by the Geneva Bureau, is to split up the 99 wave-lengths into two classes—composed of exclusive wave-lengths and common wave-lengths.

The exclusive waves are for allocation to

certain stations and for their sole use, and in such cases the wave-length will be separated from the wave-length of any other station to such a degree that no interference between that particular

station and any other station can take place.

The common wave-lengths are those which will be judiciously shared by two or more stations of limited range and separated from each other by distances which will make interference highly improbable.

The Geneva Plan means, then, that 83 exclusive waves will be used and 16 common waves. The 83 exclusive waves have been allocated as follows:—

Albania, 1; Germany, 12; Austria, 2; Belgium, 2; Bulgaria, 1; Denmark, 1; Spain, 5; Esthonia, 1; Finland, 2; France, 9; Great Britain, 9; Greece, 1; Holland, 2; Hungary, 1; Iceland, 1; Italy, 5; Latvia, 1; Lithuania, 1; Luxembourg, 1; Norway, 3; Poland, 4; Portugal, 1; Roumania, 2; Russia (West), 5; Sweden, 5; Switzerland, 1; Czecho-Slovakia, 3; Jugo-Slavia, 1.

This leaves 16 common wave-lengths for the benefit of about 116 stations and, therefore, the Bureau has decided that low-powered stations with a strictly limited range shall share these waves between them.

(Continued on page 858.)

THE GENEVA WAVE-LENGTH PLAN

Frequency x 10,000.	Geneva Wave-length Plan.	Name of Station.	Country.	Present Power.	Present Wave-length.	Frequency x 10,000.	Geneva Wave-length Plan.	Name of Station.	Country.	Present Power.	Present Wave-length.	Frequency x 10,000.	Geneva Wave-length Plan.	Name of Station.	Country.	Present Power.	Present Wave-length.
51	588.2	Vienna II.	Austria	0.75	530	71	422.6	Rome	Italy	3	425	100	300	Bratislava	Czecho-Slovakia.	?	300
		Linkeping	Sweden	0.25	467	72	416.7	Stockholm	Sweden	1.5	427						
		Grenoble	France	0.5	475	73	411	Berne	Switzerland	1.5	435	101	297	Agen	France	0.25	318
		P.T.T.				74	405.4	Glasgow	Gt. Britain	1.5	422			*Edinburgh	Gt. Britain	0.5	324.5
		Vilna (?)	Lithuania	—	—	75	400	Mont de	France	0.3	390			Hanover	Germany	0.75	297
52	577	Madrid II	Spain	1	392			Marsan.						Carthagena	Spain	0.5	330
		Joenkoe-	Sweden	0.025	285			Tampere	Finland	0.25	373			Eidsvold	Norway	0.05	?
		phg.						Cadiz	Spain	0.5	355			Jyvaskala	Finland	0.1	301.5
		Frelburg	Germany	—	—			*Liverpool	Gt. Britain	0.2	313	102	294.1	Dresden	Germany	0.75	291
		Uzhovod	Czecho-	—	—			Falun	Sweden	0.4	370			*Hull	Gt. Britain	0.2	335.5
		(Ungava)	Slovakia.	—	—			Warsaw	Poland	—	—			*Plymouth	Gt. Britain	0.2	338
53	566	Berlin II.	Germany	1.5	562			Koszie	Czecho-	—	—			Trollhattan	Sweden	0.25	345
		Mikkeli	Finland	0.1	561			Cork	Ireland	—	—			Bilbao	Spain	0.5	418
		Orebro	Sweden	0.25	237			Aalesund	Norway	—	—			Valencia	Spain	0.5	400
		Saragossa	Spain	—	—			Charleroi	Belgium	—	—			Liege	Belgium	0.1	280
		Sarajevo	Jugo-Slavia	—	—			Bremen	Germany	—	—			Innsbruck	Austria	—	—
		Varde	Norway	—	—			Frankfurt	Germany	0.75-4	470	103	201.3	Lyons	France	1.5	280
		Bloemen-	Holland	—	—	76	394.7	Toulouse	France	2	430			(Radio).			
		daal.				77	389.6	Radio.				104	288.5	*Birming-	Great	1.5	477.5
54	555.6	Budapest	Hungary	2	546			*Belfast	Gt. Britain	1.5	440			ham	Britain.		
55	545.6	Sundsvall	Sweden	1	545	78	384.6	*Stuttgart	Germany	0.75-4	446	105	285.7	Reval	Esthonia	?	350
56	535.7	Munich	Germany	0.75-4	485	79	379.7	Madrid	Spain	1.5	373			(Tallin).			
57	526.3	Riga	Latvia	1.2	480	80	375	Oslo	Norway	1.5	382	106	283	Dortmund	Germany	1.5	387
58	517.2	Vienna	Austria	5	590	81	370.4	Graz	Austria	0.75	397			Barcelona	Spain	2	324
59	508.5	Antwerp	Belgium	—	—	82	365.8	London	Gt. Britain	3	363.5	107	280.4	Caen	France	?	332
60	500	Zürich	Switzerland	0.5	515	83	361.4	Breslau	Germany	0.75-4	416	108	277.8	Barcelona	Spain	1	462
		*Swansea	Gt. Britain	0.2	482	84	357.1	*Newcastle	Gt. Britain	1.5	404.5			II.			
		Helsingfors	Finland	0.5	522	85	353	Prague	Czecho-	5	365.5			*Notting-	Great	0.2	323.5
		II.				86	348.9	Seville	Spain	0.5	357			ham.	Britain.		
		*Dundee	Gt. Britain	0.2	330.5	87	344.8	Paris Petit	France	0.5	358			Seville II.	Spain	0.5	300
		Palermo	Italy	—	—	88	340.9	Parisien	France	—	—			Hango	Finland	0.1	259.5
		Tromsø	Norway	—	—			Copenhagen	Denmark	0.7	340	109	275.2	Stavanger	Norway	—	—
		Karlstad	Sweden	—	—			Naples	Italy	1	350			Salzburg	Austria	—	—
		Bourges	France	—	—	89	337	Reykjavik	Iceland	?	—			Angers	France	0.25	275
61	491.8	Aberdeen	Gt. Britain	1.5	496	90	333.3	Nürnberg	Germany	0.75-4	340			Sheffield	Gt. Britain	0.2	301
62	483.9	Berlin	Germany	4	505	91	329.7	*Manchester	Gt. Britain	1.5	378			Madrid III.	Spain	1	340
63	476.2	Lyons	France	1	480	92	326.1	Leipzig	Germany	0.75-4	452			Eskilstuna	Sweden	0.25	243
		P.T.T.				93	322.6	Dublin	Ireland	1.5	390			Zagreb	Jugo-Slavia	—	—
64	468.8	Elberfeld.	Germany	0.75	259	94	319.1	Milan	Italy	1	320	110	272.7	Ghent	Belgium	—	—
65	461.5	Jassy	Roumania	?	?	95	315.8	*Bourne-	Great	1.5	387			Cassel	Germany	0.75	273
		(alternative)				96	312.5	Mouth.	Britain.	—	—			San	Spain	1.5	343
		Bergen	Norway	1	350	97	309.3	Marseilles	France	0.5	351			*Sebastian.	Gt. Britain	0.2	343.5
66	454.5	Boden	Sweden	?	?			P.T.T.						Norrköping	Sweden	0.25	280
67	447.8	Paris P.T.T.	France	0.5	453			*Cardiff	Gt. Britain	1.5	353			Klagenfurt	Austria	—	—
68	441.2	Brno	Czecho-	3	527(?)	98	306.1	Münster	Germany	1.5	410						
		(Brünn).	Slovakia.	—	—	99	303										
69	434.8	Bilbao	Spain	0.5	415												
70	428.6	Hamburg	Germany	4	392.5												

(Continued on page 858.)

NOTES FROM BERLIN.

By Dr. ALFRED GRADENWITZ
(Our Correspondent in Germany).

Special Type of Acoustic Drama.

WIRELESS is fast giving birth to new forms of literary art. While the sole ambition of those in charge of transmitting stations, in the first years of the service, was a satisfactory broadcasting of actual theatre performances, the next step was the provision of ordinary drama, opera and operetta specially performed at the studio on acoustic principles in keeping with the true character of wireless broadcasting, with artistes no longer acting in the same way as on the stage, but with a perfect disregard for visual effects and with a view to produce on the ear such intense and delicate effects as would make up for the absence of any optical impressions.

A further step is now being taken by the creation of what could be termed "acoustic drama." After Alfred Braun's "Sounding Stone" performed in Berlin at the beginning of March, the Hamburg broadcasting station has now come forth with a mammoth serial extending over six nights and re-transmitted from the principal German stations.

The "Lord of the Earth" availed itself of the possibility of leading like a moving picture film without any transitory stage from one place to the other, the scene extending over the space encompassed by New York, Tokyo, Calcutta and Lima, between which the three protagonists are freely moving.

The plot comprises the most adventurous events, the scene shifting from offices and streets to ships and aeroplanes, gambling clubs and the palace of an Indian Maharajah. The noise of the streets of New York and many other sounds are symbolised by music, and special musical interludes are interwoven with each evening's performance. Though the literary merits of the production were rather limited, its dramatic effects on the listener were astounding.

A Curious Accident.

The Madgeburger Platz transmitter has for more than a week been out of commission, a heavy gale having overturned the antenna mast, 90 feet in height, erected on the roof of Rütgers Building. The part of the roof struck by the mast was completely uncovered, the chimney was carried along in the fall of the mast and the ridge was partly damaged. Nobody, however, was injured.

How the mishap occurred is not exactly known. The mast was installed in the centre of the roof and braced by four tight iron wires, a similar mast being erected on the roof of the adjoining building, so that the antenna was carried between the two. One of the four bracing wires was broken, but the fall of the mast was damped somewhat by the three others giving way only gradually. There is no break in broadcasting, messages on wave 504 being re-transmitted by the Witzleben main transmitter.

Broadcasting Photographs.

Successful attempts have been made to

transmit photographs and handwriting by the Telefunken-Karolus system between Nauen and Berlin on a very short wave. Experiments made with a wave of 40 metres took place in the presence of the new Secretary of State at the Postal Department, Mr. Feyerabend and the foremost officials of that department, as well as the Telegraph Research Office.

The shorter the wave, the higher was the rate of transmission found to be. In connection with previous tests on wave 1300, a transmission between Berlin and Vienna lasted 60 seconds; on wave 850 this was reduced to 20 seconds, while 10 seconds was the time required on wave 40. Preparations are being made with a view to an experimental radio Picture Telegraphy

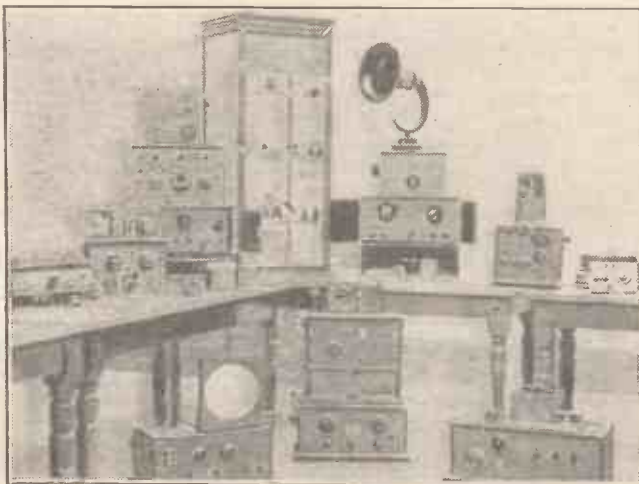

Apparatus made by members of the Savings Bank Department Radio Society and shown at their annual exhibition.

service between Berlin—Rome and Berlin—Buenos Aires, using the same short-wave transmitter with which some most successful wireless telephony experiments were, a few days ago, carried out between these two cities.

Forthcoming Third German Radio Show.

The Third German Radio Show which will be opened at the Radio Industry Building, Berlin, on September 3rd, and which is to last until the 12th of the same month, will not be a mere Radio Fair destined to promote sales, and a means of getting an idea of the latest developments of radio industry, but is primarily intended to afford instruction to those wishing to come into closer contact with radio.

This is why the German Postal Department will be represented by a most interesting special Show organised by the Telegraph Research Office, the demonstration of wireless picture transmission proves of special interest, the Karolus scheme being on the eve of its being adopted in actual practice. The German Broadcasting Company will, beside statistical returns illustrating the extent and nature of its activities, show models of studios and transmitting stations, and the Berlin "Funkstunde" (Broadcasting Co.)

will organise its broadcasting re-transmitted from the Radio Industry Building to the transmitter.

Experimental lectures on wireless subjects are to be another feature. Amateurs will be interested in the big Constructive Show which, for the first time, is to comprise exhibits by all German amateur clubs. Another new feature is a series of comprehensive tours of the show conducted by experts and comprising visits to the Königswusterhausen Main Broadcasting Station. It is also expected to exhibit Professor Dieckmann's Picture Telegraph enabling weather bulletins by means of a simple receiver to be recorded continually.

Wireless Waves Checking the Engine Driver.

Experiments with a view to using wireless waves in acting upon a railway train having travelled beyond the "stop" signal were recently made by Messrs. C. Lorenz, of Berlin-Tempelhof. This scheme is based on the inductive effect of an electro-magnetic circuit installed on the rail (without any actual current supply) and which on setting the signal to "stop" is short-circuited on an electro-magnet traversed by low-frequency alternating current and fixed to the locomotive.

This is so arranged as to be carried along the rails over the magnet without ever touching the short-circuit. An absolutely safe and energetic action was noted even at a travelling speed of more than 120 kilometres per hour. A dynamo driven by a small steam turbine generates low-frequency alternating current of about 10 volts. The same machine, however, at the same time serves as continuous current generator for electric train lighting.

FRAME-AERIAL CRYSTAL RECEPTION.

I HAVE seen it frequently stated that for distances exceeding a quarter of a mile, a frame-aerial is useless with a crystal set. Hence it may interest some amateurs to know that some months back I was desirous of hearing a message that was to be broadcast. My outside aerial having collapsed shortly before, and my valve set being in course of reconstruction, I connected the frame, which had four-foot sides, to the crystal set and, at a distance of three to four miles from 2 L O, I received the message with comfortable distinctness. I would not, of course, advise anyone to use a frame for the reception of musical items—the volume is not sufficiently satisfactory for that. But it is an idea worth bearing in mind should anyone find himself in a similar predicament to mine. Also, of course, the direction of the frame and the condenser reading should be known, approximately, so that a valve set must be used in the first instance. J. B.

The "COSMOPOLITAN" FOUR



THE set described in this article was designed for the benefit of those radio listeners who live outside the guaranteed range of B.B.C. stations. It can be used for receiving distant stations on the 'phones, and then by means of plug and jack switching, the volume can be brought up to loud-speaker strength. Three jacks are employed so that 2, 3 or 4 valves can be used, as desired. This provides an extremely flexible and economical arrangement, for as the receiver employs 1 H.F. (transformer coupled), 1 detector and 2 L.F., it can be used in the various combinations for all sorts of signal-strengths.

As the title implies, the set is suitable for the reception of continental stations,

 The Set Designed, Constructed and
 Described by
G. V. COLLE
 (Technical Staff.)

this, in the writer's opinion, gives greater selectivity than the former, without making the circuit more complicated.

A reaction reversing switch was incorporated on the set, as this enables the operator to try out different coils without

is no likelihood of interaction between components, causing howling or self-oscillation. As may be seen from the photographs of the back of the panel, the L.F. transformers have been placed as far apart as possible from each other, while the components have been so arranged that grid leads and other wires at high potential are kept as short as the lay-out will allow.

The Valves to Employ.

Dull-emitter valves can safely be used on this set, as 30-ohm rheostats are recommended, while the valve holders are of the

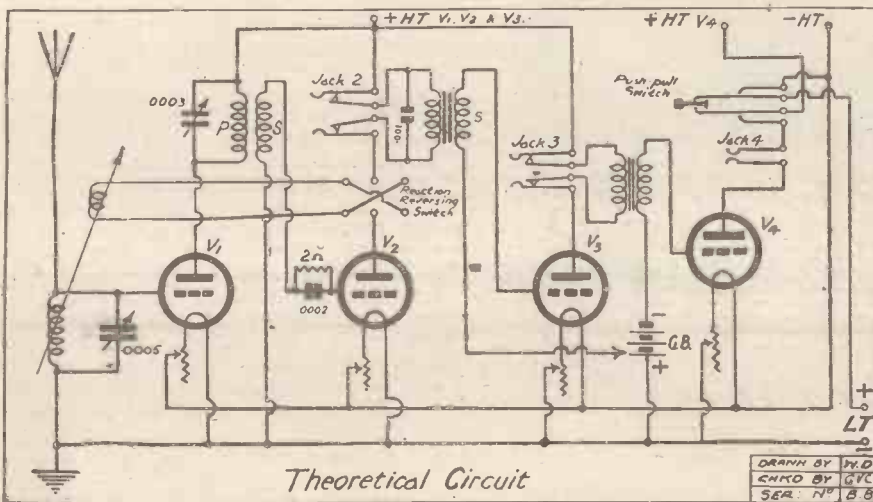

and, as this necessitates the use of an H.F. valve, this was left permanently connected and no switching was provided for cutting it out. In the place of tuned anode coupling, an H.F. transformer has been employed, as

having the bother of reversing the leads to the reaction coil itself, should windings of the coil be in the wrong direction.

The set is very compact, and overcrowding has been carefully avoided, so that there

THE COMPONENTS REQUIRED FOR THE 4-VALVE SET.

	£	s.	d.
1 Panel, 21 x 7 x 1/4 in.			
1 Cabinet to fit with baseboard and ebonite terminal strip (Peto Scott)	2	4	3
4 Antiphonic valve holders (Benjamin)		11	0
4 Filament rheostats (Peerless Junior), 30 ohms		10	0
1 D.P.D.T. switch (Nesthill)		2	0
1 2-way coil holder (Agnat, Klein Bros., 219, Bishopsgate, E.C. 2)		6	6
2 Jacks, No. 3 (Ashley Radio Co.) or Bowyer-Lowe		6	0
1 Jack, No. 1 (Ashley Radio Co.)		2	2
1 Plug for above jacks		5	0
1 .0005 variable condenser, with vernier		9	6
1 .0003 variable condenser, with vernier (Klein Bros.)		9	0
1 Grid leak and condenser, .0002 and 2 megs. (Dubilier)		5	0
1 L.F. transformer, 4 to 1 (Sullivan)	1	1	0
1 .001 mfd. fixed condenser (Dubilier)		3	0
7 Terminals, W.O. type		10	1/2
1 L.F. transformer, 2nd stage Max.-Amp. (Peto-Scott)		19	6
4 Valve sockets, countersunk type		1	2
1 2-way push-pull switch, "Wearite," from Bond's, Euston Road, London)		3	0
1 Grid bias battery, 9 volts		2	0
Wire, screws, transfers, etc.		2	6

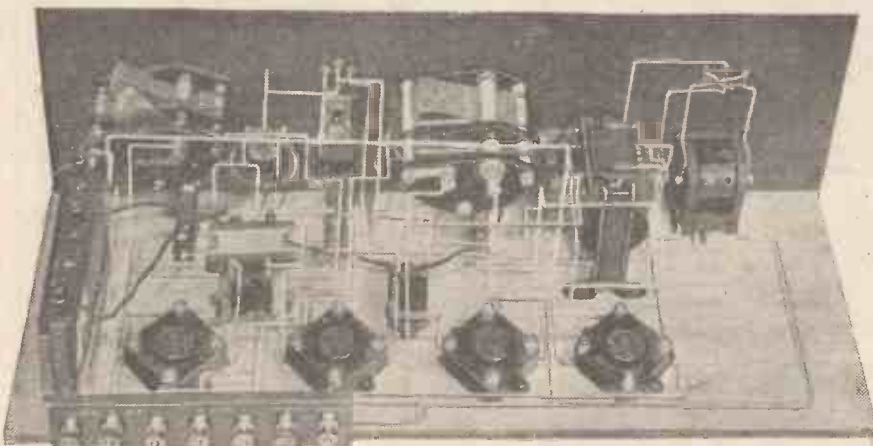

A good idea of the lay-out of components can be obtained from this photograph.

antiphonic type which eliminate any microphonic noises, should the panel be knocked. On the original receiver dull-emitter valves of the '06 type were used with good results, a power valve of the same class, but taking .1 amp., being used for the second L.F. Particular valves which

(Continued on next page.)

THE "COSMOPOLITAN" FOUR.

(Continued from previous page.)

gave good results were B.T.H. B.5's and Osram D.E. 3's, but it was found that a P.M. 4 was the most suitable for the last stage. This was using $1\frac{1}{2}$ volts grid bias on the first L.F. and 9 volts on the second.

Other types of valves taking either 2 or 6 volts can also be used successfully in this receiver, but in every case a power valve is necessary in the last L.F. stage if distortion is to be avoided.

A suitable combination of 2 volt valves is: H.F. Cossor red top (H.F.), or Mullard P.M.1 H.F.; Detector, Cossor, plain top, (or the Mullard P.M.1 L.F.); L.F.1 Cossor plain top (or green top), or Mullard P.M.1 L.F.; L.F.2 Mullard P.M.2, Ediswan P.V.6 D.E., or Osram D.E.6.

when the set is fitted in. As this cabinet is a commercially-made article (obtainable from Peto-Scott), the reader will not have the bother of making and fitting this terminal board. Two +H.T. terminals are employed; the centre one is connected to a positive plug which is tapped into the H.T. battery at any voltage between 20 and 80 volts. The +H.T. terminal on the extreme end of the terminal strip is tapped into the H.T. battery at its full extent—i.e. 100-120 volts. An H.T. battery of at least 100 volts is therefore necessary.

Some readers may wish to use two power valves for both L.F. stages or some means of L.F. coupling other than transformer for the 2nd stage. If it is desired to try a valve taking an H.T. voltage different from those of the H.F. and Det. positions, this involves the use of a separate H.T. tapping to the 1st L.F. valve, which in the ordinary way (using D.E.3's) would not be necessary, as these valves take the same anode potential.

It is not advisable to try and do this unless the circuit is fully understood. However, if the constructor has had previous experience of such an arrangement, the

0003 variable condenser and centre +H.T. will not be taken to the top outside contact of the 2nd jack, as shown in the wiring diagram.

Instead, the top outside contact of the 2nd jack should be connected to an additional +H.T. terminal. The arrangement of H.T. is then one common voltage for the H.F. and Det. valves, separate H.T. to the 1st L.F. and separate H.T. to the 2nd L.F.

A push-pull switch, which automatically disconnects the H.T. and L.T. batteries, is a useful feature of the set. Such a switch allows the operator to leave the filament rheostats in their most suitable positions without the need of turning them off after the programme.

Mounting the Components.

It is important that the push-pull switch named in the list of parts is used, and no other, as owing to its construction it cannot be replaced by a switch of the ordinary push-pull type.

If it cannot be obtained from Bonds o' Euston Road, Ltd., 254, Euston Rd., the reader is advised to try Hamleys Ltd., 200, Regent St., W., or J. W. Carr & Co., Ltd., 35, Queen Victoria St., London. Alternatively, Messrs. Peto-Scott Co., 77, City Rd., London, are in a position to supply the switch, as well as a suitable two-way coil holder.

Construction is commenced by fitting the panel and baseboard into the cabinet and seeing that both fit smoothly, so that should the reader desire to take them out when screwed together, they can be removed without force. After fitting the panel it should be marked out and drilled as per panel lay-out below. Having drilled the panel and removed all traces of ebonite dust, etc., the components can be mounted on it. The fitting of these should present no difficulties, as, with one exception, everything is of the single-hole fixing type. The exception is the D.P.D.T. switch, which can, however, be marked out from the jig supplied with it. The ebonite panel should now be screwed to the baseboard. This is best done with the panel and baseboard fitted to the cabinet. The baseboard should be held firmly against the base of the cabinet so that its bottom edge is level with the bottom of the panel. Having done this, the ebonite strip supporting the terminals, which should have been screwed on previously,

(Continued on page 855.)

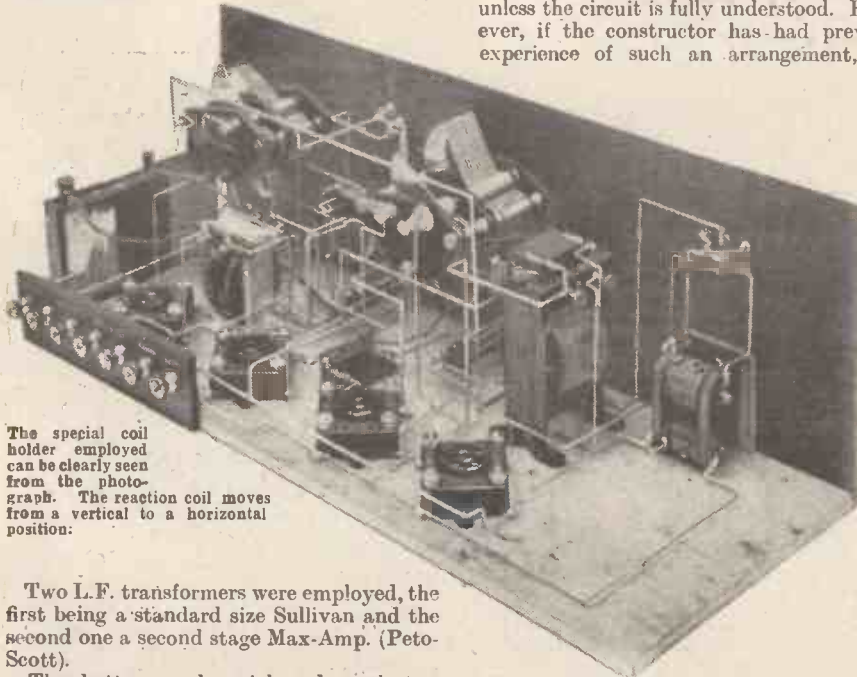

The special coil holder employed can be clearly seen from the photograph. The reaction coil moves from a vertical to a horizontal position:

Two L.F. transformers were employed, the first being a standard size Sullivan and the second one a second stage Max-Amp. (Peto-Scott).

The battery and aerial and earth terminals are situated at the back of the baseboard and are fitted to a strip of ebonite which lies flush with the back of the cabinet

modifications can be made as follows: The wire joining the top outside contact of the 1st jack with the moving vanes of the

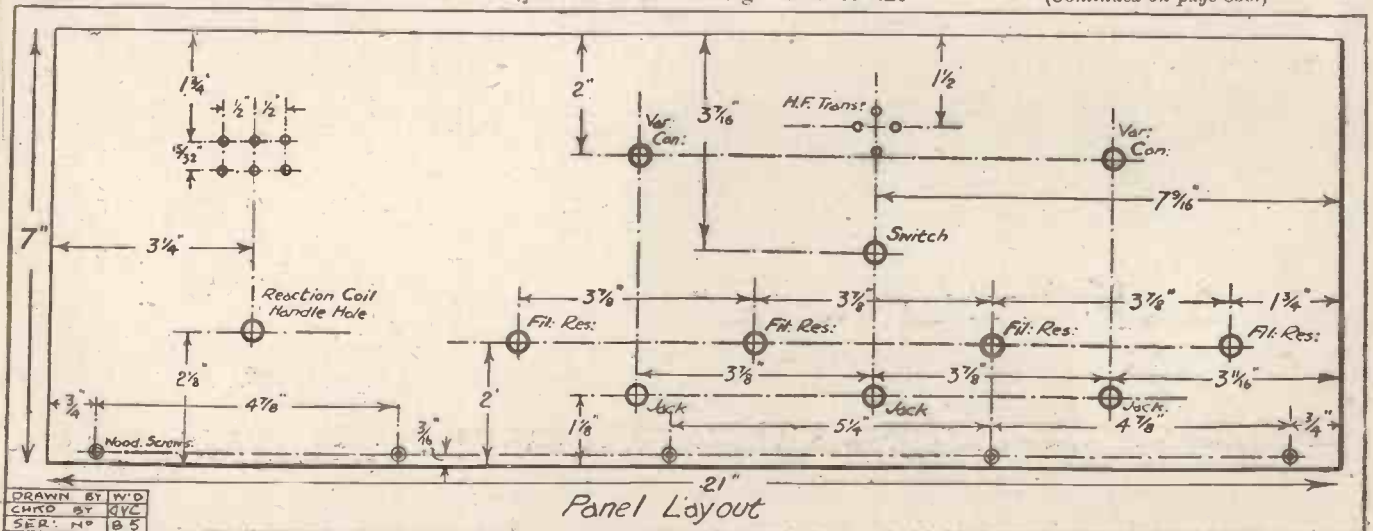

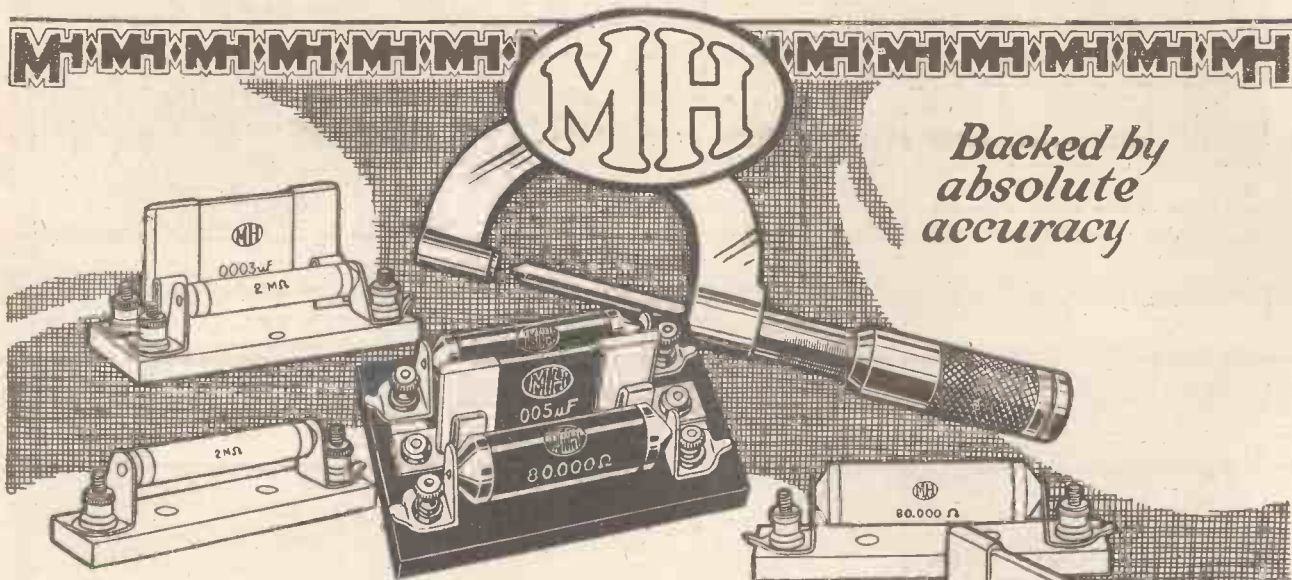

Backed by absolute accuracy

FAITHFUL TONE QUALITY

Radio Experts all agree that the Resistance Coupled Amplifier gives the most faithful reproduction of all the tones received from the Broadcast Station. In an Amplifier using the **MH** Resistance Coupling Unit, the higher or lower audible frequencies so essential for the perfect reproduction of all instruments are faithfully reproduced.

With the **MH** Resistance Coupling Unit a violin sounds like a violin, a flute like a flute, etc. The perfectly designed **MH** Resistances and Condensers forming the unit, transfer the music from valve to valve with perfect fidelity. They do not age or deteriorate. Once they are in your set you can forget them.

As with the **MH** R.C. Unit, all **MH** Components are backed by the experience and resources of the **MH** experts, and are therefore absolutely reliable.

Demand of your dealer **MH** Components.

They're British.

MH GRID LEAKS.
Price (in Cartons).

All values (040) 2/6 each
(Supplied with two clips.)
Mounted on ebonite base, with terminals,
1/- extra.

MH GRID LEAK AND CONDENSER, MOUNTED.

Price (in Cartons) (020) 5/- each
On base with terminals.

MH ANODE RESISTANCES.
Price (in Cartons).

40,000 to 100,000 ohms (041) 4/6 each
(New type.) (Supplied with two clips.)
Mounted on ebonite base, with terminals, 1/- extra.

MH RESISTANCE CAPACITY COUPLING.

Price (Complete as illustrated) (200) 12/6

MH MICA FIXED CONDENSERS.

(Two clips are supplied with each Condenser.)

0.0001 to 0.0000 μ F. (030)	2/6 each
0.001 to 0.01 μ F (031)	3/- each
0.015 to 0.02 μ F (034)	4/- each

Mounted on ebonite base with terminals, any value, 1/- extra.

Prices (in Cartons) Unmounted.



The **MH LOUD SPEAKER FILTER UNIT.**

To be inserted between the Receiving Set and the Loud Speaker. Will—Improve the tone of your Loud Speaker, because it allows speech or music variations to pass only, and not the H.T. current. Allow the tone to be adjusted at will by plugging in suitable Condensers in the clips provided outside. Save your Loud Speaker from becoming demagnetised, because no direct current passes through it. Save your Loud Speaker windings from becoming burned for the same reason. Allow you to take the Loud Speaker by a long lead to any part of the house or into the garden. Permit of greater volume without harm to the Loud Speaker.

Price 27/6

The New **MH VERNIER DIAL**

Price :
5/6

Telephone :
Slough
441-442.

L.M^cMICHAEL LTD
Manufacturers of Wireless and Scientific Apparatus
WEXHAM RD., SLOUGH, BUCKS.

Telegrams :
Radiether,
Slough.





Valve sockets and springs are stamped in one piece. Thus there are no rivetted, soldered or clamped joints to work loose and cause microphonic noises.

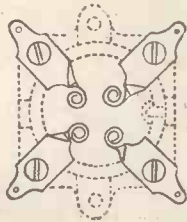

The four one-piece springs allow the valve to move in every direction, and absorb both lateral and vertical vibration.



Suitable stops control spring movement, making it easy to insert valves and without risk of damaging either the springs or the valves.

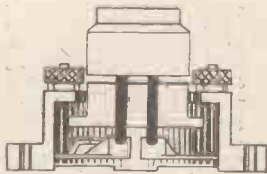

Valve legs, however far pushed home, cannot possibly foul base-board and thus destroy the springing.



Both terminal and soldering tabs are provided for temporary or permanent connections.

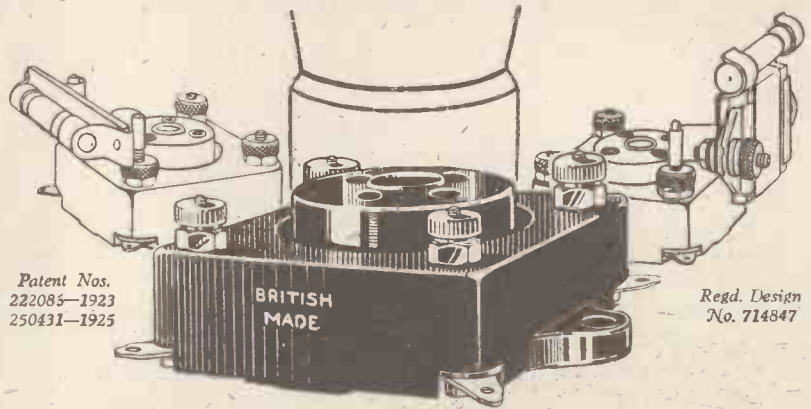

Patent Nos.
222085-1923
250431-1925

Regd. Design
No. 714847

Certified Sales.

19-7-1926.

44, Gresham Street,
E.C.2.

"We have examined the records of the Company and certify that during the ten months from 1st September, 1925, to 30th June, 1926, the Benjamin Electric Limited have manufactured and sold 351,455 Benjamin Clearer Tone Valve Holders."

(Signed) G. N. Read, Son, Cooke & Watson,
Chartered Accountants.

The explanation of this amazing popularity as compared with other valve holders lies in the five vital constructional features outlined on the left.

Benjamin Valve Holders are now offered either alone or with the following attachments. Constructors will instantly appreciate what an enormous saving of space and wiring these ingenious attachments mean.

Benjamin Clearer Tone Valve Holder	- - -	complete	2/9
Equipped with Dubilier Dumetohm Grid Leak	- - -	complete	5/3
With same Grid Leak and also Dubilier Grid Condenser (.0003) (series or parallel)	- - -	complete	7/-

From your Dealer or direct from the Manufacturers:

BENJAMIN

CLEARER TONE, ANTI-MICROPHONIC VALVE HOLDER

THE BENJAMIN ELECTRIC LIMITED

Brantwood Works, Tottenham, London, N.17

STAND N^o. 105 AT THE NATIONAL RADIO EXHIBITION

THE "COSMOPOLITAN" FOUR.
 (Continued from page 852.)

is then screwed to the baseboard while it is in the cabinet.

The whole can now be removed bodily from the cabinet and the components mounted on the baseboard.

Again, no difficulty should be experienced in mounting the valve holders, L.F. transformers, etc., as the exact positions of these

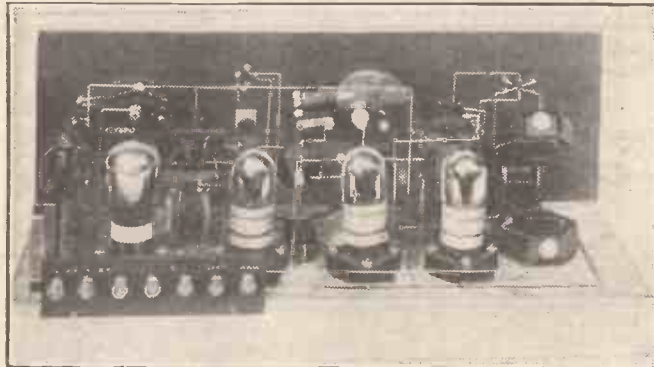
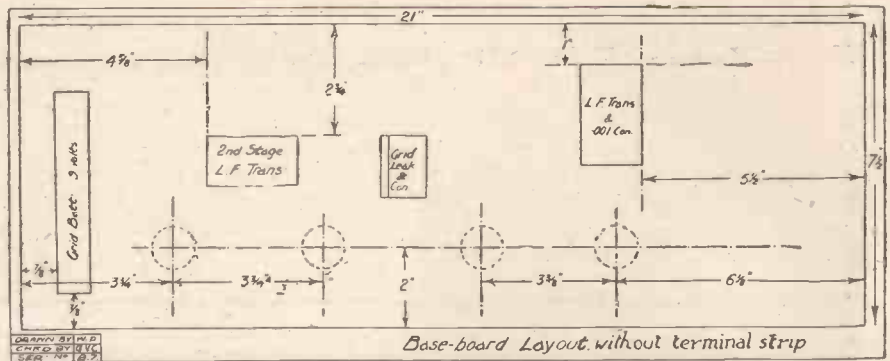

The coils and valves shown in position.

components are given on the baseboard layout diagram. It can be mentioned here that any good second stage L.F. transformer other than the make mentioned can be used, as there is plenty of space on the baseboard for one of a large size.

The photographs show well the appearance of the set when all mounting of the components and wiring has been completed, and give a good

idea of the positions of the various wires. It is an excellent plan to commence the wiring of the set with the filaments, as these wires are the most straightforward.

Before doing so it is advisable to remove the grid battery and, if necessary, the L.F. transformers, so as to have easy access to the filament rheostats. Care should be taken to see that no filament wires cross over the points where the transformers are fitted, otherwise it will be necessary to reshape new wires.

Final Hints.

In the same way, see that all wires clear the largest sizes of coils to be used in the two-way coil holder.

(Continued on next page.)

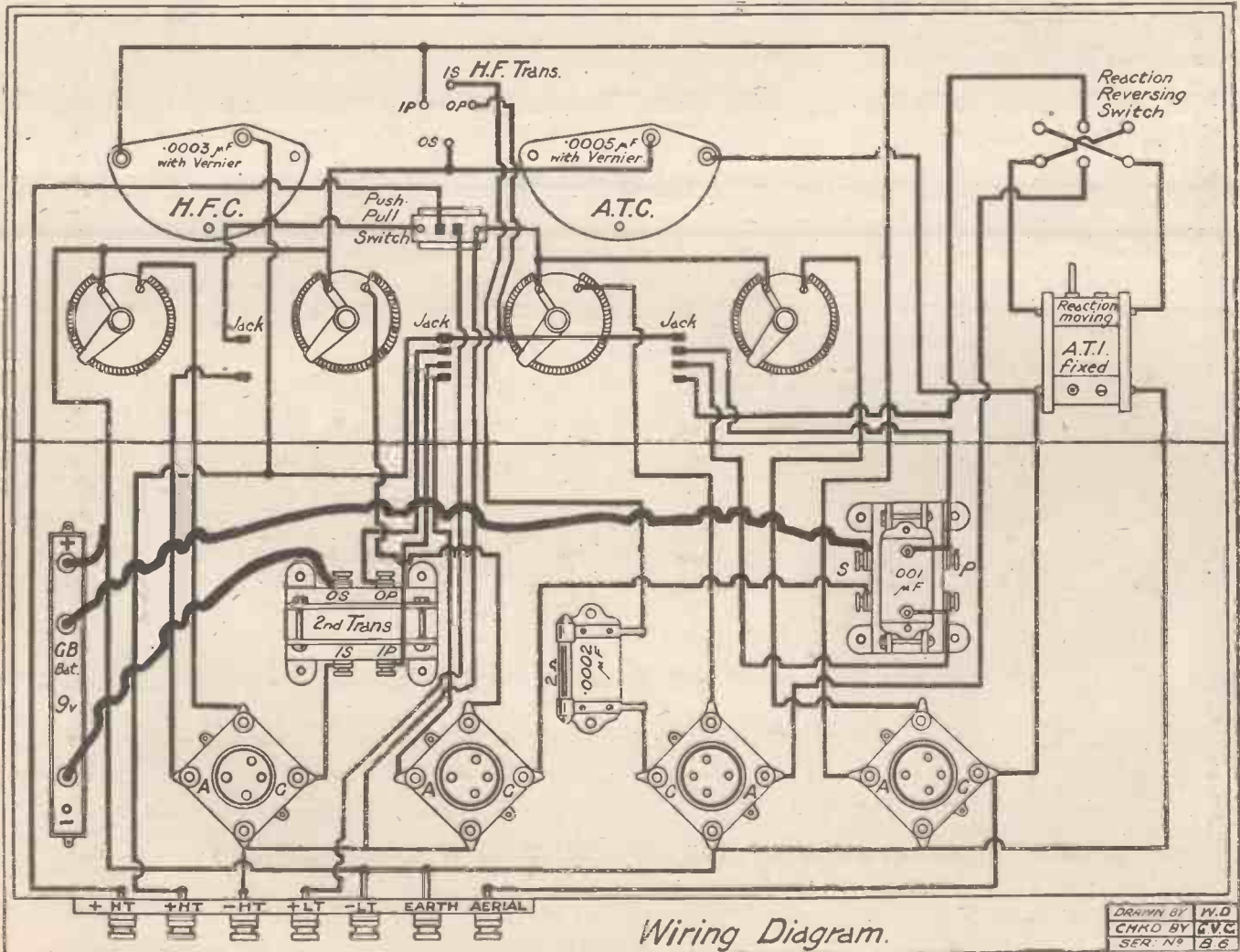

THE "COSMOPOLITAN" FOUR.

(Continued from previous page.)

So as to avoid errors, a list of point-to-point connections is given by which the wiring can be checked when completed.

Another view of the wiring of the receiver showing the clip for holding the grid battery in position and the plugs from the L.F. transformers.

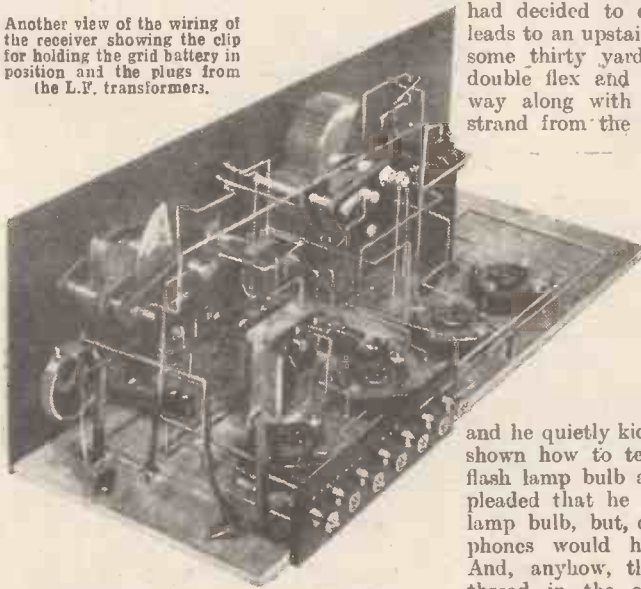

A few general facts about the set will be useful. The H.F. transformer sockets are wired for McMichael or Bowyer-Lowe H.F. transformers.

As parallel aerial tuning is permanently employed, the coils required will be as follows:—B.B.C. stations: Aerial coil (fixed), 35 or 50; reaction coil (moving), 35 or 50; H.F. transformer, 300 to 600 metres. 5 X X.: aerial coil, 150; reaction coil, 75 to 100; H.F. transformer, 1,100 to 3,000

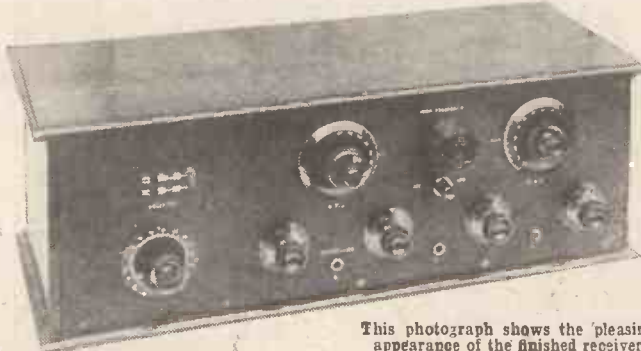

This photograph shows the pleasing appearance of the finished receiver.

metres. Results will vary greatly, according to location, etc.; but even in Brighton (a bad district) six stations were tuned in at full Loudspeaker strength in less than an hour.

Under good conditions, with an outdoor aerial most of the B.B.C. and continental stations should be received.

INGENUITY. FROM A CORRESPONDENT.

THE great fascination of wireless constructional work is summed up in the words "I did it," but there is still more pleasure if one can add, "And it's

entirely my own idea." Wireless, more than any other hobby, offers continual scope for ingenuity, in little things as well as in big things. It compels one to think, in fact. If one simply plunges ahead without thinking, the trouble involved may be appalling.

The other day the writer called on a friend who had recently installed a set, and had decided to extend the loud speaker leads to an upstairs room. He had bought some thirty yards of nice plum-coloured double flex and was slowly working his way along with a finger separating one strand from the other, in order to make sure that the negative output terminal on the set should be connected with the negative terminal on the loud speaker.

Saving Time.

He had already been half-way along the wire three times, and then lost count, and had to start again, and he quietly kicked himself when he was shown how to test for continuity with a flash lamp bulb and a small battery. He pleaded that he did not possess a flash-lamp bulb, but, of course, a pair of telephones would have done equally well. And, anyhow, there was the usual red thread in the covering of one of the strands that was absent from the other!

An easy way of wasting an hour is to try to mount a four-hole fixing condenser without a template, but it is quite a simple matter—when you think of it—to cut an X in the middle of a sheet of paper, insert this carefully over the spindle, and mark on the paper the positions for the other holes. In planning a panel time can always be saved by covering the whole of the ebonite with a sheet of paper of the same size, and marking out the positions for the terminals and components on the paper before commencing to drill.

Useful Tips.

Occasionally one wishes to mount a component, such as a small dry battery, or a fixed condenser, which is not provided with convenient brackets and screw-holes. Chatterton's Com-

pound is invaluable here, and will stick things to either ebonite or wood quite securely. Another useful method of holding awkward things in position on the panel, or on the base-board, or to the side of the cabinet, is a loop of No. 16 S.W.G. square wire, bent to the shape desired and secured by screws or bolts and nuts.

Telephones are a mystery to many listeners-in, but the essential parts of a pair of telephones or a loud speaker are simply coils of wire and magnets. The continuity of the winding of the telephone or loud speaker coils may be tested in the same way as any other coils by means of a small battery and another pair of phones.

Fixed condensers are things which amateurs regularly made for themselves a

couple of years ago. Now they are bought and taken for granted, but they ought to be tested occasionally. When one is found to be defective, it is often a simple matter to put it right by taking it to pieces and putting new mica (.002 of an inch thick) in place of the old.

POINT-TO-POINT CONNECTIONS OF THE "COSMOPOLITAN" FOUR.

One side of each filament rheostat to one filament contact of each valve holder. Remaining sides of the first and second filament rheostats joined together, connected to the right-hand outside contact of the push-pull switch, to one filament contact of each of the third and fourth valve holders and to the - H.T. terminal. Right-hand inside contact of the push-pull switch to the + L.T. terminal. Socket side of the fixed coil holder to the remaining filament contacts of the first and second valve holders, to the earth terminal, to the - L.T. terminal, to the positive grid bias (by means of a flexible wire), to the remaining sides of the third and fourth filament rheostats, to O.S. of H.F. transformer and to the moving vanes of the .0005 mfd. variable condenser. Fixed vanes of the .0005 mfd. variable condenser to the plug side of the fixed coil holder to the grid contact of the first valve holder and the aerial terminal. Plate contact of the first valve holder to I.P. of H.F. transformer and to the fixed vanes of the .0003 mfd. variable condenser. O.P. of H.F. transformer to the top outside contacts of the first and second jacks, to the moving vanes of the .0003 mfd. variable condenser and to the centre + H.T. terminal. Grid contact of the second valve holder to one side of the grid leak and condenser. Other side of the grid leak and condenser to I.S. of H.F. transformer. Plate contact of second valve holder to centre bottom contact of D.P.D.T. switch. Top centre contact of D.P.D.T. switch to the bottom outside contact of the first jack. Plug side of moving coil holder to the bottom left-hand contact of the D.P.D.T. switch and to the top right-hand contact of the same switch. Socket side of the moving coil holder to the bottom right-hand contact and the top left-hand contact of the same switch. I.P. and O.P. of the L.F. transformer (which have a .001 fixed condenser across them) to the top and bottom inside contacts of the first jack. One side of the secondary of the first L.F. transformer (Sullivan) to the grid contact of the third valve holder. The remaining side of the secondary of the first L.F. transformer is then connected to a black plug by means of a flexible wire. The plug is tapped into the grid bias battery at one and a half or three volts. Plate contact of the third valve holder to the bottom outside contact of the second jack. O.P. and I.P. of the second L.F. transformer to the top and bottom inside contacts of the second jack. I.S. of the second L.F. transformer to the grid contact of the fourth valve holder. O.S. of the second L.F. transformer is connected to another black plug (by means of a flexible wire) and is tapped into the grid bias battery at six to nine volts. Plate contact of fourth valve holder to the bottom contact of the third jack. Top contact of the third jack to the left-hand outside contact of the push-pull switch. Left-hand inside contact of the push-pull switch to the remaining + H.T. terminal. This completes the wiring.

REDUCED PRICES

(Effective 16th August, 1926)

The Edison Swan Electric Company Ltd. announce reductions in the prices of Ediswan Valves as shown in the following table of combinations:-

Receiving.	Old Price	NEW PRICE	Accumulator or Battery Volts	Power	Old Price	NEW PRICE
G.P. 4...	16/6	14/-	4	P.V. 4	22/6	18/6
*A.R. } *A.R. }	8/-	As before	4	P.V. 4		
				6	P.V. 5	22/6
*A.R.D.E.	14/-	As before	2	P.V. 6	18/6	As before
*A.R. .06	16/6	14/-	3	P.V. 8	22/6	18/6

* MADE IN L.F. & H.F. TYPES.

ABOVE ARE ALL DULL EMITTERS EXCEPT A.R.

EDISWAN VALVES

The Edison Swan Electric Co., Ltd.,
123-5 Queen Victoria Street,
London, E.C.4.

CURRENT TOPICS.

(Continued from page 849.)

Making Room.

They have been given the somewhat grandiloquent title of "International Common Waves," and the range of a station using an International Common Wave is limited to a specific area around the transmitter where it is strong enough to override the other interfering station.

Consequently, low-power stations having only a localised area to serve can be given common waves, and the Bureau have thus been able to accommodate the 116 stations by decreasing that seven of them each taking of the 16 common waves.

It was this formula which formed the foundation of the new Geneva Plan which was officially adopted a few days ago.

NEXT WEEK.

**HOW TO MAKE
A "P.W." LOW LOSS
ULTRA CRYSTAL SET.**

Coming Shortly.

**A SIMPLE
D.C. MAINS H.T. UNIT.**

Place a **REGULAR ORDER** for
"P.W." NOW.

**THE GENEVA
WAVE-LENGTH
PLAN.**

(Continued from page 849.)

Frequency x 10,000.	Geneva Wave- length Plan.	Name of Station.	Country.	Present Power.	Present Wave- length.
120	250	Gleiwitz	Germany	0.75	251
		Oulu	Finland	0.1	233
		Oporto	Portugal	—	—
121	247.9	Lille	France	—	—
122	245.9	Posen	Poland	—	—
		Toulouse	France	0.5	260
		P.T.T.			
123	243.9	Trondhem	Norway	1	?
124	241.9	Königsberg	Germany	0.75-4	462
125	240	Helsingfors	Finland	?	313
		(1).			
126	238.1	Bordeaux	France	—	—
127	236.2	Bucarest	Romania	—	—
128	234.4	Vilna	Poland	—	—
129	232.6	?	Holland	—	—
130	230.8	Trieste	Italy	—	—
131	229	Malmoe	Sweden	1	270
132	227.3	Vigo	Spain	1	270
133	225.6	Belgrade	Jugo-Slavia	—	—
134	223.9	Leningrad	Russia	?	?
		(2).			
135	222.2	Strasbourg	France	—	—
136	220.6	Odessa	Russia	—	—
137	219	Kovno (3)	Lithuania	—	—
138	217.4	Luxemburg	Luxemburg	—	—
139	215.8	Sofia	Bulgaria	—	—
140	214.3	Viborç	Finland	—	—
141	212.8	Cracow	Poland	—	—
142	211.9	Kiev	Russia	?	231.9
143	209.8	Smolensk	Russia	—	—
144	208.3	Tirana	Albania	—	—
145	206.9	Minsk	Russia	—	—
146	205.5	Jassy	Roumania	—	—
147	204.1	Gålle	Sweden	0.025-1	208
		Salamanca	Spain	—	—
		Speyer	Germany	—	—
148	202.7	Christlan- hamu.	Sweden	?	202
		Asturias	Spain	—	—
		Oviedo	Spain	—	—
149	201.3	Karlskrona	Sweden	—	—
		Aix-la- Chapelle (Aachen).	Germany	—	—

(1) Helsingfors can repeat 375 m. wave-length of Madrid. (2) Leningrad can repeat 434.8 m. wave-length of Bilbao. (3) Kovno can repeat 344.8 m. wave-length of Seville. * These wave-lengths were allotted in the Geneva Plan. For subsequent modifications see page 250.

**EDISON BELL
RADIO**

**THE FINEST FIXED CONDENSERS MONEY CAN BUY
OR SCIENCE PRODUCE.
FIT THEM TO YOUR SET AND BE SATISFIED.**

CAT. No.
139/327.
**E.B. FLAT
TYPE**
fitted with
**GRID LEAK
IN SERIES.**

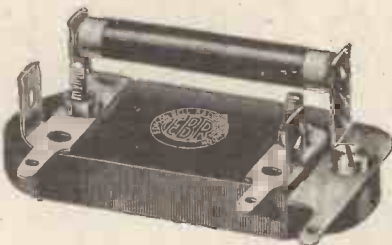

Ask your Dealer
for Catalogues &
List R/E. 144. If
unable to obtain
write direct to
Manufacturers—
**EDISON BELL
Ltd.,
Edison Bell
Works,
LONDON, S.E.15,
and at
Huntingdon.**



CAT. No.
139/328.
**E.B. UPRIGHT
TYPE**
fitted with
**GRID LEAK IN
PARALLEL.**

In these condensers the two clips used when the grid leak is in parallel are fitted under the terminals. The third clip is supplied loose and should be held in position by the screw which holds the condenser to the panel. The exact position of the third clip is clearly indicated in the above illustrations, and full directions are supplied with each condenser. The parallel connection is usual in valve detectors, and the series arrangement is used in tuned anode and resistance couplings, etc.

**TESTED 500 VOLTS
FLAT TYPE**



The above can be supplied with or without grid leaks fitted.

**TESTED 500 VOLTS
UPRIGHT TYPE**



INSIST ON EDISON BELL CONDENSERS

THEY ARE BRITISH MADE AND GUARANTEED BY A NAME WITH 30 YEARS REPUTATION BEHIND IT



SUM IT UP

for yourself. The British Made Lustralux '06 H.F. Det. or L.F. Valves cost 9/- each. The Lustralux '34 Power Valve costs 11/-. You can get an ideal three-valve combination for 29/- and no valve calls for more than 2 volts!

Quite apart from the low initial cost, think of the current economy of arranging your accumulator cells in parallel—and the three valves together only call for '46 amps.

Quality and reproduction? Well just try! Compare the Lustralux with any valve you like, quite irrespective of cost. Your own good opinion will be confirmed by your most musically inclined friend.

Ask your dealer.

Lustralux Valves also obtainable from Lewis's Ltd., Liverpool and Manchester, and LUSTROLUX Ltd., West Bollington, near MACCLESFIELD.

Send for Catalogue A.

LUSTROLUX

NI+FE

STEEL PLATE ACCUMULATORS

FOR HIGH TENSION

only 1/- per Volt.

Absolutely Noiseless. No Acid.
No Fumes. Last a Lifetime.

BATTERIES LTD., REDDITCH



Ask your Dealer for the

BECOL FORMER

THE FORMER OF THE FUTURE.

Low Loss. Size 3 ins. diameter to outside of wings. Made from the famous BECOL EBONITE. Specially designed for low loss. Large air space between wings. Easy winding. Thoroughly dependable and British made.

From all dealers, in 6 inch lengths, 3/-

THE BRITISH EBONITE CO., LTD., HANWELL, LONDON, W.7.
Rods, Tubes, Sheets, Panels, Mouldings, etc.

TRANSFORMER RATIO 4-1 MARCONI OSRAM R.3 VALVE

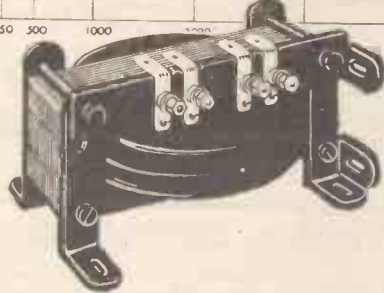
CERTIFIED FREE FROM DISTORTION

The Pye Transformer curve was plotted from figures officially certified by the National Physical Laboratory. It shows graphically that a very high amplification is obtainable on high and low notes without distortion: and that between 250 and 4000 cycles a second amplification is absolutely uniform.

Primary and Secondary windings are wound in special Bakelite bobbins and very carefully insulated (Fig. 1). The laminated core is 5.6 sq. cms. in area (Fig. 2). Voltages up to 300 v. can be used with perfect safety. All noise and crackling is eliminated. Double angle brackets allow the Transformer to be mounted in two positions (Fig. 3). Connexions can be made to screw terminals or to soldering tags.

Low Frequency Transformers

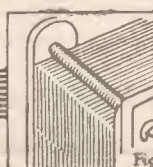
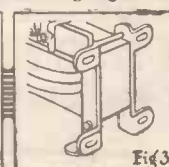
Ratio 2.5 : 1 Ref. No. 651	£1 2 6
" 4 : 1 " " 653 (curve illus.)...	£1 2 6
" 6 : 1 " " 654	£1 7 6

Telephone Transformers

120 ohms. Ref. No. 655.....	£1 0 0
2000 " " 656.....	£1 0 0
350 " Western Electric Ref. No. 657 ...	£1 0 0

Every Transformer guaranteed for 12 months

Low Frequency Chokes

Same appearance as L.F. Transformer

Reference No. 658. Inductance 32 henries. Impedance 197,000 ohms. at 1000 cycles per second. Suitable for insertion in anode circuit of the final Valve of a power Amplifier, Loud Speaker being connected across windings with Condenser in series. Price 15/-

Reference No. 659. Inductance 110 henries. Impedance 700,000 ohms. of 1000 cycles per second. For use in Choke-coupled Amplifiers using Valves with internal impedance up to 30,000 ohms. Price 15/-

Suitable Grid Condenser for above .05 mfd.
Pye Grid Leak .25 or .5 megohms. Price 1/6

Write for booklet giving particulars of all Pye products

W. G. Pye & Co., Granta Works, Montague Road, Cambridge

Manufacturers of Scientific Instruments and Radio Apparatus

PYE COMPONENTS



'Bring Reception To Perfection'



Traders and manufacturers are invited to submit wireless sets and components to the "P.W." Technical Dept. for test. All tests are carried out with strict impartiality in the "P.W." Test room under the supervision of the Technical Editor, and the general reader is asked to note that this weekly article is also intended to provide a reliable and unbiased guide as to what to buy and what to avoid.—EDITOR.

THE ARTIC VALVE HOLDER.

THE Artic Fuse and Electrical Manufacturing Co., Ltd., of Birtley, Co. Durham, recently sent us an Artic valve holder to test. It is claimed that the component embodies an entirely new principle for the elimination of vibration and microphonic noises. It has been taken up by the Admiralty and other large users of electric lamps to protect the filaments of these against mechanical shocks or vibration. The system is most effective and ingenious. The four valve sockets are held together by a thin disc of Bakelite, which is well cut away to minimise absorption losses. This section of the holder is suspended by a number of phosphor bronze gauze strips, so arranged that no single strand of any one strip is connected directly between the valve sockets and the body of the holder. The gauze strips are so cut that the warp and weft strands lie obliquely.

The interrupted woven strands of the Phosphor Bronze gauze forms a suspension which has no "period"; it is absolutely inert, and when the valve inserted in the holder is pushed with the finger it sways over with as little resistance as would be offered by very light metal springing. But the damping is so great that when released it merely sags back into its vertical position. As a crude simile, it might be floating in a viscous liquid or in mercury.

As was anticipated, the Artic holder passed very stringent tests. Even with a hardened old microphonic sinner of a valve it fulfilled its purpose with every satisfaction. It offers, additionally, such protection against shocks that we should imagine a set using Artics could be dropped on to the floor from a considerable height without causing damage to the valve filaments.

The Artic holder is rather large, but

it is very well made and imposing in appearance. Properly designed for base-board mounting, it is supplied with four mounting holes in its Bakelite base. It is a "de luxe" holder we can recommend to the attention of all our readers. It costs 3s. 9d., and in our opinion is most excellent value for money.

"GOLSTONE" H.T. BATTERY ELIMINATORS.

Contrary to a fairly general belief, A.C. mains H.T. battery eliminators are frequently more satisfactory than similar devices designed to operate on D.C. mains. The reason is to be found at the generating station itself. Alternating current dynamos do not use commutators, they employ what are known as slip rings. Two of these are used, and each one is in permanent contact with a collecting brush. On the other hand, the two collecting brushes of a direct current dynamo come into contact with successions of contacts; each brush passes from one to another of a large number of individual sections on what is known as a commutator. Thus commutator ripple is caused, and if the commutation is bad a "hum" is developed that it takes a very excellent smoothing system indeed to smooth out.

Therefore, readers of "P.W." who have A.C. mains are, in a sense, fortunate, although it must be admitted that an A.C. eliminator is somewhat more costly to purchase than a D.C. type. For instance, the "Goltone" H.T. unit for A.C. mains, a product of Messrs. Ward & Goldstone, costs £5 10s., but this is by no means an unreasonable figure in the circumstances.

(Continued on page 862.)

The Sensation of the Show!

Loud Speaker
reception
for ALL

63/-

SEE
OUR
STAND
143

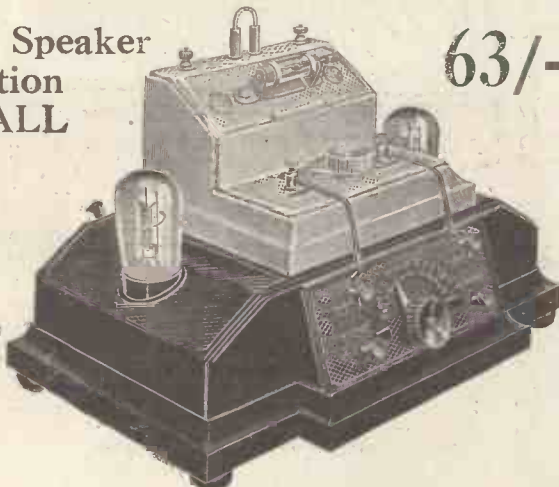

At last—
loud speaker
results with-
out trouble
or expense.

This latest "Brownie Wireless" achievement will be seen for the first time at the National Radio Exhibition, Olympia (Sept. 4-18). For the first time also it will put loud speaker reception within the reach of everyone. It is simplicity itself to operate and a really handsome little instrument—come and see for yourself at the show.

The "Brownie" Amplifier

The Brownie Wireless Co. (of Gt. Britain) Ltd.,
310a-312a, Euston Road, London, N.W.1.

Telephone: Museum 3747.

JACK SWITCHING DIAGRAMS

Switching in modern circuits is now carried out with jacks and plugs. The Igranic Electric Co., Ltd., has just issued an attractive leaflet containing a number of circuit diagrams showing different switching operations carried out with jacks and plugs. You will find these diagrams very useful for reference. A copy will be sent you on receipt of your request.



149, Queen Victoria Street, LONDON
Works: BEDFORD.

HAVE YOU SENT FOR YOUR COPY OF THE
NEW IGRANIC CATALOGUE (No. R20).

WORLD

The Master Valve Holder

PATENTS

FACTS
VERSUS
FICTION

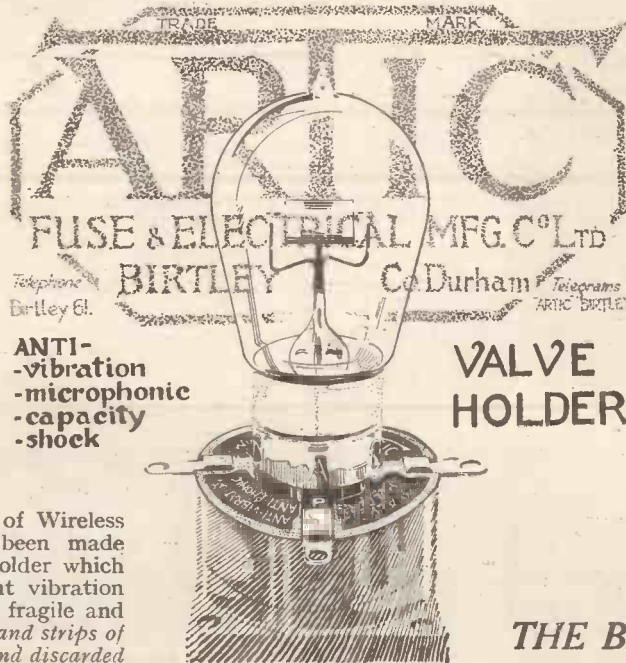

THE BEST IS
THE CHEAPEST
THE INFERIOR
ALWAYS THE
MOST
EXPENSIVE

EVER since the advent of Wireless Valves efforts have been made to provide a Valve Holder which would damp out or prevent vibration from reaching the extremely fragile and delicate filament. Springs and strips of sheet metal have been used and discarded as useless, because in each and every instance the supporting springs and metal strips had a sectional area equal to a thousand times the sectional area of the valve filament they were supposed to protect, thus allowing vibration to pass through and create microphonic noises or destroy the filament: furthermore, springs and strips of metal having periodicities of their own, set up additional vibration which proves absolutely fatal to the life of the valve filament.

The "Artic Valve Holder" completely solves all the problems, as it is based on an entirely new principle, covered by Master Patents in Great Britain and abroad. It is wholly inert to the passage of vibration: it has no inherent periodicity in itself, and provides a strong supporting medium unaffected by vibration, shock, heat, or atmospheric conditions. The principle of the device has been in use for a number of years by all large consumers of Electric Lamps, including the British Admiralty, and it is the only known device which is wholly effective in preventing the breakage of Metallic Filaments, either from shock or vibration.

The suspension consists of a plurality of Phosphor Bronze Gauge Strips arranged with the warp and twist strands cut on the bias, in such a manner that no single strand is connected directly between the outer casing and the suspended valve holder sockets.

We claim to have solved the problem where others have failed, and we offer you a Valve Holder embodying all the known characteristics which make for efficiency and crystal-clear reception.

The only known device which is wholly effective in increasing the life of your valves, preventing valve filament breakages from vibration or shock, increasing the range and efficiency of your set, enabling you to obtain better and purer reception by eliminating microphonic noises and reducing capacity effects.

See what POPULAR WIRELESS has to say under "Apparatus Tested."

THE BEST and WHY?

- Because:**—The "ARTIC" Suspending Medium is absolutely inert to the passage of vibration or shock.
- Because:**—All Springs or Strips of Metal have been eliminated, having been found to increase vibration and reduce the life of the valve.
- Because:**—No Perishable Material, such as rubber, is used.
- Because:**—They are the only Valve Holders that will give that even and steady flow of Electrons from filament to plate, which is necessary and vital for purity of reception and elimination of distortion.
- Because:**—They will increase the life of your Valves, give lasting satisfaction and quickly pay for themselves.
- Because:**—The valve, being the most delicate part and the heart of your set, demands an "ARTIC" Valve Holder if you are to secure protection, stability and perfect results.

FROM YOUR DEALER OR DIRECT FROM US

EACH **3/9** POST FREE

Postal and Money Orders only, payable to
ARTIC FUSE & ELECTRICAL MFG. CO., LTD.,
BIRTLEY, CO. DURHAM.

APPARATUS TESTED.

(Continued from page 860.)

We have had one of these instruments on test for some time, and it has given perfectly satisfactory service. It employs a small dull emitter valve rectifier, but no filament resistance is provided or needed, as purchasers are asked to specify their main's frequency and voltage when ordering, and suitable units for special conditions are provided accordingly.

Four voltages are obtainable with this unit, viz., approximately 30, 60, 90, and 130 volts. Each of the four "tappings" is duplicated, so that two "stages" can be taken without difficulty to the same point. A long flexible cord with adaptor is supplied and this latter can be plugged into any convenient lampholder. It does not matter in what manner the device is connected, no trouble in respect of plus and minus connections can occur, and altogether the unit is as "fool proof" as can be. Running costs are almost negligible and results equal to those given by battery supplies. We can fully recommend this "Goltone" product to our readers.

Messrs. Ward & Goldstone also supply a direct current model with five tappings at the price of £3. It is an excellent unit and gives as good results, comparatively speaking, as the A.C. model. In cases where commutator ripple gives undue trouble and when most other units fail to give any satisfaction, possessors of Goltone's are able to bring into use a special and additional

smoothing unit which is available at quite a low cost. With this practically "silent" reception is possible in the case of the most "ragged" of supplies. A novel feature of the Goltone D.C. unit is the provision of a current indicator permanently fitted to the instrument. Thus the necessity of "pole finding" by means of cut potatoes or the like is obviated.

An ample supply of H.T. current can be obtained from either of the above units for all ordinary purposes, and there is less limitation comprised in this respect than with some makes.

THE H.T.C. BATTERY ELIMINATOR.

We recently published a favourable report concerning this instrument, but omitted to mention that it can be supplied to suit any voltage or periodicity to order.

LIBERTY PERMANENT CRYSTAL DETECTOR.

The manufacturers of this component, Radi-Arc Electrical Co., inform us that a patent, No. 25,524, has been granted to them in respect of that detector.

AN IMPORTANT PRICE REDUCTION.

The Burdept anti-microphonic valve holder, which is stated to be the first

component of its kind placed on the market, has been reduced in price from 5s. to 2s. 9d.

AN INTERESTING APPOINTMENT.

It was recently announced that Mr. L. Hermes, late general sales manager of the Marconiphone Co., Ltd., and Sterling Telephone and Electric Co., Ltd., has been appointed director of sales of the Cleartron Radio Co., Ltd. We are informed that the Cleartron people contemplate the inauguration of a separate company to handle certain new propositions, details of which will be to hand in due course.



An Amplion Dragonfly loud speaker is "featured" with Tom Mix in a Fox film entitled "The Everlasting Whisper," but the lusty little instrument has nothing in common with the title of that "picture."

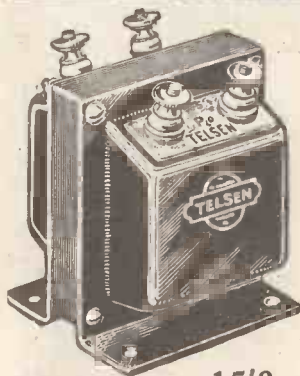

Shrouded Popular 15/6

TELSEN
L.F. TRANSFORMERS

Radio's Choice

British Made

The L.F. TRANSFORMERS that give maximum volume without distortion.

Other types:—

Standard Open 14/-
TELSEN ACE 9/6

All models in ratios 5-1, 3-1, and Guaranteed for 12 months.

TELSEN ELECTRIC CO.,
207, Aston Road, Birmingham

See us at **STAND No. 50**
At the National Radio Exhibition!

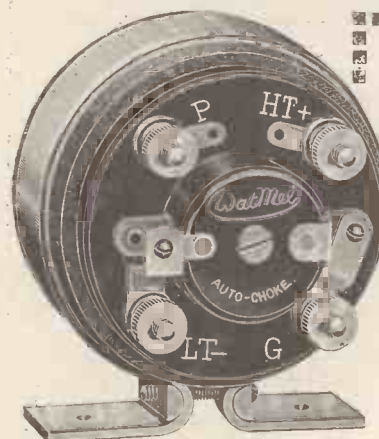

The Watmel exhibits at Stand No. 50 will comprise the Watmel Auto-Choke (as illustrated), the Watmel Variable Grid Leak, and the Combined Fixed Condenser and Fixed Grid Leak. All three of these ingenious components are being used with great success by constructors and are now widely known for good results. If interested in the Auto-Choke please send for the N.P.L. CURVE 103/1, and Booklet (or ask for it at Stand 50 if at the Exhibition).

Watmel

THE WATMEL WIRELESS CO. LTD.,
332a, Goswell Road, London, E.C.1.

Lancashire and Cheshire Representative:
Mr. J. B. LEVEE, 23, Hartley Street, Levenshulme, MANCHESTER.
Telephone: 475 Heaton Moor.

A Word to Advertisers!

Our Issues for Sept. 4 and 11 will be **SPECIALLY ENLARGED EXHIBITION NUMBERS** containing full details of Special Exhibits and latest Apparatus

**SECURE YOUR SPACE NOW
NO INCREASE IN RATES.**

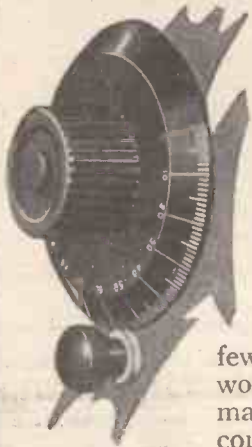

The "MIDGET"

An inexpensive friction tuning device giving excellent results.

The "Midget" can easily be fitted to all sets in a few moments, and it will work equally as well as many higher priced vernier controls.

Complete with full instructions for fixing.

9^d. Each.

All metal parts heavily nickel-plated, highly polished Bakelite knob and best quality rubber washers. It is self-adjusting. Fit one and add 100% efficiency to your set.

Full particulars of other "STANDARD" Radio Products on application. "Belden" Battery Cord, 5, 6, and 7 way. Headphone and Loud Speaker Cords. "Belden" Loop Antenna Wire. Trade enquiries solicited.

THE STANDARD INSULATOR Co. Ltd.,
Winsley House, Wells Street, Oxford Street,
LONDON, W.1. Phone: Museum 5978 and 7571.

APPOSITE ADAGES No. 5.

'Don't Spoil the Ship'

Specify

DUBILIER
PRODUCTS

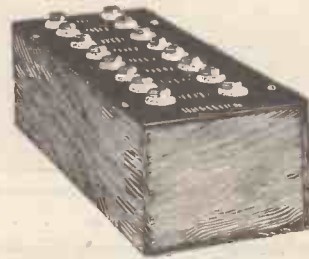

Have you entered for the Dubilicon Competition yet?

If not, write to us now for full particulars.

Cash Prize £200.

Don't forget to use

GLAZITE
BRITISH MADE REGD.

COLOURED CONNECTING WIRE

[RED YELLOW BLUE BLACK WHITE and GREEN]

Write for descriptive leaflet to

The LONDON ELECTRIC WIRE CO & SMITHS LTD.
Playhouse Yard, Golden Lane, London, E.C.1

Makers of Electric Wire  for over 40 years

Visit our Stand, No. 216, at Olympia.

FORMO
ARTHUR FORM & CO. LTD.

ULTRA LOW-LOSS

Straight Line Frequency Condenser
Cone Bearings. Braced Vanes. Positive Collector. A real precision job.

Condenser only, '0003uF., '0005uF. . . 9/-
Condenser, with plain Dial. Standard 10/6
F dia. shaft

Send for Catalogue and Descriptive Literature of complete Formo Range
THE FORMO COMPANY
Crown Works, Cricklewood, N.W.2
Phone: Hampstead 1787.

Manchester:
Mr. J. B. Levee, 25, Hartley St., Levenshulme.
Phone: Heaton Moor 475.
(See page 865 for Formo Transformer.)

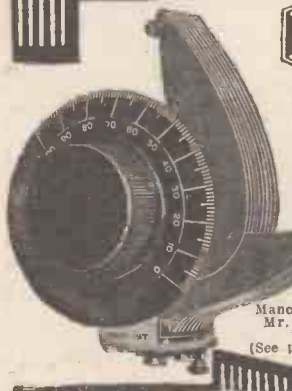

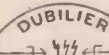
REGISTERED  TRADE MARK.

DUBILIER
CONDENSER CO (1925) LTD

ADVT. OF THE DUBILIER CONDENSER CO. (1925) LTD., DUCON WORKS,
VICTORIA ROAD, N. ACTON, LONDON, W.3. Tel. Chiswick 2241 2-3.

E.P.S. 217.

RADIOTORIAL

All Editorial Communications to be addressed to The Editor, POPULAR WIRELESS, The Fleetway House, Farringdon Street, London, E.C.4.

Editor:
NORMAN EDWARDS, M.Inst.R.E., F.R.S.A.,
F.R.Q.S.

Technical Editor:
G. V. DOWDING, Grad.I.E.E.

Assistant Technical Editors:
K. D. ROGERS. P. R. BIRD.

Scientific Adviser:
Sir OLIVER LODGE, F.R.S.

Staff Consultants:
Dr. J. H. T. ROBERTS, F.Inst.P.; J. F. CORRIGAN, M.Sc., A.I.C.; C. E. FIELD, B.Sc.;
E. J. SIMMONDS, M.I.R.E., F.R.S.A.

Foreign Correspondents:
F. M. DELANO, Paris; Dr. ALFRED GRADENWITZ, Berlin; L. W. CORBETT, New York; P. F. MARTIN, Italy; W. PEETERS, Holland.

The Editor will be pleased to consider articles and photographs dealing with all subjects appertaining to wireless work. The Editor cannot accept responsibility for manuscripts and photos. Every care will be taken to return MSS. not accepted for publication. A stamped and addressed envelope must be sent with every article. All inquiries concerning advertising rates etc., to be addressed to the Sole Agents, Messrs. John H. Lile, Ltd., 4, Ludgate Circus, London, E.C.4.

As much of the information given in the columns of this paper concerns the most recent developments in the Radio world, some of the arrangements and specialities described may be the subject of Letters Patent, and the amateur and the trader would be well advised to obtain permission of the patentees to use the patents before doing so.

Readers' letters dealing with patent questions, if sent to the Editor, will be forwarded to our own patent advisers, where every facility and help will be afforded to readers. The envelope should be clearly marked "Patent Advice."

TECHNICAL QUERIES.

Letters should be addressed to: Technical Query Dept., "Popular Wireless," The Fleetway House, Farringdon Street, London, E.C.4.

They should be written on one side of the paper only, and MUST be accompanied by a stamped addressed envelope.

Queries should be asked in the form of the numbered questions: (1), (2), (3), etc., but may be accompanied by a short letter giving any necessary additional particulars as briefly as possible.

For every question asked a fee of 6d. should be enclosed. A copy of the numbered questions should be kept, so that the replies may be given under the numbers. (It is not possible to reproduce the question in the answer.)

BLUE PRINTS. A series of 20 Blue Prints can be obtained from the Query Dept., price 6d. per Blue Print.

Only a limited number of circuits are covered by this series, and full details of the circuit arrangements available in Blue-Print form are published fortnightly in the advertisement columns of this journal.

All other back-of-panel diagrams are specially drawn up to suit the requirements of individual readers at the following rates: Crystal Sets, 6d.; One-Valve Sets, 6d. One-Valve and Crystal (Reflex), 1s. Two-Valve Sets, 1s. Three-Valve and Crystal (Reflex), 1s. Four-Valve Sets, 1s. 6d. Multi-Valve Sets (straight circuits), 1s. 6d. Except SUPER-HETERODYNE DIAGRAMS, all of which, irrespective of number of Valves used, are 2s. 6d.

If a panel lay-out or list of point-to-point connections is required, an additional fee of 1s. must be enclosed.

Wiring diagrams of commercial apparatus, such as sets of any particular manufacture, etc., cannot be supplied. (Such particulars can only be obtained from the makers.)

Readers may submit their own diagrams, etc., for correction or for criticism. The fee is 1s. per diagram, and these should be large, and as clear as possible.

No questions can be answered by 'phone. Remittances should be in the form of Postal Orders.

Questions and Answers

FADING.

"FADEAWAY" (Solihull, Birmingham) — Why do the signals fade away very often? Sometimes when I am receiving well the sounds slowly die away, and at other times they will fade away fairly quickly but come back again. Is this all due to what is known as fading? And, if so, what causes it?

There is a scientific phenomenon known as "fading" which affects long-distance signals, but all "fading"

(Continued on page 866.)

THE BEST AMPLIFIER and the CHEAPEST both to fix and operate IS THE NEW NON-VALVE MAGNETIC MICROPHONE BAR AMPLIFIER

(Patent No. 248581/25).

Complete Amplifier

PRICE

38/-

Post Free.

Dry Cells Extra.

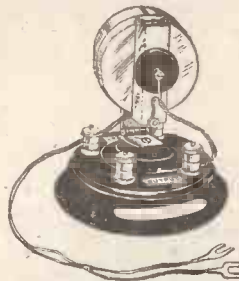

Microphone and other parts of Amplifier also supplied separately.

Illustrated lists free.

REALLY GOOD LOUD-SPEAKER RESULTS from CRYSTAL RECEPTION of average strength. WEAK CRYSTAL or VALVE RECEPTION made STRONG and CLEAR. ENABLES even very DEAF PERSONS TO HEAR from Crystal Sets.

Not a Microphone Button. Entirely free from distortion and micro-phonous noises. No valves, accumulators or H.T. Batteries. No fragile parts. Nothing to get out of order. A child can adjust it. Operates on one or two Dry Cells lasting over 3 months.

EQUALLY EFFICIENT ON VALVE SETS.

Order from your dealer or from Sole Manufacturers and Patentees:

NEW WILSON ELECTRICAL MANUFACTURING CO., LTD.,

18, Fitzroy Street, Euston Road, London, W.1.

'Phone: Museum 2703.

"BEST WAY"

PORTABLE SETS



A Useful Guide for the Wireless Constructor.

6d.

Details of the three splendid sets described in this "Best Way" Wireless Guide are given below. The book is amply illustrated with photographs and diagrams, and constructors will find the wiring directions most lucid and straightforward.

ALL STATION LOUDSPEAKER PORTABLE

A remarkably compact six-valve SUPER-HET. Aerial batteries and loudspeaker all completely enclosed and permanently connected.

THREE VALVE PORTABLE

Several stations on the loudspeaker and many on Telephone receivers can be obtained. A frame aerial is built into the lid of its neat carrying case.

BABY PORTABLE

A two-valve receiver in a very small attaché case. Batteries and telephones are enclosed and wire and earth pin for temporary aerial are provided.

The secret of success in soldering- **FLUXITE**

FLUXITE 7/6 SOLDERING SET—Complete

All Hardware and Ironmongery Stores sell FLUXITE in tins, price 8d., 1/4 and 2/8.
Another use for Fluxite—Hardening Tools and Case Hardenink. Ask for leaflet on improved methods.
FLUXITE Ltd.
(Dept. 324)
Rotherhithe, S.E.16.



C.E. PRECISION RHEOSTATS 7 & 15 ohms 2/9, 30 ohms 3/-.
C.E. PRECISION POTENTIAL METERS, essential for efficient E.F. control 3/9.



Used in such famous Circuits as: The 1926 Unidyne 2-Valver; The Marcuse Short-Wave Receiver; The Household 3-Valver; The Trindyne 1-Valver, &c.

WHY PAY MORE?

You may pay more, but you certainly will never require a better rheostat than the C.E. Precision. They are perfectly finished, and the neat silvered dial which mounts flush with the panel, lends an air of distinction to any set.
Call in and see one; you will buy it.
C. EDE & Co., LTD., High Road, Byfleet, Surrey.





A MONUMENT IN THE MARCH OF PROGRESS

The Formo Shrouded Transformer is the universal favourite
Made in Ratios 1-1, 1-2, 1-3, 1-4 and 1-5
10/6 1-3 and 1-5 for 1st and 2nd stages

Send for Catalogue and Descriptive Literature of Complete Formo Range
THE FORMO COMPANY
Crown Works, Cricklewood, N.W.2
Phone: Hampstead 1787.
Manchester: Mr. J. B. Leves, 23, Hartley St., Levenshulme.
Phone: Heaton Moor 475.
(See page 863 for Formo S.L.F. Condenser.)

Invaluable to **EVERY Amateur and Constructor.**

The "POPULAR WIRELESS"

BLUE PRINTS of TESTED CIRCUITS

Every wireless amateur and every wireless constructor will find these "POPULAR WIRELESS" Blue Prints absolutely reliable. They have been most accurately drawn, and every circuit has been tested under normal broadcasting conditions by the technical staff of "Popular Wireless." It will be seen from the complete list given below that the series covers a very wide field. The veriest tyro will find each print most straightforward to follow and the receivers most easy to construct.

P.W. BLUE PRINT Number

1. DETECTOR VALVE WITH REACTION.
2. UNIDYNE DETECTOR VALVE WITH REACTION.
3. 1-VALVE L.F. AMPLIFIER.
4. CRYSTAL DETECTOR WITH L.F. AMPLIFIER.
5. H.F. (Tuned Anode) AND CRYSTAL, WITH REACTION.
6. H.F. AND CRYSTAL. (Transformer Coupled, Without Reaction).
7. 1-VALVE REFLEX WITH CRYSTAL DETECTOR (Tuned Anode).
8. 1-VALVE REFLEX AND CRYSTAL DETECTOR (Employing H.F. Transformer, without Reaction).
9. H.F. AND DETECTOR (Tuned Anode Coupling, with Reaction on Anode).
10. H.F. AND DETECTOR. (Transformer Coupled, with Reaction).
11. DETECTOR AND L.F. (With Switch to Cut Out L.F. Valve).
12. DETECTOR AND L.F. UNIDYNE (With Switch to Cut Out L.F. Valve).
13. 2-VALVE REFLEX (Employing Valve Detector).
14. 2-VALVE L.F. AMPLIFIER (Transformer coupled with Switch to Cut Out Last Valve).
15. 2-VALVE L.F. AMPLIFIER (Transformer-Resistance Coupled with Switch for Cutting Out Last Valve).
16. H.F. (Tuned Anode), CRYSTAL DETECTOR AND L.F. (with Switch for Last Valve).
17. CRYSTAL DETECTOR WITH TWO L.F. AMPLIFIERS (with Switching).
18. 1-VALVE REFLEX AND CRYSTAL DETECTOR, with 1-VALVE L.F. AMPLIFIER, Controlled by Switch.
19. H.F. DETECTOR AND L.F. (with Switch to Cut Out the Last Valve).
20. DETECTOR AND 2 L.F. AMPLIFIERS (with Switches for 1, 2, or 3 Valves).

ALL "POPULAR WIRELESS" BLUE PRINTS ——— 6d. EACH

All orders for these Blue Prints should be sent direct to the "Popular Wireless" Queries Department, Flectway House, Farringdon Street, E.C.4, enclosing a stamped addressed envelope and a postal order for 6d. for each Blue Print Ordered.

Stand 84. Olympia Radio Exhibition

The name 'LOTUS' is your guarantee of sound results and solid satisfaction

The 'LOTUS' JACK

Designed to take up the least space, the depth back of panel being 1 1/4 in. Made from best Bakelite mouldings, with nickel silver springs and pure silver contacts. One-hole fixing. Soldering contacts can be brought into any position.

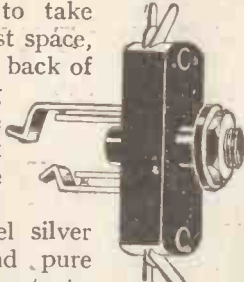

Prices No. 3, as illustrated 2/6 others from 2/- to 3/-

The 'LOTUS' JACK SWITCHES

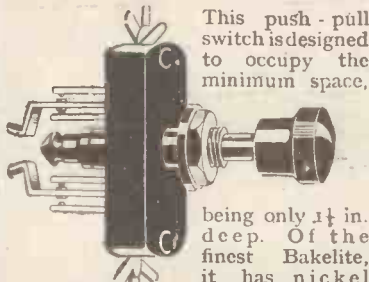

This push-pull switch is designed to occupy the minimum space,

Prices No. 9, as illustrated 4/- others from 2/9

being only 1 1/4 in. deep. Of the finest Bakelite, it has nickel silver springs and contacts of pure silver. Soldering contacts can be made to suit any wiring.

The 'LOTUS' JACK PLUG



Designed for use with Lotus Jacks. Made from best Bakelite mouldings and nickel plated brass. To fix, the wires are placed in slots and gripped in position by a turn of the screw cams.

Price 2/-

Made by the makers of the famed 'LOTUS' Vernier Coil Holders and 'LOTUS' Buoyancy Valve Holders
Garnett, Whiteley & Co., Ltd.,
LOTUS Works
Broadgreen Road, Liverpool

RADIOTORIAL QUESTIONS & ANSWERS.

(Continued from page 864)

away" effects are not due to this cause. An effect like fading is often produced by a run-down battery. This is particularly the case when a large dry battery is used for lighting dull-emitter valves. When the battery is nearly exhausted it will sometimes become irregular in its action, the voltage falling away almost entirely and then picking up spasmodically nearly to its full value.

It is possible for a fading effect to be produced by the intermittent energising of a near-by aerial. Somebody living not very far away may own a valve set, and may have his first H.F. valve on the point of oscillating, so that when he adjusts any of his tuning condensers the aerial may be energised. Sometimes interference received in this way will produce a drop in signal strength and clarity of tone without any howling or whistling being audible.

When very weak signals are being received, movements of the aerial may be sufficient to cause fading. A slack aerial running in close proximity to a wall or the branches of a tree may be blown sufficiently by each gust of wind to produce an appreciable weakening of signals.

There are other causes which produce a similar effect, but the foregoing are those most likely to be found in everyday conditions.

For the Constructor

NO. 4—TEMPLATE FOR SPIDER-WEB COILS.

Spider-web coil formers having a centre diameter of 1 1/2 inches can be made from this sketch.

The heavy lines show how eleven segments should be marked out, and how the slots are cut down towards the centre. The dotted lines show the arrangement for nine slots. (Note:—The angles are the same for Basket coils.)

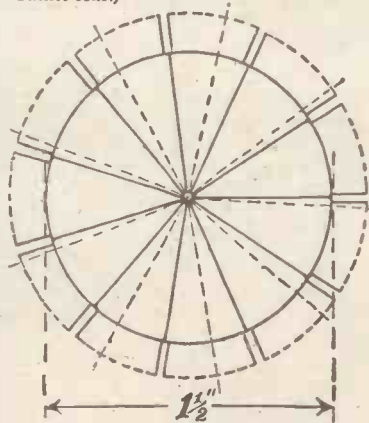

EXTENSION HANDLES.

M. C. O. (Twyford).—What is the object of long extension handles fitted to tuning condensers?

These handles are used to keep the hand of the operator at a distance from the condensers during tuning, and thereby avoids a certain amount of capacity, which is added when the hand is placed near the condenser, and lost on removal of the hand. Much finer tuning is also obtainable owing to the fact that a large variation of the extension handle does not alter the condenser adjustment much.

'PHONE CONNECTIONS.

W. B. H. (Woldingham, Surrey).—It is important in a valve set to connect the telephones correctly in order to avoid depolarisation. Does this apply to crystal sets also, and, if so, what are the correct connections?

The depolarisation of telephones which have been connected in circuit the wrong way round is solely due to the current from the H.T. battery, which creates a strong magnetic field that opposes the fixed magnets of the telephones. In crystal sets, where no H.T. battery is employed, there is no strong magnetic field of this kind, and, therefore, there is no danger to the telephones when connected either way round.

Reception to Perfection

Perfect reception can only be certain if you have a Coil Holder in which the moving block cannot fall back



Stand No. 5, Olympia, Sept. 4-18. No other Coil Holder combines this quality with so many other essential features as the PENTON Type "A." The Only Perfect Coil Holder. 6/- of all good Radio Dealers, or post free direct from the manufacturers:— THE PENTON ENGINEERING CO., 15, Cromer St., Gray's Inn Rd., London, W.C.1.

'PHONE REPAIR SERVICE 'Phones rewound and remagnetised, 4/6 per pair. Remagnetised only, 2/-. Loud Speakers and Transformers rewound. Glass Jars for making up wet H.T. units, waxed, 1/3 doz.; plain, 1/-. Post extra. The H.R.P. Co., 1, Cottrell Road, nr. Hackney Downs Station, E.8.

Valves Repaired AS GOOD AS NEW!!

HALF PRICE (Except Weco, S.P.'s, and low capacity types). Minimum D.E. Current 0-15 amps when repaired. ALL BRIGHT & DULL EMITTERS Listed at less than 10/-. Minimum charge - 5/-. VALCO LTD, Dept. P.W., Labor Grove, Wimbledon, S.W.

REPAIRS SETS. PHONES. TRANSFORMERS Officially Approved by Radio Association. ALL WORK GUARANTEED LOWEST RATES 24 HOUR SERVICE Cash on Delivery if Desired. JOHN W. MILLER, 68, Farringdon St., E.C.4. 'Phone: Central 1950.

GLASS TUBES FOR WETH.T. BATTERIES

Best English Make at Lowest Prices I. ISAACS & CO., North London Glass Bottle Works, 106, Midland Road, N.W.1 'Phone: Museum 4209 Telegrams: Isaglasbot, Kinross, London. Established 100 years.

STERLING RECEIVERS. SENSATIONAL OFFER. Having purchased a large number of Sterling 2-Valve Loud Speaker Sets we are offering them to the public on Unprecedented Terms. A Genuine Sterling 2-Valve Loud Speaker Set complete ready for immediate use with D.E. '06 Valves, H.T. and L.T. Accumulator, Aerial Equipment, and one of our World Famed De Luxe Excellence Loud Speakers. Price £15.15.0. Royalties paid. Terms 15/- Deposit and 15 Monthly Payments of 20/-. Send for one of these superb Sets at once as the number for sale is limited and when sold cannot be repeated under double the price. Free Catalogue on application. THE WIRELESS DISTRIBUTING CO., LTD., (Dept. O.W.), WIRELESS HOUSE, STOKE NEWINGTON N.16.

CORRESPONDENCE.

Letters from readers discussing interesting and topical wireless events or recording unusual experiences are always welcomed, but it must be clearly understood that the publication of such does in no way indicate that we associate ourselves with the views expressed by our correspondents, and we cannot accept any responsibility for information given.—Editor.

"SINGERS" BY WIRELESS.

The Editor, POPULAR WIRELESS.

Dear Sir,—Now that wireless speakers have been drilled in the niceties of pronunciation, what of the sins of the singers?

When a speaker used one of two alternative pronunciations for a word the listener-in did at least know what he meant. Can the same be said of the impression left by certain singers' songs?

It may appear incredible, but it is a fact, that there are wireless singers to-day who actually do not trouble about the words of the songs they sing. They think of the voice, of how they can arrange for a particular effect, and the result of all this posturing is quite disastrous for the unhappy listener-in:

"Nerves" are another frequent cause of failure. I myself do not broadcast but in my gramophone; work I sing into a microphone, and I am never nervous there unless I have been away for a time, and then I take perhaps an hour before I get into my stride.

Many wireless singers, on the other hand, do get a fit nerves when they remember the millions who are listening to them, and that makes them go for the song with much too much voice. Now, economy in voice is the greatest asset of a wireless artist. A whisper is heard where a shout would become a blur, and the singer from whom the listener-in hears every word is the one who sings quietly at the microphone mouth.

Surely a little gentle supervision here would be at least as welcome to listeners-in as the selection of the more correct of two correct pronunciations of "idyll".

Yours faithfully,
PETER DAWSON.

10, Evelyn Grove,
Ealing, W.5.

DRY H.T. BATTERIES.

The Editor, POPULAR WIRELESS.

Dear Sir,—I have noted your remarks in POPULAR WIRELESS regarding the above. I do not know whether it is a correspondent's personal experience in the use of them; if so I am very surprised, and must conclude they were the "so-called cheap" foreign ones.

I have a one-valve crystal reflex set which I made in September, 1924, all components being mounted on glass strips with a Sterling Baby loud speaker. An "Ever-Ready" 60 volt H.T. battery, price 12s. 6d., was installed on that date and has continued regularly in use up till May 31st, 1926—i.e., a period of one year eight months, which works out at a cost of exactly 7d. per month. After it had been in use for a year, out of curiosity I had it tested at Halford's Cycle Depot, and it was found to register no less than 56 volts. This, I think, is remarkably fine service, and therefore take exception to the statements referred to.

During this period I have received the following stations on the loud speaker; not, of course, at loud-speaker strength, but in most cases audible all over the room, viz.:—Newcastle, Bournemouth, Radio-Paris, Hamburg, Cardiff, Radio-Belgique, Madrid, Toulouse, and Barcelona.

I use a 4-in. cardboard solenoid, wound with 16 gauge enamelled wire for about 7 in., with no space whatever between turns, and B.T.H. B.5-06 valve and double aerial 35 ft. long, 8 ft. spreaders, and 30 ft. to 23 ft. high with numerous insulators.

Yours truly,
WILLIAM C. SMITH.
32, Sudbourne Road,
Brixton Hill, S.W.2.

RECENT B.C. TESTS ON DIFFERENT WAVELENGTHS FROM OXFORD STREET AND MARCONI HOUSE.

Dear Sir,—I received these tests on crystal and single valves with and without coupled circuits. The unqualified success of the transmissions may lead the B.C. to introduce this system, which, although undoubtedly a great boon to crystal and single valve sets, would be very objectionable to men like myself, possessing more powerful sets. For instance, during the test I tried for Birmingham and Radio Toulouse, both loud stations to me with one stage of H.F. only. During the test I had to employ two stages of H.F., and then the reception was very poor.

To my mind, the original idea of fewer stations on much greater power is the ideal. Single valve sets would certainly be able to pick up two or three programmes at good strength. This would, incidentally, cause a small boom to the manufacturers, as many crystal sets would be discarded in favour of one-valvers.

Might I suggest your raising the point in the columns of POPULAR WIRELESS?—Yours faithfully,
T. H. HALL.

36, Richmond Road, Kingston-on-Thames.

ALWAYS BUY TUNGSTONE HIGH TENSION ACCUMULATOR

3 a.h. ACTUAL AND GUARANTEED

otherwise heavy cost constantly recharging. BEWARE of High Tension with Voltage only Stated. Amp. Hour is the Absolute Essential. Absolutely refuse High Tension with Wood Separators between Plates creating filament noises and the primary causes of early destruction of entire Battery.

LOW TENSION CELLULOID 2-VOLT CONTAINERS (EXCEPT TUNGSTONE) CONTAIN CAMPHOR WHICH THE ACID ATTACKS CREATING CONSTANT FOAMING. ALSO HOLDS THE HEAT.

Manchester Evening Chronicle.

February 8th, 1929.

THE TUNGSTONE H.T. BATTERY

After having one of the above in use for two months, I shall never go back to the dry battery, although I have had excellent reception from the large-sized cells.

After my experience with this battery I can speak with confidence about it. The makers' claims appear rather far-reaching, but each one is fully borne out in practice. The battery is quiet in working, and testing the voltage as the set was working on the Newcastle's transmission last evening the voltage was 60.

My batteries have not an easy time by any means, as on some evenings I have had five valves (three of them power valves) working, and the fact that the battery has stood up speaks well for the units.

The cells are small, but the plates are large, and are prepared in a special manner which the makers claim give them a tremendous holding capacity. The whole sixty volts occupy little more space than a dry battery of the same capacity, so that it can safely be called "the box of stored-up energy."

TUNGSTONE High Tension 60 Volt Battery 3 a.h. is sold in the United Kingdom on monthly payments over an extended period. Apply for particulars. Further interesting information on points of this advertisement are to be found on pages 58, 59 and 67 to 73 of the Illustrated Booklet "Photography tells the Story" which will be sent free on application to the TUNGSTONE ACCUMULATOR CO., LTD., St. Bride's House, Salisbury Square, Fleet Street, London, E.C.4. T.A.42

Birmingham Mail.

February 10th, 1926.

HIGH TENSION ACCUMULATOR.

Lately I have been experimenting with a Tungstone H.T. accumulator, 60-volt 3 a.h., and the results have been so satisfactory that I have no hesitation in saying it is worthy of recommendation. The makers claim several advantages for this accumulator, namely its light weight (23 lb.), particularly standardisation and interchangeability of parts, perfect rubber insulation between each cell, etc., but what the average wireless enthusiast will appreciate more than anything else is the perfectly quiet and steady flow of current to the plate, with the result that there is no distracting cackle on the phones or the loud speaker.

Nott. Evening News & Journal.

December 19th, 1925.

TUNGSTONE H.T. ACCUMULATOR.

When superlative claims are made concerning the quality of an article we invariably approach it with a caution and a certain amount of diffidence. It was therefore, after thorough tests, a real pleasure to find that in no sense whatever has the Tungstone H.T. accumulator been over-rated.

The accumulator gave an unvarying and reliable discharge at uniform rates over long periods of continuous or intermittent work with no drop in voltage.

More Bargains

ACCUMULATORS.—Fuller "BJX24," 2 volt 24 amp, 6/-; 4 volt 24 amp, 11/-; 6 volt 24 amp, 16/-; "BJX30," 2 volt 30 amp, 6/6; 4 volt 30 amp, 12/-; 6 volt 30 amp, 17/-; Fuller.—2 volt 45 amp, 10/-; 4 volt 50 amp, 20/-; 2 volt 80 amp, 13/-; G. Exide.—6 volt 18 amp, 16/-; H.D.—2 volt 40 amp, 7/-; H.D., 4 volt 40 amp, 13/6.

POLAR SURPLUS. ALL NEW.—Precision Condensers, '0003 and '0005, list, 12/6. Sale, 4/6. Polar Varia H.F. Transformers, 300/500, 3/6. Dübiller Anode Res., all sizes, 3/6. Holders on ebonite, 1/- Polar Cosmos Variometer on panel, scale and dial. Fit Detector for complete Crystal Set. List, 21/- Sale, 8/6.

68 page Catalogue, post free, 4d.

ELECTRADIX RADIOS
218 Upper Thames Street, E.C.4

Listen now Pay later!

Choose any guaranteed Set from our Catalogue, make a small payment, and start to listen! The balance you pay in convenient monthly instalments. It is worth your while to write for our Catalogue "P" and tell us what you want.

New Times Sales Co., Ltd., 5675 Vulcan House, Ludgate Hill, E.C.4.

LITTLE WIRELESS GADGETS
MAP
SMALL PARTS TO THE TRADE.
M.A.P. Co. 246, Gt. Lister St., Birmingham.

ALL APPLICATIONS FOR ADVERTISING SPACE IN "POPULAR WIRELESS" MUST BE MADE TO THE SOLE ADVERTISING AGENTS—JOHN H. LILE, LTD., 4, LUDGATE CIRCUS, LONDON, E.C.4.

TECHNICAL NOTES.

(Continued from page 840.)



It will pay you to see this exhibit!

Visit Stand No. 84 at the National Radio Exhibition—see the "Lotus" Valve Holders and learn just how and why they excel in absorbing shock, protecting the valves and eliminating all microphonic noises.

Rigorous tests at the factory ensure that "Lotus" Valve Holders will give entire satisfaction under any conditions. That is why you should insist on them for your set.

Valve sockets and springs locked together by a mechanical process, making a definite and permanent connection. Bakelite mouldings, nickel silver springs and phosphor bronze valve sockets. nickel plated

2/6 With terminals
2/3 Without terminals

LOTUS
BUOYANCY
VALVE HOLDER
ANTI-MICROPHONIC

Made by the makers of the famous Lotus Vernier Coil Holder.
GARNETT, WHITELEY & CO., LTD.,
Lotus Works, Broadgreen Road, Liverpool.

0.06 filament. Flashlamps are excellent protectors for certain types of filament, but they are obviously not applicable to all. Moreover, a flashlamp is only suitable as an H.T. fuse, not as an L.T. fuse, for obvious reasons. There is, in fact, excellent scope here for the inventor.

Interesting Frame Aerial Experiments.

With reference to the matter of frame or loop aerials, which was discussed in these columns recently, a reader sends me a long account of experiments which he has made with large loop aerials formed around the walls of a room, and some of the results he has obtained are really surprising. As a matter of fact, in view of the difficulty of erecting a good outdoor aerial, as well as the objection which many people seem to have to an outdoor aerial in any case, it has always seemed to me that a good deal more attention might, with profit, be devoted to the loop aerial. The reader in question sets up two loops on two adjacent walls of the room, that is, two walls meeting at a corner. These loops are made by means of a few turns (usually not more than half-a-dozen) along the floor, up the wall, along the ceilings of picture rail and down the wall again. They are further arranged so that they may be put electrically in series.

When receiving a station, first one loop is tried, then the other, and then the two in series. It may be that one or the other gives the best results, according to the bearing of the desired station, or it may be that the two together give a resultant directional effect better than that obtained with either separately. Furthermore, the loops are arranged so that they may be reversed electrically. In these and various ways it is evident that, although the loops are actually fixed, it is possible so to manipulate them electrically that practically the same result is obtained as if they were mechanically movable.

Although there is a good deal in all this that is well known, it seems to point the way to interesting and useful developments.

Broadcasting Atom Noises.

An interesting experiment, in what was described as "The rattling of Atoms," was recently made at the Broadcast Station KFKU, U.S.A. The exact arrangement of the apparatus would take some little time to describe, but briefly an arrangement was made by which ions from a speck of radioactive substance were caused to enter a brass cylinder, there to ionise the air molecules. This "ionisation by collision" caused a considerable increase in the electrical conductivity of the air in the brass cylinder, and with a high electrical, potential difference applied between two metal plates immersed in the air in the cylinder the ionisation current could be caused to pass through a circuit where it was amplified by means of a 3-stage amplifier, giving a magnification estimated at about 100 million times. When a loud speaker was operated from this system, each time an alpha particle (that is, one of the ions from the radioactive substance) entered the cylinder, the loud-speaker produced a sound like that of a small bell sharply struck and then muted, or of a plucked violin string.

When substances strongly radioactive were presented to the instrument a continuous rattle ensued, but for substances less radioactive the single atoms were separated sufficiently to be easily counted.

Since the operation of ionising the air and producing the electric current required (according to estimate) about 10^{10} of a second, it ought to be possible, by means of automatic recording apparatus, to count alpha particles projected into the cylinder at the rate of something up to 1,000 a second. According to Dr. Cady, one of the scientists engaged in these experiments, it would, however, be very difficult to register these particles at such a high rate.

Underground Aerial Results.

In consequence of the mention I made recently in these Notes of the uses of underground aerials, I have had several letters from readers who use this type of aerial, and their experiences are both interesting and useful. One reader, who uses an aerial nearly 200 ft. long, finds that he gets excellent reception practically free from any of the usual interferences, although he is located in a position where he suffers a great deal of interference from electric power lines when using an ordinary extended overhead antenna. This, indeed, was his reason for resorting to the underground aerial.

Other correspondents report good reception and in all cases they make a point of the absence of interference. But there seems, nevertheless, to be a consensus of opinion that the underground antenna is, in general, less sensitive than the outdoor aerial. In cases where extreme sensitivity is not imperative, but where it is important to avoid interference, the underground aerial commends itself.

REPAIRS

By specialists skilled in every form of accurate and intricate coil windings.

Headphones, Loud Speakers & Transformers rewound, remagnetised, and reconditioned **EQUAL TO NEW** and returned the same day on C.O.D. system. The unsolicited opinion of one of our many satisfied clients "—all I can say is, they are better than when new."

VARLEY Magnet Co. Repairs Dept., Woolwich S.E.18

VARLEY Proprietors: Oliver Pell Control Ltd.

EASY PAYMENTS

LOUD SPEAKERS, HEADPHONES, H.T. ACCUMULATORS, or any parts to your selection.

Send a list of the parts you require and we will send you a definite quotation spread over a period of six months.

H. W. HOLMES.
9, Foley Street, Gt. Portland Street, W.1.
Phone: Museum 1414.

"CROIX" TRANSFORMERS (31. and 51.)

Guaranteed genuine. 4/- each. Post 4d.

CONTINENTAL SUPPLIES.
497, OLD FORD ROAD, LONDON, E.

PLEASE be sure to mention "POPULAR WIRELESS" when communicating with Advertisers. THANKS!

A Filament

that is tough enough
to support four valves
without breaking

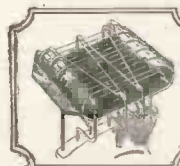

Every feature of the wonderful P.M. Filament has a superiority all its own.

In this case you can judge the high mechanical strength of the P.M. Filament, particularly when you realise that an ordinary filament will barely

support a single valve compared to the four possible with the P.M. filament.

This great difference in the strength is due to the special core of rare metal in the P.M. Filament, which is so tough that it can be tied in knots after 1,000 hours' life, and cannot be broken except by the very roughest handling. The P.M. Filament is set around 5 strong resilient hooks in such a way that it is free from tension or sag and cannot become displaced during the long life of the valve.

The multi-coating on the P.M. Filament core is prepared from an alloy of precious metals that secures a copious and powerful stream of electrons at a temperature so low that no sign of glow can be discerned.

The low current consumption of the P.M. Filament, only one-tenth ampere, will make your accumulator charges last seven times as long, reducing your recharging costs and journeys to one-seventh. The emission of the P.M. Filament is completely within the field of the grid and anode, despite the fact that this emission is up to 5 times greater than that of an ordinary filament.

Finally, this vastly increased emission gives a wide range of power free from microphonic disturbances, and the P.M. Filament is so conservatively rated that it will stand a reasonable overload without fear of damage.

You will never really be satisfied until you have secured the valves with the P.M. Filament. There are many attempts to imitate its individual features, but all the advantages of the P.M. Filament can only be found in P.M. Valves:

ASK YOUR DEALER FOR P.M. VALVES. HE
SELLS THEM BECAUSE THEY SATISFY.

NEW REDUCED PRICES

For 4-volt accumulator or 3 dry cells
THE P.M.3. (General Purpose)

0.1 amp. 14/-

THE P.M.4 (Power) 0.1 amp. 18/6

For 6-volt accumulator or 4 dry cells
THE P.M.5 (General Purpose)

0.1 amp. 18/6

THE P.M.6 (Power) 0.1 amp. 18/6

For 2-volt accumulator

THE P.M.1 H.F. 0.1 amp. 14/-

THE P.M.1 L.F. 0.1 amp. 14/-

THE P.M.2 (Power) 0.15 amp. 18/6

These prices do not apply in Irish Free State



Mullard

THE MASTER VALVE



If it's a question of easier tuning

You'll find what you want in the R.I. Retroactive Tuner. Simple Tuning over the range of wave-lengths from 175-4,000 metres. All in one unit, not a multitude of coils to choose from. Cheaper, too, than a set of coils with coil holder to cover the same range.

Former wound with a single layer of double silk covered wire, proved to be more efficient than multi-layer winding.

R.I. Workmanship—R.I. Results. Altogether the right Unit to tune in the station you're after, easily and quickly.

Whatever future changes in wave-length the B.B.C. adopt they will be well inside the range of the R.I. Retroactive Tuner. It is a safe investment.

Price 39/6

Write for the R.I. Blue and Gold Catalogue.



THE MARK



OF BETTER RADIO

Advt. R.I. Ltd., 12, Hyde St.,

New Oxford St., London, W.C.1.

P.C. 36.

CAPT. ECKERSLEY AND THE NEW WAVES.

Popular Wireless

Every Thursday
PRICE
3d.

No. 221. Vol. IX.

and Wireless Review

August 28th, 1926.

Scientific Adviser: SIR OLIVER LODGE, F.R.S., D.Sc.



Special Features.

How to Make a "P.W."
Low-Loss Ultra Crystal Set.

Professor Fleming's Farewell.

Adding H.F. Valves.

The Microscope in Radio.

Our cover photograph shows the apparatus used by Mr. Maton, of Hythe, to relay radio concerts by landline to a number of "subscribers." Note "P.W." blueprints on the wall.

MARCONI

For Power and Purity of Reception



VALVES



Every Marconi Valve is guaranteed for efficiency and service by the name it bears—Marconi—first and foremost in radio for thirty years.

The following types have been **REDUCED IN PRICE**

	Old Price	New Price
D.E.2. L.F. & H.F. (2-volt)	15/6	14/-
D.E.3 & D.E.3B (4-volt)	16/6	14/-
D.E.Q. (4-volt)	27/6	25/-
D.E.4 (4-volt)	22/6	18/6
D.E.5 & D.E.5B (6-volt)	22/6	18/6
D.E.5A (6-volt)	26/-	22/6
D.E.8. L.F. & H.F. (6-volt)	22/6	18/6

Write for Marconi Valve Publication No. 443a to Registered Office, Marconi House, Strand, London, W.C.2

ASK FOR THE VALVE IN THE PURPLE BOX

Come and See the best Coil Holders!

At Stand No. 84 at the National Radio Exhibition you are invited to inspect for yourself the Coil Holders that are used in fully half the sets that are made—the "Lotus" Coil Holders. Their popularity with constructors everywhere is due to their unvarying good performance and the following unique features:—

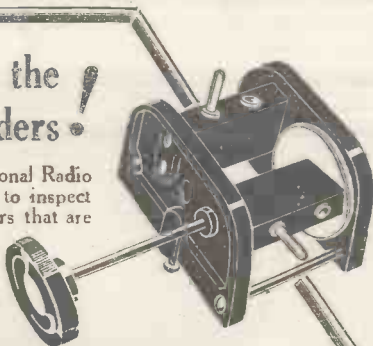

Moving Block cannot fall

Moves in same direction as knob, thus preventing confusion. Holds heaviest coil securely in any position. Dead accurate tuning possible because encased precision cut gears reduce speed by 8 to 1.

From all Radio Dealers

LOTUS

VERNIER
COIL HOLDERS

GARNETT, WHITELEY & CO., Ltd.,
Lotus Works, Broadgreen Road,
LIVERPOOL.

Makers of the new Lotus Buoyancy Valve Holder.

Two Types:
For outside base mounting:
Two-way - 7/-
Three-way 10/6
For inside base-board mounting with 6-in. handle:
Two-way - 8/-
Three-way 12/6

Bakelite mouldings for the side plates, coil blocks and knobs; heavy nickel plating for the metal parts.

SIMPLY WONDERFUL!

"The 'AF3' I have fitted is simply wonderful."
ENGINEER COMMANDER, R.N.

WONDERFULLY SIMPLE!

YOUR RADIO WILL BE IMPROVED
SIMPLY BY SUBSTITUTING

FERRANTI

British Made

AUDIO FREQUENCY

TRANSFORMERS

TYPE AF3

FOR THE OTHERS

No better Transformer is available at any price.



25/-

ASK YOUR DEALER FOR LEAFLET W-401.

FERRANTI, LIMITED, HOLLINWOOD LANCASHIRE.

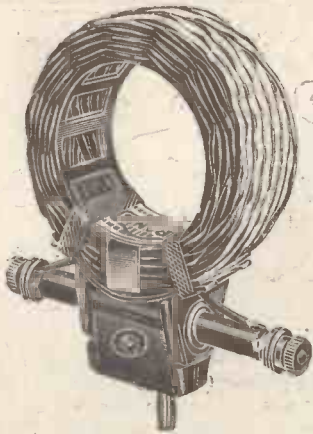

**THE IGRANIC UNITUNE
APERIODIC FIXED COUPLER**

The most simple means of increasing the selectivity of your aerial circuit is to fit an Igranitic Unitune Coupler.

Just take out your usual aerial coil and insert the Unitune in its place, connecting the aerial and earth to the terminals on the extension arms. That is all—no additional parts, no alterations to wiring.

The Unitune Coupler gives you the ease of tuning of a direct coupler circuit combined with the signal strength and selectivity usually associated with a loose-coupled circuit.

When using the Unitune the condenser settings for different wave-lengths will remain almost constant, no matter what size of aerial is used.

Fit the Unitune, and give yourself the choice of alternative programmes. Range 250 to 500 metres. Price 4/6.

**SELECTIVITY
IN
AERIAL AND ANODE
CIRCUITS
WITH**



**IGRANIC HONEYCOMB H.F.
TRANSFORMER (With Tapped Primary)**

Igranitic H.F. Transformers are now made with a tapping taken from the centre of the primary winding, making them particularly suitable for neutrodyne circuits.

The two coils are of the honeycomb formation, giving a highly inductive coupling, low capacity between windings, and the many other advantages which characterise Igranitic Honeycomb Coils. Used as plain transformers they have a ratio of 1:1, but when used in neutrodyne circuits a step-up ratio from primary to secondary is obtained.

The wave-lengths stated below are those obtainable when the Igranitic H.F. Transformers are used in neutrodyne circuits, and the primary tuned with a .0005 mfd. Dual Condenser.

- No. 1. 170-420 metres. Price 6/-.
- No. 2. 250-600 metres. Price 6/9.
- No. 3. 530-1280 metres. Price 8/3.
- No. 4. 850-2180 metres. Price 10/-.

Send for your copy of
the new Igranitic Radio
Accessories
Catalogue No. R21
and
Visit the Igranitic Stands
Nos. 72 and 73 at the
National Radio Exhibi-
tion, Olympia,
September 4th to 18th

149, QUEEN VICTORIA STREET,
LONDON.



WORKS: BEDFORD.



Ask your
Dealer
for the



THE FORMER OF THE FUTURE.

Low Loss. Size 3 ins. diameter to outside of wings. Made from the famous BECOL EBONITE. Specially designed for low loss. Large air space between wings. Easy winding. Thoroughly dependable and British made.

From all dealers, in
6 inch lengths, 2/6

We are exhibiting at Olympia (Sept. 4-18). Stand No. 81.
THE BRITISH EBONITE CO., LTD., HANWELL, LONDON, W.7.
Rods. Tubes. Sheets. Panels. Mouldings, etc.

Makes short circuit impossible

The "Peerless"

JUNIOR

Rheostat

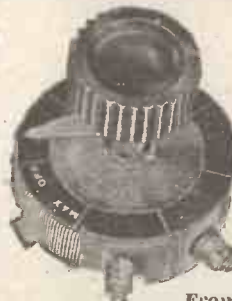

An OFF position is provided, while definite stops make short circuit impossible. Resistance element is immune from damage. Will safely carry current of two valves. Complete with nickelled dial and one-hole fixing. Three types: Size 1 1/2" diameter, 1/2" high, 6, 15 or 30 ohms. Price only

2/6

From all dealers or direct:

THE BEDFORD ELECTRICAL & RADIO CO. LTD.
22, Campbell Road, Bedford.

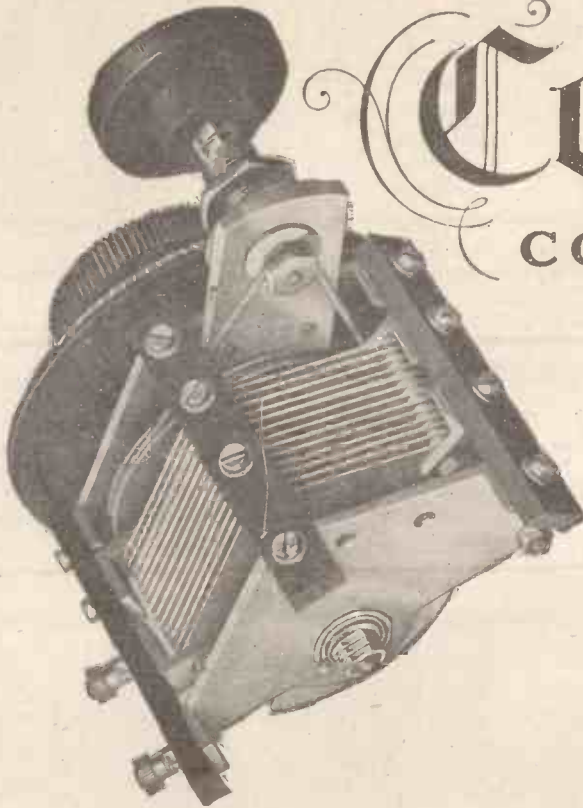

Cosmos

COMPONENTS

THOSE constructors who desire smooth working, reliable and neat-looking sets, use "Cosmos" Precision Components.

"COSMOS" LOW LOSS SQUARE LAW SLOW MOTION CONDENSER

The "Cosmos" Condenser is a slow motion condenser with absolutely no backlash either when new or after use. This desirable feature is accomplished by the use of a spring belt held in tension which permits coarse tuning with the large knob, and a 10:1 slow motion with the small knob. Cone bearings allow for adjustment and the slow motion bracket can be mounted for remote control.

The Condenser for fine tuning.

Slow Motion	'00025 mfd.	14/9	Ordinary Motion	'00025 mfd.	12/-
"	"	'0005	"	"	'0005
		15/6			13/-

"COSMOS" PERMACON

The "Cosmos" Permacon is an ideal fixed condenser, being light in weight, of guaranteed accurate capacity, and having the lowest possible losses.

The dielectric is mica, and each condenser is tested at 500 volts during inspection. Nickel-plated cases give them a particularly neat appearance.

'0001 mfd.	1/6	'001 mtd.	1/8
'0002 "	1/6	'002 "	1/10
'0005 "	1/6	'005 "	2/8
'0003 "	(with clips for grid leak)	1/8	'01 "	3/9

"COSMOS" GRID LEAKS

are uniform and permanent. 1/2, 1, 2, and 3 megohms, each 1/6.

"COSMOS" High Frequency CHOKE COIL

Suitable for use in reflex circuits or in circuits similar to the Reinartz. The sectionalised windings have the lowest possible self capacity (5.5 mmfd.) and an inductance of 55,000 microhenries.

Owing to its small inductive field, which lessens the chance of stray capacity or inductive coupling, it is far more suitable for use as high frequency choke than large inductance coil.

Price for "Cosmos" H.F. Choke Coil 6/6 each.

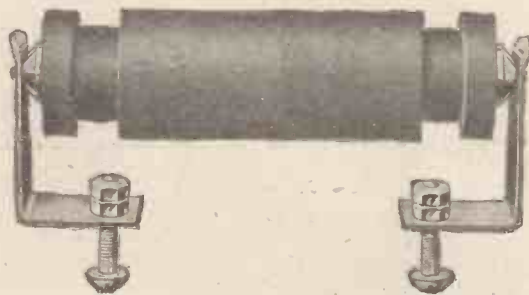

Ask for copy of "Cosmos" Components List

VISIT STAND No. 162
RADIO EXHIBITION, OLYMPIA,
SEPT. 4 to 18.

METRO-VICK SUPPLIES, LTD.

(Proprietors: Metropolitan-Vickers Electrical Co., Ltd.)

METRO-VICK HOUSE, 145, CHARING CROSS ROAD, W.C.2.

Popular Wireless

Scientific Adviser:
 Sir OLIVER LODGE, F.R.S.
 Technical Editor:
 G. V. DOWDING,
 Grad. I.E.E.
 Assistant Technical
 Editors:
 K. D. ROGERS,
 P. R. BIRD.



Editor: NORMAN EDWARDS, M.Inst.R.E., F.R.S.A., F.R.G.S.

Consultants:
 Dr. J. H. T. ROBERTS,
 F.Inst.P.
 J. F. CORRIGAN, M.Sc.,
 A.I.C.
 O. E. FIELD, B.Sc.
 E. J. SIMMONDS,
 M.I.R.E., F.R.S.A.

RADIO NOTES AND NEWS.

Frame Aerial Feat—World-Tour on Two-Valve Set—More Powerful Programmes—Crystals Tune in the Continent—Wireless Trance—The National Radio Exhibition

Frame Aerial Feat.

SOME very interesting experiments have recently been conducted by Mr. W. A. S. Buteman, of Hampstead, who has been communicating with an enthusiast in Rio de Janeiro.

This remarkable performance, during both transmission and reception, utilising Marconi valves, was conducted on a three-foot frame aerial, constructed of four turns of wire.

The wave-length was 45 metres, and Mr. Buteman was employing a power of only 75 watts.

More Wireless Pictures.

THE British-American wireless-picture service across the Atlantic is now being copied in other parts of the world. I understand that



Two well-known consultants and contributors to "P.W."—Mr. J. F. Corrigan, M.Sc., and—

Radio-Wien (Vienna) authorities have installed a transmitter for photographs, etc., at Laerberg, and if all goes well this service will be extended as soon as possible.

Seaside Programmes.

FOLLOWING the Brighton broadcast, about which such a fuss was made last month by rival resorts, the B.B.C. has arranged more seaside programmes.

These include Blackpool, Margate, and Eastbourne, the respective dates being September 2nd, 10th, and 24th.

Government Encourages Radio.

BERLIN'S Wireless Exhibition is being held from the 3rd to the 12th of September, with between two and three hundred firms represented. I hear that the German postal authorities are displaying elaborate exhibits, and that every official assistance which the Government can give to the trade is being rendered.

Meanwhile, our own Government diverts broadcasting revenue, and plays aged Henry with the British wireless prospects.

Well might Mr. Dubilier ask the British listener "Are you a patient man?" If we weren't patient, we should probably be standing our trial for murdering somebody in a Government office.

World Tour on 2-Valve Set.

I HAVE heard 36 Australasian stations, three separate North Pole expeditions, a Californian station using only 30 watts input, and ships off China, whilst Schenectady (N.Y.) comes in most nights on 32 metres, to say nothing of K D K A (East Pittsburg)."

This fine reception has been carried out by a Hale-Cheshire reader (Mr. F. N. Baskerville, 9, Arthog Drive), using the Marcuse 2-valve short-wave set, described in POPULAR WIRELESS No. 178.

Most of these stations have confirmed the feat in writing, and within the last 4 months this reader has tuned in Morse from India, Argentine, Honolulu, Philippines, Mexico and Japan.

B.B.C. Staff Changes.

A GREAT many listeners will be very sorry that Mr. Dan Godfrey, jun., has resigned from his position as conductor of the 2 L O Wireless Orchestra. His successor is Mr. John Ansell, formerly conductor at the Winter Garden Theatre.

Mr. G. C. Beadle, of the Durban station, has been appointed station director at Belfast.

Training for Radio Drama.

THE B.B.C. has been negotiating with the Royal Academy of Dramatic Art, and as a result a special course of training for the microphone will shortly be instituted at the Academy. Examinations will be held, and two £10 Prizes will be awarded to successful students at the end of the term. So that the conditions shall be right, the B.B.C. has installed microphones at the Royal Academy of Dramatic Art, and these operate loud speakers in adjoining rooms.



—Mr. C. E. Field, B.Sc.

New Stations.

NEW stations for listeners are constantly springing up the world over, and amongst those announced recently is a powerful station at Seville, erected by the Union Radio Espanola.

The Chinese are proposing a station at Canton, and the Mexicans have just come on the ether at Vera Cruz. The wave-length of this latter station is 337 metres, and its call-sign is C Y C.

W G Y's Silent Night.

WHILST I remember it, let me warn you against sitting up losing beauty sleep by trying to get W G Y (Schenectady, N.Y.) on Monday nights. For the sake of local listeners this famous American station has decided to close down and have a silent night, one in seven. Monday is the night chosen, and until further notice W G Y will stay at home that night, and not venture out on the ether.

More Powerful Programmes.

QUITE apart from new stations, the ether is being enlivened by broadcasting transmitters which are increasing their power. Amongst these is the already well-received American station W P G (World's Playground, Atlantic City), and the Norwegian station at Porsgrund.

(Continued on next page.)

SPECIAL EXHIBITION NUMBER

Next week's issue of "P.W." will contain a preliminary description of the exhibits at the Olympia Radio Exhibition, which opens on September 4th.

As a considerable demand for this special number of "P.W." is anticipated, you should

ORDER YOUR COPY NOW.

NOTES AND NEWS.

(Continued from previous page.)

The former is now going to use 5 k.w., whilst Porsgrund has increased from 200 to 1,000 watts.

Big Ben.

BIG BEN'S "conduct-report" has just been made by the Astronomer Royal, and it is a booming good one! It shows that about one-third of the time-signals were less than one-fifth of a second out, and another third of the chimes were less than '3 seconds wrong.

Although occasionally Big Ben has erred as much as one second, he has never been as much as two seconds away from the straight and narrow path, all the time that he has been under observation at Greenwich—if we except his glorious "night out" some month or so ago, when the chimes were booming out the wrong hours!

Improvements at Croydon.

LISTENERS who tune in to the transmissions to aeroplanes from Croydon, will be interested to hear that the service is now being overhauled. The new plans for the Croydon aerodrome station have already been drawn up.

Radio on Air Route.

TALKING of Croydon's overhaul reminds me that the Royal Air Force is going ahead with the wireless stations on the air route to the East. The annual report on aviation states that on the Egypt and India route the necessary wireless stations are being installed, and soon planes following this route will be assisted by meteorological reports, and direction-finding radio-stations.

The Latest Wonder.

AN evening paper, in a report of an interview with the inventor of television headed "New Radio Wonder," states:

"I have begun to broadcast," said Mr. Baird. "I am sending broadcast pictures of real life from the aerial of my laboratory here in London, and receiving them—or rather seeing them—in a house rented at Harrow, nine miles away."

"This is surely something more than television," says the Manchester Guardian. "It seems to be nothing less than a solution of the hitherto baffling problem of being in two places at the same time!"

Crystals Tune-In the Continent.

I CAN'T help reverting to the topic of good conditions in the ether. Already this year, whilst plenty of good people are still away at the seaside on their annual, and long before reception conditions should be really good, I am receiving reports of foreign stations being picked up on *crystal sets*! Not on special low-loss semi-oscillating crystal-sets either, but on the common or garden variety, which generally have as much as they can do to work a couple of pairs of 'phones properly, from the local station.

I said before that this is going to be a glorious season for long-distance work; and when crystals start scooping in the

SHORT WAVES.

"On an island in the South Pacific there are no rates, unemployment, crime, income tax, jazz bands, wireless 'talks' to inhabitants."—"London Opinion."

In fact, the local politicians have it all their own way.

A correspondent in the "Manchester Evening News" writes: "Broadcast faces and panoramas may be seen in the private house of any listener within twelve months, very much as broadcast music and speech is heard to-day." We trust the television sets will be a trifle discerning in this matter; some of the younger generation even now suffer badly from nightmare.

A headline in the "Manchester Evening Chronicle" reads: "Wave-lengths: Why Birmingham and Aberdeen Share." Our sincere sympathies to Birmingham.

"During March 1,965,000 licences were issued by the Post Office, in April 2,912,000, in May 2,050,000, June 2,076,000, and July 2,100,000."—"Western Morning News and Mercury."

Won't that surplus Licence Money be worth having?

"The idea that relativity disposes of ether is only true mathematically in the sense that you do not have to talk about it," says Sir Oliver Lodge. "Very well: we won't."—"Punch."

We understand that there is no truth in the rumour that, following on the decision of Mlle. Lenglen to give professional exhibition lawn tennis games, Captain Eckersley has accepted an offer of £250,000 to tour the music halls as an expert exponent of the songs of the canary and other oscillating birds.

Professor A. M. Low, asked by a daily newspaper to give his views on the Radio Death Ray scheme, suggested by M. Lucien Levy, and published exclusively in a recent issue of "POPULAR WIRELESS," stated that he considered the scheme the most likely of all the suggested death ray inventions.

We understand that M. Levy was overjoyed at this unexpected compliment.

"Was Columbus a Spaniard?" is the title of a talk given from 2 L O on August 24th. This raises the interesting point as to whether Robinson Crusoe was born in Aberdeen or Timbuctoo. No doubt this elevating topic of enquiry into the nationality of the illustrious dead will vastly intrigue Britain's 2,000,000 licencees.

Cardiff's new feature, "The Silent Fellowship" has attracted much attention among the leading oscillators of Wales.

Two B.B.C. items:
"7.25.—Handel, interrupted by Lucy —." —Evening Paper.

The least the B.B.C. can do is to let the dead rest in peace.

"7.25.—Bach, interpreted by Jean Baptiste Toner. Concerto in the Italian style. Allegro moderato; Andante; Presto.

7.40.—Musical Interlude." B.B.C. Programme.

The "lowbrow" will no doubt appreciate this.

Continental in August, it looks as though my prophecy is justified.

A Wireless Trance.

MISS DORIS HINTON, the 17-year-old Nottingham girl who has been in a "wireless trance" for nearly a year, is reported to be recovering. The case is one of the most mysterious on record, but in spite of the term "wireless" being applied to it, there seems to be only a slight connection between the symptoms and radio.

It is nearly twelve months ago since Miss Hinton entered the trance, at a time when she happened to be wearing headphones, and listening to 5 N G. Since then she has lain like a statue, but now hopes are being entertained of her recovery.

Eighty Programmes at once!

ONE important point about the "Geneva Wave-plan," which does not seem to be fully realised, is that we are promised *eighty stations* to choose from! Mr. Arthur Burrows—at one time Britain's "Uncle Arthur," and now Europe's Director of International broadcasting—estimates that when the scheme is in full swing there will be quite eighty transmissions in the European ether, working without mutual interference. When the scheme is tried next month readers can help the B.B.C. by sending in reports. These should not be furnished haphazard, but should be in accordance with the requests that will be broadcast from your local station.

The National Radio Exhibition.

THE promoters of the National Radio Exhibition tell me that the arrangements are going very smoothly, and everything points to the show being a great success. It will open with a bang on September 4th, and unless I am very much mistaken it will be far and away the best wireless exhibition we have had so far.

Further details of the exhibits will be given in "P.W." next week, but in the meantime the dates should be remembered—September 4th to September 18th.

Will Lighthouses Become "Soundhouses"?

TO Calais belongs the distinction of having the first crystal-controlled "soundhouse." At the end of the sea-wall is a vibrating quartz-crystal wireless-valve device, which sends out an under-water sound-beam that can be received by ships better than a light beam, through fog, blizzards, etc. It is possible that these soundhouses will in time replace lighthouses altogether. The one at Calais is a near relative of the crystal-controlled broadcast transmitter, and it is another instance of radio helping its sister-sciences.

Licences in Ireland.

THE Irish Free State Postmaster-General has recently announced that the licence-fee for wireless sets of all types is to be reduced to 10s.

This is a set-off against the recently-imposed import duty (33½ per cent), the purpose of which is to create a fund for the development of broadcasting.

Broadcasting a Film.

MANCHESTER is trying a novel stunt on Monday next (Aug. 30th), when the film "Greater Glory" is to be broadcast from that station. This will not be television, but merely a kind of radio-drama, with orchestral music. The picture scenes have been converted into dialogue, and the sub-titles will be announced, instead of being screened.

The idea is that a form of art intended for the eyes only, may possibly be very suitable for presentation to the ears.

G-5 L U.

I HEAR that the call-sign 5 L U (they call it "Five Lucy Uncle" on the ether) has been allotted to Messrs. D. T. Blunden and C. F. Scruby. The address is 8, Penrith Road, Basingstoke, Hants.

ARIEL.

PROFESSOR FLEMING'S FAREWELL



By P. R. BIRD,
(Assistant Technical Editor).

The "Father of the Valve"—Professor John Ambrose Fleming, has retired from the Chair of Electrical Engineering at the University of London at the age of 77. In the following article Mr. Bird tells of his last interview with the famous inventor before he left the University—and we feel sure our readers will join with us in paying tribute to a man who throughout a distinguished career has done so much for the science of Radio.—EDITOR.

"SO this is where the wireless valve was born!" I thought, as I waited inside University College, Gower Street, London, for Professor Fleming, the inventor of the Thermionic Valve.

He had come to that building forty-one years ago to take charge of laboratories designed and equipped under his own direction. And he was leaving that day—retiring, with a wonderful series of important discoveries behind him. Amongst them was the one that made broadcasting possible, the application of the thermionic valve to wireless.

The books will tell you much about Dr. John Ambrose Fleming, and give a list of his high honours—Doctor of Science, Fellow of the Royal Society, eminent scientist, pioneer radio-inventor, and so forth.

I found that in addition, he has a charm of manner that permits one to forget those illustrious achievements: a keen wireless enthusiasm that "talks radio" as naturally as though it had all happened without him; and a wonderful gift of clear exposition that can only be described as spell-binding.

"You shall have the whole story for POPULAR WIRELESS," he promised, drawing up a chair in the historic room which had seen his life-work for science.

And he gave it to me—a romance of invention, to which I listened enthralled.

The Inventor's Story.

The story began with Edison's researches into the peculiarities of electric lamps. It ended with the modern 3-electrode valve, which makes wireless telephony possible. And every word of it was packed with insight, authority, and profound knowledge. Modestly, precisely, and brilliantly, the inventor described the invention of the thermionic valve.

"How came you first to apply it to wireless?" I asked.

"Because we wanted a sensitive, reliable, rectifying device," Professor Fleming replied. "There were no crystal-detectors in those days, for Dunwoody's discovery that certain minerals would detect came later."

"Up till 1904, coherers, or else magnetic detectors, were used," he continued, "but both had serious disadvantages. Striving to overcome these, I remembered my own earlier researches into the 'Edison Effect,' and I recalled that a glowing filament will pass a current to the adjacent plate in one direction only. I thought, 'That's just the

thing for a wireless detector.' As soon as I tried it, it worked!"

Making History.

"When that first valve-detector picked up its very first wireless signal, were you alone, or was anyone else here?" I queried.

"Oh, I was not alone. Dyke was here," was the reply, and Professor Fleming paused, reached for a portrait, and passed it to me. It was of a young soldier—a sad, well-loved portrait—for its subject was killed at the Front in 1915. I noticed it was almost the only photograph in the room. Evidently the romance of the valve, like all true romance, was tinged with tragedy.

After an interval, I reverted to that memorable first wireless valve, and learnt that the historic experiment had taken place on an October evening in 1904, about five p.m. And then I asked the question that every listener would have liked to ask the inventor:

"From what station did the very first wireless signals come, that you received with the first valve?"

The First Detector Valve.

"You are forgetting," said Professor Fleming smiling, "that in those days wireless stations were few and far between. There was no control by the Postmaster-General, and no licensing; so naturally we

had our own transmitter rigged up, and the first signals the valve detected were from that."

"Were you excited?" I said.

The inventor of the thermionic valve is now 77 years of age, but he laughed like a boy.

"Oh, yes. We were excited," he admitted. "Certainly we were excited, when it worked straight away!"

"I was living in the Finchley Road at the time," he went on, "and we used to communicate from there to the University College here, at first. After the patent had been granted, Marconi tried the valve on his long-distance experiments, and it was an immediate success on trans-Atlantic reception."

Still smiling reminiscently at those early radio triumphs, the great scientist told me how he had been too busy to devote all his time to his discovery. For the benefit of the scientific world, which was agog with (Continued on next page.)

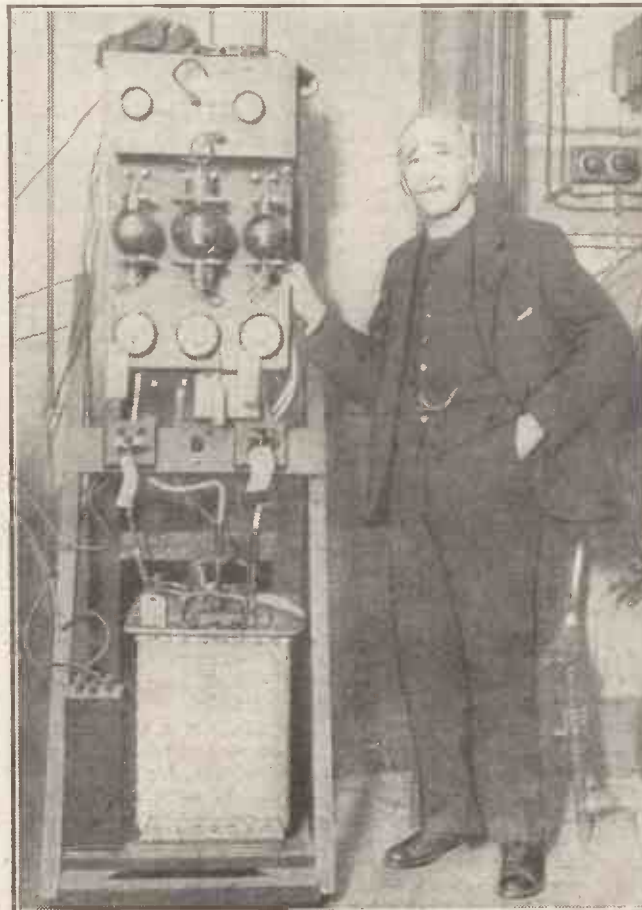

Professor Fleming in the Wireless Room at University College, London.

PROFESSOR FLEMING'S FAREWELL.

(Continued from previous page.)

interest, he had described the invention fully in a paper before the Royal Society.

He drew up the first characteristic curve for a valve, and discovered the effect of altering the shape and position of the anode. One plate he experimented with was a spiral of wire exactly like a grid, and this valve is now on exhibit in the National Science Museum, at South Kensington.

It was after the publication of these facts that Lee de Forest, in America, tried the effect of placing the two new electrodes together in the valve, and lo! the three-electrode valve, as we have it to-day, sprang into existence. With the advent of the valve



This "faceograph" of Prof. Fleming was published in the "P.W." series of "Wireless Pioneers."

telephony became inevitable—broadcasting was born.

"Do you listen-in frequently, now?" I asked.

"Yes," he replied. "I enjoy the serious music most of all. Some of the talks are very good, too; but I can't say I enjoy the jazz much! Would you like to see my set?"

This was just what I had been hoping for, so we went down the corridor to another room, where the set was kept.

"It is a straight circuit," he told me, as he opened the receiver. "I use it with a frame aerial, so generally I employ three valves. If I want loud-speaker results, four valves are ample."

The Inventor's Own Set.

The loud speaker was an Amplion, I noticed, and the circuit employed by Professor Fleming was a straightforward H.F., Det. and L.F., which could be switched over into H.F., Det. and 2 L.F. when desired. Extra H.F. amplification was available if required (there were seven valves in all), but Professor Fleming is not a long-distance searcher. He prefers the easily-obtained, good quality, local programmes.

Whilst we chatted over the set, he told me that he thought the B.B.C. had done extremely well ever since they began. When I questioned him about the new B.B.C. and Government control of broadcasting, I found him somewhat sceptical. "We shall be fortunate if the Government do as well as the B.B.C. has done," was his conclusion.

He told me, too, that super hets. and similar circuits had no special attraction for him. The straight circuit was reliable and efficient, and moreover it made for consideration for others, and for the polite use of the ether.

As he came with me down the corridors, Professor Fleming stopped before a locked museum, took a key from his pocket, and said:

"You ought to see these—they are some of the very first wireless valves.

"It is a curious thing," he soliloquised, as he passed some of these historic relics out to me, "people nowadays know all about the 'Cossor' valve, the 'Marconi' valve, and so on, but I wonder how many of them have heard of the Fleming valve?"

I am afraid I was unable to reply to this, for in my hands I had five or six priceless examples of scientific history. And still

the inventor brought out more of the wonderful relics, and passed them on to me.

Truth to tell, I was badly afraid of accidentally dropping one of these unique and irreplaceable specimens, but I managed to examine them all, with interest and admiration—those grandfather bulbs, whose children number many millions to-day! They have a place in history, those Fleming valves. Not merely a place in radio history, but in the history of the progress of mankind.

A Message from Readers.

So when Professor Fleming shook hands, I told him that we "P.W." readers—who owe so much to him—all wished him well in his retirement. And I ventured to tell him—diffidently, and unskilfully, I am afraid—how proud we are of him to-day, as he says farewell to the scene of his life-work. He smiled, gaily and light-heartedly, and waved, as he went cheerily back to complete his preparations for departure. I rather wondered at his cheerfulness, until I remembered that it befits the man who has bestowed a priceless boon upon his fellowmen, and who now looks forward to a well-earned rest, and to recreation after much labour.

TESTING A NEW VALVE SET.

FROM A CORRESPONDENT.

A NEW set should always be tested with a very loose reaction coupling. No "margin of safety" will be present unless good results are obtainable without bringing the receiver near to the point of oscillation. A new set generally means fresh batteries, an accumulator showing perhaps a little more than two volts per cell and an H.T. battery with a lower internal resistance than it will ever have again during its "life." Under these conditions it will be a poor set indeed that does not evince considerable liveliness.

Care with Rheostats.

Care should be taken that the capabilities and limitations of the filament rheostats are fully understood. The amateur may have been using 30 ohm resistances in the past and in this case he may damage his valves if he handles 5 ohmers in a similar manner.

If the new set is provided with a filament "on-off" switch it should be ascertained for future guidance exactly how it operates. A Lissen "Key" switch must be pushed in to switch a set on, although, on the other hand, a Bulgin push-pull must be pulled out to do this and be pushed in to switch off. Unless the possessor of a new set memorises the action, he may leave his valves burning all night.

Unless the amateur is a keen musician he may fail to detect the presence of comparatively bad distortion. Curiously enough few people appear to have the necessary "ear" to do this, unless they are provided with some means of comparison. For instance, a listener may have a loud speaker in use which he regards as a faithful reproducer—until he hears a better one belonging to a friend, and then all the little

"harshnesses," etc., of his own instrument become most apparent.

A good plan is to obtain a large fixed condenser of the order of about 1 mfd. capacity and to listen to the set in operation for a few minutes with this temporarily connected across the loud speaker terminals. Reproduction will be very mellow but rather muffled, and even although the results may be pleasing to some, they will not be "faithful" reproductions of speech and music. But when the fixed condenser is removed, all the distortion on both high and low notes will be revealed in its most exaggerated form by the comparison offered. Of course, it may not be that the loud speaker is at fault, more probably this component is receiving a distorted output from the set.

Grid Bias and H.T. Plugs.

In the case of a set provided with separate H.T.appings, full use should be made of those, and, if necessary, the existing H.T. supply should be supplemented with another battery. It is a mistake to short the separate H.T. plugs and employ only one H.T. plus wander plug. To do this and to short the grid bias battery terminals is to go back two years to the days when such refinements were seldom incorporated in a receiver.

Finally, the old proverb "More haste, less speed" is well worth bearing in mind. Terminal arrangements on the new set may differ slightly from those on previous receivers and care should be taken that the aerial lead really goes to the aerial terminal and not to that one provided for the earth connection and that the H.T. battery is not connected so that it can have a chance to burn out valve filaments.



A "P.W." Low Loss Ultra Crystal Set

THE SET DESIGNED AND DESCRIBED

by G. V. DOWDING, Grad. I.E.E.
(Technical Editor)

CONSTRUCTIONAL WORK

by G. V. COLLE (Technical Staff).

HERE is a "P.W." Ultra crystal set designed to operate on all wave-lengths, and built on the most modern low-loss lines. The "P.W." Ultra system has proved its popularity and efficiency many times over in the past, and many thousands of crystal sets incorporating it are now in use. Since the day the principle was first made known to the public through the



The completed set showing a loading coil in position of the panel lay-out.

columns of "P.W." it must have enjoyed the most wonderful innings of any method of obtaining selectivity and signal strength. Constantly are we receiving reports from readers obtaining more than average results with Ultra crystal sets, and many have been the remarks made upon its fascinating "pick up" qualities.

With but one tuning control an Ultra set offers the selective advantages of a double circuit tuning system, and by virtue of its balancing end effects, a sensitivity above any other form of tuning is obtained. The Ultra coil patent, it is interesting to note, was acquired some year or two ago by the Igranic Co., who manufacture coils, which, retailed under the name of "Ultronic," can be employed with standard sets using plug-in coils.

As the theoretical diagram shows, one coil figure in the main circuit. This coil is broken into two sections, each section

LIST OF COMPONENTS.	
Panel and box (10" x 8" x 1 1/4") (Peto-Scott)	12 6
1 .0005 S.L.F. Variable condenser (Peto-Scott)	10 6
1 Harlie crystal detector	5 6
1 single coil holder	1 0
1 Low-loss coil former	3 0
1 lb. 24 S.W.G. enamelled wire	1 2
Screws, transfers, etc.	1 0

being tapped, one of these tapings being for the aerial connection and the other for the earth. A loading plug is situated in a series position between the two-coil sections, and this plug must be shorted when loading is not required.

The coil is wound on a special low-loss former, and its two sections are well separated—a most important point.

There are several types of low-loss formers on the market, and it is not essential that the one specified be used. But it should, if possible, be of the skeleton

it should be "de luxe." Naturally, one of "straight-line" frequency or wave-length design is to be recommended.

Bare wire is advised, although slight deviations in gauge or quality will be of no great moment.

The panel drilling diagram shows how the ebonite for this set should be fashioned, and for detailed hints on the handling of this substance the constructor is referred to the regular "Radiotorial" feature which deals with such problems.

Winding the Coil.

A novel method of mounting the coil is employed, and should be noted before the work of component mounting is tackled. A thin strip of fibre is drilled with holes corresponding with those in the panel for the crystal detector mounting. The strip of fibre is held by the nuts of this, and bearing on two ribs of the coil former holds this article firmly in position.

Before the components can be mounted, however, the coil must be wound. It consists of two sections, each one containing exactly 30 turns.

Also each section is tapped at its twentieth turn from the end of the former. Actually, as will be seen in the theoretical diagram, the result is that one coil of 60 turns is divided into three portions, each consisting of 20 turns, the centre portion being split

(Continued on next page.)

Note the symmetry

type, and must measure at least 7-in. x 3 1/2 in.

The panel is rather large for a crystal set, but this is necessary in order to accommodate the rather bulky coil. A Harlie automatic crystal detector was used on the original model and gave excellent results.

A complete list of components and materials used is appended, and, as will be seen, it is by no means a long and expensive one. The most expensive item, indeed, is the variable condenser, and while this should be of good quality, it is not absolutely essential that

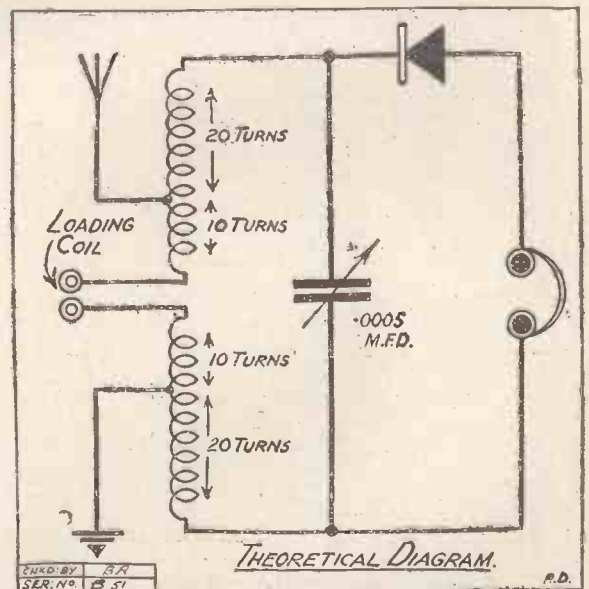

A "P.W." LOW-LOSS ULTRA CRYSTAL SET.

(Continued from previous page.)

into two parts and separated in order to insert the loading plug.

The turns of the coil should be wound so that no two turns touch. For this reason a low-loss former provided with serrated edges or grooves is to be recommended.

Having wound the coil, allowing two or three inches of spare wire at each of its four ends (two ends to each section) for connecting purposes, this and all the other components can now be mounted on the panel.

The Wiring.

The two outside ends of the coil can be connected, one to the moving vanes of the variable and one to the fixed (see wiring diagram and point-to-point check list). The two inside ends should be taken to the single-way coil holder which will take an ordinary plug-in coil when loading such as for Daventry is required. This coil holder may necessitate the drilling of two small holes in the panel for the leads to pass through—it depends upon the type used. Some panel mounting coil holders consist merely of a socket and a plug which, directly fixed on the panel, can have leads taken straight away to their securing nuts.

The crystal detector and the telephone receiver terminals are connected directly across the outside ends of the main coil or, as is the same thing, across the variable condenser. This latter has only two "sides," although leads are shown going to three points on it in the photographs. Two of these points represent the moving

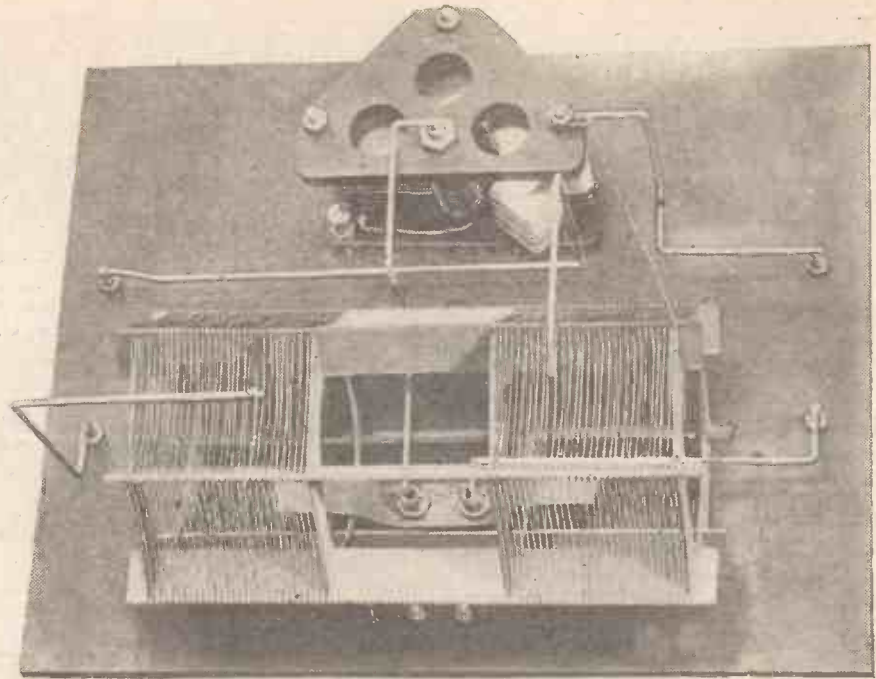

This back-of-panel photograph clearly shows the wiring and disposition of components. The method adopted of holding the coil former in position can also be plainly seen.

vanes, and both are used merely as a method of wiring expediency.

A refinement some constructors may wish to include is a .001 mfd. fixed condenser across the telephone terminals. There is plenty of room for this, although in most cases it will not make much difference to the results.

The Loading Coil.

As previously mentioned, four of the coil connections are taken direct, the two tappings which should be soldered go to aerial and earth terminals. This part and

the remainder of the wiring should be carried out with square-section tinned-copper wire in preference to other kinds of wire.

Now it must not be forgotten that when a loading coil is not in use the coil plug must be shorted. A shorting plug can be used for this, or a coil holder provided with a shorting arrangement, of which there are several makes on the market, could be incorporated in the first place. Another alternative is to have a single way switch on the panel to carry out the shorting, in which case the loading coil can remain in place, whether it is required or not, and brought in or out of circuit by means of the switch.

The tuning range of the Ultra coil, without any loading, will be from 290 or 300 to about 530 metres, depending to some considerable extent on the size of the aerial used. If the aerial is large and the desired wave-length short (such as that of a relay station), the tuning range can be decreased by placing a fixed condenser of .0002 mfd. or so capacity in series with the aerial lead and the aerial terminal of the set. A 150-turn plug-in coil will be required for 5 X X, and this will, of course, take its place in the loading coil holder.

Only One Tuning Control.

By the way, although a Harlie crystal detector is specified any other type or make can, if desired, be used, although the Harlie is easy to handle and very sensitive. There is only the one tuning control on the set, the variable condenser dial, so that it will be unnecessary to deal with the tuning of this little set in detail. Suffice to say that the tuning is sharp and that the condenser dial should be rotated slowly until loudest signals obtain.

Finally, we trust readers who construct this low-loss Ultra will obtain as much satisfaction from it as do the many others who already possess Ultras of various types. It will not perform miracles, and constructors

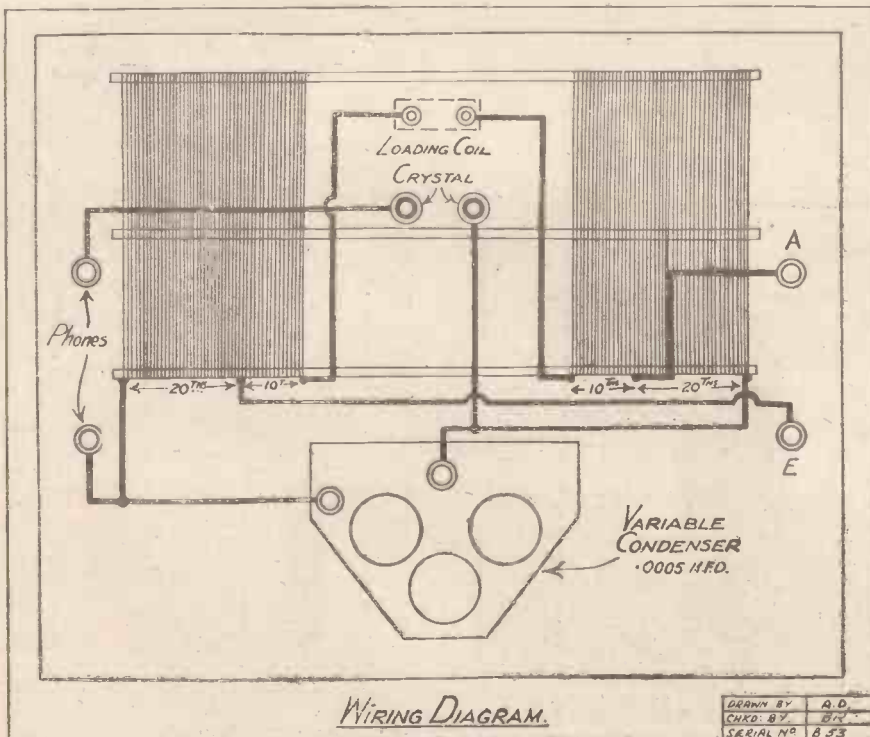

WIRING DIAGRAM.

DRAWN BY	A. D.
CHECKED BY	B. G.
SERIAL NO.	853

(Continued on next page.)

TWO HINTS.

Insulators and Conductors—An H.T. Reminder.
(From a Correspondent.)

AN insulator is an insulator only so long as its surfaces are free from conducting materials. This might look a very trite sort of statement in print, but is the fact always realised? Many amateurs who construct their sets with scrupulous care erect aerials with little egg-shaped insulators at their ends which are left for years to collect conductive deposits of dust and soot which tend to destroy their purpose. An electrical current will not hesitate because the "innards" of an object are insulators, if a path is offered over its surfaces. H.F. currents in fact even travel over the surfaces of conductors,

and do not have time to penetrate through to the centres of leads, etc. Therefore dusty ebonite or other such expensive insulating material might just as well be replaced for wood, or a cheap substitute, for all the useful purposes it will serve.

On the other hand it is wasteful to employ stout gauge tinned copper wire of a high-class nature for connecting leads, if "dry joints" and other bad conducting points are allowed to introduce high resistances into the circuit.

Finally, there is no perfect insulator, and there is no perfect conductor, but when either is very much imperfect it must be classified as the other!

WHEN an ordinary unenclosed H.T. battery is allowed to stand for any length of time in a room, its surface becomes covered with a layer of dust. Now, the dust of city atmospheres is not a particularly good insulator. In fact, in many cases, such material constitutes quite a good conductor!

This fact granted, it will become evident to the amateur that in this direction lies a possible source of H.T. inefficiency, a source of noisy reception due to the lack of a perfectly steady flow of H.T. current.

It is always advisable to keep an eye on the outside of the H.T. battery, and to periodically remove all traces of dust from it. Particularly is this precaution necessary when the set, together with its accumulator and H.T. battery, is employed for outdoor reception in the garden.

Dust falls into the plug-in sockets of the H.T. battery, and an occasional minute or so spent with a pin in picking out this accumulated debris will be time well expended in keeping up the battery to its highest degree of efficiency.

A "P.W." LOW-LOSS ULTRA CRYSTAL SET.

(Continued from previous page.)

must not expect to get valve results with it. An ordinary crystal detector cannot amplify, but the ultra tuning system makes the most of the available energy received on the aerial and by virtue of those balanced end effects, tends to provide increased signal strength by a conservation of energy.

The Set on Test.

Reference was made in the first part of this article to the fascinating "pick up" qualities that many receivers employing the Ultra system of tuning appear to possess. This was experienced in an interesting manner when the original model of the "P.W." Low-loss Ultra crystal set was being tested prior to it being

"written up" constructionally for the benefit of "P.W." readers.

Some three miles from the London broadcasting station it was possible to bring in quite good signals with only an ordinary earth connection, no aerial of any sort being used. It was necessary to use a good outdoor aerial for 5 X X, but it speaks well for the selectivity of the little set when it is stated that Daventry was received without any "break through" whatever on the part of the closely-situated, powerful 2 L O. Different

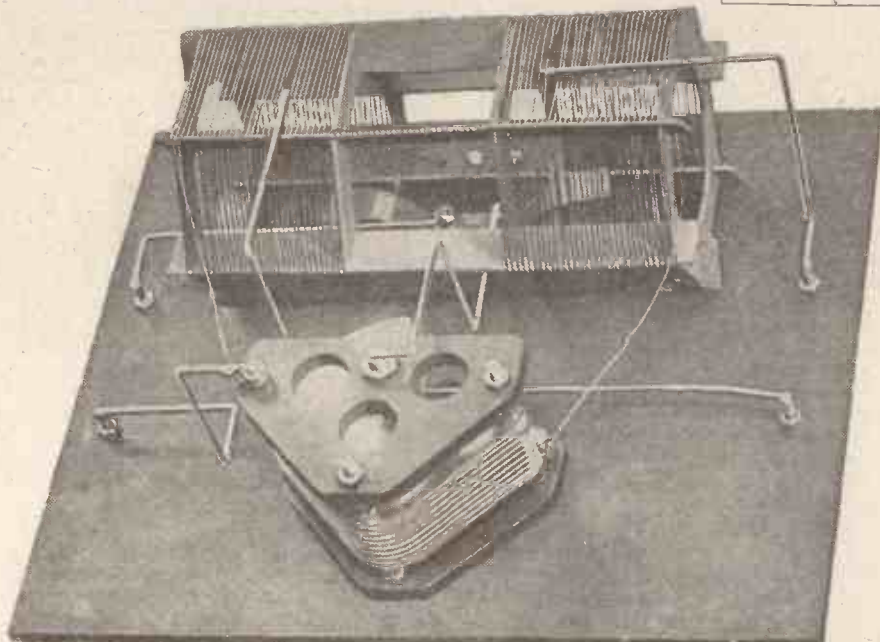
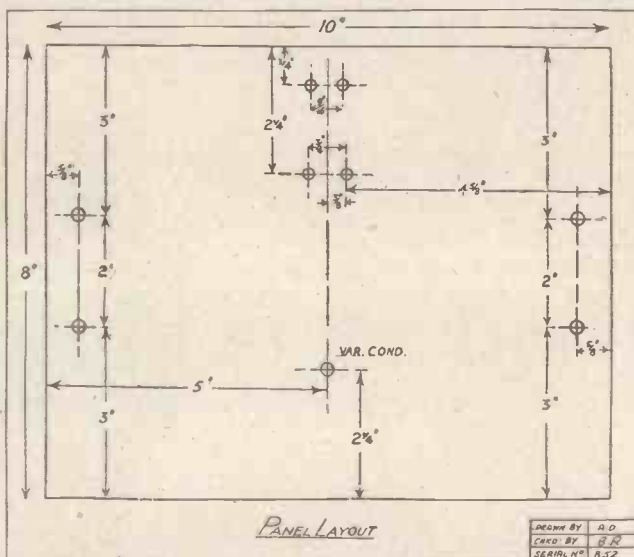

Another back-of-panel view, clearly showing the connections to the coil.

programmes were being transmitted by these two stations during the period of the test.

POINT-TO-POINT CONNECTIONS OF THE "P.W." LOW-LOSS ULTRA CRYSTAL SET.

Aerial terminal to tap on right-hand half of coil, earth terminal to tap on left-hand half.

Outside end of right-hand half to moving plates of variable condenser and one side of crystal detector. Outside end of left-hand half to fixed plates of variable condenser and 'phone terminal. Top 'phone terminal to other side of crystal detector.

The inside connections of each half of the coil are taken to either side of the loading coil holder.

Fifteen miles from 2 L O in a northerly direction signals from both stations were still of excellent strength.



Conducted by our Staff Consultant, J. H. T. ROBERTS, D.Sc., F.Inst.P.

REFLEX circuits, which enjoyed such great popularity about a year or two ago, do not now seem to be in such favour. Perhaps the reason is that their undoubted advantages are to a large extent offset by their instability and uncertainty. The successful working of a reflex circuit depends more than usual upon the valves which are employed; and, furthermore, amateurs object to the use of a crystal detector.

A point which is often noticed with a reflex circuit employing crystal detector is that, when the contact is removed from the crystal, the signals actually increase in strength. The explanation of this apparent anomaly is that the removal of the crystal contact reduces the damping, thus allowing the valve to approach more nearly to the oscillation point; in other words, the circuit becomes more sensitive. The valve will be acting as rectifier owing to the fact that it is operating on or near the lower bend of its characteristic curve. It is important to note that in these circumstances, although the increase in signal strength on breaking the crystal circuit might seem to be an advantage, the circuit is not, in fact, acting as a reflex circuit at all.

Reflex Circuits.

It is not always easy to say why the set may not act as a dual amplifier. Probably the crystal may be insensitive, or the voltages applied to the valve (either the high or the low tension) may be incorrect. Another probable cause of the trouble is an improper arrangement of the H.F. coupling between the valve and the crystal. In many cases the type of coupling employed requires—or, at any rate, works best with—a high-resistance detector, such as carborundum-steel, and may operate inefficiently with galena.

The Solenoid Coil.

According to some investigations recently published, the best type of coil, amongst the great variety that have been developed in connection with receiving circuits, is the old single layer solenoid. The relation of length to diameter of former should be attended to carefully, if the maximum efficiency is to be obtained. The best results, from an all-round view, are obtained when the length of the cylinder is about equal to the diameter. Coils of other shapes than the cylinder will require a greater length of wire for a given inductance value, and therefore, assuming the same gauge of wire to be used, the ratio of the

resistance to the inductance will be greater, with a consequent reduction in the overall efficiency of the coils.

A Low-Loss Myth.

The distributed capacity may be reduced by slightly spacing the turns on the former. The wire used may be between 20 and 30 gauge, and it is found that the H.F. resistance with any size between these limits will be sufficiently small. As a matter of fact, in spite of the frequent recommendations to use a fairly heavy gauge of wire in order to keep down resist-



A well-made, self-contained set, constructed by Mr. H. Rummer, of Kirkdale, Liverpool.

ance, many experimenters have found that there is no detectable difference when using extremely fine wire. Double-cotton-covered wire, or single- or double-silk-covered, is generally regarded as preferable (except on the ground of price) to enamelled wire.

Accumulators in Transit.

A reader asks me whether it is possible for him to send an accumulator through the parcels post, provided it is charged up before despatch and refilled with acid by the recipient immediately it arrives. It is difficult to answer this question very definitely, as so much depends upon the length of time the accumulator will be without acid. Generally speaking, it is undesirable to empty the acid out of an accumulator. But provided the cell is not left without acid too long (two or three days), and that it does not receive too much jarring in transit, there should be no great harm done by the procedure suggested. But it must not be assumed that the cell will function, after arrival and subsequent filling up with fresh acid, as a freshly charged cell. On refilling, it should be given a fresh charge and the specific gravity of the acid should then be carefully adjusted. The acid in an accumulator,

after the latter has been charged and discharged a number of times, becomes, so to speak, part and parcel of the accumulator, and when fresh acid is introduced it is some little time before it gets into thorough working order again. Incidentally, on emptying out the cell for despatch, it would be desirable to wash out with distilled water also.

A New Valve.

A type of valve is now available which employs a spiral grid and spiral anode, but instead of the convolutions of the spirals being connected together, as is usual in valves with this type of electrode, they are left separate, so that the electrode as a whole constitutes a solenoid. The valves are known as "relays," and it is claimed that, owing to some magnetic effect produced in the solenoidal electrodes, a better characteristic is obtained. Amongst the advantages claimed are that the set is rendered more sensitive and stable than the conventional type of three-electrode valve, that the relay is particularly adapted to special circuits such as the neutrodyne, tropodyne, supersonic and ultrasonic, that it is especially effective with very short waves and that it is less liable to break into self-oscillation. The valve or relay is provided with six terminals, four pins of the usual kind, and two extra screw terminals at the side of the base. These six terminals connect to the two ends of the filament, grid and anode respectively, and thus permit special experimental circuits to be tried.

Variations of Capacity.

When experimenting with different circuits you will often find that you have not a condenser of the correct capacity for the required purpose. Although every amateur probably knows that the capacity may be increased by connecting a number of condensers together in parallel and decreased by connecting them together in series, it is curious how seldom this knowledge is put into practical effect in an emergency. A fixed condenser across a variable condenser gives the latter a new range, whilst another fixed condenser gives it yet another range, and so on. A fixed condenser in series with the variable condenser gives it a new range. It is surprising what can be done with one variable condenser and two or three fixed condensers of different values, or even of the same value, for that matter.

Valve Impedance and Coupling.

Following my remarks recently upon the question of resistance and choke coupling, a reader wants to know whether he is likely to obtain better results, or a higher amplification, in the first stage of a resistance-coupled L.F. amplifier, by substituting a high-factor resistance-coupling valve for the low-factor but high-impedance general-purpose valve which he is at present employing. From what I said previously it will be clear that the amplification will depend, amongst other things, upon the impedance of the choke or the resistance, as the case may be. But assuming a high-value impedance is employed, some fair approximation to the amplification indicated by the amplification factor of the valve may be obtained, and therefore, in these circumstances, it would be better to substitute the special resistance-coupling valve, with the high factor, for the general-purpose valve.

(Continued on page 900.)

LAST week I indicated how to add one stage of intermediate-frequency amplification to the frame receiver, and the final arrangement obtained I have illustrated again in Fig. 1.

I would not advise you to go any further until this stage is thoroughly mastered and understood. It must give clean, good quality signals, and there must be no trace of instability.

When you are quite satisfied with the working and have heard a number of stations on the telephones, you can prepare a second stage of intermediate frequency. The I.F. stage so far used is actually the rectifier, but, of course, it amplifies as well. This rectifying stage now becomes an amplifying stage and the only change you need make to it is to put grid bias, say one and a half volts, on to the valve instead of the zero or positive bias used for the valve when it was a rectifier.

The L.F. amplifier connection should be

BUILDING UP A SUPER-HETERODYNE RECEIVER.

By Captain H. J. ROUND, M.C.
(Chief Research Engineer, The Marconi Co.)

In this article Captain Round continues his novel and interesting description of how the amateur can make up an efficient Super-Heterodyne, step by step.

Get a station with the two coils set approximately in the right position by guess. Now shift one coil in one pair to get the best tuning, then shift one coil in the other pair to get the best, then finally re-tune on the oscillator condenser.

Leave these L.F. coil settings fixed now unless you run into long-wave jamming, when you will have to choose another intermediate-frequency wave-length. You should have gained sufficient experience with the one stage L.F. to know more or less what to do to change the L.F. wave-length.

Working with the local station will be troublesome because you have now a big magnification, but in this set you can mistune your frame current and weaken signals a lot. Then dulling the filaments of any of the intermediate-frequency or high-frequency amplifying valves (not the rectifier) will reduce signals up to a certain point without distortion. Sometimes pulling out the high-frequency

as the D.E.8 or D.E.5 or B.4 are much lower resistance and the result with these will be to give less tuning.

If of two valves, such as D.E.R. and D.E.8 H.F., which have the same plate resistance, one (the D.E.8 H.F.) has a much higher "M" value, it will give more magnification with the same tuning and also more tendency to instability.

Obtaining Stability.

I should advise you just to try what valves you have and get them working well, but remember the above points, and if by

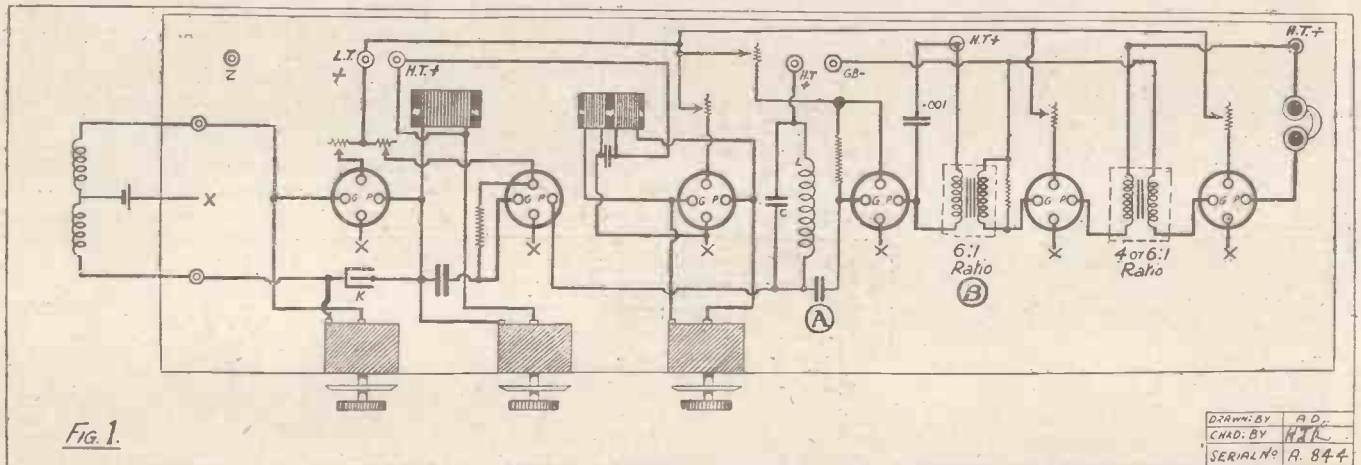

Fig. 1.

removed and another pair of 400-coils with a condenser and leak and another valve, the plate of which goes to the low-frequency amplifier. Fig. 2 shows the whole arrangement. This new valve now becomes the rectifier and should be adjusted accordingly. The set should now be much more sensitive, but you may run into instability, which you will have to cure before you can go any further.

Valves for I.F. Stages.

A little information on the intermediate-frequency circuit will now be useful. The two 400-coils with a .001 mfd. condenser across them is shunted with:

- (1) The valve before the coils;
- (2) The grid leak.

If you have chosen very approximately a coil and condenser arrangement such as I have indicated then these two shunts will give sharp, but not too sharp, tuning, if the valve has a plate resistance of about 25,000 ohms and the leak is about 250,000 ohms. You are not unlikely to use a valve with a much higher resistance than this, which is about the resistance of the R, D.E.R., D.E.8 H.F., or D.E. 5 B, but valves such

any chance you wanted to use one of the D.E.5 type, you can either increase the condenser or decrease the inductance, or tap the valve anode connection down the coil to get the same tuning. The two sets of intermediate-frequency coils can be fixed, if you like, in some way like the nentrodyne people set their coils—i.e. at a slope to prevent magnetic induction.

I do not recommend positive bias for stabilising; decreasing the grid leak value is better. The effect of this is to damp the circuit more, but if you have to do it you lose tuning. Lowering the high tension is a good way of lowering the magnification to get stability without losing tuning.

I always reckon that not only should my intermediate-frequency stages be stable with the right grid bias, but at any value of grid bias they should be stable also, so that if a strong signal comes in it will not start the set oscillating. (This is true of any type of amplification.)

I should now advise you to rest awhile with the set as it is and get it working very smoothly. First of all, you must make sure that your two intermediate-frequency coils are in tune with one another, and this is a little tricky.

valve will leave ample signals from the local station to work with, the small neutralising condenser carrying through sufficient energy. I leave it to you to get good quality by one of these methods, but it is an essential feature of a good design that it shall give the local station with first-class quality.

Grid Leak and Condenser Values.

If you had nice quality from the local station on the four-valve arrangement before we added the oscillator, try to get equally good quality with this seven-valve set. But now, of course, you can tune in all sorts of stations.

A short note here on rectifiers will not be out of place. When you were using the four-valve set before we added the heterodyne, I told you to use as a rectifier a .0003 mfd. condenser and a 2-megohm leak with the bottom of the leak connected to, say, the positive end of the battery. Now this grid leak rectifier has some rather serious tonal defects; it exaggerates the low tones in a drummy kind of way unless you keep the condenser much smaller than .0003 and the leak value rather low.

(Continued on next page.)

BUILDING UP A SUPER-HETERODYNE RECEIVER.

(Continued from previous page.)

Actually putting the bottom of the grid leak on to the positive end of the filament is to some extent the same thing as lowering the value of the grid leak, except that it does not weaken signals, and a little experiment will show you it will give higher-pitched quality there than on the negative end.

If, however, you put negative on to the grid leak you will arrive at the anode

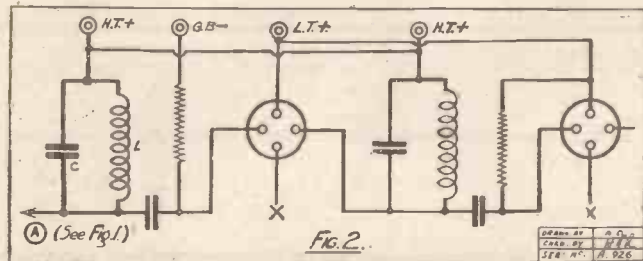

rectification point and with a fine mesh valve and just enough volts to keep one and a half volts grid bias, you should get fair signals.

However, the matter is not so important in the high-frequency rectifier, as when it is used as a beat tone rectifier the action is different. I have indicated that grid bias will give you an advantage when you are heterodyning, but when one comes to the second rectifier for the intermediate frequency, anode rectification is probably the best method to use; and if you want to use it, increase the .0003 mfd. to, say, .002; use a 250,000 ohm grid leak and a fine-mesh rectifier, such as the D.E.8 H.F. or the D.E.5 B. or a D.E.3 B., and then search for the best grid bias position.

Your low-frequency transformer is shunted so that you need not fear any tone changes with this arrangement due to transformer resonance.

I find that careful handling of the rectifier is of great importance on a set, and very often strength must be sacrificed for quality.

When everything is to your satisfaction in the set, if you like you can try adding another intermediate-frequency stage, putting it in just as you did the second stage; but for this stage you will probably have to use a valve with small magnification or damp the circuit with a lower grid leak value to get stability, and it will not now do much harm as the previous circuits gave you a very fair tuning curve.

The complete set will now be as shown, only, of course, the detectors may be modified as you have found best (Fig. 3).

Some Recommended Valves.

I suggest below the combination of valves for your set, but I recommend you strongly

as settling on filament resistances, voltages, grid bias, etc., etc. I do it myself that way with any set, and in the end you will have much more luck and a lot of satisfaction.

Finally, get your two first tuning condensers running nicely together by altering windings, and then calibrate them. If you would like a bit stronger signals at any stage, you can wind a bigger frame, the rough rule being to get the same length of wire in less turns as the frame gets bigger.

If you finally want to box the set up, you can experiment on re-arranging the parts in such a way as to give good results, but the long form I have indicated will always give least trouble. The following combinations of valves are suggested:

FOR MAXIMUM SIGNALS

	H.F.	DET.	Osc.	I.F.	I.F.	I.F. DET.	L.F.	L.F.	Total Current
6-volt set	D.E.8	D.E.8	D.E.8	D.E.8	D.E.8	D.E.8	D.E.8	D.E.8	One ampere
	H.F.	H.F.	L.F.	H.F.	H.F.	H.F.	L.F.	L.F.	

FOR SMALLER AMPLIFICATION

	H.F.	DET.	Osc.	I.F.	I.F.	I.F. DET.	L.F.	L.F.	Total Current
2-volt set	D.E.R.	D.E.R.	D.E.R.	D.E.R.	D.E.R.	D.E.R.	D.E.R.	D.E.6	2 amp.
4-volt set	D.E.3	D.E.3	D.E.3	D.E.3	D.E.3	D.E.3 or D.E.3 B.	D.E.3	D.E.4	67amp.

If you are using the same high-tension battery for the whole set, put 2 mfd. condensers between the points where you connect to it and earth, especially if you are getting oscillation trouble.

not to take my last diagram and try to build the set up all at once. You will be bound to run into trouble if you have not had any previous experience. Build it up step by step as I have shown you, and I have left a lot for you to find out, such

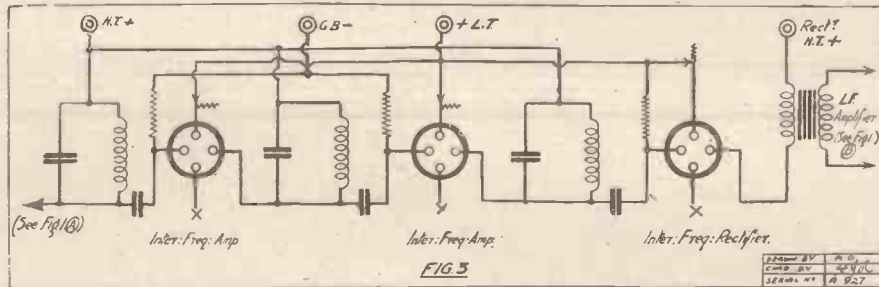

WHEN loud-speaker extension leads of any considerable length are run around the house it should not be forgotten that they will possess some considerable capacity. In cases it may be sufficient to have a very considerable effect on the reproduction of speech and music. It does not make any difference if the well-known choke-capacity loud-speaker bypass system or even if a telephone transformer be used. Therefore no fixed condenser should be employed across the two loud-speaker terminals of the set to which the extension leads are connected.

A very fine control of tone can be obtained by providing a compensating unit in the form of a number of fixed condensers so arranged that various capacities from .002 to so mfd. to about .1 mfd. can be obtained by means of switches or plugs and sockets. The extension leads can pass through this on their journey from the set to the various rooms of the house.

For the faithful reproduction of speech very little parallel capacity will be required, and enough will generally be present in the

SOME LOUD-SPEAKER HINTS FROM A CORRESPONDENT.

extension leads. With a little practice the amateur will be able to "load" the system to the best advantage for different loud speakers and for different forms of transmission. Of course, this control must not be employed to muffle signals in order to suppress distortion due to the use of bad components, unsuitable valves, incorrect grid bias, or other such causes, nor should it be employed purely as a volume control.

Controlling Volume.

And, by the way, the control of volume presents a problem that seems seldom to be solved in a correct manner. De-tuning may bring in an interfering station, while turning down the valve filaments invariably causes distortion. But the difficulty can be surmounted by placing a variable resist-

ance across the loud-speaker terminals. Such a resistance should have a minimum of but a few hundred ohms and a maximum of at least four thousand.

Now there is another very important point in connection with loud-speaker work which is seldom given sufficient prominence, and that is that some instruments operate better on certain particular sets than on others. Wherever possible, a loud speaker should always be "matched" with the set with which it is to be used, not forgetting that the term set is inclusive and brings in valves and batteries.

Finally, a loud speaker should never be overloaded. A "So-and-so" Junior loud speaker cannot handle the energy that the senior model of the same make can, although the latter will probably be able to do as much or more with a small input as the former. Therefore, whatever the set, go always for the largest model that the state of finances will allow. A "senior" can cope with an extra valve if ever one should be added, but a "junior" imposes something of a limitation.

CAPTAIN ECKERSLEY AND THE GENEVA SCHEME.

B. B. C. CHIEF ENGINEER'S VIEWS.

By "ARIEL."

In a recent interview with Captain Eckersley, "Ariel" obtained views on the Geneva Wave Scheme which indicate that Captain Eckersley has great hopes for the success of the plan, a plan which—in the B.B.C. Chief Engineer's view—is by no means ideal but which offers the only practical solution to the wave-length problem.

THE details of the new scheme of the International Radiophone Bureau of Geneva with regard to a new broadcasting wave-length scheme has aroused a considerable amount of interest among wireless amateurs throughout this country and Europe.

In a recent issue of "P.W." was published an exclusive article dealing with the new wave-length scheme by Mr. Arthur Burrows, the Manager of the Geneva Bureau, and in an interview I had with Captain Eckersley the other day, he was good enough to give me his views on one or two points in connection with the new scheme.

No Other Solution.

I told him that some listeners had written to POPULAR WIRELESS expressing doubt as to whether the new wave-length scheme really offered a substantial foundation for the building up of a system of broadcasting which would, if not entirely eliminate, at least, radically assist in reducing interference between broadcasting stations.

In reply to this query, Captain Eckersley said: "I am absolutely satisfied that the new Geneva wave-length scheme forms a basis for future building. It is by no means ideal; the ideal arrangement would be simply to allot ninety-nine wave-lengths among ninety-nine European stations. But as there are more stations than wave-lengths, I can see no other solution except that given in the Geneva plan.

Much Less Interference.

"It is obvious that stations using common waves will have a limited significance, and it will be, I hope, the future policy of European countries to concentrate upon their exclusive waves in framing national systems."

Regarding the suggestion that interference would still be fairly prevalent and that perhaps DX work among amateurs would not be greatly benefited, Captain Eckersley said: "Provided that the Continent adheres to the promises they have made, and provided that the special wave-meters calibrated and designed by the Technical Committee of the O.I.D.R. are used in the proper way, there can be no question but that the interference between the chief British and Continental stations will be much less than hitherto.

Effect On Receivers.

"DX work should be made far more practical provided every station adheres to its allotted wave-length, because there will be a definite assurance that among the principal stations there will be no interference. It will be, of course, impossible for reachers-out to get those stations which are using common waves, but this handicap is completely balanced by the assurance

that those stations using exclusive waves will be free from any interference."

With regard to the possibility of receivers being ante-dated by the new scheme, Captain Eckersley was emphatic when he said: "I see no reason why the receivers used by British listeners should not be as adequate if the scheme is put into operation as they are to-day."

to have made no changes, practically speaking, except for a 4 per cent difference in the relay stations between three hundred and five hundred metres leaves the British listener extremely favourably placed."

I then reverted to the question of the oscillation evil, knowing it to be a favourite topic of Captain Eckersley's.

I asked him whether, in his opinion, he thought that oscillation had increased among listeners since this time last year. "On its lowest terms," he replied, "the oscillation evil is about the same as it ever was, having regard to the number of listeners. Thanks to the co-operation of the technical press, and lay press, the Post Office, and a



Capt. Fried, the heroic commander of the S.S. Roosevelt, operating the five-valve set recently presented to him.

Discussing the position of certain amateurs in areas where there will be fairly substantial alterations in British wave-lengths, Captain Eckersley said: "Unquestionably certain receivers will have to be retuned to new wave-lengths.

The Oscillation Evil.

"As it has always been understood that the wave range of British broadcasting is between three hundred and five hundred metres there should be, in an adequately designed set, no difficulty at all in tuning to the new wave-lengths. In certain cases it may be that new coils will have to be plugged in but I am sure it will be appreciated that we cannot hold up the whole future of broadcasting because certain listeners have made themselves fixed wave-length receivers being under the impression that there would never be any change of wave-length at any station in Britain.

"Over a year's warning has been given that changes have been contemplated, and

considerable organisation here at Savoy Hill, we can, at any rate, safely say that the oscillation trouble is being kept in check."

Bureaucratic Rules Useless.

I suggested to Captain Eckersley that perhaps the day would come when standard rules regarding the use of reaction would have to be made, but he shook his head at this.

"I don't think," he said, "that any bureaucratic rules as to the design of wireless sets will ever do anything towards curing the oscillation nuisance.

"I feel that we have got to rely upon the good sense and sportiveness of the average inhabitants of these islands to combat the nuisance. Gradually the folly of using reaction beyond certain limits will become apparent to everyone, and just as opportunist arrangements in the early days of the motor-car have given way to mechanical devices which really work reliably, so I see the set of the future relying less upon reaction and more upon sane and efficient design."

(Continued on next page.)

ONLY HIGH & L.T. BATTERIES IN THE WORLD WITH PLATE-GRIDS AND PASTE MADE OF PURE LEAD

with the Plate Grids Die-cast and Pasted entirely by machinery. Without Wood Separators or Celluloid, eliminating internal resistance and heat which shortens the life of all other makes.

Entirely of British
Origin
and Workmanship.

TUNGSTONE
Pure Lead Grid
Accumulator

Patented in Chief
Countries
of the World.

Vital Indisputable Facts for Battery Users

**PURE LEAD IS THE ONLY METAL THAT
PERFECTLY, RELIABLY AND EFFICIENTLY
GENERATES AND STORES ELECTRICITY BY
CHEMICAL CONVERSION.**

Wasting Money on a Make-Shift

Materials used in Dry Batteries are SELF-DESTRUCTIVE and must and do continuously eat themselves away.

Gradual destruction is constantly reducing capacity.

Amp. hour is the only vital and absolute essential factor in a battery.

Makers never state and cannot give any amp. hour capacity.

Makers cannot test for amp. hour capacity.

Makers' voltage statements absolutely unreliable.

Average working value is 1 volt only.

Voltage drops haphazardly and uncontrollably.

Crackling noises caused by decaying material and cannot be stopped.

**Five Dry Batteries of 100 Volts each cost more than a
Tungstone—which will last the lives of many persons.**

Reliable Service Remembered

**TUNGSTONE 60 Volt 3 a.h. Actual and Guaranteed
is more efficient than a 100 Volt Dry Battery.
Will outlive Hundreds of Dry Batteries.**

**NO CRACKLING OR PARASITICAL NOISES ON WIRELESS
PHONES OR LOUDSPEAKER. NO FROTHING, FOAMING,
HEAT AND OTHER TROUBLES.**

Tungstone (Patented) Tapping-Off Cell-Connector. By means of the Wander Plug supplied free, Tappings can be taken off as required at any two-volt cell or any varying series of cells.

CHARGING HIGH TENSION on LOW TENSION CHARGING PLANT

All H.T. Tungstone Accumulators are fitted with a Patent Equipment whereby each series of 12 Volts can be coupled in parallel so that these H.T. Batteries of whatever voltage can be charged at local Garages and Charging Stations on a 12-16 Volt Low Tension Charging Plant.

TUNGSTONE High Tension 60 Volt Battery 3 a.h. is sold in the United Kingdom on monthly payments over extended period. Apply for particulars. Further interesting information on points of this advertisement are to be found on pages 58, 59, and 67 to 73 of the Illustrated Booklet "Photography tells the Story" which will be sent free on application to the—

T.A. 57A,
TUNGSTONE ACCUMULATOR CO., LTD., St. Bride's House, Salisbury Square, London, E.C.4

CAPTAIN ECKERSLEY & THE GENEVA SCHEME

(Continued from previous page.)

I next asked Captain Eckersley if he had anything further to make public with regard to the progress of the new Daventry experimental station, about which we have heard so much of late, but about which there is also a certain amount of mystery.

"The Daventry experimental station is going ahead as rapidly as possible," he said, "having regard to the difficulties of delivery of apparatus, which is held up owing to the Coal Strike. This station should be of extreme value in the development of broadcasting. From the point of view of the Post Office, who are responsible for seeing that one service does not interfere with another, this experimental station will give sufficient data to determine certain points in connection with interference from broadcast stations. From our point of view, the building of this station will furnish us in concrete form with an apparatus, which eliminates all the faults which have become apparent during the period under which broadcasting has operated in this country.

The Ether Drift.

"The new station will, I am confident in stating, have a performance which it will be impossible in one respect to better. I expect this arrangement of circuits will enable us to guarantee that for every frequency from 50 a second up to 19,000 there will be an equal response in the aerial current. I do not say that in the development of the next ten years better methods of achieving this performance will not be discovered, but I will definitely say that that performance will be achieved at this new experimental station.

"It should be emphasised, however, that the station is experimental, and that there is no guarantee that it will be put into service either immediately or in the future."

Before I left Captain Eckersley I had a very interesting chat with him with regard to Professor Miller of California, who, my readers will remember, recently claimed to have discovered an ether drift, thus proving, in his opinion, beyond all doubt, the definite existence of an ether medium.

I told Captain Eckersley that the Editor of POPULAR WIRELESS had heard from Professor Einstein on this matter, and that the famous exponent of relativity was rather sceptical about the discovery.

Captain Eckersley, although interested, said: "Dealing with the subject, which to me is necessarily recondite, is difficult, but, I would say that it is unlikely, seeing the great precautions which were taken in the Michaelson-Morley experiment, that its repetition has given any different results from those introduced by experimental errors.

"With a great deal of diffidence I associate my opinion with Professor Einstein. I do not know if an ether drift would have a great deal of effect upon wireless in general. It is difficult at first glance to conceive that if an ether drift were affecting radiation how to stop that ether drift or, more practically, how to compensate for it."

That last paragraph, I think, sums up the possibility of any importance being attached to Professor Miller's discovery.

Accumulator Sulphation

A practical article about one of the greatest Bugbears in Radio.

By J. F. CORRIGAN, M.Sc., A.I.C.
(Staff Consultant).



ONE of the biggest bugbears of the radio world is the accumulator, and the tendency to sulphating which that electrical storage device shows, unless it is most carefully attended to. Manufacturers, indeed, have endeavoured to place on the market accumulators of one type or another which are completely "sulphation-proof," but nevertheless their efforts, praiseworthy as they are, have not

active material of the plates, and thus inhibits (and sometimes entirely prevents) the chemical changes which must necessarily take place during the charging and discharging of the accumulator.

The commonest cause of sulphation in an accumulator is allowing the accumulator to remain in a discharged condition. If an accumulator has to stand for any length of time, it should be fully charged. Even under these conditions, however, sulphation will set in eventually.

Foliosing the Plates.

Another frequent cause of sulphation is the employment of impure acid and water in the accumulator cells. The sulphuric acid used should be of the highest quality possible. And preferably the water used to dilute the acid should have been distilled. The reasons for the above facts are not difficult to discover. Sulphuric acid, by reason of the conditions of its manufacture, is always very liable to become contaminated with metallic salts, and also traces of nitric acid and arsenic. Now, arsenic acts as a chemical poison, and its presence in the accumulator acid quickly sets up a condition of poisoning within the active material of the accumulator plates, rendering them unable to undertake their function. The presence of nitrates in the acid of the accumulator is exceedingly detrimental. Traces of nitrates will start an accumulator sulphating very rapidly.

This "nitrate sulphation" arises from the following series of chemical changes:

Any nitrates getting into the acid or water of the accumulator are converted into free nitric acid and lead oxide. The lead oxide in this state combines with the sulphuric acid, forming lead sulphate, which is deposited on the plates. The free nitric acid attacks the lead of the plates, forming further quantities of lead nitrate, and thus the process goes on continuously until the accumulator has become completely sulphated. Thus much damage may be done by the introduction into the accumulator of acid or water containing even the smallest trace of a metallic nitrate or similar salt.

Another direct cause of sulphation arises by allowing the acid level of the cell to fall below the mark indicated on the case

by the maker. When the acid is maintained at a lower level, a species of electrochemical action is set up, with the resulting well-known sulphate deposit on the upper portions of the plates. If the acid does fall below the level indicated by the maker of the cell, add the necessary amount of distilled water.

Writers on accumulator technique generally insist on the necessity of using distilled water. It is a good point, and one which should always be followed whenever possible. But to many radio amateurs distilled water is an unobtainable commodity. And you often meet such amateurs who will tell you that they have used ordinary household tap water for years without experiencing any bad effects.

Tap Water Troubles.

Well, the fact of the matter is this. Tap water, as supplied in any city, is remarkably pure, and its nitrate content is kept down to a minimum (about two parts in every 100,000 of the water). That is why those amateurs who use ordinary tap water for their accumulator charging operations very often suffer no ill effects. But, nevertheless, the risk is always there, and it is an undoubted fact that accumulators which are habitually used with ordinary tap water become dirty, and sluggish in charging, much more quickly than cells to which only distilled water has been admitted.

The trouble about the lead sulphate deposit in a sulphated accumulator is that, in the first place, lead sulphate is one of the most insoluble substances known to the chemist, and, secondly, that the material is deposited in a peculiar crystalline form which makes it even still more difficult to dissolve.

(Continued on next page.)



Fig. 1.—A difficult case of sulphation.

as yet been completely successful. And thus we have still with us our old friend and enemy, the wireless accumulator, whose ways and habits are strange, and who, upon the slightest degree of ill-treatment, will develop the most persistent and annoying troubles, much to the grief of the amateur.

Causes of Sulphation.

The only really practical and efficient way of keeping the sulphation enemy at bay is to use the accumulator, and to use it regularly and carefully. It is very seldom that a regularly used accumulator develops sulphation troubles, unless, of course, it has been badly charged over protracted periods.

The term "sulphation" may be defined as the formation of a deposit of lead sulphate, in greater or less amounts, on the plates of the accumulator. The lead sulphate is deposited in a micro-crystalline condition. In this state it not only covers the actual metal portions of the accumulator plates but it embeds itself into the



Fig. 2.—The damage done to the plates is well illustrated in this photograph.

ACCUMULATOR SULPHATION.

(Continued from previous page.)

Figs. 1 and 2 give a general view of sulphated accumulator plates. Fig. 3 shows one of the plates under a slight magnification, such as would be obtained if the plate was examined under a reading-glass. It will be seen from this illustration that one of the characteristics of the sulphate deposit is that the material is formed fairly uniformly over the whole of the area of the plate.

Some Sulphation Cures.

If, now, we examine such a plate under the low powers of the microscope, we obtain a view similar to that indicated at Fig. 4. In this case we see that the sulphate has been laid down in well-defined layers or strata, the actual physical condition of the sulphate being determined by the circumstances and length of time under which it has been formed.

Fig. 5 is a photomicrograph depicting the crystalline nature of the minute grains of lead sulphate which are deposited during the process of sulphation. The actual area represented by this photograph is about one-tenth the size of a pin's head.

Now, let us deal with the methods of curing sulphation in accumulators. Ob-



Fig. 3.—An enlarged view of a sulphated accumulator plate.

viously, the best and easiest method of remedying the trouble would be to find a solvent which would completely dissolve away the troublesome deposit. But, unfortunately, no powerful solvent for lead sulphate exists. Nevertheless, there are two substances—ammonium acetate and ammonium tartrate—which, in strong solution, exert a fairly reasonable solvent action on lead sulphate. This solvent action is sufficiently reliable to remove the traces of sulphate deposit which have been formed in slightly sulphated accumulators.

For this purpose, procure four ounces of ammonium acetate (it is not expensive, the present quoted price being 2½d. per oz.) and dissolve it in the least possible amount of hot water, so as to make up a very strong solution. Pour away the acid from the affected accumulator, and give it a preliminary rinsing out with hot water. Now pour the ammonium acetate solution into the accumulator, and shake the case vigorously for some time, finally pouring away the solution, and rinsing out the accumulator with fresh hot water before refilling it with acid.

In the case of slightly sulphated accumulators, one or two treatments of this nature will entirely remove the small deposit of lead sulphate which has been formed, and the accumulator will thus be returned to its normal conditions of working.

More serious sulphation troubles, however, require other treatment.

One method of treating accumulators which have reached a sulphation stage which cannot be termed "slight" is to pour out the acid from the discharged cell and then to fill it up with water. Shake the accumulator case vigorously, pouring away the water subsequently, in order to remove any loose particles of the sulphate which may have become detached during the shaking process. Repeat this operation a number of times. Then refill the cell with acid, and subject it to a very low rate of charging. In such cases, during the first half of the charging, the accumulator should only be charged at a third of its normal rate, and after this period the rate of charging should be reduced still further to one-sixth of the normal rate.

Washing and Brushing.

It is a good plan also to frequently reverse the direction of the current during the charging.

The above method is very slow, tedious, and troublesome to put into operation; but, nevertheless, it is capable of yielding excellent results, provided it is carried out carefully, and with the necessary patience.

The next stage of accumulator sulphation which I propose to deal with is the "snowscape" one. That is, the stage at which the accumulator plates and general interior resemble a miniature alpine landscape more than anything else. Now, in such cases, one has to do something really desperate. And even if such methods are carried out to their fullest extent, it is often a matter of luck more than anything else if the accumulator finally returns to its normal working condition.

Dealing with a badly sulphated accumulator of the above description, the first thing to do is to open the case by making incision at its upper edges with a sharp knife, and then to remove the plates bodily from the cell. Next, lay the plates out flat on a piece of paper, and scrape them very carefully with the blunt edge of a knife. This operation will remove the greater proportion of the surface layer of sulphate.

After this, it will be necessary to attack the more deeply deposited layers of sulphate. This is best done by means of a stiff bristle brush. Carefully brush away as much of the deposit as possible, and, when all but a thin layer of the deposit is left, try the effect of soaking the plates in strong ammonium acetate solution for a day or two, finally well rinsing them in clean hot water.

Another method which has been recommended for dealing with badly sulphated accumulators consists in pouring nitric acid and water (in the proportions, three parts strong nitric acid to one of water) into the accumulator, after having, of course, first removed the ordinary liquid contents of the cell. The accumulator is then vigorously shaken, and the acid is quickly poured away

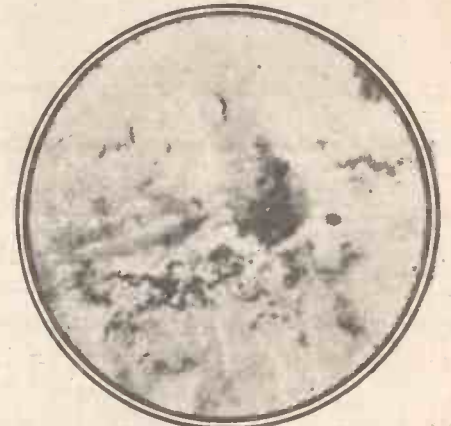

Fig. 4.—This shows the same damaged plate, as viewed by the microscope.

into some other vessel. A vigorous chemical action will take place during the shaking process and red fumes will be evolved, owing to the action of the nitric acid on the lead of the accumulator plates; but, nevertheless, this chemical action will result in the sulphate deposit being loosened, so much so that it will be able to be rinsed away almost completely by continually filling up the accumulator with hot water, shaking it about, and then emptying it.

Naturally, the above operation should be reserved only for exceptionally bad cases of accumulator sulphation, cases in which there is no other hope of a cure, for the nitric acid quickly eats into the lead of the plates, and, if it is not rapidly removed, it will destroy them altogether.

However, "prevention is better than cure," and in no other instance than in the subject under discussion is the truth of this hearty old adage more apparent. If you would keep the sulphation bogey at bay, treat your accumulator well. Use it regularly, and see that only the purest possible materials are employed in its charging. And, finally, if for any reason you find it necessary to dispense with the use of your accumulator for any length of time, charge it up before you leave it to rest.

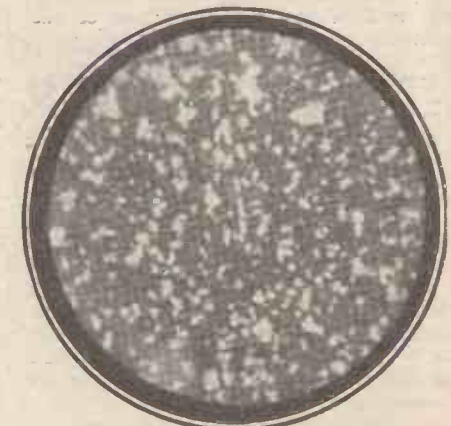

Fig. 5.—Microscopic appearance of crystals of lead sulphate, taken from a sulphated plate.

The Microscope in Radio

It has been said, and, indeed, very truthfully said, that a great amount of scientific organisation and control is necessary to place large quantities of any standardised commercial product upon the market, and to continually turn out that product in a definite state of purity. Take butter and milk, for instance. These indispensable commodities entail the careful labourings of a small army of inspectors, analysts, bacteriologists, and other scientific workers, in order to keep their standard of purity up to the scratch. Even the prosaic jam and pickle manufacturer cannot dispense with this continual process of careful control on the purity standard of his products. And, in fact, no matter where you look in our modern life, you will nearly always find a number of scientific workers continually engaged in the necessary labours for ensuring that the efficiency standard, or the purity standard, of any particular marketed commodity does not vary appreciably from a given normal.

Various Routine Tests.

So is it, also, in the radio industry. By the expression, "radio industry," is not meant here merely the manufacture of components

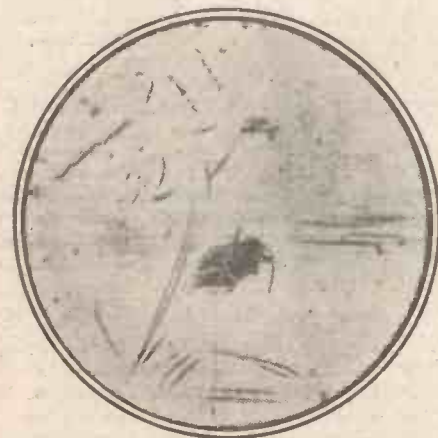

Fig. 1.—A fault in a sheet of mica.

and sets alone, but also the various auxiliary industries, world wide in situation, which are vital to the efficiency of the component and set manufacturing part of the general industry. Such side industries comprise, among others, the manufacture of ebonite, shellac, mica, metallic wires and filaments, natural and synthetic radio-sensitive minerals and crystals, and a multitude of other manufactures which combine together to make the radio set of the present day a commercial and scientific success.

We may call these subsidiary industries the "materials" part of the radio industry as a whole; and it is the object of this article to give the reader some little insight into the various routine tests which are made in order to ensure that the various radio materials in the making are turned out to the radio constructor, professional or amateur, in a reliable state of purity and efficiency.

Analytical tests of a purely chemical nature form a large portion of the control



An interesting sidelight on some of the modern methods of efficiency maintenance in the production of Radio materials.

From a Special Correspondent.

operations which are conducted on materials which are turned out for use in the radio industry. So also do physical and electrical tests. But the most interesting side of these control tests to the reader will be the various examinations made upon radio materials with the aid of the microscope.

Faults in Mica.

The microscope is an important tool in the equipment of the radio material manufacturer. With it, he can tell, almost in a moment, whether his products are being turned out in a satisfactory manner, whether they conform to the necessary degree of purity, or whether impurities are being admitted to them during some process of their preparation or manufacture.

Take, for instance, the case of mica. This material plays a rôle of enormous importance in the modern radio industry; and it is absolutely essential that it be free from any serious impurities which would set up areas of low dielectric strength. If you take up any ordinary sheet of mica and look through it, you will probably not be able to discern any leakage area in it. Place it under the microscope, however.

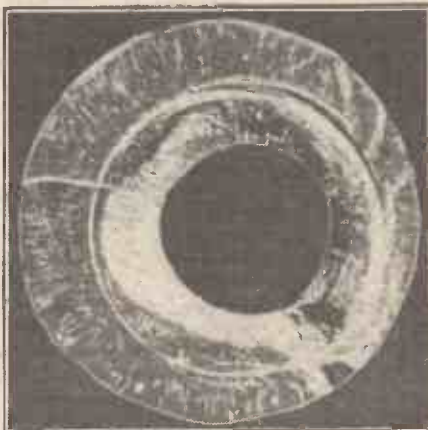

Fig. 2.—A small hole drilled in an ebonite panel (highly magnified).

That will form a crucial test. If the mica is of good quality through and through, the sheet will be almost transparent, save for a few surface scratchings which will stand out boldly under the microscope. Faults in the sheet, however, will stand out as dark grey or black patches similar to the one shown in the photomicrograph, Fig. 1. Such faults are often due to actual

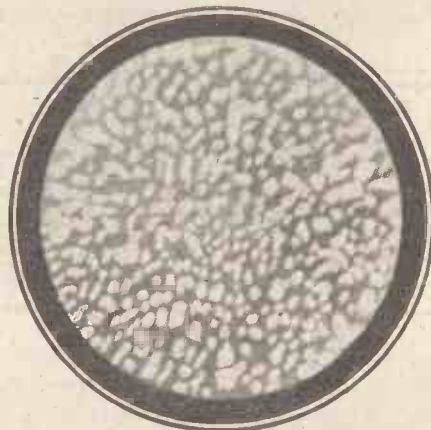

Fig. 3.—A thin layer of pure paraffin wax shows this crystalline structure when highly magnified.

metallic contamination, and, of course, their presence almost entirely ruins the insulating and dielectric qualities of the material.

Again, the quality of ebonite, particularly as regard its "working" properties, may be determined by microscopic inspection. A test of this nature used by some manufacturers is to take a small piece of ebonite and to drill a very small hole in it. Ebonite of the highest quality so treated, and subsequently submitted to microscopic inspection, reveals a perfectly symmetrical and cleanly cut hole. Bad ebonite, on the other hand, shows a hole with radial cracks and grossly jagged edges, whilst ebonite of fair quality shows the hole drilled in it to be a reasonably clean cut one, although some of the sides may have crumbled during the drilling. A hole drilled in an ebonite panel of the latter quality is shown at Fig. 2. This hole is just sufficiently large enough to admit a small terminal.

Examining Paraffin Wax.

Paraffin wax is an insulating material of some importance to the radio manufacturer, although its importance at the present day is less than in former times. Now, to the naked eye, one lump of paraffin wax seems pretty much the same as another lump. And yet the two samples may be of entirely different qualities. Owing to the fact that paraffin and similar waxes are produced by high temperature distillations, there is always a chance of them becoming contaminated with overheated and charred impurities. Nevertheless, these impurities, being buried in the mass of the wax, can seldom be detected except by microscopical means.

Thus, in order to control the purity of the wax, the manufacturer submits regular

(Continued on next page.)

THE MICROSCOPE IN RADIO.

(Continued from previous page.)

batches of the product to microscopical examination. Any amateur possessing a microscope of reasonable power can imitate this test. Take a small flat piece of glass and smear it with a thin layer of the paraffin wax to be tested. Gently warm it over a non-luminous flame until the wax is quite

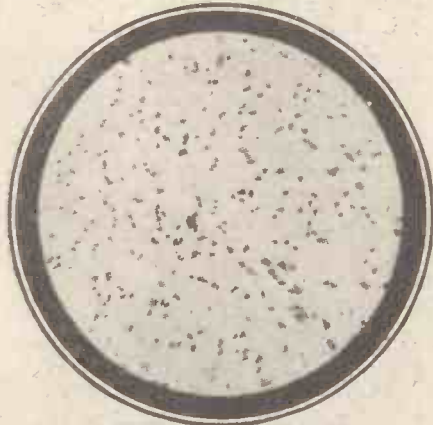

Fig. 4.—Impurities in shellac show up plainly under microscopic examination.

molten and "runs" freely. Now place the glass on a perfectly level surface, and wait for the molten wax to solidify. Placed under the microscope, such a thin layer of wax, if it is perfectly pure, as it ought to be, will exhibit a curious network of transparent crystals similar to the ones shown at Fig. 3.

Impurities in Shellac.

It should be observed in this connection that under the microscope these crystals are perfectly colourless, and, therefore, if they were photographed by ordinary illumination, a very "flat" picture would result. In order to make the wax crystals stand out from the background, the photomicrograph shown at Fig. 3 has been taken by coloured light of a definite wave-length, and through colour screens. Under these conditions the wax crystals exhibit prismatic colours, and thus a photograph of them is more easily discernible.

Shellac is another common radio commodity which calls for frequent microscopical examination on the part of the manufacturer. Smear a thin layer of perfectly clear shellac varnish on to a microscope slide and examine it whilst it is still wet. If impurities are present in the varnish, the result will be similar to the photomicrograph depicted at Fig. 4, which indicates the microscopical nature of contaminated shellac varnish. Such impurities are chiefly waxy particles, which impart to the material a lower dielectric efficiency, and make its use in conjunction with delicate lacquering work far less successful.

How Shellac is Formed.

Whilst on the subject of shellac, two other photomicrographs will be of interest to the reader. The first of these, shown at Fig. 5, is a highly magnified photograph of the tropical insect responsible for the production of shellac. This insect, invisible

to the naked eye, feeds on the leaves of a certain tropical shrub, and at certain times of the year it grows a sort of shellac tail (shown in Fig. 5). This tail forms itself into a coil, and finally separates from the insect. Such shellac coils will be seen from a glance at the photomicrograph, Fig. 6.

The result of countless millions of these minute insects feeding on the leaves of the shrubs is to cover the foliage with a sticky mass of crude shellac, which is subsequently removed, and submitted to preliminary chemical purifying treatment by the native labour of the district. Thus comes into being the familiar resin so well known by every radio constructor and amateur.

But to revert to our main subject of the microscope in the radio industry. Valve manufacturers often seek the aid of the microscope in determining the degree of accuracy to which their filaments are drawn. Even under the very highest degree of magnification, a properly drawn valve filament will exhibit perfectly parallel sides, similar to that shown in the illustration, Fig. 7. Batches of filament are thus submitted to periodical examination by this means, and any batch showing imperfections is put aside for further treatment, or, in some cases, scrapped altogether.

Studying Valve Filaments.

Microscopical examination is also of great use to the valve manufacturer as a means of showing up the actual physical state of the filament after any given period of burning. As the reader will doubtless be aware, one of the results of the prolonged heating of a valve filament is to cause a series of minute



Fig. 7.—A new valve filament highly magnified.

hollows and irregularities to be formed along the length of the filament, the whole phenomenon being technically known as "pitting." This process of pitting naturally renders the filament very fragile, until eventually the condition becomes so great that the filament in many cases crumbles

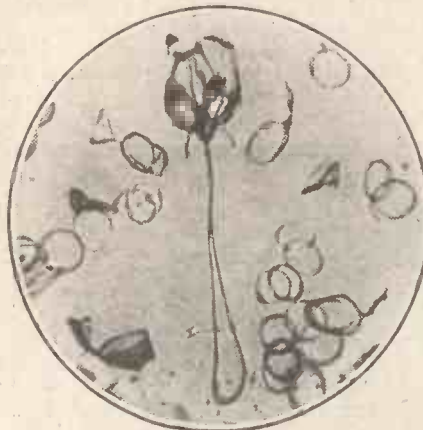

Fig. 5.—A shellac insect at work.

away altogether without in any way being burnt out.

The object of the valve manufacturer is to produce a filament which will resist this tendency to pitting in the greatest degree possible, and it is much to the credit of our

British valve supplying concerns that, in the main, this desirable end has actually been achieved. Fig. 8, however, shows what a pitted valve filament looks like under the microscope. The series of irregularities along the length of the filament will be observed by the reader, and he will also note that, after a protracted period of burning, the filament has lost its capability of being pulled straight without breaking, as in the case of the new filament, Fig. 7.



Fig. 6.—Microscopic coils of shellac as produced by the shellac insect.

The microscope has also been brought into use by the crystal dealer for the purpose of determining the physical nature of impurities existing in crystals, and for attempting to discover the effect which these contaminating particles exert upon the crystal's radio-sensitivity. Research scientists have also endeavoured to seek further knowledge concerning the mechanism of crystal rectification by means of the microscope. But in this direction, however, they have failed. All these researches have brought to light is the fact that almost the smallest microscopic particle from the surface of a sensitive crystal is capable of affording as good reception as that obtained from the crystal in the mass.

A Weapon of Protection.

Nevertheless, despite this fact, the reader will almost certainly agree that the microscope serves quite as useful a purpose in the radio industry generally as it does in any other manufacturing and commercial undertaking.



Fig. 8.—A valve filament after many hours' burning. Note the pitting which has taken place.

The microscope is a powerful weapon of protection to the radio manufacturer in the sense that it enables him to keep a watchful eye upon the efficiency standard of his wares. It is also of much use to the research physicist and chemist alike. And to the average radio enthusiast, it should stand also as an instrument of power, pregnant with the possibilities of further progress.

As before indicated, any amateur possessing a microscope of reasonable power can carry out an interesting series of investigations, although considerable knowledge of general science is essential if such are to be of really practical value.



A READER of *Popular Wireless*, living at Melbourne, Australia, has a one-valve set that reaches out and picks up Rugby every morning. He writes:

(From "*Popular Wireless*," August 7th, 1926.)

"I use home-made coils, and I can tune in Rugby *any morning at all* at 6 a.m. It certainly is great to have the Test scores laid on, and all the official British news, without having to wait for the papers hours afterwards.

"My valve is an Ediswan A.R. '06, and the two 1½ v. dry cells that have already had six months, still survive. The aerial is a standard 100-ft. single wire, of 7-22 enamelled wire."

(Signed) KEITH GELL.

FIT

EDISWAN VALVES

AND NURSE YOUR SET

BROADCAST NOTES.

By O. H. M.

Authors' Fees and Broadcasting—Microphone Publicity—The Controversial Sermon—The B.B.C.'s Responsibility—Broadcast News Changes—"Running Comments"—Radio Revues—Forthcoming Attractions.

IAN HAY (Major Beith) has been complaining bitterly to a mutual friend about the alleged infringement by the B.B.C. of its agreement with the Society of Authors, Playwrights, and Composers.

The present difficulty arises out of the series of short stories and literary extracts being broadcast by authors. Under the agreement, concluded over two years ago, there is an automatic performing right fee paid to the Society on behalf of all its members whose work may be broadcast. The minimum is, I believe, £2 2s. The B.B.C. regarded this as applying to all cases in which literary work was used by them and not to the case in which an author was to read his own work. The Society regards the agreement as comprehensive, and is of opinion that there should be a higher minimum fee when the author broadcasts.

Microphone Publicity.

The B.B.C. advances the old argument about the publicity value of the microphone. One hopes that the dispute will be settled reasonably. If individual authors are ready to broadcast their own work for nothing, I see no reason why they should not be permitted to do so. On the other hand, it is clearly open to the Society to try to establish the right of all authors to claim a microphone fee.

The sermon broadcast from St. Martin-in-the-Fields on Sunday, August 8th, nearly precipitated a religious controversy analogous to that of the famous Monkeyville Case in Dayton, Tennessee.

The Rev. H. R. L. Sheppard was prevented by illness from taking the service, and it was necessary to replace him. Canon Mathews of Thanet stepped into the breach. His sermon has been the subject of angry controversy, which may still develop into a nation-wide affair. I listened to it, and am bound to say I regarded it as one of the best sermons I had ever heard.

Nevertheless, it aroused the susceptibilities of many people of all denominations. The bone of contention was in the statement that the Bible, and particularly the Old Testament, was written in accordance with the conditions and needs of times, and should be adapted to modern requirements.

The Controversial Sermon.

Canon Mathews said that if St. Paul were alive to-day he would undoubtedly revise a good deal of his writings to conform to the character of present day conditions. All of which seemed to me not only eminently reasonable, but also obviously true. Yet thousands of people are sorely pained, and regard such a statement as denying the inspiration of the Scriptures.

The B.B.C. has nothing to be ashamed of in broadcasting commonsense religion. My only criticism of their conduct in the

present controversy is their early tendency to shirk the blame by saying that Outside Broadcasts, such as services at St. Martin's, are not subject to the usual censorship.

This was very weak and silly, and I was glad to see it contradicted. The B.B.C. is absolutely responsible for every word that is broadcast under the British system. If these sermons are not "vetoed" then either the B.B.C. accepts full responsibility, or is guilty of a dereliction of duty.

The arrangements for broadcast news services next year are now under preliminary consideration. The negotiations are likely to be protracted. The broadcasters want extended facilities all round

NEXT WEEK.

How to Make The "P.W." Ultra Selective One-Valver

A receiver incorporating an Ultra coil in an Ultra-Audion circuit, and providing wonderful degrees of selectivity and sensitivity.

ORDER YOUR COPY NOW.

and the Press interests are for applying more restrictions than exist at present.

My information is that the Press would like to see one general news bulletin a day instead of two, and they would like to cut out the early one now given at seven. They would extend the second bulletin by a third, but wish to be paid for it on the same terms as apply at present.

Broadcast News Changes.

The B.B.C., on the other hand, will ask for a suspension of the ban on news before seven o'clock, and the right to put out bulletins every few hours during the day. They are agreeable, however, to more generous payment.

The B.B.C. are also asking to be allowed to give running accounts of big sporting events like the Derby. These are prohibited under the current agreement. The gulf between the parties is therefore so considerable that I anticipate several months of talking before the new agreement will be signed.

If I might hazard a guess at the compromise that will be reached ultimately, I would say that after January 1st next, the "no news before seven" rule will remain in force; but the B.B.C. will have the right to give running comments on all the big sporting events.

The news bulletins will be considerably developed, and the broadcasting authority will pay more for the services rendered by the Agencies. The responsibility for the contents of the bulletins will move from the Agencies to the Broadcasting Corporation.

The Radio Follies Concert Party, on September 11th, promises to be a first-class show.

The problem of Revues is again engaging the attention of Savoy Hill. It has been felt for some time that the Revues so far produced have barely justified the considerable expense involved. For the future there will be less of this kind of programme, and greater care taken in its development. A special effort is to be made to secure outside engagements for Sydney Firman's Band.

October 4th is the 700th anniversary of St. Francis of Assisi. There will be a special commemorative broadcast programme on Sunday, October 3rd.

Pot-pourris of operas are being prepared by the musical people at Savoy Hill, and should soon be welcome additions to the programmes. This is an excellent idea. The majority of listeners will not sit through an opera but they are glad to have extracts.

There has been a great improvement in the topical talks lately. This is due primarily to the efforts of Mr. L. de Giberne Sieveking, and Mr. Geoffrey St. G. Strutt, who form the indefatigable team pulling the news and topicality section of the programme department.

Forthcoming Attractions.

Mr. Sieveking was a distinguished air pilot in the War. Since the War he has devoted himself to literature, his latest work, "The Ultimate Island," having achieved notable success. Mr. Strutt also has had a successful and varied career. He was prominent in the War, and took up Conservative politics afterwards with characteristic energy. Tiring of this, he had a spell at big business in the City. He then reorganised the League of Nations Union and put it on a permanent basis. The B.B.C. is exceedingly well-advised to recruit new staff of the type of these two. By the way, Mr. Sieveking is going to broadcast portions of his book "The Ultimate Island" shortly from Daventry.

Mr. Harold Brooke and his famous choir will sing from London in a special concert on December 8th.

On August 30th, the B.B.C. is broadcasting from Manchester Station a special version of "The Greater Glory," a First National Picture. This should be an interesting experiment. By the way, I am glad to learn that it is definitely an experiment, and that it is only from Manchester. If anything comes of the idea, and it is developed on a big scale, it should be a British Film Company that should benefit.

The right use for the American Film company is to let them carry out the trial, as in this case. Anyway, there is not likely to be much develop from the experiment. The difference between the ethics of broadcasting and those of the film is too great to make any considerable co-operation possible.

ADDING HF VALVES

THERE is no doubt that adding a valve in front of a detector presents a greater problem than adding an L.F. amplifier, as the latter is simply connected to the 'phone terminals on the set, the 'phones themselves being transferred to the plate circuit (the output) of the amplifier.

To add an amplifier of the H.F. type to a set consisting of a detector or detector and L.F. valves it is necessary to make some

* * * * *

A Practical Article for the Constructor.
By G. V. COLLE.
(Technical Staff.)

* * * * *

spective terminals on the set; the + H.T. lead from the H.F. valve can be connected to a separate H.T. wander plug, but if this is not desired it should be joined to the H.T. terminal on the detector panel.

coupled to the aerial coil (secondary) on the set. It is essential that the aerial condenser be in parallel with the coil, and that the coil (which will be a 35 or 50) be changed for one of 75 turns.

It is also necessary to use the same L.T. battery for both the H.F. amplifier and the set, otherwise the - L.T. lead on the set will have to be joined to the earth terminal on the amplifier. The aerial and earth leads are, of course, transferred from the set to the amplifier.

Two Simple Methods.

Now, it will become apparent to the reader that unless his coil holder is of the "three-way" type, that is, unless it has two moving coil holders and one fixed, he will experience some difficulty in coupling the primary coil to the "secondary" coil. Probably his coil holder is of the "two-way" type, the fixed coil holder being the

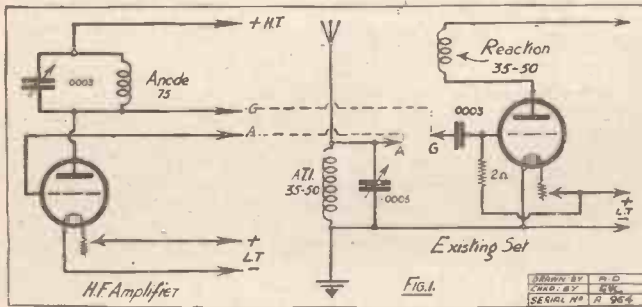

slight alterations to the circuit of the latter, as shown in Fig. 1.

The H.F. amplifier in this case consists of the orthodox circuit, using a tuned anode coil. As will be seen, the leads marked "A" and "G" are connected to corresponding points on the set, which, in the usual way, are joined together. To add the amplifier it is therefore necessary to break the wire "AG" between the aerial coil and the grid condenser, the latter unit being connected to the plate circuit of the H.F. valve, and the aerial coil (and aerial condenser) to the grid of the H.F. valve. All battery leads are taken to their re-

It is well to point out that when an H.F. amplifier is added, as in Fig. 1, the grid leak must not be connected across the grid condenser, but should be joined between the grid of the detector valve and + L.T.

If an H.F. transformer is employed, it can be either joined to + L.T. or across the grid condenser. The reason the grid leak cannot be connected across the grid condenser when the H.F. valve has a tuned anode coil is that the H.T. would leak through the grid leak to the grid of the valve, thus upsetting its operation.

Some readers may now ask, "How can I add an H.F. valve without disturbing the wiring of the set?"

An effective method is shown in Fig. 3. Here it will be seen that the aerial coil on the set is utilised as a secondary coil, so that in effect the H.F. valve is coupled to the set by means of a loose-coupled H.F. transformer.

The primary of the H.F. transformer consists of a 35 or 50 turn coil tightly

Fig. 2 illustrates the arrangement of an H.F. amplifier that is transformer coupled. Its connections to the set are, however, identical with Fig. 1.

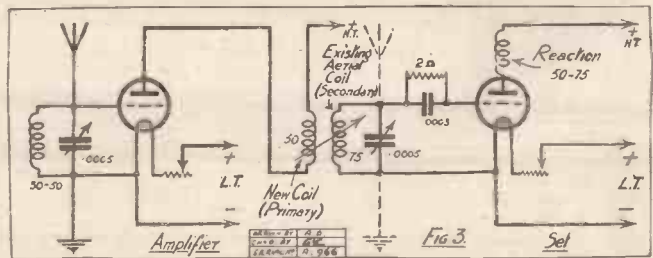

aerial coil and the moving the reaction coil.

If his coil arrangement happens to consist of primary, secondary and reaction, he will have no difficulty in the matter. All

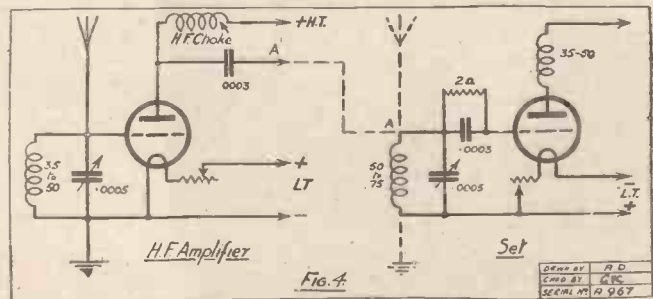
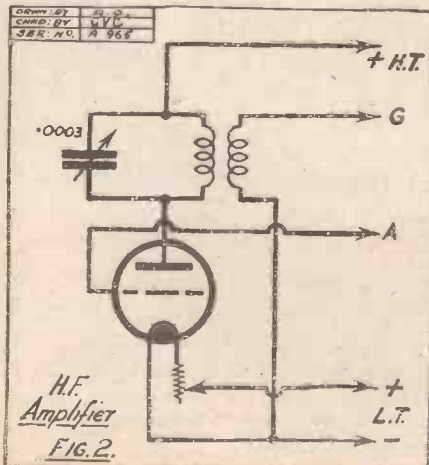

that he needs to do is to disconnect his aerial and earth leads from the set and connect them to the aerial and earth terminals on the H.F. amplifier. The plate of the H.F. valve is then joined to the aerial terminal on the set, and the + H.T.

(Continued on next page.)

ADDING H.F. VALVES.

(Continued from previous page.)

plug to the earth terminal on the set. Care should be taken in seeing that the secondary coil is not "earthed."

The reader who possesses the two-way type of coil holder has the choice of three arrangements, two of which entail the use of extra components, and the third the use of a new circuit.

In the first case he can fit a panel-mounting single coil holder in to couple closely to the fixed coil holder on the "two-way"

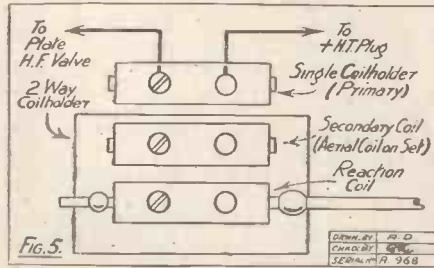

tuner, or arrange some means of supporting the primary coil against the "secondary" (the aerial coil on the set). Both systems are equally as good in operation, though the former method is more or less a fixture, and the latter a quick but "rough and ready" arrangement. Both methods are shown in Figs. 5 and 6 respectively.

The "Tuned Grid" Principle.

The method shown in Fig 5 is suitable for all types of plug-in coils, but only coils having a hollow space in their centres can be arranged as shown in Fig. 6. Such coils as Igranic and Tangent, which have the same internal diameters throughout for the complete sets of coils, are ideal for the purpose.

Referring to the third arrangement mentioned, Fig. 4 shows a method whereby an H.F. valve can be added to a set which incorporates only a two-way coil holder, but which does not require an arrangement as shown in Fig. 5 and 6.

This system works on the "tuned grid" principle, the aerial coil on the set acting as the grid coil, with an H.F. choke in the plate circuit of the H.F. valve.

It will be found, however, that this arrangement works best when the aerial ("tuned grid") coil on the set is connected to + L.T. instead of - L.T.

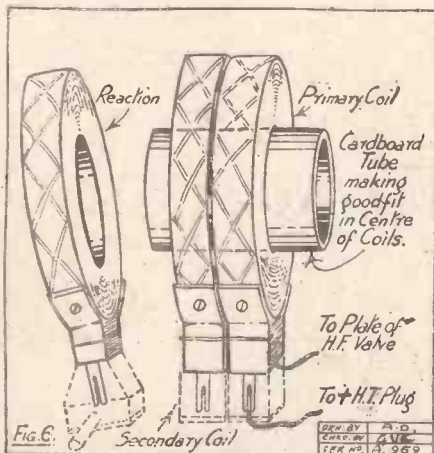

However, if - L.T. is joined to the "tuned grid" coil, it will not matter, providing the grid leak is connected to the + L.T. lead and not across the grid condenser.

The H.F. choke used in the plate circuit of the H.F. valve can be a "Lissen," or failing that, a plug-in honeycomb coil of 750 to 1,000 turns.

Such an arrangement is capable of giving excellent results, and as the reaction coil is coupled to the "tuned grid" coil, it re-radiates but little, thus avoiding interference with neighbouring receivers.

It is assumed in all the systems mentioned that the H.F. valve is to be added to sets that do not already include such amplifiers, but only to those consisting of detector or detector and L.F. valves.

When adding H.F. valves to sets which incorporate one stage of H.F. amplification, it becomes necessary to provide some means of stabilising the arrangement, otherwise howling and general instability results.

The constructor has then to do one of three things, namely, either provide a potentiometer to control both H.F., neutrodyne the first H.F. stage, or arrange the two H.F. valves on a proper panel with suitable couplings and stabilising devices.

INCREASING TUNING RANGE.

A VERY simple means of increasing the tuning range of any given coil is to use a fixed condenser, outside the set, either in series with the aerial or in parallel with the tuning inductance.

If a condenser of .0002 mfd. is used in series with the aerial, it will be possible to tune down to stations which could not otherwise be reached without a change of coil. At the same time, the selectivity of the set will be considerably improved (particularly if no H.F. stage is used), and it will be found possible to cut out interference from a near-by station more easily than otherwise. Signal strength will not be affected to any appreciable extent, but, on the other hand, it may be found that the set will oscillate more easily and will respond better to the use of reaction.

A Parallel Arrangement.

If the condenser is attached to the set in parallel with the tuning condenser, the coil may be tuned to higher wave-lengths than would otherwise be possible. Selectivity and signal strength will not be affected.

The fixed condenser may, if desired, be incorporated in the set, one additional terminal only being required on the panel.

The use of a supplementary fixed condenser in this way is of particular advantage in sets where the coils are specially wound and are not readily interchangeable. Further, by using a fixed condenser in parallel with the variable condenser, a small variable condenser, such as one of .0003 mfd., may be made to cover the same range as one of .0005 mfd., but with the advantage that the wave-lengths will not be crowded into a single half-turn of the condenser dial.

OPERATING A FRAME AERIAL.

By G. MARCUS.

NOW that the super-heterodyne receiver has become so popular amongst wireless enthusiasts, it is very probable that more attention will be given to the frame aerial. Comparatively few experimenters have given the frame a fair trial; a few words on the subject of operating a loop aerial to the best advantage would doubtless be welcome to amateurs who have just become owners of super-heterodyne sets.

Directional Effects.

In the first place it must be carefully borne in mind that the loop aerial is highly directional and signals will only come in at maximum strength while the frame is turned towards the desired station. Consequently the frame must be mounted in such a way that it can be easily turned round.

Secondly the frame must make the most of the very small energy it is able to pick up. This energy must not be wasted on account of dead-end effects or self-capacity. No switch should be used and the turns should be properly spaced.

As regards the size of the frame aerial, a compromise will have to be made between efficiency and convenience. A box-shaped frame with sides 18 inches long should be entirely satisfactory. If made at home, this frame must be wound with 16 turns of No. 20 D.C.C. wire; the cotton insulation should be green, for the sake of neatness. Properly varnished and polished, quite an attractive instrument can be made at a very small cost.

An Important Point.

The reader must remember to keep the frame well away from the walls of the room. Very often he will find that better results are obtained in one part of a house than in another.

A good compass and a map of the British Isles and the Continent are very useful when searching for distant stations. The proper direction of the frame for any particular station may be easily found with the aid of the compass and map.

The owner should keep a log of the angles of the frame for different transmissions as well as the settings of the tuning dials.

An Economical D.X. Receiver

Next week we are publishing full constructional details of

The "P.W." Ultra-Selective One Valver

A set which will undoubtedly attract considerable attention in view of its sensitivity and selectivity.

Order Your Copy Now



With a Craftsman's Pride in his Work...

THE men and women who make the **Brown** are almost as enthusiastic as we, its sponsors. This pride of work, a principle which each of the many hundred workers engaged at North Acton share, is reflected in the finished product—the famous **Brown Loud Speakers and Headphones** known the world over as faithful interpreters of every phase of the Broadcast.

Examine a **Brown Loud Speaker** at your local wireless shop. Note the superior workmanship; you'll find not even the faintest suggestion of a flaw. In its exquisite finish and extreme beauty of outline the **Brown** is unrivalled. But only when you hear it will you appreciate the outstanding success of this, the first wireless Loud Speaker.

Brown Loud Speakers are made in the following types: H.1, 120 ohms, £5 5 0; 2,000 ohms, £5 8 0; 4,000 ohms, £5 10 0. H.2, 120 ohms, £2 5 0; 2,000 ohms, £2 8 0; 4,000 ohms, £2 10 0. H.3, 2,000 ohms, £3 0 0. H.4, 2,000 ohms, £1 10 0. H.Q., 2,000 or 4,000 ohms, £6 0 0. Type Q., 120, 2,000 or 4,000 ohms, £15 15 0. Cabinet Type, 2,000 or 4,000 ohms, £8 6 0. and Crystavox £6 0 0. There is also a range of **Brown Headphones**, they are priced from 20/- to 60/-. Ask your Dealer.

S. G. BROWN, Ltd., Western Avenue,
North Acton, London, W.3.

Retail Showrooms: 19, Mortimer Street, W.1; 15, Moorfields, Liverpool; 67, High Street, Southampton. *Wholesale Depots:* 2, Landsdown Place West, Bath. Cross House, Westgate Road, Newcastle. 120, Wellington Street, Glasgow. 3-7, Godwin Street, Bradford. N. Ireland Agent: Robert Garmany, Union Chambers, 1, Union Street, Belfast.

Brown

G.A. 5699.



One of the most interesting features of the great Radio Exhibition, which opens at Olympia on September the 4th, will be, without doubt, the reproduction of the 2 L O Studio. During the run of the Exhibition broadcasting will be done by the B.B.C. from this studio, so that you may actually see your favourite artistes before the microphone.

For the first time in the history of British Radio it has been possible to arrange an exhibition that will be *complete*. No British manufacturer of standing but will be represented, so that within the New Hall, Olympia, will be found everything that is worth while in Radio.

All lovers of wireless should set aside at least one day for a visit. Each exhibit will have something of interest for them—something new, distinctive or novel. The great strike demonstrated the fact quite plainly that wireless—simplified as it is—is still the eighth wonder of the world. You cannot afford to be absent from its first really complete manifestation.

THE NATIONAL

RADIO EXHIBITION

NEW HALL
OLYMPIA

10.30. A.M. TO 10. P.M.
ADMISSION
INCLUSIVE 1/6

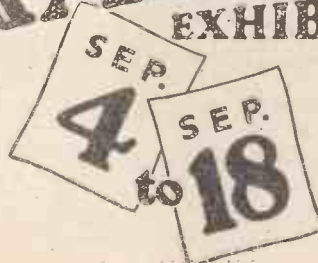

RADIO TUTORIAL

All Editorial Communications to be addressed to The Editor, POPULAR WIRELESS, The Fleetway House, Farringdon Street, London, E.C.4.

Editor:
NORMAN EDWARDS, M.Inst.R.E., F.R.S.A.,
F.R.G.S.

Technical Editor:
G. V. DOWDING, Grad.I.E.E.

Assistant Technical Editors:
K. D. ROGERS. P. R. BIRD.

Scientific Adviser:
Sir OLIVER LODGE, F.R.S.

Staff Consultants:
Dr. J. H. T. ROBERTS, F.Inst.P.; J. F.
CORRIGAN, M.Sc., A.I.O.; G. E. FIELD, B.Sc.;
E. J. SIMMONDS, M.I.R.E., F.R.S.A.

Foreign Correspondents:
F. M. DELANO, Paris; Dr. ALFRED
GRADENWITZ, Berlin; L. W. CORBETT,
New York; P. F. MARTIN, Italy; W.
PEETERS, Holland.

The Editor will be pleased to consider articles and photographs dealing with all subjects appertaining to wireless work. The Editor cannot accept responsibility for manuscripts and photos. Every care will be taken to return MSS. not accepted for publication. A stamped and addressed envelope must be sent with every article. All inquiries concerning advertising rates etc., to be addressed to the Sole Agents, Messrs. John H. Lile, Ltd., 4, Ludgate Circus, London, E.C.4. As much of the information given in the columns of this paper concerns the most recent developments in the Radio world, some of the arrangements and specialities described may be the subject of Letters Patent, and the amateur and the trader would be well advised to obtain permission of the patentees to use the patents before doing so.

Readers' letters dealing with patent questions, if sent to the Editor, will be forwarded to our own patent advisers, where every facility and help will be afforded to readers. The envelope should be clearly marked "Patent Advice."

Questions and Answers

TUNING-IN DISTANT STATIONS.

"Novice" (Bedfordshire).—I have purchased a 2-valve set, which, I am told, consists of an H.F. and a detector valve.

Having no friends interested in wireless in the immediate neighbourhood I cannot obtain any information as regards tuning the set, which appears to be working O.K., but on which I cannot receive distant stations, although I receive whistles (which I take to be their carrier waves).

Can you inform me how I can receive distant stations?

I know my aerial and earth are all right as I have had a crystal set working well from 5 X Y on them.

You are evidently receiving the carrier waves but do not know how to resolve them.

On a set of your description there are usually two variable condensers, a 2-way coil holder, an isolated coil holder, and two filament rheostats.

Assuming you know the correct coils to plug-in and that everything is connected up correctly, you proceed as follows: First turn on the filament rheostats. If the valves take 4 volts and a 4-volt accumu-

TECHNICAL QUERIES.

Letters should be addressed to: Technical Query Dept., "Popular Wireless," The Fleetway House, Farringdon Street, London, E.C.4.

They should be written on one side of the paper only, and MUST be accompanied by a stamped addressed envelope.

Queries should be asked in the form of the numbered questions: (1), (2), (3), etc., but may be accompanied by a short letter giving any necessary additional particulars as briefly as possible.

For every question asked a fee of 6d. should be enclosed. A copy of the numbered questions should be kept, so that the replies may be given under the numbers. (It is not possible to reproduce the question in the answer.)

BLUE PRINTS. A series of 20 Blue Prints can be obtained from the Query Dept., price 6d. per Blue Print.

Only a limited number of circuits are covered by this series, and full details of the circuit arrangements available in Blue-Print form are published fortnightly in the advertisement columns of this journal.

All other back-of-panel diagrams are specially drawn up to suit the requirements of individual readers at the following rates: Crystal Sets, 6d.; One-Valve Sets, 6d. One-Valve and Crystal (Reflex), 1s. Two-Valve and Crystal (Reflex), 1s. Two-Valve Sets, 1s. Three-Valve Sets, 1s. Three-Valve and Crystal (Reflex), 1s. 6d. Four-Valve Sets, 1s. 6d. Multi-Valve Sets (straight circuits), 1s. 6d. Except SUPER-HETERODYNE DIAGRAMS, all of which, irrespective of number of Valves used, are 2s. 6d.

If a panel lay-out or list of point-to-point connections is required, an additional fee of 1s. must be enclosed.

Wiring diagrams of commercial apparatus, such as sets of any particular manufacture, etc., cannot be supplied. (Such particulars can only be obtained from the makers.)

Readers may submit their own diagrams, etc., for correction or for criticism. The fee is 1s. per diagram, and these should be large, and as clear as possible.

No questions can be answered by phone. Remittances should be in the form of Postal Orders.

lator is used they should be turned right "on," so that all resistance is out of circuit. Should you, however, be using a 6-volt accumulator, the rheostats must only be turned on about two-thirds of the way round, otherwise the filaments of the valves will be over-run.

Having adjusted the filaments the reaction coil should then be moved towards the coil to which it is coupled.

Usually the reaction coil is coupled to the aerial coil, but on some sets it is coupled to the anode coil.

The important thing to remember, however, is that whatever coils are coupled together, they should never be so close together that the set howls, as this causes interference to nearby sets.

A good method of adjusting the reaction coil is to bring it gradually nearer the anode or aerial coil and while doing so keep on tapping the aerial terminal with a wetted finger.

While a series of clicks will be heard, even when the reaction coil is at 90 degrees with the anode or aerial coil, these will be suddenly intensified on bringing the reaction coil closer.

In practice, it will be found satisfactory if the set starts oscillating when the reaction coil is brought up to within approximately 45 degrees of the coil it is coupled to, although if it oscillates (heard by the intensified click) when the reaction coil is farther away, a smaller reaction coil should be used, and the same process repeated.

Having got the set almost oscillating, the reaction coil is left in this position. The two variable condenser dials are then rotated *simultaneously*, both starting at about the same number of degrees.

It is always a good plan to start at 90 degrees on each dial, as then you can tune down so many metres, and also (by rotating the condenser toward 180 degrees) tune up an equivalent number.

If the set gets away from the oscillation-point when the condensers are set at 140 degrees or more, then the reaction coil can be brought slightly closer to the other coil.

When the carrier wave of the transmitting station is heard the condensers are rotated until it is at its maximum volume, and the reaction coupling is loosened as far as possible.

Should, however, speech or music be distorted, the reaction should be "loosened" further by moving it away from the other coil. Signal strength will then decrease slightly, but it will be found that the distortion has disappeared.

It is always advisable to incorporate vernier adjustments on the variable condensers, as without their use weak signals are sometimes passed by, while they give a certain amount of selectivity and often rid distant stations of interference.

(NOTE.—This reply has been reprinted at the request of many readers.)

"2 B A."

"IGNORAMUS" (Coalville, Leics.).—What do the letters mean in the expressions "2 B A" and "16 SW G" etc., which are so often quoted in constructional articles?

The initials BA stand for British Association, and SW G means Standard Wire Gauge. The necessity for standardising screws and screwed fittings was early recognised by the British Association and the standard drawn up by them is known as the BA standard, and has been very widely adopted.

POSITION OF SET.

"CRYSTOL" (Fordingbridge, Hants.)—I have arranged my aerial so that it comes

For the Constructor

No. 5.—Cutting Out an H.F. Valve.

How to insert a single-pole double-throw switch for cutting out an H.F. valve (tuned anode) is shown above.

The existing lead from plate to grid condenser is broken, and the grid end is joined to the centre of the switch. Two new leads are then necessary, as shown by the heavy black lines.

One connects the lower switch contact to the grid of the preceding valve, and the other joins the top contact to the plate of that valve.

through a bedroom window and leads are taken downstairs for reception. Does it matter if the set is upstairs, using long telephone leads, or would a long lead-in with set downstairs be more efficient?

Generally, the set should be placed as near the ground as possible, but where the lead-in has to pass through several walls it is sometimes better to have the set upstairs and use long telephone leads instead.

No rule holds good for all circumstances, so both positions should be tried.

ADDING GRID BIAS AND SEPARATE H.T.

H. G. (Stoke-on-Trent).—I have constructed your Det., L.F. 2-valve set, described in POPULAR WIRELESS No. 195, February 20th, 1926 (and published in Blue Print form, "P.W." 6d. Blue Print No. 11) It is giving good results, and I should like to add separate H.T. supply to the last valve and grid-bias, but do not know how. Could you show me through the medium of "P.W." or by post?

Both alterations are easily made, and, if desired, a diagram of the altered connections can be obtained from the Query Dept., under the rules appearing at the head of this section.

Separate H.T. is obtained by disconnecting 'phones from H.T. +, and providing the 'phone terminal with a separate flexible lead and red plug, for H.T. + (2).

Grid bias can be inserted by breaking the O.S. to L.T. neg. lead, and inserting the grid bias battery at this point. Grid bias positive should be joined to the L.T. negative lead, and the O.S. lead should then be plugged in at about 1½ volts.

2-VOLT USERS

2-VOLT VALVES *with a* 6-VOLT RESULT

Osram D.E.2

The wonderful new 2-volt valves with a 6-volt result. Current consumption only 0.12 amps. Cannot be over-run from a 2-volt accumulator.

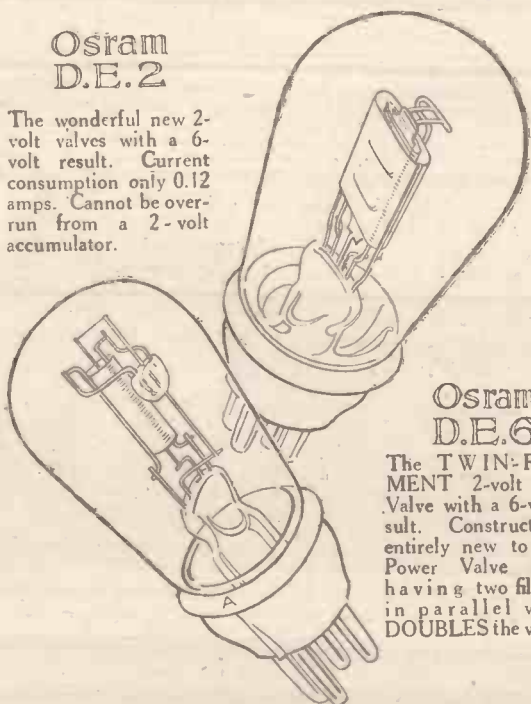

Osram D.E.6

The TWIN-FILAMENT 2-volt Power Valve with a 6-volt result. Construction is entirely new to 2-volt Power Valve design, having two filaments in parallel which DOUBLES the volume.

Severe practical tests have proved that it is possible to get the same volume and tone from the new 2-volt D.E.2 OSRAM VALVES as from many valves requiring 4 or 6-volt accumulators. The use of D.E.2 OSRAM VALVES means that accumulator expenses are halved or reduced by one-third for the same, if not better results. Use an OSRAM D.E.6 in the last stage.

Osram Valves

for Broadcasting

The S.E.C. - your guarantee



Traders and manufacturers are invited to submit wireless sets and components to the "P.W." Technical Dept. for test. All tests are carried out with strict impartiality in the "P.W." Test room under the supervision of the Technical Editor, and the general reader is asked to note that this weekly article is also intended to provide a reliable and unbiased guide as to what to buy and what to avoid.—EDITOR.

A CARBORUNDUM DETECTOR.

IT is rather curious that the carborundum crystal detector is not more widely used for broadcast reception, for it is quite sensitive and is more stable than any other known type. A typical contact is a small plate of steel pressing down on the crystal with some considerable force; "cat's whisker tickling" plays no part in carborundum detector practice. Carborundum was the first substance ever used for rectifying wireless signals, and was found to be the only crystal sufficiently stable to retain its sensitivity during the artillery activities of the Army and Navy in the Great War.

However, a carborundum detector generally needs a small dry battery and a potentiometer to bring it, by means of applied potential, to a sensitive condition. This complication, no doubt, militates against its popularity. But only a very small battery is required, as it is potential,

not current, that is mainly needed, and quite tiny cells will last for months, even if made to give long periods of service in the above capacity.

Messrs. The Carborundum Co., Ltd., of Trafford Park, Manchester, have produced a carborundum detector of modern design. It is of the permanent type, and must have far more real permanency than many other so-called permanent detectors. Without a battery and potentiometer, it is not particularly sensitive, but it is, of course, exceptionally stable and capable of carrying large inputs. Also, on account of its high resistance, it has a very slight damping effect on the tuning circuit across which it is connected. It should therefore prove very useful in multi-valve crystal circuits.

The above concern also produces a complete unit containing a detector (permanent), potentiometer, and clips for a small Everready dry cell. The whole

unit can be mounted on a panel by means of the popular one-hole fixing method. It occupies but little space, and only the potentiometer control is visible when it is so arranged. The unit gave very good results on test and, although we do not consider it has the sensitivity of the synthetic galena type of detector, its wonderful stability and robustness should obtain it considerable popularity. The potentiometer is of very high resistance, although it would seem to us advisable to remove the battery when not in use. A switch might have been incorporated in the unit with advantage.

Personally, we would prefer a carborundum detector to most others in a valve-crystal circuit, and now that a suitable carborundum unit is available it is possible that more attention will be paid to a form of "hook-up" that, once having enjoyed considerable popularity, is at the moment being left some way behind.

HARLIE ANTI-MICROPHONIC VALVE HOLDER.

Messrs. Harlie Bros., of 36, Wilton Road, Dalston, London, E.8, recently sent us one of their new model anti-microphonic valve holders for examination and test. It is a well designed little component, and is provided with plainly marked insulated safety sockets. The suspension is by means of specially shaped flat metal springs, while the insulating material upon which the sockets are mounted, is well cut away to reduce capacity losses. Two holes are arranged in projections in the base to facilitate baseboard mounting. Tested under

(Continued on page 896.)

The *NEW*
BURNDEPT
SUPER VALVES for 1926-27

incorporate the biggest advance ever effected in a season's research and improvement. These new valves definitely supersede many other valves made to-day and will be the talk of the Exhibition.

*** BETTER VALVES—REDUCED PRICES ***

The new discoveries by our Research Department give longer life, higher efficiency, still further improved reproduction and shock-proof filaments. Burndept valves are now more than ever essential for best possible results. They are a revelation.

For 2-volt Accumulators		For 4-volt Accumulators		For 6-volt Accumulators	
H.L. 213	H.L. 310	H.L. 425	L.L. 525	L. 525	H.L. 512
Dull Emitter Impedance 23,000 ohms.	Dull Emitter Impedance 20,000 ohms.	Dull Emitter Impedance 10,000 ohms.	Super Power Valve Impedance 3,000 ohms	Power Valve Impedance 6,500 ohms.	Dull Emitter Impedance 10,000 ohms.
Consumption 0.13 amps.	Consumption 0.1 amps.	Consumption 0.25 amps.	Consumption 0.25 amps.	Consumption 0.25 amps.	Consumption 0.12 amps.
14/-	14/-	14/-	22/6	18/6	18/6

Note: H L = General Purpose. H = H.F. L = Power. L L = Super Power.

Publication No. 293 contains particulars and characteristics of the complete range of Burndept Super Valves.

OLYMPIA STANDS
140, 141, 142
& 209 Gallery



Head Office & Factory: Blackheath, London, S.E.3.
Phone: Lee Green 2100. Telegrams: Burnacoll Phone London.
London Offices & Showrooms: Bedford St., Strand, W.C.2.
Phone: Gerrard 9072. Telegrams: Burndept Westrand London.
Agents & Branches everywhere.

Agents and Branches Everywhere



The Cleartron 'Di-Kast' Condenser fitted with Micro Station Selector Dial (precision movement) 10/6 extra.

THE DI-KAST CONDENSER

Both rotor and stator are die-cast in one piece. This means positive connexion, perfectly matched characteristics, and overcomes the contact resistance losses inseparable from all other assembled condensers. Specially designed vanes provide straight line reading, greater range, easy shortwave tuning and very low minimum capacity.

The Micro Station Selector—a newly designed dial precision movement—is so completely free from play or back-lash that more than ten different adjustments are possible between each degree.

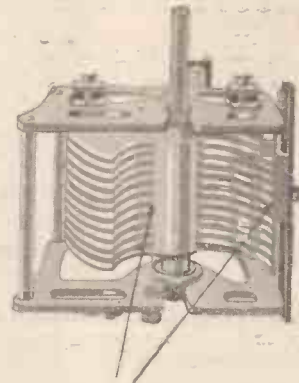

The famous Cleartron 'Di-Kast' Condenser from which, as both Rotor and Stator are die-cast in one piece, hitherto unattainable results are obtained.

and of course
CLEARTRON VALVES
 —the new 1926-7 models with NEW filaments, INCREASED electronic emission, HIGHER vacuum and LONGER life. At standard prices everywhere.

'0002, '0003, '0005 10/6

CLEARTRON RADIO LIMITED

ONE CHARING CROSS, LONDON, S.W.1.
 Telephone: Regent 2231-2.

(Works: Birmingham.)
 Telegrams: "Cleartron, Westrand, London."

See us at Stands 135, 102 and 46



National Radio Exhibition

CT/56

"BEST WAY"

PORTABLE SETS



A Useful Guide for the Wireless Constructor.

6^d.

Details of the three splendid sets described in this "Best Way" Wireless Guide are given below. The book is amply illustrated with photographs and diagrams, and constructors will find the wiring directions most lucid and straightforward.

ALL STATION LOUDSPEAKER PORTABLE

A remarkably compact six-valve SUPER-HET. Aerial batteries and loudspeaker all completely enclosed and permanently connected.

THREE VALVE PORTABLE

Several stations on the loudspeaker and many on Telephone receivers can be obtained. A frame aerial is built into the lid of its neat carrying case.

BABY PORTABLE

A two-valve receiver in a very small attaché case. Batteries and telephones are enclosed and wire and earth pin for temporary aerial are provided.

Why not do the same?

These two letters (originals of which can be seen at our offices) amply justify the claims we make for the Ormsby 4-valve selective Long Range Receiver.

Upper Holloway, N.19.

Dear Sirs,—I have made up one of your 4-valve sets from your model, and thought it my duty to drop a line and thank you for the pleasure the set is giving me. I have constructed a great number of sets during the last three years, but never had results to equal this set of yours, which is wonderful. Stations come in at nearly every degree of the condenser and at loud speaker strength. I am using one of your Reaction Units, which makes tuning as simple as A B C, etc., etc.

C. A. P.

Hford, Essex.

Dear Sirs,—I am writing expressing my appreciation of the Ormsby Selective 4-valve Receiver. I find the following features of outstanding merit:

1. Simplicity of circuit.
2. Simplicity of construction.
3. Ease with which tuning is effected.
4. Selectivity.
5. Complete absence of body capacity.
6. Power combined with good tone.

Finally, the set does what is wanted of it without variation.

H. S. P.

Why not get our Cardboard Model and do the same as these users do? Construction is simplicity itself. You cannot fail to successfully build your set from it. Price with full instructions (plus postage 5d.) 3/-

ORMSBY & Co., Ltd.,

ORMSBY WORKS,
 LOWER RICHMOND ROAD, RICHMOND

Showrooms: 10, New Oxford Street, W.C.1

Do not fail to visit our STAND No. 35 at the National Radio Exhibition.

APPARATUS TESTED.

(Continued from page 894.)

adverse conditions it fulfilled its purpose with a marked degree of efficiency.

THE B.P. PERMANENT DETECTOR.

This crystal detector is a speciality of Messrs. Partridges, Ltd., of 128-138, Northwood Street, Birmingham, who recently sent us samples for test. In appearance it is somewhat similar to many other makes, being not unlike a small neodyne condenser with an adjusting knob with which to obtain fresh settings when required. But it has, nevertheless, one or two very distinctive features. For instance, the knob is so constructed that when it is turned without being pulled out the spindle does not revolve and damage the crystals. Again, if released accidentally the spindle does not snap back but, by the action of an ingenious friction fitment, requires to be pushed into position gently, this action also providing a means of obtaining just the right pressure needed for a condition of optimum sensitivity with each fresh setting. The "B.P." detector can be mounted by means of clips and screws which are supplied, in a single hole drilled on a panel, or between clips on an existing set.

It is an excellently designed little component, and gave excellent results on test. It is sensitive, and yet of sufficiently high resistance to give satisfaction in a reflex receiver. And it is stable, too, and should

give good service over lengthy periods without requiring re-adjustment. The price of the "B.P." detector is 3s. 6d.

THE "LITTLE GIANT" PERMANENT DETECTOR.

This component, which is also due to Messrs. Partridges, is the smallest article of its kind we have ever seen, although as one of our juniors humorously exclaimed, "It is rather large for a collar stud!" Nevertheless, it is remarkably efficient in operation. Similarly to the "B.P." its larger brother, it is of what we should prefer to call the semi-permanent type. A tiny little plunger fitting enables fresh "spots" to be discovered when the one in use becomes insensitive. It is provided with small clips for mounting purposes and a drilling template to facilitate the fixing of these is supplied. Circuit connections are taken from the screws holding the clips in position.

On test, as previously indicated, the "Little Giant" gave very satisfactory results. It proved to be both sensitive and stable in crystal circuits, and well able to handle large inputs imposed upon it in a valve-crystal combination. It is very well made and the crystal enthusiast will discover this midget rectifier very good value for money at 2s.

4 - ELECTRODE VALVES



We are the suppliers of the genuine U.C. and Thorpe valves, as specially tested and recommended by the "Undyne" inventors and "Popular Wireless" U.C.5 and Thorpe K.4 (both 4-electrode 5-pin valves), each, post free..... **10/6**

Order direct from—

LUDGATE RADIO CO.,
56, LUDGATE HILL, LONDON, E.C.4

Knock!!!

Let the postman bring you that Radio Bargain you want!

It is sure to be among the thousand listed in our large revised Catalogue. Send 4d. stamps and then order your bargain by post.

You are perfectly safe in dealing with

ELECTRADIX RADIOS,

218, Upper Thames St., London, E.C.4

ACTIVE AGENTS WANTED (either sex) to sell Private Christmas Cards. Up-to-date designs. Latest Novelties. Best Paying Spare Time Agency Ever Offered. Free Book. Highest com. Valuable prizes. Apply Firth Graham Co. (Dept. F112) Accrington.



STERLING RECEIVERS. SENSATIONAL OFFER.

Having purchased a large number of Sterling 2-Valve Loud Speaker Sets we are offering them to the public on Unprecedented Terms. A Genuine Sterling 2-Valve Loud Speaker Set complete ready for immediate use with D.E. '06 Valves, H.T. and L.T. Accumulator, Aerial Equipment, and one of our World Famed De Luxe Excellence Loud Speakers. Price £15.15.0. Royalties paid. Terms 15/-

Deposit and 15 Monthly Payments of 20/-. Send for one of these superb Sets at once as the number for sale is limited and when sold cannot be repeated under double the price. Free Catalogue on application. **THE WIRELESS DISTRIBUTING CO., LTD.,** (Dept. O.W.), WIRELESS HOUSE, STOKE NEWINGTON, N.16.

SCRAP H.T. BATTERIES!

THE EKCO H.T. UNIT
(PATENTS APPLIED FOR)

Derives H.T. from the mains (D.C. and A.C.) by just attaching adaptor to Electric light lampholder.

SAFE! SILENT! SOUND!

STAND No. 9
NATIONAL RADIO EXHIBITION
OLYMPIA
SEPT. 4th, 1926.
E. K. COLE
(Dept. A) 513, LONDON ROAD,
WESTCLIFF-ON-SEA.

SIZE 6" X 6" X 3 1/2"

SIZE 12" X 6" X 7"

TELSEN
L.F. TRANSFORMERS

Radio's Choice

British Made

The L.F. TRANSFORMERS that give maximum volume without distortion.

Other types—
Standard Open - - - 14/-
TELSEN "ACE" - - - 9/6

All models in ratios 5-1, 3-1, and
Guaranteed for 12 months.

TELSEN ELECTRIC CO.,
207, Aston Road, Birmingham

Shrouded Popular **15/6**

TESTED RADIO APPARATUS

Bowyer-Lowe

STAND 126,
OLYMPIA. SEPT. 4 to 18.

The complete range of Bowyer-Lowe Guaranteed Components are here for your inspection. We are so confident of their careful production and accuracy that each one carries a definite guarantee for twelve months. Let us demonstrate their quality and efficiency.

Those who are unable to visit Olympia may obtain a copy of the Bowyer-Lowe Radio News by sending 1½d. in stamps to Radio Works, Letchworth. This issue, in addition to giving particulars of the latest components, contains two constructional articles of special interest. A single valve portable receiver weighing, complete with batteries and telephones, 10 lbs., and also a four valve receiver

ANNOUNCEMENT BY THE BOWYER-LOWE CO. LTD. LETCHWORTH HERTS

Cosmos

WIRELESS VALVES

VISIT
STAND No. 162

RADIO EXHIBITION
OLYMPIA,
SEPT. 4th to 18th.

Two New Shortpath Valves are now available of the 6-volt class; they have the same remarkable characteristics that the public have so much appreciated in the S.P.18 2-volt class.

"COSMOS" S.P.55/R (RED SPOT) 18/6
The 6-volt Loud Speaker Valve Supreme. It will handle a very large output, while owing to its exceptionally low impedance it eliminates the imperfection and resonances of the loud speaker. The connoisseur's valve for perfect reproduction.
Extract from the "Sunday Chronicle," August 8th:
"I have discovered whilst designing, assembling and testing a new Reflex set for the forthcoming edition of the Wireless Guide, that there was one valve which gave about double the volume of any other."

"COSMOS" S.P.55/B (BLUE SPOT) 18/6
A 6-volt shortpath valve which gives enormous amplification and is specially designed for H.T. tuned anode, detector, and resistance capacity coupling amplification. Its unique features are:
1. Very high amplification factor of 33, which in conjunction with its low impedance, gives more amplification than any other receiving valve known.
2. Designed to operate on 60-120 volt H.T. in the H.F. and detector stage—this eliminates the need for two H.T. supplies.
3. It consumes only 0.09 amps. filament current.

OTHER COSMOS VALVES INCLUDE:

D.E. 55. 18/6. A	D.E. 11. 14/- A	A. 45. 8/- A
6-volt General Purpose valve.	1.1-volt Dull Emitter valve.	4.5-volt Bright Emitter valve.

"COSMOS" S.P.18/G (GREEN SPOT) 14/-
A 2-volt valve which gives much more amplification than any other 2-volt valve (except the S.P. 18 Blue Spot) owing to its high amplification factor (15) and low impedance. It is for use in the H.F. detector and L.F. stages, and should be followed by an S.P. 18 Red Spot.

Ask for copy of folder 4117/3

"COSMOS" S.P.18/R (RED SPOT) 14/-
A real 2-volt power valve, suitable for supplying a powerful loud speaker without distortion. Equal to an average 6-volt power valve. Consumes only 0.3 amps.

"COSMOS" S.P.18/B (BLUE SPOT) 14/-
This valve, which has an amplification factor of 35 and a mutual conductance of 500 micromhos, gives much other amplification than any other 2-volt valve. It is specially designed to operate off 80/120 volt H.T., thus eliminating the need for two H.T. supplies when 120 volts is required on the last valve. Especially for use with resistance capacity coupling (when it gives as much amplification as ordinary valves with transformer coupling). H.F. tuned anode and detector. When 80/120 volts is not available a Green Spot valve should be used. Filament current 0.09 amps.

The following table shows which types of Cosmos Valves are suitable for use in the different positions or stages in various circuits.
(1) When a H.T. Voltage up to 60 or 80 Volts is available.
(2) When a H.T. Voltage up to 120 Volts is available.

The combination recommended for best results in each case is indicated by heavy type.

	L.T. Battery: H.T. Battery:	Recommended Valves.			
		2 Volts.		6 Volts.	
		20-80 V.	80-120 V.	20-60 V.	60-120 V.
H.F. Amplifier	Tuned Anode (stabilised by neutrodyne or otherwise)	S.P.18/G	S.P.18/B	D.E.55*	S.P.55/B
	Tuned Anode (non-stabilised)	S.P.18/G	—	D.E.55*	—
	Transformer tight-coupled (stabilised)	S.P.18/G	—	D.E.55*	S.P.55/B
	Transformer tight-coupled (non-stabilised)	S.P.18/G	—	D.E.55*	—
	Transformer loose-coupled	S.P.18/R	—	S.P.55R	—
Resistance-coupling (for long waves above 2,000 metres)	S.P.18/G	S.P.18/B	—	S.P.55/B	
	S.P.18/R	S.P.18/R	S.P.55R	S.P.55/R	
Dual or Reflex Stage	Loose H.F. Coupling	S.P.18/R	S.P.18/R	—	D.E.55
	Tight H.F. Coupling	S.P.18/R	S.P.18/R	—	—
Detector (Grid-Leak)	Resistance Coupling	—	S.P.18/B	—	S.P.55/B
	L.F. Transformer or Choke Couplings	S.P.18/G	S.P.18/B	D.E.55*	S.P.55/B
Detector (Anode Bend)	Resistance Coupling	—	S.P.18/B	—	S.P.55/B
	L.F. Transformer or Choke Couplings	S.P.18/G	S.P.18/B	—	S.P.55/B
L.F. Stages (except last)	Resistance Coupling	S.P.18/G	S.P.18/B	—	S.P.55/B
	Choke Coupling	S.P.18/G	S.P.18/G	D.E.55*	S.P.55/B
	L.F. Transformer Coupling	S.P.18/G	S.P.18/G or S.P.18/R	S.P.55/R	S.P.55/R or D.E.55*
Last Stage Loud Speaker	All Couplings	S.P.18/R	S.P.18/R	S.P.55/R	S.P.55/R

*NOTE.—Type A.45 (Bright Filament) may be used wherever type D.E. 55 (dull emitter) is recommended, their characteristics being similar. Type D.E.11 is a 1-volt General Purpose Valve, and is suitable for most of the purposes mentioned in the above table.

METRO-VICK SUPPLIES, LIMITED
(Proprietors: Metropolitan Vickers Electrical Co., Ltd.)
Metro-Vick House, 145, Charing Cross Road, London, W.C.2



It will pay you to see this exhibit!

Valve sockets and springs locked together by a mechanical process, making a definite and permanent connection. Bakelite mouldings, nickel silver springs and phosphor bronze valve sockets nickel plated.

2/6 With terminals
2/3 Without terminals

Visit Stand No. 84 at the National Radio Exhibition—see the "Lotus" Valve Holders and learn just how and why they excel in absorbing shock, protecting the valves and eliminating all microphonic noises.

Rigorous tests at the factory ensure that "Lotus" Valve Holders will give entire satisfaction under any conditions. That is why you should insist on them for your set.

LOTUS
BUOYANCY
VALVE HOLDER
ANTI-MICROPHONIC

Made by the makers of the famous Lotus Vernier Coil Holder.

GARNETT, WHITELEY & CO., LTD.,
Lotus Works, Broadgreen Road, Liverpool.

CORRESPONDENCE.

Letters from readers discussing interesting and topical wireless events or recording unusual experiences are always welcomed, but it must be clearly understood that the publication of such does in no way indicate that we associate ourselves with the views expressed by our correspondents, and we cannot accept any responsibility for information given.—Editor.

COIL WINDING.

The Editor, POPULAR WIRELESS.
Dear Sir.—Ament the letter re Coil Winding in your issue of the 24th ult., below are particulars of some tests made with a view to ascertaining the effect of decreasing the number of turns, yet using the same wire. In the case of each re-wound coil the winding was done round an article of the diameter given, the coil, resembling a large ring, being slipped off and tied with twine. Signals in all instances seemed quite as good as usual, and ordinary sized reaction coils were used. I have never received Birmingham better. This may interest, and shows that the number of turns in a coil can be varied much more than the number of feet.

Perhaps someone with a prominent bump of curiosity will now see how few turns will get 5 X X 1

Coil.	Length in feet.	Turns.	Diameter.	Condenser reading.
Straight Wound	20	23	3 1/2"	0005
		12	6 1/2"	2 L O
3 in. Basket	32	48	2 1/2"	50
		19	6 1/2"	130
Straight Wound	92	103	3 1/2"	B'ham.
		54	6 1/2"	25

Yours truly,
C. W. GROVES.

17, Albany Road,
Leighton Buzzard.

AN INTERESTING CIRCUIT.

The Editor, POPULAR WIRELESS.
Dear Sir.—The enclosed circuit diagram may be of interest to your readers. I do not know whether same has already been submitted, but in any case it would appear to be worthy of consideration, on account of the rather extraordinary volume obtainable from a single valve so arranged.

I find that a loud speaker can be operated quite comfortably from an indoor aerial, within four miles

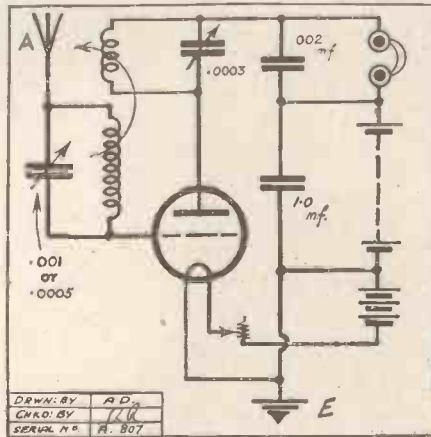

of a main B.B.C. station, while the loud-speaker results with a good outdoor aerial are really excellent at a similar distance.

The potentiometer is not essential, as the aerial circuit can be coupled direct to the filament-positive. The condenser C.2. is rather critical, so that a vernier is necessary in order to get the utmost from the circuit.

The plate voltage should be considerably higher than that usually employed for a detector valve, and with most types of valve I find 80-90 volts to be preferable.

Yours faithfully,
GEO. R. INSHAM.

5, Maxwell Terrace,
Pollokshields, Glasgow.

A NEW RADIAX COMPONENT
Highly efficient in use and economical in price,
THE "HERALD" L.F. TRANSFORMER



A screened model of our well-known open type "Herald." With earth terminal and nickel finish. Ideal for modern circuits and compact arrangement. We guarantee power and purity equal to any more expensive transformer and will refund cash if not entirely satisfied and goods returned within 10 days. Ratios 3-1 and 5-1. Price 12/6.

RADIAX LOW LOSS COILS

give you improved tuning volume and selectivity.
No. 25-1/8 No. 75-2/- No. 200-4/3
" 35-1/8 " 100 2/6 " 250-4/8
" 50-1/9 " 150-2/9 " 300-5/3
See Radiax Goods, Stand 32, Olympia Wireless Exhibition.



RADIAX DX COILS

increase selectivity 100% Give an auto-coupled tuning circuit without altering your set. You will cut out the local, or separate two difficult stations to an extent undreamed of. Five terminals make it a Universal coil. Free chart given with each purchase, showing the many circuits in which this coil can be used—Auto-coupled, Neutrodyne, etc. No. 35-4/8 No. 50-5/- No. 75-5/6 No. 150-7/6 Set of 4-21/- Post. extra.

RADIAX H.T. ACCUMULATORS

Give a perfect H.T. Supply for many months with one charge. Improve reception wonderfully. 10 VOLT UNIT . . . 6/-
60 VOLT BATTERY 45/-

RADIAX LTD.
10, Accessory House, Palmer Place, Holloway, London, N.7



ZINCS FOR WET H.T. BATTERIES.
The perfect H.T. supply. Build your own battery. Use our zincs with special connectors. NO SOLDERING. 1/- doz. Post extra. Trade supplied. COLE & VINCENT, 147, Barclay Rd., Walthamstow, E.17.

PICKETTS CABINETS
: For every Wireless Constructor :
Send for Cabinet Designs and Lists Free
CABINET WORKS, BEXLEY HEATH (nr. London)

Valves Repaired
AS GOOD AS NEW!!
HALF LIST PRICE
(Except Weeco, S.P.'s, and low capacity types). Minimum D.E. Current 0.15 amps when repaired. ALL BRIGHT & DULL EMITTERS Listed at less than 10/-. Minimum charge . . . 5/-
VALGO LED, Dept. P.W., Tabor Grove Wimbledon, S.W.

REPAIRS SETS, PHONES, TRANSFORMERS
Officially Approved by Radio Association.
ALL WORK GUARANTEED LOWEST RATES 24 HOUR SERVICE
Cash on Delivery if Desired.
JOHN W. MILLER, 68, Farringdon St., E.C.4.
Phone: Central 1950.

WET H.T. BATTERIES
British made round or square Leclanché Glass Jars, 2 1/2 x 1 1/2 x 1 1/2, for wet H.T. Units. Waxed, 1/3 doz., plain, 1/- doz. Carriage and packing extra. Phones and Loud Speakers reconditioned, 4/6 & 5/-.
The H.R.P. Co., 1, Cottrill Road, nr. Hackney Downs Station, E.8.

HEADPHONES REPAIRED
Re-wound & remagnetised 5/- per pair. Loud Speakers repaired 5/-. Transformers re-wound 5/- each. All work guaranteed and tested before delivery.
Write for Trade Prices. Phone: Clerk. 1795.
MASON & CO., 44, East Road, City Road, N.1.

ACCUMULATORS ON EASY PAYMENTS
60-volt High-Tension Accumulator complete in varnished case, built up in 20-volt sections. Tapping arranged every 10 volts, 45/- CASH, or 12/6 DOWN and 6 monthly payments of 6/-. Carriage Paid. Satisfaction or money back. Write for Lists to DEPT. 11.
COVENTRY DIRECT SUPPLIES Ltd., Coventry.
Any Wireless Goods supplied on easy payments.

It is
**Perfectly
Natural**

that you should prefer

**Player's
Navy Cut
Cigarettes.**

(Medium Strength)

because the Virginia leaf
is

10

for

6d.

50 for 2/5

Naturally

Perfect

20

for

11 $\frac{1}{2}$ d.

100 for 4/8

Plain or Tipped with Cork of Pure Natural Growth

Issued by The Imperial Tobacco Company (of Great Britain and Ireland), Limited.

P1367

Stand 84. Olympia Radio Exhibition

The name 'LOTUS' is your guarantee of sound results and solid satisfaction

The 'LOTUS' JACK

Designed to take up the least space, the depth back of panel being 1 1/4 in. Made from best Bakelite mouldings, with nickel silver springs and pure silver contacts. One-hole fixing. Soldering contacts can be brought into any position.

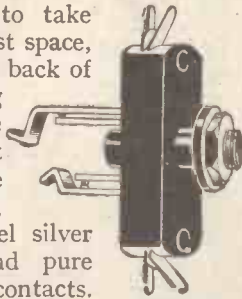

Prices
No. 3, as illustrated 2/6
others from 2/- to 3/-

The 'LOTUS' JACK SWITCHES

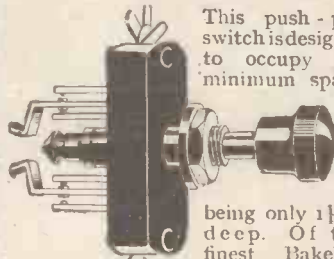

This push-pull switch is designed to occupy the minimum space,

being only 1 1/2 in. deep. Of the finest Bakelite, it has nickel silver springs and contacts of pure silver. Soldering contacts can be made to suit any wiring.

Prices
No. 9, as illustrated 4/-
others from 2/9

The 'LOTUS' JACK PLUG



Designed for use with Lotus Jacks. Made from best Bakelite mouldings and nickel plated brass. To fix, the wires are placed in slots and gripped in position by a turn of the screw cams.

Price 2/-

Made by the makers of the famed 'LOTUS' Vernier Coil Holders and 'LOTUS' Buoyancy Valve Holders
Garnett, Whiteley & Co., Ltd.,
LOTUS Works
Broadgreen Road, Liverpool

TECHNICAL NOTES.

(Continued from page 878.)

It may be mentioned, whilst referring to this subject, that although in general a high value of the H.T. voltage is necessary, or at any rate desirable, with resistance coupling, this may not be so necessary with special valves—that is to say, with valves specially designed for this type of coupling. In the case of choke coupling, since a well-designed and well-constructed choke will have little resistance, there is little drop of the H.T. voltage in the choke. Personally, I much prefer, where possible, to use choke-coupling rather than resistance-coupling.

Battery Eliminators.

In connection with the matter of choke-coupling, it is important that the components be adapted to amplify the lower frequencies, and for this the chokes must have a high inductance value and the coupling condensers a sufficiently large capacity. Values up to 100 henries are desirable for the choke and perhaps up to a quarter of a microfarad for the condensers. If the choke be of insufficient inductance value it may be shunted by a small fixed condenser, but this is a poor expedient compared with the use of the proper value of the choke.

Since the advent of the battery "eliminator" I often receive queries as to whether this device will function successfully with this, that, and the other type of circuit—questions, I may say, which are most difficult to answer satisfactorily, since so much depends upon the type of eliminator, the electric supply, the construction of the set, and other factors of which I am not informed by my well-meaning correspondents.

Current From The Mains.

In particular, I have often been asked whether the system referred to will work with a super heterodyne set. The best answer to this is that I have myself operated super hets. with the electric supply obtained in this way, and I have known others do the same equally successfully. Of course, there is a tendency to regard the super het., since it employs a frame aerial, as a self-contained or portable set, and the use of electric supply direct from the mains at once destroys its feature of portability. On the other hand, there is no reason why a super het. should be regarded as a portable set. Why not regard it as a long-range set without the portability? And there is a very good reason why it should, if possible, be operated from the mains, since its H.T. current consumption is usually pretty high, although the L.T. consumption has been brought down by the use of the '06 type of dull emitter.

Experiment Worth Carrying Out.

In sets which I have worked in this way I have been able practically entirely to eliminate traces of the mains hum. Any reader who operates a super het. and is at all doubtful as to whether he can work it from the mains, should set to work to experiment. Once it is successfully adjusted in this way it constitutes a wonderful receiver, since its greatest drawback—its high current consumption—is finally removed.



The precision of the finest Valve

in a wire wound Anode Resistance

To make valves for every purpose, valves that hold the laurels in any of their respective fields, is no small achievement, and now the experience that is the basis of that achievement has produced the new Mullard Wire Wound Resistance.

In this resistance every particle of mechanical shock is taken up by a strong fibre core of textile material, and a system of interlaying and covering with the same material eliminates all self capacity.

To add to this there is a perfect dispersion of heat, as the resistance, differing from others is not filled with wax.



WIRE Wound ANODE RESISTANCE (100,000 ohms) - - 5/-
Complete with holder - 6/6

Mullard Grid Leaks and Condensers.
Type Grid B 0.5 to 5.0 mfd. - - 2/6
Type Grid B combined with '0003 mfd Condenser Type MA - - 5/-
Type MA Condenser '0001 to '0009 mfd. - - - - - 2/6
Type MB Condenser '001 to '01 mfd. 3/-

Leads: P.W. free on application.

Advt. The Mullard Wireless Service Co., Ltd., Mullard House, Denmark St., London. W.C.2



For Certainty

Six terminals that ensure perfect amplification in every circuit and with every valve. Six terminals that mean a choice of seven ratios and three impedance values. These six terminals are found on the R.I. Multi Ratio Transformer, the transformer that makes set construction so simple.

No matter what circuit or valve you are using the R.I. Multi Ratio Transformer will give maximum amplification and purity of reproduction every time. It is not necessary to be satisfied with one ratio! Try the effect of the others, another impedance value may be more suitable.

It is the only transformer you can use with the assurance that the results will please you, because it is the only transformer that is adaptable to all circumstances.

Users will gladly confirm this.

Price 27/6

Write for the new R.I. Catalogue.

Visit Stand 45 and 47 at the Radio Exhibition.



Judge a valve by its filament

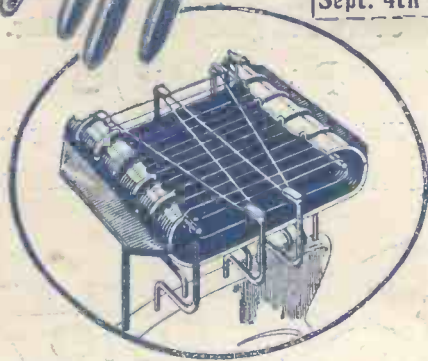

VISIT
STANDS
136 & 138
OLYMPIA
Sept. 4th - 18th

If you have
ever been disappointed by a valve that has expired with premature old age
or been cheated by the weakening results due to lost emission from a valve
or cursed by a valve's insatiable appetite for current that made your accumulator recharging an incessant annoyance,

You will agree
that when it comes to purchasing radio valves all the anodes, grids and features in the world cannot alter the trenchant fact that

It is the filament that counts
Whether you have learnt by sad experience or not you will eventually make a point of finding out all about the filament of a valve before you buy it.

Look at the P.M. Filament

Its core of a special rare metal is so thick and tough that it can be tied in knots after 1,000 hours' life and its length is up to 3 times greater than any other filament on the market. This greatly increased length is set around 5 strong resilient hooks by an ingenious device that completely eliminates all tension and possibility of displacement, thereby ensuring consistent characteristics throughout its life.

Its emission as a result of these larger dimensions and the multi-layers of high emitting alloy of precious metals, is up to 5½ times greater than that of any ordinary filament, and this emission continues for a proportionally increased life.

The operating temperature is so low that no sign of glow can be discerned and the current consumption being only one-tenth ampere, your accumulator charges will last seven times as long. In other words, you will reduce your accumulator recharging journeys and costs to one-seventh.

The P.M. filament is completely within the field of the grid and anode, and is so tough and well designed that it cannot be broken except by the very roughest handling.

You can be sure that the manufacturers of a masterpiece like the P.M. filament will supply it with fitting grid and anode of equally masterly design. The sectional illustration will tell you all their best features.

You will only find the P.M. Filament in P.M. Valves.

NEW REDUCED PRICES

For 4-volt accumulator or 3 dry cells
THE P.M.3. (General Purpose)

0.1 amp. 14/-
THE P.M.4 (Power) 0.1 amp. 18/6

For 6-volt accumulator or 4 dry cells
THE P.M.5 (General Purpose)

0.1 amp. 18/6
THE P.M.6 (Power) 0.1 amp. 18/6

For 2-volt accumulator

THE P.M.1 H.F. 0.1 amp. 14/-

THE P.M.1 L.F. 0.1 amp. 14/-

THE P.M.2 (Power) 0.15 amp. 18/6

These prices do not apply in Irish Free State

Mullard

THE MASTER VALVE

ADVT. THE MULLARD WIRELESS SERVICE CO., LTD., MULLARD HOUSE, DENMARK STREET, LONDON, W.C.2

Printed and published every Thursday by the Proprietors, The Amalgamated Press (1922), Ltd., The Fleetway House, Farringdon Street, London, E.C.4. Advertisement office, Messrs J. H. Lile, Ltd., 4, Ludgate Circus, London, E.C.4. Registered as a newspaper and for transmission by Canadian Magazine Post. Subscription rates: Inland 17/4 per annum, 8/8 for six months; Abroad, 19/6 per annum, 9/6 for six months. Sole Agents for South Africa: Central News Agency, Ltd.; Sole Agents for Australia and New Zealand: Messrs. Gordon & Gotch, Ltd.; and for Canada: The Imperial Co (Canada), Ltd. Saturday, August 28th, 1926

R/R