

ANOTHER FREE BOOKLET WITH THIS NUMBER.

Popular Wireless

PRICE 3d.

EVERY FRIDAY.

No. 72. Vol. IV.

SCIENTIFIC ADVISER: SIR OLIVER LODGE, F.R.S., D.Sc.

October 13th, 1923.



A complete crystal receiver built on to an ordinary pencil.

FEATURES IN THIS ISSUE.

Notes on the "May" Circuit.
The Bournemouth Station.

The Broadcasting Committee's Report.

Six Simple Reflex Circuits.

Chat About Multi-layer Coils.

General Principles of Amplification.

"The Thermionic Valve."—By Dr. J. A. Fleming, F.R.S.

What
do
you
use
your
filament
control
for



Does it light
your valves,
or does it
help your
tuning?



The **LISSENSTAT** embodies something new in rheostat construction. This new feature is properly protected.

Variation of surface contact is obtained by interposing elastically deformable metal discs so that compression applied brings about a flattening of the metal discs, and a consequent widening of the area of contact, while releasing the pressure allows the metal discs to expand so that there is only a fractional area of contact between each metal disc and the resistor unit. Resistance is finely variable, there is an entire absence of noise, and movement of the whole resistor column is perfectly free. This **FEATURE OF LISSENSTAT CONTROL IS COVERED BY PATENT CLAIMS AND CANNOT BE DUPLICATED.**

FOR LONG DISTANCE WORK LISSENSTAT CONTROL IS ESSENTIAL

— it adds range to a receiver in a way never previously associated with filament control. —

- Use a separate LISSENSTAT for the detector and each H.F. Valve
- One LISSENSTAT will control 3 L.F. stages
- One LISSENSTAT for each power valve
- One LISSENSTAT for each dull emitter

It is easy to fit—length below panel only 2-in.—diameter 3/4-in.—its size makes it go between anything—usual LISSEN ONE HOLE FIXING, of course! **7/6**

CORRECT GRID POTENTIAL.

Continuously variable 1/2 to 6 megohms. Use the LISSEN VARIABLE GRID LEAK. You can select the exact value of leak resistance. In this way the charge that can accumulate on the grid can be closely regulated so that the free negative grid potential is always at the correct value for the best operation of the detector. The LISSEN VARIABLE GRID LEAK gives great sensitivity in some circuits—in others variable grid control is not so important. **POSITIVE STOPS AT MINIMUM AND MAXIMUM RESISTANCE.** Length 3 1/2 in.—pencil thickness—LISSEN ONE HOLE FIXING, OF COURSE! Note the price for a LISSEN part **2/6**



LISSEN VARIABLE ANODE RESISTANCE.

Continuously variable 20,000 to 250,000 ohms. For use in dual, super-regenerative circuits, across the secondary of a transformer, and in any circuit in which a stabilising resistance is required. Outward appearance exactly the same as the Lissen Variable Grid Leak. **POSITIVE STOPS AT MINIMUM AND MAXIMUM RESISTANCE.** Note the price for another LISSEN part. LISSEN ONE HOLE FIXING, OF COURSE .. **2/6**

LISSEN VERNIER ADJUSTER

—adds vernier adjustment to any existing condenser—drill one hole close enough to bevelled edge of usual condenser dial so that depression of adjuster knob engages its rubber friction washer on edge of dial **2/-**

AN EXCELLENT LIGHT TRANSFORMER.

One of the best light transformers made is the LISSEN T 3. May be used for all stages of audio frequency. Actually compares with many expensive transformers because of its skilfully balanced design **16/6**

DELIVER ALL THEIR STORED-UP ENERGY

LISSEN FIXED CONDENSERS

never vary—they never leak—they are absolutely quiet—they do not hum—they deliver all their stored-up energy

.0001 to .0009	2/-
.001 to .003	2/6
.004 to .006	3/-

BUILD YOUR STATION WITH ALL LISSEN PARTS THROUGHOUT

Use also

LISSEN TUNER, 150-4,000 metres, tunes sharply, length 4 inches, diameter 4 inches, 150-4,000 metres **22/6**

LISSEN MICA VARIABLE CONDENSER, straight line wave-length curve, '001, '00025, and '0005 **17/6**

LISSENAGON COILS—TUNE WITHOUT ENERGY LOSS—prices see list.

LISSEN PARTS ARE SOLD EVERYWHERE—SEND DIRECT IF ANY DIFFICULTY

DEALERS—claim your liberal stocking discount. ALL RADIO, MOTOR, ELECTRICAL and HARDWARE FACTORS SELL LISSEN PARTS—-or send direct.

LISSEN LIMITED

8-16, Woodger Road, Goldhawk Road, Shepherd's Bush, London, W.12.

N.B.—Close to Goldhawk Road (Met.) Station, Shepherd's Bush (Central London), or Hammersmith Tube. Buses 11 and 32. Phone: 1072 Hammersmith.

LISSEN PARTS—WELL THOUGHT OUT, THEN WELL MADE.

POPULAR WIRELESS

THE WIRELESS WEEKLY WITH THE LARGEST CIRCULATION.

October 13th, 1923.]

SCIENTIFIC ADVISER, SIR OLIVER LODGE, F.R.S., D.Sc.

[Every Friday.

TOPICAL NOTES AND NEWS.

Super-sensitive Receiver.

THE latest progress in wireless to come to my notice is in the form of an attachment which increases so enormously the sensitiveness of the receiver that by its means 2 L O has been clearly heard in Bombay, 6,000 miles away. The attachment is the invention of Mr. W. Sutherland of the Marconi Company.

* * *

Broadcast Opera.

ON October 14th principals of the British National Opera Company are giving a concert in the studio of 2 Z Y. This concert will be simultaneously broadcast by other stations.

* * *

The Expenditure of B.B.C.

I AM told on good authority that the annual amount received by the B.B.C. from their share of the licences does not exceed one-third of the B.B.C. expenditure.

* * *

Education and Wireless.

M. AUDRA, Director of the Institute Française, is shortly to continue his talks upon languages from 2 L O. I am informed by Uncle Arthur that these talks will be given as often as can be arranged.

* * *

So Simple!

MISS BETTY COMPSON, the famous American screen "star," during a visit to London decided to buy a wireless set. I was asked to accompany Miss Compson and her friend Oscar Sheridan, the well-known screen writer, and was amused at the technical explanations given by the latter. "It is really simple," he said. "The whole apparatus is quite mechanical; you take one of the knobs in one hand and the other in the other, and turn in opposite directions while the 'phones are on your ears, and that's how it's done."

* * *

American Broadcasting.

I HAVE received a letter from Messrs. Burndept, Ltd., stating that their demonstration van at Whitby received telephony from W G Y, using the ultra three H.F. amplifier and one power valve, with a 9 ft. aerial on the roof of the van and the earth connected to the chassis.

* * *

Glasgow Testing!

THE engineering staff of 5 S C is to be congratulated upon the enthusiasm and energy with which they carry out their tests. Several times I have listened-in and marvelled at their light-heartedness in what must be rather dreary technical experiments.

But as humorists they still lack that little something or other which would enable their quips and jests to "come over" without losing their humour. Though

I should be the last to advocate solemnity and monotony in such tests, I think that too much "humour" is likely to give listening amateurs a wrong impression.

* * *

Symphony Concert from 2 L O.

THE symphony concert recently broadcast from 2 L O was very well received. The programme included Saint Saëns' violin concerto in B minor with Miss Daisy Kennedy as soloist, and works by Elgar and Weber. The orchestra was conducted by Mr. Percy Pitt. The transmission of this concert was above reproach.

* * *

Recital by 5 S C's Director.

ON November 2nd an organ recital will be given by Mr. H. A. Carruthers, the Glasgow station director, in Westminster Cathedral. This recital will be

"ARIEL" IN BOURNEMOUTH.
"Ariel" is in Bournemouth this week, and will be staying in that town until the 17th inst. He will be pleased to meet old and new readers of POPULAR WIRELESS, and should they require it, assist them in any way he can if they will apply in the first case by post to "Ariel," care of the Town Hall.

broadcast simultaneously by all stations. Mr. Carruthers will play from 6.30 to 7.45 p.m.

* * *

John Henry.

ANOTHER Radio artiste with a sense of humour has dawned on the Broadcasting horizon within the last few weeks. I refer to John Henry—not without pain, however! Judging by the lugubrious tone of his voice he must have had the misfortune to have been born in Wigan, though rumour has it that Yorkshire had that honour. Still, let that pass. Ever if he talks as though he were the late John Henry, his style of humour is admirably suited for the microphone. I rank him with Norman Long in many respects—and that is saying something, because the latter was born with a pair of 'phones on his head instead of the proverbial silver spoon in his mouth, and in my opinion is the best humorist let loose in the aether since broadcasting began.

* * *

Jeff in a New Role.

UNCLE JEFF makes a good partner for John Henry. I listened to these two the other day singing a duet. True, all that Uncle Jeff had to do was to end up each of John's verses with "Henry John," but when John produced a melodrama he had written and assigned the rôle of heroine to Jeff—well, the latter's

feminine falsetto was really funny, and H. J. seemed quite sincere when he referred to him (I mean her) as "Oh, wrecker of hearts," and "Carissima." I must ask Jeff about this.

* * *

A Jolly Concert.

TO listen to Mr. Maurice Cole playing Saint Saëns' Piano Concerto the other evening was to capture the thrill of an evening at the Queen's Hall Promenade Concerts. Readers who feel suspicious of the "highbrow" may be surprised to hear that this concerto is by no means highbrow; it is not even a "classic," it is just jolly stuff which is admirably adapted for the piano with orchestral accompaniment—and I'm sure very few listeners-in with any ear for music at all can honestly say they did not enjoy the vivacious second and third movements of this difficult but genial concerto.

* * *

Popularity of Concertos.

THE B.B.C. have a wide selection of concertos to choose from if they fancy. I hope they will. Here are one or two which should appeal to a large public: Concerto No. 1 (Liszt); Rhapsody No. 14, for piano and orchestra (Liszt); Concerto by Schumann; Concerto No. 3 (Beethoven); Concerto No. 2 (Rachmaninoff). Of course, if you have not heard these works before, you may not reap the full enjoyment, but I feel pretty confident listeners-in will find them a pleasant change from syncopated Jazz music.

* * *

Candid Opinions.

COMING up in the train the other day it was interesting to listen to the remarks passed on the publication of the Broadcasting Report. The people in my carriage all seemed to approve of the P.M.G.'s interim regulations. Criticism of the actual recommendations made by the Committee were discussed very frankly, very rudely, but very truly!

* * *

New Installation for Clifden.

NEGOTIATIONS have been opened with the Marconi Co., with a view to re-equipping the Clifden wireless station, and it is stated that the prospects of agreement are brighter than they hitherto were. In the event of the re-opening of this station, negotiations with the United States are contemplated as well as with Canada.

* * *

The Imperial Colonial Institute.

I WAS a privileged guest at the dinner given by the Royal Colonial Institute in honour of the Colonial Prime Ministers at which H.R.H. The Duke of Connaught took the chair. I was surprised

(Continued on page 198.)

NOTES AND NEWS.

(Continued from page 197.)

to hear from listeners-in that they heard the speeches distinctly, because in the large dining hall at the Hotel Victoria many of the 600 guests were unable to hear, especially those sitting some distance away from the speakers. Listening-in gains a point in this case.

Finding the Microphone.

I MADE many attempts to find the microphone, but I failed for no other reason than that no one knew where it was except the engineer, whom I did not meet, but I am told that it was behind the chair of H.R.H. The Duke of Connaught.

Wireless and the Colonies.

I ASKED the Rt. Hon. W. F. Massey, Prime Minister of New Zealand, after the dinner, what he thought of wireless as an aid to drawing the British Empire closer. He replied that wireless would, in the near future, assume great importance to the Colonists, especially when longer range sets were made. The Prime Minister for Canada, the Rt. Hon. W. L. Mackenzie King, C.M.G., in response to my questions replied: "Wireless is now playing an important part in the British Empire, and I am of the opinion that as developments are made the British Empire will benefit."

Empire Wireless.

THERE is only one answer to the question on whom lies the blame for the deadlock which has overtaken the scheme for linking up the Empire with a wireless chain. The fault rests with the Post Office, and with no other authority.

It is now thirteen years since the plan was originated. During all these years—surely an unlucky number of them—the officials of St. Martins-le-Grand have had the scheme in their grip, and have played fast and loose with it.

Wireless in Bournemouth.

THE secretary of the Bournemouth Radio and Electrical Society, Mr. A. Reynolds, tells me that he is surprised by the keen interest taken by the residents in the forthcoming opening of the new station. I advise readers in Bournemouth who wish to join the army of amateurs to become members of the above-mentioned society. Particulars can be obtained from Mr. A. Reynolds, Hon. Sec., Town Hall, Bournemouth.

Hardly Appropriate!

ONE of the most popular features of social life in the villages during this winter will undoubtedly be radio concerts, and energetic honorary secretaries are organising wireless clubs in many parts of the Eastern and Southern Counties just now.

Usually the local clergy take an active part, as in the case of a Northern club which arranged a special wireless concert. The

local parson opened the proceedings with a short address, and after concluding with a prayer switched on the set. A voice came through the loud speaker: "Oh, for a Night in Bohemia!" will be sung by Miss James Carew.

Wireless and Trunk Calls.

RECENTLY I had occasion to phone to Liverpool, and during the conversation was interrupted by music. I asked the telephone operator the cause, and was surprised when she curtly replied "Broadcasters." This looks much as if a number of amateurs are employing "telephone earths."

General Broadcasting Transmissions.

Regular transmissions of news and concerts take place daily from the following stations. Full details appear in the daily Press.

LONDON	2 L O	369 metres.
BIRMINGHAM	5 I T	420 "
MANCHESTER	2 Z Y	385 "
NEWCASTLE	5 N O	400 "
GLASGOW	5 S C	415 "
CARDIFF	5 W A	353 "
BERDEEN	2 B D	360 "
BOURNEMOUTH	6 B M	410 "

A comprehensive list of the Continental broadcasting stations appears on another page in this issue.

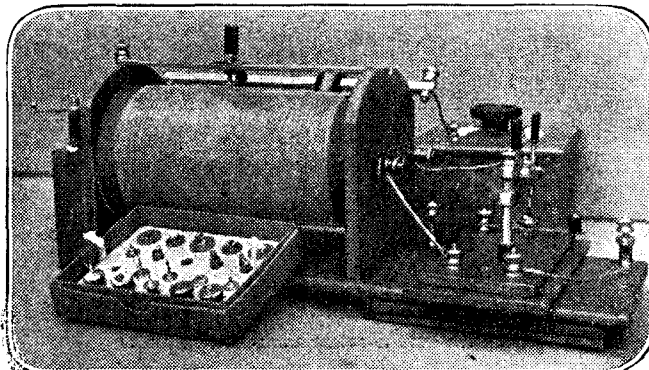

An efficient crystal set constructed by Mr. C. H. Land, 1276, Leeds Rd., Bradford.

Tasmania and Wireless.

TALKING to Mr. A. H. Asholt, the Agent-General for Tasmania, recently, I asked him if he found wireless to be of any particular value to that country.

"Wireless is one of the discoveries which has benefited the greatest Empire in the world," he replied, "but bigger stations are required. I have recently been given to understand that a station is to be built in Tasmania which should be able to communicate with England, but I doubt if you have a station which could reply with any degree of regularity."

63, Kimberley Road, Nunhead, S.E.15.
 Dear Sir,—With reference to your "P.W." Combination Set, allow me to congratulate you and your technical staff on the production of such an excellent combination. I have made a similar set, and am more than pleased and surprised at the excellent results obtained. On the morning of Tuesday, September 25th, I endeavoured to receive some of the American broadcasting, and at 1.20 a.m. succeeded in receiving W G Y, and a little later W F A F. Signals from the latter station were loud and clear. The only item that I listened to from this station was entitled "I heard you go by," and every word could be easily understood without strain. Also Glasgow, Manchester, Birmingham, and Newcastle are quite good on phones, and 2 L O works the loud speaker using the single valve dual circuit alone. I find the circuit quite easy to control and would recommend it to all amateurs.—Wishing success to your paper,
 Yours faithfully,
 J. GRINTER.

Simultaneous Broadcasting.

AT the moment of writing I am sitting in a small corner of my dining-room, while the major portion is occupied by from ten to a dozen enthusiasts who have collected to hear 2 L O broadcast "Rob Roy" frae "Glasgae," as they term it. Undoubtedly simultaneous broadcasting has its uses, and is a wonderful scientific achievement, but I have found a far more useful rôle for it than the mere provision of amusement. I thoroughly believe that if the census takers require to know how many people of a certain nationality there are in any part of the country, they have only to turn to simultaneous broadcasting and the problem is solved.

Gathering of the Clans.

FOR instance, take the performance of which I speak; a good play, well acted, and, above all, free; and I know at once how many gentlemen there are in my village who welcome Sir Walter Scott as one of their own.

This method of census-taking has infinite possibilities, and I can picture quite a different audience gathering round my loud speaker (the only one in the village) upon the occasion of the broadcasting of "Land to My Fathers" or "Come Back to Erin." But if this is to be the inevitable result of the B.B.C.'s latest achievement, I shall give up wireless and buy a gramophone.

Talks from 2 L O.

- MONDAY, OCTOBER 15TH.—7.15, Mr. John Strachey, "Book Talk." 9.15, Captain Richard Twelvetrees on "Motoring."
- TUESDAY, OCTOBER 16TH.—7.15, Mr. C. L. J. Unwin on "Sweet Peas." 9.15, Mr. G. H. Palmer, B.A., Keeper of the Library at the Victoria and Albert Museum, on "The Making of Books, and the Exhibits in Illustration in the Museum."
- WEDNESDAY, OCTOBER 17TH.—7.15, Mr. Archibald Haddon, "Dramatic Criticism." 9.15, Professor A. J. Ireland on "History."
- THURSDAY, OCTOBER 18TH.—7.15, Mr. Percy Scholes, "Musical Criticism." 9.15, Shakespeare recital (no talk).
- FRIDAY, OCTOBER 19TH.—7.15, Mr. G. A. Atkinson, "Cinema Criticism." 9.15, Rev. Father Jackson on "Bureau." Rev. Jackson is blind, and is escorted everywhere by a Burmese boy. He will read his talk from a Braille copy.
- SATURDAY, OCTOBER 20TH.—7.15, Mr. John Merchant, President of the British Esperanto Association, on "Esperanto, the Cure for a Tongue-tied World." 9.15, Colonel C. D. Crisp, O.B.E., director of the Arsenal Football Club, and President of the Middlesex Football Association, and mayor elect of Lewes, on "The Humours of Football."

Forthcoming Simultaneous Transmissions.

- SUNDAY, OCTOBER 14TH.—Organ recital from Steiny Hall. "Hymn of Praise," broadcast from Newcastle, to Birmingham and Glasgow. Dean of Manchester (London).
- MONDAY, OCTOBER 15TH.—Literary talk by John Strachey, B.B., critic, to all stations. Composer evening, conducted by Sir Alexander Mackenzie, to all stations. Savoy "Orpheans" to all stations.
- WEDNESDAY, OCTOBER 17TH.—Dramatic criticism to all stations by Archibald Haddon. Opening of Bournemouth station by his Worship the Mayor of Bournemouth, introduced by Mr. J. C. W. Reith. Speech by Viscount Burnham, introduced by Lord Gainford.
- THURSDAY, OCTOBER 18TH.—Musical criticism by Mr. Percy Scholes, musical critic of the B.B.C. Savoy "Orpheans," to all stations.
- FRIDAY, OCTOBER 19TH.—Film criticism to all stations by film critic of the B.B.C., Mr. G. A. Atkinson.
- SATURDAY, OCTOBER 20TH.—Lt.-Col. Crisp on the Humours of Football—director of the Arsenal Football Club, Mayor-elect of Lewes.

ARIEL.

THE THERMIONIC VALVE.

By Dr. J. A. FLEMING, F.R.S.

In this article the inventor of the thermionic valve discusses the numerous problems that beset the early experimenters in wireless. The various uses of the valve are explained, and the reader is given a clear insight into the theory upon which these uses are based.

IN the history and development of the wonderful instrument called the thermionic valve is to be found a striking example of the important industrial applications that sometimes follow from discoveries which take place in the course of purely scientific researches. In 1883 Edison sealed into the ordinary electric incandescent lamp in use for domestic lighting purposes a metal plate between the legs of its carbon filament. This plate was carried on a wire sealed through the wall of the glass bulb. He noticed that when the filament was made incandescent by the direct current sent through it, simultaneously a small electric current could be observed to be flowing through any delicate current-detecting instrument joined up in a circuit between the positive terminal of the filament and the wire carrying the metal plates; on the other hand, when the same instrument was in a circuit between the negative end of the filament and the plate, there was no sensible current. This phenomenon was called the "Edison Effect," but no explanation of it was given by its discoverer, nor was any practical use made of it at the time.

Scientific investigations on the nature of this "Edison Effect" were undertaken by me, beginning in 1883, and the discovery was soon made that this effect was connected with the projection in straight lines of particles from the filament. Sir William Preece in 1885 communicated to the Royal Society a paper on this effect, and there was another paper by me in 1889, in which last it was shown that these projected particles carried a charge of negative electricity, and could convey negative electricity from the filament to the plate, but not in the opposite direction. A long paper on this subject was sent by the present author in 1896 to the Physical Society of London.

The Marconi System.

A further step in advance was made about 1897 by Sir Joseph Thomson, the present Master of Trinity College, Cambridge, who, whilst carrying out his remarkable researches in the Cavendish Laboratory, found that the chemical atoms of matter, which at the time were thought to be incapable of being divided, were built up of still smaller atoms of electricity, now called *electrons*, and it was soon definitely ascertained that the incandescent filament of the ordinary electric lamp is continuously sending out vast number of these little electrons in all directions.

All these achievements were purely scientific, and attracted no popular attention.

About 1897 the application by Senator Marconi of Hertzian electric waves for the purposes of wireless telegraphy began to create public interest. For detecting these waves he first used his improved form of the coherer of Branly and Sir Oliver Lodge. It was, however, rather capricious and some-

what difficult to manage, and Marconi soon replaced it by his magnetic detector, in 1901.

In Marconi's system of wireless telegraphy, the electric waves are generated by creating powerful vibratory currents of electricity in a wire called an aerial wire stretched up through the air. The electric oscillations in this wire produce in surrounding space an effect called an electric wave, which travels outward with the speed of light—viz., 186,000 miles per second. When these waves cut across another similar wire, called a receiving aerial, they create in it feeble electric vibrations of the same type.

First Applications.

In considering this matter, in researches carried out at University College, London, on wireless telegraphy, in 1904, I saw that if means could be found of converting the very rapid to and fro, or alternating, movements of electricity in the receiving circuits into a uniform motion of electricity in one

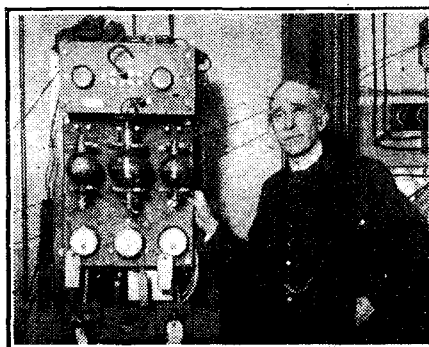

Dr. Fleming in his laboratory at University College, London.

direction, it would then be possible to detect them, and therefore the electric waves, by the use of the telephone or galvanometer as in ordinary telegraphy, without the use of a coherer. The vibrations of electricity in wireless telegraph aeriels are, however, very rapid, even up to a million per second, and none of the devices for "rectifying" or converting slow alternating electric currents into direct currents are of any use. Recalling to mind, however, my scientific investigations on the "Edison Effect," I found, on experiment, that, if a metal cylinder was placed around the filament inside the vacuum bulb of an electric lamp carried on a wire sealed through the bulb, this appliance could "rectify" and therefore detect by the aid of a telephone or galvanometer the feeble high-frequency oscillations of electricity. These cannot directly affect a telephone, because of their rapid reversals of directions thousands of times per second, but the instrument described above acts as a valve when placed in the path of these oscillations, and converts them into motions of electricity in one direction in virtue of the fact

that negative electrons are passing in the vacuum space only from the filament to the surrounding metal cylinder.

I therefore named this appliance an *oscillation valve* and subsequently a *thermionic valve*.

Later, in 1909, I suggested the use of tungsten as the material for the filament in place of carbon, as it withstands a higher temperature and emits more electrons.

The above-described two-electrode or hot and cold electrode thermionic valve was soon extensively adopted as a means of rectifying and detecting electric oscillations and detecting wireless waves.

In the spark system of wireless telegraphy then exclusively used the waves come in little groups of 20 or 30 with longer intervals of time between the groups. The Fleming valve rectifies the groups of oscillations produced in the receiving aerial into short gushes of electricity in one direction, and when these are passed through a telephone they give rise to a more or less musical sound which can be cut up by a key in the transmitter into *dot* and *dash* or short and long sounds making signals in the Morse Code.

Subsequent Improvements.

In 1907 an addition was made to the author's oscillation valve by Dr. Lee de Forest, who had been following in the United States very carefully the work done on this subject. Dr. de Forest introduced into a low vacuum valve a grid or zigzag of wire between the filament and the plate. This started a new line of development, and it was found that, if a cylinder of metal gauze or spiral of wire was introduced into the hard or high vacuum Fleming valve between the cylinder and the filament, it enabled the device to act as an amplifier of oscillations as well as a detector, so that very feeble high-frequency oscillations could be magnified five or ten times by its aid. This suggestion was developed practically by the resources of the Western Electric and General Electric Companies of America.

This modified form then became known as a *three-electrode valve*, and is sometimes called for shortness a triode, or other trade names. To employ it as an amplifier we have to connect a high-tension battery giving, say, 40 to 140 volts with its negative pole joined to the filament and its positive pole to the plate. A torrent of electrons is then forced from the filament, through the holes in the grid or gauze, to the plate. If, however, a feeble electrification is given to the grid positive or negative it increases or decreases this electron current. The grid potential electrification can be obtained from any two points on a circuit in which a feeble high-frequency current flows, and the variation of the plate current of the valve will follow the variations of its grid potential. A number of such valves can be used in series and inter-connected by suitable induction

(Continued on page 200.)

THE THERMIONIC VALVE.

(Continued from page 199.)

coils or transformers, and the plate current variations in one valve made to create changes of grid potential in the next valve.

By a series of such coupled amplifying valves we can then magnify in any required proportion feeble electric oscillations. It is the invention of this detector, comprising a series of amplifying valves, which has given us a detector of electric oscillations so enormously sensitive that wireless signals can be detected by it at the antipodes of the sending station, and has enabled us to signal half round the world by its aid.

As Oscillation Generator.

The thermionic valve in its two and three electrode forms possesses the power not only of rectifying and detecting electric oscillations, but also of creating so-called continuous or undamped oscillations. This discovery at once rendered possible radio-telephony on a large practical scale, whereas it had previously only been an occasional feat of experts. The proper coupling through a transformer of the grid and plate circuits results in the production in these circuits of self-sustained oscillations by energy drawn from the plate circuit.

During and since the war, improvements have continually been made in the construction of large generating valves. Beginning originally with very small powers of a few watts in valves with bulbs like incandescent lamps, very large valves in glass bulbs the size and shape of Rugby footballs, yielding an output of 6 or 7 kilowatts, are now made. Valves of 10-20 kilowatts output or more have been made with bulbs of silica. The most recent advance in this direction has come to us from the United States. A method of making high-power valves with bulbs partly of glass and partly of copper has been developed by the Western Electric Company of America, based on the fact that a copper tube with a sharp edge can be welded to a glass tube.

In large valves a source of trouble is the heating of the metal cylinder by the bombardment of the electrons. In the metal bulb valves the copper part forms also the anode cylinder, and it can be kept cool by immersion in water. Large generating valves of 10-100 kilowatts have been made in this manner, and the General Electric Company of America are said to be preparing a thermionic generating valve of the two-electrode or Fleming type with an output of 1,000 kilowatts or 1,300 horse-power. If this can be done, large thermionic valves will replace high-frequency alternators entirely in long-

distance wireless stations. Already Marconi's Wireless Telegraph Company have a valve panel of 56 large glass valves in their Carnarvon radio station with which communication is made direct to Australia. The present public wireless telephone broadcasting stations in Great Britain employ large valve generators in their transmission plants.

Modern Valve Receivers.

The improvements made in the construction of the thermionic valve, and the close study of its action imposed by the necessity for developing wireless telegraphy and telephony during the great European War, have given us an extraordinarily sensitive and easily managed detector of electric waves, and the advent of wireless telephone broad-

by the hundred thousand per annum for wireless broadcasting purposes. Large factories employing hundreds of workers are devoted to their manufacture.

An additional great service the thermionic valve renders is as a perfect telephone relay or repeater. Telephone electric speech currents are enfeebled by flowing along a telephone wire, and for long-distance working very thick and therefore costly wires were required. Thermionic amplifiers can, however, be inserted in the run of line to re-enforce the currents so that they start on a further journey with fresh strength. By the use of these repeaters, telephonic speech is now transmitted right across the Continent of America (4,000 miles) and they are being now much used by the British Post Office. For shorter distances a great economy in copper can be obtained by their use. It would be feasible to speak from London to Delhi if it were worth while to erect the line and repeater stations. In short, the thermionic valve has effected a revolution in ordinary telephony just as it has made possible wireless telephony.

Recent Advances.

It will be seen, therefore, that out of purely scientific researches and discoveries by Edison, J. J. Thomson, Irving Langmuir, Lee de Forest, the invention of the two-electrode thermionic valve by the author in 1904 and the subsequent development of these discoveries by the expert investigators of great commercial organisations such as The Western Electric, The General Electric, The Marconi Wireless Telegraph, The Osram Lamp and Edison Swan Electric Lamp Companies, an immense industry has been built up, which, starting from very small beginnings when the first Fleming valves were made at The Edison Swan Electric Lamp Works in 1904, and the Steam Electric Lamp Works, England, in 1907, has attained now (1923) enormous proportions and created an industry which has yet a great future before it.

Further advances have been made in the last year or so with the object of doing away with the low tension battery.

Considerable success has been achieved and the filament consumption of many modern low temperature or dull emitter valves has been cut down to well below one quarter of that of the ordinary types. Indeed so great has been the success obtained by the dull emitter valve that the accumulator, so often the greatest drawback to wireless reception, can be dispensed with and primary cells substituted in its stead.

But it may not be long before even these will be unnecessary and we shall have a "cold" filament valve that will operate by the application of H.T. to the anode, the filament being coated with, or consisting of, radio active salts, that will readily give off electrons.

(Reproduced by courtesy of The British Science Guild and Publicity Service.)

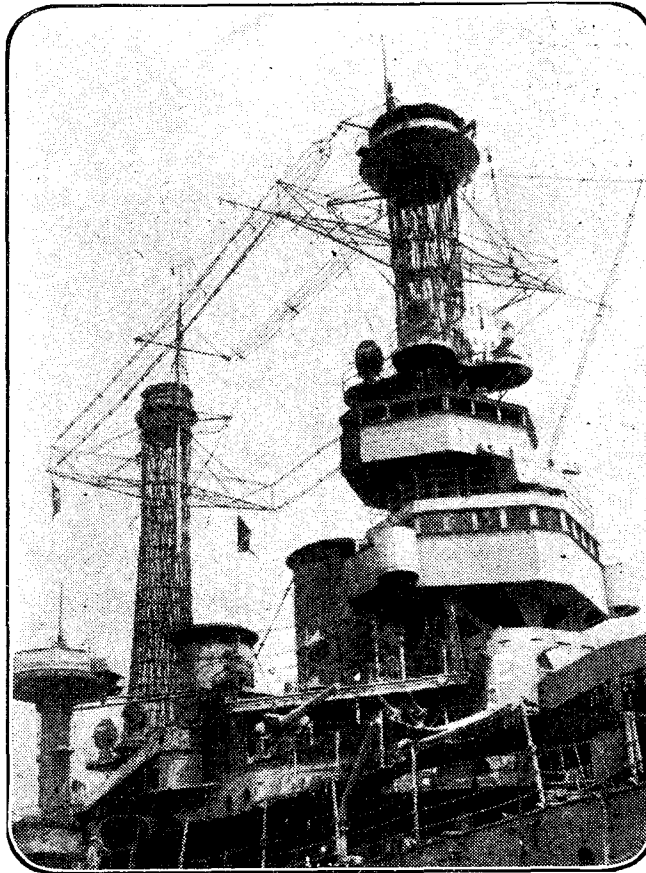

The complicated aerial system employed on one of the larger vessels of the United States Navy.

casting has created a novel trade in the manufacture of these valves for generating, amplifying, and detecting electric waves.

In the receiving valve most commonly used, a straight filament of tungsten, or thoriated tungsten, or else platinum-iridium, coated with oxides of barium and strontium, is used. This is surrounded by a spiral wire forming the grid, and by a nickel or molybdenum cylinder, forming the plate. The ends of the filament, grid, and plate are connected to pins on a cap so that the valve can fit into a socket like an electric lamp.

In modern wireless telegraph receivers, one or more valves are used to amplify the oscillations—one to detect, and one or more to amplify the rectified currents.

Valves of this type were made to the number of three or four million during the war (1914-1918), and are manufactured now

The Two-valve set that will give YOU satisfaction—

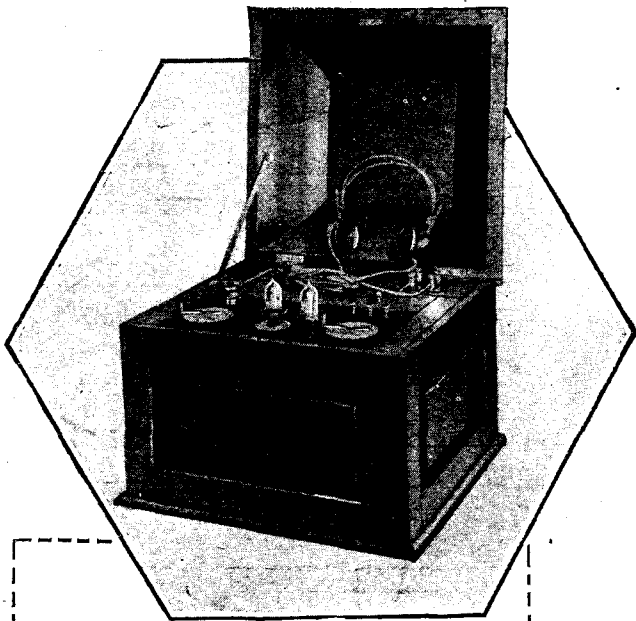

THE NEW V.S.1.
TWO-VALVE

COSMOS RADIOPHONES

LONDONDERRY. 14th September, 1923.

"2-Valve set safely to hand and tested on standard aerial at 5.30 p.m. to-day. Glasgow (150 miles) came in without effort, and listeners all decided that earphones were TOO LOUD. Loud speaker accordingly connected (which was never attempted on 2-valve set here before) and music came out beautifully, being distinctly heard all over shop. Out of over a score of sets (2-v. and 3-v.) tested under same conditions, I propose now to place an order for six sets for opening of coming season."

POTTERS BAR. 6th September, 1923.

"Last night I had the pleasure of testing your latest 2-valve tuner, after 2 L O had closed down, the results being beyond my expectation, having received 2 Z Y, 5 N O, 5 S C, 5 I T on the loud speaker (Amplion A.R.23). It is necessary to add that I am an absolute amateur, and that this set was tried on my own aerial at Potters Bar."

ST. ANNES-ON-SEA. 26th September, 1923.

"It may interest you to know that on one of the new 2-valve reaction sets I am receiving W G Y (America), and the School of Posts and Telegraphs (Paris), and several other stations in America perfectly. In fact, I don't tune them in properly, as they come in too loudly if I do. The aerial I am using is 26 feet high and 70 feet long."

The Mark



of Efficiency.

are giving highly satisfactory Broadcast and Telephony reception in all parts of the British Isles, as is shown by the few extracts given from the numerous testimonials we are receiving.

These sets are now fitted with :—

- (i) a dual amplification circuit whereby results are obtained with *two* valves fully equal to those hitherto obtained with *three*.
- (ii) a highly efficient non-radiating reaction circuit.

The results are:

**UNEQUALLED RANGE
ENORMOUS AMPLIFICATION
PERFECT REPRODUCTION**

and the sets are designed for simple operation so that these results can be obtained by the beginner who has no wireless knowledge or skill.

"Cosmos" Radiophones are sold through the trade, but we extend a hearty invitation to all who contemplate the purchase of a set to pay a visit of inspection to our showroom in your district. You will not be pressed to buy, but you will have the opportunity of hearing "Cosmos" reception and of seeing the whole range of "Cosmos" components, and the very latest development "RADIOBRIX".

We are showing at the Wireless Exhibition to be held at the White City, from November 8th-21st.

LONDON :
232-233, High Holborn, W.C.1.
BIRMINGHAM :
Daimler House, 33-34, Paradise St.
BRISTOL :
43, Park Street.
CARDIFF :
Metrovick House, Custom House Street.

**METROPOLITAN
Vickers**
ELECTRICAL CO. LTD

Head Office & Works: TRAFFORD PARK, MANCHESTER.

EDINBURGH :
127, George Street.
MANCHESTER :
14, Long Millgate.
NEWCASTLE-ON-TYNE :
Cosmos House, 7, Saville Row.
SHEFFIELD :
Howard Gallery, Chapel Walk, Fargate.

The "Amplion" again



Better reproduction of Radio Broadcast Music, whether vocal or instrumental, is afforded by the 1924 Amplion Models now introduced.

The new Amplion Series render all ordinary loud speakers obsolete, yet with the latest improvements the Amplion is one of the least expensive loud speakers on the market.

Having a world-wide sale the Amplion is produced upon a scale so large that it is possible to offer greatly increased value at the strictly moderate prices of the original types.

Folder W.D.8 describes the Amplion range for 1924. Prices from £2 - 2 - 0.

The Portable Amplion is fully detailed in Booklet W.D.3.

These catalogues will be forwarded with the greatest pleasure.

Amplion Loud Speakers are standardised by the leading producers of Radio Receiving Sets and stocked by all Wireless Dealers of repute.

Patentees and Manufacturers:

ALFRED GRAHAM & COMPANY (E. A. GRAHAM),
St. Andrew's Works, Crofton Park, London, S.E.4.

Telephone Nos.: Sydenham 2820-1-2. Telegrams: Navalhada, Catgreen, London

West End Showrooms:

The Algraphone Salon,
25-26, Savile Row, Regent Street, W.1

Telephone: Regent 1075

Telegrams: Sonalgra, Piccy, London.

AMPLION

Leads the way!

All New Models of the Amplion

have non-resonating acoustic amplifiers and wood trumpets.

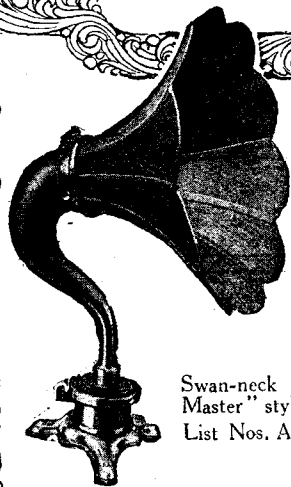

Swan-neck or "Music Master" style £6 0 0
List Nos. A.R. 13 & 15



Curved Horn or "Dragon" pattern - - £5 5 0
List Nos. A.R. 17 & 19



The Junior-de-Luxe design at - £3 5 0
List Nos. A.R. 41 & 43

Catalogue Nos.
The first No. refers to 120 ohm windings and the second to 2,000 ohm coils.



Universal Style for Wall or Table - £8 5 0
List Nos. A.R. 5 & 7

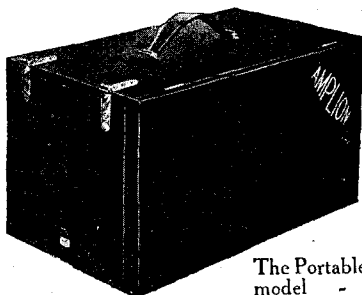

The Portable "All Purpose" model - - £6 6 0
List Nos. A.R. 60 & 61.

"Buy British Goods Only."

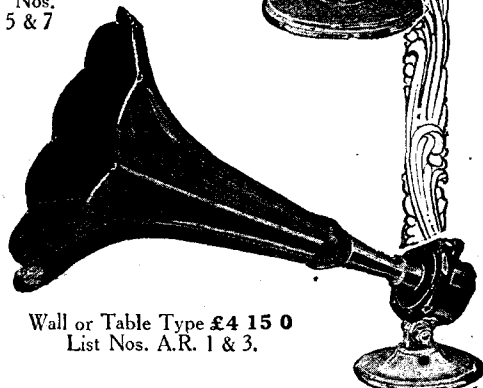

Wall or Table Type £4 15 0
List Nos. A.R. 1 & 3.

AMPLION

EDISWAN

for reliability

In the "Ediswan" factory only selected materials are admitted. This combined with skilled workmanship results in finished products which never fail to give complete satisfaction under the severest of conditions.

Model 1923B
P.O. Regd.
No. 433

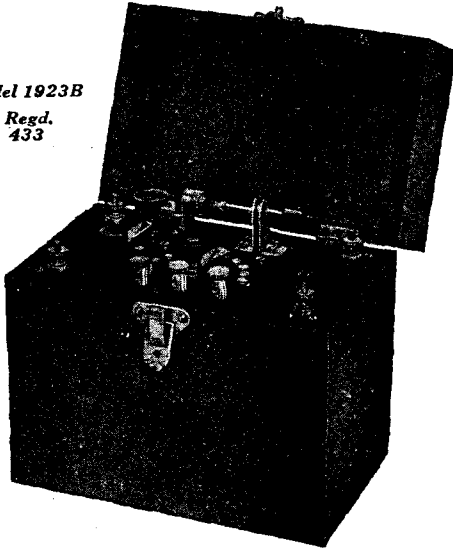

THE EDISWAN CRYSTAL SET

Clear and loud reception is readily obtained over a range of 25 miles, under favourable conditions. Receives on wave-lengths between 200 and 500 metres. Special type Cat's-whisker detector and super-sensitive crystal, special provision made for the addition of a Valve Note Magnifier.

Including headphones and all accessories ready for immediate use.

PRICE £3 - 7 - 6 B.B.C. Tax 7/6 extra.

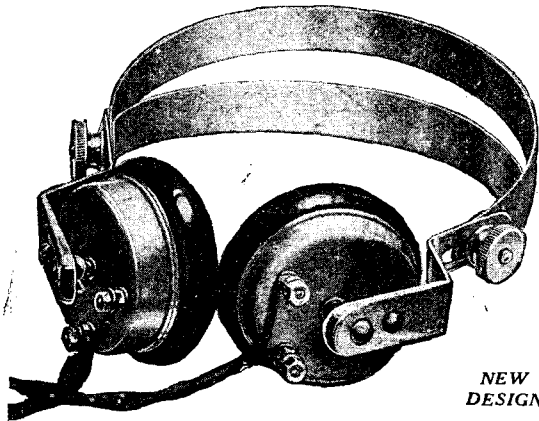

NEW
DESIGN

EDISWAN HEADPHONES

Total Resistance 4,000 ohms.

Adjustable Double Headbands, polished Pressed Aluminium Cases, Moulded Ear-pieces and six feet of Flexible Cord.

PRICE 24/- PER PAIR.

We manufacture Complete Valve Sets and Accessories, also H.T. and L.T. Batteries. If your Dealer does not stock, send us a postcard with his name and address.

Ask or write for leaflets.

FREE ON REQUEST. Write now for our Illustrated Booklet "The Thermionic Valve"—a postcard will do.

The EDISON SWAN ELECTRIC CO., LTD.,

Contractors to H.M. Admiralty, War Office, Royal Air Force

123/125, Queen Victoria Street, E.C.4,
and 71, Victoria Street, S.W.1.

Works:
Ponders End, Middlesex.

Branches in all
Principal Towns.



POST OFFICE NOTICE

Use of Unlicensed Wireless Receiving Sets

The Postmaster General calls attention to the new arrangements announced in the Press for the issue of wireless licences.

Many persons are known to be using wireless receiving sets without a licence, owing to the fact that no licence has hitherto been available for home-made sets. A new form of licence known as an "Interim Licence" has now been introduced to meet the case of persons *who are already in possession of unlicensed sets*. It imposes no condition as to the make of existing apparatus.

This licence will be issued at an annual fee of 15s. to persons who apply *before the 15th October*. No charge will be made for past user, and no proceedings will be taken in respect of past user if the licence is applied for before the 15th October. *Any person who uses unlicensed apparatus after that date will render himself liable to heavy penalties under the Wireless Telegraphy Act, 1904.*

The "B.B.C." Licence at 10s. still remains on sale, and a second new form of licence, known as a "Constructor's Licence," which will meet the case of persons who intend to make their own sets but have not yet done so, is also issued at 15s.

The new licences are on sale at all Head and Branch Post Offices and certain Sub-Offices. Forms of application can be obtained at any of these offices and also at any Sub-Office at which Money Orders are issued.

THE BROADCASTING COMMITTEE'S REPORT.

"Better Late than Never."

A review of the situation. By THE EDITOR.

THE Broadcasting Committee's report has at last been issued for the edification of the public. There is nothing in it which has not been anticipated, and which could not have been decided on in almost less time than it took Carpentier to knock Beckett into sweet oblivion. But that is by the way. The important thing is the "compromise" emanating from the P.M.G.

The Postmaster-General has agreed with the Broadcasting Committee that a constructor's licence should be issued for a limited period at an annual fee of 15s., provided that no foreign parts are knowingly used in the construction.

To those who have already unlicensed sets, a special interim licence will be issued at a fee of 15s., provided they apply for licences before October 15th.

This scheme will last until December 31st, 1924, after which it will be possible for the single form of licence recommended by the Committee to be introduced, without any condition as to the marking or origin of the licensed apparatus, if it should be then thought desirable.

The statement adds:

"The existing experimental licence at an annual fee of 10s. will continue to be issued from the General Post Office to persons who are able to satisfy the Postmaster-General that they desire the licence for bona-fide experimental purposes, and are qualified to conduct experiments, and who sign a declaration to the effect that they will not use the broadcast programme except for experimental purposes."

Committee's Recommendations.

The actual broadcasting report contains recommendations which cannot be put into operation immediately, but the above compromise will serve for the time being. The Broadcasting Committee's chief recommendations are as follows:

"That a Broadcasting Board should be established to assist the Postmaster-General in the administration of broadcasting and advise him on important questions concerning the service.

"That the broadcasting service should not be operated by a Government department, but that those entrusted with the service should work under Government licence.

"That no part of the cost of broadcasting should fall on the taxpayer, but that the Government should not endeavour to

make a profit on the administration of the service.

"That the bulk of the revenue required for the service should be obtained from the receiving licence fee, which should be retained at 10s. a year, subject to consideration of a reduction in the event of more revenue being received than is sufficient to carry on an adequate service.

"That, instead of 5s., as much as 7s. 6d. out of the 10s. fee might be allocated under any new scheme to meet the cost of broadcasting, subject to a sliding scale under which the payment per licence would decrease as the number of licences increased.

"That, in place of the present broadcast and experimental receiving licences, a

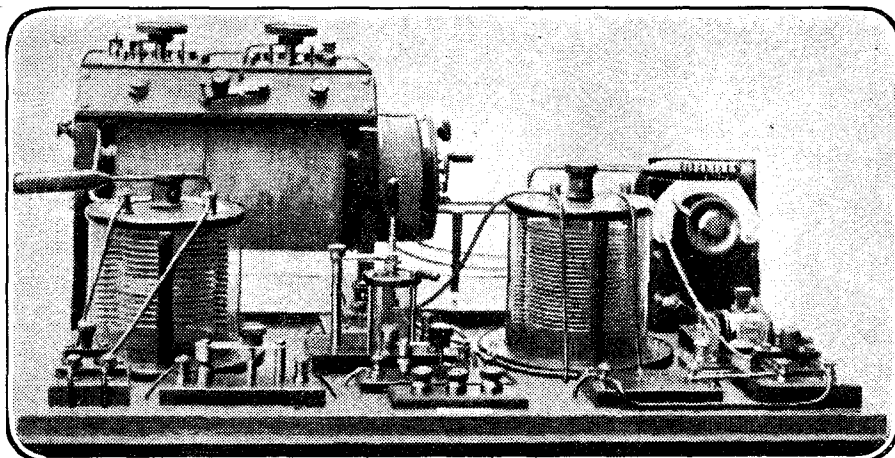

A typical well-finished home-made receiving set, constructed by Mr. F. Hill, 23, Baker's End, Merton, Wimbledon, S.W.

uniform and simple type of licence be issued containing a clause forbidding improper use of back-coupling on pain of withdrawal of the licence, but no other limitation on the apparatus allowed to be used.

"That effective measures be taken to enforce such a licence, and that additional statutory powers be obtained to strengthen the Postmaster-General's position."

Referring to the question of wave-lengths and hours, the Committee recommend:

"That arrangements be made for the greatest possible extension of the existing broadcast band of wave-lengths (350 to 425 metres), preferably by the allocation of a band from 300 to 500, excluding 440 to 460 metres.

"That all possible steps be taken to protect the band allocated to broadcasting from interference by other services.

"That the present restriction of the hours of broadcasting be removed, thus enabling additional facilities to be provided."

Dealing with the broadcasting of news, the report says:

"The public is well served by the Press in the matter of news, and we consider that any extension of the broadcasting of news should be carried out gradually, the effect of each extension being carefully watched.

"The British Broadcasting Company are required, as a condition of their licence, to broadcast weather reports without charge, and the Committee are strongly of opinion that weather forecasts should be broadcast at least twice a day in non-scientific language calculated to be of the maximum value to agriculturists and others."

Exactly what listeners-in have gained may be summed up concisely as follows:

Constructors' licences are to be issued for a limited period at 15s. per annum, as compared with 10s. charged for the B.B.C. licence, provided that no parts manufactured elsewhere than in Great Britain and Northern Ireland are knowingly used in the receiving apparatus.

For those who already have sets unlicensed (estimated to number 200,000) a special interim licence will be issued at 15s., provided application is made before October 15th.

Practical Solutions.

Out of the 15s. the company will receive 12s. 6d., and out of the B.B.C. licences 7s. 6d., if the House of Commons agrees.

Royalties will continue on a reduced scale—approximately 50 per cent—except in the case of crystal sets, in respect of which the reduction will be greater. These reductions, it is pointed out, should enable a cut to be made in the prices of receiving sets.

The existing licence for bona-fide experimenters at 10s. will be continued.

As to unlicensed sets, no charge will be made for past use, and no proceedings taken in respect thereof, if the licence is taken out before October 15th.

The licence held by the company will be prolonged, "under suitable conditions," to the end of 1926, as recommended by the Committee.

The P.M.G.'s recommendations are very different from those made by the Broadcasting Committee, which is not surprising, for the latter's labours do not appear to have been productive of anything really original or immediately practical to have warranted their appointment by Sir W. Joynson-Hicks. Taken all round, the actual recommendations made by the Committee are theoretical, while those of the P.M.G. are, at least, practical, and will help to inspire a certain amount of confidence in the trade, especially as they will still retain protection.

It is interesting to note that the Committee views with disfavour the continuance of the B.B.C.'s privilege to insist on the purchase of apparatus stamped B.B.C. This system, the Committee finds, is open to many objections, and should be abandoned.

We agree with this, and feel sure that the majority of listeners-in will be glad to see the end of this particular bugbear of broadcasting.

THE BOURNEMOUTH BROADCASTING STATION.

After a great deal of discussion as to its site, the last of the eight main broadcasting stations to be built in this country is in process of erection at Bournemouth. Some interesting details of the station, which should be in operation in a few days, are given in this article.

BOURNEMOUTH, "the forest city by the Southern Sea," has added one more attraction to its already long list in that it has been chosen as the broadcasting centre for the south coast.

It is admirably centred for this purpose,

which is close to Charminster Road, on the outskirts of Bournemouth. The site is a very excellent one, having, as it has, good elevation and absolute freedom from screening. The site is, moreover, unique in that it is on land belonging to the B.B.C.

This will allow perfect freedom for modifications or experiment.

The two masts are each 120 ft. high, and the earth system consists of a ring of zinc plates 80 ft. in diameter wired through to the centre of the ring. It is quite possible that an earth screen will be used. This would permit very sharp and efficient transmission.

The transmitting set is similar in all respects to those at present in use at Cardiff, Glasgow, and Manchester, and

was supplied by Marconi's Wireless Telegraph Co. The power is 1,500 watts. The lighting and power current is drawn from the Bournemouth and Poole Supply Co.

It is confidently asserted by the engineers in charge of the plant that Bournemouth

will be the most efficient of all the B. B. C. stations, and, in view of the inevitable "jamming" from ships and coast stations that must be expected, this is very fortunate. As a matter of fact, it was in order to counteract this nuisance as much as possible that such strict attention has been paid to the technical details, and many of the most important members of the engineering staff of the B. B. C. have made frequent visits to Bournemouth in order to advise and assist the technical men engaged with plant installation at the new station.

In respect of the programmes, it is anticipated that Bournemouth will provide a wonderful selection of items whose popularity is already assured, owing to the fact that they will be chosen from the "rest's best" and will take advantage of months of experience gained elsewhere.



Mr. Bertram Fryer, the Station Director of Bournemouth.

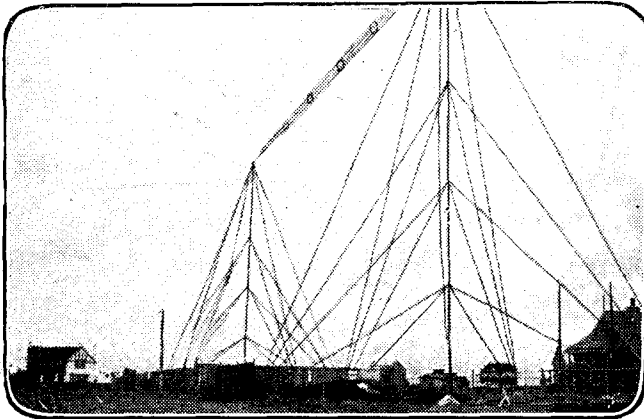

The aerial masts and station buildings.

and a great number of listeners-in will be created by the bringing of the towns and villages of the New Forest, Isle of Wight, etc., within comfortable range of a broadcasting station. For a long time it was quite an open question as to which town would form the southern representative of the activities of the B. B. C., but it will be agreed that the final choice has been a wise one.

It is not for the actual town that a broadcasting station is erected; consideration must be paid to a whole area, the radius of a normal broadcasting station's range.

The Bournemouth station studio is situated in Holdenhurst Road, very near to the railway station and the principal hotels. The whole of the second floor of No. 68, above Messrs. Vernal's Pram Department, has been taken, and a special entrance made into the Holdenhurst Road. The area covered is about 78 ft. by 35 ft. The studio itself measures 33 ft. by 20 ft.

There are three offices, a band-room, waiting-room, control-room, and a certain amount of spare storage space. It is the largest provincial studio, and provides ample room for the largest of bands.

It will not be draped as heavily with "blanketing" material as 2 L O's studio, but it is not anticipated that there will be the slightest trouble from resonance or outside noises. Nor is it thought likely that "neighbours" will be worried with "directly received" broadcasting.

The studio is connected to the actual transmitting station by three pairs of Post Office land lines, which are partly overhead and partly underground.

The station is some two miles from the studio, and is situated in Bushey Road,

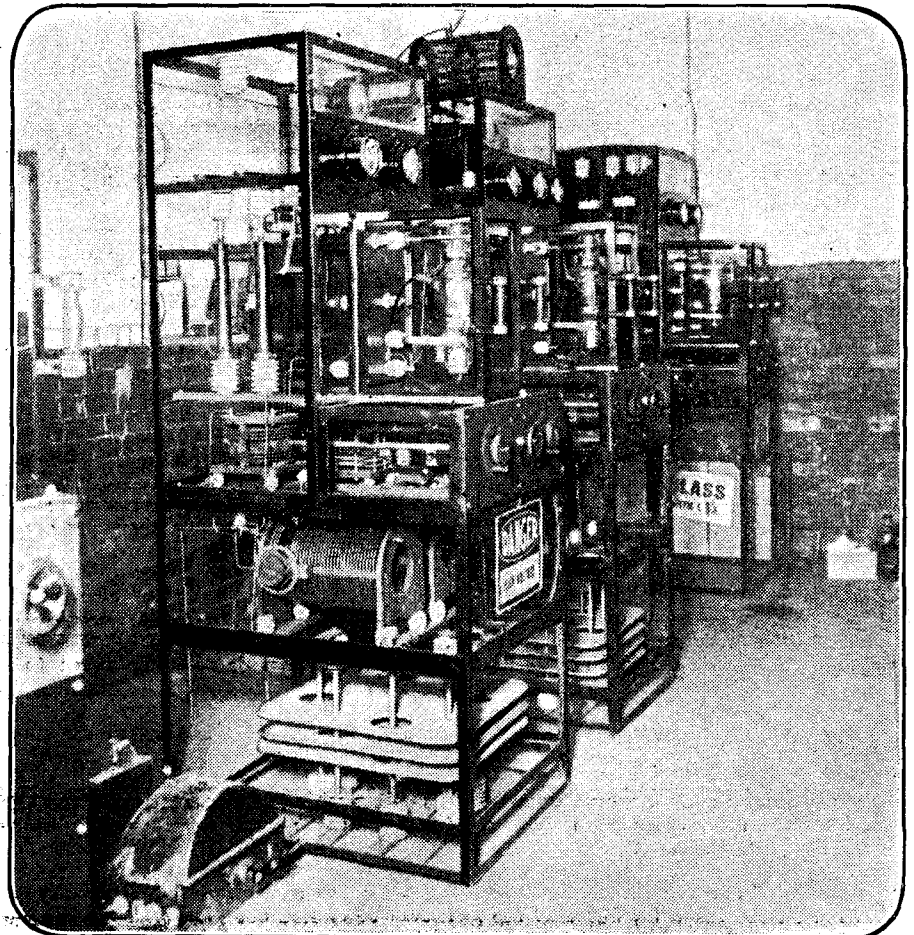

The 1,500-watt transmitter supplied by Marconi's Wireless Telegraph Co.

A CHAT ABOUT MULTI-LAYER COILS.

Amateurs constructing sets will find the following article extremely useful in assisting them to choose an efficient method of tuning. The various coils now in use are briefly described, and details of the methods of construction are given.

IN the first place it must not be forgotten that the multi-layer coil is a compromise between two things, efficiency and compactness. Those who remember the earlier days of wireless will recollect the huge, unwieldy tuning coils that were used. Large and clumsy they were, but they were certainly efficient. But with the advance of the science it was found impossible to build receivers employing these coils owing to their size, so a compromise between size and efficiency had to be made. This resulted in the multi-layer coil.

The whole trouble is this: the coils have to be small, they have to have a large enough inductance to reach the desired wave-lengths, and at the same time they must not have a very great self-capacity or they will be inefficient and give flat tuning.

In order to keep the size down, the layers are wound in various ways, but with the main object of getting as many turns in as small a space as possible. This is simple, until it is remembered that the closer the wires are together, especially if turns between which there is a comparatively great difference of potential lie close together. For instance, it is a bad arrangement to have turn 20 next to turn 2, and so on. The worst arrangement being to wind a coil of, say, 150 turns and then another layer of 150 turns on top of it. This would result in a compact coil, no doubt, but it would have a tremendous self capacity.

An Inefficient Type.

It therefore follows that the best system is to wind the coils so that there is a reasonable distance between the turns, and also so that turns with a large difference of potential between them shall be kept as far apart as possible. Again, as large a wire as is practicable should be used, and this also increases the difficulties already mentioned.

The most important multi-layer coils are as follows, and I intend giving a brief description of the construction, advantages and disadvantages of each as we go on.

First is the slab coil. This consists of a more or less flat disc of wire, with diameter anything up to 5 in. or so. It is held together by means of paraffin wax, a point which at the outset is bound to increase the

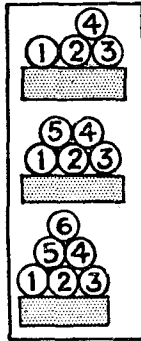

FIG. 3

self capacity of the coil. The process of winding is simple; a bobbin similar to those used for plug-in transformers is used, Fig. 1, and the requisite number of turns of wire are wound round and round it. This results in the piling up of layer upon layer in the fashion that has been seen to be the worst possible as far as efficiency is concerned.

When the coil is wound the sides of the bobbin are removed from the centre spindle after the whole has been fried in paraffin wax and cooled. The result is a firmly set mass of wire with a tremendous self capacity, and which gives extremely flat tuning. Obviously then this is not a type to be recommended if the best results are to be obtained on low wave-lengths, and so the use of slab coils should be confined to wave-lengths above 3,000 or 4,000 metres. For long waves the coils are usually wound with 32 D.C.C., and have from 400 to 1,500 turns.

Pile-wound coils, next, differ from the slab coils in that they are of the solenoid type, though a great many more turns per inch can be obtained. The diagrams will show how these coils are wound, and it will be seen that the layers are so arranged that only turns having a small difference of potential between them are together.

In the case of two-pile winding, the first two turns are wound on, and then the third is wound on top of the other two, as in Fig. 2. The fourth is then wound on the bottom layer, and the fifth above No. 3. A little skill is required in order to get the layers neat, but this will soon come with practice.

Amateurs are advised to try the two pile type of winding at first, as the three and four pile coils are still more difficult to construct. Finally the coil is finished off in the same way as the usual single layer coil. It should be coated thinly with shellac and baked. Fig. 3 shows

the formation of a three-pile winding, and Fig. 4 gives a clear idea of how the four-pile type is wound.

The next coil that we will consider is the lattice coil, which is quite easy to wind by hand. It possesses advantages over the pile wound inductances in that it has less self capacity and is more compact.

It consists of a simple layer by layer winding with a regular zigzag spacing turn which serves to keep the wires apart. The former used. Fig. 5, consists of a wooden cylinder of about 1½ in. diameter and 2 in. long, while a series of pins are driven into its circumference as shown. The pins are

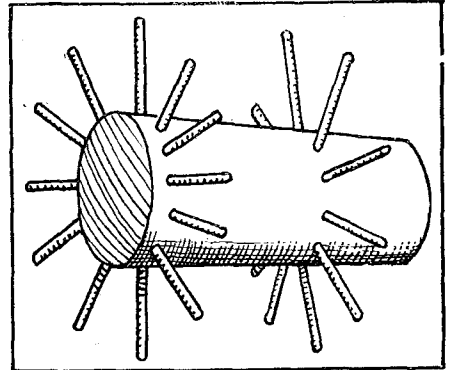

FIG. 5.

“staggered” in their rows, the rows being separated by any convenient distance, depending upon the thickness of coil. Wire nails make very useful pins.

Novel Basket Coils.

To wind the coil, a hitch is taken round the first pin, and then the winding is continued zigzag fashion round the pins until one complete turn has been made, Fig. 6. Then the winding is continued in the ordinary solenoid fashion right across the width of the former between the pins. After this another zigzag turn is wound, followed by another series of straight turns. The result is that a zigzag turn spaces each layer.

(Continued on page 208.)

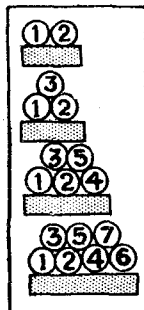

FIG. 2.

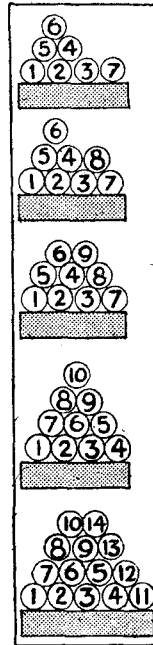
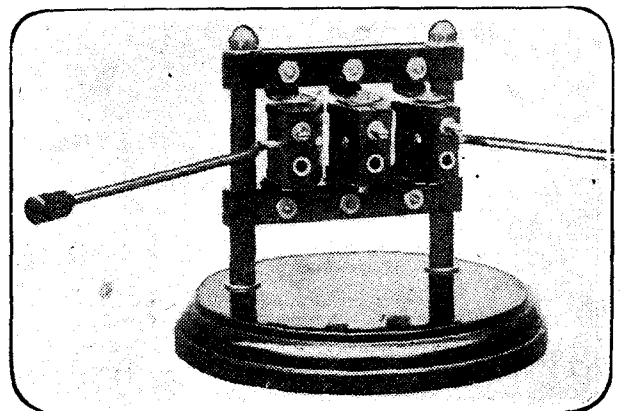

FIG. 4.



A neat three-coil holder made by the Igranio Electric Co., Ltd.

A CHAT ABOUT MULTI-LAYER COILS.

(Continued from page 207.)

Finally the coil is soaked in wax, drained, and when cool, the pins are removed and the coil resembles Fig. 7. Coils should be wound with 24 gauge wire up to 400 turns, and after this with 26 or 30.

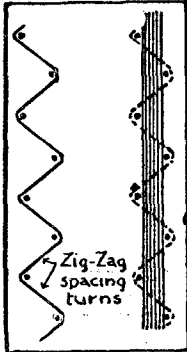

FIG. 6.

Basket or spider coils should also be included under the heading of this article, but are so well known that there is no need to detail the method of winding them. It might be mentioned, however, that a greater number of turns per unit diameter can be obtained if every other slot is used instead

of winding the wire in and out of each peg or slot. This increases the width or thickness of the coils, but does not decrease their efficiency.

Popular Type of Coil.

The best known of all multi-layer coils are the honeycomb and duolateral types.

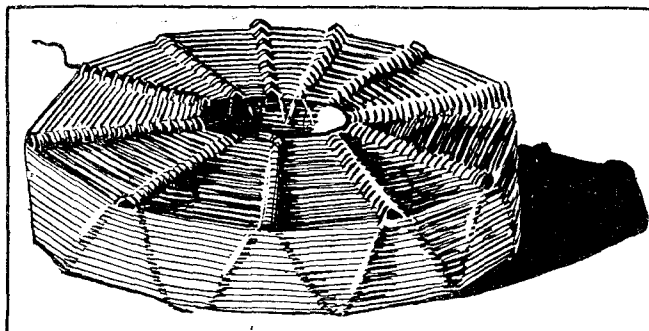

Fg. 7.

These are, of course, in general use among a great many amateurs, and therefore need very little introduction. In efficiency they are a little higher than the lattice coil, or the basket coil, especially upon long wavelengths, when the latter are not to be recommended. On short waves, the writer

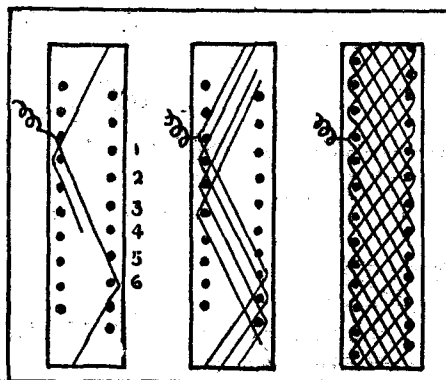
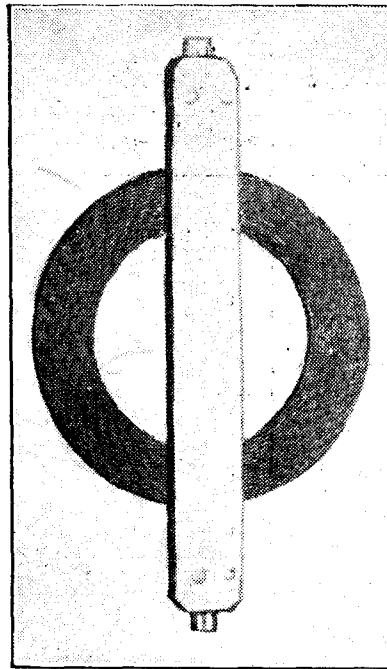

FIG. 8.



A Slab Inductance with Gimbal Mounting.
(Igranic Electric Co., Ltd.)

prefers basket coils, though this is open to criticism.

The method of winding honeycomb coils is rather complicated, and it is indeed almost impracticable to construct one by hand if any but the smallest sizes are to be attempted.

The coils are wound on a former resembling that used for lattice coils, the only difference being that more pegs are required.

The wire is wound in a peculiar fashion, travelling slant-wise across the former from side to side. Fig. 8 will give some idea of the method employed, and it will be noticed that the wire is taken from the start round the 6th peg on the opposite side. From this it again misses 5, and goes round the 11th peg on the first (the starting side). This is continued, missing 5 each time until the required number of turns have been wound. The number of pegs on the former can be anything from 10 to 20, according to convenience.

The only difference between honeycomb and duolateral coils is that in the latter the layers do not lie directly over one another as they do in the former type. This naturally results in the duolateral coil having an even lower self capacity than the honeycomb. As a matter of fact, those coils often described

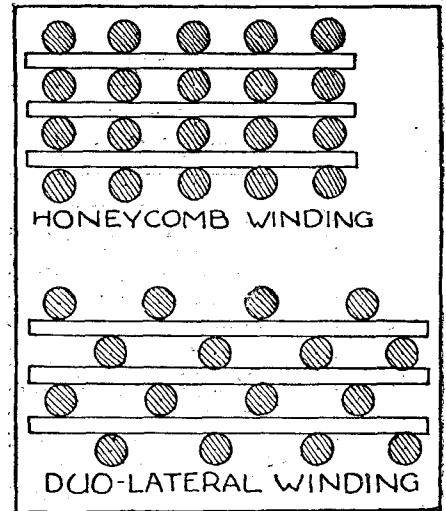

FIG. 9.

as honeycomb coils are really of the duolateral type, the real honeycomb being very little used now.

For the duolateral coil it is best to have about 24 pegs, and the winding should be made so that certain fixed numbers are counted at each cross over. Those generally used are 6, 7, and 9. The difference between the two types of coils will be readily seen by Fig. 9.

Finishing Off.

When finishing off coils, it is advisable to use shellac in preference to paraffin wax. Especially is this the case when dealing with duolateral coils, for if this type of inductance is dipped in wax, no matter how carefully it is drained afterwards, the wax will clog up a great number of the air spaces between the layers, and will greatly increase the self capacity of the coil. Shellac, on the other hand, will drain off very readily and yet sufficient will adhere to the coils to keep the coil rigid. The idea of dipping coils is not so much for the purpose of increasing the insulation between the turns, though it has this effect, as to enable the coil to stand up without undue support. Here, again, shellac is better than wax, for if the coils are frequently handled, shellac will remain firm, while wax will tend to soften and the coil will gradually get out of shape, if it does not totally disintegrate.

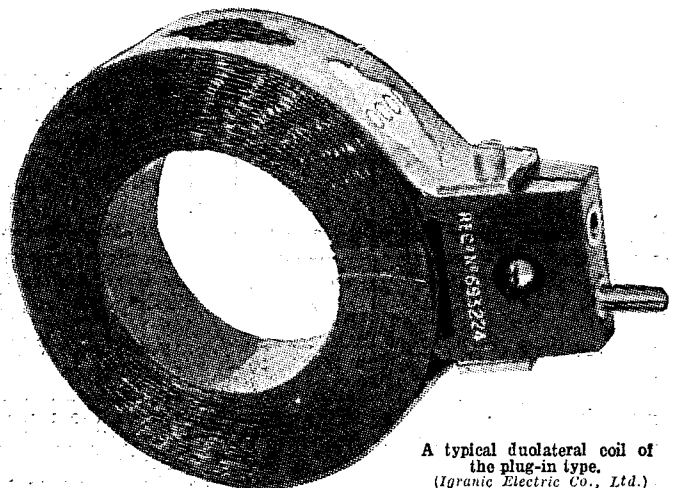

A typical duolateral coil of the plug-in type.
(Igranic Electric Co., Ltd.)

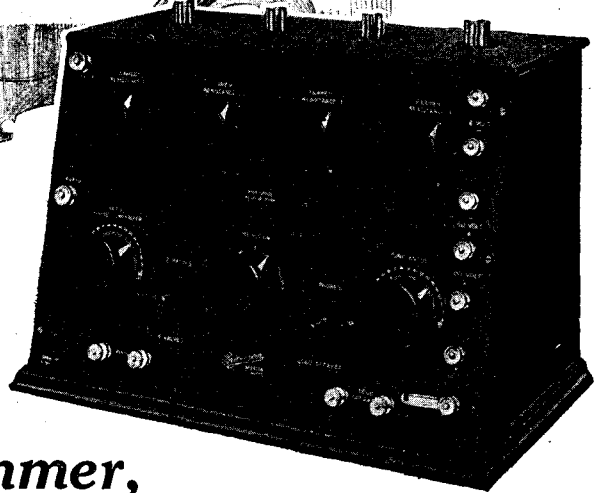

**“Good-bye, Summer,
Good-bye, Good-bye.”**

FALLING leaf and chilly twilight are here—restoring broadcasting to its niche in the home.

Start *this* season well—get the very best from the music-laden ether *this* winter—through an **Ericsson** two, three or four valve set. Hear the music of Britain from end to end—the operas and concerts of Europe—in unsurpassed purity and volume.

There’s an **Ericsson** model to suit every purse and taste—superbly made by craftsmen of a firm with a generation’s experience behind it.

*Write us to-day for detailed lists
(Sets, Telephones, Components, etc.).*

**THE BRITISH L.M. ERICSSON MFG. CO., LTD.,
International Buildings, 67/73, Kingsway, W.C.2.**

- Selling Agents:*
MANCHESTER:
 19, Bridge Street, Deansgate.
NOTTINGHAM:
 W. J. Furse & Co., Traffic St.
BIRMINGHAM:
 14 15, Snow Hill.
SCOTLAND:
 57, Robertson St., Glasgow.
N.E. ENGLAND:
 Milburn Ho., Newcastle-on-Tyne.
COLCHESTER:
 121, High Street.

**We are Exhibiting at the N.A.R.M.
Exhibition, White City, Nov. 8th—21st.**

Ericsson
**WIRELESS
APPARATUS**

**Buy British
Goods only.**

Quality Assets = for Home Assembly =



Crystal Detector
3/6



Filament Resistance with Vernier Adjustment .. 3/6



Basket Coil Mount 1/3



Tuned Anode Variable Reactance Coil .. 5/6 tance .. 10/-



Standard Coil Socket .. 1/-



P. 24 Two-Valve distance type reactance set £ 5.- Marconi Royalty 25.-



Plug-in Transformers, 350-500 metres 5/6
2600-4000 " 7/6



Everset Crystal to Crystal Detector .. 2/9



LOUD SPEAKER. Brown's with the famous adjustable reed. We believe this to be the most efficient speaker made. 4000 ohms. £2 : 10 : 0



Variable Grid Leak, steadily variable 1/2 to 5 mags. .. 2/6



CONDENSERS
For panel mounting, with knob, pointer and scale. Complete in Oak Case with engraved ebony dial.

00r	11/6	18/9
00075	10/9	17/9
0005	8/6	15/6
0003	7/6	14/6
Vernier, 3 plates	4/6	10/6



Basket Coils Set of 7, tuning to about 3600 metres 3/10



Radiax Super-Sensitive Headphones, 4000 ohms, 22/6 with cords, French Headphones, well finished and efficient, 4000 ohms .. 13/9

MINIMISE the possibility of failure in your experiments. Make sure beforehand by asking for Radiax Components. Some are illustrated here, and any one of these will immediately improve any wireless set. Made with a complete understanding of their uses and the need for accuracy throughout their manufacture—and guaranteed efficient. Send stamps 3d. for Complete Catalogue of Components, Complete and Home Construction Sets.



Museum 490 **RADIAX** **Museum 490**
WE SATISFY YOU

RADIAX LTD.,

10, Radio House, Percy Street,
Tottenham Court Rd., London, W.1.
(5 Mins. Tottenham Court Road or Goodge Street Tubes.)

Scientific Baskets are Still at the Top.

200 to 4,000 metres, 2/6 per set, complete with Calibrations and Circuits (post 3d.).
REWIND YOUR DUD 'PHONES! 47 D.S.C. Wire, 1/2 oz. Bobbins, 1/-; Enam., 10d. (postage 2d.).
STALLOY DIAPHRAGMS, 2 1/2 diameter, 4d. each (postage 1 1/2d.).
SENSITONE—the World-Famed Crystal. Sensitive all over. 6d. per specimen (postage 1 1/2d.).
'PHONE LEADS, 1/3 per pair (postage 2d.).
SCIENTIFIC FILAMENT RESISTANCES, need only one hole drilled for mounting, very smooth action, 2/9 each, complete with dial (postage 3d.).
FILAMENT RESISTANCE DIALS, engraved 0 to 10, 6d. each (postage 2d.).
FIXED CONDENSERS, any capacity, 2/- each (postage 2d.).
SPIDER FORMERS, 1 1/2 slot, 3d.; Wound, 6d. each (postage 1 1/2d.).
TINNED COPPER WIRE, 3d. per hank (postage 1 1/2d.).
SISTOFLEX, 4 1/2d. per yard length (postage 1 1/2d.).
BROADCAST COILS, 1/3 per pair (postage 2d.).
COMPLETE SET OF CRYSTAL DETECTOR PARTS, 1/3 (postage 2d.).
BASKET COIL HOLDERS to fit standard tuning stands, 1/6 each (postage 2d.).

EX-GOV. HIGH-TONE REED BUZZERS, 2/9 each (postage 3d.).
 EX-GOV. L.R. 'PHONES, only a few left, 2/9 each (postage 3d.).

SCIENTIFIC SUPPLY STORES, Phone: 4177
 126, NEWINGTON CAUSEWAY, S.E.1.

WINDSOR High-Grade EBONITE RADIO FITTINGS.



ONE Way .. 2/3



TWO Way .. 3/11

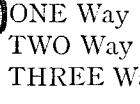

THREE Way .. 5/11

EBONITE H.F. Transformers 300/500 M. .. 3/3 each.
All these Prices are Post Free.



Fixed Coil Holder .. 1/3



Basket Coil Holder .. 1/6

Trade Enquiries Invited.

WINDSOR WIRELESS WORKS,
 413a, Brighton Road, CROYDON, SURREY.

"IGRANIC" RADIO DEVICES

assure absolute accuracy and dependability of operation.

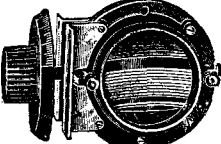

Type H VARIOMETER.
 Recommended for use in the aerial circuit of crystal and valve sets. Wave-length range approximately 150-600 metres, with P.M.C. standard aerial. Stator and rotor best quality mouldings, windings self-supporting and impregnated solid. Price, with knob, dial, and fixing bracket, 15/-.

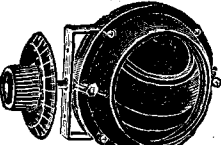

Type SR VARIOMETER.
 Designed for secondary and tuned anode circuits. Wave-lengths 150 to 600 metres approximately. Similar to type H, but with larger winding. Moulded insulation and windings impregnated solid. Price 18/-.

Type HR VARIO-COUPLER
 Stator and rotor of hard moulded insulation and windings impregnated solid. Tappings on primary enable fine tuning to be obtained, thus eliminating condenser. Coupling continuously variable over wide range. Price, with knob, dial, and fixing brackets, 19/-.



Write for Lists
Z 105.

IGRANIC
ELECTRIC Co. Ltd.

149, Queen Victoria Street,
LONDON.
Works: BEDFORD.

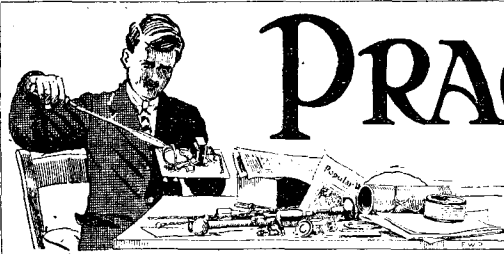

PRACTICAL IDEAS for the AMATEUR.

A NOVEL FORM OF INDUCTANCE.

A NOVEL form of variable inductance for panel mounting is shown in the illustration to this paragraph. Unlike the usual type of coil-wound inductance, in which the wire is wound round the exterior of the former, the windings are taken through the inside of the former as indicated. The insulation is bared from each turn at that end of the former which is free from the panel, in order to allow of the switch arm making good contact.

In operation the inductance values are varied by the method employed in the circular type of filament rheostat for adjusting the filament current.

The coil is mounted on the rear of the panel, and supported in position by means of a piece of L-shaped brass strip, held in place by two small screws and lock nuts, one screw running from the face of the panel to be locked at the rear, and the other being taken through the thickness of the former at the point where the winding ceases.

In winding the coil, due allowance should be made for the positioning of the strip, a suitable width of former being left uncovered for the purpose.

Two terminals, A and E, are sunk through the face of the panel to enable the necessary aerial and earth connections to be made.

The connecting wire from A is taken to one end of the coil winding, and the lead from E is joined to that end of the switch-arm which is attached to the shaft supporting the control knob.

An ordinary condenser knob or a filament rheostat control will answer the latter purpose admirably and give the panel facing a neat appearance.

A DUAL EARTH-SWITCH AND SPARK-GAP.

TO construct the switch shown in the diagram will present no difficulties to the amateur who is handy with his tools and who happens to possess an odd piece of brass strip.

An ordinary "two-way" earthing switch is first of all procured, and modified by removing from one end one of the spring-gap

contacts which grip the blade of the switch when it is in position. This grip, shown at A in the diagram, is re-installed considerably nearer to the hinged base on which the blade works.

In itself this modification is an advantage, as any extremely heavy currents in the aerial would spark across the smaller gap thus provided more readily than across the original distance.

Provision is made for the removal of heavy charges from the aerial by inserting the small spark-gap, B, in the earth circuit as illustrated.

This is composed of two pieces of sheet brass separated by a thin sheet of prepared

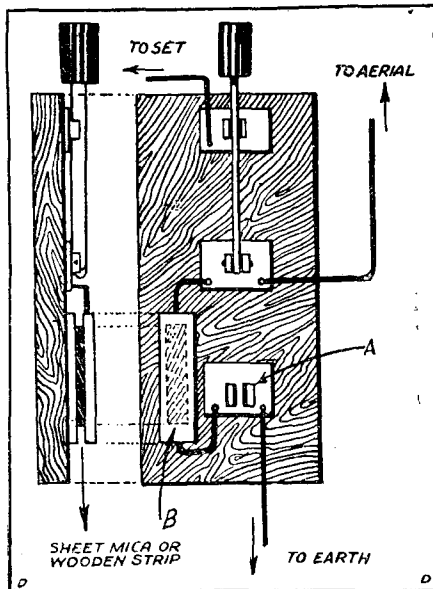

wood, mica, or other insulating material. The two brass strips should overlap the separating medium for a distance of about one-eighth of an inch.

The distance between the exposed edges of the two strips should be as small as possible—as small, in fact, as can be managed without the strips making actual contact.

Accumulated charges on the aerial can then spark across to earth without damaging the apparatus, despite the fact that the instrument is actually connected to the aerial by the switch arm.

AMATEUR PHOTOGRAPHS

The Editor is always prepared to consider photographs of readers' sets or anything of wireless interest and will pay 10¢ each for those used. If employed on the cover 25¢ will be paid. Do not send negatives or small blurred snapshots, quarter plate size prints or larger are required. Prints cannot in any circumstances be returned.

MULTIPHONE TERMINALS.

IN place of the ordinary 'phone terminals construct and use the following, which can be made from oddments left over from condensers, etc.

Procure two pieces of 2 B.A. screwed rod, and file a "cut" as Fig. 1, the length according to requirements. File notches on small spacer washers as Fig. 2. Fit together as Fig. 3.

The spacer washers just fit over the 2 B.A. rod. The number of spacer washers used should be according to maximum number

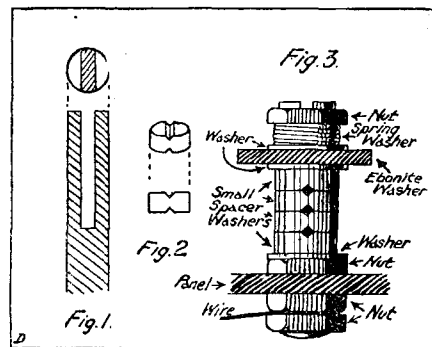

of 'phones required. The 'phone tags can be quickly fixed or unfixed by lifting up the ebonite washer against the tension of the spring, and pushing in or pulling out the tags from the file cuts.

The tension of the spring ensures good contact between the spacer washers, and the tags are also firmly held.

A pair of 'phones can be added or withdrawn without interfering with the others, and amateurs will find this type of terminal extremely useful. For experimental wiring-up of circuits where a number of connections are to be made to one point the terminals will be invaluable, as the wires can be inserted or removed with a minimum waste of time.

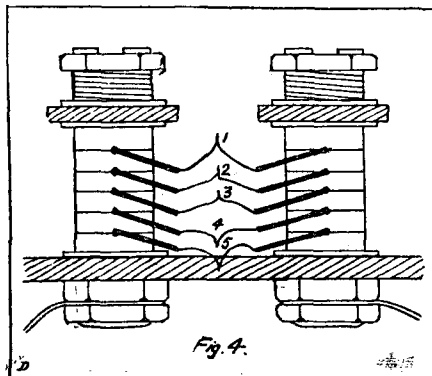

NOTES ON THE "MAY" CIRCUIT.

The brief account of the "May" circuit recently published in "Popular Wireless" has created enormous interest all over the country. The following remarks upon its operation will prove of great assistance to all amateurs.

AS inquiries about the "May" circuit are continually arriving, it is my intention here to give a short, simple account which will answer practically every one who has difficulties concerning this circuit.

The best results I have yet obtained have been with an Ediswan A.R. valve, using from 120 to 140 v. H.T. and a 6-volt L.T. battery. A five megohm grid leak gave better results than 2 megohms.

The variometer—and it must be a good one—with loading coil if necessary, functions well up to between 3,000 and 4,000 metres. I have been unable to get any results whatever by substituting a coil and condenser for variometer, but I don't say that it cannot be done. The one fact wireless teaches most plainly is that you must never in the most obvious circumstances become dogmatic.

To tune in I first set my '001 V.C. at 90 degrees, then slowly turned the variometer through the broadcasting zone. Nothing doing. Reducing capacity 10 degrees—placed pointer of '001—on 80. I repeated the action with variometer, placing pointer on 60, this with 18 volts. I now struck a weak carrier wave which turned out to be 2 Z Y (44 miles away). Then increasing H.T. gradually in 6 volt steps to 66 volt, I found that the signal strength increased very quickly with each move; the strength and quality were now equal to what I was able to produce on a fine valve set twelve months ago.

I now turned the pointer downwards to see if I could locate 2 L O and was successful, but very weak. Next, moving upwards, I picked up 5 N O and 5 I T very weak, and of microscopic proportions.

Loud Speaker Results.

It now struck me that by increasing the wave-length on the variometer I could reduce the capacity, so I made my first move towards real success, and within the next hour I had results which rewarded me for all my trials and troubles. By manipulating variometer and '001 condenser I got 2 L O on 10 degrees—165 miles—with a sweetness and clearness I had never imagined possible, especially on one valve and that without reaction.

My next move was to add another 66-volt battery in series, 4 inches of tinned copper wire soldered to two valve legs proved very suitable. I now increased the voltage to 120 volts, and "Hallo! Hallo!" "London calling" was just wonderful, and I now connected up another pair of 'phones in series with a 48 ft. lead of electric lighting flex, so that my wife downstairs could hear the results of this wonderful circuit.

At this point I discovered what could be done by using the best combination of H.T. and L.T. With the rheostat I found that I could cut out the carrier waves, which by now came in with vigour.

I now brought 5 I T and 5 N O on to the operating-table—the vicinity of 10 degrees on '001—and literally skinned them alive, although with two pairs of 'phones on;

that familiar voice "From the Newcastle station, 5 N O of the etc.," came in so strong and clear that I could not resist the temptation to couple on the loud speaker, an Amplion, and I could very clearly and distinctly hear the director read the News Bulletin. I don't, however, wish anyone to think that you could hear it in the next room.

Simple Lay Out.

I then tried 2 Z Y on the loud speaker. It was far better, of course, but at least 80 odd miles nearer.

You will note on the wiring diagram that the filament terminal is wired in one piece, being connected en route to one side of the

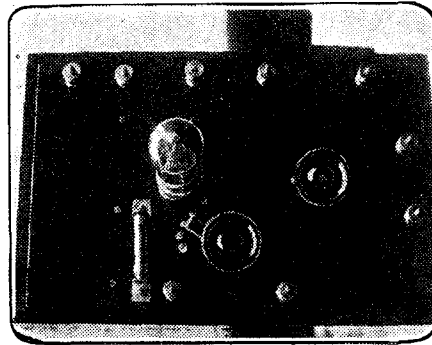

Top view of the panel.

filament, one stud of 3-way switch, and the battery terminal on right side of front of panel. When using the detector panel for the "May" circuit, it is necessary to connect this battery terminal to the positive side of the battery, and have the rheostat on the negative side of the accumulator or L.T. battery.

Then the reactance terminal at the bottom, the one that is soldered to the plate leg of the valve, is connected to the aerial end or side of the variometer, the ordinary grid input terminal is connected to the other, or earth side, of variometer. That leaves the third input terminal, L.T. positive, which is connected to the earthed side of the '001 condenser.

The panel shown is very efficient and easy to construct, and the 3-way switch can well be omitted.

Now for an easy way to get good results on one valve. This is absolutely essential before you are fit even to experiment with the "May" circuit.

I advise those of you who live in the south to practise on F.L. concert 2,600 metres 6.20 p.m., or Radiola until proficient, then you will be

able to get the broadcasting stations far better and with little fear of annoying everyone around you.

First of all, provide yourself with plenty of H.T. You will find as you increase this and L.T. in sympathy with it, that with each advance you can loosen the coupling more and more, until you can get the coils separated four inches or more. As the space widens between the coils the reception becomes better and stronger, and the oscillating point less and less critical and unstable, and the margin beyond the oscillating point so great that there is no excuse for ever annoying your neighbours, as you will now have plenty of room to get silent sweet reception. If you reach the limit of extension in your coupling, and still have the carrier wave, lower the filament current and you cut out all trace of carrier wave and any sign of oscillation.

Hard Valve Necessary.

You will find the stations that come in on little capacity—that is, zero to 30 degrees on your tuning condensers, will require the loosest coupling, and as the capacity increases the coupling increases.

On Sunday evening, August 26th, I received several amateurs transmitting on 10 watts from 40–80 miles away; Croydon several times, 200 miles away, telling someone they were 12½ miles N.E. of Dungeness Point; Radiola, the Hague Concert; F.L. 6.20 p.m. This I could hear, and distinguish the tune when the 'phones were worn by someone else, and no trace of carrier wave. Later, each one of the British stations. I used 138 volts H.T. and Ediswan A.R.

In conclusion, let me point out that for successful operation you must use a fairly hard valve, the "May" circuit will not function well with valves of the very soft variety. As yet, I have not tried dull emitters, but should imagine that on difficulties would arise if this type of valve were employed.

If any further help is needed, please write to POPULAR WIRELESS, and through that paper I will answer anyone.

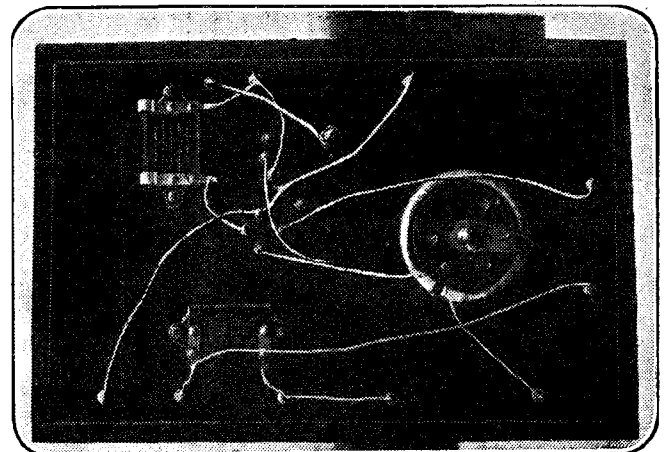

The interior of the set. As will be seen the wiring is very simple.



Result of
15 years'
experience.

Brandes

SUPERIORITY!

Constant and exacting usage in no way detracts from the all-round excellence of "Brandes" Headphones—the distinctive "Matched Tone" feature ensures a clarity and fineness of reproduction which is remarkable. This, coupled with their hard-wearing propensities, sound construction and design, makes them more sensitive, durable and comfortable than any other Headphones in existence.

Your dealer stocks Brandes—
Ask him!

PRICE 25/-

Made in England and bears the B.B.C. Stamp.

CANADIAN BRANDES LTD.,
Walmer House, 296, Regent St., W.1

Telephone: Langham 1525.
Trade Enquiries Invited.

Matched Tone
TRADE MARK
Radio Headphones

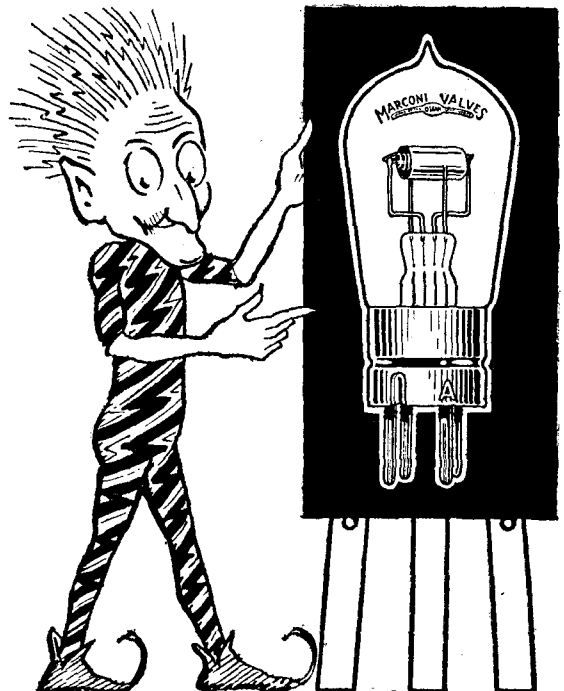

*This is what
really counts*

YOUR set may contain all the latest 'gadgets'—it may be of the most beautiful design and finish—it may be the last word in appearance; but unless you've got the best **valves** your outfit is going to be like a house built on the sand.

MARCONI VALVES have the "OSRAM MADE" reputation behind them. They are made at the famous Osram Works at Hammersmith—and they are **MADE TO LAST**.

Put first things first, by insisting on

MARCONI VALVES
MADE AT THE OSRAM LAMP WORKS

BUY BRITISH GOODS ONLY.

Manufactured by the GENERAL ELECTRIC CO., LTD., and sold by all leading Wireless Dealers, Electrical Contractors, Stores, etc.

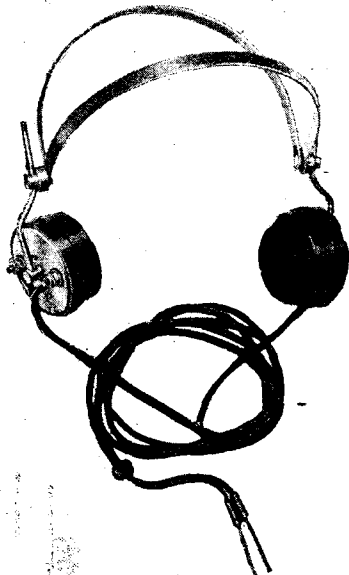

Price 18/6

FELLOWS

NEW LIGHTWEIGHT HEADPHONES

are just what you require. They weigh under 6 ounces and are extremely comfortable. With the special spring adjustment the earpieces may be moved into any desired position or separated without the use of adjusting nuts. This fitting is specially designed not to tear the hair. Wound to 4,000 ohms, they are very sensitive and well made with duralumin headbands, stalloy diaphragms, etc.

FELLOWS MAGNETO CO. LTD.,
LONDON, N.W.10.

TELEPHONE:
WILLESDEN 1560

TELEGRAMS:
QUINMAG, PHONE, LONDON

E.P.S. 27

SINGERS.

The Wireless Experts.

Build your set with our reliable parts. We are Experimenters of old standing, and have a reputation (which we mean to maintain) for Quality, Lowest Prices and Good Service.

- HEADPHONES.** Singer's Lightweight Headphones, 4,000 ohms. Each pair tested and guaranteed. Wonderful value..... 12/9
 Genuine N. & K., 4,000 ohms..... 15/6
 "Opera" Featherweight, 4,000 ohms. A British-made phone 16/6
Aerial Wire, 7/22 H.D.C. 100 ft., 2/- coil.
Aluminium Condenser Vanes, fixed or moving, 5d. doz.
Crystal Detectors on Ebonite, screw cup, 1/3. Glass enclosed, 1/6 and 2/6. Perikon, glass enclosed, 1/10.
Crystal Detector Parts, 3-screw cup, complete, 10d.
Coil Holders for 3 coils, long arms, 6/6; 2 coils, 5/6.
Coil Plugs, ebonite, 1/- and 10d. **Condenser Scales,** engraved, 3d.
Contact Studs, 1 in. x 1/2 in., 3d. doz.; 1 in. x 1/4 in., 6d. doz.
Condenser Plates, top and bottom, with bush, 1/- pair.
Ebonite Dials, engraved 0-180, 11d.
Filament Resistances, Eureka Wire, 2/- and 1/9. **Dials,** brass inset, 6d. each.
Fixed Condensers, 10d. and 1/6. All capacities.
Knobs, best quality, 3d. **Switch Arms,** complete, 9d. each.
Insulators, Reel, 1d.; Egg, 1d.; Green Shell, 2d.
L.F. Transformers, 4/-, very efficient, 13/6; "Formo," 18/-;
Radio Instruments, 25/-
Nuts, 2 B.A. 2d.; 4/5/6/8, 2d. doz. **Washers,** 2 E.A., 1d.; 4 B.A., 1d. doz.
Spade Terminals, 6d. doz. **Stop Pins,** with nut, 1d. each; 9d. doz.
Spacer Washers, 3 in. or 3-32 in. Large, 2d.; small, 2d. doz.
Terminals, Phone and Pillar, with nuts and washers, 1d. each. W.O., with nuts and washers, 2 for 3d.
 Small 4 B.A. Terminals, with nuts and washers, 2 for 2d.
Variometers, 3/6. Ball Rotor, 6/6. Variometer and Tapped Loading Coil combined, 5/6. All very efficient.
Valve Holders, with 8 nuts and washers, 8d. each.
Valve Sockets and Valve Pins, with nuts and washers, 1d. each; 9d. doz.
Wire. All gauges in stock at lowest prices.

Try our Special Crystal. Sensitive all over. 9d., 1/- and 1/3.
 ALL OTHER PARTS SUPPLIED. SEND FOR FREE LIST.
 Please remit ample postage.

Orders despatched same day as received **AND WE DO IT.**

L. SINGER (Removed from 17, Bouverie St.),
397A, EDGWARE RD., LONDON, W.2.

Phone:
 3455 Paddington.
 TRADE SUPPLIED.

Hours of Business:
 Daily—8.30-8 p.m.
 Sundays—11-1 p.m.

The SUPER CRYSTAL SET

BRITISH MADE. Complete with
 1 pair Phones 4,000 ohms, Aerial Wire 7/22 100 ft.
 Coil, Lead-in Wire, Insulators, Lead-in Tube.

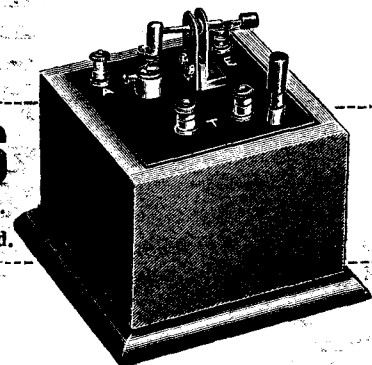

32/6

Post Free.
 Guaranteed.

32/6

Post Free.
 Guaranteed.

- L. and A. Phones 4,000 ohms 12/6 each.
 Genuine Brunet Phones 4,000 ohms 17/6 each.
 L.F. Transformers, ratio 5 to 1 11/6 each.
 Switch Arms, Best Quality 9d. & 1/- each.
 Filament Resistances, velvet action 2/- each.
 Crystal Detectors 1/-, 1/6 & 2/- each.
 Dutch Valves 7/- each.

We have a large stock of Mullard, Ediswan & Cossor Valves.

L. APPLE, LTD., Telephone:
 Regent 1584.
13, Brewer Street, Regent Street, W.1,
 also at 79a, Tottenham Court Road. W.

Artistes of the Aether

BY 'ARIEL'

Some of the artistes who have given you pleasure while listening-in

AS the needs and requirements of broadcasting become greater, the strain on the artiste who "radios" his talent before the microphone increases.

Naturally the greatest diversity is to be found amongst the singers, and it is here that the master of his—or her—art conquers, for if the microphone registers pleasant sounds, it must also be remembered that it also registers imperfections as well as perfections, and woe betide the singer whose breath control is unequal, or tone production ill-trained. We listeners-in hear all.



Miss Isabel Hirstfield.

When "Sunday comes" it often brings with it a pleasant afternoon spent at the Æolian Hall, metaphorically if not literally. This is due to the genius of Mr. Frank Armstrong. One of

London's best-known organists, Mr. Armstrong, may be said to have made the "golden pipes" of Æolian Hall peculiarly his own, and for many years past some fine concerts have taken place here.

The pipe organ is not an easy instrument to "radio," and to command its performance before the microphone is somewhat like experimenting with the elephant at the Zoo, but with better results, however, for Mr. Armstrong succeeds in the majority of the stops "across the ether," and the admirable results are due also in no small measure to the careful selection of the works chosen, due probably to his long experience at this hall.

Demand for Classics.

It is almost surprising how greatly the broadcasting programmes are changing their character, though, of course, dance music still plays a prominent part, there is obviously a growing demand to hear music of a type that this time last year would have been labelled as "highbrow" and impossible stuff. Particularly is this the case with the pianoforte solos.



Mr. Herbert Langley.

In this branch of music we have had some of the great classical concertos and sonatas performed by orchestra and soloists in real Queen's Hall Symphony fashion. As witness to this, one cannot conceive better work than was done again recently by Mr. Maurice Cole, when with the

support of Mr. Stanton Jeffreys and an augmented orchestra a wonderful interpretation was given of Tchaikowsky's great B flat minor concerto, while in pianoforte work solos, the playing of Miss Isabel Hirstfield stands out prominently.

In the Provinces.

Miss Hirstfield has had a very wide experience, both as teacher and as executant, while as a composer, too, she is known, and her latest work is a musical act entitled "Our Musical Ancestors," which will gain big bookings. Miss Hirstfield has had continental experience, being formerly a pupil of Professor Klindworth in Berlin, and of M. Moszkowsky in Paris. It is perhaps due to the latter's influence that the delicate passages of the old French and Italian composers are so delightfully played by her.



Mr. Frank Armstrong, the well-known organist, at the organ in the Æolian Hall.

Works that "came over" especially were "Toccata," by Paradies, a "Pastorale," by Scarlatti. Miss Hirstfield is a familiar figure at the special concerts of the Albert Hall, the Queen's Hall Promenade Concerts, and throughout the provinces. Her radio work was remarkably successful.

As usual, the provinces have been having very good radio programmes, and amongst the soloists mention must be made of a clever violinist, Mr. Herbert Isaacs. A gold medalist of Bristol Eisteddfod of 1909, he has won numerous prizes, and is a pupil of Percival Hodges, the leader of the Birmingham String Quartette. Mr. Isaacs comes of a musical family, and has done ample credit to them. Like most people he put aside his

own career for the war, and joined up in the infantry, going through many engagements; but it is good to know that throughout his campaigns his fiddle accompanied him, and both came through unscathed. Just six months before Peace was signed, Mr. Isaacs played in the Trouville Symphony Orchestra. Violinists, perhaps, may be interested to know that this capable young player uses a Sebastian Klot violin of 1730, and it is possibly due to the powerful G string on this that his radio solos came over so well.

The opera season is with us again, and listeners-in will doubtless have the pleasure of hearing two people return "to the fold," as it were, from far away. These are Miss Eda Bennie and Mr. Herbert Langley. Miss Bennie has returned from Australia, and Mr. Langley from Berlin, where he has been a film star playing in the screen production of the famous play, "Chu Chin Chow." Mr. Langley is noted for his fine baritone voice, and he has sung in every known rôle, but his best parts are perhaps Iago in "Otello," and Hans Sach in "The Meistersingers."



Miss Eda Bennie.

A Popular Soprano.

Miss Eda Bennie is an Australian by birth, and has just been spending a few months' holiday in her native Dominion.

As a member of the British National Opera Company she has appeared in every important rôle, and is returning to take up fresh parts with them. Miss Bennie, in relating her Australian experiences, tells

vividly what an opportunity there is for opera in Melbourne. Every company has been warmly welcomed, and there is no doubt that could the B.N.O.C. be transported there we should have no Christmas season at Covent Garden, and no golden opportunities for Londoners to hear Miss Bennie's beautiful soprano voice.

Miss Daisy Kennedy, that delightful young violinist who has frequently entertained 2 L O's listeners-in, recently rendered some unaccompanied solos. She "came over" really excellently.



Mr. Herbert Isaacs.

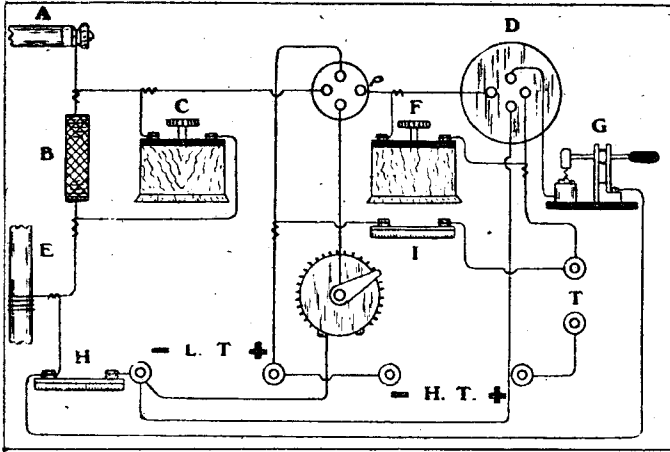

Fig. 1. The simplest reflex circuit. A, B, C, and E, aerial circuit; D, plug-in H.F. transformer; F, .002 mfd. var. cond., in shunt with primary side of D; G, crystal; H and I, .001 mfd. fixed cond.

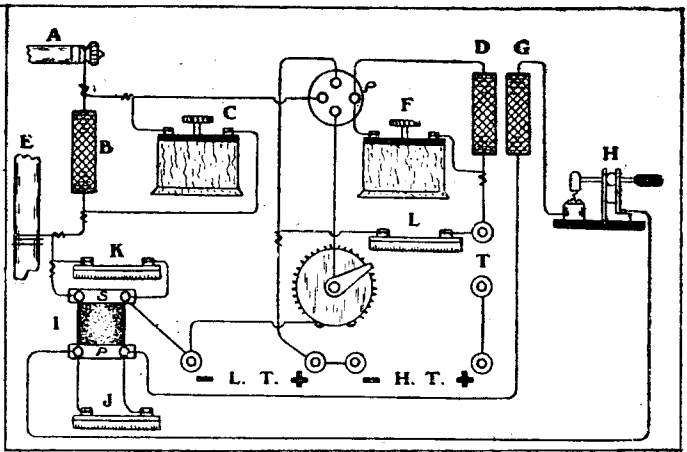

Fig. 2. Modified arrangement of Fig. 1. A, B, C, and E, aerial circuit; D, tuned anode coil; F, .003 mfd. var. cond.; G, reaction coil; H, crystal; I, intervalve transformer; J, K, and L, .001 mfd. cond.

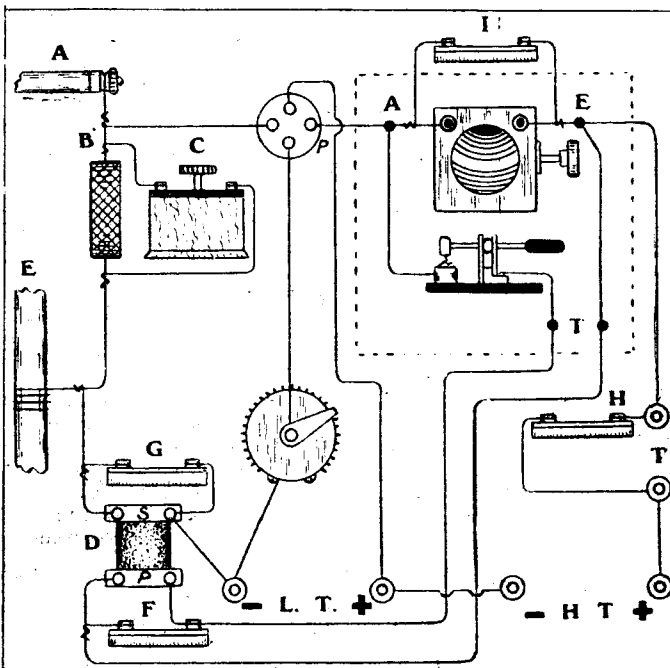

Fig. 3. Adapting reflex circuit to crystal receiver. A, B, C, and E, aerial circuit; D, intervalve transformer; F, G, and H, .001 mfd. fixed cond. Components in dotted lines represent crystal set.

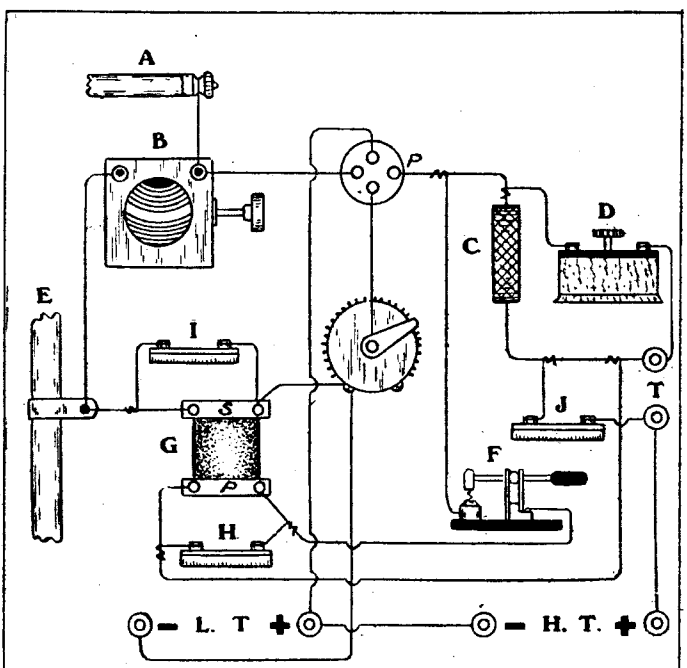

Fig. 4. Another simple reflex circuit. A, B, and E, aerial circuit; C and D, tuned anode circuit; F, crystal; G, intervalve transformer; H, .002 mfd. fixed cond.; I, .0005 fixed cond.; J, .003 fixed cond.

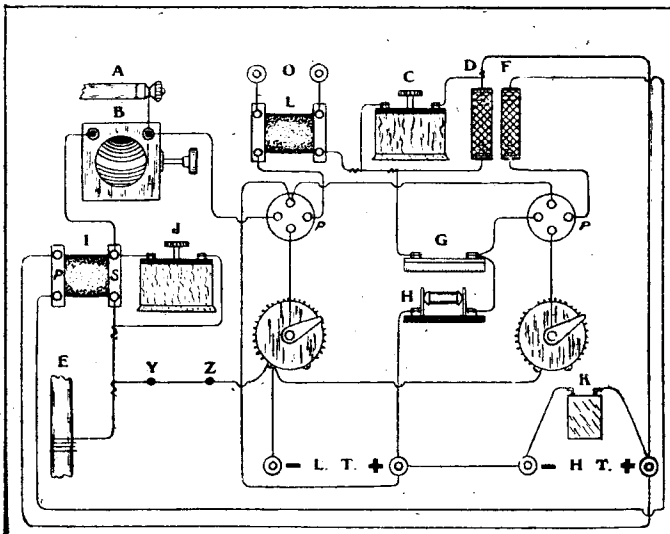

Fig. 5. Two-valve reflex circuit. A, B, and E, aerial circuit; C and D, tuned anode circuit; F, reaction coil; G, .0003 mfd. grid cond.; H, 2 meg. leak; I, intervalve transformer; J, .002 mfd. fixed cond.; K, 2 mfd. fixed cond.

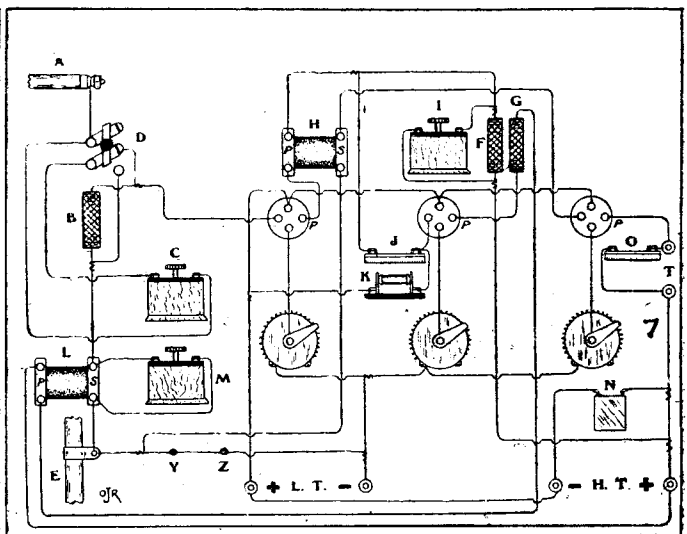

Fig. 6. Three-valve reflex circuit. A, B, C, D, and E, aerial circuit; F and G, anode and reaction coils; H and L, intervalve trans.; I and M, .002 mfd.; J, grid cond.; K, grid leak; N, 2 mfd.; O, .002 mfd.

SIX SIMPLE REFLEX CIRCUITS.

By OSWALD J. RANKIN.

An interesting selection of circuits each of which employs dual amplification.

IT is proposed to describe some practical reflex "hook-ups," and, although no attempt is made to delve into theory and basic principles, it may be well briefly to explain the difference between this type of circuit and any of its rivals. The reflex circuit, together with its name, originally came from America, but it was left to our own experts to perform the difficult task of simplifying matters and to bring it up to its present standard of efficiency.

"Six simple reflex circuits" has been chosen as an appropriate title for this article because, in the writer's opinion, the circuits to be described are really simple. Any attempt to use more than three valves in a dual capacity will invariably end in disappointment, and therefore the reader is advised to confine his ambitions within this limit.

Superimposed Currents.

A reflex circuit must not be confused with a regenerative circuit. Regeneration means feeding back the plate current through a coil inductively coupled to the grid circuit in order to induce a larger current in the latter. Thus the resistance of the grid circuit is considerably reduced, and when the coupling is adjusted just short of oscillation point the increased current flowing in the grid circuit boosts up the current in the plate circuit, in which are connected the telephones, and consequently this results in an all-round increase in signal strength.

The action taking place in a reflex circuit is entirely different. Here electrical waves of different frequencies are superimposed upon each other without interference, just as the vision of one person may cross the vision of another without interference. It is easy to detect two distinct sounds simultaneously, and any effect in light or heat may be similarly superimposed without affecting the identity of either.

The reflex circuit may therefore be described as a circuit embodying the principle of superposition, since two currents of totally different frequencies are superimposed upon each other without losing their identity.

If this phenomenon did *not* exist, then, although it would not be possible to wire up a reflex circuit, it *would* be possible to listen to only one sound at a time, and in this case there would be no such thing as interference from spark stations when "tuning" our ears to the frequency of the waves of the broadcasting station. Thus it is not necessary to study physics in order to comprehend the underlying principles of superposition.

In a reflex circuit the ordinary valve is used for a dual purpose—that is, as a high-frequency amplifier and a low-frequency amplifier, and the obvious advantages of such an arrangement should appeal to all enthusiasts. I am firmly convinced that the coming season is to be a "reflex season," and I have visions of many thousands of the present type of commercial receiving sets

being returned to the factories for alterations. After all, who will purchase two valves, when a certain wiring system not known when most of the commercial sets were rushed on the market will give the same and sometimes better results by using only one valve?

There is little or no distortion with reflex circuits, one reason being because regeneration is not employed, and another because a crystal detector may be used, this giving perfectly clear rectification at all frequencies. The crystal is a distortionless detector, and this is a fact which we cannot ignore. A simple reflex set employing one valve and a crystal is an excellent example of what can be accomplished with a minimum amount of apparatus, and is indeed something to be proud of.

Fig. 1 shows what is probably the most

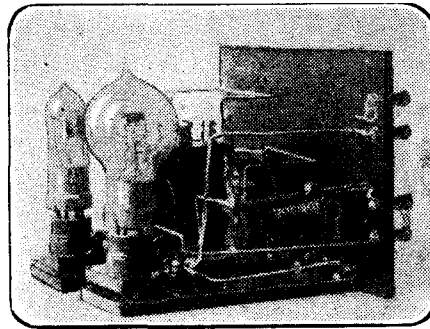

A neat method of constructing a reflex set.

simple form of reflex circuit, employing a crystal for rectifying. The incoming high-frequency currents pass direct to the grid of the valve, and through the .001 mfd. fixed condenser, H, to the negative filament line. A small condenser such as this offers a very small resistance to high-frequency currents, and a very high resistance to low-frequency currents, and this simple phenomenon is a most important factor which forms the basis of most reflex circuits.

Useful Circuits.

The amplified high-frequency currents of the anode circuit now pass to the crystal detector, via the H.F. transformer, D, and the low-frequency currents from the detector are fed back to the small condenser, H. As explained, this condenser will offer a very high resistance to these currents, with the result that in taking the path of least resistance they flow to the negative L.T. line in one direction, and back to the grid, via the aerial tuning inductance, in the other direction. During this period they are amplified at low frequency, and finally delivered to the telephones at a greatly increased strength. This, briefly, is the action of a simple reflex circuit.

Fig. 2 shows how a still greater degree of efficiency is obtained by the addition of a low-frequency intervalve transformer. Here the familiar tuned anode coupling replaces the H.F. transformer, but this, of course, is optional. Fig. 3 shows a circuit which is

likely to appeal to the beginner who is already in possession of an efficient crystal set, and this represents one of the most effective methods of employing a single valve in a dual capacity. The components surrounded by the dotted lines represent the existing crystal receiver, which may include any suitable tuning device, and preferably a detector of the hertzite and fine gold wire tentacle combination.

Fig. 4 shows another simple arrangement which is easily handled by the beginner. This circuit is now fairly well standardised, and can be recommended on account of its simplicity and efficiency. Better results are sometimes obtained by connecting the I.S. transformer lead to the arm of the rheostat, instead of to the resistance helix, as shown, this depending on the type of valve and the amount of H.T. current used.

Fig. 5 shows a good two-valve reflex circuit, giving about six times the signal strength obtained from any efficient two-valve receiver employing a tuned anode coupling and inter-valve reaction.

A Loud Speaker Set.

The values of the components are given in the descriptive text, as in all other diagrams. If it is found necessary to use more than about 60 volts on the anode, a small battery of dry cells should be inserted at Y and Z, this being tapped off at every 1½ volts up to the total value of 18 volts. The negative side of this battery should be connected to Y, and the positive side to Z. Low-resistance phones are used, these being connected to the output side of the telephone step-down transformer, L, which is preferably shunted with a small fixed condenser, the value of this being best determined by experiment.

The circuit, as presented, opens out much scope for experimenting. A variable or fixed condenser may be tried shunted across the primary side of the intervalve transformer, I, and the values of other components may be slightly modified to suit the particular valves employed. Fig. 6 is similar to the circuit shown in Fig. 5, but a third valve and an extra intervalve transformer is added, and this makes an excellent combination for use in conjunction with a frame aerial and loud speaker. As in Fig. 5, the circuit should be broken at Y and Z, and a small variable battery inserted if the H.T. current exceeds 60 volts.

The given values of any of the components, and especially of the fixed condensers, should not be taken as universal. So much depends on the type of valve used, the knowledge of the characteristics of any particular valve, and the quality and quantity of H.T. and L.T. current, that it would seem almost a misleading policy to specify component values at all. Any experienced experimenter will easily understand this.

The tuning of most reflex circuits is somewhat flat in comparison with the tuning of regenerative circuits, but this may be minimised by using a directional frame aerial.

AMPLIFICATION, REACTION, AND SUPER-REGENERATION.

By C. E. FIELD, B.Sc.

1.—GENERAL PRINCIPLES OF AMPLIFICATION.

This is the first of a series of eight articles specially written for "Popular Wireless." Mr. Field needs no introduction to readers, who will remember the very useful and authoritative data that he has provided in his condenser capacity and wave-length tables.

Amplification of signals is perhaps the most important of the many functions performed by the three-electrode valve, and it is, in fact, that for which this valve was originally intended.

There are many ways in which signals can be amplified, but before considering these in detail, we will first see exactly what is required in order that a three-electrode valve can be made to act as an amplifier.

In the simplest single-valve receiving circuit, shown in Fig. 1, oscillating currents in the aerial are made to pass through an inductance coil, on their way to the earth. Whenever an alternating (or oscillating) current passes through an inductance, a similarly alternating voltage is set up between its terminals, and so, by joining the ends of the coil to the grid and the filament of the valve, alternating voltages, or potentials, are produced on the grid, relative to the filament, and it is these variations of grid potential which produce variations in the current driven by the H.T. battery through the valve and the telephones.

Multi-Stage Amplification.

The important point to note is this. The inductance coil does not shunt the aerial current into the valve; on the contrary, practically no current flows along the wire joining the coil to the grid. The operation of the valve depends entirely upon the voltage applied to the grid, or, in other words, a valve is *voltage operated*.

The output of a valve takes the form of a current, drawn from the H.T. battery, and as very *small* variations in the *input voltage*,

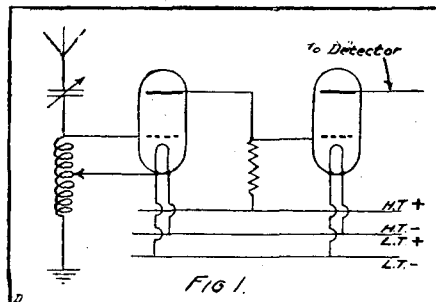

brought about by small variations in the aerial current, produce *large* variations in the *output current*, the valve has the effect of amplifying, or magnifying the signals. The number of times by which the output current is greater than the current producing the input voltage gives a measure of the current amplification of the valve.

If we desired still further to amplify this current, it would have to be made to vary the potential of the grid of another valve. These variations might be, say, five times as great as the corresponding potential

variations on the grid of the first valve, in which case the valve would be providing a voltage amplification of five.

In order to vary the grid potential of one valve by means of the anode current of the preceding one, we might think of joining the plate of the first valve directly to the grid of the second, as shown in Fig. 2. A glance at these connections, however, will reveal two serious faults. First, as the plate of the first valve is joined to the grid of the second, which is, as it were, a blank end, we are blocking the current which we desire to amplify. Secondly, there is no H.T. voltage applied to the plate of the first valve, which means that no energy can be liberated from the battery, and no electron stream will be attracted from the filament.

We must therefore find some means whereby the output current of the first valve is allowed to flow, and at the same time is as far as possible entirely utilised in producing voltage impulses on the following grid. The various methods of carrying this out will be discussed in subsequent articles.

Somewhere in their transference from the aerial circuit to the receiving telephones, wireless signals must be *detected*—i.e. the high-frequency currents must be made to give impulses occurring at low- or audio-frequencies. The question then arises, shall the signals be amplified before or after they are detected—i.e. shall high- or low-frequency amplification be employed?

Note Magnifiers.

This depends very largely upon the strength of the signals being received. A detecting valve, or crystal, operates by allowing very much more current to flow through it in one direction than in the other, which results in one-half of each current cycle being practically cut out. When the signals are very weak, however, this rectification is far from complete, and so, for the efficient operation of a detector, strong signals are desirable. Therefore, for the reception of weak signals (in the case of British broadcasting, from stations at a distance of fifty miles or more), high-frequency amplification should be employed.

As a general rule, it may be laid down that unless a single detecting valve or crystal gives audible signals, it is no use adding low-frequency valves, unless high-frequency amplification is resorted to in addition. Low-frequency amplification has the advantage of simplicity, however, and the amateur who lives within twenty or thirty miles of a broadcasting station cannot do better than employ one stage of note-magnification. When signals are required of sufficient strength to operate a loud

speaker, low-frequency amplification is necessary, but in no case is it advisable to use more than three stages.

Perhaps the best all-round circuit for the reception of British broadcasting is one employing one high-frequency and one low-frequency valve.

The ultimate extent to which amplification can be employed depends upon many factors. For instance, when signals are amplified, it is very difficult to prevent stray noises being similarly strengthened

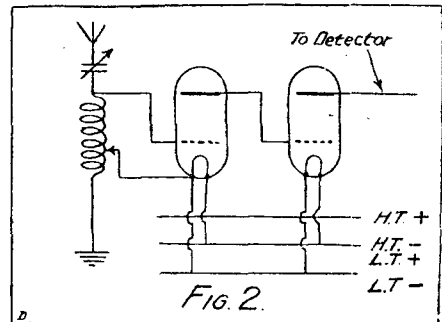

Even if all undesirable noises could be avoided, the power capacity of the valve itself sets a limit to the strength of signal current which can be dealt with.

After a certain signal strength is attained, changes in the grid potential of the last valve will produce very little alteration in its output current. This not only prevents any further amplification, but also distorts the signals, and so spoils the quality of any speech or music. To a certain extent this can be remedied by increasing the plate voltage and filament current of the valve, but if much further amplification is desired it will be necessary to employ a larger valve, or connect two valves in parallel.

A circuit made up of five or six high-frequency amplifying valves, a detector, and two or three note-magnifiers, represents about the practical limit for the satisfactory reproduction of music or telephony, if any consideration is given to the quality of the sounds produced.

A Useful Tip.

On account of the difficulties introduced as amplification is increased, the amateur who is constructing a multi-valve set for the first time is strongly recommended to *add one valve at a time*, and to get the set working perfectly before introducing any further stages of amplification. Otherwise, he will find himself listening-in to a medley of strange sounds which he is unable to locate and eliminate.

Finally, it should be remembered that amplifying valves are a necessary evil, and an efficient three-valve set is much to be preferred to a badly designed set employing four valves.

VARIOMETERS

LOW FREQUENCY TRANSFORMERS

Unequaled for Reliability, Silence and Efficiency. No Transformer gives better results. No. N 54/801 with loose Wires as illustrated, 18/6
No. N 54/800 Terminal Type, 18/-

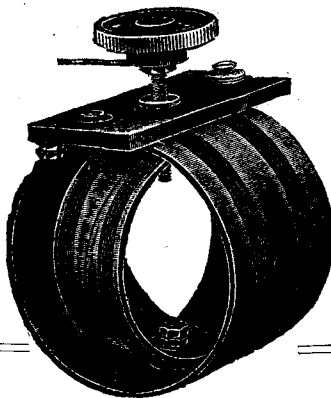
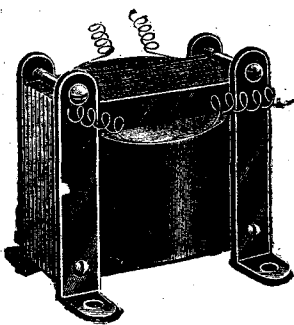

Wave-length 350 to 3,200 metres. Suitable for Panel Mounting. As illustrated. No. N 54/100 22/6 each. Plug-in Type to fit the Standard Valve Socket. Fitted with 4 point Double Pole Switch. No. N 54/500. 27/6 each.

HIGH-FREQUENCY TRANSFORMERS.

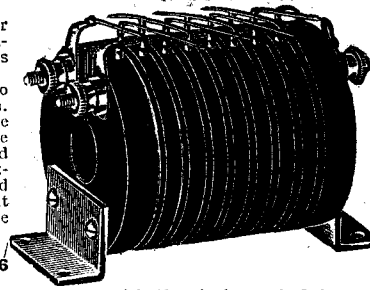

Mounted on Ebonite Base with Terminals marked for respective connections and fitted with 4 point Double Pole Switch. No. N 54/200. 30/- each.

CRYSTAL DETECTOR

Fitted with Ball Socket Adjustment. Mounted on Ebonite Base. No. N 59/380. 2/3 each. Enclosed Type fitted with Glass Dust Shield, as illustrated, No. N 59/400. 3/6 each.

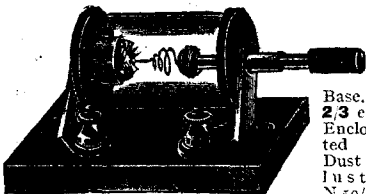

Wave-length 340 to 560 metres. Reliable Model fitted with Ebonite Knob, suitable for Panel Mounting. No. N 54a/15. As illustrated. 5/6 each. Fitted with Ebonite Knob and Ebonite Engraved Dial, suitable for Panel Mounting. No. N 54a/16. 3/- each. Mounted on substantial Ebonite Panel with Terminals. No. N 54a/17. 12/- each. Complete with Detector and Crystal, mounted on Ebonite Panel. No. N 54a/12. 15/- each.

Illustrated Radio Catalogue R/102, showing a complete range of Wireless Receiving Sets and Components, post free on request. Enclose Business Card or Memo for Special Trade Terms and Discounts.

REGULATING RESISTANCE

fitted with Engraved Dial, as illustrated 2/8

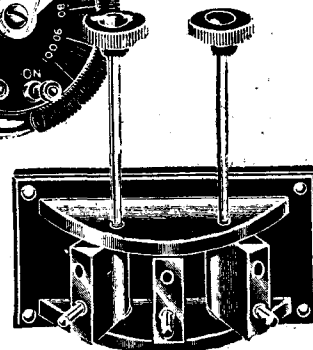
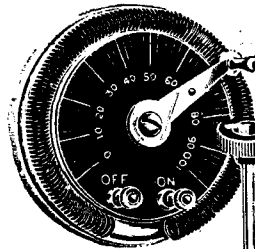

COIL HOLDER

Well designed, perfectly finished. Mounted on Ebonite Panel 2 Coil Type, 9/- 3 Coil Type, as illustrated, 15/-

EXTENSION HANDLE

Fits over Knobs, 1 1/4 to 1 1/2 in. dia. Eliminates all Hand Capacity effects, ensuring accurate tuning. No. N 60/650. 1/4 each.

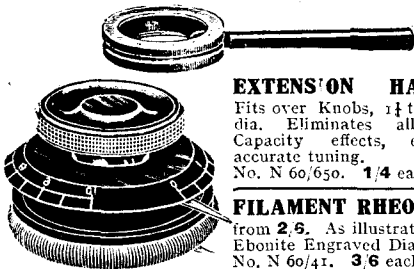

FILAMENT RHEOSTAT

from 2.5. As illustrated with Ebonite Engraved Dial. No. N 60/41. 3/6 each.



Address all communications to Head Office & Works, PENDLETON, MANCHESTER. GLASGOW DEPOT: 65, BOWWELL STREET.

RADIONS LTD.

BEGB to announce that in consequence of their ever increasing business in **REPAIRING WIRELESS VALVES** they have now taken extensive works, and equipped them with the most modern plant. This plant is operated by a highly skilled staff, and they are now in a position to give the utmost satisfaction combined with

PROMPT DELIVERY.

Write for prices and particulars.

RADIONS LTD., Radion Works, Bollington, Nr. Macclesfield ::

Telegrams :
RADIONS, BOLLINGTON.

WIRELESS IN SCHOOLS.

By S. V. HEAP, A.C.P. (Headmaster of Sittingbourne Council School).
A SERIES OF PRACTICAL NOTES FOR THE GUIDANCE OF TEACHERS AND PUPILS.

II.—THE AERIAL—CONSTRUCTION OF THE SET.

FOR reasons already explained, the first efforts of the wireless class should be the construction of a simple crystal receiving set. The set will comprise aerial, tuned inductance coil, variable condenser, crystal detector, and telephones, together with the usual aerial and earth connections.

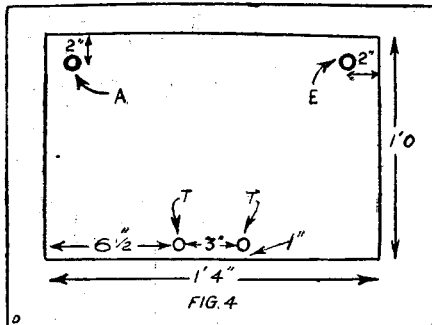

At the outset it is desirable that the functions of the various parts should be roughly understood.

The Aerial is the arrangement of wire, single, double, or multiplex, suspended horizontally as high as possible, for the interception of the ether waves set up by the electric energy in the transmitting aerial system. These, striking the receiving aerial, set up electrical changes in it, which take the form of rapidly oscillating currents of small magnitude.

The aerial wire, like every other conductor, possesses capacity and inductance. The former term is self explanatory—the latter may be looked upon as a sort of electrical inertia.

The sympathetic response of the aerial to ether waves depends upon its individual capacity and inductance, and either or both of these may be varied to suit waves of different frequencies. Hence, selectivity, or the possibility of receiving messages on a certain wave-length, to the exclusion of those on other wave-lengths, is rendered possible.

Rectification.

The inductance of the aerial could be increased by lengthening it, and its capacity by bringing it closer to earth, but such an arrangement would be highly inconvenient and unsatisfactory. An alternative to this, for increasing inductance, is to add to the aerial the whole or portion of a coil of wire. This constitutes the aerial tuning inductance or A.T.I.

The capacity of the aerial is similarly varied by adding to it a variable condenser consisting of alternate fixed and moving vanes or plates, one set of which is connected to the aerial and the other to earth. In practice it is found desirable to work with the capacity factor as low as possible.

The Detector is a simple contrivance for holding in contact two dissimilar crystals, or a crystal and a fine metallic wire or metal plate. It has already been noted that the currents in the aerial are oscillatory, and of such inconceivable frequency that they can produce no effect in the telephones. Many crystals possess the property of permitting electricity to pass in one direction very much more readily than in the opposite direction. This property is made use of in the crystal detector for rendering the current passed on to the telephones unidirectional, and thus capable of being converted into sound.

Method of Winding.

This rectification can be brought about in various other ways, but of all rectifiers the crystal detector is the simplest, and when in correct adjustment, the most efficient.

The Telephones consist of single or double ear-pieces, each containing a double-pole permanent magnet, about each limb of which a very large number of turns of fine, insulated wire are wrapped in the form of bobbin-like coils. Over the poles of each magnet and almost in contact with them rests a thin diaphragm of sheet iron

the first named is used, it must be thoroughly impregnated with melted paraffin wax.

The actual winding, if carried out as described on page 677 of No. 30 of POPULAR WIRELESS, should present no difficulty. Six or eight inches of wire should be left at the beginning and at the end of the coil for connecting purposes.

Wiring Up.

The coil may be mounted in position on the baseboard between end supports, as shown in Fig. 3 in last week's issue.

The top of each end support should be cut or notched to receive the bar on which the slide contact moves. This may be made by the metalworkers of the handicraft class, or if no facilities exist, the squared rod and slide contact with plunger may be bought ready for fixing for about a shilling. The rod must be fixed quite parallel to the coil so that the slide plunger makes even contact throughout its entire traverse.

By sliding the plunger from end to end of the coil a few times a well-defined mark may be made on the enamel of the wire. With a sharp knife, the enamel may be scraped off along this line, thus ensuring good electrical contact.

Four terminals should be fixed in the baseboard in the positions indicated in Fig. 4, one each for aerial and earth connections, and two for the telephones. The efficient insulation of these terminals is important, and can readily be accomplished by making bushes of ebonite from sections of the round part of a tobacco pipe mouthpiece. Holes are bored to the depth of half an inch in the appropriate positions in the baseboard with a suitable sized centre-bit. The ebonite bushes are dipped in hot glue and gently tapped into their several holes. When firm and dry, the bushes are ready to receive the terminals, which they insulate as effectively as if the base were of ebonite throughout.

This being a school demonstration set, the leads and circuits should not be concealed, but should be clearly differentiated by different coloured systoflex, or wire covering. A very useful device with young children is to use orange and red for the oscillatory and rectified circuits respectively.

The lay-out and wiring may appropriately take the form shown in Fig. 5.

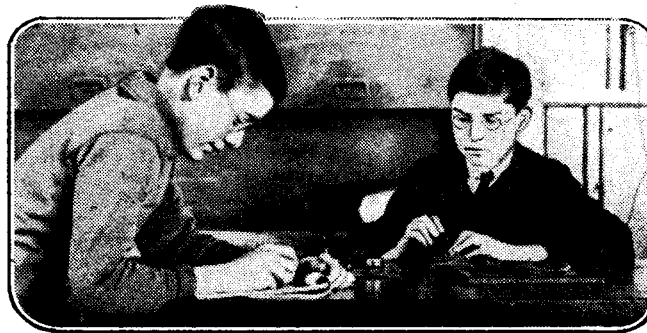

Part of the telegraphy section of the Wireless class in a Leyton school.

(or of aluminium bearing an iron reed). As the rectified current passing through the telephone leads encircles the magnets their power is augmented or decreased with the varying power of the current, and the diaphragms are more or less strongly attracted, thus acquiring a vibration corresponding to the original sound or impulse which controlled the amplitude of the ether waves sent out by the transmitting station.

A Baseboard, measuring 16 in. by 12 in. and about $\frac{5}{8}$ in. thick, will serve admirably to support the inductance coil, condenser, and detector. This may be made, by the handicraft class, of any suitable well-seasoned wood, or a drawing-board of similar dimensions may be used for the purpose.

The inductance will consist of a single layer of 24 S.W.G. enamelled copper wire uniformly and tightly wound on a cylindrical former, 2½ in. in diameter and 9 in. long. This former may be a strawboard tube, a glass cylinder, or an ebonite tube. If

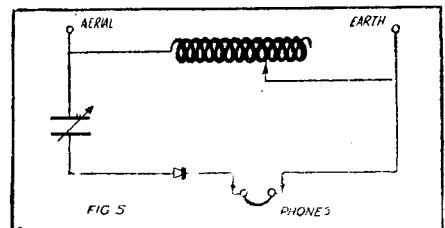

PERFECT RECEIVING SETS

BY POST DIRECT AT NEW AND REDUCED PRICES.

THE "ELTHORNE" DETECTOR PANEL

(Part I. of new Unit System.)

Tuned by a Tapped Coil and Variable Condenser with a wave-length of 100-900 metres. This set is a complete receiving unit and various stages of amplification can be added.

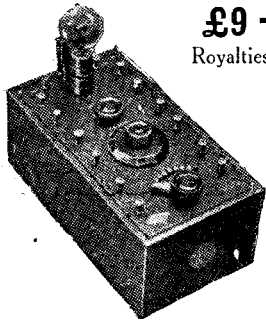

£9-5-0
Royalties £1-0-0

Inclusive of 6 volt 80 amp. Accumulator, Tapped H.T. Battery. Headphones and Valve.

FULL PRICE LIST FREE.

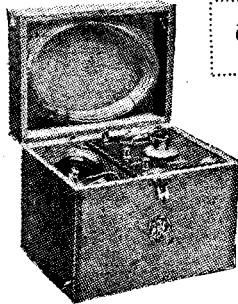

ALL SETS CARRIAGE PAID.

THE "ELTHORNE DE LUXE" CRYSTAL RECEIVER.

Contained in Handsome Oak Cabinet and constructed on best quality Ebonite, with Variometer Tuning (range 20-25 miles), wave-length 150-600 metres. Complete with one pair of Headphones, 4,000 ohms, 100 ft. Aerial Wire and 4 Insulators .. **£4-10-0**

Without 'Phones, Aerial Wire and Insulators .. **70/-**

Carriage and Royalties paid.

CHEAPER SETS FROM **40/-**

THE "ELTHORNE" CRYSTAL AND TWO-VALVE RECEIVING SET.

Consisting of Crystal Detector and Two-Valve Amplifier. An ideal Set for the Home. Built on best quality Ebonite. Nickel-plated Fittings, and Mounted in Solid Mahogany Case.

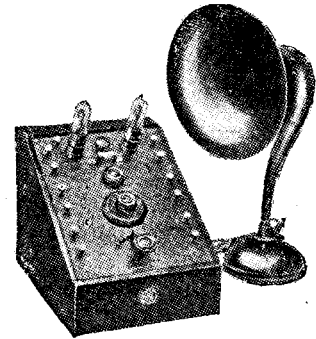

Complete with Loud Speaker, 6 volt. 80 amp. Accumulator, Tapped H.T. Battery, Headphones and Valves .. **£18-5-0**

Royalties £2-2-6

ABSOLUTE SATISFACTION OR YOUR MONEY REFUNDED IN FULL.

Treasury Notes should be Registered. Cheques and P.O.'s. crossed & Co., and made payable to:

ELTHORNE MANUFACTURING COMPN., ST. KILDA HOUSE, 24, MILTON ROAD, LONDON, W.7.

Within 24 Hours

GUARANTEED ACCESSORIES—money returned in full if not perfectly satisfied. Delivery by return. Send at once for free list.

- | | | | |
|-------------------------------|-------------|-----------------------------------|----------------|
| BASKET COILS, Set 6. | 2/- | EBONITE | 3 lb. |
| BATTERIES 36 v. 5-; 60 v. | 9/6 | SCREWED ROD 2 B.A., 2 1/2; | 3/3 |
| CATSWHISKERS, 9 ct. gold. | | 4 B.A. | 11/- |
| 2d.; silver 1d.; spearpoint | 1d. | L.F. TRANSFORMERS 5-1 | 2d. |
| COIL HOLDERS. Solid ebonite; | | L.F. TRANSFORMERS, | |
| 2-way, 4/6; 3-way, 5/6; | | NICKEL | 12/6 |
| Sockets, .. each | 8d. | H.F. TRANSFORMERS 4/6 upwards | |
| CONDENSERS, FIXED. To | | SWITCH ARMS, first quality | 8d. |
| '001, 10d.; to '005, 1/-; | | SLIDER ROD | 3 1/2d. |
| to '006, 1/3; with Grid Leak | 2/6 | PLUNGER | 2d. |
| CONDENSERS, VARIABLE, | | PLUNGER, BEST | 6d. |
| aluminium end plates, '001, | | SWITCHES ON EBONITE, | |
| 8/9; '00075, 7/8; '0003, 6/9; | | S.P.S.T. 1/3; S.P.D.T. 1/9; | |
| '0003, 5/11; '0002, 4/11; | | D.P.S.T. 1/9; D.P.D.T. | 2/6 |
| '0001 | 4/1 | NUTS, 2 B.A. | 2 1/2d. |
| CONDENSER SCALES | each | NUTS, 4/5/6/8 | 2d. |
| SET OF LABELS | 6d. | WASHERS, all B.A. | doz. 1d. |
| CRYSTALS, Hertzite | 9d. | SLEEVING, 2 mm. | 3 yds. 1 1/2d. |
| Zincite, 9d.; Bornite | 6d. | SPACING WASHERS, large, | |
| Every Crystal stocked. | | doz. 2 1/2d.; small, .. doz. | 1 1/2d. |
| CUPS, 4 screw | 1 1/2d. | INSULATORS, Egg, 2d.; Reel, | |
| CONTACT STUDS | doz. 4d. | 1d.; Shell | 3d. |
| STOPS | 1d. | INDUCTANCE COILS, taped | 2/6 |
| CRYSTAL DETECTORS, Glass | | VALVE PINS | 1d. |
| case, 1/9, 2/-, 3/6; Brass, | | VALVE LEGS | 1d. |
| 1/-; Nickel | 1/9 | VALVE HOLDERS | 9d. |
| FILAMENT RESISTANCE, 1/6, | 2/- | VARIOMETERS, Silk wound | 3/6 |
| FILAMENT RESISTANCE, | | And any accessory required at the | |
| WITH DIAL | 2/6 | lowest prices obtainable. | |
| FILAMENT RESISTANCE, | | | |
| PORCELAIN | 4/6 | | |
| FOIL, COPPER | ft. 3d. | | |
| FOIL, TIN | ft. 4d. | | |
| INSULATED ROOKS | 1 1/2d. | | |
| TAPE | roll 6d. | | |
| KNOBS, Finest | 4d. and 2d. | | |

TRADE SUPPLIED.

RADIO "STOCKS" LTD., MAIL ORDER RADIO HOUSE, 89, NEWMAN STREET, LONDON, W.1.

(In between Oxford Circus and Tottenham Court Road.)

and at 43a, CRANBOURNE ST., LEICESTER SQUARE, W.

Telephone: Museum 4213.

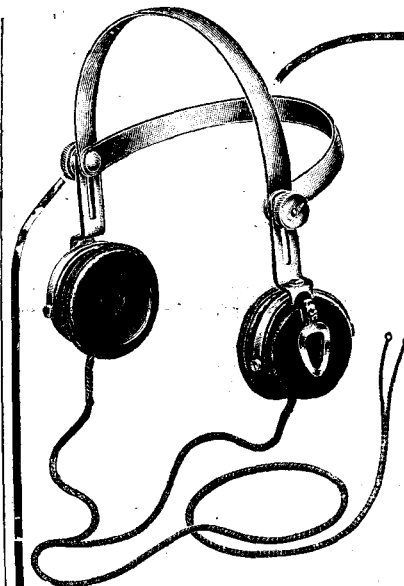

PIVAL HEADPHONES

4,000 ohms, moulded ebonite receivers. Double duralium rustless bands.

16/-
Post 6d.

Ditto, 8,000 ohms,

18/-
Post 6d.

PIVAL SINGLE RECEIVERS

in moulded ebonite, completed with Hook and Cord. 2,000 ohms. 6/- Post 1d. 4,000 ohms, 7/- Post 1d.

THESE headphones and single receivers were introduced by us to the British Public over 12 months ago and have STOOD THE TEST OF TIME. Thousands have been sold. If your local Dealer cannot supply, send direct to us, the DIRECT IMPORTERS AND DISTRIBUTORS. Revised List sent post free.

TRADE SUPPLIED AT RIGHT PRICES.

W. JOANES FOR PHONES,

42, Jenner Road, Stoke Newington, London, N.16.

Telephone: Dalston 4747.

DUBILIER CONDENSERS

WHEN you buy a Vanicon, you pay slightly more, but when you consider the improvement which it will make to the results from your set, you agree with thousands of other users of Dubilier Condensers, that it is WORTH IT.

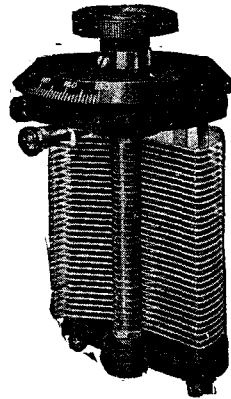

THE VANICON.

PRICES

Capacity	PRICE	Extra for Ebonite Box
·0003 mfd.	17/6	7/6
·0005 „	£1 0 0	7/6
·0007 „	£1 2 6	10/-
·001 „	£1 5 0	12/6

Each Condenser can be supplied with a calibration Chart at an extra charge of 10/6.

Write to us to-day for our Trade Terms and Descriptive Leaflets.

THE DUBILIER CONDENSER CO. (1921) LTD.

Dept. E,

Ducon Works, Goldhawk Road, LONDON, W.12

Telegrams: "Hivoltcon, Phone, London."

Telephone: Hammersmith 1084

(E.P.S. 22)

YOU MAY KNOW

something about the following:—

Dual Amplification, Resonance, Impedance, Capacity, Earths, The Microphone, Self-Oscillation.

BUT do you THOROUGHLY understand them?

These and all other essential matters are fully treated in Our SPECIAL WIRELESS COURSE.

This has been written to impart to Listeners-in and Amateur Experimenters a sound knowledge of Radio Science.

THE COST IS SMALL.—The fee for the complete course of 12 lessons is 30s. in one payment or 6 monthly payments of 6s.

LEARN BY POST AT YOUR LEISURE.

Let us help you to attain a higher standard of personal efficiency Professional Courses in the following subjects:—

Civil Engineering, Mechanical Engineering, Marine Engineering, Electrical Engineering, Automobile Engineering, Internal Combustion Engines, Draughtsmanship, Mathematics, Preparations for the Examination, Matriculation, B.Sc., A.M.I.C.E., etc.

BEGIN NOW.—Full particulars of our course and moderate fees, payable monthly, will be forwarded on receipt of a post card.

THE NATIONAL INSTITUTE OF APPLIED SCIENCE
3, 5 & 7, Old Queen Street, Westminster, S.W.

FILTRON-COMBINATION (Patd.) 7/6 EACH

consists of a combined

VARIABLE GRID LEAK (Zero-7 Megohms)
VARIABLE GRID CONDENSER (Zero-0005 M/F)

Efficient in every Radio application

Filtron—VARIABLE GRID LEAK 4/- each
(Zero-7 megohms)

Approx. Calibration with H Graphite.

Degrees Rotation Megohms Resistance	0°	90°	180°	270°	360°	540°	720°	1080°	1170°
·001									
'01		'4	'8	1'2	1'6	3'2	4'1	7'6	10'7

Harder Graphites increase and softer decrease these readings proportionally. A variable High Ohmic resistance of precision.

"STATIC-RSTER," 2/9 each. Lengthens the life of Coils, Condensers, and Headphones, and ensures perfect safety to your Set. Fitted to any Set in two minutes and needs no further attention.

RADIO SPECIALITIES,
57a, Denbigh Street, Pimlico, S.W.1.

Phone: Victoria 5463.

Generous Trade Terms.

200,000 Magnet Letters

have been supplied by us to WONDERSIGNS of HOLBORN. Each letter is a perfect Magnet. Hence our knowledge of what a Magnet should be, and our ability to produce the BONTONE PHONE under mass production.



Ohms
4,000
Per
Pair

POINTS TO CONSIDER.

Every Phone is sold under GUARANTEE.

Every Phone is tested before leaving Factory.

We are old-established British Manufacturers, whose object is to give complete satisfaction.

14/6

per pair.

Carriage paid United Kingdom.

Why saddle yourself with Continental Phones distributed by unscrupulous Importers with small offices and elaborate notepaper and NO GUARANTEE or hope of redress if found faulty?

Originals of upwards of 100 unsolicited Testimonials and letters of appreciation can be seen at our Offices.

GUARANTEE. We agree to replace or return cash if Phones do not give complete satisfaction, subject to Phones being returned to us within 7 days of purchase, undamaged.

BONTONE PHONES (4,000 ohms.)

BRITAIN'S BEST.

SENSITIVE, DURABLE, COMFORTABLE, AND BEAUTIFULLY FINISHED.

Manufactured entirely by British Labour.
LIBERAL TERMS TO THE TRADE.

B. D. & Co. (Edward A. Boynton),

Works: GOSWELL ROAD and CITY ROAD, LONDON, E.C. 1.

Offices: 167-173, GOSWELL ROAD, LONDON, E.C. 1.

Admiralty, War Office, and India Office Contractors.



A Receiver in a Cigar Box.—Protection Against Lightning.

A RECEIVER IN A CIGAR BOX.

WITH the coming of the autumn and the longer evenings, a revival of interest in wireless telephony is sure to make itself apparent, and those amateurs who last year were content to "listen-in" on ready-made apparatus, or even to hear broadcasting on the set of a friend, will undoubtedly, in the majority of cases, wish to go a step further and construct their own instrument.

The Parts Required.

It is sound common sense for the uninitiated to begin by making up a crystal receiver, and while the following description is intended primarily for the young amateur, newcomers to the field of wireless might do

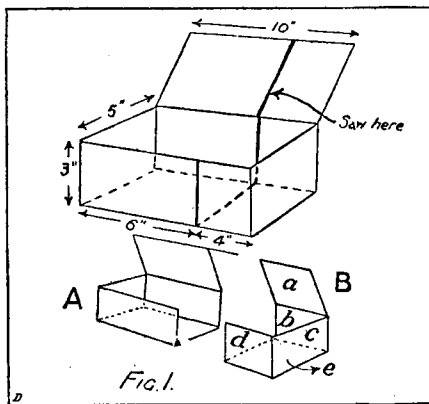

worse than to make the set described in this article. The details given are of a simple crystal set which can be easily made at the total cost of a shilling or two, and this little set, when completed, has been found to be very efficient at a distance of over 12 miles from 2 L O.

The requisites are as follows:

A cigar box about 10 in. long, 5 in. wide, and 3 in. deep.

Four terminals for the necessary aerial, earth and telephone connections.

A set of crystal detector parts and a piece of crystal.

Some 22-gauge double-covered cotton wire.

Two small pieces of stout cardboard about 5 in. square.

Some seccotine or glue, or alternately some small screws or brads.

It will be seen that the total cost of the necessary articles is about 2s. When

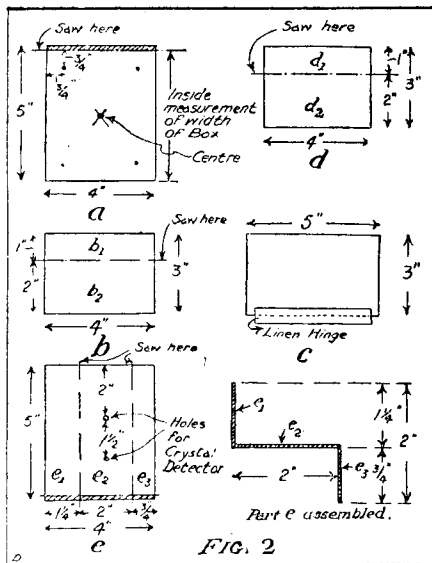

these have been procured, a start can be made.

Mounting the Terminals.

If a very neat result is required, it will first be necessary to remove the labels from the cigar box. This can be done either with sandpaper, or by placing on the labels cloths which have been saturated in hot water; if the latter method is used, be careful to avoid making the wood too wet, as in this case it may subsequently warp. The box should then be cut into two parts as shown in Fig. 1—one part, A, being 6 in. long, and the other portion, B, 4 in. Take great care not to break the larger part, A, as this forms the basis of the set. Part B is then taken to pieces (of which there are five), and dealt with as indicated in Fig. 2.

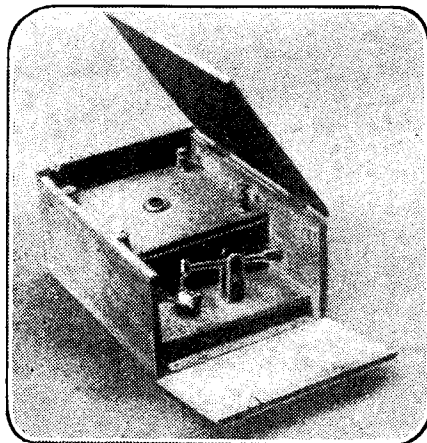

The completed set.

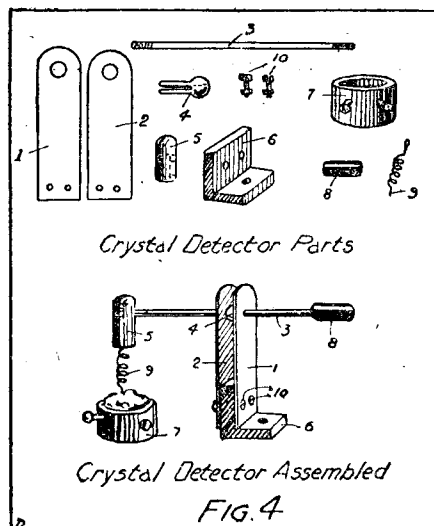

Piece "a" should have just enough taken off its longer edge to allow it to rest inside the box. A small hole should next be made in each corner, to allow of the terminals being mounted, and the exact centre of this panel should be clearly marked.

Pieces "b" and "d" are treated alike; each is sawn into two, as shown in the diagram.

Assembling the Detector.

Piece "c" is cut into three parts, the sizes of which are given, and the two holes for mounting the crystal detector are bored through the largest piece. It should then be fastened together in the "step" form, as illustrated in Fig. 2.

The remaining piece "e" has a linen hinge, or, if so desired, two small brass hinges, attached to one of its longer edges, and is fastened to the set as shown in Fig. 3. The pieces "b2" and "d2" are then glued into position on the inside of the box as shown in the same diagram.

It is now necessary to give attention to the building up of the crystal detector. To describe this literally in detail would

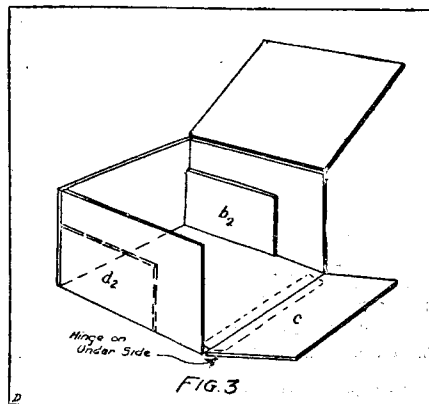

occupy a great deal of space, and the necessary parts of the detector are, therefore, shown in Fig. 4, together with an illustration of the complete component. The "key" figures will serve as a guide when the detector is being assembled. The detector is then mounted on the base previously referred to as "e2."

Attention must next be given to the coils. Take the two pieces of cardboard

(Continued on page 224.)

PROTECTION AGAINST LIGHTNING

A very simple device for earthing the aerial when not in use or during thunderstorms.

TO people who are nervous of lightning, the aerial is frequently an object of dread. During a thunderstorm they are sometimes so frightened in case it should act as a lightning conductor that they are unwilling to operate a simple switch connecting it with earth, and the following method, which automatically "earths" an aerial whenever necessary, will amply repay them for the little trouble involved beforehand.

It is well-known that a lightning discharge seeks a *direct* path to earth, and therefore all that is necessary to safeguard wireless instruments indoors is to provide an outside pathway, which will be so direct and suitable that lightning would never attempt to travel by the round-about coils and wire of the indoor route.

Easily Constructed.

For instance, in the case of the window shown in Fig. 1, the aerial could be extended from the point where it turns to go to the instruments, a lead inserted between A and B, as shown by the dotted line, and wireless signals can be prevented from taking this route by inserting a tiny air gap at X.

This gap would act as an insuperable barrier to an incoming wireless current, which would therefore travel to earth via the instruments in the ordinary way; but lightning would impatiently bridge the small air-space at X, and spark across the gap to earth in preference to traversing the longer indoor path. The smaller the air

space interposed between aerial and earth at X the better, and a very effective little gap can be constructed from a cigar-box, two pieces of wood measuring about 3 in. by 3 in. by $\frac{3}{4}$ in., and two pieces of brass strip about 3 in. by 1 in. For insulators we shall need also two strips of waxed paper, about 1 in. by $\frac{1}{4}$ in., or any other very thin insulator, such as mica.

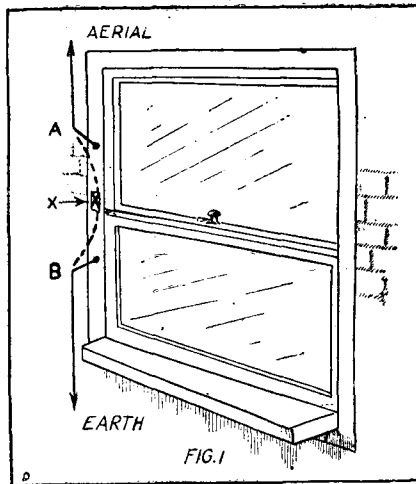
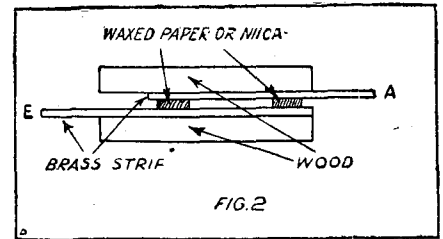

FIG. 1

The construction can be seen from Fig. 2. One block of wood forms the base upon which is placed the brass strip E. This is left protruding from one edge of the block, to enable a soldered connection to be made



with the earth-lead. Across the strip about $1\frac{1}{2}$ in. apart, are placed the two pieces of waxed paper (or mica), and the second strip (A) is then placed on top as shown. The waxed paper must be only just thick enough to prevent the two brass strips from touching when all is held firmly in place by the second block of wood.

The whole contrivance should be placed inside a cigar-box, and secured by two screws passing down from the top block through holes drilled in the bottom block, and into the base of the box. (The holes drilled in the bottom block should be large enough for the screws to pass through it without touching this block.)

At each end of the cigar-box a small hole will admit aerial and earth-leads, and the box should be made as weather-tight as possible. A coat of shellac varnish inside and out will keep it damp proof, but if damp is allowed to settle on the blocks of wood inside, or if beads of moisture form there too readily, they will provide a conductor, and thus weaken or destroy the insulation of the aerial. If a little care is taken to keep the inside of the box dry, it can be relied upon to provide a thin cushion of air-space between aerial and earth-strips; this will always divert wireless signals, but at the same time would provide an irresistibly easy and direct path to earth for lightning.

A RECEIVER IN A CIGAR BOX.

(Continued from page 223.)

and cut them into circles 4 in. in diameter. Mark off a small circle of $1\frac{1}{4}$ in. diameter in the centre of each. Make seven slots about $\frac{1}{16}$ in. wide, as shown in Fig. 5, and then wind the 22 D.C.C. wire on these, making 16 turns on each side, or 32 turns in all for each coil. These are then mounted on a small piece of wood $\frac{1}{4}$ in. square, and 2 in. long, the final positions of the coils being clearly shown in Fig. 6. It will be noticed that the wooden axis supporting the coils is held to piece "a" by an ordinary wood screw, for which, it will be remembered, a mark was made in the centre of piece "a" previously. Take care not to break the wire between the winding of the two coils.

Only One Adjustment.

The set should now resemble Figs. 3 and 6 (after the terminals have been placed in position) and all that remains to be done is to connect up the wiring. Mark the terminal nearest the crystal cup A, as this is the terminal to which the aerial will be connected. The terminal to the left of it should be marked E for a similar reason, namely, that it is to be joined to the earth lead. The remaining two terminals P1 and P2 are for the telephone connections.

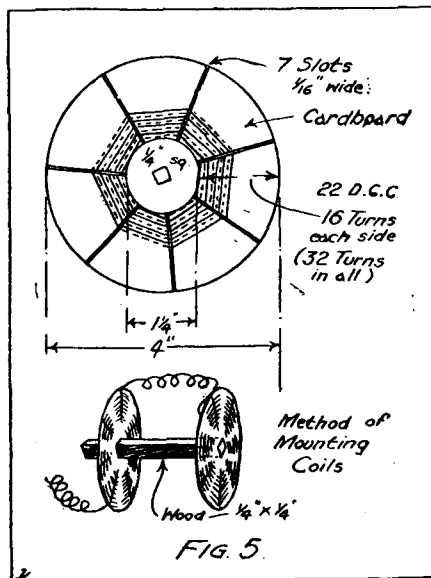

Connect one end of the coils to the "A" terminal, and the other end of the coils to the "E" terminal. Next join the "A" terminal to the crystal holder, that is to say, the crystal cup. Then connect a wire between the base of the detector arm-holder and P2, which is one of the telephone terminals. Finally, join P1 (the other 'phone terminal) to E, and the wiring is complete.

Before putting the set together permanently it is advisable to test it, so that adjustments can be made to obtain the best results. After connecting the earth lead, aerial and telephones to the apparatus, find by experiment the sensitive spot on the crystal, and then vary the distance between the two coils until the signals are heard at their best. The coils should then be fixed in this position either by means of cardboard washers, or a block of rubber.

The chief features of this effective little instrument are its size, and the absolute simplicity of its working. It is, of course, strictly limited to the reception of broadcasting on a given wave-length, but against this is the undoubted advantage of simplicity in operation, which consists solely in finding a sensitive spot on the crystal.

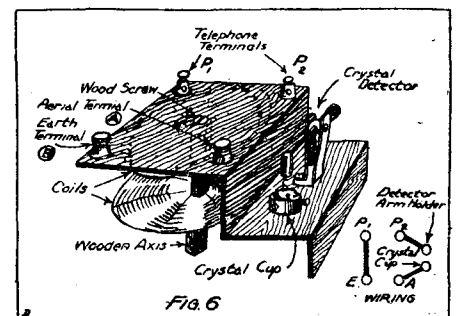

The Wonderful MARCONIPHONE V 2

has been installed at the places shown on the accompanying map and the London Broadcasting Station received with excellent results.

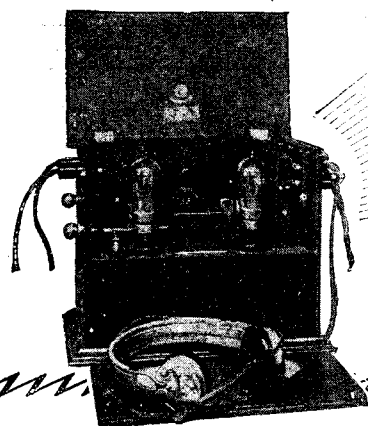
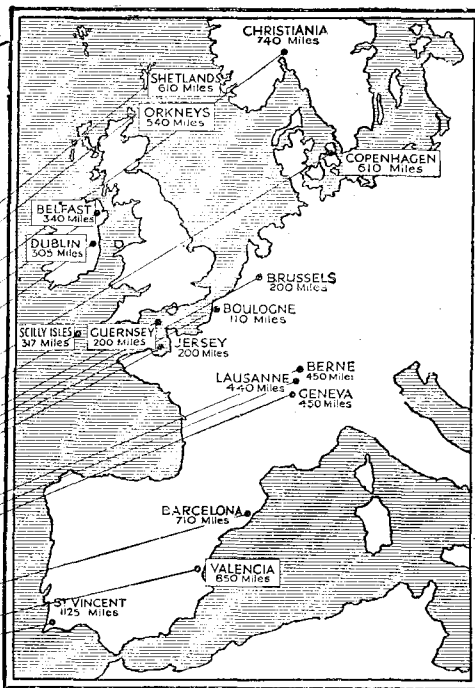

The Marconiphone

The Triumph of the Master Mind

MARCONI'S WIRELESS TELEGRAPH CO. LTD., Marconiphone Dept, Marconi House, Strand, W.C. 2.

BUY

AND

BUILD

YOUR SETS FROM BROWN'S OF MANCHESTER

A Few Good Lines to be going on with

SINGLE EARPIECES (complete with cord), 2,000 ohms	6/-
" " " " " " " 4,000 ohms	7/-
DOUBLE HEADPHONES (French make), 4,000 ohms	16/-
" " (French Thomson-Houston), imitation tortoiseshell bands, 4,000 ohms	22/-
" " (" Sterling " type R 1269), 4,000 ohms	25/-
" " (" " " " R 1238), 4,000 ohms	42/-
" " (Brown's Featherweight), 4,000 ohms	25/-
" " (" D " type), 4,000 ohms	52/-
CRYSTAL DETECTORS (on ebonite base)	2/-
" " (enclosed)	2 6
" " (Perikon)	4 9

VARIOMETERS. Panel Mounting 6/- and 7 6 each. " Sterling " type 21/-
All IGRANIC components stocked.

ACCUMULATORS, all sizes in stock. We also charge and repair same.

EVERYTHING for the Wireless Enthusiast.

CALL AND SEE US to discuss your wireless problems, or send P.C. for list.

Postage free on orders of 39/- and over in U.K.

BROWN & Co.,

Electrical and Radio Engineers,

17, NEWTON ST., PICCADILLY,

MANCHESTER.

'Phone :
City 0912.

THE J.B. VARIABLE CONDENSERS

SCIENTIFICALLY DESIGNED BY EXPERTS.

ONE HOLE ONLY FOR FIXING TO PANEL.

LARGE METAL-TO-METAL BEARINGS.

Owing to the ACCURATE CLOSE SPACING these Instruments take up much less room in Panel.

COMPLETELY ASSEMBLED WITH **KNOB** and **DIAL**.

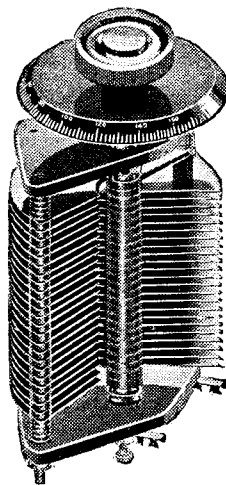

.001	8/6	PACKING and POSTAGE Extra. One only gd. Two .. 1. Three .. 1.3
.00075	8/-	
.0005	7/-	
.0003	5/9	
.0002	5/-	
VERNIER	4/-	

These Condensers are being used by leading makers of sets, who after severe test for best results have given their preference to the **J.B.** which is **YOUR GUIDE TO REAL SATISFACTION**. They are unconditionally guaranteed to be scientifically correct, mechanically perfect, and built for unusual durability.

Obtainable through your Dealer or direct from
JACKSON BROS., Condenser Specialists,
FIRST FLOOR **8, POLAND ST., OXFORD ST., LONDON, W.**
'Phone : GERRARD 6187.

Works: LEWISHAM, S.E. 'Phone : Lee Green 1225. Trade Inquiries Invited

STOCKISTS :

Messrs. J. H. TAYLOR & Co., Maucaluy Street, Huddersfield.
Messrs. LEWIS Ltd., Liverpool and Manchester.

THE CONTINENTAL BROADCASTING STATIONS.

Station.	Call Sign.	G.M.T. Hours of Transmission.	Items Transmitted.	Wave-length in Metres.	Remarks.		
BELGIUM.							
Brussels (1)	B A V ..	12 noon	Weather report	1100 ..	Working days.		
		4.50 p.m.	"	1100 ..	Daily.		
		6 p.m.	Concert	1100 ..	Sunday.		
		9 p.m.	"	1100 ..	Tuesday & Thursday.		
HOLLAND.							
The Hague	P C G G ..	1.40-4.40 p.m. ..	Concert	1050 ..	Sunday.		
		7.10-9.40 p.m. ..	"	1050 ..	Monday & Thursday.		
The Hague (Laboratorium Heussen)	P C U U ..	6.45-9.0 p.m. ..	"	1050 ..	Tuesday.		
		8.40 a.m.-9.40 ..	"	1050 ..	Sunday.		
The Hague (Velthuyzen)	P C K K ..	7.40-8.40 p.m. ..	Various	1050 ..	Friday.		
Ymuiden (Middeiraad)	P C M M ..	7.10-8.40 p.m. ..	Concert	1050 ..	Saturday		
Amsterdam	P A 5 ..	7.10-8.10 p.m. ..	Concert and News ..	1050 ..	Wednesday.		
FRANCE.							
Lavallois-Perret (Radiola)	S F R ..	11.30 a.m.	Financial News	1780 ..	Daily.		
		11.45 a.m.	News and Concert	1780 ..	"		
		3.45 p.m.	Commercial News	1780 ..	"		
		4 p.m.	Concert	1780 ..	"		
		7.30 p.m.	General News	1780 ..	"		
		8.0 p.m.	Concert	1780 ..	"		
		4-5 p.m.	Dance Music	1780 ..	Tuesday & Friday.		
		9-9.45 p.m.	Dance Music	1780 ..	Thursday & Sunday.		
		Paris (2) (Eiffel Tower)	F L ..	6.40 a.m.	Weather Forecast	2600 ..	Daily.
				11.15 a.m.	Weather Report and Forecast ..	2600 ..	"
2.30 p.m.	Bourse News			2600 ..	"		
5.10 p.m.	Concert			2600 ..	"		
6.20 p.m.	Weather Forecast			2600 ..	"		
10.15 p.m.	Weather Report and Forecast ..			2600 ..	"		
School of Posts and Telegraphs		5.10 p.m.	Concert and Weather Report ..	2600 ..	Sunday.		
		7.30 p.m.	Concert	450 ..	Tuesday & Thursday.		
		1.30-6.30 p.m. ..	"	450 ..	Saturday.		
Lyons	Y N ..	9.45-10.15 a.m. ..	Gramophone Records	3100 ..	Weekdays.		
GERMANY, CZECHO-SLOVAKIA, AND SWITZERLAND.							
Berlin (Koenigswusterhausen)	L P ..	10-11 a.m.	Music and Speech	4000 ..	Sunday.		
		11-12 noon	"	2700 ..	"		
		6-7 a.m.	Financial & Miscellaneous News ..	4000 ..	Daily.		
		11 a.m.-12.30 p.m. ..	"	4000 ..	"		
		4-5.30 p.m.	"	4000 ..	"		
Prague	P R G ..	7 a.m.	Weather Report and News	1800 ..	"		
		11 a.m.	"	1800 ..	"		
		3 p.m.	"	1800 ..	"		
		9 a.m.	Concert	4500 ..	"		
		2 p.m.	"	4500 ..	"		
		9 p.m.	"	4500 ..	"		
Geneva	H B 1 ..	5-7.30 p.m.	Concert	900 ..	"		
Lausanne	H B 2 ..	5-7.30 p.m.	Concert	1350 ..	"		

(1) If, at the indicated times, a station has to send or receive service communications, the weather transmissions will take place after these communications. Tuesday: Operatic selection on the gramophone. Thursday: Various on gramophone. Sundays: Various by artistes.

(2) Special concerts given during the evening are announced in the course of the preceding transmissions.

NOTE.—All times are G.M.T., not B.S.T.

AMATEUR TRANSATLANTIC TESTS.

THE final American arrangements for the forthcoming tests are awaited with great interest on this side of the Atlantic, especially in the British Isles and in France and Holland.

The ceaseless progress of radio science is nowhere better demonstrated than by these long-distance international communications between amateurs. The experiments, however, are not mere affairs of the scientific laboratory, where the results are secrets to be jealously guarded until the tests are completed, and where the apparatus used is unfamiliar and inaccessible.

Organised Transmissions.

Nowadays, the march of science has become more apparent to the man-in-the-street. The figures engaged in it do not all wear an unfamiliar look; in fact, in this instance everybody knows "the man-with-the-aerial" who is to be the actual demonstrator. The experiment and its conditions

are essentially popular, and any owner of a valve set can be a participator.

It has been demonstrated repeatedly that with comparatively simple apparatus American amateurs can be heard in this country, and now it is proposed that a further twenty days' trial should be carried out in the near future. Starting about December 20th, there will probably be two separate ten-day tests. The first period will be devoted to transmissions from this side of the Atlantic, mostly from Britain, but including messages from some ambitious amateurs in France, Holland, and Switzerland.

America Listens-in.

The American Radio Relay League (which is a large organisation representing the wireless amateurs of Canada and the U.S.A.) is arranging for its members to listen-in and to record all communications from European amateurs, and the results obtained should be exciting. British amateurs who succeed in transmitting to America will not only have something to be proud of, but will also have a phenomenal post-bag to answer from correspondents on both sides of the Atlantic who want to know exactly how they did it!

The second ten-day period will be devoted to an attempt at two-way communication—that is, selected European amateurs will transmit signals addressed not to America in general, but with a call-sign indicating one particular amateur in Canada or the U.S.A. He will acknowledge the message, and address his reply not simply to Europe, but to one specified amateur here.

Difficult Conditions.

Hopes run high, although the test is a severe one. It must be remembered that there is to be no universal "hush" for the experiment, but instead the ether will be carrying its enormous volume of telegraphic traffic—the ceaseless chatter of the shipping and continent calling to continent.

Scientific advance under these conditions seems a very real accomplishment, where the expense is not prohibitive and results are truly spectacular. For however one looks at it there is no denying the reality of the thrill! which will animate a resident of (say) Battersea Park, who succeeds in communicating with a brother amateur of Brooklyn, N.Y., or in lifting up his voice among the skyscrapers of Boston, Massachusetts.

Build this splendid "P.W." Set now!

—British throughout, cannot possibly cause interference, conforms to the P.M.G.'s new regulations.

THE new regulations made it quite clear that for the payment of 15/- a constructor's Licence can be obtained which will enable anyone to build his own Set. You cannot build a better Set than the famous "P.W." Combination Set shown here. It uses a reflex circuit, and gives sufficiently strong signals to work a Loud Speaker within three or four miles from a B.B.C. station on *one Valve only*.

Think what a saving in first cost and upkeep! It is designed to cover all wave-lengths and will receive from all stations throughout the country and also from many Continental Broadcasting Stations. The Editor of "P.W." said:—

"I have examined a set of these complete parts and can thoroughly recommend them to the consideration of all amateurs who intend to construct this Receiver. As a matter of fact, when a complete set of parts can be produced for the price asked by the Peto-Scott Co., it is hardly worth while carving out each individual accessory oneself."

Remember, this Set is complete even to the smallest detail, all engraving is done, holes are drilled and tapped on the panel, there is nothing for you to do but to follow the simple wiring diagram and instructions supplied with every set of parts.

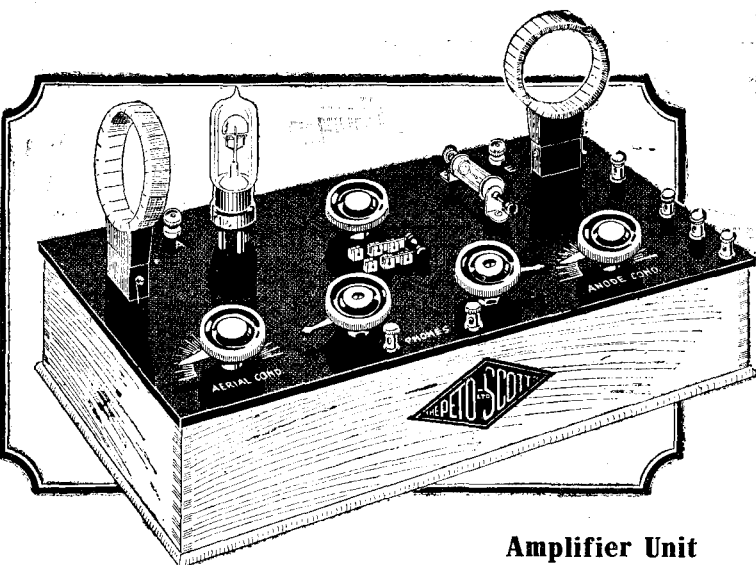

Amplifier Unit

This Unit is designed to fit on the right of the "P.W." Set, and will give sufficient volume to enable a Loud Speaker to be used for receiving practically all B.B.C. stations. It is coupled to the "P.W." Set by means of short brass rods, and presents a very neat appearance. All components British throughout.

Complete Set of Parts

Ebonite panel, drilled, tapped, and engraved, polished cabinet, MAX-AMP Transformer, rheostat, terminals, wire, etc., and full assembling instructions .. 43 6

Complete Set of Parts

Ebonite Panel, 1/4 in. thick, engraved, drilled, and tapped. Polished Cabinet to fit. Variable Condenser '001 assembled; ditto '002 (in parts for assembling); one MAX-AMP Transformer; Rheostat, two Utility Switches, Series-parallel Switch, Crystal Detector, two Coil Holders, Valve Sockets, all terminals, screws, insulating sleeving, etc., etc., £4-12-6 and full instructions . . . (All Royalties, etc., included)

Peto-Scott Co. Ltd. Head Office: 64, High Holborn, W.C.2. Branches: 99, High Holborn, W.C.1. 3, Wellington Street, Strand, W.C.2. 4, Manchester Street, Liverpool.

HERE'S REAL RADIO SERVICE

Aerial Wire, 7/22 bare copper, per 100 ft.	2/6	
Insulators, reel, 1d. each, egg 2d., shell	6d.	
Heavy Rubber-covered Stranded Copper Lead-in Wire, per yd.	3d.	
Variometers, complete with ebonite knob, 2/6; with dial	3/6	
Vario-couplers, wound d.c.e. with 8 tappings, complete with		
variometer	5/-	
Variable Condensers—		
Capacity. Panel Mounting. Celluloid Case.		
.0001	4/-	5/-
.0002	4/9	5/6
.0003	5/3	6/-
.0005	6/3	7/-
.001	7/6	8/9
Fixed Condensers, any capacity	each	1/-
Marsbridge Condensers, 1 mfd.	each	2/6
Dutch Hard Valves, ideal for amplifying		9/6
Dutch Soft Valves, ideal detectors		9/-
High Tension Batteries (British)	30 volt 6/6; 66 volt	10/6
Pocket Lamp Batteries, guaranteed 4.5 volts	per doz.	3/6
Duo-Lateral Coil Holders	two-way 4/6; three-way	5/6
War Office Terminals, with nuts	per doz.	1/6
Ex-Government 6-piece Terminals, with 2 Ebonite Bushes,	per doz.	10d.
Basket Coils, set of 7, 150-3,000 metres		3/-
Switch Arms. Excellent laminations	9d. and	1/-
Rheostats. Best quality, silent action	1/9 and	2/3
Valve Holders. Polished ebonite, screwed legs, with 2 nuts		1/-
Crystal Sets, with variometer tuning, perfect results		10/-
Unassembled parts for above		7/-
4,000 ohms, best French double headbands,		12/6
"Featherweight"		15/-
French, real ebonite earcaps	4,000 ohms	17/6
"Brunet," known to all amateurs, 4,000 ohms		20/-
British, stamped "B.B.C."	4,000 ohms	19/6
8,000 ohms		23/-
'SPARK COILS, MARCONI TUNERS, GALVANOMETERS, and		
Ex-Government Surplus in Stock.		
PRICE LISTS FREE. MAIL ORDER CUSTOMERS KINDLY		
INCLUDE POSTAGE.		

THE WATERLOO ELECTRIC CO.
129, WATERLOO ROAD, S.E.1
Telephone: HOP. 5649
HOURS OF BUSINESS:
Monday 9-8 p.m. Wednesday 9-8 p.m. Friday 9-8 p.m.
Tuesday 9-8 p.m. Thursday 9-1 p.m. Saturday 9-9 p.m.

If Winter Comes—

And all your nights are grey,
A "DESKOPHONE"
Will charm the gloom away.

THERE is one thing that is necessary in a Wireless Set besides Efficiency, Reliability and Handsome Appearance, and that is absolute Purity of Reproduction.

The "DESKOPHONE" is noted for its Purity of Tone, and in addition to this it is most Reasonable in Price.

A
"DESKOPHONE"
for
Purity of Tone.

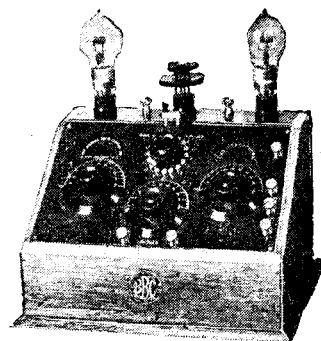

THE "DESKOPHONE" TWO-VALVE SET (P.O. No. 2020).

Tuner, High Frequency Amplifier, and Detector, complete with Headphones, H.T. Battery, Aerial, Lead-in Wire, and Insulators.

PRICE COMPLETE
£12 : 17 : 6

PRICE WITHOUT ACCESSORIES £9:17:6
Royalties £2:2:6 Extra. Valves Extra.

LOW FREQUENCY AMPLIFIER, built to the same design, can be added to greatly increase the volume of sound.
PRICE, £4:12:6. Royalty Paid. Valve only Extra.



Phone: Holborn 2368

THE TRADE SUPPLIED

THE HOLBORN RADIO CO., LTD.
267, HIGH HOLBORN, LONDON, W.C.1.

Over HALF A MILLION Satisfied Customers WIRELESS! WIRELESS! WIRELESS! and EVERYTHING for it.

PIONEERS OF CHEAP PRICES. DON'T PAY MORE! GREAT BRITAIN'S LARGEST EXCLUSIVE WIRELESS STORES.

NOTE.—We are exclusively WIRELESS—NOT DABLERS!

QUALITY, QUANTITY AND CONSISTENCY OUR MOTTO

See Our Six - Window Display of Popular Bargains

We offer for the first time the new "FELLOWS" 18/6 Special Offer—BROWN'S 19/6
Lightweight Headphones, 4,000 ohms. A masterpiece of workmanship. A guarantee with every pair. Honestly worth 30/-. Per pair.
Featherweight Headphones. Stamped B.B.C., 4,000 ohms. Our Price

ELKAY Lightweight Headphones, 4,000 ohms 12/9
BRUNET 'Phones. The genuine article 13/11
EDISWAN Valves 12/3
COSSOR Valves 12/3
 Bankrupt Stock and of Limited Quantity. Guaranteed All New.
MARCONI "R" Valves .. 12/3
MULLARD "ORA" Valves 12/3
EDISWAN DULL EMITTER. Our price 25/9

N. & K. PHONES. The genuine article. Our Price 12/9

- DUTCH VALVES** 8/3
- L.F. TRANSFORMERS** Ratio 5 to 1. All guaranteed (postage 1/-) each 11/3
- CRYSTAL DETECTORS** 1/9, 1/3, and 10/d.
- CRYSTAL DETECTORS**, enclosed in glass case 2/6, 2/3, 1/6
- AERIAL WIRE**, 7/22, guaranteed hard-drawn copper, 100 ft. (postage 1/-) ... 1/10 1/2
- CONDENSER VANES**, fixed or moving, per doz. 3 1/2 d.
- REAL GOLD CAT'S WHISKERS** ... each 2d.
- SILVER CAT'S WHISKERS** each 1/5
- "CONDENSER SCALES,"** 0 to 150 per doz. 7d.
- IVORINE LABEL SET**, 12 different titles, the set 3 1/2 d.
- BASKET COILS**, set of 5, up to 3,000 metres 2/4
- SLEEVING**, 3 yds. assorted colours, for NUTS, 2 B.A. per doz. 11 1/2 d.
- NUTS**, 4, 5, 6 and 8 B.A. per doz. 2d.
- WASHERS**, 4 B.A. per doz. 1d.
- WASHERS**, 2 B.A. per doz. 1 1/2 d.
- CONTACT STUDS**, with nuts and washers per doz. 4d.
- TERMINALS**, with nut and washers, each 1d., 1 1/2 d. & 2d. 2d.
- EBONITE KNOBS**, 2 B.A. each 2d. and 3d.
- SPACING WASHERS**, large per doz. 2 1/2 d.
- SPACING WASHERS**, small per doz. 1 1/2 d.
- CRYSTAL CUPS**, 2 screw each 1d.
- CRYSTAL CUPS**, 4 screw each 2d.
- FIXED CONDENSERS**, all capacities, each 10 1/2 d.
- EBONITE**, cut to any size by machinery while you wait 3/6
- TELEPHONE TERMINALS**, nuts and washer, each 1 1/2 d. per doz. 1/3
- W.O. TERMINALS**, nuts and washers, each 2d.
- PANEL BUSHES**, drilled per doz. 1/3
- TOP CONDENSER** bushes each 1d.
- BOTTOM CONDENSER** bushes each 1d.
- SWITCH ARMS**, 4 laminations, ebonite knob, complete with panel, bush, nuts, and spring washer 8 1/2 d.
- STOPS**, with nuts per doz. 6d.
- FILAMENT RESISTANCES**, smooth action, marvellous value 1/9
- With engraved dials 2/6

- BELL WIRE**, tinned copper, 12 yds. 6d.
- VALVE LEGS**, nut and washer each 1d.
- VALVE PINS**, nut and washer each 1d.
- PLUNGER SPRINGS**, complete each 1d.
- SLIDER ROD**, brass, 13ins. long, 1/4 in. square, drilled each 3 1/2 d.
- SLIDER KNOB** each 2d.
- SWITCHES ON EBONITE**, S.P.S.T. (quality the best) each 1/6
- SWITCHES ON EBONITE**, S.P.D.T. (quality the best) each 1/11
- SWITCHES ON EBONITE**, D.P.D.T. (quality the best) 2/9
- CONDENSER SPINDLES**, all sizes in stock, from each 1 1/2 d.
- SCREWED ROD**, 2 B.A., 12ins. long, each 2 1/2 d.
- SCREWED ROD**, 4 B.A., 12ins. long, each 2 1/2 d.
- RUBBER - INSULATED LEADING - IN WIRE** per yd. 1 1/2 d.
- CHINA INSULATED SPRING CONDUCTORS:**
- 1 way 3d.
- 2 way 4d.
- 3 way 1 1/8
- INSULATORS**, white reel, 2in., each 1d.
- INSULATORS**, white egg, each 2d. per doz. 1/8
- WOOD INDUCTION COILS** (postage 6d.):
- 12 X 4 2/5
- 9 X 4 2/3
- 8 X 2 1/2 1/11
- 6 X 3 1/8
- 6 X 2 1/5
- TAPPED INDUCTION COILS**, 20 tap-pings, wound to 1,500 metres each 2/6
- VARIOMETERS** (Tube type), complete with knob 3/11 and 2/11
- DOUBLE 'PHONE CORDS**, full length
- HERTZITE**, Genuine Large Piece 11 1/2 d.
- TALITE**, Genuine Large Piece 9 1/2 d.
- PERMANITE**, Genuine Large Piece 9 1/2 d.
- ZINCITE**, Genuine Large Piece 9d.
- BORNITE**, Genuine Large Piece 6d.
- MIXED CRYSTALS** (6 kinds) 9d.
- CARBORUNDUM** 5 1/2 d.
- ZINCITE and BORNITE**, both in box 1/-
- COIL PLUGS**, real ebonite, 1/3, 10 1/2 d., and 9 1/2 d.
- H.F. PLUG TYPE TRANSFORMER:**
- 1..... 250 to 600 metres 3/9
- 2..... 350 to 700 " 4/-
- 3..... 500 to 900 " 4/3
- 4..... 800 to 1350 " 5/6
- 5..... 1600 to 3200 " 4/9
- 6..... 2200 to 5600 " 5/-
- FILAMENT COMPLETE CIRCLE RESISTANCE SCALES**, 0 to 300, each 6d.
- EBONITE CONDENSER KNOB AND DIAL** 1/6

- VARIABLE CONDENSERS** of high quality. With Aluminium Top and Bottom plates. Complete with knob and dial, guaranteed accurate:
- 9d. Vernier 3/-
- 1d. .0002 4/6
- 1d. .0003 5/6
- 3 1/2 d. .0005 6/-
- 2d. .00075 7/-
- .001 8/-
- SUPER QUALITY 2-WAY COIL HOLDER** 5/3
- REAL EBONITE 3-WAY COIL HOLDER** 7/9
- O.B.A. NUTS** per doz. 4d.
- DETECTOR ARMS**, Ball Joints, Ebonite Handle and Whisker Holder 3 1/2 d.
- WOOD SCREW TERMINALS** each 1 1/2 d.
- SHELLAC** per bot. 10 1/2 d. and 6d.
- AERIAL PULLEYS**, each 10 1/2 d., 8 1/2 d., 6d. and 4 1/2 d.
- TINFOIL** large sheet 4d.
- COPPER FOIL**, 6in. wide per ft. 5d.
- GRID LEADS**, 2 1/2 and 2 meg. each 10 1/2 d.
- FLEX (Twine)**, various colours, per yd. 2d.
- CONNECTING WIRE**, tinned copper, 20 gauge 3d.
- ENAMEL WIRE**, in 1/4, 1/2 and 1 lb. reels: 4d.
- 6d. 22 24 26 28
- 1d. per lb. 2/4 2/8 3/2 3/6
- Note: Robbins 2d. each extra.
- POTENTIOMETERS**, guaranteed up to 900 metres, superior make, compact size 7/3
- CRYSTAL DETECTOR**, glass enclosed, fitted on 4 X 2 ebonite panel with terminals for aerial, earth and 'phones, already wired and beautifully finished 4/9
- VALVE HOLDERS** each 10 1/2 d. and 1/3
- BATTERIES**, H.T., dry:
- 30 volts, including Wander Plugs 5/9
- 60 volts, including Wander Plugs 9/6
- FILAMENT RESISTANCE DIALS** 8 1/2 d.
- AMALGO-PLASTIC METAL**, for fixing crystals. No Wood's metal necessary 6d.
- GOLD SEAL PLASTIC METAL**, for fixing crystals 6d.
- IVORINE NAME-PLATES**, all readings, each 1d., per doz. 9d.
- EARTH CLIPS**, Copper, adjustable, each 5 1/2 d.
- RADIONETTE CRYSTAL SET**, complete, stamped B.B.C. and including one pair 4,000 ohms 'phones, 100ft. 7/22 aerial wire, 4 insulators, lead-in tube, 6 yds. lead-in insulated wire and adjustable earth clip. Ready to listen-in. Honestly worth 3 gns. 36/6
- RADIONETTE ONE-VALVE L.F. AMPLIFIER** for above 34/6
- CABINETS**, all shapes and sizes in stock. 1/6

IMPORTANT NOTICE. In view of the enormous increase in our Mail Order business, we wish to inform our customers that all post orders are dealt with in strict rotation and at the earliest possible moment. **Follow the Crowd to Elkay Corner.**

"ELKAY" WIRELESS CO.,

225 and 227, BISHOPSGATE, LONDON, E.C.2.

Open Saturday all day. To the Trade—New Trade Counter now open. Send for NEW LIST. Please remit ample postage. We open Sundays 11—2.30. Note new Telephone No.: CENTRAL 8544.

SPECIAL TERMS TO RADIO CLUBS:
SAVE MONEY BY STUDYING OUR ADVERTISEMENTS.

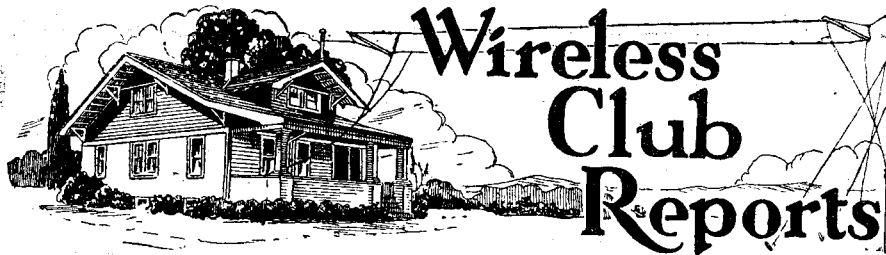

The Editor will be pleased to publish concise reports of meetings of Wireless clubs and associations, reserving the right to curtail the report if necessary. Hon. secretaries are reminded that reports should be sent in as soon after a meeting as possible. Reports sent in cannot appear in this paper in less than ten days after receipt of same. An asterisk denotes affiliation to the Radio Society of Great Britain.

Honor Oak Park Radio Society.

At the conclusion of the ordinary business of the Society at a well-attended meeting on September 19th, the secretary made an announcement which was enthusiastically received to the effect that the President, E. A. Graham, Esq., had written a very encouraging letter expressing his deep interest in the Society and enclosing a handsome donation to the funds.

Messrs. Pollard and Lane, demonstrating with a specially constructed two-valve set, then gave an interesting talk on simple valve circuits. Hon. sec., G. J. Price, 22, Honor Oak Park.

Hackney and District Radio Society.*

At a recent weekly meeting, Mr. Skinderviken, the inventor of the famous microphone button bearing his name, explained in detail the latest type and gave several very interesting demonstrations.

Forthcoming Events: Oct. 18th, "Television," by G. W. Walton, Esq., of General Radio Co.; Nov. 8th, Accumulators, their Maintenance and Manufacture, by F. J. Holmes, A.M.I.E.E., Mangr. Hart Accumulator Co.; Nov. 21st, 22nd and 23rd, Wireless Exhibition and Demonstration at Clapton Palais de Danse. Full particulars to follow.

Hon. sec., Chas. C. Phillips, 247, Evering Road, Upper Clapton, E.5.

Kensington Radio Society.

The monthly meeting was held at 2, Penywern Road, Earl's Court, on September 13th, at 8.30 p.m.

The president, Mr. J. H. Reeves, who has been elected Group Representative on the enlarged Committee of the R.S.G.B., gave an outline of the present position, and members present joined in the general discussion on this subject. It was agreed to hold an informal club meeting on the second or third Thursday of each month, full particulars of which will be given at the next club meeting in October.

Hon. sec., Mr. J. Murchie, 33, Elm Bank Gardens, Barnes.

Liverpool Co-operative Radio Association.

Under the auspices of the above newly formed association, Mr. S. Frith (president) delivered his "Wireless Talk for Beginners" to a large and enthusiastic audience at Unity House, Byrom Street, Liverpool, on Friday evening, September 21st. He traced the origin of, and explained the growth and development in wireless telegraphy from the earliest times, some eighty years ago, to the modern three-electrode valve.

Mr. Frith's lecture was highly instructive, and the practical demonstration he gave on electrical apparatus of the existence of the wireless wave proved very interesting.

Intending members of this association are requested to communicate with the hon. Secretary; Mr. J. Kearns, 162, Walton Road, Liverpool.

The Radio Society of Highgate.*

An interesting lecture was given on September 14th by Mr. J. L. Jeffree, F.R.A., entitled "Freak Circuits." The lecturer explained the action of the Lee de Forest circuit, the Cockaday 4-circuit arrangement, the Round Reflex circuit, and, finally, the S.T. 100 circuit. This was followed by a short lecture by Mr. C. H. P.

Nutter, F.R.A., entitled "Hints and Tips."

On September 21 Mr. G. A. V. Sowter gave a lecture on "A Portable Receiver." This receiver was entirely self-contained, and was built into a small attaché case. Several different circuits could be used.

Full particulars as to membership of the society may be obtained from the hon. secre-



A new portrait of Captain C. A. Lewis of the B.B.C.

tary, J. F. Stanley, B.Sc., A.C.G.I., 49, Cholmeley Park, Highgate, N.6.

**Catalogues
Book Reviews
Etc.**



The Formo Co. informs us that it has come to their notice that inferior imitations of "Formo" Radio Components are being retailed on a fairly extensive scale. They state that every genuine "Formo" part is clearly marked with the name "Formo."

Brandes, of 296, Regent Street, London, W. 1, have issued a small leaflet in which is fully described the well-known "Matched Tone" Telephone Receivers manufactured by this firm and retailed at 25s. per pair. These telephones are so constructed that the tonal quality of each earpiece is exactly

similar, while in use they are both sensitive and comfortable.

Two new attractive coloured showcards have recently been produced by the G.E.C. and are now available for traders. The first of these advertises "Gecophone" Headgear Telephone Receivers of both the headband and lorgnette types. The other showcard features Marconi-Valves and embodies the "Wireless Wonder" figure so familiar in the G.E.C. Valve advertisements. We understand that copies of these showcards will be sent gratis to all applicants.

A large, well printed, and fully illustrated catalogue has been forwarded for our inspection by the Cambridge and Paul Instrument Co., Ltd. This catalogue deals with the famous Cambridge Alternating Current Instruments which, owing to the growth of wireless telegraphy, have been designed to measure the constants of high-frequency circuits. Some novel instruments having many industrial as well as scientific applications are described in the catalogue, perhaps the most striking being the Rectifier Voltmeter.

In this voltmeter a triode valve is used as a rectifier, and the rectified current, produced either by the curvature of the anode current-grid potential characteristic, or by the curvature of the grid current-grid potential characteristic, is used to measure the applied electro-motive force by means of a galvanometer. It is stated that for low voltages of from 0—10 volts, the voltmeter is about 40 times as sensitive as the best electro-static voltmeter.

The catalogue is divided into two parts, the first containing brief descriptions of the many instruments themselves, while the second part is devoted to various methods of using these instruments for high frequency measurements are described in some detail.

In spite of the fact that there are many thousands of amateurs in this country with valve sets, comparatively few of them could give a really clear explanation of the working of their sets. To make more clear the general principles of receiving wireless telephonic and telegraphic signals, George Philip & Son, Ltd., have lately published a very good cardboard folder which explains diagrammatically and by a working model the action of valves. This model is by no means difficult for the average person to understand, and by carefully following the instructions and the explanation of the model, it should not be long before anyone using this method acquired a really thorough knowledge of the subject.

Perhaps the neatest extension handle that I have so far seen is that which has lately been placed on the market by Leigh Bros. The "El-Bee," as it has been termed, consists of a light yet strong brass handle with an ebonite knob and with a specially shaped red rubber sucker at the end. By damping this rubber and pressing it on to any control knob (it fits easily the standard condenser knobs) a vacuum is instantly formed, and it remains firmly stuck until removed by a pinch. Besides its adaptability, it has the advantage that the handle can instantly be removed and re-affixed in any convenient position.

RADIOFORIAL

All Editorial Communications to be addressed The Editor, POPULAR WIRELESS, The Fleetway House, Farringdon Street, London, E.C.4.

So at last the Broadcasting Committee's report has been made public, and we are in a position to judge whether the months of delay have been warranted. Personally, I am inclined to doubt this. I am of opinion that the interim constructor's and a general constructor's licence could have, without trouble, been issued months ago. The delay has caused serious harm to the wireless trade, and it is doubtful whether it will ever really recover from it. Had such licences been available when enthusiasm for wireless in this country was running at its highest, great things would have been accomplished and the British wireless trade would have been in an invincibly secure position. The P.M.G. is hardly to blame; he had to wait until his committee had tendered him their report before he could take action. However, we do know where we stand now, and the term "wireless pirates" will henceforth be applied not in humour to thousands of people, but in "terms of law" to but few.

Readers will agree that the presentation of the booklet "The 'P.W.' Combination Set" with last week's issue of POPULAR WIRELESS, marked very appropriately a happy occasion, and no barriers, except that the parts used must be of British manufacture, are presented to any reader who now desires to construct that really first-class receiver.

Finally, I trust that we have seen the last of depression in trade circles and licence grumblings among the amateurs, and that the most popular "hobby" and amusement of the day will still further advance in its popularity.

THE EDITOR.

Owing to the enormous number of queries received daily from readers of POPULAR WIRELESS, I have temporarily decided to limit the number of questions sent in by one reader to three. Readers are asked to keep their questions as short and as concise as possible in order that the minimum of delay can be exercised in answering queries. Until further notice three questions

from one reader will be the limit for one letter. All questions should be addressed to POPULAR WIRELESS Queries Department, Room 138, Fleetway House, Farringdon Street, London, E.C.4. Readers are requested to send the necessary postage for reply.

The Editor desires to direct the attention of his readers to the fact that, as much of the information given in the columns of this paper is of a technical nature and concerns the most recent developments in the Radio world, some of the arrangements and specialities described may be the subject of Letters Patent, and the amateur and trader would be well advised to obtain permission of the patentees to use the patents before doing so.

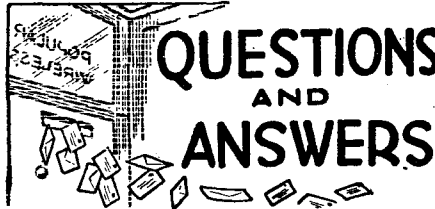

R. J. F. (Tamworth).—I am adding one or two valves to my crystal set to bring in the 5 IT concerts louder. How many valves will give loud signals, and do you recommend

THAT CONGESTION IN THE ETHER.

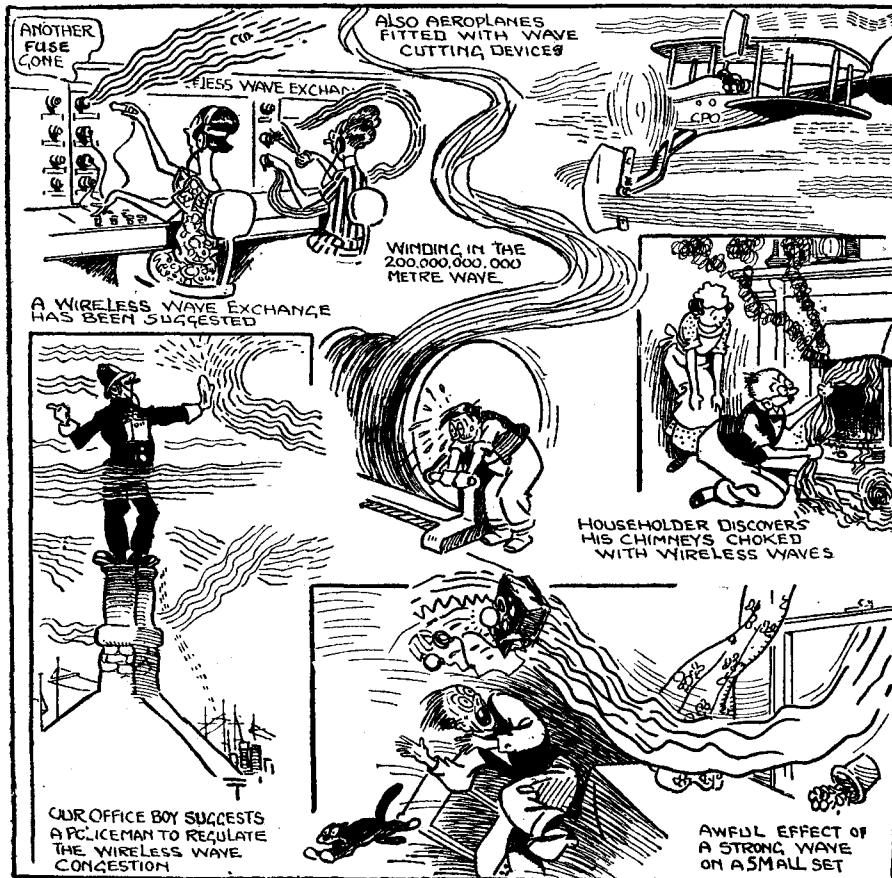

using H.F. or L.F.? If the latter, will the dull emitter type be O.K.? At present signals are clear but not loud enough.

At your distance from Birmingham you will have best results from the low-frequency amplification, and probably one valve will be quite sufficient. Try one-stage at first, as it would be easy to add a second L.F. stage if found necessary. The dull emitter type will be quite suitable.

M. J. T. (Gorleston-on-Sea).—Spending as little as possible, what additional apparatus shall I require to convert my crystal set (loose-coupled, with good aerial) into a valve set? I want strong 600 metres signals, as I am learning to read Morse with a friend, and we shall be using the ship messages for practice.

You will get all the loud Morse you want on a one-valve set, for which you will require 1 valve, 1 filament resistance, 1 filament battery, and 1 H.T. battery, a grid-leak and condenser, and a '001 condenser to go across the 'phones and H.T. battery.

G. D. (E.8.) asks how he can add loading coils to his crystal circuit, which uses both primary and secondary coils.

It will be necessary to add loading coils in series with both the primary and the secondary, the coil for the latter being about 30 per cent larger than that for the primary. In your diagram you show no method of varying the inductance of the primary. This should not be so, and a variable condenser of '005 mfd. should be connected across it, especially when a large loading coil is in use.

"PETER PAN" (Settle).—Is there any definite rule for connecting the various terminals of an L.F. transformer to a detector panel as long as the output of the detector goes to the primary side of the transformer?

No, there is no definite rule, but experiment is sometimes advisable before best results are obtainable. Should I P go to plate it is usual to take O S to grid, or I S to grid should O P go to plate.

A. E. B. (Birmingham).—I have made a two-valve dual amplification set, but find that it is not at all selective. The tuning coil has 35 turns and is of the honeycomb type tuned with a '0005 condenser. The anode coil has 50 turns. Birmingham, 10 miles away, comes in very loudly, but I cannot tune him out at all. Can anything be done to make the set more selective?

Reflex circuits are, as a rule, inclined to be non-selective, especially if you are using one coil tuning. You will be able to obtain finer tuning by adding a three-coil helix to your set. Reaction can be utilised except during broadcasting hours, or on other wave-lengths than 300-500 metres, by reacting the anode coil on the secondary coil, and this will assist in the tuning of the set. The primary coil should be of 50 to 75 turns with '001 condenser in series, the secondary, to which are connected the grid and filament of the first valve, being of 70 turns with '0005 condenser in parallel. The anode coil, also used as reaction for higher wave-lengths, should be of 75 turns with '0003 condenser across it. For the reception of broadcasting we would advise the use of basket coils and as loose a coupling between the primary and secondary coils as possible when stations other than 5 I T are being received. It will take a little practice before you are able to manipulate the set with the extra coil, but the results will repay the trouble of fitting the coil and the greater care required in tuning-in. Always work with the reaction coil as loosely coupled to the secondary as possible, for a great deal of non-selectivity is caused by the reaction coupling being too tight. For near stations, such as Birmingham, you will probably find that best results are obtained with the reaction coil at about 30 degrees from the horizontal, and the secondary coil vertical. The primary will be about half-way between the horizontal and vertical positions, or perhaps a little nearer the vertical.

A. C. S. (Mill Hill).—What do you consider is the most economical circuit for loud speaker work from 2 L O? I have a fairly large room and the usual type of loud speaker.

Cutting down running expenses as far as possible without sacrificing volume of sound and clarity we would advise the use of a reflex circuit. A circuit similar to that which appeared in the last issue of POPULAR WIRELESS would be quite O.K. and dull emitter valves could be used very successfully. This circuit, the Duplex Reflex circuit, will be found to give very loud results with a remarkable absence from distortion. Another very useful circuit is the "P.W." Combination circuit, also described fully in the booklet that was given away with last week's issue.

(Continued on page 231.)

RADIOTORIAL QUESTIONS & ANSWERS.

(Continued from page 230.)

This circuit has the added advantage of providing a useful one-valve dual, or simple crystal set if it is desired to listen in on 'phones instead of using the loud speaker.

* * *

F. G. (Palmer's Green).—I have had a home-made set now for several months, and on a friend's advice I took out a broadcasting licence for 10s. Must I now replace this with a constructional licence, or will my present one do?

I am afraid that your present licence will not do, and you will have to apply for a constructional licence, which may be obtained for 15s. from any head post office. You must obtain this licence before October 15th, otherwise action may be taken against you by the P.M.G. A rebate will be allowed on the unexpired portion of your present licence.

* * *

"JAMMED" (near London).—I have great difficulty in tuning out 2 L O when I wish to listen to any of the other broadcasting stations. I live about 15 miles from the local station, so there should be no great difficulty in making a set capable of receiving all the stations on headphones and cutting out the local transmissions. What circuit do you advise?

We would advise the use of a two or three valve set employing H.F. and detector and, if desired, one L.F. amplifier. The H.F. amplifier should be of the tuned anode variety with a fairly large condenser for tuning the anode coil. Two-coil tuning should be employed, using a 50-turn aerial coil with a '001 condenser in series and a secondary coil of 50 or 75 turns with a '0005 condenser in parallel. These two coils will, of course, be coupled together, the coupling being varied according to whether the interference is serious or not. Loose coupling always tends to reduce interference. The anode coil will be of about 75 turns and should be tuned with a '0003 or '0005 condenser. The former will give easier tuning, and if the latter is employed we advise the use of a vernier 3-plate condenser to enable fine tuning to be obtained. The set should employ reaction from the plate of the detector valve, the reaction coil being coupled to the anode coil of the first valve. In cases where interference is serious it is advisable to use a large reaction coil, so that there is no danger of the plate circuit of the detector being tuned to anywhere near the wavelength of the unwanted signals. A reaction coil of 100 to 150 turns should be employed for broadcast reception. Another refinement that will be useful in receiving distant transmissions is a variable grid leak, which should be connected between the detecting valve grid and the L.T. positive filament connection. An ordinary L.F. amplifier can be used if desired. Keep the aerial and secondary coils well away from the anode coil so that there is no chance of mutual reaction between the two circuits and its consequent effect upon the selectivity of the receiver.

* * *

B. S. (Aberdeen).—I am about 3 miles from the new Aberdeen station. Shall I be able, with a good outdoor aerial, to receive this station with fair strength on a crystal set, using three pairs of 'phones? Do you advise these to be high or low resistance? I intend using a variometer for tuning. Can this be improved upon?

Yes, you should get quite good results at this range with three pairs of 'phones. These latter should be of a high resistance, the higher the better. The extra cost in investing in 'phones of 8,000 ohms resistance would be well advised. A variometer will give good results, and could not be improved upon in your case.

* * *

"EXPERIMENTER" (Torrington).—Is it essential to have a good knowledge of the Morse code, and, if so, at what speed must I be able to receive before I can obtain an experimental licence for receiving only?

This is not essential, but a knowledge of the subject would help in the application for such a licence. It is, however, necessary to be able to transmit and receive Morse before a transmitting licence can be obtained.

* * *

A. L. N. (Wilton).—I intend listening in for New York during this winter, and cannot decide what type of set to use, whether two or

(Continued on page 232.)

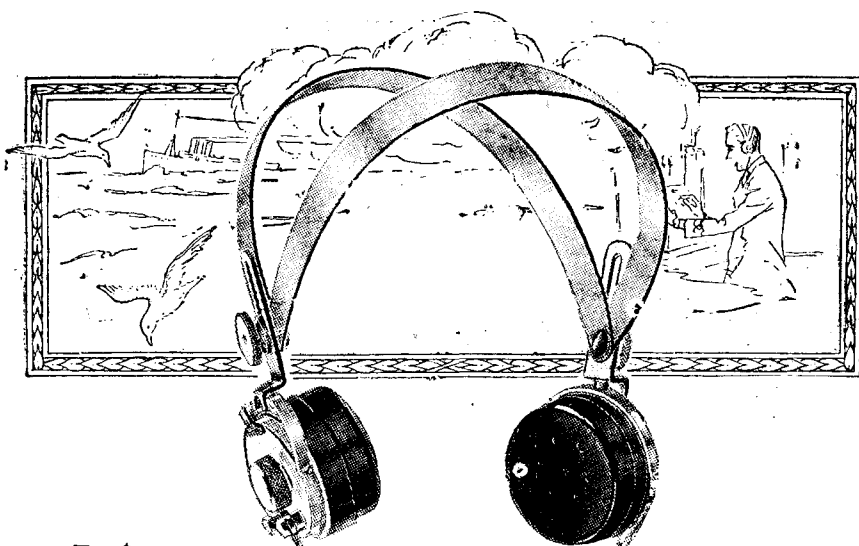

Brown A-type

- phones which speak when others are dumb.

FOR the Brown A-type Headphone to be selected by practically every merchant service in the world is a unique compliment to their outstanding qualities. But then Brown A-type 'phones are unique Headphones.

Their principle of construction embodies laminated pole pieces—an adjustable vibratory reed—and an aluminium diaphragm.

Here, then, is the secret of their wonderful sensitiveness. Whereas every other 'phone uses a comparatively thick iron diaphragm, the aluminium diaphragm used in the A-type is as thin as paper, yet, due to its cone shape, it is even more robust than the iron type.

Obviously, the thinner the diaphragm the more sensitive it will be to the slightest fluctuations of current in the magnet coils. This is why Brown 'phones speak when others are dumb.

When choosing your Headphones, let your natural pride in wanting the world's best persuade you to select Brown A-type. You are then assured of 'phones which will greatly improve the efficiency of your Set—which will be a continual pleasure to wear—and which, above all, will give you years and years of faithful service.

PRICE LIST OF HEADPHONES.

A-type: 120 ohms	per pair	58/-
2,000 & 4,000 ohms	per pair	62/-
8,000 ohms	per pair	66/-
D-type: 120 ohms	per pair	48/-
2,000 & 4,000 ohms	per pair	52/-
F-type: 120 ohms	per pair	22/6
4,000 ohms	per pair	25/-

S. G. BROWN, Ltd.

Retail: 19, Mortimer Street, W.1.
Wholesale: Victoria Road, N. Acton, W.3.

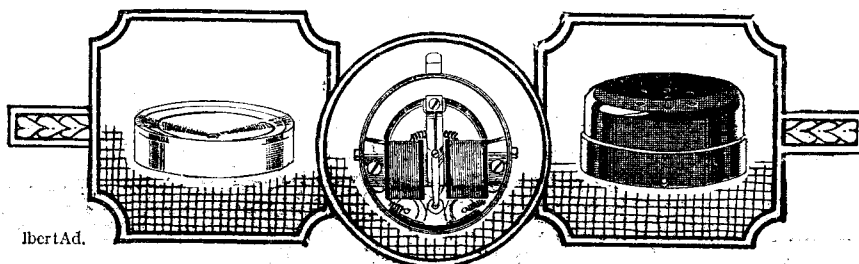

libertAd.

"LAKER" STEEL MASTS



These substantial well-made Aerial supports are built for service. The steel tubing is of large diameter (2 inches), having a big margin of reserve strength. It is very important to ascertain diameter of tubing before purchasing a steel mast. "LAKER" masts are strong and rigid, easily erected, and present a handsome appearance when set up. They are the best value obtainable in Steel Masts.

25 ft.,	35/-	30 ft.,	42/-
35 ft.,	52/6	40 ft.,	63/-
45 ft.,	75/-		

J. & J. LAKER Co.
ENGINEERS,
Aerial Mast Specialists,
457, Romford Rd. London, E.7.

PLUGS:
Red, Blue, and Black handles. Solid brass plunger and socket for making any terminal into a plug point. NEATNESS AND EFFICIENCY ARE CLOSELY RELATED. 2/6 pair (postage 2d.).—THE AUSTIN RAYCLIFFE TRADING CO. (Dept. G1), Palace Cinema Chambers, SLOUGH.

WIRELESS FOR THE HOME

A little book for amateurs by N. P. Hinton, B.Sc., written in simple language that all can understand, fully describing the apparatus and showing how the best results can be obtained from it. Illustrated.

Price 1/6 net of Booksellers or
PITMAN'S, PARKER STREET, W.C.2

GENUINE PHILIPS "R" VALVES, 8/- Each.
Best Dutch "R" Valves, Guaranteed, 7/- Each.
Apply Trade Terms. Phone: Regent 1791.
HARRIS & RUSSELL LTD. 15, Great Chapel St., Oxford St., W.1.



WASTE MONEY BUYING ACCUMULATORS FOR YOUR VALVE SETS
Unskilled chargers will only ruin them. For 12/- a quarter **ONLY 1/- A WEEK inclusive** we will supply you continuously with reliable charged L.T.

Batteries replaced at time of collection by motor, anywhere in London. Phone: East 5655.
Write Now **BRITISH BATTERY SUPPLY SERVICE**, for pamphlet B. Free, Carr St., London, E.14.

TO WIRELESS EXPERIMENTERS. PATENT YOUR INVENTIONS.

They may prove very valuable. Particulars and consultations free. **BROWN & CO.** Patent Agents, 9, Warwick Court, Holborn, London, W.C.1. Established 1840. Telephone: Chancery 7547.

SPENCER'S STORES

4-5, Mason's Avenue,
Basinghall Street, London, E.C.2.

Telephone: LONDON WALL 2292

Valves Repaired

7/6 POSTAGE 6d.

Two or more valves Postage Free
SPECIAL TERMS TO TRADE

PORTLAND'S BRITISH

EBONITE

3/4d. square inch. Any size 1/4" thick.
(Postage extra.)

6, Cheapside, E.C.; 188, Blythe Road, Olympia; 39, Sinclair Road, W.14. (One minute from Olympia.)

BEGINNERS' GUIDE TO WIRELESS—BEST BOOK OBTAINABLE.

Explains in plain everyday language, everything you wish to know about **WIRELESS TELEGRAPHY**. How to ERECT, CONNECT and MAKE Aerials, complete crystal and valve sets, tuners, coils, etc., also the latest two and three valve tuned anode receivers, and one and two valve amplifiers.
144 pages (including 28 diagrams). 1/3 post free.

SAXON RADIO CO. (DEPT. 14), BLACKPOOL

RADIOTORIAL QUESTIONS AND ANSWERS.

(Continued from page 231.)

three valves, and whether they should act as H.F. or L.F. Do you advise a crystal in such a circuit?

The reception of American broadcasting stations is still more or less experimental, although reports are being received daily from all over the country of successful reception of these stations with one, two, and more valves. Perhaps three valves, including one H.F. and one L.F., would be about the most successful combination, although one H.F. and one detector only, might give good results, but not, of course, so loud. The tuning should not be made too difficult, but should be as selective as is possible with a fairly simple arrangement. The addition of a crystal detector is liable to complicate matters owing to the difficulty sometimes experienced in finding a really sensitive spot.

B. S. T. (Plymouth).—Why is it that we rarely hear of the British broadcasting stations being heard in America, although it is practically an everyday occurrence for us to receive the American stations? Do they use greater power?

As a general rule the American stations do not use very much more power than do the British stations, but they have an advantage as far as distant transmission is concerned, in that it is dark both at the transmitting end and in England for the greater part of their programmes, owing to the difference in time, while it is still afternoon in America when our evening transmissions are taking place. In spite of these disadvantages, quite a number of U.S. amateurs have reported reception from 2 L O and other B.B.C. stations, which is really creditable both to the transmitters and to the receivers, owing to the interference that usually takes place at this time of the day.

J. N. L. (Chatterton).—I wish to receive long-wave stations sending Morse as well as the broadcasting on my loose-coupled crystal set. I am told that in loading up the two circuits it is important to keep a correct relation between the values of the two inductances. Is there a practical rule or guide which governs this?

Yes. The inductance of the secondary should be sufficiently high to enable you to get the longest wave-length you desire by adding a parallel condenser which does not exceed 0.0005 mfd. Roughly the secondary inductance is 1½ times as large as that of the primary.

"NOLUCKYET" (Richmond, Surrey).—Is it possible to solder Litzendraht stranded enamelled wire? Although generally very successful with soldering, I cannot make a satisfactory joint with this wire, and would like to know if it can be done.

The following method will give results that are quite satisfactory, provided the cleaning is done very thoroughly.

It is necessary to untwist the strands and clean them separately by burning off the enamel. This can conveniently be done in the flame of a candle, and then each strand should be rubbed clean with a piece of fine emery paper, or lightly scraped with a knife.

Solder in the ordinary way, but use a flux composed of powdered resin in methylated spirits.

"RECORDER" (Henley - on - Thames).—What is the principle of a Morse recording instrument, and can the same be successfully worked by good signals of a crystal set?

There are several kinds of recorder in which the principle is fundamentally simple, the various types having been evolved for different classes of work. They generally consist of a wheel dipped in ink, which is made to bear upon a moving tape. An arrangement of clockwork keeps the tape regularly moving just above the wheel, which is mounted on a spindle and kept in the "off" position by a spring.

Opposing the direction of the spring is an electro-magnet, which pulls the spindle when current flows in the receiving circuit. The wheel is then lifted from the ink by the action of the magnet, and makes contact with the moving tape, leaving a mark upon it which exactly corresponds to the duration of the received signal—i.e. dots and dashes similar to the Morse which is being received.

It will be realised that the action of the electro-magnet is a comparatively powerful one, and the current flowing in a crystal receiver is quite insufficient to operate such an instrument. You need a relay system in conjunction with your set before you will be able to work a Morse inker.

Wireless Review and Science Weekly

On Sale Every Tuesday
Price 3d.

THE Popular Science Section of this famous weekly journal has now been enlarged.

Purchase a copy of next week's issue and see for yourself what a fascinating section this is.

NEVER before in the history of British Journalism has Science been presented to the general reader in such an informative yet popular way.

You cannot fail to appreciate the contents of

Wireless Review and Science Weekly

Order a Copy NOW.
PRICE - - - 3d.



THE "MAY" CIRCUIT.

The Editor, POPULAR WIRELESS.

SIR,—Owing to my name being at the end of my letter on the "May" Circuit, I have had the surprise of my life.

First post Saturday morning I had a handful of letters asking for advice over the lay-out of the "May" Circuit; many asked for complete diagrams, as they were not capable of materialising the one you published.

I am still receiving letters by the half-dozen by every post.

I have been writing letters and drawing diagrams for three days now, and to tell you the truth, I can hardly trust myself to draw any more, I am dead beat.

And the questions—about shielding gauge of wires; number of vanes in condensers; will a coil act as variometer? will twenty turns do on the rotor?

My dear sir, you have my whole-hearted sympathy for evermore. I enclose a rough, simple plan of the actual set I have connected up just as it lies on my table. Will

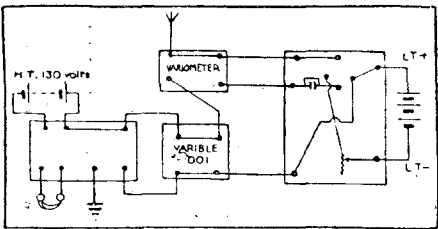

you, please, insert it in your paper and apologise for me in your own words, then they will see how the thing wants hooking up.

The circuit is very good, and I have even had better results since writing than I described in my letter which you published in last week's issue.

I am sorry to put you to the trouble, but will you kindly explain that I have done my best? In fact, I have even by now received several favourable replies, informing me that they had got good results, and profusely thanking me for my explanation of an easy and suitable hook-up.

Thanking you in anticipation. I am convinced, beyond the shadow of a doubt, of the popularity of POPULAR WIRELESS, and wish you every success.

Yours faithfully,
ALFRED FRANCE.

33, Church Street, Rotherham.

CRYSTAL RECTIFICATION.

To the Editor, POPULAR WIRELESS.

Dear Sir,—May I be allowed to answer briefly the points raised by Mr. Wallace. I welcome this criticism as showing that interest in intelligent research is not as dead as one might otherwise reasonably believe in this subject.

1. When heat is applied to a crystal contact the E.M.F. developed is enormous as compared with ordinary thermo-couples. I should be pleased to demonstrate this to Mr. Wallace.

(Continued on page 236.)

Essort

Dull Emitter

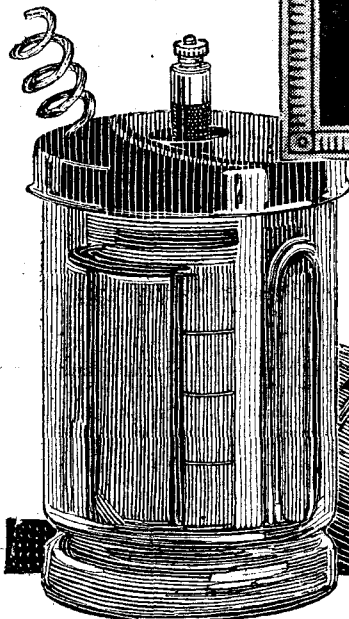
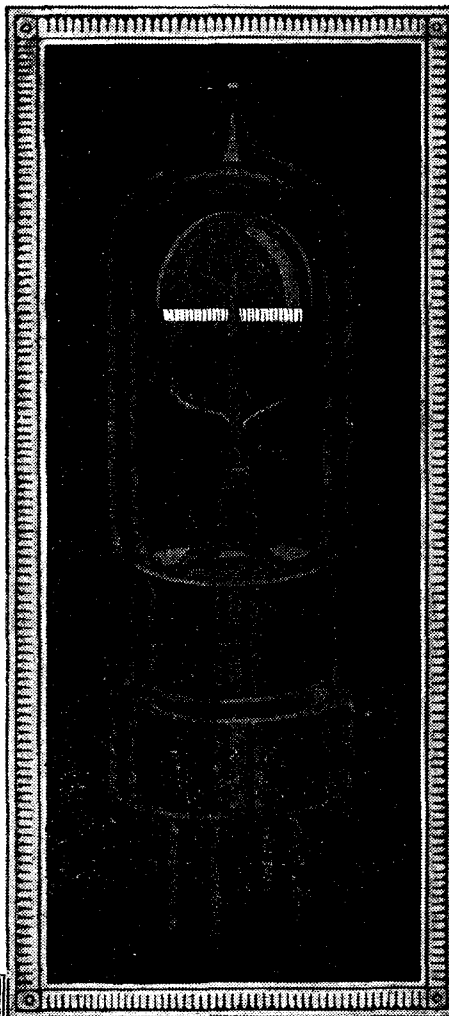

Worth waiting for!

Renders the accumulator obsolete

HULLO

Raymond Variable Condensers

CHEAPEST! BEST!!

Note New Features!

Fully Assembled as Sketch

ALUMINIUM TOP & BOTTOM PLATES

Prices Include—

EBONITE DIAL KNOB & BUSH

EBONITE BUSHES.

ADJUSTABLE BEARING.

ACCURATE .088 SPACERS USED

(Making condenser more compact for a given capacity.)

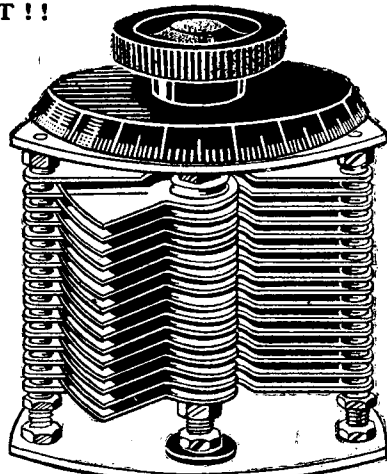

Post 6d. set U.K. only. Over 5/- free. 1/- each carriage abroad.

Price fully assembled with **ALUMINIUM END PLATES** and Ebonite Dial, '0-180.

•001	8/-
•00075	7/-
•0005	5/11
•0003	5/2
•0002	4/6
•0001	4/-
Vernier	3/9

Assembled but without end plates or dial.

•001	6/-
•00075	5/6
•0005	4/6
•0003	3/3
•0002	2/6
•0001	2/3
Vernier	1/9

Postage 6d. Set. Over 5/- Post Free. U.K. only.

Carriage abroad 1/- each.

HEADPHONES.

Brunet, best type, 4,000 ohms, 17/11 pair. Post 1/- pair.
P.T.C. British Headphones, 4,000 ohms, very fine value, full of music. Every pair guaranteed. Light in weight, no spacing washers, 18/11 pair. Post 1/- pair. Stamped B.B.C.
Sidpe, 4,000 ohms (genuine only stocked) 16/11 pair. Post 1/- pair.
Ladies' Single Receivers, with handsome handle, 4,000 ohms, 12/9. Post 1/-.
Loud Speaker Receiver, with 50 laminations in each pole, 21/-. Post 1/-.

HOURS OF BUSINESS:
 9 a.m. to 8 p.m. every day.
 11 a.m. to 2 p.m. Sundays.

ACCUMULATORS.

Rotax 4 v. 40 amp	17/6
4 v. 60 amp	22/6
6 v. 80 amp. (Oldham)	35/-
6 v. 80 amp. (Oldham)	45/-
6 v. 50 amp., in splendid carrying case, leather strap handle	27/6
H.T. BATTERIES—	
60 v.	9/6
36 v.	5/-

NO POST ORDERS ON ABOVE.

AMPLION (JUNIOR) LOUD SPEAKER.
 Recognised as the one and only. 52/6. Post 1/6.

VALVES.

All valves offered are new and manufacturers' guaranteed quality. No Rejects, Done-up, Renewed or "Dud" Goods are offered. Beware of Rubbish.

Pea-nut (latest type) (Sockets extra)	30/-
French "R" Best type	10/6
Cossor, Pink Top	15/-
Cossor, P.2	15/-
Marconi "R" a.v. 45/60	15/-
Mullard Ora	15/-
Ediswan	15/-
Dull Emitter	27/6

ALL VALVES 1/- each extra on post.

INTERVALVE TRANSFORMERS.

Low Frequency Ratio 5-1.

Igranic, highly efficient	21/-
Radio Instruments, Ltd., Special Transformer	25/-
Tested on Aerial, high quality, perfect results	15/11
Very Good Transformer, Guaranteed	12/6

COIL HOLDERS.

3-way, very handsome design, first-class article, good appearance, worth much more	10/-
3-way, second quality, a good serviceable holder	7/-
3-way, cheaper quality, but worth more	5/9
2-way first quality 6/6, second do. 5/-, third do. 4/6	4/6

CRYSTAL DETECTORS.

High-class Enclosed Whisker Detector, well-made, generous size, on ebonite base	3/-
Enclosed Whisker Detectors, all good value, 1/8, 2/-, 2/6, 3/-	3/-
Perikon Detector, glass enclosed, with 2 crystals, adjustable pressure, on ebonite base	2/-
Perikon Detector, built on generous lines, complete with 2 crystals, glass enclosed, dustproof	3/- and 3/6

HONEST GOODS AT THE RIGHT PRICE.
I ADVERTISE WHAT I SELL, AND SELL
WHAT I ADVERTISE.
TRADE AND RADIO CLUBS SUPPLIED.

NO POST ORDERS EXCEPT WHERE STATED IN SPECIAL LISTS.

RIGHT OPPOSITE
DALY'S
 GALLERY DOOR

M. RAYMOND
 27, LISLE STREET, W.C.2

RIGHT OPPOSITE
DALY'S
 GALLERY DOOR

OPEN EVERY DAY 9 a.m. to 8 p.m. SUNDAYS 11 a.m. to 2 p.m.

EVERYBODY

CALLERS 1d. in the 1/- Discount on a Large Number of Articles. See our Windows.

Aluminium Vanes	doz.	5d.
Aluminium End-plates for Condensers	pair	1/3
Brass Nuts, best quality 2 B.A.	3 doz. 7d., gross	1/10
Brass Nuts, best quality 4, 5, 6 B.A.	3 doz. 6d., gross	1/6
Aerial Wire, 7/22	100 ft. 2/6 and 2/4	
(No post orders.)		
Basket Coils, 6 and 7 inset. Equal to higher-priced sets. WL up to 3,000 metres	2/2, 2/4, 2/6	
Best Quality Variometers, excellent results, complete with knob	3/5, 3/8	
Switch Arm, 12 studs and nuts, the lot	1/-	
Switch Arms, various designs, good value, 8d., 10d., 1/-. 1/3		
Terminals, Telephone, with nut and washer	4 for 5 1/2d.	
Terminals, Pillar, with nut and washer	4 for 5 1/2d.	
Terminals, P.O., with nut and washer	4 for 5 1/2d.	
Terminals, W.O. pattern, nut and washer	4 for 5 1/2d.	
All above, 1/3 doz. nett.		
Small Terminals, nut and washer	6 for 5d., doz.	1/-
Real Ebonite Knobs, good quality. Bushed 2 B.A. each 3d., 5d. and 6d.		
Good Knobs, bushed 2 B.A.	each 2d., doz.	1/8
Bell Wire, D.C.C., indiarubber covered	12 yds. 6d. nett.	
Twin Flex, good quality	12 yds. 1/7 1/2d., 4 yds. 7d. nett.	
Steering, takes 18 gauge wire, good quality	3 yds. 1/-	
100,000 ohms Resistance, scientifically made	2/6	
Fixed Condensers, up to .001	1/-	
Fixed Condensers, up to .005	1/6	
Fixed Condensers, .006	2/-	
These fixed condensers are made, not "so called."		
French "R" Valves, impossible to equal	(Post 1/-)	10/6
Grid Leak, 2 meg., highly recommended	1/-	
Grid Leak and Condenser	2/-, 2/6, to 3/-	
Ebonite Valve Holders with 8 nuts. Hand-turned	1/3 and 1/-	
Moulded Valve Holders, with nuts	each 9d.	
D.C.C. Wire, 18 to 36 gauge in stock.		
Enamel Wire, 22, 24, 26, 28, 30, 32, 36 in stock.		
Egg Insulators, best quality	each 2d. and 3d.	
Ebonite Dials, 0-180	1/- and 1/3	
Ebonite Dials with knob	1/4, 1/6, 2/-	
2 B.A. Rod, 12 in. lengths (No post orders.)	each 3d., doz. 2/3	
4 B.A. Rod, 12 in. lengths (No post orders.)	each 2 1/2d., doz. 2/-	
Igranic Coils, number 25 upwards	from 5/-	
Spring Washers	3 for 1d.	
Extra Good Lead-in Wire	10 yds. 1/3, 1 yd. 1 1/2d.	
Variable Grid Leaks	2/6	
D.P.D.T. Switches, on ebonite	2/9	
Igranic Filament Resistances	4/6	
Igranic Vernier Resistances	7/6	
Filament Resistances, wound on core	2/4 and 2/8	
Filament Resistances, very good value	1/10, 2/-, 2/3, 2/6	
Filament Resistances, 7 ohms	3/6	
Duplex Waxless Basket Coils, min. self capacity. Set of 5		2/6
Anti-Capacity Handles, Brass or Ebonite	each 9d.	
D.P.D.T. Switches for Panel Mounting	each 2/6	
Shaw's Genuine Hertzite	9d., 1/-, 1/3	
Galena and Silicon	each 3d.	
Copper Pyrites	3d.	
Zincite and Bernite	pair 1/-	
"Taitte" genuine	9d., 1/-, 1/3	
4 Cats-whiskers (one gold)	6d.	
Valve Pins, split	1 doz. 7d., 3 doz. 1/6	
Contact Studs, best polished, with nuts	doz. 6d.	
Contact Studs, good quality	doz. 4 1/2d.	
Spade Terminals	doz. 6d., 2 for 1 1/2d.	
Wood Screw Terminals	2 for 3 1/2d.	
Stop Pins, with shoulder	2 for 1d.	
Ebonite (Real) Slider and Plunger	8d.	
Pin Terminals, screw pattern	each 2d.	
Ebonite Coil Plugs	9d., 10d., 1/-	
Filament Resistance Dials, according to quality	8d. to 1/-	
Basket Coil Holders, single, well-made	each 2/-	
Basket Coil Holders	2-way 4/-, 3-way 6/-	
2 B.A. Washers	3 doz. 3d., gross 9d.	
4 B.A. Washers	3 doz. 2d., gross 7d.	
Crystal Cups and Screws	each 1d., 1 1/2d., and 2d.	
Valve Sockets, with shoulder and nuts	4 for 3 1/2d., doz. 1/-	
Valve Sockets, with nuts	doz. 9d., each 1d.	
Spade Terminals, screw patt.	doz. 1/6, each 2d.	

NO POST ORDER EXCEPT ON SPECIAL LIST.

POST ORDER COLUMN.

NO POST ORDERS except for goods in this column, and at prices marked, which include all post, rail and packing charges, U.K. only.

ALL ORDERS STRICTLY IN ROTATION.

Fixed Condensers, up to .001	each	1/4
Fixed Condensers, up to .005	each	1/10
Fixed Condensers, .006	each	2/6
Fixed Condensers, .01, .02	each	2/6
Ebonite Valve Holders, hand-turned, 8 nuts	1/4, 1/6	
Moulded ditto, 8 nuts	1/2	
Ebonite Dials, with scale 0-180	each 1/3, 1/6	
Ebonite Dials and Knob	each 1/8, 2/-, 2/6	
Duplex Waxless Coils, 5 in set up to 2,300 m.	set	2/9
Variable Grid Leak, 1/2 to 5 meg.	each	2/9
Variable Grid Leak (Bretwood) (3 years' guarantee) ..	4/-	
Filament Resistances	each 2/3, 2/6, 3/-, 3/6	
Filament Resistance (Igranic)	5/3	
Potentiometers (Igranic)	8/3	
Grid Leak and Condenser, .0003	3/-	
Grid Leak, 2 meg.	1/4	
Dubilier Fixed Condensers, .0002 to .0005	each 3/-	
Ditto .001 to .006	each 3/6	
Dubilier Grid Leaks	each 3/-	
Dubilier Anode Resistances, 50,000 meg., 70,000 meg., 100,000 meg.	6/-	
D.P.D.T. Switches, nickelled, on ebonite	3/6	
S.P.D.T. ditto	2/6	
Ebonite Coil Plugs	each 1/-, 1/3	
Two-way Coil Holders	6/-, 6/6, 7/-	
Three-way Coil Holders	7/9, 8/3, 9/-	
4 Cats-whiskers, gold, silver, etc.	set 6d.	
100,000 ohms Resistance	2/9	
Pin Terminals, screw patt.	6 for 1/-	
Spade "	6 for 1/-	
Telephone Terminals, nuts and washers'	doz. 1/9	
Pillar " nuts and washers	doz. 1/9	
W.O. Patt. " nuts and washers	doz. 1/9	
Very Large Terminals, 2 B.A., nuts and washers	6 for 2/6	
Valve Sockets and nuts, plain	doz. 1/3	
Valve Sockets and nuts, polished, with shoulder	doz. 1/6	
Bell Wire I.R.C. D.C.C., 20x	36 yds. 1/10	
Twin Flex for Extension Leads	12 yds. 2/3	
L.F. Intervale Transformers, Igranic 5-1	22/-	
L.F. Intervale " Radio Instruments, 5-1	25/-	
L.F. Intervale " "Formo" 5-1	15/-	
L.F. " various makes	12/6, 15/11	
Shaw's Genuine Hertzite Crystal	1/-	
Crystal Detectors, Whisker	2/-, 2/3, 2/6	
Ditto glass enclosed	2/6	
Ditto glass enclosed, large, fine value	3/3	
Ditto Perikon, 2 crystals, fine value	3/9	
Ditto Perikon, small, 2 crystals	2/6	
Double Phone Cords, long	pair 1/4	
Telephones. See Special Notice.		
Valves. See Special Notice.		
Variometers, 250/650	4/6	
Variable Condensers. See list.		
Single Basket Coil Holders, with coil plug	2/3	
Three-way Basket Coil Holder	6/-	
Switch Arms, high-class, complete with 12 studs	2/-	
72 yards Twin Flex, for connecting loud-speaker receivers, 50 laminations in each pole	22/-	
Ladies' Single Receivers, complete (4,000 ohms), with hand- some handle and cord	13/9	

ALL PREVIOUS LISTS CANCELLED.

RIGHT OPPOSITE
DALY'S
GALLERY DOOR

M. RAYMOND
27, LISLE STREET, W.C.2

RIGHT OPPOSITE
DALY'S
GALLERY DOOR

CONSTRUCTOR'S LICENCE BRITISH PHONES

EX-GOVT. WESTERN ELECTRIC RECEIVERS

- 4000 ohm Pair, complete with Cords and Bands 14/-
- 1500 ohm Pair, complete with Cords and Bands 12/6
- 300 ohm Pair, complete with Cords and Bands 11/6
- 2000 ohm Single Receiver 6/6
- 750 ohm Single Receiver 5/6
- 150 ohm Single Receiver 5/-
- 120 ohm Single Receiver 4/-



MANSBRIDGE CONDENSERS, 2 m.f., 2/-
'025 1/-; HIGH NOTE BUZZER 2/6;
TAPPING KEYS 2/-; TELEPHONE INDUC-
TION COILS 1/3 Each; HEAD-BANDS
1/3 Pair; BROWN'S CORDS, 7 ft., 2/6.

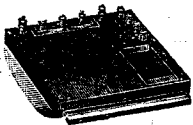

BASEBOARD fitted with 9 Terminals, slide-in leaf, suitable S.T. 100 or Crystal Valve Set 3/6 (Post 1/-)

PLUG AND JACK 2/3 pair; PLUG 1/6;
JACK 9d.

A. ROBERTS & CO.,
 42, Bedford Hill, Balham, London, S.W.12

"CATSEYE" CRYSTAL DETECTOR.
 Ever-set and ready. Smallest, Loudest, Latest. Complete with holder 1/6
 Post Free.
 APAIL, 37, Red Lion St., LONDON, W.C.2.
 AGENTS WANTED.

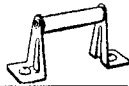

A BETTER WAY

of charging Accumulators from alternating current is by using the **TUNGAR BATTERY CHARGER**. Simple, Safe, and Economical. No moving parts. Requires no attention. No Garage, Owner-Driver or Wireless Enthusiast should be without one. Will charge from 1 to 10, 6-12 volt batteries at a time. Descriptive Booklet free on application. Deliveries from stock.

THE BRITISH THOMSON-HOUSTON CO., LTD.,
 Mazda House, 77, Upper Thames St., E.C.4.

AN OPPORTUNITY FOR MANUFACTURER of Wireless Sets and Parts.
 Small workshop and extra opportunity for sales.
 Reply B, 38, Cecil Mansions, Balham, London, S.W.

WIRELESS INVENTORS

Patents and Trade Marks, Advice Hand-book and Cons. free.—**B. T. KING**, Regd. Patent Agent (G.B. & U.S.A.), 146a, Queen Victoria St., E.C.4. Phone: Central 682. 36 yrs. refs.

VALVES

All valves **BROKEN IN TRANSIT** will be replaced, free of charge, if returned within **SEVEN** days from date of dispatch. Post

- EDISWAN A.R. - - - - - 15/- free.
- " R. - - - - - 15/- "
- " A.R.D.E. (Dull Emitter) 27/6 "
- MULLARD O.R.A. - - - - - 15/- "
- " R. - - - - - 15/- "
- COSSOR P.1. Detector and Amplifier 15/- "
- " P.2 (Red Top) Particularly designed for High Frequency Amplification - 15/- "
- MARCONI R. Anode voltage 45-60 15/- "
- " D.E.R. (Dull Emitter) - 27/6 "

All valves offered are new and have the manufacturers guarantee.
TRADE SUPPLIED.
The Radio & Electrical Supply Co.,
 29, Paternoster Row, E.C.4.
 Phone: Central 7669.

CORRESPONDENCE.

(Continued from page 233.)

2. Platinum-bismuth couples were not used for measuring stellar radiation, nor was such work ever carried out by Professor Thompson. Reception of signals can be had with platinum-bismuth contact, and this also I should be glad to demonstrate. Apart from these corrections, section 2 is probably correct.

3. The time lag objection is pure assumption. A certain lag must, of course, exist, the evidence simply shows that the lag is small compared with the period of sound vibrations.

The statement that the difference in resistance "fully explains" the rectifying action is about the most blatant example of question begging I have ever seen. The whole problem is why this difference in resistance exists.

With reference to the "efficient" thermo-junction I presume the word efficient is misused, as it is about fifty times weekly in all wireless periodicals. In this connection I should be extremely obliged if anyone could mention any machine which has a lower efficiency than a "valve" receiver, say about 0.0001 per cent. If an effective junction is meant, iron-eureka, iron-nickel or particularly antimony-bismuth are all better than copper-eureka. The statement that the latter couple gives 20 microamps. at hand temperature is meaningless, because the resistance of the discharge circuit is not stated. It would be more scientific to say that an E.M.F. of about a millivolt is developed.

With regard to the 95 per cent. half-wave calculation, I am hoping that you will shortly be pleased to publish a further experiment of mine which, in my humble opinion, is strong evidence against any half-wave or filter theory. I should be extremely pleased to investigate experimentally, or discuss personally with him any further points Mr. Wallace may care to raise.

Yours faithfully,
 ERNEST C. CRAVEN.

59, Southern Road,
 Plaistow, E.13.

Recent Wireless Inventions

The following abstracts are specially contributed by Mr. Harold J. C. Forrester, Fellow of the Chartered Institute of Patent Agents, 88-90, Chancery Lane, W.C.2.

Grant of the following patents can be opposed, and printed copies of the full application obtained.

201,585.—**E. GREEN.—VALVE GENERATORS.**—To avoid losses from eddy currents in the thin metal film deposited on the inside of the valve, a metal ring outside one or each end of the valve is connected to the plate or grid terminal, or both. This reduces the internal electric field causing the eddy currents.

201,660.—**TELEG-GES. SYSTEM. STILLE.—LOUD SPEAKERS.**—Amplification is caused pneumatically with the aid of two valve plates formed centrally with non-registering apertures. One plate is clamped peripherally to act as a diaphragm, and is supported centrally by the other plate. The diaphragm is operated by an electro-

magnet having a movable core piece connected to the centre of the diaphragm.

201,720.—**A. E. CHAPMAN.—CONDENSERS.**—A multiple variable condenser, for use in two or more interconnected circuits, has three or more groups of vanes, at least two of which are independently movable relative to the other group or groups. The plates may be arranged to vary the series or parallel capacity of a circuit, a contact being provided to short circuit the series condenser when using the parallel condenser.

201,782.—**R. H. MARRIOTT.—TELEPHONE DIAPHRAGM.**—The diaphragm is heart shaped, and tapers from its centre outwardly. It may be made of wood or aluminium, with a magnetic armature suitably attached. Stiffening ribs may extend outwardly from the centre.

201,816.—**H. SAVILLE & C. H. THORNTON.—CONDENSERS.**—The movable plates of a variable condenser are divided into two groups, the spindles of which are in line, and associated together by a lost motion connection so that the plates may be rotated as a whole or in sections by a single operating knob.

201,845.—**W. DORNIG.—CONDENSERS.**—A fixed condenser consists of metal plates with insulating plates on opposite sides thereof, the sets of plates being spaced apart by peripherally grooved spacing members and the whole clamped together between end plates. Oil or air may be passed between the plates for cooling purposes.

201,890.—**A. B. COLE INC.—CONDENSERS.**—The plates of a variable condenser are provided with integral projections round the spindle or post holes to serve as distance pieces in place of the usual washers. The lower end of the spindle may rotate on an adjustable pointed pivot screw.

2/6 Weekly or 39/6 cash buys a Mead Gramophone with a giant metal horn, extra loud sound, box, massive oak case and 40 tunes. Carriage paid. 10 Days' Trial. 200 Needles and 5/- "Rooleet" gramophone game **FREE**. Table-Grands with Wireless Set; Portables and Cabinet Models at **HALF SHOP PRICES**. Write for catalogue. (Pat. 6100) Birmingham

'PHONES REWOUND
 Repairs and Rewinds to any Resistance.
 1,000 w. 5/-; 2,000 w. 8/-; 4,000 w. 7/6. Returned, Resistance and Signal Tested, in 3 days.
 (Cash, please; postage extra.)
HARRISON, 289, Weston Street, Southwark, S.E.1.

TELEFUNKEN E.V.N. 171 VALVES
for long distance. 6/9 post free.
 Filament 2-3.5 v. Plate 50-150 v.
 "What did we tell you! Read this."
 "All British Station's, Christiana and even American Broadcast received on ONE E.V.N. 171"
 (An extract from a recent customer's letter. Lancs.)
A few K.T.D. Valves now in stock at 3/9 each.
NEW TELEFUNKEN:—
 Variable Fixed Condensers, .001 at 2/- each, post free.
 BALL BEARING TRANSMITTING GENERATORS by A.E.G.
 12-v. D.C. Input, 400-v. D.C. Output, £12/10, car. free.
 TRANSMITTING "BOTTLES," 10-w. and 20-w., at £3/3, post free.
 Crystal Detectors, with Crystal, at 3/6 each, post free.
 Wavemetres, with charts 50-7,500 metres, £10/10, carriage free.
 Transmitting Set, Mod. Control, £10/10, car. free.
 2-v. Amplifiers, with double grid valves, £7/10, car. free.
 Moving Coil Volt and OHM Metres (comb.) from 12/6, post free.
 Roller Switches Various, 10/6 each, post free.
 H.T. Batteries, 60-v. — 3-v. Tappings, 9/- post free.
 H.T. Batteries, 35-v. — 3-v. Tappings, 6/- post free.
ELEFACTORS, Ltd.,
 68, Granville Road, Child's Hill, London, N.W.2.

Our Improved Type A.II Condenser

FOR PANEL MOUNTING—is unsurpassed for workmanship, quality of materials employed, efficiency and Price, which, by the way, has NOT BEEN INCREASED.

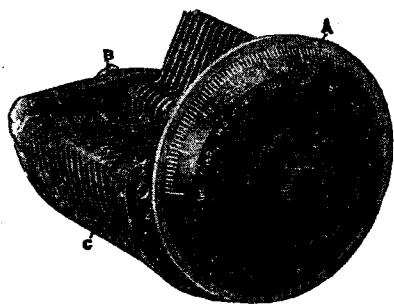

Type A.II.

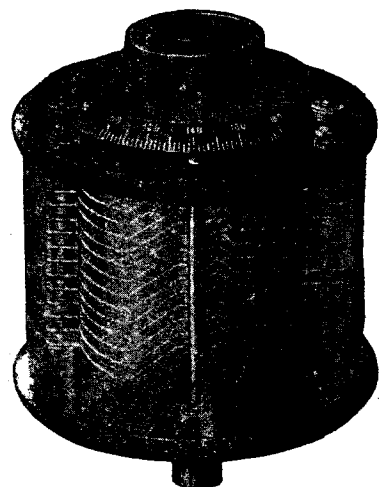

Type A.I. Capacity '0005.

Complete in every respect and exactly as illustrated to the following specification:—

Rotary, Air Dielectric, 22 Gauge Aluminium Vanes, Metal to Metal Adjustable Bearings. Spacing between plates sufficient for pressure up to 1,000 volts. Engraved Ebonite Dial. Is suitable for mounting on any panel up to 3/8 in. thick by drilling 3 holes. Supplied with screws for fixing.

PLATES	Type A.II.	PRICES
57	.. '001	.. 10/-
29	.. '0005	.. 8/6
19	.. '0003	.. 6/9
13	.. '0002	.. 5/6
5	.. Vernier	.. 4/6
3	.. "	.. 3/9

Postage and Packing: 1, 1/-; 2, 1/3; 3, 1/6. If more than 3, kindly include 1 ample for packing and carriage.

SPECIAL FEATURES:

- A. Aluminium Screening Disc which, besides enhancing the appearance of the Dial as it lies flush with the Panel, prevents the hand of the operator producing capacity.
- B. Metal to metal adjustable bearings, of which we were the originators, as applied to Condensers.
- C. 22 Gauge hard Aluminium Vanes.

Most Dealers stock these. If unable to obtain locally, buy direct from us. Don't allow our low prices to prejudice you. They are no criterion whatever of the value we offer. Our motto is QUALITY FIRST, and every Condenser carries our money-back guarantee.

TYPE A.I. in Celluloid Transparent Case (as illustrated), with circular Ebonite top and bottom plates. High-class finish. A very fine piece of workmanship which will compete favourably with the most expensive Instruments on the market. If preferred, supplied in Polished Mahogany Cases at same prices.

Type A.I.	PRICES	PLATES
'001	.. 17/6	.. 57
'0005	.. 15/-	.. 29
'0003	.. 13/9	.. 19
'0002	.. 12/6	.. 13
Vernier	.. 8/6	.. 5
"	.. 7/6	.. 3

FALLONS

THE CONDENSER PEOPLE

230a, HERMITAGE ROAD, LONDON, N.4.

Telephone: Tottenham 1932.

Prompt Delivery - - - Cash with Order

London Agents: VANSTONES, LTD., 61, Chandos St., London, W.C.2.
Sole Trade Distributors: Messrs. G. W. I. Ltd., Shanklin Rd., Crouch End, London, N.8, to whom all Trade Enquiries should be sent.

WARNING!

Don't buy shoddy sets of Condenser parts which are well-nigh impossible of assembly, or half assembled Condensers, which are merely thrown together. BUY OURS. We specialise in Condensers, Complete in every respect and exactly as illustrated.

REPUTATION

Your Condenser is not a "FALLON" unless the name "FALLON" appears on same.

FALLON CONDENSER MFG. CO., LTD., Makers of half the World's Variable Condensers.

HULLO!! G.O., WILL DAY CALLING

you to inspect a new selection of WIRELESS ACCESSORIES.

HAVE YOU SEEN THE NEW WADE LATHE, with slide rest complete 50/-

SET OF NICKEL PLATED SPANNERS, set of 9 for B.A. Threads set 1/6

VARIO-COUPLER with 10 Tappings .. each 19/6

A NEW TYPE OF FILAMENT RHEOSTAT each 3/-

PORCELAIN REEL INSULATORS .. dozen 1/-

Valves of every make, including the new Dull - Emitters, always in stock.

Write for our new Catalogue. Now ready, sent post free. Postage and Carriage on all goods extra.

When you are tired of wasting both time and money on so-called Wireless Crystals, secure one of the new Super Marvel Crystals

DAYZITE (REGD.)

and put an end to all your troubles. Sold only boxed with Silver Cat's Whisker, 2/6 each. Postage 3d. extra.

WILL DAY, LTD.,

19, LISLE STREET, LEICESTER SQUARE, LONDON, W.C.2.

Phone: Regent 4577.

Telegrams: "Titles, Westrand, London."

FREE

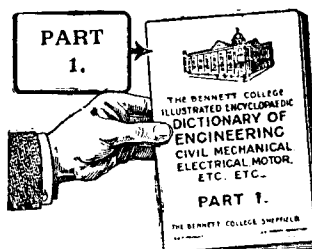

To extend the name of the Bennett College to everyone engaged in the different branches of Engineering, we are publishing an Illustrated Dictionary of Engineering, in about 24 MONTHLY PARTS (16 pages each part). You can have each monthly part as it comes out FREE.

1/- Postage only to pay.

The Dictionary is free to those engaged in any of the following trades: Engineering, Civil, Mechanical, Electrical, Structural, Motor, Sanitary, Boiler, Internal Combustion, Draughtsmanship, Marine, Shipbuilding, Naval Architecture, Building, Architecture, Quantity Surveying, Aviation, Chemistry, Foundry Work, Metallurgy, Matriculation, Mining, Surveying and Levelling, Telegraphy, Telephony, Wireless, and the conditions are that you send your name and address, your age and occupation, with one shilling (to cover postage on the 24 parts), writing your name and address very clearly. We shall then place your name on our Free List and send you Part 1 at once. The others will be forwarded as issued. Address your application fully to:

(We teach the above trades by Post; particulars Free).
Department D 106,
The Bennett College,
Sheffield.

STERLING RADIO TELEPHONES

Unsurpassed for quality and reproduction of Radio Speech and Music.

Wholly British
Manufacture.



No. R 1260
HIGH GRADE
with double pole
permanent magnets.

120 ohms ..	£1 2 6
2,000 ..	1 4 0
4,000 ..	1 5 0



No. R 1238
SUPER QUALITY
with multiple
permanent magnets.

120 ohms ..	£1 17 6
2,000 ..	2 0 0
4,000 ..	2 2 0

Hand Telephones

No. R 1281

SUPER QUALITY
double hand telephones as
illustrated, with multiple
permanent magnets

120 ohms ..	£2 16 0
2,000 ..	2 19 0
4,000 ..	3 0 0

No. R. 1230

HIGH GRADE

Single hand telephones
with double pole perman-
ent magnets

2,000 ohms ..	17/6
---------------	------



No. R 1281

WE ARE EXHIBITING AT
THE ALL-BRITISH WIRE-
LESS EXHIBITION, WHITE
CITY, SHEPHERD'S BUSH,
NOVEMBER 8th-21st.

Obtainable from all Electrical Dealers
and Stores.

STERLING TELEPHONE & ELECTRIC Co., Ltd.,

Manufacturers of Telephones and Radio Apparatus, etc.
(WHOLESALE ONLY).

Telephone House, 210-212, Tottenham Court Road, London, W.1.

Telephone: Muscun 4144 (7 lines). Telegrams: "Cucumis, Wesdo, London."

BIRMINGHAM: CARDIFF: MANCHESTER:
150, Edmund Street. 10, Park Place. 14, St. Peter's Square.

NEWCASTLE-ON-TYNE: 27, Mosley St. WORKS: Dagenham, Essex

GREAT CLEARANCE of WIRELESS PARTS

Drastic Reductions in all Accessories and Parts—
everything must be sacrificed to make room
for Winter Stocks. Every Offer a Genuine Bargain.

GAMAGES AUTUMN SALE

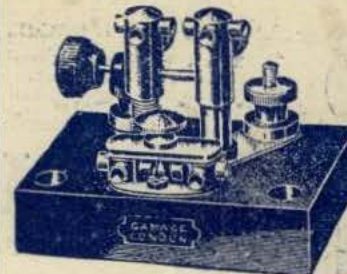

**CAPSTAN TYPE
CRYSTAL DETECTOR**

The finest Perikon Detector
made. With two spare Capstan
Heads. Ebonite
Base, 3 by 2 by 1 1/2 in.
Sale Price .. **15/3**
Usual Price 21/-

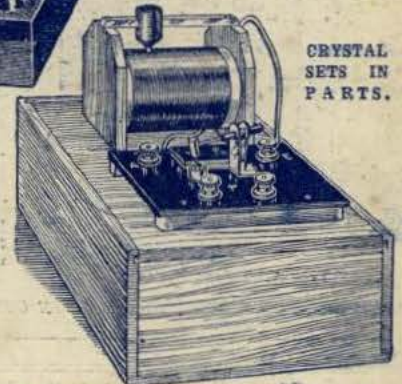

CRYSTAL
SETS IN
PARTS.

The best Crystal is PERMANITE

(Regd. No. 438341.)

Clear, powerful results.
Price per large
specimen, Post-
age Free .. **1/6**

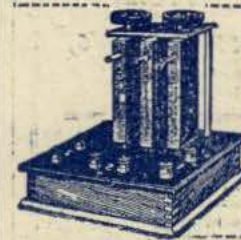

THREE-COIL HOLDERS (as sketch on left)
Beautifully finished throughout. Suitable for
Honeycomb and Burndept Coils.
Simple in construction and most
practical in use. Sale Price .. **12/6**
Postage 6d.

Best quality Geared Type. Sale Price .. **20/-**
Postage 6d.

Special Offer of these splendid Crystal Sets in
parts. The illustration shows the set made
up ready for use. All parts are beautifully
finished. Size of box 10 1/2 in. x 8 in. x 4 in.
Complete instructions, simple to
carry out, are given with each one. **15/-**
Usual Price 21/- Post 9d. extra.

VARIABLE CONDENSERS.

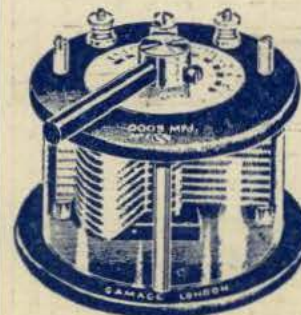

Variable Condensers of our well-
known design offered at bargain
prices.

	Sale Price	List Price
0005	7/6	16/6
00045	7/-	14/0
0003	6/9	13/-

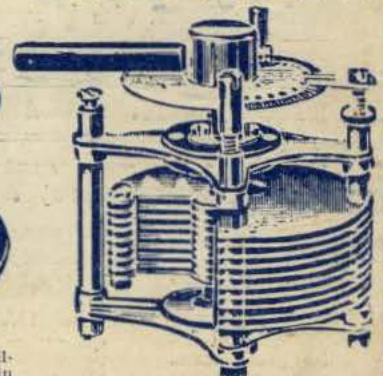

For Panel Mounting, as illustration.

	Sale Price	List Price
0003	5/9	10/-
00045	6/6	12/-
0005	7/-	11/6
001	8/6	18/6

GAMAGES, HOLBORN, LONDON, E.C.1.

All applications for Advertisement Space in POPULAR WIRELESS to be made to JOHN H. LILE, LTD. (Sole Agents), 4, Ludgate Circus, London, E.C.4. Phone: 10808 Central.