

No. 14. OUR FIRST EXHIBITION NUMBER: SEE PAGE 254

# POPULAR PW WIRELESS Weekly

3d

No. 14. Vol. 1.  
Sept. 2, 1922.



Receiving a Wireless Concert at a Garden Fête.

### SPECIAL FEATURES IN THIS ISSUE

How to Make an H.T. Battery.  
New Series for Beginners.  
About the Wireless Exhibition.  
Hints to Amateurs.

Wireless Control.  
Step by Step in Wireless.  
Inter-Planetary Communication.  
Land Stations in Germany



**THE LOKAP** (PAT. APP. FOR).  
**INDUCTANCE COIL WINDING MACHINE**

THIS ILLUSTRATES THE LATTICE LAY OF "LOKAP WINDINGS."

**IN 15 SECONDS YOU CAN MAKE A "LOKAP" COIL TO TUNE A BROADCASTING STATION**

*SIMPLE—WONDERFUL—EFFICIENT—STURDY*

**BY MAKING YOUR OWN COILS YOU SAVE MONEY**

The only machine of its kind in the world which effectively enables an Amateur to wind a genuine "LOKAP" Coil in a few seconds. Makes a large range of various diameters and thicknesses. Special pamphlet upon request.

Obtainable from the Manufacturers below or :—

London, W.—**ECONOMIC ELECTRIC LTD.**,  
10, Fitzroy Square.

London, E.C.2.—**WELLER & PILBROW**,  
68, Basinghall Street.

London, S.E.1.—**H. D. BUTLER & Co.**,  
222, Great Dover Street.

Birmingham.—**M. Lawrence & Co.**, 25, Bright  
Buildings, 110, John Bright Street.

Cardiff.—**R. W. Robins & Co.**, Park Place.

**AGENTS WANTED WHERE NOT REPRESENTED FOR THIS LINE**

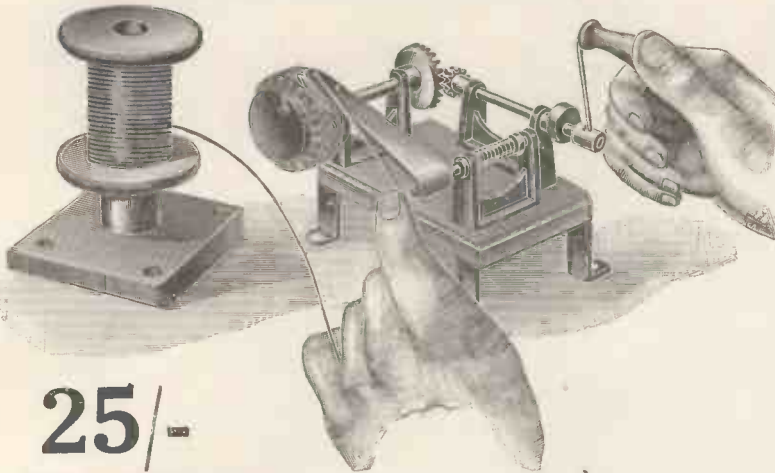

**25/-**

POST 1/- EXTRA.

SOLD BY EVERY WIRELESS FIRM OF IMPORTANCE IN THE WORLD

**INSIST UPON HAVING THE GENUINE "LOKAP." THE NAME IS YOUR GUARANTEE**

**MITCHELL'S ELECTRICAL & WIRELESS, LTD.**

McDermott Road, Peckham, S.E.15.

THIS ILLUSTRATES THE TRUE SINE WAVE LOKAP WINDING (1/4 WIND).

**LORNETTE 'PHONES**

2,000 Ohms.

THE IDEAL PHONE FOR LADIES

No more disarranging of hair. No cumbersome weight on the head. Beautifully finished. Equal in reception and clarity of tone to any double headphone.



**25/-**

Postage Paid.

With ebonised handle. Also supplied with handles of Tortoiseshell, Ivory, Mother-of-Pearl, etc. Prices on application. Special Terms to the Trade.

Manufactured Exclusively by :

**THE ECON MANUFACTURING CO., LTD.**,  
6, Holborn Viaduct, London, E.C.1.

Telephone : City 4148.

**OUR PRICES CANNOT BE BEATEN.**

**CRYSTAL SETS.**

£3 7 6 Complete with Double Head'phones.

**VALVE SETS**

FROM £6 5 0

Don't Pay More for Wireless



**COIL HOLDER.**

2 Way - - 16/-  
 3 " - - 25/-  
 Best British Make.



**HEAD 'PHONES**

4,000 ohms total.

**30/-** each Complete.

THOUSANDS IN USE.

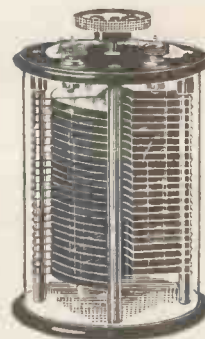

**VARIABLE CONDENSER**

Capacity '0005 mfd.

PRICE 30/-



**HONEYCOMB COILS**

FROM 5/6 EACH.

According to Wave-Length.

**INTERVALVE TRANSFORMERS**

20/- EACH.

SEND FOR LIST (P.W.) TO

**BRITISH CENTRAL ELECTRIC Co., Ltd.**

6 and 8, ROSEBERY AVENUE, LONDON, E.C.1.

Telephone — Holborn 5848.

THE EXHIBITION.

Be sure to visit the POPULAR WIRELESS Stall at the Exhibition at the Central Hall.

All are welcome.

Popular Wireless TOPICAL NEWS AND NOTES.

HOW TO MAKE AN H.T. BATTERY.

By W. S. Sholl, A.M.I.E.E.

See Instructive Article in this Issue.

Good Business.

DURING 1921 some 45,000 wireless messages were dealt with in White Star liners. For the first six months of this year 39,000 have been handled.

An Explanation.

IN reply to one or two readers who have written to the Editor, the author of the article entitled "The Principle of the Graph or Curve," which appeared in a recent number of POPULAR WIRELESS, wishes to point out that in the diagram illustrating the article he has shown the voltmeter connected in series instead of in shunt, as he



Miss Madge Stuart, the well-known cinema actress, is a keen wireless amateur.

The dance music of an orchestra could be heard clearly and distinctly, and the dancers had no difficulty in executing the various movements, which included a fox trot. The aerial was erected on one of the trees in the grounds for the occasion, and was connected by a single wire to the ballroom.

Mr. William Le Queux.

MR. WILLIAM LE QUEUX wrote to me the other day from Nantes.

He is holidaying in France and has been motoring to his heart's delight, for he is especially fond of driving a car.

At Nantes, Mr. Le Queux tells me, he was allowed to inspect the great Naval Wireless Station (U A), and, although he gave few details in his letter, I gather he was considerably impressed by the latest French improvements.

Mr. Le Queux has, by this time, probably visited the Bordeaux station and the Sainte-Assise station, which he assured me he would be certain to inspect before leaving France.

A New Battery.

THE greatest obstacle to the production of a perfect battery up to now has been to secure a suitable medium for separating and insulating the positive and negative plates. This has been overcome by the threatened rubber insulated battery, which ensures perfect insulation for the plates and prevents short-circuiting, constant voltage for a long time so that adjustment of current is retained when once set, and a minimum internal activity while idle and no creeping of acid.

In recognition of the superiority which the threatened rubber insulated battery possesses over other types, the C.A.V. Company has obtained the exclusive right to its manufacture throughout Great Britain and Ireland.

Wireless Control.

A MODEL submarine on wheels, whose course will be directed by wireless, a wireless equipment in motor-cars, and a broadcasting concert in aid of London hospitals will be features of the Radio and Wireless Exhibition and Convention in the Central Hall, Westminster, from September 2nd to 8th inclusive.

The exhibition is organised by British business men in order to stimulate interest in the development of wireless.

Exhibits will range from complete wireless installations for battleships to the "super antenna," an American substitute for the aerial, which can be attached to an electric light bracket.

The motoring wireless equipment will enable motorists to receive or transmit messages as they travel along the roads of the country.

In the course of his new series of articles, Major Raymond Phillips will deal with the

construction of a wireless-controlled toy train in such a manner that the youngest amateur will be able to control his engine by wireless.

A Wireless Drama.

THE following story of a wireless drama appeared recently in the "Evening Standard."

"A radio set in the Charles Street gaol, in Boston, brought news to a prisoner there which so startled him that he staggered to his feet, white as death, and would have fallen had not the warden caught him in his arms.

"But the reaction was almost immediate, and, throwing off the headgear, he shouted and wept for joy as he wrung the warden's hands.

"George Rollins, who in 1917 had been convicted of manslaughter and sentenced to a long term in prison, had been a model convict, and as a 'trustee' was accorded various privileges.

"He was allowed to 'listen in' at the warden's wireless outfit while news of the day was being broadcasted.

"What he heard that occasioned his emotion was that Jesse Murphy, inmate of the penitentiary in Harrisburg, the capital of Pennsylvania, had confessed to having in 1917 committed the murder of Ordway Hall, a grocery shop manager in Boston—the very crime for which Rollins and his brother, who always had most earnestly protested their innocence, were 'doing time.'

"Later the warden obtained by telephone confirmation of the news from local police headquarters, where he was informed that two detectives with extradition papers would soon leave for Harrisburg to bring Murphy to Boston for trial."

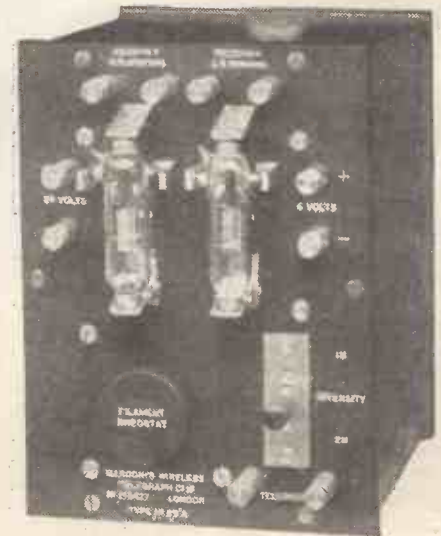

A Marconi Double Note Magnifier.

only intended to convey (diagrammatically) the fact that both voltage and amperage were being measured. For practical purposes, of course, the voltmeter is connected in "shunt" with the circuit.

New Station at Stockholm.

I HEAR that the Swedish Telegraph Administration has now contracted with an American company for the delivery of the wireless gear for the large trans-oceanic station on the west coast of Sweden. The wireless station will consist of one transmitting station and one receiving station, the former to be built between Varberg and Falkenberg, and the latter near Kungsbacka, both to be finished during 1923.

Dancing by Wireless.

AN experiment in dancing by wireless has been successfully introduced at Harrogate by Messrs. Haxby and Brady. The demonstration took place at the Beechwood Hotel, and was voted a great success.



NEWS AND NOTES.

(Continued.)

Wireless and Fishing Boats.

A PRESS telegram from Aalesund to the Norwegian newspaper, "Aftenpost," states that very successful experiments have been made with wireless telegraphy outfits on small fishing cutters.

Wireless Concert.

A BOY Scout gathering on September 2nd in the "Ten Acre," Chapeltown, will be notable for the fact that the first wireless concert in the district will be one of the attractions. The St. Oswald's (Sheffield) Boy Scout band will also be in attendance, and the Chapeltown troop will give a display.

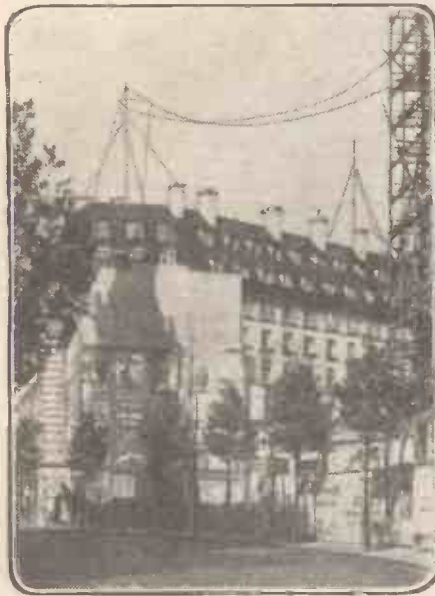

The New Aerial at Marconi House.

Broadcasting.

THE articles of association of the proposed British Wireless Broadcasting Company have now been submitted for the approval of the Postmaster-General. Mr. Kellaway is on holiday, and it was stated at the General Post Office recently that after the permanent officials have examined the articles it may be necessary to forward them to him.

Portugal and Wireless.

A "TIMES" message from Lisbon says that the Portuguese Parliament has approved a contract with the Marconi Company for the erection of wireless stations in Lisbon, Madeira, the Cape Verde Islands, Angola, and Mozambique, to be ready in four years. A forty years' concession for working them will be granted to a syndicate with Portuguese capital and with a majority of Portuguese directors on the board.

Clifden Damage.

I HEAR that the estimated damage done to the Marconi station at Clifden is about £70,000. The receiver and other parts of the station were entirely destroyed.

Uruguayan Station.

THE Uruguayan Minister of War has been requested to authorise the erection of a Radio station at Isla Grande, Port of La Paloma. The station would have a range of 200 miles.

ARIEL.

THE FIRST WIRELESS EXHIBITION.

OUR first International Radio and Wireless Exhibition and Conference will be held at the Central Hall, Westminster, London, from September 2nd to September 8th.

It is no exaggeration to say that this exhibition will attract all London and visitors from the Provinces, for it is the first of its kind ever held in this country.

To-day the whole country is deeply interested in wireless. The organising director—Mr. E. Schofield—has borne in mind this fact, and in consequence the exhibition will have a very wide "popular" appeal. The man in the street, who knows nothing about wireless at all, will find this exhibition of entralling interest.

Some of the special features arranged include the offer of prizes of £5 and £3 for the best piece of amateur wireless apparatus exhibited.

Mr. George Sutton, A.M.I.E.E., and Mr. Waring S. Sholl, A.M.I.E.E., A.Inst.A.E., both on the regular contributing staff of POPULAR WIRELESS, and representatives of the paper, will lecture.

Mr. Sutton (Hon. Secretary of the Wireless and Experimental Association) is speaking on "Wireless Club Matters" on September 4th (Monday) at 7.30 p.m. On Thursday Mr. Sholl will lecture on "Wireless in the Home," and Captain B. G. Martell is speaking on Tuesday evening at 7.30. Other well-known experts have been engaged to deliver lectures.

All members of Wireless Societies will be received by Percival Marshall, Esq., who will be in the chair at the various debates.

A special licence has been granted to the exhibition by the P.M.G., and the use of wireless will be demonstrated daily.

A feature of the exhibition will be various mechanical devices controlled by wireless, and all those who are following Major Phillips's articles should on no account miss this attraction and his lecture.

The Central Hall faces Westminster Abbey, the nearest station being St. James's Park.

POPULAR WIRELESS will have a special stall at the exhibition, and our representatives are at the service of all who have questions to ask.

Bear in mind that this is the First Wireless Exhibition ever held in Great Britain, and that all that is latest and best in wireless science will be present.

A demonstration emphasising the usefulness of wireless in tracking down criminals will be another feature of the exhibition.

Full details will not be given here because the demonstration is in many ways a unique one; but the public will have the opportunity of controlling a wireless set and actually causing the arrest of a pseudo criminal.

A wireless-controlled submarine is another attraction that will prove very popular.

The importance of the exhibition from the point of view of wireless clubs cannot be over-estimated. The daily lectures and meetings will prove of inestimable benefit to club representatives.

An exchange of ideas will be possible; points of interest common to all can be thrashed out round a table and mutual advantage gained thereby. And the fact that Mr. George Sutton is lecturing on wireless clubs should draw many members and representatives from various clubs.



# Broadcasting Programmes

What you can hear every evening of the week on your set.

WITH the formation of a single broadcasting company extensive tests are being carried out by the various firms concerned.

The Marconi House station is ready, and only waits for the word "Go."

The Radio Communication Co. are also well to the fore, and, in conjunction with the

Metropolitan Vickers, Ltd., should provide excellent fare for the patient amateur.

The number of amateur transmitters in this country, increases steadily.

On 400 metres some really excellent telephony and music may be heard any night of the week—and some of the messages that are hurled into the ether are in themselves a complete variety entertainment.

TELEPHONY TRANSMISSIONS.

Station.	Call Letters.	Wave-length.	Remarks.
Croydon .. ..	GED ..	900 metres ..	Throughout day to aeroplanes.
Marconi House, London	2LO ..	360 metres ..	Between 5 p.m. and 6 p.m. (not regular).
Writtle, England ..	2MT ..	400 metres ..	Tuesdays, 8 p.m. (B.S.T.).
Paris .. ..	FL ..	2,600 metres ..	Daily, 5 p.m. (B.S.T.).
Königswusterhausen ..	LP ..	2,500 metres ..	Daily, 7 and 10.30 a.m. (G.M.T.).
The Hague .. ..	PCGG ..	1,050 metres ..	Sundays and Thursdays, 8 to 9 p.m. (B.S.T.).



# INTER-PLANETARY COMMUNICATION.

By P. J. RISDON, F.R.S.A.

"To Nature nothing can be added, from Nature nothing can be taken away—the utmost man can do is to shift the constituents of the never-varying total. The law of conservation rigidly excludes both creation and annihilation. Waves may change to ripples and ripples to waves—asteroids may aggregate to suns, suns may resolve themselves into nebulae—the flux of power is eternally the same. It rolls in music through the ages, and all terrestrial energy—the manifestations of life as well as the display of phenomena—are but the modulations of its rhythm."—PROFESSOR TYNDALL.

WHEN asked to contribute this article the above quotation struck the writer as singularly appropriate, although, when penning those words, Professor Tyndall perhaps had no thought of such a thing as broadcast music by wireless.

The consumption of fuel to generate power, of power to generate electricity, of electricity to generate electro-magnetic waves for wireless transmission, merely consists of "shifting the constituents of the never-varying total." The criminal waste of fuel of which man is guilty is only loss in so far as man is concerned. It is not lost in Nature's vast laboratory—the Universe.

Our great world is but a speck in space. The sun and the planets—all solar systems are but clusters of specks in the Universe, separated from each other by incalculable distances, compared to which the distance of the outermost planet, Neptune—nearly 2,800,000,000 miles from the sun—is as nothing.

## Ether Disturbances.

Every star is a sun, like our own sun, radiating forth waves of energy into space. Of these waves of energy the only ones of which we are conscious that reach us, even from the nearest star, are light waves. We say "of which we are conscious" because light waves merge imperceptibly into other vibrations, such as electro-magnetic waves.

Although doubts have recently been cast upon the ether hypothesis, pending further investigation it will be convenient still to regard that mysterious something, which we call the ether, as filling all space, permeating all matter, possessing uniform density, and serving as a medium for the transmission of energy waves.

Now it is reasonable to suppose that in vast, inter-stellar spaces the ether is disturbed by such vibrations to a comparatively small extent, from our point of view. But when we come to those portions occupied by solar systems—our own solar system, for instance—we know that ether disturbances are considerable. To bring the matter right home, between the sun and the earth and other planets the ether vibrations must be comparatively violent, for it is the medium for the transmission of all light, heat, and other rays from the sun.

## "The Initial Catastrophe."

As these waves extend, they become weaker and weaker beyond the confines of the solar system, until at last the sun appears as a star to the inhabitants of the worlds of other solar systems. And at still greater distances presumably they die down and become imperceptible.

What is the origin of all this energy?

Energy takes various forms: it may be that of the electro-magnetic waves of wireless or other ether waves, or of heat or electricity or life itself. One of its forms is that of matter in motion. To seek its ultimate origin is to essay an impossible task. The late Dr. Lowell preferred to start with what he termed "the

initial catastrophe"—the collision in space of dark, dead suns and worlds, which astronomers believe they have seen take place in the heavens.

A collision end-on between two such hard bodies, even although ice cold, would generate such tremendous heat as to change the bulk of the solid matter to gases and dissipate it through billions of miles of space. Accepting Newton's law of gravitation, in the course of ages these atoms of matter would gradually draw together again, countless collisions occurring and again generating heat.

## Sun Spots.

The late Sir Robert Ball explained how the ultimate tendency of these collisions would be to form a whirling or spiral nebula having a nucleus, and aggregations forming enormous "knots" in the spiral. Ultimately the nucleus would become a sun, and the knots gaseous planets, which, continuing their revolutions, and subjected to the cold of space, would gradually form solid spherical, or nearly spherical, bodies, thus constituting a new solar system. As the gaseous matter of suns concentrates more and more, the collisions become more frequent and violent, and more intense heat is generated and dissipated in space.

It is not our purpose here to enter into a detailed astronomical discussion of the sun or of its chemical composition, although these are essential to complete comprehension of the subject, but out of it all emerges the fact that energy, once represented by dark, cold bodies in motion, is thus partially transformed into radio-active energy propagated as different kinds of waves.

There has been much discussion of late years as to the cause and effect of sun spots. It is generally accepted that they are vast gaps thousands of miles deep in the sun's glowing surface, revealing its dark, gaseous interior. Some believe that they are primarily due to masses of matter that have combined from the sun's own outer layers of gases, and that fall in vast showers on to its surface, where they are again vaporised.

## A "Dust" Screen.

The more probable view is that they are the results of explosions due to the pressure of the outer gases on those within. Around their rims vast tongues and fountains of flame shoot out, some of the jets and flames extending to distances of hundreds of thousands of miles. Of such magnitude are these disturbances that they appreciably upset the otherwise comparatively uniform radiation of waves that reach the world, this being made manifest by fluctuations in the magnetic field of the earth, sometimes sufficiently strong to interfere seriously with magnetic recording apparatus.

We know that the energy radiated by the sun is sufficiently powerful for light waves to reach Neptune—a distance of nearly 2,800,000,000 miles—and to be reflected back to the earth, a further distance of 2,700,000,000 miles, and still be visible with the aid of a telescope. It is important to consider also that the temperature of the sun is estimated at 14,000 degrees Fah., which gives some idea of the energy diffused.

The foregoing alone, apart from other important factors, enable us to conclude that the ether within the confines of the solar system is in a state of continual and powerful agitation.

Professor Fleming, whose charming works on scientific subjects are familiar to many, suggests that among other things the sun projects "dust" that reaches our atmosphere, in which it is held in suspension. Thus it would constitute a screen, possessing electrical properties,

round the world at a height of some thirty miles. It is thought by some that it may be the electro-magnetic properties of this screen that prevent the waves of wireless from radiating into space, and cause them to travel round the world between the dust screen and the earth.

Although not everyone is convinced that such a guiding screen is a necessity, for the magnetic properties of the earth itself may possibly be sufficient to effect this (Einstein has proved that light is deflected by gravitational or magnetic attraction), the fact remains that the electro-magnetic waves of wireless do follow the curvature of the earth, so that wavelengths at present in use would, on that score alone, appear to be useless for the purpose of signalling to another planet.

We have here, however, an important consideration. Sufficiently short electro-magnetic waves gradually merge into light waves, and light waves do not (except perhaps to a negligible extent) follow the curvature of the earth, but radiate approximately in straight lines in every direction.

## The Red Planet.

Let us take Mars—for that is the planet most popularly believed to be inhabited. At its nearest, Mars is some 48,000,000 miles from the earth.

For artificial light signals from the earth to be observed on Mars it would be necessary for the side of the earth where the signals are produced to be practically in darkness, otherwise the mightiest light we could produce would simply be obliterated by the reflection of sunlight from the earth to Mars.

And since Mars is further from the sun than the earth, night-time would have to be selected at a time when the earth occupies a certain angular position in relation to the sun and Mars. That means that the earth itself would be invisible to the Martians, whose astronomers, however, must be supposed to know our position and be on the look-out. Conversely, similar conditions must necessarily obtain on Mars before we could receive light signals from the Martians. (Incidentally, exactly similar conditions could not obtain on Mars.)

Let us consider what this implies. The Martians would need to generate, at a particular point on their globe and at a precise time, power sufficient to project light waves equivalent to an appreciable percentage of the sun's rays reflected to us from that planet!

The next point is that, whether we consider light or electro-magnetic waves, atmospheric conditions are serious factors in the matter of obstruction. It appears doubtful to the point of impossibility whether we could ever produce energy sufficient to generate waves of either type of such power as would be capable of piercing our atmospheric blanket, traversing intervening space, and penetrating the atmosphere of Mars so as to be perceptible as signals, even supposing that their hypothetical inhabitants are on the look-out for them. Conversely, a similar difficulty applies.

In the next place, supposing that by prodigal expenditure of energy we could transmit such signals, then, in the vast torrent of waves of every variety from the sun, there is every conceivable chance that they would be swamped—depolarised—time after time before they could effect their purpose.

Although the writer is the last person in the world to suggest "closing the door" on experiment and investigation in any branch of science, it appears as though inter-planetary communication is barred by one of Nature's inexorable laws—the limitations of human control over events in the Universe.



# HOW TO MAKE AN H.T. BATTERY.

By WARING S. SHOLL, A.M.I.E.E., A.Inst. A.E.

NUMBERS of wireless enthusiasts with valve receivers, or transmitters, have found the maintenance of high-tension batteries a rather expensive and uncertain business, and will doubtless welcome any suggestions whereby this element may be raised in efficiency and reduced in cost.

In the first instance it may be asked: "Can the amateur make his own dry cells?" The answer is in the affirmative, with certain reservations.

The construction of dry cells, while calling for care and experience, is not beyond the capabilities of the worker who is fairly skilled in soldering and elementary metal work, but—and it is rather a big but—home-made cells will cost in materials alone more than the professionally manufactured article.

There are, however, two sides to a subject

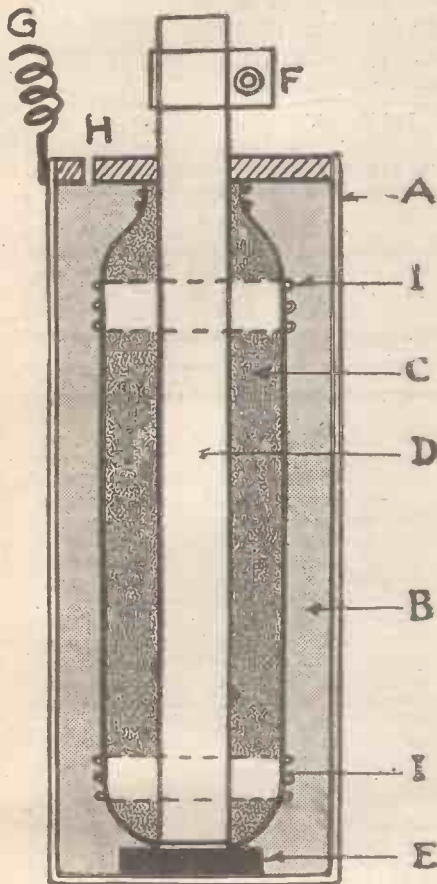

Figure 1.

such as this, from the reader's point of view as a constructional article is of considerable educational value, quite apart from its use in offering practical guidance to the man who wishes to know "how to make."

The worker, therefore, will do well to follow articles of a practical nature as a means of acquiring useful knowledge, which cannot fail to assist him in getting the best results whether he desires to undertake the construction of the apparatus or not.

There need be no mystery about "dry" cells; they are simply a sort of "flapper," an up-to-date edition of the homely Leclanché battery, which, stored away in the cellar, performs as it were the duties of an electrical Cinderella in connection with the electric bell

Strictly speaking, the term "dry" cell is a misnomer, as if the battery were really "dry" there could be no chemical action, and therefore no output of current.

The state of the interior of a dry cell in good order is neither "dry" nor "wet," but "damp," the necessary exciting fluid, or "electrolyte," being taken up by the various chemicals and powders, and held by them very much as sea sand retains moisture, and for the same reason, viz., that saline solutions attract moisture and easily keep in a more or less damp condition any materials mixed with them.

Fig. 1 gives a section of a typical dry cell, and illustrates the arrangement of the various elements, from which it will be seen that the zinc element also forms the container of the whole assembly which it encloses.

The paste excitant B consists of a solution of sal-ammoniac, etc., applied to the inner surface of the zinc cell in the form of a paste, releasing hydrogen which is "depolarised" by the contents of the bag C.

The positive pole is the carbon terminal F, while the negative terminal G is merely a few inches of insulated wire soldered to the zinc container.

At E will be seen an insulator to prevent the carbon from sinking through the paste and causing a short circuit with the bottom of the zinc cell, while at H there is a layer of wax compound to seal the top of cell, pierced with a small vent to obviate the gases liberated bursting the cell.

Having now obtained a clear idea of the principles underlying the construction of a dry cell, let us try our hand at making one or two, if we do not mind paying a few pence for the experience gained.

It may be observed at the outset that an 11-cell 16-volt battery may be purchased at the very low figure of under fourpence per cell, so that we are certainly not on a money-saving proposition so far as dry cell making is concerned; but the alternative suggested farther on will fully justify our going into further details with the prospect of ultimate saving.

It will be clear that at every stage of making the utmost care must be taken to avoid any contact between the zinc and the carbon, or

the black mixture surrounding the carbon, otherwise internal short circuits will be set up and the cell speedily consumed without furnishing a vestige of current externally.

With these precautions in mind we will cut out a sufficient number of pieces of thin sheet zinc,  $2\frac{1}{2}$  ins. by  $3\frac{1}{2}$  ins., and bend the longer side round a former 1 in. in diameter, which may be made from any suitable round piece of wood or metal tubing, the overlap of a shade over  $\frac{1}{2}$  in. providing the joint, which must be soldered up perfectly tight, also a disc 1 in. diameter in the bottom of the cylinder. In soldering zinc the best flux is hydrochloric acid, or "spirits of salts," which should be diluted with an equal bulk of water, and *not* in this instance "killed" by adding zinc. It may be mentioned that this is the only case calling for the use of hydrochloric or "muriatic" acid, in its simple form, as a flux.

Under no circumstances should it be used for any "electrical" joints, as it is not only corrosive but "deliquescent" also, and therefore attracts moisture, to the detriment of the insulation. Have the soldering bit well tinned, apply the flux with a feather to the cleaned edge of the seam, and run a neat line of solder along the joint; serve the bottom likewise, and finish off the container by soldering a 3-in. length of insulated copper wire to the top to serve as the negative terminal.

Having thus prepared the necessary number of zinc containers, we now proceed to make up the positive elements, viz., the carbons and the depolariser.

The carbons are 3-in. lengths of  $\frac{1}{4}$ -in. carbon rod, which must be fitted with a suitable terminal, which is easiest done by cutting a strip of thin copper sheet  $\frac{1}{16}$  in. wide, and bending it round in the form of a clip, the two ends being drilled for the reception of a terminal, which is passed through and pulled up tight. Good contact is very important here, or resistance will be introduced to the detriment of the output. The ideal method is to "copper" the ends of the carbons electrolytically, and force on a little metal cap or "thimble" to which a terminal screw is attached.

This is, however, rather beyond the capabilities of the amateur, so provided the greatest care is taken to secure a tight fit, the method already given will be found satisfactory. The completed carbon clip should be pointed over with Brunswick black to avoid "creeping" and subsequent corrosion of the terminal.

Manufactured cells usually have the black mixture rammed in under considerable pressure, but, as the beginner will probably force the black mixture through the white paste and short circuit, and thereby ruin the cell, it is advisable to employ the "sack" method of construction.

To prepare the depolariser, take powdered carbon 10 parts, powdered manganese dioxide 10 parts, and mix thoroughly, heaping the mixture up on an old plate and making a hollow in the centre in the same way as a mason mixes his mortar. Now make up the following solution: zinc chloride  $\frac{1}{2}$  lb., water  $\frac{1}{2}$  pint, in a clean glass jar and stir occasionally until no more of the zinc chloride will dissolve, then add a little more water until the whole is just in solution known as a "saturated" solution, and then add  $\frac{1}{4}$  pint more water.

To this solution now add  $\frac{1}{2}$  lb. sal-ammoniac, powdered, and well stir until all is dissolved, adding a very little more water in case a few crystals remain as the whole solution is near

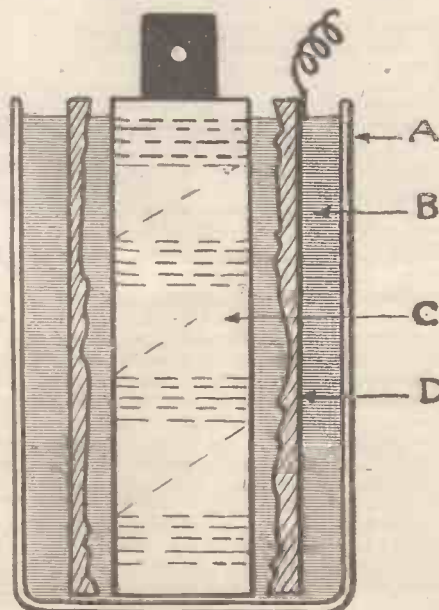

Figure 2.

(Continued on next page.)



# HINTS TO AMATEURS

**V**ERY often, when about to mount a terminal on your ebonite board, it will be found that the screw that fastens down the terminal is too short to go through the ebonite. This may be easily remedied by drilling, first, the hole to take the screw, and then drill out with a larger drill (large enough to take the head) a recess until deep enough to allow enough thread to appear above the board to hold the terminal.

When winding small coils from a reel of wire always mount the reel on something that will allow it to revolve freely and take the wire away from the reel properly and not to allow the wire to come off the ends in a spiral form. The last method will be the means of giving a lot of trouble in the way of kinks. Should a kink occur, do not straighten it out by passing it through the fingers, but take the kink out in the proper direction; it will save a lot of trouble.

Soldering an earth lead on to a water pipe that has water in it will not be found an easy job. A much better plan is to make a small brass slip similar to a pump-clip on a cycle, clean the pipe where the clip is to be fastened, and use the tightening or fastening screw as the terminal to fasten your earth wire on with.

High-tension batteries should be well insulated when in use; it is worth while to make a small wood box and well paraffin-wax the inside before standing the batteries in. This specially applies when pocket batteries are used. A good plan is to make the box with a set of points on the top lid that will act as a switch, to make a selection of voltage quickly.

When soldering two pieces of flat metal together it is a good plan to "tin" both pieces first; that is, clean the parts that are

to be soldered together, and then, after putting the flux on, melt a small quantity of solder on the two pieces, rubbing with the soldering iron till the metal is quite "silvery." If you have a Bunsen flame it is much easier to hold the metal in the flame and run a little solder on, wiping off the surplus with a piece of rag whilst hot. If soldered together in this way—that is, the two "tinned" faces put together and pressed whilst heated—a very firm joint will result.

If you are building a set with very hard wood, such as teak, and joining up with small brass nails, a very firm hold will be made by the nails if you just "nick" them first with something sharp—like a small cold chisel.

Make small nicks by holding the nails on a piece of flat iron and dig the cold chisel into the nails by slanting the chisel away from the point. This will make the nails hold much firmer.

If your ebonite does not seem to be quite flat, do not try to alter it whilst cold; simply warm it in hot water or in front of a fire and lay it between two pieces of stout wood with a heavy weight on top and do not take out till quite cold.

Small steel parts to be "tempered" are best heated in molten lead; the heat in this manner will be very equal.

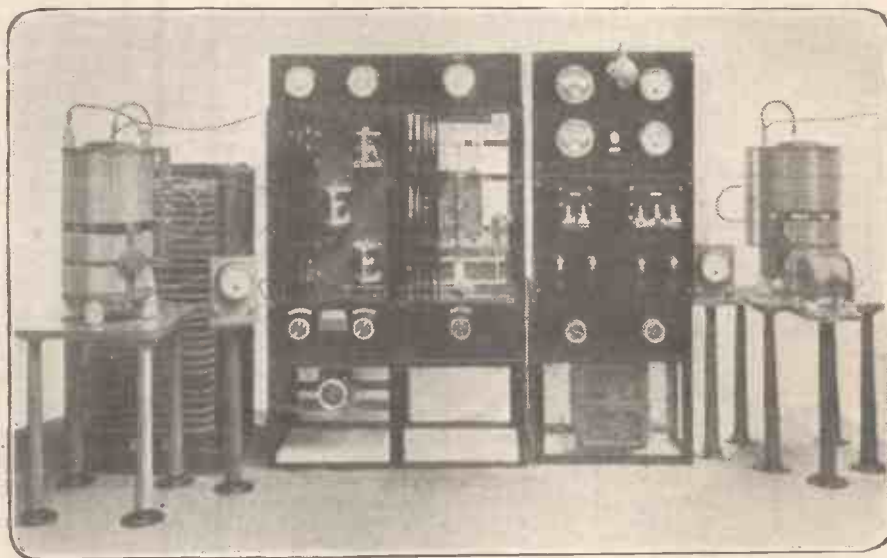

A Marconi 3-kw. Valve Transmitter.

## HOW TO MAKE AN H.T. BATTERY.

(Continued from previous page.)

saturation point. While the solution is dissolving, prepare some small bags of cheese cloth or similar cotton material  $\frac{3}{8}$  in. diameter by 2 ins. long to hold the depolariser and the carbon rod.

Next pour a little of the battery solution into the heap of carbon mixture and mix thoroughly with a bone knife or flat piece of wood. The mixture must be just damp and "crisp," and not sloppy or sticky, and is tightly packed round the carbon, which is placed in the centre of the bag until the latter is almost full, when the mouth should be closed and tied with thin string.

The whole bag should now be tied tightly in single layers, spaced as shown in Fig. 2, in order to force the depolariser tightly in contact with the carbon rod, and thus keep the resistance low, otherwise the output of current will be much reduced. Any excess of carbon mixture that may have exuded must be cleaned off before passing the elements as finished.

A slice of cork boiled in paraffin wax must now be put in the bottom of cell and the bag element stood vertically on it and concentric with the zinc container. The space between the carbon bag and the zinc must now be filled to just level with the top of bag with the following mixture: Plaster of Paris 10 parts, flour 2 parts, and sufficient of the solution, already used, to make a thick cream. Take

the greatest care that no trace of carbon mixture is allowed to encroach over the white paste and come in contact with the zinc.

A waxed paper disc should now be laid over the top of filled cell, and the whole sealed down with paraffin wax or wax and pitch in equal parts. When the seal has set, pierce it with a hot wire and leave the wire in until it can just be withdrawn so as to leave a clear vent for the relief of the gases generated by chemical action. The cells should be insulated by being encased in waxed paper or, better still, by arranging them in a card box and filling in with paraffin wax at as low a temperature as possible to avoid overheating the cells.

The battery is now finished, and if carefully made should give 1.5 volts per cell, and a current of about 5 amperes on a momentary short circuit through an ammeter. It may have occurred to the observant reader that the bag element might be used in a glass cell with a sal-ammoniac solution instead of the plaster paste, and thus produce a type of cell capable of being recharged, which is not the case with the dry battery.

This can be done, and is another reason for adopting the "bag" type of positive element, the resulting cell being a convenient "half-way house" between the small dry cell and the large and unwieldy Leclanché battery.

In this case the zinc need only be rolled into a cylinder with the edges about  $\frac{1}{8}$  in. apart, and the paste replaced with a plain solution of sal-ammoniac, 3 ozs. to the pint of water. For this purpose the zincs had better be "amal-

gamated," i.e., coated with mercury, which is done as follows; add one part of sulphuric acid to two parts of water, pour into a shallow dish and add a globule of mercury about the size of a sixpence. Dip the cylinder well into the acid, avoiding the soldered wire terminal, and with a rag tied to a stick coax the mercury over the zinc, to which it will adhere with a silvery coating.

Keep all rings and jewellery severely away from mercury, as it will speedily ruin all such articles; also, remember that mercury is exceedingly poisonous, and act accordingly. If it is decided at the outset to make "wet" cells it will probably be advisable for the worker to select his glass jars first and work to the size adopted, as in many instances small glasses, such as potted meats, etc., are retailed in, will be available, and thus save the purchase of special cells.

The completed battery of 40 cells, giving in all about 60 volts, is best housed in a stand, having a suitable hole for each cell, and provided with a cover to keep out dust and reduce evaporation.

A complete cell of this design is given in Fig. 2.

Such a battery will outlast several sets of dry cells, and can be recharged at intervals, thus effecting a considerable economy in the long run. The cells are best filled originally with a "wash bottle" or a pipette, any occasional "topping up," to replace evaporation, being conveniently managed by means of a clean fountain pen filler.



# HOW TO MAKE A SHORT-WAVE RECEIVER.

By PHILIP R. COURSEY, B.Sc., F.Inst.P., A.M.I.E.E.

## PART 6.

**T**HE spindle for the reaction coil can be a straight piece of brass rod,  $\frac{1}{4}$  inch diameter by  $2\frac{1}{8}$  inches long. One end of it should be fitted tightly into the  $\frac{1}{4}$ -inch hole, which has already been drilled through the block on to which the reaction coil has been mounted, and may be gripped firmly in place in that hole by means of the cheese-head screw passing through the brass plate in the manner already described.

The outer end of this spindle will pass through a hole in the ebonite panel, the position of which will be shown in the drilling diagram for the panel to be given later. On the outer end of the spindle an ebonite knob with brass pointer is to be fitted. The dimensions of this knob are given in Fig. I. The knob itself, marked A in the two parts of this diagram, should be turned up out of ebonite to a diameter of  $1\frac{1}{2}$  inches, the lower part being reduced to  $\frac{3}{4}$  inch diameter.

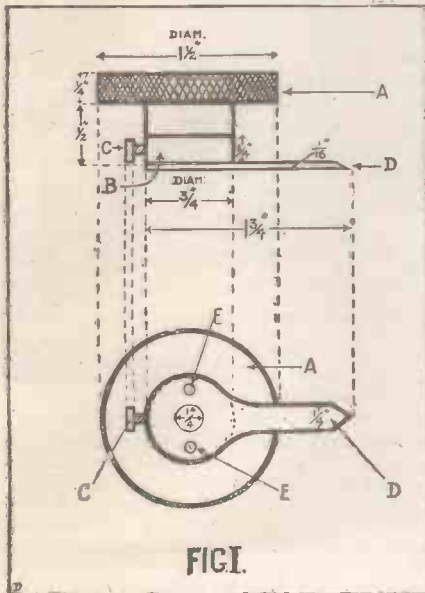

The overall thickness of the ebonite is  $\frac{1}{2}$  inch. To its lower surface a brass collar B,  $\frac{3}{4}$  inch diameter by  $\frac{1}{4}$  inch thick, is secured by two 5 B.A. countersunk-head brass screws marked E E in the lower part of Fig. I. These screws also serve to secure in position the pointer D, which should be cut out of sheet brass,  $\frac{1}{8}$  inch thick, to the approximate shape and dimensions shown in the diagram. Through the brass collar a hole should be drilled and tapped to take the 5 B.A. round-head or cheese-head brass screw marked C, which serves to grip the complete knob on to its spindle.

A hole  $\frac{1}{4}$  inch diameter should be drilled through the pointer and brass collar and up into the ebonite, to accommodate the spindle, care being taken that this hole does not come through on to the upper surface of the knob. The screw C should, of course, project into this hole, a screw  $\frac{1}{8}$  inch long under the head being required for this purpose.

While building this knob two other exactly similar ones can be constructed, as these will be required for the variable condenser and filament regulator respectively. The ebonite part only of a fourth knob can also be prepared, since it will be required for the range switch.

Knobs to these dimensions can be purchased ready-made from dealers in the component parts of wireless apparatus if preferred.

In order to maintain the spindle as rigidly in position as possible while allowing freedom of rotation, a bridge piece can be bent up from strip brass to the dimensions shown in Fig. II. The brass strip should be about  $\frac{1}{2}$  inch wide and  $\frac{3}{8}$  inch to  $\frac{1}{2}$  inch thick.

### The Condenser.

Through the centre of its upper flat part a hole should be drilled  $\frac{1}{4}$  inch diameter to fix the spindle accurately, preferably being reamed out to an exact fit. Two brass washers  $\frac{1}{2}$  inch diameter with  $\frac{1}{4}$ -inch hole and about  $\frac{3}{16}$  inch thick to fit loosely on to the spindle will be required later when assembling the spindle with its reaction coil in place on the panel.

Turning now to the variable condenser, this can either be purchased ready-made for panel mounting, the maximum capacity required being 0.0005 to 0.0006 microfarad. For those who wish to build up the condenser entirely themselves the dimensions of the fixed and moving plates are given in Fig. III. These can be cut out from sheet aluminium, zinc, or brass as desired, of about No. 22 gauge thickness.

The edges and corners of the plates should be carefully smoothed up so as not to leave any burrs, and the plates require to be very carefully flattened. Three holes  $\frac{1}{8}$  inch diameter should be drilled through each of the fixed plates in the position indicated in Fig. III.

When drilling these holes it is advisable either to clamp the pile of plates rigidly together in a vice and drill them all simultaneously, or to first cut out a single plate in sheet steel which can be used as a template for drilling each of the condenser plates. If some such procedure as this is not adopted it will be found very difficult to assemble the plates.

### Component Parts.

Twenty of the larger plates will be required to form the fixed plate of the condenser, and nineteen of the smaller ones. Fifty-seven spacing washers about  $\frac{7}{16}$  inch diameter with  $\frac{1}{8}$ -inch hole and  $\frac{3}{32}$  inch thick will be required for spacing out the fixed plates of the condenser. Twenty washers  $\frac{3}{8}$  inch diameter with a  $\frac{1}{4}$ -inch hole and  $\frac{3}{32}$  inch thick will be required for spacing the movable vanes of the condenser.

Three brass rods,  $\frac{1}{8}$  inch diameter by  $3\frac{1}{2}$  inches long, threaded for a length of about  $\frac{1}{2}$  inch at each end, will be required for clamping together and holding in position the fixed vanes of the condenser.

The condenser will be mounted directly on the back of the top panel of the instrument,

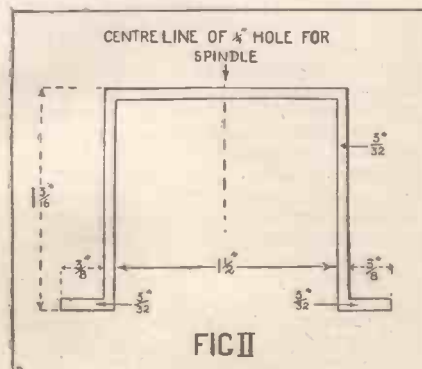

so that the upper ends of these rods will be screwed directly into the ebonite and fixed in place with lock-nuts. Their lower ends should be passed through a disc of ebonite 3 inches diameter by  $\frac{1}{2}$  inch thick, which will hold them in position and also provide an insulated support for the end of the spindle on which the movable plates are to be mounted.

### Assembling.

The condenser spindle is a brass rod  $3\frac{1}{2}$  inches long by  $\frac{1}{4}$  inch diameter, one end of it being threaded 0 B.A. for a length of  $\frac{1}{2}$  inch, the last  $\frac{1}{4}$  inch of the rod being reduced to a diameter of  $\frac{1}{8}$  inch to form the bearing for the spindle. This reduced part will pass through a hole  $\frac{1}{8}$  inch diameter drilled in the centre of the above-mentioned ebonite disc, which is clamped on the ends of the fixed rods which are holding the plates.

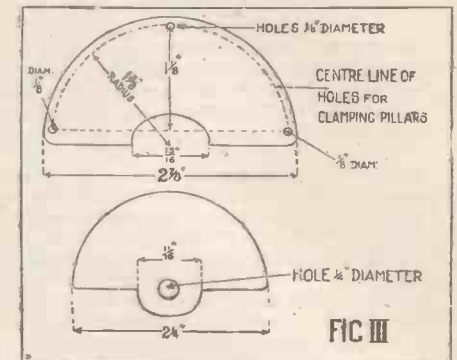

A 0 B.A. nut can be screwed on to the spindle below this ebonite disc so as to clamp the movable vanes firmly in position, a spacing washer being placed between adjacent vanes, up against a brass collar  $\frac{3}{8}$  inch diameter by  $\frac{1}{4}$  inch thick, which should be soldered on to the spindle, at a distance of  $2\frac{3}{4}$  inches from the end of the spindle which has been threaded and reduced in diameter.

When all the condenser plates have been properly assembled in position on the ebonite panel, using the holes shown in the drilling diagram of the panel to be given later, it will be found that a few extra washers will probably be required in order to adjust the relative positions of the fixed and movable plates so that the latter can pass freely into the spaces between the former when the spindle is rotated.

(To be continued.)

## The FIRST Exhibition.

The First Wireless Exhibition ever held in this country opens at the Central Hall, Westminster, on September 2nd.

Don't Forget to Pay a Visit to the POPULAR WIRELESS Stall.



# WIRELESS CONTROL.

By Major Raymond Phillips, I.O.M., Late Member of the Inter-Allied Commission of Control.

## PART 3.

IN this article I purpose explaining simple "selective wireless control," and at the same time to give details of my methods of "direct selective control." The latter system was adopted in connection with the construction of my "wireless-controlled carillon."

In my previous article I referred to "selection by sequence," or "simple selective control," such as would be found in a "step by step" movement. For instance, a ratchet wheel may be caused to revolve in desired stages, by means of impulses from a pawl

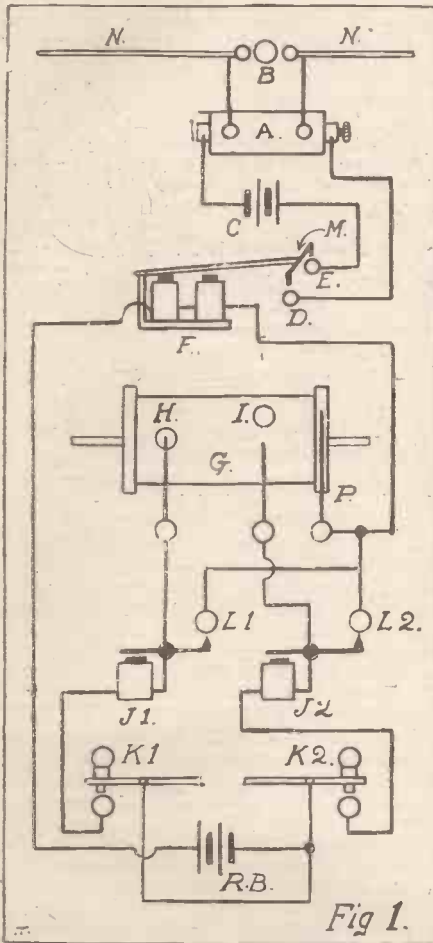

Fig 1.

attached to an armature attracted by the pole pieces of an electro-magnet; the source of power used for energising the latter being wirelessly controlled.

### Direct Selection.

If a drum (suitably studded with contact pins) was attached to the ratchet wheel in question, and the whole mounted in a suitable manner, it will be apparent that, by revolving the drum in stages, various electric circuits could be opened or closed at will. Such a simple method of selection would be found useful if applied to the control of mechanism where "sequence of operation" was desirable, but it can easily be imagined that considerable confusion might arise if in order to independently control, say, three electric motors, it was necessary to do so in "sequence." For instance, it might be desirable to first control,

say, motor No. 3, and afterwards motor No. 1, and so on. This would involve a system of "direct selection": the transmitting apparatus being provided with keys corresponding to the number of mechanisms to be controlled.

Figs. 1 and 2 show, respectively, a scheme of transmitting and receiving circuits, which proved very successful in connection with my "wireless-controlled carillon."

### No Aerial or Earth.

In Fig. 1 is shown a modified form of "Hertz" oscillator with other apparatus for "direct selective control." As I explained in my first article, a modified "Hertz" oscillator is shown in order that experimental apparatus may conform to "official" regulations in cases where it is not intended to connect wireless apparatus to an "aerial" and "earth."

The transmitting apparatus as shown in Fig. 1 consists of an induction coil A, spark gap B with metallic rods N N (which represent an "aerial"), battery C (for circuit connected to primary winding of the induction coil A), contacts D and E (which are closed by means of the "short-circuiting" device M, which is attached to but insulated from the armature of the relay F), metallic drum G with contacts H and I, "common return" contact P, relays J1, J2 with armatures, and contacts L1, L2, Morse keys K1, K2, also relay battery R B.

The receiving apparatus as shown in Fig. 2 consists of a coherer with base A, de-cohering device B B, with contact C, coherer battery C B, metallic rods H H (which represent an aerial), relay D with contacts E, relay F with contacts G and G1, also contact device V W (which is attached to but insulated from the armature Y; a dashpot, not shown, is attached to the relay F to retard the upward movement of the armature Y), relay battery R B, relay J with contact U, metallic drum X with contacts L, L1 and "common return" contact K, relays M, M1, with armatures and contacts R, T, relays N, N1, with contacts Q, R, small series wound motors O, P, battery for motors M B. The motors are shown merely as examples of mechanism or apparatus it might be desired to control.

In operation the metallic drums G and X (as shown in Figs. 1 and 2) are caused to revolve synchronously, so that, for example, contacts H (on drum G) and L (on drum X) are closed simultaneously. The apparatus for effecting synchronism of the metallic drums G and X is not shown.

By depressing Morse key K1 (as shown in Fig. 1) current will flow from the relay battery R B through relay J1, drum contact H, and "common return" P, through relay F;

the latter attracting its armature will close contacts D and E, thus admitting current through the primary winding of induction coil A (the trembler of induction coil is not shown), causing a high potential discharge (from the secondary winding of the induction coil A) across the spark gap B, setting up oscillations which will continue so long as the Morse key K1 is depressed, as although drum G may revolve and break contact at H, the relay J1 will have attracted its armature and closed contact L1 through which current will flow to relay F until Morse-key K1 is released.

The same cycle of operations would take place if Morse key K2 was depressed, except that drum contact I and relay J2 would be involved.

By referring to the receiving circuits and apparatus as shown in Fig 2, it will be observed that simultaneously with depressing Morse key K1 (as shown in Fig. 1) and the coherer A detecting a transmitted wireless wave, and the metallic drum X being in the position shown, current will first flow from the coherer battery C B through relay D, closing contact E, and admitting current from the relay battery R B through relay F, closing contact G, and afterwards contact G1.

The latter contacts are arranged so that contact G is closed before contact G1, and a dashpot (not shown) being fitted to the relay F causes a retardation of the "upward" movement of the armature which keeps contact G closed after current has passed from the relay battery R B through contact G1 and de-cohering device B B.

(Continued on next page)

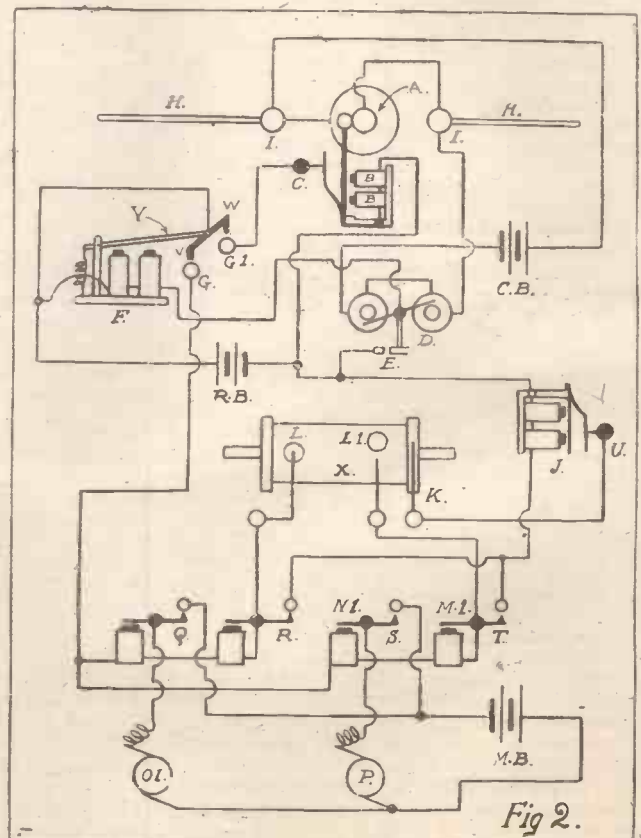

Fig 2.



## WIRELESS CONTROL.

(Continued from previous page.)

From contact G, current flows through relays N M through contact L, "common return" K, and contact U of relay J. Contacts Q and R will simultaneously be closed by the armatures of relays N and M admitting current through electro-magnet windings of relay J, breaking contact U connected with "common return" K, cutting off communication with contacts L, Ll, and admitting current from motor battery M B to motor (shown series wound) O1, although drum X may revolve, and contact at L be broken.

The motor O1 may be kept working so long as Morse key K1 (shown in Fig. 1) is kept depressed, and the secondary winding of induction coil A discharges a high potential discharge across spark gap B.

The motor marked P in Fig. 2 could be operated in the same manner, by depressing Morse key K2 as shown in Fig. 1. It will be observed that with a "fixed" wave-length the scheme of circuits shown in Figs. 1 and 2 admits of numerous mechanisms being controlled.

In subsequent articles I hope to give details showing the construction of a model wireless-controlled airship and train, and other experimental apparatus.

(To be continued.)

## A NEW GIANT STATION

THE new transmitting station which the Government propose to erect at Bourne, near Spalding, Lincolnshire, for the purpose of direct wireless communication with, in the first instance, India, South Africa, and Australia, and later with Canada and other parts of the Empire, will surpass in magnitude anything of the kind hitherto constructed in this country. While it will not equal in actual size the great new French station, which was opened recently at Saint-Assise the varying functions of the respective stations have to be borne in mind, the one being for commercial purposes, the other for official purposes.

There will be, at the English station, eight steel masts, each 800 ft. high (more than twice the height of St. Paul's). These masts are used for supporting the antennae, and constitute the most costly item of a wireless station. Because of the fact that steel is a conductor, and therefore liable to cause loss of electrical energy, the masts will be insulated in sections, and will stand on an insulating base. They will be guyed to concrete anchorages, and will be designed to take a horizontal pull of ten tons at the top, and a wind load of 60 lb. per square foot. The masts will be arranged in the form of a square, in the centre of which the transmitting station will be situated.

The buildings will include an operating-room, a boiler-house, an engine-room, and a high-frequency room, together with workshops and an emergency operating-room. The apparatus will consist of thermionic valve sets capable of transmitting continuously at ninety words a minute for reception in Poona, Johannesburg, or Perth, as the case may be.

The new receiving station at Banbury, which will represent the other terminal of the Imperial chain, will be built on similar lines to the station already in existence there in connexion with the Leafeld-Abu Zabal (Egypt) link of the chain. In general, it will comprise a central plot, 250 yards by 50 yards, for the operating building, and two other plots, 220 yards square, on either side of the operating building, and about 550 yards removed from it, on each of which will be erected a mast 300 ft. high.

## "WHIRLED INTO WIRELESS."

By BILLY MERSON.

The chief laughter-maker in the Revue "Whirled into Happiness."

I AM a wiry little chap myself, but wireless is in my blood. I can see the whole of its wonderful future. I am going to make you a present of that future.

When politicians start pulling the wires by wireless you can say that wireless will really have come into its own. But that time is not yet. When that happens wireless will have done most other things. I've often said the day will come when vehicles—our Norbury to Westminster trams, for instance—will be driven by wireless—overhead wireless, of course—from a broadcasting station. Don't think I am fooling when I say this. I believe it most tremendously. People don't realise what wireless will do in the future. I do.

And I know something about wireless—or, at least, my son does. He's crazy on it. He and I are putting up a wireless mast shortly at Ditton, the shortly depending on how long it will take for wireless sets to become really cheap. They will very soon, believe me. Eleven guineas is much too much.

I flatter myself I am not a fool when it comes to matters telegraphic or telephonic. It was my job before I fell to the boards. I used to be employed by the old National Telephone Company—as one of the present-day operators well knew after he had come to effect a repair at my house at Streatham.

There was a fault in our telephone, and after he had been at it for two or three hours I came in. I saw in an instant what was wrong. The

thread of one of the wires under a screw was causing a "short." So I bet him I'd put it right in two minutes. He took the bet, foolish boy. I took the affected part, and, in my very best bedside manner, blew on it very gently. When I had finished I brought him a looking-glass so that he could study the look on his face. But I gave him the 2s. 6d. back.

So you see I know what I am talking about. In the old days we had wires. Now there aren't any. So much less to learn, you see.

Yes, in the days to come we will be playing the piano by wireless. Why not? Stranger things than that have happened. I don't suppose we'll ever milk cows by wireless, but I bet you we'll be kissing by wireless. Oh, to be the transmitter!

It's going to affect the theatre, too. I can see the doom of the actor. All you will have in the wireless age will be marionettes, built up from a cinematograph basis, controlled by wireless wires and speaking by wireless telephony. It sounds wild; doesn't it? But wilder things than that have happened.

Just to show you what can be done by wireless I may tell you—'sh!—that I'm pulling legs by wireless now. I've got a hat with a steel band inside to prevent it getting out of shape when I get swelled head. The number of people who believe that the wireless receiver is under the leather band is incredible. That's my little wireless joke. But all I've told you otherwise is dead serious.

## BENDING A WIRELESS WAVE.

IT has always been believed that when a wireless message was sent out from a transmitting station that it sped equally in all directions in perfectly straight lines of wireless waves, just as when a stone is dropped in water the ripples float out steadily in all directions from the centre of the disturbance until they reach the side of the pool or from want of power vanish from sight.

But it has recently been discovered that a train of wireless waves can be easily turned aside by certain objects.

Great attention has, of late, been focused upon directional wireless—that is to say, upon wireless signals transmitted from a special type of aerial which has more or less concentrated them so that they travel only in one desired direction.

If it is true that certain objects will deflect the course of wireless waves, directional experimenters will find themselves faced with another problem.

Washington, U.S.A., has been the scene of experiments which have resulted in the above-mentioned beliefs. Tests were instigated to determine the effect (if any) of objects such as electric cables, steel structures, iron monuments, trees, stones, and rivers upon the direction of wireless waves.

The experiments were conducted as follows: From a transmitting station certain signals were radiated, and at different points from their origination their strength was measured by a direction-finding receiver.

The aerial of this finder can be rotated until a position is reached when the signals are loudest in the telephones. By this method the direction from which the wave has come can be detected.

Measuring a wireless wave after it had come into contact with a large concrete bridge, it was

found that the rays had been bent fourteen degrees out of their course.

Similar measurements were taken after a wireless wave had come in contact with the Washington monument, which, it may be mentioned, is a plain square obelisk of white Maryland marble. It was found, to the amazement of most concerned, that the wireless waves had been bent to the extent of eighty degrees; or, to put it more clearly, had been deflected to a course nearly at right angles.

Therefore it must be admitted that such obstacles as monuments, buildings, and bridges affect wireless waves as reflectors. A wave coming in contact with them will glance off again at an angle.

An interesting discovery arising out of these experiments was that the obstacle itself tends to become a receiving agent, acting very much as a sort of aerial.

Certain obstacles, depending a great deal upon their height and size and the material of which they are made, have a tune of their own!

Sometimes the tune of an obstruction will be about the same as the tune or wave-length of the wireless signals. It was discovered that this was so when the reflection was the greatest.

It seems as if, therefore, under certain conditions, the best reception will be obtained if the receiving set aerial, should it be near an obstacle known to reflect wireless waves, is placed at an angle. In this case the aerial of a receiving set near the Washington monument might with advantage be set in a line at eighty degrees to the expected line of the wireless wave instead of in a direct line with the direction from which the signal is expected.

The discovery, although probably not welcomed by experimenters, already harassed by many difficulties, is very important, and will lead to many modifications and developments in wireless.



**COMPLETE AND EFFICIENT ONE-VALVE RECEIVING SET**

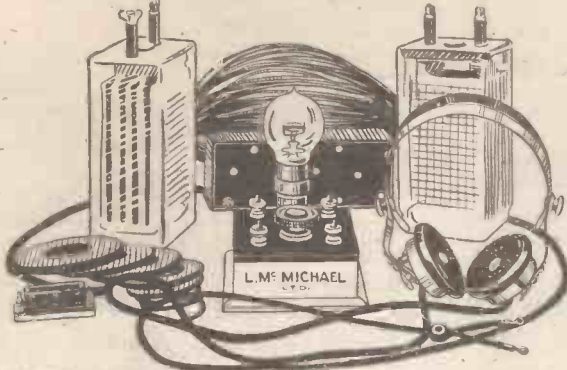

1 Valve Panel, in mahogany box, with circular filament resistance	£	9.	d.
1 Variable Condenser		14	0
1 Complete set of slab coils for all wave-lengths	1	15	0
1 Valve (Ex-Government, if in stock)		12	0
1 Battery, 72 Volts, tapped off every 4 Volts		15	0
1 4-Volt Accumulator	1	10	0
100 ft. Aerial Wire, best enamelled, stranded Copper		7	6
2 Insulators		2	0
1 pair Head Telephones	1	10	0
60 ft. 19/30 Tinned and Rubber-covered Cable, for earth connection and wiring		1	6
	£6	17	0

VISIT OUR STAND, No. 43,

All-British Wireless Exhibition, Horticultural Hall, Sept. 30—Oct. 7.

Illustrated Catalogue (P/W) 16 Pages. 100 Illustrations. 6d. Post Free. When writing please mention this publication.

**LESLIE McMICHAEL, Ltd.,**  
 Providence Place, West End Lane, KILBURN, N.W.6  
 (Bus Services 1, 8, 16, 28, 31 all pass West End Lane.)  
 Telephone: HAMPSTEAD 1261. Nearest Tube Station: KILBURN PARK (Bakerloo).

**For they are jolly good-FELLOWS**



**FELLOWS HEAD TELEPHONES, 4,000 ohms.**

Two earpieces in light die cast non-ringing metal.

PRICE - - 30/- per pair.

DELIVERIES. Immediate against cash with order.

MANUFACTURE. The same high grade workmanship as the Fellows Magneto.

SEND YOUR ORDER TO-DAY.

(Cheques, P.O., P.O.O., or M.O. to be crossed London, City and Midland Bank, Ltd.)

Trade terms for quantities on request

**FELLOWS MAGNETO Co., Ltd., LONDON, N.W.10.**

Telephones - - Willesden 1560-1  
 Telegrams - - { Quinmag  
 Phone, London.

For all radio apparatus and components.



To ensure the earliest attention send this page with your order

*And so say all of us*

OPENED BY WIRELESS.

THE FIRST

INTERNATIONAL

**RADIO EXHIBITION**

**WIRELESS CONVENTION**

**CENTRAL HALL, WESTMINSTER,**

**SEPTEMBER 2nd to 8th,**

**FROM 11 a.m. to 10 p.m. DAILY,**

WILL FOR THE FIRST TIME ON THIS PLANET BE OPENED BY WIRELESS.

Licences for Transmitting and Receiving have been issued by the Postmaster-General specially for the Exhibition.

The Exhibition is not confined to British Firms, and is therefore representative of all the latest and best developments connected with Wireless.

Important Conferences daily at 3.30 p.m. and 7.30 p.m. "MODEL ENGINEER" Day, Wednesday, Sept. 6th. The Editor will receive all members of Wireless Societies on this day, in the large Reception Hall.

Wireless Experts daily in attendance to give Free advice in all matters connected with Wireless.

Competitions for (1) The Best Amateur piece of apparatus (excluding aerials). Prizes £5, £3, and numerous other prizes and diplomas.

(2) The best Juvenile set or piece of apparatus (excluding aerials). Age limit, 16. Numerous prizes and diplomas will be awarded.

(3) The Best Invention connected with Wireless. Prizes and diplomas awarded.

Entry forms should be applied for immediately, and may be filled in on arrival at the Central Hall.

There is no Entrance Fee for any of these Competitions.

Numerous inventions connected with Wireless in the fields of transit, telephony, telegraphy, etc., will be demonstrated daily.

A Competition demonstrating the use of Wireless in the detection and prevention of crime will be held daily. This will be open to all visitors. No entrance fee will be charged.

Admission 1s. 3d., including tax. Tickets in bulk to Secretaries of Wireless Societies 8d. each (including 2d. tax). Motor Buses from all parts pass the Hall, which faces the Houses of Parliament and Westminster Abbey. Nearest Station, St. James's Park (District).



# RADIOPHONES

WE ARE THE ACTUAL MANUFACTURERS.  
MASS PRODUCTION PRICES.

WE ARE EXHIBITING  
AT THE  
**ALL-BRITISH  
WIRELESS  
EXHIBITION**

HORTICULTURAL HALL,  
WESTMINSTER, S.W.1.

September 30th to October 7th

We Specialise in  
**COMPLETE SETS.**  
NO "EXTRAS." Write for List 45.

Also  
**COMPONENT PARTS**  
FOR BUILDING OWN SETS.  
Write for List 46.

All our sets are complete with all necessary accessories.  
Double 4,000-ohm headphones, H.T. Batteries, Accumulators,  
Variable Condenser, Valves, Aerial Equipment, Etc.

- The **POPULAR** Crystal Set, £4-5-0 Complete
  - The **PRINCE** Single-Valve Set, £10-10-0 Complete
  - The **KING RADIO** Two-Valve Set, £15-0-0 Complete
  - The **WIRELESS WONDER** Three-Valve Set, £25-0-0 ..
  - The **WIRELESS WIZARD** Four-Valve Set, £35-0-0 ..
- All these Sets are approved by the Postmaster-General.

**PROMPT DELIVERY  
FROM STOCK.**

**BUY NOW!**

Send Cash with  
Order addressed  
"Sales Manager"

**LOOK! LOOK! LOOK!**

## WIRELESS HEADPHONES

We lead **25/-** PER PAIR  
every time

POSTAGE 1/-

High Resistance (4,000 ohms total) double. Headphones with adjustable double head Bands. Beautifully finished. Brand new. Specially made for the reception of wireless broadcasting, and Complete with flexible cords.

Money returned if not completely satisfied.  
**DELIVERY BY RETURN FROM STOCK.**  
Compare our Prices.  
Inspect our unsolicited Testimonials.  
Satisfaction guaranteed.  
**H. STANLEY PRINCE & Co.**



## H. STANLEY PRINCE & Co. (H.S. PRINCE)

WIRELESS ENGINEERS AND MANUFACTURERS,  
ETHERLEY WORKS, ABBOTSFORD AVENUE, WEST GREEN, LONDON, N.15.

City Office: 126, BISHOPSGATE,  
LONDON, E.C.2.

## RADIO **K.B.** EQUIPMENT.

IMMEDIATE DELIVERY—IMMEDIATE SATISFACTION

**VARIABLE CONDENSERS** (with Scale and Pointer).

CAPACITY.	FOR PANEL MOUNTING.		IN POLISHED MAHOGANY CABINET (ASSEMBLED).
	SET OF PARTS.	ASSEMBLED.	
.0015	27/-	30/-	38/6
.001	21/-	24/-	31/6
.00075	17/-	20/-	26/-
.0005	14/-	17/-	22/6
.0003	11/-	14/-	19/-
.0002	8/-	11/-	16/-
.0001	7/-	10/-	14/6
.00005	3/6	5/-	9/-

ENGRAVED EBONITE DIAL .. 3/3 extra.

LAMINATED SWITCH ARMS (Complete) .. 2/5 each.  
FILAMENT RESISTANCES (Panel Type) .. 4/- each.

### "K.B." UNITS.

DETECTOR PANEL .. .. .	£1	14	6
CONDENSER PANEL .. .. .	£1	14	0
L.F. AMPLIFYING PANEL .. .. .	£2	3	0
H.F. " " .. .. .	£1	13	6

Price includes Engraved Panel and Polished Mahogany Cabinet. Parts also supplied.

### "K.B.H." 2-VALVE RECEIVER (1 Rect., 1 L.F.)

COMPLETE from Aerial to Earth .. .. .	£15	15	0
PANEL ONLY .. .. .	£8	8	0

LARGE STOCKS OF ABOVE NOW IN HAND. ALSO STOCKS OF ALL OTHER AMATEUR REQUIREMENTS.

Carriage extra on orders under £2. CATALOGUE P/W, POST FREE, 4d.

"Listen in" at our Showrooms: Open 9 a.m. till 7 p.m.

## THE "K.B." RADIO EQUIPMENT COMPANY,

Head Offices & Showrooms: 109, High Road, Kilburn, N.W. 6.

Bus Services— 3 minutes Kilburn Park Station  
8, 16, 28 & 51 Pass Door. (Bakerloo Rly.).

TRADE SUPPLIED.

## EVERYTHING FOR WIRELESS Instruments, Parts, and Materials.

- Aluminium Condenser Vanes, 3 1/2" .. 2d. pair
- Spacing Washers for fixed and moving plates .. 3d. and 5d. doz.
- Brass Rod, threaded 3-16th .. 6d. ft.
- Brass Rod, 1" square, 4d. ft., 3-16th round .. 3d. ft.
- Brass Screws, 1" and 3/4", 4 B.A. or Whitworth .. 1/3 doz.
- Brass Hex Nuts, 1-8th, 4d. doz.; 3-16th, 1d. each, 9d. doz. .. 7d. doz.
- 6 B.A., 4d.; 5 B.A., 5d.; 3 B.A., 6d.; 2 B.A. .. 14d. ft.
- Brass Strip, 1" x 22 gauge, 2d. ft.; 1" x 21 g. .. 8d. ft.
- Brass Tube, 5-16th bore (All sizes) .. 9d. doz.
- Brass Screws, 1" and 3/4", 4 B.A. or Whitworth .. 2d. doz.
- Washers, all sizes, 3-16th and 2 B.A. ..
- Condenser Spindles, 1" sq., threaded top and bottom, for 25 plate condenser, 8d.; Brass Bushes .. 6d. each
- Ebonite Knobs, 7d. tapped, 1" Whitworth .. 8d. each
- Extension Handles, 1/-; Valve Holders, 1/6 .. 1/6
- Stops, 1-8th threaded, 8d. pair; Knob with pointer .. 1/-
- Filament Resistance with Knob and Pointer .. 3/9 each
- Grid Condenser and Leak, 2/6; Telephone Condenser .. 2/6 each
- Contact Studs, 1d. and 2d. each; Copper Foil, .005, 6" sq. .. 6d. piece
- Crystal Cups, 6d.; Tested Crystals, 6d.; Wood's Metal .. 4d.
- Ebonite Sliders, 1/3; Brass Detector with vernier adjustment .. 5/- each
- Ebonite Valve Panels, 0" x 6" x 1", 3/-; 4" x 4" .. 1/3 lb.
- Ebonite Discs, 3 1/2" diam. .. 1/4 each
- Mica, best ruby, 2" x 1 1/2", for condensers, 2d. each .. 1/6 doz.
- Lead-in Tubes, Ebonite and Brass, 1/- tube .. 8d. ft.
- Ebonite Rod, 1/2" diam., 4d. ft.; 1", 6d. ft.; 1 1/2", 1/6 ft.; 1 1/2" .. 3/6 ft.
- Ebonite Tube, 1-8th and 5-32 bore by 3 outside .. 6d. ft.
- Ebonite Sheet, 1-8th and 3-16th, 5/- lb.; 1" .. 4/- lb.
- Porcelain Insulators, Reel, 4d.; egg shape .. 6d.
- Laminated Switch Arms, 1" to 1 1/2" radius .. 2/6
- Variable Condenser, .00075 M.F., in mahogany case .. 19/6
- Variable Condenser, .00075 M.F., for panel .. 15/-
- Ivoryine Scales, engraved 180° .. 1/- and 1/6 each
- L.F. Intervalve Transformers .. 18/6 each
- Enam. Copper Wire, 24 S.W.G., 2/8 lb.; D.C.C. 3/6 lb.; 30 S.W.G., 3/10 lb.; D.C.C. .. 5/6 lb.
- Aerial Wire, 7/22 Stranded, enamelled, 100 ft. .. 6/6
- H.T. Batteries, 15 volt .. 3/- each

LIST 3d., POST FREE ON ORDERS VALUE £2.

## J. BRIDGE & SONS,

Nelson Street Works, SOUTHEND-ON-SEA; and 300, London Road, WESTCLIFF-ON-SEA.



# NEW SERIES FOR THE BEGINNER

By E. BLAKE, A.M.I.E.E.

## PART 7.

### SUMMARY OF LAST ARTICLE.

The ether is the seat of electro-magnetic waves. It is supposed to be distributed throughout the whole universe, and to penetrate all material bodies. Ether waves are transverse waves, propagated at a velocity of 186,000 miles (300,000,000 metres) per second. They vary in length, light waves being the shortest and wireless waves the longest, so far as we know.

The length of a wave may be taken as the distance between its crest and that of the next wave, but see the more correct definition given in the article.

$$\text{Wave-length} = \frac{\text{Velocity}}{\text{Frequency}}$$

$$\text{Frequency} = \frac{\text{Velocity}}{\text{Wave-length}}$$

$$\text{Velocity} = \text{Wave-length} \times \text{Frequency.}$$

In other words, the higher the frequency, the shorter the wave, and vice-versa. The velocity never alters appreciably.

To effect communication by wireless telegraphy or telephony we need a sending station and a receiving station. The sending station consists of an apparatus for the production of high-frequency oscillations

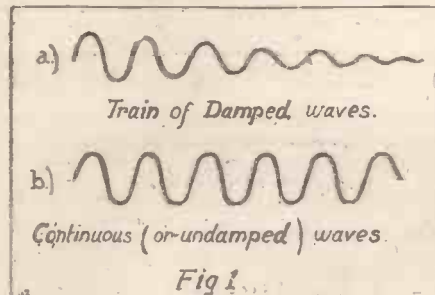

in the aerial, the radiator proper, which is an elevated wire or system of wires.

Two types of ether waves are employed in wireless.

(a) "Damped" waves. These are produced by the discharge of electricity across an air-gap by means of an electric spark, and are termed "damped," because they are radiated in short series or trains, which gradually die out. See Fig. 1 (a). Transmission by the spark method is being superseded by a newer and better method (b), but is still used on ships, coast stations serving ships, and certain of the older high-power stations.

### A Transmitting Station.

(b) "Undamped" or "continuous" waves. These are produced by various devices, chief of which are the arc, the Alexanderson alternator, and the thermionic valve or vacuum tube. Of these the most efficient is the valve transmitter, developed by the Marconi Company to a degree which has enabled them to communicate from Carnarvon to Australia by this method. Continuous waves are so called because they are radiated in an unbroken series of constant power. See Fig. 1 (b). On account of the fact that the energy is radiated continuously, this method is more economical than the spark method, besides presenting advantages at the receiving end.

A brief description of the operation of a transmitting station is as follows: Electric current, either drawn from public supply, or generated on the station, is converted into high-frequency oscillating form by one of the

methods mentioned above. This H.F. current is caused to flow in a "closed" circuit, closely associated with which is the aerial circuit, which is an open circuit connected to earth at its lower end. The closed and open circuits are said to be "coupled" together, which means that they are brought into proximity with each other, so that the oscillating electro-magnetic field set up round the closed circuit can cut the open circuit and cause to flow therein a H.F. current of the same frequency. If you have properly digested my previous explanations of what happens when a moving electro-magnetic field cuts across a conductor, you will now see how those phenomena are turned to the service of wireless.

### Wiring Diagrams.

Suppose the engineer is instructed to test with another station, using a wave 600 metres in length. By the simple formula:

$$\text{Frequency} = \frac{\text{Velocity}}{\text{Wave-length}}$$

he knows that he has to produce in the aerial or open circuit a current with a frequency of 500,000 per second, because

$$\frac{300,000,000 \text{ (metres per second)}}{600 \text{ (wave-length in metres)}} = 500,000 \text{ cycles per second.}$$

Therefore, he must adjust the closed and open circuits to that frequency. Now the adjustment of a circuit so that an electric current will oscillate therein at a given frequency is accomplished by a suitable variation of two physical quantities called "inductance" and "capacity," which regulate frequency. These terms will be explained later on. Suffice for the moment to say that, within certain limits fixed by the design of the particular apparatus on the station, the engineer can vary the frequency at which the current oscillates in the closed and open circuits, and therefore the length of the ether waves radiated.

We have, then, when the current is flowing, an H.F. oscillating current in the aerial circuit. Fig. 2 is a simple diagram of a transmitting circuit. Please notice how the various parts are represented, because the lines are really symbols which are employed by engineers to represent electrical circuits and connections, and you must learn how to read wiring diagrams. This diagram does not show the apparatus for producing the H.F. current, but only the closed and open H.F. circuits.

A closed circuit is a poor radiator; that is why its energy is transferred to the open aerial

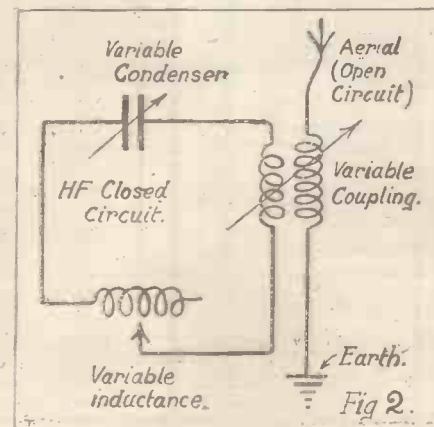

circuit, which is a good radiator; for our object is to get the energy away into space. The electric and magnetic fields set up by the current in the aerial are propagated in all directions as alternating stresses and strains of the ether. This effect spreads outwards from the sending station like the walls of a bladder being inflated, the station being in the centre of the space enclosed by the bladder.

When the waves penetrate the ground they are soon used up by the resistance of the earth; upwards they spread as far as a certain portion of the atmosphere, called the "heavenside layer," from which they are reflected. But they are propagated over the surface of the globe without opposition other than that offered by the resistance of the surface, which varies according to its nature—whether water, sand, or forest, and so on—and the absorption of their energy by the atmosphere and by obstacles such as mountains.

The range of a wireless station is simply the distance at which its signals can be usefully received. In practice, the range varies according to the direction in which reception is desired, the nature of the terrain between transmitter and receiver, the time at which transmission takes place, the season of the year, the wave-length employed, the sensitiveness of the receiver, the design of the receiving aerial, and numerous other factors.

Although the radiation of energy is greater in the case of short waves, experience has

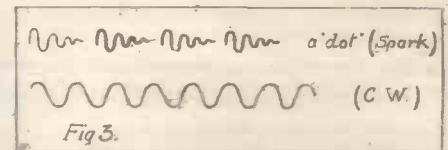

shown that, as a general rule, long waves are better for long-distance work, because they are less easily interfered with. It is true that American amateurs succeeded not long ago in transmitting across the Atlantic with waves only 180 metres long, but you will notice that the commercial trans-Atlantic stations all use waves of great length. Not only is this so because of the reason just mentioned, but also because, in order to get into the aerial sufficient power to ensure a satisfactory service, an aerial of a certain size is necessary.

### Radio Signalling.

It is wasteful and altogether bad practice to attempt to overload an aerial with power. Thus with increased power increased capacity of aerial is needed, and this tends, beyond a certain limit, to increase the wave-length.

Radio signalling is performed telegraphically by making and breaking one of the circuits of the transmitter by means of a telegraph key, or by special mechanism in the case of automatic high-speed working. If the system is "spark," then when the telegraphist depresses the key, thereby closing the circuit, a series of damped wave-trains is radiated from the aerial. If a long series is radiated, the corresponding signal received is a "dash," a short series resulting in a "dot." Various combinations of dots and dashes can thus be sent according to the Morse code, and these can be transcribed into the letters of the alphabet by the receiving operator. In the continuous wave system the same means is employed, though in this case a dash is not a series of separate wave-trains, but a continuous series of waves several times longer than that sent out by a dot. Fig. 3 will make this clearer.



## A HOME-MADE RECEIVER.



Mr. D. Jobling, 51, Frazer Terrace, East Hoodon-on-Tyne, spends most of his free evenings with his wireless friends. They are seen constructing a receiver in the photograph.



A fine experimental transmitting and receiving station built by Mr. W. Hoppenback, the Ritz Hotel, Piccadilly. Practically all the gear was constructed by Mr. Hoppenback.

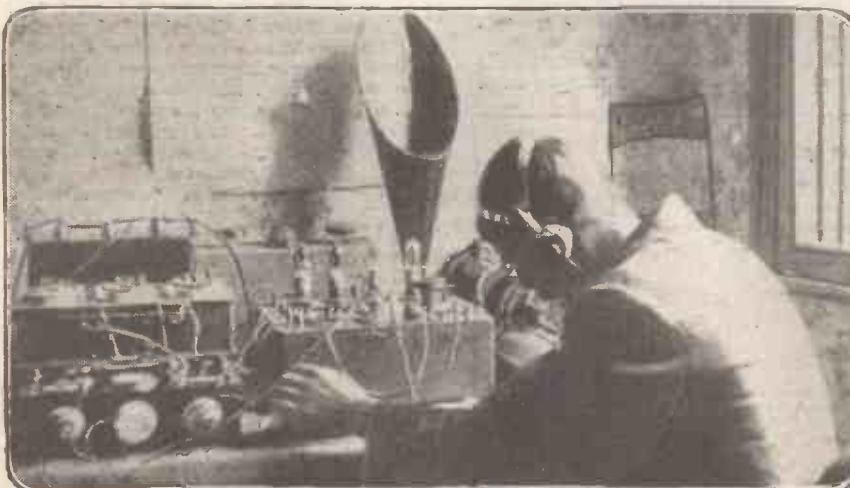

This photograph was sent in without any name and address attached. Will the owner please communicate with the Editor and claim his fee?

## ONE OF TEDDY TA



This young gentleman is rapidly acquiring a taste for listening-in on the S.E. Using four valves, Mr. Rose receives

## PHOTOGRAPHING E

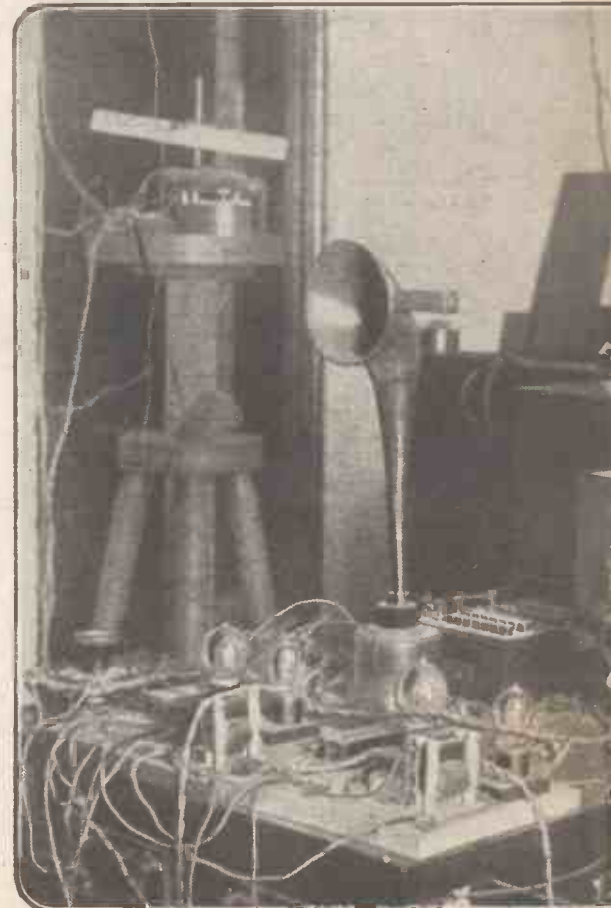

One of the most interesting wireless devices is the oscillograph—a machine which records the work or permits the operator to watch them in action. It utilises two valves and produces sounds that correspond with the



# MAIL'S ADMIRERS.

# OLD HORNS FOR NEW.



A fine set made by Mr. George A. Rose, 43, Radford Road, Lewisham, who uses the Hague concerts quite clearly.

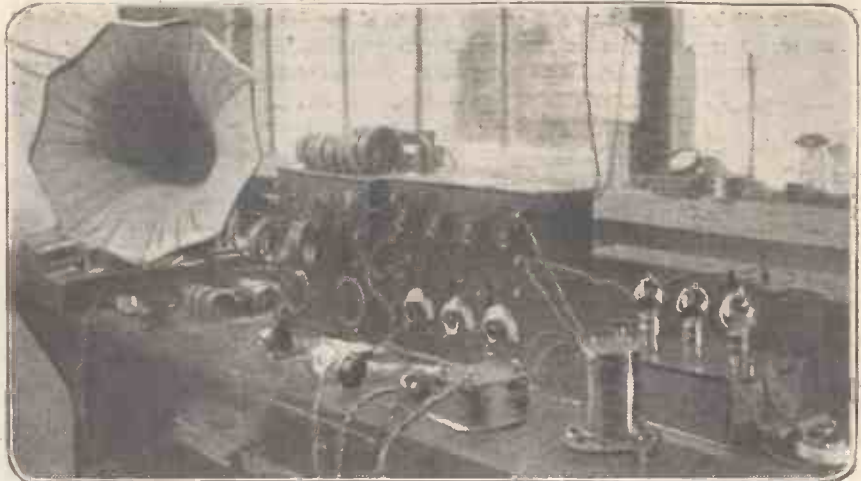

This comprehensive amateur set belongs to Mr. John F. Halliday, 21, Laburnum Street, Birley, Cobusbam. Mr. Halliday uses an old gramophone horn with his loud speaker, and finds the results greatly improved.

# ELECTRIC CURRENT.



A machine that either photographs currents produced in wireless research amplifying valves and two power valves. The loud speaker produces the waves being photographed.

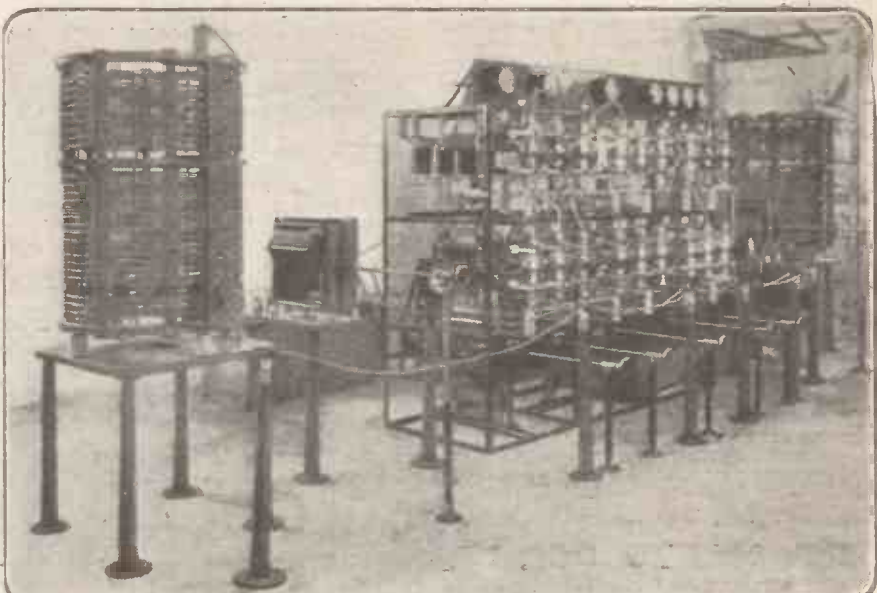

A 15-kw. Marconi valve panel, with two A.T.I.'s. This fine set is practically the last word in 15-kw. valve transmitters yet produced by the Marconi Co.

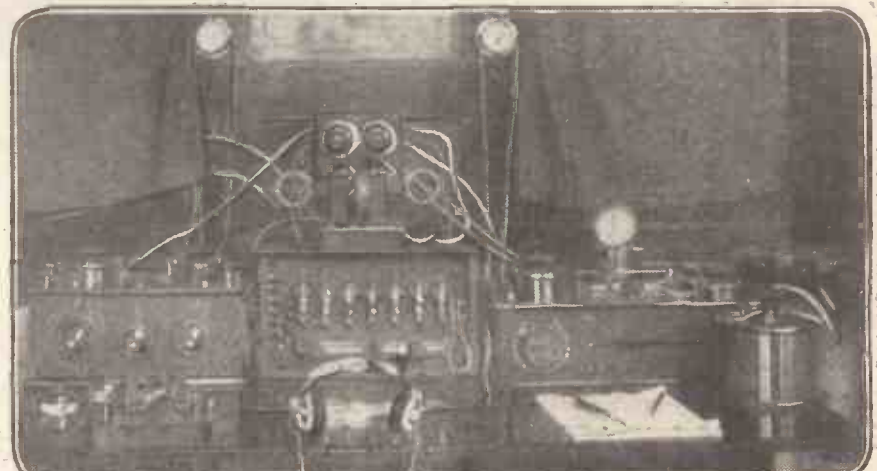

A first-class set belonging to Mr. C. E. Green, Humberstone Avenue, near Grimby. Note the 7-valve Marconi amplifier—probably the most efficient amplifier of its kind yet produced.



# WIRELESS CLUB REPORTS.

The Editor will be pleased to publish concise reports of meetings of wireless clubs and associations, reserving the right to curtail the reports if necessary. Hon. secretaries are reminded that reports should be sent in as soon after a meeting as possible. Reports sent in cannot appear in this paper in less than ten days after receipt of same. An asterisk denotes affiliation with the Wireless Society of London.

## Otley and District Wireless Society.

Second general meeting of above held in "Café," Queen's Hall, Otley, on August 3rd, 7.30 p.m.

Minutes of last meeting read and passed. Honorary secretary then gave a lecture on "Electrostatics and Magnetism," which was well received.

The vice-chairman, Mr. Deny, then gave a short address on "Visible and Audible Methods of Signalling."

Mr. N. Weston and Mr. N. Johnson are giving a series of lectures in the forthcoming session.

Will all interested in the work of the society please communicate with the hon. sec.?

Hon. sec., 24, Gaycroft, Otley.

which was enthusiastically endorsed by the many members present.

## The Liverpool Wireless Society.

A very successful and interesting meeting of the above society was held at the Royal Institution, Colquitt Street, Liverpool, on August 10th.

The early proceedings were devoted to the answering of the question box, which had been passed round, and Mr. Hyde explained away the difficulties of the questioners in his usual inimitable manner, illustrating his answers by very clear blackboard diagrams.

An advisory committee was then elected, consisting of Messrs. S. Lowey, C. J. Williams, W. A. Robinson, Hyde, Forshaw, Henderson, Balmer, and Coulton.

A vote of thanks was passed in favour of Mr. J. M. Wilkie, in recognition of his very able work on behalf of the society when occupying the position of honorary secretary, which position he has, unfortunately, found it necessary to resign, and a new secretary was selected. All members and interested readers are requested to note carefully the name and address of the new secretary.

The evening was concluded by Mr. A. W. Robinson bringing into operation a "Burndept" three-valve receiving set (1 H.F., 1 Rect., 1 L.F.) very kindly lent to the society for the evening by Messrs. Burndept's Manchester agent, Mr. Barraclough. Very successful results were received of both telegraphy and telephony, which were perfectly audible to all present, and which, in view of the fact that the instruments were operated in conjunction with an indoor aerial of but moderate dimensions, reflected great credit upon both the operator and the manufacturers of the set.

All amateurs in the district not already members of the society are cordially invited to join, and are assured of a continuance of entertaining and instructive meetings.

Hon. secretary, Mr. C. L. Lyons, 76, Oldhall Street, Liverpool.

## Barnoldswick Wireless and Technical Society.

A meeting of the above society was held in the Gladstone Liberal Club on August 16th.

At the termination of the usual 30 minutes' buzzer practice, a lecture was given by Mr. A. G. Petty, B.Sc., entitled "Magnetism."

The lecture was delivered to a very enthusiastic audience, and was augmented throughout by very interesting and highly instructive experiments.

Already the society has reason to be proud of the mental status of its members, who are exhibiting a keen desire for technical knowledge.

Rapid progress is justifiably anticipated, and, thanks to the fact that several of the members are skilled in scientific matters, the provision of suitable lectures does not present any difficulty.

The secretary solicits application for membership from all gentlemen who have a genuine interest in science.

Hon. sec., G. Balderston, 6, Clough Terraces, Barnoldswick.

Owing to extreme pressure on our space club secretaries are requested to keep their reports as short as possible.

## WE ARE EXHIBITING AT THE FIRST ALL-BRITISH WIRELESS EXHIBITION AND CONVENTION

HORTICULTURAL HALL,  
VINCENT SQ., WESTMINSTER, S.W.1.  
SEPT. 30th TO OCT. 7th  
(SATURDAY) (SATURDAY)  
10 A.M. TO 10 P.M. DAILY.

ADMISSION

1/3

including tax.

SPECIAL TRADE DAY

Oct. 2nd. Admission 1/3 including tax.

SPECIAL PUBLIC DAY

Oct. 3rd. Admission 5/- including tax.  
(Public admitted both days after 6 p.m. at usual price.)

The only Exhibition whose CONVENTION will be held under the auspices of the WIRELESS SOCIETY OF LONDON.

Auckland, G. Z., & Son.  
Automatic Telephone Manfg. Co., Ltd.  
Bertram Day & Co., Ltd.  
Bower, J. B., & Co., Ltd.  
British Thomson-Houston Co., Ltd.  
British Wireless Supply Co.  
Brown, S. G., Ltd.  
Burndept, Ltd.  
Chloride Electrical Storage Co., Ltd.  
Coomes & Co.  
Cossor, A. C., Ltd.  
Dubilier Condenser Co. (1912), Ltd.  
Econ Manfg. Co., Ltd.  
Economic Electric, Ltd.  
Elwell, C. F., Ltd.  
Ever Ready Co. (Great Britain), Ltd.  
Fellows Magneto Co., Ltd.  
Gamage, A. W., Ltd.

Gambrell Bros., Ltd.  
General Radio Co.  
Graham, A., & Co.  
Hambling, Clapp & Co.  
Hart Accumulator Co., Ltd.  
Harwell, Ltd.  
H. P. R. Wireless, Ltd.  
Igranic Electric Co., Ltd.  
Isted, T. H., Esq.  
"K.B." Radio Equipment Co.  
Marconi Scientific Instrument Co., Ltd.  
Marconi Wireless Telegraph Co., Ltd.  
McMichael, L., Ltd.  
Metropolitan-Vickers Electrical Co., Ltd.  
Mitchell's Electrical & Wireless, Ltd.  
M. O. Valve Co., Ltd.  
Mullard Radio Valve Co., Ltd.  
Peto Scott & Co.

Pettigrew & Merriman, Ltd.  
Radio Communication Co., Ltd.  
Radio Instruments, Ltd.  
Radio Press, Ltd.  
Radio Service, Ltd.  
Rogers, Foster & Howell, Ltd.  
Siemens Bros. & Co., Ltd.  
Stanley Prince & Co.  
Sterling Telephone & Electric Co., Ltd.  
Sullivan, H. W., Esq.  
Telephone Manfg. Co., Ltd.  
Tingey, W. R. H., Esq.  
Wates Bros.  
Western Electric Co., Ltd.  
Wireless Equipment, Ltd.  
Wireless Press, Ltd.  
Wireless Supplies Co.  
Zenith Manfg. Co., Ltd.

ORGANISERS:

BERTRAM DAY & Co., Ltd., 9 and 10, Charing Cross, London, S.W.1.  
Wireless Publicity Specialists.

# SOMETHING DEFINITE

Mr. E. J. BARNARD, Welling, Kent, writes :

" I think I ought to tell you how much I value 'The Amateur Mechanic.' It has proved of great assistance in a variety of jobs, and especially as to the article on WIRELESS TELEGRAPHY. I constructed an instrument entirely according to the instructions, and was rewarded with success on the first trial. Sunday last was, for me, a red-letter day, as I succeeded, with the same instrument, in picking up the telephonic message from London to Geneva at 9.40 a.m. Considering that my aerial is only 42 feet long and 18 feet high, I think these are grounds for self-congratulation. I may add that until I became interested in the article in your 'Amateur Mechanic,' I had not the slightest elementary knowledge of Wireless Telegraphy."

## YOU CAN DO THE SAME WITH

The Brains of over 50 Expert Craftsmen at your service at any time.

# The Amateur Mechanic

In Language you can Understand, supplemented by over 6,000 Illustrations

### THE CHAPTERS ON WIRELESS TELEGRAPHY GIVE COMPREHENSIVE "EASY TO FOLLOW" INSTRUCTION ON THE FOLLOWING SUBJECTS :

CONDUCTION AND INDUCTION SYSTEMS—RADIATION SYSTEMS—TUNING AND RESONANCE—OSCILLATORY CIRCUITS—THE MARCONI COHERER—A SIMPLE ANALOGY—TRANSMITTING—RECEIVING—THE CRYSTAL DETECTOR—FOUR TYPES OF TRANSMITTING APPARATUS—THE THERMIONIC VALVE—RECEIVING CONTINUOUS WAVES—LOGICAL SEQUENCE OF THE INFORMATION—AERIALS—THE SINGLE-WIRE AERIAL—THE T TYPE AERIAL—THE TWIN-WIRE AERIAL—THE EARTH CONNECTION—WAVE-LENGTH OF AERIAL—MAKING A LONG-DISTANCE CRYSTAL RECEIVING APPARATUS—GENERAL DESCRIPTION—CAPABILITIES OF THE APPARATUS—SPECIFICATION—THE TUBULAR CONDENSER—THE VARIABLE CONDENSER—THE CRYSTAL DETECTOR—CONNECTING UP COMPLETE SET—WORKING THE SET—MAKING A COMPLETE VALVE PANEL—GRID CONDENSER—FILAMENT RHEOSTAT—RESERVOIR CONDENSER—WIRELESS TELEPHONY—THE TRANSMITTING STATION—THE RECEIVING STATION—GENERAL ADVICE—LIST OF CHIEF STATIONS.

### IT ALSO TEACHES YOU :

How to Build Your Own Sheds, Outhouses, Poultry Houses, etc.—How to Cure Damp Walls, Leaky Roofs, and Smoky Chimneys—How to Make Garden Frames, Garden Furniture, and Garden Paths—How to Mend Windows, and to Make, Mend, and Strengthen Locks and Bolts—To Clean, Overhaul, and Repair Motors and Motor-Cycles—To Instal Wireless Telegraphy, Electric Light, etc.—To work in every kind of Metal—To etch on Brass—To write on Glass—To Make Hectographs—To Build a Boat, a Canoe, a Canvas Canoe, etc.—To paint and paper a room—To sole and heel and patch boots and shoes—To make a pair of hand-sewn boots—To restore colour to old brown shoes—to make household furniture—To re-seat chairs—To upholster sofas, etc.—To instal a speaking-tube—To clean a stove—To repair bicycles—To work in metal—To colour metals—To repair water taps—To varnish a violin—To remedy damp walls—To repair the piano

—To make a padded chair from an old cask—To stuff animals—To dress furs—To stuff and mount birds—wood inlaying—To prepare working drawings—To renovate a grandfather clock—To make garden arbours, arches, seats, summer-houses, etc.—To use metal drilling tools—To renovate mirrors—To mend china—To do fretwork—To limewhite poultry houses—To do gold-plating and silver-plating—To clean a watch—To mend keyless watches and ordinary watches—To distemper ceilings and walls—To make picture frames and frame pictures—Curtain fitting—Metal castings—To clean paint off glass—To clean boilers—To fix an anthracite stove—To re-gild and restore picture frames—How to use spanners—To make doors and windows draughtproof—To paint walls—To do nickel-plating—To cure noises in hot-water pipes—India and glue varnishes—To make plaster casts, etc. etc.

The booklet which this coupon brings is free and places you under no obligation whatever. It tells you all "The Amateur Mechanic" does for you, and shows actual pages with clear illustrations.

## GET IT NOW.

Send this form in unsealed envelope, with penny stamp,

To THE WAVERLEY BOOK CO., LTD.  
(P.Wir.I. Dept.), 96, Farringdon Street, London, E.C.4.

Please send me, without charge or obligation to order, your Free descriptive Booklet, explaining contents, etc., of "THE AMATEUR MECHANIC," with specimen pages and pictures, and particulars as to your terms for small monthly payments beginning thirty days after delivery.

NAME .....

ADDRESS .....

P.Wir.I 1922 .....



# LAND STATIONS IN GERMANY.

DF—Direction-finding Stations. CW—Continuous Wave System of Transmission. T—Telephony.

Amateurs desiring a complete and detailed list of all the wireless stations in the world should purchase the International List of Radio-Telegraph Signals, published at Berne, price 18 francs.

Call Sign.	Name of Station.	Approx. Range in Miles.	Wave-Lengths in Metres.	Call Sign.	Name of Station.	Approx. Range in Miles.	Wave-Lengths in Metres.
K A F	Annurmbank Lightship, Berlin	200	300—450	K O	Königsberg	—	2,500
D K	Berlin Wolff	—	600	L Z	Leipzig	—	1,100
K B O	Borkum (D F)	—	—	K A O	List (D F)	—	—
K B M	Borkum	—	600	K A L	List	—	600
K B R	Borkum Lightship	60	300—600	M A	Magdeburg	—	1,200
K B H	Bremerhaven	80	300	C W	Munich	—	1,200
K B K	Bülk (Kiel)	—	600	W I	Münster Ruhr	—	1,200
X U	Cassel	—	1,200	P O Z	Nauen (spk & CW)	8,000 to 10,000	5,500 12,600
K N	Constance	—	1,450	O K	Newenmünster	—	1,200
K B X	Cuxhaven	325 to 650	300—600	K A R	Newenmünster	—	—
D A	Darmstadt	—	1,724	K A V	Norddeich	450 to 800	300—600 1,800
DR	Dortmund	—	1,400	K B Q	Nordholz (D F)	—	—
K A J	Eider Lightship	30	300—600	K B N	Nordholz	—	600
K B L	Eiderlotsengaliote Lightship	100	300—600	X I	Nuremberg	—	1,200
Ø U I	Eilvese (C W)	—	15,000	K A P	Pilau	—	600
K B F	Elbe Lightship	60	300	K B V	Sassnitz	110	375
K B C	Fehmarnhelt Lightship	105 to 210	300—450 600	S K	Stoaken	—	—
F M	Frankfort-on-Main	—	1,975	S N	Stettin	—	1,800
W H	Frankfort-on-Main	—	1,200	G M	Stettin	—	1,200
F 4	Frankfort-on-Oder	—	1,200	K A Y	Stolpmunde	—	—
F D	Friedrichshafen	—	—	S G	Stuttgart	—	1,200
H G	Hamburg	—	2,100	K A W	Swinemünde	350 to 650	300—600 1,800
H W	Hanover	—	2,300	K B Y	Warnemünde	—	—
S F	Hanover	—	1,200	K B E	Warnemünde	—	—
K A H	Heligoland	100	300—600	K B W	Weiser Lightship	80	300
LP	Königswustershausen (T)	—	2,500 5,500	K A N	Wilhelmshaven	—	600

## “Ever-Ready” British Made

### DRY CELLS & BATTERIES

for High and Low tension current.  
As supplied to H.M. Government.  
“FIRST AND FOREMOST”  
Highest electrical efficiency maintained.

The “UNIT” Dry Cells. Unlimited flexibility in size, voltage, and intermediate tapings. Efficiently insulated to prevent current leakage. E.M.F. 1½v.

High-tension batteries. All sizes and voltages with all types of tapings at various intervals, or sockets for Wander Plugs.

No. UW. 1.  
7/6 doz.  
Size 2½" x 1½"

No. W11, EMF 15v.  
3/6 each.  
Size 9½" x 7" x 2½"

Art Catalogue (P.W.) of Standard Sizes sent on request.

**HORTICULTURAL HALL.**  
**WIRELESS EXHIBITION**  
SEPT. 30th. to OCT. 7th.  
**STAND NO. 11.**

WHOLESALE ONLY  
**The Ever-Ready Works,**  
Hercules Place, LONDON, N.7.



## THIS IS THE BOOK!

### WIRELESS VALVES SIMPLY EXPLAINED

By  
**JOHN SCOTT-TAGGART,**  
I.F.Inst.P.

2/6 NET 3/- CLOTH POST FREE



The latest and most complete low-priced book, which is selling in very large quantities.

**CONTENTS.**—Preliminary Remarks—Introduction; Fleming Valves—The Three-electrode Valve and its Applications—Cascade Valve Amplifiers—Reaction Amplification and Self-oscillation—Reaction Reception of Wireless Signals—Continuous Wave Receiving Circuits—Valve Transmitters—Wireless Telephone Transmitter using Valves—Notes on Wireless Broadcast Receivers—Conclusion.

## THE CONSTRUCTION OF WIRELESS RECEIVING APPARATUS.

By  
**PAUL D. TYERS.**

2ND EDITION.

10TH THOUSAND.

1/6 NET. POST FREE.

## RADIO PRESS, LTD.,

Publishers of Authoritative Wireless Literature,  
34, Norfolk St., London, W.C.2.



# SPECIAL WIRELESS PLUGS & JACKS

## FOUR-PIN VALVE SOCKETS.

With several special features. All terminals marked at top and bottom. Earthing clips for valve caps are fitted. Special insulating fillets give the maximum creeping distance between terminals. Suitable for mounting above or below panel as desired.

PRICE 2/6 EACH.

## CONDENSER AND GRID LEAK.

A very neat combination of a Dubilier condenser with a Mullard patent resistance. Either may be used singly. A compact little unit ready for mounting. No special clips are required.

PRICE 7/6 EACH.

Condenser, 2/6. Resistance, 5/-.

## INTERVALVE TRANSFORMERS.

An ironclad pattern of the smallest possible dimensions compatible with efficiency. Particularly well made and attractive in appearance. Easily mounted. Silent in operation. Amplification by this transformer is particularly good. Sealed, and fully guaranteed while seal is intact. Tested at 1,000 volts between windings.

PRICE 29/- EACH.

WE offer a complete range of plugs and jacks specially designed for Wireless purposes.

The mere act of inserting the plug connects the telephone to any desired valve, disconnecting the intervalve transformer (thus cutting out a source of inefficiency) and only lighting up the filaments of the correct number of valves.

They are a great asset to the experimenter, enabling him to carry out important tests with a minimum of time and bother and a maximum of certainty.



Illustrated descriptive leaflet and trade terms on application

**C. F. ELWELL, Ltd.,**  
 CRAVEN HOUSE, KINGSWAY, W.C.2

Builders of the first Imperial Wireless Stations at Oxford, Cairo, and of Lyons, Rome, Nantes, Eiffel Tower, etc.

## THE ARISTOPHONE.

The supreme wireless receiving set. Made in a variety of models, including a wide range of beautiful self-contained cabinets. Write for the Aristophone Booklet.

Prices on application.

## THE ARISTOPHONE SOUND PROJECTOR.

For the enjoyable reproduction of musical items, this beautifully made instrument is essential. It represents a notable achievement in scientific acoustics. Both the reproducer and the sound amplifying chamber are designed on entirely new lines, resulting in a purity of tone quite unapproached by any "loud speaker." A really nice looking cabinet with louvre front.

PRICE £7-10-0.

## ELWELL AMPLIFYING UNIT.

Comprising valve socket and ironclad intervalve transformer, mechanically and electrically combined in one unit. When fitted with a valve this unit contains all that is necessary to give one stage of amplification to your existing set.

PRICE 39/6 ONLY.

(E. P. S.) 31

## Quality PRICE --- RIGHT and see you get the address

Complete sets of Metal Parts with Knob and Engraved Scale for making Variable Condensers,

·001	10/6
·0005	8/-
·0003	6/-

Postage 9d. extra.

Oak cases for above, 4/- and 4/6 each. Postage 9d.

### HEAD PHONES, 4,000 OHMS.

The greatest bargain ever offered, one quality only, THE BEST. 25/- per pair. Complete with Cords and ends. Call and see these at our Showroom. Postage 1/- extra.

### BUILD YOUR OWN CRYSTAL SET.

12-inch Coil, Base and Ends in Teak, Rod and Slider. Crystal Detector and Terminals. First class finish throughout 16/-. Postage 1/6. 100-ft. Aerial, 4 Insulators, 10 yds. Leading-in Wire, 7/6 Postage 1/6.

YOU CANNOT BEAT US FOR PRICE AND QUALITY.

We stock the one and only Crystal for best results—HERTZITE.

Do not fail to secure this, it is MARVELLOUS.

Every Accessory for Wireless in stock at Lowest Prices, consistent with Best Quality. CATALOGUE FREE.

## WILL DAY, LTD.,

19, Lisle St., Leicester Sq., London, W.C.2.

Phone: Regent 4577. Telegrams: Titles, Westrand, London.



Specially designed for Broadcasting.

## HEADGEAR RECEIVERS

Designed and manufactured by leading Telephone Manufacturers. Backed by many years' experience. Highest efficiency, concentrated magnetic field, instantaneously adjustable to the ears, comfortable in wear, either receiver detachable from headband, protected terminals, light weight, twin series cord.

**A.T.M. LOUD SPEAKING RECEIVERS.**  
 Three types of amplifying horn.

**A.T.M. CRYSTAL DETECTOR SETS.**  
 Highest Grade. Maximum Efficiency. Moderate Cost.

Ask your dealer for

**A.T.M. Broadcasting Apparatus**

**AUTOMATIC TELEPHONE MANUFACTURING CO., LTD.**  
 Head Office and Works, Milton Road, Edge Lane, Liverpool.  
 London Office, 60, Lincoln's Inn Fields.



# WATES Specialities



## The Ideal Valve Accumulator

6-Volt 50-amp. PRICE **35/-**. Carriage 3/-.  
(In wooden case with leather strap handle.)  
4-Volt 50-Amp. PRICE **24/-**. Carriage 2/-.

- Exclusive features of these Accumulators:—
1. Basket pattern positives so constructed that it is impossible for active material to become displaced.
  2. Glass containers specially constructed with rib separators.
  3. Absolute absence of frothing.
  4. Practically impossible for plates to sulphate due to special materials used.
  5. Non-corrosive terminals.
  6. Impossibility of acid creeping.
  7. Last feature, but not least—**LOW PRICE BUT HIGH QUALITY.**

SEND THREE STAMPS FOR ILLUSTRATED CATALOGUE

Visit Our Stand No. 15. A.1-British Wireless Exhibition, Sep. 30 to Oct. 7.

**UNIT SYSTEM RECEIVING SETS.**  
From 2 to 6 valve.  
Price of 2-valve set (without valves) **£8.**



## SPHINX H.T. BATTERIES.



(Size 9 1/2 in. x 7 in. x 2 1/2 in.)



Standard 15 Volt. Price **3/6** each. Mahogany case for holding 4 standard 15-Volt H.T. Batteries. Tappings for obtaining either 30, 45 or 60 Volt, fitted with flexible leads and supplied with terminal connectors, no soldering required. Handsome polished case and lacquered fittings. Price with 60 Volt batteries - **29/-**. Price without batteries - **15/-**.

# THE OMNIPHONE CRYSTAL RECEIVER



Price **£4-10-0.** (Carriage free.)  
**FULLY GUARANTEED.**

A carefully designed and well-made wireless instrument, capable of receiving the concerts clearly up to distances of at least 25 miles.

Special provision is made for the attachment of a valve amplifier.

No previous knowledge required to operate; only two adjustments to make. In polished walnut cabinet, complete with aerial, insulators, lead-in tube, 4,000 ohm phones, and full instructions. Call for demonstration, or send for further particulars and terms of guarantee.

**ALL WIRELESS ACCESSORIES. LIST FREE.**

**THE OMNIPHONE WIRELESS CO.,**

24, Warwick St., Regent St., London, W.1.

'Phone: Regent 3335. 20 yards from Regent Street, between Robinson & Cleaver's and Maison Lewis

## The "OFFICIAL" Crystal Receiving Set.

Assembled **£1 16 0** carr. paid. Unassembled **£1 1 0** carr. paid. Wave-length 150—900 Metres (approx.).

The "CENTRAL" Single Slider Crystal Receiving Set. Assembled **£1 13 6** carr. paid. Unassembled **18/6** carr. paid. Wave-length 180—1500 Metres (approx.).

The "GOSWELL" Loose Coupler Crystal Receiving Set. Assembled **£4 16 6** carr. paid. Wave-length 150—900 Metres (approx.).

Please send 3d. for our new Catalogue, printed on art paper and profusely illustrated, giving full descriptions of receiving sets and all Wireless Components. 3d. returned on all orders of 5/- and upwards.

**P. H. BOYS AND CO.,**  
ELECTRICAL AND WIRELESS ENGINEERS.  
187, GOSWELL ROAD, LONDON, E.C.1.  
'Phone: Clerkenwell 4454.

## OUR PRICES CANNOT BE BEATEN !

A FIRST-CLASS CRYSTAL RECEIVING SET in POLISHED CABINET, complete with Double Head-phones, 4,400 ohms, Federal make, Silicon Detector. All Terminals, etc., plated. 150 ft. Copper Aerial and two Insulators. Pocket inside Cabinet for Head-phones. Broadcasting Range, 250 to 3,200 metres, or 25 miles Telephony and 800 miles Telegraphy.

Wiring Diagram and Instructions with each Set.

Price, Complete . . . **£4 0 0** net cash with order

Price, without 'phones **£2 10 0** net cash with order

- CRYSTAL DETECTOR, Swivel Arm, Terminals, Cup, etc., all plated and mounted on Ebonite Base, ready for use . . . each 5/-
  - FILAMENT RESISTANCES, for panel mounting, a speciality . . . each 4/-
  - VALVE HOLDERS, best-quality Ebonite, with nuts . . . each 1/6
  - KNOBS, Ebonite, 1 1/2 inch diameter, superior . . . each 7d.
  - BRASS RODDING, Screwed 12-inch lengths, 0, 2, 3 and 4 B.A. . . each 9d.
  - CONDENSER SPINDLE, 1/2-in. sq. x 2 1/2 in. long, screwed 2 B.A. x 1 in. one end, and 2 B.A. x 3/8 in. at other end . . . each 6d.
  - CRYSTAL CUPS, excellent finish, nut and washer . . . each 5 1/2d.
- Prices of all component parts on application, and delivery from stock. Kindly forward sufficient to cover postage; any balance returned. Carriage paid on all orders over £2. All orders dispatched in strict rotation.

T. W. HALL & CO. (Manufacturers), 58, Hardman St., Deansgate, Manchester.

# A Perfect Aerial for 10/6

NO SOLDERING REQUIRED.

- 100 feet 7/22 Stranded Copper Wire.
- 100 feet 7 Stranded Steel Insulated Cord for guys and bracing (as pliable as string, but of enormous strength).
- 2 Pluton Patent Insulators (no soldering of aerial joints required).
- 1 Steel Coil Spring.
- 1 Mast Pulley.
- 1 10-inch Ebonite leading-in tube, with brass rod and terminals.

Plan, with complete instructions for erection of various types of Aerial.

## TEN SHILLINGS AND SIXPENCE

Carriage Paid.

Cannot be purchased elsewhere at double the price. All material guaranteed finest obtainable.

**Econ Manufacturing Company, Ltd.,**  
6, HOLBORN VIADUCT, LONDON, E.C.1

'Phone: City 4148



STEP BY STEP IN WIRELESS.

# No. 14.—THE CAUSE OF BACK E.M.F.

NOTE.—Articles on this page are for the more advanced amateur.

THE manner in which an alternating current flow generates a "back" E.M.F. in the same conductor is by no means easy of explanation. An endeavour will be made, however, in the following article to describe not only "self-induction" in as simple a manner as possible, but also something of the theory of "Inductance."

It has already been shown in the pages of POPULAR WIRELESS that if a wire or coil of wire in which an electric current is flowing is quickly placed in close proximity to another, and unenergized coil of wire, a temporary current will be induced to flow through the latter. If the "live" wire be then withdrawn, a further "pulse" of current will be discerned in the second wire.

This was explained by the fact that a current flowed in the second wire, only when it was cutting a varying number of lines of force radiated from the electrically charged wire. When, therefore, a current of electricity is passing through a conductor, lines of force are set up, or radiated from it.

### A Constant Field.

Let us now consider the action of the lines of force upon the conductor in which they are generated. In other words, instead of imagining the lines of force cutting through a second wire, let us see what happens when the conductor itself is cut by its own lines of force.

We know that a current can only be induced in a conductor when the lines of force passing through the conductor are varying in number; namely, once the "field" becomes constant in value, the induced current will cease to flow.

If we now refer to a simple electrical circuit, say a length of wire attached to the two poles of an accumulator, or other source of direct current supply, what happens when the current is switched on? When the wire is connected up, and the circuit completed, the current will commence to flow from one side of the cell or battery to the other, via the wire. It is presumed that this current does not immediately attain its maximum strength, but for a fraction of time is building up from zero to its full value.

### Varying Current Strength.

During this period the lines of force set up by the passage of the current are also increasing in number, and the "field" gaining strength. The cross-sectional area of the conductor is therefore cut by a varying number of lines of force during the time taken by the current flowing in the wire to build up to its maximum value. Thus, for an instant, a second electro-motive force, acting in opposition to the applied voltage, will be induced in the wire.

It is this electro-motive force, or "E.M.F.," as it is generally called, that is known as the E.M.F. of self-induction. It must be remembered that the circuit that we are considering is one in which direct current is flowing. The current, therefore, having once attained its maximum value, will continue to flow steadily at a uniform voltage and amperage. The number of lines of force will also remain uniform, and as the density of the field ceases to vary, so does the induced current cease to flow. When the circuit is "broken," and no further supply of current is forthcoming, the field "collapses" back on to the wire, which is again cut by a varying number of lines of force, and a second slight induced E.M.F. is caused to flow, this time in the opposite direction, thus helping to maintain the original flow of current.

From the foregoing it may be seen what will happen in a circuit in which alternating current

is flowing instead of direct. Supposing the original voltage supplied to such a circuit is equal to the voltage previously applied to the direct current circuit, the resultant amperage or flow in the alternating circuit will be less.

This is due to the fact that in a direct current circuit the influence of the E.M.F. of self-induction is momentary only, being apparent at the instant when the circuit is made or broken. The strength of the current flowing in an alternating circuit is continually varying in value, and the resultant lines of force emanating from such a current will likewise be continually altering in numbers and strength.

### The Retarding Effect.

We might liken such a circuit to a direct current circuit which is being continually "made" and "broken," in so far as the lines of force are continually altering in number. This will cause a continuous flow of self-induced E.M.F. in the circuit.

The induced current, according to Lenz's Law, will oppose the original current and tend to retard its progress. The self-induced E.M.F. is always trying to prevent either the rise or fall of current through the circuit, because immediately the current starts to alternate the induced E.M.F. will also alternate, and endeavour to assist the current to continue to flow in the one direction.

This retarding effect upon the alternations results in a corresponding diminution of amperage in the circuit, although it should be

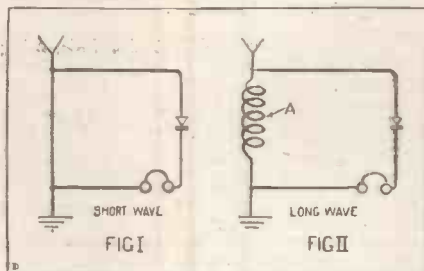

clearly understood that no actual loss of energy takes place.

The retarding action exercised upon a circuit by inductance is frequently compared to mechanical inertia in text-books dealing with the subject; and the analogy is, perhaps, as good as any.

The main point to be remembered is that while a certain amount of opposition in the form of back electro-motive force has to be overcome, the energy required to overcome such opposition is eventually given back into the circuit.

Resistance in a circuit entailing the loss of electrical energy in the form of heat is waste, and quite a separate factor.

The combined opposing effect of self-induction and of resistance in a circuit is known as "impedance." We have seen that once the current flowing in a direct current circuit attains a steady value, no self-induction takes place, but that with an alternating current it is ever present. If we now wind the wire carrying the alternating current into a coil, the self-induction of the coil will be much greater than that of the straight wire, owing to the fact that the lines of force radiated will not only cut through the cross-sectional area of the wire, but will also cut through the adjacent turns of wire forming the coil.

A coil of wire is employed to "tune" wireless circuits. Most of us know it as a tuning inductance. Before it is possible for us to receive a signal from any given station it is necessary to know the wave-length which is being used for transmission. We require to know this to enable us to so adjust our receiving instruments that they will respond to a frequency which is the same as that of the transmitted wave. From the formula for calculating wave-length, which is velocity (a constant) divided by frequency, it is easy to see that the slower the frequency of any given wireless circuit, the greater will be the resultant wave-length.

The inclusion of inductance then into a receiving circuit will have the effect of making the receiver respond to longer wave-lengths than was previously possible. While a receiving circuit has a natural frequency of its own, the gradual introduction of inductance, and therefore self-induction, which always tends to oppose any change in the strength of current passing through that circuit, will cause the circuit to respond to a lower frequency.

We can see this by taking a simple circuit as shown in the accompanying figure. The tremendously long wave-lengths are, of course, the result of keeping the calculation simple.

Fig. I shows a circuit which has a theoretical wave-length of 186 miles. We know that velocity is a constant, namely 186,000 miles. From the formula  $V = F \times W$  where  $V =$  velocity,  $F$  frequency, and  $W$  wave-length  $F = \frac{186,000}{186}$ , a frequency of 1,000.

If we now introduce sufficient inductance as shown in Fig. II at A, to reduce the frequency at which the circuit oscillates to 100, we shall have

$W = \frac{186,000}{100}$ , which gives us a wave-length of 1,860 miles. Such a circuit would be of little use because of its fixed wave-length. We therefore employ the well-known variable or "sliding" inductance by which we can vary the amount of inductance in the circuit until the desired frequency or "tune" is obtained.

Practically, the frequency is often a question of millions. For instance, the two wave-lengths used for general working by ships at sea, namely 600 metres and 300 metres, have frequencies of 500,000 and one million respectively.

### Oscillatory Circuits.

There is, of course, another factor, namely capacity, which will affect the tuning of the received circuit.

It does not come within the province of the present article, which has been written with the sole purpose of trying to convey something of the manner in which back electro-motive force is generated in alternating current circuits, and the effect which the presence of such a current has upon the frequency of the alternations.

It is true that when referring to wireless in this respect the current is in some instances referred to as an oscillatory one, but the expression "oscillatory" could be equally well expressed as "rapidly alternating."

Capacity has been mentioned, in order that the reader, in perusing the foregoing article, should not confuse the formula for wave-length previously given with that which deals with the amount of capacity and inductance contained in a circuit, namely—

$$\text{Wave-length} = 1,885 \sqrt{C \times L}$$



### CRYSTALS! WIRES!

Zincite, Bornite, Chalcopyrite, Copper Pyrites, Iron Pyrites, Tellurium, Perikon Combination, Carborundum, Selenium, Galena, Wood's Metal, Gold Wire.  
6d. per box, postage 2d.

Copper and resistance wires, all coverings. List, stamp.

Stand 82, Radio Exhibition, Central Hall, Westminster—September 2-8.

**A. HINDERLICH,**  
Central Hall, Southall, Middlesex.  
Phone: Southall, 121.

**STEVENS COUNTERPOISE EARTH BOX & CABLE OUTFIT.** Send cash 5/6 (includes postage in U.K.). ENSURES BEST RESULTS WHEN INSTALLED. Instructions supplied. Length of cable 30 ft. Additional 10 ft. lengths, 1/- each.—A. H. STEVENS, 12, Shrubby Rd., London, S.W.16. Phone Streatham 1816.

### TOOLS!! TOOLS!!

HERE IS ONE OF OUR MANY BARGAIN LINES. SEND FOR A PAIR TO-DAY. THEY ARE USEFUL FOR HUNDREDS OF ODD JOBS IN THE HOUSE.



OUR NEW BARGAIN LIST (No. 22 C) IS NOW READY. SEND FOR YOUR COPY TO-DAY. Post Free.

**GEORGE ADAMS,**  
255-6, HIGH HOLBORN, LONDON, W.C.1.

### PARTS

- Condenser, panel type, '001 .. 21/-
- " '0005 .. 15/6
- Telephones, 4,000 ohms, first-class make .. 27/-
- Telephone Transformers, for 120-ohm 'phones .. 15/-
- Interval Transformers, L.F. .. 18/6
- Single-valve set, panel with 2 condensers, fil. res., Valve, Accumulator, H. T. Battery and Phones, .. .. . £5/5,0

**S. E. PARKES & Co., Ltd.,**  
46, Camberwell Green, London, S.E.5.

# RADIOTORIAL

All Editorial Communications to be addressed The Editor, POPULAR WIRELESS, The Fleetway House, Farringdon Street, London, E.C.4.

The International Radio and Wireless Exhibition and Conference at the Central Hall is a sign of the times.

Within a few months Wireless has aroused an almost universal interest as the possibilities of broadcasting become more apparent.

It gives me great pleasure to think that POPULAR WIRELESS should be so closely allied to the organisation, the aims and aspirations of the International Radio Exhibition, and there is no doubt in my mind that it will be a yearly and long-looked-for event.

I am sure all readers of POPULAR WIRELESS will join with me in wishing the Exhibition every success and that it will have every encouragement so deserving a cause should have.

THE EDITOR.



Owing to the enormous number of queries received daily from readers of POPULAR WIRELESS, I have decided to reply individually by post. A weekly selection of questions will, however, be printed on this page, together with the answers, for the benefit of readers of POPULAR WIRELESS in general. Questions should be clearly and explicitly written, and should be numbered and written on one side of the paper only.

All questions to be addressed to: POPULAR WIRELESS, Queries Dept., Room 131, The Fleetway House, Farringdon Street, London, E.C.4.

Readers are requested to send necessary postage for reply.

H. G. (Devonport).—What size foils, using .002-in. mica between, will be required for a grid condenser?

For this purpose paraffin waxed paper should be employed as the dielectric because, owing to the high specific inductive capacity of mica, it is unsuitable for fixed condensers of the smaller values. In this particular instance the plates would be so small that accurate measurement would be impossible. Two foils, each 2 by 2 in., are all that are required when using waxed paper.

J. L. (Brussels).—Some diagrams show the L.T. battery connected by the negative terminal to the general circuit, and others by the positive; which is the more correct?

The negative, otherwise a positive potential will be applied to the grid, thus tending to neutralise the shielding action of its negative charge.

"NOVICE" (Liverpool).—Self-oscillation of a valve set is said to be deleterious. Is that evidenced by the vibration of the filaments of the valve?

No, it is not the valve that oscillates, although it is generally mentioned in that way; it is the oscillation of a high-frequency current in a circuit or circuits that is referred to when it is stated that the "valve is oscillating." You should refer back to Mr. Coursey's article in Number 10 for a clear explanation of regeneration.

(Continued on page 274.)

### CONTRACTS WANTED.

**The Wellington Engineering Works, Aldershot,**

offer their services for the manufacture of:

- 1, 2, 3, or 4 Valve Receiving Sets,
- Valve Panels on the Unit System,
- L.F. & H.F. Transformers,
- Telephone Transformers,
- Variable Condensers,
- Filament Resistances,
- Complete Crystal Sets.

Superior Finish. Prompt Delivery. Keen Quotations.

### BANKRUPT'S STOCK

The purchase of the above stock has enabled me to offer same at Knock-out Prices.

High-Class Variable Condensers (complete) for Panel Mt. Cabinet, 1/- extra.

- '0002 - each 8/- 4,000 Ohm Receivers 25/- pair.
- '0003 - " 9/3 Double Slide Tuning Coils.
- '0004 - " 10/- approx. W.L. 180-1,200
- '0005 - " 11/6 metres .. .. . 8/6
- '001 - " 14/9 Postage Extra.

Send for list of other Radio Accessories (3d).  
W. H. SALT, Elec. Engineer, 161, York Rd., Battersea, S.W.11.

## A MESSAGE FROM "MARS."





# WE ARE NOT INFANTS IN THE WIRELESS WORLD.

We were established long BEFORE the BOOM.

ALL-IN SERIES, No. 1.  
 SET OF PARTS 15/9 **VALVE PANEL** SET OF PARTS 15/9

Set includes:—Ebonite Panel matt finished, 7" x 5", and drilled. "Velvet" Filament Rheostat, Grid Condenser and Leak, Blocking Condenser, Systoflex, V. Holder Terminals, Set of Ivorine Tablets and Blue Print. Polished Mahogany Cabinet to fit, 3/6.

## THE BROADCASTING TUNER

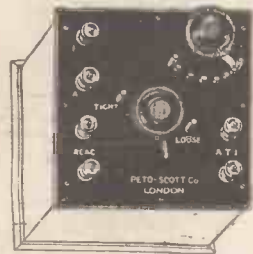

Complete set of parts.  
 Require only fitting together.  
 All holes drilled. Wiring diagram.  
 Complete .. .. 18/6  
 Cabinet to fit .. .. 4/6

10 times more efficient than a coil and slider.

NOTE.—The Broadcasting Tuner and Single Valve Panel and Condenser, together with Value, Phones and Batteries, make a complete Station, which will get all the speech and telephony going.

Visit Our Stand, No. 16. All-British Wireless Exhibition, Horticultural Hall, September 30th to October 7th.

Send 6d. for our NEW ILLUSTRATED CATALOGUE (P) with List of Stations.

The Trade is offered Attractive Terms.

**PETO SCOTT (The Condenser King),**  
 FEATHERSTONE HOUSE, 64, HIGH HOLBORN,  
 LONDON, W.C.1.



Established 1900.

WE TEACH BY POST.

ADVICE FREE  
 Most moderate charges—payable monthly.

LEARN A TRADE OR PROFESSION

Can I help you?

I WILL GIVE YOU £50

if I fail to produce over 7,000 testimonials from others I have helped TO A SUCCESSFUL CAREER.

Yours to success,

*J. Bennett*

## ARE YOU QUALIFIED FOR THE JOB YOU SEEK ?

Write for one of our FREE BOOKLETS on WIRELESS TELEGRAPHY, or on any of the following subjects—

Architectural Drawing }  
 Building Construction }  
 Clerk of Works' Duties }  
 Aviation }  
 Boiler Engineering }  
 Boiler Making }  
 Chemistry }  
 Civil Engineering }  
 Concrete and Steel }  
 Draughtsmanship }  
 Electricity }  
 Engineering }  
 Foundry Work }  
 Internal Comb Engines }  
 Marine Engineering }

Mathematics }  
 Matriculation }  
 Metallurgy }  
 Mining }  
 Mine Surveying }  
 Motor Engineering }  
 Naval Architecture }  
 Pattern Making }  
 Salesmanship }  
 Sanitation }  
 Shipbuilding }  
 Structural Engineering }  
 Surveying and Levelling }  
 Telegraphy and Telephony }  
 Special Course for Apprentices }

What proof do you carry? Your word to an employer is not proof that you are efficient, but a College Qualifying Diploma or Certificate, signed by the Professional Staff, is a proof of efficiency, and a valuable asset in seeking a remunerative position.

We specialise in all exams, connected with Wireless and other technical subjects. If you are preparing for any exam, ask our advice. All particulars FREE OF CHARGE. Parents should seek our advice for their sons. If you are interested in Wireless, or any of the subjects mentioned above, write naming the subject, and we will send you our FREE BOOKLET. Please state your age.

COURSES SPECIALLY COMBINED TO MEET ALL REQUIREMENTS.



## CQ Do you get FL?

YOUR crystal or valve may be the best of their kind—your aerial high as Snowden, your tuner perfectly accurate, but unless your 'phones are O.K. you won't get maximum "sigs."

Signals come "thumping in" through ERICSSON 'PHONES—they're built that way—for never-failing clarity and sensitivity. The magnets never lose their strength and "shorts" don't exist. And they're easy and comfortable to the head.

Back of ERICSSON 'PHONES is the accumulated experience of a generation in telephone manufacture.

Write for Particulars

The BRITISH L.M. ERICSSON MANUFACTURING Co., Ltd.  
 Head Office: 60, Lincoln's Inn Fields, W.C.



**Ericsson**  
 Telephones

# Exide BATTERIES FOR WIRELESS

We specialise in the manufacture of batteries for filament current supply to Valves, and high-tension batteries for application of Anode Potential. We can supply these batteries in glass, ebonite, or celluloid containers to any desired voltage.



Exide batteries can be relied upon for Wireless work, and retain their charge over very long periods.

Prices and Particulars upon Application.

6 v. 80 amp. hour Exide Battery.

THE Chloride ELECTRICAL STORAGE COMPANY LIMITED.

Head Office:  
 CLIFTON JUNCTION,  
 MANCHESTER.

London Showrooms:  
 219/229, SHAFTESBURY  
 AVENUE, W.C.2.



## ELECTRADIX RADIOS.

Immediate Delivery from our Huge Stocks.

Everything from a Recorder to an Earth Clip.

The best-equipped City depot.  
**COME AND SEE US.**

9, Colonial Avenue is first opening on left in the Minorities, near Aldgate Station, Metropolitan Railway.

**LESLIE DIXON & CO.** Tel.: Avenue 4166.  
9, Colonial Avenue, London, E.1.

### SPECIAL PURCHASE

2,000 Pairs Super-Sensitive High-Resistance Head-phones, 4,000 Ohms. Brand New. Delivery from stock. £1 7 6 post free.

**OLIVER'S WIRELESSORIES,**  
196, Wandsworth Bridge Road,  
Phone: Putney 1257. London, S.W.6.

### AMATEURS AND RETAILERS PARTS SUPPLIED FROM STOCK.

LISTS FREE. Condenser plates 1/6 doz. pairs; post 3d. FRASER, Sentinel Ho., Southampton Row, London.

### LISTEN IN!!!

Midland Wireless Enthusiasts—We are here for your Benefit.

**D. A. S. H. WIRELESS SERVICE,**  
Wireless Apparatus Manufacturers,  
241, PARK ROAD, ASTON, BIRMINGHAM.  
Everything Supplied. Enquiries solicited.

### F. W. ILE'S WIRELESS SUPPLY.

Aerial Insulators, Porcelain (special), each	£0	3
Aerial pulleys, ex-Govt. aluminium, each	0	1 6
Aerial Wire, 7/22 copper, per 100 ft.	0	6 0
1/2 in. Slider Rods, 13 ins. long, bored, each	0	0 7
Lacquered crystal detectors on ebonite bases	0	5 0
Murdoch double head sets (2,000 ohm total)	1	10 0
Ebonite knobs, knurled and polished, each	0	0 8
Mullard Ora valves, limited number only, each	0	15 0

All orders sent by return on receipt of cash.  
**BOSCOMBE, EAST BOURNEMOUTH.**

### TO WIRELESS EXPERIMENTERS. PATENT YOUR INVENTIONS.

They may prove very valuable. Particulars and consultations free. **BROWNE & CO.,** Patent Agents, 9, Watwick Court, Holborn, London, W.C. 1. Established 1840. Telephone, Chancery 7547.

### GENUINE MARCONI RECEIVING SETS

complete with Telephone, Aerial Wires, Plugs and Clips. Full instructions for fixing and operating. These Sets are as simple in use as a Gramophone, wonderfully compact, and have behind them the traditions and full resources of the Marconi Company, the Pioneers of Wireless. Orders executed in rotation. Price £4 13s. 6d. Carriage and Packing, 2s. 6d.—Chas. Orme and Co., 93-94, Chancery Lane, London, W.C.2.

### WIRELESS AERIAL POLES.

Steel and Wood; Wire; Insulators; Strainers, etc. (to suit all pockets). Send stamp for list.

**JENNINGS, LTD., WIRELESS, BRISTOL.**

## DAVIS & TIMMINS, LTD.,

34a, York Road, King's Cross, N.1.

## SCREWS AND TERMINALS

FOR WIRELESS SETS  
Write for Illustrated Lists.

## RADIOTORIAL QUESTIONS AND ANSWERS

(Continued from page 272.)

How can I tell, when adjusting the reactance coil, when my valve is oscillating?

The moment the circuit commences to oscillate there will be a slight click followed by a hollow rushing noise, together with a very slight grating that, compared to the comparative quiet previously in the phones, is very easily recognisable.

A. S. (New Cross).—Can I use honeycomb coils in a crystal set?

Yes; but for this purpose the single layer cylindrical inductance is the more efficient.

If so, would the addition be an advantage? Not if you have an efficient coil of the above-mentioned description.

N. H. (Drogheda).—What wave-length would an inductance wound with 285 turns of 22 S.W.G. copper wire on a 3 1/2 in. former have?

1,200 metres on a P.M.G. aerial.

What would be the capacity of a condenser having 33 aluminium plates 6 by 4 in. separated by glass 1-16th in. thick?

.02 mfd.

J. P. (South Shields).—Can you give me the size of an inductance to tune from 200–20,000 metres wave-length?

Such a range would be impossible with one inductance coil. If a coil is wound to give that maximum value, it certainly would not tune down to the minimum required. If such a range is essential, a set of basket or honeycomb coils must be used. By the way, is such a range essential? We know of no spark stations that transmit on such a long wave, and, as you have a crystal set, you will not be able to hear the C.W. stations that transmit on waves that nearly approach the higher figure.

Is it possible to use a crystal set for this distance?

That question would indicate that you were confusing wave-length with range of reception. A coil wound to give a wave-length range to 3,000 metres would cover practically everything of interest that is likely to be received on such a set. 350 or so turns of 22 S.W.G. on a 5 or 6 in. former would be quite suitable for this latter purpose.

Which would give the better results with a crystal set, a twin aerial 60 ft. long, or a treble 40 ft. in length?

The double aerial.

What is the nearest broadcasting station to South Shields?

Writtle and Marconi House at present, but it is probable that very shortly a station will be in operation in Newcastle.

J. C. (London).—Can I rewind a watch-type pattern telephone to 4,000 ohms resistance, and what wire should be used?

Unless you have a lathe, or a small motor arranged for winding purposes, we would advise you not to attempt to do so. In any case, it is a task that calls for no little mechanical skill and experience. Gauge 48 S.W.G. is used. This wire is sold in two and four thousand ohm spools.

What would be the inductance and wave-length of a tuning-coil 5 by 5 in. wound with 129 turns of 20 S.W.G.?

1,400 microhenries; 950 metres on a P.M.G. aerial.

D. B. M. (Ilford).—Can wood be used instead of ebonite for crystal and switch bases?

Not unless it is a hard, well-seasoned material, and has been baked in paraffin-wax—that is, in point of highest efficiency.

(Continued on page 276.)

### GLASGOW WIRELESS SUPPLY CENTRE:

All Materials and Accessories for Amateurs. Panels Engraved. Write for Price List enclosing stamps. W. and J. JAMIESON, Ltd., 68, Shamrock St., West.

## WIRELESS SUPPLIES

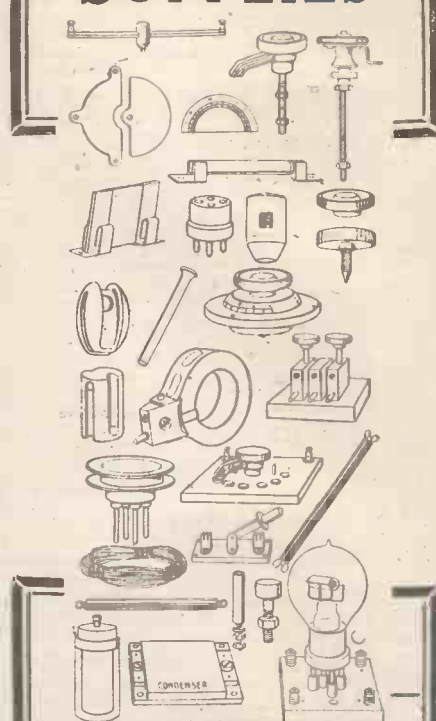

**ACCESSORIES & PARTS FOR MAKING SINGLE, TWO, THREE, & FOUR VALVE RECEIVING SETS, CRYSTAL SETS, VALVE PANELS, TUNING PANELS, ETC. ETC.**

Made in agreement with the Patent Holders.

**TRADE ONLY CATALOGUE A/23**  
Free on request

**Ward & Goldstone**  
PENDLETON. MANCHESTER. LTD.

**PHONES, Marconi, H.R., 15s. pair; Valve Legs, 3d. each; Terminals, 3d. each; Detector Panel, parts, including drilled etc. top ready to assemble, 18s. 9d.; H.F. and L.F. Panels, parts, H.F. with cond., L.F. with trans., eb. top ready to assemble, 23s. 6d.; Tuner, complete parts, 33s. 6d.; Fraser Patent Coil Holder, 10s. extra; Slab Coil Carriers, Patent, standard plug pitch, fits any holder, 2s. 9d. each; Rev. List B, gratis. JAMES FRASER & CO., address as E.T.O. below. Wireless Instruction, Day, Evg., Postal Courses in Radio, Valves, etc. P.M.G. Exam. and Amateur Classes. Also Telegraphy and Cable. Prospectus free. Phone: North 1036. Principal, Electrical Training College, Radio House, Manor Gardens, London, N.7.**

### THE BEST BOOK ON WIRELESS FOR AMATEURS

How to make and use a Wireless Valve Receiver Set. By E. K. Spiegelhalter. This book has been specially written for Amateurs in Wireless. Clear Constructional details accompanied by 24 very practical Illustrations are given, which will enable the operator to build his own set economically and to work it successfully when made.

Price 2/- net. Send P.O. for a copy.  
**E. & F. N. SPON, Ltd., 57, Haymarket, London, S. W. 1.**

**ACCUMULATORS, etc.** New & Guaranteed.  
4-Volt, 25-Amp. Celluloid 11/3d. Postage 1/-  
4-Volt, 40-Amp. 17/6d. | 6-Volt, 40-Amp. 25/6d.  
4 " 60 " 21/3d. | 6 " 60 " 31/-  
4 " 80 " 27/- | 6 " 80 " 38/-  
4 " Packing 1/6d. extra. | Packing 2/- extra.  
7/22 Aerial, 6 1/2-100 ft.; Mullard Ora Valves, 15/-  
15-V. Siemens, H.C.T. Batteries, 4/-; Marconi R. Valves, 28/6d.; Accumulator or Charging Board, 37/6d.; Voltmeters, Watch pattern, 0 1/2 Volts, 6/-.  
Cash with order. Goods despatched per return.  
**LOWKE & SONS Ltd., Northampton.**

## HIGH QUALITY CONDENSERS

Complete with scales.



'001 mf. 24/-      '0005 mf. 18/-      '0003 mf. 14/-

## UNIT-COIL HOLDERS



Patent.

Shows method of fixing.

To fit any standard coil. Made of ebonite and brass throughout, with excellent gun-metal finish.  
Fixed Unit .. .. . 4/2  
Moving Unit .. .. . 5/8

### FILAMENT RESISTANCES.

All Post Free. Send your order to:—  
Dept. B.,

ASHLEY WIRELESS  
TELEPHONE Co., Ltd.,

69, Renshaw St., Liverpool.

Tel. 4628 Royal.

'Grams',  
'Rotary',  
Liverpool

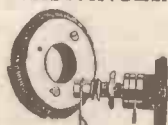

Patent:  
5/3 each.

## SELF CONTAINED OR UNIT SYSTEMS

Marconiphones,  
Marconi Scientific Units,  
Waveora Units, Etc.

We give demonstrations to purchasers at our showrooms.

Tuners, Coils, Rectifiers, Amplifiers, Valves, Magnavox & Brown Loud Speakers, Microphone Amplifiers, H.T. & L.T. Batteries, and all Wireless Accessories.

Special quotations for Technical Colleges,  
Schools and Educational Institutions.

The Radio Waveora Co. (Dept. P.),  
168, Regent Street, London, W.1.

Telephones: Gerrard 3039; Western 847.  
Telegrams: Wychwood, Phone, London.

## WIRELESS ENTHUSIASTS.

ABSOLUTELY COMPLETE

FOR £3 10s. 0d. CASH,

OR £1 0s. 0d. DOWN AND 5/- WEEKLY FOR 12 WEEKS

OUR BEAUTIFUL CRYSTAL SET No. 1, WITH 4,000 OHMS HEADPHONES, AERIAL WIRE, AND INSULATORS. TESTED AND GUARANTEED FOR CLEARLY RECEIVING BROADCAST SPEECH, MUSIC, AND MORSE MESSAGES.

THE COIL IS WOUND ON BEST 'ISOLO' UNSHRINKABLE TUBE 12" x 4", GIVING A GOOD PICKING-UP RANGE AND MOUNTED ON POLISHED BASE, WITH CONDENSER, ETC.

BOOK OF INSTRUCTIONS WITH EACH SET.

Cheques, P.O. or M.O. to be  
crossed NATIONAL BANK, Ltd.

SEND YOUR ORDER  
TO-DAY WITHOUT DELAY.

H. A. WHITE & SON, 229, Pentonville Road,  
London, N. 1. 'Phone: Central 3045.

## THE PRESENT WIRELESS BOOM

has given an enormous impetus to the manufacture of wireless apparatus. The tendency has been to sacrifice quality to quantity in endeavouring to keep pace with the demands. Throughout this period of increasing wireless activity S. G. BROWN, Ltd., have wisely refused to lower their high standard of quality even at the expense of occasional delay in fulfilling orders. As a result, they have more than maintained their enviable reputation as RELIABLE wireless manufacturers, and to-day it continues to be recognised by amateur and professional alike that wireless instruments and parts manufactured by and bearing the name "BROWN" can be bought with absolute confidence in their quality, value, and efficiency.

### The "Brown" Super-Sensitive Telephones

These Telephones are unquestionably the clearest and most sensitive made, and, consequently, increase the distance over which wireless can be heard.

BROWN'S are recognised as the most comfortable to wear, due to their extreme lightness in weight and adaptable adjustment. There is no wireless head 'phones in the world to compare with BROWN'S.

"A" TYPE  
Low Resistance  
58/-

High Resistance  
62/- to 66/-



"D" TYPE  
Low Resistance  
48/-

High Resistance  
52/-

(These prices include  
cords.)

IMPORTANT NOTICE.—When purchasing BROWN'S, you should see that the name BROWN is stamped on the back of each ear-piece. This is the hallmark and proof of their genuineness, excellence of finish, and highest efficiency. In universal use. As supplied to British, Allied, and Foreign Governments.

VISIT OUR STAND, No. 43, ALL-BRITISH WIRELESS EXHIBITION  
Horticultural Hall, Sept. 30 to Oct. 7. ILLUSTRATED CATALOGUES  
POST FREE

Head Office and Works:  
Victoria Road,  
North Acton, London,  
W.3.



London Showrooms:  
19, Mortimer St.,  
London, W.1.

## CHESTER AND NORTH WALES WIRELESS INSTALLATION CO.,

35, COMMONHALL STREET, CHESTER.

Local Agents, "Crystophone" Receiving Sets and "Esi-Fix" Aerial.

Immediate Delivery from Stock.

SPECIAL OFFER.—Re-conditioned Marconi Trench Sets, H.F. Valve and Crystal Combined.

Note the price—£8 15 6, carriage paid.

Every set tested before sale. Wonderful results.

R.A.F. Ebonite Mark II. Insulators.

Per set of four, 6/-, carriage paid. Very highly recommended.

Head Sets; Accumulators; H.T. Batteries; Wire.

Our representative is travelling the district now.

Send a card for Free Demonstration.

## The London Wireless Electrical Co.

40-44, HOLBORN VIADUCT, LONDON, E.C.1. [Phone Holborn 5051.]

WIRELESS APPARATUS DIRECT TO THE PUBLIC.

Look At These Prices! Send Us Your Enquiries!

Superior No. 1 Crystal Receiving Sets	47/6
Superior Single Valve Detector Panel	32/-
Superior Formers, 12in. x 4 1/2, specially prepared	7d. each
Superior Formers, 10in. x 4 1/2, wound 24 S.W.G. enamelled Copper Wire	6/3 "
Superior Valve Legs, complete with Washer and two nuts	2 1/2d. "
Superior Condenser Plates	1/4 doz.
Superior Filament Resistance	5/0 each
Superior Crystal Detector, complete with crystal, on ebonite base	4 9 "
Superior Valve-Holder, on ebonite base	1 2 "

AERIAL WIRE, 7/22, Enamelled Copper, 100 ft. 6/-

ALL GOODS GUARANTEED AND OF HIGH-CLASS  
MANUFACTURE.



## RADIOTORIAL QUESTIONS AND ANSWERS.

(Continued from page 274.)

**"VALVE" (Aberdeen).**—Will you give me the full particulars for the construction of a low frequency inter-valve transformer?

An iron core  $\frac{1}{2}$  by 3 in. is required, upon which is first wound 10,000 turns of 44 S.W.G. for the primary. This is covered with four waxed papers, and then a further 10,000 turns of 44 are wound on for the secondary. After the winding has been completed, and the 44 attached to a stouter gauge wire for the final turns on each winding, in order to be carried to the external circuit, the whole should be immersed in paraffin-wax. It will be as well to give the weight of wire that each winding takes, so that it will not be necessary to patiently count each turn. The primary will take  $1\frac{1}{2}$  ozs., and the secondary  $2\frac{1}{2}$  ozs., making 4 ozs. in all. The resistance of the primary will be some 1,700 ohms, and that of the secondary 2,500 ohms.

To what wave-length can I tune with an inductance-wound with 210 turns of No. 30 wire on a 3-in. former?

1,100 metres.

**"BEGINNER" (Thornton Heath).**—Can you tell me the length and diameter of former and turns of wire to give me a range to 3,000 metres?

350 turns of 22 S.W.G. on a 12 by 6-in. former.

Can a double-slide tuner be used with advantage with a variable condenser?

Yes; a variable condenser is always advantageous to give the very fine adjustments of tuning necessary with sharply tuned and weaker stations.

Are steel aerial poles advisable?

Wooden poles, such as a good straight fir, are less liable to cause leakage to earth. Even when employing the most efficient insulators this trouble assumes serious proportions during wet weather, and signals become very much weaker. A good tip is to smear a layer of vaseline round the centre of the insulators; this will prevent the coalescence of the moisture.

Can 'phones be used in series on a crystal set?

Yes; but signals will be somewhat weakened.

**"ENTHUSIAST" (Colchester).**—What transformer will be required for a 'phone of 3,000 ohms?

No transformer is required.

**"BEGINNER" (Thornton Heath).**—Can you tell me the length and diameter of the tube and gauge of wire to wind a coil to tune to 3,000-metres?

10 in. by 5 in. 24 S.W.G.

Does the earth lead from the tuning coil and the wire from the 'phones have to be connected to the earth while the receiving set is in use?

The point is that the telephone receivers and detector are connected across the inductance, therefore one of the telephone leads must necessarily be connected to that point of the coil that goes to earth.

Can a variable condenser be used with a double slide inductance?

Yes.

Are steel aerial poles advisable?

For masts of any considerable height steel is the only practicable material that can be used, but for the shorter masts wood, such as a good light fir, is to be preferred, as there will be less possibility of leakage and absorption.

Can 'phones be used in series on a crystal set?

Two pairs of telephone receivers of similar resistance can be placed in series with very little signal strength reduction. If more than two pairs are required a separate crystal and telephone circuit can be placed across the coil.

**J. S. R. (Haverhill).**—To what wave-length will an inductance tune that is wound with 22 enamelled wire on a former 9 $\frac{1}{2}$  in. by 3 $\frac{1}{2}$  in. on a 50-ft. twin aerial?

One thousand two hundred and fifty metres.

What range has a single-valve set?

That depends upon many factors, not the least being the power of the transmitting station. Telephony from the Hague and Paris has been heard in this country on single-valve sets employing regenerative circuits. Fifty miles from a station of medium power would be a fair average with a set of that description. Without the reaction it would be considerably less.

**J. H. (Blackpool).**—What would be the wave-length of an inductance of 4 $\frac{1}{2}$  in. diameter by 7 $\frac{1}{2}$  in. long wound with 28 S.W.G. enamelled wire on a 50-ft. twin aerial?

Four thousand metres.

**J. H. (Rossington).**—What would I be able to hear on a crystal receiver living about five miles out of Doncaster?

Stockton (B Y T), Hunstanton (G H C), and other coastal stations, ships; and if you can tune to 2,000 metres you should hear Eiffel Tower.

Do I require a licence for a crystal set?

Yes.

**A. B. K. (Preston).**—Is it possible to hear the Hague and Paris on a 2-valve set?

Quite possible.

What aerial would you suggest, the longest part of my premises being 16 yds.?

A double aerial of that length, obtaining as much height as possible.

I am only a few yards from a railway. Will that prove detrimental?

Not if you keep the aerial well away from the parallel to the telegraph wires.

**O. B. (Tooting).**—What should be the resistance of a filament rheostat in order that the current from a 6-volt accumulator can be graduated from 6 volts down to 1 volt?

Assuming the resistance of the valve to be as is most usual, about 3 ohms, the additional resistance required to be placed in series so that 1-volt potential difference existed across the filament would be 15 ohms.



**THE S.V.  
CRYSTAL  
OUTFIT**

*Enjoy listening-in  
at a reasonable cost.*

THE "S.V." is the cheapest reliable long-range crystal set yet produced. It has an effective listening-in range for telephony up to 50 miles and for telegraphy up to 300 miles. Supplied complete in every detail, it is only necessary to erect the seven-strand Aerial to enjoy immediately the pleasures and fascinations of wireless. The 2,000-ohm nickel-plated double headphones give perfect reproduction.

**£3-15-0**

(Postage 7/-)

COMPLETE WITH 100-ft. AERIAL, INSULATORS & 2,000-ohm DOUBLE HEADPHONES  
Delivery from Stock.

SUMNER, VAUGHAN & CO., LTD.,  
28, Victoria Street, London, S.W.

Telephone—  
Victoria 1,702



HELLO

HELLO

## COVENTRY WIRELESS

'PHONE 1343 SUPPLIES CO. 'PHONE 1343.

### CLAY LANE, COVENTRY.

---

## 3-VALVE RECEIVING SET

# £17 - 10 - 0

CARRIAGE PAID.

COMPLETE WITH ALL ACCESSORIES READY FOR USE, INCLUDING 60-VOLT BATTERY, 6-VOLT ACCUMULATOR, AERIAL WIRE AND INSULATORS, AND ONE PAIR OF 'PHONES 4,000 Ohms. VALVES 45/- EXTRA.

**WE GUARANTEE THIS SET WILL GIVE EXCELLENT RESULTS.**

Condensers, var. '001 .. each	16/-	High-Class Accumulators at low cost. Fully Guaranteed.
" " "0005 .. "	11/8	4 Volt 20 amp .. .. . 18/-
" " "0003 .. "	9/6	4 " 40 " .. .. . 18/6
" vernier .. .. .	4/-	4 " 60 " .. .. . 20/-
" valves .. doz.	11/-	4 " 80 " .. .. . 26/6
Filament Resistances		4 " 100 " .. .. . 29/6
First quality .. each	5/8	6 " 20 " .. .. . 23/-
Second .. .. .	3/6	6 " 40 " .. .. . 26/6
Third .. .. .	3/-	6 " 60 " .. .. . 32/-
Intervalve Transformers, improved design, British made, guaranteed .. .. .	29/-	6 " 80 " .. .. . 38/6
Terminals, with washer and two nuts .. .. . doz.	£/5	6 " 100 " .. .. . 42/-
Valve Legs, with two nuts, set of four 8d. .. doz.	1/9	
'Phones with Cord:		Carriage Forward.
Western Electric, 4,000 ohms	32/-	Brand New. In Stock.
Superior French .. .. .	35/-	British Made.

**COMPARE OUR PRICES**

## IMPORTANT NOTICE.

Owing to recent advertisements in the Wireless and Daily Press seriously reflecting upon the quality of the Radio Head-phones at present being offered for sale by us, we have invited opinions from our customers on the general quality and efficiency of these 'phones, and reprint below a few typical replies.

As a result of this advertisement we have instituted legal proceedings against the Manufacturers of the Headphones in question.

We refuse to believe that the Wireless Public will allow themselves to be prejudiced against the quality of the goods we offer in the face of such overwhelming evidence.

### BROWN "A" TYPE.

120 ohms 42/6

8,000 ohms 49/6

Postage 1/- extra.



### SULLIVAN

8,000 ohms 36/6

Postage 1/- extra.

Every order executed within 4 hours of receipt, per Registered Post.

Cords 2/9 per pair.

### WE GUARANTEE

- (I) That these are in brand new condition, and have never been used.
- (II) That they have never been reconditioned.
- (III) That they are equally efficient to any Headphone on the market.
- (IV) That should they fail to give absolute satisfaction in any shape or form, and the 'phones are returned to us within seven days.

### WE WILL FORTHWITH REFUND THE FULL AMOUNT PAID.



The "Parliphone" Loud Speaker.

(Prov. patent No. 21,967)

August 19th, 1922.  
Having purchased from you a pair of Brown's 'Phones 8,000 ohms for £2 9s. 6d., I was naturally interested in the recent announcement by Messrs. S. G. Brown, Ltd. I already possessed two pairs of Brown's 'Phones; one pair which have been reconditioned and one pair of the new series, so I decided to test them against those I purchased from you. You will, no doubt, be gratified to learn that the pair purchased from you are equal in every way to the new pair of the new series, but considerably more sensitive than the pair which have been reconditioned. All three pairs are used directly in circuit with an anode voltage of eighty to one hundred. Had they been old stock they would have burnt out consequent on deterioration of insulations and windings. I have no hesitation in saying that the pair purchased from you are all that could be desired, and I have already recommended them to my several wireless friends. (Signed) GEOFFREY M. JONES.

August 20th, 1922.  
In reply to yours of the 18th inst. re 'Phones. These have been tried and the result has been highly satisfactory, also the quality of same are A1. (Signed) L. POTTER, junr.

Your letter to hand re S. G. Brown, Ltd. "A" Type head-phones as supplied by you. I have not had a trial with the test by wireless, but have tested them in various manners, and they appear to be in good order. I am thoroughly satisfied, and if the makers can get 16s. extra for an improved diaphragm "good luck to them!" (Signed) E. L. SMITH.

August 20th.  
With reference to your letter of the 18th inst., and in line with your request for my opinion of the "Wireless Telephones" you supplied to me recently. Although I have not yet had a real opportunity of testing them, they are, in my opinion, in perfect condition, and appear to be as new and unused. I am perfectly satisfied with same and they are a bargain, considering the market price for new 'phones of same make. (Signed) P. GREEN.

August 21st, 1922.  
In reply to your letter of the 19th inst., the head-phones recently supplied by you were purchased for my son, who has a one valve set. They appear of excellent quality, and so far have fulfilled all requirements. Since the receipt of your letter I have had them examined by a local expert, who has an eight valve set, and he pronounced them to be perfect in every respect. (Signed) M. W. JONES.

August 21st, 1922.  
Messrs. The City Accumulator Co., 79, Mark Lane, E.C.3.  
In reply to your letter of inquiry dated August 19th, regarding quality of Brown's 8,000 ohms 'phones supplied to me, I beg to state they are working splendidly and quite as good as I expected. I am quite satisfied. Have compared them with other Brown's 'Phones 8,000 ohms which cost more than mine, and I find signal strength quite equal. You can use this letter as you think necessary. (Signed) H. WELSH, Marine Wireless Operator.

## THE LATEST WIRELESS SURPRISE

### The "Parliphone" Loud Speaker.

Made in one solid piece of moulded ebonite. Interior screwed, and made to receive Brown's Standard Pattern receiver.

LOOK OUT FOR OUR STAND AT THE EXHIBITION.

# THE CITY ACCUMULATOR CO.,

79, Mark Lane, E.C.3. Room 116 (4th Floor).

'Phone: "Avenue 91" (3 lines).

AGENTS: London. A. W. Gamage, Ltd., Holborn.  
Selfridge & Co., Ltd., Oxford Street.

South Wales. South Wales Wireless Installation Co., Ltd.,  
18, West Bute Street Cardiff.

North Wales, The "All British" Wireless Manufacturers Co.,  
Lancashire and Ltd., 70, Central Buildings, 41, North John  
Cheshire. Street, Liverpool.  
Gloucestershire. The Bristol Wireless Co., 52, Cotham Hill, Bristol.  
Yorkshire. The Barnsley British Co-operative Society, Ltd.,  
Barnsley.



# "MAGNAVOX" LOUD SPEAKER

Radio

brings it.

MAGNAVOX

tells it.



The **MAGNAVOX** Loud Speaker is based upon the electro-dynamic principle. This form of construction accounts for the fact that the **MAGNAVOX** is not only the most sensitive but also the most powerful of Loud Speakers.

No. R1282  
(18" Horn)

To enjoy and get the greatest possible satisfaction from your Wireless Receiving Set, equip it with a **Magnavox Loud Speaker**. Hear the voice of the singer faithfully reproduced, the perfect intonations of the lecturer, or the natural sound of music. The **Magnavox** is established as

## The World's Finest Loud Speaker.

The introduction of the **Magnavox Loud Speaker** for use with Radio Receiving Sets marks a most important development, and will be the means of making Broadcasting extremely popular.

*Order Now if Early Delivery is Required.*

SOLE AGENTS FOR THE UNITED KINGDOM:

**Sterling Telephone & Electric**  
TELEPHONE HOUSE, Co., Ltd.,

210/212, Tottenham Court Road, London, W.1.

Telephone No. 4144 Museum (7 lines). Telegrams 'Cucumis, Wesdo, London.'

Works: **DAGENHAM, ESSEX.**

BRANCHES: **NEWCASTLE-ON-TYNE: 9, Clavering Place.**  
**CARDIFF: 8, Park Place.**

WRITE FOR LEAFLET No. 326.

# MAXIMUM ENJOYMENT and the PROGRESS of your WIRELESS EDUCATION lies with

## THE *Crystophone* REGISTERED



Crystophone 20 T.T.

**Type 20 T.T.** A handsome instrument of high selectivity with wave-length range of 180—3,500 metres. No extra coils required. Designed and constructed for use as a complete Crystal Receiver. As shown, Price £5 10s. 0d.

or in conjunction with

**Crystophone V.1.** (single valve detector), £2 10s. 0d. extra.

OR

**Crystophone V.1. L.F. Crystal Detector** and single valve, £4 10s. 0d. extra. (L.F. Amplifier).

OR

**Crystophone V.1. H.F. H.F. Amplifier** and Crystal Detector, £4 10s. 0d. extra.

OR

**Crystophone V.2. L.F. (Crystal Detector and two-valve Amplifier);** £7 10s. 0d. extra.

OR

**Crystophone V.3. H.L.F. H.F. Amplifier, Crystal Detector, and Double L.F. Amplifier,** £12 0s. 0d. extra.



Crystophone  
Amplifier V.1. L.F.



Crystophone  
Amplifier V.2. L.F.

**Sterling Headphones,** £1 12s. 0d. extra.

*Above prices do not include Valves,  
H.T. and L.T. Batteries.*

# The CRYSTOPHONE is ALL you require for ALL purposes for BEST results—ALWAYS

Write for full particulars to:

**WIRELESS SUPPLIES CO.,**  
64, Mortimer Street, London, W.1.

'Phone: Museum 2672. 'Grams: "Adragonax, Wesdo, London."

All Applications for Advertisement Space in POPULAR WIRELESS to be made to JOHN H. LILE, Ltd. (Sole Agents), 4, Ludgate Circus, London, E.C.4. Phone: 10806 Central.



No. 15. HOW A WIRELESS VALVE WORKS: By J. SCOTT-TAGGART, F.Inst.P., A.M.I.E.E.

# POPULAR WIRELESS Weekly

3d

No. 15. Vol. 1.  
Sept. 9, 1922.



WILL IT COME TO THIS?

### SPECIAL FEATURES IN THIS ISSUE:

Radio Notes and News.  
 Hints to Amateurs.  
 The Broadcasting Company.  
 Step by Step in Wireless.

A Solution of the Ether Riddle.  
 New Series for Beginners.  
 Wireless Control.  
 The Choice of Receiving Sets.



**WHEN YOU SEE AN AERIAL THINK OF**



**MITCHELL PRODUCTS**

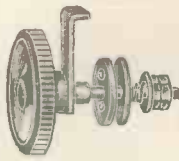

**CONTROL KNOBS** beautifully made with  $1\frac{1}{2}$  in. radius laminated arm. The addition of this component will considerably improve your station.

2/6 each. Postage 3d. extra.



**NEW PATTERN FILAMENT RESISTANCE**

suitable for 1 to 3 valves. Finished in the Mitchell standard manner. The actual article slightly differs from the illustration.

5/6 each. Post free.

BEING MADE IN BULK



TRADE TERMS UPON REQUEST

**MITCHELL HEDGEHOG TRANSFORMERS.**

For Valve Coupling, guaranteed equal to any. Sent for approval if desired to enable you to make any comparative tests. Made of the finest material that can be obtained, and used in the manufacture of all our amplifiers. **INTERVALVE TRANSFORMERS, each 21/-** **TELEPHONE TRANSFORMERS, each 20/-**



**WIRELESS HEADGEAR**

wound to a total resistance of 4,000 ohms, recommended highly for crystal or valve sets without having to use a telephone transformer, 35/- per pair. Postage 1/- extra.

**MITCHELL'S — B.T.H. "R" Valves.**

Price 15/- each. Postage 1/-. Also stocked, "ORA," 15/-; "ORA" special low filament valves (2 volts at 18 amp.), 50/-; Marconi Osrams, etc., etc. Transmitting Valves from 10 to 1,000 watts.

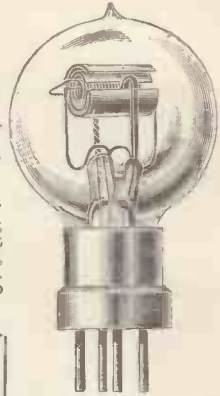

**"DOT" GRID LEAK**

for Valve Circuits as illustrated, 4/6 each, or larger and superior pattern, 6/6 each.



Switch Arm 1-in. radius 1s. 9d. Switch Arm  $1\frac{1}{2}$ -in. radius 2s. 3d. Switch Arm 2-in. radius 2s. 6d. Postage 3d.

**CONTACT STUDS** to suit above arms:—

No. 163,  $\frac{1}{2}$  in. Head,  $\frac{1}{2}$  in. long, dozen 1s. 6d., postage 2d. No. 164L,  $\frac{1}{2}$  in. Head,  $\frac{1}{2}$  in. long, dozen 1s. 6d., postage 2d. All complete with nuts and washers.

**VALVE HOLDERS**

as illustrated, 1/3 each.



Get our **"SYMPLION BOOKLET"** to-day, 6d. post free. The most recent wireless invention fully described.

**MITCHELL'S ELECTRICAL & WIRELESS, LTD.**

Retail Stores: 188, RYE LANE, PECKHAM, S.E.15.

Wholesale and Retail: McDermott Rd., Peckham, S.E.15.

Telephones: New Cross 1540/1541.

**A Perfect Aerial 10/6**

NO SOLDERING OF AERIAL REQUIRED.

- 100 feet 7/22 Stranded Copper Wire.
  - 100 feet 7 Stranded Steel Insulated Cord for guys and bracing (as pliable as string, but of enormous strength).
  - 2 Pluton Patent Insulators (no soldering of aerial joints required).
  - 1 Steel Coil Spring.
  - 1 Mast Pulley.
  - 1 10-inch Ebonite leading-in tube, with brass rod and terminals.
- Plan, with complete instructions for erection of various types of Aerial.

**TEN SHILLINGS AND SIXPENCE**

Carriage Paid.

Cannot be purchased elsewhere at double the price. All material guaranteed finest obtainable.

**Econ Manufacturing Company, Ltd.,**  
6, HOLBORN VIADUCT, LONDON, E.C.1

Phone: City 4148

**WATES Specialities**

will satisfy and please you in every way. It will pay you to visit our showrooms, inspect our accessories, and have our sets fully demonstrated to you.



**The Ideal Valve Accumulator**

6-Volt 50-amp. PRICE 35/- . Carriage 3/- . (In wooden case with leather strap handle.)

4-Volt 50-Amp. PRICE 24/- . Carriage 2/- .

Exclusive features of these Accumulators:—

1. Basket pattern positives so constructed that it is impossible for active material to become displaced.
2. Glass containers specially constructed with rib separators.
3. Absolute absence of frothing.
4. Practically impossible for plates to sulphate due to special materials used.
5. Non-corrosive terminals.
6. Impossibility of acid creeping.
7. Last feature, but not least—LOW PRICE BUT HIGH QUALITY.

**VARIABLE CONDENSERS**

These are "built up" and of first-class manufacture. In polished mahogany case.

PRICES. (Carriage gd. extra)  
'001 . '0005 . '0003  
28/- . 24/- . 22/-



**BROWN'S LOUD SPEAKERS**

(As illustrated)

Small, 12-in. high, low resistance £3  
Large, 21-in. high, low resistance £6 5s.  
High resistance, 2s. 6d. extra.

**MAGNAVOX LOUD SPEAKERS**

"Junior," £10 10s. "Senior," £20.  
All in stock.

Large size, 21 in. high

Why not make up your own sets? We have all parts and accessories in stock. Mail orders dispatched within 24 hours of receipt.

SEND THREE STAMPS FOR ILLUSTRATED CATALOGUE.

VISIT OUR STAND, No. 15, All-British Wireless Exhibition, Horticultural Hall, September 30 to October 7.

**WATES BROS.** 13/14, GT. QUEEN ST., KINGSWAY, LONDON, W.C.2. Phone: Gerrard 576.

**HOW A WIRELESS VALVE WORKS,**

An instructive article

By

**John Scott-Taggart,**

F. Inst. P., A.M.I.E.E.,  
appears in this issue.

# Popular Wireless

TOPICAL NEWS AND NOTES.

TWO ARTICLES OF IMPORTANCE.

**A Solution of the Ether Riddle.**

(For Advanced Amateurs.)

**The Choice of Receiving Sets.**

(For Beginners.)

**A Correction.**

THE author of the article "The Heterodyne," which appeared in No. 13 of POPULAR WIRELESS, asks me to state that Fig. 1 should read Fig. 2, and vice versa, in his article.

**The Highest Station.**

WHAT is thought to be the highest spot on which a regular wireless station is situated is the top of Mount Hood, U.S.A., 11,200 feet above sea level. It is a link in the chain of fire prevention for the National Forest Reserve.

**A Wireless Proposal.**

A MARRIAGE which had been arranged by wireless was reported at Plymouth on the arrival of the s.s. "President Monroe" from New York. The proposal was made while the bridegroom was a passenger in the "Mauretania."

**All-British Exhibition.**

THE next wireless exhibition to be held in this country will take place from September 30th to October 7th, at the Horticultural Hall, Vincent Square, Westminster, and not at the Central Hall. Some fifty-five well-known firms are exhibiting. Further details will appear shortly in POPULAR WIRELESS.

**Tesla Looks Ahead.**

WIRELESS transmission of power will be the next astounding and revolutionary development of science, according to Nikola Tesla, the famous electrical engineer and inventor. "It is not a mere vision," said Tesla, in a recent Press interview. "I have perfected this system in all its details, and can transmit power to any terrestrial distance—say 12,000 miles—with a loss not exceeding five per cent."

**French Market Reports.**

FRENCH wireless amateurs—and probably some English—have recently found the customary broadcasted messages from the Eiffel Tower varied by a recital of market prices of vegetables and fruit. This is a new system of distributing market information to French agriculturists. As an example of the important developments which are possible, it may be pointed out that one of the messages stated that "on the London market early English apples, of which the crop is rather good, are abundant at the moment, and sales are difficult."

**Marconi Company's Good Work.**

THE Marconi Company does a great deal of its business with foreign Governments, but the English public is daily getting more and more in touch with the company by means of the great progress that

is being made in broadcasting. The company has kindly given permission to other manufacturers for the use of its numerous plants, and as the Government has granted protection for two years, a fine and flourishing new trade should be established in this country.

**The Burial Service by Wireless.**

THE Canadian Government steamer "Canadian Trooper" was at sea, and when a fireman died it was found that there was not a prayer-book on board. The captain wirelessed, asking for aid, and his call was picked up by the Cunard liner "Carnania" off the Irish coast. The operator on board the liner immediately wirelessed the full order for a burial at sea, which was taken down by the operator of the "Canadian Trooper." This was used by the captain when

mainly to "connect" the aerial traffic controller with the machines that daily fly from London to the Continent, and which permits the pilot at the same time to get in touch with any office at the aerodrome.

This exchange has been lately added to the central control tower at Croydon, from which the express air services for the Channel have been directed. Nearly every machine on this service is to-day fitted with wireless telephony, and the pilots have orders to ring up the traffic controller about every fifteen minutes during the journey, to report their position and see if there is any change in their orders.

It is like a huge signal-box, and no machine may land until permission is granted. For instance, if any incoming express arrives at the station and finds that the outgoing service is about to start, he will be rung up by the con-



Receiving Room at the Eiffel Tower Station.

the body was committed to the keeping of the deep.

**Broadcasting in South Africa.**

I HEAR that the Postmaster-General of the Union of South Africa has announced that the Government approve of the Post Office granting applications for licences for broadcasting services in various parts of the Union. Licences will soon be issued through the Post Office, but broadcasting stations are barred from circulating advertisement propaganda and handling commercial traffic. The transmitting stations will have fixed wavelengths, and sufficient powers to operate successfully in whatever zones they are erected. The regulations for transmitting and receiving will be very similar to the lines on which the English and American services are established.

**New Wireless Exchange.**

THE first wireless telephone exchange that the world has ever seen is now being daily used at the London Air Station, Croydon. It was installed by the Air Ministry,

roller, who will order the pilot to "circle round," giving the other machine time and plenty of room to get away. When that has been done the controller will instruct him where to land.

Besides receiving reports and issuing his instructions through the exchange, the controller at regular intervals broadcasts weather reports to all his machines, so that they may know what kind of weather they are running into.

The other day, one of the expresses rose off the ground and left one of its landing wheels behind, and it was not noticed by the pilot. But the air controller soon did, and if you were listening in at the time, this is what you might have heard:

"Croy—don speaking. Is that —? Is that —? Landing wheel broke away on ascending. Yes, left wheel. Make normal landing," etc., etc.

Thus was the controller able to advise the best thing to be done, and also to warn the pilot of something that he didn't know had happened.



**NOTES AND NEWS.**

(Continued from previous page.)

**Why "Wireless"?**

THE words airophone and airograph might be substituted for the word wireless and convey exactly the same meaning to the ordinary layman. I consider the two words above are better than earthophone or earthograph, or etherophone and etherograph.—Mr. D. R. BROADBENT, A.M.I.E.E., etc., Royal Societies Club, in a letter to "The Times."

**Australia and Wireless.**

MR. E. T. FISK, managing director of the Amalgamated Wireless Co., is now busy at Australia House, making arrangements for carrying out an agreement with the Australian Commonwealth Government for the erection of a high-power station to establish direct communication with the United Kingdom by 1924. In a recent Press interview, Mr. Fisk said:

"We propose erecting the station somewhere in the south-east of the continent. Seventy or eighty per cent. of the commercial messages which go to Australia

the service between Australia and England. Even to-day our experimental station is able to receive messages direct from the Continental stations, from Canada, and from the Atlantic coast of America at speeds ranging up to thirty words a minute."

**Radio Education.**

THE University of Alabama is shortly to begin the broadcasting of lectures, reports, and lessons from its headquarters to secondary colleges, high schools, and city schools throughout the State. It has ordered a transmitting plant and 200 receiving sets for the purpose.

At least one commercial school shorthand pupils get their speed practice by taking down

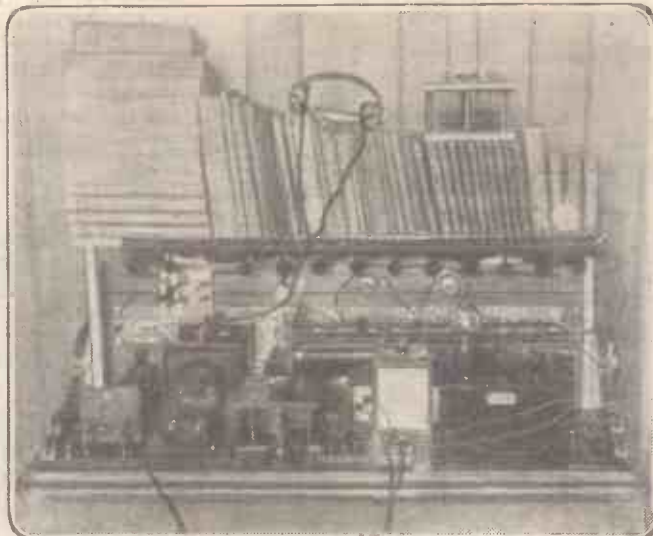

Mr. J. E. Turner's apparatus at 29, Turks Road, Radcliffe, near Manchester.

**Amateurs, Attention!**

WILL amateurs holding transmitting licences please forward particulars of call signs, wave-length, hours of working, power used, and situation, to the Editor as soon as possible?

It is hoped to publish a special and comprehensive list of amateur transmitters in the country, and all holding transmitting licences are earnestly requested to help in compiling this useful list.

**An "Unparalleled Event."**

FROM an East Pittsburg works, which was sending out a trainload of equipment for the electrification of the Chilean State Railways, a train was recently started by wireless.

"The president of the Westinghouse Company," says the "Radio Digest," of Chicago, "closed a switch on a pole near the railroad track on which the train was standing. The closing of this switch closed the radio electrical circuits, and this reaction on the circuits in the locomotive released the controller, thus starting the train—an event unparalleled in engineering history."

I think Major Phillips's experiments with wireless control have already accomplished this feat

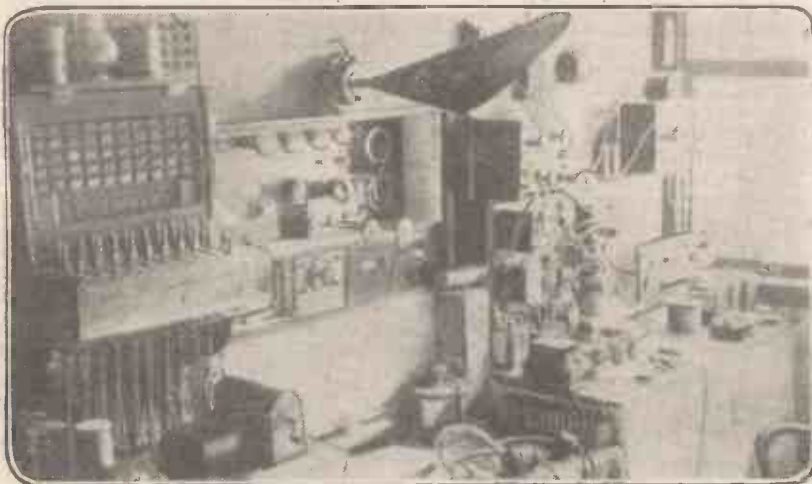

Mr. B. C. Underhill's fine experimental receiver at 33, Newhall Street, Birmingham.

are addressed to Sydney or Melbourne, and with the station near to both cities the expense and labour of re-transmission from a distant point will be saved. In addition to this, the station will be of vital strategic importance to Australia.

"In time of war, she must be able to communicate with the outside world, and for this reason alone it is essential that the station should be near the big centres of population, where it can be defended against an enemy. The sending station will probably be capable of operating over a range of twelve thousand miles. It will cover over a square mile of ground, and part of the equipment will consist of twenty-four great towers.

"It is five years since I first tried to pick up messages direct from Carnarvon. After twelve months of tests I was able to give practical demonstration. In September, 1918, Mr. Hughes and Sir Joseph Cook (who were in London for the Conference held in that year) sent wireless messages to the Australian people. Carnarvon called 'Sydney' three times, and I picked up the call at my own house at Wahroonga in New South Wales, almost instantaneously. As a matter of fact, the waves carrying these messages covered the distance between England and Australia in one-fifteenth of a second.

"Communication will not, be restricted to

the speeches, lectures, and readings by wireless from a number of broadcasting stations.



**Broadcasting Programmes**

What you can hear every evening of the week on your set.

**TELEPHONY TRANSMISSIONS.**

Station.	Call Letters.	Wave-length.	Remarks.
Croydon .. .. .	GED	900 metres	Throughout day to aeroplanes.
Marconi House, London	2LO	360 metres	Between 5 p.m. and 7.30 p.m. (not regular).
Writtle, England .. .. .	2MT	400 metres	Tuesdays, 8 p.m. (B.S.T.)
Paris .. .. .	FL	2,000 metres	Daily, 5 p.m. (G.M.T.)
Königswusterhausen .. .. .	LP	2,500 and 4,100 metres	Daily, 7 and 10.30 a.m. (G.M.T.)
The Hague .. .. .	PCGG	1,050 and 1,300 metres	Sundays, 2.30, 5.30, and 8 to 9 p.m.; Thursdays, 8 to 9 p.m.

Will all amateurs who transmit at regular hours please send full details to the Editor in order that the table of Telephony Transmissions may be kept as comprehensive as possible?

## NEWS AND NOTES.

(Continued.)

### Oxford and India.

JUST recently Oxford started transmitting short Press telegrams to India, where the signals are picked up at the station at Karachi, and from there transmitted to newspapers in Bombay and Calcutta.

Except as regards Egypt, the service is at the moment unilateral, because the receiving stations have insufficient power for acknowledging; but so far this absence has not proved a very serious handicap.

\* \* \*

### Flowers by Wireless.

"FLOWERS can be sent by wireless," is the announcement of a Bond Street florist.

If you've got anybody across the water, in either America or Canada, to whom you want to send a few flowers, all you've got to do is to walk into the shop, state the name and address of the people to whom you want the flowers sent, the kind of flowers, and how you want them to be sent, and sure enough, within two days, a beautiful bouquet will be delivered at your friend's door.

"Flowers can be delivered in all parts of America and Canada in a few hours," stated the manageress in a recent interview. "The idea is spreading rapidly in this country, though we receive more orders from the other side than we send."

\* \* \*

### Aerials and Landlords.

THE following recently appeared in "The Times":—

"The majority of wireless amateurs have probably erected aerials for their instruments without asking permission of their landlords, although it is likely that with most landlords an undertaking to repair any damage that might be caused to the property would gain the required consent.

"The London County Council gives permission to the tenants on its estates on condition that the method of making attachments to houses is to be approved by the Council, that the aerial is to be insulated from the building, is to be fitted with an efficient lightning arrester and earth lead connected with an earth plate, and that the applicant deposits £1 with the Council as a security against any damage that may arise. Further, the permission may be withdrawn at any time should such action be considered necessary.

"One company owning a large number of houses in the suburbs of London not only gives permission, but fixes to its houses the necessary iron fittings for supporting the pole to which the aerial is attached."

\* \* \*

### Dr. Steinmetz.

AT a recent meeting of the International Radio Congress, Dr. Charles P. Steinmetz said:

"There may be a time when power to turn the wheels of industry will be furnished by radio. In some respects radio power transmission exists to-day, for the message you receive by radio has been carried by the power of electro-magnetic waves from the sending to the receiving station.

"The problem of power transmission essentially differs from that of the transmission for communication in that in power transmission most, or at least a large part, of the power sent out by the generating station must arrive at the receiving station to make it economical to transmit the power.

### Resonant Vibration.

"Hence the problem of radio power transmission is that of directing the radio waves so closely that a large part of their power remains together, so as to be picked up by the receiving station. Much successful work has been done in directing radio waves, and, for instance, our Transatlantic stations send out most of their power eastward.

"But still, even as directed, the power scatters over the coasts of Europe from Norway to Spain, so that it is impossible to pick up an appreciable part of it.

"The second possibility of radio power transmission—at least theoretically—is by resonant vibration or standing waves.

"A station tuned for the same wave-length as the sending station would resonate with the standing electro-magnetic wave issuing from the sending station, thereby stopping its passage by absorbing its energy. It would, as we may say, punch a hole in the standing wave-sheet coming from the sending station.

Power would then flow into this hole; the sending station would begin to send out additional power to maintain the wave-sheet."

\* \* \*

### Wireless on Trains.

"A PARTY of wireless telegraphic engineers have made experiments in the receipt of wireless messages on board a railway train on the Paris-Orléans line.

"They employed the electric light wire as receiving wire, and between Limoges and Châteauroux they were able to pick up clearly messages from the Greenwich station. Later messages from the French station at Saint-Assise were received. The engineers arrived at the conclusion that with a special wire on the roof of the carriage it would be easy to hear the wireless telephone messages from the Eiffel Tower."—From "The Times."

ARIEL.



Mr. W. R. Wood, The Star Inn, Robert Town, Liversedge, Yorks, and his receiving set.



This young lady has a quick shine and a quick radio concert in New York.



# NEW SERIES FOR BEGINNERS.

By E. BLAKE, A.M.I.E.E.

## PART 8.

**T**HE fundamentals of wireless reception are the interception of some of the electro-magnetic energy radiated by a distant transmitter and the production by its means of audible or visible signals.

An electro-magnetic wave in space may be regarded as an alternating electro-magnetic field, the energy of which has become dissociated from the wire round which it was first manifested; instead of collapsing, the field which was caused to appear around the transmitting aerial wire by the high-frequency oscillating current which was therein generated has escaped, taking its energy with it.

Nevertheless, when such a free moving field of electro-magnetic energy cuts a conductor it imparts some of its energy to the free electrons in that conductor, and these oscillate, producing in the conductor the phenomena of a H.F. oscillating current. Here, then, is the basis of a signal, if the effect of that current can be rendered audible or visible.

### Loss of Power.

The method employed to intercept the transmitted energy is the suspension of a suitable conductor or system of conductors as high above the ground as practicable or necessary. Receiving aeriels in general are the same as transmitting aeriels; the latter throw the energy, the former catch it.

The energy of a wireless wave diminishes very rapidly as it travels from its point of origin. Take the case of an average ship station as an example. The power of its input is, say,  $1\frac{1}{2}$  kilowatts; owing to unavoidable losses, the power actually

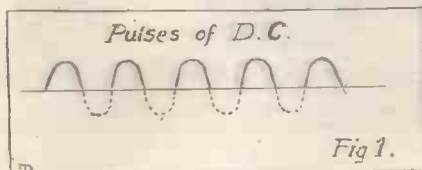

delivered to its aerial is much less, say 750 watts.

Calling the effective working range of an efficient ship station, using a spark transmitter, 300 miles, it is a matter of simple mensuration to arrive at the fact that the 750 watts of power has to be spread over an area of  $(\pi \times 300^2)$  square miles, that is, about 282,000 square miles. If you think of that area as a slice of bread over which the station spreads 750 watts (just over one horse-power) of jam, you will see that the space occupied by a normal receiving aerial will not receive much power. Therefore the bigger the aerial the more power it will intercept. The bigger the bite the more jam you get.

To get a correct analogy, however, you must imagine the jam to be spread more thinly towards the edge of the slice, so that a bite near the centre of the slice gets more jam than a bite of the same size at the edge of the slice. The farther the receiving aerial is from the transmitter the less energy it can pick up from a given station.

Having placed the receiving aerial so that it will be cut by the transmitted field of energy as it passes outwards from the sending station, there remains the problem of making ourselves aware of the minute

oscillating current which the waves cause to flow in it.

Most reception is done by means of the telephone. Rapidly alternating currents will not operate a telephone, for its metal diaphragm cannot respond to high frequencies, and even if it could, the human ear could not hear sound waves of very high frequencies, because the pitch of the note is too high. Hence a means has to be devised of making the note delivered by the telephones within what is called "audio-frequency."

If the transmitter is of the spark type, the receiver used is such that the waves are, in effect, cut in half; thus instead of oscillating currents there are delivered to the telephones pulses of direct current (see Fig. 1). Every series of pulses of direct current make one click in the telephones, and a rapid succession of such series will give a "note" of audible frequency. So that if a series of wave trains, which are emitted as a "dash" of the Morse code, are cut into two, every train will help build up a note, for the rapid succession of clicks will sound like a buzz.

Therefore, a certain number of wave trains will sound like a long "buzz," and a lesser number of wave trains like a short "buzz." These will be dashes and dots of Morse code, and controlled by the sending operator by means of his telegraph key.

### Local Oscillations.

If certain crystalline substances are inserted in the receiving circuit, their effect is to allow only half the oscillation to pass to the telephone receivers. Thus the result mentioned above is obtained, audible sounds being emitted by the telephones, corresponding to the dots and dashes, or short and long trains of waves, which the transmitting operator allows to radiate from the aerial. The operation of cutting the oscillating currents into half is called rectification, and the H.F. current is said to be rectified into pulses of direct current.

The problem of receiving from a station which sends out "undamped" or continuous waves is different. A "dash" sent by continuous waves gives simply two clicks in the telephones, and a "dot" gives the same. Therefore the continuous stream of waves must be broken up so as to produce a frequency which can operate the telephones in the required manner. This is accomplished by making a small oscillating current in the receiving aerial by local means, as a result of which there are two sets of oscillations in the aerial, namely, that set up by the intercepted waves, and that produced locally.

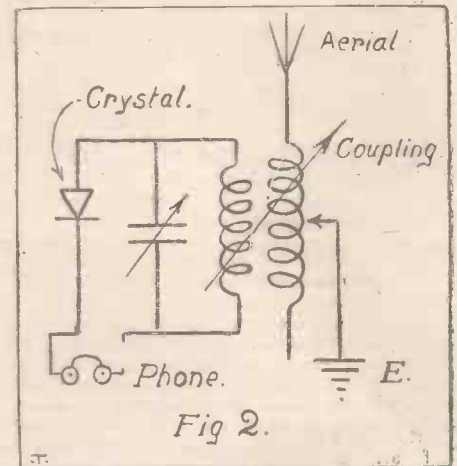

The frequency of the local oscillations is adjusted so that it is different to that of the incoming waves, because the sum effect of the imposition of the one frequency upon the other is to produce "beats" of a frequency equal to the difference between the two primary frequencies. By suitable adjustments of the apparatus it can be arranged that the "beats" are of an "audio-frequency," and, when the current is rectified, give an audible note in the telephones.

### "Note" Magnification.

In order that the received currents may be a maximum, and give a maximum strength of signal, the receiving circuits must be tuned to the frequency of the incoming waves. Tuning is accomplished by methods similar to those used at the transmitting station, the "inductance" and "capacity" of the circuits being varied until the electrical "length" of the circuits is such that their frequency corresponds to that of the currents set up in them by the oscillating electro-magnetic field cutting the aerial.

Fig. 2 shows a typical simple receiving arrangement.

For the magnification of weak signals relays operating a local battery are used, the thermionic valve being the most common, because most successful, type in use at present. The H.F. currents received may be either first rectified and then amplified, or amplified and rectified afterwards. The signals may then be amplified by the use of another valve. This is called "note magnification."



The first wireless set, invented by David Hughes, now in the Science Museum, London. It was invented in 1879.

# HOW A WIRELESS VALVE WORKS.

By JOHN SCOTT-TAGGART, F.Inst.P., A.M.I.E.E.

(Chief Technical Advisor to *Popular Wireless*)

Author of "Wireless Valves Simply Explained," "Elementary Text-book on Wireless Vacuum Tubes," and "Thermionic Tubes in Radio Telegraphy and Telephony."

BEFORE 1914 it was customary to employ crystal detectors as wireless receivers; no other detector attained to such wide and general use. Since that date, however, the crystal detector has been almost completely replaced by what is generally called the valve. The valve is an apparatus which in outward appearance is rather like an ordinary electric lamp. Its action, however, is entirely different, although in both cases a glass bulb exhausted of air is used and a metal wire or filament is heated to almost white heat.

The wireless "valve" is so called because it allows an electric current to pass only in one direction. A crystal detector is also, in a sense, a non-return valve for electric currents, but the expression "valve" is now exclusively applied to vacuum tubes or bulbs in which the air has been exhausted.

The valve, as generally used, consists of a glass bulb containing a filament, or fine metal wire, which is heated to incandescence by a battery. Electric lamps have their filament heated by high voltage electric mains, but the wireless valve usually has its filament heated by a six-volt battery. In addition to the filament, we have a metal structure, called the grid, which often takes the form of a spiral, or more accurately a helix of wire surrounding, but not touching, the heated filament. Another metal structure surrounds the grid and is often in the form of a hollow cylinder of metal sheet. This cylinder is sometimes called the plate, although the most accurate term is the anode. The anode, grid, and filament are sometimes shaped differently, according to the manufacturer who makes the valve.

The chief use of the three-electrode valve is as a magnifier or "amplifier" of wireless signals; for example, the currents from a crystal detector, which would in the ordinary way operate a telephone receiver, may be applied to a three-electrode valve and magnified to perhaps five times their original strength. The valve may also be used to strengthen the incoming signals before they are detected.

## A Modern Valve.

Fig. 1 shows a typical form of a modern valve; the different parts are labelled. It will be seen that four prongs or pins project through the foot or cap of the valve, and these pins are connected to the different elements or "electrodes" inside the bulb. One pin, for example, is connected to the cylinder or anode; another pin is connected to the spiral wire, called the grid, and the other two pins are each connected to one end of the filament wire. If these last two pins are connected to a battery outside the valve an electric current will flow from one pin to one end of the filament, through the filament and back through the other pin, the current

through the filament heating it to incandescence; in other words, the filament lights up.

There are three electrodes in the valve, the filament, the grid, and the anode of plate. For this reason the valve is called a three-electrode valve. The term "thermionic valve" is also applied to this class of device because "thermionic" currents, which will be explained later, are involved. Another term used is "vacuum tube," because the electrodes are mounted in a very high vacuum; during manufacture all the air is drawn out of the bulb. Readers must therefore get used to the different terms as they will meet all of them in different articles and books. Different kinds of three-electrode valves will also be met with by many readers, but it will be found that they almost all work in exactly the same way, although their shapes may differ.

## Uses of the Valve.

Having described what a valve is like, it is as well to explain what part it plays in a wireless receiver. The three-electrode valve may be used as a detector of the oscillations set up in a wireless receiving circuit by broadcast or other signals. These oscillations may be detected by a crystal detector, but we may also use the three-electrode valve, in which case rather louder signals are obtained and the arrangement is far more reliable. A single valve used in this way needs special batteries and is more expensive as regards upkeep, and is generally rather more troublesome.

These are the chief uses of the three-electrode valve in receiving circuits; but it has very many more applications in wireless transmitting stations, and valves are used at all the broadcasting stations for producing wireless waves. Before explaining in detail how the valve works in each case, it is proposed to describe some of the more elementary facts concerning valves.

Fig. 2 shows an ordinary electric lamp, such as is used for lighting purposes. The bulb is represented by a line and the filament by a loop, although, of course, the shape of the filament varies with different types of lamp. When an electric current from the mains or a battery is passed through the filament it heats it; if you touch the bulb you will find that it is warm. The temperature of the filament has been increased by the electric current through it, and it reaches a bright red or white heat and consequently gives out light. By varying the current through the filament we can vary its temperature and therefore its brightness. The more the current that passes through the filament, the brighter the light given from it. If we

pass too much current through the filament it will melt and the lamp would consequently be useless. Although the only use we generally make of the electric lamp is to give us a bright light, yet inside the bulb of the lamp a most interesting process is going on, and phenomena are taking place which we cannot see and of which we take no advantage. Although we can see nothing, the incandescent filament is not only giving out light, but is also projecting particles of electricity into the vacuum surrounding it.

## Nature of Electricity.

What is electricity exactly? The problem has been approached by many distinguished scientists and as yet there is no definite theory of what electricity really is. We know, however, what electricity does. It may be used for heating purposes, and is so used for heating the filament of electric lamps so that they give out a white light; it is used for driving electric motors, for ringing bells, and a thousand and one other purposes. It is, of course, the beginning and end of wireless telegraphy and telephony. When an electric current is flowing through a wire what exactly is happening? Such questions can be answered by applying the modern theory of electricity, which is called the "electron" theory.

To understand the electron theory, we must know something about the constitution of matter; that is to say, what material objects are made of. If we took a piece of metal such as copper and kept on cutting it up into little bits, we would finally have a small speck which, if subdivided further, would no longer remain copper. Such a speck is termed an "atom." An atom is extraordinarily minute and, of course, invisible under the most powerful microscope. It would, therefore, be impossible to obtain an atom in the manner suggested—namely, by cutting up a piece of copper. The smallest particle of matter known to us would contain millions of atoms all packed closely together and adhering to each other.

Each atom, although so minute, is itself a complicated structure. It really resembles a minute solar system. There is a central core, which is supposed to be electrified with positive electricity. Around this core we have a ring of electrons revolving, somewhat in the same way that the planets revolve round the sun. Each electron is a particle of negative electricity, and it would take about 100,000 electrons in line to equal the diameter of an atom.

(To be continued.)

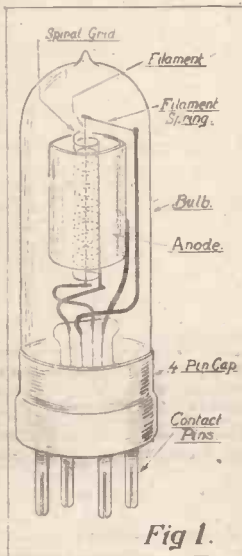

Fig. 1.

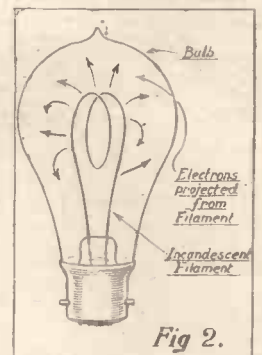

Fig. 2.



# A SOLUTION OF THE ETHER RIDDLE.

By JOHN HILL

NOTE: This article will prove of interest to the advanced reader.

ON my study table is a paperweight. I lift it; one inch, two inches, a foot. How much force am I making use of in lifting the weight? I tell myself—just as much as is represented by the "pull" of the earth on it. Too easy; I recall my question. How much force am I making use of?

Clearly, if I am inseparable from all that has been and is, I am making use of everything within the limit of my being. The universe is my limit. My first solution was inadequate, because it was an attempt to separate myself—and the amount of force sensed by myself—from that unity in which both have being. I assumed I had a purely personal share of existence allotted me, whereas I exist no more in myself than in all things else.

I touch the table. I may assume that the resultant experience is due wholly to the action of the material world. On the other hand, I may believe it to be a purely mental operation. The first assumption is impersonal in character; the second is altogether personal. In either case I find it impossible to bridge the gap opened up between the personal and the impersonal, unless I call in the aid of a further assumption. So I shall never be certain, either that the world is as it appears to be, or that I have reality of experience I can hold to.

And if I must bridge the gap in order to keep my faith, as a thinker, in the worth of doing or thinking anything, I can do so only by conceiving that human experience is inseparable, spacially and motionally, from all that has been, is, and shall be; that the sensation of touch belongs no more to the toucher than to the world he touches, and vice versa.

It is no assumption, either in fact or in principle, to say that "mental" and "physical" are simply convenient and analytical terms of our conception of existence. Man interrogating Nature is Nature interrogating herself.

Correlatively considered, then, it is not difficult to understand that we are in, and of, an existence in which nothing is happening outside the mind that is not, in principle and in fact, happening within the mind. Eliminate centrifugal force; you have movement without direction; an impossibility. Eliminate centripetal force; you have extension without movement; again an impossibility. Strip the world of both forces, and you will be doing, nothing more and nothing less, than stripping the mind of those spacial and motional "properties" in the consideration of which we have knowledge of existence.

What has all this to do with the ether? I shall try to tell you. Here is an air-pump with which I have extracted the air from a glass jar. The unscientific observer may assert that the jar now encloses empty space. But light is passing in and out of it. Moreover, we can see every side of the jar through any and every other side of it. Would the unscientific observer be prepared to say that his perception, which cannot exist without something to be perceived, can pass right through the jar, leaping a gap in which perception cannot be? What, then, is that in the absence of which the interior of the jar would present an impenetrable and black void?

This is, in principle, the problem before us when we try to understand, on the orthodox

basis of the process of thought, how we receive light and energy from the sun. The scientists have conceived a gap, and have filled it in with ether. They have been logically compelled to bridge "empty space" with a medium altogether different in kind and in degree from anything coming within human experience. The scientists are quite right, on their psychological basis.

Human thought demands a comprehensible bridge not only between the "objects of space," but also between mental and physical happenings; that is, it demands some form of continuity. The conception of the ether is needed according to the evidence of the senses, and the results of experiments, as understood by the physicists. But they interpret those results on the basis of a previous assumption as to the meaning of "the evidence of the senses."

The experimental side of the proof as to the existence of ether, apart from the necessity of the conception of ether in orthodox science, is not an unquestionably additional proof. Bear that in mind.

When you think this out, not from the standpoint of the world, nor from the standpoint of mentality—singly, but correlatively, it becomes evident that whatever is happening according to the senses is not the result of two

in the foreground; and one half of every interpretation will be fact, the other half will be necessary assumption.

I now offer the physicist another world in which his ether is identified with what is a self-evident term of experience; a world in which the terms "motion" and "space," like coins in economics, are in themselves but the counters of experience.

The physicist conceives his ether as something different in kind from his space. The considerations herein show that space is not a thing-in-itself. I, therefore, bring to the surface the fact underlying the physicist's conception of the ether and identify it with that which has meaning only in correlation with the spacial aspect.

We do so correlate the spacial and motional aspects involuntarily, or we should not have experience. Hence there is nothing that in some way or other does not come within that experience. And since the universe is the limit of knowable experience, there can be no gap in it.

But the jar is still empty. Yes, if you consider it in terms of "space" only, or "of lack of air" only. But we have no conception of space apart from that of motion. Our world is a space-motion one. There cannot be

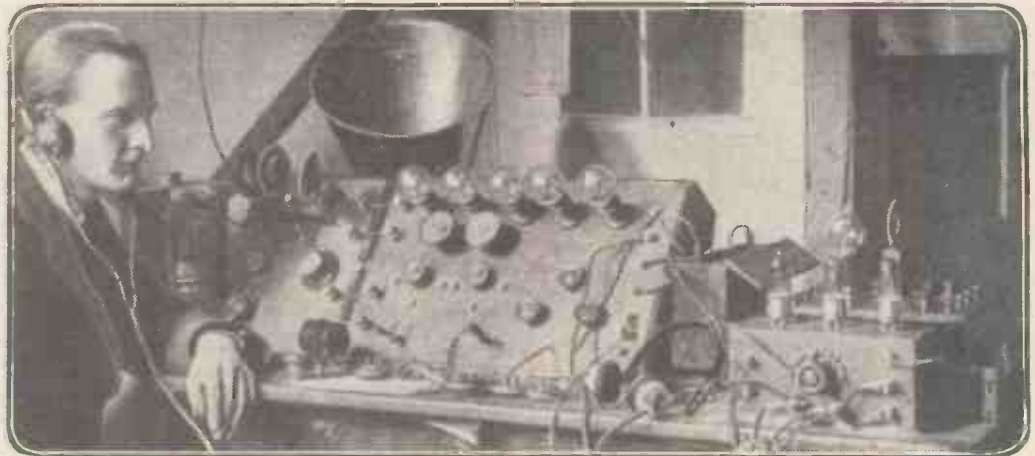

Mr. T. D. Lawton, The Vicarage, Brown Edge, Stoke-on-Trent, and his home-made set.

processes, the one involved in "objects of space" and the other in an introduced motion, but that in the building-up of your environment, of your loves and hates, of a poem, of your evidence as to the sweetness of sugar, or of Beethoven's Sonatas, there is but one process.

You and the process and your environment are one. There is no genesis apart from our conveniently, or inconveniently, thinking so. And to come under the necessity of conceiving a disparate etheric carrier is an admission of what is true in a correlative sense—that a conception of space, and therefore of consciousness, is impossible without bringing in the further conception of a motional aspect of experience, and which is not an assumption as is that "something outside human experience."

For these reasons. I give the physicist a world of space only; he can do nothing with it; thinking is impossible in it, or of it. I give him a world of motion only; he is in a like predicament. I offer him the "world" of Sir Isaac Newton, which has space in the foreground; or, like Einstein, our physicist may prefer to investigate a world with motion

empty space, or space that would be empty were it not filled with something not coming within human experience. Such a conception has meaning only when based in a previous assumption.

Light at least is passing through the jar. Here is a space-motion correlation. The jar and my perception comprise one event. Hence we can look into an interior which otherwise would present an impenetrable and black void in the brightest sunshine. And it would be still impenetrable and black in that interior if it was a "space" filled with something not coming within human experience.

Nevertheless, the assumption of the existence of the ether marks a perfectly legitimate stage of knowledge.

But since Einstein has stripped the ether of all mechanical qualities, reducing it to the status of a help to mechanical and electromagnetic events, it is not difficult to prophesy that the present stage of relative science is about to be merged in the beginning of the next.

That next, and natural, stage will have a correlative basis.



# HOW TO MAKE A SHORT-WAVE RECEIVER.

By PHILIP R. COURSEY, B.Sc., F.Inst.P., A.M.I.E.E.

## PART 7.

BEFORE proceeding further with the construction of more components of the receiver, it will be convenient to lay out in detail the ebonite panel which will form the top of the instrument, and on which all the parts will be mounted.

The outside dimensions of this panel, as has already been stated in an earlier part of this description, should be made to fit the outside of the wooden box on which it is to be mounted. They will, however, be of the order of 12½ in. by 12½ in., allowing quarter-inch thickness for the wood of the box.

These dimensions are shown in Fig. 2, but should the actual outside dimensions of the panel as constructed by any reader differ slightly from these figures, it need cause him no anxiety, since all the other vital sizes shown in this diagram have been marked out from the centre lines, and are suitable for enabling the parts all to go comfortably inside the box, having inside dimensions of 12 in. square.

### Engraving the Panel.

In Fig. 1 is given a plan of the instrument with the various parts labelled, so as to form a guide when assembling the parts. Convenient markings or engravings for the terminals and other parts are also shown in this diagram in the relative positions which they should occupy.

While, of course, not essential to the working of the instrument, suitable engraving of the panel not only improves the appearance but also is a not inconsiderable aid to operating it.

It is therefore in many cases well worth while sending the panel to an instrument-maker's for engraving as soon as all the holes, etc., have been marked out and drilled, and before anything is mounted on the ebonite.

Alternatively to this procedure, engraved scales can be purchased from dealers in wireless components, and can be secured in place with a few small screws when the parts have been assembled in place. Small labels suitably engraved for the various terminals can likewise similarly be purchased and affixed to the panel in the correct positions as an alternative to engraving.

It will be noted from Fig. 1 that the double-pole range switch, with the extra blade for the valve filament circuit, occupies the top left-hand corner of the panel; that the valve holder is in the top centre, with the filament regulator adjacent to it; that the variable tuning condenser is in the bottom left-hand corner; and that the knob controlling the reaction coil is immediately to the right of the condenser. This arrangement is a convenient one in use, since generally both the condenser and the reaction coil need to be adjusted together, one being controlled by each hand. The positions given are suitable for this.

### Mounting the Condenser.

With regard to Fig. 2 (shown on next page), special note should be taken of the fact that this has been drawn the reverse way round from the plan given in Fig. 1, since all the holes should be marked out from the back of the panel, and this necessitates reversing all the relative positions. By drawing the plan for drilling in the

manner here done, this disadvantage is obviated, since all the dimensions are arranged in their correct relative positions for marking off on the back of the panel.

in position the variable condenser, of which the main details were given last week. Some little care will be required in adjusting the packing washers for both the fixed and movable plates, in order to ensure the free movement of the latter between the former without any risk of contacts taking place between them.

Before finally mounting the movable plates in place, a short length of flexible copper wire should be soldered to the spindle, or to one of the spacing washers, close to the ebonite panel, and the wire twisted round the spindle two or three times, so as to form a flexible connection to the movable plates which will not impede their motion.

The end of this stranded flexible wire can be secured to a small brass screw in the ebonite panel placed close up to the spindle, so that the stiffer wire which will be used for connecting the condenser to the remainder

of the circuit can also be secured to the same screw.

(Fig. 2 is shown on next page.)

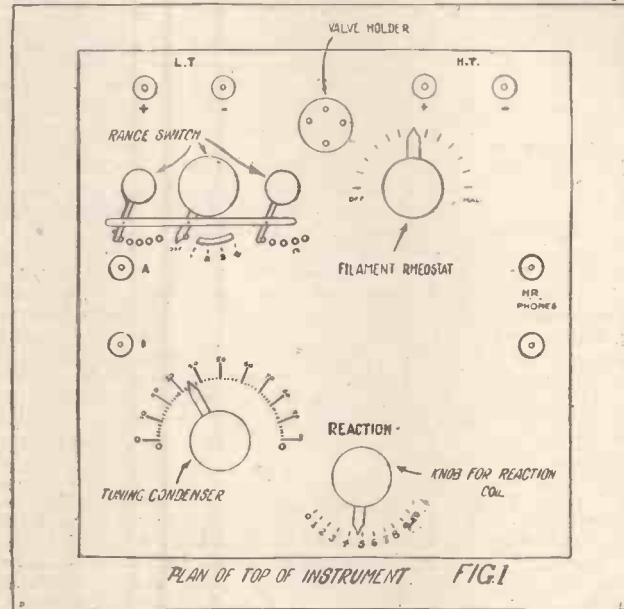

After the panel has been drilled and all the holes have been tapped out as necessary, it will be found convenient to mount

## CORRESPONDENCE.

The Editor has received the following letter from Mr. L'Estrange Malone, M.P.

[Mr. L'Estrange Malone has been associated with wireless telegraphy for a number of years. In 1911, serving as a lieutenant in H.M.S. Essex in the South Atlantic, he manipulated a kite aerial to receive "Poldhu" when out of range of the aeriels of all the ships of the Fleet. Later, in 1912, he was the first naval airman to carry out experiments with wireless telegraphy in naval aeroplanes.]

To the Editor, POPULAR WIRELESS WEEKLY.

DEAR SIR,—May I trespass on your valuable space to put a suggestion before your readers, who comprise the bulk of those who are interested in broadcasting?

The British Broadcasting Company is about to be formed, and will apparently control our destinies so far as wireless broadcasting is concerned.

The company is to be a private concern, and, I am creditably informed, it is not proposed to issue any prospectus in connection with it.

How are the rights of the users and "listeners in" to be protected?

There is a grave danger that this company may develop into a combine which will further bleed the amateur receiver; and that the undesirable legislation now before Parliament will strengthen the power of those who by patents already extract extortionate monopoly prices for essential parts, which are required by everyone, and could be purchased far cheaper abroad if the company did not

prevent it. I might instance the fact that, owing to the high cost of valves, many amateurs are forced to be content with inadequate and out-of-date crystal sets.

I have myself with other members of Parliament attempted to modify this legislation by putting down amendments. These, however, will not be discussed until November.

I suggest that there should be on the board of this company representatives of the users, elected by the wireless societies or in any other way that seems desirable. It would be their duty to try and protect the hundreds of thousands of persons who hope to make use of broadcasting.

Yours faithfully,

CÉCIL L'ÉSTRANGE MALONE.

House of Commons, August 21st, 1922.

## COMPETITION RESULT.

The entries for the competition for the best summary of Sir Oliver Lodge's article on "For and Against the Ether" were both numerous and interesting.

After careful adjudication, the Editor has decided to award a prize of One Guinea to the following gentlemen:

Mr. Phillip C. Humphreys,  
145, Elms Road,  
Clapham, S.W.

Mr. George Lennie,  
8, Whitehall Street,  
Dennistoun, Glasgow.

Mr. H. M. Poccock,  
21, Northmoor Road,  
Oxford.



# HINTS TO AMATEURS.

By A. W. DRANSFIELD.

EVERY amateur can make, with a little ingenuity, a very useful attachment to his set by designing a lever hook mounted on a piece of ebonite, so that when the 'phones are hung up the aerial is earthed. An old telephone hook will serve, but it is a very easy thing to make, and can be made to suit the position, etc., to the set.

When winding coils to build a "set" always test the winding before carrying on with the assembling. A quick way is to put one end of the coil on to a battery; the other end join to a voltmeter or a buzzer, and the last connection is made to the other side of the battery. If a voltmeter is used you will see a drop in voltage according to the gauge of wire used.

Hard soldering, or silver soldering, cannot be done with the ordinary soldering iron: much more heat is required; but the joint so made is very much stronger and, after all, is not at all difficult to accomplish. All you require is a handy gas jet, a Bunsen for preference, and a small blow-pipe. First clean the part to be soldered and rub on a little common borax (that is for a flux); nip off a very small portion of the silver solder and lay on the

joint; then project a flame with the blow-pipe on to the joint, carefully at first. The borax will melt and run in, and as soon as the heat is correct the solder will follow the borax.

A piece of iron wire flattened out at the end to act as a "spoon" is very useful to add a little more borax or solder if required.

A good Bunsen burner may be made out of an old incandescent gas burner. Remove all the top-portion that holds the mantle and use the tube part only. Should the burner used in this fashion keep lighting back, it may be easily remedied by lengthening the tube portion or a small piece of metal gauze pushed into the top of the tube.

Keep all your wire bobbins; they come in for many odd jobs as well as being handy to wind on spare wire at times.

Never consider that "anything will do"; such is not the case in wireless. Remember the articles that go through this paper are compiled by experts, and they take into consideration all things that matter, such as capacity, etc.; so if you are trying to build a set from the pages of this paper be sure and use the gauge of wire that is specified, etc. Perhaps the gauge of a certain coil is

given as 20 gauge; if so, 22 gauge will not do "just to try."

If your telephone ear-piece does not seem to function nicely, take off the ebonite cover, remove the diaphragm carefully by sliding it off the magnets, and carefully cut a paper washer that will slightly raise the diaphragm; or, if there is a washer there already, take it out and then try it. Should the 'phone be a sealed pattern like the Brown's, on no account meddle with it. In any case never attempt to interfere with the winding of any make of high-resistance 'phone; the wire is extremely fine and very easily broken.

The time has now arrived when all "out door" adjuncts to the wireless set, aerial, earth lead, etc., should be thoroughly overhauled.

Much as we dislike admitting it, the next few weeks will see the commencement of autumnal weather, and maybe heavy winds will play havoc with aerial guys and ropes which have "weathered" all the summer.

It is much better to test outdoor apparatus now than to be forced to clear away in wet and wintry weather a conglomeration of wire and wood that was once an aerial.

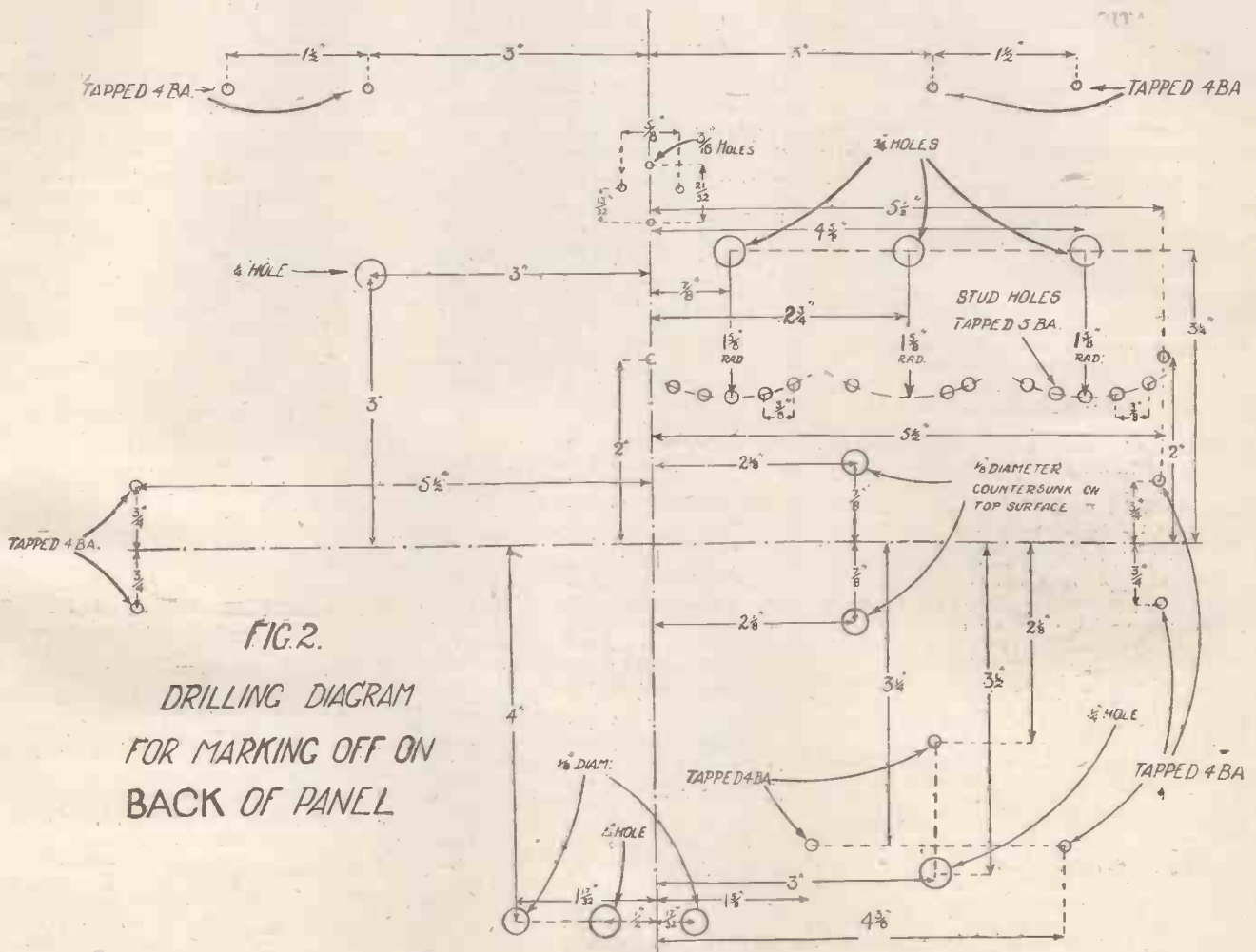

FIG. 2.  
DRILLING DIAGRAM  
FOR MARKING OFF ON  
BACK OF PANEL

# WIRELESS POST FREE.



2,000 ohms, 24/-  
4,000 ohms, 25/-

## SPECIFICATION.

**CORDS.** Twin conductors, Tinsel, 3 ft. long between butt and fork, 12 in. long from fork to each receiver. Instrument end fitted with 2-plug type Metal Tags.

**RECEIVERS.** Arranged in series and wound to 2,000 ohms, 4,000 ohms, or as required. Magnets of specially treated Tungsten steel mounted in Aluminium cases fitted with adjustable steel Headbands of extremely light but serviceable pattern.

## SPECIFICATION.

**RESISTANCES.** 120, 1,000, 2,000, 4,000, 8,000 ohms. Other windings to order.

**INSULATION.** Highest possible.

**MAGNETS.** Selected Tungsten steel, manufactured under our own special process and guaranteed for ten years.

**CORDS.** Heavily insulated Tinsel conductors.

**FINISH.** Polished Aluminium Cases and Fittings with Oxydised Relieved Coppered Headbands. Simple and comfortable adjustments. Ebonite Ear Caps fitted as standard.

**INSPECTION.** Every Head set carefully tested under actual reception conditions and guaranteed to specification.



DE LUXE PHONES  
2,000 ohms, 34/-  
4,000 ohms, 35/-

## CRYSTAL SETS

(Including De Luxe  
Headphones)

£4 5s. 0d.



**AERIALS.** Complete with insulators and instructions for erection, 6/- POST FREE.

**The New System Telephone Co., Ltd.,**

212-214, Gt. Portland Street, W.

Tel. No.: MAYFAIR 3779.

G. R. C. 25

# "AMPLIPHONE"

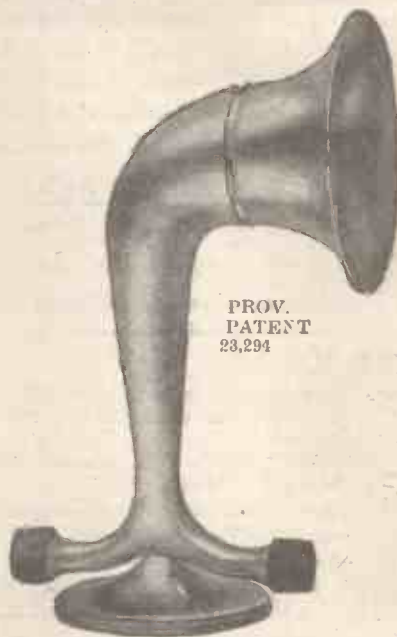

PROV.  
PATENT  
23,294

## LOUD SPEAKER.

Just slip your headphones on the "Ampliphone" and you have a perfect Loud Speaker.

Nothing further required. Most Loud Speakers are merely a single receiver attached to a horn. With the "Ampliphone" the volume is doubled because two headphones are blended into one powerful tone—and you save half the usual cost when you buy the "Ampliphone."

Polished cast Aluminium body with nickel-plated base and horn—a fine addition to any receiver.

**PRICE £2 : 2 : 0**

When you forward your order, request a copy of our Catalogue. It will interest you.

**Factors and Dealers.**— We protect you with reasonable discounts and prompt deliveries.

Manufactured by

**GENERAL RADIO COMPANY**

Affiliated with The

COX-CAVENDISH ELECTRICAL Co., Ltd.,

Twyford Abbey Works,

HARLESDEN, N. W. 10.

SHOWROOMS :

105, Great Portland St.,  
LONDON, W.1.

Branches :

Daeefield, Church Street,  
BRADFORD  
15, Hanover Street,  
EDINBURGH.

AGENTS :

WIRELESS SUPPLY CO.,  
High Street,  
BIRMINGHAM.

MOTTERSHEAD & CO.,  
7, Exchange Street,  
MANCHESTER.

And all Principal Countries.



# REALLY???

**IF YOU** are **REALLY** disappointed with deliveries, quality, and price, and **REALLY** want **WIRELESS MATERIALS** that are guaranteed, send for our Price List (4d. in stamps), which includes all Wireless Transmission Signals from 8 a.m. to 11.55p.m.

All Goods are **REALLY** sent by Return of Post.

We **REALLY** are Wireless Engineers and our Consulting Department is at your disposal.

### SPECIAL LINES—

- No. 24 Enamelled Wire, wound on 1-lb. Wheels, guaranteed true to gauge, 2/8 per lb. Postage 9d.
- Radial Switch, Laminated Arm, 1/9 complete. Postage 2½d.
- Aerial Wire, 100 ft. 7/22, Stranded Bare Copper, 4/9. Postage 9d.

**RADIO APPLIANCES LTD.**  
185, High Road, Streatham, S.W. 16.

## A Receiving Set without 'Phones

is like a ship without a rudder  
The "Brown" Super-Sensitive Telephones

These Telephones are unquestionably the clearest and most sensitive made, and, consequently, increase the distance over which wireless can be heard. **BROWN'S** are recognised as the most comfortable to wear, due to their extreme lightness in weight and adaptable adjustment. There is no wireless head 'phones in the world to compare with **BROWN'S**.



"A" TYPE  
Low Resistance 58/-  
High Resistance 62/- to 66/-  
"D" TYPE  
Low Resistance 48/-  
High Resistance 52/-

(Above prices include cords.)

**WIRELESS INSTRUMENTS** and parts manufactured by and bearing the name "BROWN" can still be bought with absolute confidence in their quality, value, and efficiency, because throughout this period of increasing wireless activity **S. G. BROWN, Ltd.**, have wisely refused to lower their high standard of quality

**IMPORTANT NOTICE.**—When purchasing **BROWN'S**, you should see that the name **BROWN** is stamped on the back of each ear-piece.

IN UNIVERSAL USE. AS SUPPLIED TO BRITISH, ALLIED, AND FOREIGN GOVERNMENTS.

VISIT OUR STAND, No. 43, ALL-BRITISH WIRELESS EXHIBITION Horticultural Hall, Sept. 30 to Oct. 7. ILLUSTRATED CATALOGUES POST FREE

Head Office and Works:  
Victoria Road,  
North Acton,  
London, W.3.



London Showrooms:  
19, Mortimer St.,  
London, W.1.

### IMMEDIATE DELIVERY. AGENTS.

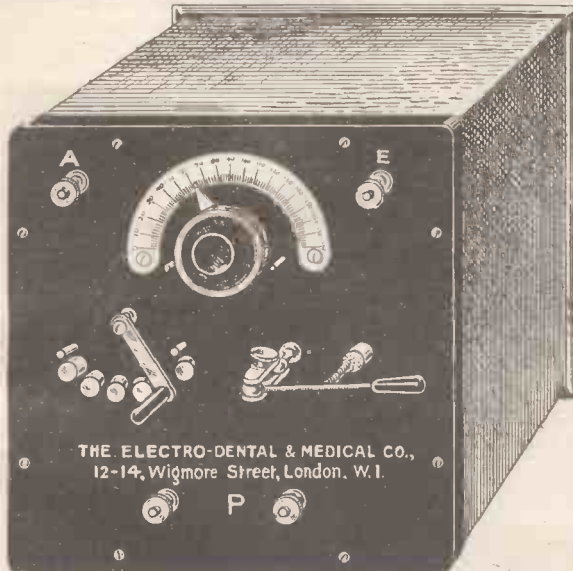

THE ELECTRO-DENTAL & MEDICAL CO.,  
12-14, Wigmore Street, London, W.1.

- No. 2 Crystal Receiver as illustrated, £3 10s.  
Range for Telephony, 15 miles. Range for Morse Signals, 500 miles.
- Head Telephones, 4,000 Ohms - £1 10s.
- Single Valve Set - £7
- 2 " " - £10
- 3 " " - £15
- 4 " " with Indoor Aerial, 50 guineas

WE ARE THE ACTUAL MANUFACTURERS OF ALL THE ABOVE SETS  
THE ELECTRO-DENTAL & MEDICAL CO., 12-14, Wigmore St., London, W.1  
Telephones: Langham 1416-7. Telegrams: Dulcinoids: Werdo: London.

## HIGH QUALITY CONDENSERS

Complete with scales.



'001 mf. 24/-

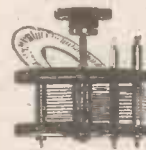

'0005 mf. 18/-



'0003 mf. 14/-

## UNIT-COIL HOLDERS



Patent.



Shows method of fixing

To fit any standard coil. Made of ebonite and brass throughout, with excellent sun-metal finish.

Fixed Unit .. .. 4/2  
Moving Unit .. .. 5/8

### FILAMENT RESISTANCES.

All Post Free. Send your order to:—  
Dept. B.,

ASHLEY WIRELESS TELEPHONE Co., Ltd.,

69, Renshaw St., Liverpool.

Tel. 4628 Royal.

Grams: "Rotary,"  
Liverpool

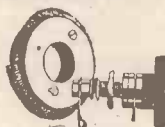

Patent. 5/3 each

# WIRELESS CONTROL.

By Major Raymond Phillips, I.O.M., late Member of the Inter-Allied Commission of Control.

## PART 4.

IN previous articles I referred to "simple selective wireless control" (or "selection by sequence") and "direct selection." I explained that in some instances (especially where consideration of weight of apparatus was involved) it might be desirable, and in fact necessary, to adopt "selection by sequence" when wirelessly controlling mechanism.

A case in point was my well-known wireless-controlled airship, the construction of which I shall describe in this article.

It will be apparent that the wireless control of an ordinary model motor-boat is a comparatively simple matter compared with the control of a model airship, when one considers that the former involves the "starting," "stopping," and "reversing" of one electric motor, and the movement of a rudder to "right," "left," or "central" position, whereas the latter (in the case of my model) involves the "starting," "stopping," and "reversing" of four electric motors, the control of a trap-door, and six signal lights. In addition, it will be realised that it is necessary to control mechanism for "raising" or "lowering" a model airship whilst in flight, which problem is non-existent in a craft floating on the surface of water.

In the construction of a model wireless-controlled airship the first consideration is "lifting power." For that purpose it is necessary to have a balloon of sufficient capacity to ensure that there will be a reserve lift of not less than 1/2 lb. over and above the weight of the whole structure.

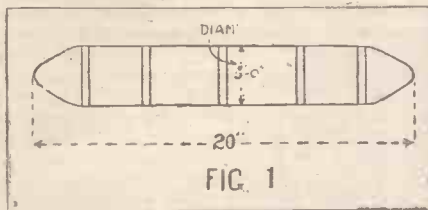

By adopting that precaution a great saving of hydrogen gas will be effected, as it will not be necessary to "freshen up" the gas in the balloon as often as would be the case where "reserve of lift" had not been taken into account.

I had perhaps better explain what is meant by "freshening up." It simply consists of admitting pure hydrogen gas into a balloon in such a manner that "stale" gas may be blown out, thus restoring its lifting power.

### Steering the Airship.

The balloon of my airship was elongated (20' 0" long x 5' 0" dia.) as shown in Fig. 1.

It was secured to the framework of the airship by eight light cords, and was balanced on "even keel" by means of sand contained in a bag, which could be placed in any convenient position on the airship.

The framework was made of white pine, and aluminium tubes, the latter also forming "conductors" for conveying electric current from accumulators (carried at the rear of the airship) to the various motors and other mechanism; the supply of current being wirelessly controlled by a "receiver" and "controller" suspended from the centre of the airship frame. A sketch of the latter is shown in Fig. 2. It consists of a compartment A, carrying accumulators N, a receiver and controller C fitted with a drum and "step by step" mechanism (for "simple selective control"), coherer H, de-cohering device L.

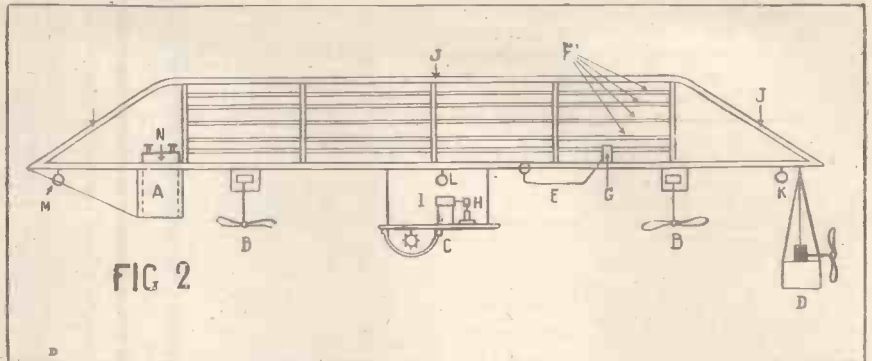

Steering and manoeuvring of the airship is effected by means of two electric motors, and propellers mounted upon a "swivelling" beam D, so that by starting, or reversing, either or both electric motors and propellers, the airship could be caused to travel in any desired direction; whilst it could be raised or lowered by means of the electric motors and propellers B B.

### The Question of Weight.

A trap-door E is shown attached to the frame JJJ, and arranged to be released by the electro-magnet G. The latter can be energised as desired by electric current from the accumulators in compartment A. On the trap-door E being released, it automatically cuts off the source of electrical energy from the electro-magnet G. Such a procedure prevents a waste of energy, which is a most important item in a model airship, having regard to the necessity of cutting down the weight of accumulators to the lowest practicable limit.

The aluminium conductor tubes are shown at F.

The airship was also fitted with two "head-lights" K, green "star-board," red "port" lights L, and two red "tail lights" M.

Consideration of weight of the apparatus made it imperative to adopt a system of "selection by sequence" for the wireless control of the airship.

A system of "direct selection" would have involved the use of a much larger balloon for lifting purposes, which for demonstrations in theatres or public buildings would have been impracticable.

Figs. 3 and 4 show respectively a sketch of the "receiver" and "control" circuits of the airship. It will be observed that the coherer circuit is not provided with a potentiometer.

In my second article I described a special coherer which I designed for use with the airship. That coherer when once adjusted did not need any further attention, nor was a potentiometer necessary.

### The Circuit.

The circuits and mechanism shown in Figs. 3 and 4 consist of a coherer with base A, de-cohering device B, relay C with contacts D D, electro-magnet E with armature J, and contacts FF (one of these contacts is attached to but insulated from the armature J), coherer battery CB, insulated supports G G for rods H H (the latter representing an aerial), relay battery RB, contact drum K with a ratchet wheel R secured to one spindle of the drum.

Although not shown in the diagram (for the sake of clearness), the armature J (shown in (Continued on next page.)

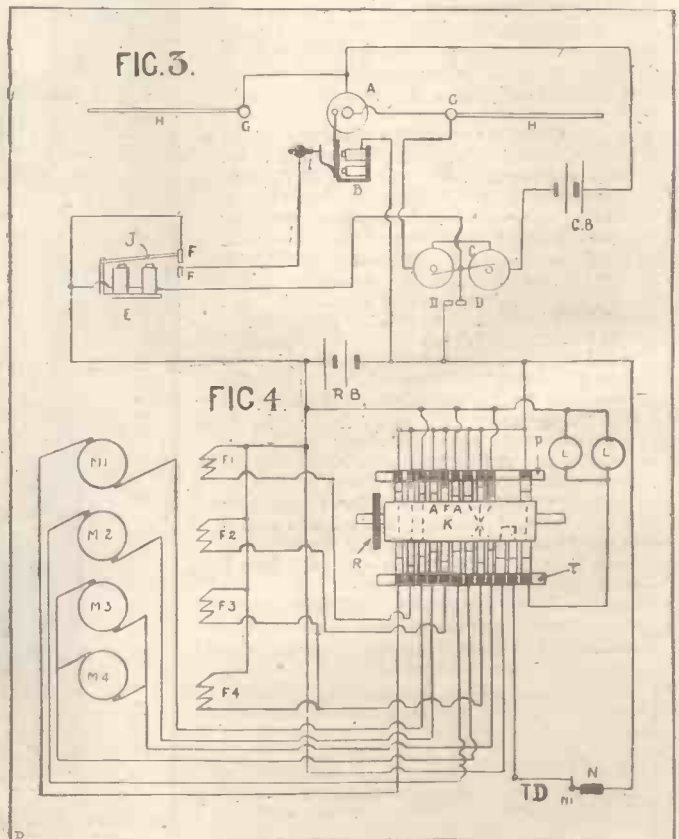



## WIRELESS CONTROL.

(Continued from previous page.)

Fig. 3) is fitted with a "pawl" and (with the electro-magnet E) is mounted in a suitable manner so as to engage with the ratchet wheel R, so that the drum K can be caused to revolve "step by step" each time the electro-magnet E is energised (by current from the battery RB) and attracts the armature J.

M1 and M2 show the two shunt wound motors for "steering" and "manoeuvring" the airship; F1 and F2 showing respectively the field magnet windings. It will be observed that these motors are connected with and controlled by the contacts on drum K; electrical energy being obtained from the battery RB (which is marked N in Fig. 2).

M3 and M4 show (connected in parallel) the two shunt wound motors for "raising" and "lowering" the airship (marked BB in Fig. 2); F3 and F4 showing respectively the field magnet windings (also connected in parallel). It will be observed that these motors are also connected with and controlled by the contacts on drum K. In the interior of the latter dotted lines show crossed connections to the contact pins.

The object of this is to reverse the direction of current flowing to the armatures, but not the field magnet windings of the motors. Thus the propellers (attached to the armature spindles) can be caused to revolve in either direction as desired according to the position of the drum K.

TD shows a trap-door with supporting contact N1 and electro-magnet N. It will be observed that in operation current flows through the trap-door, contact N1, and electro-magnet N, and when the latter is energised contact N1 is broken, allowing the trap-door to fall and completely cutting off its source of electrical energy. LL show lamps (the airship was fitted with six lamps although only two are shown). PT show insulated supports for contacts.

It will be further observed (on reference to the diagrams) that on the coherer A (Fig. 3) detecting a wireless wave, current would flow from the battery CB, energising relay C, closing contacts DD, and admitting current from battery RB through the windings of electro-magnet E closing contacts FF, and thus energising de-cohering device B. The "pawl" attached to the armature J would thus engage with the ratchet wheel R and move the drum K one step forward. It will thus be obvious (on further reference to Figs. 3 and 4) that by revolving the drum K into various positions by each impulse from the electro-magnet E (Fig. 3) the motors M1, M2, M3 and M4, also lamps LL, can be controlled as desired, whilst the trap-door TD can be opened once only when the drum K makes one complete revolution.

This method of "selection by sequence" worked very well in connection with the wireless control of my airship, as the drum K, being a very light weight could be caused to rapidly move "step by step"; thus the inevitable starting of motors not required was really of no account owing to the short duration of contact made by the contact pins on the drum K.

As I have on many occasions been asked how my airship was controlled, I trust this article has now made the matter clear. In my next article I hope to describe a system which I christened "time period control." This is a totally different method to "simple selective control" and "direct selection" as already described in previous articles.

(To be continued.)

Readers of POPULAR WIRELESS will shortly enjoy full instructions from Major Phillips's pen on the way to make a wireless-controlled toy train. The first five articles of this series are intended to be in the nature of a survey of the possibilities of wireless control. In No. 6 the author will give explicit details for making a wireless-controlled apparatus at very little cost.

## THE BRITISH BROADCASTING CO.

(From a Special Correspondent.)

RAPID progress is now being made with the formation of a broadcasting company.

For some months past the principal manufacturers of wireless apparatus could not arrive at an agreement, and it was feared at one time that there would be at least two companies operating in this country. This would not have been satisfactory either from a working or an economical point of view, and it would not have given the same satisfaction to the public. All difficulties have been settled and the whole of the manufacturers concerned have come to a definite agreement to the formation of one company named the British Broadcasting Company.

Six of the principal companies, viz., the British Thomson-Houston Company, the General Electric Co., Marconi's Wireless Telegraph Co., Metropolitan-Vickers Electrical Co., Radio Communication Co., and the Western Electric Co., have guaranteed the capital required. All bona-fide manufacturers of wireless apparatus in this country may join the company by taking one or more shares. The first body of directors will be drawn from the six companies named—one from each company. The chairman of the company will be a public man not connected in any way with any of the manufacturers constituting the company.

A memorandum and articles of association, and an agreement between the British Broad-

casting Company and the members thereof, have been prepared and are now being considered. When they have been approved by the Postmaster-General, the company will be registered.

There are still a few essential matters to be settled before actual broadcasting can begin; but the directorate will no doubt see that no undue delay takes place.

At the outset there will be, as we have previously stated, about eight stations, and these will be located in London, Plymouth, Cardiff, Birmingham, Manchester, Newcastle-on-Tyne, Glasgow or Edinburgh, and Aberdeen. After these have been in operation it will be ascertained whether they cover the whole country, and, if not, the Broadcasting Company will have to consider what further stations will be required.

It is probable that the company will agree at the outset to use the station in Marconi House for the London area, in order that broadcasting in the metropolis may not be unduly delayed. Whether this will be a permanent station or not is for the directors to decide.

The sites for the provincial stations will be selected without delay and the stations will be built with the utmost expedition. Broadcast programmes may be in operation in the London area about October 1st. It is not possible to name a date for the Provinces, but most of the stations should be in operation early in the winter.

It is part of the agreement that only sets manufactured by firms who are members of the British Broadcasting Co. will be approved by the Postmaster-General, so that the public should ascertain before purchasing a set that it has been so approved.

Many adverse comments have appeared in the Press about the delay which has taken place in the commencement of broadcasting in this country, but we think the public will be better served than would have been the case had less deliberation taken place.

### BOOK REVIEW.

Wireless Circuits. By A. V. Ballhatchet, M.J. Inst. E. (London: Percival Marshall & Co. Pp. 56. Fully illustrated. Price 6d. net.)

THIS is a little book which should make a general appeal. It possesses no text, but the numerous diagrams are clearly drawn, and each is accompanied by a short description which is something more than a mere title.

There are many circuits given which should prove of value to the experimenter, and for the novice there is a table of constants in addition to a number of the symbols generally employed in text-books dealing with wireless matters.

Sixpence is the price of this very useful little book.

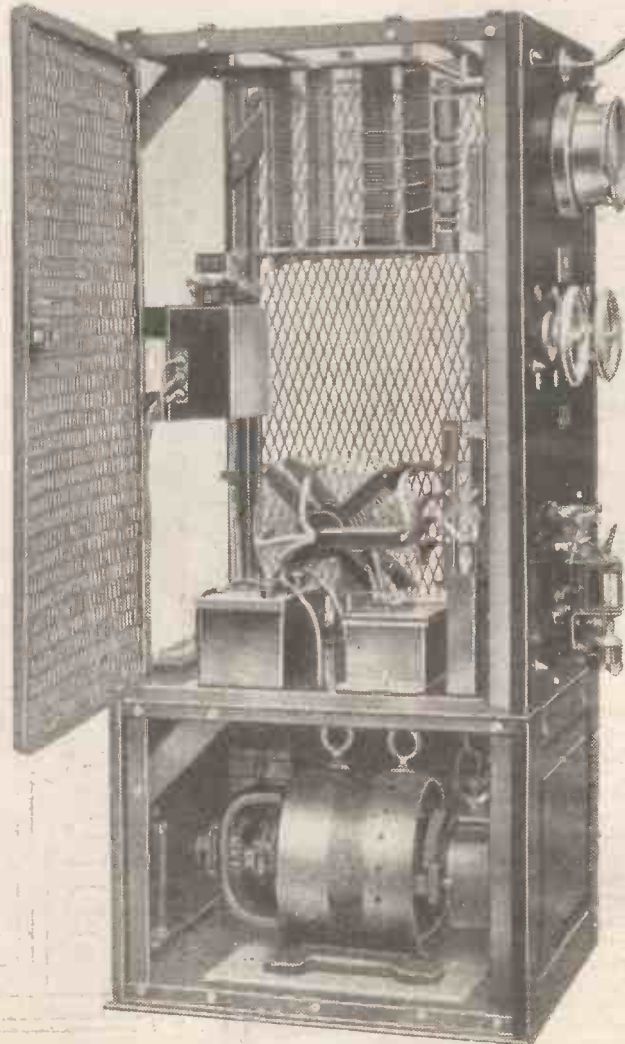

A 1-kw. Transmitter designed and fitted on ships by the Radio Communication Co.



# THE CHOICE OF RECEIVING SETS.

NOTE.—This article, to appear in two parts, is intended for new amateurs.

## PART I.

FOR the benefit of beginners in the wireless world, we shall endeavour, in this article, to set forth the conditions under which amateurs in Great Britain are permitted to indulge in this latest and delightful recreation, and to give such general advice as should be helpful to anybody who desires to purchase a receiving set, but who does not know how best to go about it.

In this country the restrictions at present are rather vexatious, and almost correspond to those in force in the early days of motor-cars, when every automobile had to be preceded on the road by a man with a red flag. Afterwards, the legal speed limit of twenty miles an hour was imposed, but now even that is to be abolished, and the notion of a man with a red flag is very remote, if it exists at all, in the minds of owners of Rolls-Royce cars as they speed along main roads at sixty or seventy miles an hour. That is just an illustration of our simple British way of encouraging a great new industry—to put every possible obstacle in the way of the pioneers.

### Here and There.

In the case of wireless, it is to be hoped that amateurs and others concerned will not permit an analogous state of affairs to obtain—that they will *not* exercise patience, but that they will leave no stone unturned in the matter of agitating for greater freedom, and so avoid having to wait a quarter of a century before our lethargic "authorities" awake to the fact that they are not omnipotent.

In the United States of America there has been formed a Radio Relay League, consisting entirely of wireless amateurs who co-operate in many ways, and our second piece of advice to amateurs in this country is to form a National Radio League for furthering their interests, not only by securing greater freedom from official restrictions, but with the idea of mutual assistance and of arranging between themselves for broadcast concerts, etc. For these things cost money, and it is not to be supposed that there is—or ever will be—a sufficient number of philanthropists ready to fill the ether with music free of charge, indefinitely.

Reverting to the subject of restrictions: in the United States, where, it is said, there are more than a million amateur receiving sets in use, amateur transmission is also practised on a considerable scale, messages being transmitted direct for distances of a thousand miles and, by relaying them, all over the continent.

There an amateur is allowed to use one kilowatt (one thousand watts) for his transmitter, whereas in this country, even if granted a transmitting licence at all, he is not permitted to use more than ten watts—less than half the current consumed in an ordinary 16-candle-power lamp!

Again, whereas American amateurs are free to exchange messages with anyone they please, our amateurs are not only limited to three stations, but the subject-matter of their communications may only relate to tests, and they are not allowed to communicate with each other at all.

### Telegraphy and Telephony:

As regards aerials, the British amateur is not permitted to use more than 140 feet of wire (for a twin aerial), and although this is sufficient under ordinary circumstances, in the majority of cases it tends to kill the hopes of the more ambitious.

For every amateur transmitting station there will probably be a very large number of receiving sets, for a receiving set is within the means of a vast number, and can be used in wireless telephony by unskilled persons, whereas transmission requires no little skill and experience. It is the choice of receiving sets, therefore, that we shall deal with.

The first thing for an intending purchaser to do is to ask himself what he expects of the instrument, and what he is prepared to pay for it. In this connection it must be remembered that wireless telegraphic signals from sufficiently powerful transmitting stations can be picked up in practically any part of the world, whereas telephony *at present* is confined, for all practical purposes, to a two or three hundred mile range.

### Function of Receivers.

Another point to bear in mind is that, under favourable atmospheric and other conditions, a comparatively small receiver will sometimes pick up messages from greater distances than will a more powerful set at shorter range under unfavourable conditions.

Theoretically, the slightest sound—a whisper—in any part of the world should be capable of transmission in wave form, and of reception and reconversion in any other part of the world, but the difficulties and expense involved render this out of the question in practice.

As most readers are aware, electro-magnetic waves used in wireless vary from about 4½ metres to 25,000 metres in length, although they all travel at the same speed. Different wave-lengths are adopted for different conditions; thus, for Transatlantic and other long distance transmission, wave-lengths of from 10 to 25,000 metres are employed, because of their greater carrying power for a given output of energy—in other words, wave-lengths are adopted that give the most economical results in practical working.

But another important feature is that, by

different transmitting stations using different wave-lengths, each station can be readily distinguished and recognised, and they can all be sending messages at the same time without material interference with each other or with any receiving apparatus.

For this reason receivers are constructed so that they only respond to one wave-length at a time, and may be "tuned" simply by turning switches, so as to respond to any of a large range of wave-lengths in use. It is said that, theoretically, 3,000,000 different wave-lengths are available, but this is not practicable because there must be a distinct difference in each wave-length employed, otherwise receivers would partially respond to different wave-lengths at the same time, and so cause confusion.

The other function of a receiving set is to magnify the signals received and reconvert them into sounds, and it is according to the degree of perfection with which they do this that their price varies.

### Two Extremes.

The most nearly perfect set for receiving messages, say, from the Pacific or from the Antipodes (always supposing that the transmitted signals are sufficiently powerful), is very expensive, but such apparatus is, of course, mainly used for commercial and experimental purposes. At the other end of the scale we read of freak sets contained in safety razor cases, pill boxes, and on finger rings, but readers may rest assured that, although such freak sets are possible, they are of little practical use.

Between these two extremes there is already a wide selection of good receivers to choose from, at prices varying from about fifty to five pounds and even less, according to one's purse, and to what one expects from the instrument purchased.

In the next article we shall outline the possibilities and prices of different types of receiving sets.



Senatore Marconi (right) with Dr. Alfred Goldsmith at a demonstration of short-wave signalling in New York.



**STEP BY STEP IN WIRELESS.**

NOTE.—Under this heading will appear a weekly article for the more advanced amateur.

**No. 15.—MEASURING AMPERAGE AND VOLTAGE.**

FOR the benefit of those readers who at a future date hope to instal a transmitter, or who may be called upon suddenly to assist in the inserting of a voltmeter or amperemeter in a power circuit, the following brief outline concerning the two instruments in question is given.

It is not intended to give a detailed explanation of electro-magnetic induction, including the theory of lines of force, etc., as this subject has previously been dealt with in POPULAR WIRELESS. A brief survey of the action of a galvanometer, however, which is an instrument used to detect the passage of an electrical current in a circuit, may possibly assist the new

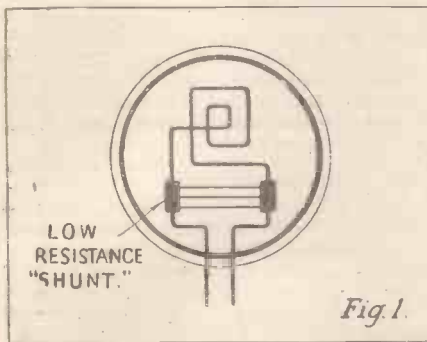

Fig. 1.

experimenter, and help the uninitiated to a better understanding of both the voltmeter and amperemeter.

**The Swinging Coil.**

There are many types of galvanometer, one of the simplest consisting of a number of turns of copper wire wound in the form of a rectangle, and suspended in the air between the poles of a horseshoe magnet by means of two wires, one attached to either end of the coil. To strengthen the magnetic field, an iron core is placed between the poles of a horseshoe magnet in such a position that, while it is immovable, it has a considerable effect upon the coil.

When the galvanometer is connected in a circuit through which a current of electricity is flowing, the coil will try to swing or turn in an endeavour to accommodate the maximum number of lines of force. It is prevented from doing this to a certain extent by the tension exercised upon it by the wires to which it is connected, and by which it is suspended.

The absolute distance over which the coil will vary or swing from its normal position will, of course, be governed by the strength of the current in the wire. An indicator or pointer is then attached to the coil, which will be deflected whenever the coil tends to move under the influence of an electric current.

It is on this principle that both voltmeter and amperemeter are constructed. The voltmeter coil has a higher resistance than the coil of the amperemeter, which is wound with a comparatively few turns of relatively thick wire.

**Connecting Them Up.**

It is only natural to suppose that, if we connect up both the voltmeter and amperemeter in series in a circuit, the

former will register the voltage and the latter the amperage. It also seems reasonable to presume that if it is required to measure the voltage or amperage of, say, a battery of cells, the result could be obtained by connecting either piece of apparatus across the terminals of the battery. Unfortunately, the measuring of current or voltage, while quite a simple matter, is not quite so easy as that.

A voltmeter is connected in "SHUNT" across a circuit in which it is desired to measure the voltage. It is a recording instrument used to register the difference of electrical pressure, or drop in potential between two points.

An amperemeter, or ammeter, as it is frequently called, is ALWAYS connected in SERIES with any circuit in which it is required to register the electrical flow or amperage.

The latter rule is the more important one of the two to remember. The price to be paid for inadvertently connecting the ammeter in shunt with a power circuit will be just as much as a new ammeter will cost—for you will surely ruin the instrument. On the other hand, if by error a voltmeter is connected in series instead of in shunt, it will not be damaged; the only apparent difference it will make will be to cause a considerable reduction in the flow of current through the circuit.

The reader will now, of course, want to know why the ammeter will be spoiled, and why the voltmeter will remain intact.

Let us, first of all, consider the ammeter. It is an instrument possessing a very low resistance. As previously stated, it consists partly of a small coil of comparatively thick wire, which generally has a resistance of somewhere about 2 ohms. This coil is connected in parallel with a low resistance shunt, consisting of several metal strips, as shown diagrammatically in Fig. 1.

When the instrument is connected in series with the power circuit, it will be seen that the low resistance shunt is almost short-circuiting the coil, the current being divided so as to allow only

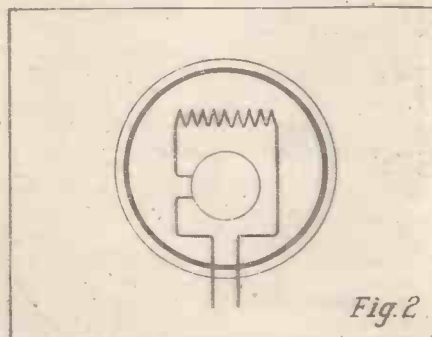

Fig. 2.

a small proportion to flow through the coil. If an instrument of this character, having such a low resistance, was connected in shunt with the circuit, across a pair of supply mains, for instance, it would immediately "burn out."

With a voltmeter it is different. We need to measure pressure, and the instrument must be so constructed that it is capable of registering high voltage while

eliminating as much of the current or amperage as possible.

From Fig. 2 it will be seen why the connecting of a voltmeter in series with a circuit will effectively reduce the current flow. The coil may have a resistance which is only little more than that of the ammeter, but instead of being connected in parallel with a low resistance shunt, it is connected in series with a high resistance, of some thousands of ohms.

Both instruments, of course, have a calibrated strip, or chart, over which the external pointer moves as it registers increases or decreases of current or voltage, as the case may be.

**A False Reading.**

To the average amateur who possesses a valve receiving set, a word of warning may be given with regard to the use of a voltmeter. In testing the voltage of the filament battery, or of the high-tension battery if it is composed of wet cells, do not be content with connecting the voltmeter

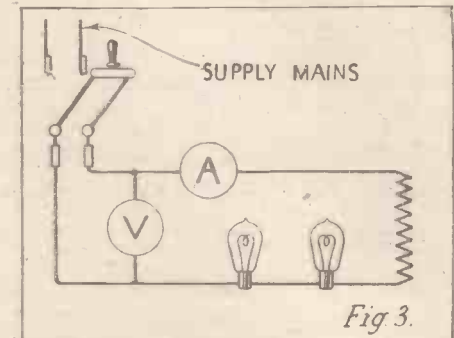

Fig. 3.

meter hastily across the cells and taking a quick reading. Accumulators, when out of circuit, are apt to give a false "spurt" of electro-motive force if their terminals are short-circuited in this manner, and the voltage registered by the meter may not be a true indication of the state of the battery.

This "recuperative" effect is not so noticeable in small or dry cells as it is in the larger type, but it is a point worth consideration. If the cells are off circuit, keep the voltmeter connected across them for a second or so, and note if any rapid drop in voltage takes place.

Do not measure the voltage of batteries freshly taken from the charging board. It is a waste of time to endeavour to get a true reading from a cell which is still "gassing." Fig. 3 shows both ammeter and voltmeter diagrammatically connected to a power circuit. The voltmeter will register the drop in potential across the mains, and the ammeter the amount of current flowing in the circuit.

In conclusion, do not, under any circumstances, connect an amperemeter across the terminals of a source of electrical supply, in the fond hope that you will be able to read the amperage from it—the point is worthy of repetition. You may connect your voltmeter in either series or parallel with the circuit without detriment to the instrument, but to join up your ammeter in shunt is like connecting your receiving valves to the high-tension battery.

It is what heartless people call "buying experience."



Two-Valve Receiver Set No. 11.

We are Exhibiting at the Forthcoming  
**ALL-BRITISH WIRE-  
LESS EXHIBITION,**  
Horticultural Hall, Sept. 30 to Oct. 7.  
(STAND 22.)

# Place An Order NOW For YOUR BROADCASTING INSTRUMENTS.

If You Are Expecting Perfect Reception  
You MUST Use R.F.H. RECEIVING INSTRUMENTS,  
R.F.H. 'PHONES, THE MAGNAVOX LOUD SPEAKER.  
*For which we are factors and retail agents.*

We manufacture our own Components; Coils; Condensers;  
Resistances; Switches; Cabinets, etc., which not only enables us to  
ensure perfect Workmanship and Materials, but enables us to give  
quick delivery, and to offer guaranteed high quality Radio Goods at  
the lowest possible price to the purchaser.

For super-excellence in reception and simplicity in operation, you  
must get an R.F.H. 2, 3, or 4 Valve Radio Set. **IMMEDIATE  
DELIVERY.** Write to us for particulars. **LISTS FREE.**

**ROGERS, FOSTER & HOWELL, LTD.,**  
Edward Rd., Balsall Heath, Birmingham

## R.F.H.

For they are jolly good Fellows.

### THE "FELLOCRYST" (REGISTERED) WIRELESS CRYSTAL RECEIVING SETS. BRITISH THROUGHOUT.



**COMPLETE (As Illustrated) £3 : 7 : 6**  
with one pair of double headphones—postage 1/6  
**NO BATTERIES REQUIRED.**

The set comprises tuning coil with a wave-length of approx. 300  
to 1,500 metres; Silicon Crystal Detector; 4,000 ohms double head-  
phones; 100 ft. coil of 7/22 stranded copper wire; 2 shell insulators,  
terminals, etc.

Each set tested and guaranteed to receive broadcasting within a  
range of 15 to 20 miles, and Morse signals from a much longer range.

Extra headphones, complete, 30/- per pair. Postage, 1/-.

**FELLOWS MAGNETO CO., LTD.**  
LONDON, N.W.10. Telegrams: Quizmag, Phone, London.

Telephone: Willesden 1560-1. Visit our Stand, No. 10, All British Wireless Exhibition, Horticultural Hall, September 30th to October 7th.

(E.P.S.) 3.

## LORGNETTE 'PHONES

2,000 Ohms.

THE IDEAL 'PHONE FOR LADIES

No more disarranging of  
hair. No cumbersome  
weight on the head.  
Beautifully finished.  
Equal in reception  
and clarity of tone  
to any double  
headphone.



25/-

Postage Paid.

With  
ebonised handle. Also  
supplied with handles of  
Tortoiseshell, Ivory, Mother-  
of-Pearl, etc. Prices on applica-  
tion. Special Terms to the Trade.

Manufactured Exclusively by:

**THE ECON MANUFACTURING CO., LTD.,**  
6, Holborn Viaduct, London, E.C.1.

Telephone: City 4148.



# WIRELESS CLUB REPORTS.

The Editor will be pleased to publish concise reports of meetings of wireless clubs and associations, reserving the right to curtail the reports if necessary. Hon. secretaries are reminded that reports should be sent in as soon after a meeting as possible. Reports sent in cannot appear in this paper in less than ten days after receipt of same. An asterisk denotes affiliation with the Wireless Society of London.

## Stoke-on-Trent Wireless and Experimental Society.\*

At a meeting of the Stoke-on-Trent Wireless and Experimental Society on Thursday, August 24th, it was announced that permission to utilise the mast over the Dew Drop Inn to support the free end of the aerial had been refused by Messrs. Worthington. A fresh scheme is being devised, and this is being left in the hands of the technical committee.

An interesting discussion took place on several points raised by some of the newer members concerning the working of their apparatus.

The proposed exhibition which the society hopes to hold in Hanley at the end of the year, or the beginning of the new year, was discussed, and inquiries are now being made to find a suitable hall in which it can be held.

An interesting programme is being drawn up for the next few weeks, commencing shortly with a demonstration with the aid of an indoor aerial and the society's three-valve set.

Hon. sec., Mr. F. T. Jones, 360, Copbridge Road, Hanley.

## The Durham City and District Wireless Club.

The fourth meeting of the above was held recently at headquarters (Y.M.C.A., Claypath). The meeting was well attended, and several new members were enrolled. It was very pleasing to note the presence of lady members, and also to hear that more are coming along. The chair was very ably taken by the Rev. T. H. Perkins of Shadforth.

After the minutes were read and passed, a most interesting lecture was given by Mr. Geo. Barnard, hon. sec., on "The Production of High Frequency Oscillations." He confined his remarks chiefly to the "spark" method, leaving the more advanced "valve" transmission to be discussed at a future meeting.

After pointing out clearly the difference between static charges of electricity and electro-dynamics, he demonstrated the effects of static induction, and described thoroughly the action of a condenser.

Frequency, amplitude, wave-length, and damping were shown diagrammatically upon the blackboard. Inductance and capacity were explained in a very elementary fashion, the lecturer using several helpful analogies.

Open and closed oscillatory circuits were

shown upon the blackboard. The methods adopted to vary the amount of inductance and capacity, thereby varying the wave-length produced, were also shown. A very hearty round of applause was given at the finish of the lecture.

After the announcements a most lively discussion took place. Questions were asked concerning the last lecture on "The Electro-Magnetic Theory," and also on the lecture just given.

Atmospherics were discussed, and the secretary pointed out the advantage of a "double pole change-over switch," so that the apparatus could be disconnected from the aerial at will, at the same time connecting the aerial to earth, the aerial when so connected acting as a first-class lightning-conductor.

The secretary also described briefly the existing theory concerning the reception of tremendous wave-lengths from the unknown. He did not give the Mars theory much credit, but considered it highly probable that these large wave-lengths were the result of oscillations of tremendous energy set up by the discharge and vice versa of the electrified clouds of gases surrounding the sun.

Mr. Sargent, F.R.A.S., of the Observatory, Durham, has consented to give a lecture discussing these phenomena in more detail.

It was decided to hold the meetings every Friday. The 14 days' interval, however, will still be adhered to between the important meetings, leaving the alternate Fridays for Morse buzzer practice, demonstrations, and discussions of minor importance.

The meetings are still open for intending members. It is hoped shortly to organise a field day, also a social evening. At future meetings there will be buzzer practice, and small demonstrations with apparatus kindly lent by Mr. S. Kelly (hon. treas.).

The merits of a free library for members will also be discussed.

Hon. sec., George Barnard.

## Wireless and Experimental Association.\*

On Wednesday, August 23rd, the Wireless and Experimental Association at the Central Hall, Peckham, had the pleasure of listening to a very interesting and instructive lecture by Mr. Haynes on the "Johnson Rabek Loud Speaker."

Starting from the very beginning, the lecturer went through every point of the construction of the apparatus, giving enough of the theory to enable his listeners to appreciate the various parts and their uses.

Instructions were given to enable amateurs to cut and polish their own agate cylinders, if they had the right sort of agate. The necessity for a polarising battery to make the apparatus sensitive to weak signals was well brought out.

The association's installation engineer was unfortunately not present, and the wireless receiving set not available for purposes of demonstration of the capabilities of the loud speaker, but a couple of orators and a songster in another room made up a scratch broadcasting programme, though they did not tell the tale of the stuffed dog.

The lecturer afterwards demonstrated the use of the Neon tube as a generator of oscillations, and more than one present had an idea that it might be very useful in the installation of an Armstrong receiving circuit.

The meeting closed with a cordial vote of thanks to the lecturer.

Hon. sec., George Sutton, A.M.I.E.E.

## Wolverhampton and District Wireless Society.\*

A meeting of the above society was held at headquarters, 26, King Street, Wolverhampton, on Wednesday, the 23rd ult., when a lecture was given by Mr. D. P. Baker on "Tape Recording by Wireless."

The lecturer dealt very ably and lucidly with the subject, explaining the necessity for rectification and the use of two relays to operate the inker, also demonstrating with the actual apparatus and with diagrams. The meeting was well attended, and the members present were greatly interested. It is hoped to secure the services of Mr. Baker again.

The resignation of the secretary, Mr. G. W. Jones, was tendered, and received with regret, Mr. Jones feeling reluctantly compelled to relinquish the secretarial duties owing to pressure of business. The meeting passed a very hearty vote of thanks to Mr. Jones for his past services, special reference being made to his work as one of the founders of the society.

The newly appointed secretary is Mr. J. A. H. Devey, 232, Gt. Brick-kiln Street, Wolverhampton, who would be glad if correspondents would kindly note.

## THE ENTHUSIAST.



**SIMPLICITY**

# "K.B." UNITS

## EFFICIENCY

**ECONOMY**

**PROMPT DELIVERY**

**IMMEDIATE SATISFACTION**

By means of these units you can build up a complete one to seven valve receiving set in easy stages to suit your pocket; while in the meantime the units already bought are in themselves a complete receiving set, whatever their number may be. All you have to do is to place the units side by side and connect straight across with the brass links provided.

### HERE THEY ARE:

**UNIT No. 1.**



**CONDENSER PANEL.**  
No. Reqd.: Optional  
**Price.**  
Complete (as shown) 34/- each.  
Set of Parts (panel only) 22/6 per set  
Mahogany Cabinet 6/- each.

**UNIT No. 2**

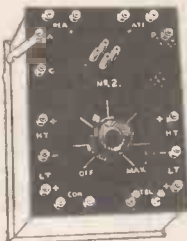

**DETECTOR PANEL.**  
No. Reqd.: 1.  
**Price.**  
Complete (as shown) 34/6 each.  
Set of Parts (panel only) 20/- per set.  
Mahogany Cabinet 6/- each.

**UNIT No. 3.**



**L.F. AMPLIFYING PANEL.**  
No. Reqd.: 1, 2, or 3.  
**Price.**  
Complete (as shown) 43/6 each.  
Set of Parts (panel only) 33/- per set.  
Mahogany Cabinet 6/- each.

**UNIT No. 4.**



**H.F. AMPLIFYING PANEL.**  
No. Reqd.: 1, 2, or 3.  
**Price.**  
Complete (as shown) 33/6 each.  
Set of Parts (panel only) 18.6 per set.  
Mahogany Cabinet 6/- each.

We also hold large stocks of complete Receiving Sets, Coil Holders, Coils, Variable Condensers (Assembled and in Parts), Valve Holders, Filament Resistances, H.T. Batteries, Accumulators, Aerial Insulators; in fact, ALL AMATEUR REQUIREMENTS.

VISIT OUR STAND, No. 8, ALL-BRITISH WIRELESS EXHIBITION, HORTICULTURAL HALL, SEPT. 30 to OCT. 7.

TRADE INQUIRIES INVITED.

CATALOGUE P/W, POST FREE, 4d.

COME AND "LISTEN IN" AT OUR SHOWROOMS. OPEN DAILY from 9 a.m. till 7 p.m.

## THE "K.B." RADIO EQUIPMENT COMPANY,

Head Offices and Showrooms: 109, High Road, Kilburn, N.W.6.

Bus Services—8, 16, 28, and 51 pass door.

3 minutes Kilburn Park Station (Bakerloo Rly.).

USE

# THREE STAR ACCUMULATORS

and have **THE BEST**

WE SPECIALISE IN ACCUMULATORS FOR WIRELESS SETS.



WRITE FOR OUR LATEST PRICE LIST.  
LIBERAL TERMS TO THE TRADE.

**THREE STAR ACCUMULATORS,**  
CROWLAND ROAD, LTD.,

Phone: TOTTENHAM 2473. SOUTH TOTTENHAM, LONDON, N.15.

**CQ**

Do you get FL?



YOUR crystal or valve may be the best of their kind—your aerial high as Snowdon, your tuner perfectly accurate, but unless your phones are O.K. you won't get maximum "sigs."

Signals come "thumping in" through ERICSSON 'PHONES—they're built that way—for never-failing clarity and sensitivity. The magnets never lose their strength and "shorts" don't exist. And they're easy and comfortable to the head.

Back of ERICSSON 'PHONES is the accumulated experience of a generation in telephone manufacture.

Write for Particulars

The BRITISH L.M. ERICSSON MANUFACTURING Co., Ltd.  
Head Office: 60, Lincoln's Inn Fields, W.C.

**Ericsson**  
Telephones





Enjoy "listening-in" at a reasonable cost.

THE "S.V." is the cheapest reliable long-range crystal set yet produced. It has an effective listening-in range for telephony up to 50 miles and for telegraphy up to 300 miles.

Supplied complete in every detail, it is only necessary to erect the seven-strand Aerial to enjoy immediately the pleasures and fascinations of wireless.

The 2,000-ohm nickel-plated double headphones give perfect reproduction.

**£3-15-0**

(Postage 1/-)

COMPLETE WITH 100-ft. AERIAL, INSULATORS & 2,000-ohm DOUBLE HEADPHONES  
Delivery from Stock.

SUMNER, VAUGHAN & CO., LTD.,  
28, Victoria Street, London, S.W.

Telephone—  
Victoria 1702

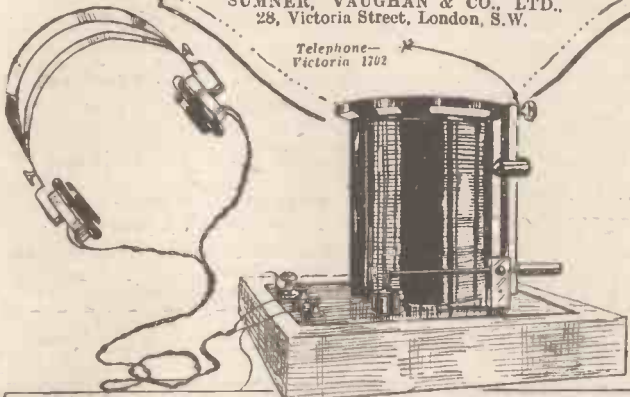

HELLO ●●●●●●●● HELLO



# BE READY FOR BROADCASTING

BY PLACING YOUR ORDER NOW.

THE STUART WIRELESS TELEPHONY INSTRUMENTS ARE DEVELOPED TO THE ZENITH OF EFFICIENCY IN ALL RESPECTS. DEMONSTRATIONS DAILY, FREE OF CHARGE. PURCHASE YOUR SET FROM THE ACTUAL MANUFACTURERS AND SECURE BEST VALUE.

## THE STUART "FAMILY SET."

THREE-VALVE TYPE, ENORMOUS RADIUS. . . . . **£26 10 0**

Transformers, High-Frequency Anode Tuners, all Wireless Accessories and Spare Parts, Magnavox Megaphones, Brown Loud Speakers, etc., supplied from Stock. Prices on application.

Send for a copy of our Illustrated Booklet giving full particulars.

**STUART WIRELESS TELEPHONY CO.,**  
Kingsway Corner Buildings, 109, Kingsway,  
London, W.C.2.

# Bower's

HAVE GREATLY REDUCED THE PRICE OF THEIR

## Wireless Parts

Workmanship on every article still up to the Highest Standard. Write now for comprehensive Money-Saving Price List. Post Free.

- Aerial Wire, 7/22 Stranded Bare Copper . . . . . Per 100 ft. hank 5/-
- Ring Pattern Insulator 2" x 1", 5/8" hole . . . . . 4d. each.
- 1/4" Section Brass Rod for Sliders cut in 13" lengths and drilled each end ready for fixing . . . . . 6d. each.
- Inductance Slider, complete with plunger . . . . . 9d. each.
- Cardboard Cylinder, diam. 4", length 12" . . . . . 8d. each.
- No. 24 Enamelled Wire, H.C., true to gauge . . . . . 2/8 per lb.
- Large or Small Condenser Plates (Aluminium) . . . . . 1/- per doz.
- Large Space Washers for Condensers, cut true to 1,000th of an inch . . . . . 7d. per doz.
- Small Spacer Washers . . . . . 5d. per doz.
- Ivory Scales . . . . . 9d. each.
- 0003 mf. Condensers complete—sembled in polished Mahogany Box . . . . . 15/- each.
- All necessary parts for above condenser—no drilling or fitting required, but unassembled . . . . . 12/6 each.
- As above, but without Box . . . . . 9/6 each.
- Ditto, but without Ebonite Top and Box, suitable for Panel Mounting . . . . . 8/6 each.
- Crystal Detector, mounted on Ebonite, complete with Crystal . . . . . 4/6 each.
- Large or Small Contact Studs . . . . . 9d. per doz.
- Valve Legs, complete with nuts and washers . . . . . 2d. each.
- Government surplus Accumulators, 16 volt, 15 amp. hrs. In case complete. (F.O.R.) . . . . . 20/- each.
- Hart Accumulators, 4 volt, 24 amp. hrs. . . . . 14/9 each.

Packing and postage for last item, 1/3 each.

Leading Firm for High-Grade Instrument Wire.  
Postage extra.

**J. B. BOWER & Co., Ltd.,**  
WIRELESS APPARATUS MANUFACTURERS,  
15, High Street, Wimbledon, S.W.19.

\*Phone: Wimbledon 1030.

Works, Merton.



Specially designed for Broadcasting.

## HEADGEAR RECEIVERS

Designed and manufactured by leading Telephone Manufacturers. Backed by many years' experience. Highest efficiency, concentrated magnetic field, instantaneously adjustable to the ears, comfortable in wear, either receiver detachable from headband, protected terminals, light weight, twin series cord.

**A.T.M. LOUD SPEAKING RECEIVERS.**

Three types of amplifying horn.

**A.T.M. CRYSTAL DETECTOR SETS.**

Highest Grade. Maximum Efficiency. Moderate Cost.

Ask your dealer for  
**A.T.M. Broadcasting Apparatus**  
AUTOMATIC TELEPHONE MANUFACTURING CO., LTD.  
Head Office and Works, Milton Road, Edge Lane, Liverpool,  
London Office, 60, Lincoln's Inn Fields.



# PLAYING TO 500,000 PEOPLE.

By MARIE NOVELLO.

**NOTE**—Miss Novello has recently returned from America, where she was the first British artist to broadcast music by radio. At my invitation Miss Novello has written her impressions for *Popular Wireless*.—EDITOR.

**T**HE *blasé* and sensation-weary will tell you there is no such thing as novelty, but a few weeks ago, in New York, I experienced the most novel sensation of my life.

I had gone to America with the avowed intention of having a holiday, but importunate managers and a "live wire" Press quickly banished this hope, and I was persuaded to give a "recital by wireless" from the broadcasting station at Newark, New York.

Newark—popularly known as WJZ—is probably the best-known station in the States. Its nightly programmes are heard by thousands of "radio fans," and its reputation has been established far and wide.

### The Unexpected.

Like a good many other people, to me wireless has always been a rather mysterious, if fascinating, brand of black magic, and I was rather hazy about the whole business of broadcasting, despite the daily booming of the new craze in the Press.

However, on the night fixed for the concert, a motor-car arrived at my hotel, and I was

The manager led me to the piano and asked me to try the instrument. One or two of my friends came into the room and sat down gingerly on the chairs, very much as if they were in a dentist's waiting-room.

The very absence of anything unusual made me feel just a trifle nervous. I don't know what I had expected, but I could not reconcile this comfortable room with wireless. I missed the complicated apparatus I had seen in photographs and the atmosphere of wizardry, I suppose.

### Let her go!

However, a few preliminary bars on the piano made me feel more at ease. At any rate, the piano was real!

At a sign from the manager I ceased playing. He picked up the 'phone:

"Hullo! All ready? Right, let her go!"

I sat tight. Now for it!

But nothing happened. The manager merely motioned my friends to keep perfectly quiet, and did something to the switchboard, and turned the horn-shaped contraption in the direction of the piano. At another sign I began to play.

I had chosen a Chopin polonaise. It was a piece that required a certain amount of concentration, but all the time my thoughts were whirling with the knowledge that my playing was being listened to by a vast audience—all the more vast to me because I could not see them.

It was an extraordinary feeling. Here was I giving a concert to half a million people, and only about five or six of them visible!

When I had played the final chords I automatically stood up and bowed. Not a sound. Not a hand-clap. I was stunned!

The sound of applause becomes a natural event to a concert pianist; not to hear it is bewildering, because, whether one pleases an audience or not, clapping, *piano* or *fortissimo*, usually follows as a matter of course.

While I stood there—looking rather silly, I suppose—the manager again did something at the switchboard, and then turned round with a smile.

### Some Audience!

"Very nice; very nice indeed, Miss Novello," he purred. "Glad you did not forget my hint about using the pedal as little as possible. No chance of blasting while you play!"

The idea of people swearing while I played was novel and a little startling, and I suppose my expression indicated my surprise.

The manager smiled again.

"Too much pedal sometimes causes a blurring of the piano notes when broadcasted," he said. "We call that 'blasting.'"

The 'phone bell tinkled, and he lifted the receiver.

The conversation was one-sided, but when he had finished he turned to me again.

"Reports from our listening-in critics are good," he said. "There's no need for me to bring the microphone nearer."

After that I went through my programme and went home to bed.

But just before I dozed off my brain was rioting with the extraordinary—and yet, to-day, so very ordinary—feat of playing to half a million people.

As they say over there, "some audience!"



Miss Marie Novello.

borne off to the Newark station at a speed rivalling that of wireless waves. And that was "going some."

At the station everything was quite unlike what I had expected. Evening dress was *de rigueur*; there were no clattering dynamos to be seen, no smell of oil or suggestion of a modern wizard's abode.

### Something Missing.

I was shown into a cosy dressing-room and told the time I must play.

Prompt to the minute the manager escorted me into the broadcasting-room. The walls were hung with thick velvet curtains. A grand piano, a gramophone, one or two chairs, a telephone, a small switchboard, and a curious horn-shaped device supported on a tripod arrangement completed the furnishing.

No. 1. JUST OUT!!! No. 1.

## 1/- RADIO CHART Post Free.

### "THE CARE AND MAINTENANCE OF ACCUMULATORS."

By G. D. HINKS, A.M.J.Inst.E., A.I.Radio E.

In addition to being full of comprehensive matter concerning accumulators, there are also several diagrams relating to Wireless Receiving Circuits.

Obtained direct from the publishers:—

Publishing Branch, G. D. HINKS, HARDINGTON, YEOVIL.

**ACCUMULATORS, etc.** New & Guaranteed  
 4-Volt, 25-Amp. Celluloid 11/3d. Postage 1/-  
 4-Volt, 40-Amp. 17/6d. | 6-Volt, 40-Amp. 25/6d  
 4 " 60 " 21/3d. | 6 " 60 " 31/-  
 4 " 80 " 27/- | 6 " 80 " 38/-  
 Packing 1/6d. extra. | Packing 2/- extra.  
 7/22 Aerial, 6/- 100 ft.; Mullard Ora Valves, 15/-;  
 15-V. Siemens, H.T. Batteries, 4/-; Marconi R. Valves, 26/6d.; Accumula or Charging Board, 37/6d.; Voltmeters, Watch pattern, 0/22 Volts, 6/-; Cash with order. Goods despatched per return.  
**LOWKE & SONS Ltd., Northampton.**

### TO WIRELESS EXPERIMENTERS. PATENT YOUR INVENTIONS.

They may prove very valuable. Particulars and consultations free. **BROWNE & CO., Patent Agents, 9, Warwick Court, Holborn, London, W.C. 1.** Established 1840. Telephone, Chancery 7547.

The Polytechnic, 309, Regent St., W. 1.

## RADIO - BROADCASTING

Evening Courses in Elementary and Advanced "Wireless" by expert Engineers commence on September 25th. Enrolments begin September 13th. Accommodation in the Classes is limited. Particulars free on application to the Director of Education.

### VARIABLE CONDENSERS.

0003 MFD., 13/6. Mineral Crystals and Accessories. Stamp for List.

**SMITH, ANCHOR HOUSE, PENRITH.**

## Wireless Headphones.

4,000 ohms, 24/6, Post Free.

Don't confuse these with the cheap foreign-made 'phones now on the market. These are BEST French Make Satisfaction guaranteed or cash returned. List Free

### LIBERAL DISCOUNT TO TRADE.

## W. JOANES (PARIS AND LONDON)

42, JENNER RD., Stoke Newington, London, N. 16.  
 Single-Valve Detector Panel, Mahog. Cabinet, 30/-.  
 Variable Condensers in ditto with scale 0003, 12/6; 0005, 15/6; 001, 21/6.  
 Grid Condenser and Leak, 3/6. Anode Resistance with Condenser, 5/6. Fixed Condensers; any capacity, 4/6. Filament Resistances, 3/6.  
 Immediate delivery. Trade terms on application.

### KENWARD BROS.,

## WIRELESS MANUFACTURER, RYDE, I.W.

**STEVENS COUNTERPOISE EARTH BOX & CABLE OUTFIT.** Send cash 5/6 (includes postage in U.K.). ENSURES BEST RESULTS WHEN INSTALLED. Instructions supplied. Length of cable 30 ft. Additional 10 ft. lengths, 1/- each.—A. H. STEVENS, 12, Shrubbery Rd., London, S.W. 16. Phone Streatham 1316.

## ELECTRADIX RADIOS.

Immediate Delivery from our Huge Stocks.

Everything from a Recorder to an Earth Clip.

The best-equipped City depot.

COME AND SEE US.

9, Colonial Avenue is first opening on left in the Minories, near Aldgate Station, Metropolitan Railway.

**LESLIE DIXON & CO.** Tel.: Avenue 4166.  
 9, Colonial Avenue, London, E. 1.



## SPEARS and COMPANY FOR TERMINALS

SCREWS, NUTS, WASHERS, PLUGS and  
SOCKETS, CONTACT STUDS, BUSHES,  
VALVE LEGS, CONDENSER PLATES,  
and TURNED and PRESSED PARTS OF  
:: :: EVERY DESCRIPTION. :: ::

Actual Manufacturers to Trade Only.

We regret we cannot supply small lots to amateurs.

CAPSTAN REPETITION WORKS,  
PARK RD., HOCKLEY, BIRMINGHAM.  
Phone: 3255 Central. 'Grams': "Firettes," B'ham.

## SPECIAL PURCHASE

2,000 Pairs Super-Sensitive High-Resistance  
Head-phones, 4,000 Ohms. Brand New.

Delivery from stock. £1 7 6 post free.

OLIVER'S WIRELESSORIES,  
196, Wandsworth Bridge Road,  
Phone: Putney 1257. London, S.W.6.

AMATEURS AND RETAILERS  
PARTS SUPPLIED FROM STOCK.  
LISTS FREE. Condenser plates 1/6 doz. pairs; post 3d.  
FRASER, Sentinel Ho., Southampton Row, London.

WRIGHT BROS., Electrical and Radio Engineers,

38, CROSS STREET, SALE, MANCHESTER.

Aerial Wire, 7/22's, bare copper, per 100 ft., 4/6.  
" " 7/22's, enamelled, per 100 ft., 5/6.  
Condenser Vanes, hard, aluminium, accurate,  
1/- doz., 10/- gross.

Variable Condensers, ebonite plates and knob,  
best finish. Ivorine scale. '0002, 3/6 each;  
'0004, 10/6; '0005, 12/6; '001, 16/6 each.  
Panel or Cabinet or separate type, same price.  
Complete in mahogany polished Cabinet, '0602,  
2/6 extra; '0004, 2/9 extra; '0005, 3/- extra;  
'001, 3/6 extra. Filament Resistances, panel-  
mounting type, 3/6 each.  
List on application. All items kept in stock.  
TRADE SUPPLIED.

## "A" MODEL DOUBLE RECEIVERS

4,000 ohms, 29/6, Post Free.

The headphones are considered by experts to be the  
most sensitive on the market. Beautifully made, light  
and comfortable. Limited stock only. A Bargain.

Money gladly returned if not satisfied.

NICHOLAS DALE ELECTRIC SUPPLIES,  
12, St. Ann's Road, London, S.W. 18.

## GLASGOW WIRELESS SUPPLY CENTRE:

All Materials and Accessories for Amateurs. Panels  
Engraved. Write for Price List enclosing stamps.  
W. and J. JAMIESON, Ltd., 68, Shamrock St., West.

SEND FOR OUR SPECIAL TRADE TERMS  
FOR  
MAHOGANY BOXES FOR ALL  
PURPOSES.  
EBONITE UNIT PANELS,  
PLATES, &c.  
COIL HOLDERS, CONDENSERS, &c.  
ASTON & MANDER (1917), Ltd., London, N.W.10.

## DAVIS & TIMMINS, LTD.,

34a, York Road, King's Cross, N.1.

## SCREWS AND TERMINALS

FOR  
WIRELESS SETS

Write for Illustrated Lists.

# RADIOTORIAL

All Editorial Communications to be addressed The Editor, POPULAR  
WIRELESS, The Fleetway House, Farringdon Street, London, E.C.4.

The article on the British Broadcasting Co. which  
is published in this issue of POPULAR WIRELESS  
is from a correspondent who is very much *au fait*  
with the broadcasting plans. My readers will  
naturally appreciate the fact that it is not desirable  
to publish the author's name, but what he writes is  
probably the most accurate account of the broad-  
casting companies' plans that has yet appeared in  
print.

Amateurs have had so many disappointments with  
regard to broadcasting that I determined to secure  
some really reliable information, and I think my  
correspondent is to be relied on in that respect.

With the approach of the winter months amateurs  
are paying more and more attention to their sets.  
September is really the month for a wireless "spring  
clean," especially with regard to the aerial.

And with a definite assurance of a broadcasting  
service, this winter should prove an interesting one  
for all wireless enthusiasts.

THE EDITOR.



Owing to the enormous number of queries  
received daily from readers of POPULAR  
WIRELESS, I have decided to reply individu-  
ally by post. A weekly selection of questions  
will, however, be printed on this page, together  
with the answers, for the benefit of readers of  
POPULAR WIRELESS in general. Questions  
should be clearly and explicitly written,  
and should be numbered and written on one  
side of the paper only.

All questions to be addressed to: POPULAR  
WIRELESS, Queries Dept., Room 131, The  
Fleetway House, Farringdon Street, London,  
E.C.4.

Readers are requested to send necessary  
postage for reply.

O. B. (Tooting).—In the circuit illustrated,  
how can there be an "earth" if there is a  
variable condenser in series in the primary  
circuit?

If the aerial and earth are regarded as a large con-  
denser as described recently in an article entitled "An  
Important Condenser," the word "series" becomes  
self-explanatory. In any case, it is obvious that the  
condenser is included in the primary circuit, and one  
terminal goes directly to earth.

Why does a frame aerial require no earth?

The circuit is completed from the aerial terminal  
through the turns to the earth terminal.

When using a reaction coil in conjunction  
with a fixed coupled inductance, should this  
reactance slide inside the secondary coil?

The better plan is to place a small fixed coil in  
series with the secondary and couple that loosely  
with the reaction coil.

"METEOR" (Barnsley) asks for the best  
method of arranging basket coils for use with a  
valve set.

Wind six coils of 64 turns of 26 S.W.G. with  
2 1/2-in. hole. These should be mounted in line on a  
stand separating them 3/4 in. The first coil, which  
should be movable, can act as a reactance, while the  
remaining five are connected in series, each being taken  
to a tuning switch so that any number can be brought  
into the circuit. A variable condenser of '00045 mfd.  
capacity should be placed across for tuning purposes.  
The wave-length range will be from 300-4,500 metres.

G. F. H. (Croydon).—Can you tell me how  
to make a potentiometer?

Wind a former 4 in. by 1 in. with 36 "Eureka" or  
german silver resistance wire. That will take about  
20 yds. A slide should be fixed on the same principle  
as that of a single slide inductance coil. Both ends  
of the winding should go to terminals. The battery is  
connected across the winding by means of the two  
terminals, the external connections being from the  
slide and one terminal. Between this latter and the  
varying position of the slide exists a directly varying  
potential drop.

"INTERESTED IN WIRE" (Malvern Link).—  
Is there any secret way of transmitting direc-  
tive telephony?

At present no, but experimenters are working hard  
to discover a method to do this. Some success has  
been achieved in directive transmission, and we do not  
doubt that eventually some scheme that will necessi-  
tate the co-operation of some arrangement between  
a certain transmitting station and a certain receiving  
station will be evolved that will render it impossible  
for any other station to overhear the conversation.

A. C. (N. 8).—Can good results be obtained  
with a crystal set in the way of concerts and  
other telephony?

Yes; very clear and undistorted telephony can be  
received on a crystal set within a limited range, using  
a good outdoor aerial.

Is there any means of amplifying to extend  
the range of a crystal set?

The only satisfactory method is to employ valves.

Would there be any difficulty in the obtain-  
ing of a licence for a 5-valve set?

Providing that no reaction coil or connections for  
such are included there will be no difficulty.

F. B. (Clapton) submits a small sample of  
a heavy gauge bare copper wire and asks if  
it is suitable for the aerial.

Quite suitable.

R. D. B. (Binley).—I am situated twenty  
miles from Birmingham. Should I be able  
to hear telephony on a crystal set from that  
town?

With a good outdoor aerial and careful tuning and  
adjustments, yes.

Are basket or honeycomb coils suitable for  
a crystal set?

The single layer cylindrical inductance coil is to be  
preferred.

Is a battery required for a zincite copper  
pyrites detector?

No.

Is the enclosed diagram correct, and would  
it be suitable for the reception of telephony?

Place the condenser across the coil and the crystal  
in series with the 'phones. Cut out the potentiometer  
and battery. '003 mfd. is too great a capacity for  
the variable condenser if you desire to cut down to the  
lower wave-lengths. '0005 mfd. would be more  
suitable. The circuit will then be quite O.K. for the  
reception of telephony within a limited range of  
twenty miles or so.

A. T. (Winsford).—Will a pair of 'phones  
with a total resistance of 4,000 ohms be suit-  
able for any crystal or valve receiving set with-  
out a transformer?

Yes.

"HISTORICAL" (Bradford).—When did wire-  
less first feature in an "SOS" call?

In 1899, when the steamship R. F. Matthews ran  
into the East Goodwin lightship during a dense fog.  
A wireless message brought lifeboats from the shore.

Does "SOS" mean Save Our Souls?

No. This distress call was initiated by the Berns  
Wireless Conference held in 1906, and was adopted  
simply on account of its unmistakable character and  
ease of transmission.

"SPARKS" (Plymouth).—Would an aerial  
30 ft. high and 35 ft. long be all right for  
receiving messages on a crystal detector?

Make it a two-wire aerial, and it will be quite effi-  
cient for the purpose.

Can insulated wire be used for the earth  
lead?

Certainly. As a precaution, more especially when  
using valve sets, it is very advisable that all wiring  
and leads should be insulated.

(Continued on page 299.)



Established 1900.

CONSIDER WILL YOUR FUTURE

**WE TEACH BY POST.**

ADVICE FREE Most moderate charges—payable monthly.

**LEARN A TRADE OR PROFESSION**

*J. Bennett*

**Can I help you?**  
**I WILL GIVE YOU £50**  
 if I fail to produce over 7,000 testimonials from others I have helped TO A SUCCESSFUL CAREER.  
 Yours to success.

**ARE YOU QUALIFIED FOR THE JOB YOU SEEK?**

Write for one of our FREE BOOKLETS on WIRELESS TELEGRAPHY, or on any of the following subjects—

Architectural Drawing	Mathematics
Building Construction	Matriculation
Clerk of Works' Duties	Metallurgy
Aviation	Mining
Boiler Engineering	Mine Surveying
Boiler Making	Motor Engineering
Chemistry	Naval Architecture
Civil Engineering	Pattern Making
Concrete and Steel	Salesmanship
Draughtsmanship	Sanitation
Electricity	Shipbuilding
Engineering	Structural Engineering
Foundry Work	Surveying and Levelling
Internal Comb Engines	Telegraphy and Telephony
Marine Engineering	Special Course for Apprentices

What proof do you carry? Your word to an employer is not proof that you are efficient, but a College Qualifying Diploma or Certificate, signed by the Professional Staff, is a proof of efficiency, and a valuable asset in seeking a remunerative position.

We specialise in all exams, connected with Wireless and other technical subjects. If you are preparing for any exam, ask our advice. All particulars FREE OF CHARGE. Parents should seek our advice for their sons. If you are interested in Wireless, or any of the subjects mentioned above, write naming the subject, and we will send you our FREE BOOKLET. Please state your age.

**COURSES SPECIALLY COMBINED TO MEET ALL REQUIREMENTS.**

**The Bennett College**  
 Department 106. SHEFFIELD

**BUILD YOUR OWN CONDENSERS**

**NOTE REDUCED PRICES**

SETS OF PARTS.

Approx. Capacity In Micro-farads.	No. of Plates	Ready to assemble for Panel Mounting. Add 1/- each size for Cabinet Mounting.	Price assembled for Panel Mounting. Add 6d. if required for Cabinet Mounting.	Complete in Polished Mahogany Cabinet ready for use.
.0015	85	24/-	27/-	35/-
.001	57	18/-	21/-	27/6
.00075	43	14/-	17/-	22/6
.0005	29	11/-	13/6	18/6
.0003	19	9/-	11/6	16/6
.0002	13	7/-	9/-	14/-
.0001	7	6/-	8/-	12/6
.00005	3	—	4/6	9/6

Prices are for parts with Ivorine Scale and Pointer. Bevelled Dial, 3/6 extra.

Illustration shows for Panel Mounting

**THIS WEEK'S SPECIAL OFFER (DELIVERY FROM STOCK)**  
**FRENCH HEAD-PHONES, 4,000 ohms .. 35/-**

VISIT OUR STAND, No. 16, ALL-BRITISH WIRELESS EXHIBITION, HORTICULTURAL HALL, SEPTEMBER 30th TO OCTOBER 7th.

**CRYSTAL DETECTOR**  
 (as illustrated). Ready for use with crystal.  
**Price 4/6**

SEND FOR ILLUSTRATED CATALOGUE (P/W) with list of stations. Crammed full of the latest and best.

**THE PETO-SCOTT Co**  
**THE CONDENSER KING**

**DON'T FORGET THE NEW ADDRESS:—**  
 Featherstone House,  
 64, High Holborn,  
 London, W.C.1.  
 Still at 17, Frome Rd.,  
 Wood Green.

**HEAD SETS.**

4,000 Ohm, best value in London	27/-
Complete set of parts for .0005 variable condenser, unassembled, easy to assemble	8/9
Aerial wire, 100 ft. lengths, No. 7/22 stranded, 4/3; No. 18 copper	2/9
Crystal detector mounted on Ebonite base	3/3
Valve holders, Ebonite, best finish	1/6

Carriage paid on all orders of £1 or over.

The above are an example of all our prices; send for our price list of complete sets and spare parts, post free.

All the above articles in stock. Trade supplied.

Bring your troubles to us. Advice given to those in difficulties by our technical adviser, who has had several years' actual practical experience.

**THE HOLBORN RADIO CO.,**  
 8, High Holborn, London, W.C.1. (5 doors from Gray's Inn Road)  
 'PHONE: CHANCERY 7278.

**STOP!!**

READ THIS, IT WILL SAVE YOU MONEY. EVERYTHING FOR "WIRELESS." INSTRUMENTS, PARTS, AND MATERIALS.

OUR SPECIALITY—One-Valve Note Magnifier ... .. £3 3s.  
 ONE-VALVE PANEL (a beautiful little instrument) ... .. £1 7 6  
 TWO-VALVE H.F. Amplifier (Transformers extra) ... .. £6 10 0  
 TWO-VALVE H.F. and 1-valve L.F. Amplifier (transformers extra) ... .. £8 10 0  
 SOMETHING NEW, COLOURED H.F. TRANSFORMERS.

Interchangeable type to fit standard valve holders. These Transformers are supplied in various colours, to quickly distinguish the different wave-lengths. Supplied either wound or unwound. Unwound but complete with split pins, 3/6 to 5/-.

Wound, 4/6 to 13/6.

EBONITE PANELS OF BEST QUALITY, 12 x 10 x 1/2 ... .. 8/6  
 Other sizes, 5/6 per lb.

VALVE LEGS, with two nuts and washer, set of four, 9d.; TERMINALS, with two nuts, 3d.; SPLIT VALVE PINS, 2d. each, set of four, 7d.; CONTACT WITH NUT, 10d. per doz.; FILAMENT RHEOSTATS, wound on erinold former, 5/6 each; INSTRUMENT CASES, made from well-seasoned mahogany, and polished, 11 x 9 x 3 in. deep, 9/6 each; Ditto, for one valve, 8/- each; Ebonite knobs, with screw cast in for filaments, 6d.; Ebonite Dials, including engraving, 2/6.

LOUD SPEAKERS. "THE MAGNAPHONE" with improved curved tone arm, latest pattern ... .. £2 15s.  
 CONDENSER for .0001 Panel Mounting, with Ivorine Scale ... .. each 10s.  
 Carriage paid on orders of three pounds upwards. Please include postage when ordering. Money refunded if not satisfied. 15 Years' Experience.

**THE BROADCAST WIRELESS INSTRUMENT CO.,**  
 144, WARBRECK ROAD, BLACKPOOL, N4.

**WIRELESS ENTHUSIASTS.**

ABSOLUTELY COMPLETE

FOR **£3 - 10 - 0** CASH

OR **£1 - 0 - 0** DOWN AND 5/- WEEKLY FOR 12 WEEKS

OUR BEAUTIFUL CRYSTAL SET No. 1, WITH 4,000 OHMS HEAD-PHONES, LEADING-IN TUBE, AERIAL WIRE, AND SIX INSULATORS. TESTED AND GUARANTEED FOR CLEARLY RECEIVING BROADCAST SPEECH, MUSIC, AND MORSE MESSAGES.



THE COIL IS WOUND ON BEST 'ISOLO' UNSHRINKABLE TUBE 12" x 4", GIVING A GOOD PICKING-UP RANGE AND MOUNTED ON POLISHED BASE, WITH CONDENSER, ETC.

**BOOK OF INSTRUCTIONS WITH EACH SET.**

Cheques, P.O. or M.O. must be crossed  
 NATIONAL BANK, Ltd., King's Cross Branch.

**SEND YOUR ORDER TO-DAY WITHOUT DELAY**

**H. A. WHITE & SON, 229, Pentonville Road, London, N. 1. 'Phone: Central 3045.**



# OWING TO THE SUCCESS OF OUR CAMPAIGN WE HAVE DECIDED TO CONTINUE THIS OFFER FOR A FURTHER WEEK

**THIS OFFER WILL BE WITHDRAWN ON SEPT. 16th,**

HENRY J. BREWSTER & Co. (Manufacturers of "Aerowave" Specialities) have decided to extend their offer as part of their Advertising Campaign, knowing that satisfied customers are the best possible recommendation.

## FOR THIS WEEK ONLY

## we will accept HALF THE USUAL PRICES

**SINGLE VALVE**  
**"RELIANCE" No. 1 SET**  
 (£12 12s. Od. less 50 per cent.)  
**SPECIFICATION.**  
 1 Polished Oak Cabinet  
 1 8in. x 6in. Ebonite Panel with all terminals  
 1 Filament Resistance  
 1 Mullard "Ora" Valve  
 1 Vernier Condenser  
 1 Grid Leak & Condenser  
 Set of Tuning Coils covering broadcasting wave-lengths  
 Set High Resistance Headphones (4000 ohms)  
 1 H.T. Battery (30 vts.)  
 1 Accumulator (4 vts.)  
 Complete Aerial Equipment. Full Instructions and Blue Print.  
**Price This Week - £6 6s. Od.**

**TWO VALVE**  
**"RELIANCE" No. 2 SET**  
 (£15 15s. Od. less 50 per cent.)  
**SPECIFICATION**  
 1 Polished Mahogany Cabinet  
 1 10in. x 8in. Ebonite Panel with all terminals  
 1 Separate Filament Rheostat  
 2 Mullard "Ora" Valves  
 H.F. Transformer Socket  
 Grid Leak & Condenser  
 Set of Tuning Coils covering broadcasting wave-lengths  
 Set Headphones (H.R. 4000 ohms)  
 Fixed Condenser  
 1 Accumulator (4 vts.)  
 H.T. Battery (30 vts.)  
 1 Variable Condenser  
 Complete Aerial Equipment. Full Instructions and Blue Print.  
**Price This Week - £7 17s. 6d.**

**THREE VALVE**  
**"RELIANCE" SUPER SET**  
 (£30 0s. Od. less 50 per cent.)  
**SPECIFICATION.**  
 Heavy Polished Mahogany Cabinet  
 Sloping Front  
 Ebonite Panel 14in. x 12in.  
 3 Separate Filament Rheostats  
 3 Mullard "Ora" Valves  
 Grid Leak & Condenser  
 Vernier Condenser  
 Phone Condenser  
 Complete Set of Tuning Coils for broadcasting wave-lengths  
 Accumulator (4 vts. 60 amps.)  
 H.T. Battery (60 vts.)  
 1 L.F. Transformer  
 1 Plug-in Transformer  
 Set H.R. Headphones (4000 ohms)  
 Complete Aerial Equipment. Full Instructions and Diagrams.  
**Price This Week - £15 0s. Od.**

**NETT CASH WITH ORDER — CARRIAGE PAID — DELIVERY IN ROTATION.**

IF YOU ARE NOT COMPLETELY SATISFIED WITH YOUR PURCHASE AND RETURN THE APPARATUS TO US UNDAMAGED WITHIN SEVEN DAYS FROM RECEIPT, WE WILL REFUND YOUR MONEY IN FULL.

**NOTICE TO THE TRADE**

WE cannot allow the usual Trade discount off these prices. It must be understood that we are selling at these prices as an advertisement. We shall be pleased to give quotations to Traders who wish to take advantage of this advertisement by stocking

**"RELIANCE"  
Radio Apparatus**

**NOTE**

Only one of any of these Sets can be supplied to each customer at the reduced prices.

**FILL IN & POST ORDER FORM  
NOW**

Letters containing cash should be registered.  
Cheques and Money Orders must be crossed and made payable to:

To HENRY J. BREWSTER & Co.  
11 Queen Victoria St., London, E.C.4.

Please forward, carriage paid, one RELIANCE SET No. .... for which I enclose Money Order value £ : : : on condition that if I am not satisfied my money will be returned in full.

Name .....  
Address .....  
Date .....

WRITE CLEARLY.....

# HENRY J. BREWSTER & CO.

MAKERS OF "AEROWAVE" SPECIALITIES

Telephone:  
CITY 768

11, Queen Victoria St., London, E.C.4

Telegrams:  
"AEROWAVE"  
PHONE LONDON.

## RADIOTORIAL QUESTIONS AND ANSWERS.

(Continued from page 296.)

"HIGHTENSION" (Felixstowe).—Could a battery of small accumulators be used for the high tension of a valve receiving set?

Yes, but both the initial cost and cost of upkeep would be greater than that of the dry batteries retained in 15-volt units for that purpose.

What would be the high tension voltage required for an amateur valve transmitting set? Could batteries be used?

If equipped with a suitable valve 200 or so volts supplied by dry batteries will suffice for a short range of transmission. To obtain greatest efficiency in radiation 700 or so volts would be required.

\* \* \*

"AMATEUR" (Newcastle-on-Tyne).—As I live within a mile of the centre of the above town, would it be worth while to purchase a valve set to receive from the proposed broadcasting station?

Not if you do not intend to use a loud speaker.

### THE OMNIPHONE SUPER-EFFICIENT CRYSTAL RECEIVER.

Price £4:10:0 COMPLETE.

(See last issue.) With terminals for the addition of valve amplifier. Wave-length range 300-500 metres. Fully guaranteed. Call for demonstration, or write for full particulars.

ALL WIRELESS ACCESSORIES.  
LIST FREE.

We undertake the Installation,  
Alteration and Repair of Apparatus.

THE OMNIPHONE WIRELESS CO.,

24, WARWICK STREET,  
REGENT ST., LONDON, W.1.

20 yards from Regent Street, between  
Robinson & Cleaver's and Maison Lewis.

'Phone: Regent 3335.

#### WIRELESS WORTH WHILE.

When K.E.W.S. Apparatus is used, High Class Instruments at Reasonable Prices.

Single-Valve Receiving Station:—Detector Unit, Tuner Unit, Condenser Unit, 50v. H.T. Battery (Siemens), 4v. 40c. Accumulator, 4,000-ohm Phones, Aerial Wire, Insulators, Lead-in Tube, Earthing Switch, £10 10s., ready for signals.

Crystal Receiver, 200-2,500 Metres, Range 200 miles Telegraphy, 25 miles Telephony Concerts, £2 5s. Complete with Phones, Aerial Wire and Insulators, £4 5s. Phones! Phones! Phones! 4,000 ohms double headgear, 30v. Accessories, Cheapest and Best; List, Stamp for details, Unit System.—K.E. Wireless Service, 10, Glenview Rd., Lewisham, S.E.13.

"CURIOUS" (Highgate).—If one is within a very short distance of a transmitting station, can a loud speaker be used in conjunction with a crystal receiver?

No. To obtain good results with a loud speaker, signals must be very strong. In the case of a crystal detector it is necessary to tune down very strong signals, otherwise the sensitive adjustment will be destroyed, therefore sufficient signal strength cannot be maintained on a crystal detector set to operate a loud speaker with any success.

Why cannot crystals be added to act as amplifiers to a crystal set by means of applying a local current?

For several reasons, not the least being that given in answer to your first question.

\* \* \*

"LITTLE WILLIE" (Liverpool).—How many tinfoil plates 3½ in. by 4¼ in., separated by glass 1-16th in. thick, would I need for a fixed condenser of .01 mfd.?

30 on each terminal.

How many tinfoil plates 1 in. by 2 in., separated by waxed paper, would I need for a .01 mfd. fixed condenser?

26 on each terminal.

How many moving and fixed vanes 2½ in. and 3½ in. diameter, respectively, separated from each other by ¼ in., must I have for a variable condenser of .0005 mfd.?

13 fixed and 13 moving, if the fixed vanes are separated from the moving vanes by ¼ in. That seems rather a large distance, and it may be assumed that it is meant that like vanes are separated that distance, making it ½ in. less the thickness of the metal. In this case some 7 fixed and 6 moving will be required.

What is the wave-length of a set using a coil 5 in. diameter, wound for 11½ inches with 22 S.W.G.?

250—2,400 metres approx.

\* \* \*

T. E. B. (Southsea) asks for information in respect of 21 coastal stations.

All these stations with but one or two exceptions were detailed in a list that appeared in No. 6 of POPULAR WIRELESS, which may still be obtained upon application to the Back Number Dept., 7 and 9, Pilgrim Street, Ludgate Hill, London, E.C.4.

\* \* \*

"WAVE-LENGTH" (Bradford).—Of what value is the self-capacity of an inductance coil?

That varies considerably from the few centimetres of the single layer of ordinary dimensions to some .001 mfd. or more for the larger multi-layer coils.

Could it be introduced into the formula  $\lambda = 1885 \sqrt{LC}$  in order to give the natural frequency of a coil?

The self-capacity of a coil cannot be calculated with any great degree of accuracy, and therefore the results obtained would not be satisfactory.

(Continued on next page.)

## WE SUPPLY EVERYTHING FOR WIRELESS FROM STOCK SEND FOR OUR LISTS AND SAVE MONEY

PORCELAIN INSULATORS, Reel Type	each	4d.
Shell Type		1/6
SPREADERS, 6 ft. x 1 in. diameter, best quality ash	each	2/6
100 ft. 7/22 ENAMELLED AERIAL WIRE		
50 ft. 10 G. BRACING WIRE		18/-
4 WIRE STRAINERS: 1 Doz. FERRULES		5/-
CONDENSERS, .0005 Vernier	each	10/6
" .0002 Variable	"	16/8
" .0005	"	16/8
PANEL CASES, polished mahogany, 7½ in. x 5½ in. x ¾ in.		5/-
PANEL CASES, polished mahogany, 6½ in. x 5½ in. x ¾ in.		4/6
SPRUCE AERIAL MASTS, 10 ft., fitted with Aluminium pulley		14/-
EBONITE PANELS cut to your requirements while you wait.		TRADE SUPPLIED.

### S. ALTON, Ltd.

165, High Road, Kilburn, N.W. 6  
'PHONE: HAMSTEAD 8018

### F. W. ILE'S WIRELESS SUPPLY.

Aerial Insulators, Porcelain (special),	each	£0	0	3
Aerial pulleys, ex-Govt., aluminium, each.		0	1	6
Aerial Wire, 7/22 copper, per 100 ft.		0	6	0
¾ in. Slider Rods, 13 ins. long, bored, each		0	0	7
Lacquered crystal detectors on ebonite bases		0	5	0
Murdock double head sets (2,000 ohm total)		1	10	0
Ebonite knobs, knurled and polished, each		0	0	6
Mullard Ora valves, limited number only, each		0	15	0

All orders sent by return on receipt of cash.  
BOSCOMBE, EAST BOURNEMOUTH.

# 3

Three points we always watch

**SPEED  
QUALITY  
PRICE**

Send two stamps to-day for our lists  
and test our service for yourself.

**ELECTRICAL SUPPLY STORES,**

5, Albert Terrace, King Cross,  
HALIFAX.

## WIRELESS MASTS

45 ft., 39s. 6d. 29 ft., 29s. 6d.  
Complete with necessary Iron Fittings, Stay Lugs, etc., for IMMEDIATE ERECTION. Will save you endless trouble. Don't buy odd, unfinished or inferior thin steel poles. Bamboo Spreaders. Galvanized Guy Wires. Actual List, particulars, post free 3d. Manufacturers: [Trade Enquiries Invited]. THE AMATEUR WIRELESS SERVICE, Dept. 1 P.W., 33, Elms Road, Aldershot.



## The Hallmark of Authoritative Wireless Literature

ALL our books are sold on the understanding that, should the purchaser think that the merit of the book does not more than justify the expenditure, the purchase price will be refunded.

The great success of our books is evidenced by the recent sale of nearly 100,000 copies.

## SELF CONTAINED OR UNIT SYSTEMS

### Marconiphones, Marconi Scientific Units, Waveora Units, Etc.

We give demonstrations to purchasers at our showrooms.

Tuners, Coils, Rectifiers, Amplifiers, Valves, Magnavox & Brown Loud Speakers, Microphone Amplifiers, H.T. & L.T. Batteries, and all Wireless Accessories.

Special quotations for Technical Colleges,  
Schools and Educational Institutions.

**The Radio Waveora Co. (Dept. P.),**  
168, Regent Street, London, W.1.

Telephones: Gerrard 3099; Western 847.  
Telegrams: Wychwood, Phone, London.



# RADIOTORIAL QUESTIONS AND ANSWERS.

(Continued from previous page.)

A. H. G. (Dublin).—Would it be possible to hear the Hague and Paris concerts on one wave with an aerial 30 ft. high at one end and 55 ft. at the lead-in end?

No. You would hear the carrier wave most probably, but you would require three valves to hear the telephony.

R. A. H. (West Barnes).—I propose erecting an aerial in our garden within about 9 ft. of some telegraph-wires. Will this be successful?

Using a crystal set, there would be little or no interference, but with valves it is probable slight interferences would be noticed. Keep the aerial as far from the parallel to these wires as possible, and, if employing valves, avoid the introduction of more than one stage of low-frequency amplification.

L. W. I. (London).—What is the wave-length of an inductance coil 6 in. in diameter wound with 140 turns of 20 S.W.G. on an 80-ft. aerial?

1,100 metres.

"BEGINNER" (Barnsley) complains that he cannot obtain results upon his crystal set, and asks whether the diagram that he submits is correct.

The diagram is incorrect. The correct connections are as follows: Aerial to the slide of the inductance, the end of which should go to earth. The slide of the inductance to the crystal, crystal to 'phones, 'phones to earth.

"AMATEUR" (Birmingham).—What is the average Morse speed that the larger C.W. stations transmit?

By hand, about 22 words a minute.

I thought that I had a fair speed, having been an army telegraphist; but the other night I heard a station working; and I commenced to read the Morse signals. But all I could read was "N W," and he was away like a fire-engine, the dots and dashes sounding like one continual stream. Is it possible that it was automatically transmitting?

Yes, undoubtedly that was the case. "N W" is a warning to the receiving station that it is intended to transmit by means of a Wheatstone transmitter. The letters are an abbreviation of "Now Wheatstone."

D. E. L. (Forest Gate).—I have a five-valve set (diagram enclosed) with which I am experiencing considerable trouble owing to instability. For instance, I may adjust to a certain station, but the moment I move my hands away from the set, or even my head, the whole adjustment seems to be thrown out of balance, and I lose the station. Can you put me right?

With a resistance-coupled multi-valve set, such as the one you possess, there is a liability of trouble occurring through stray capacity effects. This is very noticeable when high-resistance telephone receivers are used, and for that reason it is advisable to employ low-resistance 'phones with a transformer. Long ebonite handles should be affixed to the various points of adjustment. When adjusting allow slightly more capacity than is required, as this will be dropped when removing the hands from the proximity of the instruments.

A. L. M. (New Barnet).—What wave-length would I have with a former 11 by 6 in., wound with No. 22 S.W.G., with an aerial 60 ft. long and 25 ft. high?

300—2,800 metres.

What quantity of that wire will be required?

1 lb.

J. B. F. (Barcote).—Should I be able to hear the Marconi House concerts from just outside Abingdon with two valves?

You should have no difficulty in doing so.

J. C. (Darlington).—Is the enclosed diagram of a single-valve set correct, and what is its radius?

The fixed condenser should be placed across the primary of the telephone transformer, and the H.T. range for reception of telephony will be about 50 miles.

Does the P.M.G. prohibit the erection of an aerial across a back street when full permission has been received from owners of houses?

Yes, and so do the local authorities.

Is there a limit of wave-length for amateur reception?

No.

"SPUD" (Blackburn).—Is it possible to hear Manchester telephony with a crystal set which has a 45-ft. twin aerial 30 ft. high, down lead 15 ft., earth lead 1 ft., and an inductance 11 by 4 1/4 in. wound with 22 S.W.G.?

The distance is about 20 miles, so that there is no reason why you should not do so with very careful adjustments and tuning.

Could I hear the Paris time signals?

No, because you will be unable to get above some 1,700 metres, whereas F L transmits the time signals on a 2,600-metre wave.

"BEGINNER" (Wembley) complains that he can obtain no results with a crystal set, a diagram of which he submits.

The connections of the set are quite correct, and from the meagre details submitted we can see no reason for the failure. A great deal depends upon the adjustment of the crystal. Galena, the crystal that you are using, requires particularly careful handling.

"CHARLIE" (Leyton).—Why is it that I can get Marconi House and amateur telephony better with my earth cut out?

Most probably because you could not otherwise cut down to their rather low wave-lengths. The 001 mfd. variable condenser, instead of being across the reactance, might more usefully be placed in series with the earth lead to bring down the wave-length range of the set. The value of a variable condenser across the reaction coil should not exceed 0003 mfd.

"X. Y." (London).—If a near-by amateur possessing a transmitting set received a "Daily Mail" Hague concert, would it be possible for him to retransmit same so that I might receive it on a crystal set?

No, for the simple reason that he would be unable to receive and transmit simultaneously on the one aerial.

T. W. (Darlington).—What is the greatest number of valves that have successfully been employed?

As many as 19 in cascade, giving a magnification of a million times, were used by the Navy in detecting buzzer signals that passed between enemy ships.

K. E. B. (Bournemouth).—Will 28 enamelled wire be suitable for winding honeycomb coils?

No, because the enamel will most probably crack at each turn. Use 26 silk or cotton covered.

What will be the capacity of a variable condenser with 7 fixed and 7 moving vanes, the fixed being 1/4 in. apart?

Assuming the diameter of the moving vanes to be 3 in., and the thickness of the vanes 1-16th in., 0015 mfd.

"CONDENSER" (Llanely).—What will be the most useful on my crystal set, a fixed or moving condenser?

The variable condenser across the coil to sharpen the tuning and increase the wave-length range.

What is the wave-length range of a coil 9 1/2 by 5 in. wound with 300 turns of 28?

2,000 metres.

Will a twin 45-ft. aerial 30 ft. high give good results?

Yes, quite.

## WE PUBLISH PRIZE WINNERS, Issue 12th August, 1922.

Question: Why did the Grid Leak?  
A Parcel of Goods has been sent to:  
Mr. W. Griffin, 17, Melvin Road, Anerley, S.E.20., for the following:  
"Because Fila. ment 2 MT it but forgot. (Mr. D. Short—D. Good, but too D. Short, as you were ohmless. Besides, Mother would be vexed)."  
Aerial Wire, 7/22's Enamelled Hard Drawn Copper, 6/- per 100 ft.  
Aerial Pulleys, 2 3/4", 1/-; 5" with tackle hook and bicket, 2/6.  
Aerial Insulators, Shell type, 2 1/4" x 2 1/4", 1/6 each.  
Aerial Insulators, Reel type, 2" diam., white, 4d. each.  
Batteries. For H.T. Make your own. Flash Lamp Batteries, 5/- doz.  
Buzzer for Morse practice, new improved line, best quality, 4/6.  
Condenser Discs, Ebonite, 3 1/2" diam. 1/- each. (each condenser Discs, engraved, fine finish, 2 1/2" diam., 1/9 Condensers. Fixed. Exceptional quality. Made with copper foil. From .001 to .001, 2/6 each.  
Condenser Vanes. Not rubbish. Best strong aluminium. Fixed 3 1/2", Moving 2 1/2", 1/- doz.  
Condenser Spacing Washers. Remember they must be accurate. Small, 4d. doz.; Large, 6d. doz.  
Condenser Screwed Rod, Brass 12" lengths, 2 B.A. or 4 B.A., 6d. each, 2 B.A. and 4 B.A. nuts, 7d. doz., 2 B.A. and 4 B.A. washers, 8d. doz.  
Contact Studs. Studs, not rubbish, 1/6 doz.  
Copper Foil Sheets, 10" x 4", 6d. each.  
Core Wire, soft iron, 2/4 per lb.  
Ebonite. Best quality. Any size, rod or sheet, 5/- per lb. Carriage extra. Please remit ample postage, balance returned. Orders over £2 carriage paid. Money back if not satisfied.

Filmant Resistances. For panel mounting with knob pointer and good contact. A speciality. 4/- each.  
HEAD RECEIVERS. Light, sensitive, of good design and superior finish. Tested and guaranteed perfect. Complete with cords. 140 ohms 30/- each, 4,000 ohms 32/- each, 8,000 ohms 33/- each. Postage 9d. each.  
Inductance Tubes. 12" long. Specially impregnated. 2 1/2" 6d., 3" 7d., 3 1/2" 8d., 4" 10d., 4 1/2" 1/-, 5" 1/2. 6" 1/6 each. Postage 9d. each.  
Inductance Slider Rod. 1" square in 13" lengths. Not jagged but smooth, 6d. each.  
Insulating Tubing, 6d. per yard.  
Ivory Scales. 0 to 180°. Engraved (not printed), 1/2 each.  
Ivory Tablets. Strong, Engraved not printed. Aerial, Earth, Primary, Secondary, On, Off, Reactance, Phones, H.T. +, H.T. -, L.T. +, L.T. -, A.T.I. 2d. each.  
Knobs. Ebonite, 1 1/2" diameter. Superior finish. Knurled, 7d. each.  
LOUD SPEAKERS. Exceptionally efficient. 70 ohm, 2,000 ohm, 4,000 ohm, £2 10s. each.  
Mica. Pure Ruby. Pieces, 3" x 3" x .002" thick, 6d. each.  
Paraffin Wax. 1/- per lb.  
Resistance Wires. "Elsi" brand, 22's (1 ohm per yard), 24's (1 1/2 ohms per yard), and 28's enamelled (4 ohms per yard), 2d. per yard.  
Switch Arms. Exceptionally strong and well made, 2/6 each.  
Terminals. A very neat wireless terminal. Polished, complete with nut and washer, 2/8 doz.

Tin Foil. Free from Lead. Sheets, 26" by 13", 4d. each.  
Valve Sockets. With nut and washer. Fine finish, set of four, 9d.  
Valve Holders. Best quality ebonite, with nuts, 1/4 each.  
Wood's Metal, 6d. per packet.  
CRYSTALS. Carborundum, Copper } 8d. per Silicon, Manganese } packet.

### SUPERIOR QUALITY WIRE. British made. All wire wound free. Post extra.

S.W.G.	S.C.C.	D.C.C.	Single Silk	Dble. Silk	Enamelled
12	1/10	1/11	4/-	5/4	1/8
14	1/11	2/-	4/-	5/4	1/9
16	2/-	2/1	4/2	5/6	1/10
18	2/1	2/2	4/4	5/6	1/11
20	2/2	2/3	4/8	6/2	2/6
22	2/6	2/11	5/-	6/8	2/8
24	3/-	3/6	5/6	7/4	2/8
26	3/7	4/1	6/8	8/2	3/2
28	4/4	4/7	7/2	9/-	3/6
30	5/-	5/6	8/-	10/-	3/10
32	6/-	7/3	9/2	13/-	4/2
34	7/-	8/3	11/6	14/-	4/4
36	8/8	10/2	14/-	15/6	4/8
38	11/3	13/2	16/-	19/-	5/3
40	15/-	18/-	18/6	22/6	6/6
42	17/3	21/-	31/6	34/-	9/-

Phone (Ct. 422) J. L. CARTWRIGHT & Co., Manufacturing Electrical and Radio Engineers. Dept. P, 130-132, London Road, Manchester. [Grams: "Pladuram," Manchester.]

Special Terms to the Trade.

Price Lists 3d. Post Free.

WORKS: BERRY STREET.

**There is No Need to Pay More than our Prices for BROWN or SULLIVAN RADIO HEADPHONES.**

We guarantee these 'phones to be in perfectly new condition and as efficient as any 'phone obtainable irrespective of the price paid. These 'phones were supplied to His Majesty's Government and every instrument has therefore passed the strictest test.

We have received **HUNDREDS OF TESTIMONIALS** from delighted and satisfied customers, many of which we have reprinted in our catalogue, and we earnestly commend them to the notice of the Wireless Public. These are convincing proofs from those who have actually tested the 'phones, and, together with our personal guarantee set out below, will, we feel confident, dispel any doubts in the minds of anyone as to the quality and efficiency of the goods we offer for sale.



**BROWN HEADPHONES**

("A" Type. Reed Pattern. Aluminium Diaphragms)

MUCH BELOW MAKER'S PRICES.

120 ohms **49/6** (Maker's Price 66/-)

8,000 ohms **42/6** (Maker's Price 58/-)

Sullivan 8,000 ohms **36/6**

Cords 2/9 extra.

Packing and Postage (Registered) 1/- extra.

**Brand New Condition & Unused.**

**IMPORTANT.** Our stock must not be confused with the "reconditioned" 'phones at present on the market.

**We Guarantee**

that these 'phones are in brand new condition and have never been used. that they are equal in efficiency to any 'phone on the market at the present time. that if after these 'phones have been thoroughly tried and tested and compared with any other 'phone on the market, you are in the least dissatisfied, return same to us within 7 days and **WE WILL REFUND THE FULL AMOUNT PAID FORTHWITH.**

**The "PARLIPHONE" LOUD SPEAKER** (Prov. Patent No. 21,967)

**ECONOMICAL :: NO METAL USED IN ITS CONSTRUCTION. EQUAL IN EFFICIENCY TO THOSE THREE TIMES THE PRICE.**

This Loud Speaker comprises horn and stand moulded in one solid piece of Ebonite. It contains no receiver, but the interior is screwed and made to receive a Brown's Patent Standard Receiver. In this way, by simply unscrewing one ear-piece from the existing Headphones and inserting it in the "Parliphone," an efficient Loud Speaker is obtained at a small cost. The remaining ear-piece can still be utilised for tuning in the ordinary way.

**32/6**

As no metal is used in its construction, the objectionable metallic "ring" so common to most Loud Speakers is entirely obviated, the result being a rich, mellow note without the slightest distortion. (Packing and Postage 1/3 extra.)



**BROWN'S STANDARD PATTERN RECEIVERS, 60 ohms, 15/-; 4,000 ohms, £1.**

**THE CITY ACCUMULATOR CO.,**

'Phone: Avenue 91 (3 lines). **79, Mark Lane, London, E.C.3.** Telegrams: "TYCHE, FEN, LONDON."

Agents—  
 London: A. W. GAMAGE, LTD., Holborn, E.C. SELFRIDGE & Co., LTD., Oxford Street, W. RICHFORD & Co., 153, Fleet Street, E.C.3  
 Yorks: BARNSELY BRITISH CO-OPERATIVE SOCIETY, LTD., Barnsley.  
 Glos: BRISTOL WIRELESS Co., 52, Cotham Hill, Bristol.  
 S. Wales: SOUTH WALES WIRELESS INSTALLATIONS Co., LTD., 18, West Bute Street, Cardiff.  
 N. Wales, Lancs., Ches., & I.O.M.: THE "ALL BRITISH" WIRELESS MANUFACTURES Co., LTD., 70, Central Bldgs., 41, N. John Street, Liverpool.



# STERLING - - - No. 1 CRYSTAL W/T RECEIVING SET.



*The Sterling No. 1 Crystal Receiver has been specially designed for use in connection with the Wireless Telephony Broadcasting Scheme, and is suitable for a range of about 25 miles.*

**The set comprises:—**

**1. TUNER.**—This consists of an inductance which can be varied by means of tappings taken to stud switches. Two of these are fitted, one for coarse and the other for fine adjustment. A separate coil is provided which can be plugged into a fitting at the back of the instrument (as illustrated) for reception of time signals, etc., from Eiffel Tower.

**2. DETECTOR.**—This is of the crystal type, requiring no battery, and is designed to give universal adjustment over all parts of the crystal.

The apparatus is mounted on ebonite panel and fitted in polished walnut case.

The equipment includes one pair of No. R1258 DOUBLE HEAD TELEPHONES wound to a total resistance of 2,000 ohms the pair.

**PRICE £7 - 12 - 6**  
IMMEDIATE DELIVERY.

**Sterling Telephone & Electric**

TELEPHONE HOUSE, Co., Ltd.,  
210/212, Tottenham Court Road, London, W.1.  
Telephone No.: 4144 Museum (7 lines). Telegrams: 'Cucumis, Wesdo, London'  
Works: DAGENHAM, ESSEX.

BRANCHES: NEWCASTLE-ON-TYNE: 9, Clavering Place.  
CARDIFF: 8, Park Place.

Visit our Stand, No. 34, All-British Wireless  
Exhibition, Horticultural Hall, Westminster,  
S.W.1, September 30th to October 7th.

# THE Crystophone REGISTERED

is all you require for any  
given range or degree of  
audibility

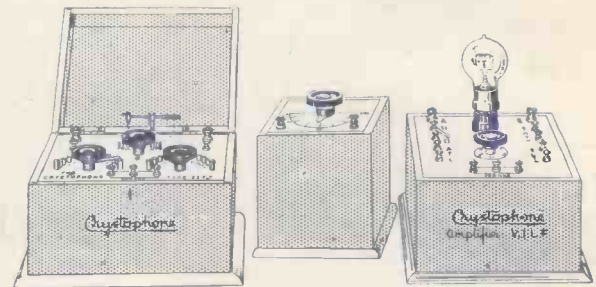

The Crystophone Combination, 20 V.1 L.F., has a broadcasting range of 50 miles, and a degree of audibility 200/300 per cent. greater than any single-valve receiver on the market.

Crystophone, Type 20 V.1 L.F.,  
with Condenser, Price £13.

The Crystophone Complete Wire-  
less Receivers range from £2/10/0  
to 85gns. Catalogue on request.

# Crystor REGISTERED COWL INSULATORS (PROV. PATENT)



Horizontal Wall or  
Window  
**LEAD-IN**  
10/6 Post  
Free.

**Guarantee  
100%  
Efficiency  
from any  
Aerial to Receiver**

### Crystor Aerial Outfits

**SINGLE-WIRE AERIAL**  
Containing 2 Crystor  
Cowl Aerial Insu-  
lators, 1 Crystor Cowl  
Lead-in (vertical or  
horizontal), 100 ft.  
Best Quality stranded  
copper Aerial Wire,  
100 ft. Best Hemp  
Rope, and one pulley  
block, packed in box.  
Price complete 21/-  
Postage 1/6 extra.

**TWO-WIRE AERIAL**  
Containing 4 Crystor  
Cowl Aerial Insu-  
lators, 1 Crystor Cowl  
Lead-in (vertical or  
horizontal type), 100 ft.  
Best Quality stranded  
copper Aerial Wire,  
100 ft. Best Hemp  
Rope, and one pulley  
block, packed in box.  
Price complete 25/-  
Postage 1/6 extra.



Vertical Roof  
**LEAD-IN**  
10/- Post  
Free.

**WIRELESS  
SUPPLIES CO.**  
64, Mortimer St.,  
LONDON, W.1.

'Phone: Museum 2672.  
'Grams:  
'Adragonax, Wesdo, London.

All Applications for Advertisement Space in POPULAR WIRELESS to be made to JOHN H. LILE, Ltd. (Sole Agents), 4, Ludgate Circus, London, E.C.4. Phone: 10806 Central.



No. 16. AN INTERESTING ARTICLE by Sir J. KENNETH MACKENZIE, B.

# POPULAR PWIRELESS

3d

Weekly

No. 16. Vol. 1.  
Sept. 16, 1922.



Mr. A. W. Lane, of  
Woolwich, and his  
Wireless Receiver.

## FEATURES IN THIS ISSUE:

Condensers in Receiving Sets.  
Hints to Amateurs.  
New Series for Beginners.  
Radio Notes and News.

How a Wireless Valve Works.  
Wireless Control.  
The Choice of Receiving Sets.  
How to make a Short Wave Receiver.



**GREAT REDUCTION**  
**IN PRICE OF**  
**MITCHELL-PHONES**

STANDARD MODEL

OLD PRICE.

**35/-**

Postage 1/- Extra



4,000 Ohms

NEW PRICE.

**25/-**

Postage 1/- Extra.

Total Resistance.

**FREE.** A pair of these famous Telephones will be forwarded to the writer of the following letter, upon his communicating with us:—

Near Sheffield, August, 1922.

Messrs. MITCHELL'S ELECTRICAL & WIRELESS, Limited.

Dear Sirs,—I am in receipt of your Wireless Headphones, with which I am highly satisfied. I think they are excellent value for money.—Yours faithfully,  
 J. W.

Another Presentation Next Week.

**IMPROVED TYPE**  
**MITCHELL-PHONES**

Adjustable Coils and Magnets. Leather-covered Head Band.  
 Light and Comfortable to Wear.

**42/-**



2,000 Ohms

**42/-**

Total Resistance.

Temporary City Showroom: 68, BASINGHALL STREET, LONDON, E.C.2.  
 BIRMINGHAM; M. LAWRENCE & CO., 25, Bright Bldgs., 110, John Bright St.  
 CARDIFF: R. W. ROBINS & CO., Park Place.

**MITCHELL'S ELECTRICAL AND WIRELESS, Limited,**

Retail Stores and Registered Office: 188, Rye Lane, London, S.E.15.  
 Wholesale and Export: McDERMOTT ROAD, PECKHAM, LONDON, S.E.15.

**A Perfect Aerial** **10/6**

NO SOLDERING OF AERIAL REQUIRED.

- 100 feet 7/22 Stranded Copper Wire.
  - 100 feet 7 Stranded Steel Insulated Cord for guys and bracing (as pliable as string, but of enormous strength).
  - 2 Pluton Patent Insulators (no soldering of aerial joints required).
  - 1 Steel Coil Spring.
  - 1 Mast Pulley.
  - 1 10-inch Ebonite leading-in tube, with brass rod and terminals.
- Plan, with complete instructions for erection of various types of Aerial.

**TEN SHILLINGS AND SIXPENCE**

Carriage Paid.

Cannot be purchased elsewhere at double the price.  
 All material guaranteed finest obtainable.

**Econ Manufacturing Company, Ltd.,**  
 6, HOLBORN VIADUCT, LONDON, E.C.1

'Phone: City 4148

OUR PRICES CANNOT BE BEATEN.

**CRYSTAL SETS.**

£3 7 6 Complete with Double Head'phones.

**VALVE SETS**

FROM £6 5 0

DON'T PAY MORE FOR  
**WIRELESS HEAD 'PHONES**



4,000 ohms total.

30/- each Complete.

Postage 1/-

BEST BRITISH MAKE.

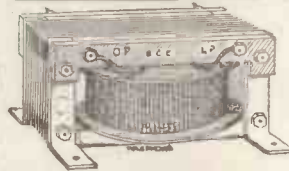

**INTERVALVE TRANSFORMERS**  
 20/- EACH.



**COIL HOLDER.**

2 Way - - 16/-  
 3 " - - 25/-  
 Best British Make.



**HONEYCOMB COILS**

FROM 5/6 EACH  
 According to Wave-Length.

**VARIABLE CONDENSER**

Capacity .0005 mfd.  
 PRICE 30/-

SEND FOR LIST (P.W.) TO

**BRITISH CENTRAL ELECTRIC Co., Ltd.,**  
 6 and 8, ROSEBERY AVENUE, LONDON, E.C.1.  
 Telephone — Holborn 5848.

**"THE FIRST ELECTRICAL EXHIBITION."**

By

**Sir J. Kenneth D. MacKenzie, Bt.**

An Interesting Article appearing in this issue.

# Popular Wireless

TOPICAL NEWS AND NOTES.

**"HOW A WIRELESS VALVE WORKS"**

AND

**"CONDENSERS IN RECEIVING SETS."**

Two Useful Articles for all Readers.

**Berlin Broadcasting.**

A CENTRAL wireless telephone office has been opened in Berlin in connection with the Post Office Wireless Station at Königswusterhausen for an express service of financial news to subscribers.

**The Transatlantic Test.**

WITH reference to the article on the Manchester Wireless Society's new station which appeared in the August 12th issue of POPULAR WIRELESS, Mr. W. E. F. Corsham, of 104, Harlesden Gardens, Harlesden, London, N.W.10, wishes me to point out that he was inadvertently omitted from the list mentioning the prize-winners in the Transatlantic Amateur Tests.

station at Stonebridge Park, N.W., the rain necessitated the provision of shelter. Consequently a train was drawn up beside the lake for use as a grand stand.

In this a wireless set was fixed, and the "passengers" were able to listen to a wireless concert.

**The Armstrong Circuit.**

REFERENCE has already been made in POPULAR WIRELESS and other journals to the Armstrong Super-Regenerative Receiver, and it is hoped very shortly to publish in this paper the most complete and authentic account of the receiver yet written for the British Press.

So far, the reports appearing in this country have not been complete or explicit, and very few British amateurs are fully *au fait* with the system. POPULAR WIRELESS, however, hopes to supply a full and detailed account very shortly.

**G B L's Record.**

TESTS by the Australian Post Office show that the wireless Press service which was opened last March between the Leafield station, near Oxford, and Halifax, Nova Scotia, can be heard at Melbourne (11,000 miles), Perth, Sydney, and other places, and that if atmospheric disturbance is not excessive official messages sent out by Leafield station can be copied with sufficient reliability to render them of news value to the Australian Press. The same applies to South Africa.

The messages to the Indian Government station at Karachi have also been encouraging. Leafield is not a very powerful station, and the proposed new imperial station in this country is expected to have a radiating efficiency seven times as great.

**Broadcasting Music.**

IN connection with the movement for the broadcasting of music and speeches, commendable enterprise is being displayed by the firm of Messrs. Ewing and McIntosh, pianoforte and music sellers, Glasgow. During the Housing and Health Exhibition which will be held in the Kelvin Hall, Glasgow, in October, the firm will give the first practical demonstration in the city of the value of broadcasting. Special concerts promoted by the firm will be reproduced by wireless at Messrs. Ewing and McIntosh's, and in the exhibition, by arrangement with the Marconi Company, and experts will be present to explain to the public how the broadcasting is carried out. Loud-speaking apparatus will be available in various parts of the hall, which will enable a large proportion of those present to hear the programme without the aid of head telephones.

**A Local Scheme.**

CAPTAIN STEVENS, of the Chase Motors, Ltd., Newcastle, a firm who are at present manufacturing wireless apparatus, has been granted a transmitting licence by the

Government, so that local amateurs will not have to rely solely upon the international radio stations, but will have concerts provided at home by Captain Stevens, commencing between 7 and 8.30 p.m. each night. The call letters which will prefix all concerts and messages sent out by Captain Stevens are "5 B A," and transmissions will take place on a 440-metre wave-length.

Captain Stevens's station, which is erected at the new radio works of the Chase Motor Company, Sandyford Square, has been constructed and designed by them, and, although only a few watts of power have been used music has been picked up at Stöcksfield, Birtley, South Shields, and many other places.

Captain Stevens would like to have reports from amateurs regarding the strength and clearness of signals received.

**Ocean Wireless.**

MANY parts of the American coast are very treacherous, and, owing to the frequent changes of the ocean's bottom, are badly charted. Hitherto sounding has been done with the Kelvin machine, in which the pressure of water compresses the air in a sensitised tube and wets it along a graduated scale. But during the war it was found that with the hydrophones employed to detect submarine activities the depth of water could be judged by the time taken to receive the echo of a sound signal. This discovery has now been developed into a system which enables a depth to be measured within a few feet.

Colonel Theodore Roosevelt, the Assistant Secretary of the Navy, announces that successful tests have been made with a new wireless sounding device which instantly registers ocean depths by measuring the time which a sound takes to travel from the ship to the bed of the ocean and back.

The tests were made during a voyage of the United States destroyer "Stewart" from Newport News, Virginia, to Gibraltar.



Mr. L. Tyers, 12, Manor Road, Smethwick, Staffs, with his set.

**Wireless at School.**

A RADIO set has been installed at a Southport elementary school.

A teacher at the school, who is keenly interested in wireless, has been the means of having the apparatus installed, and it is to be used for educational purposes for the children.

The Editor will be pleased to have particulars of other schools fitted with wireless.

**Wireless Society of London.**

THE Wireless Society of London will hold their first meeting of the session on the fourth Wednesday in September, at the Institute of Electrical Engineers. Full details of forthcoming lectures will shortly be announced.

The society will also take a prominent part in organising the social side of the Wireless Exhibition to be held at the Horticultural Hall.

**Wireless in a Train.**

FOR the first time in this country a wireless concert was heard recently in a train. At the swimming championship sports at the lake close to the L.N.W.R. generating

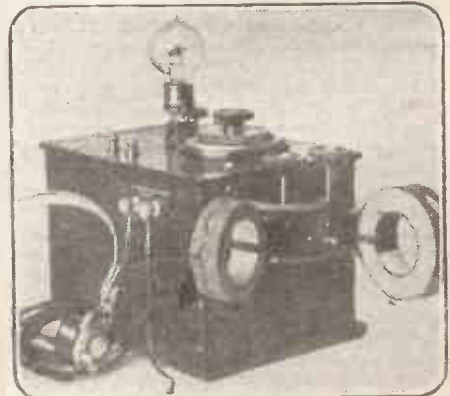

A compact One-Valve Receiver.



## NEWS AND NOTES.

(Continued.)

## Wireless Music Adviser.

I HEAR that the new Broadcasting Company intend to make the most of the musical side of the new wireless cult, and have appointed a well-known organist to be musical adviser to the company.

## "Silly."

THERE is a strong rumour—which has found its way into the daily Press—to the effect that amateurs not holding experimental licences will not be allowed to make their own apparatus or buy component parts.

Such a regulation, however, would raise a storm of protest throughout the country, and I for one cannot credit the authorities with such a silly and narrow-minded idea.

ARIEL.

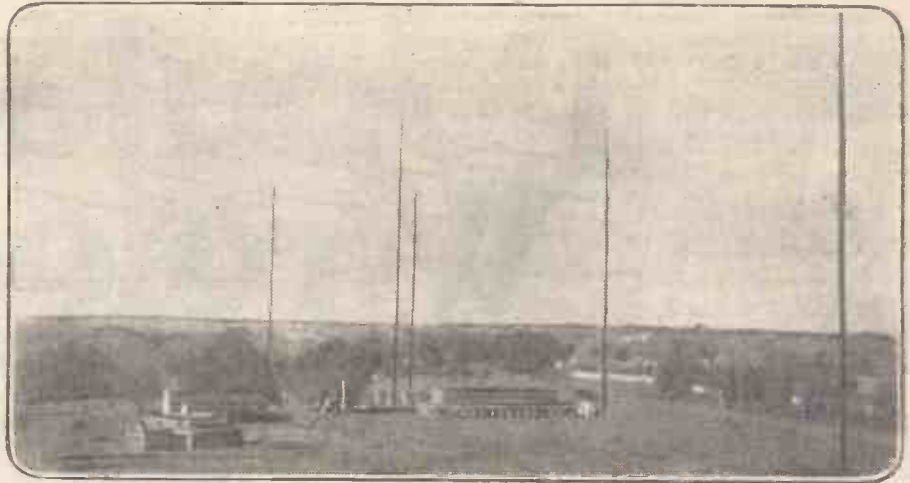

The Wireless Station at Peshawar, on the North-West Frontier.

## THE FIRST EXHIBITION.

THE first wireless exhibition ever held in this country achieved a remarkable success. From the moment the doors of the Central Hall opened the building was the Mecca of all those who have felt the fascination of the new hobby.

All classes of people were visitors, and one could not help noticing how deeply interested they were in everything connected with the exhibition.

The special lecturers, from the contributing staff of POPULAR WIRELESS, helped in no small way to make the exhibition the great success it was.

Major Raymond Phillips and his wireless-controlled airship never failed to attract a large crowd, and Mr. George Sutton, Mr. W. S. Sholl, and Mr. P. J. Risdon gave lectures that were listened to with an attention that testified to the interest and appreciation evinced by the audience.

The exhibition was opened by a wireless speech from Sir William Brancker, and at an inaugural luncheon held at the Victoria Mansion Restaurant, he said he could not claim to know much about wireless except in so far as it was associated with air transport, with which he had been connected since 1917.

Wireless was of great assistance to aviation and enabled a pilot to establish his position and to get other reliable information when the weather was too unfavourable for reliable observation. The course of aeroplanes could be effectively directed, although the innovation was only about three months old. It was improving every day.

Mr. G. H. Roberts, M.P., who declared his belief that the exhibition would be of the utmost possible utility, mentioned that the rising generation was much better up in matters of wireless than the adults. For example, one of his juveniles informed him that a wireless signal from this country to Australia could be transmitted in one-fifteenth of a second. He had made investigation and found that this was so.

Major Raymond Phillips having referred to the possibilities of wireless control as applied to various forms of mechanism, the proceedings concluded with thanks to Sir William Brancker.

The attractions at the exhibition included practical demonstrations of the utility of

wireless communication in connection with the investigation of crime, and in these demonstrations visitors were permitted to take part. Among the appliances shown was a complete wireless set made by a lad of fifteen.

Messrs. Fuller—among the many firms exhibiting—attracted considerable attention by the display of a very useful type of valve holder and filament resistance.

Mr. Percival Marshall, the well-known publisher, did much, together with Mr. Sholl, to help the wheels of the exhibition run smoothly. Both these gentlemen devoted considerable time to the multitude of little problems that crop up to worry organisers of exhibitions.

A super antenna, which makes an outside aerial unnecessary, was exhibited by the Wireless Exploitation Corporation, Beck House, 91, Shaftesbury Avenue, London, W.C.

The L. M. Ericsson Manufacturing Company, Limited, 60, Lincoln's Inn Fields, London, W.C. 2, did good business in the headphone line.

Messrs. Autoveyors are to be congratulated on the many novelties they displayed and on the excellent telephony they received on a "Magnavox."

The City Accumulator Co.'s new Parli-phone attracted much attention. It is a new form of loud speaker likely to become popular.

Space forbids a more detailed account of the exhibits, but next week further comments will be made on the apparatus, etc., shown at the exhibition.



# Broadcasting Programmes

What you can hear every evening of the week on your set.

**TELEPHONY TRANSMISSIONS.**

Station.	Call Letters.	Wave-length.	Remarks.
Croydon	.. GED ..	900 metres	.. Throughout day to aeroplanes.
Marconi House, London	2LO ..	360 metres	.. Between 5 p.m. and 7.30 p.m. (not regular).
Writtle, England	.. 2MT ..	400 metres	.. Tuesdays, 8 p.m. (B.S.T.).
Paris	.. FL ..	2,600 metres	.. Daily, 5 p.m. (B.S.T.)
Königswusterhausen	.. LP ..	2,500 and 4,100 metres	.. Daily, 7 and 10.30 a.m. (G.M.T.).
The Hague	.. PGGG ..	1,085 metres	.. Sundays, 2.30, 5.30 and 8 to 9 p.m.; Thursdays, 8 to 9 p.m.
Messrs. Burnham (Black-heath)	2FQ ..	400 metres	.. About 9 o'clock any evening.

Subject to the Postmaster-General's permission being received, Marconi House Broadcasting Set will transmit wireless concerts on Saturday, September 16th, at the following times, on 360 metres:

5 to 5.30 p.m.;      6 to 6.30 p.m.;      7 to 7.30 p.m.

These transmissions will be for the Southgate fête in aid of the Royal Northern and Passmore Edwards Hospitals, and a fête in aid of the Croydon General Hospital.

# THE SAINTE ASSISE RADIO STATION.

The top picture shows a few of the huge masts at the new French station at Sainte Assise, near Paris.

Below is the switchboard and high-frequency generating plant.

One of the high-frequency generators is shown in the circle. The output is 290 kilowatts. The machines weigh several tons, and it is suggested that Dr. Irving Langmuir's invention will soon render them obsolete. One of the 1,800-h.p. Diesel motors for driving the generators is shown on the left at the bottom of the page.

The station, when finally completed, will be able to communicate direct with Saigon, a distance of 8,000 miles.

Even now, it is far more powerful than Bordeaux, which has, hitherto, held pride of place with Radio Central of America. The Eiffel Tower Radio is a powerful station, but Sainte Assise is 35 times more powerful, and it is estimated that the number of words per day capable of being transmitted total to something like 1,000,000.

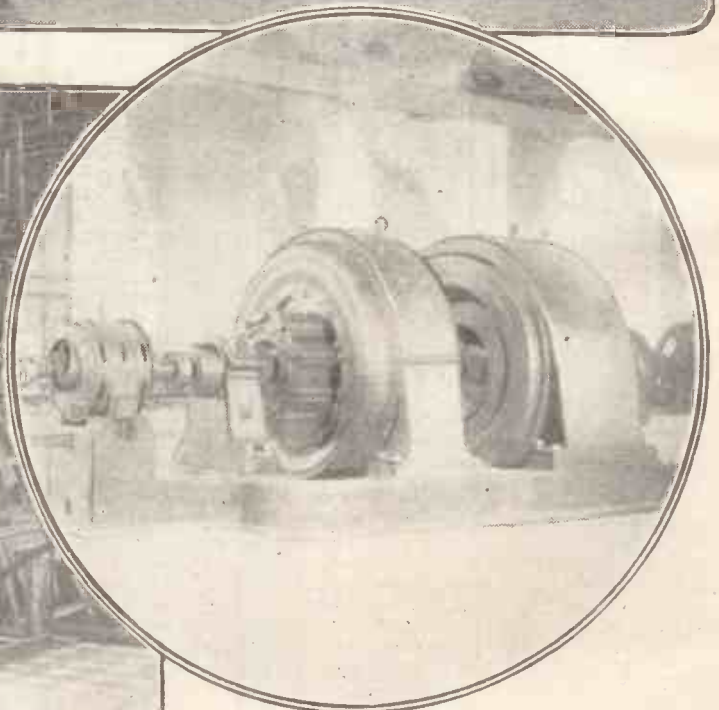
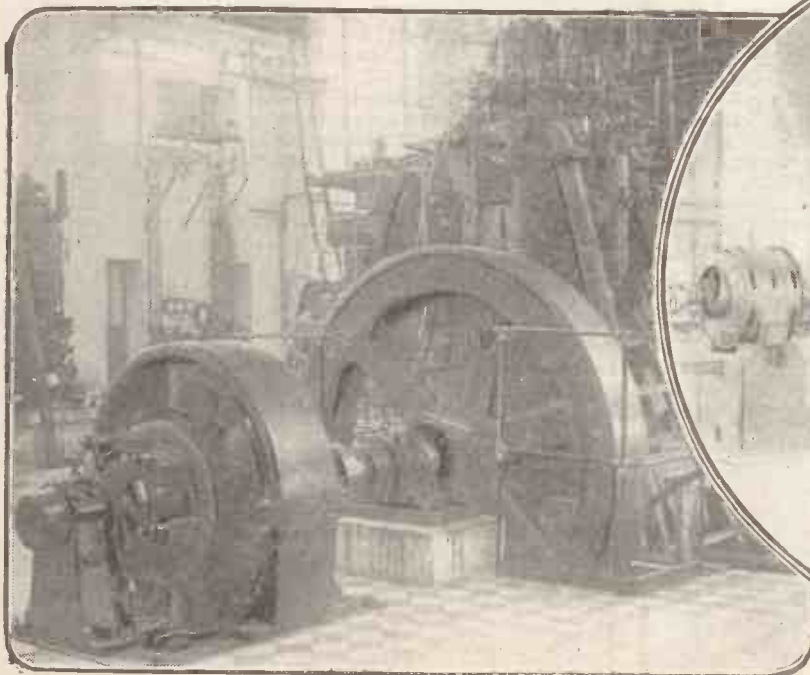
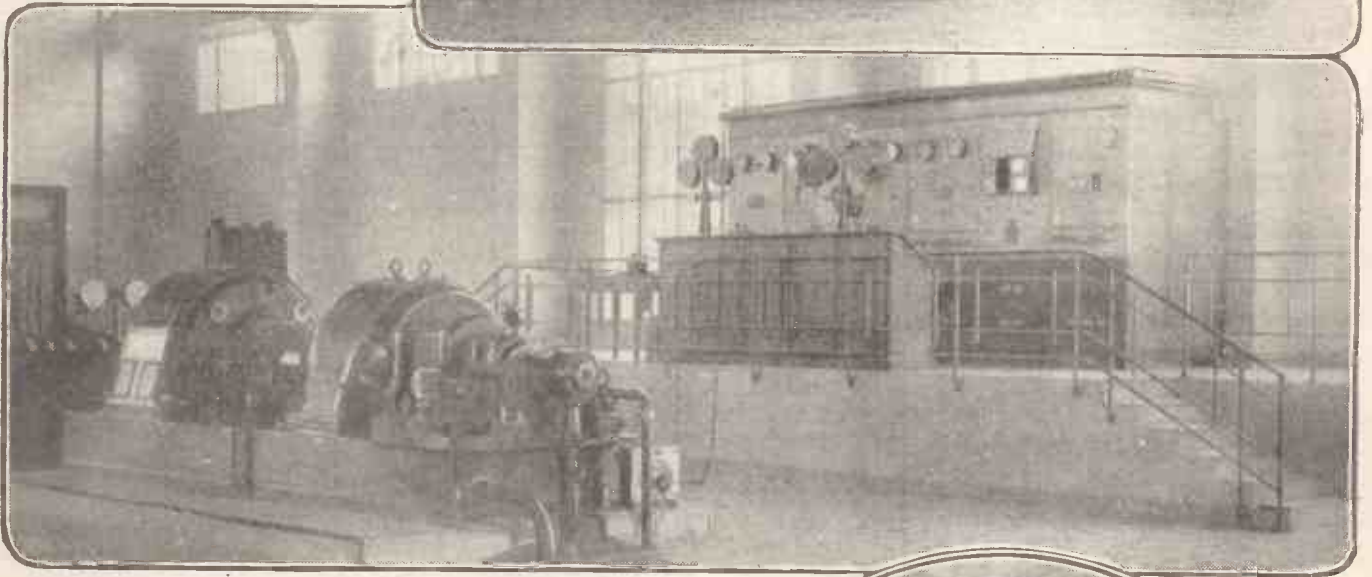
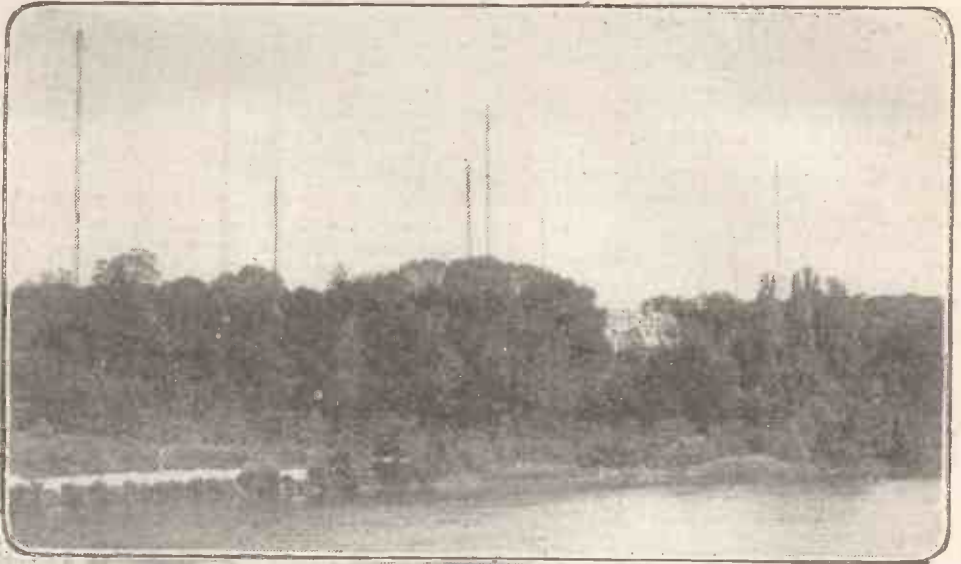



# THE FIRST ELECTRICAL EXHIBITION.

By SIR J. KENNETH D. MACKENZIE, Bart.

**NOTE.**—Two weeks ago the first Wireless Exhibition in this country was held at the Central Hall. Forty years ago the first Electrical Exhibition was held in Paris, and Sir Kenneth Mackenzie, an eminent electrical engineer, has written a series of articles on the early days of electrical science specially for "Popular Wireless." Readers will find articles of fascinating interest.—EDITOR.

"V'LA le plan—le guide! L'explication de tous les appareils électriques, numérotés! Vingt centimes au lieu de cinquante!"

How many of us who daily and nightly heard that cry are alive to-day to recall the sing-song chant of those itinerant vendors of catalogues of the first real Electrical Exhibition ever held? What memories of forty years ago last autumn those words awaken in my mind; words I have never forgotten. What recollections of gay and happy days long past do they recall; and how heartily I wish that I had one of those catalogues now, for the most interesting information and reading it would afford!

"V'la le plan—le guide!" cried those outside hawkers, offering for less than half the price what the catalogues cost inside that wonderful "Exposition d'électricité," held in the autumn of 1881 at the old Palais de l'Industrie in Paris.

A premium pupil of the old firm of Sir W. G. Armstrong & Co., Ltd., of Elswick, Newcastle-on-Tyne, and very near the end of my articles, I had got a week's leave (and a "tenner" from my father for the purpose) to run over to Paris to see the exhibition.

## The Old Palace.

Being greatly interested in the new electrical inventions and developments, and in fact supposed to be in charge of anything of an electrical nature required at Elswick—very little in those days, I need hardly say—I knew nobody connected with the exhibition when I went there, except Mr. Joseph Wilson Swan, whom I had met in Newcastle in connection with his new incandescent lamps. But I soon found on arrival friends who kindly made me feel "at home," and showed me "the ropes" in connection with everyone at the exhibition.

Situated on the right-hand side of the Place de la Concorde as you face the Seine, the Palais de l'Industrie was a big building, somewhat resembling Olympia, especially in its interior, but of a much more handsome architectural design, as well as more ornate. It was pulled down to make way for the present Grand et Petit Palais, which stand on the old site, and only its memory now remains with those inhabitants of la Ville Lumière who have come to the sear and yellow leaf of mature—not to say old—age, comme moi, par exemple.

The exhibition had only been opened a fortnight or so before my arrival by M. Cochery, the then Minister of Posts and Telegraphs, who was intimately connected with its inception and organisation, and who proved a good "friend in need" to me on one or two occasions later on, as I shall relate.

## "Listening in," 1881.

I shall never forget the impression made on me when I entered the building on the evening of my arrival, and saw the blaze of light, the crowd which thronged inside, and the huge lighthouse erected in the centre facing the main entrance, throwing its brilliant beams revolving all round the interior. What a galaxy of light, life, and interest it seemed to me, coming straight from the dull, dreary, and smoky town of Newcastle!

In relating my recollections of all I saw and did whilst at the exhibition, of those I was fortunate enough to meet and know, I shall make no attempt to do so in any definite order, but will trust to memory as particulars occur to me which luckily are clear; for the

impressions they made at the time on my youthful mind were very definite and distinct. This is all the more fortunate now, as I have long ago lost all the notes and memoranda I made at the time.

The ground-floor level contained, as usual, the heavier exhibits arranged under the galleries towards one end, such as steam and gas engines and boilers, all of a portable or semi-portable type, to run the few existing types of dynamos and motors; the central part being fitted with numerous stalls containing some samples of plant not working, but mainly various electrical devices, ideas, and novelties.

But the chief attraction was the beautiful lighthouse already mentioned, some fifty or sixty feet high, built as it were on a rocky foundation, and containing a complete revolving electric light apparatus by Sautier, Lammonier & Cie, the great French glass manufacturers.

The galleries running round four sides of the building, and approached at one end by a fine wide staircase, were filled with exhibits of all

I had not been more than three or four days in Paris when Mr. Henry Edmunds, who was in charge of the Swan Electric Lamp Company's exhibits, offered me a small post on his staff, seeing how interested I was in electric lighting, and anxious to get into the business from the start.

## The Swan Co.

He it was who had introduced the Brush Arc lighting system into Europe, and had installed some of their lamps into the "City of Richmond," one of the Inman liners; the very first passenger ship which had ever been lit by electricity. I gladly accepted his offer, provided Sir W. G. Armstrong & Co. would allow me to do so; and as my old friend, Mr. G. W. Rendel, one of the partners, happened to be in Paris, I consulted him, with the result that he agreed I might cancel the few remaining months of my indentures and join the Swan Co., believing that the new industry offered a better immediate opening than any his firm could give me then.

So I joined the staff of the Swan Electric Lamp Co., Ltd., and became one of those keen

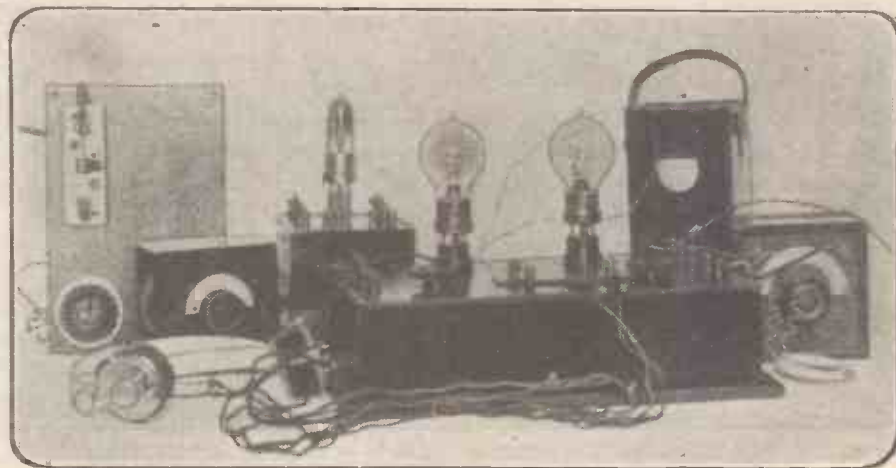

Receiving set used by Mr. E. L. Wilkinson, 55, Gloucester Gardens, Hyde Park, W. 2.

sorts of smaller electrical appliances then known; electric bells being the most common. Portions of the galleries were divided off into rooms to show various systems of interior lighting, both arc and incandescent; one of them being devoted to what was the great attraction of the exhibition, namely, the "Salle des téléphones," which was fitted with Ader receivers, to which people simply flocked to experience for a small additional payment the wonderful novelty of listening to the music at the Grand Opera House, about a mile and a half away, whilst an opera was being played.

How they crowded there to hear was shown by the fact that men had to be employed to keep the throng in order; and their shouts of "Il faut aller au queue, Monsieur!" were incessant during the evening! In those days there was no public telephone service anywhere, and more than a year had to pass after the close of the exhibition before such a thing was inaugurated in this country by a company formed for the purpose.

In fact, as my old office letter paper shows—for I still have some sheets left—there was but one exchange in London in the year 1884, to which all subscribers were connected!

and enthusiastic, not to say egotistical, bands of exhibitionists whose interests centred principally in our individual exhibits, but who all were bent on proving beyond all manner of doubt that electric lighting as represented by our "system" was the one and only hope of man's salvation on earth, as well as a true symbol of the glory, joy, and brightness in the hereafter customers might hope to attain if only they placed their orders with us!

## The "Kick Off."

What a gay and cheerful lot we all were! Not we of "le Breetisch section" only, though I think we were the most so; but those of the various nationalities who formed the exhibitors and their staffs; eager, enthusiastic youngsters for the most part, as our elders were chiefly concerned more with the strictly scientific and theoretical side of the business than the practical part which we had to do. It was indeed a wonderful show for so young an industry having its "kick-off" into commercial life from this exhibition.

(A further instalment of Sir Kenneth Mackenzie's memoirs of the exhibition will appear next week.)



# NEW SERIES FOR BEGINNERS.

By E. BLAKE, A.M.I.E.E.

## PART 9.

HAVING in the two preceding articles taken a general glimpse of radio-communication, we will now consider wireless reception in a more detailed manner.

We know that by elevating a wire in the path of the electro-magnetic waves coming from a sending station we can intercept some of their power, which will be manifested as minute high-frequency oscillating currents in the wire. In order to get a maximum current in the aerial, the latter must be "tuned" to the frequency of the waves it is receiving.

### Fundamental Wave-Length.

Every aerial has what is called its natural or fundamental frequency, which means to say that by itself it will oscillate best, and give a maximum current, at one particular frequency, and therefore receives best waves of a certain length. For a single-wire aerial its fundamental wave-length may be taken as roughly four times its length.

Now suppose you have a single-wire aerial 50 feet long. Roughly, its fundamental wave-length is 200 feet, that is, about 60

metres. No ordinary wireless station, not even an amateur one, transmits on so short a wave-length, so your aerial alone will give you little more than "atmospherics" or stray signals. In order to bring the frequency of the aerial circuit up to that of the waves which are sent out by the station whose signals we wish to receive, we must increase one or both of those two properties of a circuit which control the matter. These properties are capacity and inductance, and for a full explanation of them I must refer you to a more advanced series of articles, because I do not wish to introduce laboured technical expositions into this series.

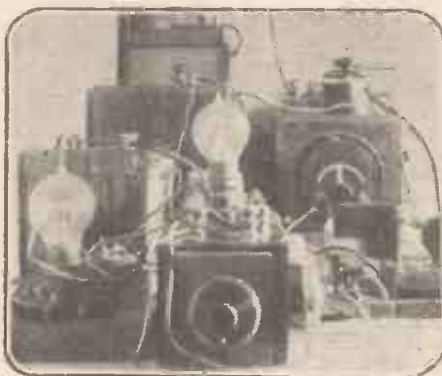

Mr. F. Ward's Receiver, 12, Shipridge Road, Huddersfield.

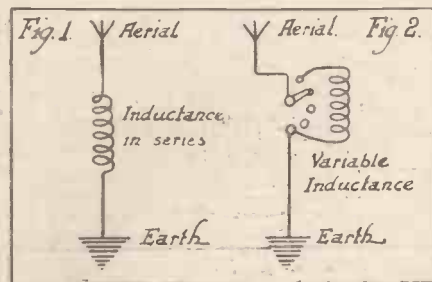

every tenth turn to a stud over which a switch can be moved. (See Fig. 2.) By moving the switch round from stud to stud we can increase or decrease the number of turns of wire in the circuit, thus increasing or decreasing the amount of inductance, and therefore the wave-length of the circuit.

To provide a finer adjustment we employ an instrument called a condenser; this, in effect, is concentrated capacity. Leaving aside the explanation of the theory of the condenser, I may say that by turning the handle of the condenser so that the pointer moves round the divided scale from 0 to maximum (this is some arbitrary number, perhaps 30 or 50), we increase its capacity. But the condenser must be connected in the circuit in a certain way, according to whether we wish to increase or decrease the circuit's total capacity.

### An Aerial Moral.

If we add a condenser to the circuit as shown in Fig. 1, in the manner shown in Fig. 3, we decrease the total wave-length. But if we connect it as in Fig. 4 we increase the wave-length. In Fig. 3 the condenser is connected, as we say, "in series" with the aerial, and in Fig. 4 "in parallel" with the aerial.

By a combination of condenser and inductance coil, both of which are variable, we can alter the wave-length of the aerial circuit, within limits, till it corresponds with the wave-length of the station from which we wish to receive. It should be well remembered,

### Use of Condenser.

I think it will be sufficient at the moment for me to explain that capacity and inductance are measurable electrical properties of circuits, which, if they are increased or decreased, tune the circuit to lesser or greater frequencies, that is, to longer or shorter wave-lengths.

The aerial by itself possesses both inductance and capacity, but these qualities are more or less evenly distributed throughout its length. For tuning purposes it is necessary to associate with the aerial capacity or inductance concentrated in one place.

The inductance of a wire increases greatly if it is wound into a spiral or coil; so much so, in fact, that a small coil of wire of many turns will have a natural wave-length many times greater than that of the aerial, even though the aerial wire may be much longer than the wire used for the coil.

Hence, if we join to the aerial a coil of wire, we artificially, so to speak, increase the aerial's

fundamental wave-length. (See Fig. 1.) If, further, we employ some means whereby we can vary the number of turns of this coil which are brought into play, we can raise or lower the total inductance of the aerial circuit at will. This variation of inductance is best accomplished by taking a connection from, say,

### Save Energy.

however, that by compensating for a short aerial with many turns of a coil we add a large amount of ordinary resistance to the circuit, and thus waste some of the energy which otherwise would be available to be turned into signals. The moral of this is that the largest possible aerial should be used, keeping, of course, within the limits allowed by law.

An ounce of practice teaches more to an observant person than a ton of theory. If you will increase the length of your aerial you will find that you will not need to use so much of the inductance and capacity in your tuning instrument; the reason being that the extra wire has both inductance and capacity of its own.

If you alter your aerial from the single-wire type to a twin-wire type of the same length, you should not notice much difference in your tuning arrangements, because although the addition of a parallel wire increases the total capacity of the aerial it decreases its inductance.

With capacity and inductance both "in series" with the aerial, the tuning to a given wave-length means more of the one and less of the other, or vice versa; generally, the stronger signals are obtained by keeping the condenser reading low and compensating for this by additional turns of inductance, especially if you are using a valve magnifier. But neither artificial capacity nor inductance will wholly compensate for an aerial of low fundamental wave-length, because of the loss of energy tailed off—and in wireless work you must save energy wherever possible.

Coupled to the aerial circuit is the circuit containing the detector, and this also must be tuned to the wave-length being received. Fig. 5 shows the circuit, and it will be noticed that the tuning is done by means of a variable condenser, the inductance being fixed.

### Tuning.

Tuning is in general practice done by ear. The aerial tuning inductance (A.T.I.) and aerial condenser are varied until signals are heard, and then adjusted, together with the condenser in the detector circuit, until the signals can be made to sound no louder.

Experienced operators can tune with extraordinary speed; recognising amongst a medley of sounds the signals they want, they quickly adjust the knobs and switches until those signals sing loudly in the telephones. In fact, one may say that a good operator's hearing is almost as much in his fingers as in his ears.

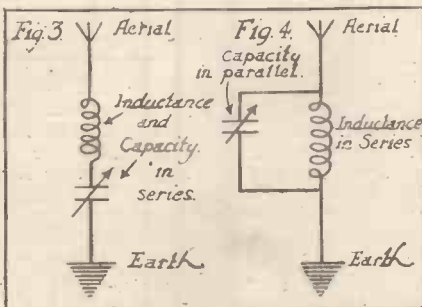

(To be continued.)



# HOW A WIRELESS VALVE WORKS.

By JOHN SCOTT-TAGGART, F.Inst.P., A.M.I.E.E.  
(Chief Technical Adviser to Popular Wireless.)

Author of "Wireless Valves Simply Explained," "Elementary Text-book on Wireless Vacuum Tubes," and "Thermionic Tubes in Radio Telegraphy and Telephony."

## PART 2.

**E**LECTRONS spin round the central core, and it appears that the chemical nature of an atom depends upon the number and arrangement of the electrons it possesses. Gold and lead, for example, probably only differ from each other in the number and arrangement of electrons which revolve round the positive core. If we could take away some of the electrons from the lead atom we would be able to obtain a gold atom. It would, therefore, seem that the idea of changing lead into gold is not such a fantastic one as might be thought. At present, nobody has been able to achieve much success in the way of changing the number of electrons around an atom. No doubt the first

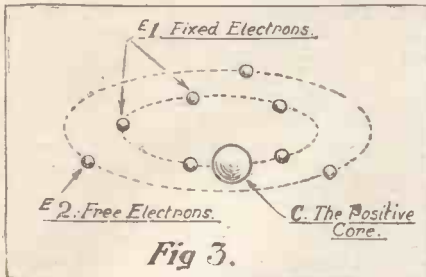

Fig 3.

(N.B.—The positive core should be shown in centre of inner ring.)

one to do so economically will achieve a certain amount of commercial success.

The electrons which determine the nature of an atom are said to be "fixed" electrons. In addition to these fixed electrons there are also movable or free electrons, as they are called, which may be taken away from the atom. These free electrons spin round the central core in the same way as the others, but probably have wider orbits. Fig. 3 is a diagram showing how an atom is constructed. The letter C represents the central core round which the fixed electrons, E1, are spinning. The free electrons, marked E2, are shown revolving round the central core at a further distance from it.

These free electrons determine the electrical charge on a substance. If the atoms of a substance have additional free electrons that substance is said to be negatively charged. If, however, we take away a number of the free electrons which the atoms normally possess, the substance becomes positively charged. This is because the positive core and negative electrons normally balance each other and the atom possesses no electrical charge. If we take away electrons from the atom, the positive core will outweigh the electrons and the atom will act as a positively charged body.

An electric current is normally simply the passage of electrons through a conductor. These electrons may be made to move along a conductor, such as a wire, by applying some source of potential, such as a battery, to that wire. The electrons will always flow from the negative side of the

battery through the wire back to the positive side.

### The "Anode" or "Plate."

Coming back to our ordinary lamp, we find that when the filament begins to glow free electrons in the wire are emitted from it. If the wire is cold, the free electrons remain inside the wire, but when the filament is raised to incandescence by the passage of a sufficiently strong electric current through it, millions of negative electrons are shot off from the filament. The brighter the filament the greater the number of electrons shot off. In the case of an ordinary electric lamp these electrons are being projected from the filament all the time, but no use whatever is made of them. The wireless valve, however, operates entirely by means of the electric currents shot off in the form of electrons from the incandescent filament. The light emitted from a valve when a current is passed through the filament is quite incidental to the operation of the device and plays no part whatever in its operation. It is only the electrons emitted which have any part in the operation of the valve.

If we put a small metal plate inside an ordinary electric lamp, it is possible to collect the electrons shot off from the filament. To cause the electrons to pass from the filament to the plate, we require to connect a battery across the filament and plate, the positive side of the battery being connected to the plate and the negative side to the filament.

Fig. 4 shows a bulb containing a filament, F, and a plate, A. The filament is shown connected to a six-volt accumulator, B1, one side of the filament being connected to the negative side, and the other side of the filament being connected to the positive side of the accumulator. One side of the filament is connected to the negative side of the battery, B2, of, say, 30 volts. The positive side of B2 is connected to one

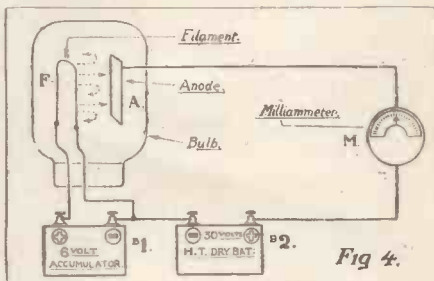

Fig 4.

side of a current-measuring instrument, such as a millimeter, which measures to 1/1,000th parts of an ampere, the unit of electric current. This millimeter is marked M in the figure and its other side is connected to the plate A. If an arrangement like that shown is connected up it will be found that the millimeter, M, will indicate the passage of electrons from the filament F to the plate A, round the plate circuit, A M B2 F.

The current, it will be found, is very small, but it can easily be measured, and it represents a flow of electrons from the filament F to the plate A, round the anode circuit. The current is called the "plate current" or "anode current," the term "anode" being applied to the metal plate A, which is given a positive potential by the battery B2. If we reverse the battery B2 we will find that no current will flow round the plate or anode circuit. This is for the simple reason that the electrons will not pass to a negatively charged body. The electrons are particles of negative electricity, and it is a common law of electricity that whereas two bodies charged with opposite kinds of electricity will attract each other, bodies charged with the

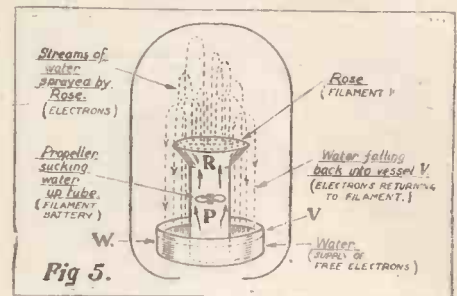

Fig 5.

same kind of electricity will repel each other. If the plate A is given a positive potential it will attract the negative electrons, whereas if it is given a negative potential by reversing the battery B2 it will repel electrons and there will, therefore, be no electric current round the anode circuit.

### An Analogy.

Since a vacuum tube of this kind will only allow an electric current to flow through it in one direction—namely, from filament to anode—it is called a "valve," being really a non-return valve for electric currents. The actual amount of current through the valve will depend partly on the temperature of the filament and partly on the voltage on the anode, the hotter the filament the more will be the number of electrons given off per second. The greater the voltage on the anode the greater will be the current through the valve.

The action of the wireless valve, or thermionic valve, as it is called on account of the electron currents emitted from a hot filament being called "thermionic" currents, may perhaps be more clearly understood by trying to obtain a mental picture, by the use of an analogy, of what is going on. Fig. 5 is intended to show what takes place in an ordinary lamp. A bulb B contains a vessel V, containing water W. Into this water dips a tube T, surmounted at the top by a rose R. This rose is similar to the rose on a watering-can. Inside the tube T is a small revolving propeller P which sucks up water from the vessel V and sprays it out

(Continued on next page.)

# HINTS TO AMATEURS.

**C**UTTING tinfoil to make condensers is a fiddling job, and it is a good plan to use glass (old photography plates do well).

Cut a piece the size that you require the tinfoil to be when finished, lay the foil to be cut on a sheet of glass, smooth it out very flat with the fingers, and then lay your pattern on top and score round with a sharp-pointed penknife.

Should you require to cut shaped pieces with lugs on, it is easier to do so if you take the trouble to cut a tin "template" first and cut on sheet-glass as above.

Another good use for old photography plates is to turn one into an "oil-stone." Cut a strip, say half a quarter-plate, and glue it to a piece of wood, pressing it well down to ensure that it lays flat on the wood. Then sprinkle emery-powder (about No. 0), and a little oil finishes the "stone."

When sharpening a tool or knife it will be found that the glass soon gets a "ground" surface in which the emery-powder rests, and by varying the grades of powder a fine or coarse "stone" may be had, as required; but it serves best as a very fine stone, and heavy tools should be sharpened

on the ordinary stone of the carborundum type.

When making up a panel for a set, it is well worth the trouble to cut a panel out of three-ply or other thin wood, mark it out for the holes to be drilled, and even go so far as to

after going so far, a better lay-out may appeal to you. After being satisfied with your lay-out and wood drilled for holes, etc., take it all down and use the piece of wood as a "template" by laying it on your ebonite and drill through the holes already in the wood. Such a piece of wood in practice would be called a "jig," although "jigs" are usually made out of metal and used for repetition work.



V. R. Mills, of Hastings Grammar School, made this complete set for the use of the school. It just shows what can be done by the young amateur.

mount all terminals, etc., on it. You will soon see if you have made any error in your calculations, and it will prevent you making any mistake and probably drilling a hole that would not be quite in the right spot. Even

very clean. To get the exact position of punch over hole with metal between is very easy if a small centre punch mark is made first. This will make a small dent that will allow the hole in the block to be located very easily.

## HOW A WIRELESS VALVE WORKS.

(Continued from previous page.)

through the rose R, the action being very similar to that of an ordinary fountain. The exact method of driving the propeller P is not important, as the diagram is only intended to convey a rough picture of what goes on inside a lamp or valve.

If we revolve the propeller P very slowly, it will not suck up any water from the container V. These are the conditions existing in a lamp or valve when the current through the filament is not sufficiently strong to cause the emission or projection

of electrons into the vacuum. If, however, we increase the speed of the propeller P, water will be sucked up and will be projected through the holes in the rose R, producing a fine spray of particles of water which may be compared to the electrons which are sprayed out from a filament when the latter is made hot enough. If we increase the speed of the propeller P, more water will be sprayed out from the rose R. In the same way, if we increase the current through the filament of a valve, we will increase the number of the electrons sent out from the filament.

It will be noticed in the arrangement shown in Fig. 5 that the water falls back again into the vessel V; in the same way, many of the electrons shot off from the filament of a valve return again to the filament after a short flight in the vacuum, unless they are all drawn away by an anode.

Fig. 6 shows an arrangement which may be compared with the valve circuit shown in Fig. 4. As before, the rose R is equivalent to the filament of the valve. We have, however, added a funnel U and a pipe E, which leads from the funnel down to the vessel V. In this pipe is a propeller H, which if rotated, say, in a

clockwise direction, will cause a draught of air to pass into the open mouth of the funnel U, through E down into V. When the propeller P is working, water is sprayed through the holes of the rose R, and makes a fountain as was shown in Fig. 5. If the propeller H is now revolved in a clockwise direction, a draught of air will suck up the water sprayed out from the rose, and this water will enter the pipe E through the funnel U, and will pass back again to the vessel V. The propeller H is equivalent to the battery B2 of Fig. 4.

The circuit, U E H V, is equivalent to the anode circuit, A M B2 F, of Fig. 4. If we increase the speed of the propeller H, we will get more water sucked up from the rose R. In the same way, increasing the voltage of the battery B2 will result in more electrons being drawn up to the anode A. In the Fig. 6 arrangement some of the water will always fall back again into the container V, but to get the strongest flow of water through the tube E we will have to increase the suction of the funnel U by increasing the speed of the propeller H. If we reverse the propeller H, we will get an outward draught from the funnel U instead of a suction upwards. The result will be that none of the water sprayed up from the rose R will pass round the circuit, U E H V. The result of reversing the propeller H is equivalent to reversing the battery B2 in Fig. 4, and the arrangement of Fig. 6 is really, therefore, a kind of valve which only allows the passage of water from the rose to the funnel.

(Further articles from the Author's pen will shortly appear, dealing with the three electrode valve.)

(To be continued.)

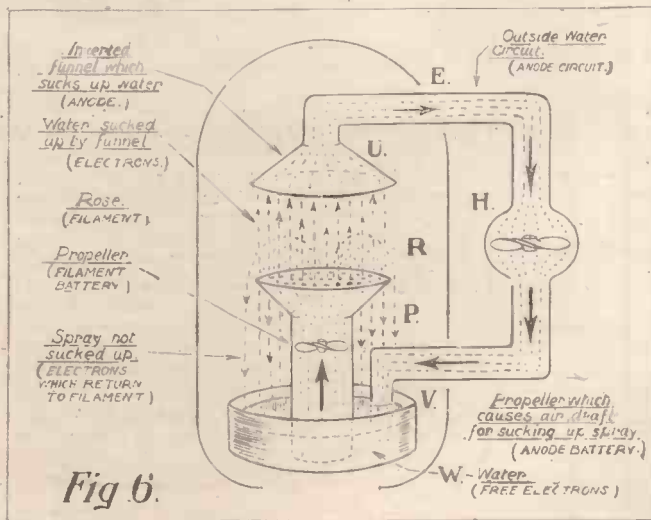

Fig 6.



# WIRELESS CONTROL.

By Major Raymond Phillips, I.O.M., late Member of the Inter-Allied Commission of Control.

## PART 5.

**I**N previous articles I gave details, and examples, of simple "selective wireless control" (i.e., control by sequence) and "direct selection." In this article I shall describe a system of wireless control which involves "periods of time" for its operation.

For the reasons set forth in my first article, the system will be described as applicable for short ranges only, but (even at short distances) it is surprising the number of interesting experiments that can be carried out with such apparatus, more especially when used in conjunction with other systems of control.

For instance, it is possible when operating a "direct selective" system to control "step by step" mechanism and, further, to operate "time period" control apparatus.

### Time Period Control.

Three systems of control were involved in connection with the wireless-controlled pianos which I constructed in 1912.

It is not anticipated that amateurs will undertake the construction of such a complicated piece of apparatus as would be capable of wirelessly controlling pianos. Much simpler experiments can, of course, be carried out with the systems described. Fig. 1 shows a scheme of circuits suitable for "time period" control.

These are arranged so that transmitted signals can (for example) cause a bell to ring, whilst it can be arranged that "continuous oscillations" will "cut out" such bell, and cause an electric motor-horn to function.

It will be understood that the circuits shown may be varied as desired, so that

additional mechanism may be controlled at will.

### Operation of Circuit.

The circuits and apparatus as shown in Fig. 1 consist of a coherer with support A, de-cohering device B, relay C, relay contacts D D, rods E E (which represent an aerial) and insulated supports for same F F, coherer battery C B, relay G with armature H, contacts

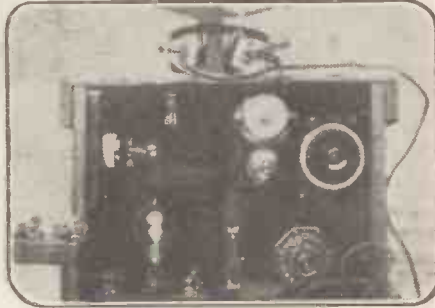

A portable receiver made by J. W. E. Nutts, 6, Frederick Avenue, Penkhull, Stoke-on-Trent.

I, J, K1, K2 (the latter two contacts attached to but insulated from the armature H).

The relay G is fitted with a "dashpot" (not shown in diagram) so arranged that whilst the armature H is free to move in a downward direction, its upward progress is retarded.

The relay L is fitted with armature M, contacts N, O, P1, P2 (the latter two contacts

attached to but insulated from the armature M), and contacts Q, R. A "single stroke" electric bell is shown at S, electric motor-horn T, and relay battery R B.

The relay M is also fitted with a "dashpot" (not shown in diagram) so arranged that whilst the armature M is free to move in an upward direction, its downward progress is retarded.

It will be seen that the effect of the "dashpot" on armature M is the reverse to that on armature H.

In operation it will be observed that on the coherer A detecting a wireless wave, the relay C will be energised by electric current from the coherer battery C B, thus attracting the relay armature, and closing contacts D D.

The latter contacts will admit electric current (from the relay battery R B) through relay G, the pole pieces of which will attract armature H, first closing contacts K1 and I, and afterwards contacts K2 and J, which latter contacts will also admit current to the de-cohering device B, thus effecting de-cohering of the coherer A.

The effect of this "cycle of operations" will be to admit current to the electric bell S ("single stroke" or "trembling" type) through contacts Q and R. Current will also be admitted to the relay L, but the armature M being provided with a "dashpot" (not shown in diagram) which retards its downward movement, contacts P1 and N, also P2 and O will not be closed, so that the electric horn T will not function.

### End of First Series.

On the coherer A detecting "continuous oscillations," the same "cycle of operations" (as previously described) will be effected, except that on account of the armature H being retarded during its "upward" movement by means of a "dashpot, contacts K1 and I will be kept closed and the "period of time" during which such "continuous oscillations" continue will enable the relay L to attract its armature M, and close contacts P2 and O, thus admitting current to the electric horn T, breaking contacts Q and R; the latter "opening" the circuit to the electric bell S, thus cutting the latter out of action.

Contacts P1 and N are only shown as "spares." It will be further observed that "continuous oscillations" may be set up by one or more transmitters, thus producing curious effects.

The apparatus and circuits described were used with great success in connection with the wireless control of musical instruments, demonstrations of which I have on many occasions given in London.

This article will conclude my first series, which have been written with a view to show that the control and operation of mechanism by means of wireless waves undoubtedly opens up a field with vast possibilities.

In subsequent articles I shall describe (in the simplest possible language) and give details of the construction of simple and inexpensive wireless-controlled working models, which I hope will provide amusement and instruction for wireless enthusiasts during the coming winter months.

Those readers who desire to try their hand at constructing apparatus involving the use of "complicated circuits and mechanism," will understand that such experiments are somewhat costly.

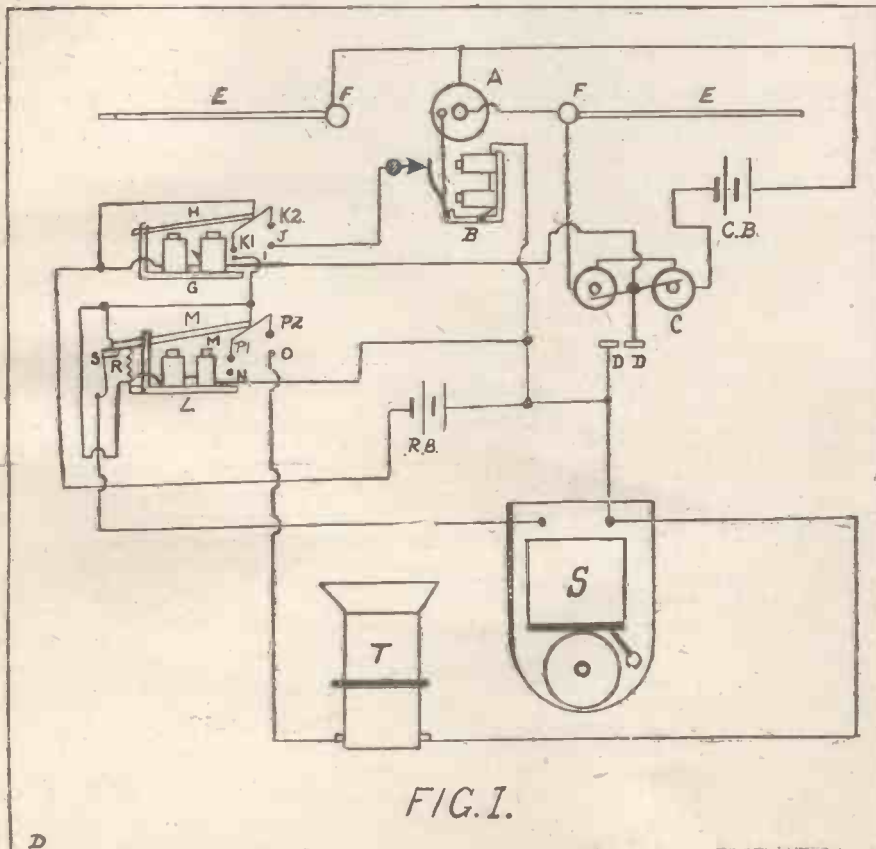

FIG. 1.

# WIRELESS POST FREE.



2,000 ohms, 24/-  
4,000 ohms, 25/-

## SPECIFICATION.

**CORDS.** Twin conductors, Tinsel, 3 ft. long between butt and fork, 12 in. long from fork to each receiver. Instrument end fitted with 2-plug type Metal Tags.

**RECEIVERS.** Arranged in series and wound to 2,000 ohms, 4,000 ohms, or as required. Magnets of specially treated Tungsten steel mounted in Aluminium cases fitted with adjustable steel Headbands of extremely light but serviceable pattern.

## SPECIFICATION.

**RESISTANCES.** 120, 1,000, 2,000, 4,000, 8,000 ohms. Other windings to order.

**INSULATION.** Highest possible.

**MAGNETS.** Selected Tungsten steel, manufactured under our own special process and guaranteed for ten years.

**CORDS.** Heavily insulated Tinsel conductors.

**FINISH.** Polished Aluminium Cases and Fittings with Oxydised Relieved Coppered Headbands. Simple and comfortable adjustments.

**INSPECTION.** Every Head set carefully tested under actual reception conditions and guaranteed to specification.



**DE LUXE 'PHONES**  
2,000 ohms, 34/-  
4,000 ohms, 35/-



## CRYSTAL SETS

(Including De Luxe Headphones)

£4 - 5 - 0

**AERIALS.** Complete with insulators and instructions for erection, 6/- POST FREE.

**The New System Telephone Co., Ltd.,**

212-214, Gt. Portland Street, W.

Tel. No.: MAYFAIR 3779.

The Electrical Wonder Book for  
Wireless Workers

# ELECTRICAL ENGINEERING

*The Book that tells you all about Wireless  
Telegraphy*

**ELECTRICAL ENGINEERING** deals with the whole Science of Electricity and describes every practical application in the Commerce and Industry of to-day. It explains all the elementary principles, and shows their practical application in the design, construction, and operation of every electrical appliance in modern practice—power, light, traction, etc.

It explains everything in Electrical Science that is difficult to explain in the simplest language. It has been written by practical men for practical men. That is one reason why it is the best book of its kind. Another reason is that it is practical. It tells you the why and how of everything. It includes everything in Electricity.

IT IS THE BOOK THAT IS INDISPENSABLE  
TO EVERYONE INTERESTED IN  
THE LATEST WONDERS OF ELECTRICITY

*It treats fully and practically with all the  
elements of Wireless Telegraphy:—*

All about Aerials, Wave-lengths and Tuning. All about Transmitters and Transmitting Systems. Detectors, Receiving Systems, Syntony, etc. Thermionic Valves, Generators, Dynamos, Motors, Transformers, Balancers, Boosters, Testing Instruments, Armatures, Commutators, Winding Schemes, Brush Gears, Controls Resistances, Switchboards, Accumulators, Lighting, Heating, Power, Telegraphy, Signalling, Telephony, Wireless, etc., etc.

**Written in Simple Understandable  
Language**

**Send for Free Booklet giving full  
details regarding price and terms  
of payment**

To THE WAVERLEY BOOK CO., LTD.

(P. Wir.S. Dept.) 96, Farringdon St., London, E.C.4.

Please send me, free of charge or obligation, your Free Descriptive Booklet explaining contents, etc., of "Electrical Engineering," with specimen pages and pictures and particulars as to your terms for small monthly payments, beginning thirty days after delivery.

Name.....  
(Send this Form in unsealed envelope, with penny stamp)

Address.....

P. Wir.S., 1922.....



# LORGNETTE 'PHONES

2,000 Ohms.

The Ideal Ladies'  
Headphones.

No disarranging of hair.  
No cumbersome weight  
on head.

Reception and clarity  
of tone  
perfection.



With  
Ebonized  
Handle,

**25/-**  
each.

Also supplied in rich decorative handles.

Prices on Application.

Special Terms to the Trade.

These 'Phones have been tested by the Post  
Office authorities and certified to show  
Ninety-Five Per Cent. of Maximum Efficiency.

**ECON MANUFACTURING COMPANY, LTD.,**

6, Holborn Viaduct, London, E.C.1.

'Phone: CITY 4148

FACTORY: HOP 2000.

All-British Exhibition - - STAND No. 50.

## COMPLETE AND EFFICIENT ONE-VALVE RECEIVING SET

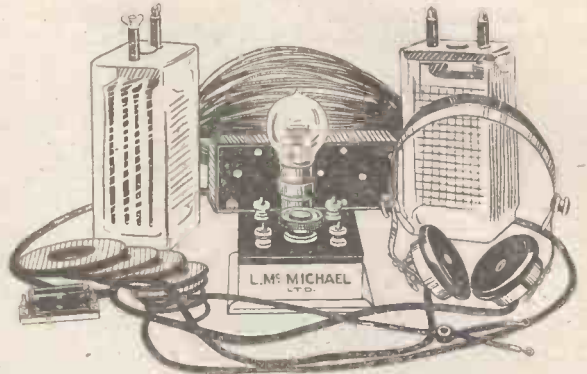

1 Valve Panel, in mahogany box, with circular filament resistance	£.	8.	d.
1 Variable Condenser	1	0	0
Complete set of slab coils for all wave-lengths	1	15	0
1 Valve (Ex-Government, if in stock)		12	0
1 Battery, 72 Volts, tapped off every 4 Volts		15	0
1 4-Volt Accumulator	1	0	0
100 ft. Aerial Wire, best enamelled, stranded Copper		7	6
2 Insulators		2	0
1 pair Head Telephones	1	10	0
60 ft. 19/30 Tinned and Rubber-covered Cable, for earth connection and wiring		1	6
	<b>£6</b>	<b>17</b>	<b>0</b>

VISIT OUR STAND, No. 43.

All-British Wireless Exhibition, Horticultural Hall,  
Sept. 30—Oct. 7.

Illustrated Catalogue (P/W), 16 Pages, 100 Illustrations, 6d. Post Free.  
When writing please mention this publication.

**LESLIE McMICHAEL, Ltd.,**

Providence Place, West End Lane, KILBURN, N.W.6

(Bus Services 1, 8, 16, 28, 31 all pass West End Lane.)

T. Telephone: HAMPSTEAD 1261. Nearest Tube Station: KILBURN PARK (Bakerloo).

### TELEPHONE DOUBLE HEAD SETS (British Make Guaranteed)

2,000 Ohms. 32/6 each.

4,000 Ohms. 34/6 each.

### SINGLE WATCH RECEIVERS 2,000 Ohms. 15/- each.

Please send your orders early, as the demand is exceeding the supply.

Please send 3d. for our New Catalogue, printed on art paper and profusely illustrated, giving full descriptions of receiving sets and all Wireless Components. 3d. returned on all orders of 5s. and upwards.

**P. H. BOYS & CO.,**  
ELECTRICAL AND WIRELESS ENGINEERS,  
187, GOSWELL ROAD, LONDON, E.C.1.

'Phone: Clerkenwell 4454.

## COMPLETE WIRELESS RECEIVING SETS

Capable of clearly receiving "Broadcast" Speech, Music,  
and general Morse messages.

ALL ACCESSORIES FOR WIRELESS IN STOCK.

Send for ILLUSTRATED CATALOGUE (P.W.), 4d., post free.  
It gives details of all we can supply.

Showrooms open 8 to 8. Saturdays, 8 to 1 p.m.

**W. R. H. TINGEY** (Specialist in Wireless).

Offices and Showrooms 92, Queen St., Hammersmith, W.6. Telephone: 1916 Hammersmith

## IMPORTANT NOTICE

OWING to the great expansion of our business in wireless literature, we have been compelled to move into very much larger premises. We propose to continue devoting ourselves exclusively to the production of technical literature in which those interested in wireless can have the fullest confidence.

Our products are written by experts, edited by a special technical staff, and published by a firm whose business is solely connected with wireless. Consider these facts.

**Radio Press, Limited,**  
Publishers of Authoritative Wireless Literature.

New Address:  
DEVEREUX BLDGS., DEVEREUX COURT, STRAND, W.C.2



# THE CHOICE OF RECEIVING SETS.

## PART 2.

IT is neither our purpose to discuss the technical details of the various sets on the market (which will be found in other articles in POPULAR WIRELESS WEEKLY), nor to discriminate between the merits and demerits of different makers' products. Nevertheless, a word of warning here may not be amiss.

Intending purchasers should not place unbounded faith in what individual manufacturers state, because receiving sets, like many other things, are made primarily to sell, and, in view of the present overwhelming deluge of orders, one may easily be landed with a defective set. Of course, there are a number of first-class firms who are above suspicion, but that does not apply to all makers.

An important point is, when you have received a quotation, to make sure that it covers every item necessary to complete your set, otherwise you may find, before you have finished, that you have spent 50 per cent. more than originally contemplated—or even more.

As mentioned in our first article on this subject, the first thing to do is to make up your mind what you expect of a receiving set, and the price you are prepared to pay for it. It is possible to buy the parts and build one up, and even to make certain parts yourself, but this presupposes a degree of skill and knowledge the possession of which would render you independent of such an article as this.

You may take it that you will not, at the present time, obtain a set of much practical value for less than five pounds. Complete sets at from five to ten pounds are good for a range up to 15 or 20 miles, so that if you live within about that distance from a broadcasting station you should get good music and speech.

They are known as crystal sets, and are simple and cheap, requiring no expensive batteries to operate them. They necessitate, however, outdoor aerials, as they are practically useless with frame aerials.

### Valve Sets.

The crystals used in these sets vary in quality; some are so sensitive that any vibration in a room will put them out of order, so that whilst readjusting one you may lose the thread of a lecture or a portion of a concert you may be listening to. Other crystals, although less sensitive, are preferable, being less likely to get out of order and therefore likely to give uninterrupted service and consequently more all-round satisfactory results than an amateur.

If you desire to receive speech from greater distances than 20 miles, or louder signals at shorter range, you will require a valve receiver, which will cost more than a crystal set, entailing, as it does, accumulators for providing the current wherewith to operate the valves, and high-tension batteries or dry cells, which cost from about 15s. upwards.

A single-valve set should enable you to listen to concerts and speeches at a distance of 100 miles from a broadcasting station, providing that you have an outdoor aerial. They possess distinct advantages over crystal receivers, and are undoubtedly worth the extra cost to those who can afford them.

Lack of space precludes a detailed description of the thermionic valve employed in valve sets, and of how it operates. Like much other useful information, this is described in one of the excellent series of articles in POPULAR WIRELESS WEEKLY.

Briefly stated, the thermionic receiving valve magnifies the power of a message received, and by passing it on to another valve it may be magnified again, and so on, according to the number of valves employed. It is certainly one of the most marvellous instruments ever invented, and is well worth a careful study by anyone with a sufficient knowledge of electricity. Books have been written on it, as well as scores of articles in various papers.

Although large numbers of wireless amateurs will be satisfied merely to know what it does, providing that it does its work properly, those who understand it will discover that a thermionic valve is capable of re-magnifying signals after they have already passed through it! This can be done several times, up to a certain point, beyond which the valve refuses to do any more and begins to cause trouble to the owner and to others.

### Range of Reception.

Apart from temporary atmospheric and magnetic disturbances that may adversely affect reception in any locality, certain places—especially certain seaside places—are peculiarly well situated. There is, consequently, no hard-and-fast rule than can be laid down as to the exact receptive power of a receiving set, and we can, therefore, only deal with average conditions. If you live in London and desire to listen to concerts broadcasted from Paris on wave-lengths of 2,600 metres, you will need an outdoor aerial and a single valve and reaction tuner, whilst if you reside on the east coast of Scotland, four valves would be required to operate a loud speaker.

The Hague concerts are wirelessed on a wave-length of 1,070 metres, and in London a three-valve receiving set would be required to hear them properly.

Crystal receivers are not suitable in either of the foregoing cases. On the other hand, from the great Nauen transmitting station in Germany, it is possible to receive with a crystal set, although for a loud speaker valves would be necessary.

### Go Carefully.

Signals from Moscow, of a wave-length of 4,000 metres, may be received by a single-valve set under favourable conditions, whilst a three-valve set will pick up time signals (wave-length 17,000 metres) from the United States, a distance of more than 3,000 miles. This has actually been done by a friend of the writer's.

It will thus be seen that a great deal of careful consideration is necessary before launching out into any appreciable expenditure. It is the greatest mistake, in a fit of enthusiasm to rush in to the first manufacturer you hear of and to order a five-pound set. You may quickly find that its limitations will cause you the greatest disappointment, and, what is worse, that it is incapable of being adapted to more ambitious ideas.

You will be well advised to study the catalogues and descriptions issued by several of the leading firms; and to call and ask for any further enlightenment you require, or alternatively to obtain the advice of an independent expert, if you feel that you are not competent to judge for yourself.

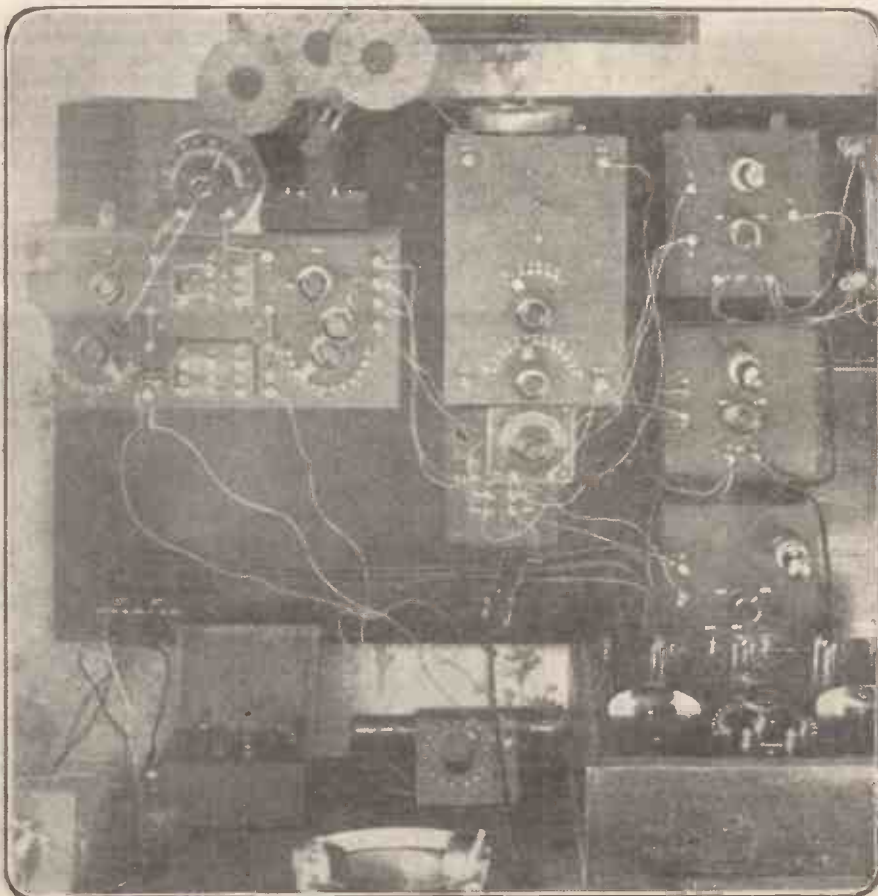

The owner of this fine set is Mr. W. G. Sherratt, of Cowes, Isle-of-Wight. Will he please send more detailed address, or his fee may go astray.



# WIRELESS CLUB EXPERIMENTS.

By GEORGE SUTTON, A.M.I.E.E.

THAT "the trivial round and common task" is sometimes a burden is evidenced in the Church hymn-book, and even in our hobbies and recreations we often get very stale if we too slavishly follow precedent.

The wireless society or association, be it ever so well officered and conducted, if it always meets in the same room, on the same night every week, under the same chairman, with the same secretary reading the same kind of minutes, there is bound to arrive a period of staleness.

The "agenda committee" can only glean between the furrows, so to speak, and it needs a lead or suggestion from some fresh source to start an original idea which will, in due course, germinate and grow into a soaring novelty, blowing like a breeze of sea air through a sleepy meeting.

There is also something lacking if the idea broached only means a char-a-banc ride or a social meeting at the club rooms, though these are all very well in their way. But either of these expedients should be made only the means to an end, and that end the furtherance of our amateur science.

It is just as well, perhaps, that we have to seek authority in order to practise anything off the usual lines of conduct for which our associations were formed, for this, perforce, means preparing for some time previous to the projected event; also, while there is some spice of excitement in spontaneity, wireless is not one of those pursuits which lends itself readily to extemporisation, particularly when one has to make arrangements for a party of participants.

The writer may perhaps be excused if he relates an actual experience. It was soon after our club had been reconstituted after the war, and we had amongst our members all grades of ex-army people, from the young R.E. sapper to the signalling officer.

## A Day Out.

It was thought that it would be a good thing if, on one of the long Saturday afternoons in the summer, we set up an earth transmitting station upon an open space, not far out of the district, and practised army signalling as a means of keeping our buzzer practice bright. Buzzer practice in a close room on a hot summer evening is certainly not conducive to alertness.

We therefore, first of all, asked permission of the Post Office authorities, and feeling sure that our modest little request would not be turned down, we also at the same time asked the consent of the Borough Council, who were the responsible custodians of the public space we wished to use.

In both cases we obtained a ready consent, and then a judicious hint in the Press aroused a certain amount of local public curiosity. The latter resulted in a Press reporter seeking us unsuccessfully all the afternoon.

The sending station consisted of a "power buzzer" and an accumulator and the receiving stations hidden in folds and hollows all over the place, where a couple of metal earth skewers, driven into the ground a few yards apart, were connected by wires in circuit with a headgear telephone receiver. We were disturbed only at long intervals by wandering and wondering couples, and, of course, the ubiquitous small boy, but we were not by any means pestered with unwelcome attentions.

The tests passed off very satisfactorily, and for two hours we got in any amount of fresh air, and original and startling buzzer messages. All who participated expressed a hope that there would be an early repetition of the experiment.

## Log Book Competitions.

The groundsman had been advised that we were coming and he, more successful in his search than the newspaper reporter, found us when we were half-way through our task.

There is, of course, no reason why club outings should be confined to power buzzer and ground reception practice, though the writer can thoroughly recommend a trial as a novelty, and one which would be less likely to be interdicted by the authorities than would the erection of a tree aerial or a kite aerial, for transmission to several improvised stations.

What would really form a most enjoyable outing would be for members to rig up each a small crystal receiving set and repair to some high ground in their neighbourhood. There, with poles, which might be light bamboo rods, not more than six feet high, they could rig up aerials not more than twenty-five feet long, and have awarded a series of prizes for the best log-book of received messages. If desired, a check could be taken with a master set containing valves, but this would hardly be necessary, and in the light of portage

for the filament and high-tension batteries, be hardly worth the trouble.

Ladies might be invited on the understanding that they did not talk within one hundred yards of the imaginary enclosure surrounding the contestants. It really would not tax their ingenuity very much to convey their ideas to the desired recipients by some means of wireless communication, of which they possess the secret, and which has had the sanction of ages long before the Postmaster-General put his foot down on A to B communications.

It is to be expected that a provincial club could give points to a purely metropolitan one, as we Londoners seem somehow to have lost the art of bivouacking.

## Improvised Aerials.

If it is projected to attach an aerial to a tree, do not on any account use a rubber-covered wire. It seems such an easy way of getting over the aerial insulation difficulty to throw a rubber-covered flexible wire into a tree and use that to receive upon, but not even previous permission of the authorities will get buzzer signals out of such an extemporisation.

Get your bare wire aerial made off on a tree if convenient, but begin the aerial proper at an insulator of some kind well clear of the leaves and, if not bare wire, at the least only thinly enamelled wire or strand.

Copper is better than bronze. The reason for the warning is that the rubber exercises an effect upon the currents, which try to range up and down the aerial, very similar to what one would experience in trying to cycle over a newly, thickly tarred road before the usual layer of gravel is put into the tar.

You simply don't get there with it. Also get as good an earth as you possibly can. Find a bed of clay or else moisten the ground with water from your water-bottle.



Two keen amateurs putting the finishing touches to a home-made receiver.

STEP BY STEP IN WIRELESS.

# No. 16.—CONDENSERS IN RECEIVING SETS.

NOTE.—Articles on this page are for the more advanced amateur.

THE simplest form of condenser consists of two plates, of some material which conducts electricity, usually arranged parallel to one another and separated by an insulating substance called the "dielectric." To obtain the full effect of plates of a large area in a compact form, the condenser

substance or "dielectric" is in a state of "electric strain," and there is a certain electrical pressure, measured in volts, which is the maximum pressure that the dielectric can withstand. If a greater pressure be applied, then the insulation is punctured and an electric current flows inside the condenser

From our analogy of the gas-cylinder it is easy to realise that the condenser in Fig. 2, connected across a source of electrical pressure, will act as a reservoir, tending to keep the current in the circuit at a steady value, despite small variations in the applied pressure. A fall in the pressure means a reduced current, which is compensated for—at least in part—by a discharge from the condenser, and vice versa.

A condenser thus used is said to be connected in parallel, and if we wish to increase the reservoir for any given pressure, then we can add more condensers in parallel. Their total effective capacity is then the sum of their individual capacities, i.e., total  $C=C_1+C_2+C_3$ . On the other hand, if we have not a condenser of small enough capacity, we can connect one or more in series, when the resultant capacity will be less than that of the smallest of them, from the

$$= \frac{1}{\text{Total } C} = \frac{1}{C_1} + \frac{1}{C_2} + \frac{1}{C_3}$$

The condenser ( $C_1$ ) connected across the high resistance of the telephone receivers in the wireless receiving set, shown in Fig. 3, performs a similar function. It does not keep the current through the telephones at a steady value, for a change of current is necessary to vibrate the diaphragm and produce sounds, but it does collect the electricity passed in spurts by the crystal rectifier (D), and, when sufficient has been stored to raise its potential, discharges through the shunt circuit of the telephones.

The capacity of such condensers is fixed by the designer of the set so that the discharge shall occur about 800 times per second, and produce an audible note in the receivers.

Before considering the function of the condenser  $C_1$  in Fig. 3, we must investigate what happens when the electrical pressure

(Continued on page 316.)

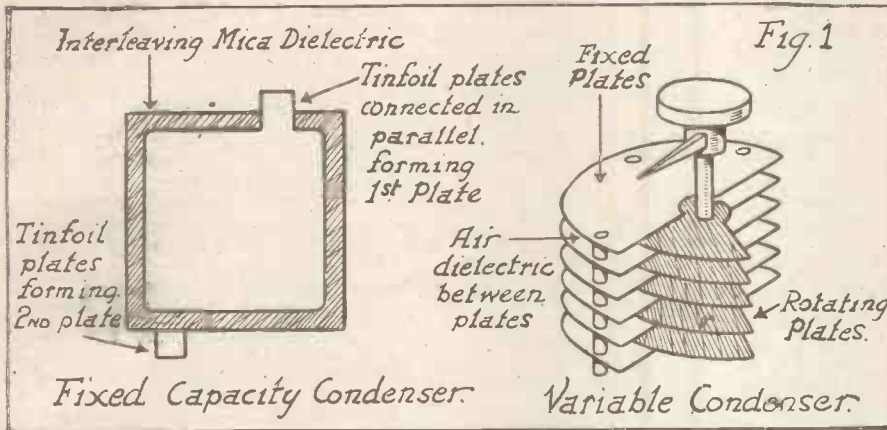

may have several layers of plates, with insulation between; alternate plates being joined to form one and the same conductor.

This arrangement has been made use of in the two types of condensers shown in Fig. 1, but the shaded plates of the variable condenser are also rotatable by means of the central spindle. The six plain plates are fixed and immovable, so that the result of turning the spindle is to increase the useful area of each of the rotating plates, as they are thus brought more and more directly beneath their respective fixed plates.

The function of the whole apparatus is, in unscientific terms, to store electricity, and the amount stored, in electrical units of quantity (Q), depends on the product of the electrical pressure or potential (V) between the plates and the capacity (C) of the apparatus. So we may write that  $Q=VC$ , when all three are expressed in consequent units.

**Dielectric Strength.**

This is a very important fact, because the capacity (C) is either fixed definitely for us, or is made variable only between certain small limits, by the designer of the condenser, when he decides on the size of the plates, the type of dielectric separating them, and its thickness. For a fixed capacity condenser, therefore, or for any particular setting of a variable one, the amount of electricity that can be stored in it is dependent on the electrical potential applied to the plates. As an analogy we may think of an iron cylinder containing gas. To increase the quantity of gas pumped in, an increased pressure must be applied, and the more gas that is pumped in, the greater the pressure necessary to force in a further quantity; so that if the pressure is kept constant, gas will flow in "quickly" at first and then more and more "slowly" until the flow finally ceases when the internal and external pressures are equal. If the external pressure decreased, gas would flow back towards the pump; given, therefore, a source of the requisite pressure, the quantity of gas stored in the cylinder is only limited by the strength of its walls.

Similarly, in a condenser, the insulating

through the dielectric until both plates are at the same pressure or potential.

The dielectric is therefore chosen for what is termed its "dielectric strength," as well as for its effect on the capacity of the condenser. For variable condensers the dielectric is, usually, air for condensers unlikely to be charged to very high potentials, but oil for use in medium-power transmitting sets, and for fixed capacity condensers mica. Ebonite is not recommended for use with high-frequency alternating potentials, as its insulating properties tend to fall off with the "fatigue" of resisting the reversing strains, but it is often used for high-power direct-current work.

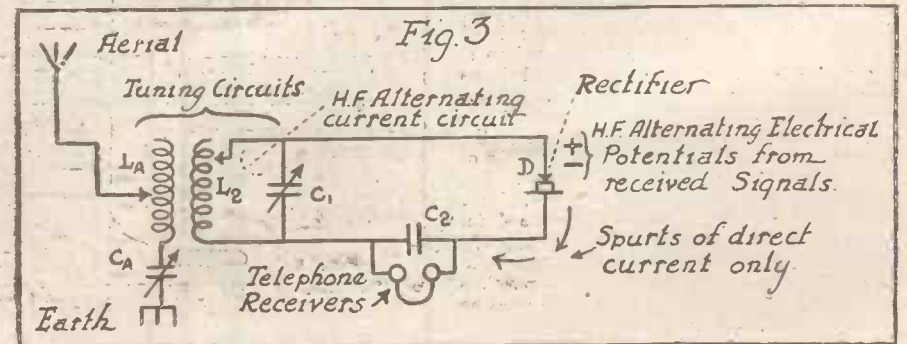
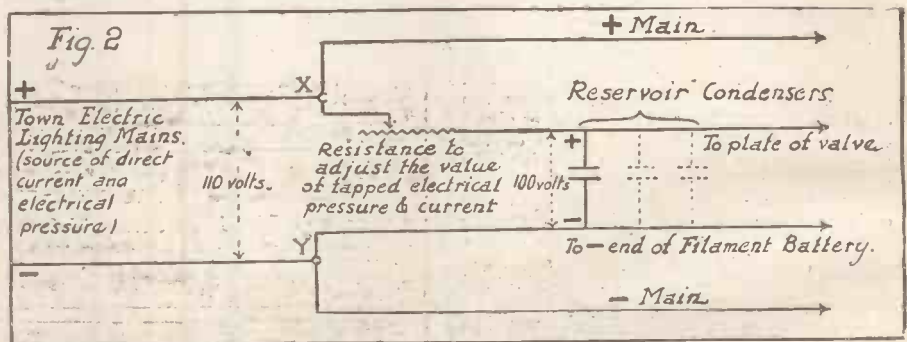



# HOW TO MAKE A SHORT-WAVE RECEIVER.

By PHILIP R. COURSEY, B.Sc., F.Inst.P., A.M.I.E.E.

## PART 8.

THE studs for the range switch are  $\frac{1}{4}$  in. diameter by  $\frac{3}{4}$  in. high, and are screwed 5 B.A. The screwed portion should be at least  $\frac{3}{8}$  in. long so as to allow room for two nuts and washers underneath the panel. Twelve of these studs will be required, five being required for the left-hand arm of the switch, one for the centre arm, and six for the right-hand arm.

These studs are spaced at  $\frac{3}{8}$  in. centres, so that the switch arms, which have a contact width of  $\frac{1}{4}$  in., can pass from one stud to the other without dropping down into the space between.

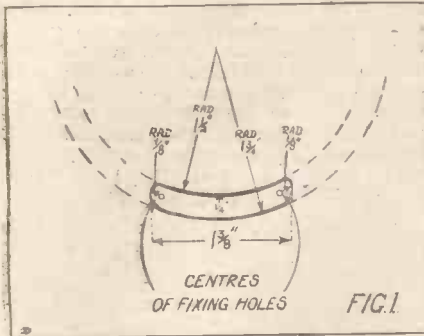

The positions in which these studs are to be fixed have been indicated on the drilling diagram for the panel of the instrument. It will be remembered that the space of four of the studs of the centre switch arm is occupied by a single brass sector, which is held in place by two screws which are passed through holes in the ebonite at each end of the sector in the positions corresponding to studs 2 and 5 of the left-hand switch arm.

The dimensions of this brass sector can be seen in Fig. 1, and its thickness should be  $\frac{1}{4}$  in., so that its upper face is level with the top of the studs.

### The Switch Arms.

Details of the switch arms, three of which are required, and of the pivots by means of which they are held in position, are given in Fig. 2. The switch blades themselves are constructed of phosphor-bronze strip of about  $\frac{1}{16}$  in. thickness, a shorter length of the same strip being inserted between each of the contact strips in order to give greater flexibility to the contact, these spacing strips extending to a distance of  $1\frac{1}{4}$  in. from the centre of the switch arm pivot. The dimensions of the pivots for the left and right hand switch arms are shown on the right-hand side of Fig. 2.

The pivot for the centre switch arm has the same dimensions except for the head, the diameter of which should be increased to  $\frac{3}{4}$  in. and thickness to  $\frac{1}{2}$  in. This larger head enables an ebonite knob to be secured to it by means of two countersunk-head brass screws passing upwards through the brass head of the pivot into the ebonite knob.

The dimensions of this knob should be the same as those already given for the knobs of the variable condenser and reaction coil.

Six brass collars will be required;  $\frac{3}{8}$  in. diameter by  $\frac{1}{4}$  in. thick, with a hole  $\frac{1}{4}$  in. diameter through each. These will be required for the switch arm pivots, one being put on to the pivot on each side of the ebonite panel.

Hence, when assembling the switch arms on their spindles, the brass spindle is first passed through the complete switch arm with its

upper brass stiffening piece, a spring washer is put on next, then one of the above-mentioned brass collars, and the spindle then passed through its hole in the ebonite panel.

Another brass collar is then put on underneath, followed by two 0 B.A. brass nuts to lock the spindle in position. The position of these nuts should be adjusted so that all the switch contact blades press evenly on the studs.

### Filament Rheostats.

The hole marked A in Fig. 2, drilled through the switch arms, should be  $\frac{1}{4}$  in. diameter, and serves for the passage of a 5 B.A. brass screw and nut to connect the switch arms to their link. The linking bar is a strip of ebonite  $4\frac{1}{2}$  in. long by  $\frac{1}{4}$  in. wide by  $\frac{1}{8}$  in. thick, pivoted to each of the switch arms by the screws through the holes just mentioned. The ebonite knob attached to the centre switch arm thus serves to move the three switches together.

Care should be taken, when linking the switch arms together, that all three switches rest on corresponding studs simultaneously.

The centre switch arm may, with advantage, be provided with an extra strip of phosphor-bronze of greater length than the contact strips so as to extend beyond the contact studs, where it can be bent down to the surface of the ebonite to form a pointer indicating the position of the switch, five separate graduations being marked on the ebonite, viz., OFF, 1, 2, 3, 4.

The right-hand switch arm needs to be provided with two extra contact strips and two extra spacing strips, these contact strips being of greater length than the others so as to

extend out to touch the additional contact stud placed in line with stud 4 of the switch. This arrangement is shown in side elevation in Fig. 3.

The filament rheostat remains to be provided for. Although this can be built up by the amateur, it is usually scarcely worth the trouble to do so, as quite good filament rheostats can be purchased for a few shillings.

These can be obtained with a  $\frac{1}{4}$ -in. spindle, and with a standard ebonite knob  $1\frac{1}{2}$  in. diameter which will be uniform with those used on the other parts of this instrument.

The resistance part of this rheostat with its contact should be screwed on the under side of the ebonite panel, so that only the knob and its pointer are exposed. It is also well worth while to purchase, ready made, the grid condenser with its leak and the telephone by-pass condenser which are required with this receiver. Convenient and suitably sized condensers for this purpose are the new Type 600 mica condensers manufactured by the Dubilier Condenser Co., Ltd.

The grid circuit condenser should have a capacity of 0.0002 microfarad, and the telephone by-pass condenser should be about 0.001 microfarad. A suitable resistance value for the grid leak is 2 megohms.

If the grid circuit condenser obtained for the instrument is one of the Dubilier Type 600 condensers, it can be obtained ready fitted with clips to hold a grid leak. Alternatively, if a grid leak of the standard Mullard type is employed it can be held between two clips cut out of phosphor-bronze strip  $\frac{1}{4}$  in. wide, bent so as to form two angle brackets about

(Continued on page 316.)

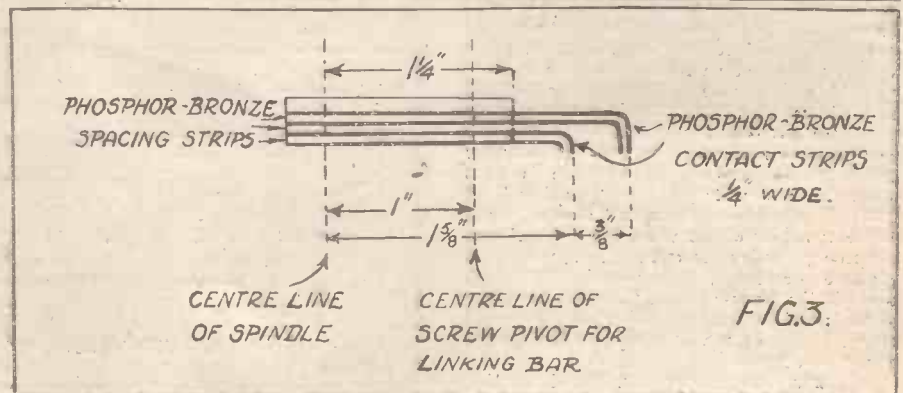
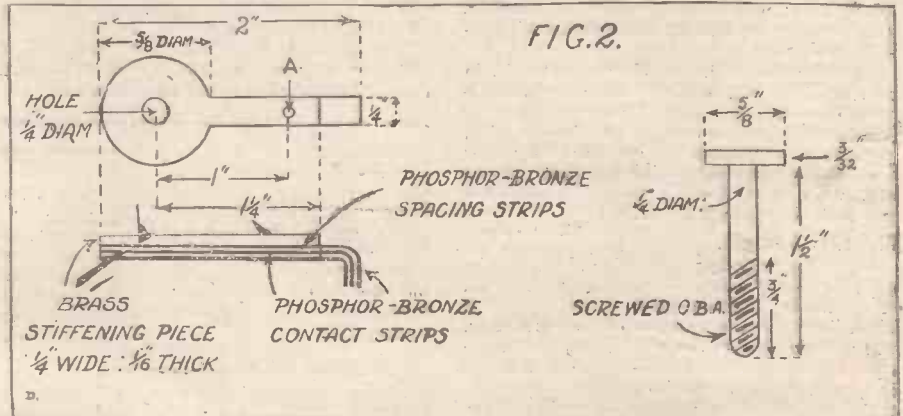

# WATES

## ONE-VALVE PANEL

AN EXCELLENT INVESTMENT



Here is an actual user's opinion:—  
 "WRITTLE comes through quite loudly and as clear as a bell.  
 EIFFEL TOWER is apparently a near neighbour. The wide range and clearness both in Morse, Music, and Speech means that the Single Valve Panel of your own make, which I bought of you three weeks ago is well thought out and carefully put together. With proper accessories the panel makes a set entirely sufficient for the average listener-in."

PRICE (without valve) £3 10.-

Owing to the large demand for this one-valve panel, we have pleasure in announcing that we can now supply same at the reduced price of £3-0-0 (previously £4). Customers can be assured that the high quality will be maintained, notwithstanding the reduced price.

Each Set is carefully tested on telephony before leaving the factory.



3-Valve Panel

WATES THREE-VALVE PANEL, 1 H.F., 1 Rect., 1 L.F. Complete with Condensers, Filament Rheostat, in handsome Mahogany Cabinet, as illustrated. PRICE, without valves or plug-in transformer, £14 14 0. H.F. Transformer for broadcast wave-lengths, 5/6 extra.

Money spent in creating home pleasures is a sound investment.

Why not call at our Showrooms and inspect our varied display of complete sets, and have them demonstrated to you?

SEND THREE STAMPS FOR ILLUSTRATED CATALOGUE. Visit our Stand No. 15, All British Wireless Exhibition, Horticultural Hall, September 30th to October 7th.

Manufacturers of best quality wireless apparatus.

**WATES BROS.** 13/14, GT. QUEEN ST., KINGSWAY, LONDON, W.C.2. Phone: Gerrard 576.

# Have this for FREE TRIAL in Your Own Home THE PERFECT RADIO RECEIVER

Designed by Wireless experts after exhaustive experiments, and All-British made

YOU CAN RECEIVE PERFECTLY WITH THIS SET

Music and speech from broadcasting stations and many amateur stations, spark signals, weather reports and forecasts from aircraft and ships' stations, time signals from Paris.

By reason of its special design and scientific construction, this Radio Set gives perfect efficiency on all wave-lengths from 200 to 2,000 metres.



Price £4-4-0.

### SPECIFICATION.

2-Slide Tuning Inductance Coil, of special design, 12 in. by 3 1/2 in., ebonite panel, 12 by 5, correctly engraved, ball and socket detector, high-class testing buzzer and key; telephone condenser, terminals for aerial, earth, and 'phones. The whole enclosed in solid Mahogany Cabinet, with drop front, as illustrated. Full instructions for setting up and operating included with each set.

Slider Rods, mounted on ebonite brackets, ensuring perfect insulation. (When mounted on the usual wooden blocks, leaks occur, wood not being a safe insulator.)

No expense has been spared in making this a thoroughly practical and easily operated instrument. No accumulators. Complies with P.O. regulations.

SEND NOW FOR YOUR FREE TRIAL

THE PERFECT RADIO RECEIVER is sent on a week's free trial, so that you may test it in your own home, on the distinct understanding that if, after you have correctly wired it up according to the simple instructions sent with each set, you do not get good signals, as stated above, we will

RETURN YOUR MONEY IN FULL

You may see and demonstrate the set at our Showrooms, or send your order, with cheque or money order payable to us, when the Perfect Radio Receiver will be forwarded post free without delay. Fuller particulars sent post free.

Double Head-phone, 4,000-ohm, 32/6. 100 ft. Aerial and 3 Insulators, 12/6.

**THE London Electrical Equipment Co.,**  
 27, FINSBURY STREET, LONDON, E.C.2.

# CQ Do you get PCGG?

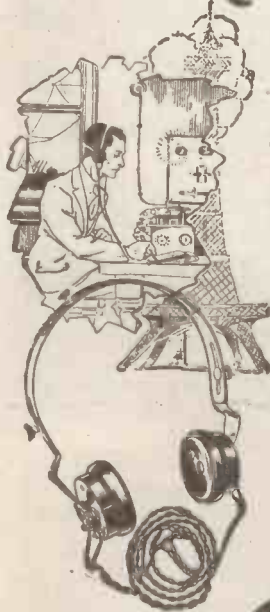

YOUR crystal or valve may be the best of their kind—your aerial high as Snowdon, your tuner perfectly accurate, but unless your 'phones are O.K. you won't get maximum "sigs."

Signals come "thumping in" through ERICSSON 'PHONES—they're built that way—for never-failing clarity and sensitivity. The magnets never lose their strength and "shorts" don't exist. And they're easy and comfortable to the head.

Back of ERICSSON 'PHONES is the accumulated experience of a generation in telephone manufacture.

Write for Particulars

The BRITISH L.M. ERICSSON MANUFACTURING Co., Ltd.  
 Head Office: 60, Lincoln's Inn Fields, W.C.

# Ericsson

## Telephones

Before Purchasing Elsewhere Write for Particulars to—

**City of London Wireless Co.,**  
 27, FORE STREET AVENUE, E.C. Phone: London Wall, 1518.  
 HEAD GEAR. Best British Made Phone: 4000 ohms, at 25/- Set.

OUR 1-VALVE SET (Fully Guaranteed), COMPRISING:

- One Valve Holder.
  - Aerial Reactance.
  - Vario Coupler.
  - Coarse and Vernier Condensers.
  - Filament Resistance.
  - Grid Leak and Automatic Blocking Condenser.
- All mounted on Ebonite Panel in Polished Oak Case for £6-0-0

CRYSTAL SETS from .. .. . £1 10 0  
 H.T. Batteries, 60 volt, from .. .. . 12 0  
 Accumulators, 4 volt 40 amp., from .. .. . £1 12 0  
 All other Accessories in stock. Cash with order. (Postage extra.)



## CONDENSERS IN RECEIVING SETS

(Continued from page 311.)

applied to the plates of a condenser is not merely increased or decreased, but is also reversed in direction—obviously the pressure on each plate will increase from a minimum to a maximum, then decrease to a minimum again in the same direction, before the same cycle of operations can occur in the opposite direction; in the same way that a shunting railway engine gathers speed, slackens speed, stops, and then reverses its direction of motion.

However quickly the pressure varies in magnitude or direction, the charge of electricity in the condenser will try to vary immediately in step with the applied pressure, for the current flow is presumed to consist of electrons, which move with great velocity, and have practically no "inertia." But unless the breakdown voltage is reached these electrons cannot pass through the dielectric as an electric current; they must therefore move via the connecting wires.

This they can only do when the applied pressure in these wires is decreasing, and is therefore, for an infinitely short space of time, less than the back pressure from the condenser. In the first quarter-cycle of operations, therefore, the condenser will be accumulating a greater and greater charge of electricity, and in the second quarter-cycle it will discharge this electricity along the connecting wires, and when the applied electric pressure, having fallen to zero, begins to increase in the opposite direction, electricity will flow into the condenser in that direction, only to be discharged in the last quarter-cycle.

### "Impedance" of Condensers.

From the very rough explanation given, we can realise that the larger the capacity of the condenser, and, most important of all for wireless work, the greater the frequency at which the electric pressure changes direction, the more nearly does the circuit behave as if there was a straight through connection; that is to say, the smaller is the "impedance" of the condenser.

An example of a condenser, so used to provide a "path" of low impedance for high-frequency currents, while presenting practically infinite impedance to direct currents, is the condenser shunting the high internal resistance of the high-tension battery in a modern valve receiver.

The impedance of a coil of wire, on the other hand, such as the coil  $L_2$  in Fig. 3, increases with the frequency at which the electrical pressure applied to its ends changes direction.

When, therefore, we wish to tune the aerial or closed circuit to a definite frequency, corresponding to the wave-length of any particular transmitting station, we can do so by varying the capacity of the condenser  $C_1$  or  $C_A$ , until its effect on the circuit exactly counterbalances the opposite effect of the coil  $L_2$  or  $L_A$ . The whole circuit is then most sensitive to alternating electrical potentials of that particular frequency, and is therefore tuned to the corresponding wave-length.

In a receiving set it is an advantage to keep the capacity of the tuning condensers small, and the coil  $L_2$  or  $L_A$  is therefore adjustable by tappings, or may be replaced by other larger coils in turn, if the circuits are designed to be adjustable over a large range of wave-lengths and therefore of frequencies.

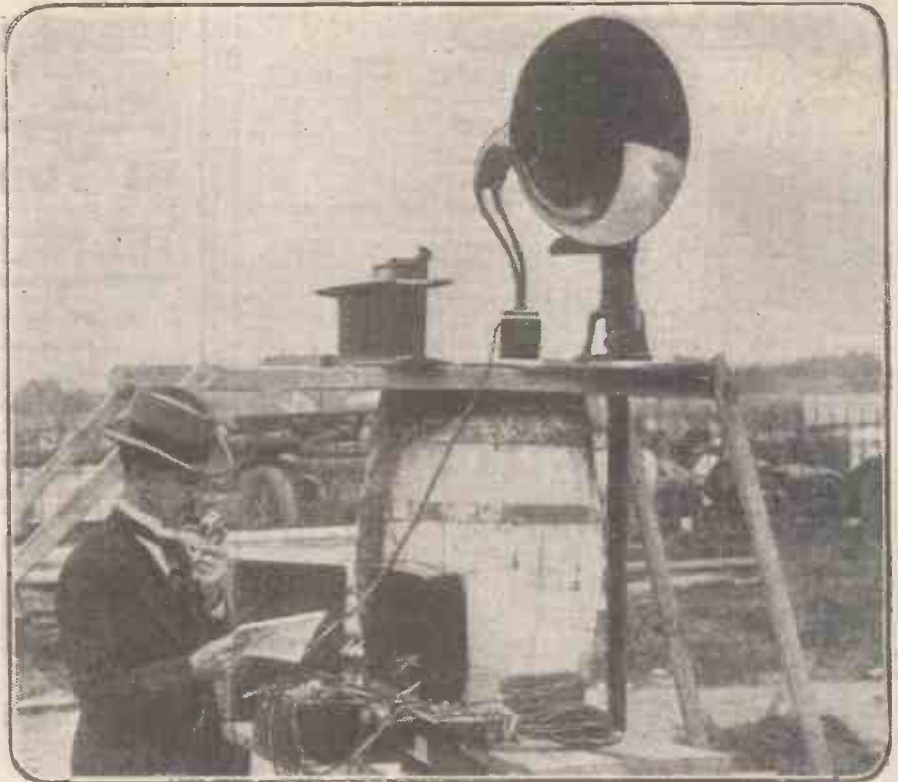

Broadcasting the results of motor races at Brooklands to the crowd.

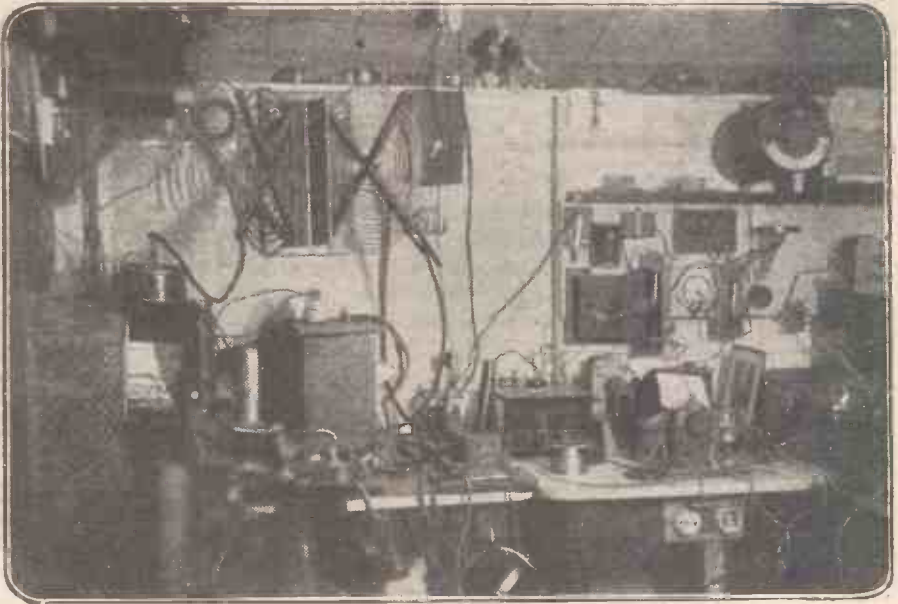

A transmitting set built by Mr. W. Happenback, the Ritz Hotel, Piccadilly.

## HOW TO MAKE A SHORT-WAVE RECEIVER

(Continued from page 314.)

1 in. high. A small hole should be drilled through the upright part of each of these clips to accommodate the contact caps of the grid leak.

The grid circuit condenser with its leak should be fitted on the under side of the panel close up to the two terminals provided at the

top left-hand side of the panel, that is between these terminals and the spindles of the range switch.

The telephone by-pass condenser should also be fitted on the under side of the panel close up to the two terminals which occupy the centre of the right-hand side of the panel.

When all these parts have been fitted into position it will only remain to wire up the instrument. The general connection scheme has already been given, but in order to facilitate the wiring operation a detailed wiring diagram will be given next week.

(To be concluded next week.)

## Five of PETO'S Useful Accessories

If you need more, just send for complete ILLUSTRATED CATALOGUE and make your selection. CATALOGUE (P) also contains list of stations. POST FREE 6d.

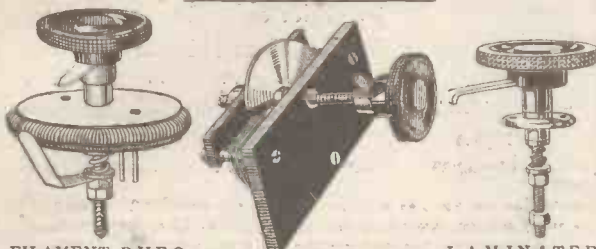

FILAMENT RHEOSTATS. "Velvet" Type. Complete with screws for panel mounting. Price 4/-

VERNIER CONDENSERS. For panel mounting. Price 4 6.

LAMINATED RADIAL SWITCH ARMS. Complete. Price 2/1. Studs with Nuts, 1/- doz.

LEAD-IN INSULATORS 8 ins. by 1 in. Price 2/- 12 ins. by 1 in. Price 2/9



SPHINX RESISTANCE UNITS with Clips. 2, 3, or 5 Meg. Price 2/6 each. 50, 60, or 80,000 Ohms. Price 3/6 each. (Guaranteed 12 mths.).

**VISIT OUR STAND, No. 16,**

**ALL-BRITISH WIRELESS EXHIBITION, HORTICULTURAL HALL, SEPT. 30 to OCT. 7. PETO SCOTT (The Condenser King), FEATHERSTONE HOUSE, 64, HIGH HOLBORN, LONDON, W.C.1.**

## WIRELESS INSTRUMENTS

and parts manufactured by and bearing the name "BROWN" can be bought with absolute confidence in their quality, value, and efficiency.

### The "Brown" Super-Sensitive Telephones

These Telephones are unquestionably the clearest and most sensitive made, and, consequently, increase the distance over which wireless can be heard.

BROWN'S are recognised as the most comfortable to wear, due to their extreme lightness in weight and adaptable adjustment. There is no wireless head 'phones in the world to compare with BROWN'S.



"A" TYPE  
Low Resistance  
58/-

High Resistance  
62/- to  
66/-

(These prices include Cords.)

"D" TYPE  
Low Resistance  
48/-

High Resistance  
52/-

(These prices include Cords.)

**IMPORTANT NOTICE.**—When purchasing BROWN'S, you should see that the name BROWN is stamped on the back of each ear-piece. This is the hallmark and proof of their genuineness, excellence of finish, and highest efficiency.

In universal use. As supplied to British, Allied, and Foreign Governments.

**VISIT OUR STAND, No. 43, ALL-BRITISH WIRELESS EXHIBITION, Horticultural Hall, Sept. 30 to Oct. 7.**

Head Office and Works:  
Victoria Road,  
North Acton,  
London, W.3.



ILLUSTRATED CATALOGUES POST FREE

London Showrooms:  
19, Mortimer St.,  
London, W.1.

USE

# THREE STAR ACCUMULATORS

and have **THE BEST**

WE SPECIALISE IN ACCUMULATORS FOR WIRELESS SETS.



WRITE FOR OUR LATEST PRICE LIST. LIBERAL TERMS TO THE TRADE.

**THREE STAR ACCUMULATORS, LTD., CROWLAND ROAD,**

Phone: TOTTENHAM 2473. SOUTH TOTTENHAM, LONDON, N.15.

## Quality PRICE and see you get the address RIGHT

Complete sets of Metal Parts with Knob and Engraved Scale for making Variable Condensers,

·001	10/6
·0005	8/-
·0003	6/-

Postage 9d. extra.

Oak cases for above, 4/- and 4/6 each. Postage 9d.

**HEAD 'PHONES, 4,000 OHMS.**

The greatest bargain ever offered, one quality only, THE BEST. 25/- per pair. Complete with Cords and ends. Call and see these at our Showroom. Postage 1/- extra.

**BUILD YOUR OWN CRYSTAL SET.**

12-inch Coil, Base and Ends in Teak, Rod and Slider. Crystal Detector and Terminals. First-class finish throughout 16/-. Postage 1/6. 100-ft. Aerial, 4 Insulators, 10 yds. Leading-in Wire, 7/6. Postage 1/6.

**PARROT LOUD SPEAKER** repeats everything it hears. 2,000 OHMS. 50/- each complete. Wall Pattern.

Hertzite Crystals, the best yet, 2/6 each. Mounted in Brass Cup with Screw, 3/- each.

YOU CANNOT BEAT US FOR PRICE AND QUALITY.

Every Accessory for Wireless in stock at Lowest Prices, consistent with Best Quality. CATALOGUE FREE.

**WILL DAY, LTD.,**

19, Lisle St., Leicester Sq., London, W.C.2.

Phone: Regent 4577. Telegrams: Titles, Westrand, London.



# "PALMER-FONES"

These "Super-Sensitive" Head Phones are the result of many years' experience, and over 30,000 of these have been purchased during the last four months, and repeat orders are being given which prove their excellent value.

## DELIVERY FROM STOCK.

Every Set is thoroughly tested, and all are guaranteed in perfect condition, readily adjusted to any position. Very light and comfortable. Standard resistance 4,000 ohms. Each complete with Double Head gear with connecting cord.

29s. 0d. price over Counter. We also supply 120 ohm, 2,000, 6,000, and 8,000 Head Phones.

MARCONIPHONES, From Each	£4 13 6	Condenser Spacer Washers, large and small, per doz. pairs	1 3
METROPOLITAN-VICKERS, Complete Sets From	4 10 0	Condensers, complete Contact Studs, with nuts and washer, per doz.	4 6
Brown's Loud Speakers	5 10 0	Crystal Cups (small and large) Each 2d. & 6d.	8
Magnavox Loud Speaker, "Junior" type	10 10 0	Crystal Detector	5 6
Magnavox Loud Speaker, "Senior" type	20 0 0	Lightning Arresters	2 0
2-valve power Amplifier, complete with valves, but less batteries (For Magnavox)	22 10 0	Lead-in Tube, 6-in. long Inductance Tube	2 0
3-valve power Amplifier, complete with valves, but less batteries (For Magnavox)	35 0 0	Valve Legs, with nuts and washer Each Set	5 0
Crystal Tuner, auto-coupled, complete with condenser and crystal	1 18 0	Valve pin	3
Crystal Tuner Double Slide, auto-coupled, complete with condenser and crystal	2 13 6	Terminals, complete, small and medium, per doz.	2
Ebonite Valve holders, 4 legs, with nuts and washers	1 0	Terminals, complete, large, per dozen	1 8
Ebonite Valve holders, complete, best quality	1 9	Square Brass centre rods for Condenser	2 0
Ebonite Slider and Plunger	8	2BA Brass Screwed Rods, 12-in. lengths	6
Ebonite knobs, 1 1/2-in. dia., knurled edges, tapped, 2BA	6	Brass nuts, 2BA, 4BA, and 5BA, per doz.	5
Ebonite sheets, various thicknesses (cut to any size) per lb.	4 6	Tuning Bar, Square Brass rod in 13-in. lengths	4
Switch arms, complete	2 6	Insulators, porcelain, large shell type	5
Condenser, fixed and moving vanes, aluminium, per doz. pairs	2 0	Insulators, porcelain, small, egg shape	8
		Insulators, 2-in. Reel Type	3
		Ironing Scales	4
		Aerial, Earth, and Phone Labels	6
		Aerial Wire, 100 ft., 7/22, with 2 Insulators	3
		Wireless Masts, in four sections, totalling 11 ft.	4 6
		Filament resistances	4 9
			5 0

POSTAGE EXTRA. WHOLESALE TRADE SUPPLIED.

**GEORGE PALMER,** Wireless and Sound Transmission Specialist.  
47, Gerrard Street, London, W.1.

# OMNIPHONE CRYSTAL RECEIVERS

Type A.—Wave-length range 300 to 500 metres for Broadcasts. Price complete .. £4 10 0

Type A1.—For Broadcasts and Paris time signals. Price complete .. £5 0 0

Type B1.—A receiver de luxe for all. Wave-lengths from 300 to 2,600 metres (Paris) inclusive. Price complete.. £7 0 0

The above are carefully designed and well-made wireless instruments, of the highest efficiency, and are capable of receiving the concerts up to distances of at least 25 miles—often much more—and are covered by our guarantee.

In polished walnut cabinet, and supplied with complete equipment, including 4,000-ohm 'phones, aerial, insulators, lead-in tube, etc., and instructions. Sent carriage free.

These receivers, while complete in themselves, may form the nucleus of a more elaborate set, as special provision is made for the attachment of a high-frequency valve amplifier.

CALL FOR DEMONSTRATION, OR SEND FOR FULL PARTICULARS.

ALL WIRELESS ACCESSORIES. LIST FREE.

**THE OMNIPHONE WIRELESS CO.,**  
24, Warwick St., Regent St., London, W.1.

'Phone: Regent 3335. 20 yards from Regent St., between Robinson & Cleaver's and Maison Lewis.

## SELF CONTAINED OR UNIT SYSTEMS

Marconiphones,  
Marconi Scientific Units,  
Waveora Units, Etc.

We give demonstrations to purchasers at our showrooms.  
Tuners, Coils, Rectifiers, Amplifiers, Valves, Magnavox & Brown Loud Speakers, Microphone Amplifiers, H.T. & L.T. Batteries, and all Wireless Accessories.

Special quotations for Technical Colleges,  
Schools and Educational Institutions.

**The Radio Waveora Co. (Dept. P.),**  
168, Regent Street, London, W.1.

Tel. phones: Gerrard 3039; Western 847.  
Telegrams: Wychwood, 'Phone, London.

## HANBLING CLAPP & CO WIRELESS SPECIALISTS

### FILAMENT RESISTANCES

We have now reduced the price of our Filament Resistance to **4/6**

### VARIABLE CONDENSERS

If you are wanting parts or complete condensers come and see our stock; we have many types to select from

VISIT STAND No. 12 AT THE ALL-BRITISH EXHIBITION, HORTICULTURAL HALL, SEPTEMBER 30—OCTOBER 7.

Showrooms and Offices: **110, STRAND.** Gerrard: 8806.

**BE READY FOR BROADCASTING BY PLACING YOUR ORDER NOW.**



THE STUART WIRELESS TELEPHONY INSTRUMENTS ARE DEVELOPED TO THE ZENITH OF EFFICIENCY IN ALL RESPECTS.

FREE DEMONSTRATIONS DAILY.

(Also Sundays, 6 to 9 p.m.)

PURCHASE YOUR SET FROM THE ACTUAL MANUFACTURERS AND SECURE BEST VALUE.

### THE STUART "FAMILY SET."

THREE-VALVE TYPE, ENORMOUS RADIUS. £26 10 0

### THE STUART "JUNIOR SET."

ONE-VALVE TYPE (Also suitable for "Broadcast") £10 0 0

Transformers, High-Frequency Anode Tuners, all Wireless Accessories and Spare Parts, Magnavox Megaphones, Brown Loud Speakers, etc., supplied from Stock. Prices on application.

Send for copies of our Illustrated Booklets Nos. 2 and 3, giving full particulars. Post free 6d.

**STUART WIRELESS TELEPHONY CO.,**  
Kingsway Corner Buildings, 109, Kingsway, London, W.C.2.



# WIRELESS CLUB REPORTS.

The Editor will be pleased to publish concise reports of meetings of wireless clubs and associations, reserving the right to curtail the reports if necessary. Hon. secretaries are reminded that reports should be sent in as soon after a meeting as possible. Reports sent in cannot appear in this paper in less than ten days after receipt of same. An asterisk denotes affiliation with the Wireless Society of London.

## The Durham City and District Wireless Club.

On Friday evening, August 25th, the fifth meeting of the above society was held. It proved to be a very enjoyable and intensely interesting evening for the members.

The Morse buzzer class, conducted by Mr. G. Nurthen, assisted by Mr. W. Rushworth, was quite exciting, the ladies particularly enjoying themselves.

After Morse practice the hon. sec., Mr. G. Barnard, gave a short lecture on diagram interpretation, using 22 diagrams upon the blackboard to represent various apparatus. These diagrams were copied by the members. After the announcements the chairman, Mr. S. Kelly (hon. treas.), commenced the question period by asking the secretary to revise briefly the last lecture on the relationship between inductance and wave-length of a closed oscillatory circuit. At the request of a lady member Mr. Barnard gave a condensed explanation of the function of a crystal detector in a receiving circuit. Mr. R. W. Holmes, at this point, drew and explained upon the blackboard the curve representing the relationship of the resistance offered by a crystal to the E.M.F. applied. A lively discussion then followed.

Several new members were enrolled. There was no time to discuss the merits of a free library.

Intending members are always welcome.

## Hornsey and District Wireless Society.

A full meeting was held on Friday, August 18th, and it was arranged that the club set should consist of 3 valves—one high-frequency, one detector, and one low-frequency. Mr. Pugh consented to make the panel, and Mr. Webster volunteered to make the cabinet to hold it. The whole of the club members meet every Friday to construct various items to include in the set, which it is hoped will be in use very shortly.

On Tuesday, August 22nd, the members present enjoyed speech and music from 2 F Q and 2 O M, as well as Morse signals from various stations, including loud signals from G F A on a 2-valve set loaned by Mr. Webster for the evening. Other members have kindly consented to lend their sets from time to time for demonstration purposes.

This society, which was recently founded, has now a membership of over 30, and is anxious to increase its numbers still further. Full particulars can be obtained from the hon. sec., Mr. H. Davy, 134, Inderwick Road, Hornsey, N.8, on receipt of a stamped addressed envelope.

## Ramsgate, Broadstairs and District Wireless Society.

The following gentlemen have kindly consented to become vice-presidents: Hon. E. C. Harmsworth, M.P.; Lieut.-Col. Sir T. B. Robinson, K.C.M.G., K.B.E.; Sir Cecil Hertslet, K.B.E., J.P.; Sir Edward Rigg, C.B., C.V.O., I.S.O.; H. Bing, Esq., J.P.; Rev. F. G. Ridgeway, M.A.; James Emery, Esq.; H. C. Flowerdew, Esq.; W. G. Riddle, Esq.; and C. F. Grossmith, Esq.

Following an informal meeting held in July, a committee meeting was held on August 24th, at Ramsgate, under the chairmanship of Mr. H. C. Norman, B.A. The committee of management, composed of Messrs. H. C. Norman, B.A., E. Guy, M.Sc., E. P. Pester, B.Sc., C. E. Hume, P. F. Weeks, M.B.E., P. E. Stanley, and F. Harrison (Ramsgate), P. F. Cotton and F. C. Marshall (Broadstairs), considered the necessary rules and details for formation, which were adopted.

It was agreed to divide membership into three sections: "Members," "associates," and "student associates." Subscriptions to be 10s., 5s., and 2s. 6d. per annum; members having two votes and privilege of bringing a friend to lectures, etc., once a month; associates having one vote but not the latter privilege; student

associates being junior members still at school. The first meeting, which was a general meeting, was held early in September, when the question of permanent headquarters was finally decided. Weekly meetings will be held to commence, which will embrace buzzer practice, instruction in construction of apparatus and individual sets, etc. All locally interested parties of either sex are invited to write to either of the hon. secs. who will be delighted to supply further information. The first list of members is most encouraging.

Joint hon. secs.: Mr. F. Harrison, "Rochester Cottage," High Street, St. Lawrence (Ramsgate), and Mr. F. C. Marshall, 6, Ramsgate Road, Broadstairs (Broadstairs and district).

## The Wireless Society of Liverpool.\*

A highly successful meeting of the above society was held on Thursday, August 24th, at the Royal Institution, Colquitt Street, Liverpool.

Special arrangements had been made with the Ashley Wireless Telegraph Co., Ltd., of Renshaw Street, Liverpool, whereby they would transmit telephony and musical items from their experimental station, 2 K H, the same being received on a 5-valve receiving set of their own manufacture (2 H.F., 1 Rect., 2 L.F. valves).

The programme commenced promptly at 8 p.m., and continued until 9.30, there being six-minute transmissions with intervals of five minutes' duration each. The receiving set was operated by Mr. C. G. Williams, of Messrs. Ashley (who is also a prominent member of the society and on the advisory committee). The whole of the items were received extremely satisfactorily (especially in consideration of the fact that the set was worked in conjunction with the society's indoor aerial, which is of but moderate dimensions), and were made clearly audible to all present through a "Brown" loud speaker. The programme was very varied, containing amongst other items selections from Gilbert and Sullivan, "Annie Laurie," "The Policeman's Holiday," a pot-pourri, and the inimitable Tom Foy in a speaking record.

The five-minute intervals were occupied in answering the questions deposited previously in the question box, Mr. S. Lowey rendering great assistance.

All intending members are advised to apply at once to the secretary for application forms, so that none of the special meetings which are being arranged will be missed.

Hon. sec., Mr. C. L. Lyons, 76, Old Hall Street, Liverpool.

## The Beckenham and District Radio Society.

The above society is now in full swing. Although only a few weeks since the inaugural meeting, over thirty members have been enrolled, and many applications for membership are being received.

At a general meeting held recently, it was decided to hold the meetings on Thursday evenings, at 8.15 p.m., at 114, High Street, Beckenham.

A committee was appointed to draw up rules and arrange a syllabus of lectures and demonstrations.

On August 19th the society gave a very successful demonstration at the annual fête of the Beckenham Allotment Society, held at the Technical Institute, when, by special permission of the P.M.G., Lieut. Walker (2 O M), Brentford, kindly transmitted music at various intervals, which was received perfectly and with marked satisfaction by a very large number of "listeners-in" of all ages.

A junior section is being formed for those under the age of 18 years. Ladies are also welcomed as members.

All applications for membership should be addressed to the hon. sec., Mr. J. F. Butterfield, 10, The Close, Elmers End, Beckenham.

## NEW CELLULOSE CASE CONDENSERS

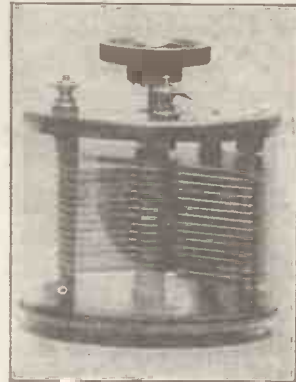

001  
24/-  
0005  
17/6  
0003  
15/-  
00005  
12/6

QUALITY TELLS:  
2½ Gross sold in six days

Every description of Wireless Goods

SPECIAL TERMS TO THE TRADE

**B. L. HOUSTON,**  
65, Endell Street, London, W.C.2.  
Phone: Regent 4911.

## TO WIRELESS EXPERIMENTERS. PATENT YOUR INVENTIONS.

They may prove very valuable. Particulars and consultations free. BROWNE & CO., Patent Agents, 9, Warwick Court, Holborn, London, W.C. 1. Established 1840. Telephone, Chancery 7547.

## THE BEST BOOK ON WIRELESS FOR AMATEURS

How to make and use a Wireless Valve Receiver Set, By E. K. Spiegelhalter. This book has been specially written for Amateurs in Wireless. Clear Constructional details accompanied by 24 very practical illustrations are given, which will enable the operator to build his own set economically and to work it successfully when made.

Price 2/- net. Send P.O. for a copy. E. & F. N. SPON, Ltd., 57, Haymarket, London, S.W. 1.

PHONES, Marconi, H.R., 15s. pair; Valve Legs, 3d. each; Terminals, 3d. each; Detector Panel, parts, including drilled eb. top ready to assemble, 18s. 9d.; H.F. and L.F. Panels, parts, H.F. with cond., L.F. with trans.; eb. top ready to assemble, 23s. 6d.; Tuner, complete parts, 33s. 6d.; Fraser Patent Coil Holder, 10s. extra; Slab Coil Carriers, Patent, standard plug pitch, fits any holder, 2s. 9d. each; Rev. List Bgrats. JAMES FRASER & CO., address as E.T.C. below. Wireless Instruction. Day, Evg., Postal Courses in Radio, Valves, etc. P.M.G. Exam. and Amateur Classes. Also Telegraphy and Cable. Prospectus free. Phone: North 1036. Principal, Electrical Training College, Radio House, Manor Gardens, Holloway, London, N.7.

## SINGLE RECEIVERS For Wireless.

A limited stock of first-class Aluminium Watch Type Receivers, quite new, 150 ohms, brass terminals and clip for head band on back, highly sensitive thin diaphragms accurately adjusted, good magnets. Bargains at 6s. each, post free; worth double; each tested on our Aerial.

One pair small reels of 46-gauge best enamelled copper wire, sufficient to re-wind bobbins of the above receiver (or any others) to 4,000 ohms resistance, 2s. 6d. pair.

ADOLPH TAYLFORTH & CO.

Works: 12, Leverington Street, Clerkenwell, London, E.C.1

STEVENS COUNTERPOISE EARTH BOX & CABLE OUTFIT. Send cash 5/6 (includes postage in U.K.). ENSURES BEST RESULTS WHEN INSTALLED. Instructions supplied. Length of cable 30 ft. Additional 10 ft. lengths, 1/- each.—A. H. STEVENS, 12, Shrubby Rd., London, S.W.16. Phone Streatham 1816.

## DAVIS & TIMMINS, LTD.,

34a, York Road, King's Cross, N.1.

## SCREWS AND TERMINALS

FOR WIRELESS SETS

Write for Illustrated Lists.



# RADIOTORIAL

All Editorial Communications to be addressed The Editor, POPULAR WIRELESS, The Fleetway House, Farringdon Street, London, E.C.4.

The success of the wireless exhibition at the Central Hall is a good indication that the delay in broadcasting has not seriously damped the general interest in amateur wireless work.

The various firms exhibiting did record business, and the technical staff at the POPULAR WIRELESS stall had a very busy time answering questions.

Judging by the questions asked—by ladies as well as gentlemen—hundreds of people are only waiting for the broadcasting service to commence before they purchase a wireless set.

Therefore, it is in the interests of manufacturers—especially those concerned with the Broadcasting Co.—to get down to business as soon as possible.

At present, public comment is not favourable to those who control the future of broadcasting.

We recognise the difficulties and appreciate the delicate position manufacturers are likely to find themselves in unless they can see a way clear to get their money back—but there is a limit to public patience.

It would, perhaps, have been far more satisfactory if newspapers had been allowed to arrange the broadcasting service.

Manufacturers would have benefited to an even greater extent than they now anticipate, and I feel sure that the organisation of a broadcasting service would have received speedier treatment.

However, we are definitely assured that broadcasting will commence this winter—in October, to be precise—and until then we must exercise a little more of that rare gift—patience.

THE EDITOR.

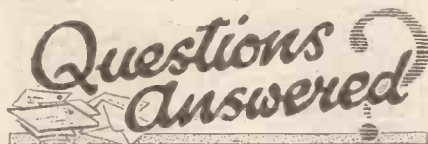

Owing to the enormous number of queries received daily from readers of POPULAR WIRELESS, I have decided to reply individually by post. A weekly selection of questions will, however, be printed on this page, together with the answers, for the benefit of readers of POPULAR WIRELESS in general. Questions should be clearly and explicitly written, and should be numbered and written on one side of the paper only.

All questions to be addressed to: POPULAR WIRELESS, Queries Dept., Room 131, The Fleetway House, Farringdon Street, London, E.C.4.

Readers are requested to send necessary postage for reply.

T. R. W. (Doncaster).—How can one obtain an idea as to the probable remaining ampere hours capacity in a partly discharged accumulator?

This is quite simple if periodical hydrometer readings are taken. Multiply the difference between the specific gravity at full charge, and at the time of test, by the specific gravity constant, subtracting from the result the rated ampere-hour capacity. The specific gravity constant is obtained by dividing the ampere-hour output measured on a test discharge at normal discharge rate by the number of degrees that the specific gravity has fallen during the last discharge.

D. M. V. (Swansea).—What is meant by the "bullet" conduction of a valve?

That would indicate colloquially the one, of the three possible methods of conduction, applicable to the thermionic valve. The ejection of electrons from the filament is compared to the discharge of bullets from a machine-gun.

The other two methods are the "birdseed," applying to liquids and exemplified by electrolysis (the bird carries the seed with it, and drops it when it reaches the electrode); and the "firebucket." This latter applies to the conduction in solids where the atoms are not capable of locomotion and must, therefore, pass the electrons from hand to hand, oscillating slightly in both directions to receive and pass them on, and so gradually being thrown into a state of vibration which is called heat.

T. R. E. (Newark).—Can you give me a simple formula for discovering the capacity of a condenser, the factors being in inches?

$$K + \frac{AK}{d} \times .000002246 \text{ mfd.}$$

"AMATEUR" (Blackpool).—By doubling the number of turns of wire on a coil, do I double the wave-length range?

You more than double it. The inductance of a coil is proportional to the square of the number of turns. By doubling the number the magnetic field is doubled, and this latter will, when the current is stopped or started, cut the windings, which are twice as many as before, and thus generate four times the E.M.F., because this E.M.F. is directly proportional to the turns and the strength of the magnetic field. It must be understood that this is an opposing E.M.F., generally termed "back E.M.F." It will not mean that the wave-length range is quadrupled; because the capacity and inductance of the aerial must be taken into the calculation.

D. F. S. (Bournemouth).—Can a resistance of high value be used for low-resistance telephones in place of the usual telephone transformer, following the same principles of the resistance interval-coupling of aperiodic nature?

Yes. A resistance of the order of 100,000 ohms is placed in series with the plate and H.T. The telephones with a condenser of .05 mfd. capacity in series are placed directly across. Finally, a small variable condenser should be shunted directly across the telephone terminals.

"INTERESTED" (Belfast).—What is the largest wave-length of the 35s. set described in No. 1?

About 800 metres.

Is a condenser unnecessary for that set?

A .0005 mfd. variable condenser across the coil will make finer tuning possible and slightly increase the wave-length range, but is not essential.

Will a nail driven into the wall do for the earth, as my nearest water-pipe is 12 yards away from the set?

No, because the substance of a wall will not be a good conductor. Although a water-pipe makes a fairly good earth connection, a direct earth to a plate or rod of metal buried in fairly moist ground is always to be preferred. In cases where the earth lead must be of some undue length, two or three wires of heavy gauge should be run in parallel to reduce resistance.

If I put my aerial wire round two chimney stacks, will I require three insulators for each chimney to keep the wires from touching the brickwork?

You should confine yourself to the orthodox double, or, if very short, four-wire aerial suspended between two spreaders. Aerial systems that employ triangular, square, or oblong runs of single wire are not likely to prove at all efficient.

S. F. D. (Sparkbrook).—Will insulated bell wire do for the earth lead?

If it is very short, yes, but otherwise it is advisable to use wire of somewhat heavier gauge.

If I connect the earth lead to a water-pipe where the telephone earth wire is, would it interfere with either instrument?

In such a case it is advisable to employ a direct earth to a plate of metal buried in the ground, because if the water-pipe is of any considerable length before reaching earth it is probable that there would be induction.

Is a lightning conductor necessary with a crystal set?

Yes. An earth arrester as described in No. 7 of POPULAR WIRELESS should be placed across the earth and aerial connections of the set.

(Continued on page 323.)

## UNITED BY A COMMON BOND





# “Ever-Ready”

British Made

## DRY CELLS & BATTERIES

for High and Low tension current.  
As supplied to H.M. Government.  
“FIRST AND FOREMOST”  
Highest electrical efficiency maintained.

The “UNIT” Dry Cells. Unlimited flexibility in size, voltage, and intermediate tappings. Efficiently insulated to prevent current leakage. E.M.F. 1½v.

High-tension batteries. All sizes and voltages with all types of tappings at various intervals, or sockets for Wander Plugs.

No. UW. 1.  
7/6 doz.  
Size 2½" x 1½"

No. W11, EMF 15v.  
3/6 each.  
Size 9½" x 7" x 2½"

Art Catalogue (P.W.) of Standard Sizes sent on request.

### HORTICULTURAL HALL. WIRELESS EXHIBITION

SEPT. 30th. to OCT. 7th.  
STAND NO. 11.

WHOLESALE ONLY

The Ever-Ready Works,  
Hercules Place, LONDON, N.7.



Established 1900.

CONSIDER WELL YOUR FUTURE

WE TEACH BY POST.

ADVICE FREE. Most moderate charges—payable monthly.

LEARN A TRADE OR PROFESSION

Can I help you?  
I WILL GIVE YOU £50  
if I fail to produce over 7,000 testimonials from others I have helped TO A SUCCESSFUL CAREER.  
Yours to success.

*J.W. Bennett*

## ARE YOU QUALIFIED FOR THE JOB YOU SEEK?

Write for one of our FREE BOOKLETS on WIRELESS TELEGRAPHY, or on any of the following subjects—

Architectural Drawing	Mathematics
Building Construction	Matriculation
Clerk of Works' Duties	Metallurgy
Aviation	Mining
Boiler Engineering	Mine Surveying
Boiler Making	Motor Engineering
Chemistry	Naval Architecture
Civil Engineering	Pattern Making
Concrete and Steel	Salesmanship
Draughtsmanship	Sanitation
Electricity	Shipbuilding
Engineering	Structural Engineering
Foundry Work	Surveying and Levelling
Internal Comb Engines	Telegraphy and Telephony
Marine Engineering	Special Course for Apprentices

What proof do you carry? Your word to an employer is not proof that you are efficient, but a College Qualifying Diploma or Certificate, signed by the Professional Staff, is a proof of efficiency, and a valuable asset in seeking a remunerative position.

We specialise in all exams. connected with Wireless and other technical subjects. If you are preparing for any exam. ask our advice. All particulars FREE OF CHARGE. Parents should seek our advice for their sons. If you are interested in Wireless, or any of the subjects mentioned above, write, naming the subject, and we will send you our FREE BOOKLET. Please state your age.

COURSES SPECIALLY COMBINED TO MEET ALL REQUIREMENTS.

*The Bennett College*  
Department 106. SHEFFIELD

## RADIO K.B. EQUIPMENT.

IMMEDIATE DELIVERY—IMMEDIATE SATISFACTION

### VARIABLE CONDENSERS (with Scale and Pointer)

CAPACITY.	FOR PANEL MOUNTING.		IN POLISHED MAHOGANY CABINET (ASSEMBLED).
	SET OF PARTS.	ASSEMBLED.	
·0015	27/-	30/-	38/6
·001	21/-	24/-	31/6
·00075	17/-	20/-	26/-
·0005	14/-	17/-	22/6
·0003	11/-	14/-	19/-
·0002	8/-	11/-	16/-
·0001	7/-	10/-	14/6
·00005	3/6	5/-	9/-

ENGRAVED EBONITE DIAL . . . . 3/3 extra.  
LAMINATED SWITCH ARMS (Complete) . . . . 2/5 each.  
FILAMENT RESISTANCES (Panel Type) . . . . 4/- each.

“K.B.” UNITS.  
DETECTOR PANEL . . . . £1 14 6  
CONDENSER PANEL . . . . £1 14 0  
L.F. AMPLIFYING PANEL . . . . £2 3 0  
H.F. . . . . £1 13 6

Price includes Engraved Panel and Polished Mahogany Cabinet. Parts also supplied.

“K.B.II.” 2-VALVE RECEIVER (1 Rect., 1 L.F.)  
COMPLETE from Aerial to Earth . . . . £15 15 0  
PANEL ONLY . . . . . 28 8 0

LARGE STOCKS OF ABOVE NOW IN HAND. ALSO STOCKS OF ALL OTHER AMATEUR REQUIREMENTS.

Carriage extra on orders under £2. CATALOGUE P.W. POST FREE, 4d.  
VISIT OUR STAND, NO. 8,  
All-British Wireless Exhibition, Horticultural Hall, September 30 to October 7.  
“Listen in” at our Showrooms: Open 9 a.m. till 7 p.m.

THE “K.B.” RADIO EQUIPMENT COMPANY,  
Head Offices & Showrooms: 109, High Road, Kilburn, N.W. 6.  
Bus Services— 3 minutes Kilburn Park Station  
8, 16, 28 & 51 Pass Door. (Bakerloo Rly).  
**TRADE SUPPLIED.**

For they are jolly good Fellows.

## THE “FELLOCRYST”

(REGISTERED)

### WIRELESS CRYSTAL RECEIVING SETS.

BRITISH THROUGHOUT.



COMPLETE (As Illustrated) £3 : 7 : 6  
with one pair of double headphones—postage 1/6  
NO BATTERIES REQUIRED.

The set comprises tuning coil with a wave-length of approx. 300 to 1,500 metres; Silicon Crystal Detector; 4,000 ohms double headphones; 100 ft. coil of 7/22 stranded copper wire; 2 shell insulators, terminals, etc.

Each set tested and guaranteed to receive broadcasting within a range of 15 to 20 miles, and Morse signals from a much longer range.

Extra headphones, complete, 30/- per pair. Postage, 1/-.  
**FELLOWS MAGNETO CO., LTD.**  
LONDON, N.W.10.

Telephone: Willesden 1560-1. Telegrams: Quixmag, Phone, London.  
Visit our Stand, No. 10, All-British Wireless Exhibition, Horticultural Hall, September 30th to October 7th.  
(E.P.S.) 2



# Some Useful Books

## AT POPULAR PRICES.

### WIRELESS CIRCUITS AND CONNECTIONS.

This handbook contains 90 useful Diagrams of Circuits and Connections, with Explanatory Notes; making an excellent guide to the most effective arrangement of the apparatus. Price 6d. net, or post free 7½d.

### WIRELESS AT HOME.

Containing all information necessary for the novice in Wireless Telegraphy and Telephony to fit up and get the best use out of his station; together with helpful hints for the receiving of broadcast Wireless News, Concerts, etc. Written in clear and understandable language. Illustrated. Price 6d. net, or post free 7½d.

### WIRELESS TELEGRAPHY SIMPLY EXPLAINED.

A popular handbook dealing as simply as possible with this highly engrossing subject. Successive chapters deal with Essential Apparatus, Sending, Receiving, Special Methods, Station-working, Miscellaneous Points, the Triode, Simple Receiving Sets, and a table of the International Morse Code. Price 9d. net, or post free 10½d.

### SMALL ACCUMULATORS: How Made and Used.

This is an Elementary Handbook, intended for the use of Amateurs and Students in electrical matters. Dealing with the Theory of the Accumulator, the making of 4-volt and 8-volt types, and how to Form, Charge, and Use Accumulators; also a valuable chapter on Charging from Alternating Currents. Well illustrated. Price 9d. net, or post free 10½d.

### ELECTRIC BATTERIES: How to Make and Use Them.

A practical handbook for Amateur Electricians, describing in a simple fashion the principal forms of primary electric batteries, together with explanations of their working and use. Fully illustrated. Price 9d. net, or post free 10½d.

*From all Booksellers, or post free as above  
from the Publishers:*

**PERCIVAL MARSHALL & COMPANY,**  
66, Farringdon Street, London, E.C.4.

# THERE YOU ARE THEN!

## GRIFFIN

FOR

# QUALITY EFFICIENCY DESPATCH

COMPLETE SET OF PARTS TO BUILD  
A SUPER VALVE PANEL FOR 17/-

CONTAINS:—Ebonite Panel, 4-in., drilled, Filament Resistance Grid Leak and Condenser, Telephone Condenser, Valve Holder necessary Terminals and Insulated Wire. Postage 6d. extra  
"Griffin" Super Crystal Set (300/2,000 metres), wonderful value Price **38/-**

Cabinets and Panels made to your own requirements.

### QUALITY PRICES.

Accumulators, "Three Star"	Condensers, special quality for panels
4 volt, capacity 10 amp. hrs., 19/3	.001, 25/-; .0003, 15/-; .0005, 20/-
4 " " 20 " " 25/9	Crystal Detectors, 4/6 and 9/6
6 " " 10 " " 23/11	Filament Resistances, superior, 4/6
6 " " 80 " " 49/-	Headphones, 4,000 ohms, 25/-
Batteries, H.T. (Siemens)	Brown's, Stirling, 52/-
15 volt, 4/-; 30 volt, 9/-; 60 volt, 18/-	Coil-holders, 3 coils, 21/-; 2 coils, 15/-
Aerial Wire.	Inductance Coils, wound, 12 in. by 4 in., 3/9; unwound, 6d.
Bare Copper, 7/22, 100 ft. ... 3/6	Transformers (Federal), 35/-
Enamelled, 7/22, 100 ft. ... 4/6	
Silicon Bronze, 180., 100 ft. 3/3	
Ebonite.	
"A" quality, sheet, per lb. 4/6	
do. tube (1), per ft. 3d.	

Send us your orders for all other accessories in stock at market prices. Terms—Cash with order + postage. Delivery free, £2 0 0 and over.

**GRIFFIN WIRELESS SUPPLIES,**  
80, Newington Causeway, London, S.E.1  
(2 minutes from Elephant and Castle Tube Station). Phone: Hop 1506.

# WIRELESS ENTHUSIASTS.

ABSOLUTELY COMPLETE

FOR **£3 - 10 - 0** CASH

OR **£1 - 0 - 0** DOWN AND 5/- WEEKLY FOR 12 WEEKS

OUR BEAUTIFUL CRYSTAL SET No. 1, WITH 4,000 OHMS HEADPHONES, LEADING-IN TUBE, AERIAL WIRE, AND SIX INSULATORS. TESTED AND GUARANTEED FOR CLEARLY RECEIVING BROADCAST SPEECH, MUSIC, AND MORSE MESSAGES.



THE COIL IS WOUND ON BEST 'ISOLO' UNSHRINKABLE TUBE 12" x 4", GIVING A GOOD PICKING-UP RANGE AND MOUNTED ON POLISHED BASE. WITH CONDENSER, ETC.

BOOK OF INSTRUCTIONS WITH EACH SET.

Cheques, P.O. or M.O. must be crossed  
NATIONAL BANK, Ltd., King's Cross Branch.

SEND YOUR ORDER  
TO-DAY WITHOUT DELAY

**H. A. WHITE & SON, 229, Pentonville Road,  
London, N. 1. Phone: Central 3045.**

# HERE'S REAL RADIO SERVICE!

OUR AIM—IMMEDIATE DELIVERY.	QUALITY HIGH, PRICES LOW.
AERIAL WIRE, 7/22, stranded copper ...	4/- per 100 ft.
REEL INSULATORS	2d. each
Wound 12 by 4 in. coil, with 24 Enamelled Wire	4/8
1 in. sq. BRASS RODS, 13 in. length	6d. each
SLIDERS (best turned Ebonite)	9d.
CRYSTAL DETECTORS, mounted on Ebonite base	4/6
CONDENSER VANES, Aluminium, cut true to 1:1,000th	9d. per doz.
SPACING WASHERS: Small, 3d. per doz.; Large	5d.
EBONITE KNOBS, best turned Ebonite	7d. each
IVORINE SCALES, 0-180	9d.
IVORINE TABS, Earth, Aerial Phones, H.T., L.T., Resistance	2d.
BLOCKING CONDENSERS	2/8
VALVE-HOLDERS, A type	10d.
VALVE-HOLDERS, better types	1/6, 1/9, 2/3 each
CONTACT STUDS	8d. per doz.
VALVE LEGS set of four, with nuts	6d.
PRAMEL WIRE, 24 gauge	2/6 per lb.
DOUBLE HEADPHONES, 4,000 ohms	27/6 per pair

Large Stocks of Enamel, Cotton, and Silk-covered Wires.  
For further enquiries and prices, give us a ring, or write.  
TO SAVE DELAY WHEN ORDERING, PLEASE ENCLOSE POSTAGE.  
**Waterloo Electric Co., 129, WATERLOO RD., LONDON, S.E.1**  
TRADE SUPPLIED. Telephone: Hcp 5619.

# No Waiting. Delivery from Stock

Perry Head Phones

4,000 Ohms **21/-** per pair



Specially designed for Wireless Telephony. Receivers arranged in series, Aluminium Cases and fitted with extremely light and efficient Head Bands, and Twin Connecting Cords.

**The JEARY Electrical Co<sup>LD</sup>**

8, LAMBETH HILL, & 97, Queen Victoria St., London, E.C.4







**ELECTRADIX RADIOS.**

Immediate Delivery  
from our Huge Stocks.

Everything from a Recorder to an  
Earth Clip.

The best-equipped City depot.  
COME AND SEE US.

9, Colonial Avenue, is first opening on left  
in the Minories, near Aldgate Station,  
Metropolitan Railway.

**LESLIE DIXON & CO.** Tel. Avenue 4166.  
9, Colonial Avenue, London, E.1.

**SPECIAL PURCHASE**

2,000 Pairs Super-Sensitive High-Resistance  
Head-phones, 4,000 Ohms. Brand New.  
Delivery from stock. £1 7 6 post free.  
**OLIVER'S WIRELESSORIES,**  
196, Wandsworth Bridge Road,  
Phone: Putney 1257. London, S.W.6.

**DON'T WASTE MONEY!** Buy Direct at Trade  
Prices! Complete Crystal Set, with 'phones, £2.  
Complete Valve Set, £4. Aerial Wire, 2/6 per  
100 ft. Write at once for list. You'll be  
astounded.—E. S. HARLEY, 115, Stracklewell  
Lane, Dalston, E.8. Established 1910.

**WIRELESS  
MANUFACTURER**

Requires additional Capital in order  
to cope with rapid increase of busi-  
ness. Working or sleeping Partner-  
ship offered. Letters only to Box C. D.,  
c/o Lile's Advertising Offices, 4, Lud-  
gate Circus, London, E.C.4.

**RUBBISH**

Is easy obtainable. Buy right and so insure custom  
**LARGE STOCKS OF**  
Ebonite, Sheets, Rods and Tubing kept. Improved  
Dials and Knobs, etc.

**DON'T HESITATE.**—Write for Price List Now.  
**RADOITE—41 BERNERS STREET, LONDON, W.1.**

**THE  
Albert Wireless Apparatus Co.**  
67, Harrington Road, Sth. Norwood, S.E.25

Manufacturers of the highest  
grade sets and component parts.

**CRYSTAL RECEIVER**

Comprising 12" x 4" coil, condenser, improved detector,  
terminals, etc. Polished mahogany cabinet.

**£2 5s. 0d.**

With 4,000-ohm 'phones, 2s 6 extra. Carriage paid.  
**COMPLETE SATISFACTION GUARANTEED.**

Component parts for crystal and valve  
receivers supplied at extremely low prices.  
**ENQUIRIES INVITED.**

**Wireless Sets Erected**

**YOUR SET WILL NOT WORK  
UNLESS PROPERLY ERECTED.**

Wireless sets are now "foolproof," but they  
must be properly assembled and the **AERIAL**  
properly erected. We have a staff of experts  
who will do this for you, and, from thence on,  
your troubles will be at any end. Remember,  
that the proximity of electric cables and tele-  
phone wires will affect your set if not properly  
erected.

For fuller particulars of our service, and  
reasonable scale of charges, write:

**THE THOMAS-NOWLAN WIRELESS  
SERVICE CO.,**

18, BEER LANE, LONDON, E.C.3.

**RADIATORIAL  
QUESTIONS AND ANSWERS.**

(Continued from previous page.)

D. W. P. (Chatham).—What will be the  
better for the earth, a 6-ft. lead to the  
waterpipe or 9 ft. to an old bicycle wheel  
buried in the ground?

The direct earth to the cycle wheel will be the more  
efficient.

"AMATEUR" (Kidderminster).—Does a  
zincite-bornite combination crystal benefit  
by the addition of a battery in the circuit?

No.

Are four-electrode valves used to any  
extent?

In reception to some considerable extent, especially  
the type known as the "Negatron," but very little in  
transmission.

A. A. T. (Bridgwater).—Should the primary  
and secondary of a loose coupler be wound in  
opposite directions?

No, wind the coils in the same direction.

F. L. J. (Ramsgate).—Is cotton-covered wire  
better than enamelled for winding inductance  
coils, and why?

Yes; cotton or silk-covered is to be preferred. In  
the first case, unless very carefully handled and  
wound, enamelling is always liable to crack, but the  
more important point is that the self-capacity of a  
coil wound with enamelled wire will be greater owing  
to the smaller insulation spacing.

F. G. (Birmingham).—How many turns to  
the inch can be obtained with 22 S.W.G.?

30, if enamelled; varying down to 16, using  
double cotton-covered according to the thickness of  
the various insulation coverings.

"NOVICE" (Gloucester).—Can bichromate  
batteries be used for the filament of a valve?

No, as the voltage rapidly falls with the rather  
large current required for that purpose.

How many feet to the pound are there of 22,  
24, 28 and 30 S.W.G. enamelled wires?

22-423, 24-684, 28-1,515, 30-2,145

W. S. S. (Bedford).—What are tonic train  
signals?

Continuous wave signals interrupted by a buzzer  
or break at the transmitting station.

Can I receive same on a crystal set, and who  
uses the system?

Yes, they will come in on a crystal set. Several of  
the amateur stations, a few service aircraft and ships.

"IDEAL" (Dundee).—Can I put up a wire-  
less set consisting of 7 or 8 valves in my  
restaurant for the benefit of customers, and  
would I be able to pick up broadcasting  
stations in London?

You would have no difficulty in accomplishing  
that range with such a set, but the P.M.G. will not  
grant licences at present, at any rate, for such  
purposes.

L. R. (Southend).—Would 24-gauge  
enamelled wire do for a lead in from the aerial  
about 50 feet long?

It will do, but in point of highest efficiency a much  
stouter gauge, such as 16, or a stranded, such as 7-22  
would be better. If the 50 feet refers to lead in alone  
it must be pointed out that a down lead should be  
taken the straightest possible line to the set, avoiding  
angles and undue length inside the house.

R. H. (Wigston).—Would a coil 24 by 4  
inches with two layers of 24-gauge wire be  
suitable for a crystal set?

No. Such a coil would give a wave-length so great  
as to be useless for reception on such a set. One  
layer on such a former 10 inches in length would  
prove much more useful.

Sullivan's Head-Phones, 120w. Sec-hand 10/6 pair.  
Single G.P.O. Receivers, 150w. Fitted with fan-  
tas head band, trap and cord, 5/- each; Single  
Receivers, 36 each; Phone Plug and 4-spring  
Jack, 1/6 each; Crystal Detector (Silicon), 4/6  
each; G.P.O. Head-Phones, 1,500w., 15/- p. pr. Post  
Free. ROBERTS, 2, Midmoor Rd., London, S.W.12

Is a licence necessary before erecting an  
aerial of an incomplete set?

The licence is the very first consideration, and  
should be obtained before commencing the con-  
struction of the set.

C. E. H. (Barnes).—Whilst connecting up my  
set last night I forgot to attach the aerial lead  
in to its terminal marked "A," and left it on  
the floor about 5 feet from the set. On  
switching on the filament current I distinctly  
heard Marconi House, and could understand the  
words fairly well. Can you explain this  
phenomenon?

For such a short range with a valve set, it is not  
at all remarkable to hear a station with no aerial  
attached to the set. The coils and the earth lead,  
and even the wiring of the set included in the open  
circuit will act as an aerial for the reception of fairly  
powerful stations, such as Marconi House, over a  
short range.

R. D. (Kentish Town).—I have a crystal set  
with an inductance wound for 12 inches with  
24-gauge wire on a former 4 inch in diameter.  
The aerial is a 45 ft. single. What will be my  
maximum wave-length?

2,300 metres.

F. S. J. D. (London).—Encloses a sketch of  
an aerial and asks whether it will prove  
efficient for reception. It runs from a chimney  
stack to a fire escape, and goes off at an angle  
of about 80 degrees to another stack, a total  
length of 100 feet.

An aerial should not double back or have angles  
in its horizontal run. A 50-foot wire between the  
stacks or one of the stacks and the fire escape will be  
far more efficient.

2 WB is situated in Wolverhampton.

"AMATEUR" (Marchwood).—Is it possible  
to create a resistance of 4,000 ohms apart from  
re-winding, for 150 ohms receivers?

The efficiency of a high resistance receiver does not  
lay in its resistance. The term is mis-applied.

In what manner are loose couplings con-  
nected; is it purely induction?

Yes.

With a good aerial what set will be necessary  
to hear the Hague and London concerts?

Three valves.

How many valves to hear the Hague on a  
high resistance loud speaker?

Five, most probably.

"CHURCHITE" (Church, Lancs).—Am I  
complying with G.P.O. regulations by erecting  
an aerial across a passage at the end of the  
gardens?

Not if it is a public right of way.

D. F. T. (Cobham).—Is a grid leak an im-  
provement in the Armstrong super-regenera-  
tive circuit?

No. Two small dry cells should be inserted into  
each valve circuit with the negative terminals con-  
nected to the grids.

Are any particular types of valves to be  
preferred?

Yes, "hard" valves should be used.

Is it correct that this circuit will only be  
useful for very short wave-lengths?

No, but the shorter the wave-length the greater the  
amplification.

"PUZZLED" (St. Albans).—How is a buzzer  
connected to a crystal set for testing purposes?

Merely by induction. The buzzer circuit preferably,  
with a small low resistance coil inserted between the  
battery and buzzer is brought into close proximity  
to the inductance, and the crystal adjusted to obtain  
the loudest induced signals that result. A point  
always to remember in connection with the adjust-  
ment of a crystal is that it should be adjusted to  
weak signals, therefore the buzzer circuit should be  
placed just as far away as will reduce the strength of  
the signal so that it is barely audible.

**There is No Need to Pay More than our Prices for BROWN or SULLIVAN RADIO HEADPHONES.**



We guarantee these 'phones to be in perfectly new condition and as efficient as any 'phone obtainable irrespective of the price paid. These 'phones were supplied to His Majesty's Government and every instrument has therefore passed the strictest test.

We have received **HUNDREDS OF TESTIMONIALS** from delighted and satisfied customers, many of which we have reprinted in our catalogue, and we earnestly commend them to the notice of the Wireless Public. These are convincing proofs from those who have actually tested the 'phones, and, together with our personal guarantee set out below, will, we feel confident, dispel any doubts in the mind of anyone as to the quality and efficiency of the goods we offer for sale.

**BROWN HEADPHONES**

("A" Type. Reed Pattern. Aluminium Diaphragms)

MUCH BELOW MAKER'S PRICES

120 ohms **49/6** (Maker's Price 66/-)

8,000 ohms **42/6** (Maker's Price 58/-)

Sullivan 8,000 ohms **36/6**

Cords 2/9 extra. Packing and Postage (Registered) 1/- extra.

**Brand New Condition & Unused.**

**IMPORTANT.** Our stock must not be confused with the "reconditioned" 'phones at present on the market.

**We Guarantee**

that these 'phones are in brand new condition and have never been used. that they are equal in efficiency to any 'phone on the market at the present time. that if after these 'phones have been thoroughly tried and tested and compared with any other 'phone on the market, you are in the least dissatisfied, return same to us within 7 days and

**WE WILL REFUND THE FULL AMOUNT PAID FORTHWITH.**

**THE CITY ACCUMULATOR CO.,**

'Phone: Avenue 91 (3 lines).  
Agents

**79, Mark Lane, London, E.C.3.**

Telegrams: "TYCHE, FEN, LONDON."

London: A. W. GAMAGE, LTD., Holborn, E.C. SELFRIDGE & Co., LTD., Oxford Street, W. RICHFORD & Co., 153, Fleet Street, E.C.3.  
Yorks: BARNSELY BRITISH CO-OPERATIVE SOCIETY, LTD., Barnsley.  
Glos: BRISTOL WIRELESS Co., 52, Cotham Hill, Bristol.  
S. Wales: SOUTH WALES WIRELESS INSTALLATIONS Co., LTD., 18, West Bute Street, Cardiff.  
N. Wales, Lancs., Ches., & I.O.M.: THE "ALL BRITISH" WIRELESS MANUFACTURES Co., LTD., 70, Central Bldgs., 41, N. John Street, Liverpool.

**HIGH QUALITY CONDENSERS**

Complete with scales.



'001 mf. 24/-



'0005 mf. 18/-



'0003 mf. 14/-

**UNIT-COIL HOLDERS**



Patent.

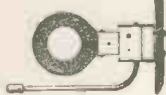

Shows method of fixing.

To fit any standard coil. Made of ebonite and brass throughout, with excellent gun-metal finish.  
Fixed Unit .. .. 4/2  
Moving Unit .. .. 5/8

**FILAMENT RESISTANCES.**

All Post Free. Send your order to:—  
Dept. B.,

**ASHLEY WIRELESS TELEPHONE Co., Ltd.,**

69, Renshaw St., Liverpool.

Tel. 4628 Royal.

Grams: "Rotary,"  
Liverpool.



Patent. 5/3 each



**Exide BATTERIES**

**THE LARGEST SHIP IN THE WORLD**—the White Star Liner "Majestic"—uses Exide batteries for her wireless installation.

No finer testimony to the general reliability of Exides, and their particular suitability for wireless work, could be given.

**THE Chloride ELECTRICAL STORAGE COMPANY LIMITED.**

CLIFTON JUNCTION, Nr. MANCHESTER.

219/229, SHAFTESBURY AVE., LONDON, W.C.2.

PRICES AND PARTICULARS ON APPLICATION.



# "MAGNAVOX" LOUD SPEAKER

Radio  
brings it.  
MAGNAVOX  
tells it.



The **MAGNAVOX Loud Speaker** is based upon the electro-dynamic principle. This form of construction accounts for the fact that the **MAGNAVOX** is not only the most sensitive but also the most powerful of Loud Speakers.

No. R1282  
(18" Horn)

To enjoy and get the greatest possible satisfaction from your Wireless Receiving Set, equip it with a **Magnavox Loud Speaker**. Hear the voice of the singer faithfully reproduced, the perfect intonations of the lecturer, or the natural sound of music. The **Magnavox** is established as

## The World's Finest Loud Speaker.

The introduction of the **Magnavox Loud Speaker** for use with Radio Receiving Sets marks a most important development, and will be the means of making Broadcasting extremely popular.

**IMMEDIATE DELIVERY.**

MANUFACTURERS AND SOLE LICENSEES FOR EUROPE :

**Sterling Telephone & Electric Co., Ltd.**  
TELEPHONE HOUSE,

210/212, Tottenham Court Road, London, W.1.  
Telephone No. 4144 Museum (7 lines). Telegrams 'Cucumis, Wesdo, London.'

Works : DAGENHAM, ESSEX.

BRANCHES : NEWCASTLE-ON-TYNE : 9, Clavering Place.  
CARDIFF : 8, Park Place.

WRITE FOR LEAFLET No. 326.

Visit our Stand, No. 34, All-British Wireless Exhibition, Horticultural Hall, Westminster, S.W.1, September 30th to October 7th.

# THE *Crystophone* REGISTERED

is all you require for any given range or degree of audibility

COMPLETE OUTFITS FROM  
**£5 : 12 : 6**

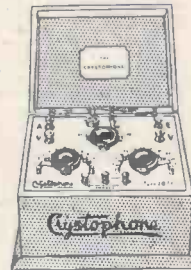
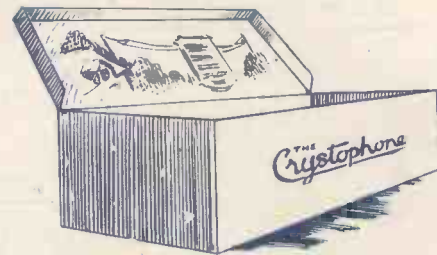

COMPLETE OUTFIT.

No. 1, containing:

Crystophone Receiver, Type 20 T.T.,  
Crystor Aerial Outfit,  
A pair of Sterling Head-Phones, 4,000  
ohms, packed in suitable box

**£7 : 12 : 6**

No. 2, containing:

Crystophone Receiver, Type 21 T.T.,  
Crystor Aerial Outfit,  
A pair of Sterling Head-Phones, 4,000  
ohms, packed in suitable box

**£6 : 15 : 6**

No. 3, containing:

Crystophone "Scout" Receiver,  
Crystor Aerial Outfit,  
A pair of British Head-Phones, 4,000  
ohms, packed in suitable box

**£5 : 12 : 6**

We might have reduced the price of all the above Complete Outfits had we deleted the Crystor Aerial Equipment, but after extended trial and experiment we are satisfied that the Crystor Gowl Insulators are absolutely essential to an efficient aerial, and as an efficient aerial is equally as important as an efficient Receiver, by combining the two we are able to offer

**A PERFECT RECEIVER with A PERFECT AERIAL.**

Catalogue on Request

**WIRELESS SUPPLIES CO.,**  
64, Mortimer Street, London, W.1.

'Phone: Museum 2672. 'Grams: "Adragonax, Wesdo, London."



No. 17. MAKING A FILAMENT RESISTANCE

# POPULAR WIRELESS

3d

## Weekly

No. 17, Vol. 1.  
Sept. 23, 1922.



**A Wireless Tea  
at the FIRST  
EXHIBITION.**

**FEATURES IN THIS ISSUE :**

**The British Wireless Relay League.  
Wireless Control.  
Step by Step in Wireless.**

**Radio Notes and News.  
Glossary of Wireless Terms.  
A Novel Loud Speaker.**

**And Other Interesting Articles.**



# GREAT REDUCTION IN PRICE OF MITCHELL-PHONES

STANDARD MODEL

OLD PRICE.

~~35/-~~

Postage 1/- Extra

4,000  
Ohms

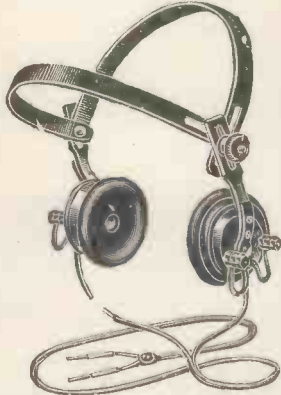

NEW PRICE.

25/-

Postage 1/- Extra.

Total  
Resistance.

**FREE.** A pair of these famous Telephones will be forwarded to the writer of the following letter, upon his communicating with us:—

Shepherd's Bush, September, 1922.  
Messrs. MITCHELL'S ELECTRICAL & WIRELESS, Ltd.  
Dear Sirs,—Please find enclosed a P.O. for 35/-, being the remittance for 1 pair of your 4,000-ohm "F" type headgear. I have already in use one pair, which I am very satisfied with, and would very much like to have the new pair on Saturday, 9th September.—Yours truly,  
F. G.

Another Presentation Next Week.

# IMPROVED TYPE MITCHELL-PHONES

Adjustable Coils and Magnets. Leather-covered Head Band.  
Light and Comfortable to Wear.

42/-

2,000  
Ohms



42/-

Total  
Resistance.

Temporary City Showroom: 68, BASINGHALL STREET, LONDON, E.C.2.  
BIRMINGHAM: M. LAWRENCE & CO., 25, Bright Bldgs., 110, John  
CARDIFF: R. W. ROBINS & CO., Park Place. [Bright St.]

## MITCHELL'S ELECTRICAL AND WIRELESS, Limited,

Retail Stores and Registered Office: 188, Rye Lane, London, S.E. 15.  
Wholesale and Export: McDERMOTT ROAD, PECKHAM, LONDON, S.E. 15.

## ABSOLUTELY COMPLETE £3-10-0 CASH.

OR £1-0-0 DOWN AND 5/- WEEKLY FOR 12 WEEKS

OUR BEAUTIFUL CRYSTAL SET No. 1, WITH 4,000 OHMS HEAD-PHONES, LEADING-IN TUBE, AERIAL WIRE, AND SIX INSULATORS. TESTED AND GUARANTEED FOR CLEARLY RECEIVING BROADCAST SPEECH, MUSIC, AND MORSE MESSAGES.



WE CAN ALSO SUPPLY A 2-VALVE SET, POLISHED OAK CABINET. QUITE COMPLETE. PHONES, AERIAL, ACCUMULATORS, H.T. BATTERIES, INSULATORS, VALVES, ETC., ETC., AS PASSED BY THE P.M.G. AND GUARANTEED,

£9 : 9 : 0 cash.

BOOK OF INSTRUCTIONS WITH EACH SET.

Cheques, P.O. or M.O. must be crossed  
NATIONAL BANK, Ltd., King's Cross Branch.

SEND YOUR ORDER  
TO-DAY. WITHOUT DELAY

H. A. WHITE & SON, 229, Pentonville Road,  
London, N. 1. 'Phone: Central 3045.

## SELF CONTAINED OR UNIT SYSTEMS

### Marconiphones, Marconi Scientific Units, Waveora Units, Etc.

We give demonstrations to purchasers at our showrooms.  
Tuners, Coils, Rectifiers, Amplifiers, Valves, Magnavox & Brown Loud Speakers, Microphone Amplifiers, H.T. & L.T. Batteries, and all Wireless Accessories.

Special quotations for Technical Colleges,  
Schools and Educational Institutions.

The Radio Waveora Co. (Dept. P.),  
168, Regent Street, London, W.1.

Telephones: Gerrard 3039; Western 847.  
Telegrams: Wychwood, 'Phone, London.

## No Waiting. Delivery from Stock

### Perry Head Phones

4,000 Ohms 21/- per pair



Specially designed for Wireless Telephony. Receivers arranged in series, Aluminium Cases and fitted with extremely light and efficient Head Bands, and Twin Connecting Cords.

## The JEARY Electrical Co<sup>LD</sup>

8, LAMBETH HILL, & 97, Queen Victoria St., London, E.C.4

**HOW TO MAKE  
A FILAMENT  
RESISTANCE.**

See Special Con-  
structional Article  
in this Issue.

# Popular Wireless

TOPICAL NEWS AND NOTES.

**CONTROLLING  
MODELS  
BY WIRELESS.**

(NEW SERIES).

By MAJOR  
RAYMOND PHILLIPS.

Will tell you how to  
make your own ap-  
paratus at little cost.

**Canada and Telephony Experiments.**

EXPERIMENTS are being made as to the feasibility of wireless telephonic communication between Winnipeg and the hydro-electric power house which is 80 miles distant.

\* \* \*

**Irish Wireless.**

THE formation of an Irish Radio Association has been suggested by Mr. H. Linton, of Shankhill, co. Dublin, and a conference of interested parties will be held at an early date in order to discuss preliminaries.

\* \* \*

**Radio and Germany.**

BEFORE leaving the warship Braunschweig, on board of which he has been attending the German naval manoeuvres in the Baltic, President Ebert addressed a wireless message to the Navy in which he expressed the hope that the latter would co-operate in the building up of the republic.

**Southport School's Radio.**

WENNINGTON-ROAD School, Southport, celebrated its coming of age recently by the installation of a wireless set. It is hoped to increase the plant in the course of a few weeks. The woodwork necessary for the fixing of the set has been executed by the boys at the local Education Committee's Woodwork Centre.

\* \* \*

**C Q.**

THE Editor again asks me to bring to the notice of all amateurs holding transmitting licences the fact that POPULAR WIRELESS will shortly publish a detailed list of stations in Great Britain.

It is estimated that there are nearly 400 amateur transmitters in this country, and it would greatly assist the compilers of the list if amateurs would kindly send along a postcard giving brief details.

\* \* \*

**The Air Race.**

THE Air Ministry, on behalf of the Royal Aero Club, carried out all the wireless and meteorological arrangements in connection with the recent air race, and gave frequent reports of weather conditions and the progress of the machines.

A special map, showing the route and giving other information, was placed in a window on the ground floor in Kingsway, and attracted a large crowd.

Six wireless stations were utilised to report the progress of the machines.

\* \* \*

**Extension in Germany.**

THE following is extracted from the "Times": The Drahtloser Uebersee Verkehr Aktien Gesellschaft (Wireless Overseas Traffic Company) of Berlin, with controlling stations at Nauen, Teltow, and Eilvisc (for Hanover), is meeting the anticipated extension of wireless communication by an increase of capital to the extent of fifty million marks [at present rates £10,000].

The prospectus gives some interesting facts of the increased use of wireless on the part of the people. For communication with the United States alone, in 1920, two and a half million words were transmitted. In 1921 the total was eight and a half millions. During the first quarter of the current year the number rose to over three millions, or at the rate of twelve million words for the year.

\* \* \*

**British Association Meeting.**

DURING the meeting of the British Association at Hull a demonstration of weather forecasting by wireless was given by the Meteorological Office with the object of showing how anyone possessing a small wireless receiving set can pick up and utilise the weather reports broadcast at fixed hours each day from the Air Ministry, the Eiffel Tower, and other European stations.

These messages were sent in code as usual; but the code is not secret, and there is nothing

to prevent any wireless amateur receiving and translating the messages and using them to draw up his own weather forecast, exactly as is done by the Meteorological Office, from the same messages. The "Wireless Weather Manual," published by the Stationery Office, price 9d., explains the whole process.

\* \* \*

**For Amateurs.**

THE following are some of the exhibitors at the First Exhibition held recently at the Central Hall whose apparatus I noticed and considered worth recommending to amateurs:

Associated Electric Traders, Ltd., telephon<sup>o</sup> head phones, small receivers. Messrs. J. B. Bower & Co., Ltd., crystal and small valve sets; components. B.N.B. Wireless, Ltd., galena, ganerite, crystal detectors, switches, condensers, etc. Messrs. Henry J. Brewster & Co., crystal receivers and accessories. Messrs. J. Bridge & Sons, crystal receiving sets, amplifiers, sets of parts, and accumulators. The Concordia Electric Wire Co., Ltd., wires and insulating linen, silk, paper, etc. The Electric Appliance Co., Ltd.; wireless instruments and parts. The Fleet Radio Co., one-valve receiving sets. Fuller's United Electric Works, Ltd., batteries and accumulators. Messrs. J. Lipowsky, three-valve receiver and general accessories. Messrs. James Macintyre & Co., valve and crystal receivers and loud speakers. Messrs. Pettigrew & Merriman, Ltd., valve and crystal receiving sets, auxiliary apparatus and parts. The Wireless Exploitation Corporation, crystal and valve sets, frame aerials, etc. The Consolidated Trading and Manufacturing Co., Ltd., crystal receiving sets. The Murray Printing Telegraph Systems, "Teletype," a new printing telegraph machine that is described above.



A portable set belonging to Mr. C. Linant, 73, Church Lane, Charlton, S.E.7.

**Progress in Sweden.**

I HEAR that the new radio station which is to be erected on the west coast of Sweden will be situated between the towns of Falkenberg and Varberg. Preliminary construction work has already been begun, and it is hoped that the ways and concrete constructions will be completed by the end of the autumn.

\* \* \*

**Business for Disposal.**

ACCORDING to the "Electrical News," the Canadian Government is desirous of getting rid of its commercial wireless telegraph business. The coast navigation and naval services will be retained, but the station at Barrington Passage (N.S.), which was used for the commercial service between Canada and Bermuda, will be closed down.



A new type of Coil Holder invented by Mr. H. C. Braun.



**NEWS AND NOTES:**

(Continued.)

**The All-British Exhibition.**

**T**HE All-British Exhibition opens on September 30th at the Horticultural Hall, Westminster, and a record success is certain to be achieved.

Among the many attractions will be a series of lectures by eminent wireless experts of the day, including Mr. John Scott-Taggart, the Chief Technical Adviser of POPULAR WIRELESS.

Next week's POPULAR WIRELESS will be an All-British Wireless Exhibition number. The paper will be greatly enlarged, and will contain a comprehensive account of the features of the exhibition.

**A Good Cause.**

**O**N another page a letter is published from the chairman of the Royal National Hospital for Consumption, at Ventnor, Isle of Wight. I commend this letter to the earnest attention of all readers.

**Valve Hints.**

**T**HE Marconi Company has several very interesting types of valves which can be operated with the filaments at a dull-red heat only. I have had one of these on test for some months now, running it from three dry cells, and rather like it. It obviates the tiresome necessity of charging accumulators and possesses a slight microphonic property which appears to add a pleasant metallic ring to speech and music, making for clarity of sound.

"This kind of valve is known as the 'dull emitter,' and is destined to be a boon to amateurs in country places where there is no electrical power supply within reasonable distance. The filaments are not of the 'coated' type, and judging from my own experience should be as long-lived as any other.

"One of the secrets of successful economics and technique in operating a valve receiver

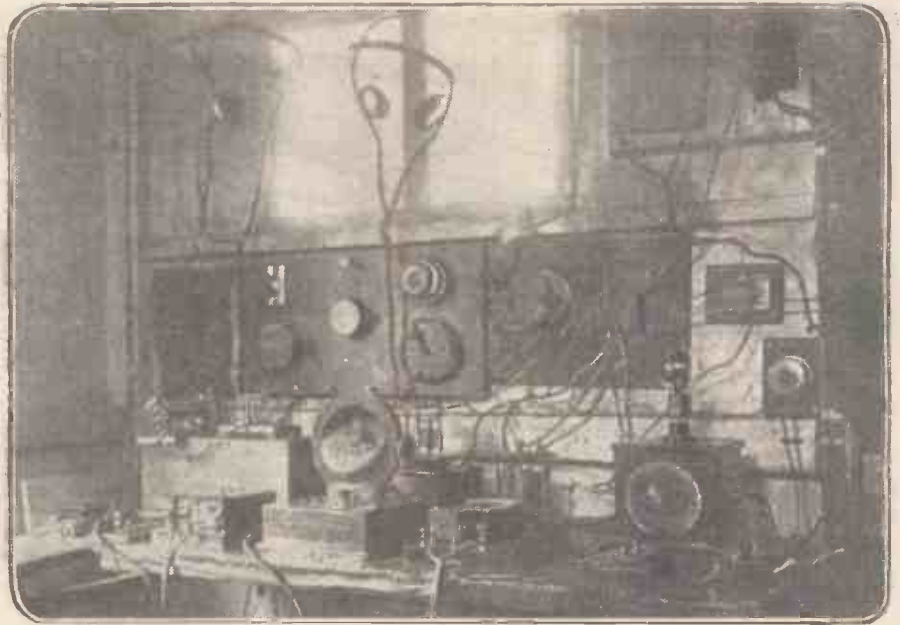

Mr. A. Stanton's receiver, at 60, Butlin Street, Nechells, Birmingham.

is 'conserve energy.' Over-loaded filaments and excessive 'plate' voltages are obviously wasteful and are too often the causes of poor results. Every valve has its own particular characteristics, and each must be adjusted with its batteries to a nicety for good critical results."—(Mr. E. Blake, in the "Daily Mail.")

**Various Items.**

**F**ROM September 12th every postal telegraph and cable company office in the United States will accept messages for transmission to Great Britain by the Transatlantic wireless circuits conducted by the Radio Corporation of America and Marconi's Wireless Telegraph Company, Ltd.

The new session of the Wireless Society of London will open on Wednesday, September 27th, at 6 p.m., at the Institute of Electrical Engineers, Victoria Embankment. It is hoped that Senatore Marconi will be present to address the meeting. Senatore Marconi, who is at present in Italy, has promised to be present if he returns to England in time.

Col. Malone's suggestion in a recent issue that a Radio Association should be formed to protect the interests of radio users from restrictive legislation, trusts and monopolies has aroused great interest, and is likely, I gather, to take material shape very soon. The advantage of such an association to small British manufacturers of instruments or parts is pointed out by the well-known solicitor, Mr. S. Landman, in our Correspondence Column. I am in full agreement with him in regard to the need of the best legal and technical advice on questions of patents and infringements.

The Editor tells me he has received information from a reliable source to the effect that amateurs will not be prevented from making their own sets. This is good news, but not unforeseen. The Editor gives details in his weekly letter.

By the way, take a tip from me and secure a licence before purchasing a set. It's the best policy.

ARIEL,



Little Geoffry Garnall, of Stalybridge, gets excited when he hears wireless music



# Broadcasting Programmes



What you can hear  
every evening of the week on your set.

**TELEPHONY TRANSMISSIONS.**

Station.	Call Letters.	Wave-length.	Remarks.
Croydon .. ..	GED ..	900 metres ..	Throughout day to aeroplanes.
Marconi House, London	2LO ..	360 metres ..	Between 5 p.m. and 7.30 p.m. (not regular).
Writtle, England ..	2MT ..	400 metres ..	Tuesdays, 8 p.m. (B.S.T.).
Paris .. ..	FL ..	2,600 metres ..	Daily, 5 p.m. (B.S.T.)
Königswusterhausen ..	LP ..	2,500 and 4,100 metres ..	Daily, 7 and 10.30 a.m. (G.M.T.).
The Hague .. ..	PCGG ..	1,085 metres ..	Sundays, 2.30, 5.30 and 8 to 9 p.m.; Thursdays, 8 to 9 p.m.
Messrs. Burnham (Black-heath)	2FQ ..	400 metres ..	About 9 o'clock any evening.

**NOTE.**—FL may sometimes be heard at 4 p.m., G.M.T., on usual wave-length, transmitting music. Also, sometimes at 7.45 p.m. G.M.T. Sainte-Assise will shortly broadcast telephony. Details will appear in this paper later.

Will all amateurs who send music, etc., regularly, kindly supply details in order that this list may be kept comprehensive? "Listeners-in" are advised that many amateurs transmit every evening between 8 and 10 p.m. on 400 metres. In fact, music and telephony may be heard on 400 metres at all times during the evening.

# MAKING A FILAMENT RESISTANCE.

By PAUL D. TYERS

(Assistant Editor of Radio Press Publications, Author of "Construction of Wireless Receiving Apparatus.")

IT is sometimes considered that the use of a separate filament rheostat for each valve is a luxury, but for all serious experimental work it is undoubtedly a necessity. This statement, perhaps, needs a little qualification, since two or three valves employed as low-frequency amplifiers can be controlled quite successfully by a single rheostat. However, it is absolutely impossible to work, say, a radio-frequency amplifier, a detector, and an audio-frequency amplifier most efficiently unless a separate control is provided for each.

An efficient rheostat suitable for panel mounting is a somewhat expensive item to purchase, considering the amount of material it contains, and hence the amateur at once considers its construction. To be electrically and mechanically efficient the rheostat must be capable of carrying the necessary current without overheating, it must vary the brightness of the filament regularly and gradually, it must work silently, evenly and smoothly,

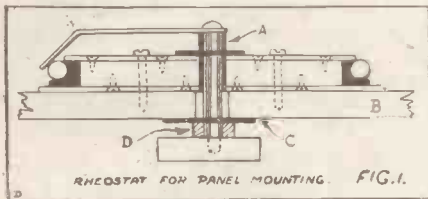

and lastly, it is desirable that when the resistance is in the "out" position, no resistance should be left in the circuit.

An additional advantage is to design the rheostat so that when it is in the minimum position the circuit is automatically broken, thus avoiding the use of a switch. It might appear at first sight that the construction of such an instrument is beyond the scope of an amateur, or at least beyond those who have neither lathe nor tools at their disposal.

### Coiling the Wire.

However, the problem has been solved by the method indicated in the following paragraphs, resulting in the production of a really efficient piece of apparatus at a comparatively negligible cost.

A piece of hard wood,  $\frac{3}{8}$  in. thick, is cut to a diameter of 2 in. with the aid of a fret-saw, or if the reader possesses a lathe it is turned up in the usual manner. The resistance is made from about 8 ft. of No. 24 Ferry, or other similar resistance wire. The resistance is wound round a rod a little less than  $\frac{1}{4}$  in. in diameter, from which it is afterwards removed, the resulting spiral being bent into a circle of 2 in. internal diameter.

The turns are wound closely together, so that on removing the wire from the rod the spiral will spring out to a diameter of about  $\frac{3}{8}$  in. Two circles of thin wood are next cut, about  $\frac{1}{8}$  in. thick, having diameters of  $2\frac{1}{2}$  in. and  $2\frac{3}{8}$  in. respectively. The two pieces of

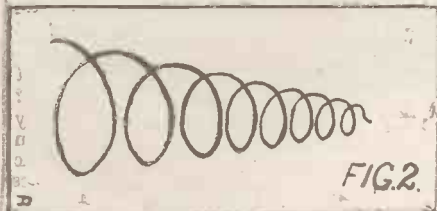

wood are screwed, one on each side of the wooden disc previously made. The relative positions of the three pieces of wood can be seen from the diagram, and they will be referred to as the resistance former.

### The Spiral End.

A hole is drilled through the centre of the former, of such a diameter as to fit a piece of brass tube quite tightly. The tube should have an internal diameter of  $\frac{1}{8}$  in., and it is afterwards driven in to the hole, so that it is "friction tight." A brass washer,  $\frac{1}{2}$  in. diameter and  $\frac{1}{16}$  in. thick, is secured to the end of the brass tube as follows. The end of the tube is filed square, and is made perfectly clean. The washer is prepared in a similar manner, the end of the tube and one side of the washer are tinned—that is, given a thin coating of solder.

The washer is placed against the end of the tube, and is held in position by a pair of pliers. These are then placed in a small gas flame until the solder melts, when they are removed, taking great care not to disturb the relative positions. When the solder has set, the tube and washer, which are to form the bush, are cleaned with a file, and the centre hole in the washer is slightly reamed out if it is not exactly concentric with the tube.

The tube is then cut to the width of the resistance former, into which it is then driven, as shown in Fig. 1. Having fixed the bush into the former, the resistance can next be mounted. The resistance is of the solid type, and is prepared as follows.

In order that the rheostat breaks the circuit in the minimum position the resistance spiral is tapered at one end so that the contact arm will not touch it. To produce a tapering end, about the last six or seven turns of the spiral are unwound, and a sharpened pencil is slipped into the spiral so that the pointed end just projects. The spiral is then completed by winding the free end over the pencil point, thus producing the desired tapering, as shown in Fig. 2.

A small loop is made in this end of the wire, by means of which it is secured to the groove in the former with a small brass screw. The other end of the resistance is fixed to a small piece of brass, let into the groove in the former. This is filed to shape from a piece of brass about  $\frac{1}{4}$  in. long and a little wider and thicker than the groove.

### Contact Arm.

Two holes are drilled in the shaped piece, in the positions shown in the diagram. The brass is screwed into the groove, about  $\frac{1}{4}$  in. from the screw holding the end of the resistance. The spiral is then pulled out until the free end reaches the brass, to which it is then secured. The last turn of the spiral must lie closely against the end of the brass, the free end being fixed under the nearest screw.

By adopting this method of fixing the end it is seen that when the resistance is in the "out" position the contact will rest on the brass, thus excluding any additional resistance from the circuit. When the wire has been properly accommodated in the groove, the screw holding the other end is removed, thus allowing the spiral to be pulled out of the groove, but, of course, not detached from the former.

As stated previously, the resistance is of the solid or filled type. The filling used is plaster of Paris.

(which should be of the best quality only) is mixed into a paste with a little water. The paste should be fairly thick, but not so thick as to solidify quickly. A thin layer is placed in the groove, as shown in the figure.

Before this has had time to dry, the interior of the spiral is quickly filled with some of the paste, taking care to leave no air bubbles between the turns. The filled spiral is then pressed into the groove and fixed once more with the screw. The former must be cleaned with a small piece of rag before the plaster sets, wiping off any plaster which covers the external surface of the spiral.

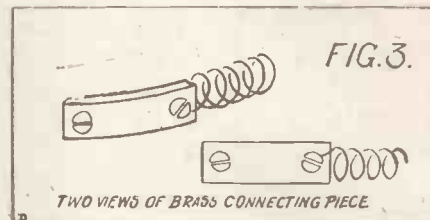

The contact is made from very hard springy brass or phosphor bronze,  $1\frac{1}{2}$  in. long,  $\frac{1}{4}$  in. wide, and at least  $\frac{3}{16}$  in. thick. The end is bent to the position shown in the diagram, at a distance of about  $1\frac{1}{4}$  in. from the other end. The contact is soldered to the end of a piece of  $\frac{1}{8}$  in. brass rod about  $1\frac{1}{2}$  in. long. It is convenient to make a hole in the end of the arm into which the rod is forced, and secured by soldering.

### Connections.

The other end of the rod is threaded to receive the knob. To raise the contact from the screw heads holding the former to the panel a small washer is placed on the rod, being shown at A in Fig. 1. The washer should be made from brass tube  $\frac{1}{16}$  in. internal diameter and  $\frac{3}{16}$  in. high. The knob can be either of ebonite or wood, the size and shape being left to suit the reader's convenience. Two holes drilled through the resistance former complete the construction of the rheostat.

The position of the rheostat in the receiver having been determined, a  $\frac{1}{4}$ -in. hole is drilled in the instrument panel B, Fig. 1, through which the contact rod passes. The rheostat is screwed on to the back of the panel, and the washer A put on to the rod, which is then passed through the hole. A brass washer C is put on to the projecting part of the rod, and a nut D screwed up to the washer. The nut is held in position with a thin pair of pliers, and the knob screwed on and locked against the nut.

It will be found that the contact arm moves quite freely and yet presses against the resistance with sufficient force to maintain an efficient electrical contact.

Connection is made to the rheostat by fixing wires to the screw on the end of the resistance, and to the brass collar. A wire can be either soldered to the latter, or a small hole may be drilled through the flange and the wire secured by means of a screw.

### COMPETITION RESULT

A prize of £1 has been awarded to Mr. Arthur McPherson, 437 Govan Road, Govan, Glasgow; Mr. P. H. Berridge, 74 Pevensey Road, Eastbourne; Mr. L. E. Richards, 77 Severn Road, Western-super-Mare, for the best criticisms on No. 11 of POPULAR WIRELESS.



# THE FIRST ELECTRICAL EXHIBITION.

By SIR J. KENNETH D. MACKENZIE, Bart.

## PART 2.

THE telegraph was the only branch that approached maturity; the telephone was still a curiosity, as I have described; electric lighting with arc lamps on anything like a large scale had hardly begun; whilst the incandescent electric lamp was only then being shown to the public for the first time, an absolute novelty!

It is hard to imagine or realise now the interest that was shown then in an exhibit of Messrs. Siemens, which consisted of a small electric tramcar that ran backwards and forwards for about one hundred yards from the exhibition towards the Place de la Concorde.

The current was supplied by an overhead trolley system somewhat similar to what is used now. Tramcars throughout the world must now be numbered in millions, and car-rail tracks in hundreds of thousands of miles; but the curiosity and novelty I mention existed only forty years ago. We were lucky to have known nothing of "straphanging" in those days!

There are so few of us left who were there then, that I may be pardoned for telling of those whom I was fortunate enough to meet, for should any be still alive and perchance read these recollections, they can surely raise no objection to being reminded of how they also formed part of that pioneer crew who, forty long years ago, helped to give electric lighting, power, storage, and speech their first "shove off" into a world to which they have become indispensable. Eminent in science and electrical experience were many of those who foregathered there, men whom I, a youth of twenty-two, regarded with much awe and reverence.

### A. Galaxy of Talent.

Amongst those whom I remember meeting were Dr. Werner Siemens; Mr. Alexander Siemens; Sir Charles Bright, who laid the first Atlantic cable; his brother, Mr. Edward Bright; Professors Ayrton and Perry; Dr. John Hopkinson; Prof. George Forbes of "The Times"; Mr. W. H. Preece, who kindly put me up for the old Institute of Electrical Engineers and of Electricians; Prof. Hughes, the inventor of the microphone as well as the printing telegraph; Sir William Thompson, afterwards Lord Kelvin; Prof. Sylvanus Thompson; Mr. Conrad Cook; Mr. T. A. Edison, who went there for a short while only; Mr. Batchelor, his representative; Sir Hiram Maxim; Dr. Graham Bell, the inventor of the telephone; Mr. George Westinghouse, junr., who later on founded the Westinghouse Electric Company in the U.S.; Mr. R. E. B. Crompton; and many others.

I have never forgotten a bit of advice given me one evening by Dr. W. Siemens: "My young friend, you should try always to know something about everything, and everything about something," a dictum I only wish it were possible for me to say I have succeeded in achieving! He and his relative, Mr. Alexander Siemens, were often together, the exhibits of the latter's firm of alternating current dynamos being the only examples of that type of generator then on the market.

These were used amongst other purposes to supply current for the now long-forgotten Jablochhoff lamps, more properly called "candles," which once lit the Thames Embankment with their flickering lights of constantly changing hues.

One of the most important and interesting exhibits, which was then shown for the first time, was the Faure accumulator or storage battery, which made the storage of electricity

commercially possible. M. Emile Faure, himself, most kindly explained the principle to me, and I can remember how enthusiastic he was at the possibilities his discovery opened, many of which have since been attained.

"Que c'est, que Ca!"

The exhibit of the Brush Co. (I forget what the exact name was then), with their 16 and 32 arc lamp dynamos supplying current to their lamps, and also to the Lane-Fox incandescent lamps as well, was, so far as my recollection goes, under the control and direction of Mr. Percy Sellon, now a director of the well-known firm of Johnson, Matthey & Co., Ltd. He may, perhaps, remember how he and I used to play practical jokes on the unsuspecting visitors to the exhibition, by running a shunt circuit off part of the main along the top of the railings erected to prevent them from approaching too close to the high voltage dynamos.

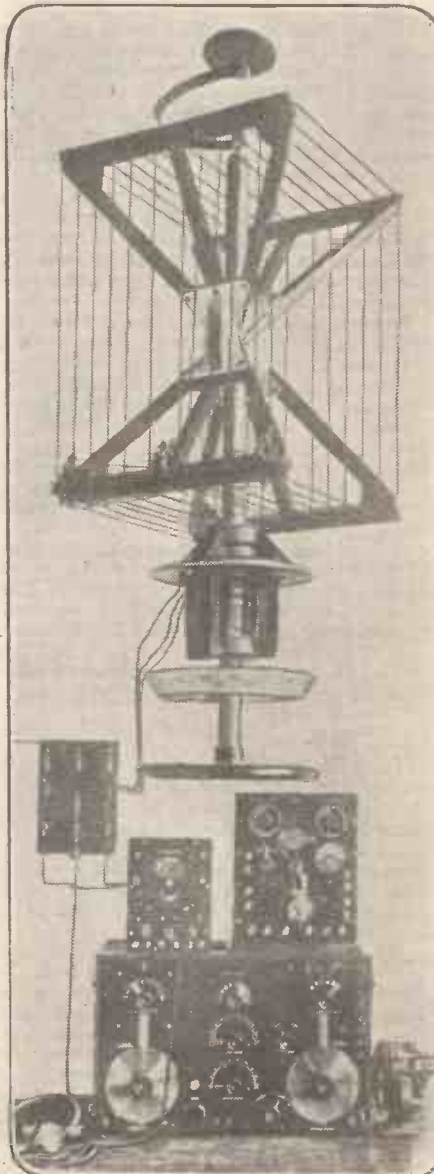

New Type of American Radio Compass, with range of 200 miles.

In this way we used to give them unexpected shocks by switching on the current when a number had their hands on the rail and so touched the shunt circuit, which was often the case, in spite of the conspicuously displayed notice—"Avis! C'est défendu de s'appuyer contre le balustrade"—which we put up knowing that what was forbidden was sure to be done.

Electricity and its peculiarities were then so little known to the general public that the cause of these sudden shocks was not always realised; and we both, as well as others "in the know," derived much amusement from the cries of "Mon dieu! Que c'est, que c'est, que ça?" "Sacristi!" and sundry similar exclamations of surprise which our pranks called forth from the unsuspecting public!

It was whilst he was in charge of the exhibit of the British Electric Light Co., Ltd.—now long defunct, but the first electric lighting company formed in Great Britain—that I met the Hon. Reginald T. D. Brougham, who afterwards joined me in partnership in London when we put up the first installation to supply current to the public by the use of the Gaulard and Gibbs "secondary generators" from the Grosvenor Gallery in Bond Street for the late Sir Coutts Lindsay, Bart. These "secondary generators," of which more anon, were the precursors of the modern alternating current transformers.

There were many "systems" of electric lighting, so called, in those days, each "system" varying principally in the lamps only; for, with but few exceptions, they were all run by current supplied from the same type of dynamos, of which there were not many. Apart from their extensive show of incandescent lamps, the Edison Co., of New York, had no dynamos of their own running at the exhibition, though they had what was then considered a very large one on view in the central part of the building. Arc lamps were used by most exhibitors to show their "system" of lighting; one form of which I well remember as effective being that of directing the light on to the ceiling so that the room was lit by reflected light and not by direct rays, an idea in common use nowadays.

### Early Electric Lamps.

With regard now to incandescent, or "glow" lamps, as my old friend the late Sir William H. Preece preferred to call them, these formed the really chief novel part of the lighting section of the exhibition. There were four principal types of incandescent lamps shown, each in a part of the building specially allocated to them. There were the "Swan System," the "Edison System," the "Maxim System," and the "Lane-Fox" lamps shown by the Brush Co.

Being a "Swan System" man, I naturally considered it to be the "one and only one" worth consideration by the public; and the little conundrum I made up for circulation amongst our rivals for public favour showed the opinion I held as to their respective claims. "Why did Ananias stand 'forth'?" as we are told he was commanded to do. "Solely that Edison, Maxim, and Lane-Fox might stand first, second, and third," was the only reason which appeared to be likely so far as I could see!

At that time incandescent lamps were only intended for interior lighting, from which it was hoped they would oust the arc lamp then used for interiors as well as for outside illumination. But very few were made of more than 16 c.p., the largest then shown not exceeding 50 c.p.

(To be concluded.)



# THE BRITISH WIRELESS RELAY LEAGUE.

## DETAILS OF INTEREST TO ALL AMATEURS,

HON. SECRETARY AND ORGANISER,  
2, PARKSIDE ROAD,  
PRINCESS ROAD,  
MANCHESTER.

August 25th, 1922.

### PROVISIONAL RULES.

Recommended to prospective members for adoption until further amendments are received.

#### NAME.

The League shall be named the "British Wireless Relay League."

#### OBJECTS.

Intercommunication between members with a view to improving existing transmitting circuits, especially with regard to wireless telephony.

Relaying of messages through stations owned by members, at times to be regulated by headquarters, the object of which will be the efficient organisation of all amateur transmitting stations, whereby a service of excellent utility will be maintained. All messages shall be confined to the business of the League.

Strict observance of all the laws and regulations applicable to wireless telegraphy and telephony, in order that facilities may be obtained from time to time from the P.M.G.

Co-operation with wireless leagues of other countries, as far as the Post Office authorities will allow.

The advancement of wireless science generally.

#### RULES.

(1). The League shall consist of members and associate members, and shall be governed by a Central Council, assisted by a Provincial Council, the latter to be elected by the members. The aforesaid Central Council is to comprise a President, four members of the Council, the Hon. Secretary and Organiser, and the Hon. Treasurer. Five shall form a quorum.

(2). Prospective members shall comply with the clauses printed hereunder before applying for membership:

(a) A member must hold the P.M.G. First Class Certificate of proficiency in wireless telegraphy, or other such certificate of equal merit, with a Morse speed of not less than twenty words per minute.

(b) He shall not be under the age of eighteen and shall possess an experimental transmitting licence of ten watts or over.

(c) His transmitting circuit shall be capable of adjustment to the following wave-lengths: from 180 to 250 metres and 440 metres, and shall be calibrated with a wavemeter on an aerial not exceeding the standard allowed by his licence.

(d) He shall possess an efficient receiver, of the non-radiating type, which circuit shall have been approved by the Post Office authorities.

(3). Associate members shall possess a non-radiating transmitting licence or an experimental receiving licence (not a broadcasting licence) or both. He must not be under the age of eighteen, and must conform to Clause d, Rule 2. *Apropos* of the above conditions, an associate member will not be able to take part in the transmissions, but may

transfer to full membership on compliance with Rule 2.

(4). Members and associate members shall be eligible for any office of the League, and shall receive all circulars and printed matter concerning the League.

(5). Prospective members shall apply to the Hon. Secretary for the necessary application form A, which shall be submitted to the Central Council at headquarters, who shall have power to elect such member, whereupon the said member shall be notified under form B.

#### SUBSCRIPTIONS.

(6). An entrance fee of five shillings shall be paid by each member on election, and the annual subscription shall be ten shillings, payable in advance, and due on January 1st of each year.

(7). Associate members shall pay an entrance fee of five shillings on election, and the annual subscription shall be five shillings, payable as in Rule 6.

(8). Members elected in the quarters ending June 30th, September 30th, and December 31st shall pay a proportionate part of the annual subscription.

(9). Any member whose subscription is one month in arrears shall be notified by the

Hon. Treasurer. Should his subscriptions not be paid at the expiration of one month from the date of such notice, the Council shall have power to erase his name from the list of members.

(10). The Council shall have power to reprimand any member who, in the opinion of one or more members, has wilfully acted in contravention of the rules of the League, or the laws and regulations governing wireless telegraphy, after such act has been investigated.

(11). Should any member wilfully break these rules or regulations a second time, the Council shall have power to recommend his expulsion from the League.

(12). Members are expected to "police the air" as regards amateur transmission, and report any flagrant breach of rules to headquarters, whereupon investigation shall be made, and if considered of urgent importance the matter shall be referred to the P.M.G.

(13). Until other rules are drawn up for the management of the League, the above provisional rules shall be considered binding.

(14). The word "members" comprises members and associate members unless otherwise stated, or where the context does not so admit.



At our stand at the First Exhibition at the Central Hall over 2,000 copies of "Popular Wireless" were sold in one week.



# A GLOSSARY OF RADIO & ELECTRICAL TERMS.

**AERIAL.**—The wire or wires by means of which wireless waves are radiated at a transmitting station, or absorbed at a receiving station. The aerial wire really acts as one plate of a condenser, of which the earth is the other plate, and the air between the insulating material.

**AERIAL CIRCUIT.**—The circuit containing the aerial, and all apparatus connected between it and the earth, usually comprising a variable condenser and tuning coil.

**AERIAL TUNING INDUCTANCE (A.T.I.).**—The variable inductance, or tuning coil in the aerial circuit, by means of which the wavelength of the circuit can be adjusted. The greater the wave-length required, the greater must be the portion of the A.T.I. included in the circuit.

**ALTERNATING CURRENT (A.C.).**—A current which reverses its direction or flow a definite number of times per second. It is a very rapidly alternating current, usually referred to as an oscillating current, which is set up in an aerial by incoming wireless waves.

**ALTERNATOR.**—A rotating machine, driven by steam or other mechanical power, which supplies alternating current.

**AMMETER.**—An ampere meter, or instrument for measuring the current, in amperes, flowing in an electric circuit.

**AMPERE.**—The unit of electric current, being the current that can be driven through a resistance of 1 ohm by a pressure of 1 volt. If the terminals of a single accumulator cell are joined by 14 yards of No. 28 S.W.G. copper wire, a current of .1 ampere will flow in the wire.

**AMPERE-TURNS.**—In a solenoid, the product of the number of turns of wire, and the current flowing along the wire. The magnetic effect due to the solenoid depends upon the number of ampere-turns; e.g., 100 turns of wire carrying 2 amperes would have the same magnetic effect as 5 turns of wire carrying 40 amperes, both being equivalent to 200 ampere-turns.

**AMPLIFIER.**—An arrangement for amplifying, or magnifying, the effect produced in a receiving circuit by wireless signals.

**High-Frequency amplifiers** amplify the signals just as they are received, before they reach the detecting apparatus.

**Low-frequency amplifiers** deal with signals that have already been reduced to audible frequency by the detector.

**AMPLITUDE.**—The maximum value which an alternating current or voltage attains in either direction. The current rushes produced by spark signals have an amplitude which decreases towards the end of the wave train.

**ANODE.**—The terminal by which current enters any piece of electrical apparatus. In a thermionic valve, the high-tension current flows in by the plate, and so the plate is the anode.

**ANODE CIRCUIT.**—See Plate Circuit.

**ANODE CURRENT.**—The current which is driven by the high-tension battery round the anode circuit, and through the thermionic valve. In a final receiving circuit it is the current which operates the telephones.

**ANTENNA.**—Another name for Aerial.

**ARC.**—The passage of electricity through air (or any gas) in the form of an intensely hot discharge, consisting of vaporised particles of the electrodes between which the discharge takes place. Before an arc can be started, either the electrodes must be touched together, or the voltage must be high enough to break down the resistance of the air and produce a spark between them.

**AUDIBLE FREQUENCY.**—The frequency at which sound waves can be detected by the human ear, lying between the limits of 30 and about 20,000. The frequency of the waves

produced by middle C on the piano is 256; a frequency of 500 is very suitable for wireless reception.

**AUTODYNE RECEPTION.**—Reception by means of the heterodyne principle, in which oscillations are generated in the receiver itself and superimposed upon those being received; sometimes called Self-heterodyne Reception.

**AUTO-TRANSFORMER.**—A transformer in which the low-tension winding is tapped off the high-tension winding, the connections being exactly the same as those for a potentiometer. The difference lies in the fact that the magnetic effect in the auto-transformer

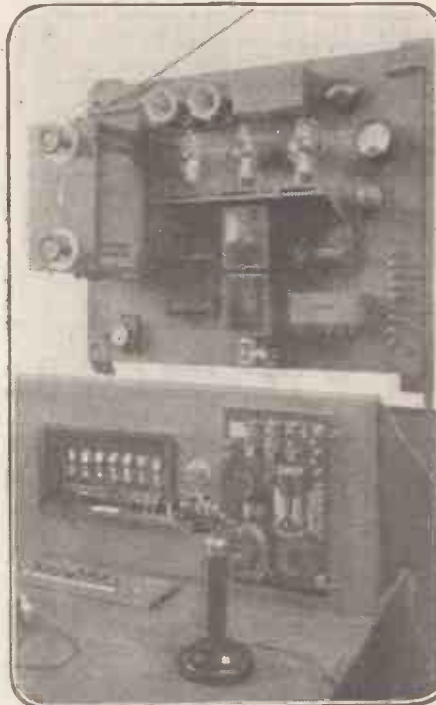

Type of apparatus used at a Handley Page Aerodrome Wireless Station

ensures that the primary and secondary currents are in the inverse ratio of the voltages, which is not the case in the potentiometer.

**BASKET WINDING.**—A method of winding inductance coils in two or more layers, in such a way that there is never a large voltage, or condenser action, between adjacent wires. If the coils are numbered 1, 2, 3, etc., as they are wound, there should never be a difference of more than 2 or 3 between adjacent turns.

**BEAT RECEPTION.**—See Heterodyne.

**BRUSH DISCHARGE.**—A discharge of high-tension electricity, which takes the form of a luminous glow, accompanied by a crackling sound. A brush discharge occurs when the voltage is almost high enough to produce a spark.

**CAPACITY.**—The property which enables apparatus to store a quantity of static electricity when electrical pressure is applied. Capacity is measured by the quantity of electricity that can be forced into the apparatus by a pressure of 1 volt. The unit of capacity is called a "Farad."

**CATHODE.**—The terminal by which current leaves any piece of electrical apparatus. In a thermionic valve, the high-tension current leaves by the filament, and so the filament is the cathode. In a cell supplying electricity, the cathode is the positive terminal.

**CHARGE.**—An electric charge is a quantity of electricity residing on the surface of a body, which body is then said to be "charged."

So long as the body is entirely insulated the charge remains, but if it is electrically connected to the earth, the charge drains away in the form of an electric current.

**CHOKING COIL.**—A coil which, by virtue of its high inductance, offers considerable opposition to a varying or alternating current.

**CIRCUIT.**—The complete path taken by an electric current in its travel from the positive to the negative terminal of a source of supply.

**COHERER.**—A detector which consists of a tube filled with loosely packed metallic filings. When acted upon by wireless waves, the filings "cohere" and form a good conducting path, and the waves can thus be made to control a current supplied from a local battery.

**CONDENSER.**—A piece of apparatus so constructed that it is able to store a large quantity of electricity under electrical pressure. It consists of sheets of metal interleaved with sheets of insulating material, such as mica, or glass, which are called dielectrics.

Some condensers have air dielectrics. Alternate sheets of metal are connected together, each set of alternate sheets being joined to one terminal. These sheets are commonly called "plates."

**CONTINUOUS CURRENT (C.C.).**—An electric current which always flows in the same direction, like a stream of water, as distinct from an alternating current which periodically reverses in direction. Also called "Direct Current." (D.C.)

**CONTINUOUS WAVES (C.W.).**—Waves of constant amplitude which are radiated from a transmitting station in an unbroken "train." As they are not split up into groups, like the waves from a spark station, special devices are required at the receiving station to render the signals audible.

**CONVERTER.**—A machine for converting alternating current into direct current, or vice versa. Not to be confused with the transformer.

**CORONA.**—The luminous glow produced by a brush discharge.

**COULOMB.**—The unit quantity of electricity, being that quantity which passes when a current of 1 ampere flows for 1 second.

**COUPLING.**—The connection by means of which the electrical energy produced by incoming wireless waves is transferred from one circuit to another. The transference may be brought about by means of condensers (capacity coupling), by electro-magnetic induction, as in the transformer (inductive coupling), or by connections similar to those in an auto-transformer (direct coupling).

**CRYSTAL DETECTOR.**—A detector which depends for its action upon the fact that the contact between a crystal and a metal, or between two crystals, will only carry an appreciable current in one direction. Thus trains of high-frequency oscillations can be converted into trains of unidirectional impulses, which produce an audible sound in a receiver telephone.

**CURRENT.**—An electric current is a movement of negative electrons, driven by an electromotive force. A current cannot flow unless there is an electro-motive force to drive it, and a conducting path for it to flow along. The unit of electric current is the ampere.

**CYCLE.**—A complete alternating current or voltage wave, extending from one maximum value to the next maximum value in the same direction.

**DETECTOR.**—The apparatus in a receiving circuit which renders high-frequency oscillations capable of producing audible sounds in a telephone, either by their own power, or by means of power which they release from an auxiliary source.

To be continued.



# NEW SERIES FOR BEGINNERS.

By E. BLAKE, A.M.I.E.E.

## PART 10.

**B**EFORE leaving the subject of wireless transmission and reception in general to pass to the consideration of certain details of the process, it may be of special interest to readers, especially those quite new to the subject, if we linger by the way to chat about wireless telephony.

We will suppose that a talented musician has been guilty of blowing into a trombone near the transmitter of the broadcasting station in Marconi House, and that you, "listening-in" at Peckham Rye or Park Lane, have just heard sounds which could be quoted as evidence against him. Between the person with the trombone and yourself with the telephone there is, as you know, a continuous expanse of ether, and when the aforesaid sounds are heard a continuous series of causes and effects operates between the trombone and your ears.

Undoubtedly something passes between Marconi House and your aerial. It certainly is not sound, because even a trombone would not be heard very far through the roar of the Strand. Evidently, however, it is something which can *cause sound*—there is no doubt about the sound of a trombone, especially if it comes through a "loud speaker"—and I hope my previous articles have been sufficiently instructive for you to understand that the thing which travels to you across the ether is *energy*.

### The Carrier Wave.

When the musician blows into his instrument he makes the column of air in the tube vibrate, and these vibrations travel outwards as sound waves in the air. Already, you will notice, muscular energy has been changed into the energy of sound.

Now, ordinarily, the sound waves would beat against the walls, floor, and ceiling of the room and be quickly damped out, only a little of the sound making its way outside; but if we catch most of them in a wireless telephone transmitter we are able by this means to bring into play other causes which start a new chain of incidents stretching out a long way into space.

So far we have succeeded in getting our sound as far as the transmitter, and we are now faced with a jump of, say, five miles, which we have to bridge by means of ether waves. There is a frequency of sound waves, or in other words a note so high as to be inaudible to the normal human ear; there is also a lower limit to the audible frequencies. The frequency of ether waves used for wireless, even that of the very long waves, does not fall within the limits which are called "audio-frequencies." They are of "radio-frequency." The problem therefore resolves itself into this: To carry vibrations of audio-frequencies by radio means.

The first thing to do is to provide the radio carrier, and this is done by means of a transmitter of continuous waves; this is, of course, the up-to-date, highly efficient valve transmitter, the most efficient transmitter known. The transmitter in operation sends out a continuous chain of ether waves of constant amplitude, generally called the "carrier" wave.

Theoretically, the "carrier" wave is inaudible to the receiver because of its high frequency; in practice it is too often rendered audible by reason of its being "heterodyned," that is, combined with waves of different frequency to

produce audible "beats," which you will have read about in articles on valves and continuous wave reception. In one respect this gratuitous heterodyning of the "carrier" wave is useful; it is an aid to tuning; for having discovered those adjustments of your receiver which bring in the "carrier" waves, you know then the whereabouts of the "tune" for the speech or music.

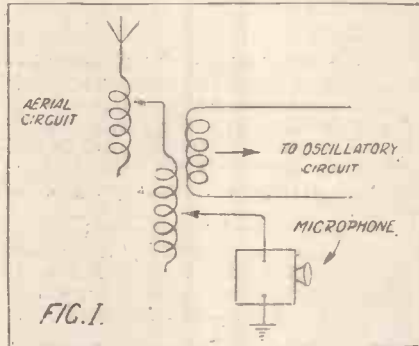

The next step is to load the "carrier" wave with its burden of audio-frequency, a process which is called modulation, and which you may regard as a modelling or moulding of the continuous waves into the wave-forms of speech or musical notes. The extent to which this modulation is accomplished determines to a great extent the success of the transmission.

The completely modulated current would vary between maximum and zero values, but in speech transmission this condition is never realised, and we express the extent of modulation by a figure representing a percentage of modulation. If you consider the "carrier" wave as a waxen surface and the modulation as an inscription thereon, the extent of the modulation may be compared to the depth of the incisions in the wax.

### Use of Microphone.

The modulation of the "carrier" wave is effected by means of the action of the sound waves on an instrument called a microphone. By this time you will have learned that an important factor governing the strength of an electric current is the resistance of the conductor in which it is flowing. In the case of direct current, assuming the voltage does not alter, the ohmic resistance is the *only* factor governing the strength of the current (see Ohm's Law).

But where the current is alternating in direction, the maximum value it attains does not depend alone on resistance of the kind to which Ohm's Law refers. However, as that kind of resistance forms part of the total resistance of an alternating current circuit, the value of the current will vary if this resistance varies.

The resistance of the transmitting system remains practically constant, barring accidents, and the waves radiated are constant in strength—"amplitude" is the technical word. Hence, if we insert in the transmitter circuit an instrument the resistance of which will vary as a result of the action of sound waves, we have a means of varying the current flowing in the circuit, because the fluctuations of the resistance will produce corresponding fluctuations in the strength of the current.

Further, if this instrument be connected in the aerial current we can by its means alter the amplitude (strength) of the aerial current and, therefore, of the waves radiated. Such an instrument is the microphone, into which the singer directs his voice when assisting at a broadcasting concert.

The microphone, in its essentials, consists simply of two blocks of carbon enclosing a space filled with carbon granules, and a thin metallic disc, called the diaphragm, which is mechanically connected to one of the carbon blocks. If this instrument is connected in the aerial circuit as shown in Fig. 1, and speech is directed into its mouthpiece while the aerial circuit is oscillating and radiating continuous waves, the following things happen.

First of all, sound waves are set up in the air by the vibrating vocal chords of the speaker. These waves are not all identical, because each vowel and consonant and combination of these produces its own particular and characteristic wave-form; that is to say, each has its own particular frequency and strength, and each varies from the rest in its relation to a pure "sine" wave, such as we draw to represent continuous waves, for instance. When these air waves strike against the thin metallic diaphragm the latter vibrates "in sympathy" and reproduces the different frequencies impressed upon it.

In so doing it transfers its vibrations to the block of carbon on which it presses, and this in turn varies its pressure on the carbon granules accordingly. This has the effect of varying the electrical resistance of the aerial circuit, a phenomenon you may study in more advanced articles.

### The Wonderful Diaphragm.

The point to grip is that we thus vary the amplitude (i.e., strength) of the waves radiated from the aerial in accordance with the variations of the speech or musical note wave-forms. I think the diaphragm of the microphone and that of the telephone of the receiver, reproducing as they can the complicated variations of frequency set up by an orchestra of fifty instruments and singers, are by far the most wonderful parts of the wireless telephone.

In this way, then, the "carrier" wave is moulded into the form of human speech, and the spoken word is, in electrical counterpart, despatched on its terrific flight through space to a hundred thousand receiving aerials. Instead of the radio-frequency waves, which are inaudible to you, come the models of the wave-forms created by Melba or Caruso or those other talented people who nightly delight the ears of their far-flung audience who "Marconiphone."

Wireless telephone waves are simply ordinary sound waves cast in a finer material—the ether. You may conceive the "carrier" wave as the smooth surface of a swiftly flowing river. Suddenly that perfect surface is broken by a breeze into ripples, which travel along it and finally shake the reeds in some distant creek. The ripples correspond to the human voice, and the reeds to the receiver.

The steady current of the river does not shake the reeds, nor does the "carrier" wave affect the telephones; but the reeds respond to the ripples, and the telephones to the less rapid and more irregular pulses of current into which the voice moulds the "carrier" wave.



# CONTROLLING MODELS BY WIRELESS

By Major Raymond Phillips, I.O.M., late Member of the Inter-Allied Commission of Control.

## PART 1 (NEW SERIES).

**I**N my first series of articles I described apparatus and circuits suitable for use in connection with the wireless control of mechanism.

It was not expected that beginners would be able to sufficiently grasp the details of such circuits that construction of experimental apparatus could be commenced forthwith, so I am now going to write a new series of articles explaining (in the simplest possible language) how wireless-controlled working models can be constructed in an inexpensive manner.

If the instructions given are carefully followed, there is no reason why wireless enthusiasts should not achieve good results, and experiments in this connection will be found fascinating, amusing, and instructive. In my second article (No. 13 of POPULAR WIRELESS) I mentioned that when constructing apparatus

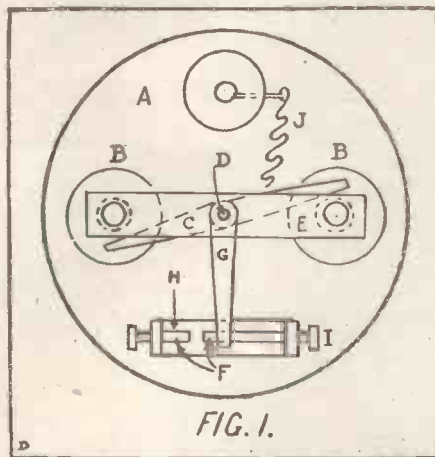

FIG. 1.

suitable for the wireless control of mechanism it was important to use a good "relay." Many readers will no doubt ask what is meant by the term "relay."

I had therefore better explain that a "relay" is generally described as an electro-magnetic instrument which, by the means of the impulses of received currents, opens and closes a local circuit.

### Junction of a Relay.

Quite apart from wireless work, relays are used for a variety of purposes. Some amateurs may ask why it is necessary to use a relay to open or close a local circuit, but I may here explain that it is sometimes impracticable to operate instruments except through the medium of a relay.

For instance, modern "burglar alarms" are generally arranged so that even, if connecting wires are cut, an alarm is immediately set going.

This is effected by means of what is known as a "closed circuit" system, which involves a relay (its electro-magnet wound to a high resistance, current consumption thereby being reduced to its finest efficient limit) connected to a battery, and so arranged that when such battery circuit is broken the relay armature is released, and the latter, making contact, closes another circuit, which, being connected with another, and usually more powerful battery, functions an alarm bell or other suitable apparatus.

By referring to Fig. 2 in my first article (No. 12 of POPULAR WIRELESS) it will be observed that a coherer is shown connected to

a relay, so that the latter may close another circuit to function an electric bell.

A coherer would be ruined if a heavy current were allowed to pass through same, but when used in conjunction with a relay the risk of damage to a coherer is obviated, otherwise it is apparent that it would be a very simple matter to connect a coherer with a battery and ordinary electric bell. Figs. 1 and 2 show respectively "plan" and "side elevation" of two types of relays.

### Simple Types.

In Fig. 1 a relay is shown with its armature mounted upon a vertical arbour, and consists of a base A, electro-magnet BB, armature C, vertical spindle or arbour with pivot D, bar E for supporting pivot of arbour D, contacts FF mounted respectively upon bar S, and support H, adjustable stop I, tension spring with adjuster J.

By referring to Fig. 3 in my second article (No. 13 of POPULAR WIRELESS) it will be observed that the electro-magnet BB is connected with a coherer and battery, whilst the contacts FF close a circuit connected with another battery.

In Fig. 2 a relay is shown with its armature mounted in a simpler and cheaper manner. It consists of a base A, electro-magnet B, contacts CC, armature D, armature spring E (delicate) attached to one pole of electro-magnet B, adjustable stop F.

The latter relay is inexpensive to construct and can be connected up in the same manner as described for the relay shown in Fig. 1.

In connection with the construction of wireless-controlled working models (which I shortly propose to describe) I shall furnish constructional details, also diagrams showing the two types of relays referred to in this article, and which are suitable for operating a simple "selector." The latter will be arranged to "open" or "close" circuits as desired, so that interesting effects can be produced.

I hope I have now made it quite clear as to the reason why a relay is necessary for the operation of certain types of instruments and apparatus. It will be understood that the diagrams illustrating the relays referred to in this article are not intended to be used as "working drawings," but merely to show the two types, of which full details will be furnished in subsequent articles.

Wireless enthusiasts will understand that it is not advisable, nor practicable, to pass heavy currents through the contacts of a delicate relay, otherwise the instrument may be seriously damaged.

### Suitable for Experiments.

In such a contingency it is better, and, in fact, necessary, to instal a supplementary relay, or relays. The latter may be provided with "mercury cups" instead of the usual delicate contacts.

The contacts of a delicate relay may be arranged to open or close a circuit connected with the electro-magnet of another relay, and the contacts of the latter may be so designed that circuits carrying heavy currents may be opened or closed as desired.

It will be understood that the relays shown in Figs. 1 and 2 (whilst quite reliable in their action) are only suitable for use with "short range" experimental apparatus, such as model airships, motor-boats, etc.

Another form of relay is called a "polarised" type. This is a very sensitive instrument, but, besides being somewhat costly to purchase, its

construction should only be attempted by a skilled mechanic.

I, therefore, do not propose to give a description of such an instrument, but perhaps it may interest amateurs if I describe its mode of action, which is as follows:—

A permanent steel magnet (forming part of the instrument) is mounted in such a position that it magnetises the extremities of the iron

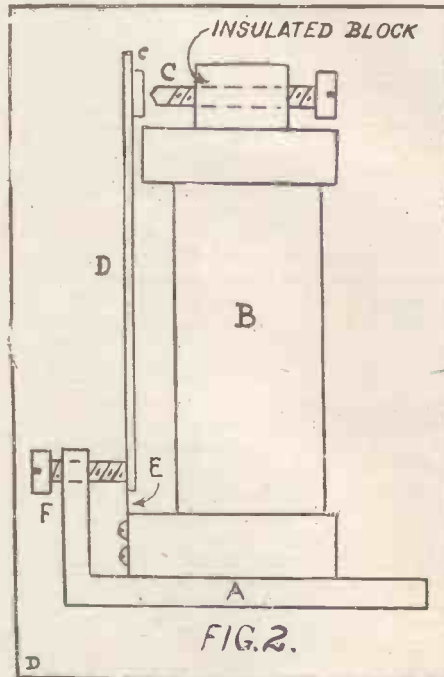

FIG. 2.

cores on which the bobbins are wound. A thin "tongue" of soft iron is mounted, and free to move between these polar extremities, and becomes magnetised in a contrary sense to the cores.

When the winding of such a relay is traversed by an electric current, the magnetisation of one core is increased and that of the other decreased, so that the soft iron "tongue," finding itself in a kind of unstable equilibrium between the two polar extremities, becomes attracted by one pole, and such "tongue," being fitted with a suitable contact is arranged to open or close a circuit connected with a local battery.

From the foregoing description it will be apparent that a "polarised" relay would be a complicated instrument to construct.

### NOTE.

At the recent exhibition held at the Central Hall, Major Phillips' wireless-controlled airship attracted considerable attention, and many amateurs questioned him as to how they could construct their own apparatus for controlling mechanism by wireless. At my request Major Phillips will, in his new series which commence this week, deal very fully with the question of home-made apparatus for wireless control experiments. He asks me to point out that the amateur need not take out a licence for these experiments, so long as the transmitter (to be described later) conforms to certain regulations.

The apparatus to be dealt with will prove very cheap and easy to construct, and if this new series are followed carefully, the reader will quite easily construct a set whereby he can control an electric toy train and other models by wireless.

If readers are doubtful on any points, please write to POPULAR WIRELESS at once.

THE EDITOR.

# FROM OUR NEW YORK CORRESPONDENT.

ONE wonders, in the light of what has happened in the United States, what attention the English Church authorities are giving to the possibilities of radio in spreading the Gospel.

The Church, or, rather, the churches, are probably the most powerful factor in American social organisation to-day. They have attained to this position not because of any particular leaning towards religion on the part of the American people, but because of the aggressive, enterprising way in which the churches have gone about the work of developing their influence.

I have already once described the installation of a radio-broadcasting set in a church, but that building is still under construction. What is still more interesting is the record of the actual results achieved by the regular broadcasting of the services of a church.

On January 2nd, 1921, the Rev. Edwin Van Etten, having consented to the installation of a transmitting apparatus in his church, Calvary Church, Pittsburg, became the first priest in history to conduct a service which was broadcasted by wireless telephony. The installation consisted of a telephone transmitter attached to a phonograph horn placed in an inconspicuous position in the chancel.

Over nine miles of telephone circuit the priest's voice, the music, hymns, and so on were conveyed to the Pittsburg broadcasting station. It is a fact that with this crude arrangement the services were picked up clearly by local receiving sets.

Encouraged by this success, experiments were begun, and carried on all the more enthusiastically as letters of congratulation began to arrive in increasing numbers at the rectory, with a view to improving the sending apparatus. After many weeks the final arrangement consisted of a number of microphones placed in various parts of the church—one in the pulpit, one near the organ, one near the church chimes, two over the choir desks, and so on.

They were led to a switchboard in a room out of sight of the congregation, and into an arrangement of tube amplifiers. During services a youth sits in the room and switches on the various microphones in the pulpit, the minister's desk, and so on, as required.

Not long after these arrangements were perfected a very striking event occurred. The neighbouring Presbyterian church lost its pastor through illness. Instead of immediately appointing a successor, the church trustees installed a loop antenna and loud speaker in the church to receive the services from Calvary Church. This was done, and with complete success. The congregation was able with perfect devotional propriety to follow and join in the Calvary services, and even held a collection at the proper moment.

The idea was so popular that soon the Calvary Church was obliged to abandon its regular morning wireless service, and broadcast only the evening service, to enable the churches of other denominations to send out their own particular services. These latter—one other Presbyterian church, an Episcopal church, and a Methodist chapel—broadcast their services regularly in turn every Sunday morning.

What the effect of these services is in spreading the Gospel may be gathered from the experience of Mr. William Jennings Bryan, the former Secretary of State, who preached a sermon from the

Calvary pulpit. He received no fewer than 5,000 letters of appreciation from people who had heard his address by radio. "Radio Broadcast" publishes a selection from the thousands of letters which have been received by the rector of Calvary from his wireless parishioners, many of them hundreds of miles away. They show that whole families listen with the deepest reverence to the services. One man wrote: "My father-in-law has not been inside a church for fifty years, but he has not missed a service from Calvary for three months."

Dr. Van Etten is emphatic that the services do actually lead people to attend the church itself who had never been regular churchgoers. It is as though, having tasted religious devotion at second-hand, they were imbued with a keen desire to participate in it regularly in church. "Every Sunday," says Dr. Van Etten, "I meet new people in the church who were drawn here by the wireless services."

Another most interesting point is that the wireless services are a source of infinite comfort to aged and infirm people who are unable to leave their houses to attend church.

The experiments of Doctor J. H. Rogers, the famous American scientist, with underground aërials, open up a most fascinating field for research by the amateur. Doctor Rogers was the first man to discover that the waves sent out by wireless transmitting stations travel through the earth, as well as through what is commonly known as the ether. In fact, he now goes so far as to say that in the case of long-distance transmission, over distances of many thousands of miles, the waves never reach the

receiving antenna through the air at all, but are received at the base of the aerial. "The energy liberated at the base of the sending aerial," he says, "is propagated through the earth as well as through the ether above."

Even now it does not appear to be known that during the war, with an antenna consisting of some 4,000 feet of wire stretched in a straight line three feet under the earth inside a tile pipe, and leading in a westerly direction, he heard communications between German Army units on the Western front, Nauen, the Eiffel Tower, and other stations.

Doctor Rogers now conducts his experiments in a building insulated from the ether, and built over a well. In this well he hangs a loop aerial, which he can turn at will. Another experimenter has obtained excellent results in a concrete-lined cellar, with a galvanised-iron roof.

With the underground aerial of this kind signals do not come in so loudly as through the overhead aerial; but this disadvantage is amply compensated for by the fact that the absence of static renders them absolutely clear.

Transmitting is a different matter, and owing to the difficulty of finding an insulating material which will stand up under the strong current used in sending, this has so far been limited to a distance of seven miles.

Here are a few American radio statistics. A group of manufacturers near New York has orders on hand for £6,000,000 worth of radio instruments. It is calculated, on the basis of the number of gramophones now in use in the United States, that there will be six million radio sets in service in five years' time. The present output of vacuum tubes is about 200,000 a month.

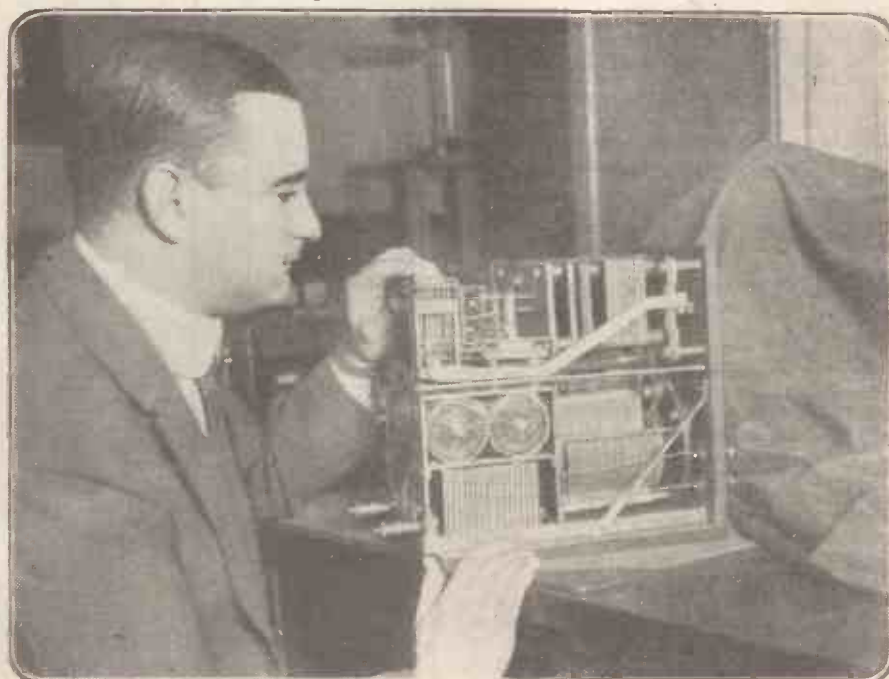

A new "Uni Control" Receiver, invented by Dr. Alfred Goldsmith, of New York. Note the gearing used to control the condenser and inductance. No tappings are used, the inductance being varied by means of copper plates rotating alongside the coil. A detector and two stage amplifier, together with L.T. and H.T. batteries, are included in this compact receiver.



**STEP BY STEP IN WIRELESS.****THE CALIBRATION OF THE TUNED CIRCUITS OF A WIRELESS RECEIVER.****PART 1.**

IF the wave-length of any desired station is known, the correct setting of a calibrated receiving set can always be found immediately and the owner will be more than repaid for the extra trouble taken; by the ease and certainty with which he can make future adjustments.

In portable wireless receiving sets where the connections to the tuning circuit condenser, or condensers, are soldered internally and are not immediately visible, it is usually sufficient to calibrate each circuit in wave-lengths with the aid of a separate wavemeter.

It must, however, be understood from the first that where several tunable circuits are incorporated in the receiver, each must be accurately tuned to the required wave-length before signals will be heard in the receiver telephones. The wavemeter, however, is self-contained and may be placed as close to the receiving set as is necessary for the best results.

Consequently, during calibration of the aerial circuit, and of the closed circuit if fitted, use should not be made of any H.F. amplifying valves included in the receiver. Their amplification is not needed, and unless they are resistance-capacity coupled their circuits will also need tuning, which may, of course, be done once the input circuits have been calibrated.

Similarly, if L.F. amplification cannot be cut out by switches, then care must be taken that the wavemeter does not "induce" direct into the iron core transformers coupling the L.F. valves. If this happens, the wavemeter must be moved further away from the receiver, and sounds will no longer be heard in the receiver's telephones at any and every setting of the receiver's tuned circuits.

In small compact sets it is usually possible to tune the aerial or open circuit and the closed circuit together, the coupling between the two having been set at an intermediate value if it is adjustable. It should not be forgotten that any subsequent alteration of the coupling will necessitate the slight re-tuning of each of the circuits. Further, any alteration to the aerial which was in use when the set was calibrated will produce a similar alteration in the tuning of the aerial circuit. The owner, however, can easily check these slight differences by recalibration, or by noticing the discrepancy between the charted setting and the setting necessary to receive "calibration waves" which are sent out regularly by certain stations.

**Accurate Results.**

A "buzzer" wavemeter is suitable for calibrating either a crystal or a valve set, and is usually fitted with either a variable condenser or a variable inductance of variometer type, by which it may be tuned to "buzz" on a definite wave-length. The variometer type is the most accurate and durable, as the moving plates of a variable condenser are liable to become slightly bent if the wavemeter is carelessly handled, with consequent loss of accurate calibration.

The wavemeter is set to the particular wave-length to which it is required to calibrate the receiving set, and its buzzer started. A note is then made of the position on the scale of the receiving set's condenser, and on the inductance tapplings if fitted, when the maximum sound is heard in the telephone receivers. For ease of reference

the calibrations for every increase of fifty metres in wave-length may be noted, and the results plotted as a graph if only a single adjustment is necessary, or else written out in columns.

The owner of a valve receiver, however, will obtain a more accurate calibration if he uses a heterodyne (or valve) wavemeter, set to the required wave-length, and adjusts his own receiver to approximately the same wave-length. If he then causes the receiver valves to generate oscillations, by tightening the coupling of the aerial and the reaction coils and by increasing the filament current if necessary, a note will be heard in the telephone receivers.

**The Silent Point.**

A very gradual variation of the receiver condenser will cause this sound to fall off in pitch from a shrill to a low bass note, and then to rise in pitch again. The greater the wave-length used, the larger the variation of the condenser over which this change of note takes place. For wave-lengths above 1,000 metres it is quite easy to find the "silent point" midway between the two shrillest notes, where the note disappears before rising in pitch again. The wavemeter and the receiver are then both producing oscillations of the same frequency, and are tuned to the same wave-length.

With the buzzer wavemeter the setting for a maximum sound is badly defined, even when the wavemeter is some distance from the

receiver and the sound of medium intensity, and the human ear can differentiate more easily between a slight sound and silence than between two louder sounds of approximately equal strength. The "silent point" is therefore always "critical," especially at short wave-lengths, and less error in adjustment is to be feared. Moreover, the heterodyne wavemeter will be useful while the set is receiving continuous wave signals, and may then be used as a separate or independent heterodyne to provide the superimposed oscillatory current necessary to obtain the "beat" effect, by which the received signals are made audible.

**"Beat" Effect.**

An independent heterodyne is greatly superior to the autoheterodyne, where the receiver valves themselves produce the necessary oscillations, as it may be adjusted to give increased efficiency of rectification for very weak signals, and in any case avoids the large loss on short-wave work of the slight detuning of the closed circuit, which is otherwise necessary to produce the "beat" effect.

Unfortunately, however, a good wavemeter is expensive, particularly if it is designed to cover a large range of wave-lengths, and it is not always possible to borrow or hire one when needed.

In a subsequent article, therefore, an alternative method of calibration will be given, which will, it is hoped, be of service to those who cannot obtain the use of a wavemeter.

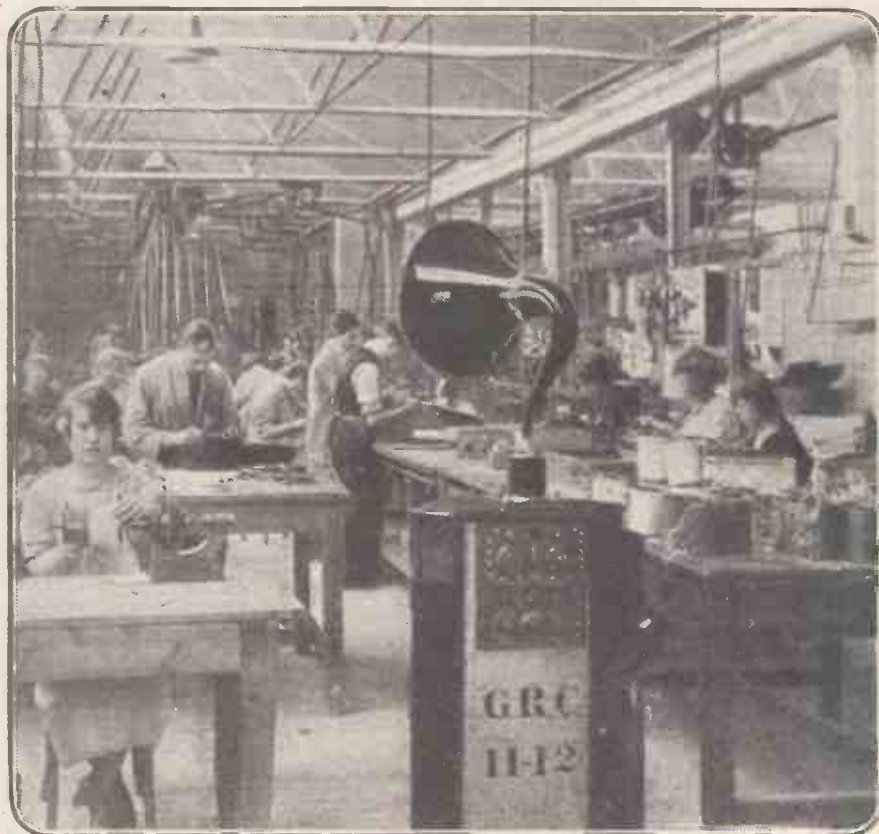

The Cox-Cavendish Electrical Co., supply wireless music for the benefit of their employees.

# HOW TO MAKE A SHORT-WAVE RECEIVER.

By PHILIP R. COURSEY, B.Sc., F.Inst.P., A.M.I.E.E.

(CONCLUSION.)

**A** PART from the mounting in position of the valve holder which is of the standard R valve type, the only remaining work to be done on this receiver is the wiring up of the different parts. An R valve holder such as can be purchased from any dealer in wireless apparatus for about two shillings can be mounted directly on to the panel of the instrument with the four pins projecting through the four holes which were set out on the drilling diagram.

Connections to these pins can be made either by soldering or by clamping the wire under nuts depending upon whether the valve holder pins are plain or threaded. Although the correct spacing for the pins of the R valve holder is properly expressed in millimetres, the dimensions given in inches on the drilling diagram will be found sufficiently close to enable the pins to pass through the holes.

The wiring of the instrument presents the neatest appearance if it is carried out in No. 18 tinned copper wire passed through Sisoftex insulating sleeving. In order to facilitate this wiring a sketch of the underneath side of the panel is given in Fig. 1 with the connections between the various terminals, screws, etc., drawn in position.

The exact run of each wire cannot be shown on a diagram of this type unless it is drawn on a very large scale, so that some of the connections in Fig. 1 have been spaced out from the positions they actually occupy in the set. Care should be taken not to crowd together more wires than can be avoided, unless they are wires of nearly the same polarity, such as the filament circuit of the valve.

It will be noted that in the wiring diagram (Fig. 1) the connection between the fourth and fifth studs of the first arm of the range switch and the grid leak has been lettered XY. For those who wish to do so two extra terminals can be fitted to the instrument and connected to these points marked XY, so that by connecting them together with a link the circuit is completed as shown in Fig. 1.

By opening the link between these two terminals a high-frequency amplifying valve mounted on a separate panel can be connected between the tuning coil and the detector valve, the grid of the high-frequency amplifying valve being joined to terminal X, and the anode of the same valve to terminal Y, the anode of this valve also being connected to the positive terminal of the high-tension battery through a suitable radio-frequency impedance—such, for example, as an anode resistance rod, or a tuned rejector circuit.

The latter arrangement is indicated in Fig. 2, in which diagram the positions of the terminals X and Y are marked, the remaining lettering corresponding with that used on the original circuit diagram of the receiver.

Any ordinary form of low-frequency amplifier or note magnifier can be added to this instrument by coupling on to the telephone terminals through an ordinary low-frequency interval transformer, the primary winding of this transformer being joined to the telephone terminals of this instrument, and the secondary winding to the grid circuit of the first low-frequency amplifying valve.

In this way the effectiveness of this single-valve receiver can be extended so as to enable weaker signals to be picked up with the aid of the extra high-frequency amplifying valve, and all signals to be rendered louder by means of the added low-frequency note-magnifying valves.

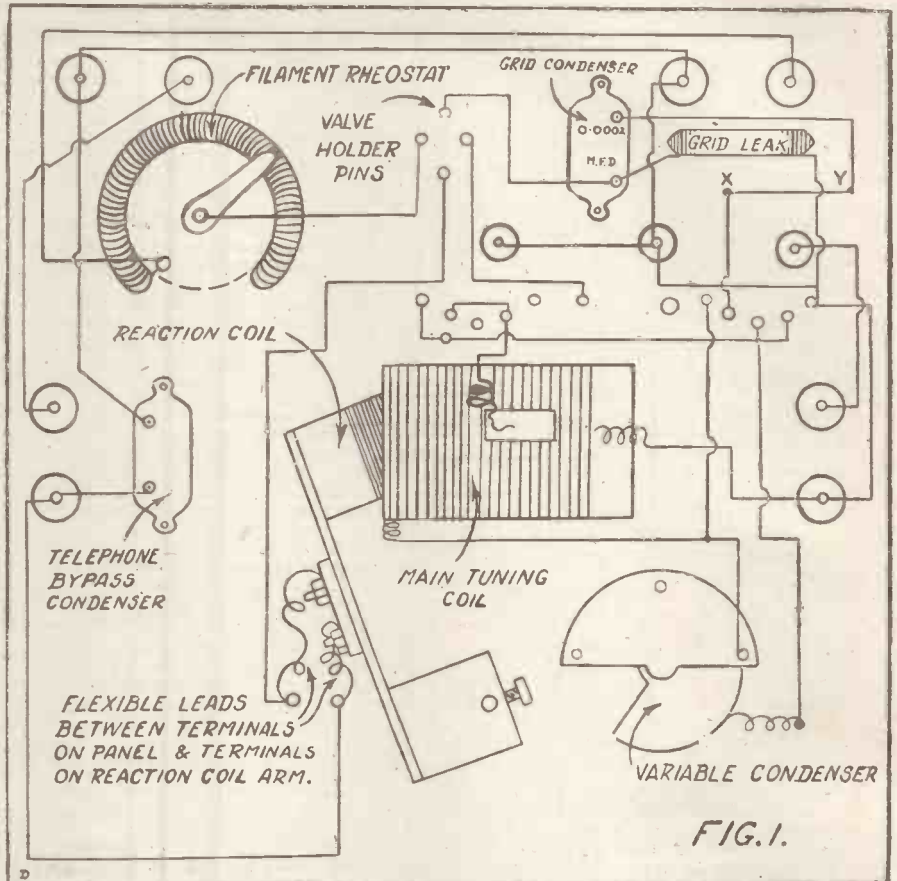

FIG. 1.

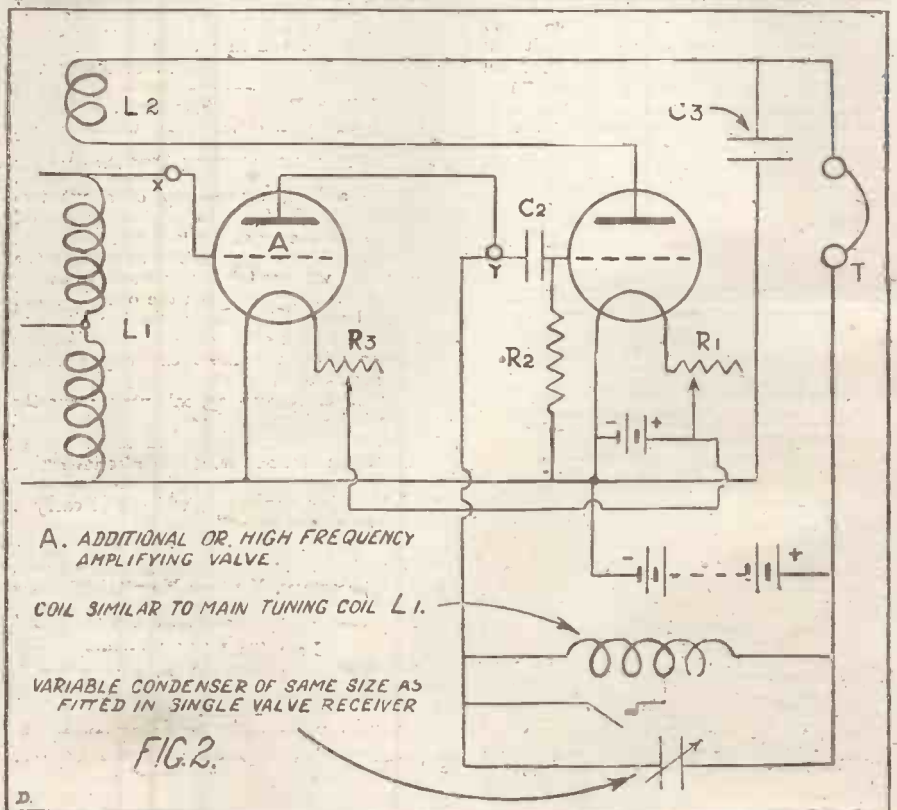

FIG. 2.



## ACCESSORIES FOR PRIVATE WIRELESS INSTALLATIONS.



TELEPHONE HEAD SETS.  
AERIAL WIRE & INSULATORS.  
PROTECTORS FOR  
AERIAL & BATTERY.  
EARTHING DEVICES.  
JACKS & PLUGS.  
H.T. BATTERIES, Etc., Etc.

Descriptive pamphlet and prices on application to  
THE MANUFACTURERS:

**SIEMENS BROTHERS & Co., Ltd.,**  
WOOLWICH, LONDON, S.E.18.

Telegrams: SIEMENS, WOOLWICH. Telephone: CITY 6400

AND AT

Belfast, Birmingham, Bristol, Cardiff,  
Glasgow, Leeds, Manchester, Newcastle,  
Sheffield, Southampton.

FOR CRYSTAL MOUNTING USE  
"SALUNITE" FUSIBLE ALLOY,  
Non-oxidizing and melts at low temperature (195 degrees  
Fahrenheit—below temperature of boiling water).  
In 1oz. bars 1/6 each, post free. Trade enquiries invited.  
H. LONGTON, A.M.I.Mech.E., 43, Johnson  
Street, Page Street, WESTMINSTER, S.W.1.

ONE OF OUR SPECIALITIES.

### "SIDLEY" HIGH-FREQUENCY TRANSFORMERS.

Double-Grooved, Highest Efficiency.

No. 1. 300/530	} 6/- each Complete		
" 2. 500/920			
" 3. 900/1500			
" 4. 1450/2600		Postage 3d.	Five
" 5. 2400/4000		Extra Post Free	

We also manufacture in-between sizes  
1a, 2a, 3a at same prices.

**G. R. MARSON, Ltd.,**  
Electrical and Radio Engineers,  
HALES ST., COVENTRY.

# WIRELESS CLUB REPORTS.

The Editor will be pleased to publish concise reports of meetings of wireless clubs and associations, reserving the right to curtail the reports if necessary. Hon. secretaries are reminded that reports should be sent in as soon after a meeting as possible. Reports sent in cannot appear in this paper in less than ten days after receipt of same. An asterisk denotes affiliation with the Wireless Society of London.

## The Durham City and District Wireless Club.

The sixth meeting of the above was held on Friday, September 1st, at headquarters (Y.M.C.A., Claypath). The lecturer for the evening, Mr. Ainsley, of the Henley Cable Co., was unable to be present owing to illness in the family. His place, however, was most efficiently filled by Mr. G. Barnard, who gave an entertaining and instructive lecture on "Simple Circuits."

Potential, Ohm's Law, closed circuits, earth return circuits, series and parallel circuits, and simple receiving circuits were explained in a simple manner.

After the lecture a hearty round of applause was given, which was endorsed by the chairman, Mr. F. Sargent, F.R.A.S., in his remarks. There was, as usual, a great deal of debating during which the Rev. Bottomley enlarged upon the lecturer's description of Ampère's Rule. He drew several sketches on the board and also explained Maxwell's Corkscrew Rule.

The chairman then exhibited an excellent tapping key which had been presented to the club by Devereux, Mordie and Co. This will prove a great asset to the Morse buzzer class. Appreciation of the gift was suitably shown.

The attendance was very large. Membership still increases; however, there is still room for more, both ladies and gentlemen.

## West Green and District Radio Experimental Club.

The first meeting was held at 1a, Abbotsford Avenue, West Green, N.15, with Mr. J. Kaine Fish in the chair.

The chairman read a letter from Professor A. M. Low, A.C.C.I., D.Sc., M.I.A.E., F.R.G.S., F.C.S., etc., graciously accepting an invitation to act as president of the club, and promising to forward the club's interests in every way.

The meeting proceeded to elect officers as follows:

President, Professor A. M. Low, A.C.C.I., D.Sc., M.I.A.E., F.R.G.S., F.C.S., etc.; Vice-President, Mr. H. Stanley Prince; Chairman, Mr. J. Kaine Fish; Vice-Chairman, Mr. R. Gill; Secretary and Treasurer, Mr. A. E. Field.

A committee was then elected, and the business incidental to a first meeting completed.

The chairman expressed the objects of the club, which in brief are: To instruct, experiment, and exchange ideas.

Applications for membership should be sent to the Hon. Secretary, and an unqualified welcome is assured all who are interested in the subject.

Hon. Secretary: E. A. Field, 1a, Abbotsford Avenue, West Green, N.15.

## Barnes, Mortlake and Richmond Wireless Society.

The first meeting of the above society will be held at Inglenook, Sheen Gate Gardens, East Sheen, on Wednesday, the 20th inst.

We have been fortunate enough to get Mr. Blake, of Richmond, as our President. All we need now is full support from local enthusiasts.

## CORRESPONDENCE.

To the Editor of POPULAR WIRELESS WEEKLY.  
PSYCHIC PHENOMENA AND WIRELESS.

Dear Sir.—In my article on this subject, on page 238 near the end of the second column, the word "virility" occurs. This is obviously an error, the correct word being "vitality."

Yours truly,

P. J. RISDON.

The Editor, POPULAR WIRELESS.

Sir,—The Royal National Hospital for Consumption, at Ventnor, Isle of Wight, accommodates 160 patients who, with the staff, comprise a little community of about two hundred persons. They are, naturally, cut off from most of the usual forms of recreation and pleasure, and your readers will appreciate the boon which wireless telephony is able to confer upon them. A breath from the outside world can be brought to bear upon the lives of patients and staff alike, cheering and soothing at times when the most carefully planned routine is irksome.

May I, therefore, appeal very earnestly to all wireless clubs and associations in Great Britain, as well as generously disposed readers of POPULAR WIRELESS, for collections and subscriptions towards the installation of really good receiving apparatus, which will carry a loud speaker.

If you can assist in this matter I shall be most grateful. Subscriptions should be sent to The Secretary, Ventnor Hospital Wireless Fund, 18, Buckingham Street, Strand, London, W.C.2.

I am, Sir, faithfully yours,  
(Signed) P. B. BURGOYNE,  
Chairman.

The Editor, POPULAR WIRELESS WEEKLY.

Sir,—I read with great interest the letter from Colonel C. L. Malone, M.P., in a recent

issue of your valuable paper, in which he points out the need of protecting the amateur receiver from trusts and monopolies. All who desire to see the radio industry develop on sound lines will be grateful to him for taking the initiative in this important matter.

There are several other directions in which an association of radio users could be of service. At the present time, amateurs have practically no voice in deciding what kind of news, music, etc., they may "listen-in" to. A representative association would be able to submit suggestions for maintaining the material broadcasted at a high literary and educational level and promoting the best interests of the users. For instance, radio may, and in my opinion should, form part of the equipment of every elementary school as a valuable aid in the teaching of certain subjects. The proposed Radio Association would be the most suitable body to investigate these suggestions and submit recommendations to the Broadcasting Company and the Postmaster-General.

Such an association could also be of great service to the small manufacturer either of complete instruments or of parts. The question of infringement of patents is, as I have seen from my professional experience, a very involved and intricate matter in which only the combined efforts of the trained legal and technical minds can see clearly. The Radio Association should be able to give its members the best legal and technical advice on questions of patent rights and infringements.

Many other possibilities for doing good and useful work will occur readily to all thinking readers, and I trust that POPULAR WIRELESS WEEKLY will give Colonel Malone's proposal its fullest support.

Yours obediently,

S. LANDMAN.

59, Chancery Lane, W.C.2  
September 14, 1922.

# ALL-BRITISH WIRELESS EXHIBITION

HORTICULTURAL HALL,  
VINCENT SQ., WESTMINSTER, S.W.1

AND CONFERENCE

SEPT. 30th (1922) OCT. 7th  
(SATURDAY) (SATURDAY)

ADMISSION

1/3

including tax.

SPECIAL TRADE DAY  
Oct. 2nd. Admission 1/3 including tax.

SPECIAL PUBLIC DAY  
Oct. 3rd. Admission 5/- including tax.  
(Public admitted both days after 6 p.m.  
at the usual price.)

The CONVENTION will be held under the auspices of THE WIRELESS SOCIETY OF LONDON.

## SPECIAL ATTRACTIONS

### THE WIRELESS SOCIETY OF LONDON

Have arranged for officers of the Society to be available each day, at the room put at their disposal, to meet officials and members of Affiliated Societies from London and Provinces. A staff of experts will be in attendance to conduct visitors round the Exhibition. The following are among the gentlemen who have kindly promised to give lectures, which will take place every afternoon and evening as announced during the Exhibition.

Admiral of the Fleet Sir HENRY JACKSON,  
G.C.B., K.C.V.O., etc.  
A. A. CAMPBELL SWINTON, F.R.S., etc.  
F. HOPE JONES, M.I.E.E.  
MAURICE CHILD

G. P. MAIR, A.M.I.C.E., etc.  
G. G. BLAKE, M.I.E.E., A.Inst.P.  
E. BLAKE, A.M.I.E.E.  
PHILIP R. COURSEY, B.Sc., A.M.I.E.E., F.Inst.P.  
W. R. H. TINGEY

R. CLINKER  
JOHN SCOTT-TAGGART, M.C., A.Am.I.E.E., F.Inst.P.  
Lt. H. WALKER, A.M.I.E.E.  
R. R. RIVERS-MOORE, B.Sc., A.M.I.E.E.  
P. D. TYERS

### THE DEMONSTRATION STAND

will provide numerous concerts daily, including the reception of Broadcast music, song and speech.

### THE EXHIBITS

will include many instruments of entirely new design and novel apparatus never before shown to the Public. At each stand highly experienced representatives will be on duty for the purpose of explaining the various exhibits.

### OFFICIAL CATALOGUE

Price 6d. Over 100 pages. Special article by F. Hope Jones, Esqr., M.I.E.E., and a Complete List giving the name and address of all affiliated Wireless Societies and Clubs in Great Britain.

### ORGANISERS:

BERTRAM DAY & Co., Ltd., 9 and 10, Charing Cross, London, S.W.1.  
Wireless Publicity Specialists Gerrard 8063/4

## A GREAT ADVERTISING OFFER 14 DAYS ONLY

## The "O.K." CASKET CRYSTAL RECEIVING SET

(PROV. PATENT NO. 21032.)

IN order to popularise this wonderful new Wireless Receiving Set, which quickly picks up Signals, Telephony, and Music within a 30 miles radius, we will supply a **complete** Set, consisting of the "O.K." Casket in a beautifully polished Mahogany Cabinet (size 6½ × 4½ × 3 inches), with One Pair of High Grade Head Phones, 100 ft. Aerial Wire with two Insulators, packed and delivered to your address, at the **Specially Reduced Price** of

**£3 - 15 - 0**

In fulfilment of every Order (accompanied by a Cash Payment) up to the limit of 1,000 Sets, received by us not later than

**SATURDAY, OCTOBER 7th, 1922.**

This Set is absolutely the best, most compact and most effective Crystal Set made.

Its usual Price is **£4-15-0**, to which it will revert after this date.

ORDER AT ONCE FROM—

**THE BARLAW ENGINEERING CO., LTD. (Dept. P.W.),**  
**47, Victoria Street, London, S.W.**

Telephone:  
Victoria 6999.



**SIMPLY CHARMING — CHARMINGLY SIMPLE**



# RADIOTORIAL

All Editorial Communications to be addressed The Editor, POPULAR WIRELESS, The Fleetway House, Farringdon Street, London, E.C.4.

## IF BROADCASTING COMES.

I learn on very excellent authority that the proposed regulation prohibiting amateurs from making their own sets will not come into force. At a recent meeting of the Post Office officials and the Broadcasting Company this important question was fully dealt with. The conference lasted four hours, and at the end of that period every obstacle but one had been overcome. The outstanding obstacle which deterred a settlement I shall refer to later. The amateur, however, will be glad to hear that his liberty in the matter of constructing his own apparatus will not be interfered with.

I understand from a special correspondent, who is in a position to supply me with news of the latest developments, that it was decided at the conference that amateurs should be allowed to purchase component parts, and that there would be no objection to their fitting up their own sets.

Since the rumour got about that amateurs were to be restricted in this matter, there has been a good deal of hysterical protest in the Press and elsewhere, but from the very first "Popular Wireless" realised that such a restriction would inevitably react on the manufacturers to such a detrimental extent that the wireless boom would be effectually damped, and that trade would be bound to suffer in consequence.

To the young amateur just taking up the hobby, the joy of wireless is in the making of various pieces of apparatus, putting the set together, and then experiencing the thrill of "getting it to work." However, the amateur may rest assured that his liberty in this respect will not be interfered with.

The obstacle I referred to above, and which cropped up between the Broadcasting Company and the representatives of the Post Office, relates to the difficulty experienced by the manufacturer of wireless apparatus in coming to an agreement with the Marconi Company with respect to the use of the latter's patents.

However, it is quite possible that by the time these words are read by readers of "Popular Wireless" an agreement may have been reached, in which case, it is clear water ahead, and, as far as I can see, there is nothing to prevent the Broadcasting Company from going ahead with the service they have so long promised, and which amateurs have so long waited for.

THE EDITOR.

## Questions Answered

Owing to the enormous number of queries received daily from readers of POPULAR WIRELESS, I have decided to reply individually by post. A weekly selection of questions will, however, be printed on this page, together with the answers, for the benefit of readers of POPULAR WIRELESS in general. Questions should be clearly and explicitly written, and should be numbered and written on one side of the paper only.

All questions to be addressed to: POPULAR WIRELESS, Queries Dept., Room 131, The Fleetway House, Farringdon Street, London, E.C.4.

Readers are requested to send necessary postage for reply.

T. R. M. (Gosport).—Can I use both a pair of high resistance telephone receivers and a pair of low resistance with a transformer in the same circuit?

Yes, if the transformer is of correct ratio. The primary of this latter should be placed in series with the high resistance telephones with a fixed condenser across, while the low resistance receivers can be placed across the secondary of the transformer.

"SPARKS" (Huntingdon).—When charging accumulators from a D.C. main of 110 volts, is it necessary to make any provision for the reduction of voltage?

No, it is a question of adjusting the flow of current through the cells by means of a resistance or lamps so that it corresponds to the charging rate.

F. A. R. (Twickenham).—My garden is about 30 feet long, and the highest aerial that I could possibly erect would be only 10 feet high. If I used three wires each 30 feet long, and a

crystal set, would it be possible for me to obtain any results?

It is quite possible that with careful tuning you will bring in Marconi House, but unless you can obtain greater height than 10 ft. results will be very poor.

T. H. (Wrexham).—London is apparently my nearest broadcasting station at present, so what set would I require to hear it?

Three valves.  
Could I hear anything from Carnarvon on a crystal set?

No, because Carnarvon transmits on the Continuous Wave system.

T. N. M. (Manchester).—What is a Corona effect?

A silent electric glow discharge that will be produced by the proximity of two conductors at high difference of potential, under certain conditions. Sometimes called a "brush discharge" it can frequently be noticed round the aerial and lead in of high-powered stations.

"SPARKS" (Leith).—What is the resistance of 1,000 feet of 36 S.W.G. copper wire?

180 ohms.  
What is the resistance of gauge 36 "Eureka" resistance wire?

4,047 ohms, for 1,000 feet.

Would it not be possible to use "Eureka" for rewinding telephones to a high resistance, thus requiring a much smaller quantity than would be necessary using copper wire?

No. As has been pointed out many times in these columns in connection with high resistance telephones and certain other instruments, it is not the actual resistance upon which the sensitiveness or efficiency of these instruments depend, but the number of turns of wire that it has been possible to obtain.

"CALCULUS" (Leith).—What is the formula for the capacity of condensers?

See reply to "Capacity" (Glasgow) in number 2.  
How does one reduce square inches to square centimetres?

Multiply by 6.45.

It was stated in one of your articles that a wireless wave once propagated would continue to travel for ever, getting smaller and smaller, but never completely ceasing to exist. If this is truly the case, might it not happen that, with the progress of science, wireless-detecting instruments will eventually reach that stage of perfection so that they will be

(Continued on page 341.)

## A WARNING TO ALL FATHERS.





# WIRELESS POST FREE.



2,000 ohms, 24/-  
4,000 ohms, 25/-

## SPECIFICATION.

**CORDS.** Twin conductors, Tinsel, 3 ft. long between butt and fork, 12 in. long from fork to each receiver. Instrument end fitted with 2-plug type Metal Tags.

**RECEIVERS.** Arranged in series and wound to 2,000 ohms, 4,000 ohms, or as required. Magnets of specially treated Tungsten steel mounted in Aluminium cases fitted with adjustable steel Headbands of extremely light but serviceable pattern.

## SPECIFICATION.

**RESISTANCES.** 120, 1,000, 2,000, 4,000, 8,000 ohms. Other windings to order.

**INSULATION.** Highest possible.

**MAGNETS.** Selected Tungsten steel, manufactured under our own special process and guaranteed for ten years.

**CORDS.** Heavily insulated Tinsel conductors.

**FINISH.** Polished Aluminium Cases and Fittings with Oxydised Relieved Coppered Headbands. Simple and comfortable adjustments.

**INSPECTION.** Every Head set carefully tested under actual reception conditions and guaranteed to specification.



DE LUXE PHONES  
2,000 ohms, 34/-  
4,000 ohms, 35/-

Ebonite Ear Caps fitted as standard.



## CRYSTAL SETS

(Including De Luxe Headphones)

£4.5.0

**AERIALS.** Complete with insulators and instructions for erection, 6/- POST FREE.

**The New System Private Telephone Co., Ltd.,**  
212-214, Gt. Portland Street, London, W.

Tel. No.: MAYFAIR 3779.

# Build your own Valve Set

only a screw driver wanted

THE home construction of a Valve Set is quite simple if you purchase a set of Peto-Scott standardised Radio Parts. You will find that all the drilling and tapping has been done for you and the various components ready built—and all you need is a screwdriver to fit them together. Full instructions supplied with every set.

## SETS OF PARTS.

No. 4 Detector Panel - 17/6  
No. 5 Low Freq. Panel 33/6  
No. 3 High Freq. Panel 13/6  
Mahogany Cabinets to fit - - - each 3/6

Postage: 9d. per panel extra, but all orders over £2 sent post free.

Our new Booklet explains the whole system

POST 6<sup>d</sup> FREE

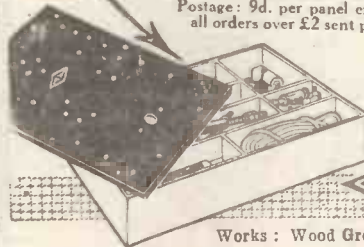

Showrooms and Offices:  
**FEATHERSTONE HOUSE,**  
64, HIGH HOLBORN, W.C.1.



Works: Wood Green, N.

# THE GOODS!!!

HAVE YOU A GRAMOPHONE?  
THEN GET A  
GRAMAPHIX LOUD SPEAKER

THE GRAMAPHIX multiplies sound!  
THE GRAMAPHIX fits any gramophone!  
HAVE YOU HEARD THE GRAMAPHIX?

IT produces full volume of sound without distortion and makes your gramophone a **RADIO LOUD SPEAKER.**

The Gramaphix is the result of considerable time and expense which has enabled us to offer a **LOUD SPEAKER** with exclusive features **AT A PRICE WITHIN THE REACH OF ALL.**

The Gramaphix utilizes the scientifically designed tone amplifier of the gramophone to secure mellowness and **BEAUTY OF TONE**, therefore doing away with all that metallic sound, scratching and "ring" associated with other loud speakers.

The Gramaphix is the talk of the wireless world.

**ADJUSTED IN A MINUTE** by a child.

**LATEST AND LOUDEST.**

Why pay pounds when a better instrument can be secured for **10/6** Immediate D livery.

To be seen at Stalls 42 and 47, All British Exhibition, Horticultural Hall, September 30—October 7

Lac and Electrical Manufacturing Agency (Dept. Q)

68, GREAT QUEEN STREET, KINGSWAY, W.C.2.

G. B. BIRD 5311.



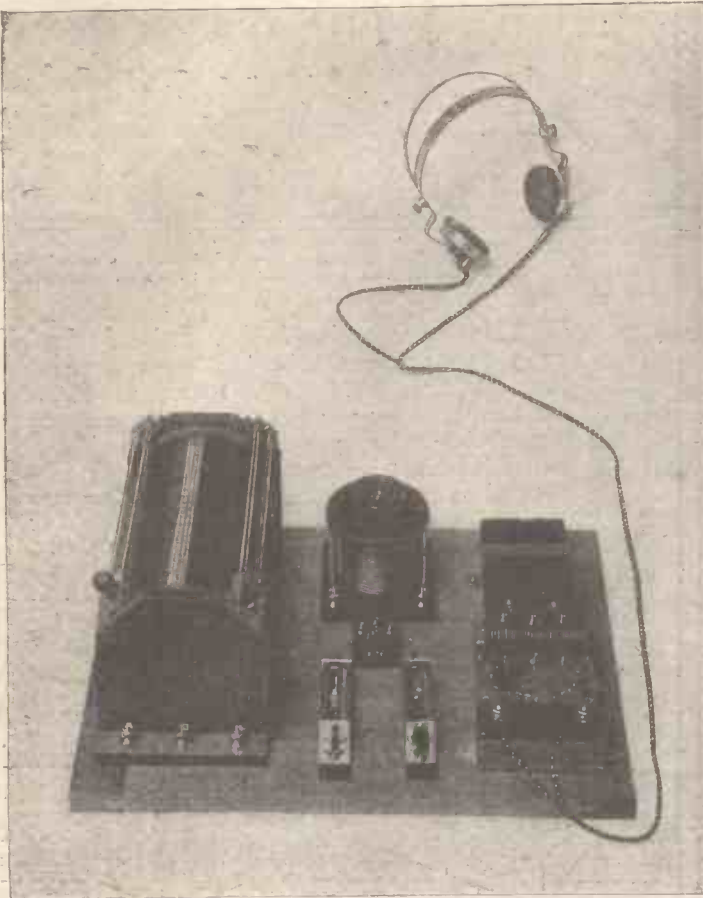

## APOLLO WIRELESS RECEIVING SETS

are unequalled in design and workmanship. They insure perfect reception of broadcasting.

Prices of complete sets, including double head phones (4,000 ohms), aerial wire, and insulators.

Set 00.—Perikon detector and variometer tuner in mahogany case. Very sensitive instrument. Range 15 miles **£4 10 0**

Set 1.—Double slide tuner, variable condenser, perikon detector. Range 20 miles **£6 0 0**

Set 2.—Double slide tuner, variable condenser, two detectors, potentiometer and battery. Range 30 miles **£7 12 6**

Set 3.—Loose-coupled tuner, two variable condensers, two detectors, potentiometer and battery, etc. Range 30 miles **£10 10 0**

Set 4.—Tuning inductance, loose-coupled tuner, two variable condensers, two detectors, potentiometer and battery, testing buzzer, etc. **£13 0 0**

Full range of accessories and aerial material at very reasonable prices. Illustrated catalogue, with very clear diagram and instructions, sent free on application by

**CRAIES & STAVRIDI,**  
Apollo House, 4, Bunhill Row, E.C. 1.



## A TEST IS BEST

We invite the public, and also the trade, to come along to our Demonstration Hall, where all can hear for themselves the wonderful wireless reception obtained when using our apparatus.

THE PROOF OF THE EFFICIENCY OF OUR COMPLETE SETS IS IN THE HEARING THEREOF.

Free Demonstrations daily, 10 a.m. to 9 p.m., also on Sundays from 6 to 9 p.m.

BESIDES OUR COMPLETE SETS WE HAVE A SPLENDID SELECTION OF ALL WIRELESS ACCESSORIES.

NOTE.—We supply complete receiving sets for cash or deferred payment. All orders despatched in strict rotation.

Two Illustrated Booklets, No. 1 and P. Post free, 6d.

**STUART WIRELESS TELEPHONE CO.,**  
109, Kingsway, London, W.C.2.

## BROWNS'

### LOUD SPEAKERS, HEADPHONES, MICROPHONE AMPLIFIERS

#### The "BROWN" LOUD SPEAKERS

With new improved curved horn

The requisites of a Loud Speaker are pure tone, clear articulation, and good volume of sound. The "Brown" Loud Speaker possesses these qualities, and they are enhanced by the new improved curved horn.

AMATEURS do not always need the full-sized Loud Speakers (H. 1) as used in Lecture Halls, and a small type (H. 2) has been designed to meet their more modest home requirements both as to volume of sound and price.

THE NEW HORN of dull blacked aluminium used with both H. 1 and H. 2 is constructed on the logarithmic law of increasing openings, and is acoustically perfect.

#### PRICES:

H. 1. (Large) Low Resistance, 120 ohms. Height 21 in.	<b>£6 5 0</b>
H. 2. (Small) Low Resistance, 120 ohms. Height 12 in.	<b>£3 0 0</b>

H1. & H2. (High Resistances) 2/6 to 5/- extra.)

The strength and clearness of all music, speech and Morse heard by one person wearing headphones is broadcasted to a whole room full of people when a Brown Amplifier and Loud Speaker are used with your set.

The most popular and perfect Loud Speakers ever offered to the public. Thousands already in use in all parts of the World

Catalogue, post free, gives you details of all our Wireless Apparatus

Visit Our Stand, No. 43, at the ALL-BRITISH WIRELESS EXHIBITION, HORTICULTURAL HALL September 30 to October 7

Head Offices  
and Works—  
**VICTORIA Rd.,**  
**NORTH ACTON,**  
**LONDON, W.3.**



London Showrooms—  
**19, MORTIMER STREET,**  
**LONDON, W.1.**



## RADIOTORIAL QUESTIONS AND ANSWERS.

(Continued from page 338.)

sufficiently sensitive to detect ether waves propagated many years previously?

If ether is the medium with the characteristics claimed for it by the authoritative exponents of the electron theory there is no reason why it should not be brought to rest from a state of motion by means of some counteractive force like that of gravity, acting upon it. If this be the case, an ether wave will definitely cease to exist at a certain point, and will not continue to infinity. On the other hand, your statement possesses the elements of reason, but until the present controversy regarding the subject of the existence or non-existence of ether has been more definitely decided one way or the other, we prefer to view the point with an open mind, inclining to the electron theory of ether as accepted by the majority of the world's scientists.

**"AMPLIFIER"** (Tooting).—Can high frequency transformers be wound with resistance wire to make them a periodic, and cover a greater range of wave-lengths, and if so, what wire should be used?

Yes; use 40 gauge "Eureka" resistance wire.

I have been carefully reading a certain book, the one you advised me to purchase (Bangay's "Elementary Principles of Wireless Telegraphy"), and one statement seems to be contrary to a statement made in one of your articles. Alluding to the inductance in a circuit, it states that when a circuit in which a current is flowing is broken a current is induced in the opposite direction. Is this correct, or did the mistake occur in your article?

It is a slip. The direction of the induced current will be in the same direction.

**"CONDENSER"** (London).—What is the area of overlap in square inches of one standard condenser vane  $2\frac{1}{2}$  inches in diameter?

That depends as to whether the other vane has greater or less area of surface. We assume that the above figure refers to a moving vane. This being the case, and as moving vanes are invariably the smaller, its total of 2.45 square inches may be taken as overlap, for the calculation of the condensers maximum capacity.

**"AERIAL"** (Southampton).—I wish to treat a pole that I intend to utilise for my aerial in a similar manner to that adopted for telephone poles to preserve that part that will be sunk into the ground. Can you describe the method?

There are several. Three of the best-known being "Rueping," "Burnettizing," and "Boucherizing." These, however, consist of processes involving the injection of various substances under considerable air pressure, and would be beyond the power of an amateur to carry out. We suggest that a thick coating of common tar will answer the purpose.

**W. G. P.** (Portsmouth).—An aerial has been likened to a condenser. Therefore, if it were composed of sheet copper two feet wide to increase the capacity, would it not improve matters?

Probably it would for the reception of the very long wave-lengths, but in order to be able to efficiently bring in the shorter wave-lengths, it is not advisable to have an aerial with too great capacity. For that reason the slightly longer single wire-aerial is to be preferred to the shorter double.

**T. M.** (Middlebrough).—What size basket coils do I require for a 200-500 metres range, using 26 S.W.G. on a  $1\frac{1}{2}$  inch former wind to 20, 30, and 40 turns?

Use a .0002 mfd. variable condenser for tuning purposes.

**"CRYSTO"** (Westcliff-on-Sea).—I find that when adjusting my one-valve receiver for the reception of C.W. signals, I can obtain practically the same results by either varying the reaction or the filament resistance. Is there any theoretical advantage in the former case, as it seems that the latter will be the more economical?

Unless the accumulators are very constant filament control is liable, with the variations of battery voltage, to give unsteady results, and although the filament brightness method is the simpler, the reaction coupling adjustment is to be preferred because of its flexibility.

**G. V. D.** (Brockley).—Which of the following crystals are red: zincite, copper pyrites, chalcopyrites, carburundum, galena, bornite? Zincite, copper pyrites.

Which two can be used in combination? Zincite with bornite, copper or chalcopyrites.

**"PUZZLED"** (Colchester).—What is the difference between low frequency amplification, audio-amplification and note magnification?

None whatever, unless it is that in the case of the last named it is applied in those cases where a stage of amplification is added to make a readable signal very loud for the purpose of bringing it in on a loud speaker.

Are thermionic, electron, and various other valves essentially the same?

Generally speaking, yes.

You have stated that the main cannot satisfactorily be used for supplying the H. T. Why is this, and does that apply to transmission or reception only?

It can certainly be used for transmission, but armature irregularities and commutation ripples render it too "noisy" for reception.

**W. W. S.** (Dorking).—What exactly is 7-22 wire?

Seven strands of gauge 22 wire twisted together.

**T. H. L.** (Tonbridge).—Can you give dimensions and windings of two high frequency transformers of the plug-in type to give ranges from 200-500 and 500-700 metres?

Obtain two ebonite bobbins  $2\frac{1}{2}$  inches overall diameter with  $\frac{1}{4}$  inch square peripheral grooves. Using 42 S.W.G. s.s.c., wind similar number of turns for both primary and secondary in the same groove. Fifty-five will be required for the smaller, and 100 for the larger. The bobbin can be fastened to the legs at the base of an old valve, or screw-valve legs can be obtained from most dealers. The ebonite can be drilled and tapped and these screwed in. A .0002 mfd. variable condenser will be required across the primary.

**"EXPERIMENTUS"** (Oldham) asks various questions as to the efficiency of a six-valve set, employing four stages of low frequency amplification, that he has designed, and asks whether it would be practicable to add one further stage of amplification, also low frequency.

It would not be wise to do so. As a matter of fact, three stages should be the limit. Due to microphonic effects with more than three a set is liable to be very "noisy," with a great tendency to "howl" or oscillate at audible frequency. Parasitic noises such as are caused by the proximity of power mains or telephone wires, "atmospherics," etc., are generally of low frequency, and for this reason also undue low frequency amplification should be avoided.

**"BEATEN"** (Liverpool).—I am much troubled lately with an interference that I cannot locate. I can only describe it as a terrible "growling," and crackling. It absolutely prevents reception. It is not due to statics, as it is the same when neither the aerial or earth are connected. It is not the set, as the same trouble occurs when I try out any one of my friend's sets. There are no power mains or telephone wires within some considerable distance. The accumulators have recently been charged. Can you suggest anything?

Undoubtedly it is due to a faulty cell or cells in the H.T. battery. These will have to be located and cut out. It is a simple matter to discover if it is the H.T. that is causing the trouble before proceeding to cut out the wax, and that is by shorting the H.T. terminals for a moment. If that causes a temporary cessation of the noises, then it is certain that the H.T. is the root of the trouble.

**S. W.** (Newcastle).—What is the easiest way to adapt valve amplification to a crystal set without dismantling it or altering the wiring?

Employ a low frequency transformer, connecting the primary of this to the telephone terminals of the crystal set; the secondary being introduced into a simple valve circuit.

(Continued on next page.)

## THE OMNIPHONE CRYSTAL RECEIVER.

Price £4:10:0 COMPLETE.

For broadcast wave-lengths. While a complete, highly sensitive receiver in itself, may form the nucleus of a most elaborate set, as provision is made for the attachment of a valve amplifier. Fully guaranteed. Call for demonstration, or write for full particulars.

ALL WIRELESS ACCESSORIES.

LIST FREE.

We undertake the Installation, Alteration and Repair of Apparatus.

THE OMNIPHONE WIRELESS CO.,

24, WARWICK STREET,  
REGENT ST., LONDON, W.1.

20 yards from Regent Street, between  
Robinson & Cleaver's and Maison Lewis.

Phone: Regent 3335.

## DAVIS & TIMMINS, LTD.,

34a, York Road, King's Cross, N.1.

## SCREWS AND TERMINALS

FOR

WIRELESS SETS

Write for Illustrated Lists.

### SERVICE and SATISFACTION.

Our expert service is at your disposal. We guarantee satisfaction. Anything from a multivalve set to a switch arm supplied. Stamp for list. State requirements. Trade supplied. K. E. WIRELESS SERVICE.  
10, GLENVIEW ROAD, LEWISHAM, S.E. 13.

## THE "S. R." SET

Complete with double slider phones, 100 ft. aerial, insulators, and mounted on superb mahogany base. Ready for use. £4-0-0.

Showrooms: 8, Cavour St., and 19, Darcy Road, Kennington at Norbury, S.W.

## STAPLETON & ROBBINS

### R. W. ILES WIRELESS SUPPLY.

Aerial Insulators, Porcelain (special), each	£0	0	3
Aerial pulleys, ex-Govt., aluminium, each	0	1	6
Aerial Wire, 7/22 copper, per 100 ft.	0	6	0
$\frac{1}{4}$ in. Slider Rods, 13 ins. long, bored, each	0	0	7
Lacquered crystal detectors on ebonite bases	0	5	0
Murdock double head sets (2,000 ohm total)	1	10	0
Ebonite knobs, knurled and polished, each	0	0	8
Mullard Ora valves, limited number only, each	0	15	0

All orders sent by return on receipt of cash.  
BOSCOMBE, EAST BOURNEMOUTH.

## PROMPT SERVICE.

Send two stamps for lists of wireless supplies. We can and do deliver promptly.

### ELECTRICAL SUPPLY STORES,

5, Albert Terrace, King Cross,  
HALIFAX.



# The EUREKA Radiophone

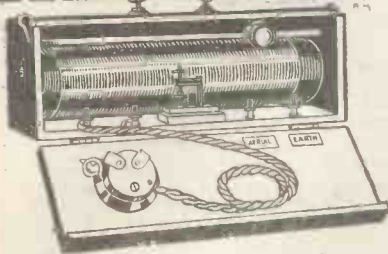

Buy Your Own Home-Set To-day, to enable you to "listen-in" to Broadcasting of Concerts, Speeches, News, Time-Signals, etc., etc. The entrancing World of Wireless will be yours.

Home Crystal Set No. 1 as illustrated. Complete with Head Phone, Detector, Tuning Coil with variable adjustment, 100 ft. Aerial and Insulators. *No batteries required.* Range: Telegraphic Signals—150 to 200 miles. Telephony—25 miles. Mounted in a Polished Hardwood Box. **Price £3 18 6** Cash with order.

COMPLETE PARTS for Building a Crystal Set in Your Own Home . . . . 45/- Complete. Post free.

Write to-day for full particulars of our No. 2 Crystal Set—the "EUREKA" VALVE-UNIT SYSTEM—enabling the experimenter to ADD to his existing apparatus as desired. The "Eureka" Unit System is by far the most flexible method of reception in existence.

British Made throughout by

**The Electric Appliances Co., Ltd.**  
(Dept. W), 8, Fisher Street,  
Southampton Row, London, W.C.1.

## POLES FOR AERIAL MASTS.

Suitably selected straight FIR POLES. Supplied for any length Mast.  
Price:—4d. per foot, any length up to 20 feet.  
Price:—5d. per foot, lengths over 20 feet sent in sections for joining (to comply with Railway regulations).  
Short lengths (for spreaders) 2d. per foot.  
Add 1/- per length or section if required prepared (peeled and treated creosote preservative).  
Carriage Paid England and Wales (Scotland 10 per cent. extra, Ireland, Channel Isles, and abroad, 25 per cent. extra).  
Coleman & Sons, 7, Cranfield, BLETCHLEY.

## WE ARE MANUFACTURING

Large Quantities of LOW-FREQUENCY INTERVALVE TRANSFORMERS, of sound design—moreover, our prices are right!  
TRADE ENQUIRIES SOLICITED.  
THERMAL ELECTRIC WORKS, LTD.,  
Hackbridge, Surrey.

## TO WIRELESS EXPERIMENTERS. PATENT YOUR INVENTIONS.

They may prove very valuable. Particulars and consultations free BROWNE & CO., Patent Agents, 9, Warwick Court, Holborn, London, W.C. 1. Established 1840. Telephone, Chancery 7547.

MAKE YOUR OWN

## LOUD SPEAKER

21/-

SIMPLE—ECONOMICAL—EFFICIENT  
18" Bell Horn—12" Stand—Highly Polished finish. With Instructions for fitting.  
Cash with Order—postage 2/-

## "AERSONG" Receivers 25/-

9" x 7" x 6" SUPERIOR FINISH.  
MUSIC—ECONOMY—SATISFACTION  
Cash with Order—postage 1/6

Wireless Dept.

44, ROMFORD ROAD, LONDON, E. 15.

## RADIOTORIAL QUESTIONS AND ANSWERS.

(Continued from previous page.)

W. Y. (Blackheath).—Is a variable condenser essential for the primary as well as the secondary of a loose coupler, because I understood that the mutual inductance is varied by the sliding in and out of the secondary and thus giving fine inductance tuning to the primary?

The variable condenser, if used—although certainly not essential—will give a greater flexibility of tuning with a maximum degree of selectivity, as the coupling between the two circuits can be varied without reference to the frequency tuning; this latter being adjusted by the variable condenser.

"ROTATOR" (Halifax).—How does one handle the Armstrong circuit having more or less satisfactorily constructed it?

First loosen the coupling of the second reaction (for the purposes of clear explanation the two circuits will be alluded to as one and two; the first being the nearer to the A.T.I.) so that it does not oscillate, and then tune the aerial and secondary circuits in the usual manner. The first reaction is adjusted until signals are at their loudest without distortion. The second reaction is then tightened until that circuit oscillates the commencement of this will be clearly heard in the phones, and, lastly, the first reaction coupling is tightened and the variable condensers are adjusted until undistorted signals come in.

S. H. L. (Ipswich).—What ratio exists between the primary and secondary winding of a loose coupler?

No direct ratio. The secondary, in conjunction with a suitable variable condenser, must be constructed so that it will give a wave-length variation coinciding as near as possible with that of the open circuit, which consists of not only the primary winding of the coupler but also the aerial and earth systems. Therefore, the secondary will, generally speaking, require to have a greater value than the primary.

"ERVAV" (Middlesbrough).—Why is it that I can hear certain stations, mostly C.W., on all sorts of condenser and inductance adjustments?

Because those adjustments represent what are known as harmonic tunings. An oscillatory circuit with fairly evenly distributed capacity and inductance will resonate to multiples of its fundamental frequency. To put it into simple language this is what happens. A circuit is tuned to pick up a station on a certain wave-length and therefore the inductance and capacity are so arranged that when a wave induces a current, this current will take just that time to overcome inductance and fill up capacity, as it were, to go to the one end of the circuit and back just as the next wave cuts the aerial and induces further current. A popular analogy is that of a swing. Therefore it can be seen that such a tuning could be arranged whereby the current completes two or even several complete oscillations before the next wave comes in. Further it will be seen that this harmonic tuning will not give the strength of signal that would the true tuning, if once again the swing analogy is remembered, the true tuning being represented by a well-timed push as the swing returns after each "oscillation."

W. H. S. (Barnsbury).—Is there any way that atmospherics can be cut out?

Not entirely. By introducing a tuned, closed circuit such as the loose coupler, they can be decreased to a great extent. There are various methods such as placing a "static leak" between the earth and aerial offering a path for parasitic currents to leak to earth, balanced crystals, etc. This latter involves the use of two carborundum crystal detectors each with a potentiometer. They are arranged in parallel so that they tend to rectify in opposite directions. Each detector is adjusted separately to give the loudest signals. They are both then brought into the circuit. The result is that no signal is heard at all, as each detector provides its easiest path to the current in opposite directions. Each detector is adjusted separately to give the loudest signals. They are both then brought into the circuit. The result is that no signal is heard at all, as each detector provides its easiest path to the current in opposite directions. One potentiometer slide is then moved towards potential zero until the signals resume their strength. It will be found that the stronger the atmospheric the weaker the resultant effect in the telephones. Using valves one stage of high frequency amplification at least will tend to reduce these disturbances, while undue low frequency amplification will increase their strength because as has been explained before in

these columns such disturbances are usually of low frequency.

Many involved circuits have been arranged with more or less successful results to eliminate "atmospherics," but up to the present no simple and really successful device has been evolved. Here at least is a field for amateur research.

S. G. (Portsmouth).—Is there any limit to which the wave-length of a fixed multi layer coil's wave-length could be increased by means of the addition of capacity. If not, why cannot but one coil be used with suitable variable condensers to cover all wave-lengths?

Yes, there is a limit; and three times the natural wave-length of such a coil in a closed circuit is as far as it can be taken by the addition of capacity without reduction in efficiency. A coil wound to give a minimum of 300 metres should not be taken beyond 900.

"CAP" (Leeds).—What is a compound condenser, and how does it work?

A compound condenser is a condenser with an arrangement whereby fixed condensers can be placed in parallel, thus giving an extensive range of capacity. If a .001 mfd. variable condenser has a switch that will bring a small fixed condenser in parallel of .001 mfd. when required, a variable range of zero to .002 mfd. will be obtained. Further fixed condensers could be likewise arranged to the values of .002 and .004 to give a range to .008 mfd., if such a range was required. The idea can be easily adapted to amateur sets. A small two-plate sliding variable condenser can have several small fixed condensers paralleled by switches to give a similar range of capacity to the more expensive multi-vane type.

"CELLS" (Wellington).—What is the construction of the Edison accumulator?

Iron cathode and nickel peroxide anode immersed in a potash electrolyte.

How does it compare with the ordinary type?

The E.M.F. per cell is but 1.3 volts or so, but in weight 14 watt-hours per pound to 12 for the lighter lead plate cells is quoted.

"CONTROL" (Glasgow).—I am very interested in Major Phillips's articles, and have a scheme for the useful adaption of the principles. What I want to know is whether it is possible to arrange a wireless control so that it will not respond to any but the one transmitter. Is this possible?

Within limits, and for purely local application, it may be, but such immunity from "jamming" would probably not hold good if such a system as the one you have in mind became general.

T. N. B. (London, S.E.).—I notice that static interruptions are becoming very intense of late. This is my first few months of wireless and I was wondering if this trouble will increase as the weather becomes cold and wet etc., finally making it not worth listening in?

No, it will not do that. As a matter of fact atmospherics, mostly due to the proximity or effects of electrical and magnetic storms, are more intense in the very hot weather or in the tropics.

"DETECTOR" (Blackburn).—What crystal should be used in combination with tellurium? Zincite.

Will the carborundum as used for grinding wheels, etc., be suitable for a detector?

No; because that form is generally powdered carborundum solidified under great pressure. The crystal as taken from the furnace is required for wireless work, and that, too, must be a special part of the melting. Generally speaking, the portions taken from the upper edges of the crucible are the most sensitive and suitable for the purpose.

What are (several patent crystals) formed of?

Most of these patent crystals are fusions of galea and silico. Galea, at any rate, figures in the composition of the majority.

Is anything to be gained by placing two detectors in parallel?

Generally speaking, no; but the balanced crystal working, mentioned elsewhere in these columns for the elimination of parasitic signals, is an example of the useful employment of paralleled detectors.

(Continued on page 344.)



## PUBLIC ANNOUNCEMENT

A compliment has been paid to Messrs. Radio Instruments, Ltd., by a new Wireless Company, who have practically copied our designs in their entirety, and are now placing on the market instruments almost exactly similar to our own in external appearance. Intending purchasers of our instruments should, therefore, exercise the greatest caution when purchasing same.

### RADIO INSTRUMENTS, LTD.

Managing Director: J. Joseph, M.I.E.E., late Manager to Mr. H. W. Sullivan.  
 Chief Designer: W. A. Appleton, M.B.E., M.I.R.E., late Admiralty Technical Research Officer.

ONLY ADDRESS—Works, Offices, Showrooms,  
 12a, HYDE STREET, NEW OXFORD  
 STREET, LONDON, W.C.1.

'Phone: Regent 1908. 'Grams: Instradio, London

Visit our Stand, No. 37, All-British Wireless Exhibition, Horticultural Hall, Sept. 30 to Oct. 7.



Established 1900.

CONSIDER WELL YOUR FUTURE

**WE TEACH BY POST.**

ADVICE FREE Most moderate charges—payable monthly.

**LEARN A TRADE OR PROFESSION**

*Can I help you?*

**I WILL GIVE YOU £50**  
 if I fail to produce over 7,000 testimonials from others I have helped TO A SUCCESSFUL CAREER.  
 Yours to success, *J. Bennett*

## ARE YOU QUALIFIED FOR THE JOB YOU SEEK ?

Write for one of our FREE BOOKLETS on WIRELESS TELEGRAPHY, or on any of the following subjects—

Architectural Drawing } Building Construction } Clerk of Works' Duties } Aviation } Boiler Engineering } Boiler Making } Chemistry } Civil Engineering } Concrete and Steel } Draughtsmanship } Electricity } Engineering } Foundry Work } Internal Comb Engines } Marine Engineering }	Mathematics } Matriculation } Metallurgy } Mining } Mine Surveying } Motor Engineering } Naval Architecture } Pattern Making } Salesmanship } Sanitation } Shipbuilding } Structural Engineering } Surveying and Levelling } Telegraphy and Telephony } Special Course for Apprentices
---	--

**What proof do you carry?** Your word to an employer is not proof that you are efficient, but a College Qualifying Diploma or Certificate, signed by the Professional Staff, is a proof of efficiency, and a valuable asset in seeking a remunerative position.

We specialise in all exams. connected with Wireless and other technical subjects. If you are preparing for any exam, ask our advice. All particulars FREE OF CHARGE. Parents should seek our advice for their sons. If you are interested in Wireless or any of the subjects mentioned above, write, naming the subject, and we will send you our FREE BOOKLET. Please state your age.



Department 106. SHEFFIELD

**COURSES SPECIALLY COMBINED TO MEET ALL REQUIREMENTS.**

## The Books YOU Want!



### WIRELESS VALVES SIMPLY EXPLAINED

By  
**JOHN SCOTT-TAGGART,**  
 F. Inst. P.,

Author of "Elementary Text-Book on Wireless Vacuum Tubes."

**SOME OF THE CONTENTS.**—Fleming Valves—The Three-Electrode Valve and its Application—Cascade Valve Amplifiers—Reaction Amplification and Self-Oscillation—Reaction Reception of Wireless Signals—Continuous Wave Receiving Circuits—Valve Transmitters—Wireless Telephone Transmitters Using Valves—Notes on Wireless Broadcast Receivers.

PRICE 3/- Post 3d. 2/6 NET.  
 CLOTH Post 2d. (PAPER)

### THE CONSTRUCTION OF WIRELESS RECEIVING APPARATUS.

By **PAUL D. TYERS.**

THE ONLY BOOK that tells you HOW TO MAKE ALL THE PARTS of a Valve or Crystal Set.

PRICE 1/6 NET. POST 1d.

Ask your Dealer at once for both these books, or they will be sent by return of post from

**Radio Press, Limited,**

Publishers of Authoritative Wireless Literature.

NEW ADDRESS (Opposite Law Courts):

DEVEREUX BUILDINGS, DEVEREUX COURT, STRAND,  
 LONDON, W.C.2.



M 3

## CQ Std bi for ERICSSON PHONES



WHEN you instal your wireless set—crystal or valve—you'll get maximum results if you fit ERICSSON PHONES—clarity, sensitivity, strength of signals and absence of "click." Specially suited to telephony.

ERICSSON PHONES embody the accumulated experience of telephone manufacture for a generation.

Easy to the head, light and comfortable. The magnets never lose their strength and "shorts" are non-existent.

Write for Particulars

The BRITISH L.M. ERICSSON MANUFACTURING Co., Ltd.

Head Office:

60, Lincoln's Inn Fields, E.C.2.

# Ericsson Telephones



## RADIOTORIAL QUESTIONS AND ANSWERS.

(Continued from page 342.)

C. T. N. (Burnham-on-Crouch).—With a view to hearing telephony from London and the Hague I propose to add a valve to my crystal set.

You must not expect to bring in the Hague on one valve. Although possible, it is only accomplished with a reaction circuit under ideal local and other conditions.

W. Y. O. (Eastbourne).—I propose to erect an indoor aerial under the galvanised roofing of our bungalow. There will be ample space for a 50 ft. twin with plenty of clearance. What results may I expect on a crystal set?

Very poor, if any. Apart from the fact that a crystal set is not likely, in any circumstances, to give good results, to say the least of it, on an indoor aerial, the effect of screening and absorption by the iron roof will diminish what little chances there might have been. Cannot you erect the aerial above the roof?

"IGNORAMUS" (Ilford).—This ether your contributors are so actively discussing. I cannot see, hear, feel, or smell it. It tickles not one of my five senses, or even my sixth, if I have one. It cannot be weighed as even a planet many millions of miles away can, and as a matter of fact, there seems to be no physical, psychological or even logical reason to suppose that there is such a thing.

As Mr. Hill aptly puts it: "The scientists have conceived a gap, and have filled it with ether. They have been logically compelled to bridge 'empty space' with a medium altogether different in kind and in degree from anything coming within human experience."—(POPULAR WIRELESS, September 9th.)

R. L. N. (Hull).—What is the simplest wireless receiving apparatus possible?

Signals have been received from a powerful station very close at hand with merely a small length of bell wire as an aerial, connected in series with a detector consisting of a small piece of coal, and an ordinary needle and an ordinary house telephone receiver. Slightly greater range has been secured with just the aerial in series with an ordinary crystal detector, and the orthodox high resistance telephone receivers. That is known as receiving on plain aerial, and is good only for short ranges, giving no tuning or selectivity. The most simple and practical crystal detector receiving set, allowing of fair tuning and efficiency, consists of a variable inductance in series with the aerial and earth, with a crystal detector and high-resistance telephones placed in parallel across the coil.

What is the difference between C.W. and spark signals, and why cannot the former be received on crystal sets?

## Wireless Sets Erected

**YOUR SET WILL NOT WORK  
UNLESS PROPERLY ERECTED.**

Wireless sets are now "foolproof," but they must be properly assembled and the AERIAL properly erected. We have a staff of experts who will do this for you, and, from thence on, your troubles will be at any end. Remember, that the proximity of electric cables and telephone wires will affect your set if not properly erected.

For fuller particulars of our service, and reasonable scale of charges, write:

**THE THOMAS-NOWLAN WIRELESS  
SERVICE CO.,  
18, BEER LANE, LONDON, E.C. 3.**

## Wireless Headphones.

4,000 ohms, 24/6, Post Free.

Don't confuse these with the cheap foreign-made phones now on the market. These are BEST French Make. Satisfaction guaranteed or cash returned. List Free.

LIBERAL DISCOUNT TO TRADE.

**W. JOANES (PARIS AND  
LONDON)**

42, JENNER RD., Stoke Newington, London, N.16.

This has been dealt with by more than one article that has appeared in "P.W." Briefly, continuous wave signals are those that come in in uninterrupted wave trains, while in the case of spark signals, each dot or dash will consist of groups of waves. Represented in rectified current after having passed the detector, "A" (dot dash) would come in on C.W. as — being two continuous streams of current capable of attracting and releasing the diaphragm of the telephones twice only, while on spark it would come in as . . . . . but with many more groups than that for each sign, the number varying with the note of the signal, and would thus attract and release the diaphragm many times, producing an audible sound wave.

W. P. V. (York).—The "catwhisker" in connection with crystal detectors does not, as you suggest, refer to the hirsute adornment of the domestic feline, but to a fine metal wire of similar gauge.

H. K. G. (Falmouth) submits for criticism a scheme for the automatic transmission of wireless messages by a phototele-vision method.

In common with any other progressive journal we do not dismiss anything as impossible that holds even the barest elements of reason. At the same time, to put it colloquially, "is it worth it?" An invention to prove of utility must be able to accomplish the desired object by either a more direct and efficient or less expensive manner than other devices of a similar nature. By the way, your theory is a little weak. Wireless waves cannot be considered as being currents of electricity; they are mere ethereal disturbances created by artificial electrical means. (See reply to "Curious" (Stockport) in this issue.)

"CURIOUS" (Stockport).—I am not quite clear as to how wireless waves are formed by a transmitting station. Can you explain in simple words?

As the transmitter of a transmitting station energises the aerial with an oscillatory current, a field of strain is established in the ether. The strain commences as the current flows in the one direction, charging the aerial to a certain polarity, rising to maximum with this current, and collapses when the current falls to zero on changing its direction. This causes a ripple or wave to be propagated quickly, being followed by others as the above process is repeated.

J. L. B. (Forest Gate).—I have been unable to hear 2 LO on my crystal set, and was wondering whether it is the aerial that is the trouble. It is fastened to a staple in the wall above the highest window at the back of the house, and runs down to a 12-foot pole at the bottom of the garden 30 feet away. It is a double aerial, and well insulated, and the down lead end points away from 2 LO as I have been told it should do.

That is wrong. For best results the down lead end should point towards the direction from which it is desired to receive the strongest signals. In the circumstances the directional effect of your aerial may prevent you receiving this station, unless you can increase the height of the aerial at both ends. The screening effect of the house will not affect you, so that it would appear more important to add a few feet to the lower and free end.

"AMATEUR" (Brondesbury).—I have been told that my condenser is of too great a capacity to use for short wave-lengths. It has 21 moving vanes and 22 fixed, both about 4 inches in diameter. My coils is 200 turns of 24-gauge wire on a cardboard tube 4 inches in diameter with a slide. If this is the case, can I reduce the capacity of the condenser by taking off some of the plates?

Yes, that is the trouble, no doubt. You can overcome that difficulty by removing at least half or even more of the vanes. The best method of doing this is to remove alternate vanes on each set, filling up the washer space with washers the thickness of the metal used for the vanes. This will have the same effect as of taking them all from the one end, and allow the instrument to retain much of its appearance.

## ELECTRADIX RADIOS.

**Immediate Delivery  
from our Huge Stocks.**

Everything from a Recorder to an Earth Clip.

The best-equipped City depot.

COME AND SEE US.

9, Colonial Avenue is first opening on left in the Minories, near Aldgate Station, Metropolitan Railway.

**LESLIE DIXON & CO.** Tel.: Avenue 4166.  
9, Colonial Avenue, London, E.1.

## TO THE TRADE.

The firm of ASTON & MANDER was established 1789 and has been making Scientific Instruments for over 133 years.

We are now making all form of Wireless Accessories and Parts. Can we quote you for your Designs and Apparatus in Metal, Wood, Ebonite, etc.?

ASTON & MANDER LTD., ALBANY WORKS, WILESDEEN, N.W.10.

**ACCUMULATORS, etc.** New & Guaranteed  
4-Volt, 25-Amp. Celluloid 11/3d. Postage 1/-.  
4-Volt, 40-Amp. 17/6d. 6-Volt, 40-Amp. 25/6d.  
4 " 60 " 21/3d. 6 " 60 " 31/-  
4 " 80 " 27/- 6 " 80 " 36/-  
Packing 1/6d. extra. Packing 2/- extra.  
7/22 Aerial, 6/- 100 ft.; Mullard Ora Valves, 15/-;  
15-V. Siemens, H.T. Batteries, 4/-; Marconi R. Valves, 26/6d.; Accumulator Charging Board, 37/6d.; Voltmeters, Watch pattern, 0/12 Volts, 6/-.  
Cash with order. Goods despatched per return.  
**LOWKE & SONS, Ltd., Northampton.**

**STEVENS COUNTERPOISE BARTH BOX & CABLE OUTFIT.** Send cash 5/6 (includes postage in U.K.). ENSURES BEST RESULTS WHEN INSTALLED. Instructions supplied. Length of cable 30 ft. Additional 10 ft. lengths, 1/- each.—A. H. STEVENS, 12, Shrubbery Rd., London, S.W.16. 'Phone Streatham 1816

## A WIRELESS BROADCAST.

34-in. Centre Bench Lathe, 12 in. between centres, 1-in. mandrel (hollow), 1/2-in. whitt. nose, No. 1 Morse centres, tool-rest. A really heavy and substantially built tool. Price £4 5 0. With compound Swivelling Slide Rest, £7 0 0. Foot Motor, 3-speed, heavy, £2 7 6.

For all tools required write to us. Stamp. "ECHO" Tool Specialists, Albert Works; Westow Hill, Upper Norwood, S.E. 19.

## VALVE PANELS 15/-

Ready wired panels with Filament Rheostat, Valve holder, Reactance and Grid Condensers, Grid Leak and all necessary terminals. Splendid Signals. 15/6 post free. Special terms to trade.

A. W. PARKES, 1, Dale Street, SMETHWICK.

## TO THE TRADE.

**Ebonite—Copper Wire, Bare & Covered—Aerials Sleevings, &c.**

Wireless Supplies. Prompt Delivery.

Cables & Electrical Supplies, Mica House, Offord St., Caledonian Rd., London, N.1. Telephone: North 805

## HERE'S REAL RADIO SERVICE!

OUR AIM—IMMEDIATE DELIVERY. QUALITY HIGH. PRICES LOW.

AERIAL WIRE, 7/22, stranded copper	3/6 per 103 ft.
REEL INSULATORS	2d. each
Wound 12 by 4 in. coil, with 24 Enamelled Wire	3/6
1 in. sq. BRASS RODS, 13 in. length	6d. each
SLIDERS (best turned Ebonite)	9d.
CRYSTAL DETECTORS, mounted on Ebonite base	4/6
CONDENSER VANES, Aluminium, cut true to 11,000th	9d. per doz.
SPACING WASHERS: Small, 3d. per doz.; Large	5d.
EBONITE KNOBS, best turned Ebonite	6d. each
IVORINE SCALES, 0-130	9d.
IVORINE TABS, Earth, Aerial Phones, H.T., L.T., Reactance	2d.
BLOCKING CONDENSERS	2/6
VALVE-HOLDERS, A type	10d.
VALVE-HOLDERS, better types	1/6, 1/9, 2/3 each
CONTACT STUDS	8d. per doz.
VALVE LEGS, set of four, with nuts	6d.
ENAMEL WIRE, 24 gauge	2/6 per lb.
DOUBLE HEADPHONES, 4,000 ohms	25/- per pair

Large Stocks of Enamel, Cotton, and Silk-covered Wires. For further enquiries and prices, give us a ring, or write. TO SAVE DELAY WHEN ORDERING, PLEASE ENCLOSE POSTAGE.

**Waterloo Electric Co.,** Electrical and Wireless Engineers,  
129, WATERLOO RD., LONDON, S.E.1  
TRADE SUPPLIED. Telephone: Hop 5619.

# The "PARLIPHONE" LOUD SPEAKER

(Prov. Patent No. 21,967)

**ECONOMICAL :: NO METAL USED IN ITS  
CONSTRUCTION :: EQUAL IN EFFICIENCY TO  
THOSE THREE TIMES THE PRICE.**

This Loud Speaker comprises horn and stand moulded in one solid piece of Ebonite. It contains no receiver, but the interior is screwed and made to receive a Brown's Patent Standard Receiver. In this way, by simply unscrewing one ear-piece from the existing Headphones and inserting it in the "Parliphone," an efficient Loud Speaker is obtained at a small cost. The remaining ear-piece can still be utilised for tuning in the ordinary way.

As no metal is used in its construction, the objectionable metallic "ring" so common to most Loud Speakers is entirely obviated, the result being a rich, mellow note without the slightest distortion.

ORDER IMMEDIATELY IF EARLY DELIVERY IS DESIRED.

**BROWN'S STANDARD PATTERN RECEIVERS, 60 ohms, 15/-; 4,000 ohms, £1.**

## 32/6

(Packing and Postage  
1/3 extra.)



## THE CITY ACCUMULATOR CO.,

Phone: Avenue 91 (3 lines).  
Agents—

**79, Mark Lane, London, E.C.3.**

Telegrams:  
"TYCHE, FEN, LONDON."

London: A. W. GAMAGE, LTD., Holborn, E.C. SELFRIDGE & Co., LTD., Oxford Street, W. RICHFORD & Co., 153, Fleet Street, E.C.3.  
Yorks: BARNSELY BRITISH CO-OPERATIVE SOCIETY, LTD., Barnsley.  
Glos: BRISTOL WIRELESS Co., 52, Cotham Hill, Bristol.  
S. Wales: SOUTH WALES WIRELESS INSTALLATIONS Co., LTD., 18, West Bute Street, Cardiff.  
N. Wales, Lancs., Ches., & I.O.M.: THE "ALL BRITISH" WIRELESS MANUFACTURES Co., LTD.,  
70, Central Bldgs., 41, N. John Street, Liverpool.

USE  
**THREE STAR  
ACCUMULATORS**  
and have **THE BEST**

WE SPECIALISE IN ACCUMULATORS FOR WIRELESS SETS.



WRITE FOR OUR LATEST PRICE LIST.  
LIBERAL TERMS TO THE TRADE.

**THREE STAR ACCUMULATORS,  
CROWLAND ROAD, LTD.,**

Phone: TOTTENHAM 2473. **SOUTH TOTTENHAM, LONDON, N.15.**

For they are jolly good Fellows.  
**THE "FELLOCRYST"**  
(REGISTERED)  
**WIRELESS  
CRYSTAL RECEIVING SETS.**  
BRITISH THROUGHOUT.



**COMPLETE (As Illustrated) £3 : 7 : 6**  
with one pair of double headphones—postage 1/6  
**NO BATTERIES REQUIRED.**

The set comprises tuning coil with a wave-length of approx. 300 to 1,500 metres; Silicon Crystal Detector; 4,000 ohms double headphones; 100 ft. coil of 7/22 stranded copper wire; 2 shell insulators, terminals, etc.

Each set tested and guaranteed to receive broadcasting within a range of 15 to 20 miles, and Morse signals from a much longer range.

Extra headphones, complete, 30/- per pair. Postage, 1/-.

**FELLOWS MAGNETO CO., LTD.**  
LONDON, N.W.10.

Telephone:  
Willesden 1560-1.

Telegrams:  
Quixmag, Phone, London.

Visit our Stand, No. 10, All British Wireless Exhibition,  
Horticultural Hall, September 30th to October 7th.

(E.P.S.) 3.



# STERLING - - - No. 1 CRYSTAL W/T RECEIVING SET.



*The Sterling No. 1 Crystal Receiver has been specially designed for use in connection with the Wireless Telephony Broadcasting Scheme, and is suitable for a range of about 25 miles.*

**The set comprises:—**

**1. TUNER.**—This consists of an inductance which can be varied by means of tappings taken to stud switches. Two of these are fitted, one for coarse and the other for fine adjustment. A separate coil is provided which can be plugged into a fitting at the back of the instrument (as illustrated) for reception of time signals, etc., from Eiffel Tower.

**2. DETECTOR.**—This is of the crystal type, requiring no battery, and is designed to give universal adjustment over all parts of the crystal.

The apparatus is mounted on ebonite panel and fitted in polished walnut case.

The equipment includes one pair of No. R1258 DOUBLE HEAD TELEPHONES wound to a total resistance of 2,000 ohms the pair.

**PRICE £7 - 12 - 6**  
IMMEDIATE DELIVERY.

**Sterling Telephone & Electric**

TELEPHONE HOUSE, Co., Ltd.,  
210/212, Tottenham Court Road, London, W.1.  
Telephone No.: 4144 Museum (7 lines). Telegrams: 'Cucumis, Wesdo, London'  
Works: DAGENHAM, ESSEX.

BRANCHES: NEWCASTLE-ON-TYNE: 9, Clavering Place.  
CARDIFF: 8, Park Place.

Visit our Stand, No. 34, All-British Wireless Exhibition, Horticultural Hall, Westminster, S.W.1, September 30th to October 7th.

# Crystor COWL INSULATORS

(PROV. PATENT)

**100% PROTECTION  
AGAINST SURFACE LEAKAGE**

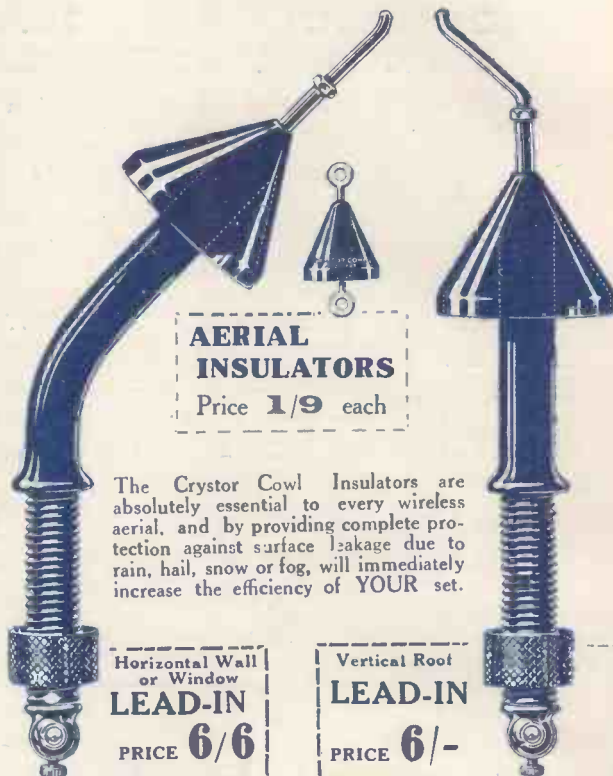

**AERIAL  
INSULATORS**  
Price 1/9 each

The Crystor Cowl Insulators are absolutely essential to every wireless aerial, and by providing complete protection against surface leakage due to rain, hail, snow or fog, will immediately increase the efficiency of YOUR set.

Horizontal Wall  
or Window  
**LEAD-IN**  
PRICE 6/6

Vertical Roof  
**LEAD-IN**  
PRICE 6/-

**IT IS TO YOUR INTEREST  
AND FUTURE SATISFACTION  
TO INSIST ON CRYSTOR  
COWL INSULATORS BEING  
FITTED TO YOUR AERIAL**

# THE Crystophone

Type 20 T.T.

Prices ranging  
from £2 - 10 - 0 to 85 gns.

Catalogue and full particulars  
on application to:—

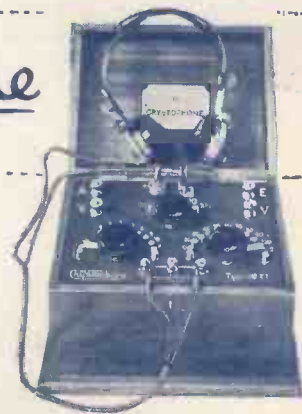

**THE WIRELESS SUPPLIES CO.,**  
64, Mortimer Street, London, W.1.

'Phone: Museum 2672. 'Grams: " Adragonax, Wesdo, London. "

All Applications for Advertisement Space in POPULAR WIRELESS to be made to JOHN H. LILE, Ltd (Sole Agents), 4, Ludgate Circus, London, E.C.4. Phone: 10806 Central.



No. 18.—ENLARGED ALL-BRITISH EXHIBITION NUMBER.

# POPULAR WIRELESS

3d

## Weekly

No. 18. Vol. 1.  
Sept. 30, 1922.

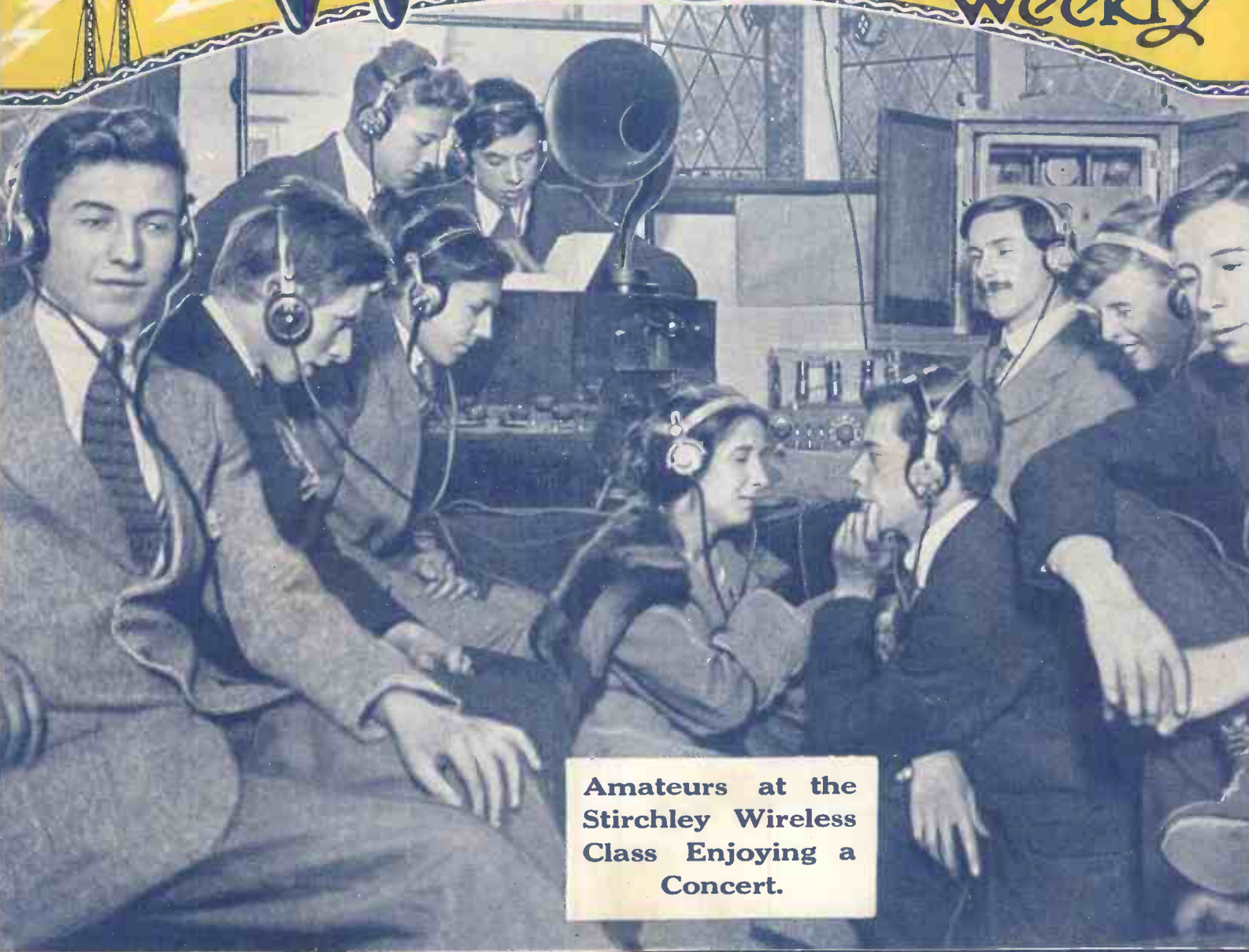

Amateurs at the  
Stirchley Wireless  
Class Enjoying a  
Concert.

A COMPLETE REVIEW OF ALL EXHIBITS.  
SPECIAL SUPPLEMENT AND USUAL FEATURES.





*We're twenty-one to day*  
and remain at twenty-one  
from **SEPT. 30<sup>TH</sup>** until **OCT. 7<sup>TH</sup>**.

The All British Wireless Exhibition gives you the opportunity of making our personal acquaintance. Fully Qualified Assistants will be in charge of our exhibits, and information will be given with pleasure.

**ALL  
BRITISH  
WIRELESS  
EXHIBITION**

MITCHELL'S  
ELECTRICAL &  
WIRELESS, Ltd.,  
ARE EXHIBITING  
AT  
**STAND  
21**

**AMONG OUR EXHIBITS YOU WILL SEE**

- ☐ "TELECEPTA" (Regd.) RECEIVING SETS.  
THESE HAVE BEEN DESIGNED EXPRESSLY FOR BROADCASTING RECEPTION. THEY ARE CRYSTAL SETS MADE IN TWO SIZES, No. 1 with single earpiece Receiver, and No. 2 with "Mitchellphone" double headgear receivers. ALL APPARATUS ENCLOSED IN POLISHED MAHOGANY CABINET.
- ☐ HUMAVOX (Regd.) 2 AND 3 VALVE BROADCASTING RECEIVERS IN CABINETS.
- ☐ THE WORLD FAMOUS No. 1 HOME WIRELESS CRYSTAL SET.
- ☐ THE "LOKAP" COIL WINDING MACHINE and complete system of coil mountings. (Several patents pending.)
- ☐ HIGH TENSION GENERATORS—MOTOR CONVERTERS AND TRANSFORMERS, Etc., Etc.



**Variable Condensers**  
Of a quality that has made them famous amongst every wireless experimenter throughout the country.  
No. M.W.2.  
Capacity to .00036 mids.  
Each 17 6 post free.  
Not exact to illustration  
M.W.2a capacity to .0005 mfd. Each 22 6 post free.

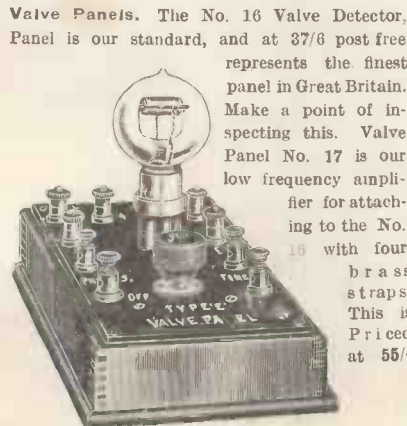

**Valve Panels.** The No. 16 Valve Detector Panel is our standard, and at 37/6 post free represents the finest panel in Great Britain. Make a point of inspecting this. Valve Panel No. 17 is our low frequency amplifier for attaching to the No. 16 with four brass straps. This is Priced at 55/-

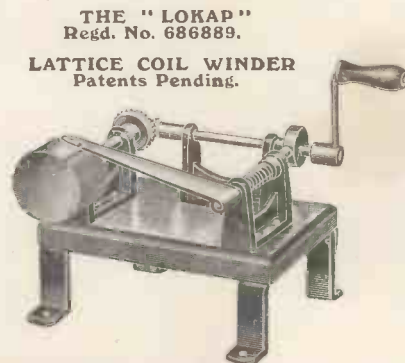

**THE "LOKAP"**  
Regd. No. 686889.  
**LATTICE COIL WINDER**  
Patents Pending.

**GREAT REDUCTIONS**  
in price of  
**MITCHELL PHONES**  
Standard Model  
4,000 ohms.  
OLD PRICE  
35/-  
**NEW PRICE**  
**25/-**  
Post 1/- Extra.

**SIMPLE—WONDERFUL—EFFICIENT—STURDY**  
**BY MAKING YOUR OWN**  
**COILS YOU SAVE MONEY**

The only machine of its kind in the world which effectively enables an Amateur to wind a genuine "LOKAP" Coil in a few seconds. Makes a large range of various diameters and thicknesses. Special pamphlet upon request.

**Temporary City Showroom : 68, BASINGHALL STREET, LONDON, E.C.2.**  
**BIRMINGHAM : M. LAWRENCE & CO., 25, Bright Bldgs., 110, John Bright St.**  
**CARDIFF : R. W. ROBINS & CO., Park Place.**

**MITCHELL'S ELECTRICAL AND WIRELESS, Limited,**  
Retail Stores and Registered Office : **188, Rye Lane, London, S.E.15.**  
Wholesale and Export : **McDERMOTT ROAD, PECKHAM, LONDON, S.E.15.**

**FREE.** A pair of Mitchell's famous Telephones will be forwarded to the writer of the following letter, upon his communicating with us:—

Southfields, S.W.8,  
September 9, 1922.

Mitchell's Electrical & Wireless, Ltd., Peckham, S.E.15.

Dear Sirs,—Having purchased a pair of your Wireless Headphones, I am writing to you to express my entire satisfaction. I have tried some of the best makes, including \_\_\_\_\_ 8,000 ohms, and find that Mitchell-Phones are equal in every way, if not better. I have recommended you to my friends, who are not very pleased with their present phones; but I am sure they will be with Mitchell's. I am sure no one could do better than trade with you to get the best value for their money.—Yours faithfully,  
R. H. C.

**ANOTHER PRESENTATION NEXT WEEK**

**SPECIAL ENLARGED ALL-BRITISH EXHIBITION NUMBER.**

SEE SPECIAL SUPPLEMENT FOR DETAILS OF EXHIBITS.

An Invaluable Guide for Amateurs.

# Popular Wireless

TOPICAL NEWS AND NOTES.

**FEATURES IN THIS ISSUE:**

TWO CONSTRUCTIONAL ARTICLES.

A SHORT HISTORY OF WIRELESS.

GLOSSARY OF RADIO TERMS.

CONTROLLING MODELS BY WIRELESS.

**Soviet Wireless.**

A MOSCOW message says that the Central Radio Telephone Station at Moscow has succeeded in communicating quite distinctly with Obdorsk, a town in the arctic region of Western Siberia, a distance of over 1,250 miles.

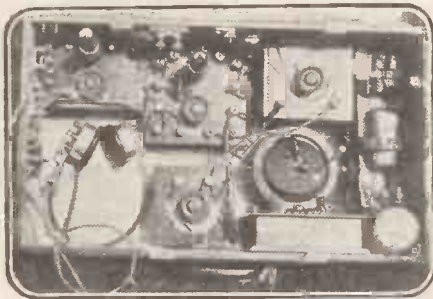

A compact receiver mounted by Mr. C. Linant, 73, Church St. Lane, near Charlton.

**Broadcasting Company Chairman.**

I HEAR, on very good authority, that Lord Gainford has been asked to accept the chairmanship of the Broadcasting Company. Lord Gainford was for some years Postmaster-General.

**Another Giant.**

MARCONI's local representative at Capetown informs Reuter's correspondent that the Government has entered into an agreement with the Marconi's Wireless Telegraph Company for the erection of a high-power station capable of direct communication with the United Kingdom. It will be approximately twice the power of the new Sainte-Assise station near Paris. The agreement is based on the terms announced by General Smuts in the Union House of Assembly on July 19th last, which provided for the formation of a South African company with a capital of £500,000, of which the Marconi Company is prepared to subscribe four-fifths, the remainder to be subscribed in South Africa. The Union Government will nominate one director, and have the right to expropriate the company or renew its licence every ten years. The company undertakes that the station shall be used as an integral part of the Imperial wireless system, priority being given, as far

as is consistent with the efficient working of the station, to communications with other stations of the Imperial wireless system.

**New Zealand Wireless.**

MR. J. G. COATES, the Postmaster-General (New Zealand), has informed Parliament that the Government is considering the establishment of a high-power wireless station.

It has not yet been decided whether New Zealand will have a system directly communicating with Great Britain, or whether it will be a link in the Empire wireless chain.

**The "Daily Mail" Concerts.**

THE "Daily Mail" concerts are liable to be changed from time to time at short notice, and it is not always possible to give particulars in POPULAR WIRELESS. Amateurs are advised to watch the notices appearing in the "Daily Mail," in case of sudden changes in wave-length and times of transmission.

**Coalmine Wireless.**

EXPERIMENTS in a South Staffordshire coalmine, 700 yards deep, have demonstrated that wireless communication in a mine is definitely possible.

This is of immense importance in the event of disaster cutting off large sections of a pit, as entombed men would be able to communicate their exact position to rescuers, thus saving valuable time and minimising loss of life.

**Sainte Assise.**

FROM the new high-power station at Sainte Assise, near Paris, which was opened recently, five or six messages can be despatched simultaneously, at an average rate of 100 words per minute per message.

Thus it is computed that Sainte-Assise can send 36,000 words an hour, or approaching 1,000,000 words per day.

This station, which will in future carry on wireless communication between France and America, is worked from Paris by means of six receiving centres in the suburbs.

In addition, direct communication has already been established with the Argentine and China.

**Hard on Amateurs.**

MR. KELLAWAY will have to face some sharp criticism on the arrangements for wireless telephony. He has just received a protest from the Wireless and Experimental Association on behalf of amateurs against the prohibition which it is asserted the Post Office intends to issue against amateur constructed receiving apparatus. Quite a large number of small manufacturers in London are also at work on receiving sets, and they are greatly alarmed by the prospects of a monopoly by the Broadcasting Combine being set up. Captain Wedgwood Benn's appeal on these lines before the adjournment had no effect upon Mr. Kellaway. Feeling is now growing so strong that there is certain to be a big movement for Parliamentary action when [the House of Commons resumes in November.

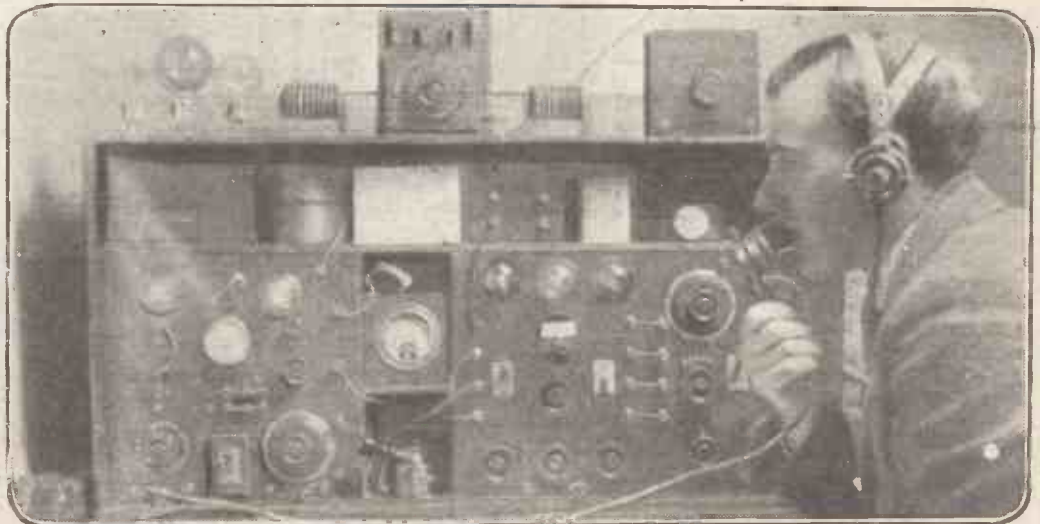

Mr. C. Miller (2 M G), of Arndene, Beavesden, near Glasgow, at his transmitting set.



## NEWS AND NOTES.

(Continued.)

## Membership Rights.

I HEAR that membership of the Broadcasting Company will not, of itself, entitle a member to use the patents of other members in the manufacture of receiving apparatus.

In particular the Marconi Company claim to hold patents which are necessary for the construction and use of valve receiving sets.

\* \* \*

## F L Experiments.

EXPERIMENTS made at the Eiffel Tower station are reported to have shown, the "Engineer" states, that the efficiency of the musical spark transmission is 47 per cent. and that of the Poulsen arc system 29 per cent. If, however, the Poulsen arc is employed with no compensating wave, its efficiency rises to 45 per cent. At the station of La Doua, near Lyons, experiments were made in order to establish the cost of transmission with the

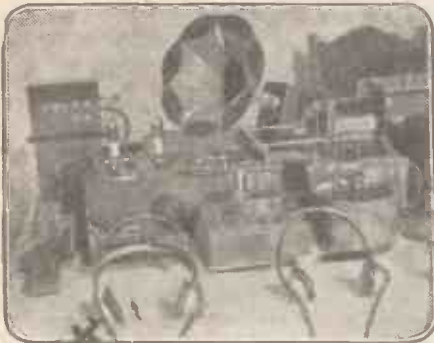

Mr. C. H. Johnson's set at 14, Benyon Road, London, N.1.

Poulsen arc and with the high-frequency alternator. The latter apparatus appears to be much more economical than the former, the alternator requiring only about 54 per cent. of the energy required by the arc. The care required by both types of apparatus, the accidents in their working, and the sundry expenses have been minutely analysed, and the result appears to be favourable to the use of the high-frequency alternator.

\* \* \*

## Amateur Licences.

THE Postmaster-General has decided temporarily to suspend the issue of licences for the reception of wireless telegraphy and telephony, except for experimental work.

This suspension, it is stated, is only until the negotiations now proceeding between the broadcasting companies and the Postmaster-General are completed. Those who already hold such licences will continue to hold them, and any bona fide experimenter from a scientific, as distinct from a mere entertainment, point of view can still have a licence issued to him.

It is pointed out that the receiving licences are issued with certain conditions attached, and it would be rather futile to issue licences at present when those conditions may require modification or alteration almost immediately as a result of an agreement between the companies. Such agreement is expected forthwith, as at the most recent conference it was only some minor difference of opinion that at the last moment led to further delay.

ARIEL.

## THE RADIO ASSOCIATION.

YOUR INTERESTS TO BE PROTECTED.

WE have often emphasised the need of an association to protect the interests of users of wireless sets, as well as manufacturers. Judging by the number of letters which have reached us on the subject, this need is keenly felt on all sides. We are, therefore, delighted to welcome the formation of the Radio Association, which took place recently.

The initiative was taken by a number of prominent persons interested in radio science in general, and wireless telephony broadcasting in particular.

The provisional committee represents all branches of the science. A full list of names will be published in our next issue, as space does not permit including it here.

The Inaugural Meeting of the Association was held at the Hotel Cecil on September 27th, and a large number of people attended, including many amateurs and manufacturers. Full details will shortly be given. The aims of the Radio Association are as follows:

1. To further the development of radio telephony and other forms of radio science.

2 (a). To protect the interests of licence-holders from onerous or restrictive legislation, and to make recommendations to the competent authorities whenever necessary for this purpose.

2 (b). To co-operate with the authorities to secure the utilisation of the facilities afforded in conformity with the needs of the licence-holders.

3. To protect the interests of licence-holders and manufacturers of radio instruments and component parts.

4. To provide expert technical advice for members.

5. To establish a Fellowship of the Radio Association and to elect as Fellows duly qualified members of the Association.

6. To protect members by the provision of expert legal and technical advice on questions of patents, infringements, and licences.

7. To establish relations and to co-operate with kindred associations in this and other countries.

8. To disseminate by means of lectures and publications information regarding all forms of radio science.

9. To act as a bureau and central source of information, and to establish a library dealing with all aspects of radio science.

These aims are wisely framed and very comprehensive, and augur well for the practical utility of the Association.

Readers who desire further particulars and membership forms should write to the Hon. Sec. (pro tem.), Mr. S. Landman, M.A., solicitor, at 9, Southampton Buildings, London, W.C.

We are informed that one of the Association's first tasks will be to protect the amateur from being imposed upon by "quacks." Mr. Landman will be pleased to give advice on the best way of obtaining redress in this question.

The Radio Association should be able to render manifold services to the new British industry, and so far as we are concerned we shall give it our warmest support. POPULAR WIRELESS will be the official organ of this new Association. Full details for application for membership will be given in our next number. In the meantime, we earnestly enjoin all amateurs and manufacturers to apply to Mr. Landman for full details. No amateur and no manufacturer who feels the need of some reliable protection should fail to join the Association.



# Broadcasting Programmes

What you can hear every evening of the week on your set.

Station.	Call Letters.	Wave-length.	Remarks.
Croydon	GED	900 metres	Throughout day to aeroplanes.
Marconi House, London	2LO	360 metres	Between 3 p.m. and 9 p.m. (not regular).
Writtle, England	2MT	400 metres	Tuesdays, 8 p.m. (B.S.T.).
Paris	FL	2,600 metres	Daily, 5 p.m. (B.S.T.)
Königs wusterhausen	LP	2,500 and 4,100 metres	Daily, 7 and 10.30 a.m. (G.M.T.).
The Hague*	PCGG	1,085 metres	Sundays, 2.30, 5.30 and 8 to 9 p.m.; Thursdays, 8 to 9 p.m.
Messrs. Burnham (Blackheath)	2FQ	400 metres	About 9 o'clock any evening.

NOTE.—FL may sometimes be heard at 4 p.m., G.M.T., on usual wave-length, transmitting music. Also, sometimes at 7.45 p.m. G.M.T.

Will all amateurs who send music, etc., regularly, kindly supply details in order that this list may be kept comprehensive? "Listeners-in" are advised that many amateurs transmit every evening between 8 and 10 p.m. on 400 metres. In fact, music and telephony may be heard on 400 metres at all times during the evening.

\* Time of evening transmissions liable to alteration.

# A SHORT HISTORY OF WIRELESS.

**B**ELOW are given a few milestones in the wonderful story of the progress of wireless. There will be no prize offered to the reader who guesses the greatest event for 1922.

- 1883—Thomas A. Edison discovered what is now called the "Edison effect," a phenomenon occurring in a burning incandescent electric bulb, showing that an electric current can be made to pass through space from the burning filament to an adjacent cold metallic plate. While not applied to wireless at this early date, the discovery was later used in developing the thermionic valve, now the very core of wireless communication.
- 1885—Electric signalling through the air without connecting wires was accomplished when an English experimenter stretched two lengths of wire one-quarter of a mile apart and by charging one with a local electric current was able to induce a current in the distant wire.
- 1887—Professor Heinrich Hertz, a German scientist, proved experimentally that electric waves are sent through space with the speed of light by the electric discharge that takes place when a spark is made by an induction coil. These waves have since been called "Hertzian waves."
- 1890—Professor E. Branly, of Paris, developed the coherer, which considerably improved reception.
- 1894—British experimenters bridged a distance of one and one-quarter miles by means of improvements on the original system of 1885.
- 1895—Guglielmo Marconi demonstrated that electric waves can be transmitted through the earth, air or water by means of sparks producing high frequency oscillations.
- 1896—Marconi demonstrated that telegraph signals can be sent and received by means of Hertzian waves up to a distance of three miles.
- 1900—A. F. Collins spanned distances up to eight miles by means of his so-called electro-static system of wireless signalling.
- 1901—Marconi, spurred by his early success, finally succeeded in bridging the Atlantic Ocean, from Poldhu, Cornwall, England, to St. Johns, Newfoundland, by sending the historical series of the letter "S," the distance being 1,800 miles.
- 1902—Professor E. Ruhmer's photophone system of wireless spanned a distance of twenty miles at Kiel, Germany. Wireless telegraphy adopted on large Transatlantic passenger vessels, the test being on the American s.s. Philadelphia.
- Professor J. A. Fleming, of London, England, invented the two element thermionic valve detector for wireless reception.
- 1906—Professor R. A. Fessenden, an American experimenter, developed a high frequency alternator system, having a range of twenty miles. The Telefunken arc system of wireless telegraphy developed and

covers a distance of twenty-five miles.

Dr. Lee de Forest, an American radio expert, improved the Fleming original vacuum valve by inserting the third or control element, known as the grid.

- 1908—Professor Poulsen perfected another arc transmitting system which covered more than 150 miles on first test.

Marconi Transatlantic wireless stations opened to the general public for the transmission and reception of radiograms between Great Britain and Canada.

Professor Marjorana perfected an arc oscillating generator and liquid microphone system and bridged Rome with Sicily, a distance of 300 miles.

- 1911—The wireless telephone covered a range of 350 miles between Nauen, Germany, and Vienna, Austria.
- 1912—The International Radio Telegraphic Conference approved regulations to secure uniformity of practice in wireless services.

E. H. Armstrong, an American, invented the regenerative vacuum tube circuit while experimenting at Columbia University.

- 1913—The powerful radio station at Nauen, Germany, successfully spanned a practical telegraphing distance of 1,550 miles.
- 1914—Laws formulated by foremost maritime nations requiring that vessels of certain sizes and grades carry wireless equipment and operators.

The Marconi Wireless Telegraph Company of America inaugurated a new American trans-ocean wireless service by opening its California-Honolulu circuit.

- 1915—The American Telephone and Telegraph Company, working in conjunction with the Western Electric Company, succeeded in telephoning by wireless from Washington to Paris, a distance of 3,700 miles, and from Washington to Hawaii, a distance of 5,000 miles.
- 1916—President Wilson and Mikado of Japan exchanged wireless messages at opening of newly established trans-Pacific radio service between the United States and Japan.

- 1917—Dr. E. F. W. Alexanderson,

consulting engineer of the General Electric Company, perfected a 200-kilowatt high-frequency alternator, now used almost exclusively in trans-oceanic radio communication.

- 1918—Both radio telegraph and radio telephone copelusively proved their tremendous importance in warfare in the World War.
- 1919—Canada and England linked by wireless telephone for the first time, valve transmitters being used.

The Radio Corporation of America formed, taking over the interests of the Marconi Wireless Telegraph Company of America and the radio activities of the General Electric Company in plans for a world-wide wireless system.

- 1920—The Lafayette station near Bordeaux completed. General wireless progress all over the world.
- 1921—Popular wireless broadcasting begins in America.

Twenty-seven amateur wireless men transmit across the Atlantic from the United States to Ardrossan, Scotland. The power used in the various stations averaged from 50 to 1,000 watts.

- 1922—E. H. Armstrong produced his super-regenerative vacuum tube circuit.

Dr. Irving Langmuir of the General Electric Company produced a 20-kilowatt vacuum tube, the most powerful ever made.

Marconi demonstrates to the world of wireless his radio searchlight, a means of directing radio waves.

Ste. Assise station opened near Paris.

Broadcasting for this country, but long delay.

POPULAR WIRELESS supplies a long-felt want.

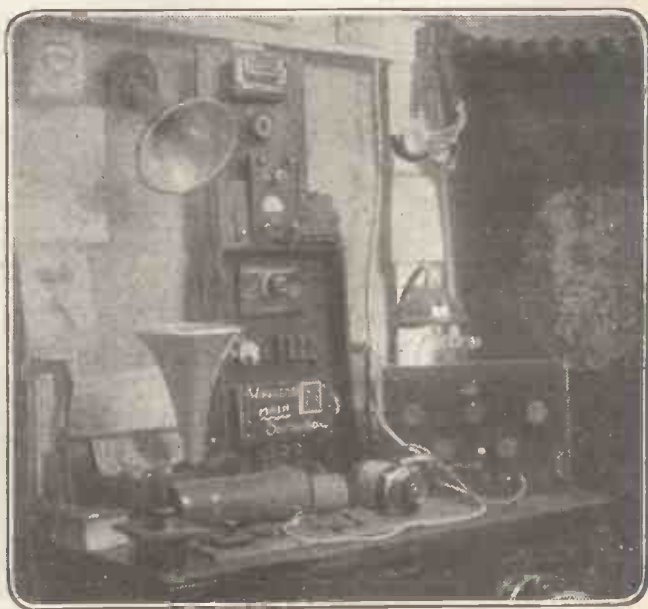

Mr. T. McCallum's set, 11, Avenue Mansions, N. Side, Clapham Common.



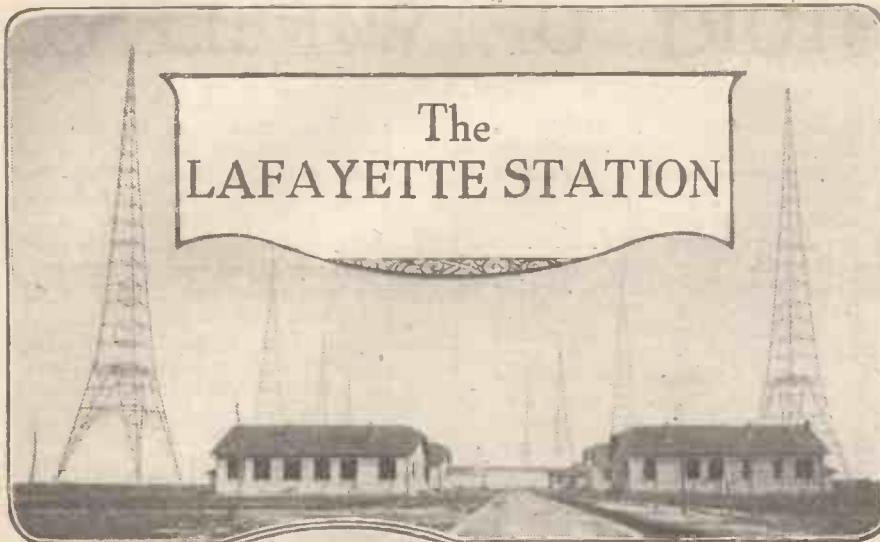

The photograph in the circle shows the method of taking the lead in wires of the aerial into the main station building.

Above is seen a view of the eight steel masts and the station buildings. The main entrance is seen at the far end of the road. Above it is the lead in tower showing the position of the lead in wires from the aerial.

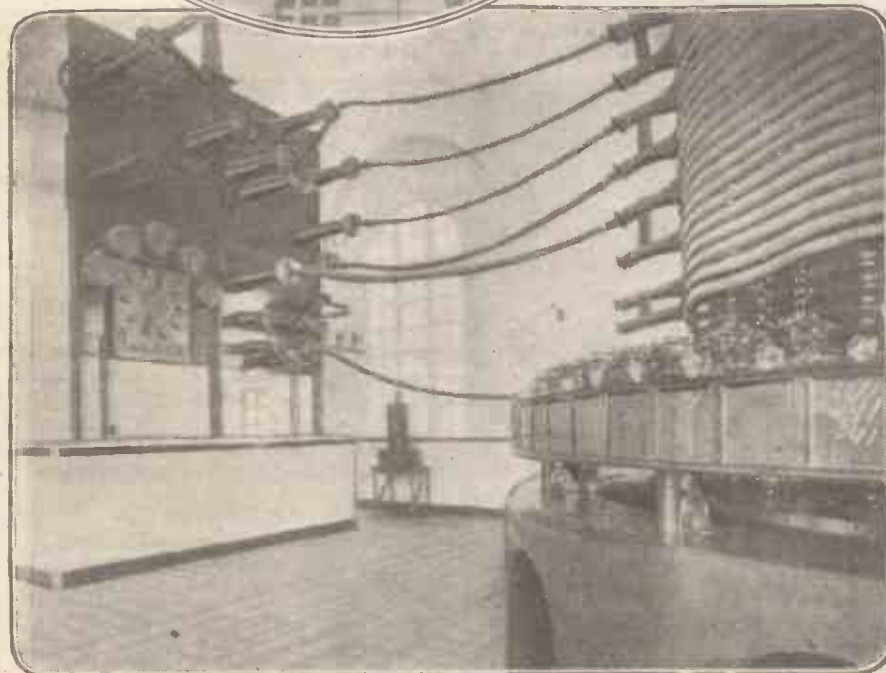

The automatic wave-length changing switch, and part of the Inductance at the Lafayette Station.

ONE of the most powerful stations in the world—the most powerful until the advent of Sainte-Assise—and one which regularly uses the longest wavelength, 23,000 meters, or approximately 14 miles is near Bordeaux, France.

It is the Lafayette Station, built by the United States navy to facilitate America's part in the world war, and since sold to France.

This station, which until recently was unchallenged as the world's most powerful station, sends its messages with ease—and practically instantaneous, of course—over the 4,000 miles of water and land that separate Bordeaux from Washington; and it has been heard occasionally in French Indo-China, 6,000 miles to the East.

Lafayette's title to first place is now challenged by the station recently opened at Sainte-Assise.

The call sign of the Bordeaux station is LY, and amateurs possessing long wave receivers will hear the station working at all times of the day.

#### The "Lead In."

The station was built in record time by American labour soon after the States declared war on Germany.

The huge alternators were supplied by the G.E.C. company of America, and were shipped across the Atlantic, mounted at the station, and enjoyed preliminary tests in a minimum space of time.

The eight steel masts are over 800 feet high. A brief glance at their positions, as shown in the accompanying photographs, will give some idea of the aerial system employed, and the acres of ground taken up by the station buildings, etc.

One of the difficulties experienced at Bordeaux was in designing an efficient "lead in."

The ordinary tube insulator—however thick—was found unsuitable because, when the station commenced transmission, the leakage on the aerial was excessive, and much energy "trickled" away at the lead in.

In the end a special lead in tower was built, as shown in the photograph. The lead in wires were then brought in and so to the automatic aerial switch without having a chance of causing a leakage by coming in contact with a lead in insulator of the ordinary type.

The eight steel masts are also insulated at the base in order to prevent leakage. No matter how big the insulators holding the aerial system to the masts, energy is always lost when transmission takes place, via the steel girders, etc., of the masts.

The Lafayette Station is certainly one of the "giants" of its kind. But the illustrations to this short article will make this point clearer than any printed word.

#### The Earth System.

One or two readers of Popular Wireless have written in asking if "water pipe earths" are used at high-power wireless stations. The answer is—certainly not. At the Lafayette Station the earth system consists of miles of copper wire—and probably tons of copper plates—and formed a most expensive item in the initial cost of the station. L. Y. is a C. W. station and amateurs with crystal sets will not hear her working.

The photo on the right gives some idea of the inductance employed at a high-power wireless station. Note the size of the cable used, and the heavy tbonite insulators.

Below is a photo of one of the 250-kw. alternators, supplied by the G.E.C. Company of America.

A comparison of the two photos at the bottom of the page will give readers of POPULAR WIRELESS some idea of the size of the masts at the Lafayette Station. The "leg" of the masts are heavily insulated from the earth support, which usually consists of a massive concrete platform. The power developed is 250 kw. by each of the larger machines. Valve transmitters are employed—the days of the spark discharge are numbered as far as the high-power stations of the Lafayette type are concerned.

The station is situated at Croix d'Hins, near Bordeaux, and was built by the American Forces in 1918.

L Y—the call sign of the station—transmits on 23,450 metres (C.W.). The station may sometimes be heard working H Z H (Brazzaville) at 7 a.m. (G.M.T.).

L Y also sends Press in English for Turkestan (W.G.G.) at 1.30 p.m. (G.M.T.), and Press in French at 8.30.

Amateurs with valve sets and a long wave range tuner will hear L Y with ease; crystal users will hear nothing, as the station only transmits on the continuous wave system.

Before the American station, Radio Central, was built, the Lafayette station used the longest wave-length in the world.

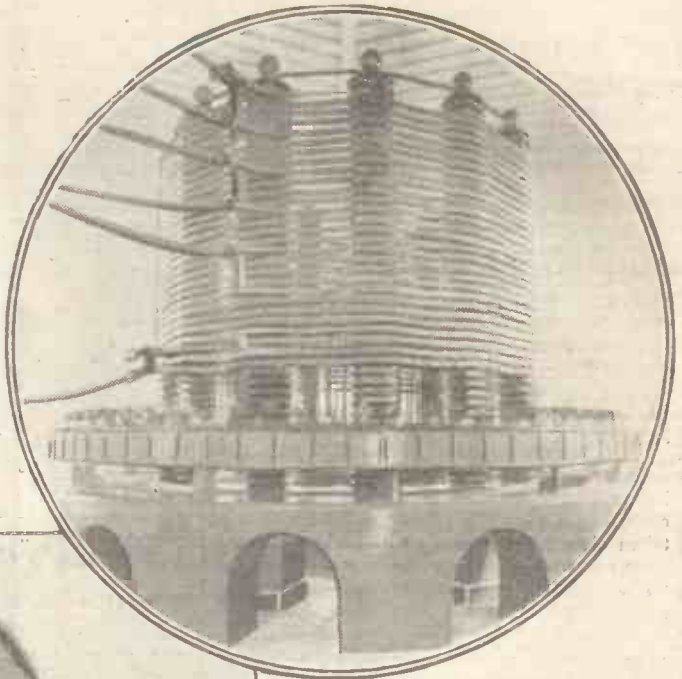

The leads from this massive inductance go to the automatic wave changer.

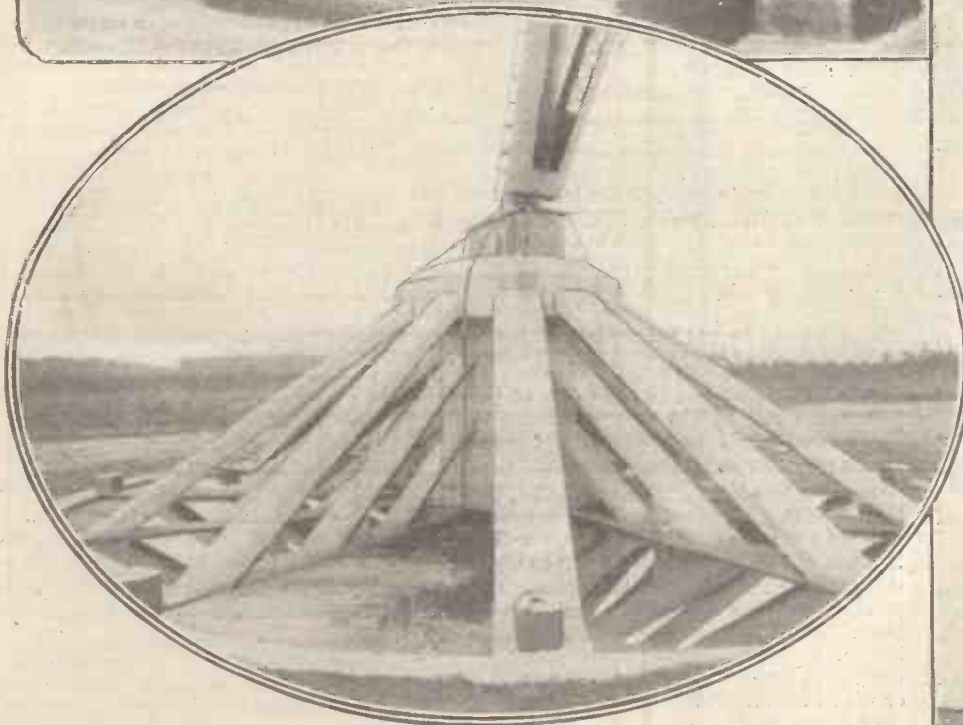
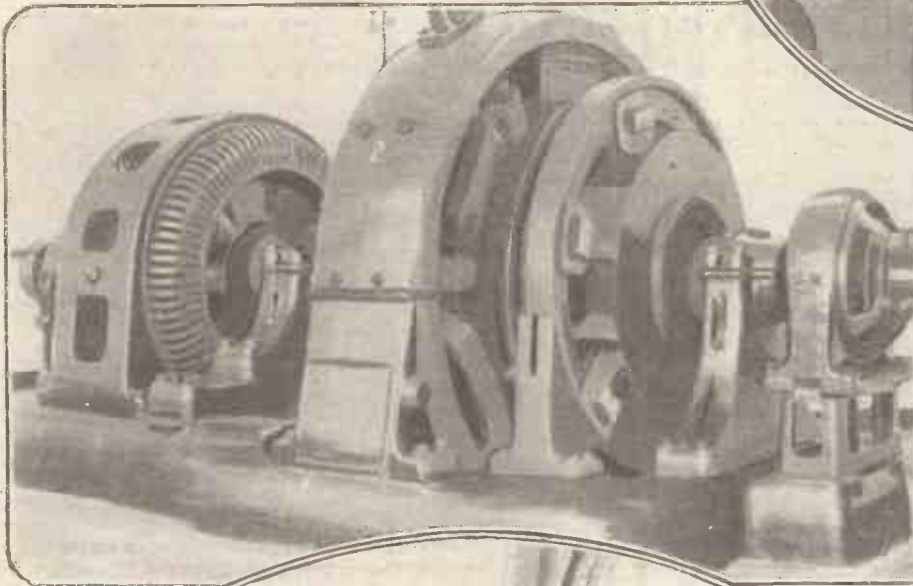

A close up view of one of the leg supports of one of the gigantic steel masts at the Lafayette Station.

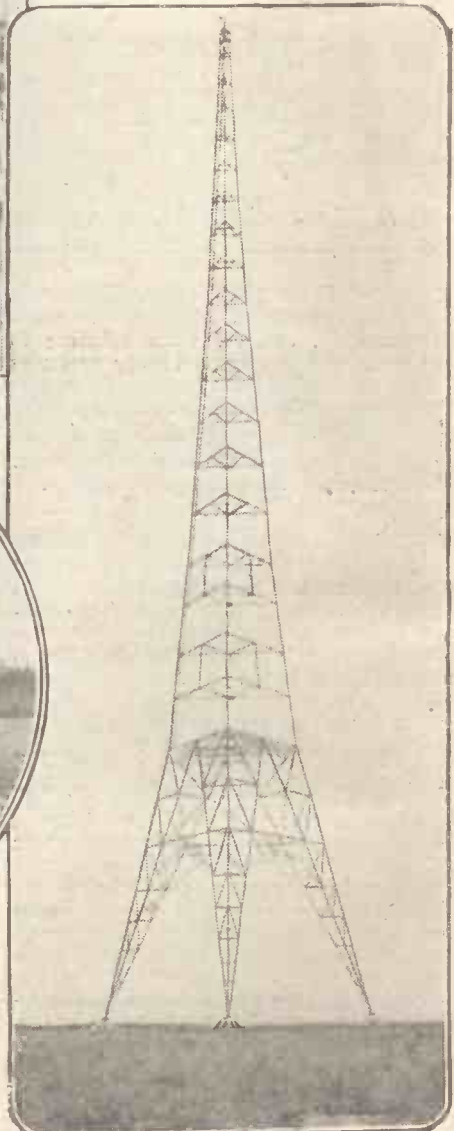

One of the 800-foot masts.



# NEW SERIES FOR BEGINNERS.

By E. BLAKE, A.M.I.E.E.

## PART 11.

**D**ESPITE my previous resolution not to introduce into this series any detailed consideration of inductance and capacity, the numerous questions received relating to these extremely important quantities, show that it will be worth while to try to explain in simple language what is meant by these terms.

### Inductances:

Inductance is not a coil or spiral or wire; it is not wire or material of any kind whatever, but a property possessed by an electrical circuit. Given a unit—and one has been adopted—it is possible to measure the "amount" of this property possessed by a circuit, or, in other words, to measure the

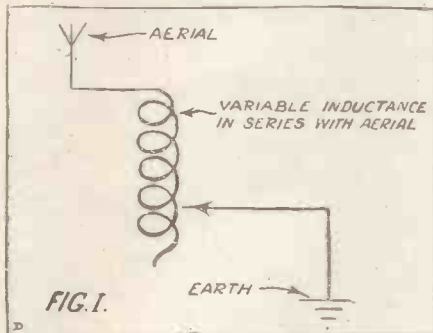

intensity of extent of its effect. Now, when a wire is coiled, its inductance increases considerably, and so, when referring to coils of wire, we often loosely speak of them as "inductances." But please note that a straight wire also has the property of "inductance."

So much for a superficial statement. Now to look at the matter a little closer.

### Inertia.

A forty-gallon barrel has a capacity of forty gallons, whether it is full or empty; its property of being able to contain something depends upon itself only. But a so-called red flower is only red in the light; it has no colour in the dark. In fact, colour depends on wave-length, and, secondarily, upon our having eyes which are affected in different ways by different wave-lengths, thus producing the various sensations to which we give the names of colours.

If now you grasp the difference between a property of a thing which belongs to that thing unconditionally, and a property of a thing which is manifested only by the action of something else, you will understand what I mean by the statement that an electrical circuit has inductance only when an electric current is associated with it. Or, to put it broadly, the inductance lies really in the current; that is, it may be considered as essentially a property of the electron. But when it is considered as such it is known by another name, relating it more to the electron than to the circuit. That

name is "inertia," which is one of the properties of mass.

### An Everyday Experience:

Inertia is that property of a body which tends to oppose the start of its—the body's—movement, and when the body is moving tends to oppose its stoppage, and also any increase or decrease in the velocity at which the body is moving. Common experience bears witness to the fact that when we begin to move a heavy truck from a position of rest we have to exert a considerable amount of force, and the truck attains only gradually its steady speed.

After the inertia has been overcome much less force is required to keep the truck moving, provided, of course, the resistance of the road does not even matters up. Finally, we know also that if while the truck is moving steadily we wish to stop it fairly suddenly, we again have to exert considerable force—in a backward direction—because the truck's inertia tends to keep it moving.

While the truck is moving steadily, too, we find that any attempt to decrease or increase its speed is opposed by inertia.

Very similar statements may be made of the inductance of an electric circuit, for inductance tends to oppose the starting, stopping, or acceleration of an electric current. Compare the following with what appears above relating to the truck. When an electro-motive force is applied to an inductive circuit, the current grows gradually to its full strength.

### Effect on Wave-Length.

When the electro-motive force is removed, the current *gradually* dies away; it continues to flow for a certain time after the E.M.F. is withdrawn. These effects may be regarded as produced by the inertia of a crowd of electrons, which, before they will move must be energised, and, before they will stop, energy must be taken from them.

When you study the matter in detail, you will learn of the machinery by which the opposition to the changes of the current in an inductive circuit is set up; the current which is induced in the turns of the inductance coil by the current flowing in the others, tends to oppose the current which produces it.

In a straight wire, such as an aerial, the inductance is distributed evenly—one reason why an open circuit aerial radiates well—but has not nearly so high a value as when a part of the wire is wound in a spiral. Depending upon its length, the straight wire has a "fundamental" or "natural" wave-length, a description which is applied to that wave-length to which it best responds or with which it is in sympathy.

But an aerial which will tune to one wave-length only, would not be a practical or economical factor in a wireless equipment, and so, by joining to it "in

series" a spiral of wire, associated with a device which enables us to switch in as many tunes of the spiral as we please, we can vary artificially, so to speak, the "wave-length" of the aerial. Fig. 1 shows an aerial circuit with an inductance coil connected "in series" with it.

If an inductance coil is connected "in parallel" with that shown in Fig. 1, the inductance is lowered. See Fig. 2. This method is not commonly employed, and I mention it chiefly to illustrate the "series" and "parallel" connections.

Inductance is one of the two properties an oscillatory circuit which governs the frequency—or, of course, the length—of the waves that circuit will radiate. Capacity, the other property, will be the subject of the next article. The greater the inductance, or the greater the capacity of the circuit, the greater the wave-length and the lower the frequency; or, to speak of the matter precisely, the wave-length of a circuit is directly proportional to the product of the square root of the inductance and the square root of the capacity. These are fundamental facts which you should thoroughly grasp.

### The Henry:

It is natural that you should inquire, after reading "the square root of the inductance," how we can extract the root of a "property of an electrical circuit." I mentioned earlier in this article that a unit of inductance has been adopted, so that we can examine the properties of an inductive circuit in a quantitative way. The unit of inductance is the Henry, named after a famous electrician, and as this unit refers to a very large quantity of inductance, a sub-unit, the micro-henry, or millionth of one henry, is also used.

As an explanation of the derivation of the henry would be out of keeping with a non-technical article I do not propose to give it here, though I hope many readers will

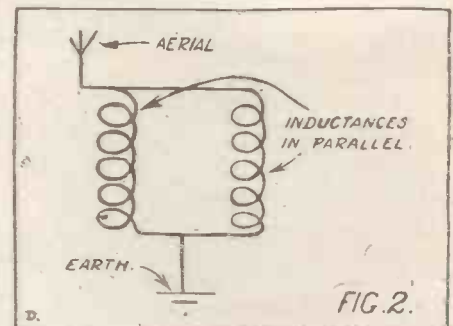

have been stimulated to commence the serious study of electricity as applied to wireless work, and will, therefore, be dissatisfied with these outline articles, and begin to dig at the roots of the wonderful art which forms their subject, for this series is intended to be merely *hors d'œuvre*.

# THE FIRST ELECTRICAL EXHIBITION.

By SIR J. KENNETH D. MACKENZIE, Bart.

## (CONCLUSION)

SO far as I remember, electric bells of every conceivable kind and design formed the majority of the smaller exhibits; but in the telegraph section there was a brave show of instruments as well as submarine cables and all kinds of electric leads and wires.

The Thompson Syphon Recorder was shown in operation, and samples of every kind of electric testing and measuring instrument then known, but no meters, as they did not come into use till about a couple of years later, when the boom in electric light and power supply companies that followed the exhibition necessitated their invention.

Mr. T. A. Edison had some exhibits of electrical "ideas" of various kinds, none of which came to anything, so far as I know. One was an exceedingly delicate "electric-thermoscope," said to be capable of measuring the "heat given out by a star," but whether one of the celestial or theatrical order was meant was not stated! Its principle depended on the expansion of a special compound on which the rays were to be focused, acting on a Thompson mirror galvanometer.

### The First Transformer.

But amongst all the exhibits there was perhaps none possessing greater interest, had we known it then, than that of a M. Lucien Gaulard, which contained the germ of all the alternating current transformer systems now in use throughout the world. My subsequent connection with him probably enables me better than anyone now living to describe what it was, for he has been dead many years.

It was quite a small exhibit shown on a table on the ground floor of the building, and consisted of three or four Ruhmkorf coils of a special construction worked in series off a primary battery, the secondary circuit of each coil actuating one or two Geissler tubes, the object being to show that a primary current could work a number of coils *in series* off each of which a secondary or induced current could be obtained for lighting purposes.

In those days, minute electric glow lamps had not been made, otherwise M. Gaulard would probably have arranged his exhibit to show them lighted off the secondary circuits instead of using Geissler tubes. He, however, showed diagrams of how he proposed to transmit a high potential alternating current through a number of compound coils *in series*, which he called "générateurs secondaires," the secondary circuits of which would be wound to produce a current of lower voltage capable of lighting a number of glow lamps *in parallel*.

This was the "germ idea" of a transformer, and it struck me so forcibly as "having something in it," that when he showed the principle modified and improved at the Electrical Exhibition held at the old Aquarium in Westminster—I think in the winter of 1883—I joined forces with him and his colleague, Mr. J. Dixon Gibbs, and helped them form "The National Company for the Distribution of Electricity by Secondary Generators, Ltd.," a company which was the pioneer of all transformer systems, though not one of them now follows the principles Gaulard enunciated as being correct.

Perhaps my old friend Colonel R. E. B. Crompton may remember telling me at the time I was several times of an adjective fool for wasting my time with alternating currents, and I fear he had some reason then, for poor Gaulard's system of running lamps *in parallel* off transformers connected *in series* never succeeded, for reasons which are obvious now;

and his "secondary generators" would probably have died a natural death had it not been for Mr. S. de Ferranti's "brain wave" in 1886, when he suggested that they should be connected *in parallel* and not in series, and designed some on that principle, which were first used at the old Grosvenor Gallery electric light supply station in Bond Street the following year.

But the things that we did in those days, and the mistakes that we made, and the money that was wasted thereby—are they not written in the books of the scribes who have recorded all electrical work and progress?

Yes, they were gay and happy days at that old long-forgotten exhibition, when we youngsters made merry over our work, and took our pleasures with both hands as and how we found them; though my recollection is that our "grave and reverend seniors" were not far behind us when after closing time at eleven each night we foregathered for supper at various cafés, of which the old "Café Sylvain" was our principal haunt, and enjoyed ourselves till the early hours before turning in. I fear the "Breetisch" section proved rather a trial to some of the exhibition officials, for one knows how the French gendarme loves to exhibit his authority, and on two occasions I was taken to "le poste," or lock-up, inside the building for failing to respond to the order "Il faut aller au queue, monsieur!" when ordered to do so by the man in charge of la salle des téléphones, who failed to recognise me as one of the équipage, or staff. An appeal at once to M. Cochéry, the kindly old minister before mentioned, caused my immediate release on each occasion; though had he known our nickname for him was "Monsieur Cochonerie," I fear he would have hardly been so prompt in ordering my release!

### Gay Days.

I remember also on one occasion a too-zealous sous-officier, trying to stop me at the head of the main staircase, had rather a nasty tumble, for I "ducked" when he tried to seize me, and, missing his grasp, his impetus caused him to fall forward and roll down to the first landing, much to the amusement of the onlookers!

It was the closing night, however, of the exhibition that put a climax to our mischief

and foolery, though I seem to remember having heard that the last nights of all exhibitions which have run for some months are not noted for being either gloomy or specially sedate. But I do not think that any have excelled in that respect the closing of this one shortly before Christmas, 1881.

### Finis.

Some days previously we, a few of the "Breetisch section," secretly made our plans and arranged that at eleven o'clock precisely on the last night one of the Robey portable engines should give the signal by blowing a blast on its whistle, whereupon immediately afterwards every engine in the building should follow suit, every gas-engine should "back-fire" if possible, every electric bell, hooter or siren should start ringing, that every exhibitor of all nationalities should blow whistles, horns, or anything that would make a noise, and shout at the top of their voices the cry which the French attendants used nightly when the exhibition was closing: "On ferme! On ferme!" to emphasise the fact that it was doing so for the last time.

And they did, for it was simply pandemonium let loose that last night in the Palais de l'Industrie! Though forty years have passed, I can still recall the awful row there was, and the look of utter consternation we saw in the faces of the poor French officials, who, never expecting such a tumult, were completely taken by surprise.

I heard afterwards that the row was heard all over the Place de la Concorde, and that the policemen on duty within hearing had rushed to the exhibition fearing a revolution had broken out.

After the exhibition closed, a trial on a practical scale of incandescent lighting was made for three months at the Grand Opera House; the great chandelier in the auditorium of 650 lights being allotted to the Swan Company, the foyer to the Edison Company, and the stage to the Maxim Company.

But all this is "another story," and has nothing to do directly with the electrical exhibition of 1881, an account of which I have tried to put on record, for from it the commencement of public lighting, wireless, and the electrical industry generally may be dated.



The musical typewriter—a new device for playing the piano by wireless.



# HOW TO MAKE A LOUD SPEAKER.

THE chief part of a loud speaker is the telephone, for, whatever its name might imply, the ordinary loud speaker is only a single receiver ear-piece, with a horn of some sort mounted on it. It requires two valves at least to obtain a reasonable volume of sound unless the amateur enjoys the questionable good fortune of being in

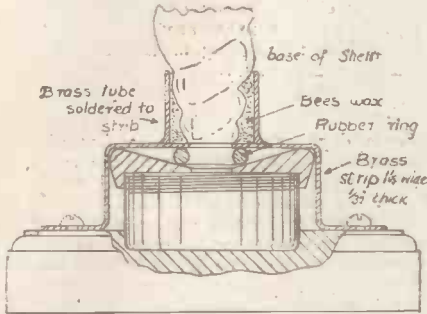

close proximity to a transmitting station. A single 4,000-ohm receiver would do admirably, but if 1,000 ohms or less is used it would be advisable to have a telephone transformer. Very good single low-resistance receivers can be obtained without difficulty. The receiver shown in the photograph is a Western Electric 150-ohm in ebonite case. It was minus the diaphragm, and the writer obtained it for 4s. 6d.

The base is made of mahogany and a shallow hole turned in the middle to keep the body of the receiver in place. The horn, as will be seen from the photograph, is a large sea shell, which answers admirably. A piece of 3/4-inch brass strip, 1 1/2 inches wide, is bent to the shape given in the sketch... It just clears the ear-piece, and a rubber ring is clamped



Home-made loud speaker with sea shell for horn.

round the centre hole. A piece of 1/4-inch outside diameter brass tubing is soldered on top of the strip.

The horn was cemented in place with bees-wax. It was propped up in the right position and the hole at the bottom stopped up to prevent the wax entering. It was warmed up and molten wax poured round it and left to cool.

A tin or zinc horn would answer very well. This could be made conical with the top slanting downwards at about 50 degrees, and could be soldered straight on to the brass bridge-piece. No dimensions have been given in the drawings, as these will depend upon the size of the telephone receiver used. A good size of horn would be about 10 inches high and 4 inches diameter.

## TO READERS.

Readers of "Popular Wireless" are invited to send concise details of a "constructional nature to the Editor.

If published in "Popular Wireless," articles will be paid for at our usual rates.

# USEFUL TOOLS TO MAKE.

EVERY amateur soon gets a collection of odds and ends of metal that can be made into quite useful articles in the spare time. Apart from being useful, it enables the amateur to become expert in working up metals, and adds to his stock of useful tools.

One often finds screws that are very difficult to get at in the ordinary way with a straight screwdriver, and with a little trouble a couple of handy tools can very easily be made.

Fig. 1 shows a screwdriver that will hold on to the screw until it has entered its thread. It is made out of a piece of 1/16-inch steel rod. Soften the rod by making it red hot and allowing it to cool off slowly; shape it as in A.

Then cut with a hacksaw two cuts, as at B, then bend the two outer pieces away from the centre very slightly, and the centre piece just a little the other way, when it will then look like C.

The next process is to harden the end so that it becomes springy; to do this get it pretty hot—say a good "red"—and quickly immerse it in oil. This will make it very hard, so you will have to again heat it to reduce the temper.

The best results are obtained by cleaning it with emery-cloth, then heat it gently in a clean gas flame and wait till the steel turns a straw

colour, when you should at once dip it in oil again.

If this is carefully done the three pieces will spring open, if closed by pinching with the fingers. Should it feel too hard, slightly warm it again and cool off in oil till you get quite a springy feeling. The opposite end is so shaped to keep it from turning in its handle.

Fig. 2 shows a screwdriver that will reach most awkward screws. This one is also made out of 1/16-inch steel rod. Soften in the same way and shape like A; next, shape the end like B, and then crank up like C. To harden this tool is a simpler matter; get it to a good "red" heat and immerse it in cold water. This will make it very hard; too hard for use. Clean up with emery-cloth and then hold it in a clean gas flame till the steel turns blue—that will be quite hard enough. Put it in a handle, and it will soon pay for the trouble it has cost you.

Small cold chisels may be easily made from small pieces of steel rod. Silver steel is, of course, the best for this purpose, and it will be found that old steel ramrods may be purchased from the marine store dealers for a few pence which are just the thing. When tempering cold chisels, harden off first and then reduce the temper to blue.

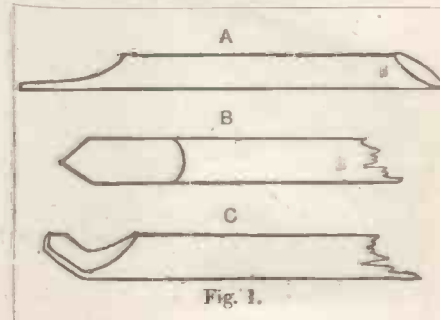
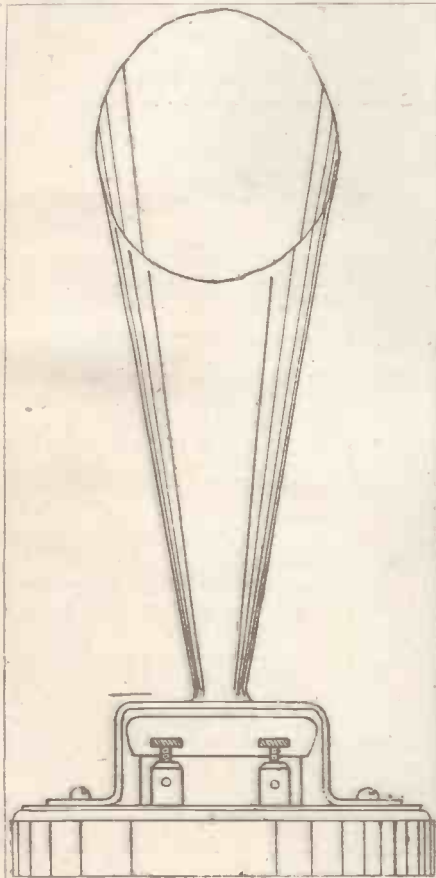

Fig. 1.

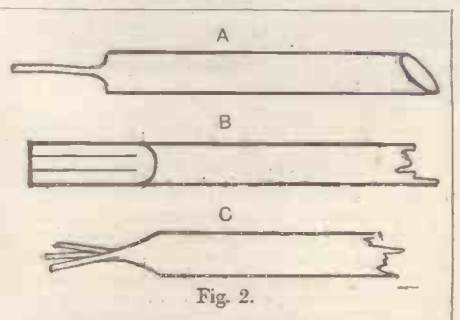
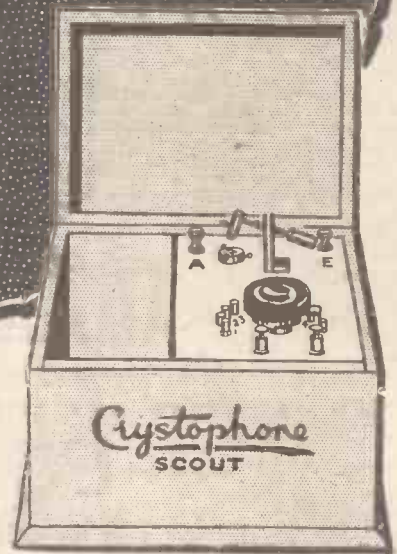

Fig. 2.

FOLLOW THE CROWD  
TO  
**STAND NO. 1.**

AT THE  
**ALL BRITISH  
WIRELESS EXHIBITION  
AND INSPECT  
THE  
Crystophone  
COMPLETE OUTFITS**



It will be to your own interest and future satisfaction to visit our stand before deciding on your wireless outfit

THERE IS A  
CRYSTOPHONE  
FOR EVERY PURSE  
AND PURPOSE

WIRELESS SUPPLIES CO.,  
64, MORTIMER STREET, LONDON, W.1.

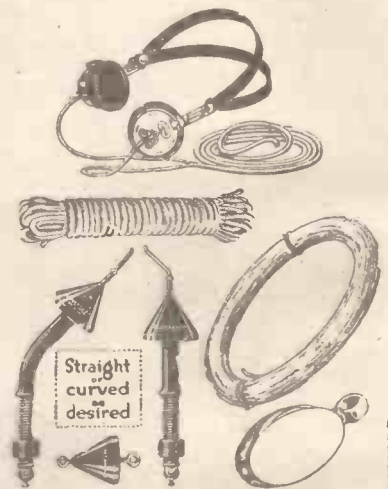

**CALL AND INSPECT  
OUR COMPLETE OUTFITS**

**OUTFIT No. 1.** Crystophone Receiver, Type 20 T.T., Crystor Aerial Outfit, a pair of Sterling Headphones, 4,000 ohms, packed in suitable box **£7 : 12 : 6**

**OUTFIT No. 2.** Crystophone Receiver, Type 21 T.T., Crystor Aerial Outfit, a pair of Sterling Headphones, 4,000 ohms., packed in suitable box **£6 : 15 : 6**

**OUTFIT No. 3.** Crystophone "Scout" Receiver, Crystor Aerial Outfit, a pair of British Headphones, 4,000 ohms., packed in suitable box **£5 : 12 : 6**

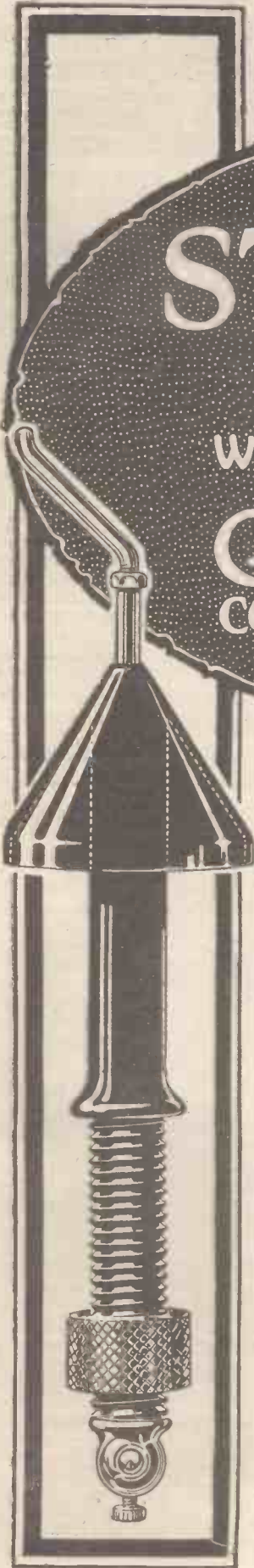

Straight  
curved  
desired



Visit Gamages  
**STAND 31**  
 At the All-British  
 Wireless Exhibition  
 Horticultural Hall, W.1.  
 Sept. 30th to Oct. 7th

# GAMAGES

**WIRELESS APPARATUS OF ADVANCED  
 DESIGN AND GUARANTEED QUALITY**

Every Enthusiast  
 should have a copy  
 of our  
**WIRELESS  
 CATALOGUE**  
 A copy will be sent  
 post free on request.

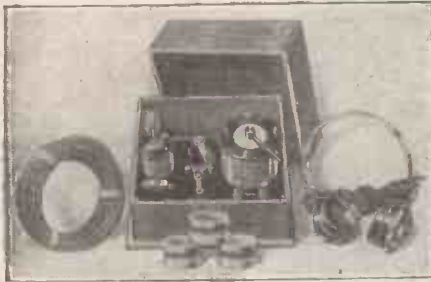

### CRYSTAL RECEIVING SET

Designed to meet the requirements of the Postmaster-General with regard to wave-length. The tuning coil is wound with best quality wire, and is tapped in four places. This, when used in conjunction with the Variable Condenser, which is of the best possible workmanship, gives a good variation of tuning. The crystal detector, designed to prevent dust from deteriorating the sensitivity of the crystal, contains our famous "Permanite" Crystal, which has given such excellent results. The task of finding a sensitive spot on the crystal is minimised by means of a buzzer. Will receive Telephony for 30 miles, and signals from Spark stations using a wave-length of 300-500 metres for 150 to 200 miles. Complete in polished mahogany cabinet, with instruments mounted on polished Ebonite;  
 \*Phones, Aerial Wire, and Insulators ready for use.

PRICE **£5:5s.**

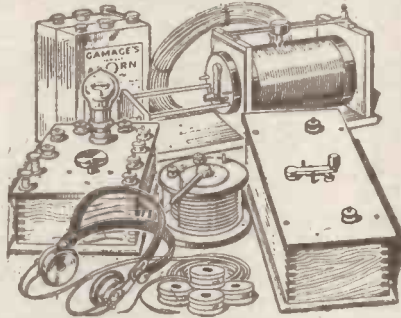

### WIRELESS APPARATUS FOR VALVE RECEPTION

Highly sensitive and selective instruments, so designed that extra valves may be added from time to time for amplification purposes. Consists of a Loose Coupled Tuner, Valve Panel complete 60 v. H.T. battery, 4 x 40 amp. Accumulator. Variable Condenser, 100 ft. Aerial Wire, Aerial Insulators capable of receiving ordinary telegraphy over a distance of 1,000 miles, and telephony, Music, etc., up to 100 miles. An ideal set for the Valve beginner, as all parts can be used in more complicated Circuits.

PRICE **£12: 12: 0**



### "SONUS" MODEL A. COMBINATION

With this set it is possible to obtain really excellent results. The combination employed is, perhaps, the best known of any, namely, 1 High frequency Amplifying, 1 Detecting, and 1 Low frequency Amplifying Valve. Long-distance work becomes a pleasure when this combination is employed, for in the construction of the panels the greatest care has been exercised in the selection of Transformers, etc., so that the familiar "howls" frequently met with may be eliminated as far as possible. The design of these panels is such that either a plain detector, 1 H.F., 1 Detecting—1 Detecting, 1 L.F., or all three together, may be used simply by strapping the panels together by means of brass strips. This set, when complete with H.T. battery, L.T. battery, phones, aerial wire, insulators, etc.,

PRICE **£22:15s.**

First in 1908

**GAMAGES, HOLBORN, LONDON, E.C.1**

Foremost To-day

## ---CQ Std bi for ERICSSON PHONES



WHEN you instal your wireless set—crystal or valve—you'll get maximum results if you fit ERICSSON PHONES—clarity, sensitivity, strength of signals and absence of "click." Specially suited to telephony.

ERICSSON PHONES embody the accumulated experience of telephone manufacture for a generation.

Easy to the head, light and comfortable. The magnets never lose their strength and "shorts" are non-existent.

Write for Particulars

The BRITISH L.M. ERICSSON  
 MANUFACTURING Co., Ltd.

Head Office:  
 60, Lincoln's Inn Fields, E.C.2.

**Ericsson**  
 Telephones



**THE LARGEST SHIP IN THE WORLD**  
 —the White Star Liner "Majestic"—uses Exide batteries for her wireless installation.

No finer testimony to the general reliability of Exides, and their particular suitability for wireless work, could be given.

THE Chloride ELECTRICAL STORAGE  
 COMPANY LIMITED

CLIFTON JUNCTION,  
 Nr. MANCHESTER.

219/229, SHAFTESBURY AVE.,  
 LONDON, W.C.2.

PRICES AND PARTICULARS ON APPLICATION.

# All British EXHIBITION SUPPLEMENT



## INTRODUCTION.

FEW recent occurrences have aroused more universal interest than the progress and diffusion of wireless telegraphy. Improvements have followed in such rapid succession that astonishment is no longer expressed at the wonderful records achieved in long-distance transmission of messages. More marvellous still is the advent of broadcasting, by which music, song, and entertainment is carried into the home from broadcast centres many miles distant. This recent development, because of its popular appeal, has created a widespread demand for authentic information on the subject of wireless.

No more fitting or practical means could be found of dealing with this desire for reliable knowledge than the welcome All-British Wireless Exhibition and Convention to be held at the Horticultural Hall, Vincent Square, Westminster, S.W. 1, from Saturday, September 30th, to Saturday, October 7th, inclusive, from 10 a.m. to 10 p.m. daily. The organisers, Messrs. Bertram Day & Co., Ltd., of 9-10, Charing Cross, S.W. 1, have secured the whole-hearted support of the trade, and this exhibition will undoubtedly be the most representative gathering of wireless interests ever held in this country.

From the public point of view, this exhibition will provide a unique opportunity of obtaining a useful insight into the possibilities of wireless as a means of instruction and recreation. The most recent advances in the transmission of music, song, and speech will be demonstrated, and the exhibits will include a display—in many cases for the first time—of wireless instruments and accessories by over fifty well-known British manufacturers and suppliers. Apart from other considerations, purchasers of wireless apparatus through the post will have an opportunity of direct personal contact with the firms with whom they have been dealing.

In connection with this exhibition a convention is being held under the auspices of the Wireless Society of London. The latter is the official society for the promotion of wireless among amateurs, and has over eighty London and provincial affiliated societies and clubs. This society has arranged a series of daily lectures, with the object of rendering the public all possible assistance in selecting the type of apparatus most suited to their requirements. In addition, information will be given regarding societies and clubs enabling prospective members to get in touch with clubs nearest their own homes.

A special feature of the exhibition will be a demonstration stand erected close to the lounge, where the public can "listen in" to various wireless transmissions, and experience at first hand the pleasure to be derived from the forthcoming official broadcasted programmes.

An excellent orchestra is to be provided,

and the catering will be in the hands of a well-known firm.

It is worthy of note that, with the exception of one or two stands devoted to technical publications, the exhibits will be confined *exclusively to wireless apparatus* or machinery, including such items as coil-winders, etc.

In all respects, arrangements are being made to cater thoroughly for a record number of visitors, and there is every indication that this All-British Wireless Exhibition and Convention will be one of the most interesting, instructive, and popular events of the year.

*The following reports by exhibitors have been sent in at my invitation.* THE EDITOR.

### AUTOMATIC TELEPHONE MANUFACTURING CO., LTD.

Automatic Telephone Manufacturing Company, Limited, of Liverpool and London, are exhibiting a full range of thoroughly practical and exceptionally well-made accessories on Stand No. 52. Among these are A.T.M. Head Telephones which have been designed to meet broadcasting requirements, and therefore will be found unusually efficient on speech reception.

The A.T.M. Co. is also showing their precision made Variable and Vernier Condensers, Fixed Condensers, Intervolve Valve to 'Phone and High-Frequency Transformers, Wavemeters, Buzzers, Coil Holders, Duo-lateral Coils, etc. etc., each of which cannot fail to impress prospective purchasers who wisely prefer quality and workmanship to inferior grade articles at cheaper prices.

They also display a wide range of "Radiak" products manufactured by Ashley Wireless Telephone Co., Ltd., of Liverpool, including highly efficient and extremely handsome wireless receiving apparatus. The "Radiak" 1 to 5-valve unit system will make a great appeal to the discriminating enthusiast on account of its simplicity and the easy way in which it is possible to add a unit at a time similar in the way one would add to a sectional book-case. The "Radiak" 5-valve complete unit will be found attractive because of its easy method of operation and adjustment.

### S. G. BROWN, LTD.

The exhibits of Messrs. S. G. Brown, Ltd. (Stand No. 43), consist of Radio Telephones, Loud Speakers, and Microphone Amplifiers.

There are three types of telephones. First, the Type "A," which, as is well known, is the most sensitive wireless 'phone in the world, and which has the novelty of adjustable magnets. Secondly, the Type "D," a flat disc type of 'phone which is excellent for all-round work and gives remarkably clear articulation. Lastly, the newly devised Type "F" Telephone, which instrument is a cheaper form, and has some novel features in that the case and straps are constructed of aluminium and duralumin, highly polished and with a fine finish, and it has a special form of magnet which gives great efficiency.

The Microphone Amplifier, for which there is at present a very great demand, is of great value when used in conjunction with a Loud Speaker to give increased volume of sound to fill a room.

Two types of Loud Speaker are exhibited, the large Type H.1 and the small H.2. The excellent qualities of these Loud Speakers with the improved curved horns are now well known. Their acoustical qualities are perfect, and their price is moderate.

A special Loud-Speaking Telephone Set is also being exhibited, consisting of a Loud Speaker with a trumpet 7 ft. in length and a special improved Transmitter. These instruments will allow a person to project his voice to a considerable distance, and would enable an orator to address a huge audience in the open air under conditions where his own voice would be almost inaudible. It is considered that this Loud-Speaking Set is the clearest and loudest yet made. The Loud Speaker is approximately eight times more powerful than the "Brown" Type H.1 Loud Speaker.



A handsome cabinet set by Radio Instruments, Ltd.



## EXHIBITION SUPPLEMENT

(Continued)

### CHAMBERS & ELLIS.

The "Esi-Fix" Complete Earthing Set provides a complete outfit designed to protect the user of wireless receiving sets from shocks or damage caused by lightning or static disturbances generally, and at the same time providing the necessary return path to earth in the most efficient manner possible for maximum reception. Its protective capacity is equally effective, whether the set is in use or not.

The outfit comprises a special combined Aerial to Earth change-over Switch, and Lightning Arrester safety spark gap, incorporated in one complete unit mounted on a glazed white porcelain base and correctly wired ready for immediate fixing to window frame or other suitable location.

This unit is well designed, sturdily constructed, and quite effective in operation; compact, neat and unobtrusive in appearance, and easily fixed in a few moments by two small screws.

Set complete as above, packed in neat cardboard box, with full instructions for using, 10s. each. Carriage paid in the British Isles. Full details supplied at our stand at the exhibition.

### HOWARD S. COOKE & CO.

It may interest amateurs who have heard Mr. H. H. Whitfield (call No. 2 L G), of Hall Green, Birmingham, to know that he is commencing business with a new company just formed under the name of Cooke & Whitfield Wireless, Ltd., 24, St. Paul's Buildings, St. Paul's Square, Birmingham. They will deal in complete sets including Marconiophone Instruments, erect Poles and Aerials, Accumulator Charging, and will also manufacture all component parts in connection with wireless apparatus.

Mr. Whitfield, it will be remembered, was one of the amateurs who successfully received the Trans-Atlantic signals with a set constructed by himself. The technical side of the business will be entrusted to Mr. Whitfield.

Mr. H. S. Cooke, of Messrs. Howard S.

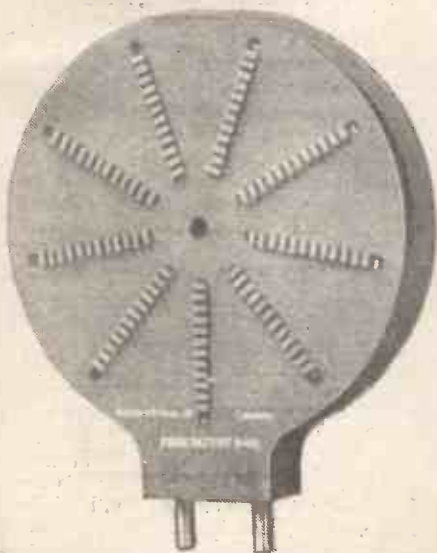

The Gambrell Patent Coil.

Cooke & Co., has been for years manufacturing component parts for wireless instruments, so that the firm will have two practical directors who are fully conversant with all branches of wireless.

### J. A. COOMES & CO., LTD.

An interesting feature at the exhibition of wireless apparatus at the Horticultural Hall will be a new Broadcasting Receiver called "The IONOPHONE."

The IONOPHONE is designed and manufactured by Messrs. J. A. Coomes & Co., Ltd., Manor Park, E. 12, who have recently opened a wireless department at their works, and have added to their directorate several gentlemen well known in wireless circles, who have been engaged in radio research work for many years and who possess unrivalled experience in the design and production of wireless apparatus.

The set contains two Radio-frequency amplifying valves and one Rectifying valve, low resistance phones, H.T. and L.T. Batteries, Aerial Wire, etc., all complete and ready for erection, valves alone excepted.

For the amplification of very weak signals and where specially loud effects are required, as for dances, concerts, etc., a Second Stage Two-Valve Audio-frequency Amplifier is supplied for attachment to the above set.

The range of the instrument enables the user to get The Hague concerts, the Eiffel Tower meteorological reports and Time Signals as well as all the ordinary broadcasting.

Messrs. Coomes also manufacture Radio-frequency, Audio-frequency and Telephone Transformers, Varicometer and a Loud Speaking Telephone Adaptor.

### THE EVER-READY COMPANY (GREAT BRITAIN) LTD.

Having specialised in the manufacture of Dry Cells and Batteries for over twenty years, the Ever Ready Company can claim to be the pioneers of this industry. The Ever Ready Company were the originators of all types of High Tension Dry Batteries for wireless apparatus, and supplied them to the various Government departments during the war.

A complete range of Ever Ready Dry Cells and Batteries for high and low tension current, and also accumulators for valve filament supply and general purposes, can be seen at Stand No. 11, and a list of the standard sizes can be procured on application.

Attention is invited to the Unit Cell method of building up High Tension Batteries, which enables any desired voltage to be obtained on the 1½ volt units, and once a battery has been installed, further cells can be added to increase the voltage, without interfering with the existing battery.

They are of compact proportions, and slightly larger than those generally used in High Tension Batteries, have relatively larger capacity and longer life, and are, in the long run, exceedingly economical, retailing as they do at 7s. 6d. per dozen.

The unlimited flexibility of this method is at once apparent and appreciated by wireless users. The "Unit" cell method possesses the further advantage over high voltage sets, that the condition of individual cells can be ascertained at any time and replacements made only where necessary.



The Stanley Prince "Wireless Wizard" Set.

### GENERAL RADIO CO.

The General Radio Company will exhibit a complete line of radio receiving apparatus of every description, from the small portable crystal set to the multi-valve installations.

An interesting exhibit is a model of their Drawing Room Receiver, which is completely enclosed in a beautifully finished cabinet of period design. It includes a loud speaker and requires no exterior connections whatever. Tuning is accomplished by rotating a single calibrated dial. To operate the apparatus, it is only necessary to press a button which operates automatically control of all five valves, loud speaker, batteries and accumulators.

General Radio Company equipment is of advanced design, and combines efficiency with simplicity of operation. All parts are enclosed and mounted in cabinets. Adjustments are easily made by simply rotating graduated dials, which are clearly marked to indicate their purpose. The entire assembly of each set is secured to the ebonite panel, so that, if desired, it can easily be removed from the cabinet.

### MESSRS. ALFRED GRAHAM & CO.

At our stand, No. 44, are exhibited several new products of this firm, including various forms of the "Amplion" Loud Speaker, which has been designed to give loud, and at the same time harmonious sound reproduction.

Owing to its clear and non-metallic tone, this instrument is especially suitable for musical and vocal effects.

By arrangement with the Marconi Company, two wireless cabinets are shown embodying wireless receiving sets of Marconi manufacture, and also "Algraphone" mechanisms constructed by Messrs. Graham. These are so arranged that the horns on sound amplifiers are employed alternatively either for the reproduction of gramophone records, or for the loud emission of radio-telephone reception, several interesting features being present in these machines.

Inter-valve and Step-down Transformers are in evidence on this stand, as also are the "Graham" improved headgears, which are capable of fine adjustment and are extremely sensitive. Each earpiece in these instruments is adapted to be readily removed from the headband and to be used independently.



**EXHIBITION SUPPLEMENT**

(Continued.)

**THE BRITISH WIRELESS SUPPLY COMPANY, LTD.**

In addition to our usual range of accessories, Britwire Coils, Balanced Condensers, &c., we are exhibiting our new one, two, three, and four-valve receivers, working in conjunction with a tuner using detachable coils.

Also one, two and three-valve note-magnifiers.

Also one, two, three and four-valve broadcasting receivers.

Also a magnificent five-valve receiver with a Chippendale cabinet, the receiving panel being mounted on one side of the cabinet, while the other side consists of a loud speaker built integral with the case.

The panel is of Mahoganite Radion, and the receiver is the last word in a luxurious wireless receiving outfits.

All the above valve apparatus is manufactured under Marconi licence.

**HART ACCUMULATOR CO., LTD.**

The following "Hart" exhibits will be shown on stand No. 17, at the above exhibition.

"Hart" 50-volt "P.L." Type Batteries. Capacity 1.2 ampere-hours.

Special 24-volt "D.P.L." 3-plate Batteries, fitted in specially insulated glass boxes of latest design. Capacity, 2.5 ampere-hours.

Set of 17 Cells (32 volts) for ship type wireless work, as supplied for transmission work. Please ask at our stand to see list of ships so fitted with "Hart" Cells.

Portable batteries in sealed glass boxes of various voltages and capacities, with wood crates and carrying handles. This is a type now greatly in demand. "M.E.U." type "splash-protected" accumulators. These are specially used for portable wireless outfits, voltage 2, 4, or 6. Capacities 10-100 ampere hours. 6-volt portable accumulators in sealed glass boxes, fitted in wood crate, with leather strap handle.

6 and 12-volt "Hart" Motor Starter and Lighting Batteries, as used for replacement on all makes of cars. Capacities 45-123 ampere-hours. 2-volt "A.P. 7" Cells in ebonite boxes, as largely used by the Admiralty. Capacity 11 ampere-hours. Portable Hand-lamps, in cases, fitted with tumbler switch and 4-volt accumulator. Capacity 45 hours light on one charge. 2-volt Inspection Lamp Outfits, fitted with accumulator. In great demand for meter reading work, inspectors, railway officials, electricity, and gas undertakings, etc.

**HARWELL, LTD.**

An interesting exhibit of Messrs. Harwell, Ltd., of 28, John Street, W.C. 1, at Stand No. 5, is a new Replaceable Dry Battery for Wireless Receiving Sets, made by Sema-phore, Ltd., whose sales managers they are. Each Cell has about five times the life of the Standard Battery, and they are made up in units of two cells, i.e., 3 volts nominally.

Each two-cell unit is connected together with a special Brass Coupling (with holes for tapping at any voltage) so no soldering is required. Either six or twelve units are fitted in a neat box, and any quantity of

such boxes can be put together where more than 36 volts are required.

Any two-cell unit can be replaced at a very low cost, if one gives out, which avoids scrapping the whole battery.

A fine range of Volt and Ammeters for Wireless Work is displayed, also many useful terminals, etc.

This firm are showing a Radio-Gramophone which is a combined valve Receiving Set and Gramophone; in a neat cabinet, and is well worth inspection.

**IGRANIC ELECTRIC CO., LTD.**

As might be expected, the Igranic Electric Company's exhibit is concerned mainly with Coils and Coil Winding. They not only have a very interesting collection of their well-known Duo-Lateral or Honeycomb Inductance Coils, manufactured under the De Forest patent, for which the Igranic Company has the sole manufacturing rights, but they also show Slab Inductance Coils wound by the self-forming cross-wind method, and Inter-valve Transformer Coils.

Various types of Coil Holders or Tuners are shown. The one called the Micro-Adjusta is designed for exceptionally fine tuning, and the Triplug, which is lower in price, is suitable for table use or panel mounting.

A new departure is exhibited, called the Gimbal Mounting, in which, in addition to the usual radial movement, the coil is provided with pivots at right angles to its axis, so that it can be rotated about its own pivot. This gives what might be described as a Vernier Adjustment, and has a number of other advantages.

A new design of Honeycomb-wound Variometer is shown as well as one or two types of Inter-valve Transformers.

**GAMBRELL BROS., LTD.**

The Gambrell Patent "Efficiency" Inductances, illustrated here, have been specially designed with a view to reducing self-capacity. It will be seen from the illustration that the construction is extremely novel. The insulating side plates are held at the correct distance from each other by keyed insulating slips which also serve to separate the layers of the coil.

Gambrell's also make a special coilholder for these and other coils in which the coupling can be reduced to an absolute zero, and even to a slight negative value when required.

**THE "K.B." RADIO EQUIPMENT CO.**

Visitors to the exhibition should not fail to make a call at Stand No. 8, where the "K.B." Radio Equipment Company are showing some very interesting Valve Sets and Components. Chief amongst these is the "K.B." unit system, by means of which it is possible to build up a set containing any number of valves from a nucleus single valve set, merely by the addition of extra panels as required.

In addition to every amateur requirement this firm will also be exhibiting a broadcast Receiving Set which has been specially designed for the reception of Broadcast concerts, etc., in Great Britain.

This will be interchangeable with the nucleus set of the unit system, so that any number of valves can be added to give the required signal strength. At the time of going to press, however, detailed particulars are not available, but we have no doubt it will be equal in every way to the present well-known "K.B." Sets and Accessories.

**MARCONI'S WIRELESS TELEGRAPH CO., LTD.**

Marconi's Wireless Telegraph Company, Ltd., will be exhibiting a number of pieces of historical apparatus used in pioneer work during the 25 years of the firm's existence.

As examples of their recent products they will display their latest pattern Wireless Direction Finder as installed at the London Air Port for the Air Ministry, also used by the British-Post Office, and in various foreign aerodromes. This instrument provides a means for determining accurately the plane of received signals and the absolute direction of reception.

The Marconi Company will also show their Aircraft Wireless Telephone combined Transmitter and Receiver, Type A.D.2, as fitted to every regular British commercial aeroplane, and to numerous machines operating in Japan, Siam, China, Newfound-

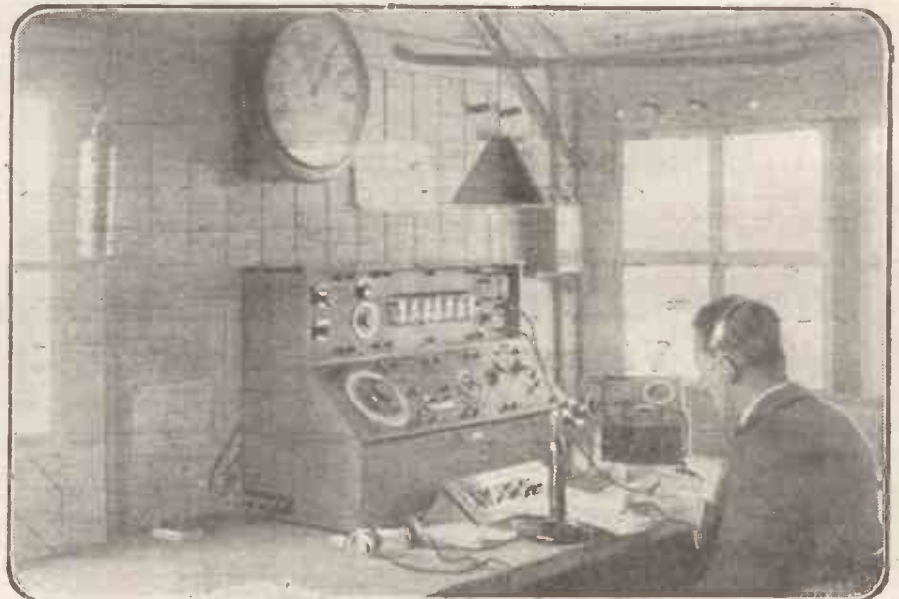

The new Marconi Direction Finder at the Croydon Station.



Stand No. 24, All-British Wireless Exhibition.

# The Marconiphone

All Models of British Manufacture, complying with  
Government Regulations. Ranges Guaranteed.

#### TWO-VALVE MODEL.

Fitted with fine tuning device,  
giving easy and stable adjustment.  
Extraordinary magnification.

#### CRYSTAL MODELS.

Only sets on the market supplied  
with two alternative crystals.  
Neat, compact and inexpensive.

CRYSTAL JUNIOR	£5-15-0
CRYSTAL TYPE "A"	£9-10-0
V. 2 MODEL	£25-0-0

## Simplicity with Efficiency

MARCONI'S WIRELESS TELEGRAPH CO., LTD.

MARCONIPHONE DEPARTMENT,

MARCONI HOUSE, STRAND, LONDON, W.C. 2.

# ANODE

## WIRELESS & SCIENTIFIC INSTRUMENTS LTD.

Contractors to the Post Office Wireless Dept. and other Government Depts.

Laboratories and Factories:  
KING'S RD., ST. PANCRAS

Registered Office:  
265, STRAND, W.C.2

STAND NO.

BE SURE  
AND VISIT

# 2

AT THE

## ALL-BRITISH WIRELESS EXHIBITION

Vincent Square, Westminster, S.W.1

SEPT. 30<sup>TH</sup> TO OCT. 7<sup>TH</sup>

We have 18,000 sq. ft. floor  
space entirely devoted to manu-  
facture of Wireless Instruments

Radio Receiving Sets  
to suit all pockets.  
Trade enquiries invited

## EXHIBITION SUPPLEMENT

(Continued.)

land, Mexico, Brazil, Argentina, South Africa, Chili, Spain, Switzerland, Holland, Belgium, Jugo-Slavia, Greece, Norway, Denmark, Sweden and Italy.

Particular interest will naturally be centred around the Marconiphones, the special instruments designed by the Marconi Company for the reception in the home of broadcast telephony. The popular models include the V.2 (2-valve) Receiver and two Crystal Receivers known as the Crystal A and Crystal Junior.

The V.2 two-valve Marconiphone has been constructed to meet the new Post Office requirements which specify that the receiver must not be capable of radiation. Reaction is not employed, but a throw-back circuit is utilised by means of which additional low frequency magnification is obtained. The set has been so designed that "R" or "Dull Emitter" valves can be fitted, the latter permitting of the operation of the set from dry cells instead of accumulators. The receiver has a guaranteed range of 50 miles from a broadcasting centre on the broadcasting wave-lengths. The price is £25, aerial and fittings being £1 ls. extra.

The Marconi Crystal "A" is fitted with two types of crystals and has provision for two pairs of 'phones. It employs the novel tuning of the V.2 model where the inductance of a fixed coil is varied by means of a copper spade. The price of this model, complete with aerial and fittings, is £9 10s.

The Marconi Crystal Junior has two interchangeable crystals and a single circuit tuning system, but provision for one single car piece head 'phone. The price, complete with aerial and fittings, is £5 15s., or with the double headpiece ear 'phones, £6.

### L. McMICHAEL, LTD.

We are exhibiting at the All-British Wireless Exhibition, where we shall be showing our M. H. 3 products, our 1 valve, 2 valve, 3 valve and 4 valve sets, all being of high class finish and design. A 2 valve amplifier is similarly attractive, and all these are obtainable at competitive prices.

In addition we are showing large stocks of accessories of all kinds, and as we claim to hold the largest stock of ex-government wireless goods in the country, we shall naturally be exhibiting samples of these. We particularly mention the Mark 3 short wave crystal receivers, which are absolutely in brand new and un-issued condition. The wireless experimenter does not need to be told what a beautifully finished and exceedingly efficient crystal-receiver this is. We also have the Mark 3 C. W. receiver, the C. Mark 2 2 valve detector amplifier, which is to be the subject of a special competition for our customers, where prizes will be issued for the best conversion of this particular piece of apparatus.

In addition to those pieces of ex-government apparatus enumerated, we have large stocks of other pieces which are readily convertible into efficient receiving and transmitting gear, the prices ranging in most cases from  $\frac{1}{4}$  or  $\frac{1}{2}$  of the ordinary present-day prices of wireless apparatus.

We shall be showing samples of a special plug unit system whereby sets may be built up from one valve to any number, and we claim that the method of coupling these

together and the various refinements connected therewith place these units far ahead of anything else at present on the market.

We have various types of loud speakers, including Messrs. Brown, Federal, Magnobox, and our own make.

Last, but not least, it is common knowledge that we have purchased a very large consignment of Messrs. S. G. Brown's reconditioned ex-government head telephones, the makers having specially overhauled these head telephones for us. We sell them with the greatest confidence to the public. We have also cheaper ex-government Brown's telephones, which have not been reconditioned by the makers, for those who are not prepared to pay the extra price for a definitely guaranteed article.



Special 'Phone Exhibit by Messrs. Alfred Graham & Co.

### FELLOWS MAGNETO CO., LTD.

We are exhibiting:

1. "THE FELLOCRYST." A simple and reliable Crystal Receiver for all wave-lengths from 300 to 1,500 metres. Complete with one pair of 4,000 ohms. double Headphones, 100 ft. 7-22 stranded copper Aerial, and two Insulators.

2. "FELLOCRYST SUPER." This is a reliable Crystal Receiver with wave-lengths from 300 to 500 metres, with six stud tuning inductance and variable condenser for fine tuning. Mounted in oak cabinet, and highly finished with one pair of 4,000 ohms. double Headphones, 100 ft. 7-22 stranded copper aerial, and two Insulators. (£4 7s. 6d.)

3. "THE FELLOPHONE 2 VALVE RECEIVING CABINET." For all broadcasting, wave-lengths from 300 to 500 metres, in solid oak cabinet, complete with H. T. Battery, 6 volt Accumulator, 4,000 ohms. double Headphones, 100 ft. 7-22 stranded copper Aerial, and two Insulators, but without Valves. (£9.)

4. "THE FELLOPHONE SUPER-FIVE RECEIVING SET." Complete with H. T. Batteries, 6 volt Accumulator, full set of Coils from 250 metres to 3,000 metres, two pairs of Headphones, 100 ft. 7-22 stranded copper Aerial, two Insulators. This set is mounted in a highly finished solid oak cabinet, and the whole is superbly finished. (£50.)

5. "THE FELLOWS HEADPHONE." Standard resistance 4,000 ohms., but also manufactured to order in 120 ohms., and 8,000 ohms. (£1 10s. 0d.)

6. "THE FELLOWS HANDPHONE." This is a single ear-piece with ebonite

handle, admirably suitable for ladies. (£1 1s. 0d.)

7. "THE FELLOWS 2-NOTE MAGNIFIER." For use in conjunction with the "Fellophone" 2 Valve Receiving Cabinet, mounted in oak cabinet, making a complete 4 Valve Receiving Set, complete without Valves. (£5)

### MESSRS. T. H. ISTD.

For a considerable time past, there has been an urgent need for a simple 1 instrument 3 Valve Receiving Station. Messrs. T. H. Isted, Wireless Instrument Manufacturers of Terling, Essex, will have one of these on view at the All-British Exhibition, which they claim to be so simple that a mere child can operate it. The type of instrument is called "The Simplex," and is designed to put on a table in the room round which a number of persons can sit, and listen-in by means of 'phones. It has 1 valve rectifying and 2 L. F. amplifying with filament resistance and .0005 Condenser.

The simplicity claimed for this instrument is, that once it has been calibrated to its Broadcast Station or other stations within its receiving area and a note made of the position of each station on the card supplied with this instrument, all that is needed is to set the Condenser in one action and switch on by another, both actions taking less than five seconds. The instrument is then ready to receive the music, etc., from the particular stations required. By means of the switch with which it is fitted, the whole is switched off by one movement of the switch which cuts off the filament current and aerial, and renders the station safe from lightning, etc. The only parts of the station outside this instrument are the Aerial Unit and L. T. Batteries. This station, with all in, is listed at £17 17s. 0d.

Messrs. Isted have also a similar instrument of a larger type consisting of five valves which will work a loud speaker in a room, by means of which a room full of persons can hear the broadcasting at their ease without the aid of 'phones. This is listed with all in at £50.

### METROPOLITAN-VICKERS ELECTRICAL CO., LTD.

The Metropolitan-Vickers Electrical Co., of Trafford Park, Manchester, exhibit an extremely interesting range of Receiving Sets, which have been specially designed for broadcasting, together with a large model of their research laboratories and wireless station. The term "Cosmos," applied to these instruments, is already familiar to the public in connection with the company's electrical appliances. The sets are extremely attractive in appearance, contain high-class workmanship, and have been designed to give a minimum of difficulty in working. They are self-contained and easily portable. The Crystal Set is listed at £4 10s., including high resistance telephones and the necessary material for the aerial and earth system. The tuner contains no sliding contacts, and two ranges of wavelength are provided. The detector has a specially selected crystal. The range is conservatively estimated at 10 to 15 miles, but reception has been recorded at much longer distances.

The Valve Set is contained in a box similar to the Crystal Set.



## EXHIBITION SUPPLEMENT

(Continued.)

To render the valve set suitable for loud speaking, or to increase the range, a note amplifier has been developed and perfected. This consists essentially of two valves for low-frequency amplification, together with the necessary inter-valve transformers and loud-speaking horn.

Cosmos receiving sets have been approved by the Postmaster-General.

The company is also showing an ingenious mains attachment, by which those having a D.C. supply to their houses can dispense with the use of batteries.

## MITCHELL'S ELECTRICAL AND WIRELESS LTD.

We are specialising in broadcasting receiving sets, and attention is being paid to the fact that they must be very simple to operate and impossible to get out of order, provided that ordinary care is used. In addition, we designed them so that all the apparatus is enclosed in a polished mahogany cabinet when not in use, thus making a tidy piece of furniture for the drawing-room. The first of these sets, the "Telecepta," is a crystal set, and two sizes are made, the smaller with a single receiver and the larger with double headphones.

For greater signal strength or for receiving from long distances, the "Humavox" Valve Sets have been designed on similar lines. At present we stock a standard two-valve set and a standard three-valve set. The only terminals in the sets are the aerial and earth, and those for the high and low



Messrs. Elwell's Aristophone Cabinet.

tension batteries, which are contained in a separate cabinet.

The controls have all been made as simple as possible, so that no skill or technical knowledge is needed to operate the sets.

## PETO SCOTT AND CO.

"Learn to walk before attempting to run," is an excellent motto applicable to wireless enthusiasts. It is safe to say that the man who, commencing with a single-valve set, thoroughly explores its possibilities, gets far more pleasure out of radio than he who commences with a ready built multi-valve set.

To get the best out of a big set requires some considerable experience and patience—an apprenticeship best served on a simple detector circuit. But, you might say, why go to the expense of building or purchasing a single-valve set only to discard some portion of it later?

An effective solution to this problem is found in the standardised unit system. Just as the expandable book-case is "always complete yet never finished," so this idea carried into radio enables the one-valve set capable of expansion to the required sensitivity and power.

In the Peto Scott Unit System, for instance, the size of the panels and the cabinets has been standardised throughout. The man with no experience whatever can begin with the detector and tuner units, and when he has gained confidence and knowledge, can progress by easy stages into the 2, 3, or 4 valve class—according to the length of his purse. At the same time he can be sure that his receiving apparatus is maintained at the utmost efficiency.

These units, we understand, are supplied in complete sets of parts, ready for the amateur to assemble, packed in strong, partitioned boxes, with each component packed in a separate partition. Full instructions are supplied for assembling.

An attractive booklet describing the whole system of home constructed sets has been issued for the exhibition, and a copy will be sent post free to any of our readers on receipt of six penny stamps.

## PETTIGREW &amp; MERRIMAN, LTD.

At the All-British Wireless Exhibition and Convention at the Horticultural Hall, Westminster, S.W.1, we are exhibiting the following apparatus: 1, 2, 3 and 4 Valve Receiving Sets; Crystal Sets with Amplifier; Loud Speakers; Low Frequency Interval Transformers; Anti-capacity Switches; Filament Rheostats; also a complete range of ebonite parts for Wireless.

The following particulars regarding the Federal Transformer may be of interest:

No. 226-W. Transformer is of the shell core type with a 1 to 3 ratio of turns. The D.C. resistance of the primary is approximately 2,200 ohms, secondary approximately 9,150. The impedance at 500 cycles is the same as the internal impedance of the standard receiving tubes. This provides maximum efficiency of operation.

The Flux leakage in the Federal Transformer is at a minimum, consequently the tendency to oscillate at audio frequencies, due to stray fields between circuits in cascade amplification, is reduced to a minimum.

## RADIO COMMUNICATION COMPANY, LTD.

Some very interesting apparatus is being exhibited by the above company. Sets

range from the simplest crystal receiver to the most elaborate outfit, designed to harmonise with furniture of any period. Contrasted with this there is the Junior Crystal Set, a complete outfit ready for immediate installation.

A double circuit tuner is of very novel construction. A number of replaceable inductance coils are provided, each fitted with a direct reading wave scale, which enables the wave-length to which the circuit is tuned to be seen at a glance, and accurate measurements of any incoming waves to be taken. The secondary circuit can be used as a standard wave-meter. The coils are tuned by the Polar square law condenser which has just been placed on the market. The condenser gives a reading such that each graduation produces the same proportional change in the wave-length, an advantage of great value in heterodyne reception when working near the zero point.

A complete unit system is provided, the woodwork of which is covered with the best camera cloth. There are both low-frequency and high-frequency amplifiers. The transformers in the latter type are tuned by square law condensers, and the wave-length indicator is provided as before.

In addition a newly designed half K.W. ship set is shown, which illustrates the progress of the company in the commercial field of wireless. A variety of components complete the exhibit.

## RADIO COMMUNICATION CO., LTD., AND C. F. ELWELL, LTD.

Cabinet aristophones for drawing-room use, having specially designed cabinets which are accurate period reproductions and contain the whole of the wireless apparatus, including batteries and "loud-speakers."

The loud speaker has several novel, important features, being hand-moulded of a special wood fibre compound to proportions which have been scientifically ascertained for the greatest purity of tone, resulting in a shape resembling that of the human ear. The wireless receiver is characterised by extreme simplicity, great care having been taken to give sufficient working with an almost entire absence of adjustments.

One particularly interesting exhibit is a lacquer-work china cupboard and bureau of 1722 into which wireless apparatus characteristic of 1922 has been built.

Standard aristophone cabinets are shown in Cromwellian, Sheraton, lacquer, and Adams styles. (Stand 23).

Various types of special "Polar" receivers and amplifiers for long ranges and various wave-lengths are also shown.

At Stand 45, exhibits which hint at activities outside "broadcasting," are shown on this stand. A complete ship's equipment as fitted by The Radio Communication Co. to a large proportion of the world's mercantile marine can be examined, and an idea may be gained of the dimensions of Elwell land stations by a comparison of some large insulators with those used on aerials for receiving broadcasting. These large masses of porcelain are subjected in use to electrical stresses sufficient to reduce them to a cinder if they are in any way imperfect. Insulators to which this has happened in use are shown.

# ORA

## The Valve for perfect reception

For receiving vocal and instrumental items you must have

### MULLARD ORA Valves

to get the best results.

Oscillates—Rectifies—Amplifies

Specially recommended where good amplification is required,

**15/-** each

### IMPORTANT NOTICE

The great demand for Mullard ORA Valves and other accessories has compelled us to open much larger works. A greatly increased output will be available shortly.

The MULLARD "R" Valve is now reduced in price from 22/6 to 17/6

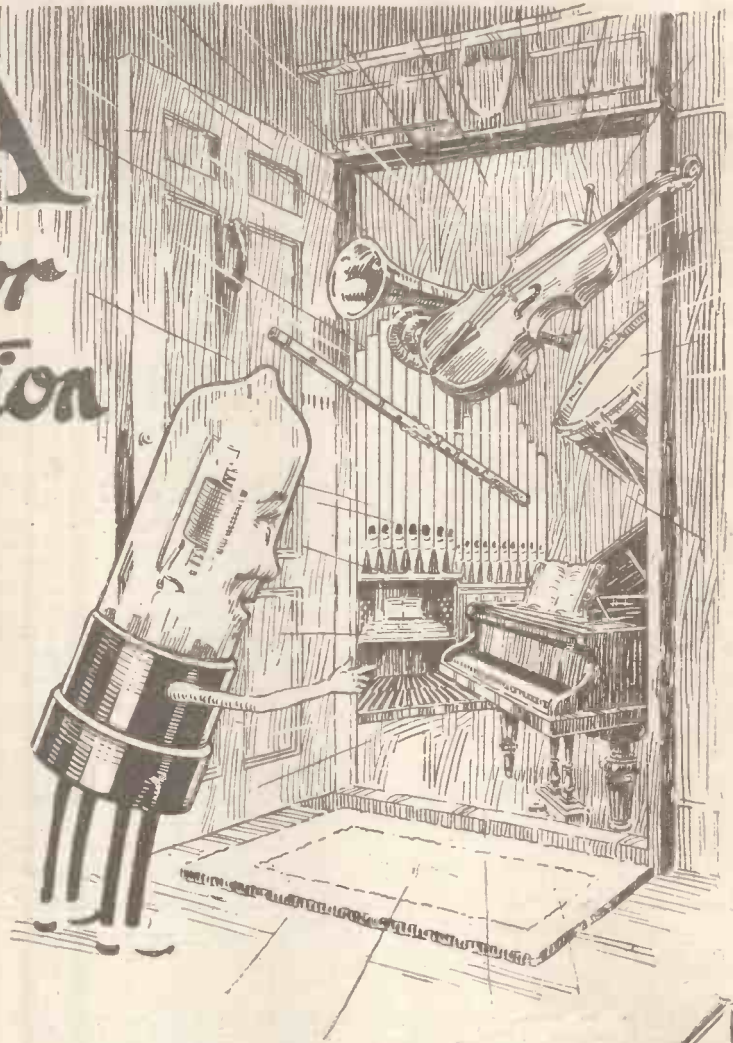

## Mullard Radio Valve Co. Ltd.

Claybrook Road, Hammersmith, W.6.

Contractors to H.M. Admiralty,  
War Office, Royal Air Force & Post Office.

Telephone: Hammersmith 312    Codes: ABC(5Ed)    Telegrams: Radiovalve Hammer Lond.



Name and Address .....  
To the MULLARD RADIO  
VALVE CO., LTD.,  
35, Claybrook Road,  
Hammersmith,  
London, W.6.

Please send me post free.

Quantity	Description	Price
.....	Telephone Head Sets	30/- per set
.....	ORA Valves	15/- each
.....	Grid A Resistances	6/- each
.....	Anode A or B Resistances	6/- each
.....	BA Condensers	2/6 each
.....	Combined Condensers and Resistances	7/6 each
.....	Valve Bases with Terminals	5/- each
.....	Valve Sockets	1/8 each
.....	Terminal Clips	9d. per pair

Name of usual Wireless Dealer .....

I enclose (cheque, Money Order, P.O.) value ..... to cover the cost.

**SEND THIS TO-DAY.**



# WIRELESS "K.B." EQUIPMENT

A Few of the Articles which we shall be exhibiting at the All-British Wireless Exhibition, Horticultural Hall, Sept. 30th—Oct. 7th, on Stand No. 8.

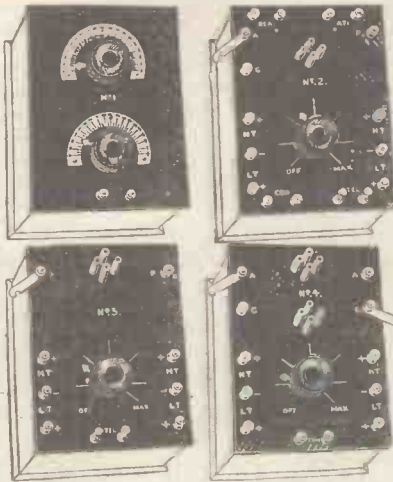

## "K.B." Units

No. 1. Condenser Panel

Price £1-14-0

No. 2. Detector Panel

Price £1-14-6

No. 3. L.F. Amplifying Panel

Price £2-3-6

No. 4. H.F. Amplifying Panel

Price £1-13-6

Parts and Cabinets also Supplied.

Trade Supplied.



## "K.B." GRIDLEAKS.

Silent. (Actual Size.) Constant.

Price 2s. 6d. each.

## Items for the Amateur.

<b>Skeleton Condensers.</b>	<b>Condenser Spindles—cont.</b>
•0001—•0005 mfd. 1/- ea.	Fixed •00005—
•0006—•001 " 1/3 "	•0015 mfd. 3d.—2/- set of 3
•002—•005 " 1/6 "	Ivory Scales - - 8d. ea.
<b>Condenser Vanes.</b>	Switch Stops - - 1/6 doz.
Rotary - - 1/3 doz.	" Studs - - 1/6 "
Fixed - - 1/6 "	Valve Legs - - 2/- "
<b>Condenser Spindles.</b>	Insulators, reel - - 4d. ea.
Rotary •00005—	" shell - - 1/9 "
•0015 mfd. 4d.—2/- ea.	Lead-in Tubes - 2/9—8/- ea.

Illustrated Catalogue, Post Free, 4d.

# THE "K.B." RADIO EQUIPMENT COMPANY,

Head Offices and Showrooms: 109, High Road, Kilburn, N.W.6.

Bus Services—8, 16, 28, and 51 pass door.

3 minutes Kilburn Park Station (Bakerloo Rly).

USE

# THREE STAR ACCUMULATORS

and have **THE BEST**

WE SPECIALISE IN ACCUMULATORS FOR WIRELESS SETS.



WRITE FOR OUR LATEST PRICE LIST.  
LIBERAL TERMS TO THE TRADE.

**THREE STAR ACCUMULATORS, LTD.,**  
CROWLAND ROAD,

Phone: TOTTENHAM 2473. SOUTH TOTTENHAM, LONDON, N.15.

## THE "POPULAR" CRYSTAL SETS.

£3 7 6 Complete with Double-Head 'phones.  
Range—15 to 20 miles.



### DOUBLE-HEAD 'PHONES

4,000 ohms total.  
30/- each Complete.

BEST BRITISH MAKE.



### COIL HOLDER.

2 Way - - 16/-  
3 " - - 22/6



### INTERVALVE TRANSFORMERS

20/- EACH.

The cheapest and best 2-VALVE SET on the market.

OUR PRICES CANNOT BE BEATEN



### 2-VALVE SETS

Complete in solid oak cabinet.  
£9 0 0. With double-head 'phones. Valves extra.



### HONEYCOMB COILS

FROM 5/6 EACH.  
According to Wave-Length.

SEND FOR LIST (P.W.) TO  
**BRITISH CENTRAL ELECTRIC Co., Ltd.,**  
6 and 8, ROSEBERY AVENUE, LONDON, E.C.1.

Telephone — Holborn 5848.

"PROMPT DELIVERIES FOR EVERYTHING WIRELESS."

## EXHIBITION SUPPLEMENT

(Continued.)

A type of receiver which is becoming very popular is the panel-type aristophone, in which all the advantages of the aristophone are obtained without costly cabinet work, and which may, moreover, be purchased in several units as required. The first unit being a complete crystal receiver and subsequent panels adding valve amplification. These panels are of high grade design and finish and are not a mass production. Panels for a large number of purposes are standardised.

The aristophone loud speaker is shown in a separate mahogany case for drawing-room use with aristophone panels.

To those who prefer greater scope for trying alternative methods of connection, and who wish to construct their own sets without going into an unnecessary amount of bench work, the "Radiocraft" exhibits will appeal.

Particularly deserving of attention are the Elwell amplifying unit, bull-dog grip fittings for telephone cords; plugs and jacks specially designed for wireless purposes; an adaptor for making use of a gramophone as a loud-speaker; an air-space coil, and a beautifully moulded ball for variable couplings.

### RADIO PRESS LTD.

Radio Press, Limited, has as its aim and object the production of reliable literature both for the beginner and the expert, on the subject of wireless in all its many branches.

It is felt that with the ever-widening interest which is being taken in the subject the public is demanding an authoritative standard of literature on which it can depend and which is kept up to date as new aspects of the subject are demonstrated.

That such a need is recognised is proved by the large sales of the books already published by the Radio Press, Limited.

For example, "Elementary Text-book on Wireless Vacuum Tubes," by John Scott-Taggart, F.Inst.P., is now regarded as the standard book on valves, and is about to appear in the form of a revised edition.

Then, "Wireless Valves Simply Explained," by the same author, is in its second edition, and bids fair to rival its predecessor in popularity. "Wireless for All" and "Simplified Wireless" are two very cheap and excellent books for the beginner, also by the same author, who is Chief Technical Adviser to this journal. The latter book gives full instructions for making broadcast receivers. The Radio Press Call Book gives a complete list of all commercial and amateur wireless stations and fills a long-felt want. The third edition of Paul D. Tyers' "The Construction of Wireless Receiving Apparatus," is selling so rapidly that the proofs of the fourth edition are already being revised.

### ROGERS, FOSTER & HOWELL, LTD.

(R.F.H.)

We are showing the following compact and highly efficient Radio Sets of their stand No. 22, at the All-British Wireless Exhibition, Horticultural Hall, Westminster, S.W. 1.

Two complete all-on, 2-valve Receiving Sets.

Two 2-valve, all-on Knapsack Type Re-

ceiving Sets for scout companies, clubs, tourists, etc.

Three standard 2-valve Receivers.

One 2-valve Amplifier.

One 3-valve Amplifier.

Three 3-valve Receiving Instruments.

Two 4-valve Receiving Instruments.

Three Crystal Sets.

An assortment of Head 'Phones.

Magnavox and other Loud Speakers.

[ An assortment of parts.

### SIEMENS BROTHERS & CO., LTD.

The company's exhibit will include the following:

Broadcasting Wireless Receiver, Type C.V. A receiver which has been specially designed to meet the demand for an apparatus which, whilst being less elaborate and expensive than the multi-valve type, is at the same time much superior to the crystal type receiver, giving a signal strength very nearly equal to that of a two-valve set. It can be operated with ease and certainty, even by a novice.

One and Two-Valve Amplifiers which greatly increase the capacity of the receiver Telephone Head Sets. Specially designed for wireless work, the terminals are enclosed to prevent the receiving circuit being interfered with. The ear-pieces are provided with a groove on the surface to minimise the condensation of moisture.

Aerial Protection. Vacuum protectors which possess a number of advantages over the carbon block type, the opposing conductors being enclosed in a partial vacuum causes them to break down reliably at about 300 volts. An insulation resistance of about 3,000 megohms is maintained right up to the point of breakdown. A damaged arrester can be immediately replaced. Being contained in an hermetically-sealed vacuum chamber, the protector, besides being highly sensitive, is also dust, damp, and insect proof.

Jacks. Enabling a number of head sets to be used simultaneously, and when used with multi-valve sets, the number of valves in circuit at any one time can be varied, the connections being established automatically.

### STERLING TELEPHONE & ELECTRIC CO., LTD.

One of the most interesting features of the exhibition is the stand of the Sterling Telephone & Electric Company, Limited. Amongst a varied array of apparatus, all of which upholds the reputation of this well-known firm of the highest quality goods, the most attractive item is perhaps the Magnavox Loud Speaker, an instrument which reproduces radio speech and music with delightful clarity and distinctness.

There are, of course many types of Loud-speaking apparatus on the market at different prices, but the Sterling Company claims for the Magnavox instrument that its unique design, protected by master patents entitles it to be described as the classic example of radio reproduction devices. A demonstration of the instrument goes far to substantiate

their claims, inasmuch as one is immediately struck by the absence of distortion and the metallic noises which are generally inherent in most forms of horned Instruments. Every point in its design appears to have been conceded only after a most searching investigation into the causes which lead to distortion, and the result is no doubt adequate reward for the years of research and experiment that have been expended on the instrument.

It is not claimed for the Magnavox that it is, *per se*, an amplifying arrangement, or that it will give perfect reproduction when distorted matter is being picked up on the receiving set to which it is connected; neither is it in any way even a distant relation to that popular fallacy—perpetual motion—which, to the intelligent reader, is another way of saying that the instrument does not and will not produce large volumes of sound unless sufficient energy in the form of fairly strong signals is applied to it. For this reason the manufacturers invariably recommend the use of a power amplifier in conjunction with the Magnavox, models of which are shown on the stand.

### H. STANLEY, PRINCE & CO.

As announced in advertisements appearing from time to time in this and other journals, Messrs. Stanley Prince manufacture extremely efficient 1, 2, 3, and 4 Valve Sets, known respectively as the "Prince," "King Radio," "Wireless Wonder," and "Wireless Wizard" sets. This, in addition to a very compact Crystal Set, known as the "Popular."

Although this firm manufacture and stock a very large complete range of component parts, their speciality is complete sets. These complete sets were advertised as far back as April last, but, since then, additions have been made from time to time and these sets now represent the last word radio equipment. No extras are recommended or desirable.

All these sets will be exhibited at the forthcoming All-British Wireless Exhibition at the Horticultural Hall, and prospective purchasers will be well advised to visit Stand No. 54, before finally choosing their equipment.

Particular attention should be given to the "King Radio" 2-valve set, as it provides many items of vital interest to those anxious to acquire an efficient receiving outfit, but who does not possess a very deep knowledge of the subject.

All these sets are supplied by this enterprising firm complete with aerial equipment, 'Phones, Batteries, Accumulators, etc., etc., and we are given to understand that, as an advertisement, an extra pair of Head-phones will be included free in every set ordered at their stand during the run of the exhibition.



The H.P.R. Universal Tuner.



# OMNIPHONE

C  
R  
Y  
S  
T  
A  
L

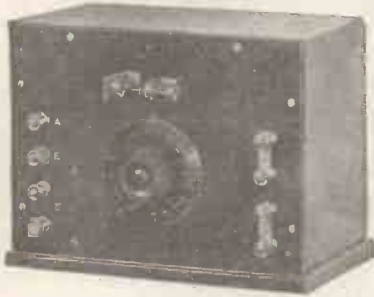

R  
E  
C  
E  
I  
V  
E  
R  
S

FULLY GUARANTEED.

Type A.—Wave-length range 300 to 500 metres for Broadcasts. Complete .. .. £4 10 0

Type A1.—For Broadcasts and Paris time signals. Complete .. .. £5 0 0

Type B1.—A receiver de luxe for all Wave-lengths from 300 to 2,600 metres, inclusive. Complete .. .. £7 0 0

Supplied with all necessary accessories. These are real wireless instruments of the highest efficiency, and whilst complete in themselves, may form the nucleus of a more elaborate set, as special provision is made for the attachment at any time of a high frequency valve amplifier in the most efficient manner. Call for demonstration or send for full particulars.

ALL WIRELESS ACCESSORIES. LIST FREE.

**THE OMNIPHONE WIRELESS CO.,**  
24, Warwick St., Regent St., London, W.1.

'Phone: Regent 3355. 20 yards from Regent St., between Robinson & Cleaver's and Maison Lewis.

## THE REASON WHY

WE DO NOT EXHIBIT IS THAT IN PRICE AND QUALITY OUR GOODS SELL THEMSELVES.

WE GIVE YOU AN EXAMPLE BELOW:

Aerial Wire, 7/32 ... 100 ft.	5/-	Switch Arms ... .. each	1/6
Batteries, H.T. ... each	3/3	Filament Switch ... .. "	3/9
Condenser Grid ... .. "	2/6	Terminals ... .. doz.	2/-
Condenser Vanes ... per pair	2d.	Ebonite, 1/2 in. ... .. lb.	4/-
Do. Washers, lge. doz.	6d.	Etc. Etc. Etc.	
Do. Do. sml. "	4d.		
Contact Studs. ... .. "	1/6		
Knobs, 5d. each; with Brass Bush	6d.		
Head-Phones, Best French			
Dbl. Receivers, complete,			
2,000 ... .. "	23/-		
4,000 ... .. "	25/-		
8,000 ... .. "	30/-		

CASH WITH ORDER.  
GOODS BY RETURN.  
CARRIAGE PAID, £2 and over.

TRADE SUPPLIED.

ANGELL'S WIRELESS SUPPLY STORES,  
95, HIGHBURY NEW PARK, LONDON, N.5.

## WIRELESS

Gentlemen of good address and superior education required in every large town in the British Isles, as

**SOLE REPRESENTATIVES,**

to call on booksellers with latest books on Wireless, on commission basis.

*Excellent spare-time occupation for keen, energetic men.*

Write fullest details and references to—  
Box 767, Sells Advertising Offices, Fleet Street, London, E.C.4.

# PATENT RADIO INSULATORS

(GOVERNMENT TESTED).

## ABSOLUTELY WATER and WEATHER PROOF

NO SOLDERING OF AERIAL JOINTS REQUIRED

## ATMOSPHERICS AND STATICS ELIMINATED

Universally adopted by the British, American, French and Italian Naval, Military and Aerial Services.

1/6  
EACH.

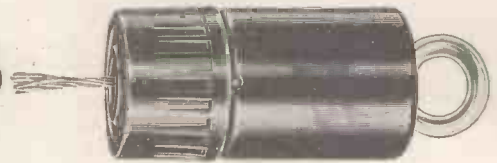

1/6  
EACH.

Provisional Patent.

## GUARANTEE.

We guarantee these insulators to have a higher consistent insulation capacity than any other form of insulation at present adopted for Radio Transmission and Reception.

Generous Terms to the Trade.

## ECON MANUFACTURING CO., LTD.,

6, Holborn Viaduct, London, E.C.1.

Factory: Paris Garden, Blackfriars, S.E.1.  
Phone: City 4148. Phone: Hop 2000.

## ALL-BRITISH WIRELESS EXHIBITION

Stand No. 50 (Annexe).

**EXHIBITION SUPPLEMENT**

(Continued.)

**W. R. H. TINGEY**

1. We are exhibiting entirely self-contained wireless receivers to cover all ranges of wave-length, intended to be inserted in a Gramophone Cabinet. 5 Valves.
2. Ditto. 4 Valves, Broadcasting only.
3. Valve Unit System.

**THE ZENITH MANUFACTURING CO.**

At the All-British Wireless Exhibition we shall be showing a complete range of regulating resistances suitable for the adjustment of current and voltage in all wireless and similar circuits. These resistances will incorporate many small but important improvements which we feel sure will render them of interest to wireless workers.

In particular, we shall show a potentiometer resistance arranged to permit an amateur to effect a very approximate measure of the voltage amplification factor of any given value in accordance with the methods described by Mr. P. R. Coursey in the "Wireless World" of February 4th, and again in a current issue of that journal. As this potentiometer resistance is a very moderately priced article it should be of particular interest to experimental workers desirous of seeking the highest efficiency in their apparatus.

We shall also be showing a considerable range of our new "Zenite" resistance units. This particular unit comprises a fire-resisting tube on which is supplied a suitable winding of resistance wire ultimately embedded at high temperature in a vitreous enamel. As these resistances are then impervious to moisture or oxidation the value remains constant, and they are in considerable demand for various wireless circuits, especially as grid leaks for large transmitting valves.

Visitors to the Exhibition will also find on our stand examples of high tension transformers, together with choke coils and smoothing condensers, such as are used for obtaining high tension rectified current for feeding the plate circuit of moderate power transmitting sets. These transformers, choking coils, and condensers are made in

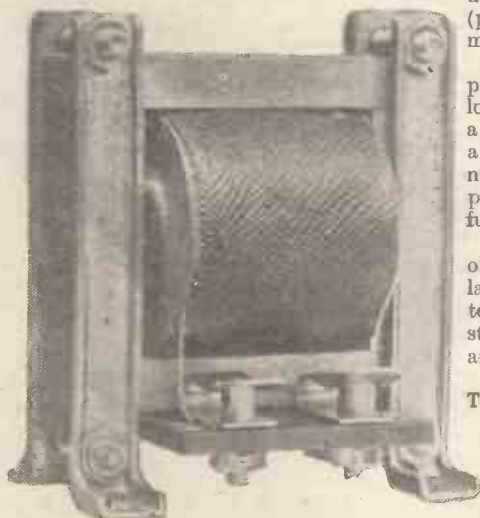

Intervalve Transformer exhibited by the Igranic Electric Co., Ltd.

a very large variety of ways to fulfil all requirements and to minimise "humming."

**The CHLORIDE ELECTRICAL STORAGE Co., Ltd.**

The Chloride Company are the manufacturers of the well-known Exide Batteries. These batteries have played an important part in wireless almost since its inception. It was an Exide Battery that enabled the operator on the s.s. "Republic" to send out the first famous S O S call for help.

On Stand 30 will be found a range of the very latest types of batteries for every wireless purpose. A large series of low voltage Exide Batteries in celluloid boxes are on view. Of greater interest to many wireless experts and amateurs are the various high voltage sets of Exide Batteries. These com-



Two-Valve Receiver and Loud Speaker set combined, exhibited by Metropolitan-Vickers, Ltd.

prise complete 24, 30, 50, and 60 volt sets in strong and neat wooden trays.

Examples of individual H.T. cells are shown in ebonite, glass, and celluloid containers.

Other exhibits of special interest include 6 volt 40 ampere hour and 2 volt 40 ampere hour celluloid cells as supplied to Messrs. Marconi's for the operation of Marconiphone sets—unspillable type accumulators—ships' wireless batteries type PW. as supplied to Messrs. Marconi's. An interesting Battery is the special XR. type Exide Battery supplied to the Colonies for use with a new automatic wireless 'phone. In this new invention the caller, on lifting his receiver, automatically rings his neighbour's call-bell (perhaps some 30 miles distant) through the medium of this battery.

Wireless enthusiasts should also make a point of seeing the special H.T. battery, the long, thin plates of which are contained in a number of glass test-tubes mounted on a wooden framework. This is a particularly neat and ingenious battery of a type that promises to become popular in the near future.

Everyone interested in wireless should obtain the booklet giving particulars of the large range of Exide Batteries for wireless telephony, the cover of which contains a striking illustration of an Exide Battery and Wireless Masts.

**THE TELEPHONE MANUFACTURING Co., Ltd.**

Our De Luxe Cabinet Receiver, has been specially designed to meet the requirements of those who desire a wireless receiving apparatus of maximum efficiency, simplicity of control, and the

whole self-contained in a "De Luxe" cabinet, designed to harmonise with other pieces of artistic furniture.

The instrument comprises a valve and crystal set, so arranged that by the manipulation of a simple switch, either can be brought into operation as may be desired, the reception being suitably amplified by means of a two-valve Audio Frequency-combination. Our patented form of permanent crystal detector—which entirely eliminates the usual troublesome setting—is fitted in duplicate as standard.

Also mounted upon the highly polished ebonite panel are the necessary controls, carefully arranged for convenience of manipulation.

The loud speaker and requisite batteries are mounted in the cabinet the front of which is provided with adjustable louvres.

Two head-sets are included in the equipment, for use on such occasions as when the loud speaker may not be required.

We can supply the cabinet in any finish to order, the overall sizes being 3 ft. high by 1 ft. 8 in. square. Price 100 guineas.

**THE M.O. VALVE Co., Ltd.**

The M.O. Valve Co., Ltd. are exhibiting a comprehensive series of all types of Transmitting, Receiving, Rectifying, and Amplifying Valves, ranging from the well-known V.24 Type Receiving Valve to the latest type of high-power Transmitter.

The amateur is well catered for in small and medium power Transmitting Valves, and the well-known R., R.4 B., and V.24 Type Receiving Valves are also a feature of this Company's exhibits.

In conjunction with this firm, the General Electric Co., Ltd., of Magnet House, Kingsway, are showing on the same stand their latest and most efficient wireless receiving apparatus. The apparatus embodies two types of crystal receiving sets for the reception of Broadcasting programmes, with an approximate range of 15 miles respectively, and an exceedingly high-class and well designed 2-Valve Set for the reception of signals within a range of approximately 100 miles.

This set is fitted with sockets for the addition of a coil for any other wave-lengths for which Broadcasting may ultimately be allowed.

The whole set is supplied complete with the necessary batteries and 'phones.

A series of panels, aerial fittings, and sundries will also be shown by the same firm.

Included on this stand is a Marconi 3-Kilowatt Continuous Wave Transmitter for telegraph or telephony—a simple and reliable installation of medium power, suitable for ship or land stations. This is a standard equipment designed for transmission on wave-lengths for 2,000 to 3,000 metres.

The M.O. Valve Co., Ltd., have recently moved with their new works, and they take



## EXHIBITION SUPPLEMENT

(Continued.)

this opportunity of informing the public that, as a direct consequence, their output will be enormously increased. They will be able to meet practically any demand.

## THE DUBILIER CONDENSER Co. (1921) LTD.

The feature of particular interest on the stand of the Dubilier Condenser Co. (1921) Ltd., is the device for enabling the ordinary house electric lighting wires to be used as radio receiving aeriels.

In the ordinary way, it is not possible to utilise the house wiring as a receiving aerial without first switching off the current at



"The Cosmos" Two-valve Receiver.

the main switch, where it enters the building, as otherwise a short circuit of the supply circuit would result, and the receiver would be damaged. The inconvenience of this arrangement can be obviated by using the "Ducon" attachment, which is designed so that it can be plugged into any standard electric lampholder, and connected directly to the aerial terminal of the radio receiving set.

Every "Ducon" is tested to withstand a voltage of 2,000 volts, so that perfect safety is assured with no possible risk of shocks when handling the apparatus with the current switched on.

The "Ducon" consumes no current from the mains, and interferes in no way with the ordinary use of the electric light, while at the same time radio signals can be picked up practically in the same way as when an outside aerial is employed. In places where the erection of an ordinary aerial is difficult, the device should prove very useful not only for picking up "broadcasting," but other radio signals as well. No difficulty is experienced in tuning the receiving apparatus when this device is employed, and the tuning is generally quite as sharp as with an ordinary type of aerial.

Many forms of condensers suitable for wireless transmitters and receivers are also exhibited by this firm, who make a speciality of highly efficient condensers for all types of radio service.

## H.P.R. WIRELESS, LTD.

Particular interest will be aroused by two of the instruments exhibited by H.P.R. Wireless, Ltd., of Carlton House, Great Queen Street, Kingsway, W.C. (Stand 35).

The first of these is a receiving set which will pick up not only British Broadcasting, telephony from Croydon aerodrome and Koenigswusterhausen, music from The Hague and Eiffel Tower, but also signals from ships at sea and such distant places as New Brunswick in the United States, Moscow, Cairo, Rome, Bucharest, Stavanger, etc.

This set is the H.P.R. Universal Tuner used in conjunction with the H.P.R. Universal 3-Valve Amplifier. The notable features of the set are that the high frequency circuit of the Amplifier is tuned throughout the whole range of wave-lengths from 150 to 20,000, and that the Tuner is fitted with the H. P. R. Patent Automatic Wave-length Indicator which allows the amateur with no knowledge of wireless to tune in to the desired wave-length at sight.

All H. P. R. instruments are British made, and are tested on a Post Office aerial before leaving the works. The company holds the interesting records of having designed the first amateur valve receiving sets ever sold in this country, and on their instruments the first wireless message ever received and printed in a London newspaper.

H. P. R. instruments have an enviable name for reliability in operation, and the perfection of their design and finish has earned for them the nickname of "The Rolls-Royce" of the Wireless trade, albeit the price of some of their instruments is as low as £5 5s.

## WIRELESS SUPPLIES Co.

On Stand No. 1 we have the most pleasing evidence of the virile enterprise of the Crystophone Manufacturing Company. As is well known, this company specialises in Crystal Receivers, or rather, we should say, in Crystal Circuits, and have certainly carried the crystal to an extraordinary degree of development.

Perhaps the most popular exhibit will be the Crystophone Scout, a handsome Crystal Receiver in a polished mahogany cabinet, which most certainly looks well worth twice its modest price of £3 10s.

No less interesting is the Crystophone Elegante, a truly fine piece of furniture of dark mahogany, in Queen Anne style, containing a 3-valve Receiver, with the inevitable crystal, here used as a rectifier. A loud speaker is fitted into the cabinet. This model is priced at 50 guineas.

Between these extremes we have a wide selection to choose from, and it would appear that there is a Crystophone to suit every purse.

The Crystophone Loud Speaker of somewhat novel design makes its debut at this exhibition, and a high degree of efficiency, entirely free from voice distortion, is claimed for it.

The Crystor Cowl Insulators are also exhibited on this stand, and are now too well known to need lengthy description.

This stand will prove to be of considerable interest to the expert as it will to the general public, and we regret that lack of space

prevents us dealing more lengthily with the many interesting features to be seen here.

## Crystophone Receivers:

Type No. 16 M.T.	.. ..	£2 10 0
The Scout	.. ..	3 10 0
• Type No. 21 T.T.	.. ..	4 15 0
" " 20 T.T.	.. ..	5 10 0

Crystophone Low Frequency Amplifiers, 1, 2, and 3 valves, prices £5 5s., £10 10s., and £14 14s.

Crystophone Broadcaster Junior, 10 guineas. Crystophone Broadcaster Major, 25 guineas. Crystophone Elegante, 50 guineas. Crystophone Loud Speaker, 3 guineas. Crystor Cowl Aerial Insulators and Lead In.

## THE BRITISH THOMSON-HOUSTON COMPANY, LIMITED.

The central feature of this stand will be, of course, the famous B. T. H. Portable Wireless Receiver—the up-to-date receiving station complete in one small cabinet. This will be accompanied by a large new and extremely interesting range of other B.T.H. Wireless equipments, each of which, like the Portable Receiver, is supplied complete in every detail for immediate operation.

For those who require to listen-in to broadcasting only, this company has designed a cheaper receiver of the Crystal type. The set will be supplied complete with aerial, earth wire, switches, telephones, and everything ready for immediate operation on receipt.

The rest of the B. T. H. equipment to be shown will include several types of loud speakers and a concertphone of extraordinary amplification, of which there will probably be two models, two and three stage respectively.



The "Amplion" Loud Speaker.

# JUST PUBLISHED

## SIMPLIFIED WIRELESS

By John Scott-Taggart, F.Inst.P.

Author of "Wireless For All," "Wireless Valves Simply Explained," etc., etc.  
Chief Technical Adviser to "Popular Wireless."

### An Entirely New Book for the Beginner

#### Why Not Make Your Own Set? This Book Tells You How!

Detailed particulars of actual sets which have received all the broadcast music, etc. It is an ideal book for the man who is keen to know the subject sufficiently to make and work his own set intelligently. Those who have read "Wireless For All" (the first of this series, 6d. net) will not fail to buy this brand-new book. We have sold nearly 80,000 copies of "Wireless For All," and this new book will, it is anticipated, achieve an even greater success. It is beautifully produced, and contains

#### Over Sixty Drawings!

Complete working drawings and full instructions for making and working broadcast receivers are included, and the price is merely a shilling! The price is in the nature of a publishers' experiment to see whether it is profitable to issue a valuable work of this kind at such a low figure. It may be necessary to increase the price on future editions.

#### IT TELLS YOU

- (1) All about elementary electricity.
- (2) What the different parts of wireless circuits are for.
- (3) How to erect your aerial.
- (4) How to make inductances, variable condensers, fixed condensers, crystal detectors, etc.
- (5) How to make several types of complete receivers out of the simplest of materials.

#### SOME OF THE CONTENTS

Some General Remarks Regarding Wireless—Sources of Electricity—Meaning of Positive and Negative—Electrical Units—Connecting Cells in Series—Electro-Magnetism—The Telephone Receiver—Transformers—Inductances—Condensers—Oscillating Circuits—Frequency and Wave-Length—The Aerial Circuit—The Use of a Variable Condenser—The Crystal Detector—The Erection of Aerials—The Earth—Frame Aerials—Loud Speakers—How to Make Broadcast Receivers—How to Work Wireless Receivers—The Use of Lightning Arresters.

#### 20,000 Copies to be Sold Within a Week

This number was sold the first day in the case of "Wireless For All." Don't get left behind. Seize your opportunity at once, and buy your copy, or order it to-day.

#### Backed by the Radio Press

whose reputation and business stands or falls by their wireless literature. All our books are guaranteed. We do not run wireless books as a side line, and you can feel the confidence resulting from the knowledge that we are wireless experts first, then publishers.

#### THIS BOOK HAS BEEN ESSENTIALLY WRITTEN

for readers of POPULAR WIRELESS, the Editor of which has said (August 12th, 1922):

"Mr. Scott-Taggart's experience of technical literary work is unrivalled, and his total writings greatly exceed those of any other writer on wireless subjects. The extraordinarily large sales of his books is a proof of their popularity, which is evidenced, moreover, by the universal recommendation of the technical press and those best able to judge."

His ability to explain difficult problems in a simple lucid, and interesting manner, without sacrificing accuracy is, no doubt, one reason why everything he writes is eagerly read by tens of thousands."

### Provisional Price 1/- Net. Post 1½d.

Obtainable from all wireless dealers, booksellers, bookstalls, etc., or direct from us.

### JUST PUBLISHED!

## RADIO PRESS WIRELESS DIRECTORY

An absolutely up-to-date list of wireless call signs of all kinds of station throughout the World:—

High-power Stations—Coastal Stations—Ship Stations—and, last but not least, British Amateur and Experimental Wireless Stations.

#### If You Had a Telephone

could you do without a telephone directory? No, of course not. Nor can you do without this Wireless Directory, which is the first of its kind, is published at a reasonable price, and is a complete guide—brought absolutely up to date—of all the commercial and amateur stations of the World. Can you afford to be ignorant of where your music, speech, and messages come from? Your hobby will be twice as interesting when you have bought this book.

PRICE 2/6 NET. Post 2d.

WE ARE EXHIBITING AT STAND No. 27  
AT THE ALL-BRITISH WIRELESS EXHIBITION

#### CUT OUT AND POST TO-DAY

RADIO PRESS, LIMITED,  
Devereux Court, Strand, London, W.C.2.

Please forward

	Post free.
..... copies of "Simplified Wireless" .....	1/1½
..... " " "Radio Press Wireless Directory" .....	2/8
..... " " "Wireless for All" (by J. Scott-Taggart) .....	7½d.
..... " " "Construction of Wireless Receiving Apparatus" (P. D. Tyers) .....	1/6½
..... " " "Wireless Valves Simply Explained" .....	2/8
..... " " "Continuous Wave Wireless Telegraphy" (Mittel) .....	2/8
..... " " "Directive Wireless Telegraphy" (Walters) .....	2/8

I enclose remittance of .....

Name.....

Address.....



# 5000 Dealers Wanted

IN

## WIRELESS APPARATUS, ELECTRICAL INSTRUMENTS, PHOTOGRAPHIC INSTRUMENTS, & GRAMOPHONES.

Those tradesmen who wish to participate in the approaching boom of wireless and participate in the profit realisable from a big trade should immediately get in touch with the R.F.H. Company. The Trade mark, R.F.H., denotes high quality, latest designs, high efficiency, and splendid service



SEE OUR EXHIBIT AT THE  
**ALL-BRITISH WIRELESS EXHIBITION**  
Horticultural Hall, Westminster, S.W.1.  
From September 30th to October 7th.

### *PRIZE COMPETITION.*

Prizes of £5 5s., £2 2s., and £1 1s. are offered during the All-British Wireless Exhibition for a name which shall be accepted as a trade mark for R.F.H. Radio Sets.

**ROGERS, FOSTER & HOWELL, LTD.,**  
Edward Rd., Balsall Heath, Birmingham.

# R.F.H.

# WIRELESS CLUB REPORTS.

The Editor will be pleased to publish concise reports of meetings of wireless clubs and associations, reserving the right to curtail the reports if necessary. Hon. secretaries are reminded that reports should be sent in as soon after a meeting as possible. Reports sent in cannot appear in this paper in less than ten days after receipt of same. An asterisk denotes affiliation with the Wireless Society of London.

## Fulham and Chelsea Amateur Radio and Social Society.

A meeting was held on September 13th at the society's temporary headquarters. The minutes of the previous meeting being read and accepted, it was proposed by Mr. Saunders and seconded by Mr. Patterson that the society should become affiliated with the Wireless Society of London. This being generally accepted, the necessary steps will be taken.

During a discussion on reception Mr. Whitts, a member, kindly gave a short but exceedingly interesting lecture on the ether, which was much appreciated.

Secretary: Mr. R. S. V. Wood, 48, Hamble Street, Fulham, S.W. 6.

## South Shields Y.M.C.A. & District Amateur Wireless Society.

A meeting of the above society was held on September 12th in the Y.M.C.A. Rooms, the chair being taken by Mr. G. Busbridge.

The proceedings opened with buzzer practice, and the members showed a marked improvement in their receptive abilities.

A very neatly arranged and compact German single valve set was exhibited by Mr. M. Twohy, which aroused great interest, excellent signals being received with the club's aerial, which had been recently extended.

The objects of this society are to assist and bring together local amateurs; the furtherance of all matters and studies connected with wireless telegraphy and telephony and allied subjects; and the promotion of intercourse and exchange of ideas between experimenters in wireless telegraphy and telephony.

Whilst the society is open to all scientific members, no technical qualifications are required to gain admission to membership, the main qualification being interest in the subject.

A series of lectures has been arranged by Mr. G. Busbridge on elementary theory of wireless telegraphy.

The hon. sec. will be pleased to hear from any gentleman desirous of becoming a member, the subscription being 7s. 6d. per annum.

Meetings are held every Tuesday and Friday at 7.30 p.m., and new members may enrol on these evenings.

Hon. sec.: J. Teasdale, 38, Readhead Avenue, South Shields.

## Stoke-on-Trent Wireless and Experimental Society.\*

At a meeting of the Stoke-on-Trent Wireless and Experimental Society at the Y.M.C.A., Hanley, on Thursday, September 14th, Mr. A. Hackney (member) continued with his series of lectures on the construction of wireless apparatus. He demonstrated a new method of winding inductance coils for tuners, to receive the transmissions sent out on short-wave lengths by the broadcasting stations and wireless amateurs holding transmitting licences. A simple coil was constructed and exhibited.

Members who have wireless receiving sets that are not giving the expected results are invited to bring them along to the clubroom on Thursday night, when they can be tested and faults cleared.

## The Fulham and Putney Radio Society.

At a meeting which was held on Friday, September 15th, and which was well attended, several new members were made, and as some of the members, notably Messrs. Hart-Smith, Winnett, H. A. Gardiner and Calver, had offered the society a collection of technical books, it was proposed a librarian be elected. Mr. S. W. Martin was elected to this post, and he will in due course notify the members as to the books available.

The Morse buzzer class started on the 22nd inst., in charge of Messrs. Winnett and Calver. The society is to be congratulated on obtaining the services of two such highly technical instructors, who have very kindly placed their services at the disposal of the members.

After the close of the business Mr. Calver introduced Mr. Adams, of Wandsworth, the winner of Messrs. Selfridge's wireless competition. Mr. Adams had brought with him the apparatus which had won the prize. This consisted of a very small and compact three-valve set with specially wound transformers and coils, the whole being well made and finely finished. The time being limited, Mr. Adams could not go into much detail of construction but with the assistance of Mr. Barker with

batteries and accumulator the members present heard some signals which were rendered very loud and clear due to the special winding and wiring of the set. Mr. Adams has very kindly promised to explain the set in every detail at a future meeting. A very hearty vote of thanks was accorded to Mr. Adams for his very interesting hour, and offer. Mr. N. A. Brown had with him a two valve set, also very neat and compact, which was also tried with very good results. After more promises from members of sets and parts for trial at the meetings, the meeting closed.

Judging by the liveliness of the proceedings and the interest displayed, the future of the society is well assured.

Hon. Sec.: J. W. Dewhurst.

## Newcastle and District Amateur Wireless Association.\*

A meeting of the above association was held at headquarters on Monday, August 28th, at which a demonstration was given by the representative of Messrs. The Sterling Telephone Co., Ltd., of the large 18-in. Magnavox loud speaker with an amplifier. Tremendously loud signals were received.

At the following weekly meeting on Monday, September 4th, seven new members were proposed and approved of by the committee, bringing the membership up to 81.

In view of the now rapidly increasing number of members it has become necessary to find a larger clubroom, and all members were requested to endeavour to find a suitable clubroom for the future use of the association.

Letters from the P.M.G. to members applying for experimental licences were then read, and after a short discussion Mr. Burdis recommended all new members to apply for a simple non-radiating circuit at first; then, after having gained experience, to apply for permission to use a more complete installation.

Hon. Sec.: Colin Bain, 51, Grainger Street, Newcastle-on-Tyne.

## Portsmouth and District Wireless Association.

At the last monthly meeting, held at the File Memorial Rooms, Fratton Road, a large number were present, and four new members were elected. In view of an anticipated large increase in membership in the near future, a vice-president was also proposed, Mr. Stevenson being unanimously elected to fill the post.

In future it has been decided to hold two business meetings each month, the first and third Wednesdays suiting the majority of the members.

Sec., R. G. H. Cole, 34, Bradford Road, Southsea.

## HORRORS OF THE FUTURE: THE "RADIO EYE."

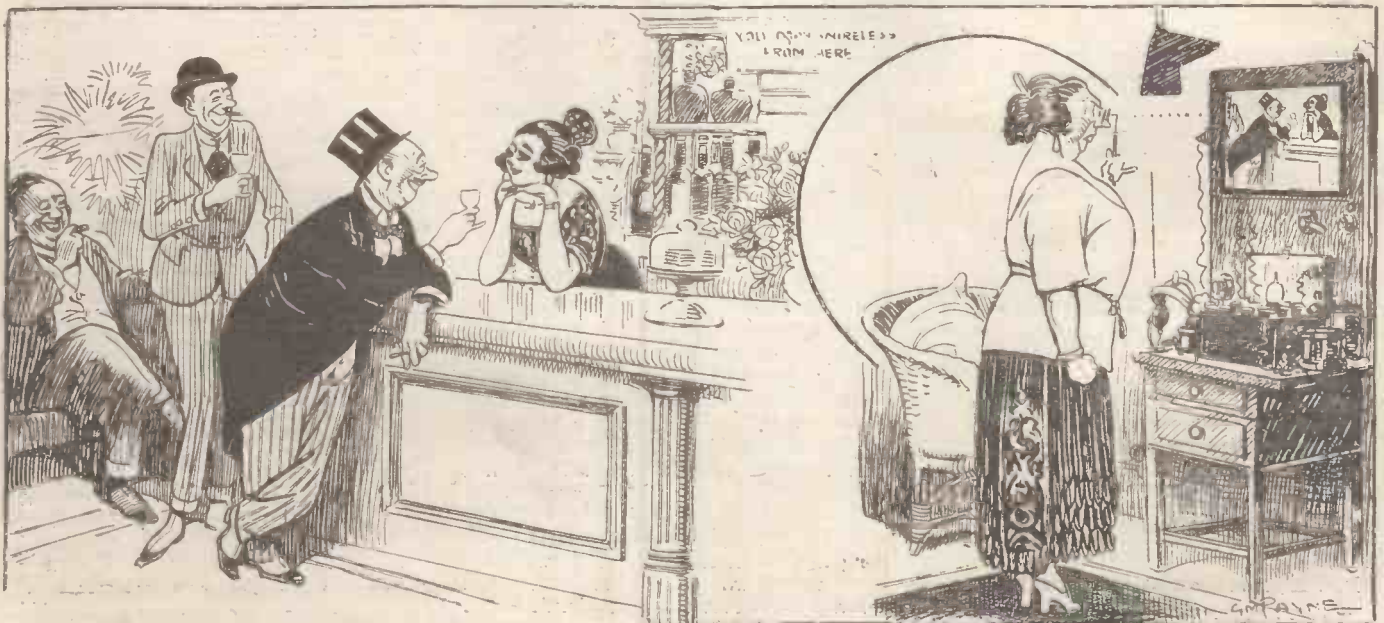



**STEP BY STEP IN WIRELESS.**

# THE CALIBRATION OF THE TUNED CIRCUITS OF A WIRELESS RECEIVER.

## PART II.

In a previous article a method of calibrating each circuit direct in wavelengths was explained, but this method necessitated the use of a wavemeter, an expensive piece of apparatus, and, moreover, left the owner still in ignorance of the individual capacities of the condensers, and the inductances of the coils.

It will be, therefore, of interest to the beginner to read of a method of determining the capacity of any condenser, the extra apparatus for which can be both easily and cheaply made. It is really measurement-by-comparison, and is called the "method of mixtures," originated by Lord Kelvin.

### Avoiding Capacity Effects

The only moderately expensive "extra" that must be procured is a fixed capacity condenser, the exact capacity of which is accurately known. This condenser could, of course, subsequently be used in the receiving set. The circuit is given for Fig. 1, where either  $C_1$  or  $C_2$  is the known condenser and the other the condenser to be calibrated.

The Resistance, marked  $R_1$ ,  $R_2$ , may be a length of high resistance "Eureka" wire, of uniform cross section, stretched taut be-

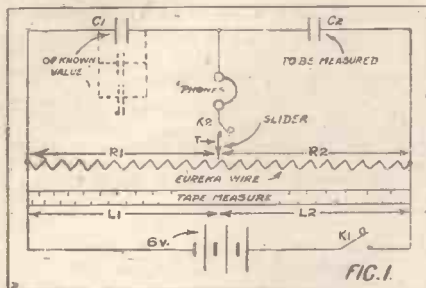

Note.—Measurement of capacity by the method of mixtures.

The dotted line indicates the manner in which additional condenser should be connected, if necessary.

tween two terminals, when its resistance may be taken as proportional to its length. If a tape measure is stretched, and pinned down directly beneath this wire, and parallel to it, the length of wire on each side of the variable tapping T may be read off at a glance.

This variable tapping should be made by means of a spring slider, but if the switch keys,  $K_1$  and  $K_2$ , are not available, the two connections may be made, when necessary, by hand, by two separate people. Two persons are necessary to avoid capacity effects, and the required result can be obtained without a great loss of accuracy if the wires are very firmly pressed together. This is, however, difficult to ensure, as care should be taken not to touch the bare part of the wires in either case.

The action is as follows. If the battery key,  $K_1$ , is first closed, the condensers will be "oppositely" charged, and on closing  $K_2$  there will generally be a flow of current

through the telephones producing a loud click. The slider, however, can be adjusted to such a position that no click is heard, when  $K_1$  is first closed and  $K_2$  afterwards.

For that particular position  $C_1 R_1 = C_2 R_2$  that is the ratio  $\frac{C_1}{C_2} = \text{Ratio} = \frac{R_2}{R_1} = \frac{L_2}{L_1}$

but remember that  $L_2$  and  $L_1$  must both be measured in the same units, i.e., both in inches, or both in centimetres; this, of course, is ensured by a tape measure reading; and whatever  $C_1$  is measured in, farads, micro-farads, micro-micro-farads, etc.,  $C_2$  will be in the same units and vice versa.

### Increasing Known Capacity

If, therefore, we decide before the experiment that  $C_1$  is the known condenser, and express its capacity in micro-farads, we can write down for the final result, when no click is heard, "Capacity of  $C_2$  in micro-farads

$$= \frac{L_2}{L_1} \times \text{capacity of } C_1 \text{ in micro-farads,}$$

provided that  $L_1$  and  $L_2$  are each measured in the same units of length.

The builder of a home-made set can thus check the actual capacities of each of his fixed condensers, before incorporating them in the set. A variable condenser could also be calibrated, within the limits of the length of Eureka wire used, by taking a series of readings with a number of different known condensers inserted as  $C_1$ .

If it is necessary to still further increase the available known capacity, these condensers should be connected in parallel, as shown dotted in Fig. 1. Use should be made of condensers previously calibrated by this method, only if more accurately calibrated ones are not obtainable.

### Tuning The Circuit

Now, the wavelength to which a circuit is "tuned" depends directly upon the capacity and inductance of the circuit. The formula is

$$\lambda = 1885 \sqrt{L \times C}$$

where  $\lambda$  is the wavelength in metres, and L the inductance in micro-henries, and C the capacity in micro-farads (the suffix micro-

standing, in each case, for  $\frac{1}{1,000,000}$

of the unit named).

In an efficient wireless receiving set the inductance of the closed circuit may be considered as concentrated in its coil or coils, and if the connecting leads are properly arranged, and the coils efficiently wound, the capacity, for practical purposes, may be taken as that of the condenser or condensers of the circuit. Where, however, there is a long length of straight wire, or several wires close together, such as the aerial which forms part of the aerial circuit, a small part of the capacity and of the inductance of the circuit will be what is called "distributed" along the length of wire. There will then be not a single wavelength, but a small band of wavelengths over which the circuit will be in tune.

With this limitation only, the capacity of the condensers having been found by the method shown in Fig. 1, the wavelength of the circuit can then be calculated for each setting of the condenser, provided that the inductance of the whole tuning coil, if of the "plug in" type, or of each tapping if wound on a cylindrical former, is known.

### Hints to Beginners

Unfortunately, however, it is only possible to find the inductance of a coil by mathematical calculations, from its shape, gauge of wire, number of turns, etc., very approximately. Even then the possible error would be very great if the value so formed

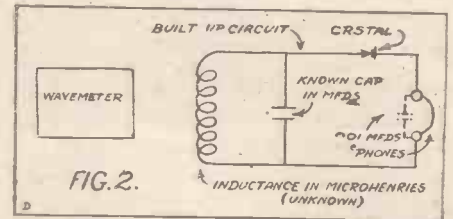

The Measurement of an Unknown Inductance

Note.—The wavemeter (when "buzzing") is a small transmitter tuned to a known wavelength. The built-up circuit is fixed, and wavemeter tuning is varied until maximum sound is heard in the telephones. Its reading is then the wavelength in metres of the built-up circuit. In the formula  $\lambda = 1885 \sqrt{L \times C}$  we know  $\lambda$  and C, hence we can find L, the inductance of the coil, by substituting these values in that formula, re-written:

$$L \text{ (inductance of coil in microhenries)} = \frac{\text{Wave-length}^2}{\left( \frac{\text{Capacity of condenser}}{C \text{ in micro-farads}} \right) \times (1885)^2}$$

were used in the wavelength calculation. Moreover, the simplest practical method of measuring an inductance requires the use of a wavemeter, as well as a known capacity condenser, as may be seen from Fig. 2.

The beginner is therefore advised to send his tuning coils, if of the plug-in type, and therefore easily removable, to a wireless dealer who possesses a standard wavemeter. If, however, he decides to have his set calibrated direct, as it stands, in wavelengths, the other method given will form a useful check, and should he subsequently wish to extend the available range of wavelengths, a knowledge of the actual capacities and inductances will be invaluable.

*The Editor welcomes contributions to this page from amateurs who wish to publish results of bona fide experiments of a nature interesting to all, or who wish to discuss the more advanced aspects of Radio Science.*

# “LISTEN IN”

## To Good News for all Wireless Enthusiasts.

Here is a book that contains the experience and knowledge of over fifty highly-specialised expert craftsmen. They tell you, in simple everyday language, how to do over 4,000 money-saving home jobs. Jobs that you will be proud of, will take a pleasure in doing. There are many special chapters devoted to

wireless. They deal with the subject from A to Z. You can achieve something definite with this great help. The novice and the practised operator will find the Amateur Mechanic a guide and mentor that will carry him through the various stages of whatever job he is doing to a very successful conclusion.

# The Amateur Mechanic

### THIS IS A LIST OF THE CHAPTERS ON WIRELESS CONTAINED IN THE WORK :

CONDUCTION AND INDUCTION SYSTEMS—RADIATION SYSTEMS—TUNING AND RESONANCE—OSCILLATORY CIRCUITS—THE MARCONI COHERER—A SIMPLE ANALOGY—TRANSMITTING—RECEIVING—THE CRYSTAL DETECTOR—FOUR TYPES OF TRANSMITTING APPARATUS—THE THERMIONIC VALVE—RECEIVING CONTINUOUS WAVES—LOGICAL SEQUENCE OF THE INFORMATION—AERIALS—THE SINGLE-WIRE AERIAL—THE T TYPE AERIAL—THE TWIN-WIRE AERIAL—THE EARTH CONNECTION—WAVE-LENGTH OF AERIAL—MAKING A LONG-DIS-

TANCE CRYSTAL RECEIVING APPARATUS—GENERAL DESCRIPTION—CAPABILITIES OF THE APPARATUS—SPECIFICATION—THE TUBULAR CONDENSER—THE VARIABLE CONDENSER—THE CRYSTAL DETECTOR—CONNECTING UP COMPLETE SET—WORKING THE SET—MAKING A COMPLETE VALVE PANEL—GRID CONDENSER—FILAMENT RHEOSTAT—RESERVOIR CONDENSER—WIRELESS TELEPHONY—THE TRANSMITTING STATION—THE RECEIVING STATION—GENERAL ADVICE—LIST OF CHIEF STATIONS.

### HERE ARE A FEW OF THE 400 MONEY-SAVING HOME JOBS IT TEACHES :

How to Build Your Own Sheds, Outhouses, Poultry Houses, etc.—How to Cure Damp Walls, Leaky Roofs, and Smoky Chimneys—How to Make Garden Frames, Garden Furniture, and Garden Paths—How to Mend Windows, and to Make, Mend, and Strengthen Locks and Bolts—To Clean, Overhaul, and Repair Motors and Motor-Cycles—To Instal Wireless Telegraphy, Electric Light, etc.—To work in every kind of Metal—To etch on Brass—To write on Glass—To Make Hectographs—To Build a Boat, a Canoe, a Canvas Canoe, etc.—To paint and paper a room—To sole and heel and patch boots and shoes—To make a pair of hand-sewn boots—To restore colour to old brown shoes—to make household furniture—To re-seat chairs—To upholster sofas, etc.—To instal a speaking-tube—To clean a stove—To repair bicycles—To work in metal—To colour metals—To repair water taps—To varnish a violin—To remedy damp walls—To repair the piano

—To make a padded chair from an old cask—To stuff animals—To dress furs—To stuff and mount birds—wood inlaying—To prepare working drawings—To renovate a grandfather clock—To make garden arbours, arches, seats, summer-houses, etc.—To use metal drilling tools—To renovate mirrors—To mend china—To do fretwork—To limewhite poultry houses—To do gold-plating and silver-plating—To clean a watch—To mend keyless watches and ordinary watches—To distemper ceilings and walls—To make picture frames and frame pictures—Curtain fitting—Metal castings—To clean paint off glass—To clean boilers—To fix an anthracite stove—To re-gild and restore picture frames—How to use spanners—To make doors and windows draughtproof—To paint walls—To do nickel-plating—To cure noises in hot-water pipes—India and glue varnishes—To make plaster casts, etc. etc.

## FREE

A handsome 16-page booklet, which tells you more about the AMATEUR MECHANIC than is possible here. It shows you specimen pages from the four handsome volumes, with many of the 6,000 instructive

illustrations, and will also tell you how you can get this great work by paying a nominal first payment and the balance by a few small monthly payments. It is quite free and incurs no obligation whatever.

→  
**SEND THIS  
COUPON OFF  
TO-DAY.**  
→

Send this form in unsealed envelope, with half-penny stamp,  
To **THE WAVERLEY BOOK CO., LTD.**  
(P.Wir.H. Dept.), 96, Farringdon Street, London, E.C.4.  
Please send me, without charge or obligation to order, your Free descriptive Booklet, explaining contents, etc., of "THE AMATEUR MECHANIC," with specimen pages and pictures, and particulars as to your terms for small monthly payments beginning thirty days after delivery.  
NAME.....  
ADDRESS.....  
P.Wir.H. 1922.....



# CONTROLLING MODELS BY WIRELESS.

By MAJOR RAYMOND PHILLIPS, Late Member of the Inter-Allied Commission of Control  
PART 2 (NEW SERIES).

**I**N this and subsequent articles I am going to furnish constructional details of various wireless-controlled models.

As wireless enthusiasts sometimes ask questions which clearly indicate that many, apparently, still imagine it is possible to wirelessly transmit electrical energy to function electric motors and other mechanism, I shall first describe a simple method of wirelessly controlling a model electric train, so that such readers as may not have understood my previous articles will now readily understand that at present it is only possible to control a "source" of electrical energy.

A model electric train can be wirelessly controlled by either controlling a source of electrical energy actually carried on the train, or that connected with the rails upon which the train runs. In the former case it would be necessary for the train to be provided with an electric battery such as an accumulator.

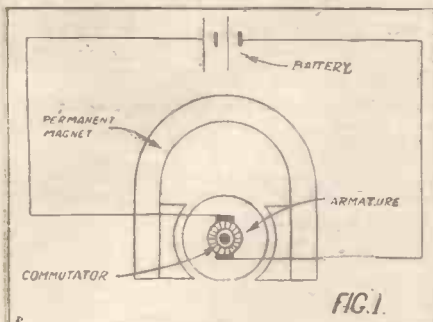

The train would thus be "self-contained," and would need no connection with a conductor rail conveying an electric current.

My well-known wireless-controlled airship—which, at the time of its introduction, was the first airship in the world to be wirelessly controlled before an audience in a theatre or music-hall—had to be self-contained, in that it carried in a receptacle at the rear of the ship its own source of power in the shape of an electric accumulator.

## Types of Motors.

Model electric trains are generally arranged so that the source of electrical energy is connected to a conductor or third rail, and also to the rails upon which the train runs. As the latter type of model can be purchased in a standard form, generally complete with rails, at prices varying from 30s. to £5—except accumulators, which are generally extra to the price quoted—and as the wireless control of the source of power involved with such models presents no difficulties, I should advise a beginner who desires to make a wireless-controlled model electric railway to purchase an electric train with rails complete, and confine his energies to making the wireless transmitting and receiving apparatus suitable for controlling the model in question.

It will be well, when purchasing a model electric locomotive, to ascertain that the

field magnet of the electric motor fitted to same is of "permanent magnet" type.

I had, perhaps, better explain that the term "permanent magnet" refers to one which retains its magnetism similar to the "horse-shoe" or "bar" permanent magnets generally so well known to amateurs. An electric motor with a permanent field magnet simplifies matters considerably, as a reversal of the motor can be effected by simply reversing the polarity of a circuit connected with same.

For instance, if the positive terminal of a battery was connected to the conductor or third rail, and the negative terminal of such battery to the outer rails of a model electric railway, the model locomotive would run in one direction; but by connecting the positive terminal to the outer rails and the negative terminal to the conductor or third rail, the locomotive would run in a reverse direction (due to a reversal of polarity in the armature of the motor). Thus the model could be made to run backwards or forward, as desired.

## Power Supply.

A wound field magnet would involve complications, and for small, inexpensive models is really not necessary.

Figs. 1 and 2 show respectively model electric motors with a permanent and wound field magnet. The latter motor is shown "series" wound, which means that the field magnet winding is in series with the armature—or, in other words, electric current passed through the field magnet winding is also compelled to pass through the armature windings. This type of motor is suitable for traction purposes, on account of its high starting torque.

Perhaps I had better explain that the term "torque" refers to a force which tends to produce torsion around an axis.

Another point to be considered when purchasing a model electric locomotive is to ascertain that the electric motor fitted to same is suitable for working with an E.M.F. of four volts. This means economy.

An accumulator with two cells coupled in series and made up as a complete unit will provide the necessary voltage, or pressure; but it will be advisable for the accumulator to have a capacity sufficiently large to enable the model train to be worked without having recourse to continual re-charging of the accumulator.

I would, therefore, recommend amateurs to purchase an accumulator with an ignition capacity of not less than 40 ampere hours or 20 actual ampere hours.

Now the term "ampere hour" is a unit of quantity equal to the amount of electricity transmitted by one ampere flowing during a period of one hour, so that 40 ampere hours' ignition capacity generally means that an accumulator should be capable of maintaining an intermittent discharge of one ampere for 40 hours, or the same current continuously

for a period of 20 hours. The latter is referred to as the "actual" capacity.

Some accumulators are capable of maintaining a very heavy discharge for one hour, but such are specially made for that purpose.

Such an accumulator as described will cost about 25s., and full instructions for charging will be found attached to the celluloid box containing the plates.

## Small Cost of Parts.

A local garage will generally undertake to re-charge such an accumulator at a cost of one shilling, and the periods for re-charging will depend upon the number of discharges taken from it.

In any case, even if not used, an accumulator should be re-charged once a month, otherwise sulphate of lead, a white substance (called sulphating), is liable to form on the plates which, if neglected, will eventually ruin the accumulator.

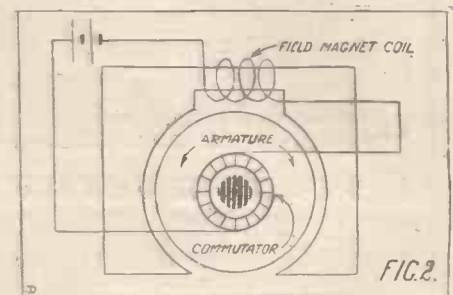

Having now described the electric train and its component parts, the next apparatus to be considered is the wireless equipment for controlling the model.

For transmitting purposes the modified form of Hertz oscillator, as shown in Fig. 1, page 211, No. 12 of POPULAR WIRELESS, can be used. But for those who find a one-inch spark coil too expensive to purchase, a small ignition coil (as fitted to motor-cars) will do. These can generally be purchased at a very reasonable rate. A second-hand one in working order can sometimes be obtained for as small a sum as 5s.

A suitable manipulating key should not cost more than 5s. 6d., and the remaining materials to complete the transmitter, i.e. balls, rods, supports for rods, and base board, for, say, 7s.

An amateur should be able to make the base board and assemble the various parts. An accumulator similar to the one described in this article should be used for supplying electric current to the transmitter.

Those who possess a valve receiver for listening in can use their accumulator which provides electric current for the filaments of the valves.

In my next article I shall furnish constructional details of a suitable receiver for controlling a model electric train.

[Address all queries regarding these articles to the Editor.]

(To be continued.)

# T.M.C. Wireless

T.M.C. "EVERSET" Patent

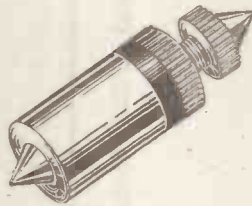

AUTOMATIC CRYSTAL

## The Crystal That Needs NO Adjustment

### CRYSTAL DETECTORS.

**T**HERE is a wide field of usefulness for the crystal detector type of receiver for wireless broadcasting.

The Crystal Receiver has three big advantages as compared with the single or multi-valve type.

In the first place it is very inexpensive; secondly, it is exceedingly simple in construction; and, finally, most observers are agreed that the received speech or music is purer and freer from extraneous noises such as are found even in the best valve sets available.

In spite of their simplicity, however, present-day crystal receivers suffer from the serious disadvantage that the tuning adjustment has to be made simultaneously with the adjustment for finding the most sensitive point on the crystal. Consequently, in inexperienced hands, crystal sets are sometimes rather puzzling, as the novice does not know whether the lack of signals is due to a fault in his receiver or due to the fact that no music or speech is being broadcasted, or, as is generally the case, that he has failed to get his crystal and tuning adjustment simultaneously correct. It will be readily appreciated that a crystal receiver in which the detector is always automatically set in its most sensitive position and requires no adjustment of any kind would be a big advance.

The Telephone Manufacturing Co. have produced and patented such a detector. The principle of this new detector is, roughly, that instead of depending on means to find one sensitive point on the crystal, a number of points of contact are always available, consequently this particular detector is automatic in its adjustment as one of the points of contact can be relied upon always to provide the necessary rectifying action.

The operation of crystal receivers fitted with the Telephone Manufacturing Co.'s patent crystal detector is exceedingly simple as there is only one operation to be made, namely, the tuning adjustment and, furthermore, the operator is never worried by the fact that his crystal may not be rectifying.

This new detector is made up in cartridge form like a small fuse, and is held between two clips.

The illustration shows the small space occupied by this new detector, and in view of the interest which is bound to be aroused in this novel feature, the Telephone Manufacturing Co. have arranged for demonstrations to be given to all interested at their Stand, No. 20, at the Wireless Exhibition at the Horticultural Hall.

Stand  
No.  
**20**

Stand  
No.  
**20**

## The TELEPHONE MANUFACTURING CO., LTD.

### Hollingsworth Works — Dulwich, S.E. 21

Telephone: Sydenham 2460-1.

Telegrams: "Bubastis Dulcrox," London.



# "LISTEN IN" TO THESE BOOKS.

## They will tell you many things worth knowing.

**Practical Lessons in Metal Turning.** By Percival Marshall, C.I.Mech. E. The best instruction book on the lathe for young engineers and amateur mechanics; with 220 original illustrations; 210 pages. Price 3s.; post free 3s. 3d.

**The A.B.C. of Dynamo Design.** By A. H. Avery, A.I.E.E. Clearly explains the principles of a dynamo and how to calculate sizes and windings of machines; with numerous designs and 70 illustrations. Price 3s.; post free 3s. 3d.

**Electric Clocks and Chimes.** Gives complete instructions for the making of successful electrical timepieces, synchronised clock systems and chiming mechanism. 150 pages, over 150 illustrations. Price 3s. 6d.; post free 3s. 9d.

**Electrical Apparatus Making.** By A. V. Ballhatchet. A splendid book for the home or school workshop, showing how to construct a useful set of apparatus for experimental and educational purposes; fully illustrated with drawings and photographs. Price 3s.; post free 3s. 4d.

**More Electrical Apparatus Making.** By A. V. Ballhatchet. A companion volume to "Electrical Apparatus Making." Further examples of experimental apparatus, some of a slightly advanced nature. Fully illustrated. Price 3s.; post free 3s. 4d.

**Maintenance and Repair of Electrical Measuring Instruments.** By H. G. Yarrell. Explains the principles of operation of all types of instruments. Well illustrated. Price 2s. 6d.; post free 2s. 9d.

**Engineering Mathematics Simply Explained.** By H. H. Harrison. A splendid textbook for apprentices, students, and engineers. Price 2s. 6d.; post free 2d.

**The Beginner's Guide to the Microscope.** By Chas. E. Heath, F.R.M.S. A well illustrated and useful guide to all taking up microscopical work. Price 1s. 6d.; post free 1s. 9d.

**Practical Motor Car Repairing.** By E. W. Walford. A handbook for motor car owners and drivers; illustrated. Price 1s. 6d.; post free 1s. 9d.

**Petrol Motors Simply Explained.** By T. H. Hawley. (Revised by E. W. Walford.) Describes the principles on which petrol motors work; and the uses to which they are applied; illustrated. Price 1s. 6d.; post free 1s. 9d.

**Practical Engraving on Metal.** A well illustrated book which also deals with Saw Piercing, Carving and Inlaying. Price 1s. 6d.; post free 1s. 9d.

**Model Sailing Yachts; How to Build, Rig and Sail Them.** A practical handbook for model yachtsmen; illustrated. Price 1s. 6d.; post free 1s. 9d.

**Practical Dynamo and Motor Construction.** By A. W. Marshall, A.M.I.E.E. A handbook of constructive details and workshop methods used in building small machines. Price 1s. 6d.; post free 1s. 9d.

**Private House Electric Lighting.** By F. H. Taylor, A.M.I.E.E. Describes modern methods in wiring and fitting, including a chapter on small generating plants. Price 1s. 6d.; post free 1s. 9d.

**Workshop Wrinkles and Recipes.** A collection of useful workshop hints in Mechanics and Electricity. Practical, and many illustrations. Price 1s. 6d.; post free 1s. 9d.

**Useful Engineer's Constants for the Slide Rule.** By J. A. Burns. All who have to make rapid calculations will find this a most helpful book. Many worked examples are given and methods of calculation. Price 2s.; post free 2s. 3d.

**A Guide to Standard Screw Threads and Twist Drills (Small Sizes).** By George Gentry. Explains all the recognised screw threads and gives sizes of twist drills for clearing and tapping. Price 9d.; post free 10d.

**Gas and Oil Engines Simply Explained.** By W. C. Runciman. An elementary instruction book for amateurs and engine attendants; fully illustrated. Price 9d.; post free 10d.

**Soldering, Brazing, and the Joining of Metals.** By Thomas Bolas, F.C.S., F.I.C. Treats of soft soldering and general methods; wiping pipe joints; brazing, etc. A useful book. Price 9d.; post free 10d.

**The Beginner's Guide to the Lathe.** By Percival Marshall, C.I.Mech.E. An elementary instruction book on turning in wood and metal. Price 9d.; post free 10d.

**Electrical Apparatus Simply Explained.** By A. W. Marshall, A.M.I.E.E. An introductory handbook on the principles and working of electrical appliances in general use; fully illustrated. Price 9d.; post free 10d.

**The Locomotive Simply Explained.** By C. S. Lake. A first introduction to the study of the locomotive engine. Price 9d.; post free 10d.

**Engineering as a Career.** A book of practical advice for parents and boys, describing the nature, training and prospects of the various branches of engineering. Price 9d.; post free 10d.

**Wireless Telegraphy Simply Explained.** By H. T. Davidge. Deals with the apparatus required and explains the working; well illustrated. Price 9d.; post free 10d.

**Wireless Circuits.** Contains 90 useful Diagrams of Circuits and Connections, with Explanatory Notes. Price 6d.; post free 7d.

**Wireless at Home.** Explains how to fit up and get the best use out of your station; with helpful hints for the receiving of broadcast Wireless News, Concerts, etc. Illustrated. Price 6d.; post free 7d.

**Small Accumulators; How Made and Used.** Contains a Chapter on Charging from Alternating Currents. 41 Illustrations. Price 9d.; post free 10d.

**Electric Batteries; How to Make and Use Them.** Describes in a simple fashion the principal forms of primary electric batteries. Fully illustrated. Price 9d.; post free 10d.

From all Booksellers or post free as above from

**PERCIVAL MARSHALL & CO., 66P, FARRINGTON ST., LONDON, E.C.4.**

READ

## The Wireless World AND Radio Review

Price 6d. Weekly.

Post Free 7d.

THE ORIGINAL RADIO JOURNAL.

It tells you HOW TO MAKE AND USE YOUR SET and in addition to the Constructional and Instructional articles, every issue contains specialised contributions of importance and value to experimenting amateurs.

READERS' QUESTIONS ANSWERED FREE OF CHARGE BY EXPERTS THROUGH THE PAGES OF THE "W. W. & R. R."

**Dr. J. A. FLEMING, M.A., F.R.S., etc.,**

the well-known Inventor, Author and Popular Lecturer on Wireless WILL CONTRIBUTE A SERIES OF ARTICLES TO

**The Wireless World and Radio Review**

COMMENCING IN OCTOBER 7th ISSUE.

DO NOT FORGET TO ORDER YOUR COPY.

Visit our STAND No. 40, at the All-British Wireless Exhibition, Horticultural Hall, Westminster, September 30th to October 7th.

12-13 Henrietta Street, London, W.C.2.



## A TEST IS BEST

We invite the public, and also the trade, to come along to our Demonstration Hall, where all can hear for themselves the wonderful wireless reception obtained when using our apparatus.

THE PROOF OF THE EFFICIENCY OF OUR COMPLETE SETS IS IN THE HEARING THEREOF.

Free Demonstrations daily, 10 a.m. to 9 p.m., also on Sundays from 6 to 9 p.m.

BESIDES OUR COMPLETE SETS WE HAVE A SPLENDID SELECTION OF ALL WIRELESS ACCESSORIES.

NOTE.—We supply complete receiving sets for cash or deferred payment. All orders despatched in strict rotation.

**£6 10/-** down secures our 3-valve Set.

Two Illustrated Booklets, No. 1 and P. Post free, 6d.

**STUART WIRELESS TELEPHONE CO.,  
109, Kingsway, London, W.C.2.**

# A GLOSSARY OF RADIO & ELECTRICAL TERMS.

**DIELECTRIC.**—A substance which will allow practically no electric current to flow through it; i.e., a nearly perfect insulator. The term is usually applied to the insulating material in a condenser.

**DIELECTRIC CONSTANT.**—See Specific Inductive Capacity.

**DIRECT CURRENT (D.C.)**—See Continuous Current.

**DISCHARGE, ELECTRIC.**—The passage of electricity through a gas or liquid in the form of a spark, arc, or brush discharge.

**DISCHARGER.**—That part of a wireless transmitting set at which the spark occurs.

**EARTH.**—In a wireless set the earth acts as one plate of a condenser, of which the aerial is the other plate. Connection is made to earth by means of a water-pipe, or a large metal plate, buried in the ground.

**ELECTRO-MOTIVE FORCE (E.M.F.).**—The force which is necessary to produce an electric current, and upon the value of which depends the amount of current measured in amperes in any particular circuit. Electro-motive force is measured in volts.

**ELECTRON.**—The ultimate particle of matter, consisting of an indivisible negative electric charge. A stream of negative electrons constitutes an electric current.

**FARAD.**—The unit of electrical capacity, being the capacity of a condenser which will store 1 coulomb of electricity at a pressure of 1 volt, or which will take 1 second to be charged to a pressure of 1 volt by a current of 1 ampere.

**FILAMENT.**—In a thermionic valve, a thread of tungsten which, when rendered incandescent by the current from the filament battery, gives off a stream of electrons.

**FILAMENT BATTERY.**—The battery, usually 4 or 6 volts, which sends current through the filament of a valve and renders it incandescent.

**FRAME AERIAL.**—A portable aerial consisting of a number of turns of wire wound on a wooden frame. Reception is most effective when the incoming waves strike the coil edgewise, so that the direction of the transmitting station can be determined by adjusting the position of the frame until the maximum signal strength is obtained.

**FREQUENCY.**—The number of times per second that an alternating current or voltage attains its maximum value in one direction; the number of complete wireless waves received per second.

**GRID.**—A zigzag piece of wire, or perforated metal sheet, placed between the filament and plate of a thermionic valve. High-frequency impulses on the grid produce variations in the current flowing from plate to filament.

**GRID CIRCUIT.**—The circuit which externally connects the filament and grid of a valve, and is completed internally by the electron stream between them.

**GRID CONDENSER.**—A small condenser placed in the grid circuit to assist the grid in rendering the variations produced in the anode current unidirectional.

**GRID LEAK.**—A high resistance placed in the grid circuit, shunting the grid condenser, by means of which electrons which have settled on the grid on their way from filament to plate are enabled to drain away.

**GROUP FREQUENCY.**—The number of groups of damped oscillations per second sent out by a spark station.

**HARD VALVE.**—A valve which is as near a perfect vacuum as possible. Nearly all modern receiving valves are hard valves.

**HENRY.**—The unit of self-inductance, being that inductance which will so retard any change in the value of a current that it takes 1 second for 1 volt to raise the current in a circuit by 1 ampere.

**HETERODYNE.**—A system for the reception of continuous wave signals. The receiving circuit is supplied with oscillations at a frequency slightly different from that of the incoming waves. The two series of oscillations alternately add and subtract as they come into, or go out of, step with one another. This produces pulsations of amplitude at an audible frequency, known as "beats." A similar effect can sometimes be observed if two adjacent notes on a piano are struck simultaneously.

**HIGH FREQUENCY (H.F.).**—A term applied to alternations or waves which occur at frequencies too high for audibility; sometimes called "Radio Frequency." High frequency may be taken to include all frequencies above 20,000.

**HIGH-FREQUENCY RESISTANCE.**—The resistance which a conducting path offers to high-frequency currents. Skin effect (*g.v.*) renders this higher than the resistance that would be offered by the same path to a continuous or low-frequency current.

**HIGH-TENSION (H.T.) BATTERY.**—The battery which supplies the current flowing from the plate to the filament in a thermionic valve. Tappings off the same battery may be used to heat the filament if the battery is of ample current capacity.

**IMPEDANCE.**—The total opposition offered by a circuit, or piece of apparatus, to a varying or alternating current, being made up of the combined effects of resistance and reactance.

**INDUCTANCE.**—The property of a circuit which opposes and retards any change in the value of the current flowing. Inductance has the same effect upon an electric current as inertia or momentum has upon a moving body.

**INDUCTION.**—The production of an electromotive force in an electric circuit through the agency of another circuit, without any direct electrical connection between the two. Induction may be brought about by lines of electric force (electro-static induction), or by lines of magnetic force (electro-magnetic induction). Upon the latter depends the

working of the transformer and the loose coupler.

**INDUCTION COIL.**—A piece of apparatus for producing high-voltage unidirectional currents from a low voltage direct current supply. It is largely used for producing the spark discharge on ships' "emergency" transmitting sets and small land spark stations.

**INSULATOR.**—A substance used to prevent the flow of an electric current. The most common insulating materials are Air, Ebonite, India-rubber, Mica, Glass, Porcelain, Paraffin Wax, Paper, Cotton, and Oil.

**IONISATION.**—The liberation of charged particles of a gas, known as ions, which travel through the gas if the applied voltage is high enough, and so produce an electric current. The anode current in a soft valve is carried partly by ionised gas, as well as by the electron stream from the filament.

**JAMMING.**—Interference in the reception of signals caused by oscillations from other stations, or electrical disturbances in the atmosphere.

**KATHODE.**—See Cathode.

**KILOWATT (K.W.).**—The unit used for measuring large amounts of electric power, being equal to 1,000 watts, or  $1\frac{1}{2}$  horse power.

**LINE OF FORCE.**—The paths along which acts the force due to a magnet or electrically charged body.

**MAGNETIC FIELD.**—The space surrounding a magnet, extending as far as its magnetic influence is appreciable. Any space pervaded by lines of magnetic force is a magnetic field.

**MAGNETIC FLUX.**—An imaginary "magnetic current" which is assumed to flow round any magnetic circuit, the value of which is given by the number of lines of force, and depends upon the value of the applied magnetomotive force (*g.v.*).

**MAGNETIC FLUX DENSITY.**—The number of lines of magnetic force per square centimetre, or per square inch of sectional area of a magnetic path.

(To be continued.)

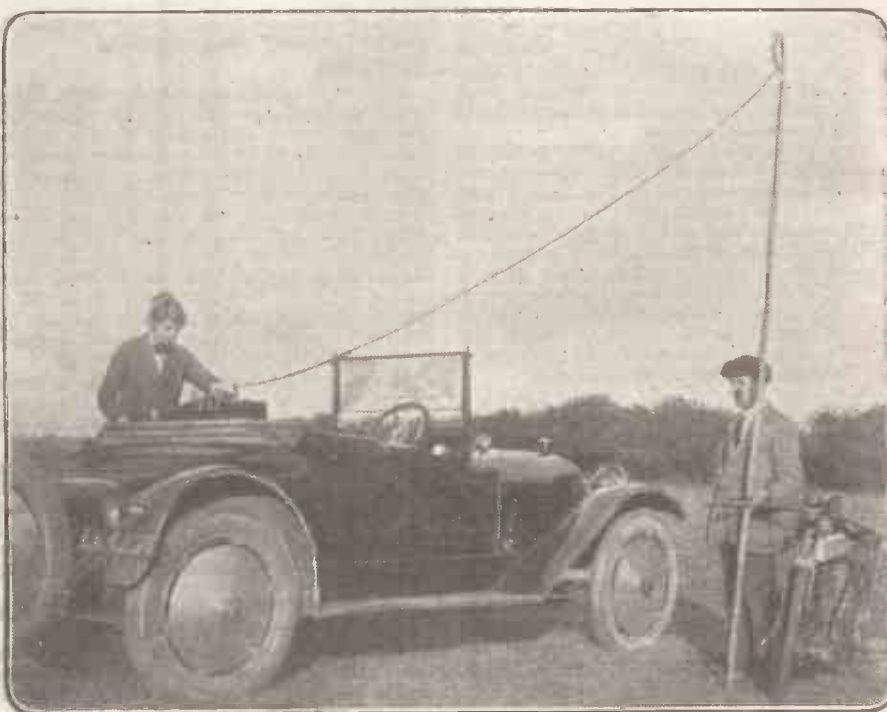

A mobile wireless set, with sectional mast.



# HOW TO MAKE A SIMPLE GALVANOMETER.

BY GEORGE SUTTON, A.M.I.E.E.

ONE of the earliest needs of the electrical experimenter, and especially the wireless amateur, is some "electrical sense."

The amateur wireless man has in his equipment already a detector much more sensitive than any galvanometer he could hope to construct, in the shape of his headgear telephones; but this very sensitiveness, in spite of the telephones being comparatively robust, is the means of its indications often being misleading.

### Magnetising a Needle

You might easily, testing for continuity of circuit with a telephone, get such indications

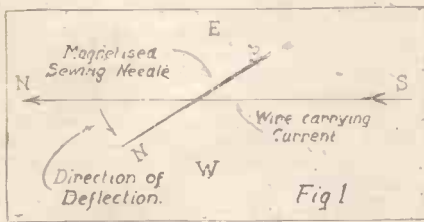

as would lead you to conclude that the circuit was continuous when it was not. The indications might be the result of a condenser so connected as to give the loud click in the telephones which is the usual concomitant of a continuous circuit containing a battery.

Now, with a few yards of fine silk or cotton covered or even enamelled wire, a magnetised sewing-needle, a single fibre of untwisted silk, and a small cork, it is easily possible to construct a galvanometer, or perhaps, more strictly speaking, a galvanoscope, which will render the experimenter good service.

To magnetise the needle, stick it in a piece of paper as one sees pins stuck in rows on paper when you buy a packet.

Then stroke it from end to end with one limb of a horseshoe magnet, or one end of a bar magnet. Say you start at the eye end of the needle and finish at the point; then lift the magnet in the air, carry it along clear of the needle, bring it down at the eye end again, and stroke along towards the point again. Do this a few times with the same pole of the magnet, and your needle will be fully magnetised. If you would like the point to point north, perform the operation with the S end of the permanent magnet.

One of the continually recurring puzzles of electricity is to know in which direction, according to the usual convention, the current is flowing, and our little galvanometer is peculiarly suited to that service, though its indications with regard to the amount of current are not to be too strictly relied upon. It is a matter of common knowledge that the current flowing in a wire creates a magnetic field in its vicinity, and it is also quite as well known that a magnetic steel needle, if hung freely, will attempt to point north and south.

The force which acts on the needle to make it point north and south is the magnetic force of the earth itself, and is, fairly constant in amount and direction. The north-pointing end of the needle points towards a spot up north of Canada, where the Earth's North Magnetic Pole is situated.

If we pass a current along a wire in the vicinity of the magnetised north-pointing steel needle, we modify the effect of the earth's magnetic field there, and we can no longer expect the magnetised needle to remain true to its first allegiance.

We therefore take a straight wire and fix it so that it is parallel to the needle as it is pointing north, and above it in position, and send

a current along it. The needle will be deflected right or left off its original course.

If we know the direction of the current, the direction of the deflection of the needle can be predicted; or, noticing the movement of the needle, the direction of the current flowing can be ascertained with certainty.

Fig 1.

If the current in a wire running parallel to a needle pointing to the north, and suspended above it, is passing from south to north, the needle will be deflected towards the west. To repeat in summary. Current flowing south to north over the needle will be deflected towards the West.

It will need a considerable amount of current if it only flows once past the needle to do the work; but if we make the current double back on its track, this time under the needle, it will have twice the effect, and a little reflection will show that as you have now reversed the direction of the current you have also reversed its position again with regard to the needle by taking it underneath, and the double reversal puts things straight again, so to speak.

Our galvanometer, then, consists simply in the means of taking a weak current many times round in the neighbourhood of a magnetic needle which we have made to point to the north, and now a very feeble current will

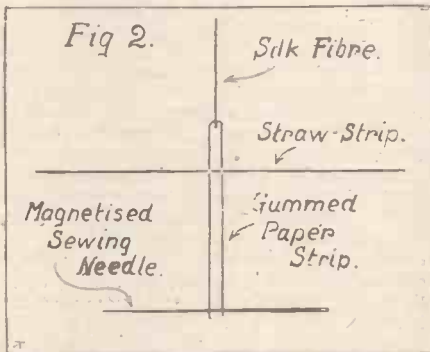

have considerable effect, because it gets its work in so many times in passing

### Construction

Now to construct our galvanometer. Take a few yards of any odd insulated wire which you have handy, and wind it upon a matchbox cover, so as to get a rectangular coil of wire. Dip it in hot melted paraffin-wax if you have it handy; if not, tie up the coil at several places with silk thread to keep it in shape, and then bring out the ends for fastening to terminals. Fine wire will be better than coarse, because you can get more turns in the space at disposal. It will be better, if you can, to wind half of the wire on each side of the box, and keep the box as a "former" to maintain the coils in shape. (Fig 3.)

If you would like a pointer outside to move over a card and give indications of the movements of the needle, a strip of light straw will be needed also. (Fig 2.)

Now put your magnetised needle into a stirrup or loop of gummed-paper, so that while it is swinging inside the matchbox, the straw is outside attached to the same strip of paper, and well clear of the coils. Everything must be as light and delicate as possible. (Fig 2.)

Resting upon the top of the coils of wire may be a card marked with degrees. (Fig 4.)

Take a piece of stiff wire, preferably not iron, and bend it round as indicated "wire frame" in (Fig. 4) making eyes in the ends so that a round-headed screw can fasten the

wire frame securely down to the wooden base board as indicated. Before bending up the second side slip on a medicine-bottle cork, as one end of the silk fibre has to be attached to this cork, forming a roller by means of which you can make the suspension longer or shorter till the needle swings clear of all obstruction.

### Connecting Up

A hole must be made in the card dial, so that the magnetised-needle can be inserted through the slit in the top of the matchbox, and swing

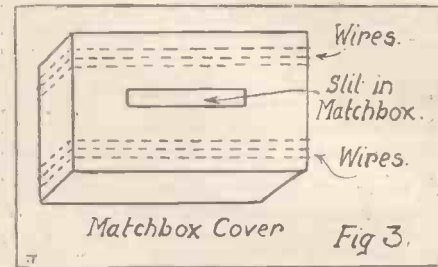

free inside. Now fix the matchbox carrying the wire under the card, bring the ends of the wire to the terminals, and your galvanometer is complete.

To use it, remove your telephone receivers, and all other permanent magnets well away, and turn the base round on the table till the needle swings freely backwards and forwards over a point which you will call your zero.

Get an old run-down dry cell, and connect the carbon terminal to one of the terminals of your galvanometer, and the zinc terminal to the other, and notice which way the needle deflects. As the conventional way of considering a current is that it leaves the positive or carbon pole, travels round the circuit, and returns by the zinc, it will be useful if you so arrange the wires from the matchbox to the galvanometer terminals that the deflection is away from the carbon terminal. In other words, make it appear as if the current were driving the magnetised needle in the direction it was going itself, and then it will be an easy indicator of direction of current.

A couple of pins stuck into the card to prevent the pointer swinging too far would be advisable. If one wire of the circuit you are testing is clamped into the binding screw, and you touch the other terminal with the free wire of the other end of the circuit in time with the oscillations of the needle, as you would push a child's swing, you can get very much magnified effects with a comparatively small current.

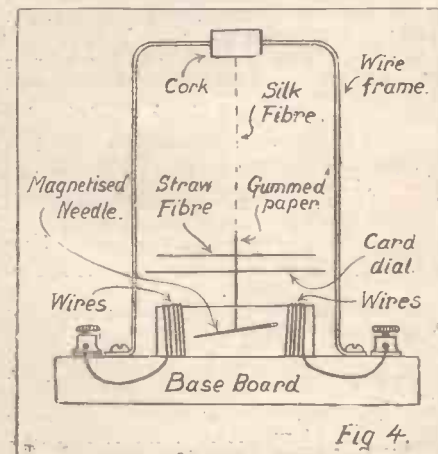

# ALL-BRITISH WIRELESS EXHIBITION

AND  
CONFERENCE

**Sept. 30 (1922) Oct. 7**

SATURDAY

SATURDAY

**HORTICULTURAL HALL,**  
Vincent Square, Westminster, S.W.1.

**Special Public Day, October 3rd**

**Special Trade Day, October 2nd**

ADMISSION **5/-** Including Tax

ADMISSION **1/3** Including Tax

*(Public admitted both days after 6 p.m. at the usual price.)*

At this Exhibition visitors are assured of several hours' pleasure, as the exhibits include the finest and most efficient instruments ever manufactured, as well as many of historical interest.

At this Exhibition there are 52 Wireless Manufacturers and Suppliers, who in every case will show nothing but Wireless goods.

At this Exhibition many Exhibitors will be showing for the first time Wireless apparatus and accessories of new and novel design.

At this Exhibition two prominent Wireless Publishing Companies are placing before the Public the finest selection of technical books on Wireless ever offered.

At this Exhibition there is one Stand occupied by the Organisers, who have made every preparation to assure the pleasure and comfort of thousands of visitors.

At this Exhibition there will be "Broadcast" Wireless Concerts and Demonstrations throughout the day.

At this Exhibition there will be an orchestra to entertain you during the periods when Wireless demonstrations are not taking place.

At this Exhibition you will find a comfortable Lounge opposite the Demonstration-stand.

At this Exhibition the Wireless Society of London have made every arrangement for a Convention, having the full support of all the Affiliated Societies and Clubs.

At this Exhibition Lectures on Wireless will be given by many of the best-known Lecturers in Great Britain.

At this Exhibition you will find courteous and competent representatives of the Exhibitors ready and willing to give you advice and assistance at all times.

At this Exhibition you will at all times be able to secure light refreshments at popular prices, as well as lunches, teas, and suppers.

At this Exhibition there will be an official catalogue containing over 144 pages.

At Stand No. 55 the Organisers will be displaying notices of times of Broadcast Wireless Concerts and Demonstrations as well as information regarding the Wireless Lectures.

**Organisers: BERTRAM DAY & CO., LTD, 9-10, Charing Cross, LONDON, S.W.1.**

## COMPLETE AND EFFICIENT ONE-VALVE RECEIVING SET

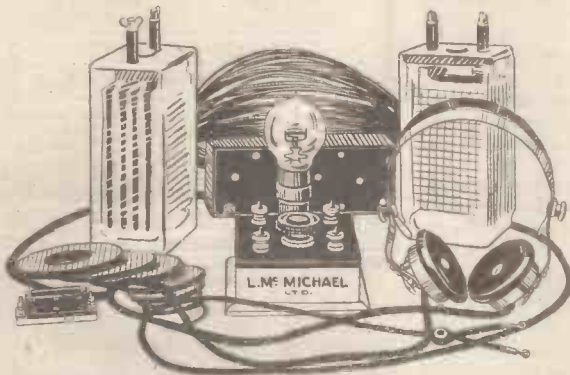

	£.	s.	d.
1 Valve Panel, in mahogany box, with circular filament resistance	1	14	0
1 Variable Condenser	1	0	0
Complete set of slab coils for all wave-lengths	1	15	0
1 Valve (Ex-Government, if in stock)	1	12	0
1 Battery, 72 Volts, tapped off every 4 Volts	1	15	0
1 4-Volt Accumulator	1	0	0
100 ft. Aerial Wire, best enamelled, stranded Copper	7	6	0
2 Insulators	2	0	0
1 pair Head Telephones	1	10	0
60 ft. 19/30 Tinned and Rubber-covered Cable, for earth connection and wiring	1	6	0
	<b>£6</b>	<b>17</b>	<b>0</b>

VISIT OUR STAND, No. 43,  
All-British Wireless Exhibition, Horticultural Hall,  
Sept. 30—Oct. 7.

Illustrated Catalogue (P/W) 16 Pages. 100 Illustrations. 6d. Post Free.  
When writing please mention this publication.

**LESLIE McMICHAEL, Ltd.,**  
Providence Place, West End Lane, KILBURN, N.W.6  
(Bus Services 1, 8, 16, 28, 31 all pass West End Lane.)  
Telephone: HAMPSHIRE 1261. Nearest Tube Station: KILBURN PARK (Bakerloo).

## A Receiving Set without 'Phones is like a ship without a rudder.

### The "Brown" Super-Sensitive Telephones

These Telephones are unquestionably the clearest and most sensitive made, and, consequently, increase the distance over which wireless can be heard. BROWN'S are recognised as the most comfortable to wear, due to their extreme lightness in weight and adaptable adjustment. There is no wireless head 'phones in the world to compare with BROWN'S.



#### WIRELESS INSTRUMENTS

and parts manufactured by and bearing the name "BROWN" can still be bought with absolute confidence in their quality, value, and efficiency, because throughout this period of increasing wireless activity S. G. BROWN, Ltd., have wisely refused to lower their high standard of quality

#### ILLUSTRATED CATALOGUES POST FREE

**IMPORTANT NOTICE.**—When purchasing BROWN'S, you should see that the name BROWN is stamped on the back of each ear-piece.

IN UNIVERSAL USE. AS SUPPLIED TO BRITISH, ALLIED, AND FOREIGN GOVERNMENTS.

Visit Our Stand, No. 43, ALL-BRITISH WIRELESS EXHIBITION, HORTICULTURAL HALL September 30 to October 7

Head Office and Works—  
VICTORIA Rd.,  
NORTH ACTON,  
LONDON, W.3.



London Showrooms—  
19, MORTIMER STREET,  
LONDON, W.1.



# THE FIRST WIRELESS.

By  
HORACE VENTON.

**NOTE: POPULAR WIRELESS** expresses no opinion on the theory given in this article. Readers' comments are invited.

It has been constantly said that all man's inventions have been anticipated by Nature, and the more extraordinary a discovery appears to be the more likely, apparently, are we to find that the law underlying it has been in constant operation before our eyes.

It is highly probable that this is so in the case of wireless telegraphy. There are many phenomena, which lead us to believe that all animals, and perhaps even plants, are endowed with the capacity of communicating with each other by means which, if not identical with wireless telegraphy, are certainly akin to it.

One of the most striking discoveries of the



Antennæ of plumed gnat.

of the head. In some cases they may certainly be used by the insects as feelers pure and simple; but in the large majority of cases they are used for a very different purpose, undoubtedly for distant communication between themselves and others of their species.

A striking example of insect wireless is that exhibited between the different sexes of certain species, the most remarkable case being that of the Emperor moth, the male being able to detect the presence of the female by means of its antennæ even though a mile away, as has been shown by constantly repeated experiments. When the male insect has had its antennæ removed it is quite unable to detect the female's presence.

Generally speaking, the antennæ of the male insect are much larger and more highly organised than those of the female. In some instances, as in that of the cockchafer, they consist of a series of extremely delicate plates, or "lamellæ," whilst in others, as in that of the gnat, they are built up of a large number of joints forming a highly flexible central stem having innumerable thread-like branches which in all probability "pick up" the wireless waves given out by others of the same species.

The antennæ of the male gnat forms one of the most beautiful microscopic exhibits, whilst that of the plumed gnat, an allied species, is almost equally beautiful.

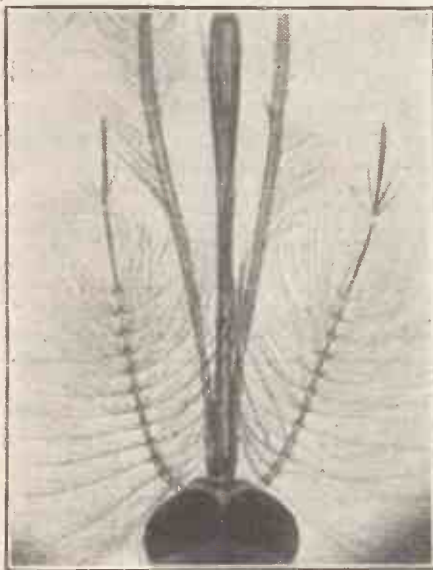

Head and antennæ of male gnat.

past few years in support of this is the fact that it has been shown that the migrations of birds are definitely affected by the electrical waves given out by a wireless transmitter. Birds within an electrical "field" seem to lose all sense of direction and are unable to find their way, and homing pigeons crossing the path of wireless waves have been unable to find their homes.

### The "Antennæ."

Telepathy between certain persons of a peculiarly sensitive type has been definitely established by the researches of the Psychological Research Society, and the most probable explanation of such phenomena is that they are electrical in origin and allied to those we are now able to produce and control by means of our complicated system of electrical apparatus.

But it is among the insects that the most startling examples of natural "wireless" are found. In this family of living creatures special organs have been evolved by means of which messages are capable of being sent over considerable distances from one insect to another, and it is a very curious fact that one of the chief parts of a wireless telegraphic plant should derive its name of "antennæ" from those curious organs of insects in which, apparently, their power of distant communication is located.

The "antennæ," or "feelers," are situated in the case of most insects in the frontal part

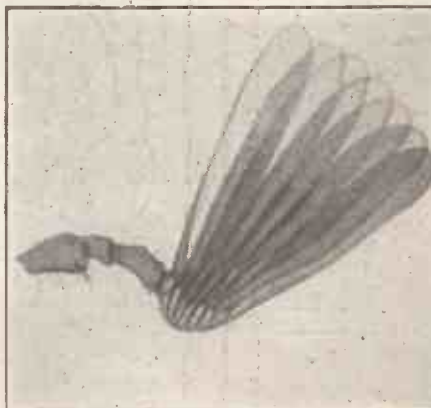

Antennæ of male cockchafer.

### TO AMATEUR TRANSMITTERS.

In order to make the POPULAR WIRELESS List of Amateur Transmitting Stations as complete as possible, will amateurs please send details on a postcard to the Editor as soon as possible.

## WIRELESS SUPPLIES

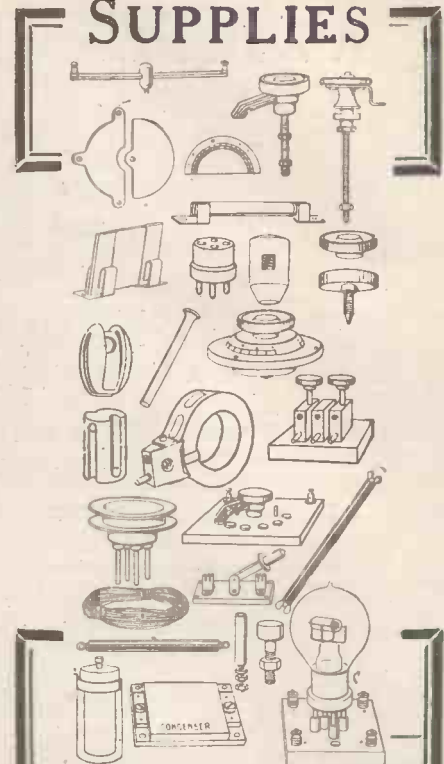

**ACCESSORIES & PARTS FOR MAKING SINGLE, TWO, THREE, & FOUR VALVE RECEIVING SETS, CRYSTAL SETS, VALVE PANELS, TUNING PANELS, ETC. ETC.**

Made in agreement with the Patent Holders.

**TRADE ONLY**  
CATALOGUE A/23  
Free on request

**Ward & Goldstone**  
PENDLETON. MANCHESTER, ENGL.

**ACCUMULATORS, etc. New & Guaranteed**  
4-Volt, 25-Amp. Celluloid 11/3d. Postage 1/-.  
4-Volt, 40-Amp. 17/6d. | 6-Volt, 40-Amp. 25/6d.  
4 " 60 " 21/3d. | 6 " 60 " 31/-  
4 " 80 " 27/- | 6 " 80 " 36/-  
Packing 1/6d. extra. | Packing 2/- extra.  
7/22 Aerial, 6/- 100 ft.; Mullard Ora Valves, 15/-;  
15-V. Siemens, H.T. Batteries, 4/-; Marconi R. Valves, 28/6d.; Accumulator Charging Board, 37/6d.;  
Voltmeters, Watch pattern, 0/12 Volts, 6/-.  
Cash with order. Goods despatched per return.  
**LOWKE & SONS, Ltd., Northampton.**

## SPEARS and COMPANY FOR TERMINALS

SCREWS, NUTS, WASHERS, PLUGS and SOCKETS, CONTACT STUDS, BUSHES, VALVE LEGS, CONDENSER PLATES, and TURNED and PRESSED PARTS OF :: EVERY DESCRIPTION. ::

Actual Manufacturers to Trade Only.

We regret we cannot supply small lots to amateurs.

Send for Illustrated List.  
CAPSTAN REPETITION WORKS,  
PARK RD., HOCKLEY, BIRMINGHAM.  
Phone: 3265 Central. Grams: "Firettes" B'ham.

# Wireless without worry

## The Cosmos Radiophone

shown in illustration is a neat and compact two-valve set capable of receiving Broadcast Concerts, etc., perfectly over a range of 50 miles under normal conditions. It is delightfully easy to understand and to manipulate. No radio knowledge is required, and worrying adjustments are unnecessary.

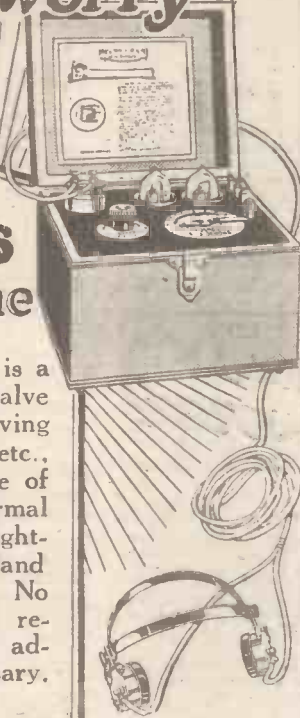

COSMOS RADIOPHONES comprise Crystal Types, Valve Sets, Amplifiers, and Loud Speakers, and are being demonstrated at the ALL BRITISH WIRELESS EXHIBITION AND CONVENTION, Horticultural Hall, Westminster, London, S.W.1. SEPTEMBER 30th to October 7th.

The "Cosmos" Crystal Type Radiophone is sold complete with aerial, insulators, "leading-in" tubes, earthing materials and one set of double head telephones for

**£4-10-0**

The "Cosmos" Two-valve Radiophone is sold complete as above (and in addition the necessary batteries are included) for

**£23-10-0**

*If you cannot see us at the Exhibition you are invited to call at our SHOWROOMS, 232-3, HIGH HOLBORN, LONDON, W.C.1.*

*Demonstrations given continually while broadcasting is in progress.*

# METROPOLITAN Vickers

ELECTRICAL

CO. LTD

Works: TRAFFORD PARK, MANCHESTER.

4007

G. R. C. 25

# "AMPLIPHONE"

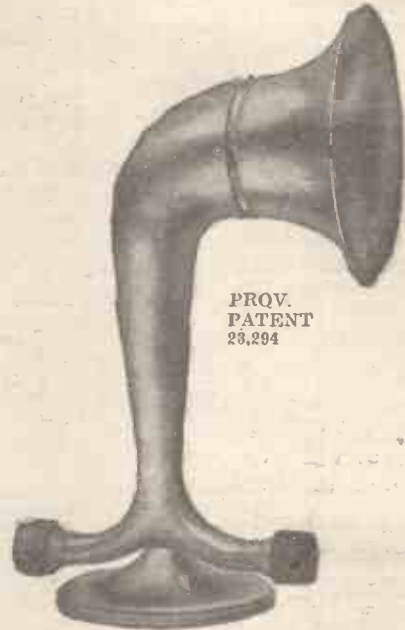

PROV.  
PATENT  
23,294

## LOUD SPEAKER.

Just slip your headphones on the "Ampliphone" and you have a perfect Loud Speaker. Nothing further required. Most Loud Speakers are merely a single receiver attached to a horn. With the "Ampliphone" the volume is doubled because two headphones are blended into one powerful tone—and you save half the usual cost when you buy the "Ampliphone."

Polished cast Aluminium body with nickel-plated base and horn—a fine addition to any receiver.

**PRICE £2 : 2 : 0**

When you forward your order, request a copy of our Catalogue. It will interest you.

Factors and Dealers. — We protect you with reasonable discounts and prompt deliveries.

Manufactured by

**GENERAL RADIO COMPANY**

Affiliated with The

COX-CAVENDISH ELECTRICAL Co., Ltd.,

Twyford Abbey Works,

HARLESDEN, N. W. 10.

SHOWROOMS :

105, Great Portland St.,  
LONDON, W.1.

Branches :

Danefield, Church Street,  
BRADFORD.

15, Hanover Street,  
EDINBURGH.

AGENTS :

WIRELESS SUPPLY CO.,

High Street,  
BIRMINGHAM.

MOTTERSHEAD & CO.,

7, Exchange Street,  
MANCHESTER.

And all Principal Countries.

We are exhibiting a complete line of Radio Instruments of every description at the All-British Wireless Exhibition, Horticultural Hall, Sept 30 to Oct. 7.  
**DO NOT MISS OUR STAND—No. 26.**



## ELECTRADIX RADIOS.

Immediate Delivery from our Huge Stocks.

Everything from a Recorder to an Earth Clip.

The best-equipped City depot.  
COME AND SEE US.

9, Colonial Avenue is first opening on left in the Minorities, near Aldgate Station, Metropolitan Railway.

**LESLIE DIXON & CO.** Tel.: Avenue 4166.  
9, Colonial Avenue, London, E.1.

### LOUQ SPEAKERS

£2 (120 w); £2 2s. (2,000 w); £2 5s. (4,000 w); Carr. Extra. Sullivan's Head 'Phones, 120 ju, Sec. Hand, 10/6 pair. Single Receivers, 150 w, 3/-, 3/6 each. Fitted Canvas Band, Strap, and Cord, 5/-. Fitted Steel Band, 5/6. Post Free.  
A. ROBERTS, 2, Midmoor Rd. London, S.W.12f

## THE "S. R." SET

Complete with double slider 'phones, 100 ft. aerial, insulators, and mounted on superb mahogany base.

Ready for use, £4-0-0.

Showrooms: 8, Cavour St., and 19, Darcy Road, Kennington at Norbury, S.W.

## STAPLETON & ROBBINS

LET US REWIND AND ADJUST YOUR RECEIVERS.

Complete Set (4,000 ohms) 15/-.

Return postage 6d. extra.

KNIGHT & WEBB, 32a, Oak Grove, London, N.W.2.

WRIGHT BROS., Electrical & Radio Engineers, 38, CROSS STREET, SALE, MANCHESTER.

### SPECIAL WIRELESS NOTE.

Notice—We beg to inform all Wireless Enthusiasts our New Wireless-Catalogue is now ready.

Filament Resistances. Complete with best Ebonite knob, pointer, heavy stop pin, 8 to 10 ohms resistance Each 3s. 6d.  
Combined Ebonite dial and knob. Engraved and Polished, 3 in. dia. Each 2s. 9d.  
Catalogues 2d. post free. Satisfaction or money refunded.

TRADE SUPPLIED.

Wireless Aircraft 'Phones, 120ohms, complete with head-band and cords, 15/-. 'Phones, 400ohms complete with head-band and cords 27/6. Variable Condensers, 59 Plate, 17/6. 25 plate, 10/6. Crystal detectors, 4/-. Everything in stock at manufacturers' prices. Condenser plates 9d. doz. Robert Lassman, 8, Leadale Rd., Stamford Hill, N.16.

## TO THE TRADE.

Ebonite—Copper Wire, Bare & Covered Aerials—Sleeving, &c.

Wireless Supplies. Prompt Delivery.

Cables & Electrical Supplies, Mica House, Offord St., Caledonian Rd., London, N.1. Telephone: North 803

## PARTS

Condenser Vanes . . . . .	doz.	1/9
Ivoryine Scales . . . . .	6d.	
Labels . . . . .	doz.	1/9
H.T. Batteries, 15 v. . . . .		3/6
Filament Resistance . . . . .		4/3
Condenser, panel type, .001 . . . . .		19/-
" " " " .0005 . . . . .		12/-
Telephones, 4,000 ohms . . . . .		25/-
Telephone Transformers, . . . . .		
for 120-150 ohm 'phones . . . . .		15/-
Intervalve Transformers, L.F. . . . .		18/6
Postage Extra.		

**S. E. PARKES & Co., Ltd.**  
46, Camberwell Green, London, S.E.5.

# RADIOTORIAL

All Editorial Communications to be addressed The Editor, POPULAR WIRELESS, The Fleetway House, Farringdon Street, London, E.C.4.

During the week amateurs will be flocking to the All-British Wireless Exhibition, there to feast their eyes and drain their purses on the many fascinating and novel exhibits. This number of POPULAR WIRELESS should prove rather more useful than ever to the amateur, because it contains a thoroughly comprehensive account of the exhibitors at the Horticultural Hall. The special supplement has been compiled with a view to enabling advertisers to acquaint readers of the paper with the particular novelty and special features they are desirous of calling attention to.

I feel sure it will be found extremely useful.

EDITOR.

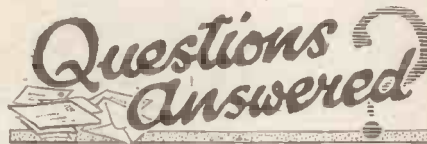

Owing to the enormous number of queries received daily from readers of POPULAR WIRELESS, I have decided to reply individually by post. A weekly selection of questions will, however, be printed on this page, together with the answers, for the benefit of readers of POPULAR WIRELESS in general. Questions should be clearly and explicitly written, and should be numbered and written on one side of the paper only.

All questions to be addressed to: POPULAR WIRELESS, Queries Dept., Room 131, The Fleetway House, Farringdon Street, London, E.C.4.

Readers are requested to send necessary postage for reply.

F. B. (Leyton).—What exactly is this polarised light mentioned by your American Correspondent and exactly how is it produced?

Polarisation is a particular modification of the rays of light by the action of certain media or surfaces so that they cannot be reflected or refracted again in certain directions, thus being in a state of having polarity. The subject is altogether too vast to deal adequately with in these columns, and you should endeavour to obtain access at a public library to the Encyclopedia Britannica and read the long article that it contains on polarisation.

Do wireless waves conform to the spectrum? If so, could they not be expressed as a colour?

The frequency of wireless waves is comparatively slow compared to light, and would be far below the lower end of the spectrum.

"CURIOUS" (Norwich).—I have been given to understand that waves, whether wireless or sound waves, have the varying values of amplitude and length only. In the case of sound waves or frequencies superimposed on C.W. for the purpose of transmitting telephony, I take it that the length of the wave will determine the pitch of the signal and the amplitude the strength. So far so good, but that gives merely a musical scale. What I mean is that if that is all there is to it I cannot understand how voices are reproduced or several instruments heard simultaneously any more than I can see how you could make a tin whistle talk. Can you explain the missing link?

All sounds have three characteristics and not two. These are Pitch, Amplitude and Timbre or quality. This latter is very difficult to define, but it is that subtle characteristic which enables one to distinguish between sounds of the same amplitude and pitch transmitted by say two different musical instruments or two different voices. The exact nature of this will depend upon the harmonics that accompany the main vibration. Therefore a sound wave is not the simple crest and trough that it is usually represented to be for the purpose of theoretical simplicity, but in the case of the human voice, for instance, it is of an

extremely complex nature. To give an example of simple quality differentiation take two similar notes emitted by two different instruments. The strings will vibrate as a whole, causing the main pitch or frequency, but they will also vibrate in sections, and thus cause the main vibration to be accompanied by harmonics at exact multiples of the main frequency which will differ in each case in accordance with the particular tone characteristic of the instrument.

"OHM SWEET OHM" (Sunderland).—How much and what kind of wire is required for a filament resistance to be of the circular type? Eight to ten feet of No. 25 "Eureka" resistance wire.

J. R. B. (Yardley).—Is it necessary to have the windows open when using a frame aerial? No; wireless waves are not air waves.

"BROADCAST" (London).—I am within a few hundred yards of Marconi House, and it is always necessary to tune them out, otherwise I cannot keep my crystal adjusted. Is there any detector that would let me tune this station in to its full strength, without using valves, so that I could use a loud speaker?

A carbonium and steel without a battery and potentiometer. These latter would be essential for the less powerful signals.

"PHONETIC" (Caterham).—How can I discover the polarity of H. R. phones that are not marked so that I shall know how to connect them up on a three valve set?

By checking the winding if visible and the polarity with a compass needle, using Ampère's rule as explained in the "New Series." Another and simpler test is to carefully remove the diaphragm and suspend as much weight by the magnets as they will carry, switching on a small current. The direction of a current that makes the weight fall is the wrong direction.

M. F. G. (Southend-on-Sea).—What length of slate pencil will be required to make a grid leak, and is there any particular objection as to its use?

The resistance is about 1 megohm per centimetre and therefore some 2 cms. or an inch will be required. The resistance of slate is liable to some considerable variation owing to dampness, and it is advisable to enclose such a grid leak in a glass tube.

"BURNTOUT" (Peebles).—Are valves that have accidentally had the H. T. put across them of any further use, and is there a firm that could undertake to repair same?

These could not be repaired for a sum less than the initial cost of a new valve. It is always advisable to keep old valves by, as the bases are very useful in the construction of plug in apparatus such as plug in high frequency transformers, etc.

T. J. D. (Farnham).—What is the cause of an awful screaming in the telephones while adjusting the reaction coil of my one valve set?

Your circuit is oscillating at audio-frequency due to stray fields in your circuit. Loosen the coupling of the reaction and see that all leads, etc., are well separated.

W. T. O. (Leicester).—What is the shortest wavelength practicable?

We are sorry to say that many amateurs are finding 50-80 metres quite practicable for illicit conversation. While listening-in on such wavelengths recently we heard several stations (no call letters given) indulging in a conversation the main topic of which seemed to be the improbability of other stations (more especially official stations) tuning down on them. Experiments have been conducted at Carnarvon using 3 metres and even lower wavelengths than that with considerable success for directional transmission.

(Continued on page 383.)



Established 1900.

CONSIDER WELL YOUR FUTURE

WE TEACH BY POST.

ADVICE FREE Most moderate charges—payable monthly.

LEARN A TRADE OR PROFESSION

Can I help you? I WILL GIVE YOU £50 if I fail to produce over 7,000 testimonials from others I have helped TO A SUCCESSFUL CAREER. Yours to success, J. H. Bennett

**ARE YOU QUALIFIED FOR THE JOB YOU SEEK?**

Write for one of our FREE BOOKLETS on WIRELESS TELEGRAPHY, or on any of the following subjects—

Architectural Drawing Building Construction Clerk of Works' Duties Aviation Boiler Engineering Boiler Making Chemistry Civil Engineering Concrete and Steel Draughtsmanship Electricity Engineering Foundry Work Internal Comb Engines Marine Engineering	Mathematics Matriculation Metallurgy Mining Mine Surveying Motor Engineering Naval Architecture Pattern Making Salesmanship Sanitation Shipbuilding Structural Engineering Surveying and Levelling Telegraphy and Telephony Special Course for Apprentices
---	--

What proof do you carry? Your word to an employer is not proof that you are efficient, but a College Qualifying Diploma or Certificate, signed by the Professional Staff, is a proof of efficiency, and a valuable asset in seeking a remunerative position.

We specialise in all exams connected with Wireless and other technical subjects. If you are preparing for any exam, ask our advice. All particulars FREE OF CHARGE. Parents should seek our advice for their sons. If you are interested in Wireless, or any of the subjects mentioned above, write, naming the subject, and we will send you our FREE BOOKLET. Please state your age.

**The Bennett College**  
Department 106. SHEFFIELD

COURSES SPECIALLY COMBINED TO MEET ALL REQUIREMENTS.

# Have this for **FREE TRIAL** in Your Own Home **THE PERFECT RADIO RECEIVER**

ALL BRITISH. Gives Perfect Reception of:—

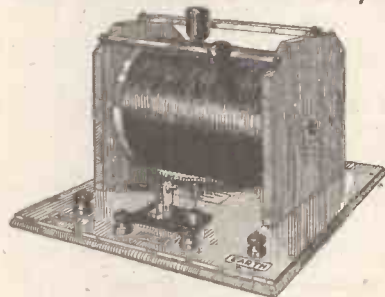

Music and speech from broadcasting stations, within the usual radius, spark signals from ships' stations, etc.

**SPECIFICATION.**

This is a thoroughly well-made and finished Receiver, consisting of Two-slide Tuning Inductance Coil 6 in. by 3 1/2 in., Ball and Socket Detector, Telephone Condenser, Terminals for Aerial, Earth and Phones, mounted on solid Mahogany Base. Guaranteed to give splendid results.

Price £2-2-0.

## THE LEFCO DE-LUXE CRYSTAL SET

A larger and more expensively fitted instrument  
Designed by Wireless experts after exhaustive experiments, and All-British made

YOU CAN RECEIVE PERFECTLY WITH THIS SET

Music and speech from broadcasting stations within the usual radius and many amateur stations, spark signals, weather reports and forecasts from aircraft and ships' stations, time signals from Paris

By reason of its special design and scientific construction, this Radio Set gives perfect efficiency on all wave-lengths from 200 to 2,000 metres.

**SPECIFICATION.**

2-Slide Tuning Inductance Coil, of special design 12 in. by 3 1/2 in., ebonite panel, 12 by 5, correctly engraved, ball and socket detector, high-class testing buzzer and key, telephone condenser, terminal for aerial, earth, and phones. The whole enclosed in solid Mahogany Cabinet, with drop front, as illustrated.

Slider Rods, mounted on ebonite brackets, ensuring perfect insulation.

No expense has been spared in making this a thoroughly practical and easily operated instrument. No accumulators. Complies with P.O. regulations.



Price £4-4-0.

Full instructions for setting up and operating included with each set.

SEND NOW FOR YOUR FREE TRIAL

Our RADIO RECEIVERS are sent on free trial, so that you may test them in your own home, on the distinct understanding that if not exactly as described above, and capable of giving the results promised, we will

RETURN YOUR MONEY IN FULL

You may see and demonstrate either set at our Showrooms, or send your order, with cheque or money order payable to us, when the Perfect Radio Receiver will be forwarded post free without delay. Fuller particulars sent post free.

Double Head-phones, 4,000-ohm, 32 ft. 100 ft. Aerial and 3 Insulators, 12/6.

THE

**London Electrical Equipment Co.,**

27, FINSBURY STREET, LONDON, E.C. 2.

# WIRELESS SUPPLIES PERRYPHONES

From Stock. Immediate Delivery.

4000  
ohms



21/-  
Per Pair

Specially designed for Wireless Telephony, Receivers arranged in series, Magnets Mounted in Aluminium Cases and fitted with extremely light and Efficient Head Bands, and Twin connecting cords

**THE JEARY ELECTRICAL Co., L'd.**

8, Lambeth Hill, and 97, Queen Victoria Street, LONDON, E.C.

Union Chambers, Temple Row, BIRMINGHAM; 95, Waterloo Street, GLASGOW.

Telephones { LONDON: Bank 5075 (Private Exchange to all Departments)  
GLASGOW: Central 5239, BIRMINGHAM: Central 2379



# THE GOODS!!!

**HAVE YOU A GRAMOPHONE?  
THEN GET A  
GRAMAPHIX LOUD SPEAKER**

**THE GRAMAPHIX multiplies sound!  
THE GRAMAPHIX fits any gramophone!  
HAVE YOU HEARD THE GRAMAPHIX?**

**I**T produces full volume of sound without distortion and makes your gramophone a **RADIO LOUD SPEAKER.**

The Gramaphix is the result of considerable time and expense which has enabled us to offer a **LOUD SPEAKER** with exclusive features **AT A PRICE WITHIN THE REACH OF ALL.**

The Gramaphix utilizes the scientifically designed tone amplifier of the gramophone to secure mellowness and **BEAUTY OF TONE**, therefore doing away with all that metallic sound, scratching and "ring" associated with other loud speakers.

The Gramaphix is the talk of the wireless world. **ADJUSTED IN A MINUTE** by a child.

**LATEST AND LOUDEST.**

Why pay pounds when a better instrument can be secured for  
Apply for **10/6** Immediate  
Trade Terms. Delivery.

See it demonstrated at the All-British Exhibition,  
Horticultural Hall, September 30—October 7, 22.

**Lacland Electrical Manufacturing Agency (Dept. Q.),  
68, GREAT QUEEN STREET, KINGSWAY, W.C.2.  
GERRARD 5341, HOLBORN END. (See also our advert. on page 388.)**

# "Ever-Ready" British Made

The Standard of Quality  
**FIRST AND FOREMOST**



## HIGH TENSION BATTERIES

As supplied to H.M. Government. The highest electrical efficiency maintained. Any size or voltage with any tappings or sockets at 3 or 6 volt intervals for use with Wander Plugs can be supplied to order. With 13 sockets as illustrated.

No. W.10. 36 volts, 24 cells, 8/6 each.  
Size 6 1/2 x 2 1/2 x 3 1/2. Weight 2 lb. 8 ozs.  
With 2 Spring Contacts.

No. W.11. 15 volts, 11 cells, 3/6 each.  
Size 9 1/2 x 1 1/2 x 2 1/2. Weight 1 lb. 2 ozs.

Art Catalogue of Standard Sizes and Voltages and list of Accumulators for Valve Filament Supply sent on request. Dept. P.W.

**THE EVER-READY WORKS, Hercules Place, Holloway, N.7**  
Visit our Stand, No. 11, for All-British Wireless Exhibition, Horticultural Hall, September 30th to October 7th.

## SELF CONTAINED OR UNIT SYSTEMS

**Marconiphones,  
Marconi Scientific Units,  
Waveora Units, Etc.**

**3-VALVE DRAWING ROOM BROADCASTING OUTFIT**, complete, and including Brown Loud Speaker; 20 gns.

**CABINETS** from £30 to £300.

Special quotations for Technical Colleges, Schools and Educational Institutions.

**The Radio Waveora Co. (Dept. P.),  
168, Regent Street, London, W.1.**

Telephones: Gerrard 3039; Western 847.  
Telegrams: Wychwood, Phone, London.

## WIRES FOR WIRELESS

TRENT MILLS

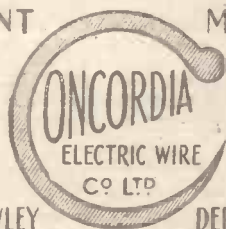

NEW SAWLEY DERBYSHIRE

Silk. Cotton. Enamel. Resistance. Aerials

## Quality - - - PRICE - - - RIGHT

and see you get the address

Complete sets of Metal Parts with Knob and Engraved Scale for making Variable Condensers, with Ebonite,  
-001 10/-  
-0005 8/-  
-0003 6/-

Postage 9d. extra.

Oak cases for above, 3/- and 3/6 each. Postage 9d.

**HEAD 'PHONES, 4,000 OHMS.**

The greatest bargain ever offered, one quality only, **THE BEST. 25/-** per pair. Complete with Cords and ends. Call and see these at our Showroom. Postage 1/- extra.

**BUILD YOUR OWN CRYSTAL SET.**

12-inch Coil, Base and Ends in Teak, Rod and Slider. Crystal Detector and Terminals. First-class finish throughout - - - **167/-**. Postage 1/6.

Set made up complete - - - **27/6**

100-ft. Aerial, 4 Insulators, 10 yds. Leading-in Wire, **7/6**. Postage 1/6.

**PARROT LOUD SPEAKER** repeats everything it hears. **2,000 OHMS.**

**50/-** each complete. Wall Pattern.

Hertzite Crystals, the best yet, 2/6 each. Mounted in Brass Cup with Screw, 3/- each.

**YOU CANNOT BEAT US FOR PRICE AND QUALITY.**

Every Accessory for Wireless in stock at Lowest Prices, consistent with Best Quality. **CATALOGUE FREE.**

**WILL DAY, LTD.,**

**19, Lisle St., Leicester Sq., London, W.C.2.**

'Phone: Regent 4577. Telegrams: Titles, Westrand, London.



## RADIOTORIAL QUESTIONS AND ANSWERS.

**E. V. D. (Wanstead).**—Will low resistance telephone receivers with a suitable transformer be as good for a crystal set as 8000 ohm receivers?

No; the high resistance 'phones are preferable.

**"PENSIE" (Halifax).**—For what useful reason is a potentiometer control included in the circuit of my four valve set with two stages of high frequency amplification? I do not use it, and it seems to make little or no difference whether I do or not.

You have not required to use the potentiometer evidently because you have not experienced any trouble due to re-generative action taking place between the two tuned circuits. When both the grid and plate circuits are tuned to approximately the same wavelength self-oscillation usually occurs, and it is then that potentiometer control operating on the grid potential of the high frequency valves is useful.

**C. S. D. (Reigate).**—How can I make a magnetic detector?

For small amateur aeriols it would not be worth while constructing such a detector. A cartorium and steel with battery and potentiometer will give you better results.

**W. B. B. (Newcastle).**—Is there any difference between an amplifier and a magnifier?

Yes; these terms are applied to radio-frequency and audio-frequency apparatus respectively.

**"LAIREA" (Bradford).**—What will be the better, a 70 ft. single aerial 40 ft. high at both ends or a 50 ft. double 35 ft. at one end and 45 at the other?

The longer single aerial will prove the most efficient.

**T. R. (Reading).**—What are the relative advantages of a grid leak and a grid potentiometer?

That is impossible to say as the functions are entirely different; they cannot be regarded as alternative pieces of apparatus. Using a grid condenser a potentiometer is useless and theoretically a leak is essential, but in practice this is not always the case owing to the presence of accidental leaks. If a grid condenser is not used a grid is useless and a potentiometer control very useful. See also reply to "Pensie" (Halifax).

**"OLD SOLDIER" (Bristol).**—I experience considerable "fading" on my single valve set and always at the most critical and interesting moment. If I disconnect the H. T. I can start all over again, but the same thing happens once more just a few moments after I have settled down comfortably. Can you advise as to the cause and remedy?

It is hard to give a definite opinion, more especially as you do not send a diagram of your set, but it is probably due to a broken grid circuit, which causes the grid to become negatively charged, thus causing the signals to "fade" until sufficient potential has accumulated for the grid to discharge itself. An easy test is to remove the top of the panel carefully while the set is in operation and at the moment of fading touch the grid leak or connection at the grid valve leg terminal with a damp finger. If signals immediately resume their original strength then the fault is as above or a grid leak of too high resistance. If this latter is of the usual commercial compound type a light lead pencil line can be run along and the effect of that noted.

**Z. M. N. (Caister).**—What is the actual difference between V24, Q and R valves, and on what anode voltage do they work?

Practically the only differences are the disposition and size of electrodes and slight variations in degree of vacuum. The Q requires 200 volts, the R 75, and the V24 24 volts.

**T. I. P. (Exeter).**—Would it be a good plan to shorten the unused portion of an inductance coil to cut out the dead end effects?

No; it would be better to leave it open, as the currents induced in it would increase the effective resistance.

**"DISGUSTED" (London).**—Is it usual to sit for hours without hearing anything? I can see Marconi House aerial from my window, but have not yet heard a sound.

That question has been asked before, but invariably because there was something wrong with either the set or its manipulation. In the first case we have no details of your particular installation, but we must mention that, judging by some of the correspondence received, it is imagined by not a few that once a set is made or purchased all that is necessary is to connect it to the earth and aerial, and then wait for signals to be heard. In this respect patience is sometimes rewarded by sheer luck. In others it is not. Apart from the searching round with variable inductance and condenser with the so-called "simple" crystal set it must be remembered that a crystal detector requires delicate and careful adjustment. To merely arrange it so that the elements are in contact is not setting the detector so that it is certain that it will function. Unless it can be adjusted to a buzzer signal it is necessary to constantly vary the pressure, which should not be heavy, and the position of the contact until first the signal and then the loudest signal is obtained. It is necessary to do this while searching round with the inductance and condenser in the neighbourhood of the wavelength of the station from which it is desired to receive. Others again invest in a complicated multi-wave set without having the slightest idea as to the "whys and wherefores" of even the fundamental principles of tuning, etc. It would seem to us that this might be compared to a man who has purchased a motor bike without having previous experience with an ordinary push-bike, forgetting that it is necessary to understand "balance" before undertaking the adjustments and control of the mechanism. It is to provide just that understanding that "Step by Step" and other articles appear in P.W., and you should turn up back numbers and thoroughly re-read them, paying particular attention to those that deal with "tuning."

**W. T. L. (Hunstanton).**—For discovering the gauge of fine wires I have been told that a volume test will answer. What is this?

Measuring the volume of a certain length of wire by its displacement of water in a small glass vessel graduated in cubic centimetres, and dividing by that length to ascertain the cross-sectional area of the wire. Needless to say, the greater length of wire employed for the test the less will be the subsequent error in the calculation.

**N. M. L. (Brighton).**—I wish to construct a set with fixed inductances so that I can tune with condensers only. I wish it to be a two circuit set and to have a range of 360-1,000 metres.

The tuned circuit condenser can be .0005 mfd. with an inductance having a value of 1,000 microhenries. It is impossible to give definite figures for the open circuit, as the question of aerial and earth must be considered. You should experiment with an inductance not above 2,000 microhenries and a variable condenser of .005 mfd.

**"AMATEUR" (Croydon).**—Which is the more efficient, low or high frequency amplification?

For weak signals H. F., but for stronger signals there is little to choose. H. F. requires more "wangling," but it reduces low frequency intermodulations, as explained elsewhere in these columns.

**G. F. B. (King's Cross).**—Are basket coils as efficient as single layer coils, if not, what is their advantage?

Not quite, and more difficult to wind, but save space and are better for dealing with comprehensive wavelength ranges.

**S. Y. T. (Durham).**—How can one recognise C.W. signals?

C. W. gives a clear musical note varying in pitch with variation of tuning.

(Continued on page 41)

## The EUREKA Radiophone

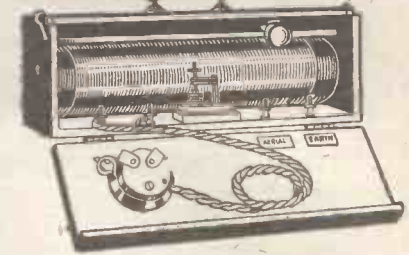

Buy Your Own Home-Set To-day, to enable you to "listen-in" to Broadcasting of Concerts, Speeches, News, Time-Signals, etc., etc. The entrancing World of Wireless will be yours.

Fore Crystal Set No. 1 as illustrated. Complete with Head 'Phone, Detector, Tuning Coil with variable adjustment, 100 ft. Aerial and Insulators. No batteries required. Range: Telegraphic Signals—150 to 200 miles. Telephony—25 miles. Price £3 18 6 Mounted in a Polished Hardwood Box. Cash with order.

COMPLETE PARTS for Building a Crystal Set in Your Own Home - - - 45/- Complete. Post free.

Write to-day for full particulars of our No. 2 Crystal Set—the "EUREKA" VALVE-UNIT SYSTEM—enabling the experimenter to ADD to his existing apparatus as desired. The "Eureka" Unit System is by far the most flexible method of reception in existence.

British Made throughout by

The Electric Appliances Co., Ltd.  
(Dept. W), 8, Fisher Street,  
Southampton Row, London, W.C.1.

### USE STEVENS' COUNTERPOISE EARTH BOX AND CABLE OUTFIT

Obviates connection to water main, ensures best results when installed to any receiving set. Send cash, 5/6 includes postage U.K. instructions supplied. Length of cable, 30 ft., additional 10 ft. lengths 1/- each.

A. H. STEVENS,  
12, Shrubbery Road, London, S.W.16.  
Phone: Streatham 1816. Trade Supplied.

### LOW RES. RECEIVERS.

150 w new 3/6 each, Post Free.  
8 ft. Stout Bamboo Poles, 2 ins. diameter, suitable Wireless Masts, in bundles of 4 poles, 3/- per bundle. Carriage forward.

HYAMS, Southville, South Lambeth, S.W.8.

### WIRELESS MASTS

45 ft., 39s. 6d. 29 ft., 28s. 6d.  
Complete with necessary Iron Fittings, Stay Lugs, etc., for IMMEDIATE ERECTION. Will save you endless trouble. Don't buy odd, unfinished or inferior thin steel poles. Bamboo Spreaders. Galvanized Guy Wires. Actual List, particulars, post free 3d. Manufacturers: Trade Enquiries Invited. THE 3-METER WIRELESS SERVICE, Dept. 2 P.W., 53 Elms Road Aldershot

### RUBBISH

Is easy obtainable. Buy right and so insure custom LARGE STOCKS OF

Ebonite, Sheets, Rods and Tubing kept. Moulded Improved Dials and Knobs, etc. Panels cut to size.

DO NOT HESITATE.—Write for Price List Now.

RADOITE—41, BERNERS STREET, LONDON, W.1

## FOR TOOL BARGAINS CALL or WRITE TO-DAY to:

Before buying elsewhere compare our prices. Remember, we have the Largest Stock of Tools to select from in London. We guarantee you satisfaction, so you can safely Shop by Post. Bargain List sent Post Free.

GEORGE ADAMS (DEPT. P.W.), 255-6, HIGH HOLBORN, LONDON, W.C.1.



## IF IT'S ABOUT WIRELESS —ASK US—

We hold a complete stock of everything wireless and can usually supply by return post.

Send to-day for complete lists.

### ELECTRICAL SUPPLY STORES

5, Albert Terrace, King Cross,  
HALIFAX, ENG.

## That book you want

On Wireless, or any Technical subject. Foyles have it, or will quickly obtain it. 1,000,000 vols. (Second-hand and New) on every conceivable subject in stock.

Write for Catalogue 120 (free) mentioning requirements.

**FOYLES, 121, Charing Cross Rd., London.**

**TO WIRELESS EXPERIMENTERS. PATENT YOUR INVENTIONS.**

They may prove very valuable. Particulars and consultations free. **BROWNE & CO., Patent Agents,** 9 Warwick Court, Holborn, London, W.C. 1. Established 1840. Telephone, Chancery 7547.

### K.E.W.S.

High-class instruments, efficiency guaranteed. Buy from the makers and save money. Valve Sets on Unit system, complete with best accessories, from £10 10s. Crystal sets (25 miles range broadcasting), complete with phones and aerial, from £3 15s. All accessories, cheapest and best. Trade enquiries invited. List stamp.—**K. E. WIRELESS SERVICE, 10, Glenview Rd., Lewisham, S.E. 13**

### INDUCTANCE COILS-COILS-COILS

Cut out those "dead-end" effects of the now obsolete "Slider" Coils by using the improved "Honey-Comb" Coils—Tuning easier—Signal strength increased. Set of 3 Coils complete with holder, mounted ebonite, in mahogany cabinet, interchangeable, for 25/-, or coils alone, unmounted, 3/6 each, any wave length. **VARIABLE CONDENSERS**—Best possible, with scale '0003, 12/6; '0005, 15/6; '001, 21/6, in mahogany cabinet. Post extra these and coils above.

TRADE SUPPLIED.

**KENWARD BROS.,** Wireless Manufacturers.  
**RYDE, I.W.**

**RADIO MASTS**—Before buying your mast, let us quote you for best quality steel mast, complete with guys, anchor plates, etc. ready for hoisting aerial. Designed on scientific principles for strength, lightness, and portability. Height to 50 feet. Competitive prices.—Trade enquiries invited.—**H. LONGTON, A.M.I. Mech.E., 43, Johnson St., Westminster, S.W. 1.**

### NEW CELLULOID CASE CONDENSERS



'001  
24/-  
'0005  
17/6  
'0003  
15/-  
'0005  
12/6

QUALITY TELLS:  
24 Gross sold in six days

Every description of Wireless Goods

I have large quantities of good and cheap Wireless Accessories.

SPECIAL TERMS TO THE TRADE.

**B. L. HOUSTON,**  
65, Endell Street, London, W.C. 2.  
Phone: Regent 4911.

## RADIOTORIAL QUESTIONS AND ANSWERS.

(Continued from page 383.)

T. R. (Birmingham) has trouble with his two valve set. The chief trouble appears to be "howling" when handling the series-parallel switch.

This trouble may be very greatly reduced by placing the series parallel condenser in the earth lead and not the aerial, as you have it at present. Judging by your diagram, you have your leads all over the place. Separate these and cut out the plug arrangement for the second valve. This will have a good effect. The condenser that you have across the reaction is far too great in capacity if the .003 mfd. is correct. .0002 or .0003 would be more suitable. Try the circuit out with no reaction condenser.

"WORRIED" (Leyton).—Is an aerial 40 ft. long, twin, of 7-22 stranded wire O.K.?

Quite, provided that you have it at a fair height.

Is cloth and rubber-covered wire suitable for a lead-in.

Not without further insulation at the point where it touches the wall or anything. An ebonite or a glass or even a thick rubber tube should be used.

I have bought a crystal detector. How am I to know whether it is carborundum, and therefore requires a battery or not?

In the first case, if it is not steely black, but green, blue, white, or some such distinctive colour, it will not be carborundum. Carborundum is invariably used with a small round steel or copper plate, or rather heavy steel needle, and will not be in combination with another crystal, or have a fine wire "feeler."

T. P. (Watford).—I wish to wind a basket coil suitable for Marconi House, Writtle, and amateur stations.

Wind with 24 S.W.G. on a 2 in. hole 32 turns, for which a .0005 mfd. variable condenser will be required. This will give a range of some 200-420 metres on an average amateur aerial, and will cover the stations that you mention.

"ENTERTAINER" (Doncaster).—Can I receive concerts on a 5-valve set, and transmit this on a land line telephone to various friends?

Yes, you can do that by placing the telephone transmitter just in front of the loud speaker. Owing to the noises invariably accompanying land-line telephonic transmission, your listeners will not credit wireless with that clarity of reception which is the remarkable point of a well-handled set.

J. K. (Plymouth).—Will rain, snow, or wind affect wireless waves?

Not directly. Rain or snow will cause aerial leakage and loss of energy unless great attention is paid to insulation. That is in point of the actual reception, but unless undue electrical disturbances accompany inclemencies of the weather, it will not affect the wireless waves one way or the other.

B. G. W. (Stockport).—If I had a very small crystal set very close to the Marconi Station at Carnarvon, would I hear what they were transmitting?

No, because that station transmits on C.W. All that it would be possible for you to hear would be a series of clicks.

Would I obtain a good range with a one-valve set and a frame aerial 6 by 8 feet?

No, you would have but a very limited range with one-valve on a frame aerial.

C. S. M. (Manchester).—What wave-length would I obtain with an inductance 6 by 6 in., wound with 26 S.W.G.?

450-4,000 meters approx. You mention that your filament battery is a single cell of 2 volts. You will require two such cells in series, giving 4 volts, unless you are using some special kind of valve.

O. J. B. (Leamington).—What is a step-down transformer?

A transformer the windings of which are such that the pressure of voltage induced in the secondary will be less than the pressure applied to the primary.

Can you tell me what to do when as often seems to happen, the acid from the accumulator creeps or spills on anything?

Apply strong ammonia solution to clothing (keep the ammonia well away from the cells), or for burns apply dilute ammonia, washing soda, whitening, or lime-water.

THE MARK OF RELIABILITY



1 to 12 volts.

1 to 35 amps.

## VOLT & AMMETER

Combined Dead Beat Pocket Type. New and not German. Splendid Instrument in Nickel Plated Case. Ideal for Testing Cells and Filament Current.

POST PAID 5/6 NUMBER LIMITED

OTHER EXCEPTIONAL VALUES.

Aerial Wire. Enamelled Hard Drawn, 7/22's Copper, 5/- per 100 feet.  
Aerial Wire. Bright Hard Drawn, 7/22's Copper, 4/- per 100 feet.  
Aerial Insulators. Shell type, 2 in. by 2 1/2 in., green, 1/2 each.  
Aerial Insulators. Reel type, 2 in. diameter, brown, 3d each.  
Filament Resistances. For panel mounting.  
E.F. Transformers, plug in type, 300 and 700 metres, 4/- each.  
E.F. Transformers, plug in type, 1,000 m. 4/6; 2,000 m., 5/6 each. (pins, 3/- each.)  
E.F. Transformers, Formers only, with Tangent E.F. Transformers. All ranges, 6/6 each.  
Switch Arms. Complete fitted with knob, 1/- and 2/6 each.  
Dewar Switches. D.P. Change over, panel type, 2/- each.  
Lightning Arresters. Carbon block type, 1/6  
Valve Holders. Flanged "A" type, 1/-.  
Ebonite with 8 nuts, 1/5 each.  
Ebonite Panel, fitted with 3 Valve Holders, complete 4/-.  
Ebonite Panel, fitted with 2 Valve Holders, complete 2/3.  
Valve Sockets, per set of 4, with 8 nuts, 7d.  
Transformer Holder. With 4 terminals and wired, 3/6 each.  
High Note Buzzer (Army type), worth treble, 2/6 each.  
Telephone Transformers (Army type), 9/- ea.  
Wireless Jacks. As illustrated, page 73, 1/- ea.  
Brown's Type "A" Headphones. Guaranteed new and unused, 8,000 ohms, 4/6; 120 ohms, 42/6; with cords, 51/6 and 44/6.  
Ever Ready Batteries (all sizes). 16 volt, 3/6 each.  
Mica. Clear Ruby, .002 in. thick, 3 in. by 2 in., 1/- dozen pieces.  
Inductance Slider Rod, 1/4 in. square, 13 in. long, drilled, 6d. each.  
Slider, complete with plunger, 1/4 in. rod, 6d. ea.  
Contact Studs. Fitted with nut and washer, 1/3 dozen.  
Condenser Vanes. Best Aluminium, 3 1/2 in., 1/6 dozen pairs.  
Condenser Spacing Washers, Small, 3d.; large, 6d. dozen.  
Condenser Screwed Rod, Brass, 12 in. long, 1/8 in., 4d.; 3/16 in., 6d. (per yard).  
Insulating Tubing. Assorted colours, 6d. Sheet Ebonite, 4 to 1/2 in. thick, 4/6 per lb.  
Terminals. Mark 3 N. Plated, 4B.A., 2/6 doz.  
Terminals. Small pattern, 9d. dozen.  
Dialler Condensers. All capacities at prices advertised.  
Grid Leaks. All resistances, 2/- and 5/- each.  
Vernier Condenser. Panel type '0005, 5/-  
Radio Instrument L.F. Transformers, 25/- each.  
Tangent L.F. Transformers, 22/6 each.  
Ivoryine Scales, 0-180, good quality, 8d. each.  
Ivoryine Tablets. Set of seven, 1/-.  
Skandinavien Microphone Buttons, 5/- ea.  
Burndept. and De Forest. Coils in stock.  
Advertised Prices. Type, 2/- set.  
Small Plug and Sockets. Coil mounting.  
Complete Illustrated Catalogue, post free 4d., allowed for off first order. Orders under 5/6 add 6d. for postage.

**J. H. TAYLOR & CO.,**  
ELECTRICAL AND RADIO ENGINEERS,  
Macaulay St., HUDDERSFIELD.  
Telephone, 341. Telegrams: "Thorough," Huddersfield

## PATENTS.

TRADE MARKS AND DESIGNS.  
GEE, Patent Agent, 51/52, Chancery Lane,  
London, W.C. 2. Telephone, Holborn, 1525.

## THE BEST BOOK ON WIRELESS FOR AMATEURS

How to make and use a Wireless Valve Receiver Set, By E. K. Spiegelhalter. This book has been specially written for Amateurs in Wireless. Clear Constructional details accompanied by 24 very practical illustrations are given, which will enable the operator to build his own set economically and to work it successfully when made.

Price 2/- net. Send P.O. for a copy.  
E. & F. N. SPON, Ltd., 57, Haymarket, London, S.W. 1.

# Build your own Valve Set

—this 24 page Booklet shows you how

It is no longer necessary for you to buy an expensive ready-made Valve Set if you possess a screw-driver and a pair of pliers:

This little Book explains in non-technical language the principle of the Peto-Scott Unit system of Standardised Radio parts, and shows how you can build, stage by stage, a wonderfully efficient Valve Set, which will always be a source of satisfaction to you.

Further, it will afford you the satisfaction of knowing that by home construction you have effected a considerable saving.

All sets of parts are standardised, and the difficult jobs, such as drilling, tapping, transformer winding, etc., have been done for you—you need only to assemble them and wire up according to instructions.

Send for this Booklet to-day—it will save you pounds.

Visit our Stand, No. 16, at the All-British Wireless Exhibition, Horticultural Hall, Sept. 30th—Oct. 7th.

Show-rooms and Offices :  
FEATHERSTONE  
HOUSE

64, HIGH HOLEORN,  
LONDON,  
W.C.1



6<sup>d</sup>  
POST-FREE

**PRICE LIST OF UNITS** (in sets of parts).

- No. 4. Valve Detector Unit 17s. 6d.
- No. 5. Low Frequency Amplifying Unit 33s. 6d.
- No. 3. High Frequency Amplifying Unit 13s. 6d.
- Mahogany Cabinets to fit each 3s. 6d.

All neatly packed with full instructions.  
Postage 9d. extra per unit, but free on all orders of £2 and over

Our big 32 pp. Cat. sent free with Radio Booklet.

## AGENTS WANTED

**STAND  
10**  
HORTICULTURAL  
HALL,  
September 30th  
to  
October 7th.

Sole agencies for the radio productions of **FELLOWS MAGNETO CO., LTD.** Agencies will be granted to one firm in each of the principal towns.

Address applications to

WIRELESS MANAGER—

**FELLOWS MAGNETO Co., Ltd.**  
CUMBERLAND AVENUE,  
PARK ROYAL, N.W.10.

Phone:

'Grams:

"WILLESDEN," 1560-1561. "QUIXMAG," PHONE, LONDON.  
E.P.S.'4.

## A Valve Accumulator of Exceptional Merit



6 Volts, 50 Amps.,  
35s. the set,  
carriage 3s:

4 Volts, 50 Amps.,  
24s. the set,  
carriage 2s.

Write for Illustrated Catalogue,  
3 stamps, or list of  
H.T. Batteries and  
Accumulators, free

Visit our  
Stand, No. 15,  
at the  
Wireless  
Exhibition,  
Horticultural  
Hall,  
Sept. 30-Oct. 7

Fitted in  
Wooden Case with  
Leather Strap Handle.

**WATES BROS.,** 13-14, Great Queen Street,  
KINGSWAY, LONDON, W.C.2.



# DUBILIER

CONDENSERS

DO NOT FAIL TO VISIT OUR STAND No. 36 AT THE  
**All British Wireless Exhibition**  
 and Convention

and inspect our new Fixed and VARIABLE Condensers. We are also exhibiting the **"DUCON"** our New Attachment for Radio Reception from any Electric Lamp-holder.

**The DUBILIER CONDENSER Co. (1921), Ltd.,**  
**DUCON WORKS, Goldhawk Rd., Shepherd's Bush, London, W.12**  
 Telephone—Hammersmith 1084      Telegrams—Hivoltcon, Phone, London      Code—Marconi International

## "PALMER-FONES"

These "Super-Sensitive" Head Phones are the result of many years' experience, and over 30,000 of these have been purchased during the last four months, and repeat orders are being given which prove their excellent value.  
**DELIVERY FROM STOCK.**

Every Set is thoroughly tested, and all are guaranteed in perfect condition, readily adjusted to any position. Very light and comfortable. Standard resistance 4,000 ohms. Each complete with Double Head gear with connecting cord.

29s. 0d. price over Counter.      29s. 6d. price by Post.  
 We also supply 120 ohm, 2,000, 6,000, and 8,000 Head Phones.

MARCONIPHONES, From Each	£4 13 6	Condenser Spacer Washers, large and small, per doz. pairs	1 3
METROPOLITAN VICKERS, Complete Sets From	4 10 0	Condensers, complete	4 6
Brown's Loud Speakers	5 10 0	Contact Studs, with nuts and washer, per doz.	8
Magnavox Loud Speaker, "Junior" type	10 10 0	Crystal Cups (small and large) Each	2d. & 6d.
Magnavox Loud Speaker, "Senior" type	20 0 0	Crystal Detector	5 6
2-valve power Amplifier, complete with valves, but less batteries (For Magnavox)	22 10 0	Lightning Arresters	2 0
3-valve power Amplifier, complete with valves, but less batteries (For Magnavox)	35 0 0	Lead-in Tube, 6-in. long	2 0
Crystal Tuner, auto-coupled, complete with condenser and crystal	1 18 0	Inductance Tube	5 0
Crystal Tuner Double Slide, auto-coupled, complete with condenser and crystal	2 13 6	Valve Legs, with nuts and washer Each Set	3
Ebonite Valve holders, 4 legs, with nuts and washers	1 0	Valve pin	2
Ebonite Valve holders, complete, best quality	1 9	Terminals, complete, small and medium, per doz.	1 8
Ebonite Slider and Plunger	8	Terminals, complete, large, per dozen	2 0
Ebonite knobs, 1 1/2-in. dia. knurled edges, tapered	6	Square Brass centre rods for Condenser	6
2BA Ebonite sheets, various thicknesses (cut to any size) per lb.	4 6	2BA Brass Screwed Rods, 12-in. lengths	5
Switch arms, complete	2 6	Brass nuts, 2BA, (BA, and 5BA, per doz.	4
Condenser, fixed and moving vanes, aluminium, per doz. pairs	2 0	Tuning Bar, Square Brass rod in 13-in. lengths	5
		Insulators, porcelain, large shell type	8
		Insulators, porcelain, small, egg shape	3
		Insulators, 2-in. Reel Type	4
		Ivoryine Scales	6
		Aerial, Earth, and Phone Labels Each	3
		Aerial Wire, 100 ft. 7/22, with 2 Insulators Each Set	4 6
		Wireless Masts, in four sections, totalling 11 ft. Filament resistance	4 9
			5 0

POSTAGE EXTRA. WHOLESALE TRADE SUPPLIED.

**GEORGE PALMER, Wireless and Sound Transmission Specialist,**  
**47, Gerrard Street, London, W.1.**

## WIRELESS BROADCASTING



### FELLOCKRYST

A simple and reliable crystal receiver for all wavelengths from 300—1,500 metres.

**£3 : 7 : 6**

(Postage 1/6 extra.)

### FELLOCKRYST SUPER

for all broadcasting wavelengths from 300—500 metres.

**£4 : 7 : 6** (postage 2/- extra)

### FELLOPHONE

2 Valve Receiving Cabinet for all broadcasting wavelengths from 300—500 metres.

**£9 : 0 : 0** (Carr. 2/- extra)

2 Mullard "ORA" valves for Fellophone 30/- extra.

Every instrument is complete with double headphone, aerial, and every necessary except valves. Extra headphones complete 20/- per pair.

*"for they are jolly good Fellows"*

**FELLOWS MAGNETO CO., LTD.**  
 Telephone:      LONDON, N.W.10.      Telegrams: Quixmag, Phone, London, Willesden 1560-1.

Visit our Stand, No. 10, All British Wireless Exhibition, Horticultural Hall, September 30th to October 7th.

# J. B. BOWER & Co., Ltd.,

Manufacturing Electricians and Wireless Experts,  
 15, Kingston Rd., Wimbledon, London, S.W.19  
 TELEPHONE: Wimbledon 1030 WORKS: Merton

We are offering, while the stock lasts—  
**5,000 Complete Wireless Sets** made in  
 our own works, each set consisting of—

## COMPLETE CRYSTAL RECEIVING SET.

With a wave length of 2,700 meters maximum,  
 and 300 meters minimum.

- 1 PAIR OF 4,000 ohms HEAD PHONES
- 1 HANK 7/22 AERIAL WIRE. (100 ft.)
- 2 REEL INSULATORS

The whole Set for the sum **£3 15 0**

Cash with order. Packed and despatched Carriage Paid.

This is the cheapest and most efficient Receiving Set on the market, and is guaranteed by us. You have no further expense. Just erect your aerial, and you are ready to listen in.

Send for our Complete Illustrated List of Wireless Parts.

**WE ARE EXHIBITING AT THE ALL BRITISH WIRELESS EXHIBITION AT THE HORTICULTURAL HALL. COME AND SEE US.**

## The Best Book About Wireless Telephony

JUST PUBLISHED

# RADIO FOR EVERYBODY

BY A. C. LESCARBOURA, MANAGING EDITOR OF THE "SCIENTIFIC AMERICAN."

EDITED BY R. L. SMITH ROSE, M.Sc., D.I.C.

With 170 Illustrations. Crown 8vo. 7s. 6d. net.

Methuen & Co., Ltd., 36, Essex Street, London, W.C. 2.

## STAND No. 37

### ALL BRITISH WIRELESS EXHIBITION

Horticultural Hall, Westminster, Sept. 30-Oct. 7.

### WE ARE EXHIBITING

- Crystal Sets. Valve Sets.
- High Resistance Telephones. Loud Speakers.
- Precision Air Condensers. Fixed Condensers.
- Series Parallel Switches.

Our 7-valve self-contained cabinet set without external aerial or wires of any description will be on show.

### RADIO INSTRUMENTS, LTD.

Only Address: 12a, Hyde St., New Oxford St., W.C.1.  
 Telephone: REGENT 1908. Telegrams: "INSTRADIO, LONDON."

SHOWROOMS:  
 BARRAS BRIDGE,  
 NEWCASTLE.

# CHASE RADIO

MANUFACTURERS OF WIRELESS APPARATUS.

TELEGRAMS:  
 CHASE, NEWCASTLE.  
 'PHONE (after Oct. 1)  
 443 CENT.

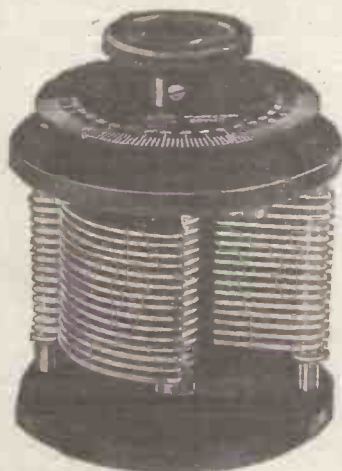

CHASE RADIO VARIABLE CONDENSER.

TO prove that the CHASE RADIO is absolutely of the best, we are offering some products at SPECIAL PRICES:

200 only of '0007 Variable Condensers, with special brass scale and knob, at 22/6. List Price 28/6.

200 only Intervalve Transformers at 18/-. List Price 22/6.

200 only Telephone Transformers at 22/-. List Price 27/6.

Magnavox Loud Speakers, Brown's Telephones and Loud Speakers, Sterling Telephones.



CHASE RADIO INTERVALVE TRANSFORMER.

## COMPLETE CRYSTAL AND VALVE SETS IN STOCK.

Valves and 'Phones, H.F. Transformers, L.F. Transformers, Inductance Coils, Switches, Accumulators and H.T. Batteries, Etc.

Write at once for our List of Apparatus. Everything in Stock. We do not keep you waiting.

BEST TRADE TERMS ON APPLICATION.

**THE CHASE MOTORS Co., Ltd.,** Sandyford Square, NEWCASTLE-ON-TYNE.



## DON'T BE CAUGHT!!! FROM FACTORY TO YOU

**NO WASTE** are really actual manufacturers, Deal direct And don't waste money. Why pay middlemen's profits? Reap the benefit yourself.

**PARTICULARLY** note our sets are guaranteed absolutely complete. Don't rush and buy a supposed cheap set and find your extras exceed your original cost. Take our advice, buy from Factory. **SURE** saving of money.

Our Sets guaranteed by experts who are holders of degrees. We Guarantee all parts new.

**NO WAR STOCK USED.**

### WE SELL COMPLETE SETS.

"LACLAND" 1 Valve Set	£12 0 0
" 2 " "	£16 10 0
" 3 " "	£19 10 0
" 4 " "	£22 5 0

Carriage Paid Immediate Delivery

Agents Wanted for (parts of) following Counties—  
Kent, Surrey, Essex, Herts, Bucks and Middlesex.

Lacland Electrical Manufacturing Agency (Dept Q.),  
68, GREAT QUEEN STREET, KINGSWAY, W.C.2.  
(HOLBORN END.)

GERRARD 5341.

(See also our advert. on page 382.)

## HERE'S

# REAL RADIO SERVICE.

OUR AIM—IMMEDIATE DELIVERY. QUALITY HIGH, PRICES LOW.  
Don't watch our Advert. only, Watch our Windows and compare our Prices and Quality.

Aerial Wire, 7/22 stranded copper	per 100 ft.	3/6
Reel Insulators	each	2d.
Inductance Coil, wound with 24 Enamel wire	per doz.	3/6
Brass Rods, 1 in. sq., 13-in. lengths	per doz.	6d.
Sliders, best turned Ebonite	per doz.	9d.
Crystal Detectors, mounted on Ebonite base	each	4/6
Cups	each	2d. and 3d.
Condenser Vanes, cut true to 1-1,000th	each	9d.
Spacing Washers	Small, 3d. per doz.; large, per doz.	5d.
Ebonite Knobs, threaded with 2B.A. nut	each	5d.
Ivory Scales, 0-150	per doz.	9d.
Ebonite Condenser Dials, 0-150	per doz.	1/6
Ivoryine Tabs, Earth Aerial, Phones, Reactance, H.T., L.T.	per doz.	2d.
Blocking Condensers	per doz.	2/6
Valve Holders, Type A	per doz.	10d.
" better types	each	1/6, 1/9, 2/3
Contact Studs	per doz.	8d.
Valve Legs, set of four, with nuts	per doz.	6d.
Enamel Wire, 24 S.W.G.	per lb.	2/6
Double Headphones, 4,000 ohms, excellent quality	per pair	25/-

Our No. 1 CRYSTAL SET, 12 in. x 4 in., Cylinder wound with 24 S.W.G. Enamel Wire, mounted on polished wood base, double sliders. Crystal Detector, mounted on Ebonite base, with Hertzite Crystal. Terminals marked with Ivoryine tabs. 1 Coil 7/22 Aerial wire, 6-reel Insulators, 1 Lead-in tube, 9 in. x 1/2 in. Ebonite. 1 pr. Double Steel Headband. Telephones, 4,000 ohms (Guaranteed tested). Postage free in United Kingdom. **£3-2-6**

LARGE STOCKS OF ENAMEL, COTTON, AND SILK-COVERED WIRES.

FOR FURTHER ENQUIRIES AND PRICES, GIVE US A RING, OR WRITE.

CATALOGUES FREE.

**WATERLOO ELECTRIC CO.,**

ELECTRICAL AND WIRELESS ENGINEERS,

129, Waterloo Road, London, S.E.1.

TRADE SUPPLIED. (1 min. Waterloo Station). Telephone, HOP 5649.

## BUY FROM MANUFACTURERS!

	£	s.	d.	
Wireless Head Phones, 4000 ohms	1	0	0	each
With 6 ft. cord, 6000 "	1	5	0	"
Single Receivers with cord, 2000 "		7	6	"
" " " " 3000 "		10	0	"
Transformer, Intervolve	-	-	12	6
" Telephone	-	-	10	0
Aerial Wire, 3 20 ex Gov. Stock, 150 feet		4	2	per coil
Insulators	-	-	2	0 per doz.
Condensers in Teak Case (43 plate)	-	14	0	each
2-Valve Set	-	5	10	0
3 " "	-	7	0	0

PROMPT DELIVERY.

**TURNOKS TELEPHONE WORKS,**  
41, HIGH STREET, ASTON, BIRMINGHAM.

## HAMBLING CLAPP & CO WIRELESS SPECIALISTS

### FILAMENT RESISTANCES

We have now reduced the price of our Filament Resistance to **4/6**

### VARIABLE CONDENSERS

If you are wanting parts or complete condensers come and see our stock; we have many types to select from

VISIT STAND No. 12 AT THE ALL-BRITISH EXHIBITION, HORTICULTURAL HALL, SEPTEMBER 30—OCTOBER 7.

Showrooms and Offices: **110, STRAND.** Gerrard: 8806.

PREPARE for  
BROADCASTING.

BUILD YOUR SET  
NOW

Send for  
Catalogue.

**FRASER'S PARTS**

All Amateurs' Accessories,  
Condenser Vanes (Alum.)  
1/6 per doz. pairs—Post, 3d.

**DUNCAN FRASER,**  
Sentinel House, Southampton Row, Lo. don.

# THE POPULAR

## WIRELESS

### PERFECT & COMPLETE SETS

All Ready Wired to Fix to Aerial. No Blue Prints to Confuse.

**DON'T BUY INFERIOR AND INCOMPLETE SETS.  
CALL AND COMPARE OURS BEFORE PURCHASING.**

**EVERYTHING  
OF THE  
BEST  
Inside & Out.**

#### The "POPULAR" CRYSTAL SET.

Finest instrument made, including:  
Double Slide Tuning Inductance. Detector with Micro-adjustment. Telephone Condenser. Terminals for Aerial, Earth and Telephone. All Brasswork burnished and lacquered. The whole mounted on a highly-polished base. Four Insulators (reel type). Capacity for 7 'Phones. Aerial 150 ft. 7/22 wire.

**PRICE, complete . . . . . £4.4.0**

**ALL BRITISH  
THROUGHOUT  
HIGHEST  
POSSIBLE  
INSULATION  
THROUGHOUT.  
Perfect  
Workmanship**

#### The "POPULAR" SINGLE-VALVE SET.

Polished Mahogany Cabinet, combed corners. Ebonite Panel (Matt finish). Terminals, highly lacquered and suitably engraved. Filament Resistance, very silent in operation, and fine contact. Grid-Leak and Condenser. Telephone Condenser. Variable Condenser for Tuning. Variometer in separate Mahogany Cabinet, combed corners. High-Tension Battery, 4.15 volt units. Accumulator, 4v. 30A. (actual), Block type. Pair of Double Head 'Phones, 4,000 ohms. Valve, "Mullard's Ora." Aerial Wire, 150 ft. 7/22 copper. Four Insulators (reel type).

**PRICE, complete £10.10.0**

#### The "POPULAR" TWO-VALVE SET.

Polished Mahogany Cabinet, Sloping Front, combed corners. Ebonite Panel (Matt finish). Terminals highly lacquered and suitably engraved. Filament Resistance, very silent in operation, and fine contact. Grid-Leak and Condenser. Telephone Condenser. Variable Condenser, for Tuning. Intervalve Transformer, first quality, wound with double silk, giving a very high insulation. Variometer in separate Mahogany Cabinet, combed corners. High-Tension Battery, 4.15 volt units. Accumulator, 4v. 60A. (actual), Block type. Pair of double Head 'Phones, 4,000 ohms. Two Valves, "Mullard's Ora." Aerial Wire, 150 ft. 7/22 copper. Four Insulators (reel type).

**PRICE, complete £14.14.0**

#### The "POPULAR" THREE-VALVE SET.

Polished Mahogany Cabinet, Sloping Front, combed corners. Ebonite Panel (Matt finish). Terminals highly lacquered and suitably engraved. Two Filament Resistances, very silent in operation, and fine contact. Grid-Leak and Condenser. Telephone Condenser. Variable Condenser for Tuning. Two Intervalve Transformers, first quality, wound with double silk, giving a very high insulation. Variometer in separate Mahogany Cabinet, combed corners. High-Tension Battery, 4.15 volt units. Accumulator, 6 volt. 60 amps. (actual) Block type. Pair of double Head 'Phones, 4,000 ohms. Three Valves, "Mullard's Ora." Aerial Wire, 150 ft. 7/22 copper. Four Insulators, reel type.

**PRICE, complete £24.10**

**ALL MAHOGANY CABINETS** beautifully finished, combed corners. Terminals highly lacquered and suitably engraved.—**CALL AND INSPECT AT OUR SHOWROOMS.**

**EXTRA** Single Ear Pieces and Attachment, 2,000 Ohms., 14s. 6d. each.

DELIVERY IN ROTATION.

CARRIAGE PAID

### GUARANTEE.

Above Sets are guaranteed thoroughly efficient and perfectly finished, if not approved return to us undamaged within Seven Days and we will refund the full amount paid, immediately.

**To BRIGG GORTLEY & Co., 39, St. Andrew's Hill, London, E.C. 4.**

Telephone—CENTRAL 2340

Please forward, Carriage Paid: .....

for which I enclose crossed Cheque or Money Order on conditions of above guarantee named. Date .....

Name ..... Address .....



## GRIFFIN FOR QUALITY EFFICIENCY DESPATCH

**COMPLETE SET OF PARTS TO BUILD  
A SUPER VALVE PANEL FOR 17/-**

CONTAINS:—Ebonite Panel, 1 in., drilled, Filament Resistance, Grid Leak and Condenser, Telephone Condenser, Valve Holder, necessary Terminals and Insulated Wire. Postage 6d. extra.

**"Griffin" Super Crystal Set (300/2,000 metres), wonderful value Price 38/-**

Cabinets and Panels made to your own requirements.

Headphones, 4,000 ohms, **30/-**

*The best and cheapest for the price. They have passed our test.*

**QUALITY PRICES.**

Accumulators, "Three Star" panels	Condensers, special quality for panels
4 volt, capacity 10 amp. hrs., 19/3	'001, 25/-; '0003, 15/-; '0005, 20/-
4 " " 20 " " 25/9	Crystal Detectors, 4/6 and 9/6
6 " " 10 " " 28/11	Filament Resistances, superior, 4/6
6 " " 30 " " 49/-	Headphones, 4,000 ohms, 25/-
Batteries, H.T. (Siemens)	Brown's, Stirling, 52/-
15 volt, 4/-; 30 volt, 9/-; 60 volt, 18/-	Coil-holders, 3 coils, 21/-; 2 coils, 15/-
Aerial Wire.	Inductance Coils, wound, 12 in. by 4 in., 4/3; unwound, 6d.
Bare Copper, 7/22, 100 ft. ... 3/6	Transformers (Federal), 35/-
Enamelled, 7/22, 100 ft. ... 4/6	
Silicon Bronze, 18G., 100 ft. 3/3	
Ebonite.	
"A" quality, sheet, per lb. 4/6	
do. tube (1/2), per ft. 3d.	

Send us your orders for all other accessories in stock at market prices. Terms—Cash with order + postage. Delivery free, £2 0 0 and over.

### GRIFFIN WIRELESS SUPPLIES,

**80, Newington Causeway, London, S.E.1**  
(2 minutes from Elephant and Castle Tube Station). Phone: Hop 1908.  
COMPLETE LIST, POST FREE, 3d.

## - OSCILLATION -

The POSTMASTER-GENERAL has prohibited direct coupled reaction. Loose coupling with high frequency amplification using Honeycomb Coils is the simplest alternative.

Letters Patent No. 141344.

**WARNING** INDUCTANCE COILS having a cellular structure and generally known as Honeycomb Coils are protected by Letters Patent as above. We are the sole Licensees in this country under the Patent, and the Trade and Public should be careful to see that Coils of this type sold or purchased by them are of our manufacture, since there are on the market certain infringements of the Patent, and all dealers in or users of inringing coils are liable to action.

**LOWEST SELF CAPACITY—SILENT WORKING—POWERFUL SIGNALS**  
See these and other coils being actually wound at our Stand No. 4 by "Leesona" Patented Winding Machines.

Also, our latest patented GIMBAL MOUNTING for Inductances and "MICRO ADJUSTA" and "TRIPLUG" patented Coil Holders.

Igranic FILAMENT RHEOSTATS (Patd.), built by Rheostat Manufacturers

"The Masterpiece of the Specialist."



**MICRO ADJUSTA**  
(Patd.)



**FILAMENT RHEOSTAT**  
with Vernier.



**TRIPLUG**  
(Patd.)

**STAND NO. 4** All British Wireless Exhibition.

GLASGOW.  
MANCHESTER.  
BRADFORD.



BIRMINGHAM  
NEWCASTLE.  
CARDIFF.

149, Queen Victoria St., LONDON. **WORKS—BEDFORD.**

## ECONOMIC ELECTRIC LIMITED

Head Office: 10, Fitzroy Square, London, W.1

Telephone: Museum 1055

Works: Twickenham

### THE "POLYGLOT" WIRELESS TELEPHONE RECEIVER

Specially designed for intercepting the broadcast Telephony and Morse signals. A really wonderfully efficient instrument that exactly meets the demand of the moment. Inductance is fitted with two sliding contacts for fine tuning. Special ball joint "Rectarite" detector, also fixed capacity mica and variable capacity moving vane air condenser, with Aerial, Earth, and Telephone terminals. Mounted in a grooved and tongued polished mahogany cabinet, with lid and drop front. Size 6 1/2 in. x 6 1/2 in. x 5 1/2 in. high. Weight 2 1/2 lbs. Price, 59/6. 'Phones extra.



Write  
To-day for  
36 page WIRE-  
LESS LIST  
Post Free  
4d.

Showrooms:  
303, Euston Rd., N.W.1

## Crystal Receiving Sets

SINGLE SLIDER INDUCTANCE TYPE  
*Wave Length 1,500 metres*  
Unassembled, £0-18-6 Assembled, £1-13-6

TAPPED INDUCTANCE TYPE *Wave Length 900 metres*  
Unassembled, £1-1-0 Assembled, £1-15-0

LOOSE COUPLER TYPE *Wave Length 900 metres*  
Assembled, £4-15-0

Send for your Illustrated Catalogue, printed on art paper, giving full particulars of Receiving Sets and all components. Price 3d., returnable on first order of 5s.

**P. H. BOYS & COMPANY,** Electrical and Wireless Engineers,  
Phone Clerkenwell 4454 187, Goswell Road, London, E.C.1.

## EVERYTHING WIRELESS!

Double Head Sets, 4,000 w.	35/-	'001 Variable Condensers	19/6
Brown-Sterling Do.	52/-	'005 " " "	13/6
ORA Valves	each 15/-	(These are special prices that will not be repeated.)	
"B" Valves	17/6	6d. Lead-in Wire	per yard 10d.
Ebonite Knobs	" 6d.	Earth clips	each 6d. 6d., and 1/-
Reel Insulators	6d.	Coil Plugs, 1", 1 1/2", 2" centres	2/9
12/22 Enamelled Aerial Wire, 100 ft., 9/6; 140 ft.	13/8	No. 25 Enamelled Resistance Wire	per lb. 5/4
(This gives best results owing to large surface area.)		Velvet Filament Rheostats	each 4/6
3 Coil Holder on base	20/-	L.F. Panels	75/-
Set 8 Slab Coils	10/-	Valvo and Crystal Panels with Variable Condenser	42/6
Set 7 Basket Coils	7/-		
H.F. Panel (Tuned Anode)	42/6		

WRITE FOR ILLUSTRATED CATALOGUE. 4d. Post Free.  
Enclose 1s. for Radio Chart No. 1.

**MAIL ORDERS ONLY, AND YET HUNDREDS OF SATISFIED CUSTOMERS.**

**G. D. HINKS, (WIRELESS DEPT.) Hardington, Yeovil.**

**B.T.H. Portable Wireless Receiver with Additional Valve Amplifier and two Head Telephones.**

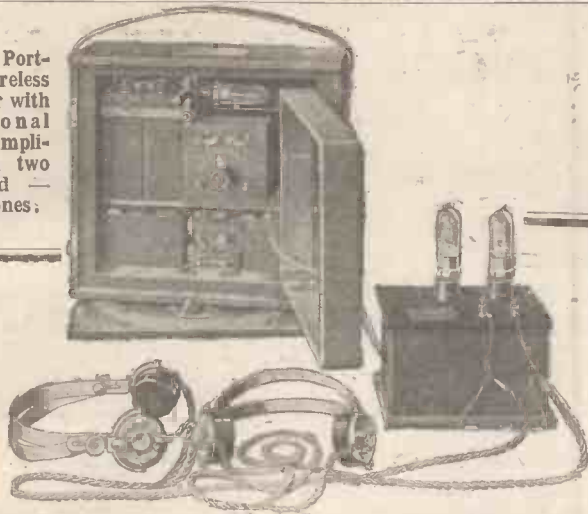

*B.T.H. Portable Receivers. Crystal Receivers. Amplifiers. High & Low Frequency. Head Telephones. Loud Speakers. Concertphones. Morse Inkers. Motor Generator Sets for Wireless. Time Flashers. Aerial Equipments. Tuning Condensers. Morse Buzzer Sets. Valves. Tungar Rectifiers for Charging Accumulators.*

# Wireless Equipments.

See Stand No. 7 at All British — Wireless — Exhibition.

B.T.H. Electrical Plant of every description—from the smallest electrical lamp to the largest turbine-driven alternator—is universally characterised by the highest standards of design and workmanship. These qualities are equally evident in the large range of Wireless Equipment manufactured by this Company, the combination of scientific accuracy and simple construction ensuring perfect operation.

**The British Thomson-Houston Co., Limited,**

Electrical Engineers

and Manufacturers.

Head Office and Works :



**RUGBY, ENGLAND.**

## WIRELESS for the Million.

### BROADCASTING SETS A SPECIALITY

WE cater for everybody—for the amateur, the professional, and the trade.

All materials used in our factory are specially selected, and all finished articles are tested before issue, and **GUARANTEED**.

We stock every form of Wireless apparatus, and make a speciality of component parts.

#### SPECIAL OFFER FOR THIS WEEK—

Component parts for our No. 1 CRYSTAL SET, only **£2:0:0 !!!**

4,000-ohm Phones, as used by the French Army, immediate delivery, post free, and **GUARANTEED**, **£1:10:0.**

Catalogue, price 4d. (including 4-page list of Wireless Stations, their call signs, system, and times of working).

DEPT. D.,

**RADIO APPLIANCES LTD.**

185, High Road, Streatham, S.W. 16.

## “SUPREME”

### RADIO INSTRUMENTS AND COMPONENT PARTS

Below will be found a few of the many lines in which we specialise and for which **IMMEDIATE** deliveries **ARE GUARANTEED.**

“SUPREME” CRYSTAL SET.—Double Slider Inductance, Ball Socket Crystal Detector, Blocking Condenser, Terminals ready to connect. Complete with 4,000 ohm H.F. Phones, **80/-** each. Aerial Wire, Insulators, Lead-in, etc.

“SUPREME” SINGLE VALVE PANEL.—Complete with Fil. Resis., Valve Holder, Grid Condenser, Leak and Phone Condenser, Reactance Terminals, mounted in Polished Mahogany Cabinet. **33/-** each. Wonderfully efficient

#### CONDENSERS.

	Cabinet.	Skeleton.
.0003 ... ..	15/- each.	13/- each.
.0005 ... ..	24/-	20/-
.001 ... ..	33/-	28/6
.0015 ... ..	45/-	34/6

#### EBONITE COIL STANDS.

Mounted on Matt Ebonite Bases, complete for Two Coils ... **12/-** each.  
 ” ” ” ” ” Three ” ... **16/-** ”

#### SLAB TUNING COILS.

No. 1. Range 300,2500 Metres: Set of Seven ... **13/-** set.  
 No. 2. ” 300/3000 ” Three ” ... **4/6** ”

#### SUNDRY PARTS.

	Doz.		
Filament Resistance ...	48/-	Condenser Plates, gross pairs	18/-
Switch Arms ...	20/-	Polished Ebonite Knobs, doz.	6/-
Ebonite Coil Sockets ...	16/-	Crystal Detectors ...	57/-
Spider Formers ...	18/-	Crystal Cups ...	4/9
Engraved Condenser Scales...	12/-	Inductance Sliders, complete	7/6
“ A ” Type Valve Holders...	12/-	L.F. Transformers ... each	20/-
Moulded Valve Holders, Nuts and Washers ...	15/-	H.F. Pin Type, Range 300/550 metres ...	each 6/3
Mica Sheets, .002, 2in. x 3in.	2/3	H.F. Pin Type, Range 500/900 metres ...	each 7/3
Mullard “ Ora ” Valves ...	180/-	H.F. Pin Type, Range 700/1600 metres ...	each 8/-

## SHENTON & CO., LTD.,

CARDIFF: 11 MOIRA TERRACE. Telephone: CARDIFF 5913.

LONDON: 68/9 SHOE LANE, E.C.4. Telephone: HOLBORN 696.

ILLUSTRATED LIST INCLUDING COMPLETE RANGE, NOW READY—WRITE TO-DAY.



"POLAR"  
RADIOPHONES



"POLAR"  
RADIOPHONES

# ALL-BRITISH WIRELESS EXHIBITION

Horticultural Hall, Westminster, September 30th.

All those interested in Wireless, should make a point of seeing our standard "Polar" Radiophones and Wireless Accessories on Stands 23 & 45.

We have established a world-wide reputation as manufacturers of the best Wireless Installations obtainable—these sets are now standardised by most leading Shipowners and Government departments.

In order to meet the demand for our receivers we have concentrated the efforts of our extensive laboratories, technical departments and works on the design and construction of special models for Broadcasting.

They will be shown for the first time at this Exhibition. Manufacturers and Amateurs who are building their own sets should inspect the new "Polar" Variable Condenser—revolutionary in design and a marked improvement over all forms of vane condensers.

If you are unable to visit the Exhibition, call at any of our branches, or write for particulars of our sets.



## RADIO COMMUNICATION CO., LTD.,

34-35, Norfolk Street, Strand, London, W.C.2.

LIVERPOOL: 67, Dale Street;

CARDIFF: Atlas Chambers, James Street;

SOUTHAMPTON: 19, Queen's Terrace.

GLASGOW: 10, Blythwood Square.

NEWCASTLE-ON-TYNE: 17, Sandhill.



Enjoy "listening-in"  
at a reasonable cost.

THE "S.V." is the cheapest reliable long-range crystal set yet produced.

It has an effective listening-in range for telephony up to 50 miles and for telegraphy up to 300 miles.

Supplied complete in every detail, it is only necessary to erect the seven-strand Aerial to enjoy immediately the pleasures and fascinations of wireless.

The 2,000-ohm nickel-plated double headphones give perfect reproduction.

**£3-15-0**

(Postage 1/-)

COMPLETE WITH 100-ft. AERIAL, INSULATORS & 2,000-ohm DOUBLE HEADPHONES

Delivery from Stock.

SUNNER, VAUGHAN & CO., LTD.  
28, Victoria Street, London, S.W.

Telephone—  
Victoria 1703

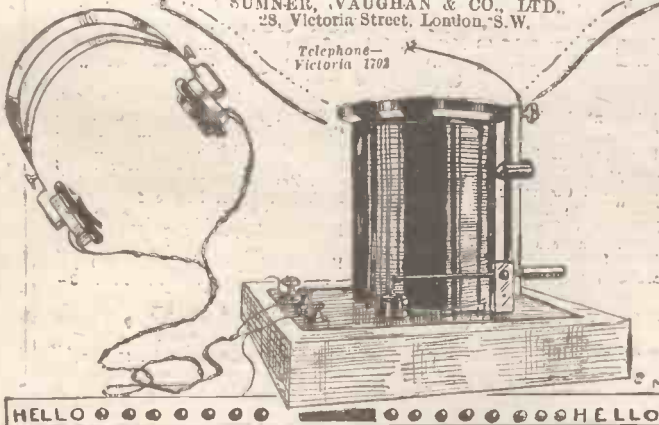

HELLO . . . . . HELLO

### INEXPENSIVE LOUD-SPEAKERS. SINGLE RECEIVERS FOR WIRELESS.

Special Purchase of 400 first-class Aluminium Watch Type **LOUD-SPEAKING** Receivers, Western Electric Co.'s make (Trade Mark), quite new, brass terminals and clip for head-band on back, highly sensitive thin diaphragms, accurately adjusted, splendid magnets. Never again occurring bargains at 6s. 6d. ea., 150 ohms; 9s. 6d. ea., 4,000ohms; easily worth double; all tested on our Aerial.

The above Receivers form Powerful, yet Inexpensive **LOUD-SPEAKERS**, when attached to our new "Acoustica" stout compressed Papier Mâché Trumpets as illustrated. (NOTE:—Papier Mâché is the material of which the best and most expensive Gramophone horns and Loud-Speaker trumpets are made. Perfect natural Amplification of all Sound without metallic resonance of any kind.)

"Acoustica" stout compressed Papier Mâché Amplifying Trumpet as illustrated, 15 inches long, smoothly varnished inside and out, narrow end provided with a solid flange and telescope-thread for joining or detaching the trumpet and loud-speaking receiver in a moment.—14s. 6d. Post free.  
"Acoustica" Trumpet, as described above, mounted on round polished base between upright pivoted stands as illustrated, trumpet and receiver adjustable to any position from vertical to horizontal; base can also be fixed to a wall.—£1 2s. 0d. complete as shown, post free.

**ADOLPH TAYLFORTH & CO.,**

Works: Leverington St., Clerkenwell, London, E.C.1.



## QUALITY "SIDLEY" EFFICIENCY SPECIALITIES

### HIGH FREQUENCY TRANSFORMERS

Double grooved. Highest efficiency.

- |                 |   |
|-----------------|---|
| No. 1—300/530   | } 6/- each.<br>Postage 3d. extra.<br>Complete set of five, post free. |
| No. 2—520/920   |   |
| No. 3—900/1500  |   |
| No. 4—1450/2600 |   |
| No. 5—2400/4000 |   |

We also manufacture in-between sizes (1a, 2a, and 3a) at same prices.

Trade terms on application.

### COIL HOLDERS

Designed and built with a minimum of metal.

Perfect insulation. Low capacity.

**FOR 2 COILS 9/-** each.

Postage 4d. extra.

**FOR 3 COILS 13/-** each.

Postage 6d. extra.

**G. R. MARSON, LTD.,** ELECTRICAL AND RADIO ENGINEERS  
HALES ST., COVENTRY. Works: Burges, Coventry.

# When selecting your Wireless Set, INSIST ON A FULLER "BLOCK" TYPE ACCUMULATOR

The only Accumulator which will hold its charge from 12 to 18 months when not in use.

**FOOL PROOF      NON-SULPHATING      UNAFFECTED BY SHORT CIRCUITS**

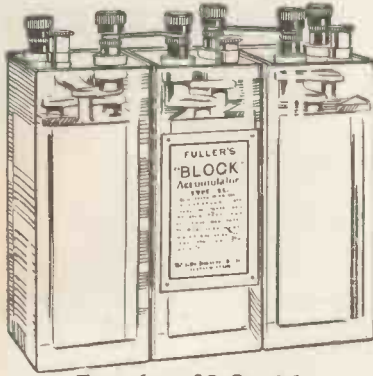

Type 640, £2 8s. 9d.

## A Summary of the Principal Advantages of Block Accumulators.

- (1). They are "fool-proof."
- (2). There are no plates to buckle.
- (3). It is impossible for the cells to be spoilt through accidental short circuiting, and even if the terminals are joined by a metal bar, the cells will not be spoiled or seriously injured.
- (4). They will retain their charge for many months.
- (5). Sulphating cannot occur to any serious extent, as this is mostly caused through cells standing in a discharged state or being discharged through accidental short-circuits.
- (6). The Blocks are so constructed that they cannot swell or grow, and this prevents the external box or container being cracked or broken.
- (7). If the cells are neglected, or left in charge of inexperienced hands, no serious harm can be done, as even when discharged down to 1.5 volts, they recover their voltage and maintain their recovery, thereby preventing sulphate forming.
- (8). They are lighter and have a higher capacity per pound weight than ordinary plate accumulators, and can be re-charged an indefinite number of times.

## Why we can sell below the makers' prices.

Some time ago we purchased an exceedingly large stock of "Block" Type Accumulators from the Government on terms which permitted our re-selling them at a much reduced price. During the last two years, we have disposed of several thousands in all parts of the world and most of the largest and best known electrical firms are numbered amongst our customers.

During this period we have built up, on sound business lines, probably the largest Accumulator business in existence. We buy only on the largest scale and no opportunity escapes us so long as the quality of the stock is right. We have recently purchased outright a parcel of "Block" Accumulators, direct from the manufacturer's works, to the value of several thousand pounds and being content with a small margin of profit on a large turnover, we are able to offer these world-famous cells for re-sale at a considerable saving to the customer.

It is our inevitable rule to share any bargains with our customers, and our system of business will be to put money into the pockets of those who deal with us. It is on these principles that our business has reached its present magnitude.

A perusal of the following prices and comparison with the cost of the identical article if bought in the ordinary way, will show the considerable saving which can be effected by dealing through us.

TYPE.	VOLTS.	Intermittent capacity at 20-hours rate *	Makers' Price.	Our Price.	TYPE.	VOLTS.	Intermittent capacity at 20-hours rate *	Makers' Price.	Our Price.
2 B K	2	16	£ 9 6	£ 7 0	B L 255	2	110	£ 2 0 6	£ 1 7 6
4 B K	4	16	19 6	14 0	B L 455	4	110	4 1 0	2 15 0
6 B K	6	16	1 8 6	1 1 0	B L 655	6	110	6 1 6	4 2 6
240	2	40	1 7 6	16 3	B J 2120	2	120	2 4 0	1 8 0
440	4	40	2 15 0	1 12 6	B J 4120	4	120	4 8 0	2 16 0
640	6	40	4 2 6	2 8 9	B J 6120	6	120	6 12 0	4 4 0
BL 12a	4	50	2 12 6	1 16 0	B L 280	2	160	2 4 6	1 12 6
BL 13a	6	50	3 18 0	2 18 0	B L 480	4	160	4 9 0	3 4 0
					B L 680	6	160	6 13 6	4 16 0
2 A D 9/s	2	64	1 2 6	18 0	B L 2110	2	220	3 0 6	2 0 0
4 A D 9/s	4	64	2 5 0	1 16 0	B L 4110	4	220	6 1 0	4 0 0
6 A D 9/s	6	64	3 7 6	2 14 0	B L 6110	6	220	8 9 0	6 0 0
2 A D 9/c	2	70	1 6 3	1 0 0	For those who require a cheaper Accumulator of the plate type, we can offer FULLER'S STANDARD PLATE TYPE BATTERIES as under.				
4 A D 9/c	4	70	2 12 6	2 0 0	S L 230	2	30	14 6	9 0
6 A D 9/c	6	70	3 18 9	3 0 0	S L 430	4	30	1 9 0	18 0
B L 240	2	80	1 15 0	1 4 0	S L 630	6	30	2 3 6	1 7 0
B L 440	4	80	3 10 0	2 8 0	S L 280	2	80	1 3 0	14 0
B L 640	6	80	5 5 0	3 12 0	S L 480	4	80	2 6 0	1 8 0
B L 21	4	94	3 8 0	2 12 0	S L 680	6	80	3 9 0	2 2 0

\* Note: The Ignition Capacity is double the Actual Capacity taken at the 20-hour rate. Prices for Teak Carrying Crates or Cases on application.

The name "FULLER" is behind every one of these batteries, a certain guarantee of quality, for nothing but the best and purest materials are used in the manufacture of their products.

# The City Accumulator Co., 79, Mark Lane, E.C.3.

Phone: AVENUE 91 (3 Lines).

Telegrams: "TYCHE, FEN, LONDON."

Agents: LONDON: A. W. GAMAGE, LTD., Holborn, E.C. SELFRIDGE & Co., LTD., Oxford Street, W. RICHFORD & Co., 153, Fleet Street, E.C.3.

YORKS: BARNSELY BRITISH CO-OPERATIVE SOCIETY, LTD., Barnsley.

GLOS.: BRISTOL WIRELESS Co., 52, Cotham Hill, Bristol.

S. WALES: SOUTH WALES WIRELESS INSTALLATION Co., LTD. 18, West Bute Street, Cardiff.

N. WALES, LANCs., CHES. & I.O.M.: THE "ALL-BRITISH" WIRELESS MANUFACTURES Co., LTD., 70, Central Bldgs., 41, N. John Street, Liverpool.

**ALL OUR GOODS WILL BE ON VIEW ON Messrs. A. W. GAMAGE'S STAND,  
No. 31, AT THE WIRELESS EXHIBITION.**



Derive the maximum amount of pleasure and  
the greatest possible satisfaction from your  
:: receiving outfit by equipping it with a ::  
**"MAGNAVOX" LOUD SPEAKER**

**STERLING No. 1 CRYSTAL  
RECEIVING SET.**

*Specially designed for use in connection with the Wireless Telephony Broadcasting Scheme, and is suitable for a range of about 25 miles.*



**The set comprises:—**

- 1. TUNER.**—This consists of an inductance which can be varied by means of tappings taken to stud switches. Two of these are fitted, one for coarse and the other for fine adjustment. A separate coil is provided which can be plugged into a fitting at the back of the instrument (as illustrated) for reception of time signals, etc., from Eiffel Tower.
  - 2. DETECTOR.**—This is of the crystal type, requiring no battery, and is designed to give universal adjustment over all parts of the crystal.
- The apparatus is mounted on ebonite panel and fitted in polished walnut case.  
The equipment includes one pair of No. R1258 **DOUBLE HEAD TELEPHONES** wound to a total resistance of 2,000 ohms the pair.

**PRICE £7 - 12 - 6**

**"MAGNAVOX" LOUD SPEAKER.**

Radio brings it  
**MAGNAVOX**  
tells it.

IMMEDIATE  
DELIVERY.



*The MAGNAVOX Loud Speaker is based upon the electro-dynamic principle. This form of construction accounts for the fact that the MAGNAVOX is not only THE MOST SENSITIVE but also THE MOST POWERFUL OF LOUD SPEAKERS.*

No. R1282 (18" Horn).

To enjoy and obtain the greatest possible satisfaction from your Wireless Receiving Set, equip it with a Magnavox Loud Speaker. Hear the voice of the singer faithfully reproduced, the perfect intonations of the lecturer, or the natural sound of music. The Magnavox is established as

**The World's Finest Loud Speaker.**

The introduction of the Magnavox Loud Speaker for use with Radio Receiving Sets marks a most important development, and will be the means of making Broadcasting extremely popular.

*To obtain the utmost strength of which the MAGNAVOX is capable, use a MAGNAVOX AMPLIFIER.*

**FULL PARTICULARS & PRICES ON APPLICATION.**

SOLE MANUFACTURERS AND LICENCEES:

**STERLING TELEPHONE & ELECTRIC CO., LTD.,**

Telephone House,

210-212, TOTTENHAM COURT ROAD, LONDON, W.1.

Telephone: Museum 4144 (7 lines),

Telegrams: "Cucumis, Wesdo, London."

NEWCASTLE-ON-TYNE:  
9, Clavering Place.

WORKS:  
Dagenham, Essex.

CARDIFF:  
8, Park Place.

**STAND  
No. 34,  
WIRELESS  
EXHIBITION**