

# Personal Computer World

US\$ 3.50/lr £1.76/BFr 127/Lire 4,500/DKr 31.00

MAY 1988 £1.30

H-P's new DeskJet  
Laser quality - matrix price

BRITAIN'S BIGGEST COMPUTER MAGAZINE

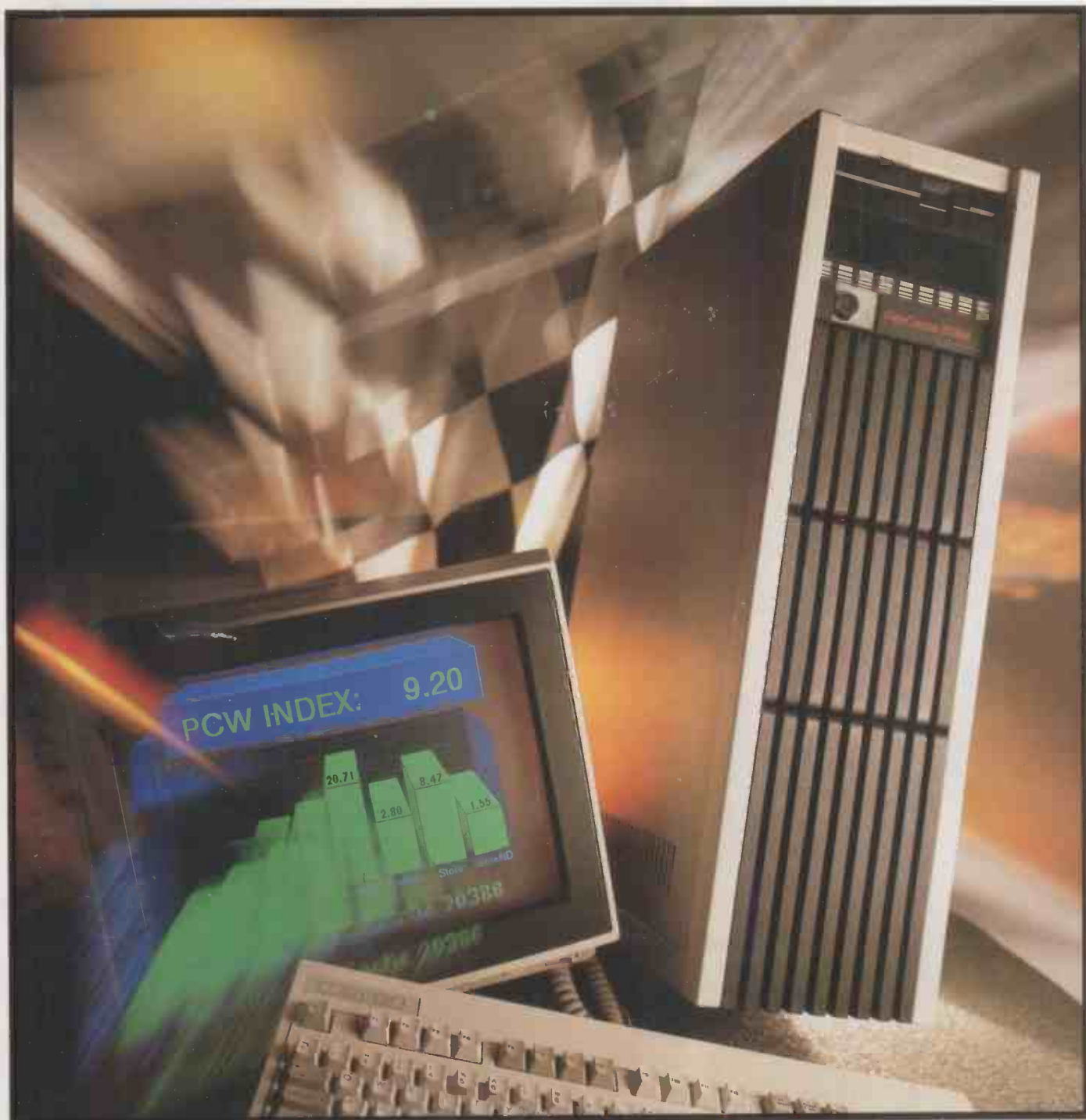

**Mission breaks the 386 speed barrier**

AST Mac28C • PC Pipedream • DataPerfect • SAM digitiser

# At Borland we mean business



**SIDEKICK PLUS • QUATTRO • PARADOX • REFLEX**



# When old standards

*At Borland we've always been in the business of setting new standards with our software.*

*We're world famous for our programming languages, and now our Business Productivity range provides the right answers to today's business questions.*

*What makes our business software special is not only its ability to instantly provide more power and better quality than the old standards but also how well it integrates into your business environment by connecting with your current system and meeting your ever growing needs.*

*We've designed our programs to work together and complement each other. The same Borland philosophy underlies them all so you always feel comfortable moving across various applications. We are also building hooks between our business products and our languages which will facilitate the development of more powerful customised applications.*

*And we're committed to providing software solutions that will span across future operating environments in a consistent manner.*

*What that means to you, is that when you purchase a Borland business product you don't only get a powerful productivity tool but the opportunity to build complete information systems, for both personal and corporate needs, by tapping into the wealth of expertise offered by Borland.*

*Expertise reflected in our fast and powerful spreadsheet, Quattro; our database manager, Reflex; our true multi-user relational database, Paradox; and now in our professional desktop manager, SideKick Plus.*

## PARADOX

The new corporate standard



Paradox is without doubt the number one relational database around. Its popularity has grown from strength to strength with major corporations making Paradox their database standard. People like British Aerospace, British Gas (North Thames), British Telecom International, and the Prudential Assurance Company Ltd., are all using Paradox to develop powerful and sophisticated applications.

---

"Paradox V 2.0 will overtake dBase anything as the world's best known, best selling, best performing, best supported database product in the world. Why? Because it's a truly amazing product."

*Microscope, 24 September 1987*

---

And that's not surprising when you look at what Paradox has to offer. It is the first relational database to offer both power and ease of use. It is also the first relational database to run in either a single user or true multi-user environment without programming. For two consecutive years Paradox has received Software Digest's\* highest rating for a PC relational database software program.

---

"The product is practically priceless. Technical support in the UK is the best I have ever encountered."

*Jerry Sanders, PC User, October 1987*

---

*Paradox combines ease of use with power and sophistication*

Paradox provides more power to single and multiple users and developers than any other relational database available. It is so easy to learn that first time users can be doing useful work within an hour. If you've ever used 1-2-3 or dBASE, you already know how to use Paradox. It has Lotus-like menus, and Paradox documentation includes "A Quick Guide to Paradox for Lotus users" and "A Quick Guide to Paradox for dBase users."

*Paradox will grow with your system*

Your investment today in Paradox applications is protected as new generations of hardware emerge. Paradox 2.0 applications will run unchanged on Paradox 386, Paradox OS/2, Paradox Unix and Paradox SQL, all of which will be completely application and menu compatible.

*Paradox 386 the next step ahead*

Paradox 386 is the next step in upholding that commitment. It is written to maximise the inherent speed and efficiency advantages of 32-bit architecture. It can store the largest tables and files in RAM and gives you a dramatic increase in processing speed by eliminating time-consuming data-swapping to and from disc.

---

"In Paradox 386 Borland has provided an exceptionally high-performance database management system and compatibility with the previous version 2.0. Paradox 386 is the PC DBMS equivalent to turbo-charging an M-series BMW".

*Giovanni Perrone, PC Week, February 1988*

---

\*Source: Software Digest, copies available on request

# are just not good enough

## REFLEX

### Breaking the bonds

Reflex breaks the bonds of traditional file management systems and gives a dramatic visual turn to data analysis.

Reflex offers you choices, you can create your own database using Reflex or manipulate data from other programs, such as Quattro, Paradox, Lotus 1-2-3, dBase, or PFS: File. Either way Reflex's form, list, crosstab, graphic and report views will enable you to look at that data in a new light.

---

"Attractive, highly usable, powerful display and analysis."

*PC User*

Reflex understands that what you see depends on how you look at it. It is the first database that probes relationships, then shows them to you in various graphic forms – scatter, line, bar, stacked bar and pie charts.



---

"Few, much more expensive, packages can compete."

*Which PC?*

---

### Tap Reflex's Power With Its Own Workshop

Whether you're a newcomer needing Reflex basics or an experienced "power

user" looking for tips, the workshop's collection of the 22 most frequently used Reflex applications in a variety of business areas will help you practice and refine methods of analysing trends and relationships.

## QUATTRO

### The switch is on

Since its launch, Quattro our new generation professional spreadsheet has quickly been accepted as the logical alternative to conventional spreadsheets.

More and more companies are purchasing Quattro for new users as well as existing ones who require more power. What they clearly want is a product that increases their productivity while allowing them to expand upon their existing applications and they don't want to wait! Quattro proves that there are better and faster ways to do graphics, to recalculate, to do macros, to save and retrieve and to search, sort and load.

In fact, to do anything and everything that a state-of-the-art spreadsheet should do.

---

"A Lotus 1-2-3-compatible spreadsheet that overwhelms the industry standard in most departments."

*Manek Dubash – Practical Computing – Dec '87*

---

### Quattro Gives You Presentation-Quality Graphics

Quattro opens new horizons in quality graphics on a spreadsheet. It also brings new variety and diversity to the kinds of graphs and graphics you can produce. Eleven types of graphs are available including bar, rotated bar, line and XY graphs, pie and area charts. You can print the graphs directly from the spreadsheet to over 300 different printers whilst Quattro also offers PostScript support.

### Quattro Recalculates With Amazing Speed

With Quattro, we have found the fastest way to recalculate a spreadsheet: it is called "intelligent recalc". It only recalculates the cells that have been affected by a change. Unlike 1-2-3, Quattro recounts just the formulas that matter.

---

"Quattro is an impressive product at an affordable price. With more features than 1-2-3, menu and macro compatibility, and better graphs, it makes it awfully hard to justify buying 1-2-3 release 2.01 instead."

*PC Magazine – January 1988*



### Quattro Provides A Full Macro Debugging Environment

Unlike 1-2-3 you're not limited by the number of macros you can create and Quattro provides you with a debugging environment which facilitates the development of sophisticated macros.

### If You Know How To Use 1-2-3, You Know How To Use Quattro

You don't have to learn a whole new program. Quattro implements all 1-2-3 functions and it directly reads and writes all 1-2-3 files, including macros. Quattro can also load and save Paradox, dBase and ASCII files.



# When you get serious about getting organised, get SideKick Plus

With SideKick we introduced more than a million businessmen to the convenience of a desktop organiser.

And now we're introducing SideKick Plus, with more features, more versatility and more power, so that you can seriously get organised.

SideKick Plus is a powerful desktop environment with eight super-charged productivity tools that work together to help focus your creativity. Collate your ideas. Manage your work and your workload.

"Experienced SideKick users will feel like kids in a candy store when they begin using SideKick Plus."

*Byte, March 1988*

### *You've Never Worked So Effectively*

Once you start using SideKick Plus you'll surprise yourself just how effective you can be. Because SideKick Plus is there to organise what you need done, the way you want it.

While you concentrate on the important things, SideKick Plus helps outline your presentation, picks up your electronic mail and gets you to the meeting on time. It does your calculations, and even moves data back and forth between applications — all without leaving the application you're working in!

To add all the productivity tools in SideKick Plus separately, you'd have to spend hundreds of pounds and use up all your computer's memory. With SideKick Plus you decide how much memory and which applications you use.

Here's a look at all the productivity tools you get.

**THE PHONEBOOK:** Turns your PC into a powerful communications tool for both voice and data. It keeps your names, addresses and phone numbers at your fingertips and stands ready in the background.



"When the news of SideKick Plus first arrived, I made up a shopping list of the improvements I would like to see in it. Borland has provided all these things and much, much more."

*Dick Pountain, PCW, March 1988*

**THE TIME PLANNER:** Will do everything from scheduling phone calls to backing up your hard disk. It will set recurring appointments like staff meetings to repeat daily, weekly or monthly. Attach notes, reminders or reference materials.

**THE NOTEPAD:** Follows your thoughts no matter which direction they're going. It's a powerful editor with familiar WordStar-type commands that lets you create up to nine files at once over any other program you're working in.

**THE CLIPBOARD:** Takes away the boundaries that separate your files and applications. It lets you transfer information from one program to another with a single keystroke.

**OUTLOOK:** A fully functional outline processor which organises your thoughts, lists your priorities, outlines long reports and minds your agenda.

**THE CALCULATOR:** Four specialised calculators; the Business Calculator, the Scientific Calculator, the Programmer Calculator and the Formula Calculator.

**THE FILE MANAGER:** Creates, moves and searches or renames DOS files and directories.

**THE ASCII TABLE:** Finds any character and pastes it quickly and easily.

## We mean business with our business software

No matter how large or how small your budgets are, buying Borland always makes good business sense. In fact, we're sure that you won't find better business software at any price.

SideKick Plus retails at £195.00 plus VAT. Quattro and Reflex with its workshop will only cost you £129.95 plus VAT each, while Paradox 2.0 sells at £449.95 plus VAT and Paradox 386 at £549.95 plus VAT.

For additional information contact your nearest dealer or simply fill in the coupon or call

**(0734) 320022**



Borland International (UK) Ltd,  
8 Pavilions, Ruscombe Business Park,  
Twyford, Berkshire RG10 9NN.

### **SideKick owners. Get a great deal from your dealer and a £20 rebate from Borland.**

Go to your favourite dealer for a great deal on the new SideKick Plus. Because you're a SideKick user we'll make it an even better deal — with a £20 refund from Borland! To receive your refund, you must return your completed SideKick Plus registration form from your manual, a copy of your dated SideKick Plus sales receipt and this completed coupon (including your SideKick serial number\*) to:

Borland International (UK) Ltd, 8 Pavilions, Ruscombe Business Park, Twyford, Berkshire RG10 9NN. Tel: (0734) 320022

\*If your copy of SideKick does not have a serial number, remove and return the front cover of your SideKick manual. To take advantage of this offer, you must purchase SideKick Plus before June 31st 1988 and return your refund request to Borland by July 31st 1988. This offer is valid for one rebate per registered copy of SideKick and is not valid with any other offer from Borland.

Name \_\_\_\_\_  
Address \_\_\_\_\_  
Tel: \_\_\_\_\_  
SideKick Serial No. \_\_\_\_\_  
(must be included to qualify for rebate)

### **I Mean Business Too! Please send me more information on:**

- SideKick Plus's ability to get me organised
- Quattro's speed and power
- Paradox 2.0's advanced relational database management
- Paradox 386's superior performance
- Reflex's ability to manage my files and analyse my data

Name \_\_\_\_\_  
Position \_\_\_\_\_  
Company \_\_\_\_\_  
Address \_\_\_\_\_  
Tel: \_\_\_\_\_  
Borland International (UK) Ltd,  
8 Pavilions, Ruscombe Business Park,  
Twyford, Berkshire RG10 9NN.

# Personal Computer World



## MISSION FLEXCACHE 20386

96

Without resorting to over-revving the chips, Mission has succeeded in producing the fastest 80386 PC seen so far. Peter Jackson investigates the techniques while Nick Walker looks at distinctive new 386 machines from Intel and Zenith.

Cover photography by Chris Bell

## FEATURES AND REVIEWS



## HP DESKJET

108

If you've lusted after laser-quality output but had a dot-matrix sized budget, Hewlett-Packard's ink-jet printer could be the answer. Derek Cohen examines the impressive text and graphics the machine can produce.

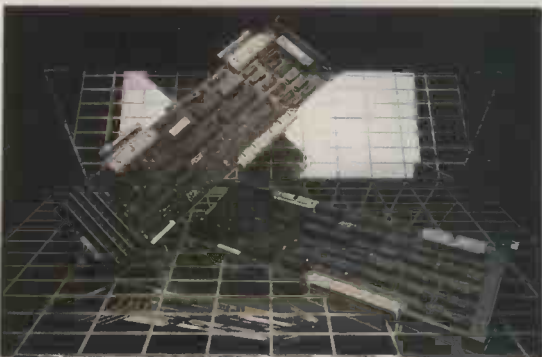

## AST MAC286

112

One of the first co-processor cards for the Apple Macintosh II gives it a degree of AT compatibility. John Donaldson checks out how well it works and questions whether the effort is worthwhile.

## SAM DIGITISER

116

Desktop publishing on the Atari ST gains a new dimension as Barbara Gaskell pulls real-time video images into her computer with this budget-priced frame grabber.

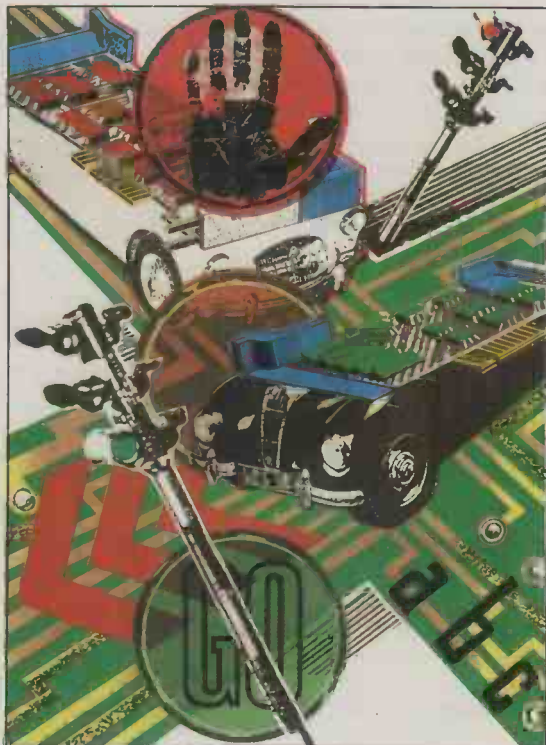

## CHANNEL LINK

120

Pat Moran reveals the secrets inside IBM's Micro Channel Architecture and explains how, as everyone feared, OS/2 will run faster on machines with an MCA.

Founder Angelo Zgorelec Editor Derek Cohen Deputy Editor Nick Walker Production Editors Lauraine Danker, Ginny Conran Technical Editor Owen Linderholm Staff Writer Andy Redfern Editorial Assistant Chris Cain Consultant Editors David Tebbutt, Dick Pountain Art Director Martyn J Rowbotham Art Editor Mike Wright Publishing Director Mike Agate Publisher David Mankin Production Controller Simon Maggs Production Manager Howard Bowles Production Assistant Adrian Goldney Group Advertisement Manager Jan Pitt Advertisement Manager Moira Thomson Deputy Advertisement Manager Nick Ascough Sales Executives Sally McLester, Derek Drewett, Helen O'Driscoll, Alan Gonsalves, Mary de Sausmarez, Fay Callow



# REGULARS

## NEWSPRINT 70

What Guy Kewney saw at Hanover, including the Atari ST laptop. Plus Amstrad's next move.

## WEST COAST CONNECTION 85

Tim Bjarin spills the beans on Apple's laptop and IBM's plans for licensing its Micro Channel.

## LETTERS 92

PCW's readers sound off on the price of CD-ROMs, and poor service from manufacturers.

## BANKS' STATEMENT 90

Martin Banks wonders why he gets a third-degree interrogation in shops.

## BIBLIOFILE 164

Become more expert about expert systems with this month's book selection.



## SCREENPLAY 168

Play an American cop, chase dragons and rescue glamorous dames with gamester Stephen Applebaum.

## MAILBOX 172

Peter Tootill takes a look at comms packages available for PC compatibles.

## MUSICAL INTERLUDE 178

Roger Howorth samples the delights of a sequencer/sampler for PC compatibles.

## SUBSET 180

Quick multiplication features in David Barrow's machine code medley.

## PROGRAM FILE 182

Andy Redfern takes you through the process of writing an image enhancer, and presents this month's readers' contributions.

## END ZONE 211

Numbers, puzzles, 'For Sale' ads and listings of user groups and bulletin boards.

## CHIPCHAT

How we discovered IBM had a sense of humour.

# FEATURES AND REVIEWS

## DATAPERFECT 128

A relational database from the maker of top-selling word processor WordPerfect should be an instant hit. Simon Jones checks out whether its promise is fulfilled.

## PC PIPEDREAM 134

The software that makes the Z88 such a useful tool is now available under MS-DOS. Owen Linderholm runs the two versions side by side and investigates what has been gained and lost in the translation.

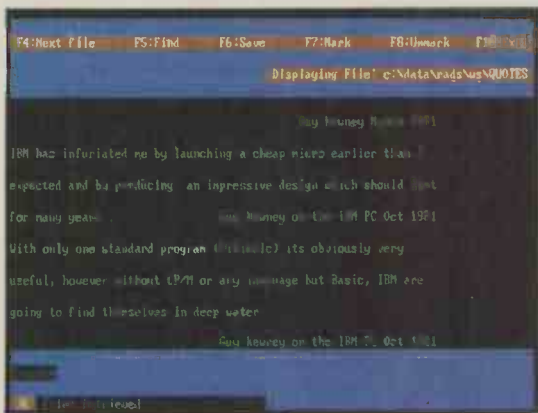

## TEXT RETRIEVAL PACKAGES 136

As hard disks become more popular, the problem of locating particular documents among the mass of files gets worse. Andy Redfern navigates his way through three different solutions: Gofer, ZylIndex and Filepoint.

## ARCHIMEDES WORD PROCESSORS 142

Roger Howorth discovers how two word processors, First Word Plus and Graph Writer, make use of the Archimedes' great power.

## FIRST-CLASS POSTSCRIPT 148

It's easy to produce exciting laser-output graphics from a humble Beeb if you know how to program in PostScript. Julian Dow provides the wiring diagrams, listings and inside information.

## SERVING THE SYSTEM 156

SQL is the common language which, in theory, will allow all database users to share the same information. Kathy Lang explains why such a standard is needed and how it works.

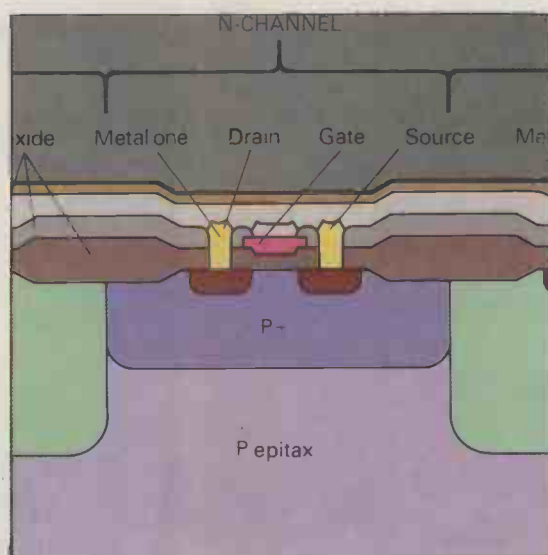

## THE BEST OF BOTH WORLDS 160

Nick Hampshire peers down his microscope to report on how the latest microcomputer chips combine both analogue and digital processing on the same piece of silicon.



## STATIONERY



Prices are per 500, minimum order total 1000. FREE delivery U.K.

2 PART STATEMENTS	26
3 PART STATEMENTS	27
2 PART INVOICES	29
3 PART INVOICES	33
4 PART INVOICES	45
SECURITY PAYSLEIPS	48
PAYSLEIPS	21
REMITTANCE ADVICE	18
BANK GIRO	15
P14/P60	34
P35	34
STATEMENT ENVELOPES	21
PAYSLEIP ENVELOPES	21

CALL FOR FREE SAMPLE SETS

## NETWORKING

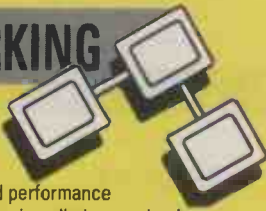

ISC support the industry standard Novell Netware for assured reliability and performance

We provide a complete installation service by qualified support staff including cabling. Call us to discuss your requirements in detail

Starter kits supplied with:

One fileserver card, two workstation cards, Novell Netware software and cables, 12 Months Guarantee (Maintenance Contract Available)

### ETHERNET - High Performance

Starter Kit Netware 86	2050
Starter Kit Netware 286	2475
Additional Workstation Card	295

### G/NET - Medium Performance

Starter Kit 8-user Netware 86	1595
-------------------------------	------

### TOKEN-RING - IBM Network Standard

Starter Kit Netware 286	3050
Additional Workstation Adapter	425

Network Installation from Site Survey & Cabling Quotation	250
	FREE

## MAINTENANCE



ISC now offer ON SITE 24 HOUR response support on all the products we supply using our own qualified staff

As with all our services we GUARANTEE the LOWEST prices and the HIGHEST level of support

We also will contract equipment not originally supplied by ourselves - example pricing below

PRODUCT	CONTRACT PRICE	RESPONSE
TANDON PCA 20	160 PER ANNUM	24 HOURS
EPSON FX1000	53 PER ANNUM	24 HOURS
PEGASUS ACCOUNTS	0 BI ANNUAL	HOTLINE

As a guide, allow 10% of the RRP for contracts

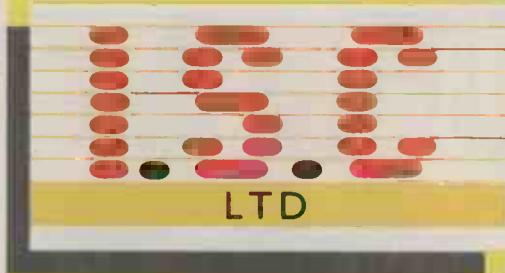

U.K.'s BEST SERVICE

COMPUTER SOFTWARE

Head Office:

**FORRESTER HOUSE  
BRAMLEY ROAD,  
ST IVES  
CAMBRIDGESHIRE  
PE17 4WS.**



**HOT LINE (16 lines)  
0480 300530**

SCOTTISH OFFICE:

19 CARDEN PLACE, ABERDEEN AB1 1UQ  
TEL: (0224) 639944 (8 LINES)

**SATURDAY  
OPENING**  
Open 10am to 4pm  
Call us Now

Prices shown exclude VAT

## TRAINING



We offer Introductory or Advanced level training at your premises on a wide range of products some of which are listed below

**PEGASUS ACCOUNTS, WORDSTAR, WORD  
WORDPERFECT, RBASE, DBASE III  
DATAEASE, LOTUS 123, SUPERCALC 4  
SYMPHONY, SMART, MSDOS, NOVELL, XENIX**

Prices are from £175 per day on most courses. Call today to discuss your requirements with our Training Manager.

## PEGASUS ACCOUNTING



TWO YEARS FREE support included

We are the largest independent Pegasus dealer in the U.K. with over 2400 modules installed to date

**PEGASUS SINGLE USER** 160  
Multi Company with 8 module integration - the standard for more than 50% of computerised businesses in the U.K.

**PEGASUS SENIOR V3** POA  
The enhanced version of single user with multi currency, cost centres, full order processing and many other features

**PEGASUS SENIOR MULTI USER V3** POA  
The multi terminal version of Senior, runs on a multi user xenix, concurrent and Network systems

**ELITE/ELITE SENIOR** 345  
Comprehensive database with the ability to read and write Pegasus data files for special uses

**WORK INVOICING** 295  
Integrates with Single User for complex Invoicing and repeat billing

**SUPPORT CONTRACT (per module)** 50  
ISC will support your Pegasus for 2 years even if it was purchased elsewhere

Also Available:  
Upgrade from Single User to Senior or to Multiuser with Full Data Transfer Service

Call Now for  
FAX machines Sales & Installation

### FAX SALES

<b>NEFAX The Market Leading FAX</b>	
NEFAX - 10	1350
NEFAX - 12	1950
NEFAX - 14	2395

<b>DOWTY MICROFAX</b>	
FAX Adapter Card for your PC	845

IF YOU PROVIDE A CURRENTLY ADVERTISED LOWER PRICE

THE  C

# COMPUTERS



All computers include

Mono Screen & Hercules Graphics  
Parallel & Serial Ports  
Keyboard & MsDos  
Full Test Prior to delivery

## TANDON

PCX - 8088, 4.7MHz, 640Kb Ram  
PCA - 80286, 8MHz, 1Mb Ram  
386 - 80386, 16/20MHz, 2Mb Ram

PCX20  
386-20 112Mb, 1.2Mb Floppy 4495  
EGA Colour Monitor - additional 295

## APRICOT XEN

286 - 80286, 10MHz, 1Mb Ram  
386 - 80386, 16MHz, 2Mb Ram (1Mb on 386/30)  
Choice of 1.2Mb 5.25" or 1.44Mb 3.5" Floppy

286/30 30Mb, 1.2/1.44Mb Floppy 1895  
286/45 45Mb, 1.2/1.44Mb Floppy 2495  
386/30 30Mb, 1.2/1.44Mb Floppy 2695  
386/45 45Mb, 1.2/1.44Mb Floppy 3395  
386/50 50Mb, 1.2/1.44Mb Floppy 3895

Paper White Monitor - additional 100  
286 EGA Colour System - additional 625  
386 EGA Colour System - additional 450

## AMSTRAD 1640

8086, 8MHz, 640Kb Ram  
PC1640SD Mono Screen, 360Kb Floppy 445  
PC1640DD Mono Screen, Twin Floppy 575  
PC1640HD Mono, 20Mb Hard Disk, Floppy 825  
PC1640HD ECD Colour Screen, 20Mb Disk 1075  
CGA Colour Screen - additional 125  
ECD Colour Screen - additional 250

## TULIP (High Quality Small Footprint)

PC2 - 8088, 9.5MHz, 640Kb Ram  
AT - 80286, 10MHz, 640Kb Ram  
386 - 80386, 16MHz, 2Mb Ram  
PC2 Twin 360Kb Floppy POA  
PC2 20Mb, 360Kb Floppy POA  
AT20 20Mb, 1.2Mb Floppy POA  
AT40 40Mb, 1.2Mb Floppy POA  
386 40Mb, 1.2Mb Floppy POA

## IBM PS/2

M30 - 8086, 8MHz, 640Kb Ram  
M50 - 80286, 10MHz, 1Mb Ram  
M60 - 80286, 10MHz, 1Mb Ram  
M30-021 20Mb, 720Kb Floppy 1725  
M50-021 20Mb, 1.44Mb Floppy POA  
M60-041 40Mb, 1.44Mb Floppy POA

## EXPANSION

PC/XT 256Kb Ram Card 129  
PC/XT 512Kb Ram Card 149  
AT 1Mb Ram Card 325  
APRICOT 256Kb Ram Card 109  
APRICOT 512Kb Ram Card 129  
8087-2 Maths Coprocessor 159  
80287-8 Maths Coprocessor 229  
20Mb Hard Disk Card 345  
EGA Card and Colour Monitor 595



U.K.'s LOWEST PRICE



Head Office:

**FORRESTER HOUSE  
BRAMLEY ROAD,  
ST IVES  
CAMBRIDGESHIRE  
PE17 4WS.**



**HOT LINE (16 lines)  
0480 300530**

SCOTTISH OFFICE:  
19 CARDEN PLACE, ABERDEEN AB1 1UQ  
TEL: (0224) 639944 (8 LINES)



Prices shown exclude VAT

# PRINTERS

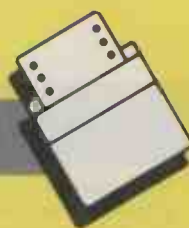

## EPSON

80 Column	A4 Size	
LX800	150CPS 35NLQ Tractor Feed	195
FX800	200CPS 40CPS Tractor Feed	295
EX800	300CPS 50NLQ Tractor Feed	395
LQ500	150CPS 50NLQ 24pin	325
LQ850	220CPS 75NLQ 24pin Tractor	475
132 Column - Wide Listing		
FX1000	200CPS 40NLQ Tractor Feed	375
EX1000	250CPS 50NLQ Tractor Feed	495
LQ1050	220CPS 73NLQ 24pin Tractor	495
LQ2500	270CPS 90NLQ 24pin Tractor	725

## NEC

P2200	80COL 170CPS 56NLQ 24pin	295
P6	80COL 180CPS 60NLQ 24pin	425
P7	132COL 180CPS 60NLQ 24pin	475

## OTHER

PANASONIC	1081 80 COL 120CPS 24NLQ	155
CANON	A55 156COL 180CPS 45NLQ	375
FUJITSU	DX2100 80COL 220CPS 44NLQ	295
FUJITSU	DX2200 136COL 220CPS 44NLQ	395

## DAISYWHEEL

JUKI	6100 136COL 15CPS	275
JUKI	6200 136COL 30CPS	425
JUKI	6300 136COL 35CPS	635

## LASER

EPSON	GQ3500 (6PPM)	1395
BROTHER	HL8 (8PPM)	1495
CANON	LPBII (8PPM)	1595
HP	LASERJET II (8PPM)	1595

## SPECIALS

APRICOT	256K RAM	99
APRICOT	512K RAM	119
IBM	256K RAM	119

# SOFTWARE



PEGASUS SINGLE USER	160
PEGASUS SENIOR V3	POA
PEGASUS MULTIUSER V3	POA
SAGE ACCOUNTANT	120
SAGE ACCOUNTANT PLUS	150
SAGE PAYROLL	85
RBASE SYSTEM (MULTI USER)	395
DBASE III +	345
DBASE II	255
DELTA4 PROFESSIONAL	335
DATAEASE	395
BORLAND PARADOX V2	445
WORDSTAR PROFESSIONAL V4	205
WORDSTAR V4	190
WORDSTAR 2000 + REL 3	259
MS WORD	270
WORDPERFECT V5	295
LOTUS MANUSCRIPT	249
LOTUS 1-2-3 V2	249
LOTUS SYMPHONY	359
SUPERCALC 4	225
MICROSOFT EXCEL	275
BORLAND QUATTRO	95
SMART INTEGRATED V3	385
ABILITY PLUS	129
VENTURA DESKTOP PUBLISHING	595
PC PAINTBRUSH	89
GEM PRESENTATION TEAM	259

5000 other titles available, please call for prices.

ARANTEE

E WITHIN 7 DAYS, THE DIFFERENCE WILL BE REFUNDED



## NETWORK

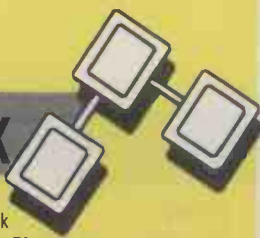

CSL fully support the industry standard network adapters: Ethernet, Token-Ring, and G Net. This allows us to supply you with the most suitable system for your requirements. Each PC in your network requires a Workstation Adapter Card, which connects to the Network cabling. The central Fileserver PC also needs an Adapter Card, which for maximum performance on 80286 machines can be a special Fileserver Card.

### ETHERNET – High Speed, Best Value – 180m Max Length

Novell Workstation Adapter Card	275
Micom Workstation Adapter Card	295
G/Ethernet Workstation Adapter Card	299
Apricot Workstation Adapter Card	275
Western Digital Workstation Adapter Card	250

Micom Fileserver Adapter Card  
3Com + Fileserver Adapter Card

### TOKEN-RING – High Speed, IBM Standard

Workstation Adapter Card	425
High Speed Fileserver Card	499
8-Station Wiring Hub	495
4-Station Wiring Hub	245

### G/NET – Medium Speed – 1200m Max Length

G/NET Workstation Adapter Card	299
--------------------------------	-----

## SAMPLE NETWORK

### FOUR USER ETHERNET

One 286 Fileserver with 40Mb Disk	1895
Four PC Workstations with Floppy Disk	3000
Five Ethernet Workstation Cards	1250
Novell Network 86	1125
Installation and Configuration	250
<b>TOTAL</b>	<b>7520</b>

This price does not include cabling

## PC/S�AVE II

### NETWORKING WITH ONE COMPUTER

An ideal start to networking or multiuser systems. Use just one Fileserver machine and add other users by installing PC/Slave II Cards inside it. Each Card is like two computers each with a separate processor and 512Kb Ram, connecting to a screen and keyboard via a 25ft cable. Simply by installing additional PC/Slave II Cards you can expand from 2 to 4 to 6 users and so on. The Fileserver operates Novell Network so high performance, complete security and software compatibility are assured.

PC/Slave II Card – 2 Processors, 1Mb Ram	750
Workstation Monitor and Keyboard	275
Novell Network 86 (8 user system)	475

### SAMPLE FOUR USER SYSTEM

One Fileserver with 40Mb Disk	1895
Two PC/Slave II Cards	1500
Four Workstations	1100
Novell Network 86	475
Installation & Configuration	250
<b>TOTAL</b>	<b>5220</b>



## U.K.s BEST SERVICE



Head Office:

**FORRESTER HOUSE,  
BRAMLEY ROAD,  
ST IVES  
CAMBRIDGESHIRE  
PE17 4WS**



**HOT LINE (16 lines)  
0480 300530**

SCOTTISH OFFICE:  
19 CARDEN PLACE, ABERDEEN  
TEL: (0224) 639944

## INSTALLATION & SUPPORT



### HOTLINE

Hotline support included with all Network

### INSTALLATION

Full Configuration and Testing prior to delivery.  
Installation on site and Configuration of Software.  
Depending on Network size – price from 250

### CABLING

We offer a comprehensive cabling service for all our Network systems. Our engineers will be pleased to carry out a full site survey without obligation.

## NOVELL NETWORK

Network is the market leading network operating system, and offers the following benefits.

**Highest Performance  
Complete Reliability  
from 2 to 100 users  
Easy to operate**

NETWORK operates on a central Fileserver machine, which contains all the shared programs, data and printers. The workstations then connect to the Fileserver via the network, to access the shared information. The Fileserver normally needs to be a high performance system with a large capacity Hard Disk Drive.

We recommend the use of a dedicated Fileserver for all Novell installations to guarantee reliability and give optimum performance.

**ADVANCED NETWORK 86** 1125  
Maximum 640Kb Ram limits performance  
Optional non-dedicated operation

**ADVANCED NETWORK 286** 1550  
For 286 and 386 servers  
Optional non-dedicated version

**ADVANCED NETWORK 286 SFT** 2850  
For 286 and 386 servers  
Offers fault tolerant features to reduce the risk of a system failure

All Novell systems are supplied with 12 months Hotline support free.

## NETWORK SOFTWARE



Pegasus Senior Network	POA
Wordstar Professional Network	325
Wordstar 2000 Network	455
Wordperfect Network Server	550
Supercalc 4 Lanpack (3-user)	325
Rbase System V	395
dBase III Plus Lanpack (5-user)	795
Paradox Network (6-user)	645
Smart Additional Lan User	275

## DESKTOP PUBLISHING



CSL now offer a full range of equipment to fulfill your desktop publishing requirements.

<b>SOFTWARE</b>	
Ventura publisher	595
Pagemaker	450
Publishers paintbrush	175

### SAMPLE SYSTEM

Tandon PCA40	
Brother HL8 laser printer	
Microsoft mouse	
Genius A4 paper white screen	
Canon IX-12 scanner	
Ventura publisher	
Publishers paintbrush	6095

**THE CONTRACT SOLUTIONS**

IF YOU PROVIDE A CURRENTLY ADVERTISED LOWER PR



# COMPUTERS



EXAMPLE PRICES		P/A
<b>AMSTRAD</b>		
1512	FROM	75
PC1640	FROM	75
<b>APRICOT</b>		
XENI286	FROM	200
XEN 386	FROM	340
<b>TANDON</b>		
PCX	FROM	90
PCA	FROM	150
TARGET	FROM	170
<b>TULIP</b>		
COMPACT2	FROM	75
AT286	FROM	170
AT386	FROM	400
<b>EPSON</b>		
EPSON PC	FROM	125
EPSON AX	FROM	190
<b>COMPAQ</b>		
DESKPRO286	FROM	290
DESKPRO386	FROM	550
<b>TOSHIBA</b>		
1000 SERIES	FROM	125
3000 SERIES	FROM	330
5000 SERIES	FROM	460
<b>IBM</b>		
IBM XT	FROM	100
IBM AT	FROM	300
IBM M30	FROM	150
IBM M50	FROM	310
IBM M60	FROM	430
IBM M80	FROM	520
<b>OLIVETTI</b>		
M24	FROM	200
M28	FROM	300
M380	FROM	440

CSL now offer ON SITE 24 Hour response support on all the products we supply using our own qualified staff.

- Guaranteed 24 hour response.
- If we cannot repair your equipment on-site we will give you a suitable replacement until yours is repaired.
- Hotline support for your immediate problems both software and hardware.
- Fully qualified and trained support staff.
- Large spare parts inventory.
- 6 day 4 hour call out available on request.

# CONTRACT SOLUTIONS

LTD

U.K.s FASTEST SERVICE



Head Office:

**FORRESTER HOUSE,  
BRAMLEY ROAD,  
ST IVES  
CAMBRIDGESHIRE  
PE17 4WS**



**HOT LINE (16 lines)  
0480 300530**

SCOTTISH OFFICE:  
19 CARDEN PLACE, ABERDEEN  
TEL: (0224) 639944

THE RANGE OF SUPPORTED SYSTEMS AND PERIPHERALS IS FAR GREATER THAN THOSE STATED ABOVE. RING FOR A QUOTE ON YOUR SYSTEM TODAY.  
NOTE: MINIMUM CONTRACT £125  
PRICES SHOWN DO NOT INCLUDE VAT  
CALL NOW FOR A COPY OF OUR SERVICE AGREEMENT

# PRINTERS

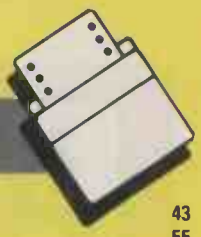

<b>EPSON</b>		
FX SERIES	FROM	43
EX SERIES	FROM	55
LQ SERIES	FROM	50
LX SERIES	FROM	30
<b>FUJITSU</b>		
DX SERIES	FROM	45
DL SERIES	FROM	75
<b>JUKI</b>		
6100	FROM	40
6200	FROM	58
6300	FROM	90
6500	FROM	130
<b>PANASONIC</b>		
P1081	FROM	25
P1592	FROM	50
P1595	FROM	70
<b>NEC</b>		
P SERIES	FROM	40
CP SERIES	FROM	75
SPINWRITER	FROM	120
<b>CANON</b>		
A-SERIES	FROM	50

# LASER PRINTERS



<b>HEWLETT PACKARD</b>		
LASERJET	FROM	200
<b>CANON</b>		
LBP8	FROM	200
<b>KYOCERA</b>		
F-SERIES	FROM	230
<b>BROTHER</b>		
HL8	FROM	170

CSL's extra cover agreement offers you fast reliable service for your personal computers, micro computers, printers and other peripheral equipment from a large number of established manufacturers.

Our highly trained workshop/field engineers have the facilities and the expertise to handle diverse products to high standards of repair quality, all geared to minimising inconvenience and downtime on your equipment.

When you choose CSL for your third party service you not only get value for money but also the caring attitude that is hard to find at any price.

**GUARANTEE  
E WITHIN 7 DAYS, THE DIFFERENCE WILL BE REFUNDED**

# ATT

# peripherals

# CORPORATION

## SPECIALISTS IN EXPORT

### PRINTERS

EPSON LX 800	£195
EPSON FX 800+	£295
EPSON FX 1000	£375
EPSON EX 1000	£495
EPSON LQ 1000	£425
EPSON LQ 2500	£725
EPSON LQ 800	£375
NEC P7	£POA
NEC P5XL	£POA
NEC P9XL	£POA
FULL RANGE OF SIEMANS, STAR, FUJITSU, AND JUKI PRINTERS ALSO AVAILABLE	

### LASER ACCESSORIES

HP 1MB UPGRADE	£295
HP 2Mb UPGRADE	£695
HP 4Mb UPGRADE	£1440
HP FONTS FROM	£110
HP TONER	£75
HP 2 TONER	£80
EPSON GQ DIABLO 6301/D	£110
EPSON GQ SERIAL I/F	£82.50
EPSON GQ 1.5Mb	£305
GQ TONER	£18

### MONITORS + ADD-ON BOARDS

NEC MULTISYNC	£534
SONY 14" 1402E	£625
TAXAN SUPERVISION 770+	£552
MEGASCREEN (A3 SIZE)	£1550
WYSE 700	£725

### MODEMS

HAYES SMART MODEM	£380
DOWTY QUATRO	£620
MIRACLE WS2000	£105
RACAL MILGO	POA
PAGE SERIES IV	POA
DACOM DSL 2123 CLASSIC	£230

### MOUSE DEVICES + SOFTWARE

MS MOUSE	£102
PC MOUSE	£130
LOGIMOUSE PLUS PACK	£99
SUMMA MOUSE	£89
DB3+	POA
WORDSTAR	POA
MS WORD	POA
WORDPERFECT	POA
VENTURA	POA
PAGEMAKER IBM	POA
PAGEMAKER IBM MAC	POA

### LAP TOP COMPUTERS AND ACCESSORIES

NEC MULTISPEED	POA
KAYPRO 200	POA
TOSHIBA T1000	POA
TOSHIBA T1100 +	POA
TOSHIBA T1200	POA
TOSHIBA T3100 (10Mb)	POA
TOSHIBA T3200	POA
TOSHIBA T5100	£1225
ZENITH Z181 2+720 DRIVE	£1940
ZENITH Z183 10Mb	POA
COMPAQ	POA
SPECIAL OFFERS	
PARALLEL PRINTER CABLES	£15.00
EP TONER CART	£75.00

## RING NOW: 01-739 4596

# ATT

# peripherals

## Corporation Ltd

(T1) INDUSTRIAL UNITS STANWAY STREET LONDON N1 6RY

TEL: 01-739 4596 Telex 895 1182 GECOMS G CALLERS BY APPOINTMENT ONLY





# ATT Corporation Ltd

## PRICE GUARANTEE

PROVIDE A WRITTEN LOWER QUOTATION FROM AN AUTHORISED DEALER WITHIN 7 DAYS OF PURCHASE AND THE DIFFERENCE WILL BE REFUNDED!

CALLERS BY APPOINTMENT ONLY "PRICES SUBJECT TO FLUCTUATION. VAT NOT INCLUDED"

## SPECIALISTS IN EXPORT

### APPLE

MACINTOSH II MONO  
MACINTOSH SE 2x800  
MACINTOSH SE 20MB  
MACINTOSH PLUS 1Mb RAM  
IMAGEWRITER II  
MAC DRIVE 800K  
HARD DISK 20Mb II  
APPLE LASERWRITER SC  
LASERWRITER II NT

£4100  
£1795.50  
£2286.00  
£1200.00  
£365  
£251  
£683.70  
£1675.80  
£2767.80

### PROFESSIONAL DESKTOP PUBLISHING

Apricot 80386 30Mb 16MHz Clock  
1Mb RAM 1.2/1.44 drive  
MDS Genius (hi-res) full page DTP  
screen  
Hewlett Packard Series II LaserJet  
Canon Imagescanner incl OCR  
Ventura Publisher edition  
Microsoft Word Version IV

★ £7000 ★

### APRICOT

XEN PC/S 30Mb mono  
XEN PC/S 30Mb P/white  
XEN PC/S 30Mb colour  
XEN PC/S 50Mb mono  
XEN PC/S 50Mb p/white  
XEN PC/S 50Mb colour  
XEN 386 1Mb RAM/30Mb/1.4  
XEN 386 2MG/50Mb/1.4  
**TOWER SYSTEMS**  
XEN 386 5050Mb p/white  
XEN 386 50Mb **VGA**  
XEN 386 100Mb p/white  
XEN 386 100 **VGA** colour

£1700  
£1870  
£2350  
£3450  
£3590  
£4200  
£2300  
£3100  
£3100  
£3350  
£3950  
£4150

### AFFORDABLE DESKTOP PUBLISHING

COMPUTER-APRICOT-286 30Mb  
80286 30Mb H/D 1.2/1.4 drive  
10MHz IBM compatible inc Lan card  
**LASER PRINTER — HEWLETT-  
PACKARD (SERIES II)**  
8 Pages per minute  
300 DPI  
512k RAM/4mb — S/P Ports  
Including Cable & Toner  
**SOFTWARE**  
Ventura Publishing  
Microsoft Word V4

★ £4400 ★

### LASER PRINTERS

EPSON GQ LASER 3500  
**HP LASER JET II S/P Ports Special Price**  
BROTHER HL8 (no toner)  
QUIME SCRIPT TEN 2Mb  
**SCANNERS**  
HP SCANNER + INTERFACE  
CANON 1x12 Imagescanner inc OCR  
MICROTEK (IBM Flatbed)

£1250  
£1550  
£1745  
£3800  
£1550  
£1450  
£1425

### FINANCE

LEASE RENTAL  
CASH  
LEASE PURCHASE  
HIRE PURCHASE  
INSTANT CREDIT (Subject to Status)

products carry a 12 months Full  
Guarantee with HOTLINE Phone Support

## RING NOW: 01-729 7033

# ATT Corporation Ltd

(T1) INDUSTRIAL UNITS STANWAY STREET LONDON N1 6RY  
TEL: 01-729 7033 Fax: 01-739 3273 Telex 895 1182 GECOMS G





# MULTIBUFFER: THE ULTIMATE PRINTER PLOTTER SHARER

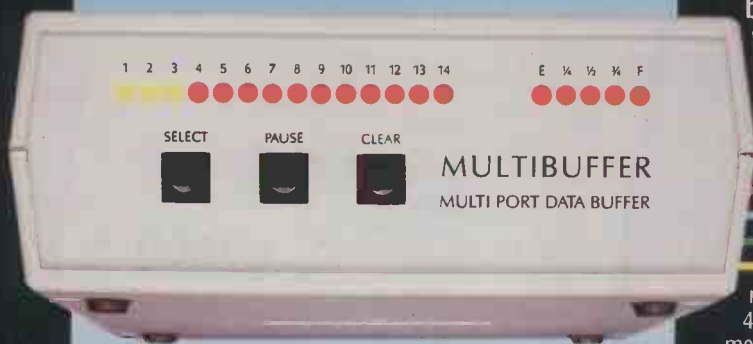

**New British-made universal buffered printer/plotter sharer and data switch**

- Up to 14 user-installable serial and/or parallel ports.
- ALL INPUT/OUTPUT PORTS CAN BE ACTIVE SIMULTANEOUSLY.
- Up to 4 MEGABYTES of common memory, automatically allocated and deallocated as required on each active port.
- SEVERAL PCs CAN SHARE ONE OR MORE PRINTERS OR PLOTTERS.
- ANY PC CAN ACCESS ANY PRINTER OR PLOTTER.

## User-configurable for future requirements

The MULTIBUFFER can be factory- or user-configured with 1-7 plug-in interface cards for up to 7 parallel ports or 14 serial ports, or a combination of parallel and serial. Each serial card provides two data ports. Data direction (input/output) of each port is selectable and all common baud rates and handshakes are supported.

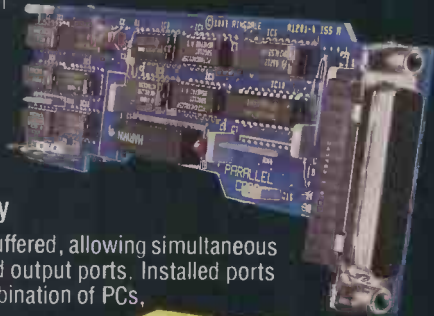

## All users can send data simultaneously

Each port is separately buffered, allowing simultaneous data flow on all input and output ports. Installed ports can be used for any combination of PCs, printers and plotters.

## Up to FOUR MEGABYTES buffer memory

With advanced high-speed algorithms, buffer memory is automatically allocated and deallocated to each user in



real time from a common 'pool' of up to 4MB. A limit can be set on maximum memory per user.

## Simple but powerful menu-driven set-up

All user-configurable features of the MULTIBUFFER are accessed via a user-friendly menu-driven program running on a PC. No fiddly switches are used. Also, when the MULTIBUFFER is driven from several PCs, each PC user can activate a RAM-resident pop-down menu for printer selection and other useful functions. Setups can be stored in non-volatile memory.

## Highest-ever data throughput

State-of the art high speed 16-bit CMOS technology allows up to 13 input ports to receive data simultaneously at a full 9600 baud without slowing-down the PCs – much faster than other printer sharers. Data rates up to 38400 baud (serial) and 30000 bytes/sec (parallel) are possible – ideal for laser printers and DTP systems such as Ventura or Pagemaker. The MULTIBUFFER can often eliminate a much more costly printer-sharing network.

## OTHER DATA COMMS PRODUCTS AVAILABLE FROM RINGDALE INCLUDE



### MEGABUFFER – Universal Data Buffer

- Reduces computer waiting time while printing/plotting.
- Allows you to use your PC more.
- New battery backup version.
- Compatible with most computers, printers and plotters.
- Software – independent.
- Data buffer and interface converter.
- 64K – £160; 128K – £216; 256K – £278; 512K – £388; 1024K – £498.



### MEGASWITCH AS – Serial Data Selector

- Single unit multiplexer and demultiplexer with 2K buffer.
- RS-232 and RS-422 versions.
- Multiplexer – ideal for printer sharing. 4 inputs, 2 outputs. Can automatically select any channel supplying data.
- Demultiplexer – ideal for driving several different printers from a PC. 2 inputs and 4 outputs.
- Software and manual selection. RS232 version – £169



### MEGASWITCH AP – Parallel Data Selector

- Connects any of 4 inputs to one of 2 outputs.
- Can automatically switch to any channel supplying data.
- Ideal for laser printer sharing.
- Universally compatible – works with all standard Centronic computer and printer interfaces.
- Use it with a Megabuffer for additional time saving – £169

## MULTIBUFFER PRICES

1/2MB	1MB	2MB	4MB	Serial Card	Parallel Card
£475	£575	£1225	£2225	£80	£40

# RINGDALE PERIPHERALS

11 Decoy Road, Worthing Sussex  
BN14 8ND England Tel: 0903 213131  
Telex 265871 (Ref: JBC 2021)

UK Delivery £4 per unit. Cables from £15 All prices excluding VAT. Dealer and Export enquiries welcome.

# Psion Organiser II. Unleash its genius.



ON ARCHAEOL...  
 ALS ON NEW PRODUCTS...  
 INSURANCE AND PENSION CALC...  
 IP USES IT TO CONTROL THE LI...  
 IT HELPS CONVEYAN...  
 REST EXPEDITION...  
 ND TO ORGANISE...  
 RTICULTURISTS...  
 ST FOR A DOCT...  
 R BAPTISMS...  
 CIDENT INVESTIG...  
 MATEUR RADIO EN...  
 DOWNLOADING... A...  
 MEASUREMENTS...  
 AGEN INTERNATI...  
 TRAVELLERS I...  
 AND CALCUI...  
 EMS. A P...  
 FRC...  
 E...

TH...  
 CONT...  
 RECORD...  
 -DAY BILLING...  
 DATA LOGGING SY...  
 SURVEYING COMPAN...  
 AUTOMATICALLY RECOR...  
 -PAGING FREQUENCY SCAN...  
 DATA HIGH STREET RETAILER...  
 USE IT WITH A BAR-CODE READER...  
 FOR STOCK CONTROL. MILK MEN...  
 USE IT TO MAKE LIGHT WORK OF...  
 HEAVY BOOK - KEEPING DUTIES...  
 MARKS & SPENCER USE IT TO CHECK...  
 PRICES AND VALIDATE CHARGE CARDS...  
 DISTRICT NURSES RECORD PATIENT DETAILS...  
 ON IT. ST. JOHN'S AMBULANCE MEN USE IT TO STORE...  
 HOSPITAL DETAILS. IT HELPS PEOPLE WITH A SPEECH IMPEDIMENT TO...  
 COMMUNICATE WITH OTHERS. IT RECORDS INFORMATION ON ARCHAEOLOGICAL DIGS. A...  
 MAJOR DRUG COMPANY FINDS IT INVALUABLE IN TRIALS ON NEW PRODUCTS. IT ENABLES...  
 FINANCIAL CORPORATIONS TO PRODUCE ON-THE-SPOT INSURANCE AND PENSION CALCULATIONS...  
 IT'S AN AID ON A SURVEYING EXPEDITION IN NEPAL. A POP GROUP USES IT TO CONTROL THE LIGHTING...  
 FOR THEIR STAGE ACT. IT HELPS A HOT-AIR BALLOONIST TO NAVIGATE. IT HELPS CONVEYANCERS TO...  
 PROVIDE INSTANT MORTGAGE CALCULATIONS. THE BRITISH SERVICES EVEREST EXPEDITION USE IT TO...  
 KEEP TRACK OF OVER 40,000 POUNDS OF STORES AND EQUIPMENT AND TO ORGANISE THE LOADS...  
 OF 540 BEARERS. IT RECORDS OUT-DOOR INFORMATION FOR HORTICULTURISTS. IT MANAGES...  
 THE DETAILS OF 600 PATIENTS AND THE WAITING LIST FOR A DOCTOR. IT STORES...  
 INFORMATION ON PASTORAL WORK FOR BAPTISMS, WEDDINGS AND...  
 FUNERALS FOR A REVEREND. AN ACCIDENT INVESTIGATOR USES IT TO...  
 RECORD INFORMATION. AN AMATEUR RADIO ENTHUSIAST STORES...  
 MESSAGES ON IT FOR DOWNLOADING. A WATER AUTHORITY...  
 EMPLOYS IT TO RECORD MEASUREMENTS ON THE CONDITION OF...  
 WATER MAINS. COPENHAGEN INTERNATIONAL AIRPORT MAKE IT...  
 AVAILABLE TO BUSINESS TRAVELLERS USING THE AIRPORT. IT IS...  
 UTILISED AS A CONTROL AND CALCULATION DEVICE IN ULTRA-...  
 SONIC MEASUREMENT SYSTEMS. A PARKING METER COMPANY...  
 COLLECTS INFORMATION DIRECT FROM PARKING METERS ONTO...  
 IT. IT IS USED AS AN INPUT DEVICE AND PROCESS CONTROLLER...  
 FOR MICROPROCESSOR CONTROLLED BOILERS. BRITISH RAIL USE...

Psion Organiser II has a genius for making life easier, by solving everyday and not-so-everyday problems. Brilliantly. (Just look at the small print up there).

For starters, it's a diary that reminds you in good time for appointments, an address book that can find the phone numbers of people whose name you've forgotten, a calculator that simplifies complex calculations, a filing system that cross references all information, and eight alarm clocks.

But even more, it is a very powerful computer, just like the one at the office.



The difference is this one slips into the pocket. And you don't have to be a genius to unleash its power.

You can plug in off-the-shelf software – like the special financial calculator, the formulae solver, the PC compatible spreadsheet and the spelling checker (to name but a few) – to give on-the-spot solutions. You can plug in extra memory to give up to 288k of data storage space at a time.

You can write solutions to your own specific problems, using its powerful built-in programming language.

And it can communicate with other computers, printers and modems through the Psion Comms Link.

Psion Organiser II. Sheer genius waiting to be put to work on your behalf. And costing from less than £100.



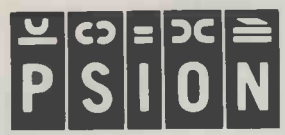

*Psion Organiser II is available from leading stores and retailers throughout the country. Or call 01-723 9408 for a brochure and stockist list.*





# RSC Ltd

  
  
 (0923) 243301  
 (24 hrs)  
 (0923) 241921  
 Fax (0923) 37946

**ALL PRICES EXCLUDE VAT**  
 Export, Government & Educational Orders Welcome  
 All enquiries & payments to  
**RSC Ltd, 75 Queens Road, Watford WD1 2QN**  
**TLX: 265871 MON REF G. REF CJJ128**  
**Tel: Watford (0923) 243301**  
**Callers Welcome**

All prices subject to change without notice — all goods subject to availability  
 Carriage Free

## COMPUTERS

### AMSTRAD PCW RANGE

Amstrad 8256	£285.00
Amstrad 8512	£379.00
Amstrad 9512	£429.00

### AMSTRAD PC1512

Amstrad PC 1512 SD Mono	£375.00
Amstrad PC 1512 DD Mono	£469.00
Amstrad PC 1512 SD Colour	£515.00
Amstrad PC 1512 DD Colour	£610.00

PC 1512 Range includes Ability and Four U.S. Gold games

### AMSTRAD PC1640

Amstrad PC 1640 SD/MD Mono	£485.00
Amstrad PC 1640 DD/MD Mono	£599.00
Amstrad PC 1640 SD/CD Colour	£625.00
Amstrad PC 1640 DD/CD Colour	£749.00
Amstrad PC 1640 SD/ECD Enhanced	£775.00
Amstrad PC 1640 DD/ECD Enhanced	£899.00

Genuine Amstrad 20Mb Hard Disk Machines	
Amstrad PC 1640 HD20/MB Mono	£899
Amstrad PC 1640 HD20/CD Colour	£1039
Amstrad PC 1640 HD20/ECD Enhanced	£1175

### RSC's OWN COMBINATIONS

PC 1512 SD Mono + 32MB Card	£625.00
PC 1512 SD Colour + 32MB Card	£770.00
PC 1512 DD Mono + 32MB Card	£755.00
PC 1512 DD Colour + 32MB Card	£905.00
PC 1640 S/D M/D Mono + 32MB card	£725.00
PC 1640 D/D M/D Mono + 32MB card	£839.00
PC 1640 SD/CD Colour + 32MB card	£865.00
PC 1640 DD/CD Colour + 32MB card	£989.00
PC 1640 SD/ECD + 32MB card	£1015.00
PC 1640 DD/ECD + 32MB card	£1139.00

### EPSON IBM COMPATIBLE

<p>Epson PCE £925                  8088, 10/4.7 MHz, MSDOS 3.2 (incl. Diagnostics), 640K Ram, 1x20 Mb Hard Disk, 1x360K Floppy Disk, 5 slots, Monochrome Monitor and Adaptor, PC AX Keyboard, Small Footprint (PC/PC+)</p> <p>Epson PC AX2 £1255                  80286, 10/8 MHz, MSDOS 3.2 640K Ram, 1x20 Mb Hard Disk, 1x1.2 Mb Floppy Disk, 4 slots, EGA Adaptor — no Monitor supplied, PC AX Keyboard, Small Footprint (PCXT)</p> <p>Epson PC AX                  80286, 10/8/6 MHz, MSDOS 3.2 640K Ram, 1x40 Mb or 80 Mb Hard Disk, 1x1.2 Mb Floppy Disk, 9 slots, No Video Adaptor or Display supplied. AX Keyboard, Floor stand optional</p>	<p>40Mb £1625</p>
--	-------------------

### HARD CARDS



Miniscribe 32Mb £259

**WESTERN DIGITAL FILECARD**  
 \* with xtree software  
 \* with speedread  
 32 Mb — £269 21 Mb — £215

## PORTABLES

Sharp PC-4501A  
 80188 Processor—256K Ram  
 Single 3.5" 760K Floppy £595  
 Sharp PC-4502  
 384K with Dual Drive  
 £795  
 Sharp PC-4521  
 Single Drive +20Mb Hard disk  
 £1495

### NEW PORTABLE PC



Amstrad PPC640  
 Portable power at a take away price.

PPC 512S Single Disc	£385
PPC 512D Double Disc	£515
PPC 640S S/D with Modem	£489
PPC 640D D/D with Modem	£615

**EPSON PC PORTABLE**  
 V30—10 MHz—640K—BACKLIT  
 TWO FLOPPIES VERSION  
 £1095

## MONITORS & CARDS

NEC Multi Sync	£549.00
Taxan 14" Supervision 770+	£499.00
Taxan 12" Green High Resolution	£199.00
Serial Card	£26.00
Parallel Card	£26.00

## ACCESSORIES

Tape streamer—cipher 1525 (for Amstrad PC's)	£299.00
Tape streamer—cipher 1510 (for All PC's)	£375.00
Intel 8087-2/8mhz math co-processor	£135.00
Intel 80287-8 maths co-processor	£185.00
64K dRam Chips (nine to make 64K)	PDA
256K dRam Chips (nine to make 256K)	PDA

## COMMUNICATIONS FOR ALL PC'S

Amstrad Pace Card Modem for PC & Compatible Datatalk (software included)	£115.00
GemComm (Software)	£58.00
Miracle WS4000 V21/23	£156.00
Sage Chit Chat Software	£69.00
Sage Chit Chat Pack (with Pace modem)	£162.00
Sage Chit Chat Pack 2 (including V22 AA/AD modem)	£475.00
Sage Chit Chat Pack 3 (including V22 Bg AA/AD modem)	£585.00

Linnert Modem £129.00

**NEW!! MC2400 3/4 length PC modem from AMSTRAD**  
 \* V21, V22, V22 bis, V23—Hayes compatible  
 \* Auto answer/dial  
 \* 5 1/4-inch + 3 1/2 media incorporated  
 \* Mirror 2 software included

ALL THIS FOR £179

## DOT-MATRIX PRINTERS

### EPSON

**FX800 SPECIAL OFFER £299**  
 Limited amount—200 cps/50nlq/80col

Epson LX800 150 cps	£189.00
Epson EX800 300 cps/50 NLQ/80 col	£385.00
Epson EX1000 300 cps/50 NLQ/136 col	£499.00
Epson FX1000 200 cps/50 NLQ/132 col	£379.00
Epson SQ2500 Ink Jet	£970.00

## DOT-MATRIX PRINTERS

### LATEST EPSON

\* 80 col 24 pin  
 \* 220 cps Draft 73 cps niq  
 \* 6k buffer  
 \* Friction & tractor  
 \* 1+3 copies  
 \* R.S.C. Price £425

\* 132 col 24 pin  
 \* 220 cps Draft 73 cps niq  
 \* 6k buffer  
 \* Friction & tractor  
 \* +3 copies  
 \* R.S.C. Price £575

Improved paper handling continuous & cut sheet support at the press and a lever/button.

### EPSON LQ2500+

The Epson LQ2500+ is a 24 pin letter quality printer that replaces the LQ2500. Its at 270 cps in draft/30 cps in lq mode. Five letter quality fonts plus a lot quieter  
 R.S.C. special price £699

### NEW 24 PIN EPSON

LO500—80 col, 150 cps, 50NLQ  
 (2 Res fonts + tractor) £295

## K.D. PRINTER STAND

### K.D. PRINTER STAND



TPS-25: K.D. Printer stand for 80 column printers, paper feeds from underneath and the dial adjustable paper feed plate guides the paper onto the collection rack for neat stacking. Sturdy steel and plastic construction with space saving design.  
**£30.00 80 COL**  
**£37.00 132 COL**

**Star**  
 PRINTERS FOR BUSINESS

### NEW STAR PRINTERS

**Star LC10—Multifont printer**  
 144cps-36niq-8 res. fonts 1/6 £169  
 Star LG10 Colour Printer  
 Same as above £229

Star NR10: 240 cps/80 NLQ/80 col £325.00  
 Star ND10: 180 cps/45 NLQ/80 col £259.00  
 Star NR15 (same as NR10 but wide col.) £339.00  
 Star ND15 (same as ND10 but wide col.) £349.00

## NEC

NEC P6 24pin/80 col/180cps £375.00  
 NEC P7 24pin/132col/180cps £439.00

**LATEST 24 PIN INTRODUCTION**  
**A SURE WINNER!**  
**NEC Pinwriter P2200**  
**(80 col)**



Print rate—168 cps/56 cps LQ  
 Paper handling—Unique front feed allows insertion without removing already installed continuous paper  
 Graphic—360x360dpi  
**Best of all Made IN UK!!**  
**RSC Price £295**



# ALL PRICES EXCLUDE VAT - CARRIAGE FREE

<b>AMSTRAD</b>	
FREE!! Supercalc 3.1 with DMP 4000	
FREE!! Wordstar 1512 with LQ3500	
DMP 4000 136 col - 200cps F/T 50 NLQ	£265.00
DMP 3160 80 col - 160cps F/T NLQ	£169.00
LQ3500 24 pin/60cps/60NLQ	£270
<b>NEW AMSTRAD</b>	
LQ5000 - 24pin - wide carriage	£365

## Panasonic

<b>PANASONIC</b>	
Panasonic KX-P1081 80col. 120cps + 120cps NLQ	£145.00
Panasonic KX-P1592 132col. 180cps + 38cps NLQ	£365.00
Panasonic KX-P1595 136col. 240cps + 51cps NLQ	£445.00
Panasonic KX-P1082 160cps/160 NLQ col	£195.00
Panasonic KX-P1083 80col. 240cps NLQ	£299.00

\* Panasonic KX-P1540 £479.00 \*

MP 135 80col/135cps F/T 27 NLQ	£135.00
MP 165 90col/165cps F/T 35 NLQ	£176.00
MP 200 80col/200cps F/T 40 NLQ	£259.00
MP 201 132col/200cps F/T 40 NLQ	£294.00
MP 480 80col/480cps F/T 74 NLQ	£339.00
MP 700 80col/700cps 120nlq	£449.00



### KEYBOARD STORAGE DRAWER

TKD21: Keyboard storage drawer. Steel and plastic construction. PC keyboard locates in the tray and can be slid out of sight when not in use, saves space on your desk and protects from dirt and dust. CPU and monitor can stack on top. £35.00

### DAISYWHEEL PRINTERS

Panasonic KX-P3131U 17cps	£240.00
Juki 6100 20 cps	£257.00
Juki 6200 30 cps	£394.00
Juki 6300 40 cps	£640.00
Juki 6500 60 cps	£955.00
Brother Dual printer twin writer	£875.00

### RSC SCOOP!! LIMITED OFFER JUKI 6100 + SHEETFEEDER ★ £399 ★

DICONIX portable printer £299

### LASERS

Epson GQ3500 (latest)	£1275.00
Canon Laser LBP 8 Mark II	£1595.00
Hewlett Packard Jet II	£1645.00
Brother HL8 - Latest	£1275.00

### NEW STAR LAZER - £1695 8 PAGE PER MIN - 1 MB MEMORY FREE 1 YEAR ON SITE MAINTENANCE

### LATEST CANON LASERS



LBP-811T Double Bin £2195  
LBP-811R Duplex printing 2650

### PLOTTERS

** NEW LOWER PRICES ON ROLAND A3 X-Y PLOTTERS **	
DKY 880A	£599.00
DKY 980A	£895.00

## Canon FACSIMILE

- \* Paper sizes to A4
- \* 5 Sheet Auto feeder
- \* Fine Mode Button
- \* Auto Contrast control
- \* Photo copy facility
- \* 26 numbers Autodial
- \* Built in telephone
- \* 1 year on site maintenance free!
- \* £1350

### CLASSIC RANGE

Lotus 1-2-3 Ver 2.1	£265.00
Lotus Symphony	£375.00
dBase III Plus	£399.00
Supercalc 4	£230.00
Wordstar 2000 Ver 2	£269.00
Framework II	£330.00
Wordstar Professional V4	£235.00
Word Perfect V4.2	£249.00
Microsoft Word	£269.00
Smart System	£395.00
Ansa database Paradox II	£375.00
Lotus Manuscript	£275
Lotus Reportwriter	£75

### INTEGRATED PACKAGES

Able One	£65.00
First Choice (PFS)	£110.00
Ability	£65.00
Pision-Four	£54.00
Logistix	£65.00
First Framework	£65.00
ABC	£95.00
Ability Plus	£115.00

### DATABASES

Sage Retrieve	£69.00
Tas +	£69.00
VP Info	£67.00
PC Promise	£45.00
Superbase Personal	£65.00
Masterfile	£45.00
Compsort Delta	£66.00
Camsort Cambase	£39.00
Tas Developer	£179.00

### WORD PROCESSING

Sage PC Write	£67.00
New Word II	£67.00
Gem Writer	£67.00
Word Perfect Jr	£65.00
Word Perfect Personal	£135.00
Word Junior	£45.00
Gem 1st Word Plus	£55.00
Super Writer 2	£55.00
Protext	£45.00

### SPREADSHEETS

Sage PC Planner	£69.00
Cracker III	£53.00
Multiplan Jnr	£45.00
VP-Planner	£65.00
Multiplan (Microsoft)	£130.00
Kurma K Spread II	£60.00
Sideways	£42.00
VP-Planner Plus	£99.00
Quattro	£99.00

### LIFETIME RANGE

Total Word	£299.00
Volkswriter delux	£29.00
Volks writer 3	£89.00
Words & Figures	£59.00

3 1/2" Available also

### PC ACCOUNTS

Sage Bookkeeper	£69.00
Sage Accountant	£105.00
Sage Accountant Plus	£145.00
Sage Payroll II	£110.00
Sage Fin. Controller	£235.00
Map Integrated Accounts	£108.00
Map Complete Accounting	£245.00
Map Payroll	£69.00
Camsort Financial Manager	£89.00
Camsort Profitmaker	£199.00
Ability Accounts	£74.00

## SAGE

PC NETWORK SYSTEMS

— LOCAL AREA NETWORK —  
Satenet is a powerful, low cost PC networking system which will connect two or more PCs easily and economically

### STARTER PACK £269

(connecting two PCs)

### EXTENSION PACK £136

(to add additional PCs)

### D.T.P. & GRAPHICS

Rank Xerox Ventura	£499.00
Fleet Street Edition	£79.00
Fontasy	£59.00
Gem Desktop Pub.	£199.00
Page - Ability	£150.00
Autosetch	£59.00
Turbo cad	£75.00
Cherry digitiser	£429.00
Electric studio video digitiser	£99.00
Handy scanner	£275.00
Finesse	£79.00
Finesse with Mouse	£135.00
Generic CADD	£89.00

### PROGRAM DEVELOPMENT

Turbo Pascal	£45.00
Turbo Prolog	£30.00
Turbo Basic	£45.00
Turbo Lightning	£45.00
Quick Basic Compiler (Microsoft)	£67.00
Learning DOS (Microsoft)	£26.00
Turbo C	£45.00
Turbo Eureka	£65.00
Zorland Powerpack	£52.00

### GENERAL & GRAPHICS

Gem Draw (Amstrad)	£69.00
Gem Graph (Amstrad)	£69.00
Delta Graph	£52.00
Norton Utilities 4.0	£55.00
Gem WordChart (Amstrad)	£69.00
Gem Font Editor (Amstrad)	£73.00
Portex	£73.00
Microsoft Windows	£59.00
VP Expert	£67.00
Copy II PC	£29.00
Microsoft Mouse	£139.00
Sharemaster	£99.00
Sideways	£42.00
Norton Commander	£39.00
PC Tools deluxe	£55.00
PC copy II option board	£65.00

### DISKETTE STORAGE



For 5 1/4"	
RSC50	
(Holding 50)	£10.00
RSC100	
(Holding 100)	£12.00
RSC120	
(Holding 120)	£15.00
For 3 1/2"	
RSC40	
(Holding 40)	£10.00
RSC80	
(Holding 80)	£12.00

Removable lid. Supplied with index labels, dividers, lock and two keys. Anti Static.

### BLANK DISCS



	Per Box	5 or more
TDK M20 D/S D/D	£11.00	£10.00
TDK M2 DD DS/D/D (96tpi)	£15.00	£14.00
TDK M2 HD/DS H/D (1.6M H. Density)	£20.00	£18.00
TDK MF 2HD D/S D/D (3.5 inch 135tpi)	£20.00	£18.00
TDK MD 2HD D/S HD (3.5 inch H. Density)	£40.00	£35.00

### RSC's OWN BRAND

Fully Guaranteed  
(With free plastic box as drawing above)

	Per Box	5 or more
RSC RM20 D/S D/D	£9.00	£8.00
RSC RM00 (96 tpi)	£11.00	£10.00
RSC RM40 (H density)	£18.00	£16.00
RSC 3 1/2" D/S (135tpi)	£18.00	£16.00
RSC 3 1/2" D/S HD	£32.00	£30.00

FOR LARGE QUANTITY  
PLEASE PHONE FOR PRICE

## THIS MONTHS SPECIALS : BROTHER HR40 £716 / \*\* ALL LASER PRINTERS \*\*

### EPSON DOT MATRIX PRINTERS

LX800 (150/25cps)	£201
FX800 (240/40cps)	£307
FX1000 (240/40cps)	£393
LQ500 (150/50cps) 24 PIN	£275
LQ850 (220/73cps) 24 PIN	£447
LQ1050 (220/73cps) 24 PIN	£597
LQ2500+ (270/90cps)	£747
SQ2500 (270/90cps) P/S	£962
EX800 (300/50cps)	£397
EX1000 (300/50cps)	£533

### JUKI DAISYWHEEL PRINTERS

6100 (20cps) P	£261
6200 (30cps) P	£376
6300 (40cps) P/S/IBM	£595
6500 (60cps) P	£714

### DICONIX PORTABLE INK JET

Portable Ink Jet Batt/Main	£287
----------------------------	------

### CANON DOT MATRIX PRINTERS

PW1080A+(160/27cps)	£199
A55 (180/34cps)	£380
A60 (200/100cps) P	£370
A65 (200/100cps) P	£434
BJ130 (220/110)BubbleJet	£652

P=Parallel, S=Serial, I=IBM, Col=Colour

### BROTHER DAISYWHEEL PRINTERS

HR20 (20cps)P/S	£320
HR40 (40cps) P/S	£716

### OKI MICROLINE D.M.P.

182 (120/60cps) P/I	£200
192 (240/33cps) P/I	£287
193 (240/33cps) P/I	£372
292 (300/100cps) Col	£446
293 (300/100cps) Col	£595
294 (400/100cps) Col	£816
393 (450/120cps) Col	£965

### MICRO P DOT MATRIX PRINTERS

MP135 (135/27cps) P	£119
MP135+ (135/27cps) P&I	£127
MP165+ (165/35cps) P	£153
MP200+ (200/40cps) P	£229
MP201+ (200/40cps) P	£266
MP480 (480/74cps) P	£275
MP700 (720/120cps) P	£372

### MICRO P DAISYWHEEL PRINTERS

MP26 (26cps) P&S	£197
MP40 (40cps) P&S	£264

### OTC High speed D.M.P.

850XL (850cps)P&S	£1515
-------------------	-------

### LASER PRINTERS

Canon Series II excl. Toner	£1435
Canon Series IIT excl. Toner	£1846
Canon Series IIR excl. Toner	£2124
HP Laserjet 500 Plus (P&S)	£2519
HP Series II	£1619
Epson GQ3500	£1274
QMS PS810 (PostScript)	£3070
Citizen Overture 110 P&S	£1155
Brother Laser	£1558
Qume LaserTen +	£2039
Qume ScriptTen (PostScript)	£3492
Micro Peripherals MP46	£1180
Micro Peripherals MP48	£1403
NEC LC866 LED	£1722
NEC LC890(PostScript) LED	£2726
Star Laser	£1558

### PANASONIC PRINTERS

P1081 (120/24cps) P TF	£142
P1082 (160/32cps) P TF	£152
P1083 (240/51cps) P TF	£268
P1592 (180/38cps) P TF	£337
P1595 (240/51cps) P&S TF	£402
P1540 (240/80cps) P&S TF	£449
P3131 (17cps) P Daisy	£226
P3151 (22cps) P Daisy	£368

### CITIZEN PRINTERS

120D (120/25) P	£131
LSP100 (175/30) P	£167
MSP10E (160/40) P	£200
MSP15E (160/40) P 136	£234
MSP40 (240/50) P	£278
MSP45 (240/50) P 136	£352
MSP50 (300/60) P	£352
MSP55 (300/60) P 136	£466
HQP40 (200/66)P&S 24 PIN	£334
HQP45 (200/66)P&S 24 PIN	£401
Premier 35 (35) P 136 Daisy	£401

### NEC 24 PIN HEAD PRINTERS

P2200 (168/56) P	£284
P760 (216/72) P/I 136	£435
P565XL (264/88) P&S 136	£667
P960XL (384/128) P 136	£801
P965XL (384/128) P&S 136	£868
8800 (55)P/I/S/Diablo 136	£801

### STAR DOT MATRIX PRINTERS

LC10 (120/30)	£166
NR15 (240/60)	£424
ND15 (180/45)	£352
NB15 (300/100) 24 PIN	£611
NB24/10 (216/72) 24 PIN	£431
NB24/15 (216/72) 24 PIN	£546

### QUME

### Amstrad PC1640 and NEW Portable PC available

### STAR

Access/Visa/Applec card accepted. All prices are exclusive of VAT. Telephone for prices for other printers and accessories.

Prices correct at time of going to press. Cables from £15 extra. Carriage Printers £8, Laserprinters £15.

Terms cash with order - Mail order only

Phone (0730) 68877 16a College Street, Petersfield, Hampshire. GU31 4AD

# BACKUP your troubles £29.95 in your old CLIP bag!

## CLIP — THE BACKUP PROGRAM STANDARD

### The PROBLEM —

Your free backup utility is slow, difficult to use, and can only restore files into ready-made directories.

It does not record its progress — so you backup everything to be safe.

Or nothing because it's such a bore.

CLIP has the longest track record of all backup programs and an enviable reputation for reliable service. Purchasers of 1000+ copies of CLIP include British Telecom, Philips and Ashton-Tate.

Only the best will do for backup.

### The SOLUTION —

CLIP keeps a log of its backups, so you can afford to be selective.

It maintains a menu of your customised commands, so you do not have to stop and think. It is fast, and it compresses data.

Result — fewer disks, less time, less effort, no worry, greater security.

- ★ High-speed data compression
- ★ Execute by highly visual Menu or by command line entry
- ★ On-line help at every point
- ★ Can select new files only
- ★ Multiple wildcard select, include or exclude basis.
- ★ Save to any media-floppy, hardcard Bernoulli etc
- ★ Save to remote/network drive
- ★ Restores directories + files
- ★ Recovery after media errors
- ★ Log of all backup operations

For an experimental period, CLIP 4.0L is offered at £29.95, (The previous advertised price was £67.85) Order now and prove that the trial price is the right one for you and us.

Available for PC/XT/AT and compatibles, PCDOS/MSDOS  
Price includes VAT and UK postage. c.w.o.



**KEELE CODES LTD**

University of Keele, Keele, Staffordshire ST5 5BG, UK Tel: (0782) 629221 Telex: 36113





# OPTIMUM TECHNOLOGY

## MORE THAN JUST LOWER PRICES

LISTED BELOW IS JUST A SELECTION  
FROM OUR WIDE RANGE OF PRODUCTS —  
(From legitimate UK sources — no 'grey' imports!)

— PLEASE CONTACT US  
WITH YOUR REQUIREMENTS



### OPTIMUM

#### WORD PROCESSORS

GEM 1st Word Plus	£139
Manuscript V1.1 NEW!	£279
Multimate Adv. II	£289
MS Word V4 (NEW!)	£245
WordPerfect V5.0 NEW!	£249
WordPerfect Library V1.1	£124
Wordstar Prof. V4	£199
Wordstar 2000+ R3 (NEW!)	£249

#### DATABASES

Cardbox Plus V3.5	£265
Dataperfect (NEW!)	
(from WordPerfect)	£445
dBase-III Plus V1.1 (U.K.)	£359
Wide range of dBase/Clipper etc add-on software available - please phone with your enquiries.	
Clipper NEW! (Summer '87)	£369
UI Programmer - Narviklet (NEW!)	£269
Foxbase Plus V2 (NEW!)	£339
Geniffer V1.01 app. gen.	£275
Paradox V2.0 (NEW!)	£295
O & A (inc. spell. chk.)	£245
Rbase SYSTEM-V	£395

#### SPREADSHEETS

BORLAND QUATTRO (NEW!)	£125
Excel MS (UK)	£295
Logistix V1.2 (NEW!)	£95
Lotus 1-2-3 V2.01 (U.K.)	£245
Lotus HAL/Metro	£98/£65
Lotus Report Writer	£69
PlanPerfect 3.0 (UK)	£295
MS Multiplan V3.03	£149
Supercalc-4 V1.1 (U.K.)	£225

#### INTEGRATED PACKAGES

ABC	£139
Ability/Ability Plus U.K.	£79/£149
ENABLE V2 (NEW!)	£425
Framework-2 V1.1 (unprot)	£325
Open Access II	£395
Smart-3.1	£385
Smart Spell Checker	£89
Symphony V2 UK (NEW!)	£335
Psion Xchange	£245

#### DTP/GRAPHICS

ALDUS PAGEMAKER (UK)	£475
Autosketch	£75
Byline - Ashton Tate (NEW!)	£195
DAVRELLE	£395
DesignCad-2D (E&P-Design)	£269
DesignCad-3D (NEW!)	£375
Finesse (NEW!)	£79
Gem Draw Plus	£163
Gem Graph	£145
Gem Desktop Publisher	£275
Graph-in-the-Box (NEW!)	£89
HARVARD GRAPHICS V2.1 (NEW!)	£369
LOTUS Freelance Plus	£279
LOTUS Graphwriter-II	£345
Newsroom Pro	£95
PageAbility from MIGENT	£149
TURBOCAD V1.5 new low price	£99
Ventura	£645

#### MISCELLANEOUS

Utilities/Languages/Games etc

BROOKLYN BRIDGE (lap-40-PC)	£129
COPY II PC V4.01	£47
COPY II PC Option Board	£89
Corefast Backup PC (NEW!)	£125
DESQVIEW V2.01 (NEW!)	£89
FastBack V5.14 (NEW!)	£149
Lap-Link V2 (NEW!)	£89
Mace Utilities V4.1 (NEW!)	£85
MS C Compiler V5 (NEW!)	£249
MS Flight Simulator	£39
MS Macro-Assembler V5 (NEW!)	£115
MS Project V4 (NEW!)	£249
MS QUICKBASIC V4 (NEW!)	£75
MS WINDOWS V2	£75
MS Windows 386 (NEW!)	£149
Norton Utilities V4	£69
Norton Advanced Utills	£99
Norton Commander/Editor	£55/87
Norton Guides (NEW!)	£65
Guides available for Assembler, C, Basic & Pascal	
PC Tools Deluxe (NEW!)	£89
Sage Accountant	£129
Sage Accountant Plus	£169
Sage Financial Controller	£225
Sage Payroll	£89
Sideways V3.2	£43
Xtree V2	£47
XTREE PRO	£95

#### AMSTRAD

Ask for free datapaks or phone for advice

PPC-512S - single drive	£399
PPC-512D - dual drive	£549
PPC-640SM - single drive + Modem	£499
PPC-640DM - dual drive + Modem	£649

#### BORLAND PROGRAMMING

TURBO PASCAL V4 (NEW!)	£57
T/Pascal V4 Toolboxes	£57
Database, Editor, Graphics, Numerical, Gameworks	
T/Pascal V4 Tutor	£37
Developers Library V4	£195
TURBO BASIC V1.1	£57
Basic Toolboxes	£57
Database, Editor	
TURBO C V1.5 (NEW!)	£57
TURBO PROLOG V1.1	£57
Prolog Toolbox	£57

#### MISCELLANEOUS

Eureka — The Solver	£67
Paradox V2	£295
Paradox 386 (NEW!)	£495
Quattro (NEW!)	£125
Reflex UK/Workshop	£89/£49
SIDEKICK PLUS/Sidekick	£179/£49
Sidekick (unprotected)	£49
Superkey	£57
Turbo Lightning	£57
Word Wizard	£37

#### COMMUNICATIONS

Our Free communications consultancy means that you can simply telephone or write for free datapaks and/or advice.

**Modems:** All modems are Auto-Dial/Auto-Answer and BAPT approved. Baud rates are V21=300/300 V23=1200/75 V22=1200/1200 V22bis=2400/2400.

We also supply modems from Dowty/Racal/Tandata/Steebek/Dacom/PC at best prices.

MODEM CABLES: IBM-PC £15 IBM-AT £23	
DACOM 2424 V22/V22bis/MNP EC	£495
DACOM (Internal, all with Datatalk)	
Unity V21/23	£299
Unity Gold V21/V22/V23	£389
Unity Quad V22bis/V22/V21/V23	£589
DOWTY Quattro	£645
HAYES 1200 V22/V21/V23 NEW!	£395
HAYES 1200B V22/V21/V23 Internal NEW!	£375
HAYES 2400 V22bis/V22	£595
MICROFAX - Dowty (NEW!)	£975
MIRACLE WS SERIES — (External)	
WS4000 V21/V23 (Economy)	£149
WS3000 V21/V23 Professional Series	£249
WS3000 V22 (& V21/V23)	£385
WS3000 V22BIS (& V22/V21/V23)	£499
MIRACLE KEYCARD — (Internal + Datatalk)	£269
Keycard V21/V23	
Keycard V22/V21/V23	£395
Keycard V22bis/V22/V21/V23	£495
PACE SERIES-4/LINNET — EXTERNAL	
Pace Linnet V21/23 (Economy)	£139
Series-4 2123S (V21/V23)	£229
Series-4 1200S (V22/V21/V23)	£349
Series-4 2400S (V22bis/V22/V21/V23)	£429
STRADCOM V22/V21 Internal	£179

**Comms Software:**

Carbon Copy Plus (each)	£137
Crosstalk-4 (NEW!)	£139
Crosstalk XVI	£99
Lap-Link V2 (pc-to-pc)	£89
Mirror-It UK (NEW!)	£69
Sage Chit-Chat -	£79
Smartcom-III V1.0A - NEW!	£149

#### HARDWARE

Hercules Graphics Boards	EPOA
INTEL BOARDS/CO PROCESSORS	EPOA
Logimouse C7+ (serial)	£94
MS MOUSE - Bus, Serial or PS/2	£135
Orchid Tiny-Turbo 286	£325
Orchid Twin Turbo-12 286	£475
Wonder EGA (Inc. VGA)	£249
Vega Deluxe Auto EGA	£199
Vega VGA (NEW!)	£279

#### SPECIAL PRODUCTS

**Also see Amstrad Section**

Dowty Telex	£849
Dowty FAX (NEW!)	£975
INTEL 80386 PC Upgrade NEW!	£795
PSION ORGANISER-II CM	£86
PSION ORGANISER-II XP	£121
Full range of Organiser products available	
TD400 Teletext Card	£269

## MAY'S OPTIMUM CHOICE

- **FREE PARKER PEN!**  
Special 'Limited Edition' genuine Optimum Parker Pen in its own presentation case free with each order. (for orders over £30 + VAT - one per customer - while stocks last).
- **FREE COMMUNICATIONS CONSULTANCY**  
Phone for free advice on your modem/software requirements.
- **CARBON COPY PLUS**  
- The ultimate remote control for your PC - multitude of uses - ideal for remote support - or accessing the office PC from home with a portable - Ask for free datapak.
- **DataPERFECT - NEW!**  
The new power database from WordPerfect now arrived - a must for any WordPerfect user!
- **DESQview V2.01 £89!**  
"Product of the Year" INFOWORLD "Best PC Environment" PC TECH Ask for datapak.
- **LAPLINK V2 £89**  
Laptop to PC file transfer - up to 115,200 Baud - easy to use - easy to carry - complete with universal 9w/25w 4-headed cable.
- **FREE SHORTFORM CATALOGUE**  
- New May issue with large editorial section and details/pricing on our full range now available.

# YES!

PLEASE RUSH ME  
 The following good(s):

A FREE Datapak on:

A FREE shortform Catalogue.

I enclose £ ..... inc. carriage/VAT

My credit card number is



Signature \_\_\_\_\_  
UK Carriage: Most items add £5 + VAT  
Express/dBASE/Smart/PPC/Modem  
please add £10 + VAT

Name \_\_\_\_\_

Address \_\_\_\_\_

Phone No. \_\_\_\_\_

## OPTIMUM TECHNOLOGY LTD

Rowlandson House, 289-293 Ballards Lane, Finchley,  
London N12 8NP

**Sales Desk: 01-446 2223**

Telex: 923729 (Roland G) Fax: 01-446 1963

PLEASE ADD CARRIAGE, THEN VAT TO ALL PRICES

The above is a sample of the goods we supply — please ask for latest shortform catalogue.  
**We welcome official PLC/Govt./Educational/Local Authority and Export orders.**  
Pro-Forma invoices available on request. Above software is in IBM 5 1/4" format — please enquire for other formats. Prices/specifications subject to change without notice. Please phone to arrange demonstrations or to collect goods.

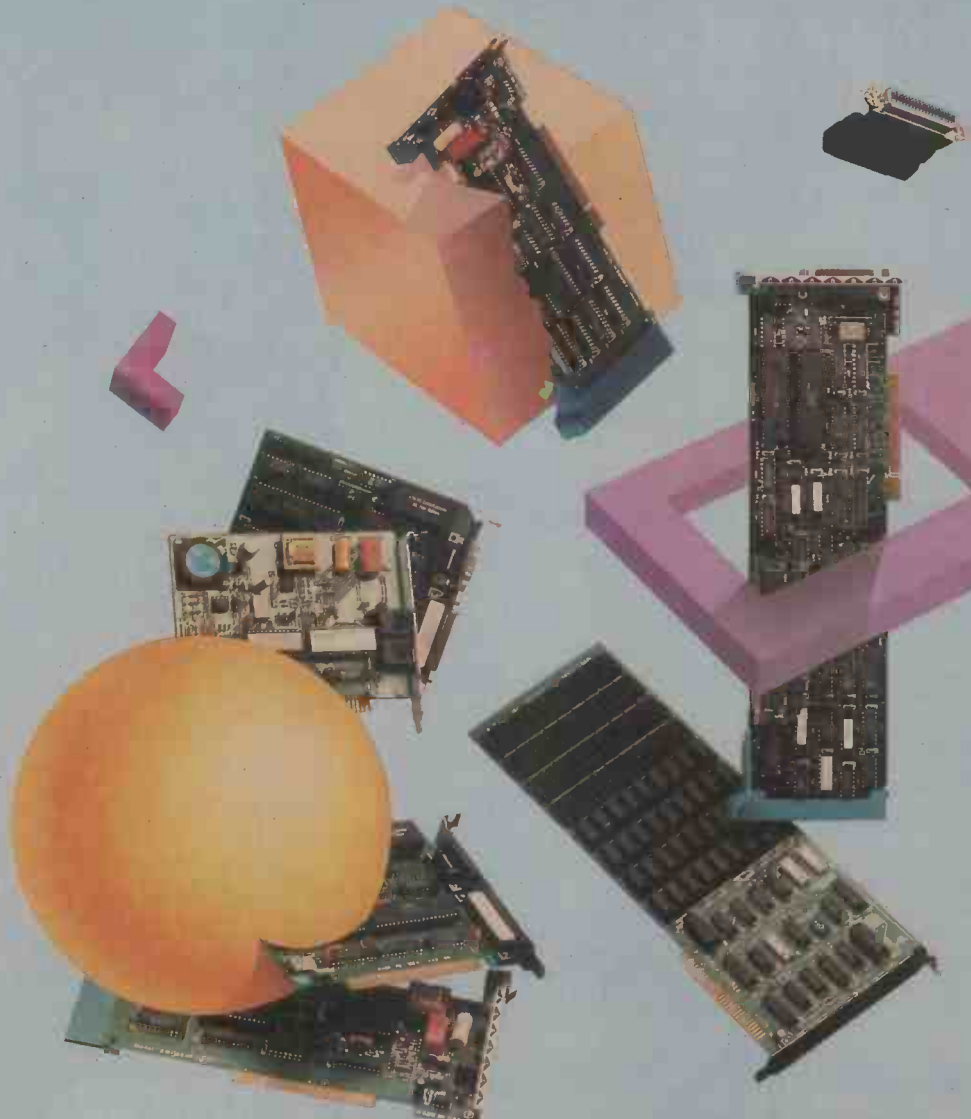

**Full Range**  
 Video, Communications, Memory,  
 Multifunction Add - On Cards.  
 Modems Internal and External  
**(2 Year Warranty)**  
*Full Product information and  
 Price on request.*  
 Tel: 0602 670360

# Add-On PS/2 Potential!

**ATD unleashes the power of your PS/2 system!**

**PS/2 Product Selection Chart**

Are you a PS/2 owner who . . .

- wants the most performance for your investment?
- wants to capitalize on built-in features?

**Then you need ATD . . .**

- the fastest growing American add-on board manufacturer.
- with the largest family of PS/2 enhancement products available.

**More than any other add-in board manufacturer, ATD gives you . . .**

- innovative products for maximum PS/2 performance.
- the broadest PS/2 product line.
- high quality and reliability.
- toll-free 800 lines for technical support.
- a standard five-year warranty.

**Dealer  
 Enquiries  
 Welcome**

PRODUCT	FEATURES	PS/2 MODEL				
		25	30	50	60	80
Memory	EMS Memory	■	■			
I/O	Parallel and Two Serial Ports	■	■			
I/O (Game)	Game, Parallel and Serial Ports	■	■			
Multifunction	Extended Memory, Simulated EMS Memory, Parallel and Serial Ports			■	■	
Modems	Internal (1200/2400 baud)	■	■	■	■	■
	External (1200/2400 baud)	■	■	■	■	■
Connectivity	Format Converter	■	■	■	■	■
	ZuckerLINK	■	■	■	■	■
Electronic Imaging	320 × 240 Resolution			■	■	■
	640 × 480 Resolution			■	■	■

Distributed by  
**Plum International Products Ltd**  
 291 Mansfield Road  
 Nottingham NG5 8SE  
 Tel: 0602 670360  
 Fax: 0602 670257



**Advanced Transducer Devices, Inc.**  
 235 Santa Ana Court, Sunnyvale, CA 94086



# WHEN YOU HAVE TO KEEP ONE EYE ON PERFORMANCE AND ONE EYE ON THE PRICE...

## ELONEX IS WHAT YOU'RE LOOKING FOR

It looks impossible doesn't it.

A personal computer with all the built in standards and the ability to take on printers and other peripherals, plus any software that comes along. On a budget so low it just has to be a misprint. But it isn't.

Elonex are familiar with this problem. That's why we've made it our business to ensure that whatever any of our competitors make, we can make better. And cheaper.

Not surprisingly, this has made us a little unpopular with other PC manufacturers, but extremely popular with our customers, especially our more established ones like universities, colleges, local and government authorities, and large corporations.

Model	CPU	Speed (MHz)	Hard Disk Drive	Floppy Disk Drive	Serial/Parallel Port	Expansion Slots/(free)	Mono System	EGA System
PC-88C Compact	V20 (8088)	4.77/10	20MB (65mS)	380k	1/1	4/(2)	£695	£995
PC-88S	V20 (8088)	4.77/10	20MB (65mS)	380k	1/1	8/(4)	£795	£1095
PC-286C Compact	80286	8/12	40MB (40mS)	1.2MB	2/1	6/(4)	£1295	£1595
PC-286S	80286	8/12	40MB (40mS)	1.2MB	2/1	8/(5)	£1295	£1595
PC-386S	80386	18	44MB (28mS)	1.2MB	2/1	8/(5)	£2495	£2795

Also available are various upgrades and peripherals, including maths co-processors, displays, hard disks, 3.5" floppy drives, tape-streamers, printers and networking cards.

*Please feel free to visit our showrooms.*

Elonex (UK) Ltd, Rays House, North Circular Road, London NW10 7XB.  
Tel: 01-965 3225. Telex: 946240 CWEASY-G./Ref: 19020170. Fax: 01-965 3246

Take for example our XT compatible, the compact PC-88C. Like all our systems, it comes complete with a hard disk, a mouse, MSDOS 3.3, BASIC, GEM, and a full set of manuals. Yet the entire EGA colour version, including monitor, costs less than £1,000.

Pushing further the price-performance barrier is the PC-286, a sleek AT compatible that whizzes along at 12 MHz with no wait states. Add an 80287 maths co-processor and AutoCAD has to be seen to be believed.

We would happily wax lyrical about our 32-bit PC-386 system,

but 'Which Computer' have beaten us to it by voting it 'Best Buy' in their recent survey. Like the PC-286, it's equally at home with MSDOS, XENIX and NOVELL, as well as the latest OS/2.

All systems are supplied set up ready for use and are backed up by our Technical Hotline Support and 12 month no nonsense warranty.

We do not claim to be the only company offering this degree of advanced technology and service.

We are not the only one offering such low prices. We think however, that we may be the only one to do both.



Elonex (UK) Ltd, 7-9 Campus Road, Bradford Science Park, Bradford, West Yorkshire BD7 1HR. Tel: (0274) 307226. Fax: (0274) 307294.

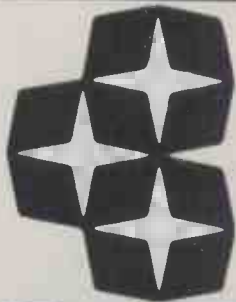

# SAMSUNG

## NOW AT R.T.M

### CHECK OUR PRICES FIRST



## SAMSUNG S300

- 8 MHz High Speed or 4.77MHz ● PC-XT® Compatible
- 6 Expansion slots ● Built in Ports - 1 parallel, 1 Serial
- intel 8088-2 ● 84 or 100 keys

SINGLE DISK _____	<b>MONO</b>	<b>EGA</b>
20MB _____	<b>£629</b>	<b>£859</b>
TWIN DISK _____	<b>£829</b>	<b>£1049</b>
32MB _____	<b>£699</b>	<b>£909</b>
	<b>£859</b>	<b>£1079</b>



## SAMSUNG

## S500

PC-AT® Compatible



- PC -AT® Compatible ● 8 or 10 MHz
- Excellent Expansion Capability 6-16 Bit 2-8 Bit
- 1Parallel Printer Port - 2 Serial Communication Ports
- Auxiliary Data Storage (1) 1.2MB 5¼" Floppy Disk Drive

SINGLE DISK _____	<b>MONO</b>	<b>EGA</b>
20MB _____	<b>£939</b>	<b>£1169</b>
TWIN DISK _____	<b>£1169</b>	<b>£1399</b>
32MB _____	<b>£1019</b>	<b>£1249</b>
	<b>£1199</b>	<b>£1429</b>

MEMORY UPGRADE TO 640K - £45

- ALL MACHINES FULLY TESTED & CONFIGURED BY ENGINEERS BEFORE DESPATCH
- 12 MONTHS PARTS & LABOUR WARRANTY

**CARRIAGE--NEXT DAY DELIVERY**

COMPUTERS £10  
 PRINTERS £6 Free If Purchased with Computer  
 SOFTWARE £5 Next Day £3 2 - 3 Day  
 ALL PRICES EXCLUDE VAT, CARRIAGE, ITEMS SUBJECT TO AVAILABILITY AND CHANGE



## R.T.M. SYSTEMS

Tel: (0772) 732281 (24 hours)

Unit 16, Riversway Managed Workshops  
Chain Caul Way, Ashton, Preston PR2 2YL



# CHECK OUR PRICES FIRST

**SAMSUNG COMPUTERS NOW IN!**  
Phone for latest prices

• PROFESSIONAL ADVICE GIVEN  
• OPEN MONDAY - SATURDAY  
9am - 6pm • ALL MACHINES  
FULLY TESTED & CONFIGURED  
BY ENGINEERS

## AMSTRAD PC

## OPUS



**FREE ALL COMPUTERS FULLY TESTED PRIOR TO DESPATCH**

## AST

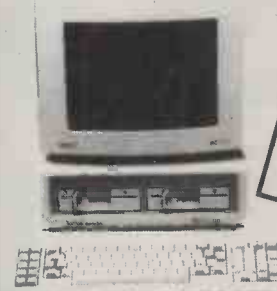

	MONO	COL	ECD
PC1640 SINGLE DISK	445	569	695
PC1640 TWIN DISK	525	649	775
PC1640 HARD DISK (Amstrad)	789	915	1045
PC1512 SINGLE DISK	369	489	
PC1512 TWIN DISK	449	579	

### AMSTRAD UPGRADES

	MONO	COL	ECD
PC1640 + 20MB (MINISCRIBE)	649	779	909
PC1640 + 32MB (MINISCRIBE)	669	799	939
PC1640 + 40MB (MINISCRIBE)	759	889	1019
PC1640 + 32MB HARD CARD	689	819	949
PC1640 T/DISK + 32MB H/CARD	769	899	1029
PC1512 + 20MB (MINISCRIBE)	569	689	
PC1512 + 32MB (MINISCRIBE)	599	709	
PC1512 + 32MB HARD CARD	599	729	
PC1512 T/DISC + 32MB H/CARD	699	819	
PC1640 + 32MB HARD CARD + 3 1/2" FLOPPY DISK			1039

FT CHIP UPGRADE £25 (18 x 4164 Chips) CO - PROCESSOR 8087—MHZ £125

### AMSTRAD PORTABLES

	RTM
PPC 512S Single Disk	379
PPC 640S Modem	459
PPC 512D Twin Disk	459
PPC 640D Modem	539

**FREE** 12 MONTHS PARTS & LABOUR GUARANTEE ON ALL HARDWARE

## HARD DISKS

	MONO	EGA
PC III 768K TWIN DISK	559	849
PC III 1024K 30MB DISK	809	1089
PC IV 768K 20MB DISK	1069	1339
PC5 A.T. COMPATIBLE 30MB DISK		
*SPECIAL*		
OPUS PC III 768K + 20MB DISK	699	999

	RTM
MINISCRIBE	
20MB M8425 KIT	189
32MB M8425 KIT	215
40MB M3650 KIT	299
70MB M6085 KIT (AT FULL HEIGHT)	749
32 MB HARD CARD	239
32MB WESTERN DIGITAL CARD + XTREE SOFTWARE	239
KIT Includes Disk Uit, Controller, Cables etc.,	
AMSTRAD FITTING KIT	£5

UPGRADE YOUR PC SERVICE WE COLLECT—FIT—DELIVER £35

### MODEMS

	RTM
Pace Internal V21, V23 + DATATALK	99
Pace Linnet V21, V23	115
Pace Linnet V21, V23 + Chit Chat + Cable	159
PACE SERIES 4	199
PACE SERIES 4 1200S	289
PACE SERIES 4 2400S	379

(Includes free CHIT CHAT & modem cable)

## PRINTERS

	RRP	RTM
<b>AMSTRAD</b>		
*DMP 3160 160 cps 80 col	199	160
*DMP 4000 200 cps 136 col		
(Includes Supercalc 3)	299	250
*LQ3500 160 cps 80 col		
(Includes WORDSTAR)	299	250
* all include cables.		
<b>PANASONIC</b>		
1081 120 cps 80 col	245	135
P1082 160 cps 80 col	265	185
P1592 180 cps 80 col	495	440
P1595 250 cps 136 col	595	340
P150 24 pin - New!	699	469
P1313 DAISY WHEEL	335	240
<b>CITIZEN</b>		
120D 120 cps Parallel	199	130
MSP 10E 160 cps 80 col	299	195
MSP 15E 160 cps 136 col	349	230
HOP 40 200 cps 80 col 24 pin	595	335
HOP 45 200 cps 136 col 24 pin	795	445
<b>CANON</b>		
PW 108A 160 cps 80 col		
A55 180 cps 156 col		
A60 200 cps 80 col		
A65 200 cps 136 col		

**call**

	RRP	RTM
<b>LASERS* HP LASER SET SERIES II</b>	2529	1699
* AST TURBO LASER	3250	2199
* AST POSTSCRIPT LASER (3MB memory)	3695	2499
Canon LPB II	2195	1479
Include 1 year on site maintenance.		
<b>JUKI</b>		
6000 10 cps	199	139
6100 20 cps	399	259
6200 30 cps	499	355
6300 40 cps	799	595
6300 + Sheet feed	1099	795
6100 + Sheet feed	499	355
<b>MICRO PERIPHERALS</b>		
MP 135 135 cps 80 col	149	119
MP 165 165 cps 136 col	209	155
MP 201 240 cps 136 col	369	279
MP 700 700 cps 136 col	499	389
MP 40 40 cps DAISY	375	265
<b>STAR</b>		
LC10 120 cps 80 col Includes Free Cable	229	159
NR10 240 cps 80 col	449	310
ND10 180 cps 80 col	349	240
NB2410 24 pin 80 col	599	410
NX15 120 cps 136 col	389	265
ND15 180 cps 136 col	489	335
NR15 240 cps 136 col	589	399
NB2415 24 pin 136 col	759	520

	AST	AST	VIDEO 7	VGA
	MONO	EGA	MULTI	SYNC
PREMIUM 286 + 20MB	1619	1889		1999
PREMIUM 286 + 40MB	1859	2129		2229
PREMIUM 286 + 70MB	2169	2439		2499

\* POSTSCRIPT PUBLISHER SYSTEM\*  
AST + 40MB, AST SCANNER, AST PS TURBO LASER,  
AST MONO + 3G CARD, AST MOUSE + VENTURA  
V1 - 1 UK ALL READY TO GO £5750

## SOFTWARE

	RRP	RTM
<b>ACCOUNTS</b>		
Sage accountant	149	105
Sage accountant + Sage Payroll	199	135
Sage financial CONTROLLER	99	69
MAP INTEGRATED	299	199
MAP Complete	175	115
MAP Payroll	299	199
TAS accounts	99	69
TAS accounts advanced	499	349
	799	559

	RRP	RTM
<b>DATABASE</b>		
TAS+	99	65
TAS+ Developer	199	135
TAS+ Multi User	349	239
DATAEASE V.2.5/3	545	409
AMSTRAD accounts	149	115
AMSTRAD PayMASTER	49	39
DBXL - D BASE III CLONE	119	79
D FAST COMPILER CLIPPER CLONE		69

	RRP	RTM
<b>COMMUNICATIONS</b>		
Sage Chit Chat	99	69
Gem Comm	62	45
Dial Up Personal	79	55

	RRP	RTM
<b>INTEGRATED</b>		
PSION PC4	69	49
PSION Xchange	495	309
PSION Xchange Network	795	495
Integrated 7+ (included Twin)	129	89
ABILITY +	199	99
WORDS & FIGURES	99	69

	RRP	RTM
<b>LOGOTRON SOFTWARE SPECIAL</b>		
3 in one (word processor, database spreadsheet)	29.95	
WRITER		12.95
PLANNER		12.95
Include VAT + POST		

	RRP	RTM
<b>WORD PROCESSORS</b>		
VOLKSWRITER De - Luxe	39	29
WORD PERFECT JNR	86	59
WORD PERFECT PERSONAL	173	125
WORD JNR (MICROSOFT)	69	49
NEW WORD II	86	59
WORDSTAR EXPRESS	69	53
GEM FIRST WORD+	86	59

	RRP	RTM
<b>SPREAD SHEET</b>		
Sage PC - Planner	99	69
Supercalc 3.21	69	53
VP Planner	86	79
Twin (MOAIC)	49	40

	RRP	RTM
<b>DTP/GRAPHICS/CAD</b>		
Page ability	169	129
Fleet St EDITOR	109	75
ventura V1:1 (UK)	795	399
Autosketch	79	55
TURBO CAD	99	69
GEM DTP	295	189
FONTASY	69	49

	RRP	RTM
<b>NEW IN</b>		
Lotus 123 2a	245	
Dbase III +	299	
WORD PERFECT 4.2	229	
Supercalc 4	209	
MICROSOFT WORD 4	259	
ventura V1:1 UK	CALL	
Freelance II		259
graphWRITER II		259
WORDSTAR 2000+		229
FRAME WORK II		345
REBASE SYSTEM V		349
Multimate		189
Symphony		359

**CONTACT US FOR ALL YOUR REQUIREMENTS**  
**CARRIAGE—NEXT DAY DELIVERY**  
COMPUTERS £10  
PRINTERS £6 Free If Purchased with Computer  
SOFTWARE £5 Next Day £3 2 - 3 Day  
ALL PRICES EXCLUDE VAT, CARRIAGE, ITEMS SUBJECT TO AVAILABILITY AND CHANGE



**R.T.M. SYSTEMS**  
Tel: (0772) 732281 (24 hours)  
Unit 16, Riversway Managed Workshops  
Chain Caul Way, Ashton, Preston PR2 2YL

# BELTRON



## BELTRON TURBO XT

- \* 8088-2 CPU \* 4.77-10.00 MHZ \* 640K RAM
- \* PHOENIX BIOS
- \* 360K FUJITSU FLOPPY DISK DRIVE
- \* 20MB 65MS SEAGATE HARD DISK
- \* FLOPPY DISK CONTROLLER CARD
- \* WESTERN DIGITAL HARD DISK CONTROLLER
- \* I/O CARD WITH 1 RS232 + OPTION FOR 2ND
- \* HERCULES COMPATIBLE MONO/GRAPHIC PRINTER CARD
- \* 150W PSU \* 84 KEY KEYBOARD
- \* HI RES 12 INCH GREEN OR AMBER MONITOR WITH TILT & SWIVELL
- \* MS-DOS 3.2 AND GWBASIC
- \* FULL SET OF MANUALS
- \* PRICE £745

## BELTRON TURBO BABY/AT

- \* 80286 CPU \* 6-14.7MHz
- \* 640K RAM EXPANDABLE TO 1MB
- \* 8 EXPANSION SLOTS
- \* CLOCK CALENDAR WITH BAT BACK UP
- \* 1.2MB TEAC FLOPPY DISK DRIVE
- \* 20MB 65MS SEAGATE HARD DISK
- \* WESTERN DIGITAL HARD/FLOPPY DISK CONTROLLER
- \* I/O CARD 2 RS232, 1 PLL PRN, 1 GAMES PORT
- \* HERCULES COMPATIBLE MONO/GRAPHIC PRINTER CARD
- \* 200W PSU \* 102 KEY KEYBOARD
- \* FLIP TOP CASE 427 DEEP X 435 WIDE X 162MM HIGH
- \* HI RES 14 INCH GREEN OR AMBER MONITOR WITH TILT AND SWIVELL
- \* MS-DOS 3.2 AND GWBASIC
- \* FULL SET OF MANUALS
- \* PRICES 10MHz £1095 14.7MHz £1245

## BELTRON 386

- \* 80386 CPU \* 16/20 MHz \* 2MB 100NS RAM
- \* CLOCK CALENDAR WITH BAT BACK UP
- \* 1.2MB TEAC FLOPPY DISK DRIVE
- \* 40MB 28MS SEAGATE HARD DISK
- \* WESTERN DIGITAL HARD/FLOPPY DISK CONTROLLER
- \* I/O CARD 2 RS232, 1 PLL PRN, 1 GAMES PORT
- \* HERCULES COMPATIBLE MONO/GRAPHIC PRINTER CARD
- \* 200W PSU \* 102 KEY KEYBOARD
- \* HI RES 14 INCH GREEN OR AMBER MONITOR WITH TILT AND SWIVELL
- \* GENIUS GM6 MOUSE MS AND MSM COMPATIBLE
- \* MS-DOS 3.3 AND GWBASIC
- \* FULL SET OF MANUALS
- \* PRICE £2395

10 MHz AT ALSO AVAILABLE IN STANDARD CASE (AS 386 SYSTEMS)

## OPTIONS

EBA LIPGRADE	350.00
CGA LIPGRADE	175.00
AUTO SWITCHING EGA CARD	99.00
MGP CARD	49.00
4CMB TAPE BACK-UP SYSTEM WITH SOFTWARE	395.00

SEAGATE 20MB, 30MB, 40MB & 80MB HARD DISKS FROM	195.00
WD CONTROLLER CARD WX1	49.00
WD CONTROLLER CARD WA2	112.50
PROFESSIONAL KEYBOARD XT/AT FROM	65.00
MOUSE INC. SOFTWARE	59.00
TEAC 1.2 MB FLOPPY	89.00

TEAC 720K OR 1.44MB 3.5" DRIVE IN 5.25" CHASSIS FROM	109.00
2MB MULTIFUNCTION CARD FROM	280.00
CALENDER CLOCK CARD WITH BATTERY BACKUP	30.00
CO-PROCESSORS FROM	135.00

# CONTINENTAL

**Sole UK Distributors  
Continental Limited**

**Staverton Technology Park Cheltenham, GL51 2DE**

**Tel: Churchdown (0452) 855222 Fax: (0452) 856794 Telex: 265871 Ref: WJJ032**

PLEASE PHONE FOR FURTHER DETAILS, COLOUR BROCHURES AND FULL PRICE LISTS

All prices quoted are ex. VAT & subject to change without notice



# computer precision ltd

## TOSHIBA PORTABLE COMPUTERS

- T5100:** 80386 16Mhz, 2MB RAM, 40MB Hard Disk (29ms)  
1.44 Mb Floppy, Plasma Display (640x400, EGA, CGA)  
80387 Socket, Ser/Par MS DOS 3.2 15Lbs
- T3200:** 80286 12 Mhz, 1Mb RAM, 40MB Hard Disk, 720K  
Floppy, Plasma Display (720x400, EGA, CGA), 2 IBM  
Expansion Slots, 80287 Socket, Ser/Par,  
MS DOS 3.2, 18.7Lbs.
- T3100 /20:** 80286 8Mhz, 640K RAM, 20MB Hard Disk, 720K  
Floppy, Plasma Display (640x400), Ser/Par,  
MS DOS 3.2, 15Lbs
- T1200:** 8086 9.54Mhz 1MB RAM, 20MB Hard Disk, 720K  
Floppy, Supertwist LCD, Ser/Par, 8 Hour Battery  
MS DOS 3.2, 11Lbs
- T1100+:** 8086 8Mhz, 640K RAM, 2 x 720K Floppy Supertwist  
LCD Ser/Par, 8 Hour Battery, MD DOS 3.2 10Lbs
- T1000:** 8088 4.77Mhz 512K RAM Exp to 1.2MB, 720K  
Floppy, Supertwist LCD, Ser/Par MS DOS 2.11  
in ROM, 6.4Lbs

We also carry a full range of Toshiba Accessories  
including 1.2Mb external disk drive

**PLEASE CALL FOR THE BEST TOSHIBA PRICES**

## TANDON & OPUS COMPUTERS

- PCA20:** 20MB HD £1165      **PCA20 plus:** 20MB HD £1385  
**PCA40:** 40MB HD £1599      **PCA40 plus:** 40MB HD £1820  
**PCA70:** 70MB HD £1965      **PCA70 plus:** 70MB HD £2185  
**TARGET:** 20MB HD £1235      **TARGET plus:** 20MB HD £1455  
**TARGET:** 40MB HD £1675      **TARGET plus:** 40MB HD £1890

All Tandon Computers Include 1MB Ram, 1.2 Floppy,  
14" Mono Monitor MS DOS 3.2 GW Basic MS Windows

### OPUS COMPUTERS

- OPUS PCV:** 80286 10Mhz, 30MB HD, 1MB Ram, Ser/Par  
£1195  
**OPUS PCIII:** 8088 10Mhz, 30MB HD, 1MB Ram, Ser/Par  
£925  
**OPUS EGA MONITOR & ADAPTER ADD** £285

### ZENITH COMPUTERS

- Z181:** 8088 8Mhz, 640K Ram, 2x720K Floppy      £1199  
**Z183:** 8Mhz, 640K Ram 20MB Hard Disk      £1799

**FULL RANGE OF ACCESSORIES STOCKED**

We are able to offer comprehensive Backup Facilities on all the Products we sell

### MONITORS & ADAPTERS

NEC Multisync II Monitor	£495
Sony Multiscan Monitor	£599
Taxan Multiscan 770 Plus	£550
Vega VGA Card	£239
ATI EGA Wonder Card	£199
Hercules Mono Graphics Plus	£189
Hercules Incolour	£225
Wyse WY-700 Monitor	£695

### MOUSE DEVICES

Microsoft Mouse v6	£130
Mouse Systems PC Mouse	£135
Logimouse C7 inc Software	£ 79
Summouse	£ 89
Logitech BUS Mouse	£ 95

### MATHS CO-PROCESSORS

8087 5MHz	£105
8087 8MHz	£135
80287 6MHz	£145
80287 8MHz	£185
80287 10MHz	£245
80387 16MHz	£375
80387 20MHz	£675

### MEMORY BOARDS

AST Rampage XT 2MB RAM	£495
AST Rampage 286 2MB RAM	£695
Intel AboveBoard 286 2MB	£595
Intel AboveBoard PS/286 2MB	£635
Intel AboveBoard PCXT 2MB	£450

### DOT MATRIX PRINTERS

Epson LQ2500+ 270cps 90nlq	£711
Epson LQ1050 220cps 76nlq	£568
Epson LQ850 220cps 76nlq	£425
Epson EX1000 250cps 50nlq	£507
Epson EX800 250cps 50nlq	£378
Epson FX1000 200cps 40nlq	£374
Epson FX800 200cps 40nlq	£293
Epson LX800 150cps 25nlq	£187
NEC Pinwriter P6 216cps 72nlq	£373
NEC Pinwriter P7 216cps 72nlq	£441
NEC P2200 168cps, 56nlq	£299
Diconix 150 Portable 150cps	£335
Toshiba P321SL 216cps, 72nlq	£385
Toshiba P351SX 360cps, 120nlq	£715

### LASER PRINTERS

*HP LaserJet II, 8ppm	£1650
Epson GQ-3500 6ppm	£1220
Mannesman Tally MT 910	£2695
Canon LBP8 MK II	£1595
*AST Turbo Laser PS 8ppm	£2695

(\* Inc 1 Year on site Maintenance)

### COMMUNICATIONS

WS4000 V21,23 AA,AD	£145
WS4000 V21,22,23,AA,AD	£339
WS3000 V21,22,23,AA,AD	£399
WS3000 V21,22,23,22,BIS	£520
Pace Series 4 V21,22,23	£320
Pace Series 4 V21,22,23,22,BIS	£389
Pace Linnit V21,23	£119
Quattro V21,22,23, 22BIS	£595
Lion Systems ORATOR	£695
Procomm 20 Telex Card	£695
Stradcom V21,V22 Int Modem	£160

### SOFTWARE

Ability Plus	£135
Advanced Norton Utilities	£85
dBase 3 Plus v1.1	£335
Framework II v1.1	£335
Lotus 1-2-3 r2.01	£239
MS Multiplan 3	£120
MS Word 4	£260
Norton Utilities v4	£50
Wordstar 2000+ Rel 3	£250
Ventura Publisher v1.1	£565
MS Windows 2	£65
MS Windows 386	£120
Word Perfect v5	CALL
Wordstar Professional v4	£215
JetSetter Desktop Publishing	P.O.A

3.5 inch Format Available

### BORLAND SOFTWARE

Turbo C v1.5	£45
Turbo Basic v1.1	£45
Turbo Pascal Tutor v4	£30
Pascal Editor Toolbox v4	£45
Pascal Database Toolbox v4	£45
Turbo Pascal Ver 4 NEW	£45
Pascal Graphics Toolbox v4	£45
Basic Database Toolbox	£49
Basic Editors Toolbox	£49
Pascal Gamesworks v4	£30
Pascal Developers Library	£155
Pascal Numeric Methods Toolbox v4	£45
Turbo Prolog	£45
Turbo Prolog Toolbox	£45
Eureka the Solver	£65
Reflex	£70
Superkey	£45
Sidekick	£45
Turbo Lightning	£45
Quattro NEW	£99

This Page was produced Using Jetsetter Desktop Publisher all Fonts are Included in Package: HP Laser Jet II Printer

Official orders are accepted from GOVERNMENT & EDUCATIONAL AUTHORITIES & PLC's Price exclude VAT. EXPORT enquiries welcome

### AUTHORISED TOSHIBA & TANDON DEALER

Comprehensive services include: Consultancy, Demonstrations & Hotline Support

**01-226 3043**

TELEX 268048 EXTLDN      FAX 01-226 7948

COMPUTER PRECISION LIMITED, 271 UPPER STREET, ISLINGTON, LONDON N1 2UQ





## SPECIAL OFFERS ON ALL OLIVETTI PRODUCTS

CALL: CHICHESTER (0243) 771786

### OLIVETTI

M240 (8086 Processor)

Options too numerous to mention but here are some examples.

M240 Dual 360Kb 5¼" Drives.

M240 1 x 360Kb 5¼" Drive, 1 x 720Kb 3½" Drive.

M240 20Mb Hard Disk, 1 x 360Kb 5¼" Drive.

M240 20Mb Hard Disk, 1 x 360Kb 5¼" Drive,

1 x 720Kb 3½" Drive.

M240 30Mb Hard Disk, 1 x 360Kb 5¼" Drive.

M240 30Mb Hard Disk, 1 x 360Kb 5¼" Drive,

1 x 720Kb 3½" Drive.

All the above come with 640K RAM, Parallel and Serial Ports and 102-key keyboard.

A wide range of displays and controllers are available. Internal Tape Streamer Systems are also in stock.

ALL PRICES ON APPLICATION.

M28 (80286 Processor)

### SPECIAL OFFER

Full 40Mb system including keyboard,

1Mb RAM, Mono monitor

& MS-DOS 3.2

£1895.00

As above, 68Mb system

£2195.00

For colour system add

£210.00

Many other configurations available - prices on application.

### NEW

M280 (80286 Processor - 12MHz)

All configurations now available.

Price on application.

### OLIVETTI M380

(80386 Processor)

M380 COMPACT 1.2Mb Floppy Drive, 40Mb Hard Disk, 1Mb RAM.

M380 1.2Mb Floppy Drive, 68Mb Hard Disk, 4Mb RAM.

M380 TOWER, 1.2Mb Floppy Drive, 135Mb Hard Disk, 4Mb RAM.

TOP JOB included in all configurations of M380.

Prices on application.

### TANDON

PCA20 £1150

PCA20 Plus (10 Mhz) £1365

PCA40 £1580

PCA40 Plus (10 Mhz) £1795

PCA70 £1940

PCA70 Plus (10 Mhz) £2155

TARGET 20 £1220

TARGET 20 Plus (10 Mhz) £1435

TARGET 40 £1650

TARGET 40 Plus (10 Mhz) £1865

The above prices include monochrome monitor, (green or amber), keyboard and Ms-Dos.

For EGA colour monitor and card, add £285.

### DOT MATRIX PRINTERS

Epson FX800 £288

Epson FX1000 £375

Epson EX800 £370

Epson EX1000 £499

Epson LQ500 £265

Epson LQ850 £419

Epson LQ1000 £410

Epson LQ1050 £565

NEC P6 £365

NEC P7 £425

NEC P5 £685

NEC P2200 NEW £265

NEC P9 £905

### PRINTERS

Star LC10 £170

Star LC10 colour £185

Star SR10 £325

Star NX15 £265

Star ND15 £330

Star NR15 £385

Star NB24-10 £395

Star NB24-15 £510

### DAISYWHEEL PRINTERS

Brother HR20 £325

Brother HR40 £710

Olivetti DY450 £795

Olivetti DY800 £1045

NEC 8800 with interface £810

### INKJET PRINTERS

Epson SQ2500 £940

HP Paintjet 3630A £760

### PLOTTERS

HP 7440 (A4) £895

HP 7476 (A3) £1275

HP 7550 (A3) £2995

Roland DXY880A (A3) £585

Roland DXY980A (A3) £515

### UPGRADES & ADD-ONS

20Mb Seagate ST225 and

Controller £195

30Mb Seagate Hardcard (40MS) £229

Everex Maxi Magic Card with

384k £185

Everex Maxi Magic Card with 1Mb

£295

Everex RAM 3000 deluxe (AT) with

1Mb £335

MS Mouse (Bus or Serial) £115

Wangtek 40Mb Internal Streamer £250

### SOFTWARE

Database

DBase III + £305

Dataease £385

Paradox 2 £285

RBase 1.01 £195

RBase System 1.11 £355

Rapidfile £189

Foxbase + £285

### Word Processors

Multimate Advantage II £270

Word IV £235

Wordcraft 3.0 £305

Wordperfect £235

Wordstar 2000 + R.3 £220

Wordstar Professional 4 £189

### Spreadsheets

Lotus 1-2-3 £245

Multiplan 3 £105

Supercalc IV £189

### Others

Lotus Symphony £335

Smart £375

Superproject Plus £275

Microsoft Excel £235

Super Project expert £485

Pagemaker £420

### Special Offers

Pagemaker, MS Windows, and

MS Mouse £550

Pagemaker, MS Windows, MS

Mouse, MS Word, and

MS Draw £925

Full range of Dot Matrix, Daisy Wheel and Laser printers - Call for best prices.

Prices for Add on Boards, Hard Disks, Modems and other software available on request.

# COMP. STAND

LIMITED

Quarry Lane, Chichester, W. Sussex PO19 2NY  
All prices include full 12 months warranty but are exclusive of VAT and delivery.

Tel: 0243 771786



# DIMENSION computers l.t.d.

27/29 High Street  
Leicester LE1 4FP  
Tel: (0533)  
517479/21874

THE MIDLAND'S LARGEST COMPUTER STORE

## AUTHORISED AMSTRAD DEALER AMSTRAD PC RANGE

PC1640 models include Spreadsheet, Wordprocessor and Database software.  
PC1512 models include Ability Software Suite and 4 US Gold games.

PC1512 Single Drive Mono	£375.00
PC1512 Dual Drive Mono	£519.00
PC1512 Single Drive Colour	£509.00
PC1512 Dual Drive Colour	£649.00
PC1640 Single Drive Mono	£452.00
PC1640 Dual Drive Mono	£592.00
PC1640 Single Drive Colour	£597.00
PC1640 Dual Drive Colour	£739.00
PC1640 Single Drive ECD	£729.00
PC1640 Dual Drive ECD	£869.00

## AMSTRAD WITH 20Mb HARD DISC PLUS DMP3160 PRINTER OFFERS

PC1512 Single Drive Mono	£735.00
PC1512 Single Drive Colour	£876.00
PC1640 Single Drive Mono	£839.00
PC1640 Single Drive Colour	£959.00
PC1640 Single Drive ECD	£1109.00

The above prices include FREE DMP3160 Printer.  
PC1640 models include Spreadsheet, Wordprocessor and Database software.  
PC1512 offers include Ability Software Suite and 4 US Gold games.

## SEAGATE HARD DISC SYSTEMS

The world's most popular hard disc unit, now available in simple to fit kit form. Suitable for the Amstrad PC1512 or 1640.

Seagate ST225, 20 Mb, 65 ms	£199.00
Seagate ST238R, 30 Mb, 65 ms	£229.00
Seagate ST125*, 40 Mb, 40 ms	£299.00

All kits are supplied complete with Hard Disc Unit, Controller, Fixing Brackets and Installation Instructions, plus Full One-Year Warranty.

\*Seagate 40 Mb units can be partitioned as two 20 Mb volumes, each with 28 ms access time.

## AMSTRAD HARD CARD SYSTEMS

	20Mb	32Mb
PC1512 Single Drive Mono	£584.00	£634.00
PC1512 Dual Drive Mono	£728.00	£778.00
PC1512 Single Drive Colour	£725.00	£768.00
PC1512 Dual Drive Colour	£869.00	£908.00
PC1640 Single Drive Mono	£660.00	£711.00
PC1640 Dual Drive Mono	£799.00	£849.00
PC1640 Single Drive Colour	£795.00	£846.00
PC1640 Dual Drive Colour	£936.00	£986.00
PC1640 Single Drive ECD	£932.00	£982.00
PC1640 Dual Drive ECD	£1072.00	£1123.00

## AMSTRAD SYSTEMS WITH 30Mb/40Mb HARD DISC

	30Mb	40Mb
PC1512 Single Drive Mono	£614.00	£684.00
PC1512 Single Drive Colour	£748.00	£818.00
PC1640 Single Drive Mono	£691.00	£761.00
PC1640 Single Drive Colour	£836.00	£906.00
PC1640 Single Drive ECD	£968.00	£1038.00

## DISC DRIVE UNITS

5 1/4" Internal 360K	£99.00
3 1/2" Internal 360K	£99.00
3 1/2" Internal 720K	£129.00
3 1/2" External 720K with Cable Adaptor	£159.95

## PRINTER OFFERS

### ALL PRINTERS INCLUDE PC PRINTER LEAD

Amstrad DMP3160, 80 col, 160 cps, 40 nlq	£159.00
Amstrad DMP4000, 136 col, 200 cps, 50 nlq	£249.00
Amstrad LQ3500, 24 pin with Wordstar 1512	£279.95
Amstrad LQ5000, 136 col, 288 cps, 96 lq, 24 pin	£349.00
Star LC10, 80 col, 120 cps, 25 nlq	£173.00
Star LC10 Colour, 80 col, 120 cps, 25 nlq	£199.00
Star NX15, 136 col, 120 cps, 30 nlq	£299.00
Star NR15, 136 col, 240 cps, 60 nlq	£426.00
Star ND15, 136 col, 180 cps, 45 nlq	£354.00
Star NB24-10, 80 col, 216 cps, 72 lq, 24 pin	£433.00
Star NB24-15, 136 col, 300 cps, 100 lq, 24 pin	£549.00
Star Laser	£1599.00
Epson LX800, 80 col, 160 cps, 25 nlq	£189.00
Epson EX800, 80 col, 300 cps, 50 nlq	£399.00
Epson EX1000, 136 col, 300 cps, 50 nlq	£539.00
Epson FX800, 80 col, 200 cps, 40 nlq	£311.00



### SHARP — THE TRUE PORTABLE

- ★ Excellent Backlit Supertwist Screen, with 640 x 200 Resolution. Useable in almost any lighting conditions.
  - ★ Rechargeable Battery Cell plus Mains Adaptor.
  - ★ True IBM compatibility.
  - ★ Serial, Parallel and 5 1/4" External Drive Ports.
  - ★ True Portable Size (12" x 14" x 3") and Weight (12.6 lbs).
  - ★ Excellent Documentation.
- |  |          |
|--|----------|
| PC4501A Single Drive                     | £599.00  |
| PC4501A Dual Drive                       | £699.00  |
| PC4502 Dual Drive with numeric keypad    | £799.00  |
| PC4521* Single Drive with 20Mb Hard Disc | £1499.00 |

\*Very civilised laptop — excellent compatibility, documentation and value for money — PC User, Feb '88

Epson FX1000, 136 col, 200 cps, 40 nlq	£399.00
Epson LQ500, 80 col, 150 cps, 50 lq, 24 pin	£299.00
Epson LQ850, 80 col, 180 cps, 60 lq, 24 pin	£452.00
Epson LQ1050, 136 col, 180 cps, 60 lq, 24 pin	£599.00
Epson GQ3500, 6 ppm Laser	£1249.00
Micro P MP480, 80 col, 480 cps, 80 nlq	£299.00
Micro P MP700, 136 col, 720 cps, 120 nlq	£449.00
NEC 2200 Pinwriter, 80 col, 168 cps, 56 lq, 24 pin	£329.00
Citizen 120D, 80 col, 120 cps, 25 nlq	£149.00
Citizen LSP100, 80 col, 175 cps, 30 nlq	£173.00
Citizen MSP10E, 80 col, 160 cps, 40 nlq	£219.00
Citizen MSP15E, 136 col, 160 cps, 40 nlq	£239.00
Citizen MSP40, 80 col, 240 cps, 50 nlq	£299.00
Citizen MSP45, 136 col, 240 cps, 50 nlq	£399.00
Citizen MSP50, 80 col, 300 cps, 60 nlq	£399.00
Citizen MSP55, 136 col, 300 cps, 60 nlq	£499.00
Citizen HQP40, 80 col, 200 cps, 66 lq, 24 pin	£369.00
Citizen HQP45, 132 col, 200 cps, 66 lq, 24 pin	£449.00
Citizen Overture, 10 ppm Laser	£1249.00

## THE NEW AMSTRAD PORTABLE RANGE

PPC512S Single 720K 3 1/2" Drive	£379.00
PPC640S Single 720K 3 1/2" Drive with Built-in Modem	£479.00
PPC512D Double 720K 3 1/2" Drive	£479.00
PPC640D Double 720K 3 1/2" Drive with Built-in Modem	£569.00

All include PPC ORGANIZER Software Suite

## PROTECT IT!!

### WITH CYPHER 1525-CT TAPE STREAMER

- ★ Specially designed for Amstrad PC1512/1640 range
  - ★ 25Mb storage capacity, with larger disc back-up on multiple cartridges
  - ★ 1Mb per minute Save/Restore rate
  - ★ Menu-driven software
  - ★ Save/Restore Specific Files, Directories or Entire Disc
- |             |         |
|-------------|---------|
| Cypher 1525 | £279.00 |
| Cartridges  | £27.50  |

## THE NEW STAR LC10 Dot Matrix Printer

- ★ 120 cps Draft 30 cps NLQ ★ Friction and Tractor Feed
  - ★ 4K Buffer ★ Paper Parking Facility
  - ★ 6 Resident Fonts and 7 Different Print Pitches
- Selectable from Front Mode Control Panel
- |   |         |
|---|---------|
| NOW AVAILABLE — the STAR LC10 7 Colour Dot Matrix | £199.00 |
|---|---------|

## HARD CARD UPGRADES

Suitable for Single or Dual Drive 1512 and 1640. Offers Amstrad users a high quality, low price hard disc system. Fast, quiet operation, takes just five minutes to install.

20Mb	£229.00
32Mb	£259.00

2 Way Centronics Printer Switch Box	£27.50
3 Way Centronics Printer Switch Box	£34.50
4 Way Centronics Printer Switch Box	£39.50
Centronics to Centronics Cables for above	£8.50
Pace Linnet Modem with Gemcomm Software	£149.00
Uninterruptible Power Supply Unit	£199.00
256K Printer Buffer	£99.00

## PERSONAL CALLERS AND EXPORT ENQUIRIES WELCOME

ALL PRICES EXCLUDE VAT

PLEASE ADD £5.00 TOWARDS CARRIAGE & PACKING ON ANY ORDER

ALL ITEMS SUBJECT TO AVAILABILITY  
ALL PRICES SUBJECT TO CHANGE WITHOUT NOTICE

## DIMENSION COMPUTERS LTD.

27/29 HIGH STREET, LEICESTER

SALES DESK Tel: (0533) 517479/21874

Fax: (0533) 511638

PCW 5

# RE: CSD IN RECEIVERSHIP

## INCLUDING ENTIRE HARDWARE STOCK OF SILICON EXPRESS

### EPSON PX8



**UNREPEATABLE OFFER!**  
PX8 inc Portable WordStar, Portable CalcStar, BASIC full manuals & charger. NEW **£195**

### LIST £795!

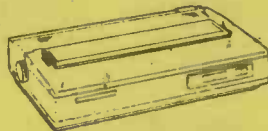

**SILVER REED EXP 600/800**  
25 CPS, 3K buffer, parallel, RS232, copy mode, 132 column, EXP 800 40CPS (£250). NEW **£195**

### TOP THREE



**FAMOUS NAME PORTABLE**  
2 X 360K drives, 512K RAM, Gas plasma display, MS-DOS 3.2, two slots, 20Mb (£1095) NEW **£795**

### LAST 8088 IBM



**IBM XT SFD**  
20Mb, 1 X 360K, 640K RAM, IBM mono monitor, GTO, IBM keyboard, final few! NEW **£1395**

### EGA PLUS RAM



**AST RAMPAGE EGA**  
Does Mono, Hercules, CGA, EGA, + 512K EMS RAM on board, expandable up to 2Mb NEW **£195**

### 123 RIVAL



**SILK**  
Lotus 123 clone with enhancements, "saves as you type" & time modelling. On line help. NEW **£45**

### SAVE £1330



**EPSON SQ-2000 PRINTER**  
175 CPS draft, 105 CPS NLQ, parallel or serial, 24 jet print head 2K buffer. NEW **£495**

### BIG MONITOR

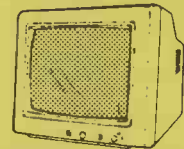

**HITACHI CM 2073**  
20" High res. (1280 X 1024 pixels) colour monitor, RGB input. Brand new, but unboxed! NEW **£995**

### IBM PRINTER



**IBM QUIETWRITER**  
IBM Quietwriter model 1 produces better than daisywheel printout fraction of noise **£395**

### MACINTOSH!

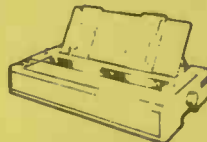

**OLIVETTI DM 290**  
Imagewriter compatible 132 column 160 CPS dot matrix printer (80 col DM280 £195) NEW **£250**

### GO FASTER!



**AST FLASHPAK**  
Doubles PC/XT speed, uses NEC V30 chip running at 9.45MHz, switchable to 4.77MHz NEW **£80**

### WAS £2000 +

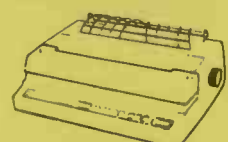

**DIABLO 630 API ECS**  
40 CPS industry standard daisywheel, 110/240 Volt, 136 column, 192 character set. NEW **£395**

### GREEN/AMBER

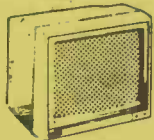

**PHILIPS MONO MONITORS**  
BM 7502 (Green) and BM 7522 (Amber) Phono & audio input Includes stand. New. Both same price. **£50**

### BEST SELLER

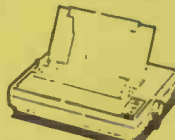

**EPSON LX-800**  
150 cps draft, 25 cps NLQ, parallel interface. IBM option. Inc tractor feed. NEW **£185**

### MULTI SCAN



**SONY TRINITRON CPD1402E**  
Compatible with IBM PC, XT, AT and similar. Uses CGA, EGA, PGA, and MDA. NEW **£495**

### LASER PRINTER



**OLIVETTI PG 101**  
Spec 8 PPM, 300 DPI, parallel & serial I/F, emulates FX-100, Diablo 630 & HP. NEW **£1195**

### PORTABLE



**DATAVUE 25**  
IBM compatible, rechargeable, 5 1/4" floppy, 640k Ram, backlit LCD, V/slight demo **£495**

### INC WORDSTAR



**NEC PORTABLE PC-8401A**  
Inc WordStar, CalcStar, Personal Filer & Telecom, (comms software). Battery/mains NEW **£195**

### 5 1/4" DISK DRIVE



**CDC FULL HEIGHT DRIVES**  
Removed from Compaq Portables being upgraded. 360K, DS/DD, 30 day warranty **£45**

### BIT PAD PLUS

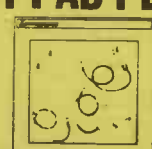

**SUMMAGRAPHICS**  
Bit Pad Plus graphics tablet for IBM PC (inc PS/2), and 100% IBM PC compatibles. NEW **£250**

### 5Mb HARD DISK



**FLOPPY DISK PRICE**  
5mb full height internal hard disk for IBM PC & BBC model B. Controller extra, (DEMO) **£50**

### POCKET PRINTER



**EPSON P-40 PRINTER**  
Rechargeable NiCads, parallel interface. 40/80 column printer. Takes thermal paper. NEW **£60**

### BUS MOUSE



**FROM LOGITECH**  
For IBM PC. works with most industry standard packages, CADD s/ware available. NEW **£65**

### SIX COLOUR



**OLIVETTI DM 590 PRINTER**  
6 colour, dot matrix, 190 cps draft, 120 NLQ, LQ 40cps 12 pin. 132 Col. NEW **£295**

Part exchanges accepted.

\* indicates brand new goods

ACCESS AND VISA ACCEPTED  
PRICES SUBJECT TO 15% VAT  
MAIL ORDER (CARRIAGE EXTRA)

# Morgan Computer Co.

OPEN MONDAY TO SATURDAY  
PRICES SUBJECT TO CHANGE  
GOODS SUBJ. TO AVAILABILITY

64-72 NEW OXFORD STREET, LONDON WC1. 01-255 2115 & 179 TOTTENHAM COURT ROAD LONDON W1. 01-636 1138



# IGNORE THE REST – WE ARE THE VERY BEST

# PiCCADILLY microS

## olivetti PERSONAL COMPUTERS

### olivetti M240

20Mb Hard Disk  
5¼" 360K Floppy Disk  
640K RAM and MS DOS  
Olivetti Enhanced Mono Monitor  
Olivetti Keyboard **£1450.00**  
Above with Extra 3½" Disk **£1550.00**

### olivetti M280

20Mb Hard Disk  
5¼" 1.2Mb Floppy Disk  
1Mb RAM and MS DOS  
Olivetti Enhanced Mono Monitor  
Olivetti Keyboard **£2275.00**

### olivetti M380

40Mb Hard Disk  
5¼" 1.2Mb Floppy Disk  
1Mb RAM and MS DOS  
Olivetti Enhanced Mono Monitor  
Olivetti Keyboard **£3150.00**

**EXTRA DISCOUNT GIVEN ON ALL EDUCATION SALES**

## COMPLETE AMSTRAD SYSTEMS

PC1512 Twin Mono **£449.00**  
PC1512 20Mb Colour **£795.00**  
PC1640 Twin Colour EGA **£799.00**  
PC1640 20Mb Colour EGA **£1067.00**

## COMPLETE Tandon SYSTEMS

PCA 20, 1Mb RAM,  
Mono Screen, Keyboard and  
MS DOS **£1250.00**  
Target 20, 1Mb RAM,  
Mono Screen Keyboard and  
MS DOS **£1325.00**  
Target 40, 1Mb RAM,  
Mono Screen Keyboard and  
MS DOS **£1575.00**  
PCA 20 Plus, 1Mb RAM,  
Mono Screen Keyboard and  
MS DOS **£1495.00**

## NOVELLE NETWORK

Leading Supplier's Throughout the U.K.  
Choice of Comms Boards G/Net, Ethernet  
& Token Ring.

**PHONE FOR BEST PRICES**

WE SUPPLY EVERYONE FROM LEADING UK COMPANIES, GOVERNMENT DEPARTMENTS, EDUCATIONAL ESTABLISHMENTS, LOCAL AUTHORITIES, THE COMPUTER TRADE TO SMALL BUSINESSES AND THE PRIVATE INDIVIDUAL – ANYWHERE IN THE WORLD!

**CALL US NOW – IN YOUR AREA!**

**EDINBURGH**  
031 556 9903  
**NEWCASTLE**  
091 276 6887  
**MANCHESTER**  
061 228 7965  
**NOTTINGHAM**  
0602 583716  
**BIRMINGHAM**  
021 643 5072  
**LONDON**  
01 481 3929  
**BRISTOL**  
0272 273665

**EXTRA DISCOUNT GIVEN ON ALL EDUCATION SALES**

## PRINTERS/LASER PRINTERS

All Epson Printers	27% Discount
All Brother Printers	25% Discount
All NEC Printers	27% Discount
All Olivetti Printers	30% Discount
HP Roland/Calcom Plotters	
Minimum	20% Discount
All Hewlett Packard Lasers	25% Discount
All Amstrad Printers	P.O.A.

**PLUS MOST OTHER MAKES**

## SOFTWARE

All IBM Compatible Software at high discounts, including:

Lotus 123	£259.00
DBase III+	£399.00
MS Word	£269.00
Smart Software	£425.00
Wordstar Professional	£215.00

## MULTISOFT ACCOUNTS

### SPECIAL OFFER

New Multisoft MICROPLAN inc:  
Sales, Purchase and Nominal Ledger  
totally integrated **£375.00**  
Dem Pack **£5.00** refundable on purchase  
**PLUS**  
Multisoft Accounting Modules  
MS DOS **£295.00**  
Xenix **£449.00**

# PiCCADILLY microS

## Opus. PC COMPATIBLES

### NEW PC III TURBO NEW

Twin 360K Disk Drive, 640K RAM,  
4.77/10MHz, Mono Display **£699.00**

### NEW PC III TURBO NEW

30Mb Hard Disk, 1Mb, RAM,  
4.77/10MHz, Mono Display  
Keyboard **£995.00**

### NEW SYSTEM V NEW

30Mb Hard Disk, 80286 Processor,  
1Mb, RAM, 1.2Mb Floppy, Mono  
Display, Keyboard **£1295.00**

### OPUS OPTIONS

Colour EGA on each system ADD **£300.00**  
Spacemaker Desk & Chair **£149.00**  
MS DOS 3-2 **£60.00**

**PHONE FOR BEST U.K. PRICES**

**EXTRA DISCOUNT GIVEN ON ALL EDUCATION SALES**

## PORTABLE COMPUTERS

### TOSHIBA T1100+

Twin 720K Disk Drives, LCD Supertwist  
Screen, 640K RAM, Battery  
& Mains **£945.00**

### TOSHIBA T3100/20

20Mb Hard Disk, 80286 Processor,  
Gas Plasma Screen **£2195.00**

### TOSHIBA T5100/40

40Mb Hard Disk, 80386 Processor,  
Gas Plasma Screen **£3350.00**

### Tandon Z183

20Mb Hard Disk, Back Lit Screen,  
Battery & Mains **£1899.00**

### AMSTRAD PPC512

720K Disk Drive, LCD Screen,  
Battery & Mains **£359.00**

### AMSTRAD PPC 640D

Twin 720K Disk Drives,  
Battery & Mains & Modem **£539.00**

Piccadilly Micros, 9 Grosvenor Terrace, Broad Street, Birmingham B15 1AU. Telephone: 021 643 5072. Telefax: 021 643 9379

★ 12 months warranty ★ 7 day money back guarantee ★ Next day del. available  
★ On site maintenance contracts available ★ Finance plans available

All prices exclude VAT and delivery and are correct at going to press. Piccadilly Micros reserve the right to vary prices without prior notice.  
Trade enquiries welcome. Additional discounts for bulk orders.

**olivetti**

**AMSTRAD**

**Tandon**

**Opus.**

**TOSHIBA**

**Z183**

**Epson**

NEW FROM

Transform

# ORGANISER FAX — £69.95

## ORGANISER II DATAPAK BATTERY CASE

(available separately) £12.95

Removable Psion Organiser II case.

Calf leather.

Provision for 6 credit cards

Removable Datapak and spare battery case.

### OBASE—£69.95

Database Creator Manipulator. User friendly. On-line help. Use multiple databases including MAIN. Import/Export Files to

Dbase-Archive. 6 Field types. Search on field. Printer formats including labels and fax paper. Not copy protected.

Space for standard FAX paper for all your maps and charts, etc. (not supplied).

2 pen loops

16 mm rings

Pocket to hold business cards, etc.

### LEATHER ORGANISER HOLSTER—£39.95

Carry the Organiser II discreetly beneath your jacket with this smart black leather holster.



Transform Ltd., 24 West Oak, Beckenham, Kent BR3 2EZ.

01-658 6350  
ORGANISER II CATALOGUE  
NOW AVAILABLE



Uninterruptible Power Supply For Complete Computer Protection

# POWER BANK PLUS



Introducing the latest protection for your computer hardware and software. Saves your time and costs.

## POWQUIP

POWER EQUIPMENT LIMITED, Kingsbury Road, London NW9 8UU. Telephone: 01-205 0033. Telex: 8952887.





# SAVE £100's ON AMSTRAD PC 1640's

FREE 10 disks containing games, utilities etc, with each computer worth over £100

## AMSTRAD COMPUTERS

1640 MD 20Mb	£719
1640 MD 32Mb	£775
1640 MD 40Mb	£839
1640 MD 64Mb	£939
1640 CD 20Mb	£859
1640 CD 32Mb	£915
1640 CD 40Mb	£979
1640 CD 64Mb	£1079
1640 ECD 20Mb	£999
1640 ECD 32Mb	£1055
1640 ECD 40Mb	£1199
1640 ECD 64Mb	£1219

All the above fitted with Miniscribe Hard Disks.

1512	Tel
PPC	Tel
1640 DD (5¼")	Tel
1640 DD (5¼" and 3½")	Tel

## AMSTRAD WORD PROCESSORS

PCW8256	£289
PCW8512	£389
PCW9512	£469

## TANDON COMPUTERS

60 DAYS LEAD TIME try

## SAMSUNG AT's

★ MFC 6000 20Mb	£1400
★ MFC 6000 40Mb	£1750
★ EGA	plus £300
★ One year's onsite maintenance	
Free of Charge	

## EPSON COMPUTERS

PCe 20Mb mono	£999
PCA X2 EGA 20Mb	£1600
PCA X40 40Mb mono	£1725
PCA X40 40Mb EGA	£2075

## AMSTRAD PRINTERS

DMP3160	£179
DMP4000	£299
LQ3500	£299

## BROTHER PRINTERS

1109 100/25 80col	£195
1209 168/35 80col	£225
1409 216/45 110col	£369
1509 216/45 136col	£429
1709 240/50 136col	£499
1724 216/60 136col	£575
2024L 192/80 136col	£655
4018 480/100 136col	£1295
HR20 22cps 117col	£375
HR40 40cps 136col	£845
HL8 8ppm	£1695

## EPSON PRINTERS

LQ850 24pin 220/73 80col	£457
LQ1050 24pin 220/73 136col	£609
LQ2500 24pin 270/90 136col	£763
LX86 100/16cps 80col	£201
LX800 150/25cps 80col	£201
EX800 250/50cps 80col	£405
EX1000 250/50cps 136col	£544
FX800 200/40cps 80col	£314
FX1000 200/40cps 136col	£401
GQ3500 Laser 6 page/min	£1299
SQ2500 Ink Jet 450/150	£982

## STAR PRINTERS

NL10 120/30cps 80col	£160
Parallel I/F	£29
Serial I/F	£65
NX15 120/30cps 136col	£284
ND15 180/45cps 136col	£357
NR15 240/60cps 136col	£430
NB15 24pin 300/72cps 136col	£620
NB2415 24pin 216/72cps	£554
NB2410 24pin 216/72 80col	£437
SD10 160/40cps 80col	£284

## OTHER NARROW PRINTERS

MP135 135/27cps	£144
MP165+ 165/35cps	£194
Canon 1080A 160/27cps	£219
Juki 5510 180/30cps	£285
Juki 5520 7 colour	£385
Panasonic 1081 120/35	£145
Panasonic 1082 160/35	£195

## OTHER WIDE PRINTERS

MP201+ 240/48	£319
MP700 700/120	£449
Panasonic 1592 180/38cps	£399
Panasonic 1595 240/51cps	£475

## DAISYWHEEL PRINTERS

MP26 26cps 136col	£219
MP40 40cps 136col	£319
Juki 6100+s/f	£394
Juki 6200 30cps 136col	£389
Juki 6300 40cps 136col	£635

## NEC PRINTERS

Pinwriter P6	£412
Pinwriter P7	£487

## LASER PRINTERS

Canon LBP-8 II	£1685
HP Laserjet II + Toner + 12 months on-site	£2145
Hitachi 672 XD Plotter	£519

## SOFTWARE

Integrated 7 Plus from	£99
Lotus 123	£295
Lotus Symphony	£399
Lotus Freelance	£295
Lotus HAL	£95
Lotus Manuscript	£295
Lotus Metro	£69
Wordstar Prof	£239
Wordstar 2000	£289
Dbase III+	£425
Rapidfile	£199
Supercalc 4	£249
Multimate Adv II	£325
WordPerfect	£285
Smart	£495
Clipper	£445

## CAD/CAM SOFTWARE

Generic Cadd3	£99
Drafting Enhancements	£49
Autoconvert	£49
Auto Dimension	£49
Dot Plot	£49

## DESK TOP PUBLISHING

GEM DTP	£225
Fleet St Editor	£78
Newsmaster	£55
Ventura	£525
Pageability	£175

## ACCOUNTS SOFTWARE

Sage Accountant	£107
Sage Accountant +	£147
Sage Payroll	£89
Sage Financial Control	£237

## MULTI USER SYSTEMS

Please ring for Pegasus or SMB systems

## CARRIAGE

Please add carriage as follows:  
Hardware — £10 first unit  
£5 subsequent  
Software — £2.50 per item  
(max £10)

**ARKEL COMPUTER SERVICES LTD**  
7A MILL HILL ROAD, MARKET HARBOROUGH,  
LEICS LE16 7DN

TELEPHONE: 0858 32495

Please add 15% VAT to all U.K. orders







# Slough Computers



245 High Street, Slough, Berks SL1 1BN. Tel: (0753) 21594/32753

FOR

## THE UNBEATABLE Opus Technology RANGE



### COMING SOON THE OPUS PCIV TURBO

HOW MUCH would you expect to pay for a turbo speed XT with a hard disk and enhanced colour graphics, WELL — this is now possible for — WAIT FOR IT **UNDER £1,000**

No, this is not a misprint! No, this is not a flimsy plastic corner-cutting exercise! This is a quality product from Britain's fastest growing PC manufacturer.

### RING NOW FOR FURTHER DETAILS

#### THE PCV TURBO AT

Incredible performance at an unbelievable price

- Turbo 80286 microprocessor
- 6/10 MHz (zero wait state) switchable clock speeds
- 1Mb motherboard memory
- 30Mb Winchester
- 1.2Mb 1/2-height floppy
- Enhanced, 102-key keyboard
- Maths co-processor option
- Parallel/serial printer ports
- 14" super high resolution flat-screen amber monitor
- Keyboard lock
- 8 expansion slots
- Phoenix BIOS
- Space for additional drive
- EGA option
- Super small footprint
- 12-month guarantee

All this from only **£1269**

#### THE PCIII TURBO XT

Retaining all of the above listed features of the PCV but with a 4.77/10MHz 8088 and 360k floppy to give you a fully expandable, professional 30Mb XT system at only **£969**. Most Opus configurations available from stock. Dealer/Consultants enquiries welcome.



### OPUS 386/XT POWER

The cheapest way to 386 power! All branded product. We can offer you an Opus XT upgraded with all these features:

- 16MHz 80386 card
- 1Mb 32 bit RAM
- 80387 option
- 1 x 5 1/4" 360k drive
- 1 x 3 1/2" drive
- 40Mb 28ms hard disk
- Partitioning software
- Disk caching
- Norton SI 16.2
- MS DOS 3.3

All this from only

**£1799**

RING NOW FOR FURTHER DETAILS

### Tandon

PCA20 1024K, 6/8MHz, 80286, MS-DOS 3.2, 1.2Mb FLOPPY, 20Mb WINCHESTER **£1495**

AT NO EXTRA COST WE WILL SUPPLY THE ABOVE SYSTEM WITH EGA CARD AND MONITOR **SAVING £500**

10MHz versions available — just add £200

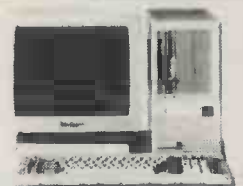

The new target range and other models available

### EGA UPGRADE BARGAIN

14" Enhanced colour monitor with multiple choice colour switch PLUS EGA/CGA/HGC Graphics card, all to suit PC's and compatibles at previously unheard of price of only **£399**

### SPECIAL OFFERS

- Miniscribe 30Mb 40MS card-mounted Winchester **£299**
- Archive 40Mb internal tape streamer only **£299**
- Tandon 20Mb Business card **£229**
- Epson FX105 wide carriage dot matrix printer **£299**
- Olivetti DY450 55cps Daisywheel printer **£599**
- Migent Ability **£49**
- Microsoft bus mouse **£129**
- Ex demo Amiga 2000 + monitor **£899**

VAT and Carriage must be added to all prices. Telephone/Mail orders welcomed. All prices subject to change without notice.



#### AMSTRAD RANGE OF COMPUTERS

For only £100 you could have on-site maintenance on Amstrad 1640 Computer range.

Only the original Amstrad hard disk in our PC 1640HD range of

Computers	
PC1640 20Mb HD Software ECD Colour Monitor	£1025
PC1640 DD Software ECD Colour Monitor	£799
PC1640 SD Software ECD Colour Monitor	£699
PC1640 SD Software Colour display	£570
PC1640 DD Software Colour display	£675
PC1640 20Mb HD Software Colour display	£899
PC1640 SD Software Mono display	£440
PC1640 DD Software Mono display	£540
PC1640 20Mb HD Software Mono display	£799
PC1512 SD Mono display	£375
PC1512 SD Colour display	£360
PC1512 DD Mono display	£495
PC1512 DD Colour display	£625

#### PERSONAL PORTABLE COMPUTER

PPC-640 DD 3.5" Floppy built in Modem	£549
PPC-640 SD 3.5" Floppy built in Modem	£435
PPC-512 DD 3.5" Floppy no Modem	£455
PPC-512 SD 3.5" Floppy no Modem	£375

#### APRICOT XEN-I SYSTEMS UK'S LOWEST PRICE

XEN-I- 286 30Mb HD keyboard, Gem, DOS, VP Planner Mono Mon	£1675
XEN-I- 286 30Mb HD keyboard, Gem, DOS, VP Planner PW Mon	£1825
XEN-I- 286 30Mb HD keyboard, Gem, DOS, VP Planner EGA Mon	£2300
XEN-I- 286 45Mb keyboard, Gem, DOS, VP Planner Mono Mon	£2299
XEN-I- 286 45Mb keyboard, Gem, DOS, VP Planner PW Mon	£2499
XEN-I- 286 45Mb keyboard, Gem, DOS, VP Planner EGA Mon	£2799
XEN-I- twin drive keyboard, Monitor, DOS, SW Mono Mon	£1399
XEN-I-386 Tower 50Mb HD 10 expansion slots green mon	£3249
XEN-I-386 Tower 100Mb HD 10 expsn slots grn mon	£4100
XEN-I-386 100Mb HD 10 expsn slots green mon	£4300
XEN-I-386 30Mb keyboard, SW, MDA card green mon	£2949
14" paper white monitor	£2599
EGA colour monitor	£2899
XEN-I-286 45Mb H/D keyboard, SW, MDA card, grn mon	£2999
14" paper white monitor	£2599
EGA colour monitor	£3499

#### APRICOT VX-386 MULTIUSER SYSTEM

Comparing two terminals Xenix op/sys 70Mb H/D 3.5 or 5.25 disk format, and installation. **£7999**

Ask us about your next multi-user requirement running any operating system, eg Novell, Xenix on Zenith, Olivetti, Apricot etc etc. Complete installation and backup service available.

#### ZENITH COMPUTERS

Z-181 Portable 3.5" FD DOS 3.2 Backlit Superwist	£1075.00
Z-183 Portable 3.5" FD DOS 3.2 LCD Monitor	£1849.00
Z-248 80286 512K RAM 5.25" FD 20MB Hard Disk Monitor	£1799.00
Z-249 80286 512K RAM 5.25" FD 40MB Hard Disk Monitor	£2499.00
Z-286 80286 RAM 3.5" FD 20MB Hard Disk Monitor	£1699.00
Z-286 80286 512K RAM 5.25" FD 20MB Hard Disk Monitor	£1499.00

Z-386 1MB RAM 5.25" FD 40MB Hard Disk Monitor	£3299.00
Z-386 1MB RAM 5.25" FD 80MB Hard Disk Monitor	£3699.00
Easy PC 3.5" FD DOS 3.2 512K RAM 14" Monitor	£450.00
Easy PC Twin 3.5" FD	£559.00
Easy PC 3.5" FD 20MB Hard Disk 512K RAM DOS Monitor	£850.00

#### OPUS COMPUTERS

Opus PCIII DD 360K FD EGA Monitor	£875
Opus PCIII DD 360K FD Mono Monitor	£599
Opus PCIII 20Mb Hard Disk 360K FD Mono	£849
Opus PCIII 20Mb Hard Disk 360K FD EGA Monitor	£1095
Opus PCV AT Compat Mono	£1095
Opus PCV AT Compat EGA	£1349
Sharp PC 4501A single drive	£589
Sharp PC 4501A dual drive	£675
Sharp PC 7100A	£1075
Sharp PC 7100	£1375
Sharp PC 7200	£2075

#### OLIVETTI COMPUTER

Tandy Laptop Computer	£995
Tandy TX1000 20Mb HD Mono Mon	£1295
Tandy TX1000 20Mb HD colour Mon	£1395
Olivetti M240 20Mb HD Mono 3.5" or 5.25" FD	£1475.00
Olivetti M280 20Mb HD Mono 5.25" floppy drive	£2199.00
Olivetti M380 40Mb HD Mono Mono 5.25" floppy drive	£2999.00
Olivetti Desktop Publishing system	£c.all

#### EPSON COMPUTERS

PC 20Mb HD Mono AT Keyboard DOS 3.2	£849.00
PCAX2 20Mb HD Mono Mon AT Keyboard DOS 3.2	£1199.00
PCAX 40Mb HD Mono Mon AT Keyboard DOS 3.2	£1599.00
PCAX 80Mb HD Mono Mon AT Keyboard DOS 3.2	£2499.00
Epson Portable Computers	£c.all

#### SAMSUNG COMPUTER RANGE IBM COMPATIBLE

XTS300 SDD 360K FD Keyboard DOS 3.1 Mono Mon	£599.00
XTS300 DD 360K FD Keyboard DOS 3.1 Mono Mon	£649.00
XTS300 20Mb HD 1.2Mb FD Keyboard DOS 3.1 Mono Mon	£899.00
ATX500 20Mb HD 1.2Mb FD Keyboard DOS 3.1 Mono Mon	£1498.00

#### HP Vectra Computer Range

Cambridge Computers Range **£c.all**

#### AST Computer Range

Cambridge Computers Range **£c.all**

#### TOSHIBA PORTABLE COMPUTERS

T1000	£799.00
T1100	£999.00
T1200	£1199.00
T3100/20	£2375.00
T3200	£2799.00
T5100	£3299.00

#### PRINTERS

Epson LQ500	£275.00
Epson LQ800	£355.00
Epson LQ850	£449.00
Epson LQ1050	£599.00
Amstrad DMP P3000 inc cable	£165.00
Amstrad DMP P4000 inc cable	£275.00
Amstrad LQ3500 inc cable	£275.00
Amstrad LQ5000 inc cable	£299.00
Amstrad New DMP 3250d inc cable	£165.00
Star Printers	£c.all
Apricot Printers	£c.all
Micro P Printers	£c.all
Toshiba Printers	£c.all

Brother Printers	£c.all
Juki Printers	£c.all
Citizen Printers	£c.all
Panasonic Printers	£c.all
NEC Printers	£c.all

#### LASER PRINTERS

Hewlett Packard Series II serial/parallel port	£1525.00
Canon LBP 8 MkII serial/parallel port	£1499.00
Canon LBP 8 MkII T dual bin	£2199.00
Canon LBP 8 MkII R dual bin & full duplex	£2499.00
Epson GD3000	£1199
Kyocera F2200	£3500
Brother HL8	£1599
Citizen	£1249
Olivetti	£1799
Star	£1599
Quime 3Mb Postscript HP emulation	£3999
New Toshiba Page Laser 12	£2099

#### SOFTWARE

Wordcraft	£299
Superwriter	£150
Easywriter	£90
Volkswriter	£199
Wordstar	£199
PC Write	£300
Lotus 123	£275
Smart Spreadsheet	£250
PC Planner	£390
Cardbox Plus	£105
Datatrix	£449
DBase III Plus	£425
All Gem software	£c.all
All Sage software	£c.all
Ability Plus	£125
Framework II	£375
Logistix	£85
XChange	£275
Open Access II	£399
Call for more software prices	

#### DESKTOP PUBLISHING SOFTWARE

Fleet Street Editor	£85.00
Gem Desktop Publisher	£199
Harvard Professional Publisher	£399.00
sCLaser Plus	£245.00
Wordcraft Elite	£375.00
Wordcraft Elite and Formaster	£649
Ventura v1.1	£475.00
Aldus Pagemaker v1.0	£475.00

#### COMMUNICATION EQUIPMENT PORTABLE PHONES & FAX MACHINES

Hayes	£c.all
Parco	£c.all
Thorn EM1	£c.all
Steebek Dowdy	£c.all
Canon Fax 110 inc Phone	£1199.00
Sanyo Sinifax 100	£1299.00
Motorola Phone equip	£c.all
Panasonic phone equip	£c.all

# SUPER LABELLER

## Fast . . . Flexible . . . Efficient . . .

### THE PROFESSIONAL LABELLING SYSTEM

#### PRINTING

- UNRIVALLED printing facilities are provided offering TOTAL FLEXIBILITY. These include:
- PRINT A SINGLE LABEL ANY NUMBER OF TIMES
- PRINT GROUPS OF LABELS USING "WILDCARDS" ANY NUMBER OF TIMES
- PRINT GROUPS OF LABELS SPECIFYING THE NUMBER TO PRINT FOR EACH LABEL
- PRINT ACCORDING TO SEARCH CRITERIA ANY NUMBER OF TIMES
- PRINT ANY LINES OF THE LABELS IN ANY ORDER
- IGNORE ANY LINES OF THE LABEL
- PRINT ONTO ANY SIZE LABEL
- ANY NUMBER ACROSS THE WEB
- ANY MARGIN SPACE AND GAP SETTINGS
- ANY TYPESTYLE YOUR PRINTER IS CAPABLE OF (INCLUDING COLOUR)
- PAUSE PRINTING BETWEEN EACH LABEL
- DIFFERENT TYPESTYLES AND BARCODES MAY BE MIXED ON THE SAME LINE WITHOUT EFFECTING ACROSS THE WEB PRINTING
- PRINTOUTS CAN BE AS LABELS, A COLUMNISED LIST OR COMPRESSED (SCRUNCHED) FORMAT USING ANY LINES OF THE LABEL IN ANY ORDER.
- OUTPUT CAN BE SENT TO A FILE, ANY PRINTER OR SCREEN.

A UNIQUE feature to SUPER LABELLER is the REQUEST command. This allows text to be merged into a label or text file "LIVE" from the keyboard while printing.

#### BAR CODES

BAR CODES are offered as an option and once again offers TOTAL FLEXIBILITY.

BAR CODE formats can be defined EASILY in a FEW MINUTES and stored on disc for use at any time. An UNLIMITED number of different BAR CODE standards can be created or indeed your own system can be designed.

BAR CODES are printed using the graphic capabilities of your printer and may be positioned anywhere on the label freely mixed in with normal text, WITHOUT effecting across the web printing.

The BAR CODE RATIO is user definable, to give a magnification effect.



12/08/87

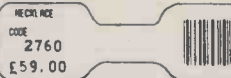
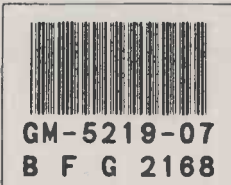
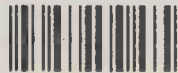

#### MAIL MERGE

As well as addressing your envelopes, SUPER LABELLER incorporates a comprehensive MAIL MERGE facility which will accept ANY standard text file. You can merge in:

ANY LINES OF A LABEL, ANY NUMBER OF TIMES IN ANY ORDER.

DAYS, DATES AND TIMES.

PRE-SET MESSAGES (16).

SERIAL NUMBERS (2).

PRINTER CONTROL CODES (UNLIMITED).

BAR CODES (UNLIMITED).

In fact ALL the advanced features available for use on a label are also available to use with MAIL MERGE.

ANY number of copies of the text file can be specified and output can be sent to the SCREEN, PRINTER or FILE.

Labels for merging can be selected by "WILDCARDS", INDIVIDUALLY or by GROUP allowing for UNLIMITED CATEGORISATION.

Furthermore the advanced SEARCHING FACILITIES allow selected data to be found and merged according to virtually UNLIMITED criteria.



#### SERIAL NUMBERING

SERIAL NUMBERING is an important feature of SUPER LABELLER and this facility is TOTALLY CONFIGURABLE.

There are TWO INDEPENDENT SERIAL NUMBERS associated with each label file and each can individually be set to have its own characteristics.

- START AT ANY NUMBER
- ANY NUMBER BASE
- ANY INCREMENT (+ or -)
- ANY NUMBER OF LABELS WITH THE SAME NUMBER
- FORMATTED TO ANY NUMBER OF DIGITS BETWEEN 2 AND 12
- LAST NUMBERS SAVED WITH FILE

0012345

ABC00001

00ABC11

#### FILES

Each group of labels are stored together in a common file and there may be as many files as will fit on your disc.

ANY file can hold up to TEN THOUSAND labels, all held automatically in SORTED ORDER by name.

Typically, even with TEN THOUSAND labels in a file, SEARCHING and SORTING takes no more than a FEW SECONDS.

A new file can be set up in SECONDS and requires NO COMPLEX CONFIGURATION. Indeed you only need to specify the maximum characters required per label and the name you wish to call your file.

FILE IMPORT  
SUPER LABELLER has comprehensive file import capabilities allowing for the import of data for files held as:

- ★ STANDARD ASCII
- ★ COMMA DELIMITED
- ★ COMMA QUOTE DELIMITED
- ★ BLANK LINE DELIMITED

Labels can be named and categorised MANUALLY or AUTOMATICALLY.

#### SEARCHING

SUPER LABELLER incorporates an ADVANCED ENGLISH TEXT SEARCH feature allowing for multiple AND OR and NOT (AVOID) operations. Below is an ACTUAL EXAMPLE of this facility to demonstrate the power.

IGNORE CASE

PLEASE FIND HOUSE ON LINES 1, 2

OR FIND BUNGALOW ON LINE 1

BUT AVOID FLAT ON ALL LINES

AND FIND LONDON ON LINES 1, 6, 8

BUT AVOID CHELSEA AND AVOID ISLINGTON

This can be used both for SELECTIVE PRINTING of labels and MAILMERGE. Furthermore this can be combined with the "WILDCARD" feature to allow UNLIMITED CATEGORISING.

#### LABEL EDITING

A BARRAGE of editing facilities are available to SUPER LABELLER to ease data entry and modification. It includes features that would compare favourably with many word processors as well as DEDICATED FUNCTIONS designed specifically for use with labels. The list includes:

VISIT A LABEL - Allows you, while editing, to quickly visit another label (for example to view the contents or to cut and paste) and then return to the original.

COPY CURSOR - AN EXTREMELY USEFUL aid to editing which allows a secondary cursor to move freely anywhere on the screen and "pick-up" characters as though they had been typed. This keeps TYPING TO A MINIMUM by avoiding the need to retype duplicated words or sentences.

It is also used to pick up graphic characters to be used for drawing.

FIND AND REPLACE TEXT - This can be performed by scanning both FORWARD and BACKWARD through the labels.

CHANGE SIZE OF LABEL - The size of the label can be changed at ANY TIME from within the editor at a key stroke.

EXPANSION KEYS - The ten function keys can be set so a single keypress "EXPANDS" into a WORD or SENTENCE again to minimise typing.

QUICK SHOT - Allows the current label being edited to be printed to see instant results.

#### EMBEDDED COMMANDS

SUPER LABELLER offers many special features by allowing COMMANDS to be embedded within a label or text file. This offers print time facilities of UNRIVALLED FLEXIBILITY. For instance:

- TWO INDIVIDUAL SERIAL NUMBERS
- DATE AND DAY STAMPING
- TIME STAMPING
- REQUEST TEXT FROM KEYBOARD DURING PRINTING
- BAR CODES
- MERGE PRE-DEFINED TEXT
- PRINTER CONTROL CODES

COMPLETE control over the printer is allowed by USER DEFINABLE PRINT CODES. Furthermore, the COMMANDS for each printer function can have any name you choose. This allows customisation of any special facilities your printer provides. If your printer supports colour you could create COMMANDS such as RED, GREEN, BLUE and so on.

#### IMPORTANT

SUPER LABELLER is the culmination of TWO AND A HALF YEARS of producing FAST, EASY TO USE, SPECIALIST LABELLING SOFTWARE.

First time users are guided through the program with PULL DOWN MENUS and EXTENSIVE HELP.

Experienced operators have the UNPRECEDENTED opportunity to leave the menu system and PROGRAM DIRECTLY using the powerful MASS-FORTH operating system, allowing new commands to be created at will.

#### DRAWING UTILITY

All printable characters are available for use on a label and selection of the required graphics character comes from an EASY TO USE PULL DOWN GRAPHICS CHARACTER WINDOW.

The cursor keys are used to "DRAW" your designs. This feature can also be used to obtain FOREIGN CHARACTERS that are not normally available from the keyboard.



FREEPOST (PCW APR)  
53 DEREHAM ROAD  
NORWICH  
NR2 4BR  
TEL: (0603) 630768

NO STAMP REQUIRED

SUPER LABELLER  
**£39.99**  
+6.00 VAT

SUPER LABELLER  
INCLUDING BAR  
CODE UTILITY  
**£79.99**  
+12.00 VAT

24 HOUR ORDERING SERVICE  
DISTRIBUTOR  
ENQUIRIES  
WELCOME



CORPORATE DEALS  
AVAILABLE INCLUDING:  
INSTALLATION  
(PLUS SOFTWARE  
CUSTOMISATION IF  
REQUIRED) PRODUCT  
SUPPORT AND TUITION

PRICES FROM  
**£295.00**

AVAILABLE FOR  
ALL PC's AND COMPATIBLES  
USING DOS-3 OR ABOVE



# DRILLER

THE NEW EXPERIENCE IN 3 DIMENSIONS  
IT'S JUST LIKE BEING THERE!

# SOLID 3D

## USING THE FREESCAPE™ GRAPHICS SYSTEM

Full control to the user! Freedom of movement within many solid and interactive 3 dimensional environments. Notice the scenery flash by in true first person perspective as you escape into the new dimension!

### CONTROL FEATURES

In addition to full movement control, extra features include: look up/down, tilt left/right, angle/stepsize adjust, actual height adjust, U turn, information screen access, drilling controls plus load/save game position options.

### GAME DESIGN

A truly original and engrossing experience combining the best elements of arcade, adventure and strategy games. Driller has already been awarded the CCI Oskar for most original game of the year.



OSKAR

### THE PACKAGE



Colour A5 box containing the Driller disc, 32 page booklet including novella and 3D mapping model. Price £19.95 inclusive.

Requires DOS 2.0 or later, CGA or EGA.

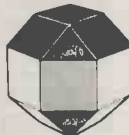

AVAILABLE FROM ALL LEADING STOCKISTS OF PC SOFTWARE OR BY MAIL ORDER DIRECT.

### Priority Order Form

Please rush me by 1st Class Post  
DRILLER FOR THE PC (includes Demo) £19.95   
DRILLER DEMO (Public Domain) £1.00   
I enclose cheque/PO for £ \_\_\_\_\_ or please debit my card

No.  ACCESS  VISA

My name and address is \_\_\_\_\_

**incentive** 2 Minerva House, Calleva Park, Aldermaston, LTD Berkshire RG7 4QW. Telephone: (07356) 77288.



### ASUKA MOUSE

A-400 MOUSE SYSTEM  
MOUSE COMPATIBLE

£35

A-800 MICROSOFT & MOUSE  
SYSTEM MOUSE COMPATIBLE

£45



£195

### DB Series-Universal 256k Printer Buffer

- ★ Memory expandable from 256k to 1Mb
- ★ I/O ports: two to two
- ★ Interface capability parallel to parallel serial to serial, parallel to serial and serial to parallel
- ★ Channel select: software code, auto scanning and manual.



### MX-2000 Programmable Multi-Port Server

- ★ Memory expandable from 256k to 2Mb by memory cards
- ★ I/O ports expandable from 5 to 10 ports by independent
  - 1 Centronics O/P x 1, I/O x 1, I/P x 3
  - 2 RS232c x 5
  - 3 Centronics O/P x 1, I/P x 1, RS232c x 3
- ★ Serial, parallel or mixed I/O ports configuration
- ★ Pairs of ports can communicate simultaneously
- ★ By software commands or sending a code from the keyboard, individual equipment may be selected either as a DCE or DTE. The selection may also be done automatically

From £338



Only £24

### Centronic Cable Booster

- ★ Extend any centronic cable by twice its length by simply connecting booster mid-way between two cables

## 4 WAY AUTO PRINTER SHARER NOW ONLY

£89

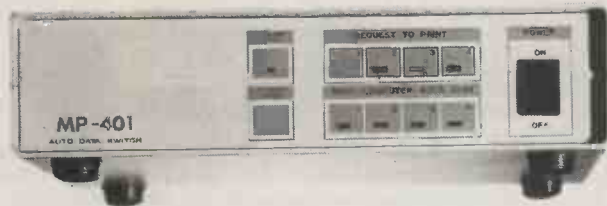

SPEC: MP401 4 way Auto-switch with 25 way D type parallel I/O suitable for IBM and Compatible machines.

### Other products available now with new low prices:

<b>Mechanical</b>			
2 way 25D type	£33	2 way Centronics	£39
3 way 25D type	£39	3 way Centronics	£55
4 way 25D type	£48	4 way Centronics	£65
2 way X over 25D	£49	2 way X over 36C	£69
<b>Auto-switch Parallel</b>		<b>Buffers</b>	
MP401 4 way	£89	PB64 64k Ram	£99
MP801 8 way	£132	PB256 256k Ram	£175
<b>Auto-switch Serial</b>		<b>Line Convertors</b>	
MS401 4 way	£99	Parallel to Serial	£69
MS801 8 way	£149	Serial to Parallel	£69

CABLES (Cables can be made to your requirements)

2M 25 way back to back £9.65 2M IBM Centronic Printer lead £12.86

To order, please send cheques but add £5 P&P plus VAT

Dealer and export enquiries welcome

**BRIGDEN TECHNOLOGY**

0322 331984

UNIT 24 ERITH BUSINESS CENTRE, ERITH HIGH ST  
ERITH, KENT DA8 1QY

# Evesham Micros

All prices include VAT and Delivery

## PRINTERS

All prices include VAT/delivery & cable

We use and recommend Star printers since we find that they do offer an unbeatable combination of features, print quality, reliability and value. Don't make the wrong decision, get it right with a Star printer at our special, all in, prices.

# star LC-10

The **NEW** No.1



- Four NLQ fonts, yes **FOUR**
- Paper Parking (use single sheets without removing tractor paper)
- IBM/parallel interface
- 4K buffer
- Comprehensive 'front panel'
- 96 NLQ print combinations
- 144/36cps print speed
- 7 colour version also available

**Only £199.00**

Colour version also available,  
**Only £234.00**  
Prices include 2 extra black ribbons free of charge.

Many similarities with the highly popular NL-10 that it replaces plus some new features not seen in this price range before combine to produce the outstanding printer in this price category. **NEW** low cost 7 colour version now available!

- Star NB24-10 includes 2 extra ribbons free of charge ..... £469.00
  - Star NX-15 budget wide carriage printer ..... £319.00
  - Star ND-10 180/45cps high quality 10" ..... £299.00
  - Star ND-15 wide carriage version of ND-10 ..... £419.00
  - Star NR-10 240/60cps professional 10" ..... £379.00
  - Star NR-15 wide carriage version of NR-10 ..... £499.00
  - Star NB24-15 wide version of NB24-10 ..... £599.00
  - Star Laser, very high spec. for cost, send for details/samples (price inc. 1 yr on site maint) ..... £1795.00
  - NEC P2200 new budget 24 pin, great value 168/56cps plus many features ..... £349.00
- Cut Sheet Feeders available for above dot-matrix printers at low, low prices - phone for details.**

## Western Digital Hardcards

Upgrading your PC to hard disk? Look no further, we offer the best prices on top quality hardcards, with free Xtree file management software and Speedread. Simple to fit - thorough documentation - low power consumption - you name it! Upgrading a 1512 or 1640? As a bonus we test and configure to your requirements (please state 1512 or 1640 when ordering).

**21 MEG...£239.00      32 MEG...£279.00**

## Central Point Software

For the best in PC utility software

- PC Tools Deluxe**.....Other utilities may claim to 'do it all' but only PC Tools Deluxe is the ideal disk utility package, providing a fast hard disk backup, the best undelete available, 100% safe formatting of floppy and hard disks, uniform, reliable disk caching, compress facility, just everything needed to manage & protect your data at a sensible price.....£59.95
- Copy II PC**.....The most effective floppy disk backup utility of it's type. We always ship the latest version. Can transfer many programs to hard disk and then run them without reference to floppy. Verifies all copies automatically - even includes a disk speed check! Supplied on 5.25" and 3.5" disk format. Can you afford to be without it?.....£29.95
- Copy II Option Board**.....The ultimate solution to backing up copy-protected software using the hardware option. The most powerful backup product on the market - copies the most highly protected software, even many non-IBM formats! Comes as easy-to-fit short card, occupying one expansion slot. The results you want, guaranteed.....£74.95

## 3.5" disks

10...£11.95 in plastic case £13.95  
25...£27.95 in 40 cap case £34.95  
Fully guaranteed double sided media

## 5.25" disks

25...£13.95 in 50 cap box £22.95  
in 100 cap box £24.95  
Fully guaranteed double sided media

## Amstrad PC1512/1640

flexible, yet affordably superior

We offer a wide choice of Amstrad PCs with many upgrade options - choose the one to suit you needs. For the hard disk option, check out our Evesham upgraded models. Only the best will do - so we normally upgrade by means of a Western Digital Filecard, which includes Xtree and speedread software; however on single drive models we can offer internal installations at the same price (leaving more expansion room but no opportunity for a 2nd floppy drive). Prices in lighter type are excluding VAT.

Free with 1512 models... Ability and 4 US Gold Games

	SD	DD	AMS 20MEG	SD 21MEG	DD 21MEG	SD 32MEG	DD 32MEG
MONO 1512	386.96 445.00	512.17 589.00	N/A N/A	591.31 680.00	716.52 824.00	626.09 720.00	751.30 864.00
COLOUR 1512	520.87 599.00	630.43 725.00	N/A N/A	725.22 834.00	834.78 960.00	760.00 874.00	869.56 1000.00
MONO 1640	486.09 559.00	599.13 689.00	842.61 969.00	690.44 794.00	803.48 924.00	725.22 834.00	838.26 964.00
CGA (COLOUR) 1640	625.22 719.00	734.78 845.00	955.65 1099.00	829.57 954.00	939.13 1080.00	864.35 994.00	973.91 1120.00
ECD (EGA) 1640	773.04 889.00	886.09 1019.00	1112.17 1279.00	977.39 1124.00	1090.44 1254.00	1012.17 1164.00	1125.22 1294.00

## optional extras

- 40MEG versions - extra to SD 32MEG prices ..... £100.00
- 640K memory upgrade on 1512 models ..... £ PHONE
- 3.5 inch drive (720K) fitted to any SD models  
- an absolute *must* for portable users ..... £110.00
- Ability and 4 US Gold games with 1640 ..... £30.00

We can also install any other items offered in this advert eg. Option Board, Maths Co-Processor, NEC v30 etc.

## Amstrad PPCs

The new price standard for portable PCs  
(prices in brackets are excluding VAT)

- Amstrad PPC512S (£390.43) ..... £449.00
- Amstrad PPC512D (£520.87) ..... £599.00
- Amstrad PPC640S (£494.78) ..... £569.00
- Amstrad PPC640D (£625.22) ..... £719.00

## PC UPGRADES

- Maths Co-Processor 8087-2 speeds calculations by up to 5 times, ideal for spreadsheets. Fits alongside 8086 ..... £149.00
- NEC V30 Directly replaces 8086, improves speed ..... £24.95
- 640K Memory upgrade for PC1512 Kit consists of 18 x 4164-15 RAM chips and detailed fitting instructions ..... £PHONE
- 3.5" Internal Disk Drive a top quality drive with all fittings and instructions for 1512/1640 SD models. 720K formatted capacity, ideal for users with portable PCs ..... £115.00
- Amstrad 5.25" Internal Disk Drive 360K formatted capacity internally fitted drive, complete kit for only ..... £115.00
- Amstrad Card Modem V21/23 compatible, inserts into an expansion socket. Includes membership to Microlink ..... £119.00
- Amstrad MC2400 Card Modem V21, V22, V22 bis, V23 compatible good value modem. Supports auto-answer and auto-dial, includes powerful Mirror II software ..... £199.00
- 21 MEG Internal hard disk complete installation kit ..... £239.00
- 32 MEG Internal hard disk complete installation kit ..... £279.00
- Cipher CT1525 tape streamer 25 Meg capacity per DC600 data cartridge (£27.50 each) backup up to 1 Meg per minute, and directory selectable ..... £299.00
- Verbatim 3.3 MEG floppy disk drive Quality Kodak fast access 5.25" external drive units, with downward-read compatibility. 2.78 Meg capacity per high density floppy disk. High speed hard disk backup utility 'Back-It' included ..... £349.00
- Verbatim 6.6 MEG floppy disk drive higher storage capacity version of above high density external drive ..... £449.00
- Brooklyn Bridge for fast, easy accurate file transfer between PCs using the serial port. Uses existing DOS commands, incredibly useful for desktop - laptop users ..... £119.00
- Knowledge Network enormously popular abroad, available now for low-cost networking, incorporating the same powerful features found in networks costing much, much more ..... £199.00

## How to order

- All prices VAT/delivery inclusive
- Next day delivery £5.00 extra
- Send cheque, P.O. or ACCESS/VISA details
- Phone with ACCESS/VISA details
- Govt., educ. & PLC official orders welcome
- All goods subject to availability E.&O.E.
- Open to callers 6 days, 9.30-5.30
- Telex: 333294 Fax: 0386 765354

## Evesham Micros

63 Bridge Street  
Evesham  
Worcs WR11 4SF  
Tel: 0386 765500

Also at: 1762 Pershore Rd., Cotteridge, Birmingham, B30 3BH Tel: 021 458 4564



**ADMICRA**An  Company  
AUTHORISED DEALER **AUTOCAD** **MISSION TECHNOLOGIES** **Tandon** **Opus** **AMSTRAD** **FACTS** **Roland** **TAXAN****AUTOCAD SYSTEMS****LEVEL 1 SYSTEM****£1799**Opus PCIII 30Mb HD Mono, 10MHz  
1Mb Ram 8087 co-processor, mouse  
Basic Autocad, Hitachi-672 x Dplotter**LEVEL 2 SYSTEM****£4449**Opus PCV, 286, 30Mb HD, EGA  
10MHz, 1Mb Ram 80287 co-processor.  
Optical Mouse, Autocad ADE3, Roland  
885 plotter**LEVEL 3 SYSTEM****£9399**Mission 386 (2Mb Ram) VGA +  
Taxan Multiscan (800 x 600) 80387,  
Summagraphics digitiser, Autocad  
ADE3, HP7570 A1 plotter**DESKTOP PUBLISHING SYSTEMS****LEVEL 1 SYSTEM****£2499**Opus PCIII 30Mb HD Mono, 10MHz,  
1Mb Ram, mouse. GEM DTP, Epson  
GQ3500 laser**LEVEL 2 SYSTEM****£4399**Opus PCV, 286 30Mb HD 10MHz  
1Mb Ram, Wyse 700 (1280 x 800  
display. Optical mouse, Ventura DTP  
HP Laserjet II**LEVEL 3 SYSTEM****£7599**Mission 386 (2Mb Ram). Viking 1  
(1280 x 960 non-interlaced)  
19" monitor, optical mouse, Ventura  
DTP, PC Paintbrush, Superfast Laser  
Canon IX12 ScannerAll systems supplied fully configured and tested, with all necessary cables etc.  
The above are some examples from the wide range of available systems. Please call for details**PRINTER PROMOTIONS**

Panasonic 1081	£149
Star LC10	£189
Epson LX800	£199
Epson LQ500	£279
Epson FX800/1000	£319/£399
Epson EX800/1000	£399/£539
Epson LQ850/1050	£459/£619
NECP2200	£319
Quendata 1120	£169
Juki 6100	£259
Epson GQ3500 Laser	£1345
HP Laserjet II	£1795
Canon Ix 12	£699

**SHEETFEEDERS & ACOUSTIC HOODS**

Please call for prices and details

**PRINTER BUFFERS**

Up to 2Mb Serial/Parallel from	£79
--------------------------------	-----

**MODEMS**

Dataflex Stradcom V22 Hayes	£149
Miracle WS4000	£135

**CONTINUOUS STATIONERY**

11" x 9 1/2" 60gm (2000 sheets)	£9.95
12" x 9 1/4" 60gm (2000 sheets)	£12.99
A4 70gm (2000 sheets)*	£14.95
A4 85gm (1000 sheets)*	£9.30
11" x 14 1/2" (2000 sheets)*	£13.50
(As above part recycled*)	
Multipart	please call
Delivery £2.85 (fixed) + £1 per box. Extra £1 per order for items marked*	

**CONTINUOUS LABELS**

70mm x 36mm	£2 (fixed) + £2.75/1000
89mm x 36mm	£2 (fixed) + £2.95/1000
Delivery £1.95 (fixed)	

**PRINTER STAND** **£11.95****UPGRADES**

20/30 Mb hard disk & controller	£219/£239
30Mb Hardcard	£249
Dataflex AT Rambank (2Mb)	£POA
80386 Motherboard for XT	£999
8087/80287 co-processors	£99/£139

**PLOTTERS-DIGITISERS-MICE**

Logimouse Plus	£69
Mouse Systems PC Mouse	£99
Microsoft Mouse	£129
Summa Bit pad +	£319
Summasketch 12" x 12" Digitiser	£395
Cherry A3 Digitiser	£449
Hitachi 672XD A3 plotter	£459
Roland 880 A3 (free buffer) Plotter	£649
Roland 885 A3 Plotter	£749
Roland DPX2200 incl stand	£2795
HP7570 A1 Plotter	£3395

**RIBBONS**

Epson FX80/800	£2.49
Epson LX80/86	£2.95
Epson FX 100/1000	£3.75
Juki 6100 SS	£1.15
Diablo HT II	£2.29
Shinwa/M Tally MT80	£3.79
Canon/Kaga	£3.99
Qume MS4	£2.65
Imagewriter 1	£3.35

**LASERTONER CARTRIDGES**

Epson GQ3500	£16.95
Canon/HP Series I	£69.95
Canon/HP Series II	£79.95

**PRINTWHEELS from £4.49**Delivery 95p any quantity ribbons,  
printwheels or toner cartridges.**LOCKABLE DISK BOXES**

40 3 1/2" disks	£6.95
70 5 1/4" disks	£8.95

**ACCOUNTS SYSTEMS**Budget SAGE AND COMPSOFT systems.  
Powerful single and multi-user  
MICROFACTS and UNIFACTS systems.  
Please call for details.**SOFTWARE SPECIALS**

Supercalc 4	£212
VP Planner	£59
VP Info	£59
Wordstar Prof 4	£209
Wordstar 2000 release 3	£239
Generic Cadd incl mouse	£159
Turbo Pascal 4	£49
Autosketch	£59

**APRICOT ADDONS**

512k Memory Board	£119
20Mb Hard Disk	£695
Hi Res Mono monitor for portable	£109

**DISKS-POST FREE**Prices for one box of 10. All extra boxes  
10% EXTRA DISCOUNT.

5 1/4	DYSAN	SONY
SS/DD	£10.90	£9.90
DS/DD	£13.90	£12.90
DS/QD	£16.90	£15.90
HD 1.6Mb	£17.90	£17.90

**ADMICRA SPECIAL**Top quality branded DS/DD £9.90  
Sony 3.5" SS £14.90 DS £16.90  
Amsoft 3" CF2 £24.90

Official Government/Educational Authority orders welcomed.

Please add 15% VAT to all prices (inc. carriage) Limited space precludes listing of our full range of products.  
Please telephone if you do not see the item you require**ADVANCED MICROCOMPUTER APPLICATIONS LTD**  
KING STREET, BEESTON, NOTTINGHAM NG9 2DL Tel: 0602 252627**ADMICRA**An  Company

# TOP NAME PRODUCTS AT DOWN TO EARTH PRICES

# SCS

## OLIVETTI M15 PORTABLE Fully IBM Compatible only £549

- ★ Weighs only 12 lbs
- ★ Intel 80C88 processor
- ★ Detachable 78 key keyboard
- ★ Smart carrying case
- ★ Large clear LCD screen 80 x 25
- ★ Battery and mains operation
- ★ 512KB of memory
- ★ Twin 720KB 3.5in disk drives
- ★ Serial and Parallel Interfaces
- ★ Optional external 5 1/2in disk drive
- ★ DOS 3.2 included
- ★ Battery backed clock/calender



Item	Price ex VAT
Olivetti M15 Portable	£549.00
Olivetti 5.25in external diskette drive	£219.00
Mydisk 3.5in Diskettes (box of 13)	£16.99

## GENIUS MOUSE

Complete with loads of  
Free software and accessories

£59

- ★ Microsoft and PC Mouse Compatible
- ★ Three buttons for maximum flexibility
- ★ Connects to a Serial interface
- ★ Free Mouse cutting board and mouse pad for small or uneven surfaces
- ★ Free *Dr Halo III* software – the professional graphics software that is fast becoming the most popular package of all time
- ★ Free Genius menu maker – create your own pop-up menus to work with almost any application – DBase, 123, CAD packages, etc.
- ★ Free Mouse pocket – a stick-on 'house for your mouse' that stores your mouse in a handy pocket on the side of your monitor or PC.

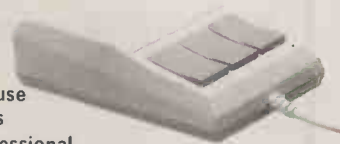

Item	Price
Genius Mouse with free software and accessories	£59.00
AT adaptor to connect Genius Mouse to an AT type PC	£8.75

## AMAZING VALUE COPAL PRINTERS 132 column 9 pin dot matrix printers

Only  
£199

Just look at the spec.

- ★ Parallel Interface
- ★ Extended Warranty Available
- ★ High speed draft printing 180cps
- ★ NLQ printing at 35cps
- ★ Built in tractor feed
- ★ Epson or IBM Graphics compatibility
- ★ Exceptional value with 12 months warranty.



If you are fed up with paying over the odds just to get a well known printer, then consider the COPAL printers. Copal Electronics of Japan make printers for the big names in the printer world. When you buy a COPAL printer from SCS you are paying only for a high quality printer and not the label. The only decision to make is whether you need a narrow (80 column) or wide (136 column) model.

Item	Price	Price for 4+
Copal SC5500 132 column printer (Epson)	£204.00	£184.00
Copal SC5500 132 column printer (IBM)	£199.00	£179.00
IBM style printer cable	£9.90	
Ribbon for SC5500 (pack of 4)	6.50 each ribbon	

## TRIUMPH-ADLER 2000 DAISYWHEEL PRINTER £179

If you need full letter quality either at home or in the office, the Triumph-Adler 2000 is the best buy in the market. For only £179.00 just look what you get.

- ★ Fast 20 cps printing speed
- ★ Takes up to 13" wide paper
- ★ Cut Sheet Feeder holds up to 200 sheets of paper, for only £79 extra
- ★ Parallel interface
- ★ Emulates the popular Diablo 630
- ★ Proportional spacing for a professional type-set finish
- ★ Full range of ribbons and daisywheels available from us

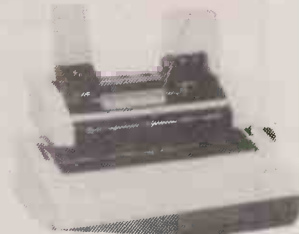

You will not find a full featured printer like this from any other well-known manufacturer at anywhere near this price.

Item	Price ex VAT
Triumph-Adler 2000 Daisywheel printer	£179.00
Cut Sheet Feeder	£790
IBM style printer cable	£9.90

## Printers & Peripherals

### EPSON PRINTERS

LQ500 80 col 24 pin, 150 cps draft 50 cps NLQ	£295.00
FX105 132 col 160 cps draft, 36 cps NLQ	£279.00
FX800 80 col, 240 cps draft, 40 cps NLQ, High Res Graphics	£299.00
FX1000 132 col, version of FX800, front panel control	£379.00

LQ800 24 pin, 80 col, 180 cps, 25 cps NLQ	£299.00
LQ1000 24 pin, 132 col, Printer 180 cps	£379.00

Tractor feeds and cut sheet feeders for above also available

### MONITORS

Monochrome amber screen, TTL	£82.00
Monochrome amber screen, TTL with tilt and swivel	£93.00
Monochrome green screen, TTL with tilt and swivel	£85.00
Thompson Colour Display (Medium Res)	£219.00
Microvitec 1322 EGA Colour Monitor	£345.00

### LOW COST 3 1/2" SOFTWARE

Able One. A neat integrated W/P, Database, Spreadsheet etc.	£45.00
Portex. A computerised Filofax, c/w software & organiser	£45.00
Sage Deskset. All the executive desk utilities you need	£45.00
Sage Book Keeper. A nifty accounting package	£45.00

Ordering Information: Quantities of all items are limited and prices subject to change without notice. We accept VISA, ACCESS and personal and company cheques (subject to clearance). All returns must have prior authorisation from our customer service department. All returns must be in like-new condition, complete and in original packaging. Incomplete goods or goods without prior authorisation will not be accepted for return. Defective products under warranty will be repaired and replaced free of charge at SCS's discretion. Carriage and insurance for goods sent to us is payable by the purchaser. SCS will pay the return carriage and insurance.

All prices are exclusive of VAT and freight, handling and insurance.

All goods carry a money back guarantee. If we are notified within 7 days of receipt that you wish to return them.

Extended warranties are available at modest cost on most items, and are subject to our terms and conditions which are available on request.

To order phone  
24 hour sales line

07357 5455

Volume Purchasers  
Phone

07357-5458



# SCS

Surplus Computer Sales Ltd.  
20a Horseshoe Park  
Pangbourne, Berks RG8 7JW  
Fax: 07357-3527

Educational and Government  
POs Welcome



# SCS ▶ Epson PC's - Choose from our Range Bargain Price or Premium Performance

IBM COMPATIBLE



Very Small Footprint

If you are considering CAD or Desk Top Publishing or you just need more computing power?...Then consider this

**Epson PCAX2 £1229.00**

When you really need the power of a 286 processor, this computer really delivers the goods. The only decision you have to make is which monitor do you require?

- ★ 80286 processor
- ★ Dual speed processor 8/10 MHZ switchable
- ★ 1x1.2MB Disk Drive + 20MB Hard Disk
- ★ CGA/MDA/Hercules/EGA adaptors all on board
- ★ 640KB Ram giving the maximum memory as standard
- ★ 6 Full length expansion slots
- ★ Full 103 key AT style keyboard

Item	Price
Epson AX2, 1.2MB DD, 20MB HD, MS DOS, K/B, excl monitor	£1229.00
High Res Mono Monitor	From £82.00
Colour Display (Medium Res)	£219.00
Microvitec EGA Display	£345.00
MYDISK AT High Density Diskettes (Box 13)	£14.99

**Twin 360KB drive PC High Res Mono Display £449**

**20MB plus 1 x 360 disk PC High Res Mono Display £659**

- ★ MS DOS included
- ★ 512KB Ram installed
- ★ Parallel port. Just plug your printer in
- ★ Serial port. Could be used for a mouse or a plotter!
- ★ 3 Expansion slots giving scope for future expansion
- ★ Optional colour display with FREE mouse + Taxi Software

Worth over £190 ★ Full 12 months warranty  
With every colour system we are including FREE the Epson Bus mouse (which is Microsoft compatible) AND EPSON'S Taxi Software. This icon orientated addition to DOS makes using your computer programmes so much easier.

Item	Price
Epson PC, 2x360KB D/D, K/B, Mono display, MS DOS	£449.00
Epson PC as above with colour display + FREE Mouse + Taxi s/w	£599.00
Epson PC 20MB H/D (Epson), 1x360KB, Mono display, MS DOS	£659.00
Epson PC as above with colour display + FREE Mouse + Taxi s/w	£799.00
MYDISK 5¼ DSDD 48tpi diskettes (Box 13)	£7.49
MYDISK 5¼ DSDD 48tpi diskettes (Box 27)	£13.99
Genius Mouse with Dr Halo III Graphics Package	£59.00

For that extra speed without the extra cost of a 286 computer.

The **Epson Pce** is just ready to go. Every thing you could need including the mono monitor is all standard.

- ★ 1x360KB D/D + 1x20MB H/D
- ★ 8088 Dual speed processor (4.77/10 MHZ) switchable
- ★ 640KB Ram
- ★ 5 Expansion slots
- ★ Serial & Parallel ports
- ★ 102 key AT style Keyboard
- ★ Mono display
- ★ MS DOS 3.2

Item	Price
Epson Pce, 1x360KB D/D, 1x20MB HD, Mono display, K/B, MS DOS	£899.00
MYDISK DSDD Diskettes (Box 13)	£7.49

## FACIT P6010 LASER PRINTER £1250

The Facit P6010 is a full specification Laser Printer. Unlike most rivals who offer 512KB memory the P6010 comes with a FULL 1MB as standard as are the serial & parallel interfaces. Not only is it easy to use, you have total control of fonts and printing size from the front panel. Just look at what is available.

- ★ 1MB memory. Upgradeable to 2MB. Just what is needed for DTP
- ★ Serial & Parallel interfaces as standard.
- ★ Diablo 630 and HP Laser Jet + Emulation as standard
- ★ 6 pages per minutes
- ★ Front panel control of all functions
- ★ Prints to A4, A5, Letter or Legal Paper
- ★ 4 Resident fonts



Item	Price ex VAT
Facit P6010 Laser Printer, 1MB Ram, Serial & Parallel	£1250.00
IBM style parallel printer cable	£9.90

## FACIT PLOTTERS

**4550 A4 PLOTTER £249**  
**4551 A3 PLOTTER £499**

For business reports, presentation or scientific use, you cannot beat the output of a plotter. There are no compromises on quality or performance with this plotter.

- ★ High quality A4 or A3 plotter
- ★ Emulates the popular HP7475
- ★ 6 pens per cartridge. No need to keep changing pens
- ★ Choice of Ball Point, Fibre or Ceramic Pens
- ★ Parallel and Serial Interface



With the FACIT 4550/1 plotter from SCS you are saving pounds over other plotters offering inferior performance.

Item	Price
FACIT 4550 A4 plotter (6 pens included)	£249
FACIT 4551 A3 plotter (6 pens included)	£499
Parallel Cable	£9.90
Serial Cable.....call for details	
Set of 4 Fibre Pens (for transparencies)	£19.00
Set of 4 Ceramic Pens	£24.00
Set of 4 Ball Point Pens	£17.00
50 Sheets Plotter Paper	£9.50
50 Sheets Transparency Film	£39.00

# PACKARD BELL

*HIGH LEVEL PC's FOR LOW LEVEL PRICES  
A GREAT AMERICAN TRADITION CONTINUES*

VX88



**VX88 SPECIAL PRICES**  
WITH 20MB ONLY £725  
WITH 40MB ONLY £895  
WITH 60MB ONLY £1195  
12" MONO MONITOR ADD£90  
14" MONO MONITOR ADD £120

**SPECIFICATIONS:**

VX88, small footprint, 5/8MHz, 640k RAM, 360k floppy, parallel/serial on M/board, mono + colour graphics on M/board, MS DOS 3.2, GW-Basic.

PB286, 6/10MHz, 640k RAM, 1.2Mb floppy, parallel/serial port, enhanced keyboard, MS DOS 3.2, GW-Basic.

FOR VERY COMPETITIVE PRICES ON  
15MHz PB286, 386 BASED MACHINE AND  
COMPUTER PERIPHERALS PLEASE CONTACT US.

**POWER  
SPEED  
PERFORMANCE  
RELIABILITY  
SUPERIOR VALUE**

**12 MONTHS FREE ON-SITE MAINTENANCE**



PB286

**PB286-10 SPECIAL PRICES**

WITH 20MB, 55ms ONLY £1215  
WITH 40MB, 40ms ONLY £1275  
WITH 44MB, 28ms ONLY £1595  
WITH 72MB, 28ms ONLY £1795

For other configurations and  
monitors please call.

**CALL NOW ON 01-842 0071**

**CAL-ABCO** - OVER 50 OFFICES WORLDWIDE

CAL CIRCUITS-ABCO (UK) LIMITED

MIDDX. HA4 6SE Tel: 01-842 0071 Fax: 01-841 3891 Telex 295441

SPENDALE HOUSE, THE RUNWAY, SOUTH RUISLIP,



**MACINTOSH SE/HD 20** £1950  
**MACINTOSH II** from £2600  
**IMAGE WRITER II** £375  
**IMAGE WRITER LQ** £850  
**LASER WRITER II SC** £1945.40  
**LASER WRITER II NT** £2850  
**LASER WRITER II NTX** POA  
**AST TURBO LASER (Post Script)** POA  
**RADIUS SCREENS** from £1200  
**PAGE MAKER V2.0** £344  
**IMAGE STUDIO** £344  
**QUARK EXPRESS** £555  
**A DOBE ILLUSTRATOR** £350  
**READY SET GO** £355

# Computer Line

0525 240243

**BULK ORDER DISCOUNT AVAILABLE**  
**PARTS EXCHANGE WELCOME**  
**12 MONTHS WARRANTY**

**WANTED ALL TYPES OF COMPUTERS**

Prices are excl of VAT & CARR

## ACORN ARCHIMEDES COMPUTERS



Archimedes A305 £704(£668)£734. Archimedes A310 £779(£736)£802. Archimedes A310M £838 (£790)£856. Mono monitor £57(£78)£142 Colour monitor £209(£221)£309. 0.5Mb ram expansion for A305 £95(£94)£99. Floppy disc £136(£141)£166. 20Mb hard disc + podule £507(£468)£532. Podule back plane £44(£51)£65. Archimedes A410 £1406 (£1319)£1407. Archimedes A440 £294(£2126) £2214. Software: Ainsy C, Isopascal, Fortran 77, Logisix. View Professional each at same price of £90 (£81)£86.

## ATARI COMPUTERS

All ST computers come with mouse, basic, Neo-chrome, Firstword and 5 public domain software discs. 520STFM £347(£340)£368. 1040STF + monitor £622(£611)£722. 2080STF + monitor £907 (£860)£964. 4160STF + monitor £1203(£1129) £1237. Cumana 1000K ST disc drives £131(£131) £154. Atan 500K ST disc drives £99(£99)£119. We offer good discounts on most ST software for example: PC Ditto £69(£63) £67. Hisoft DEVPAK £43(£41)£45. Hisoft Basic Compiler £66(£61)£65. Firstword Plus £66(£61)£65. Metacombo Lattice C £84(£78)£79. Computer Concepts Fast Basic Disc £39(£37)£41. LDW Basic ST compiler £50(£48)£54. Sublogic Flight Simulator 2 £43(£41)£45. Atari 130XE + recorder + joystick + software £126(£133) £177. Atan 2600 VCS Video-game £49(£56)£78.

## AMSTRAD PRODUCTS

Amstrad PC1640 computers.— ECD single floppy £835(£804)£928. ECD dual floppy £979(£936) £1067. ECD 20Mb HD £1293(£1222)£1362. MD single £594(£538)£662. MD dual £680(£671)£806. MD HD £991(£958)£1098. Amstrad PC1512 Computers with Migent Ability.— mono single £435(£450) £574. mono dual £596(£598)£735. colour single £740. colour dual £739(£724)£858. Miniscribe 30Mb hard card for PC1640 and PC1512 £292(£286)£322. DMP3160 printer £195(£196)£238. PCW9512 computer £474(£473)£597. PCW8512 £446(£459)£583. PCW8256 £332(£358)£482. New Amstrad portable computers: PPC512S £437(£418)£471. PPC2512

£585(£552)£610. PPC640S £526(£496)£549. PPC640D £671(£628)£685. Amstrad £128— colour £380(£381) £461. green £286(£307)£387. Amstrad DMP2160 printer £154(£155)£191. Extra disc drive for Amstrad £128 £99(£105)£136. Amstrad joystick £11(£12) £16.

## CAMBRIDGE COMPUTERS AND SINCLAIR PRODUCTS

Cambridge computers Z88 £269(£255)£268. Mains adaptor £10(£15)£25. 128k ram cartridge £48 (£48)£53. 32k ram cartridge £20(£21)£26. Parallel printer cable £30(£32)£42. Z88 PC Link £25(£25) £30. Phone for prices on all other Z88 accessories. Spectrum 128k Plus Two computer, with joystick and software pack £139(£140)£172. Spectrum Plus 3 + joystick + 6 games £199(£203)£233. Blank micro-drive cartridges for the QL and the Spectrum £2.50 (£3)£4.

## COMMODORE COMPUTERS

Amiga A500 Computer £423(£403)£453. Modulator £25(£25)£30. Amiga A500 + colour monitor £619 (£612)£722. Ram expansion £103(£96)£101. Commodore 128 computer + cassette recorder £217 (£217)£267. Commodore 64C computer + cassette £138(£141)£176. Commodore 64C + cassette joystick + games £147(£151)£187. Commodore 64C computer with mouse, cassette recorder and software £179(£178)£214. Converter to allow the use of most ordinary mono cassette recorders with the Commodore 128 and Commodore 64 £9.78(£9) £11. Commodore cassette recorder £30(£30)£36. 1541C disc drive £161(£159)£186.

## PSION ORGANISER

Organiser II XP £125(£110)£115. Datapak 128k £89(£78)£79. Datapak 64k £54(£48)£49. Datapak 32k £32(£29)£30. Harvester Superchp £69(£78)£79. Mains adaptor £12(£15)£20. Comms Link £54(£48) £54. Maths Pack £28(£25)£26. Phone for prices on all other Psion accessories.

## PRINTERS

Amstrad DMP3160 £195(£196)£238. Amstrad DMP LQ3500 with Wordstar £512. £229(£219)£332. Amstrad DMP2160 £154(£155)£191. Amstrad DMP4000 with Supercalc £302(£302)£352. Epson Lx800 £265(£259)£299. Star LC10 £222(£219) £259.

CUMANA 3.5" AND 5.25" CASED DISK DRIVES WITH CABLE AND POWER SUPPLY. 40/80 track double sided to suit floppy disc interfaces of the Sinclair QL, Sinclair Spectrum and BBC B 3.5" drives.— single £134(£126)£150. dual £224(£210) £241. 5.25" drives.— single £161(£154)£185. dual £296(£277)£312.

## SWANLEY ELECTRONICS

The Computer Export Specialists.

Dept PCW, 32 Goldsel Rd., Swanley, Kent BR8 8EZ, England Tel: SWANLEY (0322) 64851. We give an additional discount of 2% to UK personal callers who pay cash. Official orders welcome. UK prices are shown first and include post and VAT. The second price in brackets is for export customers in Europe and includes insured airmail postage. The third price is for export customers outside Europe (including Australia etc) and includes insured airmail postage.

MAKE THE RIGHT DECISION CALL

0789-765295

MIDLANDS-LONDON



0373-822933

SOUTH-S. WEST

## FILECARDS

Ready to Install in your IBM AMSTRAD or PC Compatible WESTERN DIGITAL HI-Q

20Mb.....	209	20Mb.....	199
32Mb.....	239	42Mb.....	279
		64Mb.....	475

## COMPUTERS

MITAC 286 12MHz, with enhanced keyboard, 1.2Mb 5.25" fd, 1.44Mb 3.5" fd, 14" Mono-chrome Monitor, 2 serial ports, 1 parallel port 1Mb RAM in small footprint cabinet with MS-DOS and GW Basic.

20Mb 1439 44Mb 1678  
For EGA 14" Monitor add 375

MITAC 386 16MHz, with enhanced keyboard, 1.2Mb 5.25" fd, 1.44Mb 3.5" fd, 14" VGA Monitor, 2 serial ports, 1 parallel port, 2Mb RAM in small footprint cabinet with MS-DOS and GW Basic.

44Mb 2965 64Mb 3165

WE SUPPLY A WIDE RANGE INCLUDING:

Apricot — Tandon — Tatung — Packard Bell — Mitac — Zenith — Wyse	
ALSO Special offer on TANDY 286-20 1Mb RAM Mono	1245
386-40 1Mb RAM Mono	2500

## NEW PRODUCTS

SIEMENS Ink Jet Printer — ALMOST SILENT!	599
NEC P2200 24 pin dot-matrix Printer with built-in tractor-feed and unique front-feed for single sheets	320
NEC sheet feeder for P2200	67
APRICOT — IBM File Transfer kit including 3.5" disk drive and software transfer package	170

Portable SPECIALISTS — SPECIAL OFFERS INCLUDE

Zenith Z181	1370	Zenith Z183	1999
Datavue Spark	747	Datavue Snap	2147

TOSHIBA Laptops Please call!

## PRINTERS

Examples from our wide range:

Epson LX800	205	Brother 1409	335
Epson FX800	306	Brother 1509	378
Epson FX1000	391	Brother 4018	1187
Epson LQ800	435	Brother HR40	845
Epson LQ1000	575	Panasonic P1081	180
Epson LQ2500	799	Panasonic P1595	539
H-P ThinkJet	435	Star NB24/15	665

Call for other prices

## PRINTERS — DAISY

Micro-P	Speed	HR40+SSF	40	700
MP26	26	Juki		
MP40	40	6100	20	255
Brother	Speed	6200	30	390
HR70	20	6300	40	625

## PRINTERS — LASER

Canon II	1565	Brother HL8	1695
Epson GQ3500	1295	Qume Scripten	3500
Hewlett Packard	1860	Oki Laserline 6	1320
HP 7475 A34 1345 Calcomp 23120 (12x12)			450
Hitachi 672 A34 525 Calcomp 23180 (12x18)			875
Roland 880A A3 650 TDS LC12 Tablet			650

## PC SYSTEM ENHANCEMENTS

MS Mouse	127	Graphics Quad EGA + Card	210
Miniscribe 20Mb	215	QED Enhanced 14" Monitor	350
256k RAM Apricot	95	AJWAD EGA Card	135
512k RAM Apricot	119	16Mhz 386 Turbo Card	895
D/S 720k Upgrade	110	Sagnet 2 User Card	260
10Mb + Cont. Upgrade Apricot	300	Tan EGA Monitor + Card	650
Tandon 20Mb Slave	200	Inwin Tape Drive 40Mb	410

## SOFTWARE

Aldus	520	Lotus 123	250
Autocad	2400	Symphony	355
Prodesign	245	Wordstar 2000	255
Autosketch	70	Pertmaster	510
Ventura	465	Pegasus S/User	160

## TERMINALS

Wyse 30	280	Televideo 905	280
Wyse 50	350	Televideo 955	365
Wyse 60	420	Televideo 9220	425
Wyse 85	390	Kimtron KT5	315
Wyse 700	635	Kimtron KT22	385
Wyse 680	420	Amplex 220	340

## MONITORS — MULTISYNC EGA-VGA

Mitsubishi 1471A	525	Microvync Autocan	1275
Phillips 14" 8873	470	Sony CPD 1402E	615
NEC Multisync	500	Zenith ZCM 1490	585
Taxan 770+	510	Tandon 14" EGA	395

## DEDICATED TO SERVICE

SECOND USER — EX-DEMO EQUIPMENT BOUGHT/SOLD IBM — COMPAQ — APRICOT — CALL FOR DETAILS

RAGLEY DATA SYSTEMS LTD  
114 STATION ROAD

WESTBURY  
WILTSHIRE BA13 4TW

Tel: 445687 Fax: 0373 827533

Prices exclude Delivery and VAT

Telephones:  
 0373 822933  
 0789 765295  
 (After hours  
 Ansaphone)  
 All prices based CWO





Directions to the shop



"WE WON'T MILK YOU DRY"



St. Albans headquarters

### XEROX VENTURA DESK TOP PUBLISHER (VERSION 1.1)

Desk Top Publishing (DTP) is the latest industry buzzword. There are a lot of packages about, but the general consensus is that this is the best. £479.00

### 32MB HARD DISK CARD

This hard card is revolutionizing hard disk upgrades in the U.S. and U.K. Why? Because it's cheap! It is also easy to install, reasonably fast (65ms) and readily available. Takes up one and a half slots and works great in the Amstrad, IBM, Olivetti. You name it. Supplied in Mini Scribe and/or Western Digital versions. You won't find this top product selling anywhere cheaper. Hurry while stocks last! £239.00

### EPSON LQ2500 PLUS



Although very expensive, this fast (270cps, 72cps LQ) printer continues to sell in impressive numbers even in the face of strong competition in a fiercely contested market segment. Probably the best printer Epson ever made. 24 pin printing, 132 column with built-in tractor feed. £699.00

### EPSON FX800/1000

No printer propaganda would be complete without listing the FX series. It was on the back of this range and its ancestors that Epson came to dominate the market. The 800 is the descendent of the 80 and 85, prints draft at 200cps and NLQ at 40cps and is 80 columns wide. The 1000's parents were the famous 100 and 105. It goes at the same speed and is 132 columns wide. Both include tractor feeds and Epson/IBM compatibility. Worthy pedigrees and a safe 9-pin choice. The absolute top sellers in the world at this time.

FX800 ..... £295.00  
FX1000 ..... £383.00

### EPSON LX800

Although previous LX series printers were considered under-specified compared to the NL10 and others and tended to sell more on name than on spec, the range continues to be the best seller ever, and the LX-800 not only outsells everything in sight but offers a specification that is better than most competitors at this price. This latest offering zips along at 150cps draft and 25cps NLQ and comes with Parallel Esc-P or IBM Parallel interfaces as standard, plus a top-mounted tractor feed. Good, clear typeface, 80 column wide. £189.00

### EPSON GQ3500



Now at last there is a quality laser almost anyone can afford, from a name-brand manufacturer at the lowest price on the market! Six pages per minute, wide choice of fonts, great print quality, cheap consumables! We're really shipping these out fast! £1275.00

### SHARP PORTABLES



This is the range that is going to give overpriced Toshiba a run for their money. The Laptop 4500 series offers excellent value and 4 hour battery life, while the hard disk 7100 and 7200 remain tied to the mains. All sport excellent back-lit supertwist LCD screens. The 4500's are 8088 turbo based with 3.5in floppies, while the 8086 7100 has a 20mb hard disk and single 5.25in floppy, as does the 80286 AT 7200.

PC-4501 ..... £599.00  
PC-7100 ..... £1399.00  
PC-7200 ..... £2099.00

### LOTUS 1-2-3 (VERSION 2.01)

Although imitated by half a dozen cheaper workalikes, the original business spreadsheet continues to out-sell all of its rivals and is the Number One selling software package ever. Very popular with corporates and government. Our huge volumes enable us to offer it at an exceptionally low price. No one undercuts us on this. £229.00

### SUPERCALC 4

If you want an alternative to Lotus 1-2-3 and its clones, this is the only one worth considering. They say it is everything Lotus should have been. Easy to use and quick, good graphics, it may be number two, but it tries harder! £195.00

### AMSTRAD PPC PORTABLE



At last! Amstrad is attacking the portable market, where until now the over-priced Japanese have romped. This sturdy little beast comes in four versions. Take it anywhere. The modem versions are especially good value.

PPC Single 3.5in Floppy 512k ..... £379.00  
PPC Double Floppy 512k ..... £475.00  
PPC Single Floppy 640k Internal Modem ..... £475.00  
PPC Double Floppy 640k Internal Modem ..... £569.00

### PANASONIC 1081

This 120cps draft/30cps NLQ little beast is a surprising winner. It continues to sell very well, no doubt helped by the fact that everybody (led by us!) discounts it so massively! But it has excellent 9-pin quality, is Epson and IBM compatible, comes with a tractor feed, is 80 columns wide and amazingly cheap! Has helped to up Panasonic's U.K. market share greatly! £142.00

### COMPUTER EXPRESS GOLD

This special value added service which includes delivery, installation, training, hot-line support and on-site maintenance is now available. Ask for details when placing your order.

### MIRACLE WS4000 V21/V23 Modem

This is the most popular Modem in the country today because it is cheap, reliable, looks good and does the job, which is really quite a simple one, after all. You can use it to access Telecom Gold, One-to-One, EasyLink, Prestel and all the bulletin boards that keep sprouting up. You also need a serial cable (£15.00) and software. We recommend Sagesoft ChitChat (£69.00) because that package also allows you to access Prestel. Most others don't. £129.00

### SMART SYSTEM

The trouble with integrated packages is that they tend to do one thing at most very well, and all the others not so well as a dedicated package. Smart is the only integrated system in which all of its components (W/P Spreadsheet, Database, Graphics, Communications, Diary) are competent to stand on their own against the competition. The best-selling integrated package. It retails at £695, but we sell it at nearly half that! £389.00

### WORD PERFECT (VERSION 4.2)

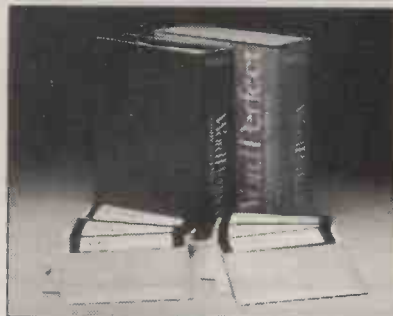

Statistics show that more Word Processing software is sold than any other kind. Word Perfect is the best selling WP package in the world today - full stop. It is also, in the view of most trade people, the best. Strongly recommended. In software terms, only Lotus outsells it. £219.00

### NEC P7 PINWRITER

Heavy duty 24-pin dot-matrix prints draft at 180cps and Letter Quality (LQ) at 72cps. A very successful product in the corporate sector. 132 column. £437.00

### NEC P2200

This 80 column 24-pin is going to revolutionise the low-end letter quality printer market. You have a choice of either 168cps or 140cps in draft and 56cps in Letter Quality. A very good buy. £289.00

### SPECIAL PCX2 EGA OFFER

At last! A fast (10MHz) AT compatible machine at a price you can afford. This Special offer comes bundled with MS-DOS, Keyboard, 14in Eizo 8042S EGA Colour Monitor and 20mb base unit. All you need in a small footprint size. £1399.00

### AMSTRAD 1640

No listing would be complete without mention of this machine. The shortcomings of the 1512 have been rectified and the 1640 is excellent value for money, coming as it does with an 8086 8MHz chip, 640k RAM, mouse, Gem, MS-DOS and choice of hercules mono, full colour or EGA screen. The old 1512 was selling massively in this country, and the successor 1640 is having similar success. For real value buy the single drive version and add a 32mb FileCard!  
Single Floppy ECD ..... £796.00  
Single Floppy Mono ..... £512.00  
20mb Hard Disk ECD ..... £1146.00

### MITSUBISHI SA-2100 FAX

It's not a computer but we're discounting them too. It's just one of the fax of life that these are in great demand. This Group 3/2 is one of the neatest around and you'll be hard put to beat the price and spec. £1499.00

Special: New shipping charges. Next day delivery. We will ship any consignment up to 25kgs anywhere in the U.K. (except the highlands of Scotland) for only £8.50. For small software orders the charge is £6.50.





# What's in a network?

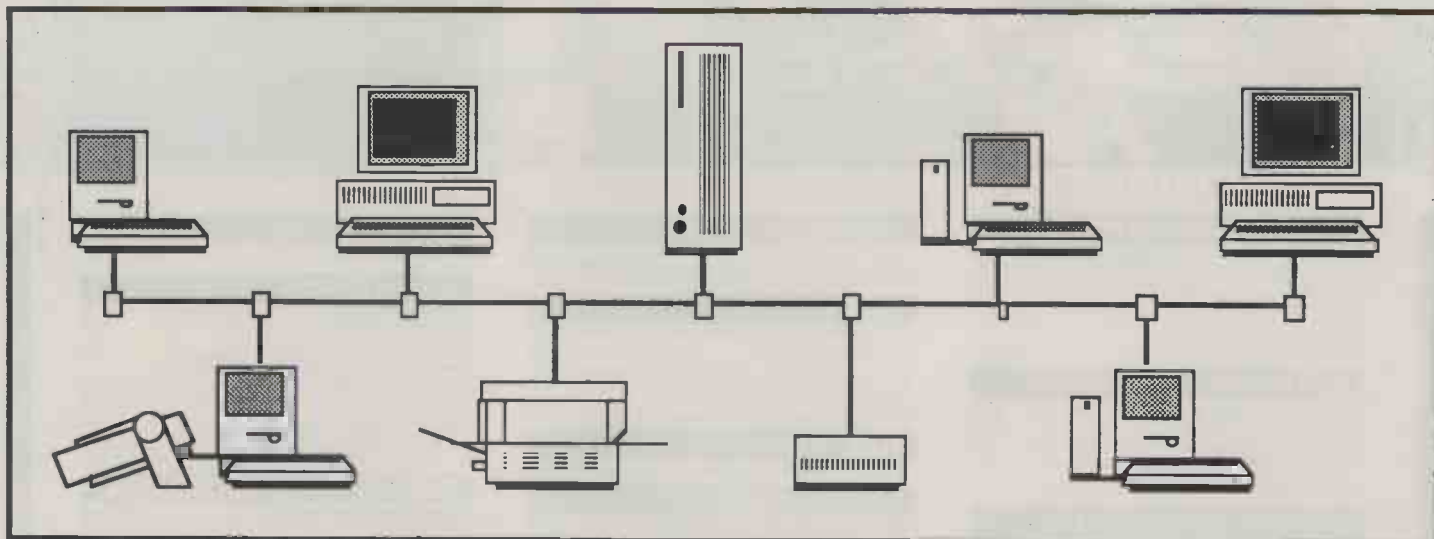

## The PC Network

As the price of hard disks falls, any workgroup for PCs will almost certainly consist of more than one hard disk. The best network solution for PCs is increasingly the distributed file server which combines the distributed processing power, storage capabilities and file data bases into a harmonious whole.

TOPS Network is the most user friendly network for PC's. Its self-configuring protocols really do mean that you can just plug in and go. With TOPS Network every computer is both optionally a server and a network station. TOPS allows any computer to share its files with any other. And by distributing the serving, it increases the speed and efficiency of the network. TOPS also saves money because you do not have to purchase expensive dedicated servers or hire a network administrator.

## The Mixed Operating System Network

Many businesses with existing DOS installations want to buy Macintoshes for specific tasks. An increasing number of UNIX users want to incorporate personal computers into their set-up, but also want their PCs to integrate to their mini or mainframe to access their files and storage capabilities. TOPS is a unique multi-operating system network providing transparent networking, peripheral sharing and file sharing between MS/PC-Dos, Macintosh and UNIX.

## The Network Gateway

TOPS provides an effective bridge between the TOPS Network and SUN PC-NFS, IBM Token Ring, EtherNET, Novell S-Net/Advanced Netware, IBM PC-Net, MS-Net, Standard Microsystems ARCNet, Corvus OmniNet, Banyan's VINES, Ungermann Bass networks, BICC networks, Tallgrass, 3Com EtherLink/3+, AT&T STARLAN, Local Net D-Link and AppleShare.

# TOPS Network

# Go-Mark Ltd

Networking & Connectivity Experts.

**TOPS/Mac version 2 £149.00 + VAT**  
New features include autopublish and automount, LaserWriter spooling, and format translators.

**TOPS/DOS version 2 £175.00 + VAT**  
New features include local printer serving and FlashTalk faster networking at 0.8Mbips. TOPS/DOS is now unbundled from the network interface card, and is fully AFP compatible to support AppleTalk-PC cards from Apple and Tangent. However to utilise the FlashTalk faster networking you must use the TOPS FlashCard and PhoneNET AppleTalk connectors. TOPS/DOS supports DOS 3.1 networking capabilities and is MS-Net compatible.

**TOPS/NetPrint version 2 £175.00 + VAT**  
Prints from within an application to the Apple LaserWriter, supports all LaserWriter Plus fonts; supports PostScript, and Diablo 630, Epson FX80 and IBM Proprinter emulations.

**TOPS FlashCard £215.00 + VAT**  
Network interface shortcard supporting FlashTalk 0.8 Mbips networking over PhoneNET cabling.

\*You must upgrade any TOPS v1.0 to work with TOPS v2.0

For more information, please cut out coupon and send it to:  
Go-Mark Ltd, 29 Harper Road, London SE1 6AW. Tel: 01-407 4340/1.

Please send me more information on:

TOPS/PC   
 TOPS NetPrint   
 TOPS/MAC   
 TOPS/UNIX   
 Upgrade Information

Please send me the name of my local TOPS dealer  
 Contact name.....  
 Company.....  
 Address.....

PCW/MAY88



# SCREENS SCREENS SCREENS

## BEST EQUIPMENT! BEST DEALS! BEST CHOICE!



### FABULOUS CL-ID PC/XT

Designed for business that accepts no compromise on quality or reliability. Every CL computer is built to last by unhurried manufacture, strict quality control and extensive checking of final product. Development while on-going is never dictated by fashion. The robust construction is evident, the subdued hum of the CL computer is reassuring, pride of ownership knowing you have the best money can buy is priceless.

Check the specification and order with confidence today.

- ★ 8088-2 Turbo Processor (4.77/8 MHz) clock
- ★ 640K user RAM installed ★ Legal Phoenix BIOS ROM
- ★ 360K floppy disk drive with 3 spare drive cavities
- ★ 84 key 'AT' style slim keyboard
- ★ Real time clock with battery backup
- ★ Hercules compatible mono display adaptor
- ★ RS232 serial port ★ Parallel printer port
- ★ 8 full sized expansion slots (7 free)
- ★ 12" high resolution amber mono monitor on swivel tilt base
- ★ One year on-site maintenance in UK included

LOOK AT OUR  
EXCLUSIVE  
PRICE **£399**+VAT!

CL-2D Dual Drive version incl. DOS **£575+VAT**  
 CL-20 20MB XT version incl. DOS **£799+VAT**  
 CGA Colour Versions ADD **£199+VAT**  
 EGA Colour Versions ADD **£399+VAT**

REQUEST OUR COLOUR BROCHURE  
ON CL-SERIES



### CL-SERIES TRANSPORTABLE PC-XT-AT

Incredible portability with desktop power. Out and out best sellers in their class and price/specification ratio!

CL-2P PC. 8088-2 (4.77/8MHz) Turbo CPU 640K Ram. Dual 360K FDD. Time clock & Battery Backup. Built in 9" Amber Monitor. Serial/Printer interfaces. MS-DOS/GW BASIC v3.2 included.

CL-20P XT. As above but 1 x 360K FDD plus 1 x 20MB HDD.  
ONE YEAR ON-SITE MAINTENANCE INCLUDED IN UK

CL-2P Dual Drive PC **£699.00!!**

CL-20P 20MB XT **£899.00!!**

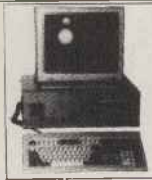

### SCREENS ST300 20MB EGA AT

Just look! An AT EGA System for the price of PC/XT

★ 80286 CPU (8.6 MHz) ★ 1MB RAM ★ 1.2 MB Floppy Drive ★ 20MB Winchester Hard Disk ★ 101 Key Enhanced Keyboard ★ 6 x XT Expansion Slots ★ Real time clock with battery backup ★ Keylock and Reset buttons ★ Serial, Parallel and Games Ports ★ 14" High Resolution EGA Colour Monitor included ★ MS-DOS/GW BASIC v3.2 included

SUPER SMALL FOOTPRINT DESIGN. FULL USERS MANUALS AND ONE YEAR ON-SITE MAINTENANCE INCLUDED IN OUR

AMAZING PRICE **£1195!**



### GENIUS MOUSE+

FOR HERCULES, CGA, EGA & VGA DISPLAYS

AN EXCEPTIONAL OFFER FROM SCREENS!

- ★ Genius Mouse (Microsoft & PC mouse compatible)
- ★ Mouse Pad and Cutting Board
- ★ Mouse Pocket (Attaches to Monitor)
- ★ Genius Menu Maker Software
- ★ Dr. Halo III Graphic Software

HURRY, LIMITED OFFER  
AT THIS PRICE — **£59.95**

### POCKET PSION COMPUTER

Organiser II CM	£84.95	Mains adaptor	£10.95
Organiser II XP	£119.00	RS 232	£39.95
Maths Pack	£24.95	128K Datapak	£82.95
Finance Pack	£24.95	64K Datapak	£49.95
Spell checker	£24.95	32K Datapak	£29.95
Spreadsheet	£32.95	Link-up Adaptors	£10.95

### EPSON PX80X PRINTER

Superb quality budget portable printer. 80 columns, 45cps. Battery/Mains power.  
SCREENS PRICE ONLY **£199.00!**



### SCREENS COPY HOLDERS

IMPORTED DIRECT BY SCREENS!  
Desk clamping holders, adjustable to any angle. Simple but essential addition to the computer desk.

**£14.95**

### LOOK!

SCREENS CDJ-002  
JOYSTICK  
PLUS GAMES PORT CARD

EXCLUSIVE OFFER **£24.95!**

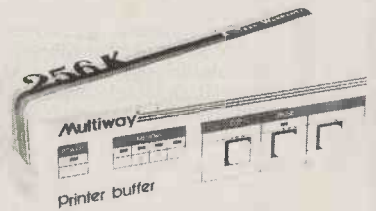

### SCREENS MPB256 MULTIPRINT BUFFER 256K

Powerful buffer. Pause/Reset/Self Test Built in  
Imported direct by SCREENS

CHECK OUR GIVE AWAY PRICE **£99.00!**

## Panasonic Micro Peripherals

star

JUKI  
EPSON

Canon

WARNING

BUYING YOUR PRINTER ELSEWHERE CAN HARM YOUR WEALTH  
CHECK SCREENS ROCK BOTTOM PRICES TODAY AND SAVE MONEY!



### SCREENS MM12/MM14 HI-RES

12/14" AMBER DISPLAY on SWIVEL/TILT BASE. ONE YEAR WARRANTY.

12" VERSION **£89.95!**  
14" VERSION **£99.95!**



### SCREENS MC14 RGB

640x200 Dot Resolution. Amber/Green/Colour switchable. Swivel/tilt base.

**£249.00!**

WE STOCK AMSTRAD · ACORN · COMMODORE & TANDON COMPUTERS & ACCESSORIES

# SCREENS

TRUST SCREENS  
TO DELIVER



## MICROCOMPUTERS & ELECTRONICS LTD

MAIN AVENUE · MOOR PARK · NORTHWOOD · MIDDLESEX · ENGLAND

TEL: SALES 09274 20527 TEL: EXPORT 09274 20664 TLX: 929224 SCREEN G FAX: 0923 835421

CORPORATE - EDUCATIONAL - EXPORT ENQUIRIES WELCOME PRICES QUOTED EXCLUDE VAT & DELIVERY 24 HOUR DELIVERY SERVICE AVAILABLE ALL PRODUCTS CARRY ONE YEAR WARRANTY  
 PRODUCTS SUBJECT TO AVAILABILITY - ON-SITE MAINTENANCE - INSTALLATION - TRAINING & CREDIT FACILITIES AVAILABLE - IBM IS REGISTERED TRADE MARK OF INTERNATIONAL BUSINESS MACHINES INC  
 MS-DOS/GW BASIC ARE TRADE MARKS OF MICROSOFT INC - SCREENS ARE LICENSED CREDIT BROKERS - DELIVERY CHARGES SOFTWARE = £2. HARDWARE UNDER £200 = £6 OVER £200 = £10 OVER £2000 F.O.C





**GROUP**

**"Tomorrow's Technology today"**

**10 SALES LINES**

**031-555 0655**

**EDINBURGH**

**01-373 3050**

**LONDON**

## 286-16 MHZ\*

- Probably the fastest 80286 available
- 1,024 K Ram 'O' Wait state
- 16 MHz\* Speed
- 2 x RS232 Ports
- 2 x Parallel Ports
- Hercules/CGA Card
- 8 Expansion Slots (6 x 16 Bit, 2 x 8 Bit)
- Bus Mouse
- MS DOS 3.3
- 1.2 Mb Floppy
- Choice of Hard Discs
- 102 Keys Keyboard
- Games Port
- 14" Flat Screen Amber Monitor
- Clock/Calendar
- Full Sets of Manuals
- 2 Years No Quibble Warranty
- Lifetime Hotline Support UK-Wide



- SUPER FAST
- RELIABLE
- COMPATIBLE
- COMPACT SIZE

### RANGE

286T16 1 x 1.2Mb monitor	<b>£895*</b>
286T16 1 x 1.2Mb 1 x 23Mb monitor	<b>£1199*</b>
286T16 1 x 1.2Mb 1 x 44Mb/28ns monitor	<b>£1399*</b>
286T16 1 x 1.2Mb 1 x 65Mb/28ns monitor	<b>£1599*</b>

What the Press say . . .

Which PC "Even before the price has been considered, this machine gives an impression of high performance, thoughtful design and solid construction" (March 1988).

\* per Landmarks CPU test

ORDER NOW  
(NEAT 286-20 AVAILABLE APRIL)

\* All prices exclude VAT

## 386-25 MHZ

- 80386 EE Processor fitted, compatible with Xenix 386, Windows 386, Novell, Autocad etc.
- 25 MHz Clock Speed
- 1.2Mb Floppy disc (3.5" optional)
- Choice of Hard Discs
- Mouse
- Hercules/CGA Colour Card
- 14" Flat Screen Amber Monitor
- 102 Keys Enhanced Keyboard
- 2 Serial Ports
- 2 Parallel Ports
- 220W Power Supply
- Clock Calendar
- 2 MB of 32 Bit 'O' Wait State Ram
- MS Dos 3.3 Supplied
- Full Set of Manuals
- 2 Years No Quibble Warranty
- Lifetime Hotline Support UK-Wide
- Fully Upgradeable to 30 MHz when parts available
- Norton SI 30

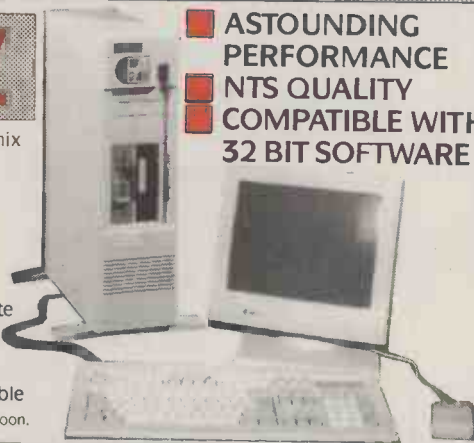

- ASTOUNDING PERFORMANCE
- NTS QUALITY
- COMPATIBLE WITH 32 BIT SOFTWARE

### RANGE

386T16 1 x 1.2Mb 1 x 44Mb/28ns monitor	<b>£2699*</b>
386T16 1 x 1.2Mb 1 x 65Mb/28ns monitor	<b>£2995*</b>
386T16 1 x 1.2Mb 130Mb Hard disc monitor	<b>£3595*</b>

\* All prices exclude VAT

## PC/XT-14MHZ

- Incredible 14 MHz B105 used
- Norton SI 6.3
- As fast as some 286 machines
- NEC V20 Processor used
- 4.77/8/14 switchable
- 640 K Ram fitted
- 360 K Floppy disc drive
- Serial Port
- Parallel Port
- Mouse
- Clock Calendar
- 101 Keys keyboard
- 150 Watt Power Supply
- Hercules/CGA Colour Card fitted
- 14" Flat Screen Amber Monitor supplied
- MS DOS 3.3 supplied
- Full set of manuals
- 2 Years No Quibble Warranty
- Lifetime Hotline Support



### RANGE

PC/XT-14MHz  
FROM **£459**  
(Call for details)

**2 YEARS  
GOLD  
STANDARD  
WARRANTY**

As a result of exceptional quality control at every stage of manufacturing NTS is able to offer every customer an unconditional 24 months warranty. Call for further details.

## HOW TO ORDER

Please call us for any information you require and we will send you full colour brochures on our entire range of products. NTS is a long-established manufacturer of compatible computers and welcomes all visitors. Our 7,500 sq. ft. factory in Edinburgh is responsible for both manufacturing and testing all of our products. With thousands of machines already in service throughout the world you can be confident that with NTS you have made the right choice. Nationwide on-site maintenance is available. Call us for details of your nearest dealer/distributor, or orders can be placed direct by calling 031-555 0655 (North) or 01-373 3050 (South). Access, Visa, etc. accepted.



### UPGRADES

■ EGA Card and Monitor	<b>£385</b>
■ PGA Card and Multisync Monitor (Fujitsu ME503)	<b>£499</b>
■ 80287 Coprocessor	<b>£199</b>
■ Printers	
■ Novell/PC Net Networking Peripherals	
■ Tape Streamer 40 MB	<b>£305</b>
■ MS DOS 3.3	<b>£65</b>

**HEAD OFFICE: 16 DOCK STREET, SANDPORT ESTATE, EDINBURGH EH6 6EY**

**E AND O E**





**GROUP**

"Tomorrow's Technology today"

10 SALES LINES

**031-555 0655**

**EDINBURGH**

**01-373 3050**

**LONDON**

## NEAT 286-20 MHZ

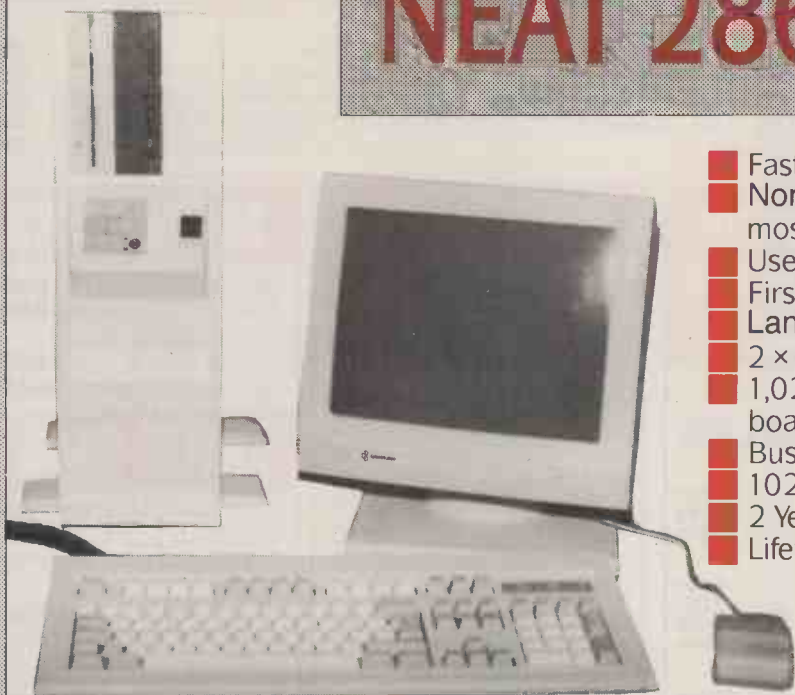

- Fastest 286 Machine in the World
- Norton SI 18.70 and outpaces most 16 MHz 80386 machines
- Uses chips neat Vlsi Set
- First available in the UK
- Landmark speed = 21.0 MHz
- 2 x RS232 Ports 2 x Parallel Ports
- 1,024K Ram expandable to 8MB on board
- 8 Expansion Slots
- Bus Mouse
- 14" Amber Monitor
- 102 Keys K/B
- Hercules Card
- 2 Years Warranty
- Lifetime Hotline Support

23Mb Model **£1,499** (exc)

44Mb Model **£1,699** (exc)

- Carrying Case Included
- Tough Durable Construction
- Supertwist Display

## PORTABLE 286-12 MHZ



- 80286—12 MHz based
- 1 x 23 Mb/40mS Hard Disc
- 1 x 3.5" 1.44Mb Floppy
- 2 x RS232 Ports
- 1 x Parallel Port
- Hercules/CGA Card

- 2 x Expansion Slots Free
- Fantastic Clarity from LCD Supertwist
- Weighs only 7.5 kg
- Fully transportable
- 102 Keys keyboard

(E and OE)

23Mb Model only  
**£1,599** (exc)

**2 YEARS  
GOLD  
STANDARD  
WARRANTY**

As a result of exceptional quality control at every stage of manufacturing NTS is able to offer every customer an unconditional 24 months warranty. Call for further details



**OVER 10,000 sq. ft. OF SHOWROOM,  
DEMONSTRATION  
AREAS, SERVICE  
AND STORAGE**

**EST. 1982  
ALL PRODUCTS  
FULLY  
GUARANTEED  
AND HOT LINE  
SUPPORT.**



# HI VO

## London's Largest

**LONDON'S LARGEST SPECIALIST  
AMSTRAD DEALER**

*We are an official Amstrad Service Centre*

### AMSTRAD PC1640

**HI-RES MONO MONITOR MODELS**

SD Single Drive .....	<b>£469</b>	Extra for CGA Colour
DD Double Drive .....	<b>£565</b>	Monitor <b>£139</b>
20Mb Hard Drive .....	<b>£845</b>	Extra for EGA Hi-Res
SD 20Mb (Single Drive + 20Mb Hard Card) ..	<b>£719</b>	Colour Monitor
SD 30Mb (Single Drive + 30Mb Hard Card) ..	<b>£739</b>	<b>£279</b>

### AMSTRAD PC1512

SD Single Drive .....	<b>£375</b>
DD Double Drive .....	<b>£469</b>
SD 20Mb (Single Drive + 20Mb Hard Card)	<b>£629</b>
SD 30Mb (Single Drive + 30Mb Hard Card)	<b>£649</b>
Extra for CGA Colour Monitor	<b>£140</b>

**USED AMSTRAD  
PC's  
PRICES  
FROM **£299****

### HARD DISKS ON A CARD

21 Megabyte	<b>£249.00</b>
30 Megabyte	<b>£279.00</b>

**AMSTRAD PCW  
WORDPROCESSORS**

**PCW 9512**  
inc Daisy Wheel Printer  
• Daisywheel Printer  
• 512K Ram  
• Paper white high resolution monitor  
• Spellchecker

PCW 8512 inc Printer	<b>£399</b>
PCW 8256 inc Printer	<b>£299</b>

**SECOND HAND MODELS  
FROM **£199****

### EPSON GQ3500 LASER PRINTER **£1249**

### PC COMPATIBLES

<b>AST</b>	
120	<b>£1799</b>
140	<b>£2049</b>
170	<b>£2349</b>
<b>EPSON</b>	
PCE	<b>£999</b>
PCAX2	<b>£1229</b>
PCAX40	<b>£1679</b>
PCAX80	<b>£1949</b>
<b>OLIVETTI</b>	
M240 20MB	<b>£1495</b>
M380 40MB	<b>£3695</b>
<b>OPUS</b>	
PCIII 2 x FD	<b>£699</b>
PC V HD 30MB	<b>£1249</b>
Extra for EGA	<b>£299</b>
<b>TANDON</b>	
PCA20	<b>£1195</b>
PCA40	<b>£1639</b>
PCA70	<b>£1895</b>

**PART EXCHANGE -  
WE ARE THE  
SPECIALISTS**

### SOFTWARE

Ability Plus	<b>£129</b>
Account Ability	<b>£79</b>
Dbase III+	<b>£339</b>
Excel	<b>£259</b>
Fantasy	<b>£59</b>
Framework II	<b>£329</b>
Lotus 123 V2.1	<b>£239</b>
Multimate	
Advantage II	<b>£289</b>
Paradox II	<b>£299</b>
Quattro	<b>£119</b>
Sage Accountant	<b>£119</b>
Sage Accountant +	<b>£149</b>
Sage Book Keeper	<b>£75</b>
Sage Financial Controller	<b>£229</b>
Sage PC Write	<b>£75</b>
Sage Retrieve	<b>£75</b>
Smart	<b>£379</b>
Supercalc IV	<b>£239</b>
Symphony V1.2	<b>£339</b>
Ventura	
Publisher V1.1	<b>£479</b>
Word V4.0	<b>£238</b>
Wordperfect V4.2	<b>£219</b>
Wordstar	
2000+Rel.3	<b>£228</b>
Wordstar Prof. V.4	<b>£199</b>

### MONITORS

NEC Multisync II	<b>£469</b>
TAXAN 770 M/sync	<b>£485</b>
VEGA Deluxe	
EGA Board	<b>£199</b>
VEGA VGA Board	<b>£239</b>

### MODEMS

AMSTRAD V21, V23	<b>£99</b>
AMSTRAD V21, V22	
V22BIS, V23	<b>£199</b>
STRADCOM	
V21, V23	<b>£169</b>
MIRACLE TECHNOLOGY	
FROM	<b>£159</b>
PACE FROM	<b>£139</b>

### CO- PROCESSORS

8087-3 5MHz	<b>£95</b>
8087-2 8MHz	<b>£145</b>
8087-1 10MHz	<b>£209</b>
80287-6 6MHz	<b>£135</b>
80287-8 8MHz	<b>£199</b>
80287-10 10MHz	<b>£269</b>
80387-16 16MHz	<b>£396</b>

### NEW AMSTRAD PPC640 Portable PC

Supertwist LCD Screen. 80 x 25 Row Format.  
101 Key AT Style Keyboard. MS DOS 3.3 640K Ram.  
8MHz Processor. (PPC640 inc. V21, V23, V22,  
V22 BIS, Comms S/W.)



PPC 512S Single 720K  
3 1/2" Drive **£399**

PPC 512D Double 720K  
3 1/2" Drive **£499**

PPC 640S Single  
720K 3 1/2" Drive, built  
in modem **£499**

PPC 640D Double  
720K 3 1/2" Drive,  
built in modem **£599**

### SBC PC COMPATIBLES

**SBC PC-Turbo**  
8 MHz Turbo. NEC V40 CPU. MS DOS  
3.2 + 6W Basic. 640K Ram.

**SBCFD** **£589**

2 x 360K disc drive mono monitor

**SBC HD 30** **£899**

30 Mb hard disc mono monitor

CGA colour **£169** extra

EGA colour **£329** extra

**SBC 286 AT**

10 MHz AT80286 40 Meg hard disc,  
1 Meg Ram. MS DOS 3.2 + GW Basic.

**SBC 286 AT** with

mono monitor **£1249**

**SBC 286 ATC** with

colour monitor **£1399**

**SBC 286 ATE** with EGA

colour monitor **£1595**

**SBC SMD 386**

16MHz AT 80386. 2 Meg Ram.

MS DOS + GW Basic

**SBC SMD 386**

20Mb Mono

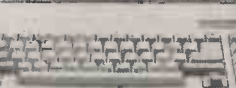

40Mb Mono	<b>£3299</b>
20Mb EGA	<b>£3509</b>
20Mb EGA	<b>£3699</b>

**£3109**



# VOLTAGE Computer Shop



**DON'T TAKE A CHANCE  
— COMPARE BEFORE YOU BUY**

**OVER 40  
PRINTERS ON  
DISPLAY. MOST  
ON DEMONSTRATION**

## DOT MATRIX PRINTERS

Amstrad DMP4000 NLQ 132 col 200cps	£299.00
Amstrad LQ3500 24 pin	£299.00
Citizen 120D	£156.00
Citizen LSP100 NLQ IBM	£179.00
Epson LX800 NLQ (150cps)	£184.00
Epson FX800 NLQ 200cps	£299.00
Epson FX1000 NLQ 132 col 200cps	£385.00
Epson EX800 NLQ 300cps	£439.00
Epson EX1000 NLQ 132 col 300cps	£579.00
Epson LQ500 NLQ 24 pin	£299.00
Epson LQ850 NLQ 24 pin	£449.00
Epson LQ1050 NLQ 132 col 180cps 24 pin	£599.00
Epson LQ2500 + 24 pin	£759.00
NECP2200 24 pin	£299.00
NECP7 24 pin	£459.00
Ok-Mate 20 Colour + software	£173.00
Panasonic KXP1081	£149.00
Riteman C+ (CBM64I/F)	£159.00
Star LC10 NLQ inc I/F	£179.00
Star LC10 colour version	£219.00
Star NX15 NLQ 132 col	£289.00

Star ND15 NLQ 132 col 180cps	£369.00
Star NR15 NLQ 132 col 240cps	£429.00
Star NB24-10 NLQ 80 col 24 pin	£429.00
Star NB24-15 NLQ 132 Col. 24 Pin	£529.00
Star NB15 NLQ 132 Col. 24 Pin	£619.00

**EPSON LX800  
£184**

## DAISYWHEEL PRINTERS

Brother HR20	£335.00
Brother HR40	£759.00
Juki 6100	£286.00
Micro-PMP40	£299.00
Silver Reed EX P500	£165.00

All popular interfaces, cables, etc. available from stock. Custom cables made to order. Let our experts match your computer to the printer of your choice. Printers - All models parallel-centronics interface Serial RS232C available at same or slightly higher prices.

## LASER PRINTERS

Prices from only **£1249**

**THE UK'S LARGEST RANGE OF LASER PRINTERS ON DEMONSTRATION**

Are you confused by the variety of lasers available? No problem! Visit our showroom and compare before you buy. Off the shelf delivery on most models.



Epson  
GQ-3500

Canon  
LBP-8 II



AST TURBO 8PPM	£2499*
AST TURBO (Postscript) 8PPM	£2995*
BROTHER HL-8 8PPM	£1695
CANON LBP8-II 8PPM	£1595
CITIZEN OVERTURE 110 10PPM	£1295*
EPSON GQ3500 6PPM	£1249
HEWLETT PACKARD LASERJET II 8PPM	£1595*
OKI LASERLINE 6 6PPM	£1395
QMS K8 8PPM	£1495
SBC SPEEDLASER 6PPM	£1595*
STAR LP-8 8PPM	£1695*

All Lasers marked with \* includes 12 months on-site maintenance.

## LONDON'S AMIGA CENTRE

Hi-Voltage are the Amiga experts. As Commodore's largest computer store we are proud to give the world's most advanced computer pride of place in our showroom. We stock the most comprehensive range of peripherals and software including colour printers, as they become available. New items are arriving every day so contact us now!

**AMIGA A500 PRICES FROM £395**  
INCLUDING FREE SOFTWARE  
**NOW IN STOCK**

**NEW AMIGA CATALOGUE JUST PRINTED - PHONE FOR YOUR FREE COPY.**

## AMIGA B2000 IN STOCK

Standard versions from **£950** IBM Compatible version from **£1385**  
**LARGE RANGE OF DISCOUNTED AMIGA SOFTWARE.**

**FULL RANGE OF CBM 64C/128D COMPUTERS AND PERIPHERALS IN STOCK**

**EXPORT CUSTOMERS SUPPLIED TAX FREE - ASK FOR EXPORT LIST**

Official orders welcomed from PLC's government and education establishments

**ALL PRICES EXCLUDE VAT  
OPEN MON-SAT 9AM-6PM**

**HI VOLTAGE**

Dept. PCW, 53-59 High Street, Croydon, Surrey CRO 10D. Fax: 01-681 8939. Tel: 01-681 3022

Prices correct at copy date. Subject to change without notice due to currency fluctuations etc. E. & O. E.

## PLOTTERS

### ROLAND

DXY880A	£649
DXY885A	£779
DXY980A	£899

**HEWLETT PACKARD PLOTTERS ALSO STOCKED**

## FAX

### LONDON'S FAX CENTRE

We carry the largest range of fax machines on demonstration at discount prices from NEFAX, CANON, PANASONIC. and SHARP. Prices from **£995**

**EGA COLOUR MONITORS  
PRICES FROM £279**

**SPECIAL OFFER ON DISKS**

Prices per box of 10	
3.5" Bulk DS/DD	£15
3.5" Verbatim DS/DD	£22
3.5" Sony DS/DD	£25
5.25" Bulk DS/DD 48 tpi	£8
5.25" Media Life DS/DD (inc library box) 48 tpi	£11
5.25" 3m DS/DD 48 tpi	£16
5.25" Dysan 1.6mb	£25

Free post and packing on disks

**Largest range of floppy disks and printer ribbons available in London over the counter.**

**London's largest range of games and software. Thousands of titles in stock.**



**Mail Order + Export Hot Line Phone 01-686 6362**

Delivery by Securicor (4 day) please add £5.75 per item.  
Delivery by Securicor 24 hour please add £9.95 per item.  
(Laser Printers and Fax machines £15 - 24 hour delivery)

Send off or order by phone quoting your Access, Visa No., Phone 01-686 6362.  
Immediate despatch on receipt of order or cheque clearance. Or Telex your order on: 946240 Attn 19001335. **EXPORT CUSTOMERS SUPPLIED TAX FREE.**



# SELTEC

## BEST OF THE BEST!!

### DISK OF THE MONTH SERIES— NEW RELEASES MONTHLY

Every month we examine hundreds of programs collected from our world-wide sources — from UK, USA, Canada, Europe, Australia and New Zealand — and select for release in our catalogue those we consider to be the most outstanding public domain and user-supported programs.

In our search we also discover some gems that stand out even in this select company; so each month we gather this special collection on to a single disk — a minimum of eight fully compiled programs — utilities, graphics, business, scientific, printing, wordprocessing, games, educational programs, etc. Most are completely new; in some cases it's a recent update of a classic program. These disks are released as part of a subscription series — the Best of the Best — at a price which is far less than if you bought the disks individually. And our subscription price INCLUDES taxes and postage/packing.

Our present Best of the Best series is for MS-DOS machines — the IBM-PC and close compatibles. 5¼" and 3½" disks are available.

#### SPECIAL BONUS OFFER!

If you subscribe now — in addition to the 12 disks of the Best of the Best Subscription Series — we will include a bonus disk of your choice that may be chosen from our advertisement on the facing page (single disks only — not sets, which have a plus sign as part of the catalogue number). Simply add the catalogue number to your subscription order. You will receive the bonus disk with your first subscription disk. See details on the coupon below.

#### MAIL AND TELEPHONE ORDERS:

SELTEC COMPUTER PRODUCTS LTD.,  
"Farley Hall", Wokingham Road,  
Bracknell, Berkshire RG12 5EU

**£69**  
per annum, subscription  
**50% Cheaper**  
than our single  
disk price!!



(0344) 86 3020

#### ORDER COUPON

Yes I wish to subscribe to the Best of the Best Series and my payment is enclosed herewith. I understand that the subscription price of £69 (for 5¼" disks; the subscription price for 3½" disks is £93) entitles me to receive 12 disks which will be released during an approximately 12 months period.

THE CATALOGUE NO. OF MY BONUS DISK IS: .....

NAME (UNDERLINE SURNAME): .....

ADDRESS: .....

STATE/COUNTY: ..... POSTCODE: .....

DAYTIME PHONE NO. (EMERGENCY USE ONLY): .....

WHERE DID YOU SEE THIS AD? .....

Payment can be by cheque or credit card. If paying by credit card, please enter the card no. below.

ACCESS/MASTERCARD  BARCLAY/VISA

CARD NO: .....

EXPIRY DATE: .....

Insert the name or address of the credit card holder. If it differs from the above please give the registered particulars: .....

SIGNATURE: .....



# SELTEC

## LOW-LOW-LOW-COST PROGRAMS

Out of the thousands of programs we have collected, for a small service charge from £4 we bring you a SELECTION OF THE BEST that have been carefully tested and documented. Suit IBM-PC and compatibles. 5 1/4" and 3 1/2". Dos 2 or greater.

Please note that in those instances where Basic is required, users should have Basica, GWBasic, or our shareware compatible version on disk M9001. Basic2 is not suitable.

Our games disks have a CGA emulator so those with Hercules boards can also play.

### MS-DOS GAMES

- M1006: CHESS.** Several extensive versions with graphics. Includes Mychess. Well written.
- M1008: SELECTED FAMILY FUN GAMES.** 2 Flight Simulators, Music Generator, excellent Pacgirl, Spacewars, etc. Some need Basic.
- M1051: 50 BASIC GAMES.** Includes a Startrek, Swarm, Baseball, Blackfri, Antonyms, many more. Needs Basic.
- M1067: BRIDGE.** Comprehensive and challenging version to sharpen your play or just to provide a good game.
- M1069: ADULT SLIDE SHOW.** Automated display of girly pics. Entertaining but not suitable for children.
- M1070: PROVOCATIVE PICTURES (3).** A collection of girly pics with Mac-type graphics, some animated. Not for children.
- M1079: GAMES FOR UNDER 8'S (2).** Suits young children. A Pacman-type, plus entertaining, educational games for alphabet, counting, adding, subtracting, telling time.
- M1080: RAILROAD SIMULATION.** For all kids at heart. On screen tracks and animation. Choose a variety of tracks, redirect the train, etc.
- M1081: PROVOCATIVE PICTURES (4) - 1988 CALENDAR GIRLS.** Sixteen different girls immodestly illustrate 12 months calendars for 1988. Pin-ups for printing.
- M1082: SUPER COMPILED GAMES (8).** Compiled versions of 21 (cards), Lazy Monday (Shootout at the Space Corral), Sopwith (Bi-plane dogfight simulation), and Rogue (classic adventure).
- M1084: POKER.** Sharpen your game or just get the satisfaction of beating (if you can!) the computer.
- M1085: GIN RUMMY.** Another excellent card game. For fun or for those budding card sharps who want to surprise their friends.
- M1086: ADVENTURE - BEYOND THE TITANIC.** New adventure that sets you against ocean perils after the sinking of the Titanic.
- M1087: CROSSWORDS CREATOR.** Not only fun to play but educational. You can also supply new dictionary of words.
- M1088: ADVENTURE COLLECTION.** New selection of five challenging adventures: command a submarine, fight monsters in a magical kingdom, search through a rain forest for a legendary city, etc.

### UTILITIES

- M2012: HARD DISK UTILITIES (1).** Park disk head safely, create secret subdirectories, catalogue, sort, backup, change file attributes, etc.
- M2014: CP/M EMULATION.** Two programs that help you run CP/M software on your PCI. Well documented.
- M2016: MENU SYSTEMS.** Create your own menus. Contains Sysmenu, Automenu, and EZmenu.
- M2035: MORE HARD DISK UTILITIES (2).** Special collection for optimising hard disk usage, re-organising fragmented files, file management.
- M2049: INTEGRATED UTILITY FOR PERSONAL MANAGEMENT.** Like Sidekick, with calculator, notepad/editor, appointments calendar, address database, cut & paste, file management, etc.
- M2059: UNPROTECTION METHODS (2).** Instruction and tools for backing up a variety of popular programs such as Javelln, DbaseIII+, Printshop, etc.
- M2061: HARD DISK UTILITIES (3):** New collection. Super undelate, AT diagnostics, easy path find, hard disk directory, better backup utilities.
- M2062: MAGIC MENUS:** Superior Dos front-end that lets you create your own menus. Full screen edit, pop-up menus for directories, dos commands, calculations, printing, etc.
- M2064: HARD DISK MANAGER.** Directory management for many files on hard disk.
- M2065: NORTON-LIKE UTILITIES.** Shareware equivalent of the Norton utilities. Undelate, check processing, repair corrupted files, etc. 17 programs.

## TOP QUALITY PUBLIC DOMAIN & USER SUPPORTED SOFTWARE

### WORD PROCESSING/ PRINTING

- M3002: TYPING TUTOR.** Improve your skill at the keyboard. Several fine programs have been assembled on this disk.
- M3007: SPELLING CHECKER.** Our 1988 version. We've again added thousands of new words, incl bus/computer terms. Works with most word processors (not Amstrad version of Wordstar).
- M3014: SIDEWRITER.** Generates printed output sideways to fit wide reports on to a page.
- M3037: WORD PROCESSOR THAT INPUTS SPREADSHEET VALUES.** Useful features plus ability to receive figures from spreadsheets to include in reports. Will also update changes in values.
- M3038: DESKTOP PUBLISHING.** Word processor for high quality printing, multiple columns, extended ASCII (solid lines/borders, foreign characters), more/less lines per page, variable print size, merge files, etc.
- M3040: HP LASERJET UTILITIES.** Control the Laserjet (L+plus) from a menu to select fonts, pitch, eject, no. lines, etc. Extensive.
- M3041+: DESKTOP PUBLISHING (2).** Fontastic is a two disk set that has multifold printing, allows you to change or create characters. Extensive printer control. £18.
- M3042: SIGNS AND BANNERS.** Print headlines, notices, flyers, signs. Large lettering, various sizes.
- M3043: TYPEWRITER EMULATION.** Use your printer like a typewriter to print envelopes, short letters, labels, etc.
- M3044: PRINTMODE.** Special utility with numerous options for use with Epson compatible printers. Set up printer from the command line.

### GRAPHICS

- M4001: SELECTED GRAPHICS.** Some of the best programs, including one of commercial standard with a library of predrawn pictures for use.
- M4014+: COMPUTER-AIDED DESIGN.** Dancard-3d will do complex drawing, 2 or 3 dimensions, print sharp lines for mechanical drawing, illustrations, animate parts. We've squeezed 4 disks on to two. £18.
- M4019: FORMS DESIGNER.** Perhaps the best available for designing your forms layout. Suits invoices, order forms, letterheads.

- M4020: DESIGN GRAPHICS.** General purpose drawing of lines, pictures, circles, boxes. Change size, rotate. For maps, logos, posters, cards, plans, etc.
- M4022/M4026: 3D-GRAPHICS.** Gives wire-frame modelling; will move, tip, change scale, rotate. M4022 is for EGA; M4026 is for CGA.
- M4027: CURVEFITTING FOR GRAPHING RAW DATA.** Produces least squares fit on X, Y data. Curves for 25 equations.
- M4028+: FLOWCHART.** Has special symbols for systems design and organization charts, block diagrams. Colour or mono. Needs Epson compatible printer. 2 disks. £18.
- M4029: GRAPHICS AND TEXT PROCESSOR.** Draw bargraphs, 3D, line graphs, pie charts, presentation snaps; add various shadings and complete with comments. Accepts input DBASE/LOTUS.
- M4031: DRAWINGS FOR GRAPHICS.** Special collection of drawings for use with PC-Key.

### LANGUAGES

- M9001: BASICA/GWBASIC-COMPATIBLE INTERPRETER.** Runs programs written in industry standard Basic.
- M5005: PASCAL.** Popular program for learning to program and for general use. Well-documented.
- M5026: MACRO-ASSEMBLER.** If you didn't get one with your computer, this is one of the best.
- M5033: ROUTINES AND UTILITIES FOR HERCULES.** Includes special emulators for running on the Hercules board many products intended to run with Colour Graphics Board.
- M5049: C WINDOWS AND SCREENS.** Library of routines for C programmers.
- M5061: BASIC MODEL - DRAWING AND ADVENTURE GAME.** Two complete programs that serve as examples for those learning Basic.
- M5053: QUICKBASIC ROUTINES.** Special collection of routines to assist those programming with Quickbasic. Build them in to your own programs.
- M5054+: MODULA-2 COMPILER.** Full featured compiler for sophisticated programming. Two disks. £18.

### COMMUNICATIONS

- M6011: COMMUNICATION UTILITIES.** Collection of compression/decompression tools, RS232 tutorial, etc. To assist with modem communications, etc.

- M6016: PRESTEL/VIATEL COMMUNICATIONS.** Two programs that enable use of split baud rate (1200/75) communications.

### BUSINESS/CALCULATION

- M7001: GENERAL LEDGER ACCOUNTING.** Has Gledger, cash book, Profit/Loss, Balance Sheet. Prints cheques. Data can be read by Lotus 123. Easy to use.
- M7004: STOCK MARKET ANALYSIS (1).** Special aids to help you "think and grow rich". For managing and evaluating portfolios and prospects. Needs Basic.
- M7029: INTEGRATED ACCOUNTING.** General Ledger, Cash Book, Debtors, Accounts Payable - all on one disk. Excellent system.
- M7031: PERSONAL FINANCE MANAGER.** Manages cheque and credit card a/c's, savings, purchases, withdrawals, interest, budgets.
- M7048: PURCHASE ORDER SYSTEM.** Keeps track of orders, goods received, quantities, prices, suppliers.
- M7055: 3-DIMENSIONAL SPREADSHEET.** Powerful, with the additional feature of calculating for 3 dimensions.
- M7056: APF PROJECT MANAGER.** Compiled, menu-driven set of planning tools. Will quickly generate, store, retrieve and update project schedules. Quality printouts.
- M7057+: SALES INVOICES/ORDERS/INVENTORY PROCESSING.** Integrated order entry, accounts receivable and inventory control system. 2 disks. £18.
- M7058: TURBO LEDGER.** System that allows creation and control of general ledger and subsidiary ledgers (eg drs, crs) through same integrated menu system.
- M7059: HOMELOAN AND MORTGAGE CALCULATIONS.** Gives you changes in term, repayments, etc when variables change.

### DATABASES

- M8009+: SUPER MANAGER** that allows 120 fields, 16 million records, fast sorting, fields anywhere on screen, calculations. two disks. £18. File Express.
- M8013: RELATIONAL DATABASE.** Menu-driven, easy to use. Allows 100 fields, up to 2 billion records, calcs, comparisons.
- M8018: DBASEIII-COMPATIBLE.** Has many similar features to DbaseIII and is compatible with files generated by it. 2 disks. £18.
- M8027: POP-UP MANUAL FOR CLIPPER/DBASEIII.** Call for instant help when you're stuck for correct syntax, etc.
- M8029: DBASEIII BUG FIXES AND HINTS.** Special collection to assist with the anomalies and idiosyncrasies of Dbase.
- M8040+: FAMILY HISTORY SYSTEM.** Accepts 3,500 individuals on floppy or 9,999 on hard disk. Print family tree, various groups. Compiled. 2 disks. £18.

### EDUCATION

- M9001: GWBASIC/BASIC-COMPATIBLE INTERPRETER.** With tutorial. Excellent introduction.
- M9008+: "C" TUTOR.** Two disk set with comprehensive and easily followed course. Needs two drives. If you don't have the C language, we recommend M5046 for use with this tutorial. £18.
- M9018: EDUCATIONAL GAMES FOR PRESCHOOLERS.** Fun with words, letters and numbers.
- M9031: BEGINNERS' TUTORIAL FOR 123.** Introduction to use of popular spreadsheet. For use with this disk and M9032, students should have a copy of 123 or our compatible version on M7040.
- M9032: ADVANCED TUTORIAL FOR 123.** Becoming a more accomplished user of this spreadsheet program.
- M9029+: CHEMISTRY.** Displays structure of electrons orbiting in atoms and molecules. 2 disks. £18.

### GENERAL

- M9504+: RECIPE MANAGEMENT.** Contains hundreds of recipes and has excellent search facilities. 2 disks £18.
- M9518: PIZZA RECIPES.** Collection of hints and recipes for cooking better and more varied pizzas.
- M9519: LIFESTYLE & HEALTH RISK ANALYSIS (2).** Reports health and heart risk appraisal for health professionals.
- M9521: PERSONAL STRATEGIES.** Analyse, plan, understand and act on a specific issue you may face.
- M9522: MODEL DIET.** Has details of many different types of food to assist with dietary planning. Needs Basic.

PHONE NOW WITH YOUR ORDER

# 0344 863020

**SHAREWARE REQUIRED FOR INTERNATIONAL DISTRIBUTION**  
We have extensive marketing and distribution facilities locally and overseas and require quality software for international distribution. Adequate documentation should be on the disk.  
Please forward submissions to our Chief Executive at the address below.

**CP/M AND MACINTOSH**  
Call or write for free catalogue.

**PUBLIC DOMAIN NEWSLETTER**  
For news, views, reviews and how to use public domain and user-supported software subscribe to our quarterly newsletter. Also includes updates to catalogue and monthly news-sheet on new releases (for MS-DOS). Only £12. (VAT not applicable.)

**ORDERS:**  
For individual disks, the first disk is £10, the second £8, the third to fifth disk £6 each, and thereafter £4 each. Sets are as specified. 3 1/2" add £2 per disk.  
Add £2 post/pack (£3 foreign). UK residents add 15% VAT to total.  
**ORDERS MUST BE PREPAID.**

**PAYMENT BY MAIL TO:**  
SELTEC COMPUTER PRODUCTS LTD,  
"Farley Hall", Wokingham Rd, Bracknell,  
Berkshire, RG12 5EU UK.  
**TELEPHONE ORDERS: (0344) 86 3020**  
Pay by Access/Mastercard or Barclay/Visa.  
**AUSTRALIA: (02) 29-4242.**  
**NEW ZEALAND: (054) 84-622.**

We cannot guarantee the suitability of public domain/user-supported software for users' needs or equipment. IC1006

# Chipboards

Specialist suppliers  
of PC Add-on/Interface Cards

## PORTS

PARALLEL PRINTER .....	£19
SERIAL RS-232 .....	£29
2 SERIAL RS-232 .....	£39
SERIAL+PARALLEL .....	£39
2 SERIAL+PARALLEL+GAMES .....	£59
ABOVE + CLOCK/CALENDER ....	£69
2 GAME (JOYSTICK) .....	£19
CLOCK/CALENDER .....	£29
SERIAL+CLOCK/CALENDER .....	£39
2 SERIAL+CLOCK/CALENDER .....	£49

Above prices apply to PC/XT compatible cards.  
For PC/AT compatibility, add £10 per serial port.

4 XENIX .....	£149
6 XENIX (INTELLIGENT) .....	£349
8 XENIX .....	£299

## MEMORY

XT EXPANSION (TO 640K) .....	£39*
384K MULTIFUNCTION .....	£69*
AT 128K (512K TO 640K) .....	£49*
2MB EMS ABOVE .....	£89*
2MB ENHANCED EMS ABOVE .....	£139*
3MB EXTENDED .....	£99*

\* Prices exclude DRAM Memory chips.  
For chip prices, please call.

## GRAPHICS

MONO (HERCULES) .....	£59
COLOUR (CGA) .....	£59
COLOUR + MONO (HERCULES) .....	£89
EGA .....	£119
PEGA .....	£149

Chipboards Limited  
134 Heath Road  
Twickenham  
Middx TW1 4BN

01-744 1087

OTHER ADD-ON CARDS - PLEASE CALL

## AD/DA

8 BIT RESOLUTION .....	£162
12 BIT RESOLUTION .....	£119
14 BIT RESOLUTION .....	£231
16 BIT RESOLUTION .....	£442

## INTERFACES

8255 PROG. DIGITAL I/O .....	£69
GPIO (IEEE 488) .....	£199
SDLC .....	£185
B.S. COMMUNICATION .....	£99
RS-422 .....	£99
DUAL RS-422 .....	£129
4 PORT RS-422 .....	£299
8 PORT RS-422 .....	£570
INDUSTRIAL I/O .....	£235
INTERFACE BREADBOARD .....	£73
EXTENDER + 3 SLOTS .....	£77

## PROGRAMMERS

UNIVERSAL .....	£499
EPROM .....	£163
BPROM .....	£347
8748 .....	£251
8751 .....	£301
PAL .....	£364
IC & MEMORY TESTER .....	£196

Prices exclude carriage and VAT and subject to c.w.o. payment. Please add £3.00 per item carriage charge plus 15% VAT.

Goods supplied against official orders from Government Departments, Educational Establishments and substantial commercial concerns.

Prices subject to change without notice.

12 MONTHS WARRANTY.

# Digital Design and Development Ltd

Interface House, Chelmsford Road, Southgate,  
London N14 4JN

Telephone: 01-886 3668 Telex: 8953742

Interfaces for industrial and scientific applications.

THINKLAB/INLAB multi channel multi function analog/digital input and output system.

GPIS integrated system with 8 channel 12 bit ADC, 4 channel 12 bit DAC, 8 digital inputs and 8 relay controls.

SPEEDLAB fast data capture and control system. Simultaneous sampling on 8 channel, 12 bit resolution ADC, sampling rate 100KHz, 1 Megabyte Ram, 2 channel 12 bit DAC and 16 digital I/O.

3D interfaces are compatible with IBM PC, BBC, Macintosh, etc.



IEEE-488

RS232C

# FREE

SAJANKA COMPUTERS LIMITED HOTLINE: 01-571 9933

14" INFRARED REMOTE CONTROL TANDY COLOUR T.V. WITH EVERY TANDY 4000/3000 AND 1000TX CALL NOW BEFORE YOU MISS IT

## SYSTEMS

<b>Amstrad</b>	
PC 1460 SDMD	£440.00
PC 1640 DDMD	£534.00
PC 1640 DDCC	£650.00
PC 1640 20Mb/Mon	£790.00
PC 1640 20Mb/C	£899.00
PC 1640 SK/ECD	£693.00
PC 1640 DD/ECD	£785.00
PC 1640 20Mb ECD	£999.00
PPC 640 DD/INT. MODEM	£525.00
PPC 512 DD	£470.00

<b>Olivetti</b>	
M240 2X360K	£770.00
M240 360K-20Mb	£1100.00
M240 720K-20Mb	£1100.00
Mono Monitor	£180.00
M15 Laptop	£999.00

Any other please call

<b>Apricot</b>	
Xen-i-286/30Mb EGA Mon S/W	£2370.00
Xen-i-386/30Mb Mono Green	£2399.00
Paper White	£2900.00
Xen-i-386/45Mb/Mono Green	£2999.00
EGA Monitor	£3399.00
Xen-i-385/50Mb Tower System/EGA Monitor/10 Exp. Slots	£3799.00
10 Exp. Slots/Green Monitor	£4450.00
EGA Monitor	£4900.00
Xen-i-286/30Mb EGA Monitor S/W	£1999.00

<b>Epson</b>	
PC Laptop/DD/CGA Comp.	£1112.00
Gem Desktop System/EGA Card/Mono Monitor/Laser Printer	£2799.00

Sharp, Atari, Commodore also available.

## ZENITH COMPUTERS

<b>Zenith Computers</b>	
Z-159 8088 Pro Twin 5.25" FD 1Mb Ram DOS 3.2	£995.00
Z-159 5.25" FD 1Mb Ram DOS 3.2 20Mb Hard Disk	£1295.00
Z-248 80286 512K RAM 5.25" FD 40Mb Hard Disk	£2490.00
Z-248 80286 512K RAM 5.25" FD 20Mb Hard Disk	£1790.00
Z-286 80286 512K RAM Twin 3.5"	£1390.00
Z-286 80286 RAM 3.5" FC 20Mb Hard Disk	£1690.00
Z-286 80286 512K RAM 5.25" FD 20Mb Hard Disk	£1490.00

FOR ANY OTHER PLEASE CALL

<b>LAPTOP RANGE PCs</b>	
<b>Zenith</b>	
Z-181 3.5" FD DOS 3.2 Backlit Super Twist	£1390.00
Z-183 3.5" FD DOS 3.2 LCD Monitor	£1990.00

## DISTRIBUTORS

Parco Monitors (Taiwan)	Call
Starcom Power Supplies	Call
Computer cases for IBM Machines	Call
Laser Jetware Memory Expansion Cards	Call
Jetfont Cartridges	Call

## PRINTERS

<b>Tandy</b>	
4000-720K/80386 Pro. (Mono)	£2995.00
EGA Monitor	£3495.00
1400 Laptop/DD + Modem	£995.00
<b>Amstrad</b>	
LQ 3500	£260.00
DMP 400	£280.00
DMP 3160	£179.00
LQ 5000DI	£360.00
<b>Epson Range</b>	
LQ 800	£452.00
LQ 1000	£588.00
LQ 1050	£666.00
LQ 2500	£799.00
Fujitsu DL 2600	£999.00

## LASER PRINTERS

Fujitsu Luna Laser	£4299.00
HP Laser Jet II	£1450.00
Canon LBP II	£1575.00
Epson GQ3500	£1258.00

## MISCELLANEOUS

<b>Everex Backup Sub Systems</b>	
60Mb SI/1/2 ht-Int.	£810.00
60Mb/QIC 36 Version/Extr.	£899.00
<b>Everex Graphics Cards</b>	
Graphics Delux	£128.00
Graphics Plus	£89.00
Steaming Tape (PS2) Controller	£290.00
Legend Hard Card 20Mb	£321.00
Plus Hard Card 20Mb	£499.00
Laser Jet Memory Expansion Cards 1Mb/Strater	£299.00
Jet Font Cartridge	£140.00
<b>SOFTWARES</b>	
<b>Smart System</b>	
Suite of DM/SS/WP	£380.00
Smart WP/Multiuser	£517.00
Ability Plus	£467.00
D Base II	£125.00
Microsoft Word VB.1	£87.00
	£299.00



# SAJANKA COMPUTERS LTD

4A, RANELAGH ROAD, SOUTHALL, MIDDLESEX, UB1 1DQ  
TLX: 915286 GOGON G FAX: (01) 843 1894 TEL: 01-571 0859 & (0860) 382 474



# Microsoft Works 1.1 - £230

(Excl VAT)

- Spreadsheet - 59 Functions & 5 Number Formats.
- Graphics - Line, Bar, Stacked, Overlay & Pie.
- Word-processor - Mail Merge & Simple Drawing.
- Database - Up to 60 Fields, List or View, 8 Reports.
- Communications - VT100, MacBinary & Xmodem.

## Spreadsheet & Graphics

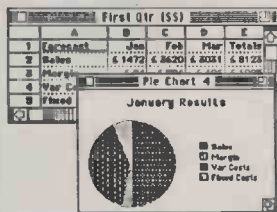

## Communications



Choose TTY, VT100 or VT52

## Database



Display a database entry, then open a WP document, which now holds the required name, address and date. Mail merge with multiple records.

## Word Processing

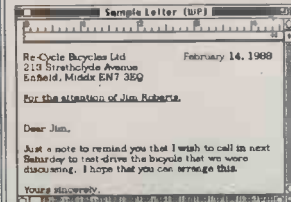

WP facilities include Tabs, Fonts, Styles, Graphics etc.

- Cut & paste between up to 14 open windows.
- UK Version supports '£' & dd/mm/yy date format.
- Spreadsheet functions available in database.

# STIRLING MICROSYSTEMS

The Specialist Centre for Apple Macintosh Systems

231 Baker Street, London NW1 6XE 01-935 5262 Authorized Apple Dealer

# FORTTRANSOFT LTD

PROFESSIONAL SOFTWARE FOR THE IBM PC/XT/AT AND COMPATIBLES, eg. OLIVETTI, COMPAQ, AMSTRAD, OPUS ...

BASIC is fine for short programs and when speed and portability are not important. Besides, you can draw pretty pictures on the screen with BASIC. However, if you are writing large programs and wish to protect all the hours (in some cases years) you spent in writing your software then Fortran comes into its own. Whilst most languages are 'here today - gone tomorrow', Fortran, designed in the late fifties, still remain the dominant language for scientific and general purpose programming today. This means that programs you write today will work tomorrow on future generation of machines with little or no change.

Fortransoft now brings you an affordable ANSI 77 Fortran Compiler. And you can still draw pretty pictures on the screen because the GRAPHKIT library comes with the compiler and is included in the price.

FS-Fortran 77 is now at level 3.17 (with 8087 support) and current users may obtain a copy of the compiler for £2 all incl.

- FS-Fortran 77 with CGA and EGA colour graphics routines..... £34.95 (suitable for PC1512/PC1640)
- FS-Fortran 77 with CGA and Hercules mono graphics routines..... £39.95 (suitable for PC1640 mono graphics)
- FS-Fortran 77 with CGA and Olivetti 640x400 graphic routines..... £39.95
- FS-Fortran 77 with CGA, EGA, VGA and Herc, mono graphics..... £49.95

FS-GRAPHKIT is a comprehensive suite of graphics and sound routines, including routines for drawing lines, circles, ellipses, painting, read/write to port, get time and date, reading a single key from the keyboard, screen dump, etc

FS-GRAPHKIT is available for use with Microsoft Fortran, Lahey Fortran, Ryan McFarland Fortran, IBM Professional Fortran, Lattice C, Zorland C, Prospero Fortran 77, and Microsoft Optimising Compiler. (Please specify which compiler when ordering).

- CGA and EGA colour graphics..... £19.95
- CGA and Hercules mono graphics..... £24.95
- CGA and Olivetti 640x400 graphics..... £24.95
- CGA, EGA VGA and Hercules mono graphics..... £34.95

FS-Sortmerge is a suite of Fortran-callable routines for sorting/merging an unlimited number of records on multiple keys. Any combination of alphabetic and numeric keys may be specified.

- FS-Sortmerge for FS-Fortran 77 Compiler..... £24.95
- FS-Sortmerge for Microsoft Fortran Compiler..... £24.95
- FS-Sortmerge for Ryan McFarland/IBM Professional Fortran..... £24.95
- FS-Sortmerge for Prospero Fortran77..... £29.95

Fortransoft acknowledges all trademarks and registered names in this advert. Please indicate Compiler and Computer type when ordering. All prices include packing, postage and VAT. Please add £3 for delivery outside Europe. All software comes on 5.25" 360K/1.2M (please specify). COD's and purchase orders are NOT accepted. Overseas dealer enquiries welcome. Send cheque with order to: (or write for further details)

## FORTTRANSOFT LTD

60 HARNESS WAY, ST. ALBANS HERTS AL4 9HB.

(Tel: (0727) 32409)

# Morgan

Morgan Industries are Europe's leading traders in manufacturers' surplus, second-user, bankrupt and liquidation PC equipment.

As well as corporate purchasing and sales on an international scale, we operate the two Morgan Computer Co. retail stores in central London.

Exceptional opportunities in our fast-growing company are open to young sales and technical staff.

Phone Tom Willet, Manager,  
Morgan Computer Co.  
01-636 1138.

# 'COMPUTEREYES'

## VIDEO IMAGE CAPTURE



COMPUTEREYES is a low cost, high resolution, professional image capture system which will digitise and store on disc images from any video source, including camera, video recorder, video disc and TV. Versions are available for:

- PC and compatibles: half size board, supports CGA and EGA 640 x 350..... £249
- use in PC paintbrush, ventura, Pagemaker..... £129
- Apple IIGS, IIe and II+ plug in board Also IIc..... £29
- Software for double hi-res and image processing..... £19
- IIGS software for 320 x 200 resolution, 16 grey levels..... £19
- Atari ST 640 x 400 in high resolution mode..... £149
- Commodore 64/128..... £99
- Atari 800/800X/130..... £79

(Prices exclude VAT and carriage at £3.45)

\* Complete systems available including high quality b/w camera and connecting cable be provided to order.

\* COMPUTEREYES software is menu driven and modular, allowing personal customisation of programs. Where appropriate, software is available to modify images for compatibility with popular graphics packages.

\* Applications include graphic art, pattern recognition, spatial measurements, desktop publishing, education, information technology, entertainment, etc.

# Stem Computing

3 Blackness Avenue, Dundee DD2 1ER Tel: 0382 65113

**A300**



**300 dots per inch (DPI)**  
**Flat Bed to scan bound documents**  
**GEM-scan & PC interface card £149**  
**OCR Software for character recognition £149**  
**Pentax A300 Scanner £799**  
**Prices DO NOT include VAT**  
**Please add £15 carriage and VAT**

**CITADEL PRODUCTS LIMITED**  
 Dept. PCW, 50 High Street  
 Edgware, Middx HA8 7EP  
 Telephone: 01-951 1848



**EPROM AND PAL PROGRAMMERS**

EW901	EPROM prog., Single gang, 2716 to 27512, 12.5v to 25v	£129
EW904	EPROM prog., 4 gang, as above.	199
EW910	EPROM prog., 10 gang, as above.	299
PAW401	PAL prog., MMI, TI & NS 20 & 24 pin types.	275
UPW48	8748/9, 8741/2, Eprom Vers. of Intel UPI-41/42, MCS-48/49.	179

**ASAHI PENTAX SCANNER**

A300	Pentax (CPscan) Desk Top Image or OCR Scanner, 300dpi, Flat-bed.	£799
PC300	PC interface card, cable & GEM-Scan software	149
CR300	Character recognition software, self learning.	149

The model A300 scanner is the result of a joint development of Asahi Optical Company (PENTAX) and Citadel Products. It is the first flat bed image scanner to sell in the UK for under £1,000.

The flat glass platen makes scanning original objects from the size of less than a postage stamp to an A4 page very simple. The advanced Pentax lens design gives a large depth of field to pick out features of not completely flat objects.

**INDUSTRIAL CONTROL CARDS**

PC14	8255 IO process controller. 48 IO lines and 8253 timer.	58
PC31	RS232 8 ports, D25 connectors. Ideal for use with Multilink or Microport Unix	239
PC26	12 bit A to D converter. 30Khz high speed. 16 channel input.	193
PC30	As above with 2 x 8 bit & 2 x 12 bit D to A. 24 IO x lines	314
PC39	As PC30 with DMA. Sampling to 80Khz.	425
PC22	Pre-Amp, Allpass/Low/High filters for PC26, PC30 and PC39.	280

**CARRIAGE PACKING AND INSURANCE**

All orders under £250 please add £5 (plus VAT).  
 All orders over £250 please add £15 (plus VAT).  
 Prices DO NOT include VAT.  
 ACCESS OR C.W.O. (Official Orders over £100 welcome)

Dept. PCW.  
 CITADEL PRODUCTS LTD  
 50 HIGH ST., EDGWARE,  
 MIDDX., HA8 7EP  
 Tel: 01-951 1848



Citadel's upgrades and components for the IBM PC range and compatibles have the quality that comes from a quarter of a century experience in electronics

In widespread use throughout industry, these parts have earned their reputation for performance and reliability

**CITADEL PRODUCTS LIMITED**  
 50 High Street,  
 Edgware, Middx. HA8 7EP  
 Telephone: 01-951 1848

## POPULAR EXAMPLES FROM OUR EXTENSIVE RANGE

### INTERFACE CARDS

EGA860	Genoa chipset, super EGA high res., 800 x 600 pixel	£199
PC21	Mono/Graphics/Printer port. Hercules compatible. Short card.	54
EGA	EGA with 256K ram. For use with Mono/Colour Graphics/EGA.	99
PC13	RS232 SINGLE port, D25 connector. COM1/COM2/COM3.	28
PC12	RS232 DUAL ports, D25 connectors. COM1/COM2/COM3/COM4.	49
PC1	RS232/Clock/Calendar, (XT only) Battery backup, COM1/COM2.	39
PC3	IO Plus 2. Clock/Calendar/Serial/Printer/Games (XT only).	69
PC5	Multi IO. As above with Floppy disc controller.	79
PC10	2Mb AT multifunct. IDEAL OS/2. Serial/Parallel, nil ram fitted.	129
PC4	Memory card for XT with 384k memory.	135
EMS2	EMS memory card for XT with 0k memory.	129
256K	512k memory for above (18 x 256k 150ns DRAMs)	99
KS1638	FAX Card. Internal 9600 baud with software (NOT approved).	549
1200C	V22 Modem. 1200/1200 Full Duplex, Short Card, (NOT approved).	99

### TRANS-NET LOCAL AREA NETWORK ADAPTOR - Price per node **£149**

TR-1000 1 Mbit/Sec, Twisted/Pair, Ideal for sharing printers, hard disks, etc.

\*\*\*\* NEW SHORT CARD \*\*\*\*

\*\*\*\* FREE FILE SERVER SOFTWARE \*\*\*\*

This card features an on-board processor and advanced data link controller giving a true 1 Megabit per second transfer rate unlike software driven networks.

### UPGRADE, SPARES AND COMPONENTS

GM6	Genius Mouse and utility software. Microsoft and PC mouse compatible	48
PC7002	XT Motherboard, 4.77/10Mhz, NEC V20, 256K ram	169
PC3001B	XT Motherboard. Directly replaces XT Board, 6/10 Mhz, 80286, 512k ram. Special Bios with built in setup which supports 3 1/2" drives up to 1.44 Mbyte	499
PS7025	150W XT Power supply. IBM compatible connectors.	79
PS7030	200W AT Power supply. IBM compatible connectors.	124
D357K	3 1/2", 720K Floppy disc drive in 5 1/4" frame (Fits XT/AT etc).	129
F-502	360K 5 1/4" Floppy disc drive for XT, AT, etc...	79
F-506	1.2Mb 5 1/4" Floppy disc drive for XT, AT, etc...	99
PC3003	Floppy controller for XT or AT (360K, 720K, 1.2Mb & 1.4Mb).	79
K102	Keyboard, IBM enhanced, XT/AT, 102 key, UK layout (US available).	59
K8AX	Keyboard, IBM AT style, XT/AT, 84 keys.	59

### CARRIAGE PACKING AND INSURANCE

All orders under £250 please add £5 (plus VAT).  
 All orders over £250 please add £15 (plus VAT).  
 Prices DO NOT include VAT.  
 ACCESS OR C.W.O. (Official Orders over £100 welcome)

Dept. PCW  
**CITADEL PRODUCTS LTD**  
 50 HIGH ST., EDGWARE,  
 MIDDX., HA8 7EP  
 Tel: 01-951 1848

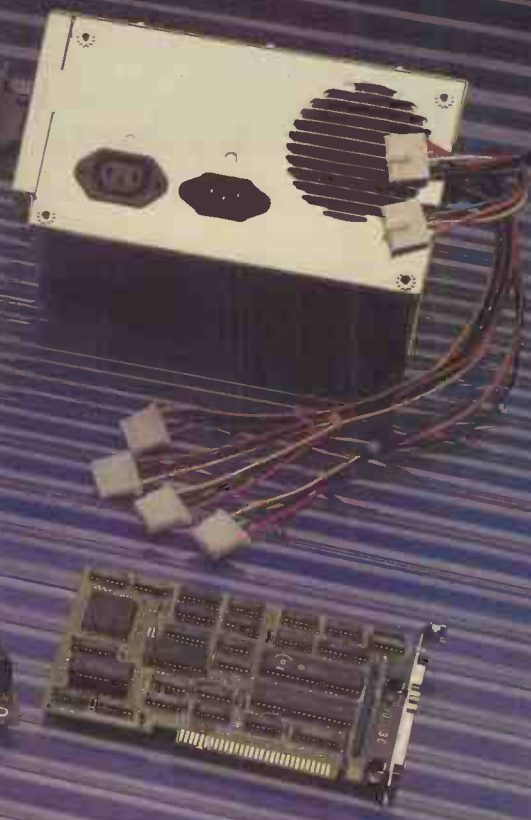

### 3 1/2" → ← 5 1/4" SOFTWARE TRANSFER

#### 3 1/2" Internal upgrade for IBM PC's and Compatibles

To read by the stream of press releases that come into the PCW editorial office, you'd think that making a PS/2-compatible machine required no more than taking an ordinary PC-compatible and fitting it with 3 1/2" disk drives.

To our rescue has come a wonderful product from Citadel — a £129 3 1/2" floppy disk drive in a 5 1/4" format chassis that slips into a spare drive slot on a PC and uses standard power and data cables.

Fitting the drive into my AT-compatible proved to be no problem. Getting the machine to format disks correctly proved more difficult. Although DOS said that there was 720k of available space on a newly-formatted disk placed in what I referred to as drive B: no other 3 1/2" disk drive would recognise the disk.



To the rescue came Citadel, who gave the following explanation:

When you format a disk under DOS, the program looks in the BIOS to see what format the disk should be. Even altering the CMOS set-up on an AT doesn't affect this process. The default for drive B: is 360k and this is what it happily does.

Using a program like PC Tools to format disks shows what is really going on as, for my newly-installed drive, it only gave 160k, 180k, 320k and 360k as possible capacities.

The trick is to use DRIVER.SYS which is supplied with DOS versions 3.2 onwards. This installs extra 'logical' drives whose parameters can be specified in your CONFIG.SYS file.

Inserting the line 'DEVICE=DRIVER.SYS/D:1' into my CONFIG.SYS produced a message at boot-up time to the effect that external drive E: had been installed. I then loaded up PC Tools and it informed me that drive E: can be formatted in just one way — to 720k. As long as I access the 3 1/2" drive as E: rather than B: I now have no problems with any DOS operation.

D. COHEN

(Reprinted from PCW December 1987)

# TECHNOMATIC

17 Burnley Road, London NW10 1ED Tel: 01-208 1177

305 Edgware Road, London W2 Tel: 01-723 0233

## Meta-Dyne

### ★ Hi Performance ★ Fast Speed ★ Dynamic Speed Switching

#### 286 AT SYSTEM

- ★80286-12 MHz CPU ★1Mb RAM
- ★80287 Co Proc Socket ★8 Expansion Slots
- ★12.5/8 MHz speeds: software/hardware switched
- ★Mono or Colour Graphics Adaptor
- ★1 × 1.2Mb floppy ★1 × 20 or 40Mb winchester
- ★One parallel/One Serial (+1 optional) ports
- ★Real Time Clock/Calendar with battery
- ★101 Key enhanced Keyboard
- ★200 watt power supply
- ★12" Hi Res Green Screen Monitor
- ★MS DOS 3.21 & GW BASIC
- ★Genius GM6+ Mouse with software

Meta Dyne AT 12MHz, 1Mb RAM, 20Mb HD	
Specification as above	£1240
Meta Dyne at 12MHz, 1Mb RAM, 40Mb HD	
Specification as above	£1360
Meta Dyne AT 10MHz, 1Mb RAM, 20Mb HD	
Specification as above	£1175
Carriage/System	£20

Alternative configurations: EGA, EMS RAM, larger winchesters etc on request.

#### 386 AT SYSTEM

- ★80386-16 MHz CPU ★512K RAM
- ★80387 Co Processor Socket
- ★8 Expansion slots including 2 slots for hi speed 32 bit RAM
- ★Mono or Colour Graphics Adaptor
- ★1 × 1.2Mb floppy ★1 × 40Mb hard drive
- ★One parallel & 1 Serial Port
- ★Real Time Clock/Calendar with battery
- ★101 Key enhanced Keyboard
- ★12" Hi Res Green Screen Monitor
- ★MS-DOS 3.21 & GW BASIC

Meta Dyne 386 System	£1779
Specification as above	
Carriage	£20
2Mb 32 bit RAM board	£465

Alternative configurations: EGA, larger Winchesters etc on request

#### PC-XT SYSTEM

- ★V20-CPU
- ★704K RAM
- ★8087 Co Proc Socket
- ★8 Expansion slots
- ★10/4.77 MHz speeds: software/hardware switchable
- ★1 × 360K floppy
- ★1 × 20Mb winchester
- ★1 parallel/1 serial (+1 optional) ports
- ★Real Time Clock/Calendar with battery
- ★84 Key keyboard
- ★150 watt power supply
- ★12" Hi Res Green Screen Monitor
- ★MS DOS 3.21 & GW BASIC
- ★Genius GM6+ Mouse + software

Meta Dyne Hi-Mem 10MHz 704K XT 20Mb HD	
Specification as above	£829
Meta Dyne Hi-Mem 10MHz 704K XT 30Mb HD	
Specification as above	£879
Meta Dyne Hi-Mem 10MHz 704K PC	
PC Dual Floppy System	£709
Carriage/System	£16

Alternative configurations on request

#### What is Dynamic Speed Switching (DSS)

A system operating in Turbo mode will also interface with all add-on cards at turbo speed. Most of the add-on cards are designed for standard speed. This creates a clock conflict and occasional unexplained parity errors. DSS avoids this problem by slowing down the clock automatically to standard speed whenever interfacing with the add-on cards allowing use of all standard cards.

#### Basis for spec & price comparison

1. Every system claims to be fast, however: is the system CPU rated for the fast speed or has the cheaper option of using only the higher frequency crystal to speed up the clock been used. Faster cpu's cost considerably more.
2. Specifying large RAM capacity sounds good but how much RAM is actually installed. RAM cost is high and how much would it cost to achieve the full capacity. Is the RAM speed compatible with the Turbo speed. Slower RAMs cost a lot less.
3. Finally a point in our favour - is the system capable of Dynamic switching or would you accept a possibility of occasional parity error.



\*All prices subject to change  
\*Prices exclude VAT.

All systems carry a full 12 month return to base warranty.

Nationwide on-site maintenance contracts available.



**MAILORDER & RETAIL**  
 17 Burnley Road  
 London NW10 1ED  
 Tel: 01-208 1177  
 Fax: 01-452 1500 Telex: 922800  
 West End Branch  
 305 Edgware Road, London W2  
 Tel: 01-723 0233, 01-402 0444

Visit our  
 Edgware Road shop  
 for demonstrations.

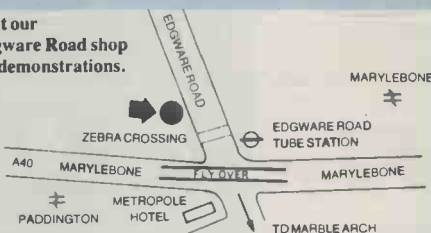

For fast delivery telephone  
 your order on 01-208 1177  
 using VISA/Access Card



Orders welcome from  
 government depts &  
 educational establishments

All prices ex VAT.  
 Prices are subject to  
 change without notice  
 Please add carriage  
 (a) £8.00 (Courier)  
 (b) £2.50  
 (c) £1.50  
 (d) £1.00

## INTERFACE CARDS

### XT CARDS

Monochrome Graphics Card (short) Includes parallel port	£49(b)
Colour Graphics Card (short) 2 video interfaces: RGB col and composite mono, & parallel printer port	£49(b)
480 Auto Switch EGA Card (Short) 256K RAM, compatible with CGA, MGA & EGA.	£179(b)
Super EGA Card (short)	£199(b)
Super Multi Display I/O Card Ideal for all XT's Colour/Mono Display, Parallel/Serial/Games Port, Real Time Clock, 2 x 360K FD controller, Mouse interface	£139(b)
Multi I/O Card 2 x FD Controller, 1 parallel, 1 serial, 2nd serial port, opt. clock/calendar battery.	£69(b)
Real Time Clock/Calendar with battery back up	£29(b)
Parallel Printer Port	£19(c)
Async. Serial Card 1 serial port fitted option for 2nd port	£29(c)
2nd Port Kit with cable	£22(c)
COM 2 Card 1 Serial Port	£29(c)
Floppy Drive Controller	£39(c)
Memory Expansion Card OK with 384K	£39(c) POA (c)
with 512K	£39(c) POA (c)

### AT CARDS

Hard/Floppy Drive Controller	£139(b)
2Mb Multi Function Card 1 Parallel/1 Serial/1 Optional Serial Ports	£139(b)
2MB	POA (b)
2Mb EMS Card OK	£179(b)
2Mb	POA (b)
Dual I/O Card 1 Parallel/1 Serial/1 opt Serial Ports	£59(b)
Multi Serial Card 4 RS232 Ports	£149(b)
<i>New additions to our range: Full details on request:</i>	
8255 I/O Card	£64(b)
IEEE 488	£229(b)
12 bit AD/DA Card	£99(b)
14 bit AD/DA Card	£239(b)

## CO PROCESSORS

8087-5MHz	£120(b)	8087-8MHz	£135(b)
8087-10MHz	£199(b)		
80287-6MHz	£150(b)	80287-8MHz	£220(b)
80287-10MHz	£260(b)		
V20-5MHz (8088)	£10(d)	V20-8MHz	£12(d)
V30-5MHz (8086)	£10(d)	V30-8MHz	£12(d)

## TAPE STREAMERS

Irwin 20Mb Int. (AT&XT)	£375(b)
Irwin 20Mb Ext. (AT&XT)	£375(b)
Irwin 40Mb Int. (AT&XT)	£415(b)
Irwin 40Mb Ext. (AT&XT)	£415(b)
Everex Stream 2020Mb int.	£585(b)
Everex Stream 6060Mb int.	£839(b)

## AMSTRAD 1640 PCs

PC1640 DD/EC	(2x a)
PC1640 HD/EC	(2x a)
PC1640 DD/CM	(2x a)
PC1640 DD/MM	(2x a)

Special Pricing on Amstrad PCs fitted with our own hard drives. All systems fully guaranteed for one year. Ask for our detailed pricing on Amstrad range.

## POINTING DEVICES

MicroSoft Mouse Ver 6.1 compatible with PS2 System	
Bus Version	£129(b)
Serial Version	£145(b)
MS PS2 Mouse	£169(b)
Genius Mouse GM6+	£59(b)
Logimouse (AT serial)	£76(c)
Logimouse PC/XT Adaptor	£6
RB2/CAD 5 Tracker Ball	£175(a)

## LOCAL AREA NETWORK

ETHERNET based RPTI-NET 10 Megabit/sec, 1024 users, 2.5Km spread	
ATR001 Intelligent Adaptor	£300(b)
ATR002 Cluster Kit (terminators & 5m thin cable)	£22(c)
ATR003 Starter Kit (2 x ATR001 + 1 x ATR002)	£620(a)
ATR Utilities Disc	£49(c)
TRANS-NET 1 Megabit/sec, 254 users, 1.2Km spread	
TR001 Trans-Net Adaptor	£139(b)
TR002 Cluster Kit	£28(c)
TR003 Starter Kit	£295(a)
TR006 Bus Repeater	£45(c)
Filer Server Software	£85(b)

Full details and specifications on request

## MONITORS

### Monochrome 12" Composite Input

Philips 7502 Green	£69(a)
Philips 7522 Amber	£75(a)

### Monochrome TTL Input

Philips 7513 12" Green	£85(a)
Samsung MD1252 12" Green T/S	£95(a)
Samsung MD1258G 12" Amber T/S	£95(a)
VM1400 14" Amber T/S	£115(a)

### RGB

Philips 8833 14"	£249(a)
Taxan Super Vision 620 12"	£269(a)
Taxan Super Vision 625 12"	£319(a)
Sanyo CRT70 Hi Res 14"	£169(a)

### EGA

ECM5400 14" Monitor	£375(a)
Taxan IV 1V12" (inc controller)	£329(a)
Taxan SV 760 14"	£439(a)
Taxan SV770 + 14" Multiscan TS	£499(a)
Taxan SV860 16" T/S	£675(a)
NEC Multisync II 14" T/S	£489(a)
Mitsubishi 1440 14"	£399(a)

T/S indicates Tilt & Swivel stand

### DTP MONITORS

Wyse 700 (1280 x 800)	£775(a)
Genius A4 (736 x 1008)	£975(a)
Viking I 19" (1280 x 960)	£1895(a)

## PRINTERS

### DOT MATRIX RANGE

<b>EPSON</b>			
LX800	£180(a)	FX1000	£405(a)
FX800	£299(a)	EX1000	£549(a)
EX800	£409(a)	LQ850	£449(a)
LQ800	£399(a)	LQ1050	£589(a)
LQ500	£329(a)		
<b>TAXAN</b>			
KP815	£249(a)	KP915	£349(a)
National Panasonic KXP1081			£149(a)
National Panasonic KXP1082			£169(a)
Star LC10 Parallel I/face			£195(a)

### DAISY WHEEL PRINTERS

JUKI 6100	£259(a)
Brother HR20 (Dual I/face)	£329(a)
National Panasonic KXP3131 (38K Buffer)	£249(a)
Integrex Inkjet Colour Printer	£549(a)

### LASER PRINTERS

Epson GQ3500	£1245(a)
Canon LBP8	£1625(a)

### PLOTTERS

Hitachi 672XD A34 pen	£490(a)
HP-GL Compatible, high speed, high precision	
Roland DXY880A A38 pen	£599(a)
Roland DXY980A A38 pen	£875(a)
PC Parallel Printer Lead (2m) (Longer Lengths available)	£9(a)

### BUFFERS & SHARERS

#### PB128 Buffer

Internal buffer suitable for Epson printers. No cables, easy to instal. Full instructions supplied. £89(a)

#### TSB 256 Auto Sharer/Buffer

256K buffer with 3 input ports. Each port scanned automatically every 10 secs until data found. PAUSE, COPY and RESET Facilities. Full spec on request. £199(a)

#### Printer Sharers:

(All lines are switched).	Parallel	Serial
2 computers to one printer	£25(c)	£25(c)
3 computers to one printer	£39(c)	£39(c)
4 computers to one printer	£45(c)	£45(c)
2 computers to 1 or 2 printers	£49(c)	£49(c)

Cable sets for above sharers available for all popular computers

## WINCHESTER & FLOPPY DRIVES

Seagate ST225 20Mb 65ms	£195(b)
Seagate ST238 30Mb + Kit (XT)	£279(a)
Miniscribe 3425P 20Mb 55ms	£199(b)
Miniscribe 3425 30Mb + Kit (XT)	£279(a)
Seagate ST251 40MB (Fast 28ms)	£395(b)
Seagate ST251 40Mb (40ms)	£349(b)
Hitachi DC521 40Mb (24ms)	£479(b)
Seagate ST4096 70Mb (f.ht/28ms)	£789(a)
Miniscribe 32Mb file card	£259(a)
WD WX1 Controller + Cables (XT)	£69(c)
Hard Drive Cable set (XTorAT)	£12(c)
5.25" 360K 48TPI DS Drive	£89(b)
5.25" 1.2Mb Drive	£119(b)
3.5" 720K Drive with 5.25" kit	£99(b)

**MAIL ORDER & RETAIL**  
 17 Burnley Road  
 London NW10 1ED  
 Tel: 01-208 1177  
 Fax: 01-452 1500 Telex: 922800  
 West End Branch  
 305 Edgware Road, London W2  
 Tel: 01-723 0233, 01-402 0444

Visit our  
 Edgware Road shop  
 for demonstrations.

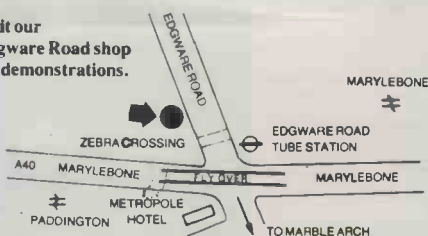

For fast delivery telephone  
 your order on 01-208 1177  
 using VISA/Access Card



Orders welcome from  
 government depts &  
 educational establishments

All prices ex VAT.  
 Prices are subject to  
 change without notice  
 Please add carriage  
 (a) £8.00 (Courier)  
 (b) £2.50  
 (c) £1.50  
 (d) £1.00

**INTEGRATED PACKAGES**

Smart System v3.1	£385(a)
Framework II v1.1	£325(a)
Symphony Ver 2.0	£409(a)
Open Access II v2.0	£355(a)
Ability Plus	£129(c)
Lotus 1-2-3 v2.01	£245(a)

**WORD PROCESSORS**

MS Word v4.0-NEW-	£275(a)
MS Word Lanpack	£710(a)
Multimate Advantage II	£320(a)
Multimate Advantage Lanpack	£810(a)
Multimate Advantage Add. Users	£225(a)
Word Perfect v4.2	£235(a)
Word Perfect Network Server	£690(a)
Word Perfect Add. Users	£130(a)
Wordstar Professional 4	£199(a)
Wordstar Professional Lanpack	£450(a)
Wordstar Prof. Educational Master	£140(a)
Wordstar Prof. Edu. (add label, min 5)	£98(a)

**DATABASES**

DBase III Plus v1.1-Free utilities-	£370(a)
DBase III Plus Lan-5 users-	£950(a)
DBXL	£90(b)
Quicksilver	£365(a)
Clipper - autumn 86	£365(a)
Foxbase Plus	£350(a)

**SPREADSHEETS**

MS Excel-NEW-	£310(a)
Logistix	£85(c)
Supercalc 4	£219(b)
QUATTRO-NEW-	£99(b)
Planperfect	£285(a)

**LOTUS RANGE**

Manuscript	£250(b)
HAL	£89(c)
Freelance Plus	£255(b)
Metro	£60(c)
Symphony Ver 2.0	£409(a)

**DISCS & CARTRIDGES**

5.25" DISCS (In packs of 10)	
3M 744 48TPI SSDD	£8.50(d)
3M 745 48TPI DSDD	£9.50(d)
3M 747 96TPI DSDD	£12.50(d)
3M 1.6M HD for AT	£22.00(d)
Dysan 48TPI SSDD	£8.50(d)
Dysan 48TPI DSDD	£11.00(d)
Dysan 96TPI DSDD	£14.00(d)
Dysan 1.6Mb HD for AT	£16.00(d)

**FREE**  
 Leather bound  
 Personal Organiser  
 with every 50  
 3M Discs

3.5" DISCS (in packs of 10)	
3M 135TPI SS	£13(d)
3M 135TPI DS	£15(d)
3M 135TPI HD for PS/2	£40(d)
JVC 135TPI DS	£16(d)
Sony 135TPI HD for PS/2	£40(d)

**BULK DISCS**

50 discs are supplied in lockable disc storage box	
5.25" 48TPI DSDD (incl sleeves)	£36(b)
3.5" 135TPI DS	£60(b)

**BUSINESS SOFTWARE**  
 (UK sourced - no grey imports)

**BUDGET INDISPENSABLES**

Ability 1.2e	£55(c)
PC-Four	£60(c)
VP-Planner	£60(c)
VP-Info	£60(c)
VP-Expert	£60(c)
Wordstar 1512	£59(b)
DBase II 1512	£95(b)

**UTILITIES**

Calendar Creator Plus	£32(d)
Computer Checkup	£39(d)
Copy II PC	£35(c)
Dos Director	£35(d)
Fastback	£125(c)
Fileclerk	£25(d)
Forms on File	£45(d)
Grid Designer	£32(d)
Labels Unlimited	£32(d)
Learning DOS	£24(c)
Norton Utilities v4.0	£53(c)
Norton Adv. Utils.	£80(b)
Norton Commander	£36(c)
Printing Press	£32(d)
Sign Designer	£32(d)
Widespread	£32(d)
Xtree v2.0	£49(c)

**BORLAND SOFTWARE**

QUATTRO-NEW-	£99(b)
Turbo C v1.5-NEW-	£47(b)
Turbo Basic	£45(b)
Turbo Basic Database Toolbox	£45(b)
Turbo Prolog	£42.50(b)
Turbo Prolog Toolbox	£45(b)
Turbo Pascal v4.0	£50(b)

**All Pascal v3.0 products at 25% off the RRP!**  
 Eureka! The Solver £75(b)  
 Sidekick £42.50(b)  
 SuperKey £42.50(b)  
**Full Borland range in stock.**

**DESKTOP PUBLISHING**

GEM DTP-inc. Desktop-	£225(b)
Page Ability	£159(b)
Page-Maker	£495(a)
Ventura Publisher	£549(a)

**LANGUAGES & O.S.**

MS Basic interpreter	£210(b)
MS QuickBasic v4.0-NEW-	£65(c)
MS C Compiler v5.0-NEW-	£250(a)
MS Cobol Compiler v4.0	£420(a)
MS Fortran v4.01	£290(a)
MS Macro Assembler v5.0-NEW-	£90(b)
MS Windows 2-NEW-	£72(c)
Zortech C-inc. Linker-	£25(d)
Zortech Power Pack	£52(c)
RM/Fortran 77-inc. Forte-	£380(a)

**PROFESSIONAL CAD**

Autosketch	£69(d)
AutoCAD basic v9	£300(a)
AutoCAD ADE 1& 3 v2.6	£2500(a)
AutoCAD complete-Education-	£500(a)
DesignCAD-formerly Pro-Design-	£245(b)
DesignCAD 3D	£299(b)

**ACCOUNTING**

Book Keeper	£80(b)
Accountant	£115(b)
Accountant Plus	£160(b)
Financial Controller	£225(b)
Payroll	£70(b)
Account-Ability	£89(b)

**MISCELLANEOUS**

Chess	£24(c)
Elite	£24(c)
Flight Simulator	£39(c)
MS Project	£220(b)
Super Project Plus	£280(b)

**GENIUS MOUSE**  
 GM6 Plus

*Introduces a new dimension at your fingertips*  
**One Mouse for all your applications software**  
*Extensive software included.*  
**Fully compatible with Microsoft Mouse and Mouse System Mouse.**

Genius mouse with solid state electronics and optical technology offers most reliability, accuracy and precision. Programmable resolution (22 to 200 dti or 0.12 to 1.08mm dot) allows you to set the cursor movement to suit your personal requirement.

Genius menu maker allows you to link the mouse with any application software with pop up menus. Use of pop up menus at every stage of operation improves the productivity considerably and the menu maker lets you create these with ease and flexibility to suit your style. Over 20 pre configured menus for some of the popular packages are included in the menu library. These menus can be edited as required.

Dr Halo III, the professional graphics and slide show software included with GM6 plus allows you to create sophisticated graphics and then merge them into a slide presentation. Features include: 256 colour type, cut, copy and store, multiple choice fonts, CGA, EGA, Hercules, PGA and

VGA displays, large selection of printer and plotter drivers, true colour or grey scales, move or cut irregular shapes non destructively, mix your own colours and virtual page in all modes and many others.

In addition to above GM6 plus is supplied with a high quality attractive mouse pad and a fixed mouse pocket to store the mouse when not in use.

**GM6 plus for only £59(b)**

We can only show a small range of the products stocked by Technomatic in this advertisement. If you would like further information, please indicate your interest by ticking the appropriate box and we will send you a brochure.

Meta-Dyne     Software     Modems  
 Printers     Monitors     BBC Systems

NAME \_\_\_\_\_  
 ADDRESS \_\_\_\_\_  
 \_\_\_\_\_  
 POST CODE \_\_\_\_\_

Return to Technomatic Ltd 17 Burnley Road,  
 London NW10 1ED    PCW 5/88





# ZELLARCH

## SYSTEMS ■ LIMITED

16 Barnton Park Grove, Edinburgh, EH4 6HG  
031 336 4751/031 312 6333

## The Logical Choice!

A free Bottle of champagne with every system

<b>COMPAQ®</b>		<b>AMSTRAD</b>	
286 Model 20.....£POA	PC/S 286 30MB	9512.....£445	Eazy PC + Monitor SD
386 Model 30.....£POA	Mono .....£1699	1 640 Mono SD .....£450	Mono.....£450
386 Model 40.....£POA	VGA .....£2500	DD .....£539	DD Mono .....£540
386 Portable 20MHz £POA	Xen 386 30MB Mono £2999	20MB .....£689	20MB Mono.....£764
Complete Range now in Stock	EGA.....£3177	1 640 CGA SD .....£599	Z286 20MB +
	Tower systems now available	DD .....£680	1 x 5.25" DD.....£1800
		20MB .....£932	
		1 640 ECD 20 .....£949	
		Complete Range now in Stock	

8 hour 8% hardware maintenance contracts

<b>Utilities</b>	<b>Backup</b>	<b>Database</b>	<b>Comms/Telex/Fax</b>
Qdos II .....£75	Fastback .....£150	Paradox II.....£340	Procom 20 Internal
Sidèkick .....£43	Backkit .....£89	Dbase III+inc. prog utils £299	PC Telex Card.....£850
Copy IIPC.....£37	Cipher 5400 60MB PS/2	Reflex .....£56	CFAX PC Internal Fax Card
Sideways.....£34	only.....£899	Rbase System .....£499	any screen image ie
CTools.....£89	Tecmar QT-40 external £590	Advanced Revelation ....£599	Lotus 123.....£1195
Norton.....£49	Irwin 20MB.....£500	Cardbox+ .....£255	Dowty Telex.....£900
Adv Norton .....£99		Smart .....£399	Full PACE, MIRACLE, DOWTY,
SQZ.....£68		Rapidfile .....£199	and GANDALF range stocked

## Free Hotline support on all products!

<b>Accounts</b>	<b>Books/Tutors</b>	<b>Spreadsheet</b>	<b>Lasers</b>
Sage Controller.....£249	Using 123 .....£21	Lotus 123.....£229	Epson GQ3500 6ppm £1349
Accountant.....£125	Using Netware .....£22	Javelin .....£84	Kyocera F1000
Payroll.....£67	Networking the IBM	Quattro .....£120	10ppm .....£1880
Payroll 2 .....£110	PC/AT.....£18	Supercalc4.....£220	H.P. Laserjet II 8ppm.....£2085
ABC .....£140	Advanced Dbase III+ .....£22	Excel .....£268	AST Turbo 10ppm.....£2585
SNIP .....£280	The SQL standard.....£25	Multiplan .....£106	Dataproduct LZR 2600
Multisoft.....£270	OVER 300 TITLES	PC Planner.....£79	26ppm .....£11000

We also stock Epson, Tandon, Qume, Olivetti, Canon, Dataproducts, NEC, Oki, Ricoh, Taxan, Dowty, Orchid, AST, Acorn, H.P., 3Com, Novell etc, etc...

# TOSHIBA

## PORTABLE POWER

*A range of IBM Compatible Computers to match the needs of today's Executive on the move*

Available from Da Vinci Computers Ltd. Comprehensive service includes: Consultancy, Demonstrations and Hotline support



**T1000**  
*Portable PC*

### SPECIFICATIONS

T1000: 8088 4.77MHz, 512k RAM Exp to 1.2Mb, 720k Floppy, Supertwist LCD, Ser/Par MS DOS 2.11 in ROM, 6.5 Lbs



**T1100 +**  
*Desktop Portable*

T1100+: 8086 8MHz, 640k RAM 2 x 720k Floppy Supertwist LCD Ser/Par, 8 hour battery, MS DOS 3.2, 10 Lbs.



**T1200**  
*Portable Desktop*

T1200: 8086 9.54MHz, 1Mb RAM, 20Mb Hard Disk, 720k Floppy, Supertwist LCD, Ser/Par, 8 hour battery, MS DOS 3.2, 10 Lbs.



**T3100/20**  
*Desktop Portable AT*

T3100/20: 80286 8MHz, 640k RAM, 20Mb Hard Disk, 720k Floppy, Plasma Display (640x400), Ser/Par, MS DOS 3.2, 15 Lbs.



**T3200**  
*Portable AT*

T3200: 80286 12MHz, 1Mb RAM, 40Mb Hard Disk, 720k Floppy, Plasma Display (720x400, EGA, CGA), 2 IBM Expansion Slots, 80287 Socket, Ser/Par, MS DOS 3.2, 18.7 Lbs.



**T5100**  
*Portable 386*

T5100: 80386 16MHz, 2Mb RAM, 40Mb Hard Disk (29ms) 1.44Mb Floppy, Plasma display (640x400, EGA, CGA), 80387 Socket, Ser/Par MS DOS 3.2, 15 Lbs.

**01-202 2272**

Official orders are accepted from GOVERNMENT & EDUCATIONAL AUTHORITIES & PLCs  
EXPORT enquiries welcome

**DA VINCI**

COMPUTERS

AUTHORISED TOSHIBA DEALERS

Also authorised Dealers for:

IBM & COMPAQ

UNIT 3, GRAHAME PARK WAY  
LONDON NW9 5QY

(NEXT TO RAF MUSEUM,  
HENDON) Tel: 01-200 5757

Fax: 200 8444

Telecom Gold: 81:MMD 102





"You've heard of Silicon Valley?  
Now you have . . ."

# Micro Mountain!!

Mountains of products at new low, low prices!!



## SALE EDITION

UNBRANDED DISC PRICES INCLUDE:  
SLEEVES, LABELS AND WRITE-PROTECT TAGS.  
ALL CARRY A CERTIFIED 100% LIFETIME  
GUARANTEE

**NO HIDDEN EXTRAS . . .**  
WHAT YOU SEE IS WHAT YOU PAY!

**ALL PRICES INCLUDE VAT AND CARRIAGE**  
ALL PRODUCTS CARRY A NO-QUIBBLE  
REPLACEMENT GUARANTEE FOR LIFE!

## WE SUPPLY

HOME USERS  
USER GROUPS  
TRADE  
EDUCATION  
GOVERNMENT  
OVERSEAS  
1-MAN BAND  
TO  
P.L.C.'s!  
WITH . . .

DISCS - 3", 3½", 5¼"  
& 8"

TAPES - REELS &  
CARTRIDGES

STORAGE - BOXES,  
LIBRARY CASES

PACKAGING - SCREEN  
PRINTING, LABELS

CUSTOMISATION -  
FORMS, LABELS ETC

SOFTWARE - IBM ETC

CABLES - CONNECTORS

ACCESSORIES -  
CLEANING KITS ETC

PAPER, RIBBONS  
ETC, ETC, ETC . . .

## UNBRANDED DISCS

	25	50	100	250
<b>5¼" BULK</b>				
Single Side 48T	£8.95	£18.95	£32.95	£74.95
Double Side 48T	£10.95	£18.95	£34.95	£81.95
Single Side 96T	£10.95	£18.95	£34.95	£81.95
Double Side 96T	£12.95	£20.95	£36.95	£88.95

	25	50	100	P.O.A
<b>3½" BULK</b>				
Single Side 135T	£23.95	£48.95	£91.95	P.O.A
Double Side 135T	£26.95	£52.95	£98.95	P.O.A

### \*\*\* SPECIAL DEALS \*\*\*

25 x 5¼" DS/48T PLUS DP100 DISC BOX	ONLY £16.99!
25 x 5¼" DS/96T PLUS DP100 DISC BOX	ONLY £19.99!
50 x 5¼" DS/48T PLUS DP100 DISC BOX	ONLY £25.99!
50 x 5¼" DS/96T PLUS DP100 DISC BOX	ONLY £27.49!
25 x 3½" SS/135T PLUS DP080 DISC BOX	ONLY £31.99!
25 x 3½" DS/135T PLUS DP080 DISC BOX	ONLY £34.99!
50 x 3½" SS/135T PLUS DP080 DISC BOX	ONLY £54.99!
50 x 3½" DS/135T PLUS DP080 DISC BOX	ONLY £59.99!

## BRANDED DISKETTES

WE CAN SUPPLY ALL MAJOR  
BRANDS AT LOWER THAN  
TRADE!!

Example:

5¼" VERBATIM DS/DD 48T	only £10.99 for 10
5¼" 3M's DS/DD 48T	only £9.99 for 10
5¼" MAXELL DS/DD 48T	only £10.99 for 10
5¼" DYSAN DS/DD 96T	only £13.99 for 10
5¼" DYSAN DS/HD 1.6Mb	only £16.99 for 10
5¼" XIDEX DS/DD 48T	only £3.95 for 10
3½" SONY SS/DD 135T	only £14.99 for 10
3½" SONY DS/DD 135T	only £17.99 for 10
3½" SONY DS/HD 2.0Mb	only £39.99 for 10

## DISC BOXES



DP050 DP080  
Lockable with hinge, index  
dividers and two keys.

DP050 - Holds 70 x 5¼"	<b>£6.90</b>
DP100 - Holds 100 x 5¼"	<b>£9.90</b>
DP020 - Holds 20 x 3" or Holds 100 x 3½"	<b>£9.90</b>
DP040 - Holds 40 x 3½"	<b>£6.90</b>
DP080 - Holds 80 x 3½"	<b>£9.90</b>

## SPECIAL LIMITED OFFER

**Solid Built Monitor  
or T.V. Swivel Stand**

Special purchase enables  
us to offer you this  
**HIGH QUALITY  
ACCESSORY**  
at the remarkably  
**LOW PRICE OF**



Limited Stocks

**So Buy Now!**

## TO ORDER

Call our Order Desk on  
**0525 853333**  
quoting your  
**ACCESS**



### BARCLAYCARD

Number or send a cheque  
or Postal Order with  
your requirements to:

**DATapro  
Computer Supplies  
DATapro House  
North Street  
Leighton Buzzard  
Beds LU7 7EQ  
0525 853333  
(10 lines)**

Fax: 0525 850485

Tlx: 826717 SHARET G-165

TRADE ENQUIRIES WELCOME!

**SAME DAY DESPATCH**

**24 HOUR ORDERLINE - 0525 853333**

## SPECIAL OFFERS

25 x 5.25" DS-DD DISKS  
PLUS  
100 CAPACITY LOCKABLE DISK BOX  
FOR

**ONLY £16.50**

OR

50 x 5.25" DS-DD DISKS  
PLUS  
100 CAPACITY LOCKABLE DISK BOX  
FOR

**ONLY £26.00**

20 x 3.5" DS-DD DISKS  
PLUS  
40 CAPACITY LOCKABLE BOX  
FOR

**ONLY £28.00**

OR

40 x 3.5" DS-DD DISKS  
PLUS  
40 CAPACITY LOCKABLE BOX  
FOR

**ONLY £48.00**

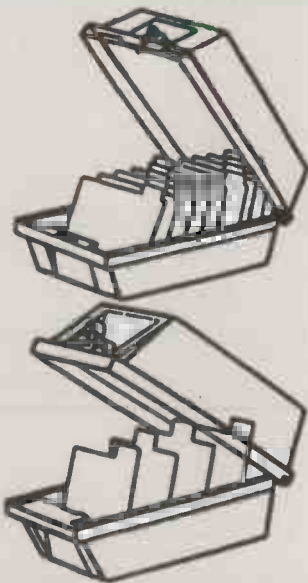

## SPECIAL OFFERS

75 x 5.25" DS-DD DISKS  
PLUS  
100 CAPACITY LOCKABLE DISK BOX  
FOR

**ONLY £34.00**

OR

100 x 5.25" DS-DD DISKS  
PLUS  
100 CAPACITY LOCKABLE DISK BOX  
FOR

**ONLY £41.00**

50 x 3.5" DS-DD DISKS  
PLUS  
80 CAPACITY LOCKABLE BOX  
FOR

**ONLY £60.00**

OR

80 x 3.5" DS-DD DISKS  
PLUS  
80 CAPACITY LOCKABLE BOX  
FOR

**ONLY £89.00**

## SPECIAL OFFERS

### DISKS 5.25"

QTY	SS/48	DS/48	DS/96
25	£9.00	£10.00	£11.00
50	£16.00	£18.00	£20.00
100	£30.00	£33.00	£36.00
200	£58.00	£61.00	£68.00

All includes envelope, labels and  
fitted hub rings  
100% guarantee

### DISKS 3.50"

QTY	SS/DD	DS/DD
10	£10.00	£13.00
20	£19.00	£25.00
30	£28.00	£37.00
50	£46.00	£52.00
100	£90.00	£100.00

Price includes labels  
100% guarantee

### UK MADE LIBRARY CASE

**5.25" or 3.5"**  
(10 capacity)  
**ONLY 95p**  
(if bought with disks)

### PRINTER CABLE

ST/IBM/AMSTRAD 1512/CLONE/ARCHEMEDES  
25 way D to 36 way cent

**ONLY £7.75**

REMEMBER THE PRICE YOU SEE IS ALL  
YOU PAY (U.K. ONLY).  
THEY INCLUDE VAT AND CARRIAGE

Cheque or Postal Order to:



**Manor Court Supplies Ltd**

Dept JT4, Glen Celyn House, Penybont,  
Llandrindod Wells, Powys LD1 5SY.  
Telephone: 0597 87784 or 0597 87792

## HEAD CLEANERS

Special offer price if  
bought with discs + box  
offer

5.25" + Fluid ..... £2.50  
3.25" + Fluid ..... £3.50

Both for use with single or  
double drives



We'd like to introduce a remarkable new range of high performance personal computers – The Deltagold Collection, comprising the Elite, Prestige and Premier models, each computer has been designed with energy saving features which reduce its power demands without reducing its performance.

The Prestige is Deltagold's hallmark of performance and style. Its enhanced version of the 80286 microprocessor operates at 6 or 10Mhz selectable from the keyboard to provide both high speed and software compatibility. The Premier 386 is the leader of the Deltagold family with a wealth of memory and applications, and the Elite, with its 8088 Turbo microprocessor, offers unequalled performance in a small package while still using far less energy than other PCs in its class.

Finished in charcoal grey, the appearance of Deltagold is as practical as it is stylish and, as you'd expect with such a high quality system the support documentation is extensive. Each model has unique user features including an integrated front panel, fingertip D.O.S. reference guide and Deltagold connection software as well as a user training video.

Deltagold is fully backed by Inspectorate International, one of Europe's fastest growing companies.

For more information and a demonstration of this unique system contact ACPM today.

# CONVERT TO THE GOLD STANDARD

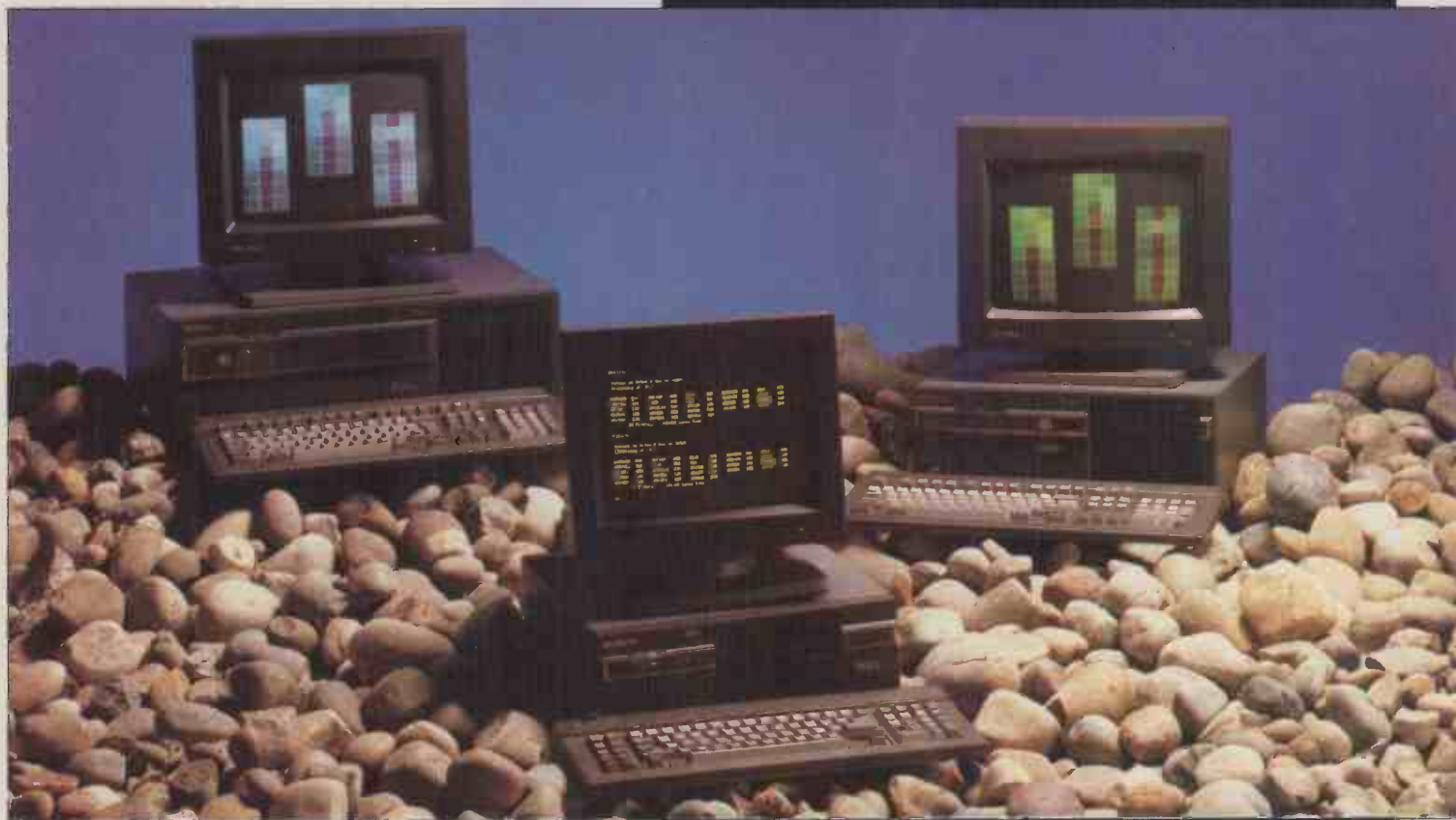

**A.C.P.M.**

Unit 6 & 8

Wealden Forest Park

Herne Common

Herne Bay, Kent

CT6 7TD

Call us now on 0227-712882

## DELTA GOLD

ELITE · PRESTIGE · PREMIER



# It's TURNING POINT...

NOW  
OS/2  
COMPATIBLE



## THE NEW TURN-POINT 286/386 SYSTEMS

80286, 6/12MHz, (80386, 16/20MHz)  $\phi$  WAIT STATE  
TWO 3½, 720KB/1.44MB FDD  
ONE 3½, HARD DISK DRIVE  
TWO SERIAL  
ONE PARALLEL



**TURN-POINT**  
SCIENCE TECHNIQUE CO., LTD.

5/F, No. 7, Alley 8, Shi-Wei Lane, Chung-Cheng Rd., Hsin-Tien, Taipei Hsien, Taiwan, R.O.C.  
Tel: (02)917-3154 (Rep), 917-3155, 917-5541. Telex: 35319 TPTEK Fax: 886-2-917-5547



## TANDON

Tandon PCX	640K	20MB	£825
Tandon PCA	1MB	20MB	£1179
Tandon PCA	1MB	40MB	£1395
Tandon PCA	1MB	70MB	£2170
Tandon Target	1MB	20MB	£1255
Tandon Target	1MB	40MB	£1495
Tandon PAC-286	1MB	30MB	£1525
Tandon 386 16MHz	2MB	112MB	£4075
Monochrome monitor option		ADD	£125
EGA colour monitor option		ADD	£425

\*\*\*10MHz Enhanced Tandon AT-available NOW\*\*

## MITAC

Mitac 386-20	2MB	20MB	£1899
Mitac 386-40	2MB	40MB	£2299
Mitac 386-80	2MB	80MB	£2899
Mitac 386-130	2MB	130MB	£3599
Mitac 386-230	2MB	230MB	£3899
Monochrome monitor option		ADD	£125
EGA colour monitor option		ADD	£425

## OLIVETTI

M240	640K	20MB	£1450
M240	640K	40MB	£1750
M380 Compact	1MB	40MB	£2810
M380	4MB	68MB	£3793
M380 Tower	4MB	135MB	£5474
Monochrome monitor option		ADD	£263
Enhanced colour option		ADD	£705

## ZENITH

Z-148 XT	640K	20MB	£799
Z-159 XT	640K	30MB	£1045
Z-286 AT	512K	20MB	£1350
Z-386 AT	1MB	40MB	£3199
Z-183 laptop	640K	20MB	£1825
Monochrome monitor option		ADD	£125
EGA colour monitor option		ADD	£425

## COMPAQ

Desk Pro 286	640K	20MB	£1683
Desk Pro 286	640K	40MB	£2246
Desk Pro 286	640K	70MB	£2733
Desk Pro 386/20	1MB	60MB	£3671
Desk Pro 386/20	1MB	130MB	£4796
Desk Pro 386/20	1MB	300MB	£6296
Monochrome monitor option		ADD	£125
EGA colour monitor option		ADD	£425

## PEACOCK

PC XT 8MHz	640K	20MB	£699
PC AT 10MHz	1MB	20MB	£999
PC 386 16MHz	1MB	20MB	£1799
Monochrome monitor option		ADD	£125
EGA colour monitor option		ADD	£425
Other Configurations available			CALL

## AMSTRAD

PC1512 Mono	640K	20MB	£599
PC1512 Colour	640K	20MB	£799
PC1640 Mono	640K	20MB	£799
PC1640 EGA	640K	20MB	£999
PPC 640 Double Floppy Drive		*NEW*	£575

## TERMINALS

Wyse 50	£371
Wyse 60	£446
Ampex 232	£415
Freedom 1 plus	£385
Kimtron KT70	£395

### Sample Configuration (1)

5 User System  
Mitac 386, 40MB  
4 Ampex 232 terminals  
Concurrent DOS

System Price £4195  
Each additional user £415

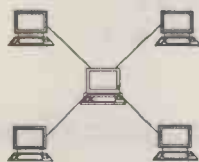

### CONCURRENT DOS

NEFAX10	£1145
NEFAX14	£1695
NEFAX25	£3150

### Sample Configuration (2)

5 User System  
Mitac 386, 40MB File Server  
4 Amstrad 1640 SD Work Stations  
MSDOS/Novell Network G/NET

System Price £6195  
Each additional user £795

### NOVELL NETWORK

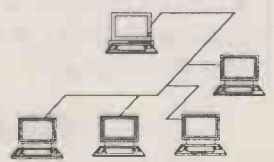

# MULTI-USER



## NETWORKING

All our networking solutions are based around Novell/Netware for assured reliability and performance.

Ethernet Starter Kit Netware 286	£2395
Ethernet Additional Workstation Card	£275
G/Net Starter Kit Netware 86 (Max 8 users)	£1595
G/Net Additional Workstation Card	£295
Token Ring Starter Kit Netware 286	£2995
Token Ring Additional Workstation Card	£425

Starter kits are supplied with One fileserver card, two workstation cards, Novell network software and cables

## SERIAL CARDS

2 port serial card	£50
4 port serial card	£285
8 port serial card	£595

Please specify Xenix or Concurrent Dos when ordering.

## TAPE STREAMERS

Kennedy 40MB internal	£495
Kennedy 60MB external	£695
Archive 60MB external	£575
Kennedy Tape controller	£199
Archive Tape controller	£195
Alloy, Everex, Cipher, Kennedy	CALL

## DISK DRIVES

NEC 5146H	40MB	40ms	£350
Seagate ST 225	20MB	65ms	£175
Seagate ST 251	40MB	40ms	£315
Seagate ST 4096	80MB	28ms	£625
Priam 130MB	130MB	25ms	£1450
Priam 230MB	230MB	25ms	£1599

Installation of hard disk upgrade, including carriage £50

## COMMUNICATIONS

Dacom AD AA	£215
Dacom QUAD V21/V22/V22	£499
Dowty Quattro V21/V22/V22 BIS/V23 AD EC	£625
Dowty Trio V21/V22/V23 AA AD EC Hayes	£525
WS 2000 Miracle V21/V23	£95
WS 3000 V22/V21/23 autodial, autoanswer	£425

## FAX

## SOFTWARE

### Concurrent DOS Software

Concurrent DOS v6 Retail (XTs and ATs)	£395
Concurrent DOS v6 IMS (XTs and ATs)	£595
Concurrent DOS 386 v2 Retail	£595
Concurrent DOS 386 v2 IMS (XTs and ATs)	£695
Commissionaire Terminal Organiser	£295
NewWord (Wordstar Workalike)	£345
Dataflex Database Software	£345
Cracker Multi-User Spreadsheet	£345
SNIP Accounting Software from	£500

### MSDOS/Novell Network

Obase III+ LAN Pack (1-4 User)	£500
Obase III+ LAN Pack (5 User)	£750
Multimate Advantage LAN Master	£750
Multimate Advantage LAN Workstation	£125
Smart Software System	£550
Smart Software System Additional User	£350
Word Perfect 3-User	£397
Word Perfect Additional User	£125
Pegasus Senior	CALL
Incomplete Records	CALL

### XENIX V Software

SCO XENIX V Operating System	£495
SCO XENIX V Development System	£495
SCO XENIX V Text Processing System	£155
complete SCO XENIX V System	£1095
SCO Multiview	£345
SCO XENIX System V 386	£575
SCO XENIX Tutor (MS-DOS based)	£245
SCO Lyrix Word Processing Software	£495
SCO Professional (1-2-3 Workalike)	£650
Multiplan Electronic Spreadsheet	£395
SCO FoxBASE (dBASE II Workalike)	£650
SCO FoxBASE Runtime System	£245
SCO FoxBASE plus (dBASE III+ Workalike)	£650
SCO FoxBASE plus Runtime System	£245
Informix Relational Database System 3.3	£795
MultiSoft Accounting Software	CALL

## PRINTERS

Epson FX800	80col	40/200cps	£325
Epson FX1000	136col	40/200cps	£390
Epson LQ800	80col	60/180cps	£420
Epson LQ1050	136col	73/220cps	£605
Epson EX800	80col	50/250cps	£380
Epson EX1000	136col	50/250cps	£425
Brother 1509	136col	45/216cps	£395
Brother 1709	136col	50/240cps	£475
Brother HR 20	117col	22cps	£350
Brother HR 40	136col	40cps	£725
Panasonic 1081	80col	28/120cps	£215
Panasonic 1092	80col	38/180cps	£205
Panasonic 1595	132col	51/240cps	£530
Panasonic 3131	120col	17cps	£279
Amstrad DMP3160	80col	160cps	£185
Amstrad LQ 5000	136col	96/280cps	£345
Star NB 24-15	132col	72/216cps	£575
Star LC-10	80col	36/144cps	£305
Citizen 180D	80col	180cps	£199
Citizen MSP 15E	132col	160cps	£265
NEC P6	80col	180cps	£425
NEC P7	132col	180cps	£499

## LASER PRINTERS

Epson GQ3500	6ppm	£1399
Citizen 110 Overture	10ppm	£1575
Kyocera F3000	18ppm	£5999
HP Laserjet Series II	8ppm	£1895



PRICES ARE SUBJECT TO VAT & CARRIAGE AND ARE FOR CASH WITH ORDER OR ACCESS. PURCHASE ORDERS FROM EDUCATIONAL ESTABLISHMENTS & CORPORATIONS MAY BE ACCEPTED AT OUR DISCRETION.

GOODS ARE OFFERED SUBJECT TO AVAILABILITY.

**CALL COMPUTER DEALS NOW on (0963) 24551 - (0256) 463771 or Scotland - (031) 315 2586**

**COMPUTER DEALS, Hornblotton House, Hornblotton, Shepton Mallet, Somerset**



# PRICE, PERFORMANCE, SUPPORT

**- The  
Unbeatable  
Combination**

**-SPECIAL OFFER-** Free software packages  
— WP, Spreadsheet, Database,  
Business Graphics, Spelling Corrector,  
Communications and Outliner  
supplied with all systems.



Ness Computers offer you the fastest, most powerful computer in its class with full user support. Our XT and AT ranges are 100% industry compatible.

With Ness you get installation, full technical support, 24 hour service, and a 1 year on-site maintenance contract for only £65 through one of Britain's largest engineering providers.

## **NESS SUPER XT TURBO 20MB**

■ Legal Bios ■ 8088-1 Processors ■ Switchable 4.77/10 MHz Clock ■ 640 RAM ■ 20MB Half Height Hard Disk ■ 360K Half Height Floppy ■ Parallel Printer + RS232 Serial Ports ■ Clock/Calendar with Battery Back-up ■ Monographic/Printer card ■ 150w Power Supply ■ Professional Keyboard ■ Hi-res 12" Amber Monitor ■ MS-DOS 3.3 Optional ■ Full Set of Manuals ■ 8 Expansion Slots ■ 12 Months Warranty

**£775**

## **NESS SUPER AT TURBO 20MB**

■ One of the fastest computers in the market ■ 640K RAM ■ 20MB Half Height Hard Disk ■ 1.2MB Half Height Floppy ■ Parallel Printer + One RS232 Serial Port ■ Clock/Calendar with Battery Back-up ■ Monographic/Printer Card ■ 200w Power Supply ■ Professional Keyboard ■ Hi-res 12" Amber Monitor ■ MS-DOS 3.3 Optional ■ Full Set of Manuals ■ 8 Expansion Slots ■ 12 Months Warranty

**£995**

## **NESS SUPER 386**

■ 386 Processor ■ 20 MHz Clock Speed ■ 2MB RAM ■ 44MB 28mS Hard Disk ■ 1.2MB Floppy Disk ■ Hercules Compatible Mono Card ■ Hi-res 12" Monitor ■ 102 Key Enhanced Keyboard ■ 1 Parallel + 2 Serial Ports ■ Clock/Calendar with Battery Back-up ■ 200w Power Supply ■ 8 Expansion Slots ■ MS-DOS 3.3 Optional ■ Full Set of Manuals ■ 12 Months Warranty

**£2295**

— **Free goods worth £50 when you join Ness users club** —

NESS INDUSTRIES LIMITED 38/40 Upper Clapton Road, LONDON E5 8BQ Telephone 01-806 8904 or 01-806 1072

\*All prices correct at time of going to press but are subject to change.

**NESS**  
FOR QUALITY

All trademarks acknowledged





**HOW GOOD ARE TANDY COMPUTERS?  
ASK SOMEONE WHO'S  
BOUGHT TWO MILLION OF THEM.**

EVER SINCE we first started manufacturing PCs, way back in 1977, Uncle Sam has had a long standing love affair with Tandy computers. ■



LAST YEAR alone, he bought over 600,000 of them, helping us to become America's number one PC supplier. ■

BUT WE aren't content with our success in the USA, so now we're offering our range of advanced MS-DOS computers and hi-tech printers through our 230 UK outlets. ■

HOWEVER we don't just sell



1000 SX



4000



1400 LT PC

computers; at our 46 "Business Point" stores, qualified staff will also show you how Tandy's technology can provide systems applications at every level. ■

IF YOU'D like a brochure explaining some of our ideas and solutions for your business problems, dial 100 and ask for Freephone Tandy Computers. ■

THEN NEXT time someone asks how good Tandy Computers are, Uncle Sam won't be the only one who can tell them. ■



**NO.1 IN THE U.S.  
NOW IN THE U.K.**





# The DTP solutions that'll have you up and running in hours not days start at just £149 + VAT.

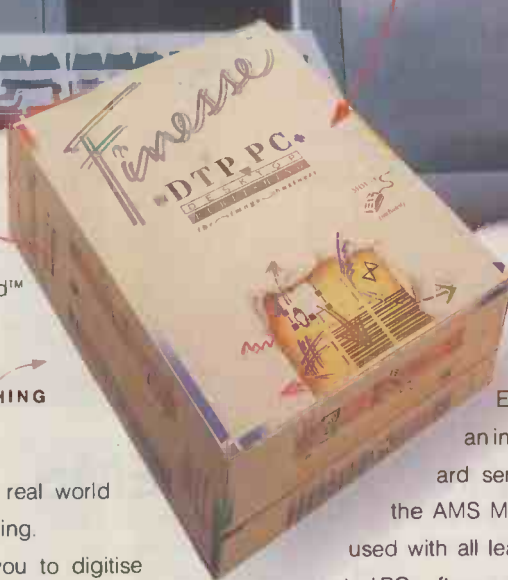
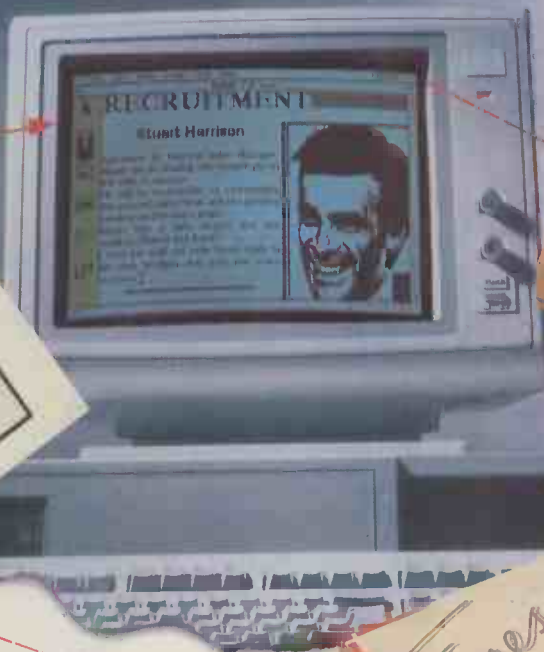

UNTIL NOW, any worthwhile DeskTop Publishing program carried a price tag of £300, not to mention the additional cost of necessities such as a Mouse and Scanner.

You were then faced with the prospect of ploughing through those 'heavy going' manuals and spending long hours of training before any real results could be achieved.

Now AMS have solved all that with a range of highly professional, but realistically priced, DTP software and peripherals that will have you 'up and running' in hours, not days!

9/24 pin dot matrix printers, while outstanding results can be achieved from 300 dots per inch Postscript™ and Hewlett Packard™ compatible laser printers.

### AMS MICROSCAN THE PERFECT PUBLISHING PARTNER

With the addition of the AMS Microscan you can enter the real world of professional DeskTop Publishing. The AMS Microscan allows you to digitise photographs, logos, signatures or illustrations, by simply moving the scanner across the desired image.



The AMS Microscan features a 105mm wide scanning head. Colour and grey scales are represented by up to 17 half-tones at a resolution of 200 dots per inch.

The software supplied operates under GEM™, WINDOWS™ or MS-DOS™ providing full editing and cropping facilities. The results can then be utilised within Finesse or any other high quality DTP software to give your work a new dimension.

### AMS MOUSE IMAGINATION AT YOUR FINGERTIPS

Designed and manufactured in Switzerland, the AMS Mouse gives you intuitive and responsive control through features which include high resolution and a patented tracking system which together provide precision interaction and surface contact at all times.

Equipped with an industry standard serial interface, the AMS Mouse can be used with all leading mouse operated PC software packages. Be it DTP, CAD or WP, you will find yourself lost without an AMS Mouse to lead the way.

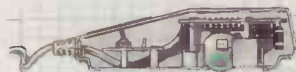

<b>FINESSE VERSION 1-I</b> INC. GEM/3™ & FONTWARE™	<b>£99</b>
<b>AMS MOUSE</b> INC. DRIVER SOFTWARE	<b>£69</b>
<b>AMS MICROSCAN</b> INC. SCANNER SOFTWARE	<b>£249</b>
<b>DTP SOLUTION 1</b> INC. FINESSE & AMS MOUSE	<b>£149</b>
<b>DTP SOLUTION 2</b> INC. FINESSE & AMS MICROSCAN	<b>£329</b>
<b>DTP SOLUTION 3</b> INC. FINESSE, AMS MOUSE & AMS MICROSCAN	<b>£389</b>

ALL PRICES EXCLUDING VAT.

The AMS DeskTop Publishing range of products are designed to operate on IBM PC/XT/AT™ and all 100% compatibles and are available from all good computer dealers or direct from AMS. For further information or instant orders Telephone 0925 413501.



**ADVANCED MEMORY SYSTEMS**  
Imagination at your fingertips.

### ADD A TOUCH OF FINESSE



At the heart of the AMS DeskTop Publishing 'solution' is the 'Finesse DTP' software package.

Utilising a WYSIWYG approach, Finesse makes it simple to create quality documents from the smallest pricelist to the largest presentation – in house!

Finesse comes with Swiss™ Dutch™ and Charter™ typefaces in a wide range of styles and sizes from 6 to 72 point. Finesse allows you to import and manipulate text and graphics from external sources such as Wordstar™, Wordperfect™, Gem Paint/Draw™ and PC Paintbrush™. In effect, Finesse provides total flexibility and freedom of design. Excellent print quality can be obtained from

# QUALITY SERVICE + UNMATCHED PRICES

Computers	£
Tandon PCA 20	1225
Tandon PCA 40	1650
EGA Systems Add	300
Tandon Plus Series Add	225
Kaypro 286 20 Mb 12MHz	1325
Kaypro 286 40 Mb 12MHz	1570
Kaypro 386 40 Mb 16MHz	3695
AST 286 20 Mb	1575
AST 286 40 Mb	1850
AST 386 40 Mb 20MHz	2850
Victor V286C 30 Mb	1495
Victor V386S 130 Mb	3750
NEC Powermate 20Mb with NEC Multisync Monitor	1995

MMC 286 20 Mb 10MHz	1095
40 Mb 10MHz	1295
MMC 386 40 Mb 16MHz	2295
70 Mb 16MHz	2695
MMC 286 Portable 20 Mb	1495
MMC 386 Portable 20 Mb	2295
1 year on site maintenance	125

Printers	£
<i>Dot Matrix</i>	
Epson FX 800	320
Epson FX 1000	410
Epson LQ 500	299
<i>Daisywheel</i>	
Juki 6200	450
Juki 6300	650
<i>Laser Printers</i>	
HP Laserjet II	1695
Epson GQ3500	1395
AST Turbolaser Postscript	2665
Qume Scripten Postscript	3999
Kyocera F1010	2000

Software	£
dBASE III Plus	375
Lotus 123	275
Pegasus (Single)	175
Pegasus (Multiuser)	350
Smart	395
Symphony	375
WordPerfect	275
Ventura	525
Pagemaker	525

Call for expert advice on  
Networks and Desk Top Publishing

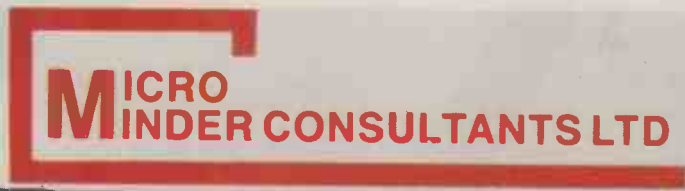

All prices are CWO and exclusive of VAT

**01-870 4650/ 7431**  
70 Upper Richmond Road, London SW15 2RP

## ACAD SYSTEMS

PO BOX 173, Bexleyheath, Kent DA7 5JZ

Only cheques accepted. Mail-order only.

Tel: 03224 30179

All prices exclude VAT and subject to change without notice and goods subject to availability. Delivery: Hardware £5, Software Free.

COMPUTERS	
Amstrad PC1640 SD/MD	£470
PC1640 DD/MD	£570
PC1640 HD20/MD	£843
PC1640 SD/CD	£599
PC1640 DD/CD	£699
PC1640 HD20/CD	£975
PC1640 SD/ECD	£743
PC1640 DD/ECD	£845
PC1640 HD20/ECD	£1095
PCW 9512 (+ PRT)	£455
PCW 8512 (+ PRT)	£389
PCW 8256 (+ PRT)	£289
Amiga A500 (+ Starter PK)	£399
Atari 520 STF (+ discs)	£258
1040STF (+ Mouse)	£399
<b>Special Offers for one month only</b>	
Free Ability with Amstrad's ECD range of computers.	
PRINTERS	
Epson LQ2500	£789
LQ1050	£599
LQ850	£454
EX800	£411
FX800	£327
Juki 6100	£293
6200	£435
Canon PW1081	£268
PJ-1080	£399
Amstrad DMP4000	£295
LQ3500	£299
Micro P MP40	£299
MP26	£219
MP700	£399
MP480	£289
MONITORS	
Atari Mono SM125	£124

Col SC1224	£318
Amiga Mono A1990M	£95
Col A1081	£269
Philips Col 8833	£249
Phone for prices for Software and Printers not shown here. Also stock Psion Organisers, Communications Hardware and expansion boards.	
SOFTWARE	
ABC Systems	£129
dBASE III Plus	£337
Autosketch	£49
Gem Desktop Publisher	£235
Gem Collection	£85
Fastback	£145
Lotus 1-2-3	£240
Manuscript	£245
RBase 5000	£216
Wordstar 2000+	£268
Page Ability	£139
Ability	£60
Ability Plus	£116
Fleet Street Editor	£75
Ventura	£465
Accountant Plus	£155
Sage Accountant	£113
Sage Bookkeeper	£79
Sage Retrieve	£70
PFS: First Pub	£89
Wordperfect	£185
Wordperfect Library	£110
Wordcraft 3.0	£345
Psion Chess	£19
Psion PC Four	£54
Multimate Adv. II	£345
Autocad	£354
Gem First Word	£139
Easycad	£262
Sideways	£47
Symphony	£330
Lotus Hal	£99
M/Soft Word	£395
M/Soft Excel	£337

## FARNHAM COMPUTERS

We are dealers for

AMSTRAD

Acorn

and ATARI

For your Computer,  
Software and  
Peripherals  
requirements

Call Us for Prices:

1 South Street,  
Farnham, Surrey  
Tel: 0252 723107







# THE YEAR OF IMC DRAGON

THE DRAGON IS A SYMBOL OF POWER AND INTELLIGENCE. TO WELCOME THE YEAR OF THE DRAGON, IMC PROUDLY ANNOUNCES ITS NEW DRAGON SERIES PRODUCTS. AS WITH THE DRAGON OF LORE, WE HAVE COMBINED POWER AND INTELLIGENCE TO CREATE SOME EYE-CATCHING PRODUCTS.

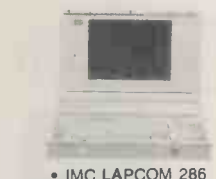

• IMC LAPCOM 286



• IMC TRAVELLER 386



• IMC McTOWER MODEL 80



• IMC PCX/2 MODEL 35



• IMC PCA/2 MODEL 45

• **IMC LAPCOM 286**

The LAPCOM is about the size of a brief case, coming with a super twist 640 x 400 LCD screen, an 80286 CPU, a 10/12 MHz or 10/16MHz clock, 1024K memory and all the major I/O on board.

• **IMC TRAVELLER 386**

Our most powerful portable computer featuring the 80386/VLSI Chips & a super twist 640 x 400 LCD display, five slots for optional add-on card.

• **IMC McTOWER MODEL 80**

The McTOWER includes the Intel 80286 CPU, running at 25MHz with 6 half high drive space and 8 slots.

• **IMC PCA/2 MODEL 45**

A super 286, running at 16MHz, comes with 1024K memory, serial, parallel, floppy disk, clock, VGA and more.

• **IMC PCX/2 MODEL 35**

Faster than the PC/XT with a 10MHz clock and 640K memory, PCX/2 Model 35 comes with serial, parallel, floppy disk, clock, VGA and more. Both models can run either MS-DOS 3.3 or OS/2.

PLEASE INQUIRE FOR CATALOG OF IMC DRAGON PRODUCTS.



**GROUP**  
Since 1974

**INTER-ORIENT & WORLD CORPORATION**

No. 231 & 233 Nanking E. Rd., Sec.5, Taipei, Taiwan, R.O.C.  
Tel: (02)766-1991/4 Fax: (02)766-9812 Telex: 15398 MATAHARI

**IMC COMPUTER, INC.**  
Suite H. 11100, S. Wilcrest Houston, TX 77099, U.S.A.  
Tel: 1-713-561-8857  
Fax: 1-713-561-9357  
Telex: 9102403368 ATTN: IMC

**IMC EUROPE AB**  
P.O. BOX: 7117, 402 32 Gothenburg, Sweden  
Tel: 031-124940  
Fax: 031-243518  
Telex: 28092 IMC S

- IMC. TRAVELLER, LAPCOM, McTOWER, PCA/2 and PCX/2 are registered trademarks of INTER-ORIENT & WORLD CORP.
- IBM PC/XT/AT are registered trademarks of International Business Maching Corp.

# System Science

## C COMPILERS

AZTEC	
AZTEC C86/PROF (MS-DOS) large mem. asm.link	£145.00
AZTEC C86/DEV (MS-DOS) adds source debug, editor	£195.00
AZTEC C86/COMM (MS-DOS) adds ROM support lib source	£295.00
AZTEC C86/COMM MAC, AMIGA, ATARI ST	£295.00
AZTEC C for PC/M-80, Apple Dos, Prodos	£ call
LATTICE C Compiler ver 3.21	£235.00
LATTICE C Sprite debugger	£129.00

MICROSOFT C 5.0 with Code View, Quick C large mem, source debugger, 8087	£245.00
MICROSOFT QUICK C with debugger & editor	£65.00
TURBO C from Borland	£65.00
Editor, Linker, Large mem options	
RUN/C - PROFESSIONAL Interp	£125.00
C CROSS Compilers 6809, 68070, 8051, 6301, 80386 8096, 63HC11	£Call

## C LIBRARIES

GRAPHICS	
METALWINDOWS — many languages	£115.00
ESSENTIAL GRAPHICS Library	£175.00
GRAPHIC — source, colour, EGA	£245.00
HALO — specify compiler	£175.00

SCREEN and DATA ENTRY	
PANEL entry screens — most languages	£215.00
DATAWINDOWS with source	£175.00
Vitamin C — Screen, print layout code	£145.00
Windows for Data, Windows for C	£215.00

ISAM & DATALIFE	
CTREE — Faircom (source) B tree lib	£225.00
RTREE — Reports generator for C Tree	£175.00
Btrieve — database library, many lang	£175.00
Btrieve/N — Novell, PC-NET networks	£395.00
C-ISAM for Microsoft or Lattice C	£225.00
LATTICE dBC-III Dbase library	£175.00
LATTICE dBC-III Plus for networks	£395.00

GENERAL	
GREENLEAF General Functions Dos, Disk, Video, Strings, Date, Keybd	£125.00
PforCe — source lib, comms, dbase, screen etc. The C programmers toolkit	£225.00
BLAISE C TOOLS PLUS — source DOS, Dos, screen, windows, keyboard etc	£125.00
C Scientific Subroutines — source Matrix, polynomial, diff, eqn, etc	£145.00
*RESIDENT* for ESSENTIAL TSR LIBRARY	£125.00

PHOENIX	
PLINK-86 Plus — overlay cacheing	£245.00
PMATE-86 programmers editor	£120.00
PRE-C Lint utility	£175.00
PFIX-86 Plus debugger	£195.00
POISK — backup, disk cache & unis	£95.00

COMMUNICATIONS	
GREENLEAF Communications	£115.00
BLAISE Async Manager	£125.00
ESSENTIAL Communications	£125.00
ESSENTIAL Breakout for Comms	£95.00

EDITORS	
BRIEF multi-file macro editor	£145.00
dBRIEF addition for DBASE programmers	£75.00
EPSILON — Emacs style editor	£145.00
PC/VI screen editor	£125.00
Lattice Screen Editor	£95.00

MKST Toolkit lots of Unix goodies, inc VI	£95.00
QUILT Software Revision Management	£99.00
PC-LINT by Gimpel	£99.00
CLIPPER — DBase III Compiler	£545.00
PCVS Personal by Polytron	£115.00

## ASSEMBLERS and CROSS-ASM

Microsoft 8086 macro Asm (CODEVIEW & LINK)	£95.00
Cross Assemblers 68xx, 68000, Z80, 8080, 6502, 8048, 8051 etc	
Simulators — Z80, 8048, 8051 etc	£ call
Quelo 6800 and 68020 cross assemblers, simulators	

LMI Forth-83	
PC/FORTH asm, Editor, DOS access	£125.00
PC/FORTH Programmers package with 8087 graphics	£195.00
UR-FORTH high perf., 8087, graphics (ver for 386)	£245.00
METACOMPILERS 8080, Z80, 8096, 6303 etc	£ call

TURBO PASCAL 4.0	
TURBO PASCAL 4.0	£55.00
Turbo Tutor	£45.00
Turbo Database or Graphics or Editor toolbox	£55.00
Turbo Numerical toolbox	£55.00
Turbo Pascal Developers Library	£215.00
Blaise Power tools plus	£85.00
Blaise Async plus	£85.00
TurboPower Professional source	£75.00
T-Debug plus	£75.00

FORTRAN/PASCAL/BASIC	
Fortran Graphics, Scientific Libraries	£ Call
Microsoft FORTRAN-77 with Codeview	£245.00
Pro-FORTRAN-77	£275.00
RM-FORTRAN-77 with RM-FORTE toolset	£475.00
PRO-PASCAL MS-DOS	£275.00
Microsoft Pascal	£185.00
QUICK BASIC — Microsoft (PC-DOS only)	£65.00
PASCAL 2 full features, Turbo compatible	£325.00
TURBO BASIC FROM Borland	£65.00

## LISP and PROLOG

MuLISP-87 Interpreter	£175.00
MuLISP-87 Interpreter & Compiler	£225.00
PC Scheme — Integrated LISP with OOPS from TI	£95.00
Golden Common LISP, TRANSLIP & more available	£69.00
TURBO PROLOG (PC only)	£245.00
micro-PROLOG PROF (full mem., wind.)	£245.00
micro-PROLOG entry level version	£95.00

MATHS etc	
MuMATH-83 Algebraic maths system	£225.00
LINDO Linear programming	£385.00
MATH-CAD ver 2.0 engineers graphics and spreadsheet	£345.00
EUREKA from Borland	£85.00
Microsoft from Ecosoft	£295.00
STATGRAPHICS	£595.00
METRISTAT for quality control statistics	£695.00

## TEXT WINDOWS, COMMUNICATION, DISK

VENTURA Desktop Publishing System	£795.00
FINAL WORD 2 — author's WP newer	£275.00
MicroTEX — scientific typesetting	from £395.00
WINDOWS II by Microsoft	£75.00
WINDOWS II Software Dev. kit	£295.00
SUPERKEY	£65.00
SIDEKICK PLUS (new)	£125.00

ZAP Communications — VT100, 4010 emulation	£85.00
PC/Intercomm — VT100, 102 Kermit etc	£95.00
UNIFORM — PC r/w, format CP M disks	£65.00
CONVERT — PC add formats	£89.00
UNIDOS run CP/M software on PC	£65.00
NORTON UTILITIES advanced	£95.00
Dan Bricklin's DEMO program	£65.00

MODULA-2	
Pecan Modula-2 Powersystem	£95.00
Pecan Modula-2 Advanced Pak	£195.00
Logitech Modula-2/86 Compiler	£69.00
Logitech Modula-2/86 Development System	£145.00

OS/2 & 386 PRODUCTS	
Many new products are starting to appear for the 386. Assemblers, C Fortran, and Pascal Compilers Operating systems and extensions. Pharlap, PC-MOS, XEMS 386, VM386 etc.	

All prices are exclusive of VAT but inclusive of Inland shipping.

A selection from our extensive range. Please enquire if the item you require is not listed



**6-7 West Smithfield,  
London EC1A 9JX  
Tel: 01-248 0962  
BTGOLD 76: CJJ028**

## When you choose to rent - Micro-Rent

Excellent service • Full technical support • Immediate delivery • Wide choice of computers, printers and other peripherals • Ex-rental machines available for purchase.

And the most competitive rates for rental by the day, week or month.

**BREAKDOWNS?** Call the new extra-fast Micro-Sprint service - for guaranteed delivery within two hours.

**Micro-Sprint 01-700 4621**

• APPLE • APRICOT •  
• IBM PC. XT. AT. PS/2 •  
• OLIVETTI • MACINTOSH •  
• TANDON • COMPAQ •  
• SIRIUS • LASER PRINTERS •  
• DESK-TOP PUBLISHING •  
• FAX MACHINES •

**01-700 4848**



MICRO-RENT  
St. Marks Studios  
Chillingworth Road,  
London N7 8QJ.

Northern Office:  
051 236 1673

MAC II 40MB



TANDON PCX



IBM PC AT



H-P  
LASERJET

£60 PER WEEK\*

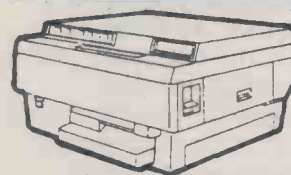

\*Prices quoted are based on 3-month rental, excluding VAT.



## COMPLETE COMMUNICATIONS SOFTWARE

### FOR IBM PC XT AT PS/2 AMSTRAD PC SIRIUS & APRICOT

#### EASE OF USE:

TRANS-SEND is very easy to use. It features POPUP menus, many HELP SCREENS and a user definable menu. From this menu, the user may dial and log on (etc) at the press of a single key.

#### MODEMS:

TRANS-SEND operates with almost any type of modem, including HAYES (tm) and non-buffered 1200/75 manual modems. Autodial is supported, and Autodial protocol is user definable.

#### VIDEOTEX EMULATION (PRESTEL)

TRANS-SEND offers full videotex (PRESTEL) on VGA, EGA, CGA, HERCULES, MDA, and AMSTRAD display types. The emulation is total - ALL Videotex features are fully implemented\*. The display is full screen or split screen. In split screen mode, you can view two Videotex pages at once, or have a HELP screen in view as well. Pages can be printed and saved in a choice of formats.

DATAMASKING allows quick and easy retrieval of data to a database or spread-sheet application.

MAILBOXES may be created offline, and later uploaded.

SOFTWARE DOWNLOAD is supported too.

#### TERMINAL EMULATIONS:

TRANS-SEND emulates VT102, VT100, VT52, ANSI, VIDEOTEX and plain TTY terminals. Graphics, function keys, and even keypad application mode are supported. The LEDs of the DEC(tm) terminal are reproduced on screen.

TRANS-SEND offers extra features via its POPUP menus from these terminal emulations.

#### FILE EXCHANGE:

TRANS-SEND offers SLIDING WINDOWS KERMIT, XMODEM, ASCII, Software Download, and its own protocol.

#### COMMAND FILES:

TRANS-SEND can be fully automated by use of its COMMAND FILE language. This powerful language supports labels, conditional branches, nested subroutines, etc. COMMAND FILES can be loaded and executed with the press of ONE key from the user defined menu. ALL TRANS-SEND operations can be automated by COMMAND FILES.

#### DISK BACKUP:

TRANS-SEND can move groups of files quickly and easily between computers. This offers an excellent method of backing up one hard disk onto another in a different computer. It can also move files between 5.25 and 3.5 inch formats, and APRICOT and SIRIUS formats.

#### WORD EDITOR:

TRANS-SEND has its own built in text editor. This feature can create and edit text files up to 80 characters wide by 800 lines long.

#### MS/DOS:

TRANS-SEND runs under MS/DOS version 2.00 or higher. It fully supports PATH names, and can execute any MS/DOS command line without a need to exit. It can remain memory resident via its SHELL option.

#### LANGUAGES:

TRANS-SEND is available in ENGLISH, SWEDISH, DANISH, DUTCH and FINNISH. A version in ENGLISH but using the SWEDISH character set is available too. More languages will follow soon.

\* Colour needs a colour monitor.

**PRICE £49.95 + £2 P+P PLUS VAT**

**MESSITER SOFTWARE**

67 Crescent West, Hadley Wood, Herts. EN4 0EQ,  
England. Tel: 01-449 2994/441 7250



# MICRO MEDIA

Computer Supplies Ltd.

Freepost,  
Dept. PCW, Rydal Mount, Baker Street,  
Potters Bar, Herts EN6 3BR (NO STAMP REQUIRED)

**0707 52698 (5 lines)**

**PERSONAL CALLERS  
WELCOME**

WEEKDAYS 8.30am-5.30pm

SATURDAYS 9.30am-1.00pm

## 5 1/4 MICRO MEDIA Brand Discs

	10	20	50	100	200
SS/DD	6.40	12.10	28.30	51.70	92.65
DS/40T	7.50	14.15	33.15	61.30	109.90
DS/80T	8.50	15.95	36.25	71.25	123.00
DS/HD for PCATs	17.90	34.30	81.20	149.80	278.00

## 3 1/2 MICRO MEDIA Brand Discs

	10	20	50	100	200
SS	13.70	26.90	64.40	122.60	236.00
DS	14.90	28.60	68.20	130.50	252.00
DS/HD	38.95	74.25	176.80	327.80	599.95

## 3M Data Cartridges

	2+	5+	2+	5+
DC 1000	16.10	13.75	DC300 XLP	20.95 19.80
DC 2000	19.40	25.95	DC 600A	22.85 21.60



All discs supplied are with labels, 5 1/4" write protects, envelopes & hub rings.

Discs purchased direct from one major manufacturer. 100% certified error free - lifetime guarantee.

## 5 1/4 Unbranded Discs

	25	50	100	250	500
SS/DD	9.30	18.40	34.60	73.60	140.00
DS/40T	10.40	19.60	36.30	76.25	145.00
DS/80T	12.20	23.10	43.10	90.85	170.00
DS/HD PCATs	39.90	71.45	133.55	293.25	570.00

## 3 1/2 Unbranded Discs

	10	20	50	100	150
SS/DD	10.95	21.50	51.50	98.05	142.50
DS/DD	11.90	22.90	54.55	104.35	151.50
DS/HD	36.25	69.20	163.75	310.50	535.00

**PRICES INCLUDE V.A.T.**



## 5 1/4 Rainbow/Colour Discs (5 colours)

	25	50	100	250	500
DS/40T	12.45	23.55	39.95	91.50	172.50
DS/80T	13.45	25.40	47.40	99.95	189.50

## AUTUMN CATALOGUE OUT NOW - CALL OR WRITE FOR YOUR COPY

### Monitor Swivel Bases

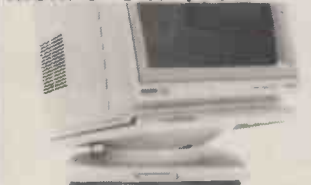

Pan tilt revolves around 360 degrees  
12.5 degrees tiltable up and down  
Adjustable by front mechanism.  
55 x 280 x 260mm 55 x 355 x 320mm

12"	14"
1+ 12.90 ea	1+ 14.90 ea
3+ 11.75 ea	3+ 13.55 ea
6+ 10.90 ea	6+ 12.75 ea

### Office Chairs

Gas lift height adjustment  
Sprung centre column  
Dark Brown, Grey, Red, Black



1+	3+
With arms 79.90	74.90
Without arms 59.40	54.90

### Printout Binder Storage Trolley

Width adjustable to store 80 or 132 column binder  
1+ 35.50



### Mobile Printer Stand

Rugged steel frame. Height adjustable basket for output paper & base shelf for input paper. Self assembly - includes castors.

80 column	£52.90
132 column	£65.40

### The Space Saver



Paper feed and refeed positioned one above the other. Dial controlled paper feed with adjustable deflectors ensures smooth flow and automatic refeeding.

80 column	132 column
41x380x460mm	530x380x460mm
1+ 30.50 ea	1+ 35.50 ea
3+ 28.50 ea	3+ 32.90 ea
6+ 26.95 ea	6+ 31.25 ea

### Printer Ribbons

	Price each ribbon		
	2	6	12
Amstrad 9512	3.80	3.60	3.40
8512/8256/LQ3500	3.90	3.60	3.35
DMP 2000/3000/3160	2.80	2.60	2.35
Atari 1029	3.70	3.48	3.20
Brother HR15/25MS	3.30	3.10	2.80
Centronics GLP	3.65	3.45	3.15
Canon 1080/1156	2.99	2.85	2.70
Citizen 120D	4.70	4.35	4.15
Diablo HY Type II MS	2.80	2.65	2.40
Epson LX 80/86 GX 80	2.80	2.65	2.40
MX/FX/RX 80 FX 800	3.35	3.20	3.05
MX 100/FX 1000/FX 105	3.90	3.70	3.50
EX 800	5.98	5.65	5.20
LQ 1000	4.95	4.65	4.26
Juki 6100 MS	2.85	2.70	2.60
Panasonic KXP 110	4.65	4.40	4.20
Qume IV MS	3.30	3.10	2.80
Star NL10	5.25	4.95	4.70
Star NB 24-15	11.90	11.30	10.70

Colour ribbons available

If the ribbon you require is not listed please let us quote

The above is a small selection of the 250 different ribbons we stock. We shall be pleased to find your ribbon, however old or obscure.

### Daisywheels

Amstrad 9512	£ 5.75 each
Brother HR15/25	£19.55 each
Diablo Hytype II	£ 4.50 each
Juki 6100	£12.45 each
Qume Sprint 5/7	£ 4.50 each
Richo 1300/1600	£21.65 each
Panasonic KXP31314	£ 4.50 each

### MD 120

1 11.90 5 1/4" x 120  
3+ 11.30 each  
6+ 10.75 each



### MD 50

5 1/4" x 50  
1 7.50  
3+ 7.10 each  
6+ 6.75 each



### Wire Printer Stand

stacks print-out in document tray automatically. Suitable for most standard printers. Made of safety coated steel wire.

80 column £13.70  
132 column £15.70

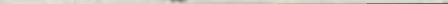

### MD 100

5 1/4" x 100  
1 9.90  
3+ 9.40 each  
6+ 8.95 each

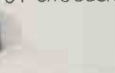

### MD 40

3 1/2" x 40  
1 7.90  
3+ 7.50 each  
6+ 7.10 each



### MD 80

3 1/2" x 80  
1 9.90  
3+ 9.40 each  
6+ 8.95 each



### Laser Toner Cartridges

Canon A1/A2	1+	85.70
Canon A8 MK II		96.95
Citizen Overture		25.95
Epson GG 3500		20.99
HP Laserjets		85.70
HP Laserjets MK II		96.95
Oki Laserline 6		20.99

### Computer paper

Size	Weight 1000s per box	Price per box	
		1 box	3 box +
11x9 1/2	60 2	14.50	13.90
	80 2	19.75	18.10
Exact A4			
11 1/2 x 9 1/4	70 2	20.50	19.25
	90 1	13.90	12.85

ALL PRICES INCLUSIVE OF POSTAGE & PACKING AND V.A.T.

# MICRO MEDIA

Computer Supplies

Freepost, Dept. PCW, Rydal Mount, Baker Street, Potters Bar, Herts. EN6 3BR



Access & Visa



Out of Office Hours (Answer machine)

**0707 52698 (5 lines)**

Orders despatched 24 hrs.

Please allow 5 days for delivery.  
For next day delivery, please ring for details. Postage covers U.K. only.

### Printer Muffler



80% noise reduction	internal dimensions 482 x 413 x 152mm	£69.00
80 col	635 x 432 x 203mm	£74.90
132 col		
Stand for bottom feed printers		£19.90



# Stacey will live on at Atari

A laptop Atari ST should be available by Christmas, at a price of under \$1000 — or so Sam Tramiel assures me.

The machine is currently in the final stages of prototyping in the Cambridge offices of Perihelion, which is best known for another Atari project — the Abaq, based on the Transputer.

Sam Tramiel spilled the beans on 'Stacey', as the laptop is codenamed, when we met at the Hannover Fair in March.

There really isn't very much to say about it, from a design point of view: it's an ST design squeezed into a portable box.

The only surprise is likely to be an alternative to the normal Atari mouse — the designers reckon that somebody with a computer on their lap is unlikely to find a level surface to run the mouse around on. 'You might be lucky and find somebody wearing a tight skirt sitting next to you on a plane,' mused Sam Tramiel, 'but otherwise it wouldn't work. So we're probably going to put in a trackball.'

The main design problems are based on power

consumption. The Motorola 68000 chip uses very little power, but all the associated electronics are rather greedy. So Perihelion has taken all the peripheral chips and has designed one large and complex, but miserly, gate array, which replaces them.

Final details of the machine depend on what silicon is available around June/July, when first working prototypes will be shown to the trade.

At this moment, the plan is to have a full megabyte of memory, a hard disk as well as a floppy disk, and a full-screen LCD for display. But memory shortages mean that, quite possibly, the first models will be 512k machines. Also, if memory is expensive, the price will be kept down by dropping the hard disk. On the other hand, there are some spectacular new liquid crystal displays just coming onto the market at around £1000 per screen — and if these drop in price, they may be available as a super option.

Interestingly, Atari is now very close to another new machine, also the 68000 family

— its Unix ST.

This is described by Jack Tramiel, owner of Atari, as 'the machine which will bring Unix to the consumer — well, to the personal user.'

He reckons (quite correctly) that there is a market for Unix machines with people who'd like some of the multi-user accounting software that runs under Unix, but can't afford the normal prices. His machine, based on the 68030, will be cheap — under \$5000. And it will include the latest Unisoft version of Unix V.

The bright idea in the package is the decision to use an industry standard bus, called the VME bus. The company's technology boss, R&D vp Shiraz Shivji, points out that there are many similarities between this bus and IBM's new Micro Channel — but that the VME bus has several advantages.

The advantages: there are a very great many VME boards doing a very great many things, already in the market. It is also (said Shiraz) quite a bit faster, and more flexible on timing.

The Atari machine won't be the first VME-bus Unix machine in the world, but it will be one of the cheapest, and it will be well-promoted if Atari does go ahead and sell it. So it could be shifting in substantial numbers by this time next year.

Few would argue with Tramiel's theory that far. But when he goes on to talk about selling this to personal users as a high-power alternative to things like the PC or the ST or the Amiga or so on, he's talking about testing a concept that has been restricted to saloon bar discussion, until now.

The question is: Can an ordinary, untrained user without the support of a programming department learn to use and love Unix?

I've read a lot of learned argument about this, none of which sounded remotely comprehensible. The gist of it is that Unix is much more powerful than DOS, and probably more powerful than OS/2, but that this power comes at a cost.

Most users I know find DOS more complex than they like. I'm not going to stick my neck out very far, but seriously, I do doubt that Unix is going to become a fad.



File Rescue Plus arrived here with a diskette with a staple through it, a staple remover, and the promise that the punctured file(s) would be recoverable.

A full test would have been to puncture one of my own disks. My courage wasn't up to it. Abjectly, I report only what Mirrorsoft says about the product. The company says that experience shows that you can recover data from folded, burned, or coffee-soaked disks with this £25 program. You can even get data off disks that aren't DOS disks — for example, strange specialist word-processing programs.

At the price, it has to be a bargain. The fact that it can actually 'shred' files which are left on a disk by the normal 'delete' command, unhide hidden files, manage disk directories and sort files by extension or data or size, makes it sound like a 'must buy' rather than a 'sounds interesting.'

Details from dealers, or from Mirrorsoft on (01) 377 4837.

## Brand new

A new brand of hard disk has arrived on the market, just in time to save a friend of mine with an Olivetti M24 from making a serious error.

The new brand is the Olivetti-owned Lexikom which is now appearing in stores, and should fetch well under £300 for a 40Mbyte drive. This will save your having to buy a Plus hard card, which will save you even more cash.

It was kind of Computer Marketing to let me know that the 40Mbyte Plus Hardcard had come down by £200. A pity the company had to spoil the effect by admitting that this brought the price to £895 plus VAT.

It just so happened that the same week this news arrived, I was trying to discover the answer to a strange problem with the Olivetti M24 — the original UK user's choice as a PC replacement.

The problem was: how do you take a machine with a piffling ten megabytes of hard disk, and add extra space?

The temptation was that adverts everywhere were saying: 'Buy our £200 30Mbyte hard disk — price includes

controller.' A friend had a ten-megabyte M24, and asked me whether the thing was suitable. It wasn't.

The first problem was where to put it: normally, an Olivetti M24 has room for one floppy and one hard — both half-height drives. To plug in these 'el-cheapo' designs, you had to throw out your original.

Having done that, you'd find that the new one didn't work.

The reason, say experts, is that Olivetti was *too clever* when it redesigned the M24.

A normal PC doesn't know about hard disks. It requires extra software, usually supplied in a chip on the controller card, to get data onto the disk and off again.

The M24, like the more modern PC AT design, had software which did understand hard disks. But unlike the AT, it didn't keep a list of all the bits and pieces added to the system, so the software in an AT disk drive won't work on the M24.

That explains why the Plus can sell for this truly absurd price — M24 buyers can plug it in without scrapping their existing drive, and it sets itself up as drive D: automatically.

Plus also sells a 20Mbyte drive for £695 plus VAT...



# Apple tries to break windows

It will be interesting to see how IBM reacts to Apple's lawsuit against Microsoft and Hewlett-Packard. Apple is claiming that Microsoft's Windows 2.03 and H-P's New Wave product infringe the copyright of the Mac's desktop or Finder.

When Apple first started throwing its legal muscles around the computer industry, Digital Research and Microsoft gave in with little fight. DR agreed to change the look of its desktop, which means that we now have a Gem without resizable windows and without its original 'trash can' to delete files. Microsoft gained a 'licence' from Apple for Windows 1.03, but the latest release — version 2.03 — in Apple's words 'goes beyond that licence.'

Comparing the two versions of Windows, it's hard to imagine that Apple is getting upset about the only noticeable visual differences between the two versions — resizable windows and movable icons.

Where IBM comes in, is that Presentation Manager, the windowing front-end to OS/2, is based heavily on Windows, and I can't really see IBM giving in to Apple. If nothing else it certainly has a larger legal department as many clone-makers have experienced first hand.

So what is the fuss about?

My guess is that Apple is clearing away barriers to its selling Macs into the major corporate environments. Its connectivity deal with DEC, announced two months ago, could mean Macs acting as front ends to minis and mainframes. And Apple is probably worried that it may be competing with IBM's own machines presenting a very similar interface under OS/2. Hewlett-Packard is also a mini and mainframe manufacturer which could build on New Wave to produce a windowing, icon-based, front end to its own large machines. That would be the end of Apple's opportunities in that market.

The whole matter smells for a number of reasons.

Apple has always billed the Mac as 'the computer for the rest of us'. In the UK at least, Mac pricing has put the machine well above the means of most of us. You've probably seen those slick TV ads where the company execs bring 'their own computers' into the office to do what the mainframe

can't manage. In the US that is a reasonable scenario. The Mac is cheap enough for enthusiasts to buy one for home use.

How many enthusiasts do you know in the UK with Macs? There are very few, so there is little grassroots pressure for the introduction of the Mac into the office environment.

This is no accident. Apple UK consciously prices the Mac to be 'a product that people aspire to.' The machine's interface is wonderfully friendly, easily customisable, and hides you from the complexities of DOS. But there is a fear within Apple that the machine will be seen as a toy and so be shunned by the corporate buyers who hold the real buying power.

Apple intends to develop its high-quality, high-performance profile. Its new connectivity strategy — with the acronym OASIS (Open Architecture System Integration Strategy) emphasises the company's commitment to link in with the main connectivity standards — OSI, token ring, LU6.2, DECnet and the like. But Apple wants it both ways. It wants an open architecture; it wants easy-to-use graphic interfaces on terminals; but it doesn't want anyone to get too close to its own standard.

Apple's chairman John Sculley isn't worried about icons or windows or mice. He believes that it is possible to innovate and develop using these desktop metaphors without infringing Apple's copyright on its operating system. But does he really think that Microsoft's making its windows resizable will make or break his chances with the corporates?

Personally, I blame Digital Research and Microsoft for giving in so lightly in the first place. Gem in its versions 2 and 3 still looks more like a Mac desktop than Windows ever did. Microsoft Windows doesn't even use icons for most of its operations. By not fighting Apple originally, Microsoft now has a harder time defending its user interface.

Ultimately, all these desktops are copies of the original ideas developed by Xerox. Xerox' Smalltalk and its descendants, such as the SunTools interface reviewed last month, still work better than the Mac. Why hasn't Xerox sued Apple?

The answer is that Xerox isn't threatened by Apple while Apple is threatened by the IBM/Microsoft alliance and by Hewlett-Packard iconising its customers first and locking out Apple.

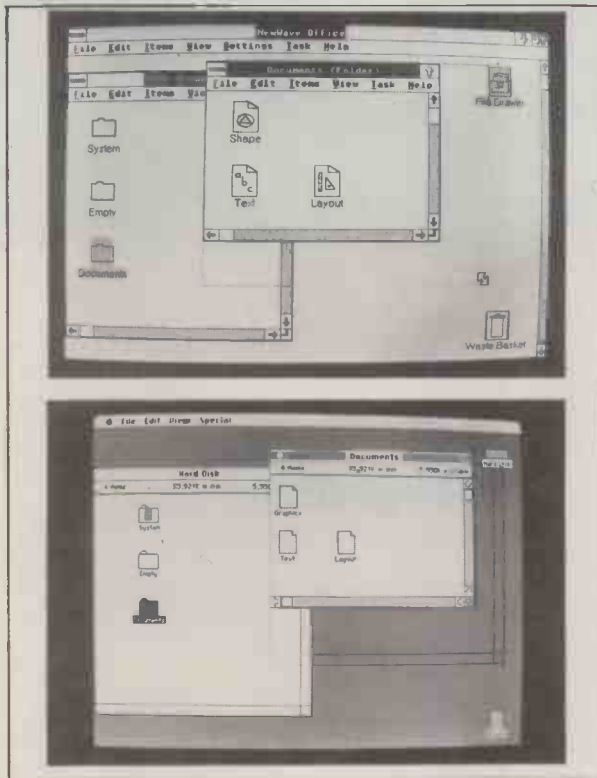

GUY KEWNEY

## Newsprint Index

Stacey will live on at Atari	70
Brand new	70
Apple tries to break windows	71
Amstrad's next clever move	75
First-class shuttle service	75
Commodore's slow lift-off	75
SideKick Plus What?	76
Migent: the sequel	76
Legal eagles	78
New release from Microsoft	78
Horse returns to find bolted stable	80
Tricom modem launch	80
Grapevine	83

What amuses me most is the fair-minded facade that Sculley puts on the whole thing. Microsoft is an Apple developer and Sculley does not want to sever his good relationship with Microsoft chairman Bill Gates. 'Bill and I talked about it and we agreed that we should not let this complaint escalate to the point that it affects our other relationships,' Sculley told me just a couple of days after the writ was issued.

Considering Microsoft's Excel is reckoned to be one of the reasons why many corporate users ever gave the Mac a second look, Sculley is wise not to risk his relationship with Microsoft just yet.

Gates' version of the story is slightly different. He had been talking with Sculley just a couple of days previously and Sculley had not mentioned the writ. 'It came as a complete shock,' he said.

Derek Cohen

N  
E  
W  
S  
P  
R  
I  
N  
T





# "Unlimited."

You can soon reach the limits of your personal computer.

Because its storage capacity is as fixed as the hard disk inside it.

Of course, you can keep changing the floppies.

But isn't it frustrating you can't do the same with the Winchester disk?

As of now, you can. With the new Tandon Personal Data Pacs.

It's an idea that just had to happen. Hard disk packages that you can slot in and out of your computer.

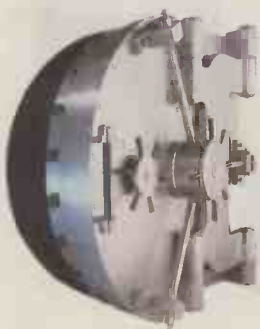

SAFE FROM DATA SPIES.

As easily as changing a videocassette.

It's possible because Tandon have invented a way of cushioning the fragile Winchester disk in a unique, shock-absorbing casing.

Each one is rugged enough to stand being dropped. You can fit a few in your briefcase, or even pop them in the post.

And you can use the Data Pac with any AT, simply by connecting a small, inexpensive 'Ad-Pac' unit. (Or on the Tandon PAC 286,



COMPUTING IN THE PALM OF YOUR HAND.



A DATABASE IN YOUR BRIEFCASE.

an AT compatible designed to accept the Data Pac.)

Think of the freedom you gain. You can increase your PC's capacity as much as you like, just by adding more Data Pacs.

Equally well, you can carry your personal database in your briefcase. And use it on a PC in another office, another town, another country.

It stays secure right up to the moment you want to share it. Then you simply transfer from one Data Pac to another: 30MB in about 3 minutes.

The Tandon Personal Data Pac. You'll wonder how you ever lived without it.



THE SHOCK-RESISTANT WINCHESTER.

Please tell me much more about the Personal Data Pac. Tandon (UK) Ltd, Freeport, Redditch B97 4BR. Tel: (0527) 46800.

Name \_\_\_\_\_

Job Title \_\_\_\_\_

Company/Address \_\_\_\_\_

\_\_\_\_\_

Postcode \_\_\_\_\_ Tel \_\_\_\_\_

Nature of Business \_\_\_\_\_

No. of employees \_\_\_\_\_

No. of installed PCs \_\_\_\_\_

PCW 5

**Tandon**

# Roland A3 Plotters - Unbeatable!



Whichever area of CAD you're working in, when it comes to specifying an A3 plotter, the cost-effective choice is a Roland.

Boasting proven design and performance reliability that has made Roland DG the number one name for A3, the range comprises four 8-pen flatbed models. Each is value packed courtesy of the very latest in PCB technology and, collectively, they cover all the user requirements of this popular format. Prices begin as low as £795\*.

From the DXY-890A, the ideal introduction to A3 and widely used throughout the education field; to the advanced DXY-990, offering fast, high-precision plotting with sophisticated pen control features and electrostatic paper hold.

The DXY-980A and DXY-885 complete the line-up and are keenly priced according to their facilities. Roland A3 plotters offer full RD-GL and HP-GL\*\* compatibility, and

interface with all leading micro computer systems.

Buying a Roland A3 plotter is as trouble-free as using one. From any of over one-hundred and thirty authorised UK Roland dealers, in fact.

For more information, give us a call or send for our individual A3 range colour brochures.

\* Retail excl. VAT  
\*\* We acknowledge all trademarks

**Roland DG**

Amalgamated Drive, West Cross Centre, Brentford, Middx. TW8 9EZ.  
Telephone: 01-568 4578 Fax: 01-847 1528 Telex: 934470 Roland G.



# Amstrad's next clever move

There's only one hobby which I'd rate as more fun than trying to guess what IBM will launch next — and that is trying to guess what Amstrad has up its sleeve.

The list of possibles has been presented as 'certain to be launched' in more magazines than I can read in a year. This list has included: a fax machine, a new Spectrum, an Amiga clone, a PS/2 clone with a 286 or a 386 chip inside, a video camcorder, a CD-ROM, a low-cost scanner, and a desktop publishing box.

Nobody has yet bet on a synthesiser, so I'm going to predict that inside a month or so, we will see the Spectrum

Plus 4 arrive as a music box.

Amstrad had the opportunity to launch any new 16-bit systems — if it had them ready — at the Hannover Fair.

It also had the incentive: its German partner, Schneider, has cut loose and launched its own range of 80286 machinery. The German element in Amstrad's PC sales has always been important, and rivals were very relaxed about Amstrad's failure to launch in competition.

All it showed in Hannover was the PPC range. That was new to Germany, and possibly an important launch. But one observer — with good City connections — reported that

this would be seen as 'not keeping his eye on the ball.'

Part of the reason for the lack of focus on Germany is the state of play in America.

There, Amstrad has just achieved the breakthrough of getting its portable PPC640 machine approved by the radio interference police, the Federal Communications Commission.

This, said Alan Sugar, means the company can start shipping in large numbers — which must mean targeting a figure of 50,000 machines per month. It will take a bit of reaching. America may be a big market, but Amstrad's prices are being pushed up by the shortage of memory.

Also, Amstrad isn't well-known there. That means money to be spent on advertising. An advertising budget of \$40 million per year isn't large, by US standards.

So my attention is focused on the Spectrum, which I know to be very nearly ready for launch — well, it was in early March, with just a few details to sort out on the manuals.

The project started out as the Loki inside Sinclair Research, and the idea was to take a 68000 and drive music and graphics with it.

Flair (designer of the Music Box) has been working on the design since, and the 68000 has definitely been dropped. But big sound and graphics chips, perhaps a MIDI interface and possibly even a piano keyboard, are real possibilities.

## First-class shuttle service

Quick and easy ways of getting program and data files between computers are always going to interest someone, and File Shuttle should interest more than most. In particular, it should interest anyone who wants to get files between a PC with 5¼in drives, and one with a 3½in drive.

The Shuttle is a Canadian product, written by GETC Software of Vancouver. It is being sold over here by Skye Industries Ltd of Leicester on (0533) 858744, and costs a mere £85 including post, packing and VAT. What is more, it works.

The most significant thing about it is that it makes use of the parallel ports on the PCs, acknowledging the fact that even some of the new, 3.5 lap portables don't come with a serial port. It comes as two disks, one 5¼in and one 3½in. Each contains the same software, so that it can be used on a wide range of PCs running MS-DOS.

It also comes with the 'Rocket Socket', an adaptor which allows the Centronics parallel connector that goes into the printer to plug into the D25 parallel port in the PC. The system can also be set up to run via serial ports at up to 115,200 baud.

Its most endearing feature is its menu terminology, as its name implies. It uses Space Shuttle 'jargon' to make functions clearer. So, 'Cargo Bay' is the drive or directory to transmit from or receive to, 'In Bound' is receiving files and 'Out Bound' is transmitting. Individual files in a cargo bay can be tagged for transmission, or whole directories sent, duplicate files can be skipped if required and a variety of options on file selection criteria are provided. These make it a good tool for backing-up hard disk systems.

Coupled to a short and concise manual, File Shuttle is extremely easy to use. This may not endear it to the techno-freaks, but for anyone more interested in simply moving files between MS-DOS PCs, it is a giant step.

Martin Banks

## Commodore's slow lift-off!

Commodore has officially entered the Transputer stakes, with the announcement that it had a product nearly ready, at Hannover Fair. More significantly, it has also announced its Amiga 2500, which has the 68020 chip, and offers a 1008 by 1024 graphics screen.

The Transputer system is not

to be taken too seriously as yet. Essentially, Commodore has two projects under its wing: one has yet to work, and the other is very unambitious, using the Transputer as an add-in card on the PC side of an Amiga. Neither is seriously intended as a rival to the Atari Abaq.

At Hannover, one of these was available for inspection, but not working. The other was said to be 'working, but stuck in an elevator somewhere.'



There's no need to regard the Amstrad PCW as 'just a word processor' and unsuitable for serious engineering hack work. SM Engineering has released a new interface which allows soldering-iron types to get their hands right inside.

The device is the parallel I/O interface, which provides the user with the equivalent of 'not one, but four BBC Micro user ports' says the company.

It's the range of add-on modules which go onto this which make it fun — see the photo here.

They include an input/output test module, which is for software testing, a breakout module for connection of your own hardware designs, an eight-channel analogue to digital converter, and a four-channel digital to analogue converter.

This set of options makes the Amstrad PCW a useful educational tool for the first time. It's also possible to use this perfectly standard CP/M machine in industrial settings, says SM Engineering.

'Industrial users have applied the hardware to an extensive range of applications varying from experimental research and development to quality control and shop floor machine control work,' the company claimed in its launch publicity.

The parallel interface costs £60 with a 30-page manual and disk with sample programs. Modules range from £19 for the breakout module to £40 for the A to D module.

Full details at St Georges, Lion Hill, Stone Cross Pevensy, Easy Sussex BN24 5ED or phone (0323) 766262.

## Sidekick Plus what?

Sidekick Plus is now available in the UK at a price of £195, and anybody who read March's review by Dick Pountain will certainly rush out and buy this very, very powerful PC desk accessory.

I'm tempted to suggest it's time to attach a health warning to software reviews from Dick Pountain. Dick is undoubtedly the best software reviewer in the UK, and Sidekick has become everything he says it is — but the fact of the matter is that like Yogi, he's a lot smarter than the average bear.

My own reaction to the product is that I'm waiting for version 2.0 before I rave about it. This one, I think, is way, way too complex.

There are areas where I know I will get used to it, and become attached to it. Others, however, I definitely want changed.

It's hard to give examples without running through the entire manual — but there are obvious problems.

For example, there are lots and lots of pull-down menus.

These look like Mac-style menus, but they aren't designed for use with a mouse. This makes them very dangerous. Typing with a menu showing can call up other menus, change setup states, delete files, paste clipboards, and so on. Some of these are real man-traps.

Never, for example, type with the Alt key down instead of the Shift key. All sorts of unpredictable disasters can result. The Alt key brings up a

menu with the letters A, C, F, H, K, N, O, S, P, T, U, and W. Other Alt-key combinations are 'short-cuts' from one menu to another.

And Alt-S actually means two things — if you just press Alt-S you get one menu, but if you hold down Alt, wait for the main menu and then press S, you get a completely different one.

The program goes way beyond what Sidekick did, but I find myself far from overwhelmed with its facilities.

For example, the notepad still can't edit a file over 64k. The outliner is a real step backwards in today's hypertext climate — a near total clone of the original ThinkTank — without ThinkTank's ability to clone outline headings (a complex feature which I'm not going to explain here).

The comms system is very powerful, but you'll never work it out without the manual, not even if you're an expert comms person. And there are lots and lots of things which must get put in.

For example, files which you are editing shouldn't just disappear if you hit escape. There should be a 'Do you really want to discard changes?' message.

Suppose you want to insert a file in the one you are editing; would you press Alt-I for insert? Or Alt-F for File?

If you're working on a big outline, wouldn't you want to be able to search through it? You can't — you can only search the headlines.

I'm going to use this package. But when version 2.0 comes along, believe me, I'm going to breathe a big, big sigh of relief.



Usually, mice for the PC family are plugged into a dedicated mouse board, or into the keyboard, or into a serial port. Logitech has decided that most people will want the mouse when they upgrade to high-resolution graphics, and so has launched a combined EGA screen card plus mouse. Software with it includes a Microsoft Windows driver. And there's also a light pen interface.

Details in the UK on (0898) 679976.

## Migent: the sequel

It wouldn't be quite right to say that Migent, with Emerald Bay, has launched a new database product that has it running hard in the opposite direction from the rest of the database world.

But it would come close, because the whole world is going after one 'standard' of database handling, SQL, and Migent has decided to produce a rival.

The idea seems to have a lot of merit, because all databases that use SQL are costly. And SQL is definitely the wave of the future. What Migent is offering is a low-cost alternative, but one which has the same advantages.

The snag is that no-one else will be able to use the Emerald

Bay alternative unless they buy something from Migent.

Micro data storage, normally, has a whole bunch of information on a central disk, and when one user wants to search through it, it gets copied across to that user's PC (usually on a network).

The SQL concept, shared by Migent, is that central data ought to be analysed centrally. Only the results of the central search ought to be sent down to the user.

This may sound like a minicomputer concept (or even a mainframe concept) but there is more to it. Tomorrow's machines will have multiple applications running together, and they will definitely have serious problems when they try to access the same data. For example: on a 386 micro with DesqView, I can run two

copies of WordStar, and each can edit the same file. Which version is the correct one?

Two versions of Lotus 1-2-3, and which is the 'final' version? Or a copy of a spreadsheet, fed over in a special format to a database manager, searched, and fed back into the spreadsheet — which may still be altering the data. Which one do you save?

Migent has already put together a product called Summit, which will give Lotus 1-2-3 users an in-built database (along the lines of Paperback's VP Planner). It has also built a 'C' language compiler which generates code to interrogate its own Emerald Bay database. And there is another language, called Eagle, which can be used by people who know Ashton-Tate's dBase products.

Other people are writing other bits for it. Someone is doing an Emerald Bay interface for the Macintosh.

Someone else is doing the Unix version. There will be Pascal, Basic, and other languages. There will even be an SQL version.

The problem is that Emerald Bay is proprietary — no-one is allowed to know how to design a network database server which emulates it.

Programmers, typically, don't like writing in proprietary databases. A major obstacle to the success of the Ansa Paradox database (Migent will do an interface to this, too) has been Ansa's refusal to release details of how the data is structured.

Almost certainly, sometime in the next two years, Migent will have to reverse this decision, and allow other people to write Emerald Bay engines — or resign itself to seeing Emerald Bay remain a small and pretty corner of the database world — as Emerald Bay itself is a small and pretty corner of Lake Tahoe, Nevada.



# 40MB for the price of 20MB!

Are we quackers?

Last month we ran the advertisement opposite and it certainly generated a lot of orders. Many people asked if we could supply 40MB tape streamers.

The answer is yes.

We are now able to offer exactly the same package but with the massive backup capacity of 40MB, at the same price! (£399 ex. VAT for 40MB internal, £499 ex. VAT for 40MB external.)

Every Everex Excel tape streamer comes with controller card, software, comprehensive manuals, scheduler program for unattended, pre-programmed backup, and free cartridge/cassette – just plug in & go.

The Everex Excel Stream 60-8 now has added value and comes with TWO FREE data cartridges.

To order an Everex tape streamer (ex. stock) or to find out more about our product range, complete the coupon below or ring 01-200 6511.



## Back-to-Quack



**Kudos breaks the tape streamer price barrier!** • Making a backup of your hard disk data is quite a chore. It takes too long and it's very complicated (You have to use 55 floppies to backup a 20MB drive). It never seems to be worth all the effort – until you lose all your data! • Tape Streamers make the task quick and easy but they're too expensive for most users to consider. • Until now. • Kudos Systems present three high-quality products which break the tape streamer price barrier:

**Everex Stream 20**  
(Internal)

**£399** (ex. VAT)

R.R.P. £895 (ex. VAT)

**Everex Stream 20**  
(External)

**£499** (ex. VAT)

R.R.P. £995 (ex. VAT)

**Everex Stream 60-8**  
(External)

**£599** (ex. VAT)

R.R.P. £1200 (ex. VAT)

These tape streamers, from the highly regarded Everex range, are suitable for most IBM PC/XT/AT compatibles. They come complete with controller card, software, comprehensive manuals, cables and free cartridge/cassette – just plug in and go. Features include:

- 5MB per minute backup speed
- Software assisted installation
- No need to pre-format tapes
- Local area network compatible (Xenix, Novell, Pkix, BOS, etc.)
- Automatic scheduler lets you preset 8 different times for unattended backup – intelligent software knows if you're using your micro and will wait for you to finish before making a backup
- Moveable, nestable windows make menus understandable
- Multiple tape capability allows unlimited capacity to backup even the largest drives
- External units can be shared by just adding additional controllers
- Multiple datasets for recording more than one session on a single tape
- Dynamic adjustments to disk and system speeds
- Context sensitive on-line help is always available with just the right messages
- Works with concurrent DOS
- 60MB has own power supply and uses DC600A media
- 20MB uses cassette media

**The Kudos Systems Price Guarantee**

If you buy from Kudos Systems then discover that you could have bought the same products at an advertised UK price lower than ours, then we will refund the difference.

To order any of these state-of-the-art products just clip the coupon below. Or call to hear more about the full Everex range of products, all available from Kudos.

All Kudos Systems' products come with a 12 month no-quibble guarantee

**KUDOS Systems LIMITED**

All tradenames and product names are the property of their respective manufacturers.

To Kudos Systems Ltd, Capitol House, Capitol Way, Edgware Road, London NW9 0ED

Please rush me the following products:

(Qty) Everex Stream 20MB internal	£476.10
(Qty) Everex Stream 20MB external	£591.10
(Qty) Everex Stream 60MB external	£711.85
<b>TOTAL</b>	

• Prices include VAT and courier delivery to your door  
Please send me your latest information pack

I enclose a cheque for £ \_\_\_\_\_  
or debit my Visa Card Number \_\_\_\_\_

Name \_\_\_\_\_  
Company \_\_\_\_\_  
Address \_\_\_\_\_  
Postcode \_\_\_\_\_ Telephone \_\_\_\_\_  
Approx No. of PC's in Company \_\_\_\_\_

**KUDOS Systems LIMITED**

All tradenames and product names are the property of their respective manufacturers/owners.

If you're a government department, education authority or PLC, just call us, quoting an official order number and your goods will be despatched on the same day.

**The Kudos Sales Team**  
Mail Order Sales: Yvonne Gayle  
Export Sales: Gary Munz  
Corporate Sales: Jane Messer  
Dealer Sales: Grant Boshier

**Kudos Systems Ltd**  
Capitol House, Capitol Way  
Edgware Road  
London NW9 0ED

**01-200 6511**  
Tlx: 8813241  
Fax: 01-205 3911  
Personal callers welcome – Call in and save on delivery charges.

To Kudos Systems Ltd, Capitol House, Capitol Way, Edgware Road, London NW9 0ED

Please rush me the following products:

(Qty) Everex Stream 40MB internal	£476.10
(Qty) Everex Stream 40MB external	£591.10
(Qty) Everex Stream 60MB external	£711.85
<b>TOTAL</b>	

★ Prices include VAT and courier delivery to your door  
Please send me your latest information pack

I enclose a cheque for £ \_\_\_\_\_  
or debit my Visa Card Number \_\_\_\_\_

Name \_\_\_\_\_  
Company \_\_\_\_\_  
Address \_\_\_\_\_  
Postcode \_\_\_\_\_ Telephone \_\_\_\_\_  
Approx No. of PC's in Company \_\_\_\_\_

## Legal eagles

The prospect of legal action between IBM and rival computer builders has come a step nearer. There are two signs — one is Phoenix's new BIOS chip, and the other is aggressive words from Tandy.

Phoenix Software was at the Hannover Fair, showing an IBM PS/2 micro — a model 60 machine — with a Phoenix 'BIOS' software chip running it.

On the face of it, there's little point in producing this software, since IBM makes the only PS/2 machines on the market, and it has its own BIOS chips.

Questioned by reporters for the online database The Source, however, the Phoenix folk shrugged. 'We have more than 20 companies who have signed to take this BIOS,' the company said.

Tim Bjarin, our US correspondent, points out that when IBM introduced its PS/2 line with its proprietary Micro Channel Architecture, the company led everybody to believe that anyone trying to clone this machine would have IBM legal eagles after them immediately.

And yet (writes Bjarin) Bill Lowe, president of the PC side of IBM, recently said that he expects to see legally-cloned PS/2 machines by the end of the year.

What this appears to mean (for those baffled by this riddle) is that Lowe expects IBM to have given its blessing, via some sort of cross licensing and royalty payment to IBM, to PS/2 clones. But since IBM has been very quiet

about licensing (and analysts do not expect IBM to explain its policy unless it has to), it will take a direct challenge to get IBM moving to declare the strategy on the subject.

The direct challenge is on its way. According to Michelle Preston, financial analyst (vp at Solomon Brothers, in New York) Tandy will be the first to show a clone.

Preston expects Tandy to introduce an 80386-based PS/2 clone using Intel's micro channel chip set, and the Phoenix BIOS.

Tandy's official comment on this came from Ed Juge, director of market planning. He said: 'It's no secret that we and lots of other firms are working on it, but I can't say when — next week, next month or next year.'

Tandy has already done some cross-licensing with IBM, though nobody knows whether this involves PS/2 technology. The company stores wouldn't be afraid to carry the new machine because any lawsuit would be against Tandy corporately, not the stores. And Tandy, being a multi-billion dollar company, has the internal legal staff to deal with IBM head on.

Most important, the legal challenge from Tandy would force IBM into declaring publicly *exactly* what it will and will not license, making it possible for other people to apply for what is available.

This could happen quickly — we might have a good number of PS/2 clones on the market by Christmas, all legally, and perhaps at better prices than IBM's.

This will greatly aid people who use more than one of the Microsoft languages as there is now only one user interface to learn.

Each language now includes the latest version of CodeView, Microsoft's source debugging program. This program allows compiled code to be run incrementally while viewing the registers, variables and the source code. This new version will debug both MS-DOS and OS/2 code and includes the new features of data browsing and the ability to follow multiple processes and threads in OS/2 applications.

The compilers themselves have been simplified and will all run directly from the new editing environment. The problems of inter-language calling have been simplified, making the inclusion of assembler in high-level languages much easier. The



It's the pyramid you should concentrate on in this picture — designed to make your office fresh and sweet by ionising the air.

I have a small warning about using it.

This thing costs £40 from Inmac Accessories, and is supposed to dissipate positive ions for three metres around itself.

I'm not one of that group of know-alls who can say exactly whether this thing really is or is not a benefit to health. I can say that all the ionisers I've had in my office have managed to get a lot of dust out of the air, which must be a good thing as long as the dust isn't deposited on something you want kept clean. This is important because the dust doesn't just disappear — it usually collects on the objects closest to the ioniser.

The problem, I'm told by a friend who used one, is simple: you must keep the thing well away from disks. It can cause errors.

Details on (0344) 424333

assembler now supports 80386/7 and compiles the source code up to 15% faster.

The OS/2 Developers' Toolkit should increase dramatically the rate at which new utilities are written for OS/2. The Toolkit, which works with all the languages, will improve a programmer's productivity significantly because there is only a single set of OS/2 calls to learn. Each piece of code makes use of OS/2's facilities through the application program interface (API) and this will support virtual programs of up to one gigabyte.

The Developers' Toolkit also contains the OS/2 Programmer's Learning Guide. This explains exactly how to get the most from the less familiar concepts contained in OS/2, such as multi-threaded applications and dynamic linked libraries. The Toolkit also comes with two hours of free support on Microsoft's technical support bulletin board DIAL.

Also shipped with the Developers' Toolkit are two new useful utilities.

BIND allows a single program to run under either OS/2 or MS-DOS. My heart leapt when I read this, thinking

that at last DesqView's power would be provided in OS/2 for old DOS applications. No such luck. Bill Gates must still believe that DesqView's power is unreliable. BIND will only work with programs compiled with new compilers, so your old DOS programs will still have to run in the compatibility box.

ILINK is an incremental linker which only links in the modules which have changed. This will encourage people to program in a modular fashion and will improve the compile time dramatically if they do.

This all sounds wonderful to those who understand what is going on, but will only serve to confuse even more the people who don't. Programming under OS/2 will be easy. Programming under DOS isn't too bad either. Programming in both at the same time is going to be very confusing. I really feel Microsoft has done the power users of its programming languages a big favour with these releases.

These packages are all available now, except for the C compiler and the Toolkit, which will not be available until the end of April.

Microsoft is on (0734) 500741.

Andy Redfern

## New releases from Microsoft

Even before the ink was dry on last month's review of Microsoft C version 5, Microsoft had announced a new release of all its language compilers. The new releases not only improve the compilers but also add the ability of producing code for both MS-DOS and OS/2. Also announced at the same time was the long awaited OS/2 Developers' Toolkit.

Each language now comes with the new Microsoft program editor. This is a multi-file, multi-window and multiple language editor, which will run in real or protected modes. It can be configured to emulate WordStar, the QuickC editor, the QuickBasic editor or many other popular program editors.



# Kudos – The Full Story

You know Kudos Systems as a supplier of hard disks and tape streamers to the general public – But did you know that most of our customers are corporations and dealers? As one of the UK's major suppliers of Everex products, our range of peripherals and software is bigger than you might think.

Now we have decided to offer our full range to you, the end user.

At Kudos all our staff are trained to the highest standards. We understand computer users. We know that invariably goods are required by the following day, or in some instances on the same day.

Kudos Systems is the one-stop-shop for peripherals and software. We aim to meet all your needs without sacrificing our commitment to service and technical support.

And, of course, the famous Kudos Price Guarantee still applies to our complete range.

## Tape Streamers

Everex Excel Stream 40 (int)	£399 (b)
Everex Excel Stream 40 (ext)	£499 (b)
Everex Excel Stream 60-8 (ext)	£599 (a)
Everex Excel Stream 60 (int)	£780 (b)
Everex Excel Stream 60 (ext)	£895 (a)
Everex Excel Stream 60 QIC-02 (ext)	£995 (a)
Everex Excel Stream 125 (int)	£1195 (a)
Everex Excel Stream 125 (ext)	£1320 (a)
Everex Excel Stream 60 for PS 2 (ext)	£1249 (a)
Everex Excel Stream 125 for PS 2 (ext)	£1570 (a)

All tape streamers come with controller card, cables, superb comprehensive software and free data cartridge cassette.

## Tape Streamer Controllers

Everex QIC 02 controller for PC XT AT	£139 (c)
Everex QIC 02 controller for PS 2	£265 (c)
Everex QIC 36 controller	£199 (c)

Additional controllers enable computers to share one tape streamer

**KudosMouse** (serial with software drivers)  
Made by Logitek **£39.95** (d)

## Graphic Cards

Everex Evergraphics Plus Hercules compatible. 720 x 348 pixels. 132 column	£85 (c)
Everex Evergraphics Deluxe Hercules compatible. 1024 x 704 resolution	£139 (c)
Everex Edge Hercules and CGA compatible	£239 (c)
Everex Micro Enhancer Auto-switch half card. full EGA 752 x 410. inc parallel port	£169 (c)
Everex EPGA professional graphics adapter. 640 x 480 resolution 256/4096 colours	£949 (c)

## Communications Products

Datalflex Stradcom Modem	£159 (c)
Communicate – Fax	£995
Communicate – Fax Plus	£1195
Procom 20 Plus	£875
Procom 20 Plus Multiline	£800

## Hard Disk Systems

Kudos Hardisk 20 (complete XT subsystem)	£199 (b)
KudosCard 20 (20MB Hardcard)	£239 (b)
Kudos Hardisk 30 (complete XT subsystem)	£249 (b)
KudosCard 30 (30MB Hardcard)	£269 (b)
Kudos Hardisk 40 (complete XT subsystem)	£299 (b)
KudosCard 40 (35 access time)	£499 (b)
Seagate ST 251 (40MB. 40ms bare drive)	£299 (b)
Seagate ST 251 1 (40MB. 28ms bare drive)	£399 (b)
Seagate ST 277R (60MB. 28ms bare drive)	£499 (b)
Seagate ST 4096 (80ms. 28ms bare drive)	£699 (a)
Amstrad Fixing Kit for Kudos Hardisk 20 & 30	£11.95 (d)
Western Digital Hard Disk Controller (XT)	£49 (c)
Western Digital Floppy Hard Disk Controller (AT)	£99 (c)

## Macintosh Products

Everex 20 MB External Hard Disk System (28ms access time)	£599 (a)
Everex 40MB External Hard Disk System (28ms access time)	£1199 (a)
Everex Stream 60 External tape backup. 3.5 MB min	£999 (a)

## Kudos System 1700

Full feature 80286. 12MHz. zero wait state computer. Each unit comes with full 1MB of RAM. 1.2MB floppy drive 28ms hard disk. 1 parallel and 2 serial ports and DOS. Each unit is made in the USA and has a 48 hour burn in test.

Kudos System 1700 M21 (mono monitor + 20MB hard disk)	£1699 (a)
Kudos System 1700 M41 (mono monitor + 40MB hard disk)	£1799 (a)
Kudos System 1700 C21 (EGA monitor + 20MB hard disk)	£1899 (a)
Kudos System 1700 C41 (EGA monitor + 40MB hard disk)	£1999 (a)

## Multi-Function and Memory Cards

Everex Expediter 80286 – turbo card	£299 (c)
Kudos 386 motherboard – Genuine Intel 80386 board with 512K RAM	£1099 (a)
Everex Magic Card 1 – up to 384K RAM. parallel port. serial port and clock	£169 (c)
Everex Magic Card 16 – up to 2MB of RAM. parallel port and serial port	£169 (c)
Everex RAM 2000 – up to 2MB of expanded extended memory for AT	£119 (c)
Everex RAM 2000 (PS 2) – up to 2MB of expanded extended memory for PS 2	£199 (c)

Everex RAM 4000 (PS 2) – up to 4MB of expanded extended memory for PS 2	£349 (c)
Everex RAM 10000	£ PDA (c)
Everex Mini Magic Card – up to 576K of base memory	£75 (c)
Everex RAM 3000 Deluxe – up to 3MB of extended expanded base memory for AT	£165 (c)
Everex Maxi Magic EMS – up to 2MB of base memory LIM compatible. for PC.XT.AT	£129 (c)
Everex Multi-Function EMS – up to 1MB of base memory. serial and parallel ports for XT or AT	£169 (c)
Everex Magic I D – 1 parallel port. 1 serial port and clock calender for XT or AT	£74 (c)

All boards come with DK RAM.

**C-Fax — £1195**  
A fully featured Group III facsimile machine, hidden in your PC. BAPT approved

## Monitors

Everex Eversision 14" flat screen mono monitor	£129 (c)
Everex Eversision 14" flat screen EGA colour monitor	£349 (c)

## Amstrads

Each unit comes with the Kudos Hardisk 20 installed. Add £50 for 30MB version and £110 for 40MB version

Amstrad PC1512 mono monitor. single floppy. Hardisk 20	£609 (a)
Amstrad PC1512 colour monitor. single floppy. Hardisk 20	£699 (a)
Amstrad PC1640 mono monitor. single floppy. Hardisk 20	£749 (a)
Amstrad PC1640 colour monitor. single floppy. Hardisk 20	£849 (a)
Amstrad PC1640 ECD monitor. single floppy. Hardisk 20	£949 (a)

## Media

DC600A Data Cartridge	£19.95 (d)
CT600H Data Cassette (40MB)	£23.95 (d)
CS600 Data Cassette (20MB)	£18.95 (d)

## Miscellaneous

Parallel Printer Cable	£9.95 (d)
8087 – 2 Maths Co Processor	£129 (d)
150W Power Supply	£69 (c)

## Printers

Amstrad DMP 3160	£189 (a)
Amstrad LQ3500	£329 (a)

Full range of Epson, Citizen, HP, Brother etc available.



## The Kudos Systems Price Guarantee

If you buy from Kudos Systems then discover that you could have bought the same products at an advertised UK price lower than ours, then we will refund the difference.

**Prices exclude VAT**

To order or to find out more about our product range, complete the coupon below or ring 01-200-6511  
Please add carriage as follows – (a) £17.00, (b) £12.50, (c) £8.00, (d) £3.00.

Prices and descriptions correct at time of going to press.

**KUDOS**  
*Systems*  
LIMITED

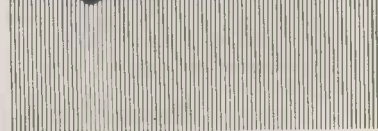

All tradenames and product names are the property of their respective manufacturers/owners.

If you're a government department, education authority or PLC, just call us, quoting an official order number and your goods will be despatched on the same day.

The Kudos Sales Team

Mail Order Sales: Yvonne Gayle  
Export Sales: Gary Munz  
Corporate Sales: Jane Messer  
Dealer Sales: Grant Boshier

Kudos Systems Ltd  
Capitol House, Capitol Way  
Edgware Road  
London NW9 0ED

**01-200 6511**

Tlx: 8813241

Fax: 01-205 3911

Personal callers welcome – Call in and save on delivery charges.

To Kudos Systems Ltd. Capitol House, Capitol Way, Edgware Road, London NW9 0ED

Please rush me the following products:

\_\_\_\_\_ (Qty) \_\_\_\_\_ £ \_\_\_\_\_  
\_\_\_\_\_ (Qty) \_\_\_\_\_ £ \_\_\_\_\_  
\_\_\_\_\_ (Qty) \_\_\_\_\_ £ \_\_\_\_\_

VAT @ 15% £ \_\_\_\_\_

Please send me your latest information pack  Carriage £ \_\_\_\_\_

I enclose a cheque for £ \_\_\_\_\_ TOTAL £ \_\_\_\_\_

or debit my Visa Card Number \_\_\_\_\_

Name \_\_\_\_\_

Company \_\_\_\_\_

Address \_\_\_\_\_

Postcode \_\_\_\_\_ Telephone \_\_\_\_\_

## Horse returns to find bolted stable

One of the best communications for the PC, ProComm, has at last been succeeded by its latest upgrade, ProComm Plus. The good news: it seems an excellent package.

But there is bad news: this one is not 'shareware' — software which you can freely copy for friends to try out.

The package itself works — I've been using it for the last couple of weeks. And it is an improvement on ProComm's earlier version 2.4.2.

The question of whether the package is or is not shareware is tricky, legally. I think the producer, DataStorm, has badly fouled it all up.

In the US, there is a shareware 'test drive' version. In Europe, however, the company says it has been 'disappointed' by the lack of

registration by ProComm users, and so it will sell the thing through the Danish publisher, Dorteck. And the Test drive version, it says, is 'not available' outside the US.

The lack of registrations from Europe is entirely DataStorm's own fault, however; it was virtually impossible to arrange. DataStorm didn't publish a phone number which would accept credit card payments, wouldn't set up a European support centre, and generally made life very difficult for people who wanted to give it any money.

Also, ProComm version 2.3 wasn't of a quality that would lead very many to pay for it.

The really stupid thing about it is that shareware registrations from the UK today are going up fast. In March, Shareware Marketing did about £18,000 worth of business collecting shareware registrations and sending cash back to US authors.

This, if you please, is the moment that DataStorm chooses to turn off the tap.

In the US, if you want to try out PC Plus there is a special free 'test version' which you can download from its own bulletin board. Anyone can download this — I have. Technically, however, I'm breaking regulations by doing so, because people outside the US *mustn't*. So even if I wanted to give the company money for it, I can't!

Complain to DataStorm, and it tells you that ProComm 2.4.2 is good enough for the Europeans, and it isn't going to argue about it.

Despite all the confusion, however, UK comms enthusiasts do now have a source for the full version of ProComm Plus: get in touch with Shareware Marketing in Tonbridge, Kent TN9 1RX.

Steve Townsley will be running a special support bulletin board for PC Plus on (0732) 770539 which runs at 300 or 1200bps (N81).

Price of the product will be £49.95 plus VAT, and £2 plus VAT carriage per consignment.

Special dealer discounts will be available.

For those who remember our original news item, there is some disappointment, in that it definitely does not do

Microcom Network Protocol error corrections. Nor, despite earlier tantalising hints, will you be able to add this ability.

The confusion arose because of the way ProComm Plus handles error-free data transmissions once you start trying to download stuff.

Typically, a ProComm user will be online to a database like The Source, or CIX, and will discover a file which *must* be transmitted without errors — say, a nice EGA

demonstration program. At this point, the normal thing to do is to ask for an error-free download. This involves starting something like Xmodem, or Kermit.

ProComm does this neatly, and ProComm Plus uses the same system. You press page-down for downloads from the remote system, and page-up for uploads to it. It then asks you which protocol.

On ProComm Plus, it is very easy to add new ones. For example, I added Zmodem, by linking in a new protocol driver. That now appears on the menu.

But MNP isn't usable as a simple download protocol. This is because you can't load MNP in the middle of a modem 'conversation' — it has to be set up when the systems first connect.

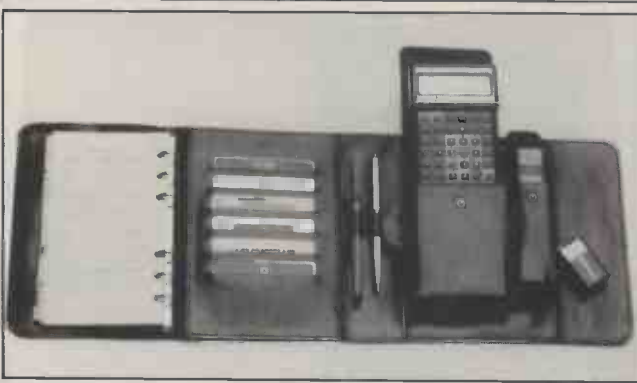

A computer diary (I remember saying) is useless without the ability to print out a paper version that you can carry with you. And that means the ability to print on Filofax-style paper.

Normally, this doesn't apply to the Psion Organiser, because you don't need to leave it on your desk — but, on the other hand, the Organiser can't hold a map of the London Underground, or a credit card. And it can't print on Filofax-style paper.

Problem solved: 'Following Psion's stock market launch, Transform has launched a calf leather case for the Organiser' — yes, it's a Filofax-style binder. It holds (to continue quoting from Transform's own announcement): the Organiser, a spare battery and a Datapak, both in detachable leather cases, six credit cards, two pens, a notes pocket, and a ring-binder to hold all the maps, sketches and accessories you can't fit into the organiser.'

At a mere £12.95, it's worth buying just for the binder — but there's more!

For £60, and £50 each, Transform offers two software packages for the Organiser.

The first, dBase, is a database creator which will print on Filofax-style paper, and the second, mail list, will also print on Filofax-style paper, but it will also print names and addresses on labels, 80-column paper, 132-column paper, 255-column paper, and everything except actual envelopes.

If only I could type on an Organiser. Mind you, my old friend and colleague, Barry Fox (an audio journalist, and winner of an award for his computer writings) says he's up to 30 words a minute on his.

Transform is at 24 West Oak, Beckenham, Kent BR3 2EZ and is contactable by phone on (01) 658 6350.

## Tricom modem launch

Cleverly disguised as an innocuous British modem from an inconsequential startup company, the Microcom modem which provides Microcom's own MNP error-correction system has arrived in the UK, approved.

It's called the Tricom 2426 by the UK agents — Tricom — a trick which seems about as clever as hiring Jeffrey Archer to write a book and insisting he does it under a *nom de plume*.

The main feature of the modem is that it will run MNP level 5, which is very fast, despite the fact that it is checking every block of data to see if it is correct.

Unusually, I can report on the performance of this modem, despite the fact that a review sample hasn't yet arrived.

It is connected to CIX, an online database and chat corner where several PCW staff can be found wasting time most weeks, and where this error-correction system has been taking quite a

pounding recently, because CIX has swapped its Quattro modems for the Tricom designs.

The reason for the change was to get a louder modem, because engineers complained that the originals were not audible across noisy lines.

I haven't been able to test it fully, so far, because the Quattro I use has MNP, but only level 2. That works fine, but slows down the data transfer from 2400 to around 1500 bits per second. But reports from users have been positive, despite the appalling problems caused by BT at the CIX exchange.

The latest exciting development has been to discover that the line noise was not, after all, due to the feeble tone of the Quattros, but to dirty switching equipment at the exchange. The reason it was dirty was simple: it is all due to be replaced with a digital exchange, and there's no point in doing routine cleaning on a system which is on its way out.

Tricom is contactable on (05827) 65171, and is situated at Irradion House, Southdown Road, Harpenden, Herts.



# GIVE YOURSELF A BREAK FOR £19.95



## ALEX HIGGINS' WORLD SNOOKER

Take a break from working on the computer and start playing on the computer. With world snooker according to Alex "Hurricane" Higgins you could soon be kissing in off the pink without getting up from your desk. And at **£19.95** you won't be out of pocket.

Recommended retail price includes VAT. Price correct at 1.1.88 but may change without notice. Software subject to licence. Note that games are suitable for use on PC 1512 MM & CM and PC 1640 CD & ECD monitors only. Products subject to availability. Amstrad is a registered trademark of Amstrad plc. All rights reserved. Available from your registered Amstrad dealer.

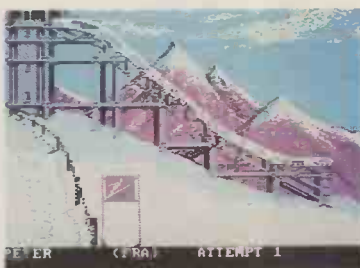

## WINTER GAMES

Instead of number crunching, how about figure skating? With Winter Games you can enjoy all the great winter season sports including the ski-jump, and the bobsleigh run. And if you're feeling fit, why not enter the Biathlon? **£19.95**

## SUMMER GAMES II

Sit back, relax and really exert yourself in Summer Games II. It'll have you running, jumping, rowing, fencing, cycling and kayaking amongst other sports. You can go for gold in every event. (But don't let your boss catch you or you'll be for the high jump.) **£19.95**

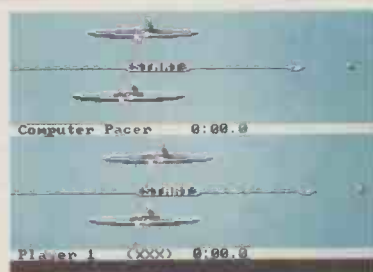

## MEAN 18 GOLF

Fancy designing your own golf course before you play? You can, with Mean 18 Golf. Make it extra difficult with more bunkers, deep rough and clumps of trees. There's a choice of Pro or Regulation tees and you'll need to use every club in the bag. **£19.95**



## PITSTOP II

You can be Nigel Mansell in your lunch hour as you race against stiff competition on the world's great circuits. And as Nigel would agree, you need good pit stop strategy to make sure of victory. You and the crew are up against the course, and the clock. **£19.95**

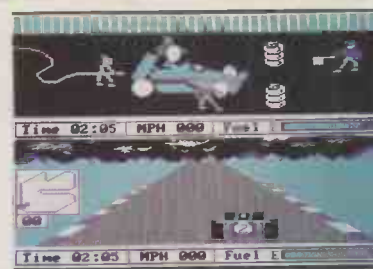

## CYRUS II CHESS

Pit your skills against the computer at any of 12 levels from beginner to grand master.

You have the option of playing in either 2D or 3D and you can even get printer support. It's well worth checking out. **£19.95**



Please send me information on Amstrad PC Games.

PCW 5-88

NAME \_\_\_\_\_ COMPANY \_\_\_\_\_

1988 20 YEARS ANNIVERSARY ADDRESS \_\_\_\_\_

TELEPHONE \_\_\_\_\_



Amstrad plc., PO Box 462, Brentwood, Essex CM14 4EF. Telephone: (0277) 262326.

# LEDGER REPORTS PROGRAMS

## FOR PEGASUS JUNIOR & SENIOR USERS

(FOR IBM/MS. DOS COMPATIBLES)

INDISPENSABLE FOR EFFECTIVE AND EFFICIENT «\*AT A GLANCE\*» LEDGER CONTROL, ESSENTIAL FOR GOOD HOUSEKEEPING. — DETECT UNMATCHED OPEN ITEMS AND OTHER IRREGULARITIES MORE EASILY. COMPRISING THE FOLLOWING REPORTS:

- DEBTORS OPEN ITEMS**  
For easy, convenient Credit Control and Cash Allocation
- DEBTORS TRANSACTIONS**  
Including Open and Allocated Items prior to «PERIOD END»
- CREDITORS OPEN ITEMS**  
Makes the reconciliation of Suppliers statements easier
- CREDITORS TRANSACTIONS**  
Including Open and Allocated Items prior to «PERIOD END»

**£49.50**

+ VAT

### NOMINAL PERIOD BALANCES REPORT

For PEGASUS JUNIOR or SENIOR Report Generators, showing on the SAME PAGE: NOMINAL Balances to PREVIOUS PERIOD — CURRENT PERIOD and YEAR to DATE Total Balances

**£14.50**

+ VAT

ALSO AVAILABLE: OPEN ITEMS ONLY REPORT FOR «TETRA» SPOOLED DEBTORS AND CREDITORS OPEN ITEMS LISTINGS, SAVING 30% PAPER IN THE BARGAIN. ASSET REGISTERS (CUSTOMISED) — FOR HIRE UNITS OR FLEET OPERATORS.

FOR MORE DETAILS PHONE OR WRITE:

**SEVERN SERVICES LTD.** — Data Processing  
Hadnock Road — MONMOUTH, Gwent NP5 3NQ  
Tel: (0600) 5363 \* Fax: (0600) 6810

MONEY BACK GUARANTEE — IF NOT SATISFIED

16.03.1988 CREDIT CONTROL REPORT (DEMONSTRATION CO. LTD.) Page 1

(Date)	(Type)	(Ref)	(Current)	(1 Month)	(2 Months)	(3 Months)	(A/C - Balance)	(NAME)
12.07.88	INV	7841	12.87				(4815)	ABBEY DEVELOPMENTS PLC
20.02.88	INV	4234		205.80				
12.02.88	INV	5432		2951.10				
19.12.87	INV	4578			108.10			
Totals :			12.87	3056.90	0.00	108.10	3177.87	Tel: 0935-29111

16.03.1988 CREDITORS TRANSACTIONS (DEMONSTRATION CO. LTD.) Page 1

(Date)	(Type)	(Ref)	(Current)	(1 Month)	(2 Months)	(3 Months)	(A/C - Balance)	(NAME)
03.02.88	INV	220782		163.00			IP (4610)	A.B. ARBUS MACHINES LTD.
29.01.88	PAYM	100710			163.00		IA	
Totals :			0.00	163.00	163.00	0.00	0.00	Tel: 0256-20123
14.03.88	PAYM	164532	1958.62				IA (4615)	A.B. CUSTOMISED SYSTEMS LTD.
26.02.88	PAYM	100755		1738.20			IA	
22.02.88	CNOTE	702047		331.95				
12.02.88	INV	813196		614.00				
06.02.88	CNOTE	702011		31.00				
05.02.88	INV	918892		371.00				
01.02.88	INV	812964		356.00				
01.02.88	INV	812956		356.00				
31.01.88	INV	81012913			163.27		IP	
20.01.88	INV	812760			342.40		IP	
19.01.88	INV	81012701			344.95		IP	
12.01.88	INV	812587			356.00		IP	
11.01.88	INV	812557			356.00		IP	
15.12.87	INV	812168				395.80	IP	
18.11.87	INV	911056				1738.20	IP	
Totals :			1958.62	404.15	1562.87	2114.00	1334.05	Tel: 9-29025

16.03.88 DEMONSTRATION CO. LTD. (PERIOD) & YEAR TO DATE NOM. BALANCES Page 1

A/C	DESCRIPTION	TO END OF PREV. PER.	THIS PERIOD	TO DATE
A000	SALES	1.00	.00	.00
A001	*****	.00	.00	.00
A100	SALES - PRINTING	-22482.03	-4443.61	-26925.64
A300	SALES - RECORDS	-26708.14	-5756.09	-32464.23
A400	SALES - STATIONERY	-33626.63	-9344.25	-42970.88
A500	SALES - CONFECTIONERY	-2206.50	-296.42	-2502.92
A		-85023.30	-19840.37	-104863.67

If you're losing ground to your computer, put it smartly in its place with the new System-Solver desk from Opus.

At only £149.95+VAT we've thought of just about everything, including a free matching swivel chair.

System-Solver is British-built, designed for all leading PC systems and offers an unbeatable range of features:

- Spacious desktop with clever keyboard cable management
- Smooth-flow paper feed channels
- Space-saving top shelf for both monitor and printer
- Separate shelves for computer and manuals
- Secure lockable diskette box and tidy tray
- Sturdy steel underframes and heavy-duty castors
- Simple self-assembly

To order your System-Solver call Opus on 0737 765080 or simply post the coupon below. Delivery in mainland Britain is free and we offer generous education and government discounts.

Desk measurements: Height 27"; Width 47"; Depth 32".

To Dept. SP, Opus Supplies Ltd, 53 Ormside Way, Holmehorpe Industrial Estate, Redhill, Surrey. Please send me the following:

System-Solver Desk(s) at £172.44 each (incl. VAT). I enclose a cheque for £\_\_\_\_\_ or please debit my credit card account with the amount of £\_\_\_\_\_

My Access  Barclaycard  (Please tick).

No. Is: \_\_\_\_\_

Name: \_\_\_\_\_

Address: \_\_\_\_\_

Telephone: \_\_\_\_\_

Opus

**£149.95**

+ VAT

**System-Solver**



**FREE CHAIR**

Put your PC in its place



## Grapevine

**Proof of life in the Archimedes world:** David Clare of Clares Micro Supplies has just proudly announced a deal to supply bulk deliveries of software to the Scottish Educational Forum. Included in the deal are all Clares' Archimedes labels. 'I wish more authorities would get their act together as Scotland has done,' commented Clare.

**Borland** has actually cut UK prices in line with the drop in the value of the dollar. This makes its Turbo C a very good deal indeed at £59.95, for anybody wanting to move over to that language. And Turbo Pascal 4.0 at the same price is a dead bargain which no-one should pass up. Finally, the Quattro spreadsheet was due to have its price put up to £195 after an introductory low price: instead, Borland will now keep the level down at £129.95.

**Who's spending what?** If you run a small company and are worried about your phone bills, a handy little device called **Siphon** may be a useful tool to find out who is making all the calls. The Siphon box sits between the RS232 port on the telephone exchange and the RS232 port on your PC. The device stores up the call data and then downloads it into a dBase file, where it can

be printed out in various forms. The data recorded includes the extension that made the call, the duration of the call and where the call was to. For more information, contact Software Ireland in Belfast on 247433.

**Going to the dogs:** When Pafec announced that its Design Office Graphics System (DOGS) was to be distributed free, many sceptics wondered what they were up to. But now the first 11,000 copies have been shipped, the disbelievers seem to have disappeared. The system requires 640k of memory, a vast amount of hard disk space and comes with no documentation worth mentioning. If none of these things are a problem, Pafec is on (0602) 292291. (By the way, free means £15 + VAT to cover disks costs and the full documentation. Telephone support and training are all extra.)

**Lotus Manuscript:** The annual Lotus User Show saw the release of version 2 of the Lotus Manuscript word-processing/desktop publishing package. This program is aimed at the gap between both markets and is intended to capture both. The new features include winding columns, better spacing and hyphenation control, graphics processing and a faster memory management system.

The package is still a heavyweight both in terms of disk space and processing power. Manuscript is seen by Lotus as everything a company should ever need from a desktop publishing system and removes all unnecessary features. In summing up other DTP packages Lotus said: 'We're not a nation of newsletter publishers; Pagemaker and Ventura only have a limited future.' Whether the company's optimism is justified remains to be seen and with only 2000-5000 (depending on whose figures you look at) copies sold, Lotus still has a lot of work to do. Lotus Development is on (0753) 840281.

**The Lee Wood Vinyl Graphics System** allows the user to create vinyl logos and templates by actually driving a plotter containing a knife rather than a pen. This system will take many types of vinyl and need not be punched as the cutter is friction-driven. The system costs around £5000 and is available from Leewood on (0480) 890860.

**Galaxy Mercury PC cards:** Galagraph has added two new graphics cards to its range. Both cards are aimed at the CAD market with special drivers for Autocad being available. The PS/2 version supports most PC screens from CGA to VGA and has two high-resolution modes of its own, 1024x768 and 800x600 with up to 256 colours displayed simultaneously. The PC card has a similar specification and runs five times faster than previous boards. The drivers also include a special 'zoom' feature which allows an area of the image to be 'zoomed into' without redrawing the screen. The cards are available in the UK through Aydin Controls on (0462) 58804.

**French poodle:** the 'first European manufacturer' to offer OS/2 is Goupil, and it has now reduced its portable machine to £1400, only three times the cost of an Amstrad portable. At least it's cheaper than a Hewlett-Packard Vectra.

**A new network for IBM's latest:** Equinet has released a new version of DNA Networks that will plug into the Micro Channel. But it works only with MS-DOS, not OS/2.

**Tracker tracked down:** an insanely useful program which keeps track of absolutely everything including

appointments, prospects, clients, phone numbers and reports, Tracker is now available for £99 from Mallian Systems in Berkshire (it comes from Australia) on (0628) 770033. It even works as a pop-up.

Tandon has at last produced a version of its PCA — the AT lookalikes — which works with its PAC — the removable disk. It's called the Tandon 286, and its main claim to fame is that it is fast. It runs at 12MHz if it is accessing fast memory on the motherboard, but can slow down briefly to access slower devices — such as plug-in memory cards, or peripheral drivers that won't run at full-speed. Availability: well, patience is a virtue much practised by Tandon buyers. More patience is needed.

**Short of memory chips?** Zenith says it can't be: it has decided to put 2Mbytes of RAM into its 386 box, instead of only 1Mbyte — but to keep the price the same. Just as well, really, since you certainly can't run OS/2 with only 1Mbyte, and the big plus about Zenith's 386 is that it does genuinely have OS/2 available.

**A quick barometer reading on OS/2, by the way:** Microsoft has just announced a programmers' toolkit and a few programming languages. Starting from today, begin writing a program to run under OS/2. No, it can't use Presentation Manager. When do you think it will be ready?

**Calling the new Acer machine** a PS/2 clone is only fair if you regard the Model 30 from IBM as a PS/2 machine. To most people, it looks more like a replacement XT. Not to worry, the Taiwanese company (which makes the new Commodore 386 machine) is prepared to let anyone who wants to build a Model 30 clone, using its chip set. And it is setting up an office in the UK, too.

**The SQL race continues:** Oracle, which provides software for minicomputer users who use SQL databases, has moved into OS/2 with a full relational database management system. It is said to 'take advantage of the operating system's multitasking and communications capabilities.' IBM versions of OS/2, sometime soon, will include their own SQL interface, so this is only of interest to clone users.

END



Colour printers now start at £259, following Star's release of the LC-10 dot-matrix machine.

Important features: the colour ribbon costs £6, and a normal black ribbon (£4) can be used for normal text output at normal speed which is 144 characters per second (draft) and 36 characters per second in NLQ mode. There's also the option of an automatic cut-sheet feeder for £65, and a push feed 'tractor' (tractor, Star, means something that pulls, but never mind) comes as standard.

There are two versions, one with a parallel interface for IBM or Epson compatibility, and the other for Commodore 64 and 128 machines.

Further details from Roger Bayley on (01) 840 1800.

# SURPLUS COMPUTER STOCKS

## MORGAN COMPUTER CO. DISPOSAL OF SURPLUS INVENTORY, LIQUIDATED STOCK, DEMO & USED COMPUTER MERCHANDISE

### APRICOT

Apricot internal modem	£50
Apricot Portable 256k	£250
Apricot Portable FP 256k	£295
Apricot F1 inc monitor	£295
Apricot F10 10Mb colour	£895
QED Plus	£25
*dBase II	£75
*Perfect Calc II	£40
*Perfect Filer II	£40
*Data Master	£45

### HEWLETT PACKARD

HP 150 inc 15Mb hard disk	£795
*HP 150 model II	£995
HP 7475A plotter HP-1B	£495
HP 7470A plotter HP-IL, HP-1B	£295
*HP Tilt unit 92240A	£5
HP 86a cpu	£250
HP 150 mkII touch screen opt	£35
HP fonts A, C, H	£60
HP fonts B, L	£120
HP Laserjet	£1150
HP 2674A thermal printer	£95
*Memo Maker HP150	£45
*Multiplan HP150	£55
*Mailmerge HP150	£75

### PRINTERS

Honeywell L34 CQ	£95
Dataproducts DP55 d/whl	£150
Dataproducts DP20 d/whl	£125
*Silver Reed EXP 600 d/whl	£195
*Silver Reed EXP 800 40 cps	£250
Fujitsu DMPG 9 IBM compat	£150
Fujitsu DLP 24, 132 col 24 pin	£125
Brother Twinwriter	£495
Copal SC1000	£75
Copal SC1200	£85
Ricoh RP1300 parallel d/whl	£150
Ricoh RP1600 parallel d/whl	£495
Dataproducts 8010 parallel	£90
Dataproducts 8020 132 col	£125
Honeywell L11 parallel	£75
*Olivetti DM 280 Epson/Mac	£150
*Olivetti DM 290 Epson/Mac	£250
*Olivetti DM 580 132 col RS232	£75
*Olivetti DM 590 colour dot mat	£295
Olivetti DM 600 parallel NLQ	£150
Olivetti DM 5020 parallel	£95
Olivetti DM 5100 RS232	£75
Olivetti DM 5050 parallel	£95
Olivetti DM 5305 parallel	£110
Ricoh 1600Q 60 cps d/wheel	£350
BDT S/F for Ricoh 1300	£25
Admate DP-80 dot matrix	£65
Quendata 1120 d/wheel	£95
Brother HR 25XL para/RS232	£225
Brother HR 15XL serial	£175
Brother HR 40 40cps d/whl	£295
Dyneer DW-36 parallel d/whl	£150
Mitsui MC-4200 132 col	£125
Brother Sheet Feeder SF-40	£75
Kaga Taxan KP-810	£95
Mannesmann Tally MT180	£150
*MT80 plus	£125
*MT80 PC plus	£150
MT180 sheet feeder	£45
Seikosha GP-700	£60
NEC 3550 sheet feeder	£45
Brother Sheet Feeder SF-50	£75
Philips P2000 d/whl RS232	£95
Seikosha GP-500	£35
Honeywell L32 parallel	£75

Part exchanges accepted.

### EPSON

Epson SQ-2500 540cps	£795
*Epson GQ-3500 laser printer	£1200
*LX-800 150cps, NLQ	£185
P80 printer demo	£75
Tractor feed for SQ 2000	£55
TF-20 dual floppy	£150
Epson PC twin drive IBM comp	£395
Sheetfeeder 7334 for LQ-1000	£45
Sheetfeeder 8344 for LQ-1500	£55
*Sheetfeeder SQ2000	£100
*P40 thermal printer parallel	£60
PX-8 inc WordStar etc	£195
*RS232 interface LQ-1500	£35
*SQ 2000 24 jet printer	£495
FX-100 dot matrix	£150
Epson PX4 (Pine) portable	£150
MX/FX 80 serial adaptors	£20

### NEW UK LOW!



#### FUJITSU ME-503

Sensational value Multi-sync monitor. Standard IBM input, 926x 580 res, text mode switch

**£395**

### OLIVETTI M24



#### 20Mb HI-RES COLOUR

640K, 8MHz, 20Mb hard disk 1 x 360K, 6 expansion slots, ext keyboard, DOS. NEW

**£1295**

### FLEA MARKET

PARTS ONLY, NO WARRANTY GIVEN	
Assorted Shredders from	£200
NEC 9" composite monitor	£25
ACT Sirius complete	£295
CRTronic terminal & disk drive	£350
*IBM BASIC manual	£10
IBM 5 1/4 inch 360k drives	£30
NEC 12" composite monitor	£35
Qume S9/55 d/wheel	£35
110V colour monitor	£45
Osborne I grey case	£75
*OKI IBM Plug'n Play	£10
Portascribe O/H projector	£125
Tandy Model III 16k	£15
War surplus 5 1/4 floppies 10s	£6
110V NEC Spinwriter	£250
Commodore 8032 computer	£35
Listing paper asstd 500s	£5
*Alphanumeric keyboards	£35
Acoustic hoods	£35
*IBM DOS 1.1	£5
Tandy colour printer	£15
Case quad telex modem	£45
IBM 5103 printer	£75
ICE PC link	£35
IBM Displaywriter	£195

### IBM CARDS

Misslink internal modem card	£125
*5250 emulation adaptor	£195
AST-PC net-II Starter kit	£250
*AST Flashpack	£80
CGA card compatible	£50
IBM CGA card	£75
*AST Rampage EGA AT inc S/W	£195
Quad board AT	£150
EGA for AT inc software	£125
EGA compatible for IBM PC	£95
TCL Network card for AT/PC	£195
IBM cluster adaptor	£150
AST 5251 Network card	£150
*IDEA Overboard EGA, I/O	£225
*IDEA All Aboard 286	£250
*IDEA Supermax m/function AT	£150
IDEA Comm 3278 card	£95

### OLIVETTI M15



#### TWO DRIVE LAPTOP. NEW!

Supertwist LCD 80 x 25 screen, twin 720K drives, 512K RAM

**£550**

battery/mains. c/w case

### FINAL SHIPMENT



#### DEMO APRICOT PORTABLE

256k, LCD display, 1 x 720k disk drive, software and carry case (FP enhanced BIOS £295)

**£250**

### MISCELLANEOUS

Compaq Portable 2 x 360k	£495
Compaq D/pro 386 40Mb comp	£2995
Compaq D/pro 386 130Mb col	£4500
Compaq 286 Portable 20Mb	£1395
Compaq Portable II 2 x 360k	£995
Olivetti M28 40Mb, mono, kbd	£1500
*Panasonic TX-14M5E CGA 14"	£195
*Panasonic TX-14M6E EGA 14"	£275
Olivetti M24 2x360K, 640K	£795
*Olivetti M19 2 x 360k mono	£395
*Panasonic JB-3301 20Mb port	£1095
Televideo 1605 PC compatible	£295
Televideo 1605H ditto inc 10mb	£495
Tandon (baby) AT	£1295
Compaq Plus inc 256k 10mb	£1100
Philips 3500 10MB multi-user	£995
Tandon PCXT 20Mb EGA colour	£1250
North Star Dimension 50 2 user	£1750
Olivetti M240 complete	£995
Kaypro 10 C/PM 10Mb inc s/w	£250
AT & T multi user system	£3500
*Sanyo MBC-775 colour port	£495
Apple Laserwriter	£2500
Samsung 20Mb AT clone col	£1195
Datavue 25 LCD IBM compat	£395
DG-One 1 x 720k LCD laptop	£395

### IBM HARDWARE

IBM Wheelprinter	£350
IBM Network cable 25ft	£10
IBM Colour printer	£250
IBM PC 256k 10mb complete	£795
IBM ATX 512k 20mb colour	£2000
IBM Quietwriter	£395
IBM SDLC card	£50
IBM AT serial cable	£35
IBM Async Comms card	£50
IBM swivel monitor stand	£25
IBM Network translator unit	£150
Tallgrass 20+20	£195
AST Sixpak inc 64k Sidekick	£150
Summa sketchpad	£250
*Thomson std. colour monitor	£150
*Thomson hi-res colour monitor	£195
Tallgrass TG8000 file server	£2500
Tallgrass TG5025	£350
*AST Preview card	£75
Alloy FT60 tapestreamer	£350
Tecmar AT multifunction card	£150
Ideadisk 10mb & 5mb backup	£150
*IBM XT SFD, 640K, 20Mb comp	£1395
IBM PS/2 model 30 comp	£995
*IBM uncased 5 1/4 floppies	£65
*IBM 6170 typewriter	£600

### IBM SOFTWARE

*Microsoft Pascal compiler	£195
*Displaywrite 3	£150
*Compsort Domino	£35
*Compsort 1-up	£10
*Compsort Bookworker A/C	£95
*Budget Delta 4	£45
*Sage Bookkeeper	£25
*Sage Payroll	£45
*Sage Retrieve database	£35
*Sage PC-Planner 123 clone	£45
*Sage Desk set pop up utilities	£25
*Borland Reflex database	£45
*Calc-it 3D Spreadsheet	£95
*Show-it graphs package	£45
*Ask-it compliments Keep-it	£25
*Sort-it ditto	£25
*QED	£25
*Micropro Datarstar	£25
*Micropro Wordstar 2000	£195
*Keep-it database	£95
*dBase II Multi user	£350
*IBM Writing Assistant	£35
*IBM Reporting Assistant	£35
*IBM Planning Assistant	£35
*IBM Professional editor	£45
*Edit-it simple text editor	£10
*Peachtree Dec Manager	£45
*Easy Junior A/C package	£150
*Fox & Geller Quickindex	£25
*Fox & Geller Quickcode	£25
*Smarterm VT100	£125
*Smarterm VT220	£125
*Smarterm VT400	£125
*Visicalc IV	£65
*Visiword	£35
*Visi Desktop/plot	£20
*Fox & Geller dUtil	£25
*Volkswriter Deluxe	£30
*Easywriter II	£25
*Multimate word processor	£95
*Graphwriter	£250
Executive Writer VP software	£35
Number Works VP software	£35
Hardware man Portable	£50
GTO IBM XT	£35

\* indicates brand new goods

ACCESS AND VISA ACCEPTED  
PRICES SUBJECT TO 15% VAT  
MAIL ORDER (CARRIAGE EXTRA)

# Morgan Computer Co.

OPEN MONDAY TO SATURDAY  
PRICES SUBJECT TO CHANGE  
GOODS SUBJ. TO AVAILABILITY

64-72 NEW OXFORD STREET, LONDON WC1. 01-255 2115. 179 TOTTENHAM COURT ROAD, LONDON W1. 01-636 1138



# Back to the drawing board



In mid-February, a 160-page document from Apple Computer got into the hands of a local trade journal which quickly became big news in Silicon Valley. The document listed in detail Apple's previously rumoured design for its laptop Macintosh — codenamed Laguna.

Apple had contended for some time that current flat panel display technology did not meet its desired goals for high resolution. According to the document, Apple has chosen the new 'Active Matrix Display' technology which lights each pixel via its own transistor, rather than just a block of pixels — thus giving it a very high resolution. The 9.8in screen has a resolution of 640 x 400. In fact, if you tried to use a mouse with conventional LCD technology, you would not even be able to see the pointer on the screen. With active matrix displays, however, the pointer is clear and crisp. Apple's laptop reportedly uses the new Motorola 68HC000 chip, a CMOS version of the 68000 series.

The major difference between the portable and the standard SE architecture lies in three ASIC chips codenamed Normandy, Omaha and Utah. These 2-micron, 84-pin CMOS ICs control most of the Laguna's function. Normandy, also dubbed the Power Manager, is an 8-bit microprocessor that replaces the real-time clock and Apple Desktop BUS transceiver. As a result, the memory expansion interface resides in Normandy. Omaha generates the video signal and screen refresh and Utah operates the serial port communications functions.

The search for the ultimate in portable computing continues at Apple Computer. Pictured above is the Dynamac, a third-party attempt at Mac portability

Another interesting feature of the portable Mac is a trackball-type device that is built into the keyboard. This sits where you would normally find a 10-key numeric pad and is convenient as it does away with a mouse cable. A mouse is still available, however, as an optional extra. Although the Laguna's primary power source is AC-driven, there is an optional external battery system. The 5lb battery (the weight of two Z88s) fits into a recessed cavity and extends the machine's portability.

The document also explains that Apple uses SLIM (Slim Line IC modules) cards to expand the RAM and ROM.

## Chips, chips and yet more chips

At a recent Dataquest Semiconductor Conference, participants discussed the growing prices and increased market demand for DRAM chips.

DRAM chips are the memory chips used in all computers, and the market will come under increased pressure as memory-hungry applications such as OS/2 and Presentation Manager come onstream. Memory prices have nearly doubled in the last year and the prices and production of these chips are almost exclusively controlled by

These manually-inserted cards are similar to the credit cards used for font delivery on some Far Eastern printers and measure 85.6mm x 54.0mm x 3.4mm.

The main system memory is 1Mbyte of static RAM which is arranged in a 512k x 16-bit array. Mass storage is two 3½in double-sided drives that can read and write on a 3.5in disk in three modes: Group Code Recording and Modified Frequency Modulation (MFM) on a 1Mbyte disk and MFM on a special 2Mbyte (1.6Mbyte formatted) floppy disk. Also available will be an optional, low power, one-third height 20Mbyte hard disk.

The Laguna is not short of external ports either. The serial communications controller, a 4MHz CMOS Z8530, drives two mini DIN-8 ports and, in addition, there is a SCSI port, a db-19 external floppy connector, a mini DIN-4 Apple Desktop Bus port, an external video connector, a 96-pin Euro DIN Mac SE-style expansion connector and a stereo audio phone jack. The machine also uses the Apple Digital Sound Chip with Sony sound chip support. The machine has some very nice features, but the document points out it will have a selling price in the region of \$6000.

Apple's official comment on the document is that: 'Apple will introduce no new CPUs in 1988.' It is rumoured that Apple has already shown the Laguna to some industry leaders who felt that the ergonomic design and weight of the machine would hinder its acceptance as a true laptop

Japanese manufacturers. One major industry vendor at the Conference felt that this tight Japanese control was a direct retaliation by the Japanese for the restrictions imposed by the US over earlier chip-dumping in the US.

But, American ingenuity is responding with a new memory-chip technology that could make DRAMs obsolete, along with just about all types of memory chips. This new technology is based on the 'ferro-electric effect'.

It has been known for some time that certain materials change polarity when an electric current is applied. Two start-ups, Krysalis Corp of Albuquerque, NM, and Ramtron Corp in Colorado



**TIM BAJARIN**

This month our West Coast correspondent, Tim Bajarin, reports on how Apple's laptop is slowly taking shape, a new generation of chips, and a package that enables you to create your own cartoons.

even though they liked the basic specifications of the machine. As a result, it is believed Apple has opted not to release the machine this year but taken it back to the drawing boards to tweak it for a January 1989 release.

● Apple is not the only big company with a laptop in the wings. According to a former company official, Compaq had actually signed an agreement to have a modified version of the Toshiba T3100 under the Compaq label for release last year but decided to pull it at the eleventh hour. Sources close to Compaq say that it opted for a similar design, but chose to 'do it in-house' and will release it mid-year.

Springs, Colorado, claim that they have developed special ceramic materials and techniques for fashioning ferro-electric microcircuits on silicon, gallium arsenide and other semiconductor materials.

The ferro-electric memories (FRAMs) seem to promise the best of all possible worlds. Unlike DRAMs, they don't forget when the power is turned off. When compared to EPROMs, FRAMs are both faster and longer-lasting.

Dataquest predicts that FRAMs could sprout into a \$350 million business by 1992. If these firms can prove that their chips can come to market quickly, it could put serious pressure on the Japanese to drop their prices on DRAMs. ▶

# IBM highlights its aggressive way forward for PC systems



I recently had the opportunity to attend a rather exclusive gathering of industry analysts in Boca Raton, Florida, the headquarters of IBM's Entry System Division, and I was invited to spend two days with Bill Lowe, president of ESD, the group within IBM that gave us the IBM PC and PS/2.

About 30 industry consultants gathered to hear

The System 30: part of IBM's drive to maintain its premier position in the PC mainframe markets. The customers will benefit, the cloners won't

Lowe and his staff discuss their plans for the PS/2 and give us a hint of how they plan to regain market share for their systems.

The two day session was extremely intense, providing insights into IBM's PS/2 architecture, how it sees the virtues of OS/2 and Presentation Manager and the System Network Architecture (SNA) as well as plans for the Token Ring networks approach to system integration.

From this meeting I was able to ascertain some very important information.

- IBM is very concerned about the customer and will work hard to make this a priority. It will move as quickly as possible to make all of its systems (mainframe, mini and PCs) work together . . . and increase the support and service at every customer level.

- IBM will move aggressively to protect its intellectual property and will allow no company to clone its MCA-based PS/2 illegally. It became clear, after talking with Lowe and other IBM officials, that IBM is considering licensing its MCA technology, but will probably make every vendor submit its clone version directly to IBM for patent and copyright checks.

Those companies who already have cross-licensing agreements with IBM, such as Olivetti, Texas Instruments and NCR, will probably get a blanket licence, but vendors such as Compaq and Tandy as well as any other MCA clone, must go through this IBM check. If IBM finds any piece of

the clone that infringes on its copyright or patents, IBM can option to grant a licence and charge a royalty based on the amount of infringements discovered. This royalty fee will immediately impact the clone maker's bottom line margins.

I am under the impression that IBM really wants to control the cloning issue this time around, and after it has granted licences to 10 or 15 leading vendors, I expect to see it add new proprietary features to PS/2 and, in effect, send the clone makers back to clone these new features.

Consequently, IBM could always stay 6-12 months ahead of the competition, and this alone could become a major selling point to the corporate US.

- It became very clear that the chip of choice for IBM-based PCs is the Intel 80386.

Although Lowe hinted that he would have a model 50-based 80286 CPU for about \$1100 later this year, he also said that we could expect to see an 80386-based model 80 box . . . (basic unit) for as low as \$1350 by mid-1989. It appears that IBM will perhaps get a licence to produce the 80386 chip itself, thus drastically reducing its own manufacturing costs. The other key to this move would be that IBM is likely to make the 80386 the chip it uses in all its machines by mid-1989.

- It also became clear that IBM believes that it is well-positioned to be the leader in mainframe, mini and PC-based systems and will be very aggressive in implementing its SNA, SAA and Token Ring strategies. Although it may take a while to get into place, I expect to see all of IBM's computers work together.

## Create your own special effects

A product that has garnered a lot of attention in the Apple II world is Fantavision, an animation and special-effects generator. In fact, when originally introduced, it received Best Entertainment product of the year award for the Apple II. Now, Broderbund, the San Rafael, California-based software firm, has just released this product under the IBM PC/Tandy and Amiga platforms.

With Fantavision, any user, from beginner to professional animator, can create smoothly animated cartoons and

'movies' — the secret: special tools called 'tweening' and 'transformation'. These Fantavision tools can instantly generate dozens of intermediate images for every one that the user draws.

This does away with the need to redraw shapes constantly as in traditional cell animation. Instead, the computer creates smooth, fluid motion from one drawing to the next. In addition, the new versions include a library of digitised sounds and music.

The program also allows users to create special self-running show disks for viewing by others, even if they don't have Fantavision. And, at \$59.95 for either version, it's a real bargain.

## General Electric chips in

Another hot development in chip technology comes from General Electric. A prototype of a 32-bit microprocessor with reported peak performance rates up to 40 MIPS has been developed by GE's Electronic Labs in Syracuse, NY.

Furthermore, the CPU has a 25 nanosecond cycle time and runs at speeds of up to 40MHz. The chip itself contains only the central processor and the integer arithmetic units and is designed to be a component in a multi-chip microprocessor unit.

The CMOS chip has 92,000

transistors configured on a 7 x 7mm die, according to David Lewis, a member of the design team. The GE chip uses an 8-member instruction set and provides 21 general-purpose registers and a 32-bit program counter. It automatically handles exceptions and interrupts.

If you compare this chip with an 80386 20MHz that runs at approximately four MIPS, you can see its potential power, especially in systems where parallel processing is called for.

Company officials did not say when the chip might be in commercial use, but they did confirm that many major computer vendors are looking at it for future integration. **END**



# PIPEDREAM

## the REALITY

PipeDream is a step forward in integrated software.

With existing integrated packages, you have to divide your work into artificial sections, such as text, numbers and calculation, and database.

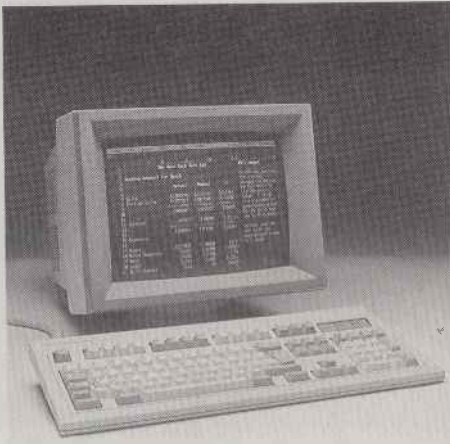

With PipeDream, you compose your work in the order you want to print it, with text and numbers all together in one document. Incorporate calculations directly into paragraphs of text and formatted paragraphs directly into spreadsheets.

**With this new approach you get a whole new dimension of power . . .**

PipeDream is a word processor offering many columns of formatted text. That film script you were going to write next holiday? Ideal.

PipeDream is a spreadsheet program with a work area of 8192 columns by over 500,000,000 rows, so you'll grow out of your computer before you grow out of PipeDream.

And being able to mix numbers and text together means you can calculate invoices and mail-shot them without resorting to expensive accounting software.

**In fact, PipeDream's unique integration means that mail-shots couldn't be easier.**

Simply type in your letter or invoice, leaving gaps for names, addresses and payment dates. Then PipeDream will print the letter to each addressee, automatically inserting all the details, and keeping the text neatly formatted and aligned.

**And database and spreadsheet functions can work together.**

You can use PipeDream as a database program to maintain your address book or sales ledger. Perform selections and sorts to invoice all of those customers living in London who have bought more than 100 products from you since February but haven't paid within 30 days.

The price of all this power? Just £99+VAT. You can't afford not to have PipeDream. Especially when you consider the price of existing 'integrated' packages.

But don't just take our word for it. This is what Michael Bywater of *Punch* had to say:

*"PipeDream itself is a remarkable achievement. It offers a spreadsheet, a word processor and a database, and if you think I am talking about a conventional integrated program, you are wrong. PipeDream does all those things within one program. No switching between modules or cutting and pasting; PipeDream simply offers you a matrix of 'slots' into which you can either type continuous text or figures or formulae or database 'fields'."*

That was PipeDream on the Z88.

Now we've completely rewritten it for IBM PC and compatibles. The result is even friendlier, faster and more powerful. There are full menus and dialogue boxes, making the most complex operations easy to carry out. You'll probably never even need to look at the comprehensive PipeDream tutorial and reference book. And keyboard wizards will love the optimised keystroke alternatives to the menus. Some will even devise their own key layouts, using PipeDream's unique keyboard programmability.

**We've maintained 100% file and keystroke compatibility with Z88 PipeDream, so you can transfer files between the Z88 and your PC.**

New facilities include:

- user-definable colour displays
- a comprehensive range of financial functions
- full usage of foreign characters including direct editing and printing
- loading and saving in several formats giving compatibility with Lotus 1-2-3, SuperCalc, Excel and many other spreadsheets

- linking files enabling you to pass the results of calculations between spreadsheets
- special 43×80 display on EGA and 50×80 display on VGA.

This in addition to all the facilities many thousands of Z88 PipeDream users have come to expect:

- fully wysiwyg display (what you see is what you get)
- many columns of formatted text on screen
- full spreadsheet power includes dates
- live calculations within formatted text
- flexible printing of special highlights such as underlining and bold text
- documents consisting of many separate files.

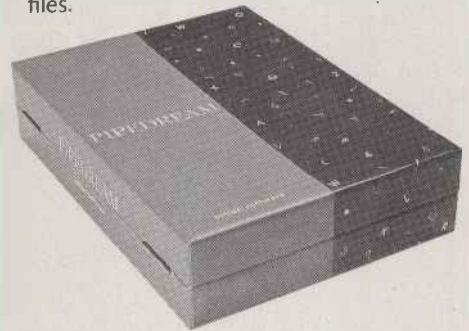

As *Punch* summed up:

*"PipeDream offers as much spreadsheeting power as you can need to bullshit the opposition, and what's more, you can write your lies and then make up your sales projections in the same document, just by telling PipeDream that this next bit is numbers or text or a database or what you will."*

Quite.



For more information or to order PipeDream cut out the coupon or phone us on 0954 211472

In most cases orders will be despatched the same day, but please allow 28 days for delivery.

Please send me more information on PipeDream

Please send me _____ PipeDream packs	Retail price	£99.00	£ _____
	VAT	£14.85	£ _____
	Postage UK	Free	
	Postage overseas	£10.00	£ _____
	<b>TOTAL</b>		£ _____

Please tick box. MS-DOS 5¼" disk  MS-DOS 3½" disk

Payment  Visa  Access  Cheque

Credit card number

Credit card expiry date \_\_\_\_\_

Name (as on credit card) \_\_\_\_\_

Address \_\_\_\_\_

Postcode \_\_\_\_\_

Send to Colton Software, Broadway House, 149-151 St. Neots Road, Hardwick, Cambridge CB3 7QJ PCW/5/88

---

‘Unbeatable...’

‘A considerable  
bargain...’



(Don't you believe it!)

---



When reviewers use words like 'bargain' and 'unbeatable' about your computers, you could just rest on your laurels.

At Dell, we accept quotes like those opposite as a challenge. (They come from reviews of the 286<sup>12</sup> and 386<sup>16</sup> in 'Personal Computer World', July '87 and 'Which Computer', October '87.)

So we're pleased to announce that we've actually improved on the specification of the 286<sup>12</sup>. Our new System 200 offers even better value in 12MHz computing.

And we're equally delighted to tell you that our 386<sup>16</sup> is renamed the Dell System 300 – and is down in price. With its new VGA and 3½" drive options, it now represents yet more value in speed and power computing.

## The new System 200

The new Dell System 200 surpasses the performance of the Dell 286<sup>12</sup> – and costs less.

We have taken your needs into account when designing it. We've combined the highest standards of AT architecture with the very latest technological developments to give you OS/2 compatibility, 3½" disk support, and VGA monitors. Plus it's simple and inexpensive to upgrade memory on the motherboard to 4-6MB.

Higher speeds and all-round performance make the System 200 the finest available 286 technology. Add to all that an incredibly low price and the inclusive package of direct service and support from Dell, and we've clearly beaten the 'unbeatable'.

## The System 300

Innovative design allows the Dell System 300 to maximise the performance of its 16MHz 80386 microprocessor. So if your applications require both power and speed this is the machine for you.

It will actually deliver advanced computing power more usually associated with

minicomputers. And because thousands of American users have found this to be the case, we've been able to reduce its price by £400 in this country. Making it an even more cost-effective alternative to the mini... and a yet more 'considerable bargain'.

## How a direct relationship benefits you

These changes reflect Dell's philosophy of dealing direct... to give you precisely the computer you need for a price you want to pay. Our machines are designed and built in Texas and configured for your needs in the UK.

And as the manufacturer we're proud to accept responsibility for them. We cut out the middleman and his margin – so bringing prices down – but we also provide better support than a dealer could.

When you buy Dell you not only get fast, powerful and compatible pc's but you get as much technical support as you want. And it won't cost you a penny.

Read the guarantee panel below and bear in mind that this support comes from the people who design and build the machines.

Our direct approach has proved popular with the end user. After just three years, we are one of the seven largest manufacturers in the USA. In less than a year in Britain, companies of the calibre of BP Oil International are already standardising with Dell.

## Order your Dell computer now

If you'd like to take advantage of an even better Dell package, get in touch today. Write to us at Dell Computer Corporation, FREEPOST (RG 1462), Bracknell, Berkshire RG12 1BR. Better still, 'phone us to discuss your computer needs in detail with our expert staff on

**0800 414535**

Monday-Friday, 9am-5.30pm.



## Dell System 200

### STANDARD FEATURES

Intel 80286 running at 12.5 or 6-25 MHz; 640K of RAM expandable to 16MB; 1-2MB, or 1-44MB 3.5" floppy disk drive; Floppy and hard drive controller; Enhanced 102 key keyboard; 200 watt power supply; Six expansion slots; Real-time clock; the Dell System Analyser.

### MONOCHROME SYSTEMS

High resolution monochrome monitor; Hercules compatible Monochrome Graphics card; 2 Serial and 1 Parallel Ports.

System 200	with	20MB, 65MS hard drive	<b>£1,299</b>
	with	40MB, 28MS hard drive	<b>£1,599</b>
	with	70MB, 28MS hard drive	<b>£1,899</b>
	with	150MB, 18MS hard drive	<b>£2,599</b>

### EGA COLOUR SYSTEMS

EGA high resolution monitor; High Specification EGA card; 2 Serial and 1 Parallel Ports.

System 200	with	20MB, 65MS hard drive	<b>£1,699</b>
	with	40MB, 28MS hard drive	<b>£1,999</b>
	with	70MB, 28MS hard drive	<b>£2,299</b>
	with	150MB, 18MS hard drive	<b>£2,999</b>

### VGA COLOUR SYSTEMS

VGA high resolution monitor; High Specification VGA card; 2 Serial and 1 Parallel Ports.

System 200	with	20MB, 65MS hard drive	<b>£1,899</b>
	with	40MB, 28MS hard drive	<b>£2,199</b>
	with	70MB, 28MS hard drive	<b>£2,499</b>
	with	150MB, 18MS hard drive	<b>£3,199</b>

## Dell System 300

### STANDARD FEATURES

Intel 80386 running at 16MHz; One megabyte of Static RAM on the system board; 1-2MB, or 1-44MB 3.5" floppy disk drive; Floppy and hard drive controller; Enhanced 102 key keyboard; 200 watt power supply; Eight expansion slots; Real-time clock; the Dell System Analyser.

### MONOCHROME SYSTEMS

High resolution monochrome monitor; Hercules compatible Monochrome Graphics card; 2 Serial and 2 Parallel Ports.

System 300	with	40MB, 28MS hard drive	<b>£2,799</b>
	with	70MB, 28MS hard drive	<b>£3,099</b>
	with	150MB, 18MS hard drive	<b>£3,799</b>

### EGA COLOUR SYSTEMS

EGA high resolution monitor; High specification EGA card; 2 Serial and 1 Parallel Ports.

System 300	with	40MB, 28MS hard drive	<b>£3,199</b>
	with	70MB, 28MS hard drive	<b>£3,499</b>
	with	150MB, 18MS hard drive	<b>£4,199</b>

### VGA COLOUR SYSTEMS

VGA high resolution monitor; High specification VGA card; 2 Serial and 1 Parallel Ports.

System 300	with	40MB, 28MS hard drive	<b>£3,399</b>
	with	70MB, 28MS hard drive	<b>£3,699</b>
	with	150MB, 18MS hard drive	<b>£4,399</b>

## Total Satisfaction Guarantee

**12** months' free on-site service – a Honeywell Bull engineer will visit the next business day. On site service covering all parts and labour can be extended up to five years at very reasonable rates.

**F**ree Telephone Technical Support to offer help, information and advice. Customers can ring our 0800 Hotline number and speak direct to Dell's technical experts.

**1** year limited warranty covering parts and labour.

**30**-day money-back guarantee. If you're in any way dissatisfied with your Dell computer you can return it within 30 days and we'll return your money in full.

Prices do not include VAT. Microsoft is a registered trade mark. All system prices and specifications are subject to change without notice. All orders are subject to Dell's standard terms and conditions of sale which are available on request.



DELL COMPUTER CORPORATION, COOKHAM ROAD, BRACKNELL, BERKSHIRE RG12 1RD. TEL: 0344 860456.



# BANKS' STATEMENT

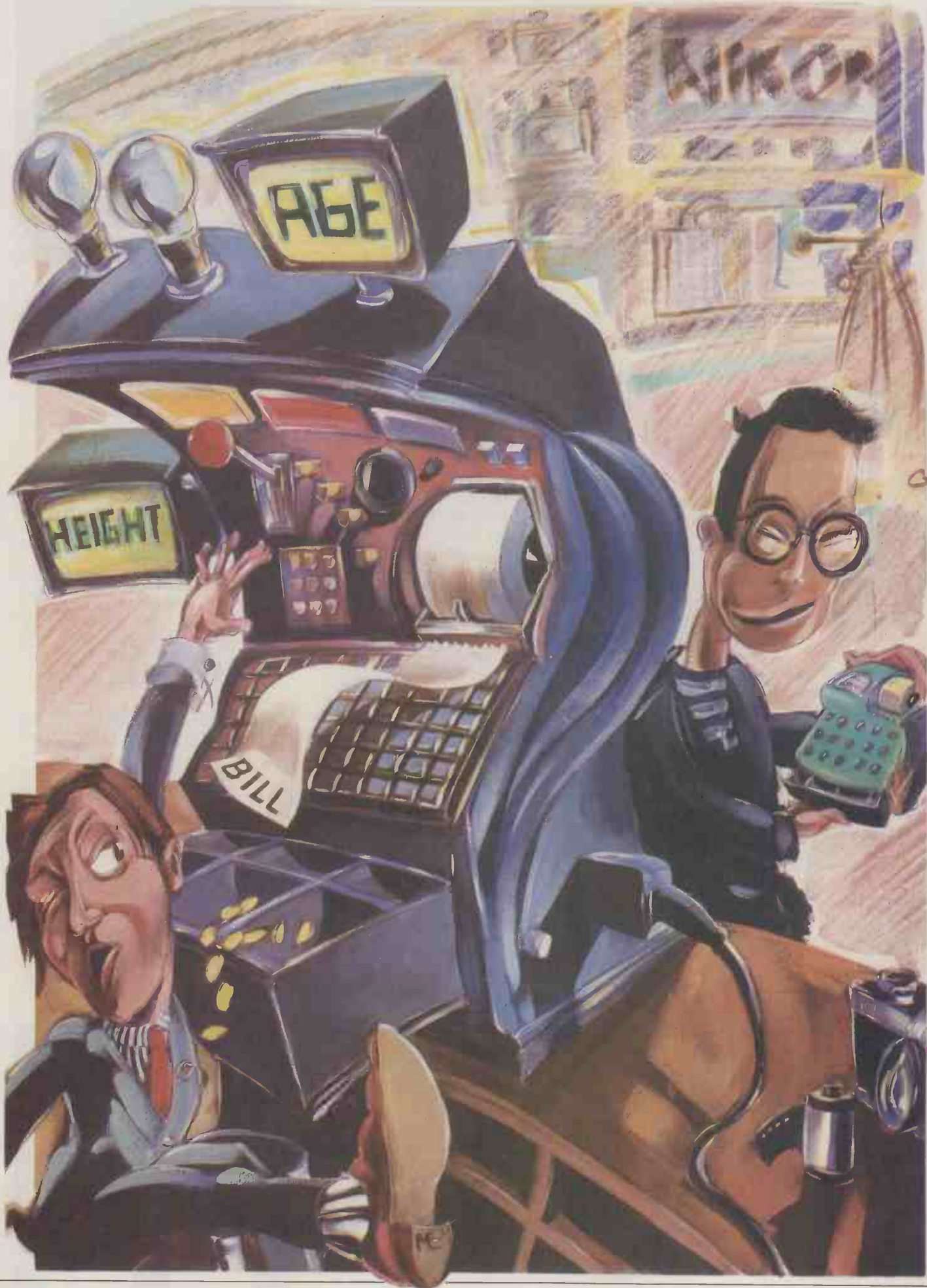

Illustration by Max Ellis



# Word play

We all agree that the computer is the ideal tool for the management and manipulation of information — or do we? Martin Banks' experience in a hi-fi shop leads him to philosophical ponderings.

It all seemed so innocent at the time. There was I, in my local hi-fi shop, attempting to buy a couple of good-quality audio cassettes for a special little recording job I had in mind. No, I was not going to pirate any games tapes.

I made my selection from the rack, went bravely towards the check-out and waited while the young man exercised his right bicep extensively on a fearsomely complicated cash-till. Needless to say the shop was one of a national chain which, like many of them, demands that their staff key-in all sorts of extraneous 'management information' about the fact that you have just bought a can of baked beans. (I keep waiting for them to start asking me my age, colour, socio-economic grouping and sexual orientation, just to make the picture complete.)

Anyway, I stood there for an hour or two while this guy frantically bashed the keyboard of the till. Just as I was getting comfortable he stopped. He looked at me. It was a very sheepish look.

'According to this,' he said, pointing at the till, 'you owe us over £1 million.' Now, I may be a bear of little brain, but this suggestion had even me doubting the veracity of the suggestion just a little.

He started frantically re-keying the whole tedious transaction. It was even more tedious this time because he was dead keen to get it right. Eventually we settled on the £4.49 it had said on the price tag all along.

This incident got me to thinking, so I rested for a while in the hope that the mood would pass. But it didn't, so I decided to put some of the thoughts on paper (the polite ones about information, not the impolite ones about a certain company's cash tills — this is a family magazine).

I think we would all be in general agreement with the theory that the computer is the ideal tool for the management and manipulation of informa-

tion. (The human brain is a good deal better, but it tends to forget this fact.) Anyway, the computer is relatively well equipped for the task.

It is at this point that I then start to contradict myself, for I am not sure whether the computer is the ideal tool, certainly in its current form. The incident in the hi-fi shop gives some clue as to why I think that way. We are entering a time when we, as either direct computer users or the sufferers of their exigencies, are having to confront information as more than something which just 'is'. We are having to think about how it is constructed and what it is made of, so that we develop the best ways of manipulating it.



In our western cultures, of course, a goodly amount of information is primarily constructed of words, which are themselves made up of character strings. This is a very convenient way of constructing information, for a limited set of symbols can be combined in any number of ways to form larger symbols that 'mean something'. The fact that they are symbols can be seen from the way it is noticeable, when we come across an unfamiliar word and have to stop reading freely, to 'construct' the big symbol from its component parts.

This is something the human brain does naturally, and we tend to forget the amount of processing that goes into its happening. Yet, the incident in the hi-fi shop shows what happens when we apply the same structure for information onto a computer-based system. To enter the information requires an amazing collection of keystrokes. As users want more information — for example, not just the price, but the product code, the product category, the sales staff ID number, the branch ID number and the customer's inside leg measurement — so these character strings get longer and longer.

This poses two questions: is the information collected really necessary? And, assuming that

it is, is the character string the right component from which to construct it? It is easy to forget, for example, just how ignorant the computer is. Working with single characters is meat and drink to the beasts, for that is the way their internal workings are structured. Yet, when compared to the dumbest human brain (possibly mine), the largest Cray supercomputer pales into processing insignificance.

These are the type of machines that scientists are now trying to teach to 'see', and are finding the problems enormous. The machine is still



MARTIN BANKS

trying to process these much larger 'symbols' as a pattern of 0s and 1s, which is about as simple as symbology can get. It is a symbology which works, but only after a fashion. Currently, you can show a computer something and come back three days later to see if it has made up its mind about what it is looking at.

So, have we come to the point where we really ought to start thinking seriously about changing the symbols that we use to define information? People are beginning to exploit the capabilities of symbolic processing languages like Lisp and Prolog, but I'm not sure such things go far enough.

I am reminded of something I once read in a book about Zen Buddhism. The author suggested that such a philosophy could not have developed in the West simply because of the linear nature of our written and spoken language. As this language is constructed from small symbols, all thought has to be constrained by the fundamental nature of the serial bit-stream from which it finds its existence.

The author suggested that the oriental pictogram was much better, much more free for expressing grand concepts in a single symbol. Is it now a valid argument to suggest that we consider the impossible — changing the whole nature of our own language so that we can grasp the concepts needed to make computers work in the same way? Without such a change in the long-term, I suspect that the computer will eventually choke itself on the millions of terabytes of serial data it will produce in the name of 'information'.

Now, anyone for Kanji? **END**

# Hardened hackers of the world unite

I do feel that PCW sometimes concentrates more on the trendy packages for computer illiterates to the detriment of the staid, 'older' and more serious applications packages now available for micros.

In particular, Fortran, despised by many, but used by many more than any other language for technical and number crunching, is now available in several micro versions. Yet I have never seen it given more than a passing mention in your magazine.

So, too, with T<sub>E</sub>X which merited no reference at all in your desktop publishing special. This is now effectively an academic standard with typesetting commands given with relatively simple

embedded commands and access to several fonts, eight font styles and ten font sizes. Laser, 24-pin and PostScript printers are supported.

Finally, is my circle of friends really unique in unanimously finding WIMP environments intensely frustrating, time-consuming and awkward to use? I suspect many of us would prefer to type *cd/downone* or *run program* than have to drag those blasted little pictures around.

Ian Johnston,  
London N12

*I think that windowing environments and structured object-orientated languages go together in producing a more*

*advanced, and to many a more creative, computing environment.*

*Using Fortran or T<sub>E</sub>X (I knew you were a T<sub>E</sub>X supporter when I saw that name so neatly printed in your letter) or a DOS command line is fine for people who know exactly what they want. Many of us are more creative with our computers and like to design fancy icons, use more than ten font sizes, and produce something which doesn't always look like an extract from Knuth's book.*

*We manipulate the world around us in objects, not atoms and embedded structures. Shouldn't we take the same approach to computing?*



Send your letters to Derek Cohen, 'Letters', Personal Computer World, VNU House, 32-34 Broadwick Street, London W1A 2HG or contact us on Telecom Gold 83:VNU200.

## You get what you pay for

I think people expect the wrong things from the average sales assistant. Nobody should expect expert advice from an assistant earning £3 per hour. The average shop assistant lasts in a job for about six months, and is never trained for anything other than sales technique. A shop is not a classroom: it's not there to teach you about computers. As PCW readers, we should all know enough not to be led up a dark alley. If you want a business consultant, and you talk to the guy in Dixons, you

are asking for trouble.

A customer can be unfair to a shop, as well as the other way round. Higher levels of service have to be paid for, but we all go for the cheapest prices available, so shops may find it necessary to reduce their friendliness to compete.

Chih C Kuan  
London NW4

*You don't get free driving lessons when you buy a car, yet we expect free training and consultancy when we buy a computer. Charging for consultancy at least stops people wasting two hours of a good dealer's time and then buying mail order from the cheapest advert in PCW.*

## A saucy approach to HP

The Morgan Computer Company advertised an HP83 but, when I enquired, knew little about it except that it had 32k of RAM. When I rang Hewlett-Packard I was frustratingly passed around a number of departments until I found someone who recognised the model.

HP informed me that it was obsolete and came with 16k expandable to 32k, but no more.

So my advice is: don't bother trying to get information from Hewlett-Packard.

Name and address supplied

*You sound like just the sort of person who gives computer users a bad name. If Hewlett-Packard's machine is obsolete, your call to them will not generate any income for them. So why should the company waste time with you? It is running a business, not a free advice service.*

*I think HP acted totally correctly. If you wish to buy cheap second-hand equipment you shouldn't expect to get the same support as a first-time buyer.*

*I think you should seriously consider the advice of Mr Kuan alongside.*

## DIY is fun

Matmos has been selling Panasonic 3.5in drives since September 1967 for £59.95 plus VAT. Since I had a single drive PC1512, it was a perfect opportunity for me to add a second drive. I had to make my own mounting kit, and adapt the connectors; and it worked out to around £75 in total.

The DIY freaks among you may find it well worth trying. The drive has been working perfectly, and backing up my 30Mbyte hardcard is far less painful. When a Tandy friend of mine received delivery of the new range of 3.5in machines, they had no demo software on 3.5in discs: I love it when they beg.

Remember to put this line in CONFIG.SYS:

DRIVPARM=/D:1 /F:2 /T:80  
Izonan Kuan, London NW4

## Whose fault is it anyway?

It was with much dismay that I read Guy Kewney's article in 'Newsprint' regarding our Sprite fault-tolerant range of systems. Is it any wonder that the UK is a net importer of some £1bn of IT equipment when our industry pundits trivialise major new UK-originated innovations.

Since the description of our new fault-tolerant systems portrayed in Mr Kewney's column is inaccurate, I will set the record straight.

First, these systems are 8- to 32-user machines. They are designed for high availability so the end user should never have his hands in the machine.

Second, your article suggests that to pull the unit out for access would involve disconnecting all the attached

cables. This is not so. The cables are mounted at the rear of the main enclosure with a 36in flexible cable between the rear of the enclosure and the main system unit. This allows access within the system without disconnecting terminals. If the system is to be completely removed from the outer enclosure, then the flexible cables can be unplugged from the rear of the system. As one 50-way cable connects eight terminals, the maximum number of cables to unplug is four. This takes a whole 30 seconds for 32 users.

Third, this not a PC. For the quoted £22,000, the customer gets an 80386 with 4Mbytes of 32-bit RAM, 300Mbytes of 18ms disk storage in the shape of two 150Mbyte-mirrored drives, a 120Mbyte file by file tape backup, an intelligent cacheing disk controller with a 10MHz 80186 and 1Mbyte of cache RAM, an eight channel

terminal controller with a 10MHz 80186 and 512k of RAM, CDOS or Unix, and one year's on-site maintenance. On top of that, the system comes with all the fault-tolerant software.

I think your users *do* want our phone number as all users rightly regard their own data as the most valuable in the world. Jarogate is based in Surrey and can be contacted on (01) 391 4433.

Last, I would like to comment that your readers expect and mostly receive accurate information on available and new products. It would be better for manufacturers, dealers, and end users alike if journalists and commentators gave us a little less biting satire, and a few more facts.

Robin Tracey,  
Managing Director,  
Jarogate, Surbiton,  
Surrey.



## The 'in' thing

Has your magazine developed an unexpected inhibition of the intellect? We read quite a lot about the various types of computer communications — LANs and WANs, Ethernet and Arcnet, and many others, distinguished mainly by their mutual incompatibility. But apart from Martin Banks' statement in your March 1987 issue, we hear virtually nothing about ISDN — Integrated Services Digital Network.

Surely, this is *the* coming networking standard, whether the computer industry likes it, or not.

Implicit, where not actually stated, in most articles on communications is the idea that, sooner or later, IBM will step in with its own definitive network, and everyone will gratefully lie back and enjoy it, but this seems to be a very blinkered and parochial view. However much as IBM may stride, like a colossus, the domain of computers in the real world of inter- and multi-national telecommunication

companies, it is merely a rather small fish in a very large pond.

I would, therefore, like to suggest that the massed brains of PCW gently rub their neurones together, and treat us to an article, or series of articles, on the state-of-the-art of ISDN, as I am certain that most of your readers, not to mention your staff, will be only too eager to learn how soon we shall be able to discard these absurd modems with their ridiculous protocols, and just send and receive our voices and data down the telephone.

With British Telecom hoping to complete its conversion of the main telephone trunk routes to optical fibre by 1990, and most of the rest by 1995, Arthur C Clarke's vision of a 'global village' may be much closer than we think.

**J Smart,  
Hitchin, Herts**

*ISDN is still some way off. Certainly ISDN cards and specifications exist, but without the networks to test them on they are as useful as a TV set on the moon.*

## Sad enigma of missing Amiga

At the 1987 Personal Computer Show, inside the Commodore Village, Enigma Publishing was taking subscriptions for its Amiga periodical. Readers were promised the next issue in October of that year.

Needless to say, nothing appeared and my many attempts to ring the company's offices, where nobody answers the telephone, has led me to conclude that the outfit has gone down the drain. I have reported this sorry state of affairs to the Trading Standards Authority and am now taking the matter to the Small-Claims Court.

Meanwhile, those unlucky to have parted with their cash might like to call Julian Rosen's home telephone number on Southsea (0705) 833830 to see what he intends to do about the matter. Not much, if my experiences are anything to go by!  
**John Nuttall,  
Guildford, Surrey**

## Mathematical computing

I am 14-years-old, in the fourth form of a comprehensive school. I am just beginning the GCSE courses. I have cerebral palsy, and so I need to use a portable computer to do all my work on. Until now I have used a Radio Shack TRS80 Model 100 portable computer. It is all right for most of my work, but maths is a big problem as the model 100 doesn't have the facility to do the following: square root signs; powers (I have to type  $a^2$  which gets very confusing when doing long algebraic sums); fractions (algebraic or normal); and, the curved algebraic  $x$ .

I would be very grateful if you could let me know of a software package that would enable me to use a Tandy or similar portable computer for my maths.

**Ceri Longville,  
Penarth, South Glamorgan**

*Offers to Ceri via the PCW office, please.*

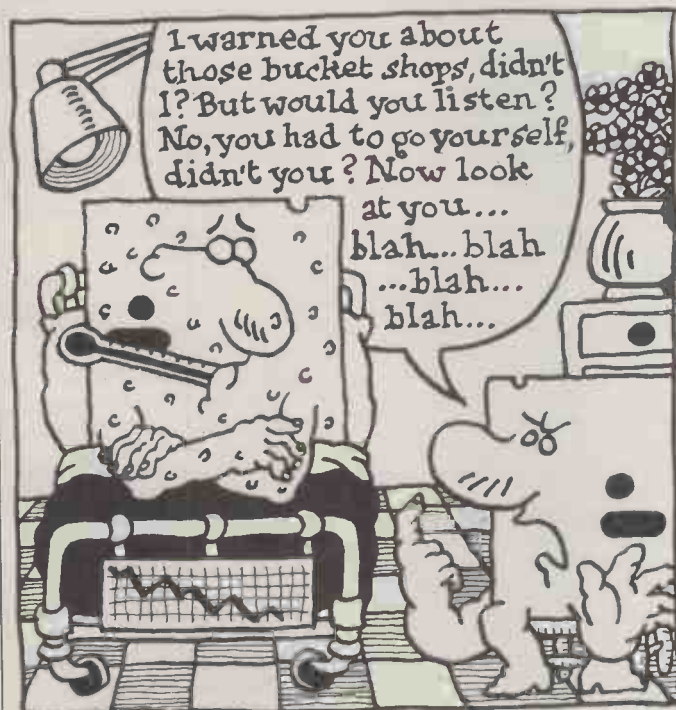

## Cure for damaging computer virus

I am very worried about the computer viruses that I hear about. It is difficult to explain just how damaging a carefully written virus can be — highly infectious in its incubating phase, and highly destructive in its attacking phase — but subtly so, in order to give the victim no chance to use any form of backup.

We run a 90% successful data recovery service, and we have had a couple of people come to us with suspected virus attacks. So far, these have been standard defunct disks, and not too difficult to fix. But we have plenty of work to do without a sudden rush of virally-infected disks (not to mention the additional

precautions we have to take with such disks).

I have two pleas to make to PCW readers. First, do *not* run any software unless you are completely certain about what it does, any more than you would put something into your mouth without knowing what it is. Software downloaded from bulletin boards is a prime candidate for spreading viruses and (I hate to say this) public domain and shareware is another good way to catch a virus. Make sure you get your shareware from a proper user group or other reputable source, not a commercial bucket shop that just wants to sell disks.

Second, if you do get hold of a virus (or think you have), please send me a specimen, so that I can think about an antibody to it, a program that will seek-and-destroy the virus.

Meanwhile, all I can offer is a program that will write-protect your hard disk, so that any virus trying to infect it will throw up a Write Protect Error message. You can use this when trying out software that isn't supposed to write to your hard disk, or else use it routinely as a permanent protection, keeping your data on floppies. Any reader of PCW who wants a copy, send a photocopy of this page plus £5 to:

**Dr Solomon (Anti-Virus offer)  
31 Holloway Lane, Amersham,  
Bucks HP6 6DJ**

## More characters, please

Can any PCW readers help me find software (or add-on hardware) that will make any standard 24-pin printer download between 160 to 190 user-defined characters? The usual capacity of printers that I know of is 127 user-programmed characters. Or, is there such a printer (24-pin head) that is able to download both sets of ASCII in program mode?

**MSH Choudhury,  
Lalmatia,  
Dhaka 1207, Bangladesh**

## Why indeed Richard?

To get away from concerns about hardware and software, *et al*, I thought I might put the following program into the public domain.

Anyone may use this program, provided they can find a compiler or interpreter that will execute it.

```
5 'WHY.BAS
6
10 INPUT fact
20 IF fact=FALSE THEN 10
30 answer=WHY(fact)
40 IF answer=FALSE THEN 30
50 fact=answer:GOTO 30
Richard Hill, Canterbury, Kent
```

## JP or not JPI

I enjoyed reading Owen Linderholm's complimentary review of the JPI Modula-2 compiler for the IBM PC (*PCW*, March 1988). However, some of *PCW*'s readers may be left a little bewildered by some of the comments made, so I thought I would write to straighten out a few points. First, you mention: 'That well-known software giant, JPI'. While I think this shows admirable precognition, I suspect that you may have meant to write 'Borland International'.

Niels Jensen, an original co-founder of Borland, started J&P in London in January 1987 together with a number of ex-Borland employees. At that time, J&P purchased the rights to a number of products under development at Borland for about £1 million, including a Modula-2 compiler. This compiler has been further developed into the compiler reviewed, and was released at the end of 1987.

I was very interested in the results of your Benchmarks.

The amazing performance exhibited by the graphics routines was not because of any special graphics software, but was due solely to the speed of the highly optimised code generated by the JPI compiler. It should be noted that the graphics routines are written entirely in Modula-2 (one of the library routines is actually shown in one of your screen pictures), so the results are even more amazing when compared to the (slower) assembler routines supplied with Turbo Pascal 4.0.

With regard to your comments on bugs in early versions of the compiler, you will be pleased to know that in the current version shipping (version 1.04), all known bugs have been corrected. Owners of all previous versions are being offered a free upgrade.

I hope this clears up any misconceptions that your readers may possibly have been left with.

**Nigel Hicks,  
Jensen & Partners, London**

*Apologies. We found the missing words on the floor.*

## Naive but happy

Full marks to Martin Banks for his 'Ignorance is bliss' statement (March, *PCW*).

During a lecture to industrial managers I posed two questions. First: why do you want to have a computer on your desk? The gist of the typical answer: because in our company it has become a status symbol. Second: what do you think the computer spends most of its time doing? Most faces were blank, some brave souls suggested 'performing calculations' and one offered 'refreshing memory and screen'. They were all dumbfounded when I suggested that at least 90% of a PC's time is spent waiting for the operator to press a key.

Now we see the advent of the 386 machines, one a portable with a clock speed of 20MHz, a 100Mbyte disk drive and up to 10Mbyte, of RAM. Reading the advert we are told how slow all other machines are in comparison; also we find that it can be used to design a Valentine card while simultaneously compiling the

company report. To complete the sell they give us a photo. Do we see a pair of blurred hands flashing over the keys to keep this powerful processor working to its full capacity? No: we see one hand using one finger to press one key — WOW!

There is the classic story of the company which provided its managers with PCs. The office girls, not being members of management staff, obviously could not be allowed to have these symbols of executive status and therefore had to retain their typewriters. It was some time before it was realised that unless something was put into a machine nothing came out. Most of them lay idle until eventually they were prised away from the managers and given to the clerks and typists.

**David Shippen,  
Sandbach,  
Cheshire**

## Who's ripping off whom?

I hear plenty of software manufacturers crying about piracy yet precious few words about their not backing warranties, nor even answering letters.

Moving to Ireland from the US, I brought with me some computer equipment including my copy of SideKick and a Mouse Systems mouse. Upgrading to an EGA system, I found my SideKick would no longer run. I wrote to Borland, asking also about the possibility of buying Turbo Prolog. It's eight weeks now and not a peep out of them.

My mouse is still under warranty and so when it failed I wrote to the manufacturer in the US who passed me on to a company in Wales. It, too, did not want to know. By this time I was well-prepared and went out to buy a Mouse Systems mouse clone at one-third of the price of the original. I just knew that after months of hassle I would be quoted a repair price that would be more than the cost of a replacement.

I thought word processors were meant to make communications easier.

**Robert Mauk, Ireland**

*And I thought that computers were meant to make the world smaller. Yet overseas purchasers are continually complaining about the poor service they get from UK dealers.*

**END**

## Let's hear it twice for CD-ROMs

I was worried by a reference in David Tebbutt's excellent review of Microsoft Bookshelf that it was 'the very first implementation of a new technology'.

The fact is, there are literally hundreds of CD-ROM database products available on the market — although most are targeted at libraries, a select few are suitable for purchase by *PCW* readers belonging to the business and professional market segments interested in IBM PCs.

Take the example of the Postcode Address File from SilverPlatter Inf Ltd. The product contains on one disk 23.5 million addresses with postcodes — every address in the UK! Using this CD-ROM database, addresses can be checked in a couple of seconds. The advantages must be obvious to any company or organisation with a large consumer mailing list — the speed and economy of this method of locating address information (priced at £3000 + VAT) are features almost too good to believe.

**Michael Shuff  
CD ROM Marketing  
Services,  
Cambridge**

David Tebbutt's article on the Microsoft Bookshelf/Hitachi CD-ROM exposed many of the problems associated with this emerging technology.

I have encountered a few more, which involve software availability, and the lack of compatibility between the 'High Sierra' format and the various formats used by WORMS.

For database purposes CD-ROM is first rate: but the contents need to be of a broad appeal changing at a slow rate. For any material that needs to be updated at intervals, the present strategy adopted by CD manufacturers means that the cost of each compact disc will be prohibitive.

Currently, the only way (as far as I can determine) that a software producer can get its product written to a CD is to get the data mastered and pressed in one of the plants built for audio-CD production. This process is not cheap; it needs considerable capital outlay (several thousand pounds) up front, plus the services of a bureau to arrange formatting.

For runs of a few hundred CDs (which may be a realistic estimate for the potential sales of a

specialised database) the cost per disc is about £150. Now add the cost of preparing the database, royalties, admin and distribution costs, and that naughty old profit margin, and we end up with a product of such dubious commercial appeal that the capital outlay is an unacceptably high risk. Larger runs bring the costs down — but not *that* much!

A self-evident solution would be a means of producing small production or test runs with in-house facilities, instead of having to approach giants like Philips.

A WORM drive sounds like a cost-effective method for a company to put its data into remotely located PCs: one WORM plus a number of CD-ROMs.

No way — even Hitachi's forthcoming WORM is totally incompatible with its own CD-ROM! Is it too much to ask that WORMS should be available which are capable of writing the 'High Sierra' format? Or would this lead to audio-cassette pirates suddenly developing an interest in WORMS — which would seem to indicate that something other than 'High Sierra' would have served computer users better.

**David Erickson,  
London**



THE  
**Canon**  
COLLECTION

Every One a Masterpiece



**LASER PRINTERS** by Canon

The archetypal laser beam printer. A Canon offers more fonts than most, more emulations than most, lasts longer than most. And because it matches the industry standard it works with far more software than you might have imagined. Options now include twin paper bins, duplex printing and an engine-only model for faster graphics output. Altogether a standard of presentation that is a delight to behold.

**Other Masterpieces in the Canon Collection: Personal Computers, OCR Image Scanners, Matrix Printers, Colour Inkjet Printers, Bubblejet Printers, Epos Terminals, Desktop Publishing.**

POST TODAY

To: Canon (UK) Ltd., Text & Data Products, Canon House, Manor Road, Wallington, Surrey SM6 0AJ.  
Telephone: 01-773 3173

Please tell me more about Canon Laser Printers.

Name \_\_\_\_\_ Company \_\_\_\_\_

Position \_\_\_\_\_ Business \_\_\_\_\_

Address \_\_\_\_\_

Postcode \_\_\_\_\_ Tel \_\_\_\_\_



THE  
**Canon**  
COLLECTION



LP/PCW19/4

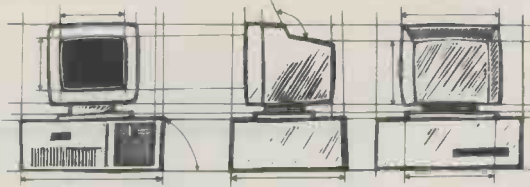

# Mission FlexCache 20386

As high-performance architectures in micro systems extract the most from existing software, it could be that Mission has managed to wring the last drop out of the 80386 chip with its FlexCache. Peter Jackson finds out how, while Nick Walker puts the new 386 machines from Intel and Zenith through their paces.

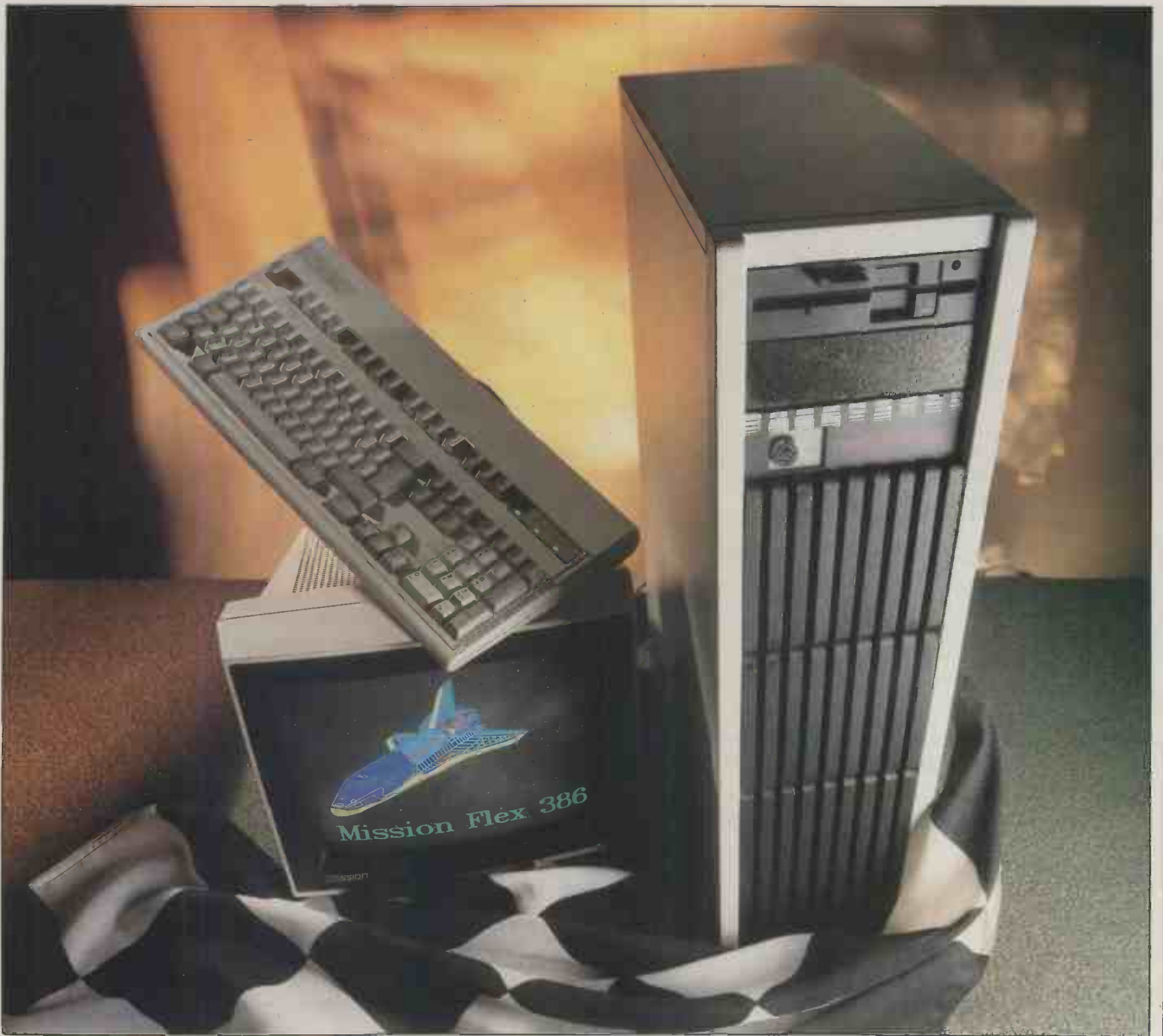



The Mission Computers FlexCache 20386 — if that is what Mission finally decides to call this US-built system when it re-badges it — demonstrates both the flexibility and the limitations of current 80386-based PC designs. The flexibility is there in the 20MHz speed of the 80386, the availability of CPU support chips that can match that speed, and the ability to run standard PC software and plug-in standard expansion boards; but there are limitations in the architecture required to make all that flexibility possible.

For while any competent designer could put together a 20MHz 80386-based system as long as price and backward compatibility with earlier hardware and software were not at issue, it is a tougher job to extract maximum performance from such a machine when compatibility means adaptation to older and slower third-party products.

Like Compaq before it, the designers at Advanced Logic Research (ALR) — the US company that designs and builds the Mission 80386 machines — had to wrestle with the competing demands of performance and compatibility. And not surprisingly, given the current states of the hardware art and the 32-bit PC market, the FlexCache 20386 uses a very similar architecture to that in Compaq's DeskPro 386/20 flagship. It includes features and facilities that will become increasingly commonplace on PCs as the market penetration of 80386 systems increases; and as with all leading-edge systems, the way it is put together is more interesting — if not more important — than the simple fact that it outperforms all the other PCs on the block when you run 1-2-3 and dBase.

## Hardware

The FlexCache 20386 is a tower system, following the usual but illogical design pattern of putting the heavy power supplies and disk drives at the top and the empty space at the bottom for minimum stability. The review machine came with a base plate to help it stand up.

The front of the case is covered by an odd set of black plastic ridges which make the system look like the pieces of hi-fi equipment that Mission is best known for supplying. There are slots for two half-height drives at the very top of the case, normally for a 5¼in floppy drive and an optional 130Mbyte tape streamer; the review machine had a conventional 1.2Mbyte 5¼in unit and a blanking plate over the second slot. The only other front panel features are the usual barrel lock and indicator lights for mains power and hard disk activity.

Opening up the case, by releasing two thumbscrews and removing one complete side panel, reveals the internal construction of the system. ALR has taken an interesting and economical approach to construction, and has simply bolted a complete desktop PC chassis inside the bulky tower case. Imagine a typical desktop AT with its main casing removed, stand it on one end, surround it with a new casing, and that is how the FlexCache 20386 is put together. The only difference is that a new disk drive bay has been added at 90° to the two conventional desktop bays, to broaden the storage options.

Doing things this way means that the mains power switch, conventionally placed on the side of the chassis, would normally be inaccessible from outside the tower casing. ALR has got round this by cutting a hinged panel in the rear of the tower case just above the switch, complete with thumbscrew to secure it, and will probably say this is a security

**'... the 80386-based PC is entering a new area where new computer architectures, often derived from minicomputer and mainframe experience, can be used to advantage to improve the performance of existing software.'**

feature. But it seems odd to open the panel and grope inside for the switch, which seems to be in a completely unnatural position.

The other consequence of building a complete desktop PC into a tower is that the system has space for a theoretical total of seven storage devices. The internal bay that would be used for floppies in a desktop PC has free space for three half-height drives, and can be used for a full-height hard disk alongside an optional 3½in floppy drive. And the second internal bay can be used to take its normal full-height hard disk in desktop AT style.

On the review system, the three-slot bay was empty, while the second bay held a 150Mbyte full-

height drive built by Control Data subsidiary Magnetic Peripherals.

The rest of the internal layout is conventional, with the main circuit board at the base of the upended chassis, the bulky 220W power supply between the disk drive bays and the rear panel, and the expansion slots left clear at the bottom of the tower.

There are eight slots altogether, six 16-bit and two 8-bit, but that does not tell the whole story; the bottom two 16-bit slots cannot be used for standard AT expansion boards, but instead are linked to form a single 32-bit 'logical' slot to accept extra RAM. ALR supplies pairs of RAM expansion boards to go in these slots, each holding up to 2Mbytes, and each board in the pair must be populated to the same capacity in increments of 1Mbyte. The 32-bit RAM expansion can therefore only be done in 2Mbyte steps, and we shall come back to the entire question of memory management in the FlexCache 20386 later.

The review system came with three slots occupied, one holding an 8-bit floppy disk controller with extra serial and parallel ports on the board, one holding the hard disk controller, and the third holding the display adaptor. This adaptor was actually a standard Paradise Auto-Switch EGA board, although the manual supplied describes an ALR-designed EGA board with an extra parallel port. A Hercules-compatible monochrome display adaptor is also available for the machine.

The hard disk controller was a Western Digital WD1007A-WAH, an ESDI type capable of transferring 779k per second using a 1:1 interleave factor and look-ahead cache facilities. This controller is standard in the top-end FlexCache 20386 machines, the ones with 150Mbyte and 300Mbyte hard disks; while the other FlexCache 20386 models and the complete 16MHz FlexCache 16386 line use a Western Digital WD1006-RAH run-length limited (RLL) controller with a throughput of 650k per second using 1:1 interleave and look-ahead cache. Disk drive capacities available from ALR range from 66Mbytes to 300Mbytes, although the larger capacity drives are only available for the 20MHz machines.

The main circuit board is basically the same as that used in ALR's earlier 386/2 machines, with one important difference. While the 386/2s simply had a 16MHz or 20MHz 80386 on the main board, the FlexCache systems have a piggyback board that plugs into the 80386 socket on the motherboard which completely re-arranges the processor architecture.

This piggyback board holds the 80386, the optional 80387 maths coprocessor, and another chip as big and complex as the 80386 itself. This is the Intel 82385 cache controller, which makes the vital difference between the FlexCache line and earlier ALR machines, and again I shall come back to this chip in detail when discussing memory organisation.

The extra processor board fills the space between the top expansion slot and the power supply, neatly obscuring the details of the motherboard beneath. But this board seems normal enough, with the exception that the motherboard RAM uses standard socketed chips rather than the now-fashionable single-in-line memory modules (SIMMs). There are sockets for 2Mbytes of RAM on the motherboard, and the total 32-bit RAM capacity of the system is 6Mbytes using a fully-populated pair of ALR RAM expansion boards.

The circuitry looks clean and finished, as it should be by now. ALR was the first company to produce a commercial 80386-based PC, at that time based on the Intel motherboard design, and soon switched to its own board design for the 386/2. That basic design lives on in the Flex-Cache line, with additions that reflect new thinking on the area of memory management for fast 32-bit PCs.

## Memory organisation

In 80386-based systems RAM is a problem, not because of quantity but because of quality. While processor speeds have climbed rapidly from the 4MHz of the 8-bit Z80 that drive standard CP/M business systems to the 20MHz of today's top-line 80386 machines, RAM access speeds have not been improved to match.

In an ideal world, RAM chips would be fast enough to let processors access data on every clock cycle. But simple arithmetic shows that a 20MHz processor would require RAM chips with better than 50ns access times to achieve that, and although such fast RAM chips are available, unfortunately they are ruinously expensive.

Even using the fastest dynamic RAM chips around, with 80ns access times, a 16MHz 80386 would need to hang around waiting for information in RAM to be ready for access. In other words, processor wait states would need to be inserted to compensate for the slow dynamic RAM, which needs time to refresh its contents at 500 or more times a second.

However, raw RAM chip speed is not the only way of getting round the problem. Compaq decided to use a technique called 'static column' or 'page mode' RAM in the original DeskPro 386/16 to improve the per-

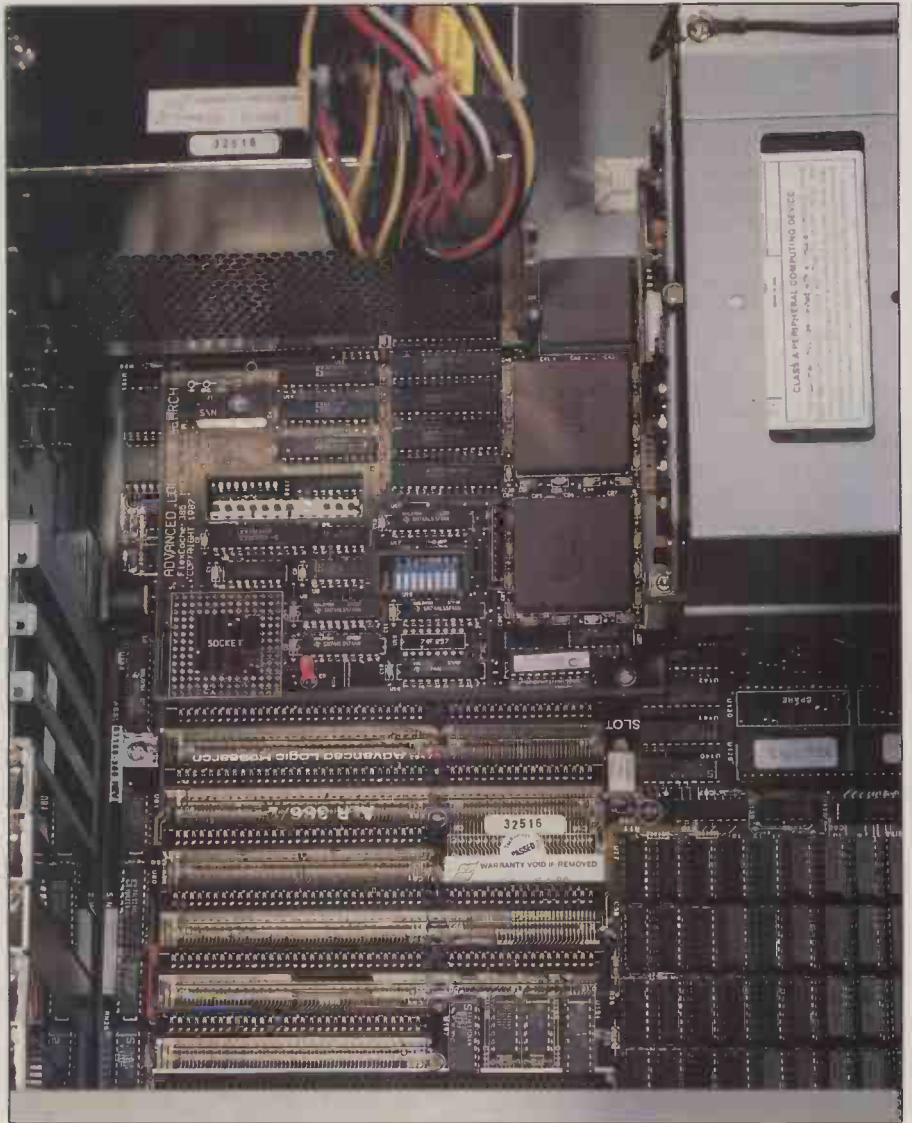

Just beneath the Mission's power supply is the piggy-back board which contains the Flex chip set. The whole of the machine features this layering, with a conventional AT-style case sitting inside a larger outer shell

formance of dynamic RAM chips to rival static chips. In this arrangement, sequential memory bytes are stored in sequential 'rows' in a single 'column' of chip locations. Then, once the central processor has addressed any location, every other location in the same column can be accessed without wait states.

Compaq claims that using static-column RAM cuts the wait states down from two to less than one, saying that the DeskPro 386/16 runs at 16MHz with an average 0.8 wait states. This means that more than half of the memory accesses are made within a column, while the remainder are two-wait-state accesses across column boundaries.

A similar technique is memory interleaving, which is going to become another advertising buzzphrase. Simply, it means dividing the RAM up into two or more blocks, arranged so that when the processor accesses sequential-memory loca-

tions, it is actually accessing alternate bytes from each block. In a two-way interleave system, the idea is that while the processor is accessing one block the other block has time to refresh itself, and as a result there are no wait states as long as the processor accesses locations in strict sequence. However, if every memory access is random, the chances of finding the appropriate block ready are cut to 50 per cent.

Similarly, RAM cache architectures are aimed at improving sequential accesses — and as its name suggests, the FlexCache 20386 uses this technique.

In a RAM cache system, a small block of very fast static RAM is interposed between the processor and the main block of slower dynamic RAM. Like the now-familiar RAM caches for disk drives, the aim of this cache RAM is to hold the most-often used segments of main RAM and make them available to the processor



# BENCHTEST

as fast as possible. The cache RAM normally comprises 32k or 64k of 35ns static RAM chips, which are fast enough to supply the processor with 32-bit data at the full 20MHz processor clock rate.

In Compaq's DeskPro 386/20, and now in the FlexCache 20386, the Intel 82385 cache controller chip is used to manage 32k of cache RAM and speed up access to data stored in the bigger but much slower dynamic RAM banks. The FlexCache main memory is fast by dynamic standards, and requires 256kbit 80ns chips. But that means wait states at 20MHz, and the 82385 and its associated cache are needed to cut out as many of those wait states as possible in order to gain maximum processor performance.

The 82385 is a 32-bit companion chip to the 80386 and 80387, and combines cache control and DMA functions for both central processor and co-processor. It sits on a separate 32-bit processor bus with the other two processors, straddling the link between the 80386/80387 combination and the 32k of cache RAM.

In use, the 82385 monitors every memory access made by the processors, retrieves data from dynamic RAM in chunks rather than single words, and stores the chunks in the cache. Logic inside the chip maintains the cache contents, flushing the least used chunks to make room for new ones and making sure that the 32k of data in the cache is the data the processors are most likely to need next. On top of that, the 82385 can also cache writes to main RAM, sending data out to main RAM with wait states but without slowing up the 80386 at all.

But the 82385 does more than simple cache management. There can be problems in cache systems caused by the cache and the main RAM contents getting out of step; for example, a hard disk drive may do a DMA transfer into main memory and overwrite data that has already been copied into the cache. Then when the processor wants the new data from the DMA transfer, it might get the old copy from the cache unless the

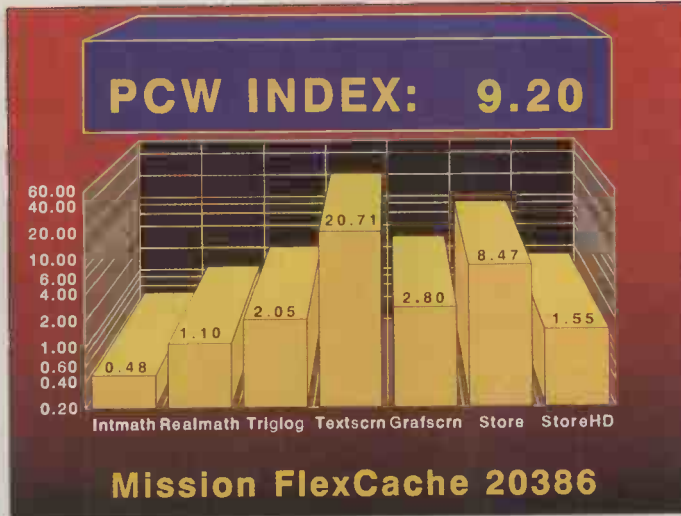

5¼in floppy drive; 110Mbyte hard disk; 80386 CPU running at 20MHz; 80387 fitted (not used by GW-Basic); FlexCache controller; 2Mbytes RAM; GW-Basic version 3.3; EGA graphics card. (See PCW, February for full Benchmark details)

cache controller is intelligent enough to spot the problem.

The 82385 actually handles all DMA for the system, removing that burden from the main processor, and this gives it a means of avoiding discrepancies between cache and main RAM contents. The chip includes 'bus snooping' logic that checks all DMA transfers to see if they affect main RAM areas that are also copied in the cache. If they do, the 82385 marks the chunk containing that data as invalid, allowing it to be overwritten by new data from main RAM.

The other advantage of letting the 82385 do DMA is that this chip can handle it without involving the 80386. When a peripheral does a DMA transfer, for example, the 82385 is interrupted not the 80386, and the central processor can go on running on data from cache RAM until the DMA transfer is over and the 82385 is released from its 'hold' state.

Similarly, the 80387 — which like the 8087 and unlike the 80287 can run concurrently with its main processor — can run out of cache RAM and keep running during DMA.

As usual, the success of the 82385 depends on the hit rate — the percentage of RAM accesses that can be satisfied from cache rather than main memory. In fact, studies have shown that cache performs better than might be expected. The repetitive na-

ture of loops and subroutines in structured programs is tailor-made for cache acceleration, and the fact that data which has just been read or written is much more likely to be accessed again than new data.

Intel claims that typical software running in an 82385-enhanced system will achieve a hit-rate of 88%, while Compaq claims 95%. Taking special pleading into account, at least 75% of RAM accesses will be from the cache with zero wait states when running typical applications.

The use of the 82385, or cache RAM in general, brings one more advantage; every RAM access is cached. This means that even memory on slow expansion boards plugged into the PC bus can be used, with at least a 75% chance of getting that data with 35ns access times rather than the slow times of bus memory access. After the first access, of course, which is at normal access speeds for the RAM chips in use.

Many cache systems use slow dynamic RAM for main memory, with 120ns or even 150ns chips, relying on the cache to make up for the lack of speed. ALR's use of 80ns chips means that even when a RAM access misses the cache and has to go to main RAM, the speed penalty is not as great as it might be.

## System software

ALR does not provide an operating system as standard with the FlexCache 20386, but offers MS-DOS 3.2 as an optional extra. As yet neither ALR nor Mission has announced a version of OS/2, but the IBM version of OS/2 Standard Edition 1.0 will run on the new machine as long as it is loaded with the processor in its slow 10MHz mode before switching back to full 20MHz speed.

As with other 80386 systems, the FlexCache 20386 reserves 128k of 32-bit RAM and copies the BIOS and

## Technical specifications: Mission FlexCache 20386

Processor:	80386, 20MHz
Co-processors:	82385 cache/DMA controller, optional 80387 maths processor
Main RAM:	2Mbytes, 80ns, expandable to 10Mbytes
Cache RAM:	32k, 35ns
Mass storage:	Single 1.2Mbyte, 5¼in floppy; optional 720k or 1.44Mbyte 3¼in floppy; 100, 150 or 150Mbyte RLL or ESDI hard disk drives
Keyboard:	101 keys, Enhanced layout, swappable CapsLock and Ctrl keys
Display:	Hercules or EGA multimode adaptor
Standard I/O:	One serial port, one parallel port
Expansion:	Paired 32-bit RAM slot; four 16-bit, two 8-bit
Bundled software:	Setup and diagnostic utilities, QEMM LIM emulator

# Intel SYP301

EGA ROM code (if present) into that area for faster execution. Unlike other systems, however, this is accomplished in hardware and the process is automatic unless it is disabled by holding down the F1 key during boot-up or by altering a switch setting on the system board.

## In use

It is something of a tribute to the FlexCache 20386 that there is little to say about it. The machine is amazingly quiet — quieter than a Macintosh II, an AT clone, and an expanded Macintosh at the review site — and sits by the desk unobtrusively doing the job.

The keyboard had a Mission label on it but was otherwise a perfectly fair implementation of the IBM Enhanced layout put together by EECO in Mexico. With one big plus; underneath the keyboard is a simple switch that swaps the Ctrl and CapsLock keys, putting the Ctrl back where it should be and CapsLock back out of the way. That feature alone makes the keyboard superior to any other Enhanced clone I have seen, and it is a plus that the feel is also rather harder and clickier than the competition.

The screen supplied was a Mission-labelled Taxan 770 multi-scan with a distinctive black bezel. The 770 is an excellent example of the multi-scan genre with clear colours and a standard screen display size whatever the graphics mode emulated by the Paradise Auto-switch, and there is nothing cheap or nasty about it. An excellent choice.

Aside from those details, the FlexCache 20386 ran everything thrown at it at full and impressive speed. Graphics-based environments like GEM and Windows and applications based on them like PageMaker and Ventura snapped windows open on the screen with considerable alacrity, and the copying of the EGA BIOS into RAM improved graphics performance noticeably. The true performance figures are given on page 000, but the speed is obvious simply by using the machine to run common applications like 1-2-3 — installed in slow mode, run in fast mode — Microsoft Word 4.0, AutoCad Release 9, and the rest.

The hard disk, divided into drives C, D, E, F, and G to get round the MS-DOS 32Mbyte volume limit, was impressively fast thanks to the ESDI interface, and the whole impression was that any software you put on the machine would instantly be more responsive and generally more usable. There is nothing that improves software more from the user's point of view than speed of response, and the FlexCache 20386 has plenty of that.



The Mission Flex may be the fastest 386 machine PCW has tested, but for the majority of users it also represents a large degree of overkill. For a single user running power-hungry applications or a modest network file server, there is no need to go to such extremes. The Intel SYP301 and the Zenith Z386-40 are aimed at the quality end of the desktop 386 market.

Intel's history goes right back to the beginnings of microcomputing. From the earliest CP/M business machine right up to the latest 386 offerings, Intel is the company that supplies the micro-processor. However, all micro-processor manufacturers need test beds for their new products. Initially, Intel's test beds were for purely internal use, then with the advent of the 286 the company produced a commercially-available expansion/upgrade card. Now the company has announced its own machine — the SYP301 386.

Buying a computer from the processor manufacturer should in theory guarantee an architecture and chip set perfect for that machine.

## Hardware

The Intel 386 is an incredibly ordinary-looking big grey box, and is

heavy and robust. The few distinguishing features consist of: a red power switch on the right-hand side; disk drive, green power light, red hard-disk light and lock on the front; and power in and out, serial port, parallel port and keyboard socket at the rear.

Be prepared to devote a lot of desk space to the SYP301 — if anything it is slightly larger than the usual PC/AT-style box and weighs in at over 35lbs. The system comes completely configured from ACPM and booted up first time. I was pleased with the almost silent-running fan, as the hum of a fan can be quite irritating in a quiet office.

The 9-pin D RS232 serial port and 25-pin Centronics parallel port are provided directly off the motherboard and so do not occupy any of the slots. The rear also features a standard DIN keyboard socket and the output from an optionally-fitted EGA card. I was disappointed that no hardware reset switch was provided — I would have expected Intel to know how to reset the processor correctly.

The CPU is an Intel 386/16 running at a maximum-rated speed of 16MHz, and tests have revealed that it is cap-





## Slim, elegant, perfect vision, tilt and swivel body, (and that's just the monitor).

You're looking at one of two models we've designed specifically for the PS/2 generation.

The Auto 480 is the only 14" VGA monitor available today. The 14" screen gives you 40% larger viewing area than IBM's 12" monitor in a similar size cabinet.

The connections to the Auto 480 are neatly made through its tilt and swivel base and its anti-glare tube gives a crisp clear image over the entire screen.

What's more, the Auto 480 is available with a VGA graphics board so you can upgrade your PC/XT/AT or compatible to VGA now.

The Multi 560 is a multiscan monitor which can

automatically lock on to your graphics card, whatever PC you choose, including the PS/2.

Its auto size control ensures that the display always fills the screen without re-adjustment unlike other multiscan monitors.

These Hitachi monitors offer true VGA compatibility and more. Who else but Hitachi could offer you such an attractive proposition?



**HITACHI**  
New Media Products

# BENCHTEST

able of the 32-bit multiply that plagued early versions of this chip. Also on the motherboard are sockets for both the 80387 and the 80287 maths co-processors. (Intel has been giving a free 80287 processor away with the SYP301 as compensation for the lack of 80387s. Apparently this practice has now ended, but if you're quick you may be able to purchase one from stock.) One wait state has been introduced into the processor cycle to accommodate the speed of the RAM used.

The SYP301 is supplied with 1Mbyte of true 32-bit RAM expandable to a maximum of 9Mbytes by means of two special 32-bit expansion slots. The memory is made up of 100ns 256kx1-bit DRAMs which are small and old-fashioned enough to miss the more expensive price increase that has hit RAM recently. The review machine was expanded to 5Mbytes.

It's interesting to note that Intel uses third-party chips for both the processor support chip set and the ROM BIOS. Chips & Technologies provides the processor support chips in the form of four custom gate arrays. The two 16k ROMs hold a Phoenix ROM BIOS and a minimal amount of start-up procedures and diagnostics.

Opening the case in the usual PC fashion reveals a PCB that betrays no trace of sophistication, such as surface mounting, but is incredibly solid. It is one of the few PCBs that doesn't flex when an expansion card is being inserted. There is room for four half-height storage devices and power leads are supplied for all four as standard.

The power supply is a large 230W affair which should be enough to drive the biggest configuration with power to spare. To the left, occupying most of the base of the unit, is the PCB. All the chips on this board are socketed and there are over 50 of them, mainly small TTL circuitry. At the rear are eight expansion slots — two 8-bit PC types, four 16-bit AT types, and two custom 32-bit slots used purely for memory expansion cards.

With the exception of IBM and its Micro Channel, no manufacturer has agreed on a 32-bit expansion standard, so third-party board manufacturers will continue to make boards for the 16-bit AT standard. At the moment this presents no problem, but as processor speeds increase it will increasingly become a 16-bit bottleneck, especially when communicating with fast-cache assisted disk drives.

Three of the expansion slots were occupied, a Paradise EGA board occupying one of the 8-bit slots, and

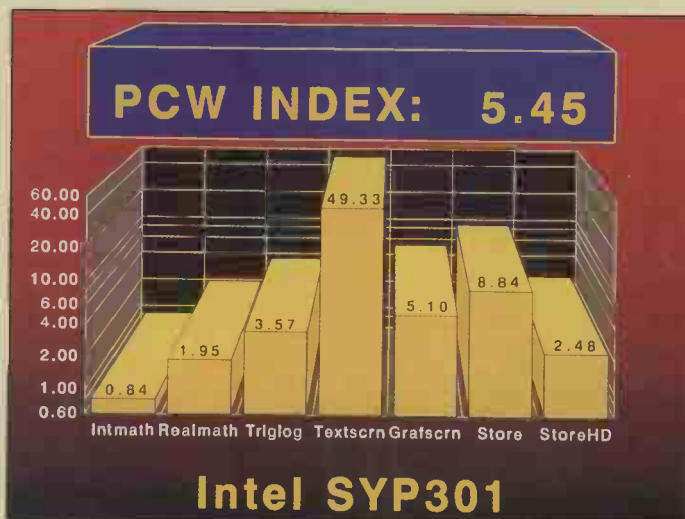

5¼in floppy drive; 40Mbyte hard disk; 80386 CPU running at 16MHz; 80387 not fitted; 80287 fitted (not used by GW-Basic); 5Mbytes RAM; GW-Basic version 3.3; EGA graphics card. (See PCW, February for full Benchmark details)

a Western Digital hard-disk controller and, surprisingly, a separate floppy-disk controller taking two others. An integrated floppy/hard disk controller from ACPM should be available by the time you read this.

The keyboard supplied was the now-standard Enhanced type, with all the failings and advantages of that design. For an obviously cheap Taiwanese keyboard it had a surprising amount of key travel and tactile and audible feedback. It was while testing the keyboard that I discovered that the processor could be switched down to 8MHz using Ctrl-Alt-PgDn. I presume this is for compatibility with the second release of IBM's PC/AT.

The monitor supplied with the Intel SYP301 was a Samsung unit, smaller than most EGA types and of excellent quality. The screen is 14in and is sharper and steadier than most straight EGA screens I've seen. It was, however, unetched and occasionally suffered from glare. ACPM has standardised on Samsung for all its monitors, including one of the best amber screens I've ever seen.

It is Intel's and ACPM's intention that the peripherals which surround the electronics are chosen by the user at purchase time. The selection offered by ACPM is wider than most and includes either 1.44Mbyte 3½in floppy drives or 1.2Mbyte 5¼in drives. There is a choice of hard drive, ranging from a slow 20Mbyte drive with 65ms access time to a 150Mbyte drive which promises 18ms access.

The review machine was fitted with a slow, noisy 1.2Mbyte floppy drive and a Seagate 28ms 40Mbyte hard disk, a combination which proved fast and faultless.

## Software

The review machine came with a copy of MS-DOS 3.2, licensed and shipped by Intel with its own disk

labels and a hard-backed manual. In all respects this was a standard, untouched version of MS-DOS.

The version of MS-DOS with a Phoenix BIOS set-up is such an established configuration that it was an almost pointless exercise checking for incompatible software. For the record the list of software tested included Microsoft Windows Release 1.04 and 2.03; DesqView with 386 QEMM drivers; GEM Version 2.0; Microsoft Excel; PC Write; WordStar Professional Release 4; and a selfishly-programmed Smartcom 3. Sure enough, the only incompatible programs I found were public domain games that expected a genuine CGA display instead of an EGA simulated one.

I also tried OS/2 on the SYP301 using the dual-boot feature found on all versions of OS/2 except IBM's. Everything seemed to work fine, by which I mean that the one OS/2 application I had, SuperProject, ran OK and the MS-DOS compatibility box was its usual not very compatible self.

## Prices

An entry-level SYP301 consisting of 512k RAM, a 1.2Mbyte floppy and MS-DOS costs £2645. To this you will need to add some of the following: a 40Mbyte hard disk, sub-30ms access time, £770; a 40Mbyte hard disk, 50ms access time, £600; a monochrome screen, £240; an EGA screen, £625; and 2Mbyte memory expansion, £595.

Intel plans to offer an 8Mbyte expansion board using a 1Mbyte SIMM. No price was available for this at press time but you can expect it to be very expensive.

## Documentation

A hardback manual which includes MS-DOS and, as you might expect, very detailed hardware information, will be included with the retail system.



# The answer is **YES**...

## *Can you supply a wide range of P.C.s?*

From basic workstations to 80386 fileservers, for CAD/CAM or accounting, on a LAN or under UNIX, we sell and support systems from Olivetti, NEC, Tandon, AST, Toshiba and Unisys – all at realistic prices.

Olivetti M240, M280 and M380 all available from stock. System prices from	£1375.
NEC:80286/80386 systems including renowned Multisync display from	£1995.
Tandon PCA 20 System	£1295.
Toshiba T3100 20MB portable PC	£2495.

## *Have you got all the latest software?*

We stock all the major applications programs, such as Spreadsheet and Database packages, as well as more specialist applications like Autocad and Ventura. We provide telephone support and we welcome enquiries for Network or Xenix software.

Lotus 123	£235	Excel	£295
Symphony	335	Windows	59
Freelance Plus	245	Smart	425
dBase III Plus	375	Multimate II	295
Paradox 2	375	Wordperfect	235
Dataease	395	MS Word 4	275

## *Do you understand Desktop Publishing?*

We can provide a variety of Desktop Publishing solutions using Xerox Ventura or Aldus Pagemaker. Full training is available for DTP users, and we have a wide range of hardware for both basic and advanced applications.

<b>Example System</b>	
AST Premium 286 40MB	
Wyse WY 700 display (1280 x 800)	
AST Turboscan Scanner	
AST Postscript Turbolaser	
Ventura Software + MS Mouse	£6995
Xerox Ventura 1.1	£450
Aldus Pagemaker	£495

## *Can you advise me on printers?*

We stock a huge range of printers suitable for every application. We specialise in the latest laser printers for document processing and computer aided publishing.

AST Postscript Turbolaser 3MB 8ppm	£2695
Hewlett Packard Laserjet II 8ppm	£1695
Qume ScriptTEN 2MB 10ppm	£3495

(These prices include 12 months on-site maintenance)

## *Will you offer a full range of maintenance services?*

As well as in house support services our engineers can provide a wide range of flexible on-site maintenance contracts to suit your needs. Full maintenance, emergency call out options and parts and labour only cover can be tailored to match your systems usage as cost effectively as possible.

For an immediate quotation please call our Engineering Department on 01-870 3255.

## *Can you arrange training for my staff?*

We can provide training for all the major software packages such as Lotus 123, dBase 3, Wordperfect etc., for as little as £150 per day. Most courses can also be arranged at your premises.

Microsoft Excel (1 day)	£150
Ventura Publisher (2 days)	£300
Aldus Pagemaker (1 day)	£150

**MAYFAIR  
MICROS**

Blenheim House,  
Podmore Road,  
London SW18 1AJ  
01-871 2555/Telex 936066

# Zenith Z386-40

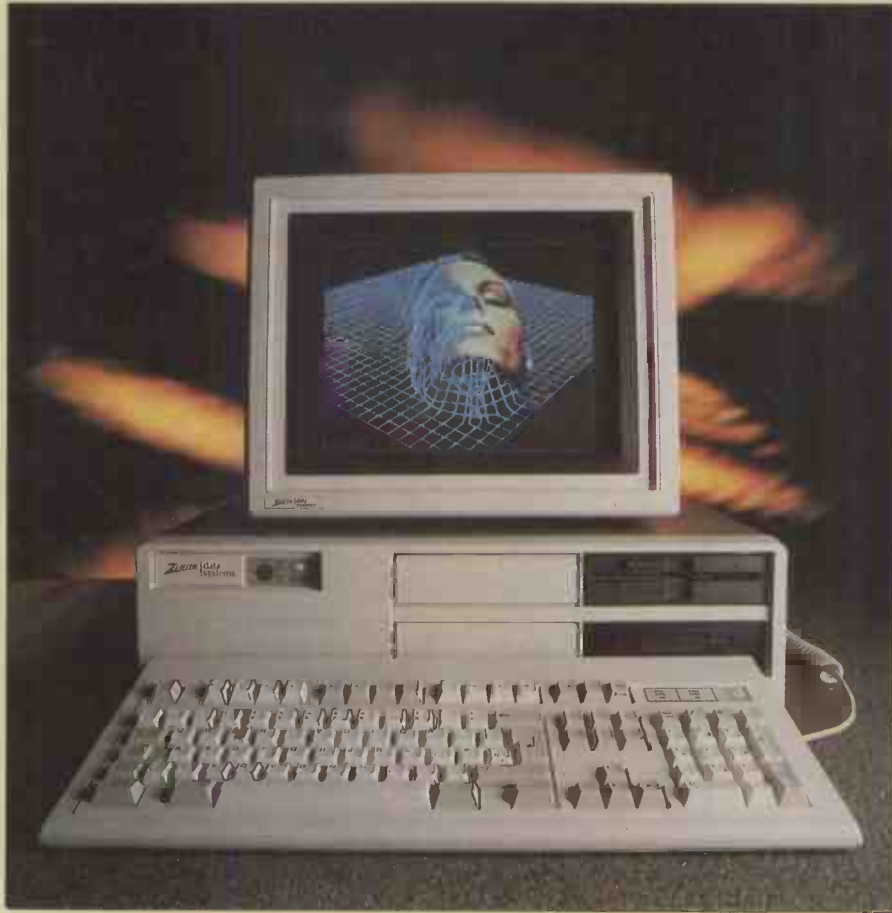

Zenith has never been particularly well-known for its innovative ideas but it does have a reputation for well thought out and well-constructed machines. The Z-181, for example, was far from being the first MS-DOS laptop on the market, but when it did appear in early 1987 it was generally accepted as one of the best. Even today, the Z-181 is the MS-DOS laptop I recommend above all others. Similarly, the Z386-40 has been launched well late of the competition and hopefully with the same well-evolved design.

## Hardware

The Z386-40 is the same size as the Zenith Z286 AT-compatible. It is really a desktop machine, but for the period of the review it balanced on one edge behaving like a tower system. The front of the machine has two LEDs for hard-disk access and power, a 5¼in disk drive, and a tacky gold sticker that looks like it came from a toy Ford Cortina. There is a nasty gap just under the floppy drive which is just perfect for losing disks down if you're not concentrating. Both sides of the machine are bare, and the rear panel contains a puny power switch, a keyboard socket and

a power in/out socket. All other ports are incorporated on expansion cards. Sadly, the Z386 also lacks a reset button.

Setting up proved to be no problem and took less than 10 minutes due to the pre-formatted hard disk and pre-installed MS-DOS. Three ports are provided as standard: a 9-pin serial port, a 25-pin parallel printer port and the video output specified by the user (VGA on the review machine). Also on the rear is a small red switch that allows the power supply to run off either European 210-250v or American 110v. I was struck by how noisy the fan was when all the other office machines had been switched off.

The Z386 uses a 16MHz Intel 80386, which has passed the dreaded 32-bit multiply test and so should be compatible with any 80386-specific software. Running the processor at 16MHz does mean that one wait state has been inserted to allow the RAM time to refresh. As far as I can tell there is no way to switch the processor down to operate at a PC/AT-compatible speed.

RAM totals 1Mbyte installed as four banks of 100ns 256k×1-bit chips. The review machine had been ex-

panded to 3Mbytes by means of two 1Mbyte expansion boards. Using 1Mbit chips in the base memory sockets and two 4Mbyte expansion cards, you could easily expand the machine to 12Mbytes. A single 32k ROM contains not only the ROM BIOS but also a complete monitor and a diagnostic program.

Like the Intel SYP301, the Z386 is low on state-of-the-art chip technology and high on old-fashioned build quality. Only two customised gate arrays were visible next to the processor, the rest being constructed out of TTL chips.

Six Phillips screws hold the lid down. I noticed that after persistent removal of the lid, one of the screw heads started to crumble — a problem I'm finding on lots of Taiwanese clones but not something you'd expect on a Zenith. Once inside I searched in vain for a motherboard, but I found that the Z386 consists of five expansion cards, a back-plane, power supply and whatever disk drive has been installed.

Ten slots are provided made up as follows: two PC/AT 16-bit slots; two 8-bit PC slots; and five Zenith 32-bit custom slots. Unusually, the 32-bit slots have been made by adding an extra block of address and data lines to an existing PC/AT slot. This means that any free expansion slot can accommodate standard expansion cards provided they don't use descenders which might foul up on the extra address lines. The bus system is non-intelligent and non-arbitrated.

In a minimum configuration five of the ten slots would be filled: one AT slot for the disk controller; one PC slot for the video; two 32-bit slots for the processor and I/O boards; and at least one other 32-bit board for memory.

In the right-hand corner of the system box is the usual silvered power supply giving a total of 220W. In addition to the fan in the power supply, Zenith has also fitted a fan to the system unit which accounts for the extra noise. To separate the air flow of the power supply from that of the system there is some real hi-tech ingenuity — a bent metal plate.

The first thing that strikes you when you look inside the system box is the twinkle of LEDs — six green ones on the back-plane signifying all the different supply voltages, and six red ones on the I/O board which extinguish as six diagnostic tests are passed.

Like Intel, Zenith has stayed away from VLSI technology and hence the Z386 has a large number of discrete components. Consequently, not all of the processor support chips will fit on a single card; the DMA controller, internal timer and interrupt controller



have spilled over on to the I/O board. Also on this second board are a 25-pin parallel printer port and a 9-pin serial port, plus a small memory buffer. Two empty sockets are provided on the processor board for either an 80287 or 80387 maths co-processor. Socketed chips are used throughout, and there is a large number of jumpers and DIP switches for controlling such things as the speed of the maths co-processor and memory configuration. On the top of the processor card is a 50-way expansion card to which can be attached 256k high-speed cache memory.

The Z386 is supplied with either 1.44Mbyte 3½in or 1.2Mbyte 5¼in floppy disks and a choice of two hard disks, either 40Mbyte or 72Mbyte. The review machine had a 5¼in floppy and a 72Mbyte hard disk manufactured by Magnetic Peripherals, and a Data Tech controller card. The hard disk is quiet and not particularly fast (50ms access time). No technical data was available for the floppy but it seemed to be quite slow.

The monitor supplied was a Zenith analogue flat-screen unit designed to work especially well with 256-colour VGA cards. It has a fixed scan rate of 70MHz and is fed by the signal from a Sigma VGA card through a weird and apparently non-standard 12-pin D plug. The quality of display from this Zenith monitor is incredible: the image is rock-steady and has more brilliance and more contrast than any colour screen I have ever seen. It is devoid of reflection and capable of producing a very deep black and not the dark grey of other screens.

All this quality is enhanced by the totally flat tube, achieved by another set of magnets around the perimeter of the screen. These extra magnets mean the machine gets quite hot in operation and a fan is needed to cool the monitor down, adding to the noise from the system unit fan. My only complaint is that the one VGA socket is the only input to this screen. I would have liked to have tried it with a Mac II and some of the other high-resolution machines.

The keyboard is the IBM standard ATE unit introduced in early 1986, and comes close to the feel of a genuine IBM keyboard — still my personal favourite. The keyboard is sturdy, well-built and gives a reassuring click when the key has registered rather than when it has reached the end of its travel. The biggest disappointment is Zenith's 'blind-following' of IBM in putting the back-lash key between 'Shift' and 'Z', which annoys touch-typists.

## Software

Zenith supplied MS-DOS 3.3 and OS/2 with the review machine, although



The Flat Tension Mask monitor is available on a range of Zenith machines. Exposure to conventional curved monitors means that, for the first few days of use, the screen appears to be curved inwards

only MS-DOS is included in a standard configuration. I tried both with absolute success and in the process discovered Zenith's excellent ROM-based monitor program. This is far more powerful than the MD-DOS 'DEBUG' program and can be entered at any time by pressing Ctrl-Alt-Ins which is dangerously near to Ctrl-Alt-Del. From this monitor it is possible to reboot from any named drive (useful for running both MS-DOS and OS/2 on the same machine), perform various diagnostic

tests, enter 'SETUP' data, display a video test signal or change video modes, and all the usual collection of programmer debugging routines.

Rather than waste time running all the usual tests such as Lotus 1-2-3, Microsoft Flight Simulator, and so on, I tested some of the more badly-behaved programs which access the hardware directly. Bricks, Stargate, Digger and Zaxxon all ran without a hitch. Bricks was quite an achievement — only genuine IBM systems and Hewlett-Packard's Vectra have

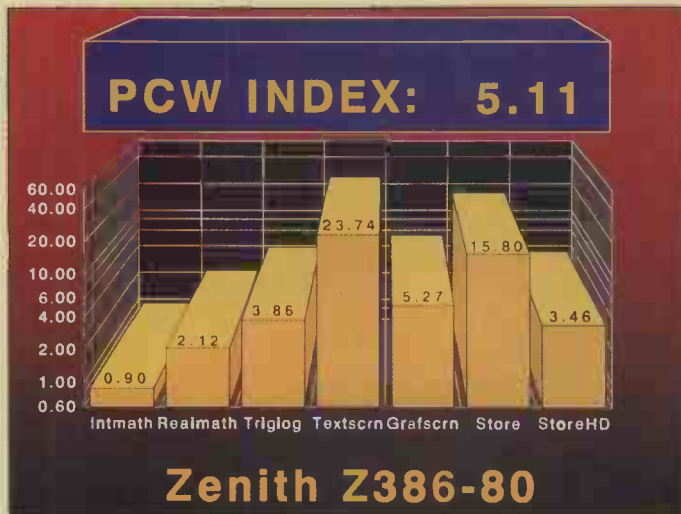

5¼in floppy drive; 70Mbyte hard disk; 80386 CPU running at 16MHz; 80387 not fitted; 3Mbytes RAM; GW-Basic version 3.3; VGA graphics card. (See PCW, February for full Benchmark details)

passed this test in the past. The only failures were programs that assumed a genuine 6845 CGA graphics chip such as the public-domain demo, 130color.

## Prices

The Z386-40 costs £4395 to which you must add the cost of a monochrome monitor at £187 or a flat-screen colour monitor at £780. Extras include a 1Mbyte RAM board at £595, 4Mbyte RAM boards at £1873 and OS/2 at £195. Zenith also offers a Z386-80 with a 72Mbyte hard disk for £4795.

## Documentation

The Z386 was supplied with a wealth of documentation consisting of an *Owner's Manual*, two MS-DOS manuals and three OS/2 manuals. The *Owner's Manual* is particularly good and contains detailed information on all the machine's components and the ROM firmware (it even

admits to some possible hardware incompatibility when expanding).

## Conclusion

In many ways the SYP301 and the Z386-40 are very similar: they both offer solid, reliable 386 performance and neither can be classed as state-of-the-art. The SYP301 is so standard in every respect that it would be a good purchase for users who often find themselves in the position of questioning whether the hardware or software is at fault. If it doesn't run on the Intel, then it's almost certainly the hardware. Programmers in particular will find it an excellent definition of a 'standard' 386 PC clone. It is so solid and robust that it might be a viable purchase for a light-industrial situation or laboratory as opposed to expensive customised hardware.

The Z386-40 is a sprightly performer and, because of its back-plane

design and excellent ROM-based monitor, is well-placed to follow any operating system trends. OS/2, for example, sits quite happily on a separate partition of the hard disk and can be booted from the monitor program. More than either machine, however, I wanted Zenith's flat-screen colour monitor; unfortunately, so did PCW's editor, and it now sits on his desk.

There are signs that 80386-based PC design is moving beyond the idea that the AT architecture can be fooled into running fast enough to show off the paces of top-speed 80386 processors. Compaq and ALR were the two originators of 80386 machines, and both have now moved beyond the AT design to offer sophisticated RAM cacheing, high-speed dynamic RAM using static-column or simple fast chips, big and fast hard disks, and complete soft-



ware compatibility with the promise of multitasking using environments like DesqView and Windows/386.

The availability of high-speed 80286 machines and the removal of copy protection from the majority of major MS-DOS applications have removed many of the worries about producing 80386 machines that run at their highest possible rate, since expansion boards and software can now generally cope with processor and bus speeds of 10MHz and up.

And, with the release of support chips like the 82385, the 80386-based PC is entering a new area where new computer architectures, often derived from minicomputer and mainframe experience, can be used to advantage to improve the performance of existing software.

The FlexCache 20386, like the Compaq DeskPro 386/20, is one of the original entrants in this new power-computing race. The competition will get stiffer and stiffer over coming months as others recognise the opportunities of high-performance memory architectures. **END**

## Technical specifications

### Zenith Z386-40

Processor: 80386 running at 16MHz  
 ROM: 32k  
 RAM: 1Mbyte expandable to 12Mbytes  
 Mass storage: 1.2Mbyte 5¼in floppy, 72Mbyte hard disk; optional 3½in floppy, 40Mbyte hard disk  
 Display: Analogue flat-screen colour display  
 Keyboard: 102-key AT-compatible keyboard  
 Size: 6ins x 18ins x 15ins  
 I/O: 25-pin parallel printer port; 9-pin serial port  
 Weight: 32lbs  
 DOS: MS-DOS 3.2; optional OS/2

### Intel SYP301

Processor: 80386 running at 16MHz  
 ROM: 32k  
 RAM: 512k expandable to 16Mbytes  
 Mass storage: 1.2Mbyte floppy drive, 40Mbyte hard disk; optional 3½in floppy drive and selection of hard disks from 20Mbyte to 150Mbyte  
 Display: 12in Samsung EGA-compatible  
 Keyboard: 102-key AT-compatible  
 I/O: 25-pin parallel printer port; 9-pin serial port  
 Weight: 43lbs  
 DOS: MS-DOS 3.2



# "£229 for all that?"

*"What's this – a new printer?"*

**"Yes, it's the very latest, the industry compatible Multi-font LC-10 from Star, there are features included as standard not found on printers sometimes twice the price..."**

*"Oh really – like what?"*

**"Well, there's the Star front control panel – so you don't have to fiddle with DIP switches – a built-in push tractor for low form tear-off. And you don't even have to take the tractor paper out to autoload single sheets with the LC-10's paper parking. There's a large 4K buffer – it's even got six NLQ fonts as standard. It prints at a realistic 120 cps and has a really fast NLQ at 30 cps".**

*"Hey, that sounds good, but what about quality? You'd have to go a long way to beat the print quality on that NL-10 you've got".*

**"True, but they've even improved on that and you can change all the resident fonts at the touch of a button".**

*"Hmm, that's really easy – £229 for all that? I wonder if my dealer will have any left..."*

**THE**  
**Star**  
**PRINTERS FOR BUSINESS**

Star Micronics U.K. Ltd.,  
Craven House, 40 Uxbridge Road,  
Ealing, London W5 2BS.  
Telephone: 01-840 1800.

A division of  
Star Micronics Co., Ltd., Japan.

Price excl VAT.

I'd like to find out if my dealer has any left. Please send me an LC-10 brochure   
Please send me details of the Star range of dot matrix printers  Or just call Belinda  
on 01-840 1829.

Name \_\_\_\_\_ Company \_\_\_\_\_

Address \_\_\_\_\_

Postcode \_\_\_\_\_

Telephone \_\_\_\_\_

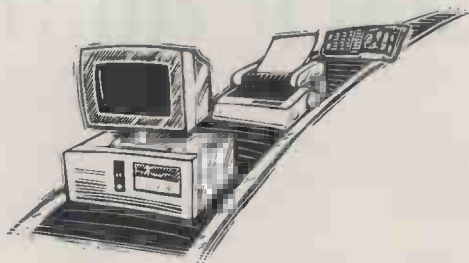

# HP DeskJet

Hewlett-Packard's DeskJet ink-jet printer provides laser-quality lettering and simple graphics at an affordable price for the small-business user. Derek Cohen was impressed by its performance.

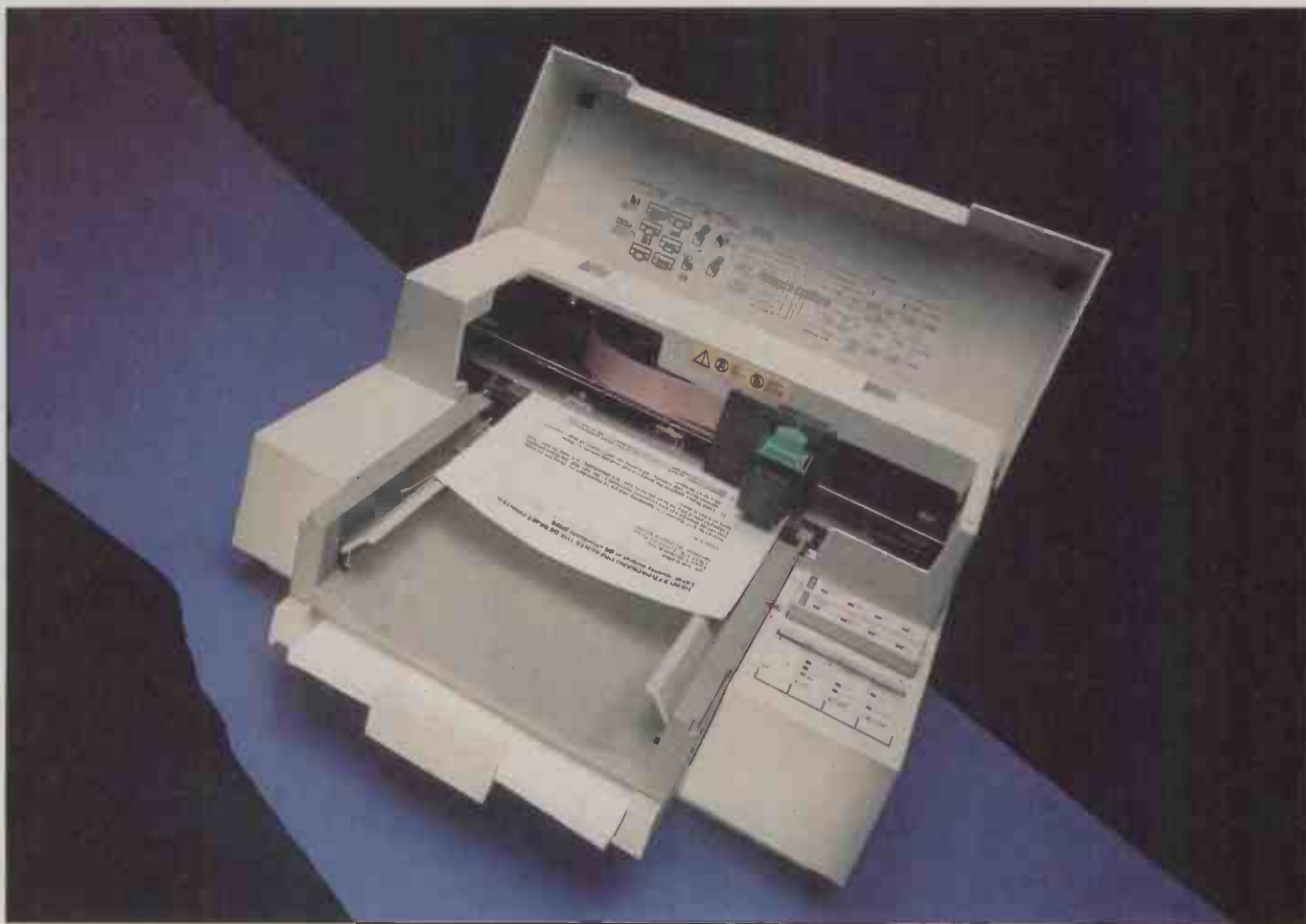

**W**ith the increasing interest in graphics and desktop publishing, many computer users are looking disparagingly at their dot matrix printers and lusting after the sort of quality output that laser printers offer. For most users, however, laser printers are far beyond their means.

In addition, while many 24-pin printers offer good-quality text and graphics output, they are limited in typefaces and are often not sup-

ported by more sophisticated applications. It is frustrating, for example, to find that Xerox Ventura Publisher will support 9-pin dot matrix printers, and laser printers, but not 24-pin devices which for many would provide adequate originals.

The final problem is that of printer drivers. Most software applications now support laser printers, and it has been obvious for quite some time that there was room for a low-cost, non-laser printer that recognised, for

example, the HP LaserJet set of instructions.

Hewlett-Packard has now filled this breach with its DeskJet, which retails at £795. The unit is HP LaserJet compatible, is based on ink-jet technology, and produces text and graphics of a quality comparable with laser printers. It uses ordinary bond paper, and font cartridges give access to typefaces up to 18pt in size with italics and bold available.

If things were so simple, however,



the laser market would collapse overnight, and as we will see, price does have its penalties.

## Hardware

Having narrowly avoided slipping a few discs moving last month's laser printers around the office, it is gratifying to find the DeskJet a small, lightweight box. Dimensions are 15ins deep by 17ins wide by 8ins high — about half the size of a standard laser printer. And at 14lbs, it is about one-third the weight. Compactness is an integral part of the design, with the 'in' and 'out' paper trays lying on top of each other and forming part of the unit's 15in depth.

Both serial and parallel interfaces are provided as standard and these, together with the power input, are recessed in the middle of the bottom plate of the printer in the style of the BBC Micro. This means that the printer can be situated almost flush against a wall or partition.

The ink-jet printing mechanism consists of a removable cartridge containing both the two rows of 30 ink nozzles forming the print head, the ink-jet electronics and the ink reservoir. One head-cartridge should last about 500 sheets, depending on the balance of text to graphics and the quantity of heavy black areas of graphics. Hewlett-Packard works to a guide of 525,000 characters or double that in draft mode. Replacement cartridges will cost £16.34. This works out at around 3p per copy. In terms of consumable costs this is comparable to many laser printers, though at 1.5p per copy, the Toshiba PageLaser 12 reviewed last month would be much cheaper in those terms. However, that printer costs £2995. And 3p per copy is considerably more expensive than the cost of ribbons for a standard impact printer.

Next to the paper trays are two slots which take font cartridges, two sets of buttons and a series of LEDs. The font cartridges are different from the standard HP LaserJet cartridges because the format in which the fonts are held is different. As we will see later, this also means that standard HP downloadable fonts cannot be used.

The machine as standard comes with Courier as a built-in font and all other fonts must be purchased separately on cartridges.

The top of each cartridge shows the name and point sizes of the fonts it contains. Alongside each combination is an LED which glows when that particular font is in use. Fonts can be selected either by software, or manually using the buttons, and in either case the LEDs glow on and off as the fonts are selected.

The review machine was supplied

with three cartridges. One each for Helvetica and Times Roman, and a demonstration cartridge which prints a sample text and graphics page on power-up. Font cartridges cost £73 and an Epson emulation cartridge can be bought for £58.

Each of the supplied cartridges provided 8pt and 10pt text in Roman (upright) and italic fonts. Compression from the standard 10cpi to 16.67 and 20cpi, expansion to 5cpi and bold effects are performed 'algorithmically'. This means that the faces are calculated rather than stored, and the results can look pretty grim. Bold is achieved by doubling the number of dots per character and you soon realise why people like Adobe make a fuss about people buying proper fonts. I found the Helvetica bold far less objectionable than the Times or Courier bold.



The removable print head also contains the ink reservoir. The large gold plate is the electrical contact, the small one underneath contains the ink nozzles.

Other buttons place the printer on and off-line, perform a form feed, change between letter-quality and draft mode, and allow for the hand-feeding of envelopes. In draft mode the DeskJet only prints every other dot, which saves ink and cuts printing time by about one third. For people who want to have fine control over the paper position before printing, two buttons produce micro feed movements of the paper.

The paper tray can hold up to 100 sheets of paper up to US legal size. An adjustable gripper holds the narrow edge of the paper in place while a lever adjusts a side bar to accommodate A4 or wider paper. The output tray holds only 25 sheets and each printed page is suspended by two bars above its predecessors for a few seconds, to allow the ink to dry before it is released on to the stack. HP recommends that standard bond paper is used, and on test I

found no difficulty using ordinary photocopier paper or laid Conqueror, which has a surface texture that rubs against the head and smears the ink on some ink-jet printers.

Pages are stacked face up in the output tray which means that a multi-page document is stacked in the wrong order.

## Software compatibility

The DeskJet is compatible with the original HP LaserJet printer. This compatibility is referred to as PCL III+. Current LaserJet Series II printers use PCL IV. It is important to understand the differences in order to realise why 'HP compatibility' is not a single standard. PCL III+ supports fonts up to a maximum of 18pt (about twice the height of a standard printer output) whereas PCL IV goes up to 48pt. Both offer up to 300x300 dpi resolution in text and graphics.

The HP control language is totally different from that used for Epson or IBM emulations. Instead of the computer saying 'now use font 3', the HP language is more like a bargaining statement — 'I'd like a bold serif face in 24pt with the international character set, what have you got? I'd prefer Century if you have it.' If the printer can't match the request exactly it provides the next best thing. So, you may get Times Roman in 18pt US-ASCII only. The very long strings of escape sequences to make such requests are frightening to say the least, so it is good that the DeskJet will work, as a default, with the LaserJet drivers provided with most software these days.

However, there are two major cautions. The DeskJet does not have any internal memory in which to assemble a page. In this respect it is closer to a serially-printing dot matrix or daisywheel printer — it processes one line of data at a time rather than accepting a page at a time like a laser printer with its 1Mbyte of RAM.

To give an example, consider a tinted box containing text. On a page printer, a virtual page is made up in RAM. The software in the computer will send the printer a series of instructions such as 'draw a box at these coordinates, fill it with a tint, now move to the top corner and write this text in this preferred font which I have just downloaded.' The printer assembles the components and then prints the page.

On a serially-driven printer (serially as in data not interface), there is nowhere to make up this page and the printer has to 'lay down' the data as it arrives. It needs some trial and error to discover whether the LaserJet printer driver provided for a given piece of software sends its data serially or to a virtual page.

GEM Output works fine, but GEM-derived Ventura does not.

In the long term, Hewlett-Packard expects that DeskJet drivers will be available for all major software packages. In the short term, the company recommends using a LaserJet or LaserJet+ driver if no DeskJet one is available. I was provided with a DeskJet driver for Microsoft Windows which worked perfectly.

The other major difference is that the DeskJet will not accept standard HP downloadable fonts. Partly this is because the standard machine does not have the memory to store them. The other reason is that the DeskJet stores the bit-map for its fonts in a vertical pattern (that is, it reads one vertical line of dots at a time) rather than horizontally as with standard HP fonts. In addition, the DeskJet's basic 'dot' is round whereas that of a laser printer is oval.

Nonetheless, Hewlett-Packard will be supplying a memory cartridge to accept special downloadable fonts. And no doubt some enterprising hacker will write a utility to convert LaserJet fonts to DeskJet ones.

## Performance

The DeskJet was run with a number of software packages. Apart from those running under Windows, all were configured for a standard HP LaserJet+. In operation the machine is almost silent and presents none of the environmental problems of smell, noise or bulk of a laser printer.

It is obvious, looking at any of the print samples, that the output quality of the DeskJet is very close to that of a laser printer. In fact, when printing solid black areas and tints in graphics mode, the DeskJet showed less streaking than a laser printer. In text mode the results are very impressive, with only occasional slight spidering revealing that a wet process has produced the text.

Using PC-Write, I selected the LaserJet+ printer driver with what was referred to as 'Soft R8 new Helv-AD' fonts. This set includes a 24pt Helvetica not contained on the cartridge, but the standard, bold and italic fonts reproduced correctly. I tried various other font cartridge drivers and most produced satisfactory results for some of the font letters.

Fontasy also reproduced its fancy text and graphics correctly, showing that this package sends its graphics data serially rather than as page commands. The HP fonts available for Fontasy printed out correctly, though again, these are transmitted as graphics streams.

Pictures were printed from GEM packages Draw and Davrelle, using the standard LaserJet+ driver. These printed perfectly with the grey tints

# PageMaker

## TIPS & TECHNIQUES

**With the increasing interest in graphics and desktop publishing, many computer users are looking disparagingly at their dot-matrix printers and lusting after the sort of quality output that laser printers offer. For most, however, laser printers are**

**with laser printers. It uses ordinary bond paper and font cartridges give access to typefaces up to 18pt in size with italics and bold available. If things were so simple, however, the laser market would collapse overnight, and as we will**

Graphics and solids reproduce quite well when the DeskJet driver is used with Windows. The Times typeface leaves something to be desired, though

actually printing finer than on a Kyocera 1200 laser printer. The LaserJet+ driver for GEM sends lines only one bit high to the printer which makes for very slow printing. The DeskJet can handle lines 12 dots high and, when a GEM driver becomes available, printing will be speeded up considerably.

Though it is possible to print from GEM, it is not possible to drive the DeskJet from Ventura Publisher at present. This is because Ventura sends the printer numerous positioning commands which cannot be acted upon. Hewlett-Packard is currently in the process of writing a Ventura driver.

Using the supplied driver for Microsoft Windows I printed out a page from Pagemaker. The sample above shows how well it can produce text and graphics, but how uneven the tinted area is. The Type menu only allows access to fonts on the installed cartridges.

## Conclusion

If the DeskJet's print quality is as good as I have made out, what are the drawbacks?

The main one is speed. A typical laser printer will output text pages at anything between six and 12 pages per minute. The DeskJet is rated at 2 pages per minute. When printing graphics, you do have to sit and wait while the head draws each line separately.

However, for many users speed is not a problem; and the ability to output at laser quality without the capital cost of that type of machine will

be a great advantage. The consumables cost is also on the high side, but I found it reassuring rather than wasteful that every 500 sheets or so I was getting a new, clean set of ink jets.

As an ink-jet printer, performance is very good. The quality of output and software compatibility ranks the printer well ahead of other ink-jet printers and at a cost below many less capable machines.

The DeskJet is clearly aimed at the small-business or discerning personal user who wants laser-quality lettering and simple graphics without the capital cost. So far these users have been buying 24-pin printers as a compromise between quality and cost.

The printer is *not* aimed at the heavyweight desktop publishing market, though it will work with Pagemaker. It will certainly appeal to those using either low-end DTP packages or the new breed of 'graphics with text' word processors such as MicroPro's Pagesetter or WordPerfect 5. Given Hewlett-Packard's position in the laser printer standards market, it is very likely that DeskJet drivers will start appearing on most printer menus in the near future.

Overall, the printer and the quality of its output impressed everyone who saw it in action, and I'd certainly recommend anyone thinking of buying either a 24-pin printer or a laser printer to consider whether the DeskJet is more suited to their needs.



# MORE POWER TO YOUR ELBOW

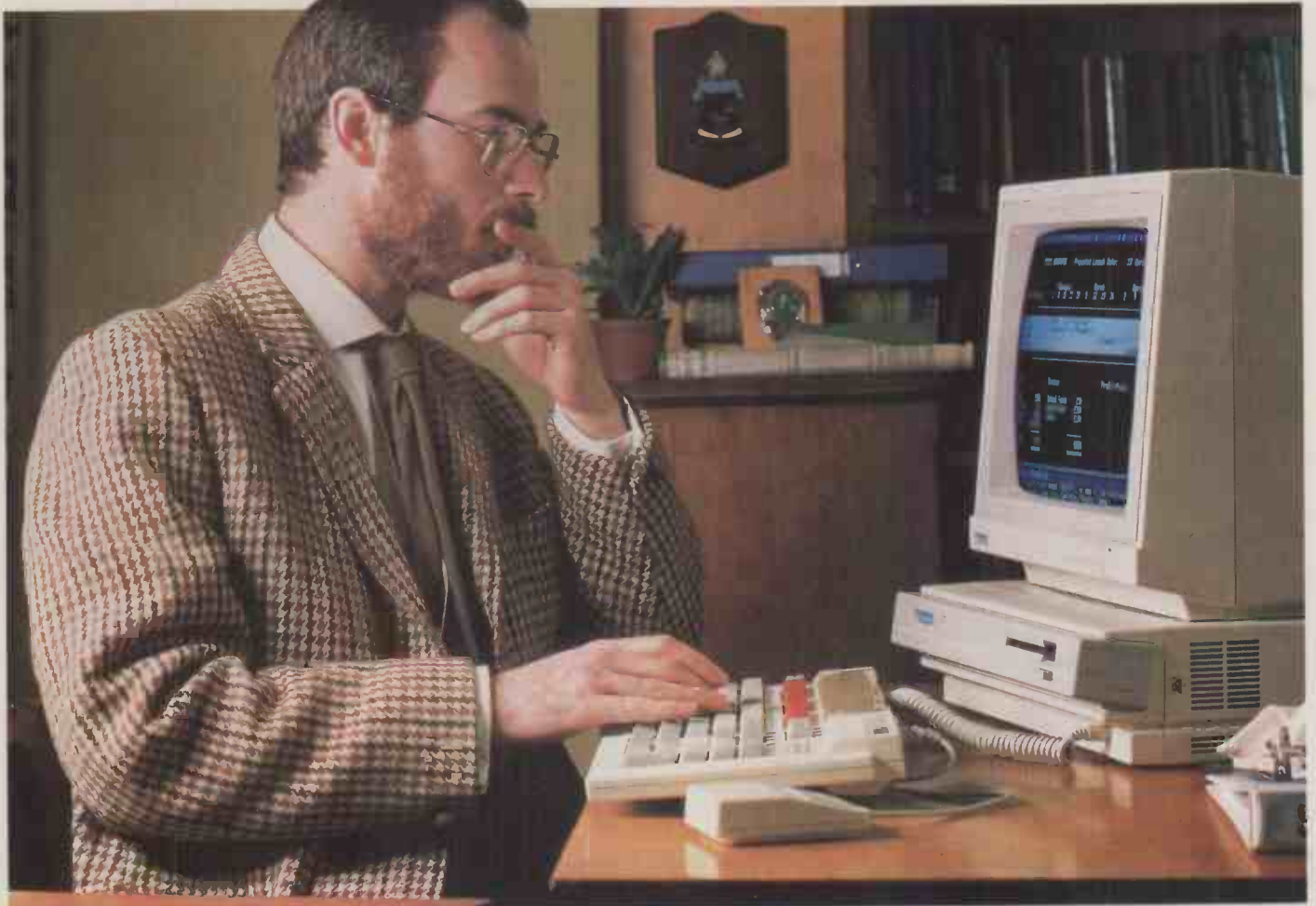

 In handling word processing, spreadsheets and project planning, the speed of Acorn's Archimedes microcomputer is hugely impressive.

The benefits of such power include superb graphics for CAD and image processing, and considerable creative opportunities in the field of sound and music.

Furthermore, with the option of a PC emulator Archimedes opens up the world of MS-DOS and a wide choice of business software applications.

Send for the Archimedes Power Pack. No other computer offers such power and performance for the price.

Tel: 0800 100 100 (Free call)

To: Acorn Computers Limited FREEPOST 4335, BSI 3YX.  
Please send me the Archimedes Power Pack.

I am particularly interested in the following areas:

- |  |  |  |                                    |
|--|--|--|------------------------------------|
| <input type="checkbox"/> Word processing       | <input type="checkbox"/> Spreadsheets          | <input type="checkbox"/> Database management | <input type="checkbox"/> Education |
| <input type="checkbox"/> Graphics applications | <input type="checkbox"/> Information retrieval | <input type="checkbox"/> Project Planning    | <input type="checkbox"/> Home      |
|  |  |  | <input type="checkbox"/> Business  |

Name: \_\_\_\_\_

Position: \_\_\_\_\_

Company: \_\_\_\_\_

Address: \_\_\_\_\_

Postcode: \_\_\_\_\_

Tel. No.: \_\_\_\_\_

Offer applies to the U.K. only.

**Acorn**  
The choice of experience.

PCWMAY  
**Archimedes**

A BRITISH BROADCASTING CORPORATION MICROCOMPUTER  
MS-DOS is a trademark of the Microsoft Corporation. Acorn and Archimedes are trademarks of Acorn Computers Limited.

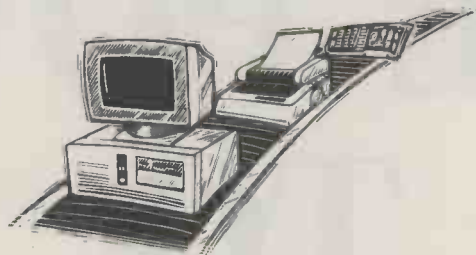

# AST Mac286

**AST's Mac286 expansion system provoked a general 'thumbs down' from John Donaldson. Although very compatible with IBM PC software, it proved unreliable and potentially troublesome in many areas, and the slowness of the display system is a major drawback.**

**T**hroughout its life, the main criticism of the Apple Macintosh has been that it is not compatible with software written for the IBM PC. There are those, of course, who argue that it is precisely *because* the Mac is not PC compatible that it is so good at what it does. Nevertheless, that lack of compatibility has severely limited sales of the Mac to companies with a policy of only buying PC-compatible machines.

However, it looks like you can now have your cake and eat it. The processing power and expansion potential of the Macintosh II means that it can run PC programs along with its own native mode systems.

There are two ways of achieving this result. You can either write a program which emulates an IBM totally in software, or you can plug an IBM-compatible processor board into one of the Mac II's expansion slots and use a Mac window to imitate an IBM monitor. This latter is the route chosen by AST with its Mac286 expansion system.

## Hardware

The Mac286 system arrives in a colourful package about the size of a shoebox complete with a picture of the product and a logo containing the less-than-inspiring words: 'We Make Apples Grow!' I suppose Americans must like this sort of thing.

Opening the shoebox reveals three manuals, two 5.25in DOS disks, one 3.5in Mac program disk and two NuBus add-on cards which contain the IBM-compatible electronics. Coming from AST, I had high hopes for the electronic portion of the Mac286 package. AST first established itself as a maker of ingenious high-quality add-on cards for IBM machines and then went on to build some of the fastest AT clones on the market.

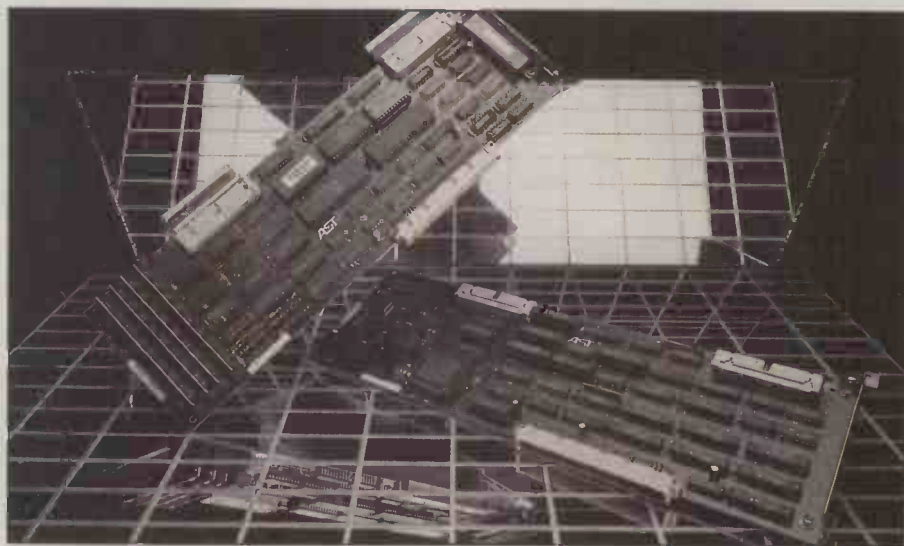

Unfortunately, I can't get excited by the Mac286 hardware. The first surprise was that it comes as two NuBus cards rather than one. The first card contains an Intel 80286 processor running at 8MHz along with a socket for an optional 80287 maths co-processor. The second card contains 1Mbyte of RAM made up of four 256k SIM modules, and a large D connector to allow the connection of an external disk drive. Both cards are joined by two short lengths of ribbon cable and cannot be moved in relation to each other.

Close examination of the hardware reveals why it was necessary to use two NuBus cards instead of one — all the circuitry is made up of old-fashioned TTL discrete logic chips with hardly a custom chip or ULA in sight. Given the falling price of custom chips, I can't understand why a company such as AST has chosen such a low-tech approach.

Installing the Mac286 hardware into a Macintosh II is straightforward. The lid of the Mac II can be removed by unscrewing the Phillips screw in

the centre of the back panel and then releasing the two catches which secure the lid. Most Mac II owners will have no trouble finding two adjacent expansion slots free for use at the moment, although the same may not be true in a year or so when greater availability of Mac II cards will lead to a corresponding lack of space inside the machines.

The two Mac286 NuBus cards are fitted by simply pushing them firmly into their slots. The cards are held in place by a series of catches on the back of the Mac casing. The only other piece of hardware you need to add is some sort of IBM floppy disk drive, which can either be a 5.25in PC compatible drive or a 3.5in PS/2 compatible unit. The Mac II's own 3.5in drive is not IBM compatible.

Any drive which is used has to be plugged into the 37-way D socket on the back of the Mac286 memory board. Most people will probably use the 5.25in IBM compatible drive which is available from Apple, although the manual states that the Mac286 also is compatible with



IBM's 4865 external 3.5in unit. The manual also gives the pin-outs for the 37-way connector so you should be able to add any disk drive you like.

Having installed the cards, put the lid back on and switch on the Mac.

## Software

Software installation comes in two parts: first you have to install the Mac software and then the IBM software. In the case of the Mac software, simply copy the Mac286 program from the distribution disk on to your hard disk.

Installing DOS is slightly more complicated. As well as being supplied with a program which runs at the Macintosh end, the Mac286 system has a copy of MS-DOS version 3.2 along with the usual range of DOS utilities.

One feature of the Mac286 system is that it can use part of the Mac's hard disk to store DOS files on, which is done by setting up a very large data file that the Mac treats just like any other file, but which DOS thinks is its very own hard disk. Before it can be used by DOS, you must run Fdisk and Format just like you would on a real PC hard disk!

At this point, give some thought to how large you want your DOS hard disk to be. Obviously, the more space you give to DOS, the less is available to your other Macintosh applications. The Mac286 system has some other tricks up its sleeve which mean that the size of the DOS hard disk doesn't need to be as large as you may think.

The DOS disk size is set up within the Fdisk utility where it is entered as the partition size. The only problem here is that Fdisk expects the size to be set in disk sectors rather than megabytes. Luckily, the Mac286 manual contains a handy little table which lets you convert from one to the other.

Once you have run Fdisk, you can then format the DOS file using the '/s' extension to copy over the DOS boot files. You can then copy over the utilities from floppy to the hard disk. Thereafter, every time you start the Mac286 system, DOS will always boot from the DOS hard disk.

## In use

Starting up the Mac286 system is achieved in time-honoured fashion by double clicking the Mac286 program, Ikon. Once the program has loaded, you are presented with a fairly standard-looking Macintosh display. Most of the screen is taken up with a display window used to emulate the monitor of a normal PC. Along the top of the screen, the standard Macintosh pull-down menu bar

contains two extra commands, 'Fkeys' and 'Misc', in addition to the usual 'Apple', 'File' and 'Edit'.

When the system first starts up, the screen display looks like a normal PC. It begins by displaying the Phoenix Technologies ROM BIOS copyright notice. It then goes through its RAM self-check and comes back saying that it has 640k of RAM and 0k of expanded memory. Note that even though the board is supplied with 1Mbyte of RAM, it doesn't support expanded memory, so the extra RAM is unusable.

After going through the hardware test, the system follows usual PC practice by trying to boot DOS from the floppy drive. If no disk is present in the drive then DOS goes on to boot DOS from the fake hard disk. Once DOS has loaded you are faced with the usual date and time prompts. These default to the date and time set inside the Macintosh and will therefore be right usually.

Finally, you are confronted with the good old C> prompt!

## IBM compatibility

In general, the Mac286 is very compatible with PC software. It uses the Phoenix BIOS which has a good reputation in the more general IBM clone market. I ran a wide range of PC software on the system, and most of it worked. The major exceptions were programs which use weird and wonderful copy protection systems. Luckily, this kind of thing is becoming less common.

In terms of outright speed, the Mac286 isn't anything to write home about. Its 80286 processor chugs along at a steady 8MHz as compared with the 12MHz of most modern AT clones. However, this is still a great deal faster than other PC emulators for the Mac which do all their emulation in software.

But, just because the software runs happily, you still aren't guaranteed a smooth ride when you try to achieve some useful results.

## Mac compatibility

Obviously, the main constraint of the Mac286 system in Macintosh terms is that it will only run on the Mac II. The other constraint that I found was that it tended to be unreliable when used with Macintosh MultiFinder.

This is a shame because one of the obvious uses of the Mac286 is to have other Mac applications loaded at the same time and then to switch between Mac and IBM applications at will. According to the manual, the Mac286 is compatible with the MultiFinder so long as you have more than 1Mbyte of RAM fitted. My machine is fitted with 5Mbytes which should be more than enough.

The other drawback of using the Mac286 with the MultiFinder is that support for Microsoft Mouse emulation (see later) is disabled — this is very irritating.

## Hardware compatibility

The most obvious hardware restriction faced by the Mac286 system is that it isn't compatible with IBM expansion cards. This isn't surprising considering that the Mac II uses a totally different expansion system. I also don't think that it is very important. Most Mac users who buy this system wouldn't be interested in PC add-on cards anyway.

It is more important that the Mac286 system doesn't support any form of extended or expanded memory. This means that the system is limited to just 640k of RAM. With the advent of memory-intensive applications for IBM hardware as well as the OS/2 operating system, for example, this lack of memory could become a problem.

Other areas of hardware compatibility are variable, to say the least. One of the areas where problems could arise is the keyboard. The standard Mac keyboard wasn't designed to be IBM compatible and some keys are missing and/or in the wrong place. The best solution to this problem is to buy the optional extended keyboard available from Apple. This is a copy of the IBM ATX keyboard and therefore has a better layout.

If you don't want to spend any more money, the Mac286 will work happily with the standard keyboard, but the user will have to do some mental juggling to remember which key does what. The biggest problem with the standard Mac keyboard is that it doesn't have any function keys. Since 95% of PC applications use function keys, this could be a problem. AST has thought of this and the 'FKeys' pull-down menu allows you to select any function key combination.

As far as mice are concerned, AST has allowed for emulation of the popular Microsoft Mouse. This means that you can use your standard Mac mouse to control PC applications which support the Microsoft Mouse software protocols. You can't use the same mouse to control both the Mac and the PC program at the same time, but it is possible to toggle easily between Mac control and PC control by holding down the Command key on the keyboard.

In the case of modems and the like, life is relatively straightforward because the Mac comes with two high-speed serial ports which can be made to pretend to be RS232 serial ports. The 'Configuration Options' command from the 'Misc' pull-down

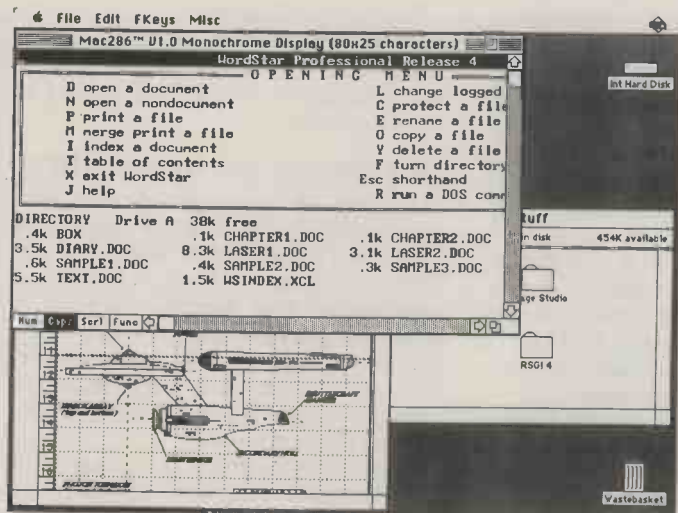

The Mac286 display window is extremely slow. Although it is claimed to be compatible with Apple's new MultiFinder operating system, there are a number of problems

menu allows you to map the DOS serial devices COM1 and COM2 on to the modem or printer port of the Macintosh. The case of printers is less straightforward because the Macintosh does not have a parallel printer port and generally handles its printing very differently from a PC.

To get around this, all PC printout which thinks it is going to the DOS printer port is sent to a sophisticated print spooler which can pretend to be either an Epson MX-80 dot matrix printer or a PostScript laser printer. The latter option is only usable if you have a LaserWriter to print out on.

The spooler can be set to start printing after 30 seconds or to wait for you to tell it to print. All spooled output is held in a disk file called MS-DOS Print which can be printed either from within the Mac286 application or from the Macintosh Finder in the normal way.

When I tried out the printing capabilities of the Mac286, I achieved decidedly mixed results. Simple text printing using the Epson emulation seemed to work well once I had installed the correct driver into the PC software, but more complicated PostScript output didn't work at all.

### Display compatibility

The Mac286 system supports three different PC display standards — MDA, Hercules and CGA. Considering the graphics capabilities of the Mac II you wouldn't have thought this was stretching it very much, but you'd be wrong. All modes will work with either a monochrome or colour screen, although to get the full low-res blast from CGA displays you need a colour monitor.

My most enduring memory of the Mac286 display system, irrespective of which display mode I was in, is how mind-bogglingly slow everything is. You almost feel like going for a jog around the block in between screen updates. This can't be

the Mac II — a full 32-bit processor complete with maths chip which can work out the meaning of life in a few seconds shouldn't have too much trouble with a monochrome PC display. It can't be the speed at which the PC cards and the Mac talk to each other. NuBus can work at up to 24Mbits per second — fast enough, one would think, to transmit a 640x200 pixel image.

So, it could be poor programming on the part of AST or hidden nasties involved in emulating PC displays. It is interesting to note that PC emulation systems which do all their emulation in software and use no extra hardware at all have much smoother displays.

### File system

While the display system used by the Mac286 is very bad, its file system is very good. As I discussed earlier, users have a number of different options open to them when it comes to storing files. The first is to use the external 5.25in floppy disk drive. Apart from being essential for loading DOS on to the system in the first place, the external floppy is also the most likely means of exchanging information between different machines.

For mass storage at the Macintosh end, the emulated DOS hard disk may be a good idea. However, there is a third option — the D: Drive.

The D: drive allows you to store DOS applications and data files in standard Macintosh folders alongside standard Macintosh files. This is both clever and useful because it makes it much easier to move data files between the Macintosh and PC environments. PC files are given their own Macintosh ikons and appear under the Finder in the normal way. Likewise, eligible Macintosh files and folders appear in the DOS window when you type 'DIR D:'.

However, all is not sweetness and

light, though it's not the fault of AST. The first problem comes with file-naming conventions. The Mac lets you call a file virtually anything you want so long as the name doesn't contain a colon. DOS, on the other hand, isn't quite as free and easy, so if you want a Mac file to be accessible by DOS, you have to be careful what you call it.

The main problem is not getting a file into or out of the Mac, but actually understanding what is inside it. The Mac has its own group of file formats such as MacWrite, MacPaint, PICT, TIFF, and so on, which are understood by most other Mac programs. PC programs don't talk the lingo. The same goes for the PC — try reading a WordStar file into MacWrite and see how far you get!

### Documentation

The Mac286 system was supplied with three manuals — the *Mac286 User's Manual*, the *MS-DOS Reference Manual* and the *GW-Basic Reference Manual*. The last two turn up with virtually every PC on earth, so I won't comment.

The *User's Manual* was generally helpful and fairly easy to follow. It only led me astray once when it failed to accurately describe the workings of the print spooler.

### Conclusion

It is definitely useful to be able to transfer data between IBMs and Macs, but I have yet to be convinced that there is much point in actually running IBM programs on Macs. For the most part PC programs are scrawny, half-baked little things and there doesn't seem much point in running them when there are better alternatives available for the Mac in its native mode.

My opinion of the Mac286 system has to be that it'll be nice when it's finished. Some aspects of the software are pleasing and the file-handling is very good. However, the whole lot is rendered totally academic by the extreme slowness of the display system.

Interestingly, AST itself seems to be feeling guilty about the shortcomings of the product (priced at £1150 excluding VAT). Included with the documentation is a leaflet advertising the improvements which will be made in the yet-to-be-released version 1.1 of the package. It is no surprise to find improved screen-handling at the top of the list.

I'll leave the last word on the subject to Guy Kewney, who happened to be wandering past when I was reviewing the system. 'It just goes to show,' he opined, 'you shouldn't buy version 1.0 of anything.'

AST is on (01) 568 4350.

END





**25,000** Zortech C users, can't be wrong!

Everybody's talking about the fantastic C explosion! The magazines are starting regular C columns. Most professional software packages are now written in C. The Universities are adopting C as the language of choice.

Doesn't it make sense to start learning C right now?

Zortech C at only £29.95 leads the way with its powerful features. The 352 page manual takes you step by step into your very first C program. You can work through the twelve introductory lessons. Go on to create your own libraries and automate the compiling process using the MAKE facility.

The sophisticated editor allows you to edit and compile up to five files at once for those advanced projects! Then you can save yourself weeks by taking advantage of our professional add-on libraries.



**Z**ortech brings you a brilliant range of add-on C libraries at only £29.95 each! These allow you to get virtually any project off to a flying start!

Zortech add-ons include **FULL SOURCE CODE** and can be applied for use with other compilers like Turbo C at a small additional cost!



**ZORTECH DATABASE** package. Includes over 70 database functions. An example indexed Name & Address application showing just how easy it is! 70 page manual!



**ZORTECH WINDOWS** gives your program that professional look — just like FrameWork and "123"! Fast Exploding and Zooming windows and menus with automatic saving and buffering in memory. Complete with great demo progs and 50 page manual!



**ZORTECH OPTIMIZER** will fine-tune your progs during compilation by running a **THIRD** pass to **OPTIMIZE** your code using state-of-the-art Global Optimizing techniques found only on mainframe C compilers! Now squeeze that last ounce of speed out of your code!



**GRAPHICS TOOLKIT** complete with over 30 different GEM drivers for screens and printers! Comes with a big 80 page manual and six discs!

**GAMES TOOLKIT** gives secrets of how to program three games in C — Chess, Backgammon and Wari with big 150 page manual.



**COMMS TOOLKIT** Must be the most comprehensive serial comms library available at any price! Supports up to 8 serial ports, terminal emulation, Kermit, Xmodem, Hayes.

**PROSCREEN!** Draw your screen, define the input fields, press a few buttons and **PROSCREEN** automatically generates the source code for you! Link into **BTREE** and **WINDOWS!**

**HOTKEY!** Now you can easily write Terminate Stay Resident programs that pop-up into any application just like "Sidekick"!

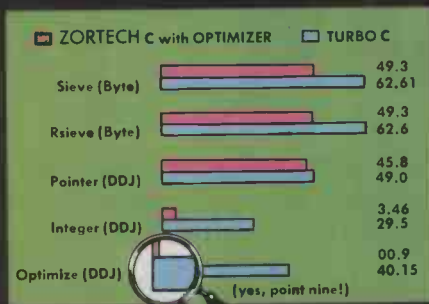

**S**peed benchmarks show that programs compiled with Zortech C execute much faster than those compiled with Turbo C! Just to prove the point, we are giving away a **FREE Zortech C Optimizer** worth £29.95 with every Zortech 'Power-Pack' at only **£59.95!**

Also, purchasers of our basic compiler at £29.95 will receive a **FREE Linker** and **Librarian** software worth **£19.95!**

We really want you to know how good Zortech C is — so don't hesitate — pick up the phone and order now!

Zortech C "Power-Pack" measures up to its giants in every way — A complete K&B specification C compiler with all the UNIX extensions and ANSI enhancements! Supports and emulates 8087/80287 math co-processor, assembly language interface, Compact, Small, Dos & Large models, includes **FULL SOURCE CODE** to the library, over 300 functions! Including trigs, fast screen access, disk sector read/write, dos/bios calls, interrupts, etc. 64 bit precision. MS-DOS compatible linker and librarian are included! together with many UNIX programming utilities like MAKE and TOOLKIT. Powerrrrrrfull!!!

Remember, you get the **FULL SOURCE CODE!** What does this mean? It means you can see exactly how more than 300 commented library functions have been written. You can alter and experiment with the library to your heart's content.

*P.S. Most other companies don't even allow you to buy the source code! (If they do — it costs a fortune).*



**ZORTECH**

BOSON LONDON FRANKFURT GENEVA

**C** Magazine provides a forum for C programmers to learn new techniques and exchange ideas.

As a registered ZC user you will receive C Magazine — The C Programmers Journal absolutely **FREE** of charge

You can even win a £250 prize if you submit a suitable article.

The highly acclaimed Zortech Technical Hotline provides one of the highest levels of support in the industry. Absolutely **FREE!**

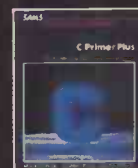

**Highly Recommended Books!**

**C Primer Plus** — £19.95. This 500 page book from USA is highly recommended for those new to C! It takes you through the basics in an easy to follow, easy to read, enjoyable style. It has many example programs that utilize sound, graphics and disk files. It has Self-Tests at the end of every chapter!

**Advanced C Primer** — £19.95 This 500 page book starts where most other books stop! It gets right down to the nitty-gritty of File I/O, PC Memory, BIOS & DOS calls, Graphics displays and integrating your Assembly Language routines into progs. Lots of questions and answers for self teaching!

Zortech have a wide selection of C books available for you. Simply request our C book catalogue.

**NEW! C VIDEO COURSE**

This video course represents absolutely amazing value for money! You get 10 one hour VHS tapes together with a beautifully produced 365 page workbook. Now learn C the easy way! All for **£129.95 + VAT.**

Yes, please send me the Zortech Information Pack!

Name .....

Address .....

..... BSG 4 88

**ZORTECH LIMITED**, 106-108 Powis St., London SE18 6LU

Tel: (01) 316 7777

Fax: (01) 316 4138



**CALL 01-854 1194 NOW!**



**ALL ORDERS SHIPPED WITHIN 24 HOURS**

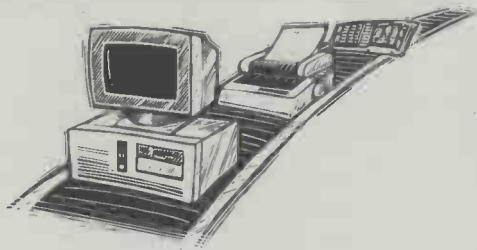

# SAM digitiser

The SAM digitiser from Silicon Solutions could break new ground for graphics formats at low cost. Barbara Gaskell judges its ability to save captured images in real time, among other features.

Until recently microcomputers have not had sufficient power or screen resolution to be able to manipulate photographic images. The advent of affordable high-resolution screens and powerful processors such as the 68000 and 80286 has changed this — increasingly, applications have the ability to incorporate graphics within them. But creating the images remains the main problem.

Although many excellent drawing packages exist, not everyone is a skilled artist, and creating pictures in this way is time-consuming. Computer users, therefore, are turning increasingly to scanners and digitisers to create pictures, especially in the desktop publishing arena.

The SAM (Silicon Animation Machine) digitiser from Silicon Solutions is capable of digitising any image fed to it in the form of a video signal and turning it into one of the popular Atari ST graphics formats. However, what sets SAM apart from other digitisers is its ability to capture images in real-time. This opens

up new areas of image manipulation.

The ability to take a standard video signal and transform it into the bit-map of a microcomputer takes some complex hardware and software. Doing the same in real time pushes

**'As a way of producing photographs for art or desktop packages, it's expensive when you add on the price of a video camera.'**

has traditionally cost in excess of £1000 and limited the 'user-friendliness' of the control program. SAM can grab a complete frame in 1/50th of a second — twice as fast as is required to stop the image from changing while the grab is taking place.

## Hardware

The SAM package consists of one very dull-looking, A5-size box that plugs into the cartridge port of the Atari ST. Atari's decision to give access to the DMA (Direct Memory Access) controller is what gives SAM its ability to grab a frame so quickly. SAM also draws its power from this port, which means that the only lead requiring connection is that of a video source which is situated at the rear of the box.

The video input socket is a single phono affair and will accept any composite signal such as a video camera, a video cassette recorder, a video disc player or a TV tuner. Once connected the unit can remain attached, as it should not interfere with other software which is being run (although certain copy-protected games might not run with anything plugged into the cartridge port).

## Software

The software supplied with SAM consists of one small GEM program



To give sufficient grey levels, SAM produces a digitised screen in the ghastly colours shown here



After turning down the colour control, the same screen looks like the one shown here



which handles the storage and playback of digitised sequences. Silicon Solutions had to play a 'swings and roundabouts' game when writing this software — every bit of memory used in the program reduces the number of digitised frames that can be held in memory at one time. Consequently, the whole system is controlled by a set of pull-down menus and alert boxes: dialogue boxes and standard GEM windows take too much memory.

SAM displays images in black and white, but requires a colour monitor to do it in order to generate the 16 grey levels needed to give the picture a lifelike appearance. The Atari normally offers only eight shades of grey, and Silicon Solutions offers very dull shades of green and red displayed to fill the gaps in the grey scale — an arrangement which seemed very dubious. However, the result brings very clear, slightly sepia images. If your monitor has a colour control or if you are using TV, SAM includes a number of palettes that can be used with the colour turned down to give an accurate image. The screenshots on these pages show the 16 unaesthetic colours chosen and the corresponding 16 grey-level effect.

SAM will digitise the incoming frames as they are received into a loop of 10 frames on a 520 ST, or 25 frames on a 1040 ST (Mega ST owners will be able to store correspondingly more). Each frame takes approximately 32k of RAM and loses very little quality when you consider that to replicate a still monochrome TV picture exactly requires 462k of RAM. No special compression techniques are used, so the memory is saved by the limited selection of colour and a 1in border around the frame.

Twenty-five frames amount to little more than a second of action, hardly

## How a digitiser works

Most digitisers, including the SAM, are fed with a composite video signal. Composite video is an analogue signal that consists of two combined signals: a synchronisation pulse and video information.

The digitiser's main task is to separate this signal into its two components parts by means of a 'sync separator'. The video signal contains colour and luminance (brightness) information; the digitiser filters the colour by means of a 'chromatrap', leaving just luminance. The sync is fed through standard TTL circuitry which digitises and separates out vertical and horizontal sync signals. This digitised horizontal sync is then used to control a 1-bit analogue-to-digital converter which converts the luminance signal into binary. The output from the ADC is stored in hi-speed RAM until the vertical sync is received, when the whole frame is transferred (usually by DMA) to the computer's video memory.

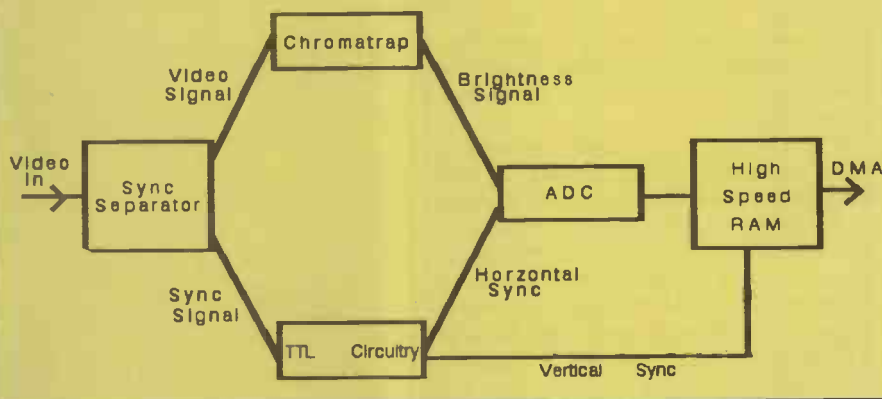

time enough to see that movement is actually taking place. Happily the software allows you to specify a gap before the next picture is grabbed. Setting this to  $\frac{1}{50}$ th of a second, for example, allows you to capture about five seconds of animation with relatively little loss of smoothness. Settings beyond this tend to result in the sort of time-lapse recording taken in many banks.

Some of the more interesting uses for SAM result from its animation and time-lapse facilities. For animation, the SAM software can be configured in such a way that it will store single-frame grabs in consecutive memory slots upon pressing the space bar. One particularly useful facility is its ability to superimpose the incoming video over the previous frame to ensure that just the right

amount of movement has taken place between one frame and the next.

Time-lapse photography involves shooting a frame every few seconds, minutes or hours. The SAM software allows you to set the system up with a gap ranging from a few seconds to a few years. Using the time-lapse mode it is possible to save the images on to hard disk, which in theory lets you record much longer films. In practice, it made me realise just how much computing power is needed to create even the most modest animations. Using the remaining 20Mbytes on my 40Mbyte hard disk drive provided a total running time of just under two minutes, and that takes one frame every  $\frac{1}{5}$ th of a second.

The software can play back any recorded sequence, and playback



The overlay facility allows the comparison of two images — very useful for animation



For users who have no colour control, SAM is capable of displaying a slightly lesser-quality image

speed can be adjusted from twice the fastest capture speed to one frame every 20 seconds. To reproduce an animation accurately, you should set the playback delay to the same as the recording delay. Four playback modes are available: forwards, backwards, bounce and keyboard-controlled. Forwards and backwards will repeatedly display a sequence. The bounce mode will play forwards from start to finish, and then backwards from finish to start, repeating this cycle until a key is pressed. Keyboard control simply means flipping through the animation frame by frame in either direction by using the cursor keys.

It is all too easy when reviewing SAM to become engrossed in the animation facilities and forget what is probably its most useful feature — the ability to save captured images in one of three standard ST graphics formats. The SAM software can save pictures in Neochrome, Degas and IFF formats which makes it capable of creating images for all the ST desktop publishing packages I know of. I was concerned, however, as to how DTP packages would cope with receiving an image made up of eight shades of grey and eight dull colours, and the example page from Fleet St Publisher (shown alongside) together with a photographic image instead of the usual drawing, shows just how good SAM's images are. The best results when digitising from a photograph are obtained by the use of a high-res black and white video camera without any of the features found on the more sophisticated Camcorder set-ups. Such a recorder can be bought for approximately £250 and will accept standard 35mm camera lenses. If all you want to do is digitise photographs, then a handheld scanner would be much better value for money.

## Documentation

The documentation supplied with SAM consists of nothing more than a 16-page leaflet. Fortunately, the software is easy to get to grips with and you should be conversant with all its features within half an hour. A more detailed explanation of compatible video equipment would have been welcome.

## Price

SAM costs £249.95 including VAT, which makes it approximately twice the price of straight static digitisers that typically take 15–20 seconds for a single scan.

## Conclusion

SAM's ability to digitise in real-time puts it in a class of its own. I do not know of any other product that can

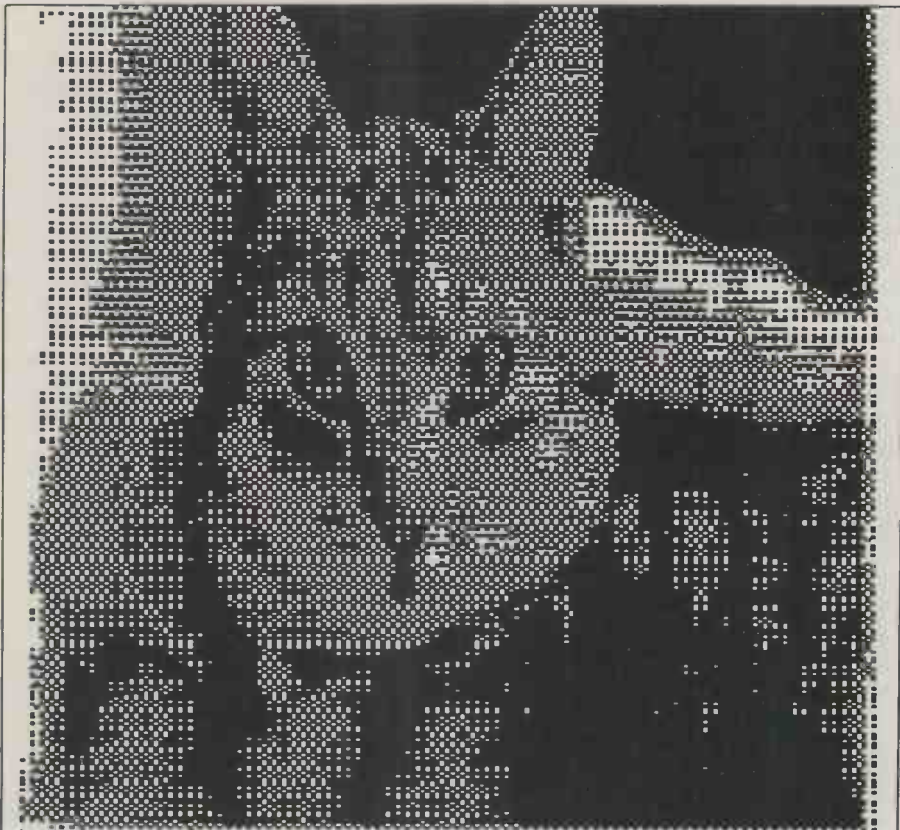

imprisoned for years, had it not been for the fact that everyone in the courtroom appeared to be a member of his family.

**Bill Beret Returns After Fraud Scandal**

By Otto Blunt

Legendary pop star and self-ordained Buddhist monk Bill Beret returned to Britain yesterday from a long vacation that took him all over the world. But the holiday also

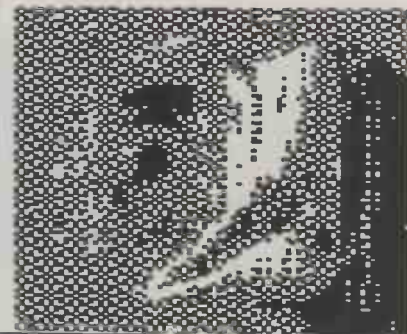

do the same for less than £800. But just how useful is it?

As a way of producing photographs for art or desktop packages, it's expensive when you add on the price of a video camera. There may be some serious applications for its animation qualities, especially when using features such as the frame-

## Twenty Years Without a Bite!

By our Angling Writer

Fisherman Bob Jordan, 60, celebrates the twentieth anniversary of his last catch this week. It was twenty years ago that Bob last netted a fish at his local river, the River Parched. To celebrate the occasion, Bob has invited a host of local fishermen to the spacious Town Hall in Dedchester.

When asked about the absence of fish, he replied "Well, it's a mystery to me! Every week I would go to exactly the same spot under a lonely tree on the bank and every week, after a long day's wait, I would trudge back home empty-handed and open a tin of beans."

comparison ability. Doing so will involve a lot of effort, and no programming information is supplied with the unit, so do check first of all that the same results cannot be achieved with existing video equipment and without the use of a computer.



**Multiscan  
Colour Monitor  
Price £299.00  
ex. VAT**



## Hi-spec monitor – Low-spec price

Since 1975, Viglen have been building up a unique position in the computer supply market. The company offer a wide range of products offered at unbeatable prices matched by sales and technical support second to none. A typical example is this colour multi-scan monitor.

### Monitor Specification

Model • ME-503 Made in Japan by Fujitsu.  
Screen • 14", .31mm Dot Pitch, High Res, Non Glare.  
Input • RGBI, RGB rgb, RGB analog, TTL and Analog.  
Colours • RGBI 16 Colours, RGB rgb 64 Colours, RGB analog all Colours.  
Scanning Frequencies • Horizontal 15–17kHz, 21–25z, 29–34kHz (exclude MDA/Hercules).  
Vertical 55–63Hz.

### EGA Card Specification

Short Card with a printer port and light pen port.  
Fully EGA, CGA, MDA and Hercules Compatible.  
Supports 132 Column on Multiscan/Multisync Monitors.  
256K video memory.  
Supports the following resolutions: 720 × 348 Hercules, 320 × 200 or 640 × 200 CGA, 640 × 350 EGA, 640 × 490 PGA quality, and many more.

### How to order

Simply write off today to Viglen and add £8.00 for carriage, packing and insurance allowing 7 days for delivery. Don't forget to add 15% VAT to above prices. Credit card holders can order by telephone. Orders for Educational Establishments, Government Departments and plc Companies welcome at preferred rates.

- Colour Multiscan Monitor and EGA Card (Up to 640×480 Resolution)

**£399.00 ex. VAT**

- Colour Multiscan Monitor on its own

**£299.00 ex. VAT**

- Compatible with IBM PC/XT/AT and 100% Compatible in CGA/EGA/PGA modes.
- Also compatible with VGA (All modes except 70Hz).
- Swivel Base included.
- Maximum dots 800×560.
- Green Switch.
- Now VGA card also available

### Generous dealer & Educational Discount

Prices correct at time of going to press and subject to availability.

All trade marks acknowledged.

# Viglen

## The Perfect Partners

Viglen Computer Supplies Limited  
Unit 7, Trumpers Way, Hanwell, London W7 2QA  
Sales Hotline 01 843 9903

# Channel link

**The method of power sharing provided by IBM's Micro Channel Architecture is not limited to OS/2 systems: many PCs can benefit from this CPU bypass operation. Pat Moran explains how.**

In April 1987, IBM announced a new series of personal computers — the PS/2 range. At the heart of this range was a new hardware architecture, the Micro Channel (MCA), which linked the central processor, memory and peripherals of the PC in an intelligent rather than in a passive manner.

At the same time, IBM and Microsoft jointly announced a new multitasking operating system, OS/2. Immediately, speculation arose that OS/2 would only run on machines which were based around the MCA. IBM did little to dispel this myth, although Microsoft has continued to claim, and manufacturers other than IBM have demonstrated that OS/2 will run on most existing 80286 and 80386-based PCs without the MCA.

Nonetheless, the Micro Channel is more than a new bus slot design for add-in cards and a pretty set of tracks on the motherboard. It is in fact a powerful, intelligent method of sharing processing control between devices on the PC's bus. This power sharing can be used to improve the performance of multitasking operating systems such as OS/2 or Unix by bypassing the bottleneck of the CPU.

## What is the Micro Channel?

The Micro Channel is a combination of several buses (address bus, data bus, transfer control bus, arbitration bus) and multiple support signals. The channel architecture uses asynchronous protocols for control and data transfer and provides several new features. These include:

- level-sensitive interrupts;
- arbitration between devices with different priorities;
- multiple masters; and a
- programmable option select.

The programmable option select (POS) was introduced to simplify the installation of adaptor cards in a PS/2 by eliminating switches and enabling card clashes to be detected automatically and resolved where possible. When clashes cannot be resolved, one of the adaptor cards is automatically disabled to enable the system to continue to function.

Although the POS is directly of in-

terest to the end user, the other new features are of much greater interest to system designers and programmers who are considering how to exploit the new systems.

This article, therefore, concentrates on the aspects of the Micro Channel Architecture (MCA) which need to be understood in order to exploit its versatility, reliability and performance

**'The design of the Micro Channel enables the PS/2 systems to be inherently more reliable than the previous PCs or ATs, even in complex environments with a multitasking operating system such as OS/2. The support for multiple masters lays the groundwork for providing powerful systems ...'**

features. The MCA incorporates many features aimed at improving the reliability of the system, and at least detecting — if not automatically recovering from — transient or non-transient error conditions.

## Multi Device Arbitration Interface

The Multi Device Arbitration Interface has been designed to support both Direct Memory Access (DMA) features and multiple masters, and to prioritise their access to the channel while providing burst capability with fairness and pre-emption features.

The aim of a DMA controller is to reduce the cost to the system processor of handling a peripheral. Without a DMA controller, the central processor has to be interrupted each time a

byte is to be transferred to or from a device. Such an interrupt can be expensive since the processor has to save the registers and its state before servicing the device, and then it has to restore its state so that its interrupted activity can be resumed. The device is serviced either by reading data from the device and storing it in a buffer, or obtaining it from a buffer and sending it to the device. Consequently, the processor also has to maintain a count of the number of bytes transferred and update the buffer pointers as each byte is transferred.

A DMA controller can be regarded as a very limited processor whose only function is to oversee the transfer of a block of data either to or from a device. The main processor simply has to inform the DMA controller of the device to be handled, the number of bytes to be transferred and the location of the buffer in memory, and the DMA controller will relieve the main processor of the burden of transferring individual bytes between the device and the buffer. The processor is only directly involved when the entire transfer has been completed.

Both the PC bus and the AT bus support DMA controllers, but the MCA provides support for more controllers and gives much greater flexibility in using them. The DMA controllers on the MCA bus are effectively masters and are assigned unique priority levels.

Although the MCA supports multiple masters or devices, only one device can use the interface at any one time. The Central Arbitration Control Point (CACP) is the logic on the main processor board which controls access to the interface. The main system processor is the lowest priority device, and is the normal or default user of the interface. The other devices have a higher priority and can temporarily take over the interface.

Whenever one or more of these other devices requires access to the interface, it is the function of the CACP to initiate the arbitration sequence which is used to determine which device is to obtain access to the interface. The interface comprises seven signal lines on the channel.



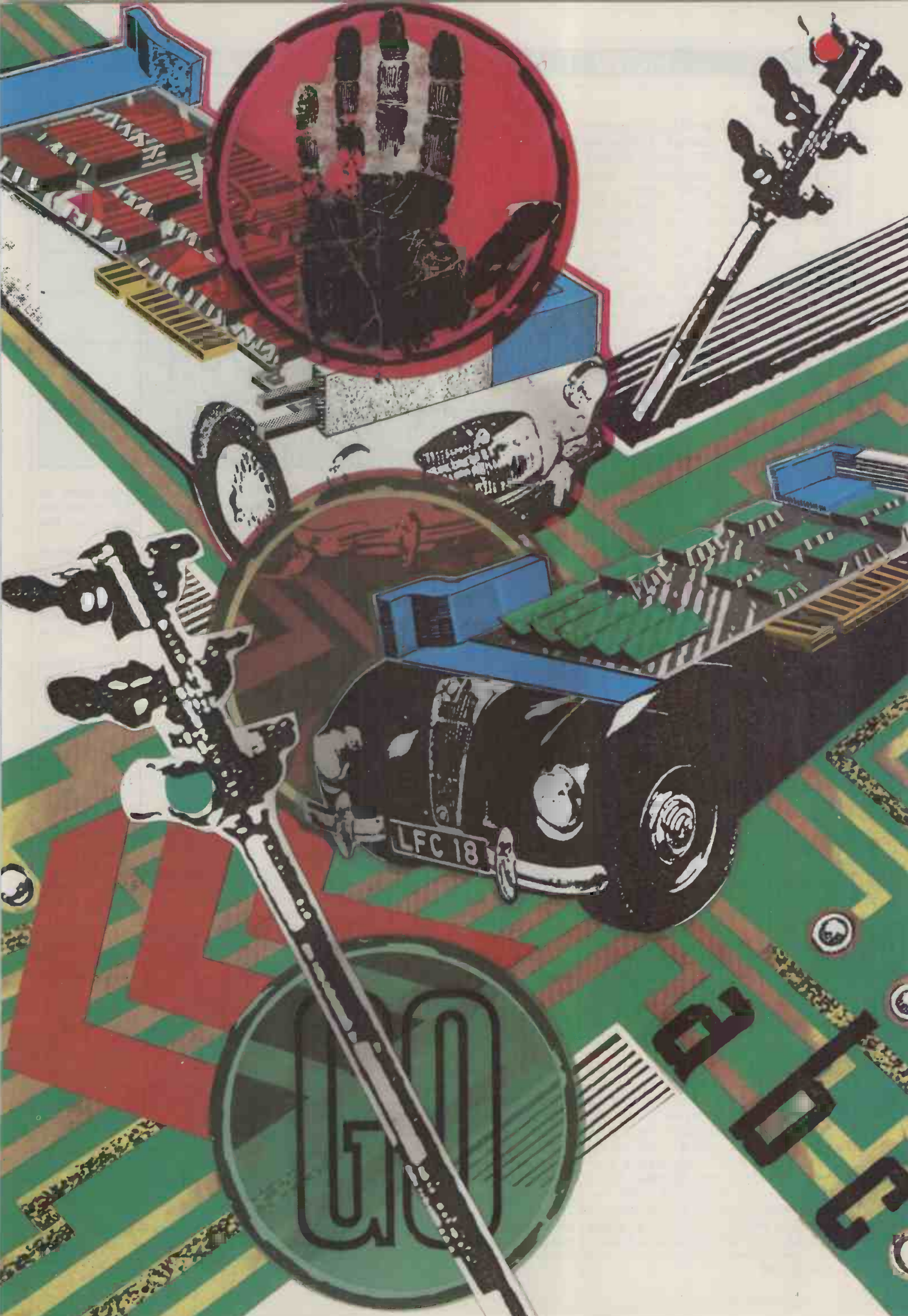

50



## +ARB/-GNT

This is the arbitration/grant output signal from the Central Arbitration Control Point (CACP) which notifies the devices if the interface has been granted to the highest priority device, or if the devices are to bid for use of the interface since an arbitration cycle is being initiated. Normally, this signal is in the grant state, and the bus is used by the highest priority device which bid at the last arbitration cycle. Whenever the CACP makes the signal active — that is, places it in the arbitrate state — data is not transferred over the interface but each device bids for the right to use the interface once the signal has reverted to the grant state.

## -ARBO-3

When the +ARB/-GNT line goes to the arbitrate state, each device that wants the channel places its assigned arbitration level on the arbitration bus (which consists of the four signals -ARB0, -ARB1, -ARB2, -ARB3) and then monitors the arbitration levels placed on the bus by other devices. The higher value (that is, lower priority) device removes the lowered order bits of its bid, so the highest priority device is left with its arbitration level on the bus. The CACP which raised the arbitration signal times out after 300 nanoseconds, and automatically returns the +ARB/-GNT signal to the grant state which informs the highest priority device left on the arbitration bus that it is the controller and that it can utilise the channel. The device normally only owns the channel for one transfer on the bus and, after that cycle completes, the ownership of the channel is returned to the default owner which is the system board processor.

## -PREEMPT

When a device requires access to the channel, it makes the -PREEMPT signal active and keeps it active until it has been granted control of the channel. When the CACP sees the -PREEMPT signal becoming active it initiates a new arbitrate/grant cycle, and the highest priority device requesting control will obtain it.

## -BURST

Some devices normally transfer data in bursts that are separated by long, quiescent periods: for example, a disk file is such a device. Typically, such devices incorporate a buffer which is used to hold a chunk of the data which is then transferred a byte at a time across the channel. Burst mode attempts to enable such devices to transfer entire blocks directly to storage without the need to stage the data in an internal device buffer.

## MCA burst mode

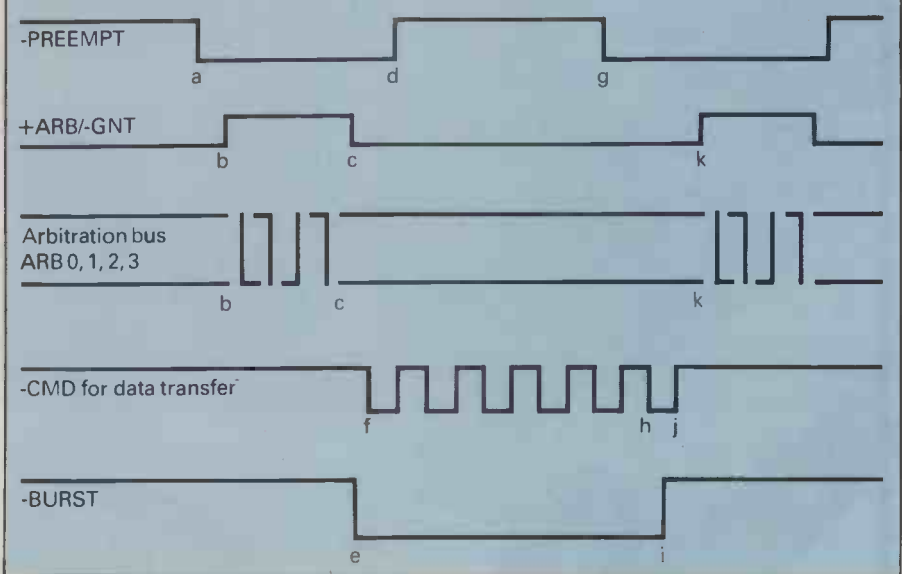

Such a mode also reduces the amount of time spent in arbitration mode since there is no need to enter arbitration for each transfer (byte or word) across the channel.

**'The benefits of using burst mode on the new Micro Channel are such that a disk, for example, can transfer data twice as fast across the channel as it could across the AT bus.'**

A device which wishes to operate in burst mode activates the burst line and holds it active until it completes the transfer of the block. The CACP will not produce arbitration cycles when another device requests the channel during burst mode. The burst mode device is responsible for monitoring the -PREEMPT line and, if it becomes active, it will terminate the transfer tidily and relinquish control of the channel by removing the burst line. The bursting device does not, however, participate in the arbitration cycle which will immediately follow.

The box on page 122 shows the timing relationship between the signals described above when burst mode occurs. The sequence of actions is as described below:

1) The -PREEMPT signal goes active to indicate a device is requesting control of the channel.

2) The +ARB/-GNT signal goes to the arbitrate state and the arbitration procedure starts to determine the highest priority.

3) After the timeout period which allows the arbitration bus to settle, the CACP changes the +ARB/-GNT signal to the grant state.

4) The device granted to the channel makes its -PREEMPT signal inactive to clear its request for control.

5) As a burst mode device, it then makes the -BURST line active to enable it to keep the channel for more than one transfer.

6) It then transfers data with each cycle of the -CMD signal.

7) If another device requires the channel, it makes the -PREEMPT line active. Since there is a burst transfer in progress, the CACP takes no immediate action.

8) The controlling device can do some more transfers to enable it to suspend its actions tidily.

9) The burst line is released after the leading edge of the last -CMD pulse in the transfer.

10) On the trailing edge of the last -CMD pulse, the CACP will action the outstanding -PREEMPT signal (as there is no longer a burst occurring).

11) The CACP makes the +ARB/-GNT signal go to the arbitrate state and the process begins again.

As described above, a high-priority bursting device would in fact only relinquish the channel for one cycle and then grab it back again. The simple algorithm above runs the risk of a high-priority high bandwidth device 'hogging' the channel. To prevent this, each device which implements burst mode must also implement the fairness algorithm which guarantees each device a share of the channel in a priority determined sequence. When a bursting device relinquishes



# HOW IT WORKS: MICRO CHANNEL

control, it is placed in the 'hogpen' (known more formally as the Inactive State Queue) and must wait until the common -PREEMPT line goes inactive before it competes for the channel again.

The common -PREEMPT line will only go inactive once all competing devices have had access to the channel. When -PREEMPT does go inactive, all the 'hogs' are released and will participate in the immediately following arbitration cycle.

Since a burst-mode device can utilise all of the available bandwidth if there are no other competing devices, the use of the burst mode can produce significant increases in the effective transfer rate of a device.

Each device on the channel must use a unique arbitration level or the above arbitration system would result in two devices, each thinking that it had control of the channel, and the uniqueness of the arbitration levels is checked during POST (Power On System Test). Each adaptor must allow its arbitration level to be program-selectable to any of the available arbitration levels (0-15). In practice, the configuration utilities will never select level 15 as this would clash with the system processor.

This requirement means that there can never be more than 15 devices active on the channel at any one time. The POST will disable some cards if more than 15 are active on the bus on power-up.

DMA ports 1,2,3,5,6,7 have a fixed matching arbitration level, but DMA ports 0 and 4 have a programmable arbitration level. The allocation of arbitration levels is shown in the box above.

As can be seen, memory refresh has the highest priority and is initiated from the CACP, and the system board processor has the lowest priority (excluding the hogpen). The reason that the processor is allocated the lowest priority is that it continually

## Allocation of arbitration levels

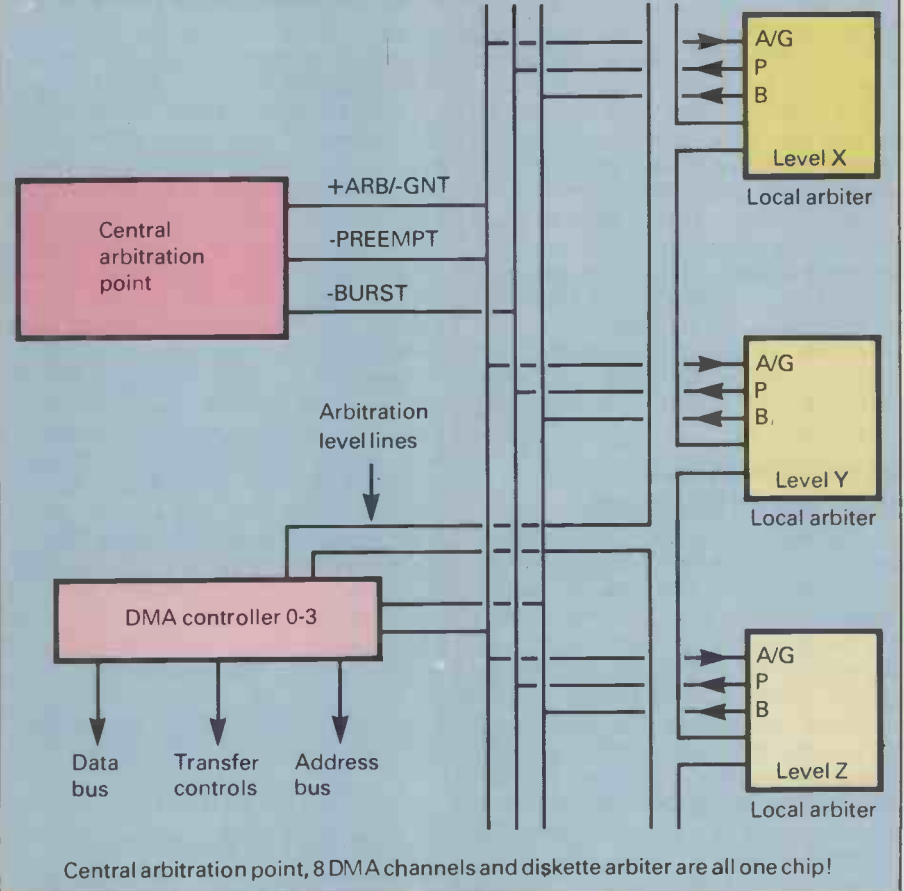

ly uses the channel to fetch instructions and the data manipulated by the instructions. Input/output devices only need sporadic access to the channel since their data rate is often very low (for example, a 9600-baud serial link only needs to transfer a byte over 1000 microseconds). Even adaptors which need to transfer data at a high rate do not do so continuously but in short bursts (for example, an Ethernet adaptor sends and receives data at more than 1Mbyte per second but may only process 50 packets every second).

Since the processor is the lowest priority device it can retain the chan-

nel once it has control without the overhead of arbitration requests, until one of the other devices signals that it needs to use the channel by activating the -PREEMPT signal. This means that an arbitration cycle is only required when a device other than the system board processor requires the channel.

The performance benefits of using burst mode on the new Micro Channel are such that a disk, for example, can transfer data twice as fast across the channel as it could across the AT bus.

## MCA reliability

In the description of the Multi Device Arbitration Interface, it was stated that the central arbitration control point will not initiate an arbitration cycle while a device is asserting the -BURST signal. If a burst-mode device were to gain control of the channel and then refuse to release control, memory refresh operations would be impeded which would cause soft memory errors.

To protect the system from such devices the CACP implements a timeout, which is started when -PREEMPT goes active and gives the bursting device 7.5 microseconds to release control. After the timeout period has passed, the CACP will place the +ARB/-GNT line in the arbitrate state and therefore remove

## Arbitration level assignments

Level	Primary Assignment
-2	Memory refresh
-1	Error recovery
0	DMA port 0 (but programmable to other arbitration levels)
1	DMA port 1
2	DMA port 2
3	DMA port 3
4	DMA port 4 (but programmable to other arbitration levels)
5	DMA port 5
6	DMA port 6
7	DMA port 7
8-14	Spare
15	System board processor
ISQ	Hogpen or Inactive State Queue

the grant from the bursting device. The memory refresh activity has the highest possible arbitration level and will set -PREEMPT every 15.6 microseconds to enable a refresh to occur.

Any memory card or device which detects an error that threatens the correct continued operation of the system must drive the channel check (-CHCK) signal active, and it must remain low until the -CHCK interrupt handler resets it. In addition, the card must set the channel check bit in the cards option select address space. This bit is interrogated by the -CHCK handler for each card position until all reporting cards have been identified.

## Level sensitive sharing interrupts

All the Micro Channel system board features and channel attached devices employ the same level-sensitive mechanism for interrupting the processor. Each card must also implement an interrupt pending indicator which is reset by the normal servicing of the device. Each card must hold the level sensitive interrupt active until it is reset as a direct result of servicing the interrupt. The advantages of the new structure are as follows.

Phantom or lost interrupts should be less frequent and more easily identified as there is an interlock between the hardware and software that support the interrupt service. With the previous PC bus, interrupts were 'edge sensitive' which meant that it was the change from inactive to active state which caused the interrupt request into the processor. With a level sensitive interrupt, the interrupt request into the processor remains pending until the device makes the signal inactive in response to the normal servicing of the interrupt.

With edge sensitive interrupts an interrupt could be lost if it occurred while a previous interrupt was still being serviced, as the interrupt signal was already in the active state. The second interrupt could not cause the inactive-to-active transition and, therefore, the processor was not notified of the second interrupt. With level sensitive interrupts, each interrupt request will be notified to the processor.

The importance of this change to the reliability and flexibility of the system is underlined by the fact that IBM has built circuitry into the system board which prevents any attempt to re-program the interrupt controller to operate in edge sensitive mode.

Each interrupt level can be used by a mixture of sharing and non-sharing hardware. An interrupt handler which

is to be used in a shareable environment must follow certain rules to enable the system to operate. When the interrupt handler is set up, it must note the address of any existing handler for the interrupt level. When the interrupt handler is invoked to process an interrupt, it must check that the adaptor that it is handling has an outstanding interrupt request by accessing the interrupt pending bit on the adaptor. If the adaptor is in the process of interrupting, it is serviced normally and the interrupt controller is reset.

If any other card on the same level still requires service, then the interrupt request line will still be active and cause the chain of interrupt handlers to be re-entered. If the handler finds that the adaptor does not have an interrupt pending, then it passes control to the previously-existing interrupt handler. In this way, control is passed down the chain of interrupt handlers until all requesting devices are serviced.

## 'The channel architecture uses asynchronous protocols for control and data transfer and provides several new features.'

An interrupt level can in fact be shared between a device on the system board and a device attached to the channel service system board as long as the devices conform to the standard rules. It should be noted, however, although many devices can share an interrupt level, the time between the interrupt being raised and the appropriate interrupt handler processing the interrupt increases as the number of devices increases.

## Multiple masters

To understand the benefits which can be gained from the use of an additional master on the channel, we need to understand the actions of the system board processor and the DMA controller when transferring data to and from a device. It should be noted that each port of the DMA controller on the system board is in effect a master but one with very limited abilities.

We will consider what is involved in the case where some data is being transferred from one device on the channel to a second device on the channel — for example, when a file

is being copied from one disk to another.

In the case where the processor is directly handling each device we would have the situation where the processor would be interrupted for each incoming byte, and would then execute code to identify and process the interrupt as well as transfer the data from the device to the processor. It would then have a similar set of actions to write the data out to the destination device. Hence, each byte crosses the channel twice and there is a significant processor overhead servicing the devices (which will involve further memory accesses across the channel). Servicing each interrupt and organising the transfer to or from the device can cost at least 100 processor instructions to be executed for each byte transferred. This is shown on page 126.

The DMA controller can be used to transfer a block of data with a greatly reduced processor overhead. The processor would instruct the DMA controller to transfer a block of data from the input device but would not be involved in the transfer of each byte. The use of the DMA controller means that the byte would be transferred across the channel from the device to the DMA controller, and then again across the channel to the memory area specified by the processor. The same double transfer would occur when the data is being transferred to the output device. Therefore, the use of the DMA controller would cause each byte to transfer across the channel four times (but would still be more effective because of the greatly-reduced system processor overhead). This, too, is shown on page 126.

In the case where one of the devices is a master it can control the other device directly as a slave, and the master can process interrupts from the slave directly off the channel without involving the system processor. If, for example, the input device is the master, it can directly transfer each received byte to the output device with each byte being transferred across the channel only once, and the cost to the system board processor of setting up the master is probably less than the cost of setting up the two DMA operations. This is shown on page 126.

From the above example, it can be seen that the use of a master device can require only 25 per cent of the channel transfers that are needed by a DMA controller while requiring no additional processor overhead.

## Enter OS/2

The real power of multiple masters will only be really exploited when the master becomes capable of provid-



NOW AVAILABLE FROM  
DIXONS BUSINESS CENTRES,  
ALLDERS AND ALL GOOD DEALERS

# Superbase™

## PERSONAL

### RELATIONAL DATABASE SYSTEM

# THE DATABASE THAT'S AS EASY TO USE AS A VCR!

#### Superbase is easy to use

If you're new to databases, or find them difficult to use, Superbase is your perfect choice. Unrivalled ease of use, unsurpassed power—a combination that's never been achieved before! Click your mouse on the VCR style symbols to speed through your data. Pick out a single record in the blink of an eye. Complete complicated searches in an instant. Display your text and graphic files.

#### VCR style symbols



Review records with CURRENT, FIRST,

LAST, PREVIOUS, and NEXT. Scan automatically with FAST FORWARD and REWIND. Interrupt or terminate scanning with PAUSE or STOP.

#### Key Look-up



Call up a single record from a file instantly by clicking on this button.

#### Filter



Select and work with any category of records from your file. The Superbase

Filter can be applied to several applications in turn—say from updating a set of address records to printing labels for the next mailing to that group.

#### Superbase is relational

Link files together in a free and flexible way. Form new links between files whenever you choose. Split one database into several or create a new

database from information in several files. Save your Queries to use again.

#### Superbase is flexible

Change file definitions at any time—add or delete fields, change their names or types, with no need to re-enter data.

#### Unique visual database



Click the camera gadget and view text or picture files alongside their database records. Spectacular slide show option!

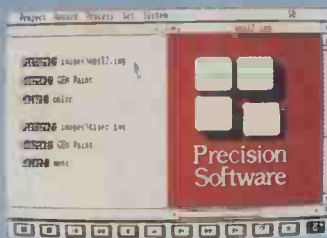

#### Specifications

Fields per record	No limit
Record length	No limit
Records per file	16 million
Files per database	No limit
Key fields per file	999
Files joined	84
Sort levels	170
Report break levels	34

"No limit" implies memory or system dependent.

For 100% IBM PC™ Compatibles (including Amstrad PC1512™), Atari ST™ and Commodore Amiga™ **£99.95**

PC version also available with GEM Desktop™ **£149.95**

PC version with GEM Desktop™ and mouse **£230.00**

(all prices include VAT)

PC versions require

- 512K RAM
- GEM software
- Graphics Card (CGA, EGA or Hercules™)
- Mouse (Microsoft® Bus or Serial, Summa Mouse™, Summa Sketch™)

Over 150,000 units sold worldwide! Precision Software has a track record of outstanding success in productivity software: with over 450,000 users of its productivity software packages worldwide. Precision promises and

delivers the best in reliability, performance and support. Precision Software acknowledges all trademarks referred to. Demonstration disks are available for £4.00 from Precision Software.



Precision Software Limited, 6 Park Terrace,  
Worcester Park, Surrey KT4 7JZ, United Kingdom.  
Tel (01) 330 7166, Fax (01) 330 2089,  
Telex 8955021 PRECIS G.



# HOW IT WORKS: MICRO CHANNEL

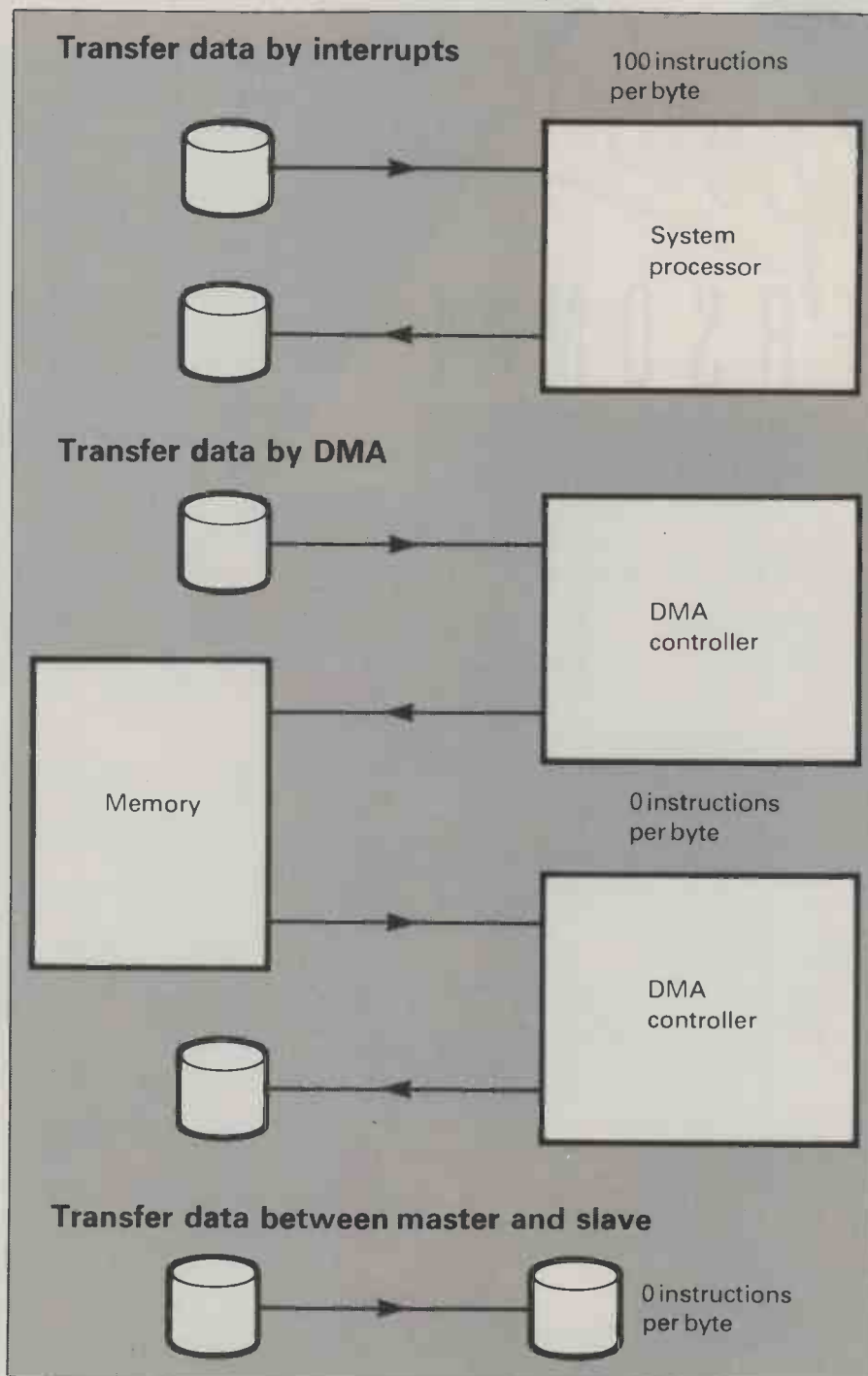

ing a significant amount of functions for each request from the system board (or, indeed, some other master).

One possible such master would be a complete file system with internal disk drive(s) and controller which would respond to OS/2 or DOS level file access requests. Such a master would carry out the directory searches and the maintenance activities (such as updating the FAT) with no channel accesses, and only the requested data being transferred across the channel. It would support multiple simultaneous transfer requests and use various techniques to optimise access to the integral disks. In the case of the example presented

here, the file copying could be achieved without any data being transferred across the MCA interface and with no interference to the operation of the system board processor.

Such intelligent masters cannot be fully exploited or cost-justified when PC-DOS is being used since DOS waits for each transfer to complete before continuing with the application. Under DOS, such masters would provide very little obvious performance benefit since the elapsed time to access the data is likely to be approximately the same and DOS is unable to utilise the processor savings. With OS/2, however, the situation is completely different. While

one application is held waiting for its data to be processed by the master device, OS/2 will be able to schedule other activities and so fully utilise the processor time which is made available by the use of the intelligent master.

We are accustomed to and familiar with changes which improve the performance of our PC-DOS systems, such as when we upgrade the clock speed from 4.77MHz to 8MHz, or change from an 8088 to 80286 processor, or move from a floppy disk to a hard disk. Such changes speed up each individual activity noticeably. With OS/2 and MCA, however, we will have to become accustomed to changes which increase the overall power of our systems but which will not necessarily make any single activity operate any faster. One of the main benefits of MCA is that it gives IBM and other suppliers a platform on which such total system improvements can be built.

It is possible that at some point in the future the database and comms manager services for IBM's OS/2 extended edition will be offered by separate masters which have been optimised to provide the required high-performance service with minimum impact on the main system processor.

## Conclusion

IBM has always stated that its reason for changing to MCA was to support fully and exploit a multitasking system such as OS/2. We have seen how MCA provides support for simultaneous transfers over the interface, and this is paralleled within OS/2 by the advanced BIOS also providing support for such concurrent activity. The availability of intelligent masters on the MCA interface further enhances the ability of the complete system to deliver a significant increase in total power when OS/2 is being used.

The design of the Micro Channel enables the PS/2 systems to be inherently more reliable than the previous PCs or ATs, even in complex environments with a multitasking operating system such as OS/2. The support for multiple masters lays the groundwork for providing powerful systems in which the major subsystems can be partitioned to operate in separate processors communicating over the Micro Channel. It is obvious that what IBM has currently announced is only the tip of a very large iceberg.

Pat Moran is Micro Support Manager at Edinburgh University Computing Service. His main interests are in communications and systems development software, and he has recently been burying himself in the OS/2 Software Developers' Kit. **END**



# THE PRICE CRASH OF '88

One of the computer industry's most important price barriers has been smashed by Opus Technology. Its new PC IV Turbo has become the first IBM XT-compatible computer to offer enhanced graphics and a hard disk drive for under £1,000.

The new 10 MHz machine features a breakthrough circuit board design with virtually all the circuitry, 8088 central processor chip and a 'microcard' no larger than a pocket calculator.

The PC IV Turbo's price of £995 includes a 14" high resolution EGA monitor and advanced graphics card, a 20 Megabyte hard disk drive, AT-style keyboard and mouse.

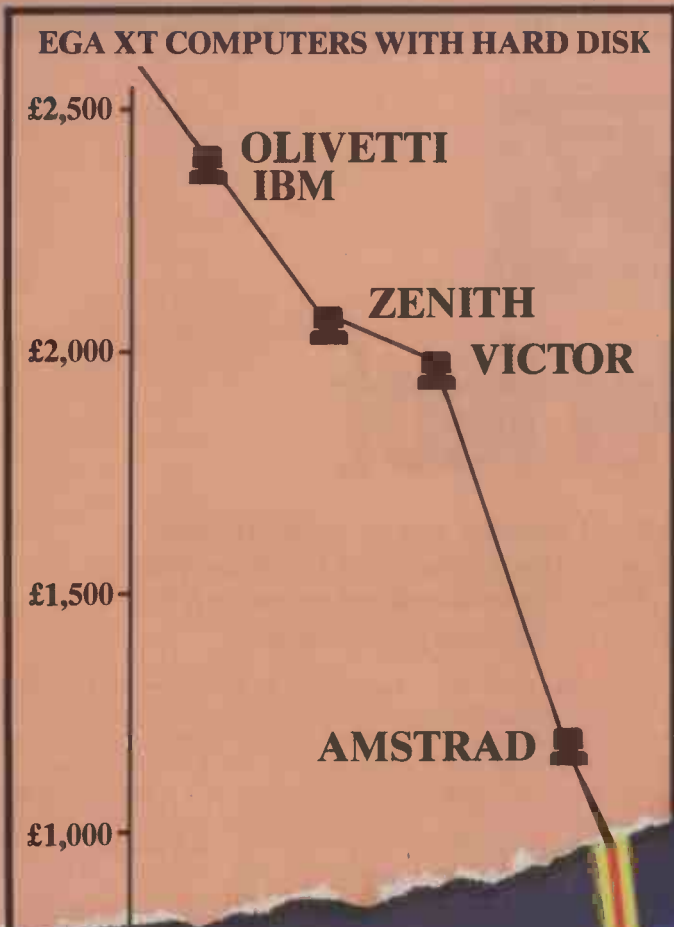

## Opus Technology.

### PC IV TURBO

- 8088 switchable microprocessor 4.77/10 MHz.
- Graphics chip supporting EGA, CGA, MDA (text) and Hercules monochrome graphics.
- 14" high resolution EGA monitor.
- 20 Megabyte hard disk drive.
- 360K floppy.
- AT-style keyboard.
- 768K motherboard memory expandable to 1Mb.
- Parallel and serial printer ports.
- Two free expansion slots.
- Mouse port.
- Light pen interface.
- Battery-backed clock/calendar.
- Super-small footprint case.



The PC IV Turbo from Opus Technology is a remarkable new personal computer at a remarkably new price – the first IBM-compatible to offer enhanced graphics and a hard disk for under \*£1,000.

Breaking the price barrier took a major breakthrough in design. Almost all of our computer's circuitry can be found on a

revolutionary new circuit board no bigger than a pocket calculator. It means greater reliability, easier maintenance and more features than you've ever seen in an XT-compatible computer costing only \*£995.

So before you invest in a personal computer call Opus Technology on (0737) 765080 and ask about the remarkable new PC IV Turbo.

**NOW OTHERS CAN ONLY FOLLOW..**

## Opus Technology

Opus Technology Ltd, 53 Ormside Way, Holmethorpe Industrial Estate, Redhill, Surrey RH1 2LW

Olivetti, IBM, Victor, Zenith and Amstrad are all registered trade marks. \* Price exclusive of VAT.

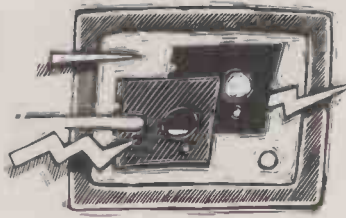

# DataPerfect

**WordPerfect's DataPerfect is claimed to be a single or multi-user relational database which provides all the power and facilities you might need. The truth, as Simon Jones discovered when he ran the program, was rather different — and very expensive.**

The WordPerfect Corporation (WP Corp) is most famous for the word processor which bears its name. This product is entering a new chapter in its life with the release of Version 5.0 for PCs. WP Corp programs have a similar user interface so that users of one package can easily learn the others. WP Corp software uses the function keys extensively, and the DataPerfect relational database is no exception. Happily, most of the major functions, such as print, cancel, exit, save, and so on, are on the same keys in all WP Corp programs.

The same company produces WordPerfect Library which contains a program called Note Book. This allows you to set up a simple card-file database: that is, one file displayed onscreen as either one record per screen or a list of records one per line (the latter option can only show a few fields). Note Book is ideal for storing details such as names and addresses, and I expected DataPerfect to build on this. It does in a way; you still have the two main display modes of full record and list of a few fields, but in DataPerfect both can be onscreen at the same time.

## Overview

DataPerfect is a relational database: that is, it has the facility to link different pieces of data together. These links are called relations because they can look like a family tree; for example, a father can have many sons and daughters but has, himself, only one father and one mother.

In exactly the same way, a school database would be based around pupils. There are many classes in the school. Each pupil will have many exam marks but will belong to only one class. In DataPerfect, information on the pupils, classes and exam marks would be held in separate panels. The links between them are

called doors, or doorways. (The difference between doors and doorways should become clear later.)

A 'panel' is a data entry area containing one or more pieces of data; for example, the pupil panel would have fields for surname, forename, date of birth, class, and so on. The class panel would similarly have fields for class number, teacher and classroom.

## Installation

The programs and some sample databases come on two 5¼in 360k floppy disks. The programs take the whole of one disk, the sample databases the other. For PS/2 or portable machines, the package also contains all the programs and sample data on one 3½in disk.

**'DataPerfect is an interesting product which will appeal to business people who know a bit about databases and want something they can put together themselves in a few afternoons.'**

Installing DataPerfect is very easy. All you have to do is copy the programs and sample databases from the floppy disks supplied onto your hard disk or working floppies. The manual gives precise instructions for novice users.

The UK version of the manual was not ready when I started the review but, luckily, I've been using WordPer-

fect 4.2 and WordPerfect Library for some time so I didn't have much difficulty getting DataPerfect to work. The manual did arrive eventually.

DataPerfect can be started from the command line by typing 'DP [RETURN]', or from within the WordPerfect 'shell'. The shell is a multitasking device in the WordPerfect Library, and allows WP Corp programs to be suspended while another one is used. It works very well and, just like the Apple Macintosh or Microsoft Windows, allows data to be copied between programs via a clipboard. All WP Corp programs use (CTRL) (F1) to switch to the shell. You can also set up macros so that pressing (ALT) (SHIFT) W will always take you to the word processor from wherever you happen to be.

Using any WP Corp program from the shell increases its usefulness, as the data in one program is easily incorporated into another.

A panel can be a maximum of 78 characters by 15 lines. It is a shame you can't use the whole screen, but the remaining lines are used for the automatic and user-defined help and for the lookup lists.

Any database in DataPerfect is defined in terms of panels, fields and indexes, and there may be many panels in each database. Each holds a part of the data; thus, a database for a school may have three panels. The main one would show the names and addresses of the students, and the other panels would show examination marks and details of classes. Note that each panel in a database takes three or four files. All files must be backed up to keep the data secure.

## Creating panels

When you are setting up your database, you first draw a panel. This simply involves typing the legends you want on the screen and then



# SCREENTEST

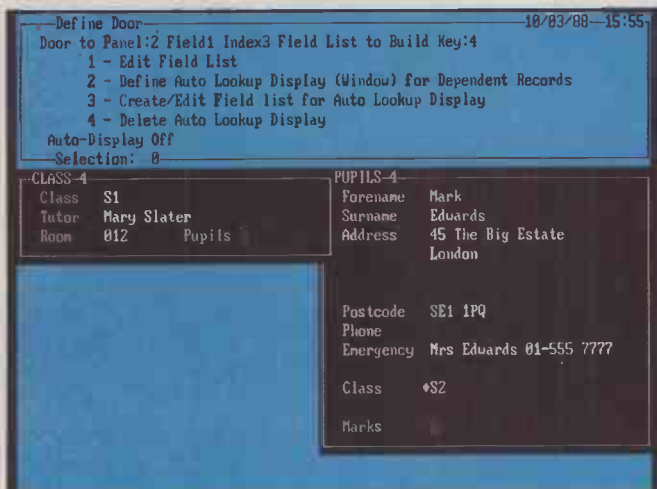

Panels can be used to show records from related files. The 'Door to Panel' formula determines which field from one file is to be used as a key to the next panel

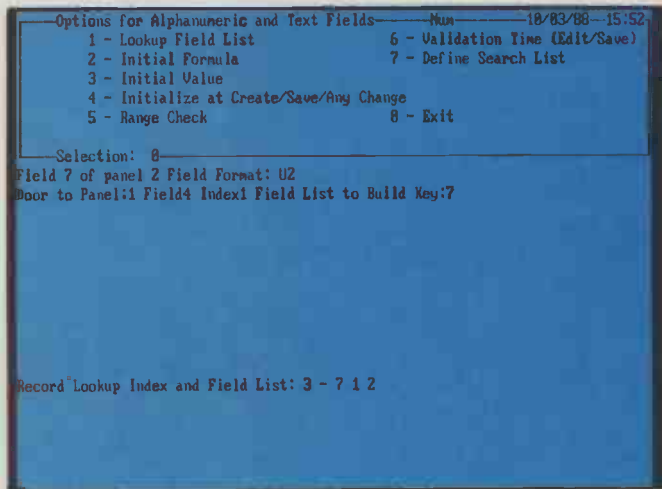

Look-up tables across the top of the screen are defined in terms of the fields displayed and their indexes. DataPerfect abounds with cryptic and numeric strings.

creating the fields. When you press the CREATE key (F9) the computer asks you to type in a field format which tells the computer whether to expect letters or numbers, and so on, and how long the field should be.

I found this to be one of DataPerfect's weak points. While it will cope quite happily with virtually unlimited-length text fields, it seems quite unable to cope with UK telephone numbers or National Insurance numbers. All telephone numbers in the US are of the form (123) 456-7890; and, having defined a telephone number field, the user would actually type only the digits, the brackets and dash being supplied automatically. This helps reduce mistakes in input as any stray letters would not be accepted. UK phone numbers, however, vary in format; for example, (01) 234 5678 or 01-234 5678 or 098-765 4321. This variety of lengths and formats cannot be coped with by DataPerfect unless you set the field to accept all characters. It cannot be restricted to just digits, spaces, brackets and dashes. Similarly, our UK National Insurance numbers are a mix of letters and numbers which DataPerfect is not capable of handling properly.

There are six categories of field format in DataPerfect:

**A** Alphanumeric fields can hold all characters. Follow the A with a number and you define a field that many characters long — for example, A25. If you give two numbers, the field will be as long as the first number and as deep as the second — for example, an address could be A30A4. This would show on the screen as four lines of 30 characters. You could actually type as many as 32,000 characters into a field defined like this, the text scrolling up in the 30x4 window. You can also use the letter 'U' instead of 'A'. U fields have

all lower-case characters converted to upper-case as you type.

**D** Date fields can show the date in any form you can think of — you are not restricted to the US format mm/dd/yy. You can have the British dd/mm/yy or German dd.mm.yy or even ISO yyyyymmdd. You choose the order of the parts and the separators. You can even choose to enter and show dates with just days and months and no year. If you do this, the program will helpfully decide that all those dates are in 1904. Beware that you cannot enter dates before 2 March 1900, so this package is not much good for genealogy. Date arithmetic is provided, though.

**T** Time fields can be shown or entered in hours, minutes and seconds, or any combination. They are always in the 24-hour system, although you can omit the leading zero for hours less than 10.

**G** The general number format holds right-aligned digits with decimal and thousand separators, minus signs or parentheses, or currency symbols. Thus, defining a field with the format G-£ZZZ,ZZ9.99 will show a value in pounds with a minus sign if it is negative, and a comma if it is over a thousand pounds. Both the pound sign and the minus will 'float' up to the numbers if not all of them are used. US and European currency symbols are catered for.

**N** This number format takes digits only and the manual suggests it can be used for things like phone numbers and social security numbers. These fields are fixed length and all the digits show. If your data doesn't use all of a field defined like this, each extra digit will display and print as a zero. The only type of data that would fit this kind of field is Prestel Mailbox numbers which are all nine digits long. Punctuation which is shown but not stored in the file, and

which cannot be changed by the user, may be put in N format fields.

DataPerfect fields can be designated as 'computation' fields. The values of these fields are not stored in the database but are calculated from the values in other fields. The formulas used for the calculation can be quite complex and involve mathematical '&' logical operators and IF...THEN...ELSE and CASE statements. There is also a limited range of functions which cater for date manipulation, stripping trailing blanks, finding the maximum and minimum of a list of numbers or character strings, and so on.

## Indexes

When you have defined your fields, you can set up the indexes (pupils' names, for example). Each panel must have at least one index. DataPerfect insists that all records to be indexed have a unique key (that is, each name must be different). You must think carefully about the data you are storing before defining your indexes. If you don't, you may find that, halfway through entering your data, DataPerfect will stop and tell you that it cannot save a record because the fields to be indexed are not unique.

The only way round this is to amend the record you are entering so that it is unique, or abandon it and change the index. If you happen to have two John Smiths in the school, than DataPerfect will stop and tell you it can't enter the second. You could get round this by adding the class into the index, but what if both John Smiths were in class 3B? Adding their date of birth into the index would probably work, but the index would become so complicated that it would slow the system down.

DataPerfect, however, allows you to define a field which is never dis-

# SCREENTEST

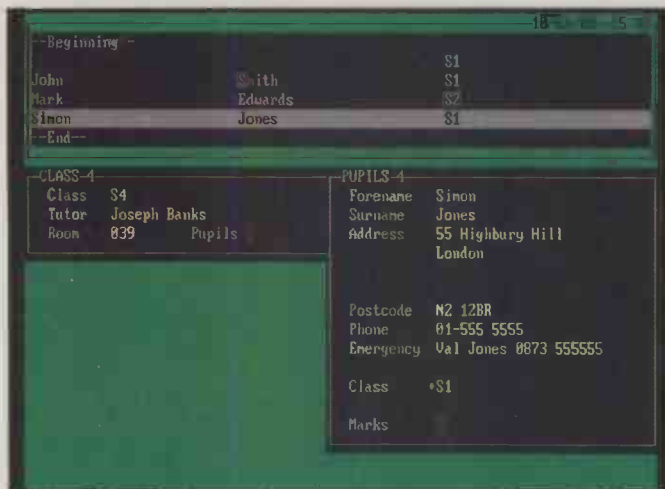

Records can be selected, as in the top box here, from a one-record-per-line display. The complete record is automatically displayed in the relevant panel below

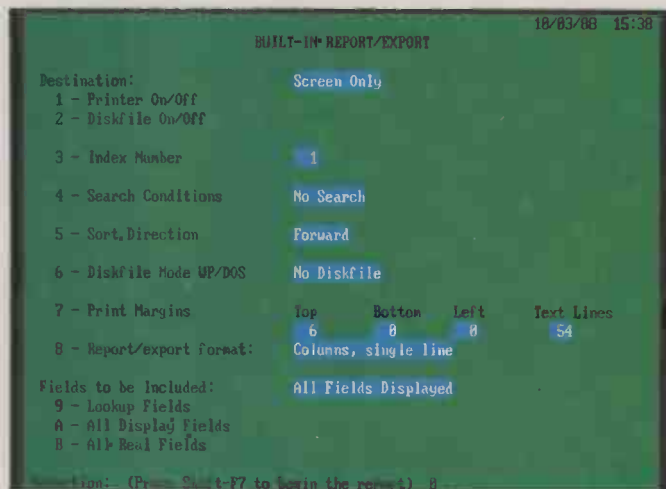

Reports parameters include numerous options all with defaults. Without meaningful field names, however, modifying an existing report can be a challenging task

played but is unique to each record. It is an auto-incrementing number, and you can add it to any index to overcome the difficulty of keeping indexes unique. Each record created has a different number, so John Smith on record 134 has a different index key to John Smith on record 597. You need never know what the number is.

Creating indexes is a simple operation. For each one, you point to the fields in the order they are to be considered and press the SELECT key (F4). You could, for instance, create three indexes for a school of pupils: (Surname & Forename), (Class, Surname & Forename) and (Forename & Surname). This would allow you to list the pupils alphabetically by surname, lumping them together or splitting them up into separate classes, and also to find the record of a pupil given only his/her first name.

For each field on a panel you can also define a lookup list. This tells the computer which fields you want to see listed, and in what order. Thus, placing the cursor on 'surname' and pressing the LOOKUP key (UP ARROW) will cause a list of the pupils' surnames to be displayed in the top third of the screen. A lookup list allows you to specify that you want the forenames and classes to be displayed at the same time. Just as with indexes, you merely have to point to the fields in question and press the SELECT key. In the example given above, the lookup list for surname would be (Surname, Forename & Class) indexed by (Surname & Forename). You can only use an index that has been previously defined.

## Doors and doorways

When all the fields, indexes and lookup lists have been defined, you can create the doorways through into

other panels. This allows you, for example, to find a student using one panel and then move through the doorway to a second panel to show and amend that student's marks.

Doors show up on the panel as little chequered blocks or diamonds next to existing fields. Creating them is a two-stage process. You first define where on the panel they are to appear and then, when all the panels have been defined, you create the links between panels. This is the hardest bit of the setting-up procedure, but there is a good amount of onscreen help should you need it and the manual is reasonably clear.

One option you can choose on creating a door or doorway is whether or not it should have a window (rather strange terminology). A window in a door allows you to see what is on the other side without having to move through the doorway. Thus, a database on personnel in a company might have a panel for staff details which has a doorway through to a panel of annual leave. There could then be a window from the first panel allowing you to see, but not amend, the annual leave data. To amend that information, you would have to put the cursor on the doorway and press the DOWN PANEL key (F5 or DOWN ARROW).

## In use

DataPerfect is quite straightforward once you have accustomed yourself to its general principles. Selecting the database and panel to use is simply a matter of choosing from a list of those available. Entering and editing data is easy, and the lookup lists are a good method of finding the record you want.

All you have to do is place the cursor in the field you want to search and press the UP ARROW key. The top area of the screen, which normal-

ly holds the help information, is replaced with a list of the records in the file showing the field you are in and some associated fields. You can use the up and down arrows to move through this list until the record you want is highlighted. Pressing RETURN will bring that record into the panel you are working on.

Moving through doors and doorways is quite intuitive. In the school database, once you have input details about a class (class identity, form teacher, room, and so on) you could move through the door into the pupils' panel and enter the details about the pupils in that class. The class field on the pupils' panel will be filled in automatically.

Moving from field to field in a panel is accomplished by pressing TAB, SHIFT UP ARROW, or '+' (on the numeric keypad) to go forward. To move back a field you can use SHIFT TAB, SHIFT DOWN ARROW or '-' (on the numeric keypad). You can use the RETURN key to step through the fields, but there is a snag. If you are in a text field, an alphanumeric field taking more than one line, RETURN will create new lines within that field. The only way out is to use one of the other alternatives. You cannot use the up or down arrow keys as they will perform lookup or down panel functions.

A bad point on the use of the keyboard is that sometimes you have to press a key twice to get it to do something. Occasionally, the first press stops what you were doing and the second starts the new function. This can be quite annoying, as you are never sure when it will take one press or two.

Response times are acceptable on a PC with a couple of hundred records in a simple file. If your database is going to be large or complex, you might find that you need either a



# COMMODORE'S NEW AMIGA SYSTEM 500.

WALK AWAY WITH  
THE ONE STOP OFFICE  
FOR JUST £599 PLUS VAT

**THERE'S NEVER BEEN A SMALL  
BUSINESS PACKAGE LIKE THIS!**

- **AMIGA 500 MULTITASKING COMPUTER.** 16/32-bit CPU, 4 custom chips, 512K RAM (expandable) power.
- **HIGH RESOLUTION COLOUR OR MONO MONITOR** for razor sharp text and graphics displays.
- **PROGRAMMABLE PRINTER** for high speed draft and near letter quality text and high resolution graphics.
- **WORDPROCESSOR** with mailmerge and spellchecker.
- **SPREADSHEET** with powerful business and financial calculation and forecasting functions.
- **DATABASE** for multifunction information storage.
- **PC TRANSFORMER** that lets you run many popular industry standard MS-DOS packages.†
- **12 MONTHS' FREE** hardware and software support.
- **RING (0628) 770088 NOW** for the name of your nearest dealer, or send the coupon.

†See package for details. MS-DOS operating system disk not included

**SAVE UP TO £414** (NORMAL RETAIL PRICES)  
(MONO £895.61 + VAT)  
(COLOUR £1,113.00 + VAT)

**AMIGA SYSTEM 500 PACKAGE PRICES:**

**MONO £599**

(+ £89.85 VAT = £688.85)

**COLOUR £699**

(+ £104.85 VAT = £803.85)



Save up to an incredible £414. Walk away with the hi-tech system that runs away from rivals at 7 million steps per second. The best selling Amiga 500 multitasking computer with monitor, printer and advanced productivity software. All in an integrated package you can collect in one stop at any participating Commodore authorised dealer. Use with instinctive ease, in both AmigaDOS and MS-DOS† environments. Expand to go in any direction you want to grow.

Phone (0628) 770088 now for your nearest dealer and you're in business. Or send the coupon!

COMMODORE BUSINESS MACHINES (UK) LIMITED, COMMODORE HOUSE, THE SWITCHBACK, GARDNER ROAD, MAIDENHEAD, BERKSHIRE SL6 7XA.

AMIGA IS A TRADEMARK OF COMMODORE-AMIGA INC. MS-DOS IS A REGISTERED TRADEMARK OF MICROSOFT INC. © 1988 COMMODORE BUSINESS MACHINES (UK) LTD. ALL RIGHTS RESERVED.

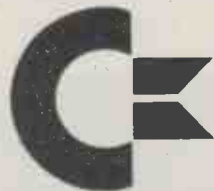

**Commodore**

Please send me the address of my nearest dealer  Details of other Commodore business systems

NAME \_\_\_\_\_

ADDRESS \_\_\_\_\_

\_\_\_\_\_

POSTCODE \_\_\_\_\_

Post to: Dept SBS, Commodore Business Machines, Commodore House, The Switchback, Gardner Road, Maidenhead, Berkshire SL6 7XA.

PCWZ \_\_\_\_\_

hard disk, an AT or both.

If you have WordPerfect Library, you can use the clipboard facility to transfer fields or records to DataPerfect from other WP Corp programs. Data written to the clipboard is in WordPerfect Merge format, and can be combined quite easily with a standard letter or form in the WordPerfect word processor.

## Reports

Reports in DataPerfect are quite flexible, giving the definer the ability to use two levels of totalling, multi-line report bodies and search conditions to report on specified records only. Reports may be sent to a disk file in WordPerfect Merge format or DOS text format, to a printer, screen or any combination of these. You can include on the report any variable in the current database, not just from one panel. The variables can be reformatted with new file formats, and character variables can be trimmed to fit neatly into other text. Creating a report is a complex operation, but it is quite logical and there is adequate online help.

To invoke a report, you press SHIFT F7 and select the report format you want from a list. When the 'options' menu is displayed, you can change any of the options and then press SHIFT F7 again to run the report. Using DataPerfect's reports for the first time can be quite bewildering because there are so many options to set. Luckily, all reports have built-in defaults so you can accept those and let the chosen report run.

The main options you can set are Destination (screen, printer, file), Index, Search Conditions, Sort Direction, and Print Margins. Some of the main options will then produce further options if you do elect to change them.

There is a standard report available for all panels which can be used for *ad-hoc* or one-off reports. This report can also be used to export all or

some of a database to another package.

DataPerfect scores highly for the complexity of its reporting, but sometimes it might be just a little too much for the end user. The reports function is powerful and flexible but is not that easy to use to its full advantage.

## Documentation

The DataPerfect manuals come in two parts, and both are bound in one three-ring binder. The *Definer Manual* is standard, loose-leaf format but the *User Manual*, which shows you how to run databases that have already been set up, is a glue-bound paperback book with three ring-binding holes. Both manuals are clearly-written with some diagrams and screenshots. Both contain sections on getting started, a tutorial and a reference section.

The getting started sections are brief and to the point. They tell you how to install DataPerfect on your

**'DataPerfect is quite straightforward once you have accustomed yourself to its general principles.'**

computer, how to start it running, and there is a little information about the keys used. The *Definer Manual* also describes, rather briefly, how to go about designing a database and the concepts of panels and linking through doors.

The tutorial sections are more lengthy and harder to read. Much emphasis is put on *doing* what is being described.

The two reference sections cover all aspects of using DataPerfect. Each

command or action is explained clearly and fully but, again, the lack of screenshots to illustrate what is being explained does hamper understanding.

## Conclusion

DataPerfect is an interesting product which will appeal to business people who know a bit about databases and want something they can put together themselves in a few afternoons. There are certainly some unique features in the package to make it even more attractive. The lookup lists and the intuitive system of doors and doorways are things I'd like to see in professional database management systems.

Apart from the lack of adequate data validation, DataPerfect has two faults which will stop it being used more widely. One fault is the lack of a 'language'. As an entire database system is constructed from screen-painting, menu choices and 'point & press' selections, there is no way of describing or documenting the finished product. You can see what it does but there is no way to print out all the field formats, formulas, doors/doorway links, and so on.

The other fault is that although the human designers and users of DataPerfect know that a particular field holds the name of a class teacher, DataPerfect knows it only as P2F3 — that is, field three of panel two. Any references to the teacher's name in formulas for reports have to be expressed like this as there are no field names. You type legends when defining the panels but you never actually name the fields.

This lack of descriptive field names could potentially lead to the creation of unmaintainable systems. The report formulas could be so complex and full of P1F2 and P2F1 that it would be a lot quicker to construct a new report from scratch than make a small change to an existing one.

Finally, one must question the pricing of this product. At £495 it is at the high end of relational database packages, yet it lacks the programming language and third-party support of dBase III, or that product's Assistant mode. There is no way to produce turnkey applications or menu-driven front ends for complex tasks.

DataPerfect has much to recommend it to people who know what they want from a database package and are prepared to invest a few days in designing a system for themselves. It is not for newcomers to computing or for software houses to design bespoke systems with.

The use of function keys will be familiar to users of WordPerfect. A knowledge of that program is almost essential to grasp the complexities of DataPerfect

DataPerfect costs £495 from Sentinel Software on (0932) 231164. **END**

18/03/88 15:44	
Ctrl Go to Shell	Ctrl —
F1 Shift Get Field from Clipboard	F2 Shift Reverse Search
Alt Get Record from Clipboard	Alt —
F1 Cancel	F2 Search
Ctrl Screen	Ctrl Move
F3 Shift Edit Help	F4 Shift —
Alt Reveal	Alt Block
F3 Help	F4 Select
Ctrl Import	Ctrl —
F5 Shift Remove	F6 Shift Report Attributes
Alt Multiple Record Remove	Alt —
F5 Panel	F6 Edit
Ctrl Report Options	Ctrl Define Index
F7 Shift Report/Export	F8 Shift Define Field
Alt —	Alt Define Panel
F7 Exit	F8 Lookup
Ctrl —	Ctrl Put Panel to Clipboard
F9 Shift System Operations	F10 Shift Put Field to Clipboard
Alt —	Alt Put Record to Clipboard
F9 Create	F10 Save



# THE LATEST THING IN AMSTRAD PRINTERS.



Prices correct at 1.1.88 but may change without notice. Product subject to availability. Amstrad is a registered trademark of Amstrad plc. All rights reserved.

Now when your Amstrad printer's ribbon runs out, you can run out and buy the latest thing in Amstrad printers: Amstrad printer ribbons.

<u>CODE NO.</u>	<u>SUITABLE FOR</u>	<u>RETAIL PRICE</u>	<u>AVAILABLE FROM YOUR REGISTERED AMSTRAD DEALER</u>
Soft 06409	DMP 2000/ 3000/3160	£5.99	
Soft 6441	PCW 8256/8512	£6.99	
Soft 50015	DMP 4000	£8.04	



Amstrad plc., PO Box 462,  
Brentwood, Essex CM14 4EF.  
Telephone: (0277) 262326.

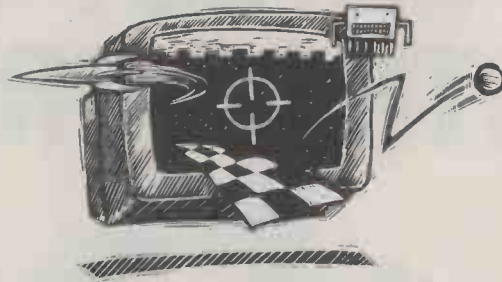

# PC Pipedream

**Users familiar with Cambridge Computers' Z88 will know about Pipedream software — now launched with increased power for the IBM PC. However, Owen Linderholm had reservations as well as praise for the program.**

**P**ipedream originally appeared on Cambridge Computers' Z88. It is the piece of software on that machine which many people will use most often since it provides word-processing, spreadsheet and some database facilities all in one program. So many people use it almost exclusively that it is generally believed to be the *only* piece of software on the Z88, rather than just one of many which can be run from the context-switching operating system.

For a program running on a small, portable, Z80-based machine like the Z88, Pipedream is very powerful. This is understandable given that it is loosely based on the popular and established BBC program, View. Pipedream is itself responsible for much of the success of the Z88 — if it, or a similar piece of software, had not been packaged with the machine, I doubt whether it would have attracted anything like the attention that it did. The question is whether or not Pipedream can successfully transfer to the 'grown-up' world of the IBM PC.

## In use

Once you have installed Pipedream on your PC (a very simple process), several immediate differences between this and the Z88 version become obvious. The screen display is 80x25, which means that the screen map on the Z88 is no longer necessary. In addition, the program is in colour and uses pop-down menus.

To use Pipedream as a word processor, just start typing and all the normal word-processing functions are available except one. If you delete backwards, the deletion won't wrap around to the end of the previous line. Also, the ENTER key doesn't 'insert'. When you type it in the middle of a line, the cursor simp-

ly moves down to the beginning of the next line and nothing else happens. These problems have been inherited from the Z88 version, where they are annoying but bearable. It is a little surprising that they haven't been corrected for the PC version.

**'... most standalone word processors and spreadsheets are much better than Pipedream in its respective modes.'**

Despite these limitations, though, Pipedream is certainly usable as a basic word processor.

The spreadsheet also functions in a similar way to Pipedream on the Z88. The program is based around the concept of 'slots', equivalent to spreadsheet cells but more flexible. For example, when you type text straight into Pipedream, each line becomes a single slot, so the first line of a document will be a text string held in slot A1. You can have several lines of text on a single display line by putting a new line of text in each slot along horizontally. Unfortunately, this results in a very confusing display but does allow Pipedream to perform a simple and straightforward form of outlining.

## Spreadsheet functions

An extensive range of spreadsheet calculation functions are available — one of the areas where Pipedream on the PC scores. There are over 20 new functions, mostly for financial and statistical calculations, and none of the functionality of the Z88 Pipedream spreadsheet is missing.

Another improved area on the PC version is the inclusion of much larger spreadsheets and documents. On the Z88, a Pipedream document can consist of 64 columns by 32,000 rows; on the IBM PC, it can consist of 8000 columns by 500 million rows (of course, you will run out of memory before you get anywhere near using this many). The forthcoming Archimedes version of Pipedream will allow 500 million columns by 500 million rows.

The pop-up dialogue boxes required to specify some of the options for commands are now easier to use. Other new commands and functions include snapshots for converting formulae to values, link files for passing numbers between spreadsheets, print macros for mailing lists, direct loading and saving 1-2-3 files, and keyboard macros.

The display is uncluttered and looks more like a spreadsheet than anything else. There are no slot index numbers down the left-hand side of the screen, only across the top. This is useful when using Pipedream as a word processor since the provision of extra onscreen columns means that less of the display is devoted to displaying text. However, as each new line is added, its index number does appear in a column on the left-hand side of the screen.

## Menus

The top line of the screen is taken up by a menu bar; below this is a further display which occasionally shows messages and carries the current slot number on the left-hand side. The menus are accessed by the ALT key pressed in conjunction with other keys. Most of the options have some sort of shortcut via the use of the function, SHIFT and CTRL keys.

When the ALT key is pressed on its own and released, the first drop-



# SCREENTEST

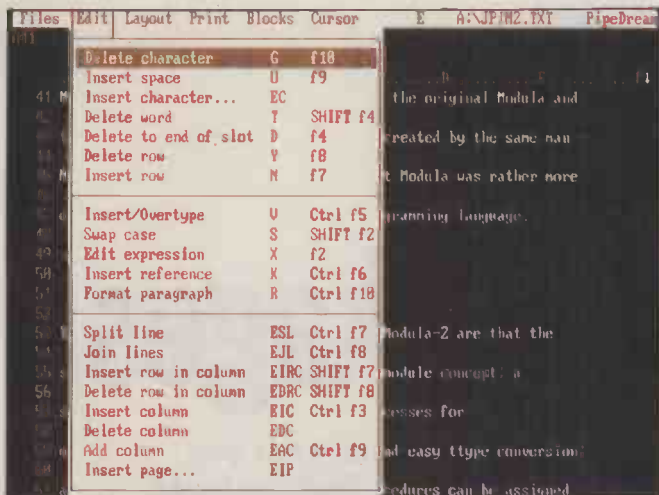

The main difference between the Z88 and PC versions of PipeDream is the pull-down menus. There are also numerous memorable keyboard shortcuts, but the Z88 keystrokes can be used. 'Alt' on its own pops up the main menu

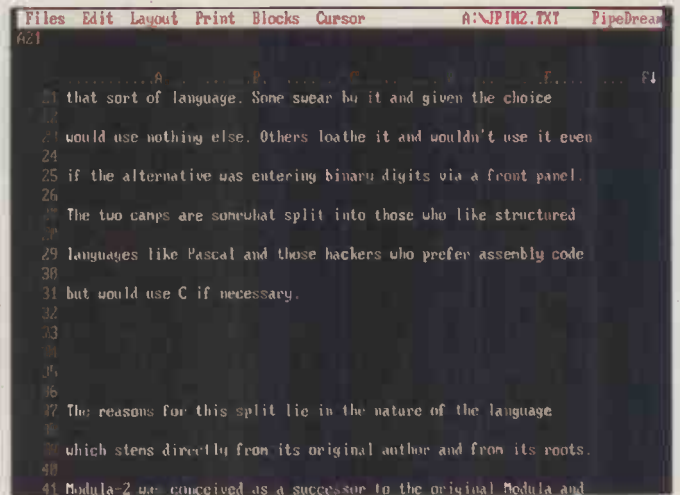

A familiar 'spreadsheet as a word processor' screen. The PC version doesn't support onscreen text attributes like underlined or italics, though bold should show brighter than the rest. Embedded codes indicate other attributes

down menu appears. These menus are all quite large, with a wide range of options. Items can be selected using the cursor and ENTER keys or by typing the index letters by each name. If the full set of letters is typed without releasing the ALT key, then you will go straight to the option.

The first menu, 'Files', holds commands for file loading and saving, renaming files, and instructing the program to edit new files. The next stage of the menu involves one of the most curious parts of PipeDream on the PC. On the Z88, you can have many PipeDream documents open at once and switch between them at will. This is because the Z88 itself allows you to switch between Z88 applications in memory. When you leave an application, it and anything being edited is suspended and preserved in memory so that you can return to it later.

The IBM PC doesn't support this sort of thing in hardware, so it has to be done in software. Several PC word-processing programs let you edit more than one document at once, although they are usually limited to only a few. PipeDream on the PC has a rather clumsy and cumbersome version of this. If you set up a list file detailing the files you want to be able to move between while editing, then the program will let you cycle between them and perform operations on all the files at once. Although much less satisfactory than context switching, it is better than nothing.

The files menu also lets you execute macro files, change options about the document and PipeDream, switch to 43-line EGA or 50-line VGA, exit temporarily to DOS, quit, get help, and display the version and serial numbers of the program.

Although editing commands can be accessed by a menu, they are

more sensibly used, as in all programs, by pressing single keystrokes or combinations of keys. The menu is really there to let you look at the options and remind you what to do for some of the more unusual ones. There is a plethora of insertion and deletion options, both for text and for slot contents, as well as formatting commands and column movement commands. Practically everything you want to do can be done.

Laying out documents in PipeDream is pretty straightforward and is mostly column-based, although commands affecting rows exist. The obvious changes for widths and margins are available and it is also reasonably straightforward to set up multi-column text. Justification is more flexible than normal with the ability to specify justification position, as well as the usual centring and flush left or right. There aren't too many spreadsheet display options, but most of the text display options affect the spreadsheet slots in the same way.

Another useful option is the ability to specify any character for leading and trailing character padding. You can also restore the default format if you mess things up too much.

The 'Print' menu lets you control the printer and printout accurately. You can alter parameters and page layout, configure the printer, check its status, instruct any characters in the text or spreadsheet to be printed underlined, bold, italic, super- or subscript, in different fonts or as user-defined characters. These can also be done in combination.

Unfortunately, the Z88 version of PipeDream again scores over the PC here. All of these options can be displayed onscreen on the Z88 but not on the PC. However, the range of options is fairly extensive and the lack of true WYSIWYG shouldn't be too

bothersome.

The final menu is the shortest and covers cursor movement between columns and words. You can save the cursor position and restore it, and swap the current position with the saved one. The most important item on this menu has nothing to do with the cursor. It lets you define any single keystroke or combination with CTRL, ALT or SHIFT to perform any combination of the commands and keystrokes available within PipeDream. For example, ALT-Y could be set up to move to a new line and enter 'Yours Sincerely', put in a few spare lines and then type your name.

## Conclusion

PipeDream is obviously intended for Z88 owners who also happen to own a PC (or an Archimedes for the next version of PipeDream). However, the rather high price tag (£99.95) compared with the cost of the Z88 system may put a few people off. I found the greatest use for the program to be in converting PC files into PipeDream format prior to transferring them across to the Z88.

Other potential purchasers may be PC owners in general. The one advantage PipeDream has over many PC products is that it combines a spreadsheet and a word processor even more closely than an integrated package can. However, most stand-alone word processors and spreadsheets are much better than PipeDream in its respective modes. Also, integrated packages such as Ability offer a wider range of functions, even if they aren't quite as tightly integrated as in PipeDream. PipeDream has not been priced any more competitively, so it is going to have problems finding its own niche in the market-place.

PipeDream is available from Colton Software on (0954) 210928.

END

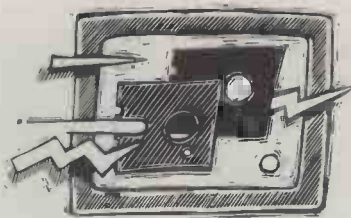

# Text retrieval packages

You can waste a lot of valuable time hunting for a document you know you've written but can't put your hands on. Andy Redfern looks at three programs designed to find that elusive file for you, and explains how their approaches differ.

If you write technical reports, articles, books or indulge in any other large-scale word-processing activity, you will have doubtless encountered the problem of 'I've written this before, but which file is it in?' Your document is somewhere on your hard disk or in that mountain of floppy disks, but how do you find it?

The solution is a text retrieval system. The popularity of this idea has soared in computer circles during the last few months because of the release of some interesting packages which aim to solve text retrieval problems.

In this review I shall be looking at three products, each of which tackle text retrieval slightly differently. There are two alternative conceptual approaches. You can either search the whole of your data files each time you want to find a document, or you can index the files and then simply search the index when you need to find the data.

Searching all the data files has some advantages in that there are no index files to store and the search is always on the latest version of your files. The disadvantage is that the time involved in conducting a serial search through all the data files can be quite significant. Indexing the data has the advantage of speeding up the search but has an added time overhead of indexing the files before you can search for any text.

The packages were all tested on a Tandy 4000, a PC-compatible 80386 machine. (I would recommend a minimum of a 286-based system with a fast hard disk.) The power of the machine is important as text retrieval systems make considerable demands on the machine's hardware, and for large volumes of data a powerful machine can be a necessity.

For the test a single directory was created on the hard disk and 887k of

WordStar-compatible files were copied into the directory. These files were then used in all the tests I performed. The four search criteria I selected were each designed to test the system in a way that would simulate a typical enquiry.

The first test was a search for a single word which I knew existed, while the second test was for a word I knew didn't exist. The third and

fourth tests were more complex and contained an array of logical operators. All the packages support these operators in slightly different ways but the tests were almost identical in their final result.

The three packages I examined were Gofer from Microlytics, Filepoint from Insoft Development and ZyIndex from ZyLab Corporation. As each treats text differently, direct

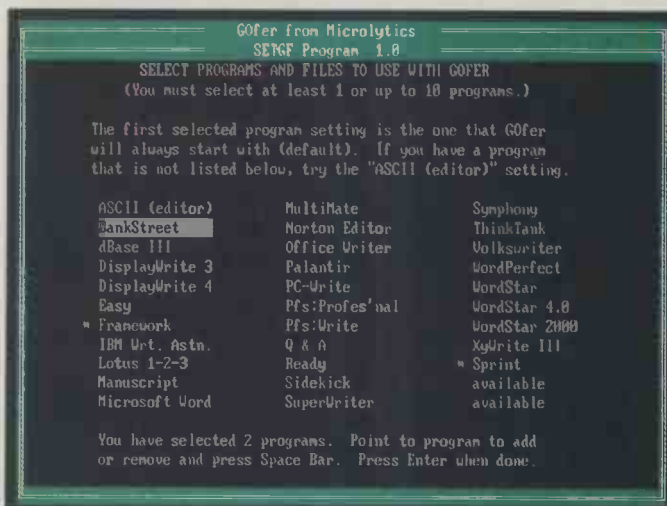

Gofer supports a wide range of word processors, and the 'available' positions can be configured to support any unlisted package. Up to 10 files can be chosen for inclusion in the memory-resident program, allowing two or more word processors to be used

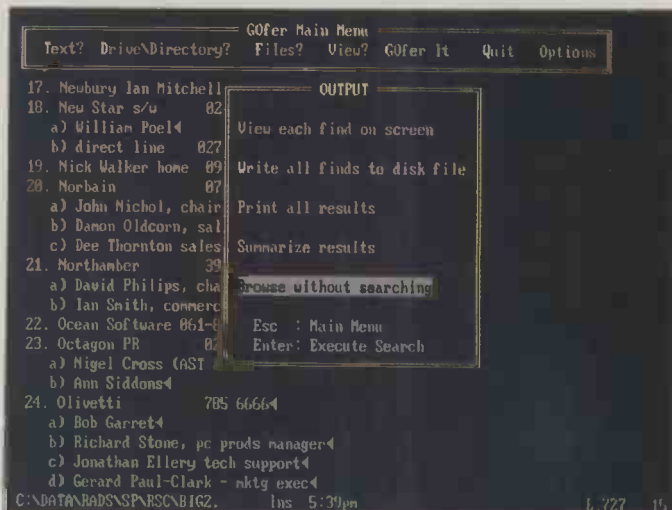

Gofer can be called up from inside your word processor. It removes the colour information from the rest of the screen, so its menus stand out. When the text has been found in a search, it can be 'piped' directly into the package you are using



comparison is difficult but means the user has a wider choice. Sometimes only one of the programs will be suitable for the task in hand, in other situations they will all fit the bill.

## Gofer

Gofer is a new package from US company Microlytics, which also markets the PC Type Right spell checker and WordFinder, an excellent thesaurus. The £69.95 package is designed to be a simple search and find program which will integrate with your usual word processor.

Gofer is a memory-resident program which not only searches for the text you require, but once the text is found will actually insert it into the file you are editing in memory. For example, suppose you're editing a company report and decide you want to include a quote from the previous year's report to prove the company has achieved what you said it would achieve. You simply ask Gofer to fetch the text you want, mark exactly the quote you require and then insert it into the document without ever leaving the word processor.

To achieve this degree of flexibility it is important that Gofer understands your word processor. Gofer comes with 30 word-processing packages already defined, with the only noticeable exception being Samna. If your word processor is not on the list, Gofer can be configured to work with it but it can be tricky. I configured Gofer to work with a new word processor I can't talk about. It worked fine, including understanding the slightly non-standard way the word processor works with end-of-line characters. The only difficulty I had was that Gofer and Cruise Control, a keyboard enhancer, appeared to interfere with each other. Whether the fault came from Gofer, the word processor or Cruise Control I'm not sure, but once Cruise Control was removed I had no further problems.

## Installation

The installation of Gofer was simple. I created a directory for it on the hard disk and then copied the one floppy full of files across. I then ran SETGF, Gofer's configuration program which allows the default activities to be set up, including the hot key. It also sets up Gofer to drive printers, screens and, more importantly, your word processor. You can choose up to 10 word processors. Choose all the ones you might need and add the ASCII text driver for plain text files and emergencies.

Once the configuration is complete, type GF and 'gofer it' (sorry). Although Gofer is memory resident it can work in three different modes:

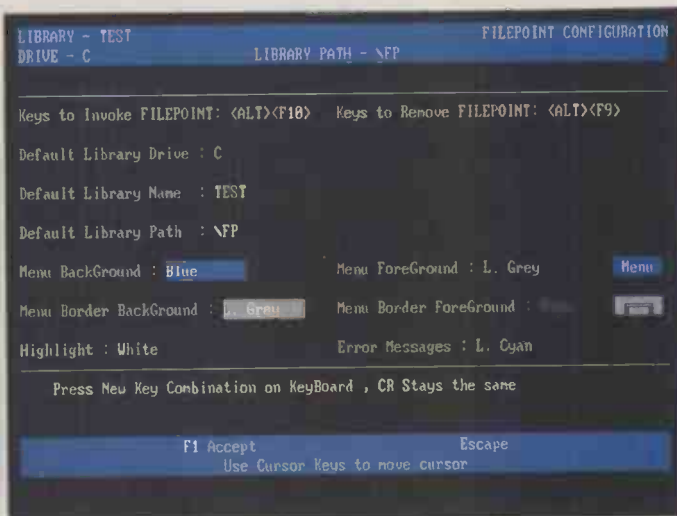

The Filepoint configuration program allows the hotkeys, the colours, the default libraries, the default drive and the directory to be set up. This allows the package to work without interfering with other memory-resident software



Updating a Filepoint library is simple. The system automatically checks for new, changed and deleted files and adds them to the screen lists. These lists can be altered if incorrect but, in normal use, I found no need to

completely memory resident, memory resident with overlay files, or non-memory resident. The minimum RAM Gofer can work in is around 79k, but for a reasonable degree of speed 130k is a better selection. This gives the user a lot of flexibility, a virtue at the heart of Gofer.

## In use

When Gofer has been loaded, you can load your word processor and begin work. To find a piece of text, invoke Gofer and enter the search criteria. Then enter the areas of the disk you wish to search and the files in those areas which you want to look at. Next, enter how you want the results to be displayed. You can either view each find on the screen, write it to disk or print it out. This may sound like a long-winded process but, after the first search, it is quicker as everything apart from the search text has been selected.

Typically, I used Gofer to search and then display the results on the screen. I then marked the block I was interested in, and this could be saved or inserted into the word processor I was using. This worked well with all the documents I tested. It will also

work with two different file formats at the same time. For example, I searched through a series of Framework II files, selected the text I wanted and imported it into Sprint. This is a very powerful feature for anyone who works in an office with two or more word processors.

The search performance can be seen in the results table. The speed is fairly fast for a straight serial search. The only program I've seen that can search such volumes of data faster was Grep, a Unix-style utility that comes free with Turbo C. Grep performed the first two searches, in 8.9 and 8.4 seconds respectively, compared with Gofer's 21.5 and 18.9 seconds. But considering all the added functions and the utilities that Gofer supports, its search speed is quite impressive.

The logical operators you can use are slightly less flexible than the other packages looked at here, but are designed in such a way as to allow fast text entry rather than complex searches. Also, the search criteria are cleverly optimised so that a search containing many logical operators takes only fractionally longer than a single word search.

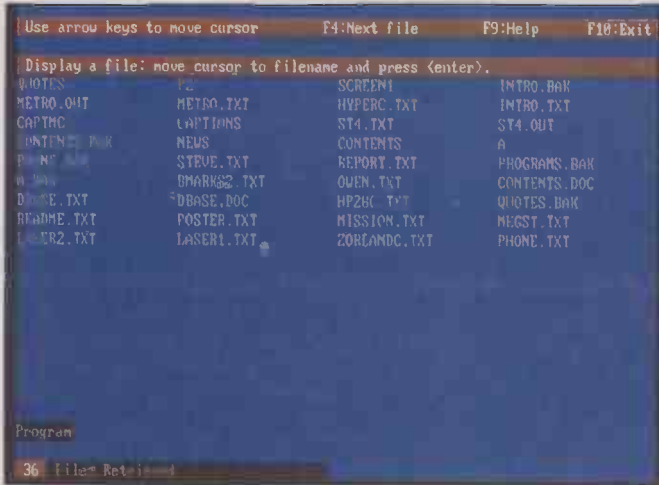

When a search has been completed by ZylIndex, the files containing the search pattern are displayed. A file can then be selected and its contents viewed.

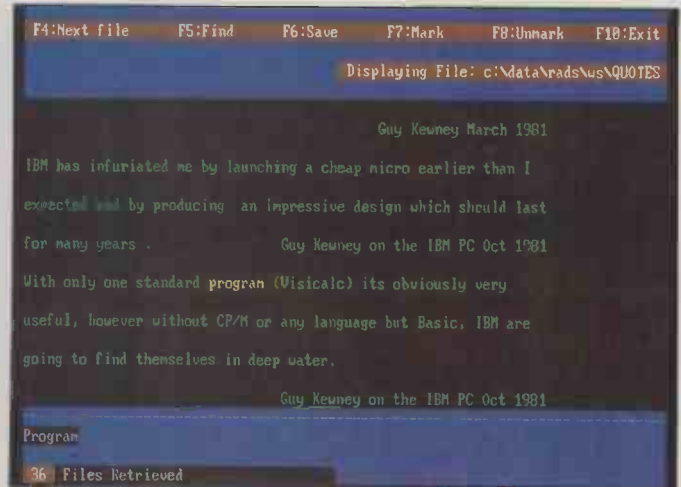

When viewing the selected file, ZylIndex highlights the word in the search pattern. A block of the file can then be marked and saved, ready for importing into another program

## Documentation

The Gofer manual begins 'Gofer is a helpful little critter...' and carries on in much the same vein. Although all the furry references can be a little nauseating the manual is well-written and easy to follow. My only criticism is that Appendix A, with its useful information on what the function keys do, would have been even more useful if I'd seen it before I'd read through the whole manual.

Gofer is a unique package in the way it operates and in its level of integration with word processors. If you are only casually interested in text retrieval Gofer is the best value for money. As one not-so-furry advertising slogan says, it finds everything but your socks.

## Filepoint

Filepoint is the only decent UK product to enter the text retrieval arena at an affordable price — £69.95 for the single user version, £795 for the multi-user. It has one or two small problems that cause the program to fall down, but according to distributor Insoft these will be cured in the latest versions of the software and only occurred in exceptional circumstances anyway. Filepoint is like Gofer in that it is memory resident, but unlike Gofer it uses index files and has no simple way of transferring the data that is found into a word processor. This can only be achieved by saving the data to a file and importing it into the word processor as a separate function.

The program works by indexing the data from all the files you want to search, and then at search time uses the index to find the word. The index consists of five files each containing different parts of the index, although exactly what they contain was not easily apparent. To speed

the program in searches and to cut down the size of the index files, Filepoint uses some interesting techniques.

First, it uses a file called COMMON.WRD to list all the words it considers to be noise; words that are so common they don't need to be indexed. Removing these words from the index file reduces the volume of data by up to 50%. The common word list is an ASCII file and can be added to if you use words which

**'The popularity of text retrieval has soared in computer circles during the last few months because of the release of some interesting packages ...'**

don't need to be indexed. Words can also be removed from the list. This could be a definite advantage if you're a solicitor, as the word 'will' appears in the current COMMON.WRD file.

Second, only the first eight characters and the length of the word are stored. In the English language there are only a few words that have the first eight letters the same and are of equal length (for example, distributed and distributor), so it's very rare for a wrong word match to get through.

Finally, the program only stores the characters of the alphabet, removing all punctuation or numbers from the index. These three techniques are aimed at significantly reduc-

ing the level of data in the index.

Advanced as these techniques seem, the program still requires large amounts of data to be stored in the index. In this example, an added 54% of disk space was filled with the index. I have it on good authority that this is an unusually high figure, but, if you're short of disk space, this is time to splash out on a new hard disk or find a different product.

## Installation

Installing the package was simple and took just a couple of minutes. During the installation you can change the keys which invoke and remove Filepoint, the screen colours and the default index file.

The next task is to initialise the first library you wish to use. You can select up to five DOS directories from which the data is to be taken. This is better than ZylIndex but I still think the program should recursively handle all the directories below the current one. This makes your hard disk more organised and discourages the user from making directories containing hundreds of files. You must also specify the word processor you want to use with Filepoint. At present Filepoint only supports 10 different word processors, but this is set to rise. Only one word processor can be specified with each library. Lastly, you must tell it what extension the text files will have. I feel this is an unnecessary feature and only stops the user from using all possible file name letters.

Filepoint has some other strange limitations. It can only handle 1000 files, although you would never use that many as the program runs slower the larger the index is. The other limitation is that the program can only hold documents with less than 256 paragraphs. This is fine for normal documents, as 256 paragraphs is



a very large document; but a phone directory file, for example, may have thousands of small paragraphs and the program cannot cope with these.

Once the library is initialised we can enter into the update menu. This lists three columns of files on the screen — those we wish to add, those we wish to delete, and the ones we want to modify. This list is calculated automatically by checking the time and date stamps and should not usually need to be altered.

The program then goes into its main library compiling session. This is a lengthy process, and indeed the time to create a library appears to go up exponentially with the size of data files. So, it is good practice never to let the data files indexed by a single library rise above 600k in size.

## In use

Once the library is complete, the memory resident part of the system is all that is needed to search for data. The memory resident program seemed to run safely with all the programs I tried it with, including Cruise Control. It takes up about 120k of RAM, and once loaded, Filepoint can be called up from inside whatever program is running.

To search for text, invoke Filepoint and enter the word to search for. It will then list all the files which contain the word or, in the fast-emerging text retrieval jargon, the 'hits'. You can view or save these files or search them with an extension to the search criteria. We could search first for the word 'text' and in the files it finds search for the word 'retrieval'. The program supports the usual logical operators and works very fast.

One disappointing feature was that only the paragraph containing the word or the whole of the file could be saved. This could be very annoying if you wanted a single page of text from a long document.

The more advanced version of Filepoint than the one I reviewed also supports networking, but it wasn't really covered by the scope of this article due to its large price tag (£795).

## Documentation

The manual is simple, small, clear and well written. I found it easy to use when I had to, but the software is self-explanatory so I didn't use it much. My only criticism is that the screen pictures are not dumps, and it was not always easy to tie up the picture with the real-life screen.

Even with all the points I didn't like about Filepoint, I'll probably carry on using it because of its simplicity and because it works. It is very fast except on making the indexes, but as I use it with the office phone directory

which only changes every month, that problem doesn't really worry me. If you need a cheap, fast-searching data retrieval system, which can be activated anywhere, then this is your product. And according to the authors the enhancements are on the way, so watch out for new releases.

## ZyIndex 2.20

ZyIndex has been around for a number of years but the latest release is certainly a leap in the right direction. The £89.95 program differs from Gofer in that it creates an index from the data files before you can actually search for a reference. It also has the distinct advantage over Filepoint in that it will index floppy disks. Although this a unique and useful feature, to be practical it still requires a hard disk on which to store the index files.

ZyIndex follows the same conceptual approach as Filepoint, but implements it in a slightly different manner. Instead of having five files with each index, it has 12 files which just grow the more data you add to the index (goodness knows what these 12 files hold). This has the advantage that all the data is available in one

**'Text retrieval has come a long way since the original version of Zyindex was launched, but it's still got a long way to go before everyone will be using it.'**

place, but has the disadvantage that those files can get very big.

## Installation

The installation of ZyIndex took about five minutes, coping admirably with the fact that my floppy drive was e: and my hard disk was d: — a useful feature for those with non-standard configurations.

The program is not memory resident and cannot run directly alongside any word processor. This makes the product far less useful in the real world where that vital piece of information is usually needed just when you're in the middle of doing something else. The last thing you want to do is stop what you are

doing, load ZyIndex, find the information, save it to file, re-enter the word processor and merge in the data. That is not what I call office automation.

Having said that, however, the package is well written, very fast and certainly useful if you want to use it as a powerful, standalone knowledgebase.

## In use

To use the program you are first asked to make an index. Select the directory you want the index of and enter a title for it if it is a floppy drive. This is where the confusion may begin. Both the manual and the program seem to be quite happy to talk about floppy and hard disks in the same sentence, even though they are both dealt with differently. It was not too confusing reading the manual in a logical order, but when I went back to clarify some aspect, confusion would reign until I had established the manual was talking about a floppy indexing system. I'm not criticising the system for having a floppy indexing system, I just wish the two different operations could have been better clarified in both the manual and the program.

Once the program understands exactly what it is you want to do, a list of all the files in the DOS directory is shown. Select the ones you want to index, the word processor which created them, and off goes the indexer. The program supports about 20 different word processor formats and you can also add your own. ZyIndex keeps a running commentary on the screen and if you've got about 15 minutes to waste it makes riveting viewing. The program would quite happily index everything from text files to binary files — something which could be useful for programmers.

The indexing program can also be run from the command line. This allows batch files to be set up, which can be run every time you want your program indexing — probably the simplest way to get around the one directory per indexing session. List all the directories in a batch file and sit back and relax while the machine does the hard work.

The search program is similar to the indexing program and accepts a wide range of operators including wild cards. The system will also search for file names or dates.

Once the program has found the little gem of wisdom you are seeking, you can view it, save it or print it out. One annoying feature is that the viewing and printing options are down different menus, so if you suddenly decide you'd like a copy of the page you're viewing, you have to go

# SCREENTEST

back up one menu and then down the other. I'm sure there must be a simpler way.

The printer driver appeared to function as expected, except that the program insisted on not recognising WordStar printer control characters — very frustrating as they govern how the document looks on paper. You also have to be very careful when splitting sections of text — so that any printer control codes which occur in pairs, for example, bold on and bold off — that the pairing still exists. If one of the codes goes missing it can have a dramatic effect on the printer output.

The final program available with the system is the utilities program which allows you to list all the indexed files, remove an indexed file and switch indexing modes. Removing an indexed file can be a tedious job if you use a large number of files. This utility simply lists all the files indexed and then waits for you to search through hundreds of files until you find the one you want. I would have preferred the system to ask me for a file specification so that I could reduce the list of files to be searched through.

ZyIndex has two indexing modes which are user selected; Full-Feature Indexing and File-Only Indexing. In the former mode, not only is the word listed in the index, but also the exact location of every occurrence in the file. To reduce the amount of data stored, the location information can be omitted. This cuts down the information, but means that some of the search operators work in a slightly different manner.

Table of results in graph form

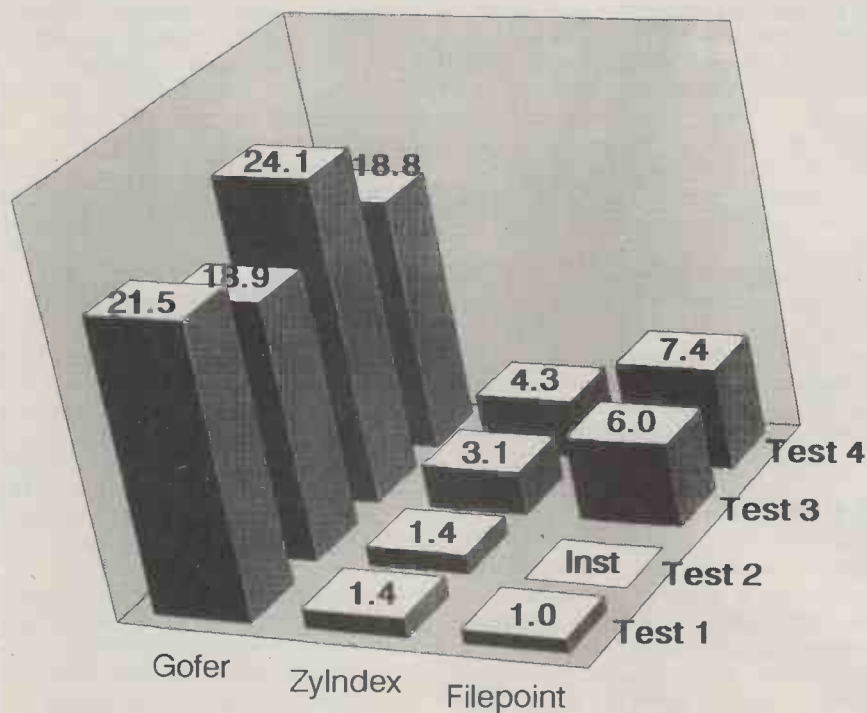

## Documentation

The manual was well written and presented, apart from the mixing of information for floppy and hard disk users. One excellent feature was an in-depth discussion of logical operators using Venn diagrams. For those of you who didn't do modern maths during your schooldays, this is a useful graphical feature which will aid

your understanding of the program.

ZyIndex is a well written, solid product. It didn't crash, no matter how hard I tried. Despite inherent limitations ZyIndex is a good buy; I recommend it to users with a large data indexing requirement.

## Conclusion

All the packages tested in this review have their individual limitations. Gofer has a significant search time on large amounts of text, Filepoint is very slow at indexing files once the amount of data has risen beyond 600k, and ZyIndex is not memory resident.

Remember that each of these may not be a disadvantage for your particular application. All three programs performed well. Don't look at the packages and decide what features you like. Look at the task in hand, decide what you need to do and what your minimum requirements are. Then see which package best fits your needs.

Text retrieval has come a long way since the original version of ZyIndex was launched, but it's still got a long way to go before everyone will be using it.

## Results

These tests were carried out on a Tandy 4000, 80386 PC compatible with a 40Mbyte hard disk. The data was stored in a directory called \data\data\ws and was made up of 887k of WordStar document and non-document files. Each program was run as the only program in memory, apart from Gofer, which was run in conjunction with a word processor. It should also be noted that the two Filepoint complex searches were performed in a number of steps as the program will not accept searches with more than one operator.

### Search Text

Test 1 search for 'Mission' and find it in files.

Test 2 search for 'Temperamental' and find it in 0 files.

Test 3 search for '(Amstrad AND Sugar) AND NOT (Videos OR Hifi OR Stereos)' and find it in 1 file.

Test 4 search for '(Amstrad AND Sugar) AND NOT (Videos OR Hifi OR Stereos OR computers)' and find it in 0 files.

	Gofer	ZyIndex	Filepoint
Test 1	21.5 secs	1.4 secs	1.0 secs
Test 2	18.9 secs	1.4 secs	INST
Test 3	24.1 secs	3.1 secs	6.0 secs
Test 4	18.8 secs	4.3 secs	7.4 secs

### Indexing Text

(Gofer doesn't index files so isn't included in these tests)

	Filepoint	ZyIndex
Time to index files	29:28.1 mins	18:17.5 mins
Size of index files	487.55k	401k
Library/data percentage	54.97%	45.21%
Remove 41k file from index	17.3 secs	0.8 secs
Add a 41k file to index	9:39.1 mins	26.2 secs

Gofer is available from Riva on (04862) 71001. Filepoint is available from Insoft Development on (0272) 268893. ZyIndex is available from In Touch on (0222) 882334/209.

END



# Psion PC-Four. Very serious software. Very silly price. £69.

(exc VAT)

Psion PC-Four. A word processor, spreadsheet, database and graphics designer. All well tried and trusted. All four £69 (exc VAT).

If you've ever dreamed of owning a suite of key programs for your PC without having to dig deep into the pocket, here's the eye-opener.

PC-Four gives you four powerful, feature-packed programs (plus a tutor for each, for good measure), all for the price you'd expect to pay for just one of them.

They're not 'pruned down' versions of other programs, either. They're all well-proven and highly rated. What's more, you can exchange data between the four programs (or with other programs, for that matter) so you can integrate your work. And they're all extremely easy to use, with help screens sensibly related to the current operation available at all times.

You might think, at such a low price, that the programs don't have all the features that you'd expect or want. You'd be wrong.

Take PC-Quill. 'Which Computer' called it "...the best general purpose word processor on the market". With good reason. It has full editing, text and page formatting facilities, automatic page numbering and word count, headers, footers, glossaries and so on. It incorporates mail merge from the keyboard or saved files. And the display reflects the print-out - with type emphases. So you can see what you're getting.

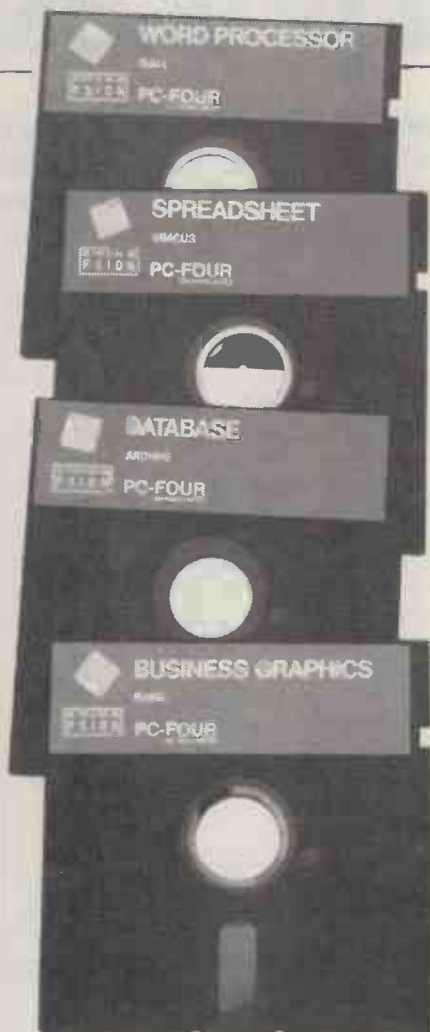

The spreadsheet, PC-Abacus, can handle 999 rows and 255 columns, and uses memory efficiently. Its numerous features include identification of columns, rows and cells by textual content (so formula can be entered in English, not computerese), split window displays, automatic replication of formulae, format control, merging from different spreadsheets simultaneously, and a full range of functions and conversions - with string handling and condition testing. PC User called it "extremely versatile."

Then there's PC-Archive. This powerful database can handle a number of huge files (up to 64k records each) at a time. It can be used direct from the keyboard, or through its comprehensive interactive programming language - which is structured so that it can be extended. And it has a built in 'forms' designer to format the screen display and print-out. "Its degree of usefulness is extraordinary" said PC User. We're not surprised.

It's the same story with the graphics creator, PC-Easel. This gives a wide choice of 3D, line and pie chart displays with interactive entry and design. Data can be entered direct or from a saved file and manipulated by formulae, or it can be created by manipulation of existing data. It provides user positioned vertical and horizontal annotations, keys and labels, and automatic scaling of the axes. And it allows multiple representations on one display. Micro Decision referred to it as "an extremely flexible graphics package".

On top of all this, remember, there is a tutorial disk, to show you how to use the more important elements of each program. And of course, there is a comprehensive manual.

PC-Four is designed for all IBM\* PC compatibles, including the new low priced clones. Now you know what it does and what it runs on, take another look at the price. Twice.

For the name of your nearest stockist or a colour brochure, contact Psion on 01-723 9408.



Psion Limited, Psion House, Harcourt Street,  
London W1H 1DT Tel: 01-723 9408  
Telex: 296489 PSION G. Fax: 01-724 6646

\*IBM is a registered trade mark of International Business Machines Corporation

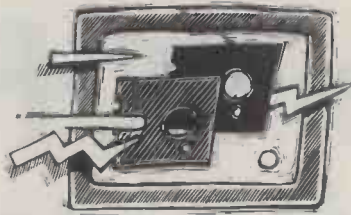

# Archimedes word processors

The considerable excitement and acclaim that accompanied the launch of Acorn's Archimedes has been overtaken by a *cri de coeur* for more software for the machine. Roger Howorth examines two new word-processing packages, First Word Plus and Graphic Writer.

The Acorn Archimedes computer has attracted considerable attention so far due to its super fast processing speed, but, like many other computers within the first year of launch, only a meagre amount of applications software is still available for it.

One reason for this is that until the release of the Arthur 1.2 ROM operating system, most software developers were reluctant to release serious applications programs for the Archimedes. Even Acorn — who surely has a vested interest in a large software base — was content to sit on First Word Plus until the operating system stabilised.

Now, within a few weeks of Arthur's update, both Acorn and Clares Micro Supplies have released new word-processing products for what is currently the world's fastest microcomputer.

## First Word Plus

First Word Plus was launched by the Cambridge software house GST about a year ago as a GEM-based word processor for the Atari ST and IBM PC clones. Its proudest features are its fully WYSIWYG (What You See Is What You Get) operation, an integral 40,000 word spelling-checker and graphics capability.

This new version, commissioned and marketed by Acorn and priced at £80, is an interesting development from the Cambridge software house who, until now, has based its consumer products around the GEM operating system. Although the Archimedes does have a windowing

system, it is quite different from GEM, requiring much of this version to be re-written.

## Installation

First Word Plus is supplied on one 3½in disk containing the main word-processing program, a mail-merge utility called First Mail, and programs for installing First Word Plus for use with a hard disk and the Econet local area network system that is an optional add-on to the basic Archimedes.

Booting the computer with the First Word Plus disk in drive 0 will load and run the program automatically, or it can be run from the desktop or command line interpreter 'DOS' prompt.

## In use

GST has gone to some trouble to make the Archimedes windowing system resemble GEM both in physical appearance and operation. The company has made a similar effort to duplicate the features of First Word Plus so that this latest version is a virtual clone of the original implementation.

Documents are loaded and edited within screen windows which can be moved around and resized according to taste. The Archimedes version limits you to having no more than four of these editing windows on the screen; this limit is carried over from the GEM versions, and is rather arbitrary — the Archimedes 305 machine with only half a megabyte of RAM would probably be uncomfortable with that many windows, whereas an

A440 machine with 4Mbytes could cope with dozens!

**WYSIWYG:** First Word Plus operates in a WYSIWYG environment, meaning that what you do on the screen is what you get on the final print-out. However, in common with most WYSIWYG word processors, the screen representation is not totally accurate: for example, First Word Plus allows access to the four 'standard' typefaces found on most dot-matrix printers (Pica, Elite, Condensed and Expanded), although these are all shown onscreen in one standard Archimedes typeface. Access to these typefaces is also limited to using only one per line. By contrast, 'text effects', such as underline, italics, bold, light and superscripts, are all displayed onscreen as they will appear on the print-out.

**Rulers:** A ruler is a crucial part of a First Word Plus document. It defines not only the position of any tabs and the maximum length of a line, but also whether the text should be justified, and what line spacing and printer typeface should be used.

Each document must have at least one ruler, but there is no limit as to how many can be added. Each ruler operates on a complete line of text, meaning that different printer typefaces cannot be mixed on a line and making multiple column documents impossible.

**Graphics:** The graphics capabilities are limited to importing Archimedes 'sprite' files from disk. These can



have been drawn in any screen resolution and may use colour, but unless you also use a colour printer First Word Plus will convert them to patterns and shades of grey before printing them out.

There are no facilities for editing the graphics within the program but they can be moved around the document by simply dragging them with the mouse. Text can be typed directly over pictures if desired; in fact, persuading text to avoid them is the tricky bit and requires extra rulers to be added to your document.

**Spell-checker:** First Word Plus boasts a memory-resident spelling checker with a dictionary of some 40,000 words. In addition to the main dictionary, an unlimited number of supplementary ones can be set up which are used alongside it. This system works quite well but, unfortunately, there's no facility to swap supplementary dictionaries without purging the main one from memory. This can cause problems: for example, if I were writing an article on programming and wanted to add the names of some program 'variables' and functions to the supplementary dictionary, as well as a few real words that hadn't cropped up before. If I then wanted to check a more 'typical' document, I would be forced to swap supplementary dictionaries to one that contained only real English words!

There is no facility for using wild cards in the spell-checker, so it will be of no use to crossword buffs; more seriously, the program uses the apostrophe as a word terminator and therefore won't recognise 'don't' as a correct word.

Those minor grumbles aside, I do like the First Word Plus checker. Its response time is virtually instant on all versions of the program when simply checking a document. There is a 'guessing' mode which suggests correct spellings for unrecognised words, which has benefited from the Archimedes' faster processor — the Atari can take 30 seconds to do what the Archimedes does in just five.

## Printing

First Word Plus comes with a library of 20 printer drivers for a mixture of 9- and 24-pin dot matrix printers and daisywheels. Printing is performed as a background task so that you can edit one document while printing another.

It is possible to experiment with the different printer drivers to find which one best suits your printer from within the program, switching printer drivers by selecting them from a file selector list. It is also possible to redirect the printer output

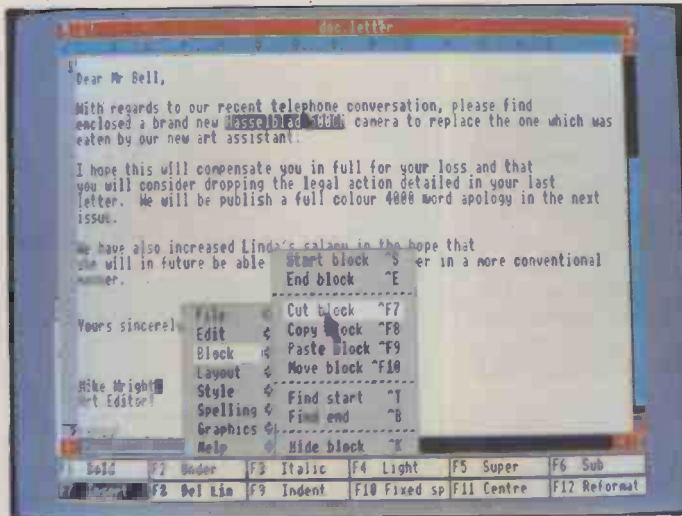

First Word Plus uses hierarchical menus, allowing quick and easy control of the package's many powerful features. Cutting out text, for example, is simply a matter of point, drag and click

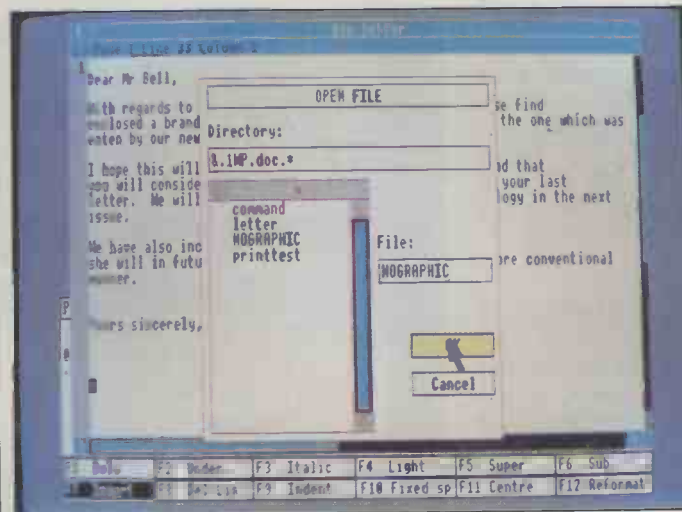

Documents and graphics files are accessed from GEM-style requester boxes, a far cry from the Archimedes' standard command line disk operating system which creates confusion

to either parallel, serial or Econet interfaces from within the program, simply by 'clicking' the mouse on a special interface icon

## Documentation

No documentation was available at the time of writing, but the retail documentation will be produced by Acorn from the original text of the GST manuals (the Archimedes computer comes with several manuals which are all of a very high standard; if they are anything to go by the documentation for this program will be excellent).

## Conclusion

This implementation is reassuringly similar to its predecessors. This means that anyone considering upgrading from ST or PC to the Archimedes won't have to spend much time learning a new program. This is true even if your familiarity lies only with GEM rather than First Word Plus. This implementation is uncanny in the way it mimics GEM, not only in the visual aspect, such as dialogue boxes and so on, but also in the methods of user interaction with them — default exit boxes are

available as is the facility to clear the editable field of a dialogue box by pressing ESCape.

First Word Plus runs noticeably faster on the Archimedes than it does on its counterparts. This is particularly so when spell-checking and scrolling: indeed, on the GEM versions GST deliberately avoided repeated single character scrolling because it was so slow!

I like the ability to have more than one document on the screen simultaneously: it not only makes comparing files quick and simple but also allows chunks of text to be 'cut and pasted' very easily.

I used an older Archimedes for this review which produced a disturbing buzz from its loudspeaker when running First Word Plus. Acorn advised me that this was a problem with the sound board and that it has been cured in newer batches. The company will upgrade any older, noisy Archimedes machines free of charge if they are returned to the dealer.

## Graphic Writer

Anyone who has seen the Archimedes at exhibitions or in High

Street shops will undoubtedly have seen a program called Artisan used to demonstrate its powerful graphics capabilities. That program was developed by Clares Micro Supplies which has now released an update to its word-processing package, Graphic Writer, priced at a very competitive £29.95.

Graphic Writer doesn't boast a spelling checker, and neither is it fully WYSIWYG, but as its name implies, Graphic Writer is a word processor with a leaning toward the graphic!

## Installation

The program itself is supplied on a single 3½in disk which contains a huge quantity of files in only a few folders, making it more tempting to run the program by holding the SHIFT and BREAK keys rather than using any of the other possible methods. As well as the main program there is a utility to install Graphic Writer onto a hard disk and another to modify the program's printer driver.

## In use

Graphic Writer operates from one of two basic modes, which I shall refer to as 'word processor' or 'everything else' mode. 'Word processor' mode controls the input and formatting of text into the program, while 'everything else' takes care of such things as disk and graphics functions.

The program is a strange cocktail of stunning graphics and neatly arranged menus mixed with a rather more old-fashioned text-based word processor. Once loaded the program drops you into 'word processor' mode and automatically loads a 'default' document; this is initially a README type file with details of updates that are not documented in the manual. It's very easy to change this to something else — your name and address, for example.

Like First Word Plus, Graphic Writer is driven from a mixture of icons and menus — the latter pop up under the mouse cursor whenever the middle mouse button is pressed. Graphic Writer's menus differ from those of First Word Plus in that they are entirely graphics-based: the menu is a series of icons pasted into a small window. As soon as the mouse is moved off the window, it disappears, leaving you back in your document. This system takes a little getting used to, but I soon found it far more usable than the text-based menus of First Word Plus which are provided by the Archimedes' operating system.

While in word-processor mode the entire screen is available for your documents, and all program func-



Graphic Writer's page composition mode gives a mini-preview of the finished document. This gives a pixel to each character and uses a sprite to display a scaled-down version of any graphics

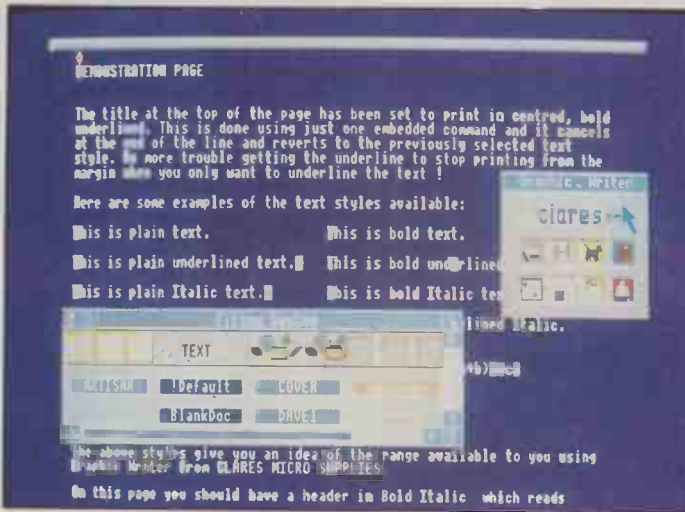

Graphic Writer's front-end is easy to use. Different type styles are controlled by hidden codes which do not alter the appearance of text onscreen

tions must be accessed via two levels of pop-up menus. When in the more general 'everything else' mode the main pop-up menu is arranged as a series of icons along the bottom of the screen that is always available, and further context-sensitive menus appear when the mouse button is pressed. For example, when using the page composition screen, which is used to select and position graphics on the page, a different menu is displayed if the mouse is over your 'pile' of graphics than were it positioned over the 'map' of the page, and still another one if the mouse is over a picture that is displayed on the page map.

Graphic Writer can only work on one document at a time, but several can be held in memory, with up to 14 possible on my 1Mbyte machine. It is very quick and easy to switch around between them as desired.

**WYSIWYG:** Although the word-processing screen is not WYSIWYG, Graphic Writer has two methods to display your document as it will appear when finally printed out. These are used by various functions but are available together from the

'mini preview' window<sup>1</sup>. This initially displays a 'map' of page 1 showing how paragraphs, for example, will be positioned on the printed page. Different pages of the document can be displayed by clicking on the '+' and '-' icons and the page can be sent to the printer and displayed in full detail onscreen. This last option clears the screen to a white background and 'prints' your document onto it, showing all text effects such as bold and underline in typical WYSIWYG style.

No editing is possible while in this WYSIWYG mode; indeed, the only thing you can do is look at the page. This method of producing a WYSIWYG display is quite effective in terms of showing what the document will look like, but I prefer a word processor that does this continually rather than only when asked.

**Word-processor mode:** This mode is used to actually type text into documents and generally fiddle around with it, adding text effects and formatting, and so on. As I mentioned above, this mode makes no attempt to provide an indication of how the document will appear on the printed page, save for the 'rulers' which con-



# WORDS & FIGURES. MORE MUSCLE FOR THE SMALLER FIGURE.



Words & Figures is unique. It's the first truly integrated Lotus compatible spreadsheet with in-built word processing.

And it has the performance that makes you wonder how it can cost only £99 (ex VAT).

Its compatibility with Lotus 1-2-3 1A (unlike some other low-cost spreadsheets), means Words & Figures not only gives peace of mind for the first-timer but also more to the power user.

With a single key function, you can switch from your spreadsheet to the word processor and back again, as

well as view and store portions of a live spreadsheet in your document.

And if you're a real power user, Words & Figures has the spreadsheet size and performance power that allows you to work with up to 9999 rows and 256 columns of data.

While its advanced "sparse memory matrix" ensures that you won't fill up your disk with empty cells.

Mistakes are swiftly detected with its unique built-in audit command, and its support for 8087 or 80287 co-processors makes calculations lightning fast.

As with all our software, Words & Figures comes with free lifetime telephone support, not the standard 90 days.

To find out more, talk to your local dealer.

Or complete and return the coupon today. For a mere £99 + VAT, Words & Figures makes other spreadsheets feel like weaklings.

Yes, I would like to find out how to get more muscle for only £99 + VAT. Please send me further information on Words & Figures.

Name

Address

Telephone:

PCW1

  
**LIFETREE**  
SOFTWARE EUROPE

*Make it Simple*

trol the left and right margins and line length. A possible limitation for some people will be that Graphic Writer limits the maximum line length to 80 characters, which is the most that will fit on a standard Archimedes screen, but not the most that can be squeezed onto a printed page.

The usual word processor functions are available, such as 'cut and paste' and 'search and replace', as well as formatting commands to justify text to the centre of the page, or either left, right or both margins.

Whenever a change is made to the overall format of the page, such as text effects, page breaks, and so on, a 'control code' is inserted into the text which appears as a coloured blob super-imposed over that character position. I have always had great difficulty in relating to the meaning of blobs intermingled with my writings (perhaps dating back to a leaky fountain pen during childhood?) and I feel that these are Graphic Writer's greatest failing.

By the time you have set a few text effects and page breaks the text becomes quite untidy and awkward to read.

**Graphics:** Graphic Writer allows up to eight 'object' and 56 'sprite'-based pictures to be included in your document by importing them from other programs. There is also a graphics editor which allows simple object-based pictures to be drawn, edited and resized. The drawing tools available are of a geometric nature, such as squares, parallelograms, triangles, and so on; no facilities exist for drawing freehand with Graphic Writer.

The program can handle colour pictures onscreen with ease, although unless you have a colour FX80, the printer driver will need to convert them to shades of grey before printing! Here the WYSIWYG screen is very effective as it displays colour graphics in monochrome, thus leaving no doubt as to what the finished page will look like.

On the whole the graphic facilities within the program are very pretty but of limited use: they are perfect for producing rough graphs but useless for preparing illustrations.

## Printing

Graphic Writer is supplied with only one printer driver, which is suitable for the Epson FX80 dot-matrix printer. There is a utility program which can modify this driver to alter the control codes that set effects such as underlined and bold text, so in theory it would be possible to convert the driver to suit other types of printer. Unfortunately, there is no

## Mice in the machine

The Archimedes computer and its Arthur operating system form a strange hybrid of 'state of the art' design and software with a flexible means of machine operation. The Arthur ROMs contain not only the operating system level functions to ferry data around the computer and to the outside world, but also a CLI (command line interpreter), BBC Basic and a mouse/icon-based 'desktop' from where applications can be launched and disk files managed. The Archimedes uses a three button mouse and a system of 'pop-up' menus to control program execution. Whenever the middle mouse button is pressed, a menu should appear containing the possible actions at that point in the program. If the possible choices are quite complex, then a system of 'sideways sub menus' can be used where moving the mouse pointer over a particular menu choice and then directly off to the right will display a sub-menu with further related options. Arthur keeps all levels of the menu visible onscreen while interaction is in progress so that the user can trace their actions back if necessary.

There are parallels in this structure to the Amiga computer which also offers the choice of mouse and menu or CLI 'text-based' operation. Arthur allows program 'modules', similar to the Terminate and Stay Resident software for PC clones, to be loaded and accessed with relative freedom.

Despite its complexity, some would argue that Arthur's WIMP system is rather crude because although it provides functions to control the bare essentials of a WIMP environment, such as routines to draw windows and track mouse activity, there are no pre-defined high level functions to communicate with the user — for example, 'dialogue boxes', which present the user with brief text instructions; editable text fields, and; exit buttons such as 'OK' and 'CANCEL' (such functions can be created using the basic working tools within Arthur, but this leads to the situation where each programmer produces a different solution to the same problem — a state of affairs that WIMP environments were supposed to help relieve).

An example of this is GEM's 'file selector' dialogue box, which is used to display a directory of the current disk drive and allow the user to select a file and path name. Despite its shortcomings, this is used in nearly all GEM application programs as the method for selecting file names, therefore setting a standard that makes GEM programs quicker and easier to use, especially in the initial learning stages.

GST has gone to considerable effort to make its extensions to the Arthur WIMP interface resemble GEM. There may be several reasons for this: firstly, because GST had already written First Word Plus using GEM. If the company were to avoid a complete re-write this time, it would need to replace all the GEM functions that Arthur can't reproduce with its own. As an example, a File Selector has been created that behaves in exactly the same way as GEM's. Having produced these new extensions to the WIMP interface, GST is now in a very strong position, being able to 'port' across its other software titles with relative ease. This will in turn provide its product line with a stable user interface that others may lack. If you already have an Archimedes, the word is to update to Arthur 1.2 ROMs and expect some interesting programs to be released in the near future.

way to modify the control codes used to print the graphics and therefore at the moment an Epson FX80 is the only printer that Graphic Writer can fully drive.

Similarly, there is no support for typestyles such as enlarged or condensed printing: if necessary, the printer driver could be modified to produce them on paper but the program would still format them in the same way as ordinary 'Pica' text. This would make document formatting difficult as the screen's maximum line length may be less than the printer's.

Clares informs me that the program is now in its finished state and, therefore, it will not be improving this situation — except for perhaps releasing a laserprinter driver some time in the future

## Documentation

Graphic Writer is supplied in a video cassette-style box with a 60-page manual which ambles through the essentials: the manual is not glossy but is certainly adequate for the task and comes with a good index.

## Conclusion

If you don't want a true WYSIWYG environment while typing documents and you don't mind the lack of a spelling checker, then Graphic Writer is worth considering. I particularly like the menu system, not simply because it is graphic-based, but because it is compact and quick to use. However, the program's printer support is limited.

The graphics editor is pretty to look at and fun to play with but I doubt whether it will be of much use to many people. The ability to include graphics not simply within the main text of a document, but also in its headers and footers is definitely useful, but probably more so if you could drive a laser printer.

The £29.95 price tag is certainly right, and I suspect that old BBC computer hacks will love this program: it does quite a lot and it does it quickly.

First Word Plus is available from Acorn Computers on (0223) 245200. Graphic Writer is available from Clares Micro Supplies on (0606) 48511.

END



# PRINTERS APLenty!

**LOW, LOW PRICES**  
with FULL BACK-UP  
SERVICE

**MICRO  
GENERAL**

**CALL OUR ENGINEERS  
NOW FOR ADVICE ON  
PRINTER SELECTION**



**OKI**  
OFFICIAL  
APPOINTED  
DISTRIBUTOR

**AMSTRAD**  
Appointed Dealer

## OKI MICROLINE PRINTER SPECIALISTS

The professional printers for all business applications. Print speeds up to 400 cps with 120 cps NLQ. PC/Epson compatible. Call for engineering advice. Competitive prices to match any competition.



### OKI MICROLINE 393 Advanced 24 pin print head

Superb print quality with a choice of paper handling modes. We highly recommend this versatile and rugged printer. Parallel and serial interfaces are fitted. Emulates Epson LQ Codes. Plug-in font modules. The best buy at just **£1195 + VAT**.



### OKI LASERLINE 6 Elite

Laserjet Plus compatible. **£1750 + VAT**  
The ideal daisywheel substitute having a wide range of emulations and resident font variations. Quiet in operation, compact and reliable. HP series II compatible

### LOW PRICE LASER TONER CARTRIDGES

Canon LBP8	£74.75
Canon LBP8 Series II	£74.75
CENTRONICS PP-8	£39.00
Citizen	£22.95
Epson GQ3500	£18.50
HP Laserjet	£74.75
HP Series II	£74.75
Kyocera	£28.50
OKI Laserline 6	£18.50
Technitron TLP-12	£17.50

## OTHER LEADING PRINTERS



### ★ CENTRONICS ★ NEC ★ STAR ★ TOSHIBA ★ BROTHER MOBILE/CAR POWER SUPPLIES

INPUT 12v, 24v, 48v. OUTPUT 240v 50HZ.  
IDEAL FOR MICROS, PRINTERS ETC. FROM  
**£249 + VAT**  
UNINTERRUPTABLE POWER-SUPPLY (UPS)  
250 VA 20 min back up **£750**  
OTHER POWER RATINGS AVAILABLE

## AMSTRAD



PC 1512 SD MONO	£399
PC 1512 DD MONO	£499
PC 1512 SD COL	£549
PC 1512 DD COL	£649
PCW 9512 single disc + daisy wheel printer.	£499
PC 1640 SD + ECD	£799
PC 1640 DD + ECD	£899
PC 1640 20M + ECD	£1199
PC 1640 incl. MONO DISPLAY	EPOA
PC 1640 incl. COLOUR DISPLAY	EPOA
PPC portable computer	EPOA
TANDON 20MB Business Card	£249

**Plus PRINTER BUFFERS • INTERFACES  
• CABLES • RIBBONS • SWITCHES etc.**

## ★ THIS MONTHS DISCOUNT OFFERS ★

### EPSON PRINTERS

LX-800	£210
FX-800	£325
FX-1000	£395
LQ-850	£465
LQ-1050	£625
EX-800	£415
EX-1000	£559
LQ-2500+	£799
Amstrad Parallel cable	£12

### OTHER PRINTERS

Star NL-10	£189
Star NX-15	£325
Panasonic KX-P1081	£169
Diconix 150 Portable	£375

### LASER PRINTERS

Canon LBP-8 Series II	£1650
Canon LBP-8 DAI	£2795
Centronics PP-8	£1395
Epson GQ-3500	£1345
H.P. Series II	£1995
H.P. 500 Plus	£2916
Kyocera	£2150

### PLOTTERS



Roland DXY-880A	£725
Hitachi 672	£535

### DAISYWHEELS

Panasonic KX-P3131P	£269
Qume 12/20	£350

ALL PRICES EXCLUDE VAT & CARRIAGE  
Prices subject to change without notice

## ORDERS AND ADVICE

  **07357  
4466**

OPEN 9 - 5.30 MON - FRI, 9 - 12 SAT  
Delivery charge £9 + VAT on printers & computers

Call us now for:  
● PRINT SAMPLES  
● DEMONSTRATIONS  
● ENGINEERS ADVICE

**DEALER ENQUIRIES  
WELCOME**

## .... STOP PRESS .... STOP PRESS

AMSTRAD PC1640 mono with 30MB CARD	£775
AMSTRAD PC1640 ECD with 30MB CARD	£1049

**MICRO  
GENERAL**

**Specialists in MICRO and PRINTER technology**  
Dept PCW4 Unit 25, Horseshoe Park, Pangbourne, Reading, RG8 7JW

# First-class Postscript

Attractive printout need not be the exclusive preserve of Macintosh users! Julian Dow takes you through the rudiments of the arcane but powerful language, PostScript, and shows you how to drive the Apple LaserWriter from *any* micro.

**D**esktop publishing is the growth area in microcomputing. Increasingly, people are discovering that it is no longer necessary to choose between dot-matrix output and the jobbing printer's beautiful but expensive product. The desktop publishing (DTP) empire is founded on the middle ground. You want your work to look crisp, neat and professional, but without having to go out-of-house to achieve it. The Apple Macintosh shot to fame for its obvious talents in this field as much as any other. The page description language (PDL), PostScript, developed by Adobe Systems, became the industry standard overnight when Apple adopted it for its LaserWriter printer.

Computer phototypesetting, the process by which text is converted to camera-ready bromides for platemaking, used to be much like any other kind of computer printing. The

printer was connected via a data cable, and the text to be printed was sent as ASCII. If a change in font size or style was required, control codes were sent, and the subsequent text was interpreted differently. This was easy to understand and cheap to implement, although the equipment was hardly cheap to purchase. Computer phototypesetters were good at handling text, awful at handling graphics, and totally unable to integrate the two.

The PostScript language, another product to have been nurtured at the Rank Xerox Palo Alto laboratories, is owned by Adobe Systems. It takes a revolutionary approach to phototypesetting. What is sent down the data cable to the printer is not a stream of text, punctuated by control codes, but an ASCII listing of a computer program written in PostScript with the text interspersed as data statements. The program is then executed by a

PostScript interpreter inside the printer.

This implies considerably more sophistication at both ends of the data cable, both in parcelling up the data to be sent, and in building up the image of the desired page at the receiving end. However, the enormous benefit is that text and graphics can be freely mixed on the same page, and can even interact. In PostScript, text can easily be fitted around an arbitrary object, like a circle. In the past, such an effect would have been impossible without recourse to Letraset and a skilled graphic artist.

The PostScript standard is accordingly becoming established. Even Hewlett-Packard compatible laser engines are starting to include PostScript interpreters. The Sun workstation (reviewed in *PCW* last month) operates as a series of PostScript windows. More importantly, the new generation of Linotronic computer phototypesetters are driven in PostScript. This may seem an unimportant point when the output of a LaserWriter seems so impressive, but rest assured that, for professional purposes, 300 dpi (dots per inch) is simply not good enough. A resolution of 900 dpi is considered adequate; the Linotronic L300 phototypesetter delivers 2540 dpi! Additionally, a full typesetter provides greatly superior justification facilities and a wider range of fonts — but at £20,000 or more, it's just as well.

The lovely thing about PostScript is its device independence. Precisely the same PostScript code can be used to drive a LaserWriter or a typesetter, and the result will look identical on both (apart from differences in resolution). The Apple LaserWriter is thus seen by the industry as an *inexpensive* proofing tool before the final bromide run on the typesetter.

## Why learn Postscript?

At one level, you may be curious as to how typesetting works. At another, you might be keen to write a desktop publishing (DTP) program yourself. Or you may simply want to achieve effects which are unavailable to you using proprietary software, even on machines like the Mac.

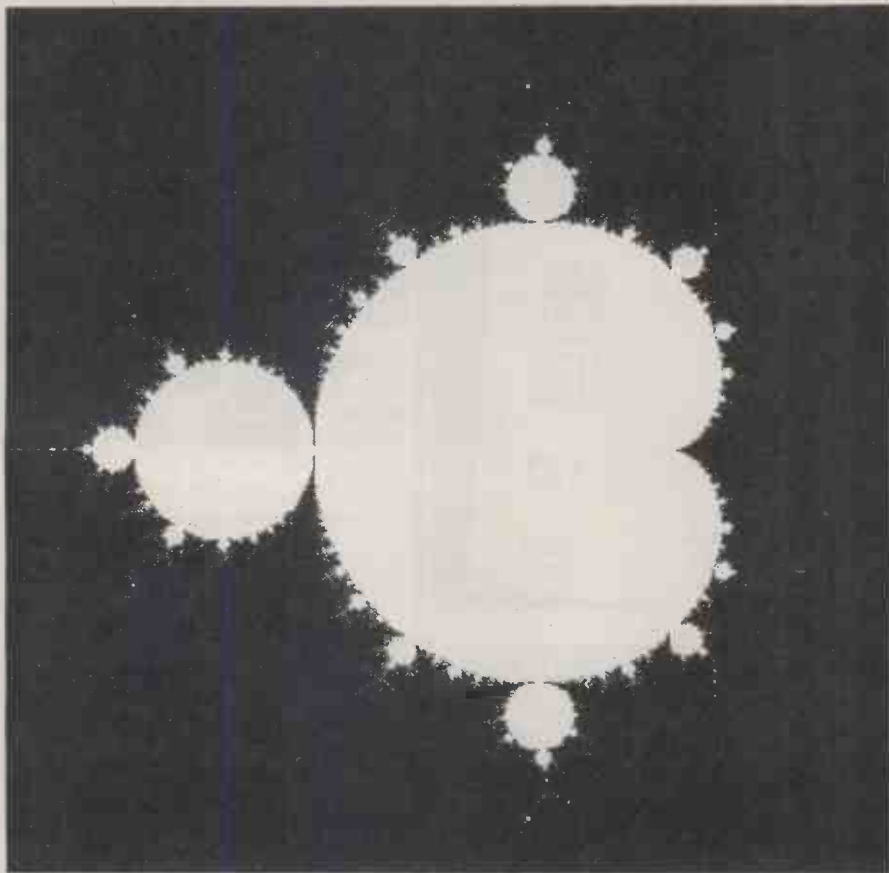

The calculations for this Mandelbrot set took 48 hours and were done in PostScript



There is a two-volume bible for experimentation in this field, published by Adobe Systems. Both the *PostScript Language Tutorial and Cookbook* and the *PostScript Language Reference Manual* are highly lucid and informative. If you want a few more examples to peruse, try the article by Pelli, *Programming in PostScript* (*Byte*, May 1987, 185-202).

Perhaps the most important reason for learning PostScript is that, like me, you find yourself in a mixed computer environment where you don't have a Macintosh computer but do have access to a LaserWriter. In that case, you must have dreamed of getting your computer talking to the LaserWriter, and getting high-quality output.

There are solutions, of course. £300 or £400 buys you an IBM card which allows you limited access to the Appletalk network, and you can then use the LaserWriter as a basic Diablo-compatible printer. Alternatively, read on. This article will tell you how to send both graphics and text, in fonts of your choice, to the LaserWriter, all for the price of a home-made cable.

## Connecting your micro to a LaserWriter

At the back of the LaserWriter, there are two D-connectors (9-pin and 25-pin) and a rotary switch. The selected connector and its behaviour depend on the switch setting. These can be one of:

**Appletalk** Input is taken from the 9-pin connector, according to the Appletalk protocol. The Macintosh is connected to this socket.

**Special Diablo 630 emulation mode.** Serial input is taken from the 25-pin socket at 9600 baud, parity ignored. The LaserWriter pretends to be a reliable, quiet, fast and expensive Diablo daisywheel printer. Only a typewriter font is available, but if speed and quietness are important to you, you could consider using a LaserWriter as your normal office printer. Note that this mode accepts text, not PostScript commands!

**1200 PostScript batch mode:** accepts input from either the 9 or 25-pin connectors at 1200 baud (parity ignored).  
**9600 PostScript batch mode:** accepts input from either connector at 9600 baud (parity ignored). The baud rate and parity for this setting, however, can be reconfigured.

The connections for two of the more popular Macintosh rivals (BBC and IBM computers) to the LaserWriter are shown in Fig 1. You should disconnect the AppleTalk connector from the LaserWriter while running it from the 25-pin port, otherwise the network will behave strangely and

you may become unpopular with the official users of the printer!

## Communication

The PostScript interpreter expects to receive only printable ASCII characters. Control codes are not approved of. This is good, because it means that you can use almost any text-processor and any comms program to send your output. Under some circumstances (for example, with bit-mapped images), you will need to send binary data to PostScript. In this case, you should send an ASCII hexadecimal version of each byte: hex 255 would be sent as the two-character string 'FF'. In this way, there's never any need to send weird ASCII codes to PostScript except for communications protocols.

PostScript is an interpreted language: that is, lines are interpreted from the source code that you supply, when the program is run. Like Basic, there is a speed penalty to pay; but it is generally rather easier to work with an interpreter than a compiler. The PostScript interpreter sits in the printing device, so you don't need any special PostScript program for your computer, only the ability to send ASCII files through your serial port.

So, any micro with a text editor and a comms program is ideal. As to the protocol, the default baud rates are 1200 and 9600. You are advised to set up communications using 1200 baud. However, once you transfer bit-map images to the printer, you'll be unlikely to get results on a reasonable time scale without using 9600 baud.

The PostScript interpreter can be stunningly slow, so it's important to make sure that you don't hang the system by sending data faster than the LaserWriter can handle it. Your communications link must be able to support the XON/XOFF protocol. Put simply, your computer must listen as it sends to the LaserWriter, and stop whenever it hears XOFF (ASCII character 19). It can resume transmission when it gets XON (ASCII 20). In theory, the protocol works the other way round too, allowing your computer to stop itself from being swamped by diagnostic messages from the LaserWriter. In practice, though, these are both rare and terse, so (provided your computer empties its input buffer occasionally) there should be no need to worry. Most terminal emulator programs will support XON/XOFF. I actually use a short Basic program to download text files from a BBC Micro to my LaserWriter, which hasn't let me down yet (Listing 1).

Sending ASCII 4 at the end of your text file is wise. If you've written bad

```

10REM FILE TRANSFER: BBC/LASERWRITER 9600 BAUD
20REM SUPPORTS LIMITED XON/XOFF PROTOCOL
30REM JATD 23/12/87
40MODE 0
50INPUT "File to transfer?" FS
60PROCinit
70PROCscan
80PROCfinish
90END
100DEFPROCinit : REM sets up serial port
110*FX8,7
120*FX7,7
130*FX6
140*FX5,2
145 F%-OPENIN(F%): IF F%=0 PRINT "Eh?":STOP
150interrupt=FALSE
170ENDPROC
200 DEFPROCscan : REM sends file to laserwriter
210 C%-BGET#F%
220 REPEAT:PROCsend(C%):C%-BGET#F%:UNTIL EOF#F%
230 ENDPROC
310DEFPROCfinish : REM sends ASCII 4
340PROCsend(4)
350*CLOSE
360VDU7
380ENDPROC
390DEFPROCsend(int)
395*FX2,1
400IF ADVAL(-2)>0 PROCunload
405 *FX2,2
410VDU2,1,int,3
420ENDPROC
500DEFPROCunload : REM empties BBC input buffer
510*FX2,1
520C%-GET
530*FX2,2
540IF C%=19 THEN interrupt=TRUE:VDU7:PROCunload
550IF C%=20 THEN interrupt=FALSE
555 IF C%>30 THEN VDU C%
560IF (ADVAL(-2)>0) PROCunload
570IF interrupt=TRUE THEN PROCunload
580ENDPROC
    
```

Listing 1 BBC program to send files

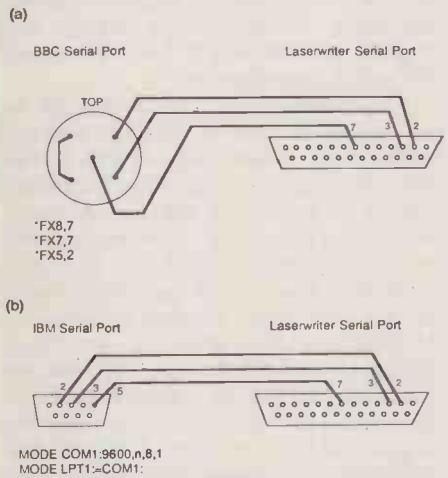

Fig 1 Connections on the LaserWriter

code, it tells the PostScript interpreter to ditch the job.

If you're using a comms program, and you're curious as to what the LaserWriter's doing, type Control-T. This causes the LaserWriter to send back a one-line status message describing its progress — idle, busy, printing, no paper tray, and so on. Programs could perform this task automatically every few seconds to warn of any problems.

## Nature of the language

PostScript is a fully-fledged computer programming language. Only about a third of its commands directly handle imaging. However, it is extremely well-suited to the task of image specification. There are two points which must be understood clearly before you dip into the language: PostScript uses a *post-fix* notation, and is *stack orientated*.

If you're a Forth programmer this will probably come as great news, but if you're a mortal like myself, you'll already be wondering if it's worth the effort coming to grips with the language at all. If these terms mean nothing to you, then here's an example. In Basic, to add 2 and 3, you'd say something like:

```
A=2+3
```

Whereas in PostScript, you'd say:

```
2 3 add
```

This means: (a) put 2 on the stack; (b) put 3 on the stack; and (c) take the top two numbers from the stack, add them, and return the result to the stack. Note that the result is not normally stored as a variable, so to program competently in PostScript, you need the kind of mind that can keep track of what has gone on the stack, and in what order.

If you're the kind of person who can remember what cards have gone down in a game of poker, or if you write compilers for a living, then this will be second nature. If not, then draw some consolation from the fact that it is possible to store to named variables in PostScript using the slightly cumbersome DEF construct (of which more below).

The question of the superiority or otherwise of post-fix notation has enlivened the letters page of more than one computer journal. The important things in its favour are its compactness and ease of implementation, while against it weighs the fact that relatively few people can ever obtain an intuitive grasp of what's going on. In selecting this style for the PostScript language, Adobe has insured that the limited processors in PostScript printers can perform quite impressively for their size, but has rendered the language difficult for any but systems developers to spend time on. This is a shame, as PostScript repays some effort in understanding.

## The ideal page

The PostScript 'ideal page' is like a sheet of graph paper, with the origin in the bottom left-hand corner. Unlike graph paper, however, the page is ruled in divisions of 1/72 inch. This corresponds to the printing industry's 'point' scale, which is great for some things (like specifying the size of type you want), and lousy for others (like specifying where on the page to put it).

Fortunately, there are simple ways to specify chosen coordinate systems, and an example will be given shortly. Another point to note is that the default origin is the physical corner of the paper, although the printable area is not so large (for A4 paper, it's a 7.41in x 10.86in size, centred on the 8.25in x 11.66in page).

Moving around on the screen will be immediately familiar to anyone who has programmed points directly to a video screen. You can either move the origin and coordinate systems with the translate, rotate and scale operators, or move relative to your coordinate system with the MOVETO command.

PostScript can handle three major groups of picture: text, paths and images. Text is handled as strings (enclosed in brackets rather than the more common quotes), and placed on the page at the current coordinates with the SHOW command. A path is a series of points, specified by (for example) a series of MOVETO and LINETO commands, and is placed on the page by the STROKE command. An image is a 2-D grey-scale bit-map which is plotted onto a unit square by the IMAGE command. Any or all of these commands can be used to build up the printer's notional representation of the page, which is then committed to the physical page of paper by the SHOWPAGE command. No SHOWPAGE, no output! Because of this emphasis on pages, PostScript is known as a 'page description language'.

By general convention, the first example in any computer language tutorial is a program to print the words 'Hello World'. Listing 2 begins with a descriptive comment, specifies a resident font, scales it to 18-point size, moves one inch up from the bottom-left corner of the page, prints 'Hello World', and commits the image to paper (Fig 2).

```
% The simplest of all programs...
/Times-Roman findfont
18 scalefont
setfont
72 72 moveto
(Hello World) show
showpage
```

Listing 2 The 'Hello World' program  
Fig 2 Output of program

# Hello World

However, even this program merits detailed study. First, the comment line: any text following '%' until the next newline is considered as a comment and ignored by the interpreter. A newline in PostScript is the 'linefeed' character (ASCII 10). However, carriage return (ASCII 13) or combinations of carriage return and linefeed are automatically interpreted as newline.

The second line is interpreted as follows: put the name Times-Roman on the stack as a 'literal' (something not to be interpreted) as it is prefixed by '/'. Then execute the 'findfont' procedure, which expects to take a font-name from the top of the stack,

find the font, then put it on the stack. Note that the entire font constitutes a single object in PostScript, and so can be dumped on the stack just like an integer or a literal.

The 'scalefont' function requires two arguments — the font, and the scale required. At the end of line two, the font is at the top of the stack. Line three puts the desired scale (18) on the stack, executes scalefont, which removes the font and the scale from the stack, and replaces them with the scaled font. This scaled font is then selected as the current font by 'setfont', which also clears the font from the stack. The next line puts 72 and 72 on the stack, then executes 'moveto' which takes them off the stack and uses them as x and y coordinates to move to. The brackets surrounding 'Hello World' are in fact PostScript's version of string delimiters, so this line puts 'Hello World' on the top of the stack as a string, then prints it at the current position on the 'ideal page'. Note, though, that this is only written on a notional page; to commit yourself to paper, you must issue the command SHOWPAGE which starts the LaserWriter's motors churning.

## Specifying a path

The second class of PostScript object is the 'path'. This is the path (or locus, if you're a mathematician) of an imaginary paintbrush, described by a series of MOVETO, LINETO or ARC commands. Once a path has been defined, it can be drawn with the STROKE command, with a line of variable width (using 'setlinewidth') or grey value (using 'setgray'). Alternatively, if the path is closed (you can force this with 'closepath'), it can be filled with 'fill'. Fig 3 shows an example of the 'path' operator. This defines a path to draw a square box, then strokes it.

This is really three examples in one. First, the box-drawing procedure is defined. As the procedure is in curly braces it is not interpreted immediately, but is stored in the 'userdict' stack of user-defined variables and procedures, to be called by name from the main program. Three boxes are then drawn at the current coordinates (specified by MOVETO).

Listing 3 Program to draw boxes

```
% examples of boxes
/box { 0 72 rlineto
72 0 rlineto
0 -72 rlineto
closepath } def
% main program
newpath % draw outlined box
144 432 moveto
box
.5 setgray
5 setlinewidth
stroke
newpath % draw filled box
144 288 moveto
box
```



# Publish and be praised.

THE COMPANY  
**BUSINESS**  
*Report*  
May 1987  
Volume 1; No. 1



**GEM Desktop Publisher Sets Price/Performance Benchmark for Software Industry**

Digital Research announces its high performance easy to use, full-function page composition software application - GEM Desktop Publisher, introducing the true price/performance, available at the end of May, at a suggested retail price of £295.

"We're excited to provide an integrated team of products for personal publishing with the addition of GEM Desktop Publisher to our family of GEM applications," said Dick Williams, Chief Executive Officer of Digital Research. "Users now have a more complete and easier to use solution for combining text and graphics than ever before. But more important for the user is the outstanding price/performance offered by our product," continued Williams.

Flexibility is a key feature of this GEM-based software product. The user can define a location anywhere in a document and automatically place text or graphics at that location.

*Continued on page 5*

**Desktop Publishing Increases Its Share of the Market**

**Employees Interested in Receiving Their Own Desktop Publishing Software**

**Projected Market Shares**



Desktop publishing expert John W. Seybold, establishes some shopping criteria for the "godsend" desktop publishing software, from the May issue of *Byte*. He feels the system should "let you compose text in a manner that comes close to the requirements of typesetting." Including well-designed and proportionally spaced characters, multiple fonts, sizes, etc.

Seybold also believes that the system should allow you to perform the composition tasks "in a manner that is considerably less code-intensive than that which characterizes trade computer typesetting." This includes the feature of WYSIWYG which "lets you point to the effects desired rather than requiring that you describe them by some sort of command and language". He feels that software programs that were "code-intensive" and required "considerable user experience" should not be included in the desktop publishing category.

"As a product offering, it's the best thing that ever happened to personal computers," says desktop publishing expert, John W. Seybold, about desktop publishing, in the May issue of *Byte*.

Desktop publishing, the latest development in microcomputers, offers the user the ability to combine text and graphics to create professional quality brochures, newsletters, fliers, sales reports, marketing briefs, books, manuals, forms, and other publications on their own computer. And, as Stewart Alsop says in the February edition of *PC Magazine*, "Ever since Cuttenberg, publishers have been looking for a better, cheaper, faster way to get words and pictures on paper."

**Growth for PC Software Market**  
Software Revenues for U.S. Suppliers

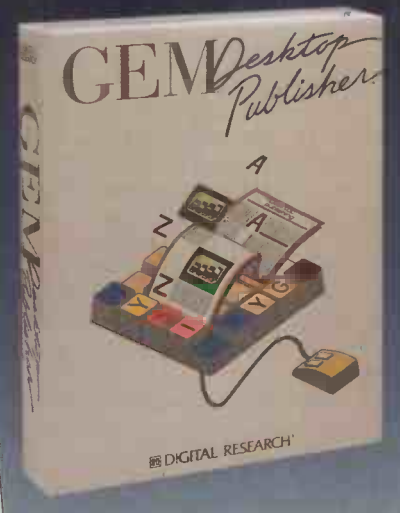
## GEM® Desktop Publisher™ makes it easy.

With GEM Desktop Publisher you can create eye catching, professional-quality reports, brochures, newsletters, mailers, marketing briefs, manuals, and many other documents on your own personal computer.

GEM Desktop Publisher is so easy to learn and use. Its icon-based, 'drop-down' menus eliminate the need to memorise complicated commands and help you become productive immediately. GEM Desktop Publisher features the fastest turn around time from concept to high quality finished output.

It is big on performance and features yet small on price, setting a new price/performance benchmark at £295 (ex. VAT).

GEM Desktop Publisher is compatible with your existing word processor software. You can easily incorporate images that you create with the GEM family of applications from GEM Draw Plus to GEM Graph.

GEM Desktop Publisher is so flexible that you can use word processor files or keyboard commands from many popular word processors, such as WordStar™ and MultiMate™.

It support the full IBM PC™ family, 100% compatibles, and the new IBM Personal System/2™ family of computers, plus a wide range of printers.

### WHAT YOU SEE IS WHAT YOU GET

- Total flexibility in inserting, deleting and rearranging pages, text and graphics.
- Style sheets for easy page formatting and layout consistency.
- Merging of text and graphics.
- Automatic text flow around graphics.
- Fonts in multiple sizes, many colours and many styles.
- Automatic reformatting of documents.
- Automatic scaling of graphics.
- Rule measure in inches, picas and centimetres.
- Mapping of menus and mouse functions to keyboard.

**Praiseworthy results . . . easily achieved.**  
**That's GEM Desktop Publisher.**

Phone (0635) 35354 for the name of your local distributor.



ANOTHER GEM® FROM  
**DIGITAL RESEARCH®**

```
.5 setgray
fill
newpath
% draw filled AND outlined box, using gsave
144 144 moveto
box
gsave
.5 setgray
fill
grestore
0 setgray
5 setlinewidth
stroke
showpage
```

Fig 3 Output of program



The first is outlined with the 'stroke' operator, the second filled with the 'fill' operator, and the third both filled and outlined.

There is an important point to note in this last example. The fill and stroke operators both erase the current path from the stack while drawing, so you can't use both on the same path. To get around this, we save the current graphics state of the machine by calling 'gsave' before the first operation. After the box has been filled, 'grestore' restores the previous graphics state in which the box was the current path so that it can also be stroked.

The gsave and grestore pairing are widely used to allow you to alter the origin and coordinate transformation

```
% use path operator to specify a polar plot:
% r = 1.5 - sin(9.theta).cos(12.theta)
/inch {72 mul} def
/doleaf { % define our path
newpath
0 1 360 {
% --- store loop variable as theta:
./theta exch def
% --- calculate r according to formula
/s theta 9 mul sin def
/c theta 12 mul cos def
/r s c mul 1.5 exch sub def
1 rotate
r inch 0 inch
% --- if theta=0 move, otherwise draw
theta 0 eq {moveto} {lineto} ifelse
} for
closepath
} def
% --- main program
4 inch 5 inch translate % move origin
0 0 moveto
doleaf
gsave
.5 setgray fill
grestore
0 setgray 3 setlinewidth stroke
showpage
```

Listing 4 Program to draw leaf pattern  
Fig 4 Output of program

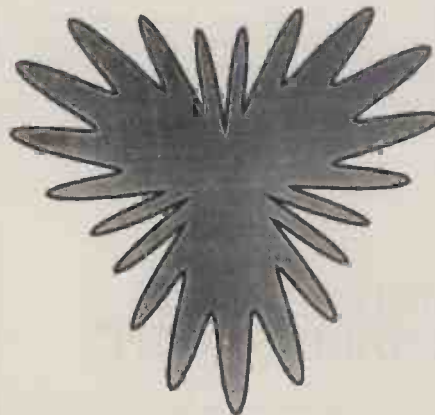

system rather promiscuously, to make some special effect rather easier, and then return to a more sanitary state.

Of course, specifying the coordinates making up a path individually (as we did for the box) is a pretty tedious pastime for all but the simplest shapes. We can simply evaluate a formula to obtain successive points on our path. (This is what we learned at school as 'plotting the locus of a point'). Unfortunately, laser printers weren't commonplace in my school-days or my career might have taken a different path, so to speak.

The third line of the simple example shown in Fig 4 shows the promised trick for converting from your desired measurement units to points. The procedure 'inch' is defined as something which multiplies the top item on the stack by 72. The curly braces indicate that this is a procedure for storage on the userdict stack and not for immediate execution. In use, a line like:

```
1.5 inch 2.5 inch moveto
is interpreted by the LaserWriter as
108 180 moveto
```

saving you the bother of making the conversion. Another point in the program is the use of a conditional clause, the IF...ELSE construct. A logical test is performed, in this case comparing two values with the EQ command, which leaves a Boolean (true or false) on the stack. The IF...ELSE takes a Boolean and two procedure names off the stack and executes the first procedure if it finds true, the second procedure otherwise. There is also an example of a DO loop. In PostScript, these take the form:

```
startvalue increment endvalue
{procedure} for
```

The loop variable is put on the top of the stack for each iteration, so be sure to get rid of it (using 'pop') if you don't use it within the loop, or the stack will overflow.

Another point is that, rather than use trigonometry to calculate x,y coordinates from my polar coordinates, I simply rotated the coordinate system repeatedly. As the coordinate system went around all 360 degrees, it wasn't too important to bother with gsave and grestore, although they would have been stylish.

Of course, most fonts are defined as paths. There are two types of font: bit-map (in which each letter is specified as a series of pixels), and analytic (in which each character is stored as a path). Analytic fonts are greatly to be preferred as they scale up much better. Bit-mapped fonts in large sizes look terrible compared with analytic fonts (like Times). If you fancy your hand at specifying your own fonts, or just special single char-

acters, then delve into the PostScript language tutorial and reference volumes.

Closed paths can be used as windows through which other patterns can be seen. They are known as clipping paths, as they clip the outlines of other components of the picture. In the example below, we set up a

```
% Clipping Path demonstration
% --- define your parameters
/left 72 def
/top 720 def
/bottom 72 def
/linespacing 12 def
/clipshape % --- specifies the clipping path
{
/Helvetica-Bold findfont 156 scalefont setfont
newpath
100 400 moveto
(PCW) true charpath clip
} def
/background % --- routine for filling background
{
/Helvetica-Bold findfont 12 scalefont setfont
bottom linespacing top {
left exch moveto
0 1 3 { (Personal Computer World) show
} for
} for
} def
% --- main program starts here
clipshape
background
showpage
```

Listing 5 Demo of clipping path  
Fig 5 Output of program

```
al Computer      ersonal Co.   ter W   Perso   omp
al Computer W   ersonal Com   er W   Perso   Com
al C   r W   J Per   omp   r W   Perso   Com
al C   r W   d Pe   r W   Pe   son   Cor
al Computer W   id Pe   Wo   J Pr   son   Co
al Computer'   d Pe   Wo   d P   on   Co
al C   d Pe   omp   World F   onal Cr
al C   l Pers   Comr   World   onal Cr
al C   Personal Cor   World   onal Cr
al C
```

clipping path made of the outlines of a huge (156 point) 'PCW', then filled the page with repeats of a tiny 'Personal Computer World'. Only those that are within the clipping path reach the paper (Fig. 5).

'Charpath' takes a string and produces a path according to one of two algorithms (governed by the selection of true/false). 'Clip' then takes the path and uses it to clip the ideal page. The page is then filled with two nested DO loops.

## Stopping startup!

The Apple LaserWriter is notorious for wasting a sheet of paper, every-time it is switched on, by printing a 'startup page'. Rooms in which LaserWriters are situated are readily identifiable by the sheaves of scrap paper littering all available surfaces and covering the place where the wastepaper basket was once rumoured to be. In fact, there is a way of turning the startup page off, described in the *PostScript Language Reference Manual*. Not only does it save paper, but it cuts the machine's warm-up time from 50 to 25 seconds! So even if you aren't too interested in PostScript programming in general, this little trick will make you a local hero.

Send the program shown in Listing 6 to the LaserWriter (from a Macintosh, use a comms program or the



# FOR TOUGH CUSTOMERS



When today's tough customers put out a contract on a computer, you can bet someone's in for a testing time.

Like Edward G. here, Britain's biggest customers – blue-chip companies, universities and hospitals – make a habit of rounding up the competition and taking them apart, bit by bit.

To survive, a computer has to be reliable, flexible and prove heavy on features yet light on price. For when the chips are down a fancy name and flashy looks count for little.

Fortunately, one AT-compatible is proving to have more muscle than most – the PC V Turbo from Opus Technology. At just £1,295 it's untouchable.

- 80286 microprocessor
- 6/10 MHz (zero wait state) switchable clock speeds
- 1 Mb motherboard memory
- 30 Mb hard disk
- 1.2 Mb 5.25" floppy (3.5" option)
- 5 free expansion slots
- Parallel and serial printer ports
- Mouse port
- High-resolution flat-screen monitor
- Enhanced 102-key keyboard
- EGA option
- 12-month warranty

**PC V** TURBO

Substantial savings on education, business and public sector orders.

**£1,295**



**Opus Technology**

For details call Opus Technology today on (0737) 765080 or Fax (0737) 769873. Price quoted exclusive of VAT and carriage. Opus Technology Ltd, 53 Ormside Way, Holmethorpe Industrial Estate, Redhill, Surrey RH1 2LW.

# DRAWING FURTHER AHEAD



Or perhaps our low cost entry level plotter – 672 XD may have just the facilities to suit you.

The **NEW**

## HITACHI 673-BM GRAPHICS PLOTTER

Add impact and professionalism to your business graphics with the **NEW** 673-BM – The latest addition to Hitachi's 670 series. Simply connect it to your PC or Micro Computer and you will be amazed at the results. Graphs, charts, technical drawings and marketing and management accounts presentations are produced at high speed with clarity and accuracy – a cost effective and colourful new dimension to your business procedures.

◆ 128K buffer memory for repeat plotting, fast and efficient use of computer time. ◆ Automatic sheet feeder. ◆ Emulates HP7475A. ◆ Automatic pen capping. ◆ Handles A3/A4 paper and overhead transparency material. ◆ Serial and parallel interfaces. ◆ Wide range of HP-GL plotting commands. ◆ Easy to use control panel.

◆ For more details on Hitachi Plotters and the name of your local distributor contact us today or return the coupon below



**Nissei Sangyo**

Nissei Sangyo Company Limited,

Craven House,  
40 Uxbridge Road, Ealing,

London W5 2ST

Tel: 01 567 3655

Fax: 01 579 2683

Telex: 261409

Please send me more information on Hitachi Plotters.

Name \_\_\_\_\_

Position \_\_\_\_\_

Company \_\_\_\_\_

Address \_\_\_\_\_

Telephone \_\_\_\_\_



```
% stop startup page by changing the
% setdostartpage persistent parameter
% serverdict begin 0 exitserver
statusdict begin
dostartpage = flush
false, setdostartpage
dostartpage = flush
end
```

## Listing 6 How to turn off the LaserWriter startup page

PostScript facility of CricketDraw). The zero in the first executable line is, in fact, the default system administrator password for the interpreter. Issuing the password takes you to a privileged level where the printer operation can be reconfigured permanently and a warning to that effect is sent back to the terminal.

The password can be reset in a similar way to the startpage, using the 'setpassword' operator. In fact, several of the persistent parameters

**'PostScript is a fully-fledged computer programming language. Only about a third of its commands directly handle imaging. However, it is extremely well-suited to the task of image specification.'**

for the LaserWriter can be changed using programs such as this; the only one that everyday Mac users may have come across is the renaming of the printer, using the 'setprintername' operator.

Beware, though, when playing with such programs. The first line of the program exits from the server environment, making your changes permanent. You could stop the printer from working permanently if you did something silly, so read the *PostScript Language Reference Manual* before experimenting. Note the equals sign in the lines:

**dostartpage = flush**

'Dostartpage' puts a Boolean value onto the stack, according to whether the machine is set to produce a startup page. The equals sign is an important way of interrogating the stack. It sends the value at the top of the stack to the terminal. 'Flush' is used to empty the terminal output buffer, to make sure you get the information immediately. This type of construct is very useful in getting information back from the machine when a program is running. In this

case, the messages returned are true then false.

The startup page on the LaserWriter is more interesting than it might appear. As well as the number of pages printed so far and the name of the machine, several operating parameters are encoded into the picture. For example, the number of ticks on the left-hand graph shows the rotary switch setting: 0=1200 baud, 1=9600 baud, 2=special, 3=Appletalk. The height of the bars in the centre graph show the baud rates of the 9-pin and the 25-pin connectors, and the colour encodes the parity setting.

As a precaution, perhaps it may be useful to keep the startup page under some circumstances.

## The image operator

If you can wait long enough for the serial data to be transferred, the LaserWriter makes an excellent and easily customised graphics screen-dump engine. The key to this is the image operator, which acts on a 2-D greyscale bit-map of an image. This allows you to use the LaserWriter as an excellent multipen plotter, or as a printer of digitised video images.

All you have to do is scan your computer screen with a pair of nested DO loops, and send the pixel values sequentially to the LaserWriter! By default, data is sent as successive rows from left to right, and starting from the bottom. Even this, however, is readily altered with a scaling matrix. The general format of an image-dumping PostScript program is shown in Listing 7.

The key point to note is the format of the data stream. As PostScript only recognises printable values of ASCII, you must send binary data as a hexadecimal version of the value, as described above. So, 255 would

```
% dumps x by y pixel by 8-bit grey level image
/inch 72 mul def
1 inch 1 inch translate
3 inch 2 inch scale % set size of picture
x y 8 % dimensions of image to be read
[x 0 0 y 0 0] % transform matrix for scaling
(<your hex data>) image
showpage
```

## Listing 7 General format for a screendump program

be sent as the two ASCII characters 'FF'. A simple Basic function to do this conversion would look like:

```
a$="0123456789ABCDEF"
DEF FNbin_hex (n) = MID$(a$,n DIV 256,1) + MID$(a$,n MOD 256,1)
```

The program as it stands expects 256-greyscale data, whereas few micro displays have such resolution. The simple answer is to scale each pixel to occupy the full range. For example, if in your dialect of Basic, POINT(x,y) returns a greyscale value from zero to seven, you want

```
FNbin_hex( POINT(x,y) * 32)
```

Of course, this is rather slow to

```
% calculates the Mandelbrot set
% --- define variables
/maxcycles 255 def % - number of iterations
/xmin -1.7 def % - left edge
/ymin -1.3 def % - bottom edge
/pixels 512 def % - image resolution
/interval .005 def % - pixel spacing
/j ymin interval sub def % - starting y-value
/rowarray pixels string def
% - string to hold 1 row of pixels
/mandel { % --- calculates 1 row
/j j interval add def % - increment row number
0 1 pixels 1 sub % - for each x-value
{ /indx exch def % - calculate x-value
/i indx interval mul xmin add def
cycle % - perform iterations
rowarray indx n cvi put % -result in correct element
} for
j = flush % - info to terminal, so you know OK!
rowarray % - return string to calling routine
} def
/cycle { % - does iterations
/n n 1 def
/x 0 def
/y 0 def
{
/y2 y y mul def
/x2 x x mul def
/y 2 x y mul mul j add def
/x x2 y2 sub i add def
/n n 1 add def
n maxcycles ge x2 y2 add 4 ge or (exit) if
} loop
} def
/doimage { % - sets up and calls image
pixels pixels 8 (pixels 0 0 pixels 0 0) (mandel) image
} def
% --- main program
100 200 moveto
512 512 scale
doimage
showpage
```

## Listing 8 Program to calculate the Mandelbrot set shown on page 148

calculate but nothing like as slow as the serial data transmission, as each pixel is being represented by one byte and two characters. An alternative is to tell the PostScript interpreter that you are sending 4-bit data, by changing the line:

```
x y 8 to x y 4
```

Then each character corresponds to one pixel. For large screendumps, it is a bad idea to load all the pixel data onto the printer's stack before calling the image operator to unload it. The stack has a limit of a few hundred items, so the program will crash. Instead, put a procedure in the braces, which produces one line of data at a time. 'Image' will call the procedure repeatedly until the right number of pixels have been read.

A powerful application of the image operator is to plot a mathematical function. If you wished to plot  $z=f(x,y)$  for a range of  $x$  and  $y$  values, you could set the computer calculating each value in turn and sending the results to the LaserWriter; or you could simply program the LaserWriter to calculate the points directly. The image operator needs a 2-D array of greyscale value, but doesn't care where it comes from. So, instead of an array of data, you need only provide a procedure which generates the data. Shown on page 148 is a printout of the Mandelbrot set, which enthralled so many people after that classic 1986 *Scientific American* article — be prepared to wait for your output, though.

Julian Dow is a lecturer in the Department of Cell Biology at the University of Glasgow. **END**

# Serving the system

The long-term use of the SQL programming language on mainframe database systems has prompted its acceptance in the micro field — not least by IBM and Microsoft in OS/2. Kathy Lang assesses its importance at all levels of computing power.

**M**any PC users already know how hard it is to transfer themselves or their data from one package to another. Many word processors initially adopted their own file formats so that most text files were far from plain, but contained scatterings of control codes and other formatting information. In the database and spreadsheet worlds there have also been few attempts to standardise on particular files or interfaces, and most moves have come from manufacturers with vested interests.

For users of databases, file incompatibility can have more serious consequences than in other fields because the information structures and the programs which handle them tend to be more complex. With no standard method of storing information in a database, there can be no standard method for inputting or extracting information from a file. On larger systems, where many different applications may be trying to access the same information, the problem is much worse. One step towards solving it on large systems has been the creation of centralised databases, with generally-agreed data structures being supervised by a database administrator.

In order for this to work, the data structures have to be appropriate for a wide range of applications which must be written in such a way that data is not duplicated. The history of

these developments is covered in the box opposite, and they have now reached the point where there is a defined standard for specifying both data structures and the way they can be interrogated.

## Data protection

Even on single-user systems, there is an obvious need to check the accuracy and internal consistency of data. For example, you should not be able to create an invoice for a customer who does not appear in your customer file. If you design, build and use your own systems, you may look after this yourself, but where a system is built by one person or group and used by another, formal checks on data integrity should be built in. And, users must be prevented from circumventing the checking by updating the database directly. The more people use the system, the more important this becomes.

Again, all the major packages, and the compilers for programs such as dBase III, have facilities to allow you to build in such checks, but few make it easy. If several applications can update the same database, all must include their own error-checking (though some programs help in this by allowing the use of a shared library of subroutines). Such checking can sometimes involve significant overheads, both in system performance and in programming.

For example, where several files

are being updated in sequence, it is possible that an error in user input will not be discovered until the last update is tried. Then all the preceding changes must be 'undone', repeating all the file accesses in reverse order. And if the system should hang in the middle of either phase, good luck!

That last example highlights one of the most error-prone aspects of PCs: what happens to your data if your system crashes, or someone pulls the power plug before data has been saved properly and files closed? And how does the system cope if a task goes berserk and steps over the border into an area of memory being used by another task running on the same processor? Some of these problems, notably the problems of multitasking, require operating system facilities not yet available but promised, for IBM PC systems, in the full version of OS/2.

To facilitate some sort of standardisation among databases, many manufacturers are adopting SQL (Standard Query Language) as their interface. SQL has been used on mainframe databases for some time, and with the growing interest in micro/mainframe connectivity, it makes sense for micro database publishers to also adopt SQL as their standard. This move was reinforced last year by the decision of IBM and Microsoft to support the language as a part of OS/2.

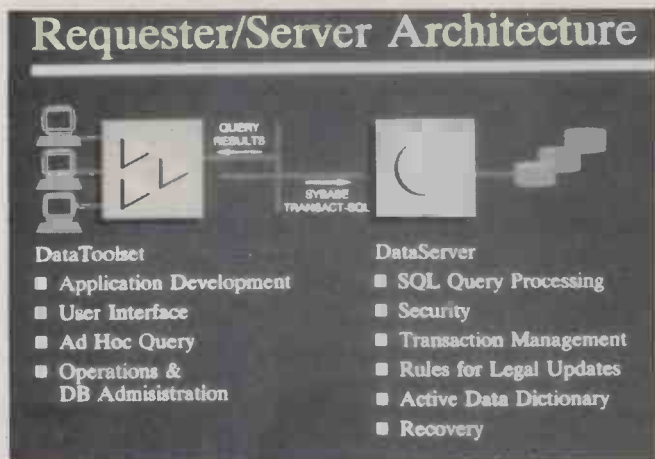

Any suitably-configured application can act as a front-end to the SQL data server, which acts in the same way as a network file server except that the whole of the server is dedicated to one database

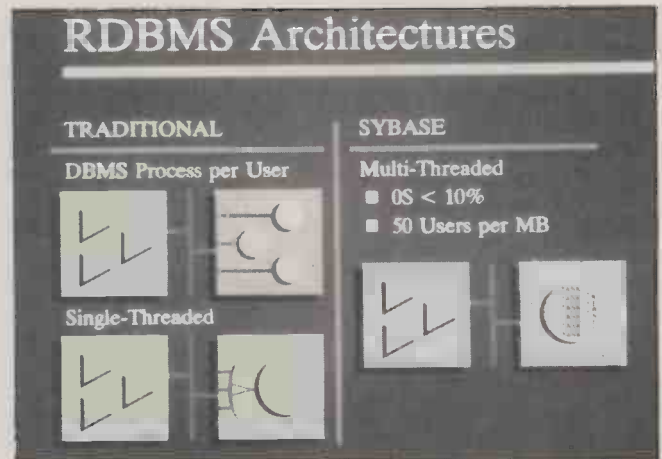

Three approaches to multi-user access: one process per user; the data server running a single task and users queuing for access; and many users at different points in the same entrant data server routine



SQL may seem just another programming language like dBase. But, its existing acceptance within many parts of the computer industry, and the fact that it is not linked to any proprietary product, will mean that increasing numbers of database manufacturers at all levels of computing power will include SQL support in their packages.

In this review I will look at some database situations and discuss why a standard like SQL is necessary. I will also give some examples of SQL in operation, though thankfully, it can be implemented as a 'black box' with users being shielded by existing friendly front-end applications from the nitty-gritty of raw code.

## Batch facilities

In systems which take instructions entirely interactively, using menus and question-and-answer, it is difficult to provide a simple way to automate repetitive tasks. Some systems try to do so by allowing the recording of a sequence of keystrokes; others by using equivalents for keyboard characters which can be stored in a file and edited. But such systems are notoriously difficult to use. And, for systems which make heavy use of the mouse without providing keyboard equivalents for all operations, they are virtually impossible to implement.

The alternative approach, used by most powerful database systems, is to use commands, either as an alternative or as a substitute for menus. This may allow, as it does in dBase, the option of using commands interactively; it will certainly permit storage of a batch of commands in a file to be run regularly. It also opens up the possibility, as has been done with many systems, of adding commands which are only appropriate in a batch setting, or where interaction is permitted only indirectly, thus developing a programming language specifically for database handling.

Standards exist for conventional programming languages such as Basic, Fortran, C, Cobol and all. In the micro world, as I have mentioned, there are no standards yet for database languages. And while many language standards are more honoured in the breach than the observance, at least they offer a minimum to which all conform. The desirability of a standard is one of the reasons for the continuing popularity of dBase products through periods when competitors have provided demonstrably better facilities more cheaply — most people being of the opinion that an *ad hoc* standard is better than none, and a widely-accepted *ad hoc* standard is better

## Landmarks in the SQL story

*(SQL is officially pronounced by its initials, as Ess-Queue-El, but it is almost universally known as Sequel.)*

**1970:** EF Codd, at that time working at the IBM Research Laboratory in San Jose, California, published his now classic paper on the relational model for large databases. This paper laid the foundation for all subsequent work on developing the relational model, from which stemmed the implementation work needed to produce workable relational systems, including relational languages.

**1974:** Creation of the relational language, Structured English Query Language, by DD Chamberlin and others at San Jose. This language formed the basis of the first IBM prototype system, SEQUEL-XRM, in 1974-5.

**1976-7:** Revised version, called SEQUEL/2, developed; a large subset of this language, subsequently renamed SQL for legal reasons, was implemented by IBM as System R. This became operational in 1977, and was subsequently installed on a joint study basis at a number of customer sites, as well as undergoing trials within IBM itself.

**1981:** First commercial version of SQL announced by IBM for its mainframe operating system DOS/VSE, followed by a version for MVS called DB2, the major SQL product now supplied by IBM. The long gap between tests beginning on System R and the release of a viable product allowed other vendors to develop SQL implementations, and that from the company which is now Oracle Corporation preceded IBM in the market.

**1982-8:** Many other implementations of SQL were launched, either as standalone products (including Sybase — see under 'The Ashton-Tate/Microsoft SQL server'), or as interfaces to existing products such as Ingres. On micros, the command language used in the Open Access database module is based on SQL, while dBase IV promises an SQL implementation alongside the current dBase command language.

**1986:** The importance of SQL in the market as a whole was recognised by the ratification of an ANSI standard for SQL. The initial standard was essentially the IBM dialect of SQL, and has been criticised for leaning too much towards protecting existing vendors' implementations and not being sufficiently concerned with the need for a solid foundation based on formal language principles. Substantial revisions of the standard have been proposed.

than an unpopular pukka standard.

There is, then, a certain irony in Ashton-Tate being the first supplier of database systems for PCs to recognise the desirability of an external standard for command languages. The reason is the popularity of the chosen language, SQL, on larger systems, which means that many dBase users and potential users are asking to have the same language available across all their database systems.

The use of a standard command language also opens up the possibility of simple inter-program communication. For example, a series of changes made to a database on a micro, using one database program, could be propagated on a mainframe using another database program simply by means of a task initiated on the micro, communicated to the mainframe and executed there, all without user intervention.

So, there are three main areas in which we might hope to see significant improvements in database systems soon, and where SQL and its implementations might help: a standard language interface for interactive and batch use and for inter-program communication; improved data protection, by separating integrity checking and failure precau-

tions; and the efficiency of access to databases on multi-user systems.

The first of these should come from implementing SQL itself. The other two depend on software developments which, in their turn, rely on the use of an agreed standard for accessing databases, so that many applications can work together harmoniously. One example of such a development, the SQL server announced jointly in January by Ashton-Tate and Microsoft, is explored here. There will doubtless be others, but the pedigree of this system, and its backing from the leading DBMS supplier and the operating system vendor, makes it likely to be of extreme importance on IBM PC/PS2 systems.

## What is SQL?

SQL is a language for the manipulation of relational databases. Any language sufficiently powerful to need an ANSI standard is far too complex to be described fully in a few paragraphs, but some idea of the language and its facilities can be given.

Assuming a single table of suppliers, each with an identifying code and a column recording their city of origin, a simple SQL statement, intended for interactive execution,

might look like this:

```
SELECT S.CITY FROM S WHERE
S.SNO="S4"
```

This would result in the display of the city in which supplier S4 is located. The prefix S before each column name is the name of the table; this is optional where no ambiguity about the source of the data is possible.

SQL includes a set of commands for the creation of tables, the insertion, amendment and deletion of rows, and the selection of data using one or more sets of criteria. Further control is exercised by adding more parameters; for example, sorting is accomplished by adding the parameter 'ORDER' to the 'SELECT' command, while 'DISTINCT' inhibits the display of rows which would duplicate those already displayed. Some built-in functions are provided to allow, for example, totalling of a numeric value across the range of rows valid for the SELECT command. A 'JOIN' facility, as befits a relational system, is provided to permit the selection of information from more than one table in a single SELECT command.

Even interactive dBase is more friendly and less wordy than the rather primitive user image of SQL. SQL is, in many applications, used as a hidden language rather than being displayed to the user in all its gory detail.

Indeed, in its standard specification, it is largely intended to be invoked from within a programming language. The effect is to provide people writing programs in languages like Cobol with a set of database-specific commands to speed up and standardise the handling of database functions. It may well be that ordinary users will never need to know any more about SQL than is covered here; dBase developers will merely use it to communicate with other programs if they need to, and shield their users from its antediluvian user image.

Given that caveat, SQL could well be the means of providing many features which developers have long sought. The most obvious is the transaction facility, which allows you to define a group of amendments as a single transaction which will only be implemented when the 'COMMIT' instruction is given, and only then if all aspects of the amendment process can be completed successfully. If problems arise, the program can issue a 'ROLLBACK' command which will cancel all updates putatively made by the transaction.

Security can also be provided through SQL, either to prevent individuals without authorisation viewing a complete table, or to restrict the

operations they can perform — for example, to prevent them changing information but allowing them to view it. The basic language also provides some elementary facilities for data checking, such as specifying that a cell must never have a null value.

So far, I've simply referred to 'SQL', but in fact all the implementations are dialects of SQL without one conforming precisely to the standard, and all are different. As with some programming languages, for example, notoriously difficult areas such as input and output commands have been left undefined. While there is a family of programs based on SQL, you cannot rely on them being fully

**'For users of databases,  
file incompatibility can  
have more serious  
consequences than in  
other fields. . .'**

compatible even at the language level. This may give the vendors of PC implementations some headaches when they try to introduce direct communication with mainframe systems — for example, to go and collect information for processing on the PC. Ashton-Tate has already said that this facility will not be implemented in the first version of dBase IV.

### The Ashton-Tate/ Microsoft SQL server

Two of the three advantages we might hope to gain from a standardised database language cannot be gained wholly and directly from SQL, but only from implementations of the language. One of its major advantages is that its design permits the separation of the application from database handling.

For example, where several applications all access the same database, each one could, with the right hardware and SQL software, handle its own interaction with the user, but leave the checking of data integrity to the SQL 'back-end'. This facility is offered by the SQL server recently announced by Ashton-Tate and Microsoft, the fruits of a tie-up with Sybase which has its own complete DBMS based on SQL for the DEC VAX and other mini systems.

The way in which networked applications work at present, contrasted with the way they would interact with the SQL server, is shown in the screentest on page 156.

Separating the functions common to all applications from those specific to each application should result in substantial savings in development time, and also lead to fewer errors both in program code and in data. Some savings in processing time can also be expected from this rationalisation of application code, but a further significant improvement should be possible because of the way this particular server works. Most current database packages on micros require each user to be running a separate copy of the program (either the full package, or a compiled program).

But in that situation there is no possibility of, for example, intelligent queuing of data requests to speed up overall throughput. Nor is it easy to prevent users — often unwittingly — from making retrieval requests which will lead them and others to sit around waiting for the results. The multi-threading approach used by Sybase shown on page 156 should answer these problems, leading to faster response times and much greater capacity on existing physical networks in which one server can be dedicated to database work.

Two types of relationship will be possible between dBase IV programs and the server. SQL commands can be embedded directly in dBase IV programs; because there is some syntactic overlap between the two, you will first have to use a 'SET TO' SQL command to show that the following commands are indeed raw SQL. It will also be possible to program using dBase IV commands which can then be passed directly to the server, undergoing translation to SQL on the way, with the results being translated back into dBase IV format on the way back.

### Conclusion

The relationship between Sybase, and Ashton-Tate and Microsoft, will be interesting to watch. As we have seen, this SQL server allows many different applications — not necessarily written in the same front-end language — to access the database through the same channels. It is certain that other companies will follow Ashton-Tate's lead in offering SQL facilities within existing products, and the agreement makes it clear that the server facilities will be made available to other front-end products.

But Sybase already has a front-end system, called DataToolset, implemented on the DEC VAX and other systems. The company has just announced that a version of DataToolset, fully compatible with its minicomputer implementation, will be produced for OS/2, providing direct competition for dBase IV. END



### PC500 +

Ultimate entry level PC with V20 processor running at 8MHz, monochrome graphics, up to 640KB RAM, serial and parallel ports, keyboard, screen and MS-DOS 3.2. Super LAN workstation!

from £499

### PC710

Small footprint PC/XT with 8088 processor running at 10MHz, colour and monochrome graphics, up to 768KB RAM, serial and parallel ports, keyboard, MS-DOS 3.2 and choice of monitors.

from £700

### PC910

Compact and powerful 80286 system now running at 12MHz, up to 1MB RAM, serial and parallel ports, keyboard, MS-DOS 3.2 and choice of display adaptors and monitors. Excellent for high-performance LAN workstation or stand alone system.

from £1221

### PC900

Upgraded full-size 80286 computer now running at 12MHz, ideal for file-servers and multi-user systems, up to 1MB RAM, eight expansion slots, 200W power supply, and room for two full-height disk drives. Supplied with keyboard and MS-DOS 3.2

from £1325

### PC1100

Ultra-fast 80386 computer with 16MHz and 20MHz models, superb for XENIX/UNIX/C-DOS or file-server applications, and unbeatable as a file-server or high-speed personal workstation. Up to 4MB RAM, eight expansion slots, keyboard and MS-DOS 3.2.

from £2487

#### ALSO FROM MULTIVAC

LP-75 Laser printer  
Novell local area networks  
Xenix and Unix systems  
CAD/CAM computers  
High capacity disk drives to 190MB

*All dealer enquiries welcome*

**Acer** 

**first**

**amongst**

**equals**



**Multivac Corporation plc**

**Unit 9, Victory Business Centre, Fleming Way, Isleworth, Middlesex TW7 6DB**

**Fax 01-568 1970**

**Tel 01-568 1976**

# The best of both worlds

Although still in its infancy, BiCMOS technology (the fusion of the high-speed bipolar integrated circuit and CMOS) has immense potential in the design of fast processors for the commercial world in general and the PC world in particular. Nick Hampshire explains.

In 1947 three researchers at Bell Research Laboratories — Messrs Shockley, Brattain and Bardeen — made a discovery which changed the world. That discovery was the transistor. In the 41 years following that discovery there were two other important developments. The first was the bipolar integrated circuit in the early 1960s which was followed about 10 years later by the CMOS integrated circuit. Now we are witnessing the birth of a third integrated circuit technology which combines the best features of both the earlier technologies — this is known as BiCMOS.

This fusion of the two older technologies, bipolar with its high speed, and CMOS with its high component density and low power consumption, is creating a great deal of excitement among both chip designers and electronic and computer system designers. In the last few months virtually every major chip manufacturer has announced plans to invest in both

research and actual production of BiCMOS chips. At the recent International Solid State Circuit Conference in San Francisco, developments in BiCMOS were one of the conference sensations.

The reason for this excitement is that at last electronic chip designers will be able to produce very fast, densely packed chips with a low power consumption. But even more exciting than this is the fact that BiCMOS will allow large-scale analogue and digital circuits to be combined on the same chip — in the past these two types of circuit had to be placed on separate chips. BiCMOS technology thus looks set to increase the speed and power of integrated circuits as well as giving rise to a whole new generation of applications chips. In both areas, BiCMOS will have a considerable impact on personal computers in the years ahead.

To understand the excitement and appreciate the potential of BiCMOS technology, it is necessary to under-

stand something about semiconductor technology, and the reasons why bipolar and CMOS technologies are different.

## The semiconductor

An understanding of semiconductor technology is firmly based on the principles of quantum mechanics and its application to the energy levels with an atom. An atom is primarily made of two components — a central nucleus which is positively charged, and an outer cloud of negatively charged electrons. These electrons do not form a random cloud around the nucleus, but are organised as a series of concentric shells. Each shell contains electrons with a similar energy level.

What quantum theory states is that the energy of an electron has to be at one of a set number of energy levels. It is the existence of these energy bands which is crucial in both the conduction of electricity and in the properties of semiconductors. For

Features of the advanced BiCMOS process

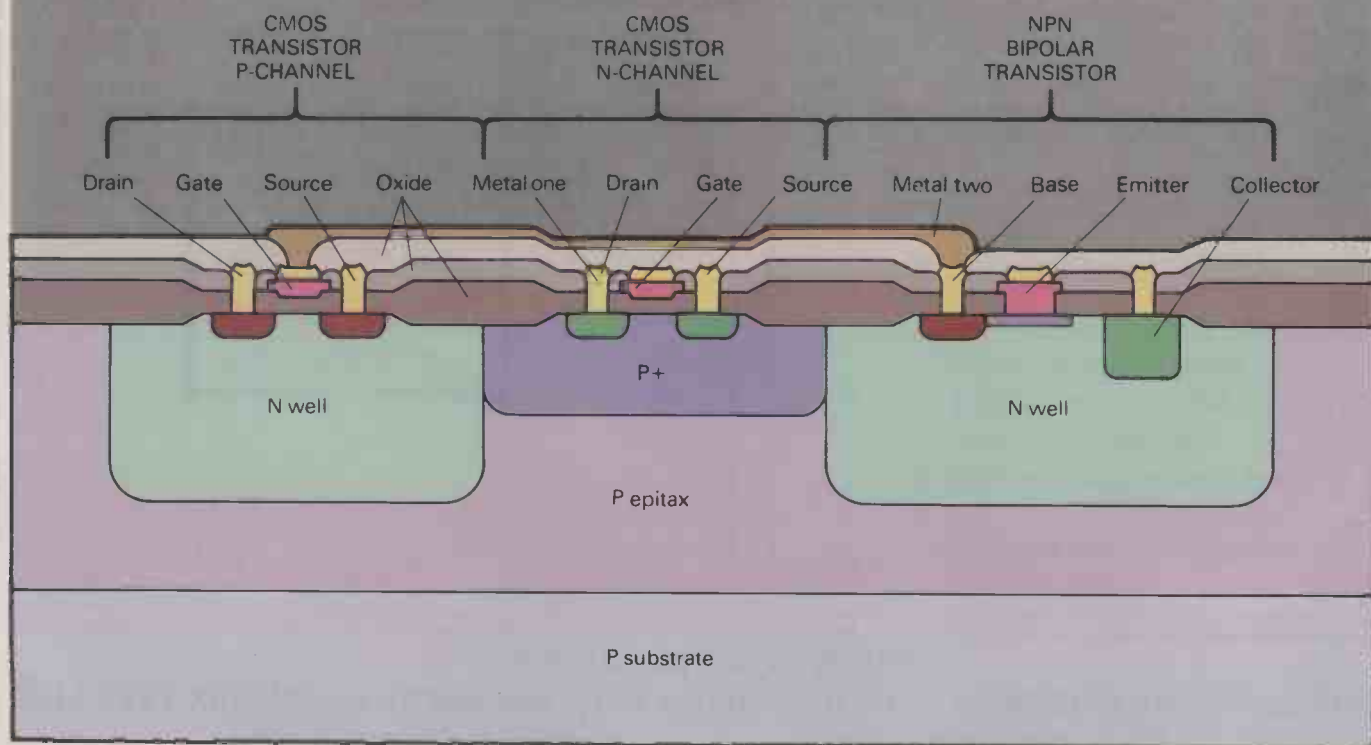

A cross-sectional diagram of a BiCMOS chip showing how the two different types of CMOS transistor are combined with a bipolar transistor on the right of the diagram using polysilicon fabrication techniques



a material to act as an electrical conductor some of the electrons must be excited above their normal levels. This excitation pushes the electron into a shell further away from the nucleus and thus frees the electron and allows it to pass from one atom to another.

When the outer shell of electrons in an element is only partially filled, it is very easy to move electrons from one atom to another. Such materials are usually good electrical conductors since very little energy is required to raise an electron to a higher energy level and thereby convert it into a charge carrier. Materials where the outer shell of electrons is entirely filled are usually insulators since they require a considerable energy input to move electrons from one atom to another.

There are, however, some insulators which do not require large amounts of energy to create charge carrier electrons. Since these elements lie between the true conductors and the total insulators they are referred to as semiconductors. Normally at room temperature the thermal vibration of atoms is sufficient to generate charge carriers within a conductor, but in a semiconductor this is usually not quite enough to make the material a conductor.

When an electron in a semiconductor becomes a charge carrier it leaves a space in the electron shell of the atom, and consequently this atom acquires a positive charge. Such positively charged atoms can also act as carriers of an electrical current in exactly the same way as an electron, and they are referred to as 'electron holes'. In a normal semiconductor the number of charge-carrying electrons is always equal to the number of 'electron holes'.

A semiconductor can be made conductive by inputting energy over and above the normal ambient thermal energy. This could be in the form of additional heat, light or electricity. All these sources of energy are utilised by different semiconductor devices. Thus a semiconductor such as cadmium sulphide becomes a conductor when exposed to ordinary light, a feature which is utilised in the construction of photographic light meters.

With semiconductors like silicon and germanium their electrical properties can be changed by adding very small quantities of another element, such as arsenic or phosphorus. The effect of these doping elements is to create an electrical imbalance between the number of charge-carrying electrons and their opposite equivalent 'electron holes'. Thus the addition of arsenic to silicon produces an excess of electron carriers

over electron holes. The doped silicon is therefore known as N-type material. Adding phosphorus has the reverse effect and creates a deficiency of electrons — in this case the material is referred to as P-type material.

Semiconductors which have an excess of either conducting electrons or electron holes are known as doped semiconductors. All semiconductors used in integrated circuits and discrete transistors use this sort of material. Just simply doping a piece of silicon with either arsenic or phosphorus does not make the semiconductor useful. That happens when a junction is created between a P-type piece of silicon and an N-type piece. A P-N type semiconductor junction of this sort creates a one-way electrical valve called a diode. Connecting the positive lead of a battery to the P-type side and the negative terminal to the N-type side will allow current to flow through the device, the semiconductor acting as a conductor. Reversing the battery leads will result in the P-N junction acting as an insulator.

A transistor is constructed in a similar manner, only instead of using just two pieces of doped silicon it uses three. A transistor is not only a one-way valve, it is one which can be electrically turned on or off. A typical transistor would thus consist of a sandwich of P-type silicon between two pieces of N-type.

If a battery is connected across the two N-type pieces no current will flow whichever way the battery is connected. However, by connecting the central P-type piece of silicon to the negative terminal of the battery it is possible to use this source of electrons to fill all the holes in the P-type and so enable it to conduct electricity between the two N-type layers. The amount of electrical current flowing through a transistor is thus dependent upon the voltage applied to the central layer of the transistor semiconductor sandwich.

The three-layer transistor and the two-layer diode form the basis of all semiconductor devices. It is from these simple devices that the bipolar integrated circuit has been developed. The difference between these and CMOS integrated circuits lies in the design of the transistor. CMOS uses what are known as Field Effect Transistors (FETs). These do not rely on the PNP or NPN junction but instead control the flow of current through a channel of P- or N-type silicon by means of an electric field. This field is produced by a metal 'gate' placed over the semiconductor channel and insulated from it by a layer of silicon oxide. Hence the term Metal Oxide Semiconductor

(MOS). The C in CMOS stands for 'complementary' which simply means that both P- and N-type doped silicon are used in the device.

## Bipolar chips

All the earliest integrated circuits used bipolar technology. This was a logical extension of the fabrication process for both transistors and diodes. This process involved taking a slice from a large crystal of silicon and selectively doping different areas of the slice with either P-type or N-type dopant. This had the effect of printing a pattern of different electrical properties into the silicon slice.

This doping process was performed by placing the silicon slice into a furnace, heating it up and then introducing the dopant chemical into the furnace atmosphere in the form of a gas. The dopant molecules would then diffuse into the surface of the red hot silicon thereby creating a doped surface layer. By masking out areas of the silicon slice it was possible to dope only selected areas of the slice.

In this way bipolar integrated circuits were formed from a number of transistors and diodes 'printed' on to the surface of the silicon slice. The undoped silicon has a very high resistance and virtually behaves as an insulator. Connections were made between the components on the chip by depositing a thin layer of metal over the surface of the chip and then etching away unwanted portions to leave a pattern of interconnections between components.

The virtue of the bipolar transistor is that it is able to switch very rapidly between acting as an insulator and as a conductor. Consequently, bipolar integrated circuits are also very fast devices, typically with clock speeds of several hundred megahertz. Bipolar transistors also have a good linear response, which simply means that the amount of current flowing through the transistor is directly related to the voltage applied to the central slice in the transistor sandwich. This means that bipolar circuits are ideal for use in any application where variable voltages are being handled — in other words, analogue circuits.

Another virtue of bipolar transistors is that it is very easy to construct devices which can handle larger currents. Increasing the dimensions of the transistor will allow it to switch larger current loads. Again this is a frequent requirement in many analogue circuits.

Against the undoubted virtues of bipolar technology for constructing integrated circuits there are also severe limitations. The first is that bipolar chips cannot be made very dense

— the bipolar transistor requires an area of the chip surface which cannot be reduced beyond certain limits. The other main problem is that bipolar circuits require substantial power to drive them — the electrical energy put into the central slice of the transistor to make it conductive. This energy input is dissipated as heat, and excessive heat production can cause severe problems in an integrated circuit. Overheating can cause the entire component to fail, and limits the maximum size of the chip. Thermal stress in large chips can also lead to failure. As a result, bipolar technology has been confined to use on relatively small integrated circuits.

The excellent analogue properties of bipolar devices means that virtually all analogue integrated circuits are fabricated using this technology. Their potentially high speed and high power output means that they are often used as the 'glue' between large CMOS chips. This very important application area includes such vital functions as bus drivers, clock generators, I/O drivers, and so on. Without these bipolar 'glue' chips it would be impossible to construct any of the fast current generation of PCs.

## CMOS chips

The MOS integrated circuit family, of which CMOS is a member, is based around the concept of the field effect transistor or FET. This type of transistor was first invented in 1961 but was not employed in the construction of integrated circuits until the end of that decade. The principles behind this type of transistor are totally different to those used in the bipolar transistor. Instead of directly injecting electrons into a normally insulating area of doped silicon, the FET induces an electric field in a channel of silicon. This induced electric field will then convert the silicon channel from being an insulator to a conductor.

This technique for constructing a transistor has many advantages as well as a few disadvantages. A major advantage is that the electrical input to the gate — the area of metal above the silicon conduction channel — is electrically isolated from the silicon channel itself. This contrasts with the bipolar device where the central 'base' layer of silicon is directly connected to the conductive layers.

This means that in bipolar transistors there is always a leakage of current from the base into the conductive layers. In contrast, the gate area of a FET transistor is insulated from the rest of the transistor, which means that in comparison to bipolar devices it requires much less current

to switch the transistor on and off. Less drive current means less heat, and therefore the ability to construct larger chips without fear of thermally induced failure.

The absence of any leakage of current from the gate area of a FET transistor to the channel also means that when the transistor is in its non-conducting mode, it has a very high resistance.

However, the use of an induced current in the conduction channel means that the FET is inherently much slower than the bipolar transistor. Indeed, there is a direct relationship between power consumption and speed in MOS circuits which does not exist in bipolar circuits. There is also a far less precise relationship between gate voltage and the amount of electricity allowed to flow through the conduction channel, which means that MOS technology is not ideal for constructing analogue circuits.

MOS technology is, however, ideal for constructing large-scale digital in-



tegrated circuits. Not only is power consumption lower and the consequent heat generation much reduced, but the properties of the FET enable chip designers to greatly reduce the chip area needed, not just for single transistors, but also for that key component of all digital circuits, the memory cell.

In bipolar circuits a memory consists of a 'flip flop' circuit. This is a digital circuit which can exist in one of two states. It requires four transistors and a couple of resistors, and this type of memory cell is still used in the so-called 'static' memory chips. The low leakage of electricity across a FET transistor allowed designers to create a new form of memory cell which only requires a single transistor and a capacitor. Data is stored in this form of memory cell by charging the capacitor to represent a '1' or leaving it un-

charged to represent a '0'.

The only problem with this type of memory is that sooner or later the charge stored in the capacitor leaks away and the data in the memory is lost. This problem is overcome by regularly reading each memory cell and then rewriting its contents, a process which simply recharges the contents of the capacitor. This form of memory is now the most widely used and is called 'dynamic memory'.

All the large integrated circuits (IC) in use today are fabricated using one of the three different sorts of MOS technology. These are N-MOS and P-MOS, where the N and P simply indicate the type of doping used for the base slice of silicon.

CMOS is a slightly more sophisticated product which uses silicon with both N and P doping. This means that CMOS has the advantage of requiring far less power than either of the other two MOS technologies. Most of the large chips in a PC will be fabricated in either N-MOS or P-MOS, while CMOS is exclusively used in low-power applications such as portable computers, calculators and wrist watches.

## Bipolar + MOS = BICMOS

The current situation is, therefore, that bipolar technology is used to create fast integrated circuits — in particular those for applications involving analogue or high-power functions. However, for densely-packed, large, complex digital functions, especially those where low power consumption is important, then MOS technology is the natural choice.

In the past this division between the two main semiconductor technologies has not been particularly important. Improvements in MOS technology has resulted in enormous improvements in speed, component density and size of integrated circuit over the last 10 years. The number of components within an IC has leapt from just a few thousand to hundreds of thousands and — in some cases — even millions. Operating speed has increased from one or two megahertz to 20 or even 30MHz, while actual component sizes are now only about 10% of what they were.

Further improvements in MOS technology in terms of speed and component size are now beginning to show signs of impending physical limitations. Up to now designers have been able to make chips faster by making the component size smaller and reducing the distance between connected components. The laws of physics dictate this process



cannot go on forever.

However, in a complex circuit such as a microprocessor chip, not all portions of the chip need to operate at the same speed. In fact, the maximum operating speed of such a chip is dictated by a relatively few components such as 'data and address bus controllers'. Implementing these in a higher-speed technology would dramatically increase the overall speed of the chip. After all, a large mainframe computer is not architecturally very different from a processor like the 80386 or the 68020 — it is simply constructed using a far higher-speed technology, such as ECL or gallium arsenide, in critical areas of the circuit.

At present, processors such as the 80386 and 68020 are limited to operating at between 20 and 25MHz. If it were possible to implement the speed-critical areas of the processor circuit in a high-speed semiconductor technology capable of running at 200 or 300MHz, then the whole performance of the chip could be boosted to twice or three times its current rating.

Further improvement in the performance of microprocessor-based computers can be obtained by integrating as much as possible of the circuit into as few chips as possible. Again, chip speed as well as chip function is the current problem. If you look at a PC circuit board you will find that a considerable number of bipolar integrated circuits are required in its construction. Some of these are required to perform operations at speeds in excess of that normally available on MOS circuits. These are usually related to parts of the circuit like the address and data bus or the clock drivers.

Another area where bipolar circuits are required in a PC is in the video board. If you look at an EGA or VGA board you will find that about 30% of the chips are bipolar devices. Some of these are high-speed digital control devices, others are analogue devices which create the variable voltage signal which drives the colour monitor or TV.

The last area where bipolar devices are required is the I/O board. MOS circuits are not good at delivering a lot of power, and that is one thing that an I/O circuit needs to do. A lot of electrical power is dissipated down a 10-foot printer cable. Consequently, I/O drivers are usually bipolar devices.

Thus, there are a lot of bipolar integrated circuits used in the construction of a device such as a personal computer. In chip count terms they probably comprise about 25% of the chips, but in terms of actual circuit complexity they account for

just a fraction of one per cent. This is not a desirable situation since the greater the number of chips, the more expensive the device is to construct, the more error-prone it is and the slower its operating speed.

Manufacturers have sought to overcome some of these problems by using special chips known as Applications Specific Integrated Circuits (ASICs) which are simply a means of putting a number of bipolar chips into a single package without having to design a special semiconductor circuit. These have reduced the package count considerably in many PCs. However, it would be infinitely preferable to be able to put many of these bipolar components directly on to the large MOS ICs.

This need to integrate high-speed digital and analogue bipolar circuits with high-density MOS circuits on the same chip has been the driving force behind the development of BiCMOS. The problem with combining the two technologies has essentially been a manufacturing problem. It was possible to put both technology devices on the same chip, but it required a vastly increased number of manufacturing steps. This made the process very expensive and also lowered the yield of usable devices to an uneconomic level.

## The application of BiCMOS

The STC development of an efficient BiCMOS process relies on the use of polysilicon-emitter technology which has been used to create high performance bipolar elements plus non-compromised CMOS technology. With this and a combination of devices, it is possible for designers to address many different applications areas which involve the integration of complex digital functions and demanding analogue functions on the same chip, in order to improve speed and reduce assembly costs. It also allows the construction of purely digital chips with compact CMOS circuitry and bipolar components, such as output buffers for better line driving.

This polysilicon-emitter technology has not compromised the behaviour of either of the two constituent technologies and, above all, is relatively easy and cheap to fabricate. It can be made in a conventional bipolar or CMOS fabrication facility and can be designed with any ratio of CMOS to bipolar. The CMOS components can be used to construct highly complex and compact digital circuits.

Already the CMOS components are being constructed with a standard 2µm technology and STC will be lowering this to 1.25µm in the very near future. This very small compo-

nent size is comparable to that currently being employed on standard pure MOS and CMOS devices. The other performance ratings of the STC BiCMOS CMOS components is equally comparable to that pertaining to conventional CMOS technology.

The BiCMOS bipolar devices have a minimum fabrication feature size of 1.5µm for any bipolar device, which is a small feature size. These BiCMOS bipolar devices have a maximum clock rating of well over 300MHz and are potentially capable of at least doubling this speed as the technology develops. They are also able to function at voltages between the normal operational 5 volts and 20 volts, and development should improve this rating further.

The initial products are all quite small devices, and mainly directed at the telecommunications industry. This is an area where the ability to integrate both analogue and digital functions on the same chip is causing great excitement, particularly when the resulting devices are also able to operate at speeds of 100MHz or more.

As manufacturers develop the BiCMOS process, so they will start to use it on larger chips. One of the largest announced so far was described at the International Solid State Circuits Conference in San Francisco by National Semiconductor. This is a very high-speed 256k static memory chip which has been designed in BiCMOS for use in supercomputers. Industry analysts are expecting a flood of such announcements over the next 12 months.

Chips of this size using BiCMOS are still very rare, and most manufacturers are adopting the same approach as STC and another company, LSI Logic — to gain experience in the technology by constructing small devices before designing much larger circuits. In fact, one of the principal initial applications to which LSI Logic is applying BiCMOS technology is in the fabrication of a mixed digital/analogue ASIC.

## Conclusion

The technology of BiCMOS is still very much in its infancy, and it will take at least another three or four years before it reaches any reasonable level of maturity.

With BiCMOS a whole range of applications become both economically and technically possible — for example, digital radio, high-definition digital TV, and miniature portable phone systems. In the personal computer field BiCMOS will enable manufacturers to create much faster processors. It will also enable designers to construct cheap voice and image input systems.

**END**

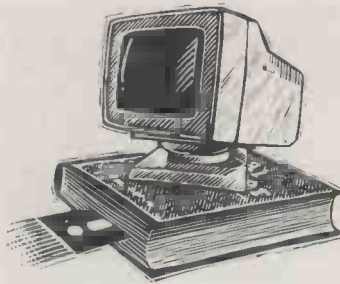

Our panel of reviewers guides you through the latest crop of books on expert systems, plus some general reading too.

## Managing Expert Systems

### MANAGING EXPERT SYSTEMS

NIGEL BRYANT

Author: Nigel Bryant  
 Publisher: John Wiley & Sons  
 ISBN: 0-471-91341-3  
 Price: £11.95

In the last six months there have been few magazines or newspapers with any pretension to the appellation 'serious' which have not had at least one article about 'expert systems'. Unfortunately, this is a term which all too easily rolls off the tongue of the man in the street or the pen of the journalist. As a result it is a subject about which many have heard, but which precious few people understand.

In this slim volume, the author, a lecturer at the Cranfield School of Management, attempts, quite successfully, to give the layman a good grounding on what an expert system is and, even more importantly, what it can do.

This is a very readable and practical book which is primarily aimed at managers and business studies students rather than computer professionals. It is, therefore, written

with the assumption that the reader has a minimal knowledge of computing.

The author leads the reader through a short introduction to the subject of artificial intelligence and straight into the very heart of an expert system 'the knowledge base' and rule structures. With plenty of practical examples he shows how a set of rules can be used by an automated inference system to generate a knowledgeable answer to a problem.

The book goes through each step in the development of an expert system, the choice of application, the choice of expert system shell, and the construction of a knowledge base. This book also gives the reader guidelines for developing their own system. This book is not machine specific; however, the majority of commercial expert systems listed at the end are for the IBM PC.

What I particularly liked about *Managing Expert Systems* was the clarity of its presentation and the fact that the author has managed to adequately cover all aspects of the subject without indulging in any obscure technical diversions. For the British reader the book has a further advantage over many of the other titles on the market. This is simply that all the contact addresses and products mentioned are located in the UK. (Many books by US authors frustratingly describe products which are unavailable in Europe.)

*Managing Expert Systems* forms an ideal introduction to expert systems, and it should be on the recommended reading list of everyone who wishes to know more about this fascinating new area of computer technology.

Nick Hampshire

## Applications of Expert Systems

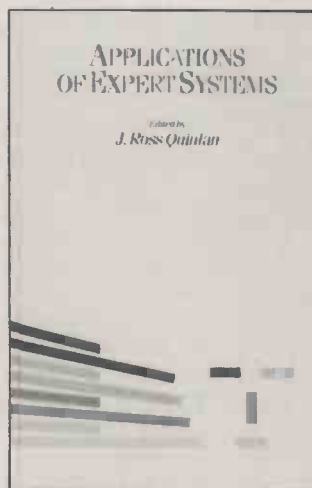

Editor: J Ross Quinlan  
 Publisher: Addison-Wesley  
 ISBN: 0-201-174-49-9  
 Price: £19.95

This book is a collection of papers which were presented at a conference on Expert Systems held in Australia in May 1986. These papers are by some of the world's leading experts in the development of expert system technology.

The collection is edited by J Ross Quinlan of the New South Wales Institute of Technology in Australia and inventor of the ID3 algorithm, which is still the best technique for knowledge induction yet devised.

This is definitely a book for readers with both an understanding of expert systems techniques and a good grounding in computer science. It is primarily an academic book, although most of the papers do deal with specific applications and there is a very good introduction to the current state of expert system development by Patrick H Winston who is well-known as one of the founding fathers of artificial intelligence and the AI language LISP.

In its 219 pages there are a total of 12 different papers covering subjects as diverse as the use of expert systems in legal decision-making and knowledge acquisition for radar classification. Each section is laid out in classic academic style with an initial synopsis and a comprehensive set of references to published source material. However, since each section has a different author, or even authors, there is a wide range of writing styles, some of which are very easy reading and some of which are rather heavy-going.

Although this is basically an academic book, if you already know about, and perhaps work with, expert systems, then you will certainly find many items of interest. However, it is *not* a book for the layman.

Nick Hampshire

## Expert Systems — Artificial Intelligence in Business

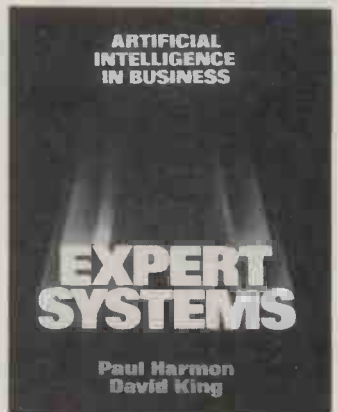

Authors: Paul Harmon & David King  
 Publisher: John Wiley & Sons  
 ISBN: 0-471-80824-5  
 Price: \$22.45

This title is written by two American management consultants who are specialists in the area of applying artificial intelligence techniques to busi-



ness. The book is a comprehensive introduction to expert systems, and is aimed at readers who already have a grounding in the use of computers and wish to know if the technology can be applied to their specific problems.

The first part is an introduction to the concepts and techniques of expert systems and their implementation. All the different ways in which expert systems can use and represent knowledge are examined. The text is accompanied by many excellent diagrams and examples drawn from some of the classic expert system developments, such as MYCIN.

In the second section the authors look at all the expert system languages, tools and systems which are currently on the market. However, it should be noted that since the authors are American, most of the programs referred to are also of US origin.

Similarly, the authors also concentrate on systems which run on special AI workstations, such as the Sun and the Apollo, which together with a preference for LISP is in contrast to the UK where most expert systems are developed with

the IBM PC in mind.

The third section is devoted to an excellent practical examination of how an expert system can be developed. The authors look at the selection of an application, the elicitation of knowledge and the construction of a knowledge base.

The last section examines the expert system market, and where it is likely to go in the next five years. This section, like the rest of this excellent book, is well-illustrated and contains frequent examples from existing applications, as well as plenty of statistics. Also included is a good glossary, a list of references and company contact addresses.

Throughout this book the authors take the reader step by step through the process of developing a practical small expert system. With this book, and one of the commercial expert system shells, the reader should be able to build their own system.

If you are into computing and want to know more about expert systems or build your own system, then this book is a good read and comes highly recommended.

Nick Hampshire

## Building your first Expert System

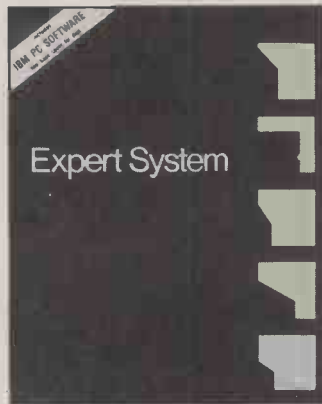

**Authors:** Tom Nagy, Dick Gault and Monica Nagy  
**Publisher:** Ashton-Tate  
**ISBN:** 0-912677-53-8  
**Price:** \$29.95

In *Building your first Expert System*, the authors aim to guide the reader into building a modest, quality expert system quickly, as well as teaching the key principles of expert systems along the way. They are well-qualified to do this as Tom Nagy is an Associate Professor of Expert Systems at George Washington University, Dick Gault is an Instructor of Expert Systems and Artificial Intelligence at the Defense Intelligence College and

Monica Nagy is a freelance Lisp and Kes programmer.

Using the MICRO-PS software disk provided with the book, you are taught how to build a small scale prototype expert system step-by-step, through Demo 1, Demo 2, Proto1 and Proto2 — Proto2 being the exact equivalent of the PC File Operation's Expert System 'the powerful and useful expert system that solves a real problem: giving good, cheap and always available consultation on file operations in PC-DOS'.

The book is divided into four sections: Part I: About Expert Systems; Part II: Building an Expert System; Part III: The MICRO-PC Manual, and; Part IV: Glossary and Appendices, but I must admit I found the format boring.

For me, there wasn't enough variety of presentation or content to keep my attention. I found the figures — that is, diagrams — difficult to differentiate from the text, and the half boxing off effect made it even worse, resulting in the page looking very messy. All the explanations of Attachments, Attributes, Rules and Actions are there, but if I were a first-time user of expert systems looking for a book to help me, then I think I could find better value for money elsewhere.

Lorna Kyle

## Build your own Expert System

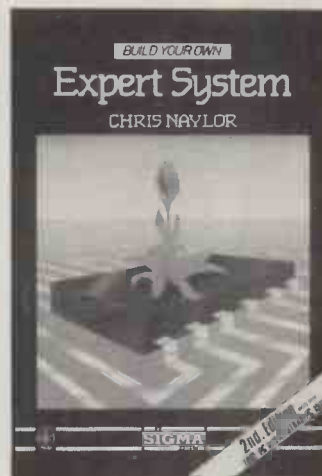

**Author:** Chris Naylor  
**Publisher:** Sigma Press  
**ISBN:** 1-85058-071-5  
**Price:** £11.95

I love a sense of humour, and therefore any author who begins a book on 'Expert Systems' with the sentence 'Once upon a time a long time ago when the Earth was still new and the Sun had a big smile on its face when it got up each morning' has me hooked from that point on. I have a mental image of Chris Naylor, the author of *Build Your Own Expert System* as a conscientious academic but also someone who enjoys a good laugh and drinks a lot of beer — his references to drink, bars, hostelry are numerous. His recommendation for buying his book is, at the least, honest: 'the real reason you should buy

this book is because, for a book on computers, it is relatively cheap.'

This honesty and humour are prevalent throughout the book, but nowhere more so than in Chapter One. Here he opens the mysteries of expert systems as if he were a surgeon in a theatre and exposes all the rubbish and fogginess that surround the term 'Expert System.' He chats at length about the clouds of confusion that have arisen around these systems because people:

- don't know what they're used for;
- haven't got one themselves; or
- haven't the faintest idea how to go about getting/building one.

The heart of this chapter explains that an expert system is, after all, only a computer program.

Naylor then moves on into the world of probability and statistics, Bayes theorem and Chi-squared, parallel and sequenced decisions, building rules and creating modes. His programs are written in Basic and have also been tested in Advanced Basic (BasicA), GWBasic and Locomotive Basic 2. Helpful examples are provided and, in Chapter 12, all the technical terms and definitions used are summarised.

I enjoyed this book very much; it's not recommended for the serious and strait-laced user, but if you'd like a text book that mixes reality, humour and knowledge in the world of expert systems, then I'd recommend this one.

Lorna Kyle

## Expert Systems for Business

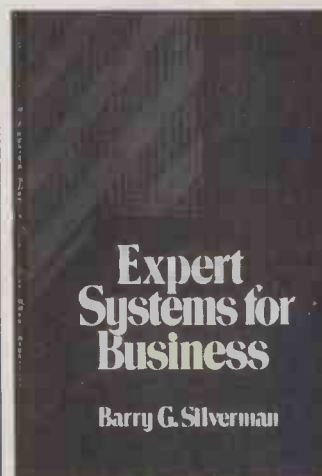

**Editor:** Barry G Silverman  
**Publisher:** Addison-Wesley  
**ISBN:** 0-201-07179-7  
**Price:** £22.95

The field of 'Expert Systems' differs in many ways from conventional 'Business Computing' practices: this book is intended for business managers and others interested in finding a realistic use for expert systems in business and management, and it starts with a good layperson's introduction to the necessary basic concepts in expert systems.

The majority of the book uses existing systems and current research to illustrate both the possible application areas and the technical issues involved. Case studies of the use of expert systems technology are presented, covering a very wide variety of applications in business.

In this respect, the book

shows little difference in comparison to similar works — that is, a collection of tales of the successes and failures of specific applications. However, what makes this book so special is that it goes several steps further, and includes a discussion on integrating expert systems into the business environment.

Over a quarter of the book is devoted to this topic, covering a wide spectrum of issues which should be highly relevant to the serious reader, and it concludes with a hype-free look at next-generation technology.

The standard of writing is high throughout the text: a total of 32 authors have contributed, and there is a fair balance between authors from academic institutions and those from commercial firms. The consequence of this is that the book has a realistic perspective on what is required and what is achievable, giving a broad introduction for the

layperson, but including extensive lists of (academic) references at the end of each chapter.

The only notable omission is the lack of discussion of 'Expert System Shells' and 'Knowledge Engineering Environments', which is acknowledged by the authors; however, these topics are arguably of little concern to business readers.

The book's biggest flaw is that it suffers from a barely adequate index; its content should qualify it as both a textbook and a reference book, but the poor indexing will hinder its use for reference purposes.

For both breadth and depth of coverage, *Expert Systems for Business* is strongly recommended as a 'best buy' for the business-person with a serious interest. It should also prove a useful browser for people with a general interest in AI: it can be enlightening to see the needs of the 'real world'.

Dave Cliff

## Z88 Computing

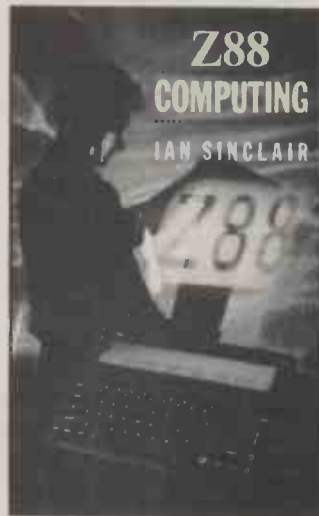

Author: Ian Sinclair  
 Publisher: David Fulton  
 ISBN: 1-85346-045-1  
 Price: £9.95

I would prefer to describe this book as an alternative to the Z88 user manual for the nervous: it covers almost all the built-in software of the Z88 in detail. This is done very clearly and concisely with a far more pleasant style than the Z88 user manual. The book is di-

vided up in a 'menu' style. It has many short sections, each with several numbered paragraphs concerning the important points being considered.

Pipedream, the built in word-processor, is given pride of place in the book. Besides its obvious functions, Ian Sinclair also shows how to use it effectively as a spreadsheet as well as a database. Other sections cover the useful pop-down utilities and the extremely important import-export functions. Unfortunately, the Basic programming language, the command line interface (CLI) and filing have been ignored in the book. This is a shame because these are precisely the areas where the user manual is itself flimsiest and where useful information would be most gratefully received.

Appendices at the back describe some useful hardware and software tips for things like connecting the Z88 to an Amstrad 1512 PC.

Overall, the book is well-written but it is a rather unnecessary addition to the user guide and would perhaps be most useful to those who are considering buying the Z88 and want to know more without spending too much.

Owen Linderholm

## GENERAL

### Fundamentals of Computing

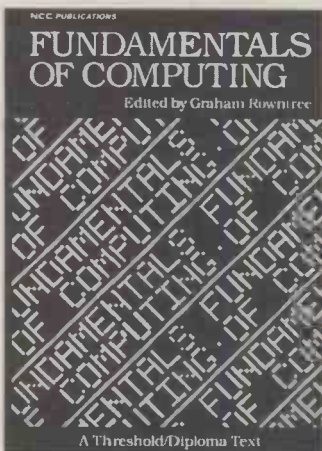

Editor: Graham Rowntree  
 Publisher: NCC Publications  
 ISBN: 0-85012-661-4  
 Price: £12.50

This book provides a survey of computing at a level appropriate to the BTEC National or NCC Threshold Diploma courses in Computer Studies. The choice of title suggests a much more theoretical exposition of computing than the book delivers. In fact, the book is essentially an overview of the practical aspects of computing. The first chapter, for example, covers the history of computers, data representa-

tions, interrupts and computer systems in 17 pages. Later chapters on data storage devices, input/output devices, operating systems, programming languages, data communications and principles of data organisation are more comprehensive but chapters on systems controls, types of system, the data processing environment, computers at work, computers in the public service and standards read like sets of lecture notes.

A lot of detail is provided in each chapter but there is an overlap between chapters. A number of terms (for example, parity and screen painting) are used without adequate explanation and other terms (for example, selectors, concentrators and teleprocessing monitors) are given undue emphasis. Some diagrams, such as those of a VDU and a cash dispenser, are childish while others (those of a wide area network) are unnecessarily complex. The questions in the appendices cannot all be answered from the material in the book. The style of writing is turgid and suffers from the wide variety of authors. Most importantly, the book fails to inspire the reader.

*Fundamentals of Computing* is a good reference source for anyone preparing lectures, but I hesitate to recommend it as a course textbook for young 'Computer Studies' students.

Dr Ray Stoneham

### The Media Lab

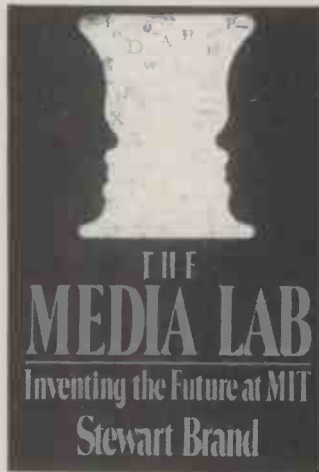

Author: Stewart Brand  
 Publisher: Viking (Penguin)  
 ISBN: 0-670-81442-3  
 Price: Not available

The first of many things to strike you about this book is the cover: it incorporates a high-quality hologram into the jacket. This hologram was produced using a technique pioneered at the Media Lab — the subject of the book. Much of the research that goes on at the Media Lab at the Massachusetts Institute of Technology (MIT) really is inventing

the future. Not every project there involves computer technology, but many do. The purpose of the Media Lab is to research into the technologies of recording, broadcasting, film, publishing, telecommunications and all the other fields that dip into them. This is where computers come in.

Stewart Brand describes the place, the people who work there, the work they do and what happens to that work. Much of it is sponsored by commercial clients with obvious uses in mind. The excitement and importance of the work being done is conveyed admirably by Stewart Brand. He brings out the personalities of the people involved and investigates the importance of the work carried out.

All in all, a very entertaining, if somewhat 'American', book.

Owen Linderholm

Nick Hampshire is a freelance computer journalist. Dave Cliff is a postgraduate student at the School of Cognitive Science, University of Sussex. Lorna Kyle is a systems analyst/programmer. Dr Ray Stoneham is a lecturer in Computing at the Joseph Priestley Institute of Further Education, Morley, Leeds. Owen Linderholm is a Z88 owner and ex-technical editor of PCW.  
 Next month: IT

END



**MORE COMPATIBLE THAN SOME  
MORE AVAILABLE THAN MOST**

**Immediate  
Stock  
Availability**

**SUBSTANTIAL SAVINGS  
ON ALL EDUCATION,  
BUSINESS  
AND PUBLIC SECTOR ORDERS**

From  
**£499**

30 Mb XT model  
only  
**£995**



**Announcing the PC III Turbo from Opus Technology – Britain's first range of 10 Mhz Super Turbo PC/XT compatibles. Enhanced performance, stunning specifications, compact design and prices which stop where many others start.**

**Now you can choose from a quality range of stylish PC-compatibles with mono, colour and EGA versions, or select a pace-setting new XT computer for as little as £995.**

#### **PC III TURBO 30 Mb XT**

- 8088 super turbo processor 4.77/10 MHz
- Flat screen amber monitor
- Extended 102-key keyboard
- Advanced multi-function card – Mono/Colour graphics adaptor, Parallel and Serial ports, floppy disk controller and mouse port
- Six free expansion slots
- 360 K floppy disk drive
- 1 Mb motherboard memory
- 30 Mb Winchester
- Super small footprint case
- Lockable keyboard
- Phoenix BIOS
- Space for second disk drive
- Battery-backed clock/calendar
- 180 watt UL-approved power supply
- Comprehensive UK user manual
- 12-month guarantee – on-site maintenance option

**PC III TURBO**  
A small price to pay for quality.

**Opus Technology.**

For details call today on **0737 765080** or Fax 0737 769873. Price quoted exclusive of VAT and carriage.  
Opus Technology Ltd, 53 Ormside Way, Holmethorpe Industrial Estate, Redhill, SURREY RH1 2LW



Behave like an adult in the guise of an American cop, or return to your childhood chasing dragons and rescuing glamour girls from the clutches of the Third Reich. Stephen Applebaum bows out of reviewing games with this month's high-class selection.

## Jack, the magic dragon-slayer

Title: Black Lamp  
Computer: Atari ST  
Supplier: Firebird  
Format: Disk  
Price: £19.95

Oh, for the days of innocence, when adventures were set in fairy-tale lands inhabited by dragons, warlocks, werewolves and witches. As computers become more advanced, so too do the games we play on them. Fairy-tale themes are *passé*; today's gamers want shadowy realism, with psychopaths and cocaine freaks as the new bogeymen. You only have to look at the likes of Police Quest, also reviewed here, to see that things have changed a great deal, and not necessarily for the better, since the days of The Hobbit.

But all is not doom and gloom. Steve Cain and GP Everett, co-authors of Star Trek (which I won't hold against them), have come up with Black Lamp, a delightful fantasy arcade adventure which not only breathes new life into the electronic fairy-tale but also revives the platform and ladders genre.

Black Lamp is set in Allegoria, a beautiful kingdom ruled over by King Maxim. In recent times Allegoria has been hit by a great blight, which has all but swept aside the general air of happiness which once prevailed across the land. The trouble began when a number of magical lamps, including the eponymous Black Lamp, were stolen from King Maxim's vaults by a group of dragons. Since the theft, Allegoria has come under attack from strange creatures apparently under the influence of some evil force.

You have probably guessed from the outline of the game's rather clichéd scenario, that you play the mug — sorry, brave gallant — who



offers his services to deliver Allegoria from perpetual despair. As heroes go, the one in Black Lamp is unusual in that he is a jester called Jolly Jack; not the sort of person you would expect to take on such a challenge. But then, Jolly Jack has an ulterior motive: for saving Allegoria he expects to be given the hand, and else besides, of the Princess Grizelda.

A humble jester Jack may be, but a fool he is not. So, before setting off on his quest, he visits his old mate Pratzweezle who presents him with a belt that emits bursts of pure magic, and a spell to enable him to defy death a certain number of times.

As Jolly Jack, you have to collect all the stolen lamps and place them in a number of chests situated in various locations around Allegoria. There are, as is always the case, a number of hitches: you are not told where either the lamps or the chests are; you are only allowed to carry one lamp at a time — the Black Lamp, of which there is more than one on the higher levels, is guarded by a massive fire-breathing dragon



that must be killed before it will give up its treasure; and, finally, the whole of Allegoria is overrun by hordes of nasty creatures, ranging from slime witches to wasps, which do not take kindly to the thought of you depriving them of the lamps.

Black Lamp is a kind of ladders and levels game. For the most part, the gameplay involves moving Jack through a number of colourful locations, zapping away at the evil fiends who, with their lightning and fire, threaten to turn him into ash.

When Jack is inside a building, he can move up and down the screen using objects and other projections for foot-holds; while outside, his movement is limited to walking left and right across a scrolling background.

Cain and Evans have allowed players to choose whether they use the ST's mouse, keyboard or joystick as their method of controlling Jack. Of the three, the keyboard is the easiest option as neither of the other two respond quickly enough. Moving Jack in time to dodge the many projectiles that are constantly thrown at him is a fraught business which only the response time of the computer's keyboard can handle satisfactorily.

Besides the magic lamps, there is a large variety of objects which, when picked up, help Jack in one way or another. Pieces of food, for instance, not only give you more points but also increase Jack's energy; the same goes for different sorts of drinks that just happen to have been left lying around.



The baddies are some of the wickedest creatures to appear in a computer arcade game. There are eleven types, from relatively harmless dragonflies and wasps to the aforementioned dragons. In between these two extremes come slime-spitting witches, lightning-tossing buzzards, explosive skull-dropping buzzards, and man-eating werewolves.

Each creature can inflict different degrees of damage on your hero. Likewise, each one earns you a different number of points when hit. This applies not only to shooting the characters, but also the objects they throw at Jack. Obviously, the most points are awarded for killing a dragon, which is no surprise. Not only are the dragons the most dangerous of the baddies, but they also have to be hit the most, in specific weak spots, before they will die.

Black Lamp's graphics are similar, though more cartoonish, to those in the brilliant *Barbarian* from Psygnosis. The backgrounds are all very detailed, although many of the interiors are alike. A lot of time has obviously been spent on creating the game's characters, all of whom are depicted as large, detailed, animated figures. My favourites are the dragons, who look every bit as formidable as the story in the game's manual would have you believe.

Another nice feature is the musical soundtrack that plays over the action. This can be turned off in favour of simple sound effects, but that would mean missing one of the game's highlights — Fred Gray's jazzed-up version of *Greensleeves*.

Black Lamp is an enchanting, fun game. Steve Cain and GP Everett have proved, most effectively, that there is still room in the market-place for good, old-fashioned arcade adventures.

## French farce

**Title:** Crash Garrett  
**Computer:** Atari ST; IBM PC  
**Supplier:** Infogrames UK  
**Format:** Disk  
**Price:** £19.95; £24.95

If you think that the French have no sense of humour, take a look at *Crash Garrett*, a brilliant war-time parody which has a dialogue with all the subtlety of a *Carry On* script.

Infogrames, *Crash Garrett*'s UK distributor, is notorious for its strange games from across the Channel. Its range of software is hit and miss, but when it strikes home with a good game, people had better sit up and take notice.

*Crash Garrett* is a mixture of high-action thriller, slapstick comedy, war-



time drama, romance, and cheap *double entendre*. The closest thing I can compare it to is *Stiff* and Co, a game excellent in its own right though not a patch on this latest Gallic offering.

The style-conscious French always know how to make a product look good, especially when it is destined for worldwide consumption. It shouldn't surprise anyone, then, to hear that *Crash Garrett* is, from start to finish, a catalogue of superb artwork, comparable in places to the graphics in adventures from *Magnetic Scrolls*. And it isn't all front and no substance: there really is a game beneath the glossy veneer — and a good one at that.

*Crash Garrett* is the game's eponymous hero, a flying ace whose past exploits include flying bootleg liquor, break-ins, shoot-outs with G-Men, gun-running, a long string of sexual conquests, and gang wars. But now he is a reformed character, with aspirations no higher than buying a transport plane so that he and his friend Grease Flanagan can set up an air freight business. All this changes, however, when his girlfriend, Glory Streek, is abducted by members of Hitler's Third Reich, operating in the US under the command of Engels Von Krul.

You know when the title screen loads, and a brilliant piece of digitised funeral jazz-blues music pipes up over the graphics, that what is to follow should be pretty special. Some programmers play their best hand at the beginning and the rest of the game goes downhill from thereon. In *Crash Garrett*'s case, its programmer, Patrick Dublanquet, has played a hand which looks almost unbeatable. Special effect is piled upon special effect to produce a game totally unlike any other you have seen.

I am not quite sure exactly what Dublanquet wants to achieve with *Crash Garrett*; whether he wants us to respond to the game as a computerised comic or as a kind of film. Whatever his original intention, the result is very effective, if somewhat unorthodox, coming somewhere between the television version of *Batman* and the Biggles comic strip.



When you have heard enough of the lugubrious refrains of the coffee-house jazz ensemble, you can play the game.

The display features a central window containing a graphic representation of whichever location you happen to be in. Although a great deal of work has gone into the design of these colourful backdrops, they merely provide a setting for the story's dastardly characters to perform in front of.

Each character — and there are quite a few — has its own portrait, which glides on and off the screen whenever the plot requires that it be in view. Most of the action is verbal, which is to say that a good deal of the game involves conversing with other characters and listening to them talk among themselves. Communication is achieved by means of speech bubbles, as you would expect in a game as heavily influenced by the comic book genre as *Crash Garrett* obviously is.

When the game begins, our hero is flying Cynthia Sleeze, a well-known gossip columnist and lush, to Lone Pine to interview the latest cinematic wonder, Shucks Shottaway, star of 'Let's Lynch'em Anyway'. On the way they stop off at a secluded clinic, which looks like an army camp and, as it turns out, has been overrun by Krul's Nazi hordes.

Garrett's meeting with Mongrel, one of Krul's heavies, is an excellent example of the sort of thing you can expect in the game. While the pair size each other up and utter a few apposite words, typing 'Attack Mongrel' sends a fist flying towards Mongrel's portrait, which hits it, sending it crashing to the bottom of the screen.

Soon, however, Garrett is surrounded by Krul's henchpersons, who include an Arab with a tattoo and a butch female nurse with the bedside manner of Dr Crippen. As Krul talks at Garrett, declaiming his master-plan to take over the world with a Master Race bred in baby factories, the portraits of the various characters present surround Garrett, pitching in with the odd threat; or, in the nurse's case, the odd punch.

As the characters talk, their por-

traits flip over, or assume new expressions, or peel off and reappear in another part of the screen, or evaporate and reconstitute. All this gives the impression that a lot of action is happening, although in reality all the characters are doing is talking to each other.

The way a character moves describes its current emotional or physical state, or the action that it is performing. For example, at one point in the game, Garrett is described as running through a hail of bullets. His portrait weaves across the screen until one of the bullets catches him, at which point he pitches onto his side and drops to the bottom of the display. Likewise, Cynthia Sneeze weaves between the characters surrounding Garrett when he is being held prisoner by Krul, except that in her case drink is the problem, not bullets.

As you get deeper into the game, the number of problems to overcome just pile up. Your main task is to rescue Glory Streek, who, it appears, has been kidnapped by twin brothers. Unless you can get her back, and fast, the game will end badly for Garrett.

Crash Garrett is one of the most inventive games I have seen in a long time. There is a great deal to do, and a lot to laugh at, because Garrett, however awful his predicament, is a character who evokes mirth rather than sympathy.

## Undercover and out of hand

**Title:** Police Quest: In Pursuit of the Death Angel  
**Computer:** Atari ST; Amiga  
**Supplier:** Activision  
**Format:** Disk  
**Price:** £24.95

All of a sudden, Sierra, producer of the Black Cauldron and Kings Quest, is writing games aimed at adults. Last month we looked at the first one, Leisure Suit Larry, a lubricious tale about a night on the town. More recently, Activision launched Police Quest, a tale about what it is like to be a policeman in America.

Police Quest, like Leisure Suit Larry, comes stamped with a small warning advising 'parental guidance' because the product contains adult material. As far as I can see, this is not to put parents off buying the game for their kids, but to stop women — who may be offended by its sexism — getting hold of it. Despite Police Quest being about the police, Sierra still manages to include a picture of a semi-naked female cal-

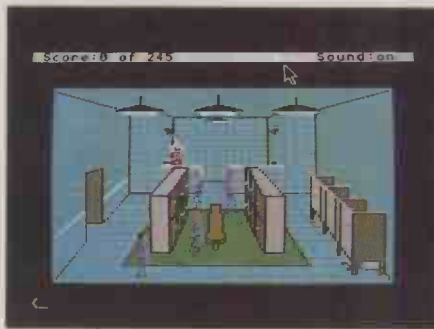

led Helen Hots, who, believe it or not, is said to be a resident of Gyrate Court. You almost expect to find Benny Hill credited as scriptwriter, such is the level of the game's humour.

Police Quest is apparently based on a factual account as told by ex-police officer Jim Walls, a man with 15 years of service under his belt. The game is so accurate, in fact, that what you experience playing it is as close as you could expect to get to the daily routine of an American cop, short of actually joining the force. Or so Sierra would have you believe.

The game is, says a blurb on the box, unlike the 'mindless garbage' made about police on television; programmes like *Miami Vice*, for example, where even the drunks wear Yves Saint Laurent rags. Indeed, 'A police officer's job consists of more than high-speed chases and "Dirty Harry" shootouts.' So what is left? I hear you ask. Well, there is drug traffic, homicide and violence; in other words, the three staple themes of the 'mindless garbage' on television.

Police Quest's action takes place in Lytton, a fictitious town in the grip of a major crime epidemic. Behind the trouble is Death Angel, a racketeer with a finger in every illicit pie; drugs, murder and robbery being his favourite fillings.

A criminal like Death Angel is big-time and way out of your league — at least to begin with. When the game opens, you are a humble uniformed policeman whose daily routine consists of filing reports, booking jay-walkers and spotting stolen cars. You do, however, have dreams of becoming an undercover agent, a move possible only after you have proved your worth as a uniformed officer.

When the game begins, you are in the austere interior of the Lytton police station. As with all of Sierra's 3-D adventures, you don't move around the game environment by typing 'GO NORTH', or whatever, but by controlling an animated figure via, in the case of the ST version reviewed here, the computer's numeric keypad or a joystick.

Using the keypad, you can make your character seemingly walk into



and out of the screen, as well as through doors into other locations. There is a drawback to this kind of game in terms of speed. The screens depicting each location require a lot of memory space, and, on an Atari ST 512 only one screen can be stored in RAM at a time. Each time you enter a new location, therefore, the computer has to access the game disk in order to load the new screen into memory.

Initially, this hardly interferes with your enjoyment, though it becomes rather tiresome after, say, an hour or so, when you return to locations for the second time.

Obviously, the quality of the game's graphics has a bearing on whether or not you enjoy this kind of program. Police Quest's graphics are some of the best I have seen in any of Sierra's 3-D adventures — and there have been quite a few. Interior 'shots' are fairly conventional, although now, when you examine something important, you very often get a full-screen close-up, much as in Leisure Suit Larry.

When you go outside the station and climb into your car, the display changes to an aerial view of a section of Lytton, complete with roads and buildings. Although the car is operated using the same controls as during the interior scenes, driving is difficult, not least because in America they drive on the right-hand side of the road. I crashed several times, which wouldn't have been so bad if it hadn't meant restarting from scratch each time. Saving your current position is essential.

You must become familiar with the controls as quickly as possible, because it isn't long before the station radios you to drive to the scene of a motor accident. And so the game goes on. Incident follows incident until, finally, you can go undercover in search of the Death Angel.

Overall, Police Quest is an exciting game full of inventive touches and, unfortunately, some rather dubious material. Original as it is, though, I'm not sure about this move towards realism: games just get tackier and more sordid. It will be interesting to see what Sierra comes up with as a sequel.

END



**FAX MACHINES**  
**Lowest Prices Guaranteed**  
**NEFAX · PANAFAX · CANON**

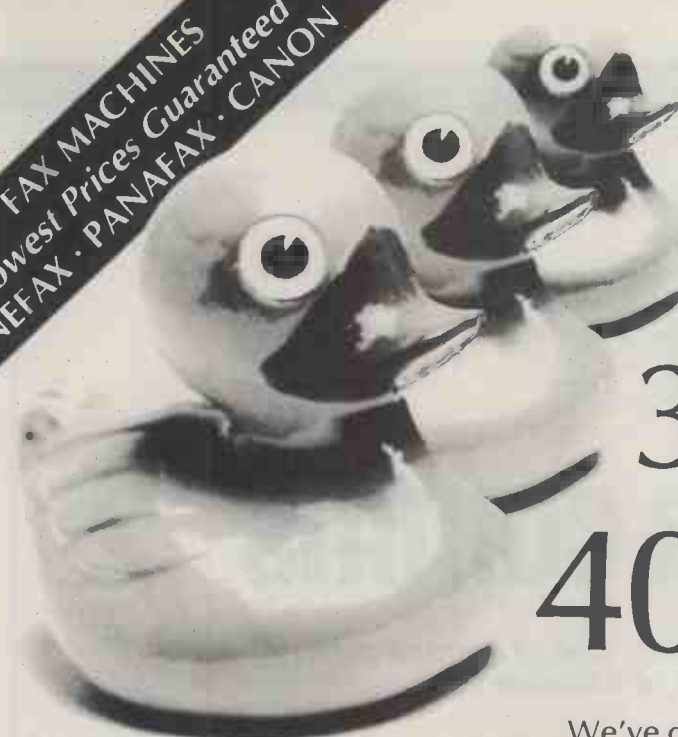

# Three Little Ducks

**20MB – £199**

ex. VAT

**30MB – £249**

ex. VAT

**40MB – £299**

ex. VAT

We've done it again!

Kudos Systems were the first to bring you a complete 20MB hard disk system for less than £300. And now the Kudos HarDisk 20 is back – for an amazing £199 (ex. VAT). We've also hatched the Kudos HarDisk 40 – a complete 40MB hard disk system for only £299 (ex. VAT). If you canardly believe it then give us a wing on 01-200 6511 or clip the coupon below.

## Kudos HarDisk 20 – £199 ex. VAT

Includes: Miniscribe 5¼", 20MB hard disk drive, Western Digital controller card, cables, manual and utility disk.

## Kudos HarDisk 30 – £249 ex. VAT

Includes: Miniscribe 3½", 30MB, hard disk drive, Western Digital controller card, cables, manual and software.

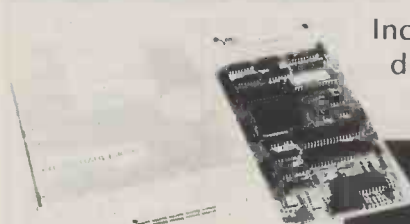

### HarDisk fixing kit

– £11.95 ex. VAT

Fixing kit and modified front bezel for installing the HarDisk 20 or HarDisk 30 in an Amstrad PC.

**KudosCard 30**  
**32MB hard card £249**  
 Call for details.

**The Kudos Systems Price Guarantee**  
 If you buy from Kudos Systems then discover that you could have bought the same products at an advertised UK price lower than ours, then we will refund the difference.

## Kudos HarDisk 40 – £299 ex. VAT

Includes: Miniscribe 5¼", 40MB, hard disk drive, Western Digital controller card, cables, manual and software.



**AMSTRADS – Lowest prices guaranteed – phone for details**

**All Kudos Systems' products come with a 12 month no-quibble guarantee**

**KUDOS**  
*Systems*  
**LIMITED**

If you're a government department, education authority or PLC, just call us, quoting an official order number and your goods will be despatched on the same day.

*The Kudos Sales Team*  
 Mail Order Sales: Yvonne Gayle  
 Export Sales: Gary Munz  
 Corporate Sales: Jane Messer  
 Dealer Sales: Grant Bosher

**Kudos Systems Ltd**  
 Capitol House, Capitol Way  
 Edgware Road  
 London NW9 0ED

**01-200 6511**

Tlx: 8813241

Fax: 01-205 3911

Personal callers welcome – Call in and save on delivery charges.

All tradenames and product names are the property of their respective manufacturers/owners.

To Kudos Systems Ltd, Capitol House, Capitol Way, Edgware Road, London NW9 0ED		Please rush me the following products:	
_____ (Qty)	Kudos HarDisk 20	.....	£241.50
_____ (Qty)	Kudos HarDisk 30	.....	£299.00
_____ (Qty)	HarDisk fixing kit for Amstrads	.....	£13.74
_____ (Qty)	Kudos HarDisk 40	.....	£356.50
★ Prices include VAT and courier delivery to your door		TOTAL _____	

Please send me your latest information pack

I enclose a cheque for £ \_\_\_\_\_

or debit my Visa Card Number \_\_\_\_\_

Name \_\_\_\_\_

Company \_\_\_\_\_

Address \_\_\_\_\_

Postcode \_\_\_\_\_ Telephone \_\_\_\_\_

Approx No. of PC's in Company \_\_\_\_\_

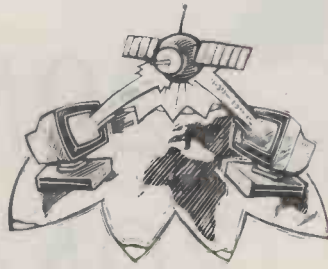

# Choices in comms

Peter Tootill takes a look at the current crop of comms software and sings the praises of Zmodem.

What constitutes a good terminal program is, like many other aspects of microcomputing, part dependent on the intended use and part on personal taste. Software that is ideal for someone who uses, say, Telecom Gold almost exclusively would probably not suit a Prestel user or a dedicated bulletin board enthusiast. What are the things that make a good Prestel/electronic mail/BBS users' program? I'll attempt to answer that by looking at a few of the popular terminal programs available.

I have selected the programs featured here partly because they illustrate the points I want to make and partly because I had ready access to them — and they run on the ubiquitous PC clone. The fact that a particular program is not included doesn't imply anything for or against.

## Chit-Chat

Chit-Chat is published by Sagesoft and, as it is a British product, offers viewdata (Prestel-type) emulation, as well as a range of other terminal emulations. Software of US origin normally doesn't include viewdata. Chit-Chat is menu-driven which makes it easy to use if you are not used to communications. It has a built-in dialling directory that can contain a staggering 32,000 numbers. It stores all its numbers (and the fairly limited logon sequences it supports) in one file; other software requires one or even two files for every system you call. If you only call a limited number of systems, then that is no problem. However, on hard disks each file takes up 2-4k and this can quickly eat up disk space if you use a lot.

The standard IBM CGA adaptor cannot cope with the non-IBM graphics and eight colours

of a viewdata system. You usually get either all the colours and limited graphics or vice versa. EGA systems can handle both, but not all software allows you to take advantage of it.

This is the case with Chit-Chat. However, Sagesoft will supply a ROM for the standard IBM CGA card that allows the full graphics and character set to be used. Some standard IBM characters are lost, though.

Chit-Chat doesn't support CET telesoftware downloading,

**Like Crosstalk,  
'Mirror is command-driven with no built-in menus ...'**

only Xmodem and proprietary file transfer protocols. It is a reasonable all-round package, fairly simple to use and with a good manual. It costs £99.

## Contact

Contact comes from a British software company called Xon, started by John Coll (in the news frequently when he was a teacher at Oundle school, which was pioneering the use of microcomputers in schools back in the days of the Nascom 1 and the Sinclair Mk14!).

Contact's main strength is its rock-solid viewdata emulation. It needs an EGA monitor but it displays the full range of colours and graphics, and it handled all the dynamic frames I threw at it without a hitch. All the other packages had at least some problems in this area. Contact can also store viewdata frames in the CET file inter-

change format which enables them to be copied between databases. It also handles tele-software as well as Xmodem and Telecom Gold's FT file transfer protocols.

Contact costs £79.95.

## Crosstalk Mk4

Crosstalk Mk4 was reviewed in PCW in November 1987. All I will say here is that it has a comprehensive programming language, supports synchronous as well as asynchronous applications, and allows up to 16 simultaneous sessions. It is a very powerful package, but don't expect it to be easy to use.

Crosstalk Mk4 costs £155.

## Mirror II

Mirror II is the new version of Mirror, the Crosstalk XVI clone. Because of a court action over the fact that Mirror copied Crosstalk XVI's status screen, Mirror II now looks different from Crosstalk. The original Crosstalk status screen, which attempts to show the status of a number of modem and other parameters, is confusing to look at and difficult to interpret. This, together with the fact that Crosstalk is command-driven (no helpful menus) could put many new users off comms for life!

Mirror II's status screen is now much better, having just a couple of panels at the top which can be scrolled to show logical groups of parameter settings for the software and for the online service that has been loaded. Like Crosstalk, Mirror is command-driven with no built-in menus, but a fairly powerful script language allows menus to be written that can make some of the program's functions menu-driven.

Unlike a lot of US software, there is a UK version that has

scripts which would be useful to UK users, including a setup script that knows about British modems and using Telecom Gold via PSS, and which writes an auto-logon script. This is excellent — much better than many UK programs.

Mirror II also includes a viewdata emulation that is quite comprehensive, even to the point of including CET tele-software downloading protocols for downloading programs from Prestel. You don't get full Prestel graphics, even on an EGA system. There is, however (like Chit-Chat) a choice of displays. Mirror II will even attempt to show viewdata frames on a monochrome display adaptor — not very well, but most viewdata terminal programs insist on at least a Hercules card.

Another unusual feature is the fact that you can automatically save a batch of Prestel pages as they are received. Most Prestel software requires you to save each frame manually. Mirror II has a setting where each page is automatically saved as it comes in. Dynamic frames can be captured and replayed — this is also unusual.

Mirror's main strong point has always been the fact that it can run in the background while you get on with another task. This means that you can log on to a system, start to download a file, and then Mirror quietly gets on with the job. The powerful script language enables quite complex functions to be automated and left to run in this way.

Mirror II is a good all-round package with a useful range of terminal emulations and file transfer protocols. It is also well-customised for the UK market and, at £69, is reasonably priced.



**Procomm, and so on**

Procomm was probably the first US shareware comms program to make a big impact in the UK. Experienced BBS users took to it in a big way because they found it easy to use and versatile. However, some people didn't like it because, when you run it, you are presented with a blank screen with just the words 'Press Alt-F10 for help' at the bottom. Pressing these keys brings up a single screen which sets out the functions of the various command keys that can be used. The information is confusingly laid out and some of the keys are not intuitively obvious. The blank screen is actually the terminal screen: if you type anything at this point you are talking directly to the modem.

You can use Procomm without needing to know anything more about how it works by dialling a number and switching your modem online. This is different to most of the other terminal programs covered here. They normally require you to enter a number in a dialling directory before you can call them, or at least to program them in some way. When you get past the initial screen, Procomm is easy to use as most of the functions use pop-up menus. There are no commands to remember.

Procomm has a dialling directory that can hold up to 100 numbers, however, and it offers most of the facilities a BBS user requires, including a fairly powerful script language that can be used for autologon scripts, and a number of terminal emulations (but not viewdata). A wide variety of file transfer protocols are included.

A modified version of Procomm, called Baudwalk, was commissioned by Dataflex to go with its Stradcom modem. This includes a viewdata mode. However, all you can do with it is look at viewdata frames; they can't be saved to disk or printed, and there is no telesoftware downloading facility. A new version of Procomm which is no longer shareware, called Procomm Plus, has just been released.

After Procomm came Telix, which is clearly son of Procomm in the way it works but has improved on Procomm in that it provides more intuitive command keys (for example, Alt-L for opening the log file instead of Procomm's Alt-F1), screen editing of modem setup strings (no need to carefully retype a whole line of AT commands when all you want to do is change S7 from 50 to 60

seconds), and a few other things that make it generally a little nicer to use.

Both Procomm and Telix allow you to set up what the Americans call 'long-distance codes'. These are dialling code prefixes that they use to connect via alternative long-distance telephone carriers — the only one we have in this country is Mercury. Such a facility is useful as it allows you to use Mercury to call a system if you have an account, simply by prefixing the number with a character such as '#' which is automatically translated into the required dialling command to route the call via Mercury rather than BT. Up to four long-distance codes can be used.

Telx doesn't allow codes to be quite so long as Procomm, and you could have problems with it if you have cost centre codes or need a lot of commas in the dial command (the minimum length required to use Mercury is 15 characters, 17 if you use cost centre codes as well). It isn't possible to use most UK software to dial via Mercury unless you store the requisite codes in with each phone number, as there is no long-distance code facility.

Boyan is the latest US shareware program to become available in the UK. From the brief look I have had, it looks very powerful, but it is much more complex than Procomm or Telix.

**Vicom**

Vicom is unusual in that it is designed to be mouse-driven (it started life on the Macintosh). The IBM version comes bundled with GEM. If you like mouse-driven software, especially if you use Prestel, you'll love Vicom. The standard ASCII terminal mode is pretty limited: its main strength lies in the features that are designed to make Prestel easy to use. For example, it has a built-in 'note pad' so that you can note a page you may want to refer to again. When you want to do so, call up the note pad, point to the entry for the page you want and Vicom takes you straight there.

Other mouse-orientated features include an onscreen numeric keypad, and the ability to choose entries from a Prestel menu frame by pointing the cursor to them on the screen and clicking. There is also a built-in text editor for normal text files and for preparing Prestel message frames offline for later uploading. However, there is no viewdata frame editor as such. The only other things missing from the

viewdata side are telesoftware downloading, and (strangely) separated graphics are not supported.

The normal scrolling mode terminal is adequate but lacks some of the features I would have expected. It has only standard TTY terminal emulation — no VT-52, ANSI, and so on. File transfer is limited to ASCII and Xmodem protocols. I would have liked more: a batch protocol for transferring a group of files would be useful. A new release of Vicom is due out later this year that will deal with many of the above shortcomings, and will include a viewdata frame editor and a powerful script language.

Vicom also provides a limited amount of multitasking. You can leave a file transfer in progress and open a window to use the built-in text editor.

The manual is good, with a useful summary of online systems. It is well laid out, being arranged by service type which makes it easy to use, especially for first-time users.

As well as the IBM PC version I used, versions are available for the Macintosh, Atari (called FaSTcom) and Amstrad PC (called GEM Comm). Prices range from £49.95 (Atari) to £150 (PC/Macintosh).

**Summary**

There is a lot of personal taste in choosing communications software. Some people swear by Procomm, others love Crosstalk. The advantage of Procomm (and Telix and Boyan) is that as they are shareware you can try before you buy.

If you use viewdata systems a lot, then look for a program with good Prestel features. If you have an EGA card, make sure the software can take full advantage of it. If you call a lot of bulletin boards, pick a program with a reasonable-sized dialling directory. Electronic mail systems are straightforward and most software is suitable for using them. However, a good script language (like Mirror II or Contact) can enable you to automate a lot of routine features.

My ideal would combine the Prestel features of Vicom, the rock-solid viewdata emulation with EGA support (when I can afford one) of Contact, a range of file transfer protocols like Procomm and Telix, with a similar-sized dialling directory, long-distance codes and script language.

**Zmodem protocols gain popularity and support**

When I wrote about file transfer protocols in *PCW* in April last year, Zmodem had only recently appeared on the scene. Now it is becoming more and more popular, with many Opus and other bulletin boards supporting it. It has been well-designed to enable it to cope with real-life conditions such as noisy lines. It has, for example, a variable block length to allow it to reduce packet size on noisy lines and increase it on clear lines. This allows it to optimise the overheads of calculating CRC's on the one hand and re-transmitting blocks on the other.

The main, even overriding point in Zmodem's favour as far as I am concerned is that if a file transfer stops part way through for some reason, it can be continued from the point at which it left off. I had practical experience of this recently. I was downloading a file from an Opus system and twice lost the carrier because of poor lines. I called back and in each case was able to resume the transfer from where it stopped. There was no need to start again from the beginning.

Even if your terminal program doesn't support Zmodem transfer protocols, you may be able to use them. There are two conditions: first, you need to be using an IBM clone; and second, you need to be able to run an external program from within the terminal program itself. Many comms programs allow this, including Mirror, Contact, Procomm and Telix. It allows you to use a program called DSZ which was written by Chuck Forsberg who devised Zmodem, and it is designed especially for BBC and terminal programs to use the protocols without having to have them built in.

DSZ can be used in a number of ways, but the command syntax can be a little complex. My favourite method is to use a shell program written by Brad Jackson of Stargate Opus, called DSZT. This has been specifically designed for use with Telix, but can be used with other programs. You can download it from Stargate on (0476) 74616. DSZ is shareware (\$25 contribution) and is available from many BBSs.

# UK BULLETIN BOARDS

## London

**Airtel - TBBS (0342) 717 800**  
W Sussex; 24 hrs; 3-24;  
Pilots' area  
**Brixton ITeC (01) 735 6153**  
24 hrs; 1275v  
**CIX (01) 399 5252**  
24hrs; 3-24; multi-user;  
conferencing  
**Communitel (01) 968 7402**  
24 hrs; 1275v  
**Crystal Tower (01) 886 2813**  
24 hrs; 3-24  
Gen interest; Apple & IBM  
**Dark Crystal Fido**  
(01) 207 2989; 24 hrs; 3-12  
**Distel (01) 679 1888**  
24 hrs; 300; Display  
electronics - Commercial  
3/1275 on 01 679 6183  
**Gnome at home (01) 888 8894**  
24 hrs; 1275v  
**Hackney BBS (01) 985 3322**  
24 hrs; 1275v  
**Health data (01) 986 4360**  
24 hrs; 1275v  
**Infotel ROS (01) 581 3376**  
24hrs; 3/1275  
**ITCU Training (01) 960 4742**  
24 hrs; 1275v  
Lots of ITeC training  
materials  
**Link Fido (01) 659 6992**  
24 hrs; 3-12  
**London U'gnd (01) 863 0198**  
24 hrs; 3-24 Wildcat BBS  
**Marcel (01) 346 7150**  
24 hrs; 3/1275 FBBS system  
**MBBS Mitcham (01) 648 0018**  
24 hrs; 3/1275  
**Metrotel (01) 941 4285**  
24 hrs; 1275v  
**NNBBS London (01) 455 6607**  
24 hrs; 3/1275  
**Nottingdale Tec Ctr**  
(01) 968 6033; 24hrs;  
1275v; Communitel system  
**OSI Lives (01) 429 3047**  
24 Ring back; 300  
**PC Access (01) 853 3965**  
24 hrs; 3-24 For PC users  
**PD-SIG Headquarters\***  
(01) 864 2633; Greenford;  
24hrs; 3-24M  
**Taecon (01) 573 8822**  
MF: 7pm-8am; WE:all day Sun  
300 Interak micro section  
**TBBS Rovoreed (01) 542 4977**  
24 hrs; 3-24  
**TBBS London (01) 348 9400**  
24 hrs; 3-12  
**Techno Line (01) 450 9764**  
24 hrs; 1275v; Commercial  
**Techno-line 2 (01) 452 1500**  
MF: evenings; WE:24 hrs  
1275v Commercial  
**The Star BBS (01) 586 6882**  
24 hrs; 3/1275; Atari ST area  
**The Village (01) 464 2516**  
24 hrs; 3-24  
Atari 520ST based  
**WBBS Wimbledon (01) 542 3772**  
Sat 7pm - Mon 8am; 3/1275

## The South East

**Acorn BBS; Cambridge**  
(0223) 243 642 24 hrs; 1275v  
**Andrew's Fido; Aylesbury**  
(08444) 4833; 24hrs; 3/1275  
IBM-based system  
**Apple Crackers Basildon**  
(0628) 778956; 24hrs; 3-1275  
Apple II/11GS; also on  
781318 and 771724  
**ARCNET; Colchester**  
(0376) 518 818 24 hrs; 300  
**Audio Output; Weybridge**  
(0932) 244906; 24hrs; 3/1275  
Viewdata & scrolling  
**BABBS; Felixstowe**  
(0394) 276 306 24 hrs; 3-24  
**Banat Board; Oxford**  
(0993) 898 441 24 hrs; 3-24  
FidoNet UK coordinator  
multi-line TBBS  
**BBS09; Portsmouth**  
(0705) 736 025 24hrs; 3-12;  
OS9; Sci-Fi; Dragon, CoCo  
**BLITEC; Basildon (0268) 22 177**  
24 hrs; 1275v

**BITEC; Basildon**  
(0268) 25 122 24 hrs; 300  
**BOOG BB; Fleet; Hants**  
(0252) 626 233 24 hrs; 3/1275  
Osborne; MS-DOS; CP/M areas  
**C A T S Fido; Maidenhead**  
(0628) 824 852 24 hrs; 3/1275  
V22/bis coming  
**CATS BBS\*; Maidenhead**  
(0628) 824852; 24hrs; 3/1275  
V22bis coming  
**C View Rochford; Kent**  
(0702) 54 6373 24 hrs; 1275v  
**CP/M User Group; Windsor**  
(0753) 868 196 24 hrs; 3-24  
CP/M and MS-DOS software  
**Datsoft Opus; Ilminster**  
(04605) 4615 24 hrs; 3-24  
Inc Datatalk Support area  
**Dr Solomon's Fido; Amersham**  
(02403) 4946 24 hrs; 3-24  
mostly for IBM programmers  
**Folkestone TBBS (0303) 42690**  
24hrs; 3-12; Portable SIG  
**Gospot Apricot BBS**  
(0705) 524 805; 24 hrs; 300  
**Ichthus; Reading**  
(0734) 484 847; 24hrs; 3/1275  
Multi-choice bedtime story  
**LABBS; Surrey (0883) 844 164**  
24 hrs; 3/1275; The Prisoner  
**Lasermail Fido; Worthing**  
(0903) 212 552 24 hrs; 3/12  
**MacTel Phoenix; Ipswich**  
(0473) 610139; 24hrs; 3-24  
Multi-line; Mac users  
**Maptel; Southend (0702) 552 941**  
24 hrs; 300; commercial system  
**Mirrorworld; Surrey**  
(0883) 844044/844164; 24hrs  
3/1275; Multi-user games  
**Music World; Weybridge**  
(0932) 245593; 24hrs; 1275v  
Viewdata & scrolling  
**Noderunner BBS; High Wycombe**  
(0494) 881289; 10pm-7am  
3/1275; Atari 520STFM  
**Patnet; Colchester**  
(0206) 844 813 Daily 8pm-8am  
12h; runs on a Spectrum  
**PD-Sig Fido 1; Crowborough**  
(08926) 61 149 24 hrs; 3/1275  
PD software interest group  
**PD-SIG System; Uxbridge**  
(0895) 420 164 24 hrs; 3-24M  
also on 0895 52685  
**PD-SIG Exch. Centre, Sandy, Beds.**  
(0767) 50511; 24hrs; 3-24M  
**Pete's Place; Colchester**  
(0206) 352 354 24 hrs; 3-24  
good IBM SIG  
**QMC Viewdata; Basingstoke**  
(0256) 471 757 24 hrs; 1275v  
Queen Mary's College  
**RICBBS; Basildon (0268) 710 637**  
MF: 5pm-10pm; WE:24 hrs  
**RSGB; London (0707) 52 242**  
24 hrs; 1275v  
**SBBS - Watford (0923) 676 644**  
9pm-11am plus 11pm-6am daily  
3/1275  
**Sentinel; Maidenhead**  
(0628) 781429; 3/12/24  
IBM PC; FidoNet  
**Sky; Guildford**  
(0483) 275455; MF:6pm-8am  
WE:24hrs; 1275v  
**Staines BBS (0784) 65794**  
24hrs; 3-24  
**Trinity 2; Faringdon**  
(0367) 81 507 24 hrs; 3/1275  
Sponsored by Courier Consultancy  
**Trinity 3; Reading**  
(0734) 484 847; 24 hrs  
3/1275 Multi-choice bedtime  
story  
**Typnet (0689) 50866**  
24 hrs; 300; Budget Typsetting  
**Vampire's Coffin; Weybridge**  
(0932) 245 593 24 hrs; 1275v  
Viewdata & scrolling

## The South West

**CBBS South West; Exeter**  
(0392) 53 116 24 hrs; 3/1275  
**Kernow BBS\*; Cornwall**  
(0209) 821670; 24hrs; 3/1275  
**Light Fingers Place; Dorset**  
(0202) 485723; 24hrs; 3-24  
Atari ST, QL

**TBBS Blandford; Dorset**  
(0258) 54 494 24 hrs; 300  
**Blandford Computers**  
**Trinity 1; Exmouth**  
(0395) 410 210; 24 hrs; 3-24  
Christian, Infomat mag

## The Midlands

**Access Fido; Worcester**  
(0905) 52 536 24 hrs; 3-24  
midi section  
**CBABBS; Birmingham**  
(021) 430 3761 24 hrs  
(not Thurs); 300 Atari based  
can send mail to Canada  
**Central Opus\* Birmingham**  
(021) 711 1451  
24hrs; 3-24; PEP; 130Mb  
storage; Trailblazer  
**Digital Matrix Fido**  
Birmingham (021) 705 5187  
24 hrs; 3/1275  
Compu-store on-line  
**Intel-Ace; Oundle**  
(0832) 73 003 MF:6pm-8am  
WE:24 hrs; 1275v  
**MacTel Green Box; Nottingham**  
(0602) 455444; 24hrs; 3-24  
Multi-line system; Mac users  
**TABBS; Tamworth; (0827) 281713**  
9pm-8am; 1275; Runs on Amstrad  
464/664; Trivia  
**The City; Birmingham**  
(021) 353 5486 24 hrs; 300  
Atari 8 bit & ST; Lonely Hearts  
**Key Board; Milton Keynes**  
(0908) 668 398  
8pm-8am exc Tues and Thurs  
12h Runs on a Spectrum.  
**MacTel HQ; Nottingham**  
(0602) 817 696 24 hrs; 3-12  
Macintosh Users  
**Norway; Northants**  
(0604) 20 441; 24 hrs; 1275v  
**Sponge; Leicester (0936) 77025**  
24hrs; 3/1275  
**TABBS Amiga BBS; Leicester**  
(0533) 550893; MF:6pm-9am  
Sun:24hrs; Amiga Users Group  
**Trinity 4; Leamington Spa**  
(0926) 28294; 24hrs; 3-24  
**TUG II; Birmingham**  
(021) 444 1484; 24 hrs; 3/1275  
Amstrad;Tandy;online Adventure  
**West Midlands Central**  
(0902) 633303; 24hrs; 3/1275  
Opus System  
**Wolverhampton BBS**  
(0902) 745 337; 24 hrs; 3/1275  
MS-DOS; CP/M; Commodore areas

## The North West

**Bolton BBS (0204) 43082**  
MF:8pm-8am; WE:24 hrs; 3-24  
8am-8pm on ring back  
**Fido Manchester (061) 773 7739**  
24 hrs; 3/1275  
Mektronik Electronic  
design cons  
**Liverpool Mailbox**  
(051) 428 8924 24 hrs; 3-24  
UK TBBS HQ system  
**Matrix; Liverpool**  
(051) 737 1882; 24 hrs; 3/1275  
Multi-user games; 4 lines  
**Mighty Micro; Manchester**  
(061) 224 1596; 24hrs; 3/1275  
Sun:24hrs; 3/1275; Fido/Opus  
**OBBS Manchester**  
(061) 427 1596 24 hrs; 3/1275

## The North East

**49'ers; Cleveland**  
(0287) 43 920 MF:10pm-4am  
WE:10pm-4am; 3/1275  
FBBS colour for BBC users  
**Forum-80; Hull (0482) 859 169**  
MF:7pm-11pm; WE:1pm-11pm  
3/1275  
Midnight-8am on Bell 103 tones  
**Kirklees ITeC; Batley, Yorks**  
(0924) 442598; 24hrs; 1275v  
Information Technology Centre  
**LEMS Fido; Leeds**  
(0532) 600 749 Daily 10pm-8am  
3/1275  
**Hannet; Hull (0482) 465 150**  
MF:6pm-8am; WE:24 hrs; 3/1275  
Radio Hams  
**LEMS BBS; Leeds; (0532) 600749**  
24hrs; 3/1275; Wildcat system

**Log On Tyne Fido; Tyneside**  
(091) 477 3339 24 hrs; 3-24  
**MacTel Sheffield**  
(0742) 350 319 24 hrs; 3-24  
For Macintosh Users  
**MBBS Leicfield (0401) 50 745**  
24 hrs; 3-12  
**OBBS Bradford (0274) 480 452**  
24 hrs; 3/1275  
Colour for BBC users  
**On-Line Systems; Cleveland**  
(0429) 234 346; 24 hrs; 3-24  
Viewdata/scrolling  
**Pyramid; Leigh; Lancs**  
(0942) 609 611 24 hrs; 3  
**Stockton Opus; Cleveland**  
(0642) 588 989 24hrs; 3-12;  
MSX and Atari SIGs  
**Stoke ITeC (0782) 265 078**  
24 hrs; 1275v  
**TeePee Link; Manchester**  
(061) 494 6938 24 hrs; 3-24  
**The Sharrow BBS; Ripon**  
(0765) 707 887 24 hrs; 3/1275  
Viewdata & scrolling BBC based

## Scotland

**Aberdeen ITeC (0224) 641 585**  
24 hrs; 1275v  
**Aberdeen Commodore**  
(0224) 781 919 24 hrs; 300  
Commodore 64 based  
**A.L.A.N. Fife (0592) 860313**  
9.30pm-8am; 3  
**Betelgeuse 5; Inverness**  
(0463) 231 339 24 hrs; 3/1275  
**Kirklees ITeC; Batley**  
(0924) 442598 24 hrs; 1275v  
Information Technology Centre  
**Livingstone BBS; Livingstone**  
(0506) 38 526 24 hrs; 300  
**People's Palace; Glasgow**  
(041) 956 6537 Daily 6pm-8am  
3/1275 Colour

## Wales

**Bulletin AT Fido; Swansea**  
(0792) 297 845 MF:6pm-9am  
WE:24 hrs; 3-12  
**Cardiff ITeC (0222) 464 725**  
24 hrs; 1275v  
**Communitree; Powys**  
(0874) 711 147; 24 hrs; 300  
**CymruTel; Colwyn Bay**  
(0492) 49 194; 24 hrs; 1275  
**FBBS Swansea (0792) 203 953**  
24 hrs; 3  
**MGBBS Mid Glamorgan; Ferndale**  
(0443) 733 343 6pm-1am daily  
300  
**Proteus Opus\*; Porthmadog**  
(0766) 514154 24 hrs; 3-24  
ANSI colour graphics

## Northern Ireland

**Deep Thought Fido; Bangor NI**  
(0247) 467 863 24 hrs; 3-24  
PC-DOS; CP/M; BBC; Tech help Sigs  
**PBBS 1 Portadown (0762) 333 872**  
Daily 10pm-1am; ring back; 300

## Prestel

**Demonstration area access**  
South (01) 618 1111  
Midlands (021) 618 1111  
North (061) 618 1111  
Scotland (041) 618 1111  
ID: 4444444444  
Password: 4444

## ABBREVIATIONS

3 V.21 (300 baud)  
1275 V.23 (1200/75)  
12 V.22 (1200/1200)  
24 V.22bis (2400/2400)  
3-12 V.21, V.22, V.23  
3/1275 V.21, V.23  
3-24 V.21, V.22, V.23, V.22bis  
v viewdata  
s scrolling (not viewdata)  
h half duplex  
r/b ring back  
M MNP error correction  
\* Fidonet node  
Most scrolling systems are 8 bits,  
no parity, 1 stop bit.



# Tandon

AUTHORISED DEALERS

Stocks available of all models

## BEST PRICES

### IBM COMPATIBLE COMPUTERS

Authorised Dealers for  
Tandon Tulip Victor Kaypro Amstrad etc

### COMPLETE SYSTEMS

Printers Plotters Monitors Terminals  
Cards Hard Disks Tape Streamers Modems

### NOVELL NETWORKING SOFTWARE AND SOFTWARE SUPPORT

All popular business software

### RAPID HELPFUL SERVICE EXPERIENCED TECHNICAL BACK-UP

PHONE NOW FOR  
FAST DELIVERY  
AT BEST PRICES



## rapid computer systems plc

151 London Road, West Sussex RH19 1ET  
Phone 0342 410284 (8 lines) Fax 0342 311215

## BUY TEN TOP QUALITY BRANDED FLOPPIES AND GET TWO FREE!

An unbeatable offer from Computec for SKC floppies, the most reliable and dependable diskettes on the market. Look at the prices below. Let alone the freebies. They even include VAT and same day despatch.

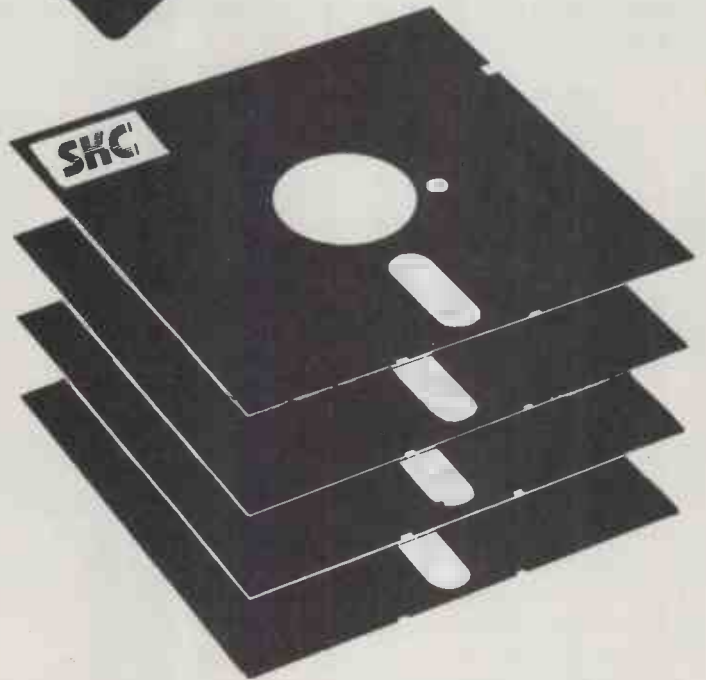

5.25" PRICES  
FOR 10

### +2 Free Disks

Single sided, double density 48tpi	£7.47
Double sided, double density 48tpi	£8.05
Double sided, double density 96tpi	£10.35
Double sided, high density 96tpi	£17.25

### 3.5" Prices for 10 +1 Free Disk

We even offer you one free disk when you buy ten 135tpi single sided, double density disks (£14.95) or ten 135tpi double sided, double density disks (£18.40)

**SKC** Authorised  
Distributor

Every disk is thoroughly inspected and carries a 'no quibble' lifetime guarantee.

To order just phone us on 0258 59330, or write to the address below. Or make an appointment and drop in on us. We take Access and Visa cards, cheques or postal orders. Delivery is by return.  
Dealer and education enquiries welcomed.

**COMPUTEC**

### PRE FORMATTING OFFER

Ready to Run  
For IBM PC/XT and compatibles.  
12 branded SKC 48tpi double sided,  
double density.  
Formatted for only **£9.55**  
fully inclusive.

Computec, Dept. B.1  
F.R.E.E.P.O.S.T  
Pimperne, Blandford,  
Dorset DT11 7BR

## HUBCOURT LIMITED — BUSINESS SYSTEMS

Established 1980

We are SBC Master Dealers and can offer a full range all with 1 year on-site warranty — Free delivery.

SBC XT V40	Twin floppy 12" mono keyboard	£590
SBC XT V40	Single floppy + 20Mb hard disk	£990
SBC XT V40	Single floppy + 30Mb hard disk	£1090
SBC AT 8/10MHz	1.2Mb floppy, 1MB RAM serial and parallel + mono monitor keyboard	£990
SBC AT	As above with 20Mb hard disk	£1390
Phone for prices on other models we can fit free of charge our hard disks into basic model see below for prices		
SBC 200W	Uninterruptable backup power supply	£190
SBC	14" mono monitor	£95
SBC	Laser Printer	£Call

### HARD DISKS

Man.	Model	Capacity	Speed	Price Complete with controller
Miniscribe	3425P	20Mb	53MS	£245
Miniscribe	3438P	30Mb	53MS	£290
Miniscribe	6053	40Mb	28MS	£625
Miniscribe	6085	85MB	28MS	£725
Seagate	225	20Mb	65MS	£235
Seagate	238	30Mb	65MS	£255
Seagate	251	40Mb	40MS	£419
Seagate	4096	80MS	28MS	£725

### FILE CARDS

Miniscribe	20Mb	65MS	£260
Miniscribe	30Mb	65MS	£275

We can supply any size of hard disk from 10Mb to over 500Mb from most major manufacturers. All hard disks are complete with controller card, cables, full instructions and a utility disk. We will format free of charge any hard disk. Also free of charge "XTREE" type disk management system.

### FLOPPY DISK DRIVES

5.25" — 360k £69	5.25" 1.2Mb £95
3.5" — 720k £114 (NEC)	3.5" 1.4Mb £199 (TEAC)

### TAPE BACKUP

Alloy Internal 30Mb £399	Wangteck 60Mb Internal £599
Identica Internal 60Mb £580	Identica 60Mb External £619

### ADD ON CARDS

80286 XT Speed Card 8k cache Ram 8MHz	£199
2Mb EMS suits up to 12MHz (OK Ram)	£119
3MS EMS + I/O suits up to 12MHz (OK Ram)	£179
Paradise auto switch EGA/CGA/Hercules	£129
Hercules compatible mono graphics (short 12MHz)	£59
Orchid Eccell Ram cards	£199

### OTHER GOODS

150W XT power supply unit	£59
14" EGA monitor + EGA card	£399

Phone for best prices on all other goods.  
Prices exclude VAT & carriage. Access accepted

Phone 0702 72588

# JPI MODULA-2 OUTPERFORMS ALL OTHER COMPILERS

JPI Modula-2 produces better code than Microsoft-C, Turbo-C, Logitech Modula, Turbo Pascal or any other compiler you might care to choose.

Here are the facts:

Sieve Benchmark*	Code size	Execution Time
Turbo Pascal V4.0	165	9.6
<b>JPI Modula-2 V1.0</b>	<b>95</b>	<b>3.3</b>
Turbo-C V1.0	115	4.4
Microsoft CV4.0	130	7.4
Logitech V3.0	165	7.4

\*Modula-2 was developed by Niklaus Wirth, the father of Pascal, as a powerful successor to Pascal.

## Compiler Highlights

Full version 3.0 implementation as defined by Wirth. Compiles 3-5000 lines/minute (PC AT 8MHz). Up to 1MB code and data. Long and short pointers. Short pointers supported in all segments. Total segment control (memory models). Generates standard OBJ files. Separate compilation of modules. Automatic "librarian". Built-in automatic "make" facility. Supports multi-tasking. 8087 support. Complete MS-DOS support.

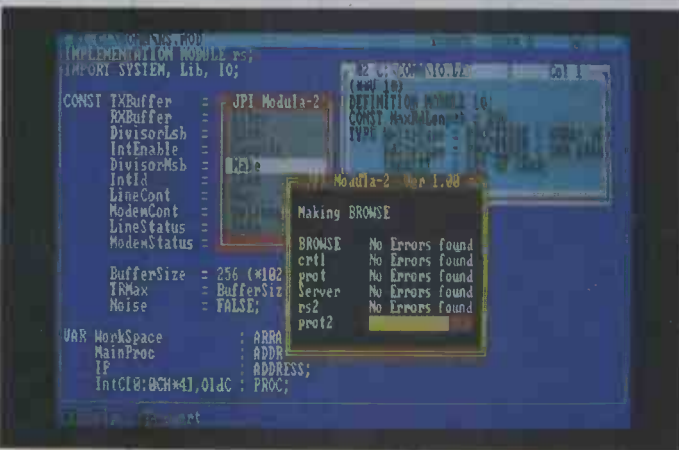

For only £79.95 inc. VAT you get all of the above including full source code to the libraries and the window manager. Shipped free of charge in the U.K.

Runs on all IBM PCs and compatibles, including the Amstrad 1512 and 1640.

No-questions-asked 30 day money back guarantee.

## ORDER NOW

Dial 0800-444143 free of charge 24 Hours. COD and credit cards accepted. We ship within 24 hours.

For further information or to order by mail contact: Jensen & Partners U.K. Ltd., 63 Clerkenwell Rd., London EC1M 5NP. Phone: (01) 253 4333.

\*25 iterations on Compaq 286 at 8MHz.

Brand and product names are trade marks or registered trademarks of their respective holders.

"I like JPI Modula-2 a lot better than any other M2 I have seen."

Owen Linderholm **Personal Computer World**

"JPI Modula-2 is a landmark product. JPI has finally created the system which this powerful language deserves."

Huw Collinbourne **Computer Shopper**

## Environment Highlights

Multiple window editor with re-configurable commands. Edit several files simultaneously. Compile, link and run programs with a single keystroke. Pin-points compile-time and run-time errors in the source instantaneously. Context sensitive built-in help system. Built-in data-communications package which will connect you to JPI's TechLine. All environment commands and menus are re-configurable. Windows may be resized, re-coloured and moved around at any time.

## Technical support 24 hours a day

Technical support is available 24 hours a day via J&P's exclusive TechLine which allows you to connect via modem directly to our computer. Technical support is of course also available during normal business hours via telephone or mail.

## Complete documentation

The system comes with a 250 page typeset manual which provides an introduction to Modula-2 and a detailed description of the JPI Modula-2 system.

```
MODULE Bench;
FROM IO IMPORT WrStr;
CONST NoOfIterations = 25;
      Size = 8190;
VAR I: CARDINAL; (* unsigned 16-bit integer *)

PROCEDURE Sieve;
VAR I, K, Prime, Count: CARDINAL;
    Flags: ARRAY [0..Size] OF BOOLEAN;
BEGIN
  Count := 0;
  FOR I := 0 TO Size DO
    Flags[I] := TRUE;
  END;
  FOR I := 0 TO Size DO
    IF Flags[I] THEN
      Prime := I + I + 3;
      K := I + Prime;
      WHILE K <= Size DO
        Flags[K] := FALSE;
        K := K + Prime;
      END;
      INC( Count );
    END;
  END;
END Sieve;

BEGIN
  WrStr("Start..");
  FOR I := 1 TO NoOfIterations DO
    Sieve;
  END;
  WrStr("..Stop");
END Bench.
```



# SPECIAL OFFER

For Personal Computers Running the  
MS-DOS<sub>®</sub> Operating System

Also available on  
3½" disks.  
Details inside.

## Microsoft<sup>®</sup> Macro Assembler 5.0

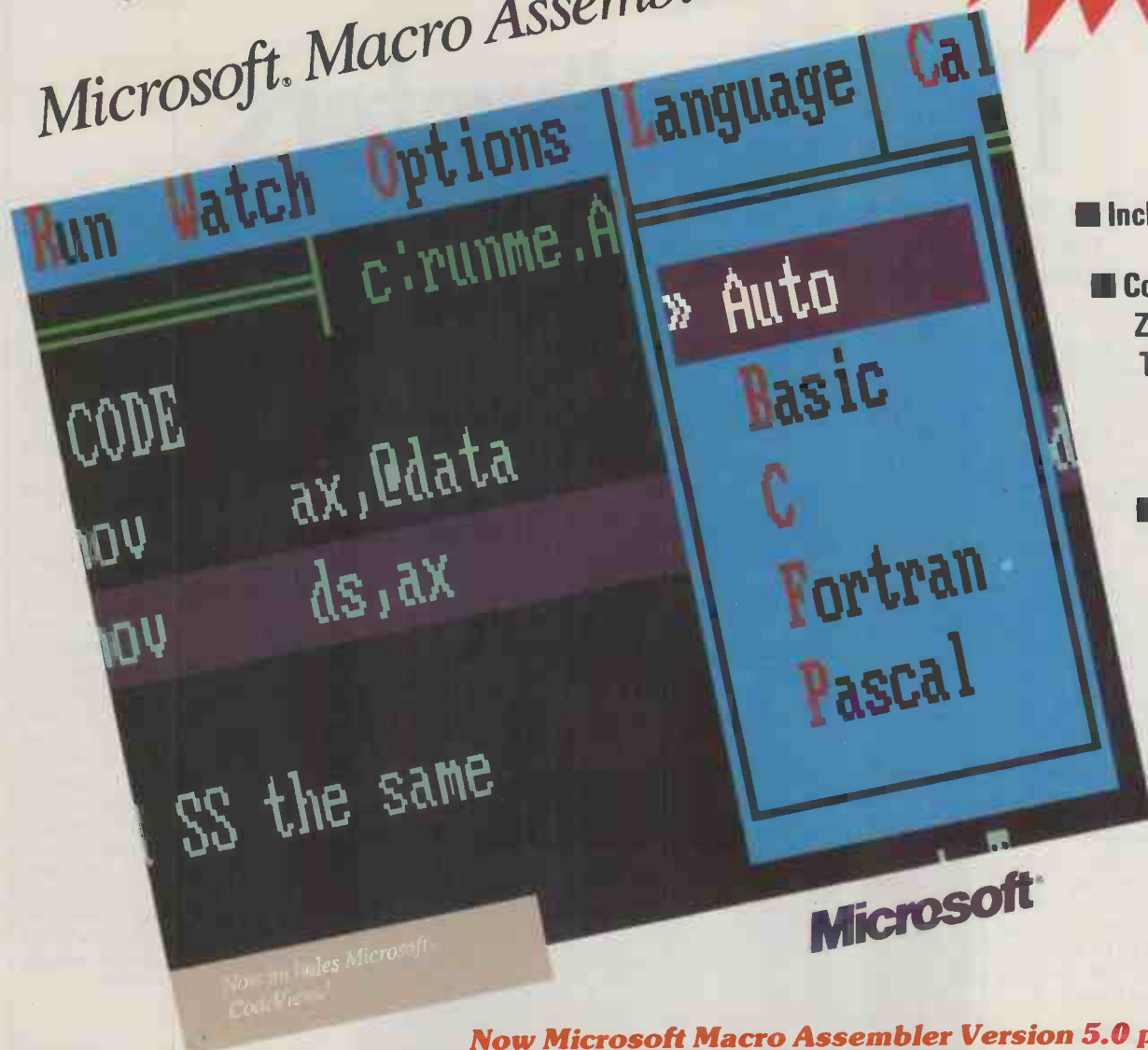

**40% OFF!**  
**£69.95**  
**+ VAT**

■ Includes "CodeView"

■ Compatible with:  
ZORTECH C  
TURBO C  
QUICK C  
MS C

■ rrp £115 + VAT

**Now Microsoft Macro Assembler Version 5.0 puts all the speed and power of assembly-language subroutines within easy reach.**

Microsoft Macro Assembler Version 5.0 gives you clear, step-by-step instructions that help you write and link assembly-language subroutines with your source programs, whether you work in Zortech C, Turbo C or Quick C. You can produce fast, powerful software and still do most of your programming in your favourite language.

Microsoft Macro Assembler is a complete software development package that offers a high-speed assembler; Microsoft CodeView, a powerful window-orientated, source-level debugger; advanced utilities; and clear, complete documentation.

- **New!** Supports mixed-language programming. Includes template programs for Microsoft BASIC, Microsoft C, Microsoft Pascal, and Microsoft FORTRAN.
- **New!** Includes Microsoft CodeView, a remarkable source-level debugger that works with programs and subroutines written in Microsoft Macro Assembler.
- **New!** Assembles 25-40% faster than Version 4.0 - the fastest assembler for the personal computer.
- **New!** Supports the 80386/80387 instruction set. Automatically generates

the correct code for both 16- and 32-bit segments.

- **New!** Provides simplified segmentation directives so you can easily write assembly-language subroutines for all memory models (small, medium, large and huge).
- **New!** Microsoft CodeView supports Expanded Memory Specification (EMS) to allow the debugging of especially large programs.
- **New!** Improved and expanded documentation includes an easy-to-use reference manual that fully documents the 8086/80286/80386 and 8087/80287/80387 instruction sets.

\* Prices exclude VAT and P&P.

**CALL THE ORDER HOTLINE 01-316-7777**

ZORTECH LTD., 106-108 POWIS STREET, LONDON SE18 6LU

FAX No: 01-316 4138

VISA



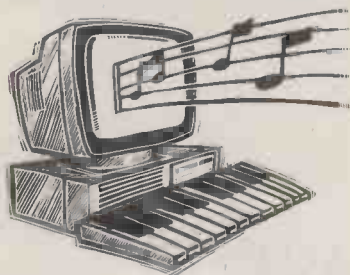

# The soundbusters

Roger Howorth looks at SoundBuster, an impressive new product for the IBM PC/XT that provides both MIDI sequencing and sound sampling, and reports on what's new in the world of intelligent MIDI.

The IBM PC and its many clones have long had the option of plug-in MIDI cards and sequencing software. It has also been possible to get hold of dedicated sampling hardware. But these two functions have always remained quite separate, using different hardware expansion boards and different software applications programs.

With the recent release of PC-SoundBuster by YAM Educational Software, all that may be about to change. SoundBuster is a unique new product for the IBM PC/XT and close clones that provides both MIDI sequencing and sound sampling from within one package and costs £199, excluding VAT.

The software requires at least 256k RAM and CGA or EGA graphics, and PC-DOS 2.10 which is supplied on the main SoundBuster disk. The current version does not run on the Amstrad 1512 but worked fine on the 1640 and my cheap Taiwanese clone.

## First impressions

The SoundBuster package comprises a 'long' expansion card which houses the sampling and MIDI hardware, and three disks: one for the SoundBuster software, the others containing Sound Samples and Midi sequences.

At the time of writing no manual was available but my program disk had a README file with some eight pages of information. YAM promises a full manual by the time it begins shipping.

The expansion card provides a 'non-intelligent' Midi interface with both Midi IN and OUT sockets, although, in common with other sequencing hardware, no Midi THRU is supplied.

There's a mono output for replaying samples via your hi-



The opening menu of the PC SoundBuster system lists operations for sampling a sound and for editing a sequence

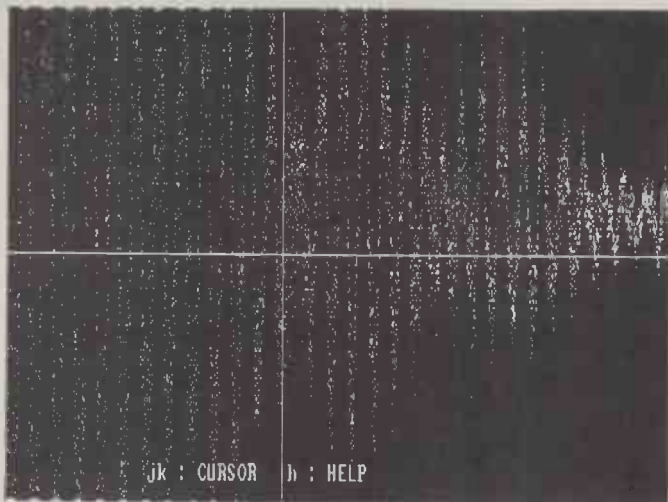

The simple but effective way of displaying a sampled sound. This is a graph of a deep human voice

fi and an unbalanced input which is switchable between 'Line' and 'Microphone' voltage levels. The input circuit also has a volume knob to adjust the sensitivity of the input amplifier.

The program is driven from a traditional 'Press X for some-

thing' test menu which branches off to the program's main functions, such as sampling and sequencing.

These are driven from similar 'forms' which usually require several pieces of numeric input. Such data can either be entered from the keyboard or a

default value chosen by pressing 'Return'.

Very little use is made of graphics with the exception of the sample editing screens, and even here the display is very black and white!

YAM explains the lack of bells and whistles with the need to conserve as much RAM as possible for sample storage. The company points out that SoundBuster is not aimed at professional musicians. It sees it as an introduction into computer-music for hobbyists and educationalists.

It is with this design philosophy firmly in mind that I have conducted this review — SoundBuster doesn't attempt to challenge the mighty Midi products with their sophisticated software that are already available for the PC. It does, however, provide an environment where experimentation with sound sampling and Midi sequencing is possible within one integrated package.

## Sampling

The business of actually recording a sample is quite straightforward. The program can display the sound present at the input as a kind of 'oscilloscope' trace as well as simultaneously routing the 'sampled' version of it back to the audio output.

This is very useful when setting the input volume control as it provides a rough visual check as well as an accurate audio comparison between the sampled sound and the original.

Having captured a sample it can be shortened by removing unwanted chunks from both the front and the end. This is done by moving a cursor over a graph sample, and is simplicity itself.

Any changes only become permanent after quitting the



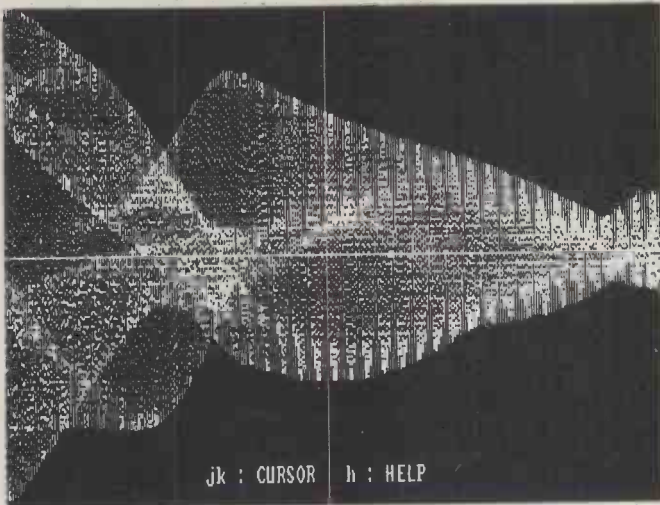

This more regular sound wave is that of a musical instrument. With SoundBuster you can edit and transform it

editing function, and as such it's easy to experiment without fear of 'damaging' a sample. There are no other, more sophisticated editing facilities such as 'looping', although YAM has said that it may include this in later releases if it can spare the RAM.

The only other characteristics that the user is allowed to alter are the overall tuning and volume of the sampler. While both of these functions are necessary, they only work on the 'voice outputs' rather than on the samples themselves. This doesn't matter if you're playing with one sample; but if you have five samples in RAM there's no way of adjusting their tuning or volume individually.

Tucked away in the software is the ability to generate a sample with a saw-tooth wave form, which may prove useful when tuning the sampler to other instruments. There is also the ability to apply vibrato and tremolo to the samples, and because these effects are generated as the samples are re-played, they do not change the sample as stored in RAM.

## Sequencer

The rest of the software is dedicated to sequencing both the samples and any external Midi devices that are connected. In essence, the SoundBuster sequencer sees no difference between its own internal sampler voices and the external Midi instruments. It merely directs one of the possible 16 Midi channels to the sampler's voices as well as to the outside world.

The sequencer is programmed in a similar way to a drum machine in that a complete piece of music is first composed of different sections. However, SoundBuster blurs the line between the

complete piece and the individual sections to the extent that, regardless of size, any section of music is a 'sequence' and SoundBuster is limited to only one of these in memory at a time.

Having recorded and saved several individual sections to disk, SoundBuster then allows these to be chained together to form one huge sequence. New sections of music can be 'overdubbed' or merged with the existing data in real time, and this process can be repeated as often as desired until the computer finally runs out of memory!

In terms of editing out mistakes, SoundBuster offers two remedies. The entire sequence can be 'quantised' so that the start of each note is aligned with an exact fraction of a musical beat, or the last overdub can be erased totally. These two options are not exactly comprehensive, but they do fit in with YAM's design philosophy.

## Verdict

Although the overall feel of SoundBuster is rather crude, it does have some nice touches. For example, it's possible to use the standard QWERTY keyboard to play samples and program the sequencer. Although not as satisfactory as a proper musical keyboard, this means that you don't need any Midi equipment to use SoundBuster.

Indeed, SoundBuster could well be attractive and certainly recommended to those only interested in sampling and without any Midi gear at all. The Sampler sounds nice and stands up well against other computer sampling add-ons, and is only let down by the lack of looping software.

One Midi interface should be much the same as another,

## News: intelligent Midi

I was interested to hear of a device made by Hinton Instruments of Oxford called the Midic, which is an 'add-on' Midi interface that connects to the host computer via an RS232 interface, thus being 'compatible' with most computers. The Midic has two basic modes of operation. It either acts as a standard Midi interface attached to a computer, or as an intelligent standalone Midi device that can be used to process a Midi data stream, relieving some processor overhead and helping avoid delays caused by unwanted data arriving at a synthesiser.

This clever box costs £300 and has no supporting applications software — it is a product either for those wishing to experiment with their own software or who want to make use of its onboard Z80 processor and memory to ease the burden on other Midi devices.

Electronic Arts has released the Music Construction Set for the Atari ST. The program is a variant of the Deluxe Music Construction Set originally released on the Amiga and is a graphics-based sequencer which allows music to be written onto a traditional musical staff.

The Atari version features a form of 'real time capture' which permits musical data to be entered into the program by playing live from a Midi keyboard as well as via the more mundane mouse. The program's output can be routed to a mixture of the Atari's three-voice internal sound chip and external Midi musical instruments. The Atari version of the Music Construction Set retails for £24.95.

## Technically speaking

SoundBuster's sample rate is fixed at 32KHz and each sample may be up to two seconds long. A PC fitted with a full 640k RAM can hold five samples in memory simultaneously, although only three may be played at any one time.

Although a sample may be of any length up to two seconds, each is always allocated a full 64k RAM — no memory is saved by using shorter samples. The main effect of this is that a 512k PC will only have enough RAM to hold four samples, a 448k three samples, and so on. These limits are tied to the way SoundBuster works. Rather than having its own processor and lots of RAM onboard, SoundBuster uses the PC's memory to store samples and the PC's DMA (Direct Memory Access) chip to ferry the data from there to its own DACs (Digital to Analogue Converters).

The PC's DMA chip has four channels in all, but one is constantly used to refresh the screen display leaving three spare. Therefore, SoundBuster can only produce three sounds simultaneously. Furthermore, each DMA channel can only access one 'page' of 64k RAM at a time, which results in the SoundBuster only being able to sample for a maximum of two seconds at 32KHz.

The only problem with all this is that there is no 'hardware' reason for fixing the sample rate at 32KHz, it could easily be faster or slower. Although raising the sample rate would exaggerate the problems of memory shortage, lowering it, or at least making it adjustable, could only help — if you halve the sample rate, you double the length of the sample within a given amount of RAM!

and again, for those interested in writing their own Midi software and generally fiddling around with the 'musical interface' it can be recommended regardless of SoundBuster's other features. YAM promises to be helpful with the necessary technical information on accessing the hardware from other software.

Unfortunately, the sequencer is less well-endowed and the same is not true here. Don't buy SoundBuster if you *only* want a sequencer. There are others that are friendlier and

easier to use, if slightly more expensive.

Hinton Instruments is on (0865) 721731.

Electronic Arts is on (0753) 49442. YAM Educational Software UK is on (01) 458 5522.

Roger Howorth is a freelance computer journalist and sound recording engineer who owns and experiments musically with an Atari ST. If you would like to share your musical experience with him or you would like to pass on any interesting snippets, write to him care of PCW, VNU House, 32-34 Broadwick Street, London W1A 2HG.

END



David Barrow presents more machine code routines and information for assembly language programmers. All helpful programming hints and short, useful new routines are welcome as are improvements to or conversions of those already printed. Submissions must be printed or typed clearly and must be documented to the SubSet standard, although documentation may be amended for publication. Send your contributions to SubSet, PCW, 32-34 Broadwick Street, London W1A 2HG.

## Times tables

Although Clive K Semmens of Tong on the Isle of Lewis was impressed with the elegance of Bjorn Sten's BYTMUL (December, 1987), he has an even faster byte multiplication routine for the 6502.

Bjorn's BYTMUL uses the difference of squares method to multiply two 8-bit arguments in anything between 51 and 77 clock cycles. The code is a heavy 127 bytes and the look-up table a heavier 512 bytes.

In contrast, Clive's QKMUL1 (Datasheet 1) is a lightweight 32 bytes of code. The look-up tables for QKMUL1 take up a mere 16,384 bytes — hardly worth the bother of typing in,

so Clive has also supplied a Basic program (Fig 1) to do the job for you.

Compared with the 16k of tables, the 32-byte program appears skimpy but that is not why Clive assembles it in page zero. The reason is that each time the routine alters the address data in one of its own instructions, one clock cycle is saved by having that instruction in page zero. QKMUL1 executes in 48 cycles — 54 cycles including "JSR QKMUL1".

But even the 54-cycle subroutine was too slow for the satellite tracking program for which Clive wrote QKMUL1. He had to include two other versions in the main program to save another eight cycles per call.

## Datasheet 1

```

=====
:QKMUL1      8-bit by 8-bit multiplication, using 4-bit by 8-bit
:            product look-up tables, giving 2-byte product.
=====
:STRUCTURAL CONCEPTS
:DATA       PART PRODUCT TABLES: see Basic Table Generator.
:PROGRAM    AB * CD = (A * $10 + B) * (C * $10 + D)
:           = (A * $1D + B) * C * $10 + (A * $10 + B) * D.
=====
:SYSTEM REQUIREMENTS
:PROCESSOR  6502
:Hardware   16K memory for part product tables.
:SOFTWARE   None.
=====
:PROGRAM DETAILS
:INPUT      X = argA, Y = argB.
:           Carryflag MUST be clear.
:OUTPUT     Product in A,X (MSB in A).
:STATE CHANGES Y unchanged, P changed.
:I/O ERRORS Carryflag set on input. Decimal mode on.
:OPTIMISATION Routine resides in page zero and rewrites the
:           address data in four of its own instructions for
:           rapid indexed access.
:           Carry is not cleared before first ADC instr.
:           May not be interrupted or re-entered.
:INTERRUPTS Code: In 32 contiguous bytes of page zero.
:LOCATION NEED Tables: Not specific but 256-byte page aligned.
:           Not relocatable. Not PROMable.
:PROGRAM BYTES 32 (in page zero).
:STACK BYTES  None.
:TIMING       48 cycles, constant.
=====
LXL RPT = LLLL ;Start of low nibble pointer table.
HXL RPT = HHHH ;Start of low nibble pointer table.
:
:QKMUL1
:
:write pointers to lo- and hi-byte tables for (Y * lo-nib X).
:
LDA LXL RPT,X ;Get lo-byte table pointer, BD LL LL
STA LXL RLD+2 ;write to load instruction. 85 ZZ
ADC #$10 ;Point at hi-byte table and 69 10
STA LXL RLD+2 ;write to load instruction. 85 ZZ
:
:write pointers to lo- and hi-byte tables for (Y * hi-nib X).
:
LDA HXL RPT,X ;Get lo-byte table pointer, BD HH HH
STA HXL RLD+2 ;write to add instruction. 85 ZZ
ADC #$10 ;Point at hi-byte table and 69 10
=====

```

```

STA HXL RLD+2 ;write to add instruction. 85 ZZ
:
:Pointers written. Code altered. Cy clear for 1st ADC.
:Perform multiplication by addition of part products.
:
LXL RLD LDA $FF00,Y ;Get lo-byte (Y * lo-nib X) 89 00 FF
HXL RLD ADC $FF00,Y ;+ lo-byte (Y * hi-nib X) 79 00 FF
TAX ;product lo-byte in X. AA
:
:Possible carry into high-byte.
:
LXL RLD LDA $FF00,Y ;A = hi-byte (Y * lo-nib X) 89 00 FF
HXL RLD ADC $FF00,Y ;+ hi-byte (Y * hi-nib X) + C. 79 00 FF
:
RTS ;Exit, product in A,X. 60
=====

```

```

=====
:BBC BASIC program to generate 4- by 8-bit part product tables.
:
:N.B. This program generates tables at $3000 and $6000.
:These addresses may be altered but should reside at
:a 256-byte page boundary (i.e. $xx00).
:
:&ABCD means hexadecimal (= $ABCD).
:?(A) = B means "poke value B into memory location A".
:
:VARIABLES: HIN: high nibble; LON: low nibble.
:
10 REM Generate Multiplication Tables
20 FOR X = 0 TO 15
30 FOR Y = 0 TO 255
40 HIN = X * 16
50 ?(&3100 + X * &100 + Y) = (X * Y) MOD 256
60 ?(&5000 + X * &100 + Y) = (HIN * Y) MOD 256
70 ?(&4100 + X * &100 + Y) = (X * Y) DIV 256
80 ?(&6000 + X * &100 + Y) = (HIN * Y) DIV 256
90 NEXT Y
100 NEXT X
110
120 REM Generate Pointer Tables
130 FOR LON = 0 TO 15
140 FOR HIN = 0 TO 240 STEP 16
150 ?(&3000 + LON + HIN) = &31 + LON
160 ?(&6000 + LON + HIN) = &50 + HIN/16
170 NEXT HIN
180 ?(&6000 + LON) = &31
190 NEXT LON
=====

```

Fig 1

## Times supplement

QKMUL2 (Datasheet 2) uses the same tables as, and a similar method to, QKMUL1 in multiplying two word-length arguments. Having only 8-bit operations available for adding the partial products results in a rather cumbersome but quite

workable routine.

It is very doubtful that you would find space in page zero for the 166 bytes of QKMUL1 but squeezing it in there would speed it up by 16 cycles. Assembling the 88-byte second section in page zero and jumping to it from the first section in main RAM could save 13 cycles.

## Datasheet 2

```

=====
:QKMUL2      2-byte by 2-byte multiplication, using 4-bit by
:            8-bit product look-up tables, giving 4-byte final
:            product.
=====
:STRUCTURAL CONCEPTS
:DATA       PART PRODUCT TABLES: see Basic Table Generator.
:PROGRAM    ABCD * EFGH = CD * H
:           + CD * G * $10
:           + (AB * H + CD * F) * $100
:           + (AB * G + CD * E) * $1000
:           + AB * F * $10000
:           + AB * E * $100000
=====

```



```

product byte 0 (LSB) =
  lo-byte of CD * 0H
  + lo-byte of CD * 00.

product byte 1 =
  carry from byte 0
  + hi-byte of CD * 0H (max value $0F)
  + hi-byte of CD * 00 (max value $0F)
  + lo-byte of CD * 0F (max value $FF, ? carry ?)
  + lo-byte of AB * 0H (max value $FF, ? carry ?)
  + lo-byte of AB * 00 (max value $F0, ? carry ?)
  + lo-byte of CD * E0 (max value $F0).

product byte 2 =
  carries from byte 1
  + hi-byte of AB * 0H (max value $0F)
  + hi-byte of CD * 0F (max value $0F)
  + lo-byte of AB * 0F (max value $FF, ? carry ?)
  + hi-byte of AB * 00 (max value $EF, ? carry ?)
  + hi-byte of CD * E0 (max value $EF, ? carry ?)
  + lo-byte of AB * E0 (max value $F0).

product byte 3 (MSB) =
  carries from byte 2
  + hi-byte of AB * 0F.
  + hi-byte of AB * E0.
    
```

### SYSTEM REQUIREMENTS

```

PROCESSOR 6502
HARDWARE 16K memory for part product tables.
SOFTWARE None.
    
```

### PROGRAM DETAILS

```

INPUT
  X = argA low order byte.
  Y = argA high order byte.
  M0 = argB low order byte.
  M1 = argB high order byte.
  Carryflag MUST be clear.
  Carryflag MUST be clear.

OUTPUT
  Product in A,X,M3,M2 (MSB in A).

STATE CHANGES
  M0, M1 unchanged.
  M4, M5, Y, P changed.

I/O ERRORS
  Carryflag set on input. Decimal mode on.

OPTIMISATION
  Routine rewrites the address data in sixteen of
  its own instructions for rapid indexed access.
  Carry is not cleared before first ADC instr.

INTERRUPTS
  May not be interrupted or re-entered.

LOCATION NEED
  Code: Not specific - not crossing page boundary.
  Tables: Not specific but 256-byte page aligned.
  Not relocatable. Not PROMable.

PROGRAM BYTES 166.
STACK BYTES None.
TIMING
  Average 213.5 cycles.
  Min 204 (12%) Max 234 (0.1%) Mode 210 (36%).
    
```

```

=====
LXL RPT = LLLL ;Start of low nibble pointer table.
HXL RPT = HHHH ;Start of low nibble pointer table.
ARGBLO = M0 ;Multiplicand low byte.
ARGBHI = M1 ;Multiplicand high byte.
PRODO = M2 ;Result byte 0.
PRODI = M3 ;Result byte 1.
CARRY2 = M4 ;Scratch.
CARRY3 = M5 ;Scratch.

QKMUL2 LDA #0 ;Clear scratch space A9 00
STA CARRY2 ;for remote carries. 85 M4
STA CARRY3 ; 85 M5

;Write pointers to part products tables into 3rd bytes (address
;hi-bytes) of indexed load and add instructions.
***** N.B. THIS ALTERS CODE *****

;Load pointer to table of lo-bytes of (argB * lo-nib X).
LDA LXL RPT,X ; BD LL LL
;Write pointer into load instruction for 0nib1 of argA,
;lo-byte argB, byte0 result.
STA LD0L0+2 ; 8D lo hi
;Write pointer into load instruction for 0nib1 of argA,
;hi-byte argB, byte1 result.
STA AD0H1+2 ; 8D lo hi
;Increment to point at hi-byte table
;(use ADC #$F if carry is set on entry).
ADC #$10 ; 69 10
STA LD0L1+2 ; 8D lo hi
STA AD0H2+2 ; 8D lo hi

;Load pointer to table of lo-bytes of (argB * hi-nib X).
LDA HXL RPT,X ; BD HH HH
STA AD1L0+2 ; 8D lo hi
STA AD1H1+2 ; 8D lo hi
ADC #$10 ;Point at hi-byte table. 69 10
STA AD1L1+2 ; 8D lo hi
STA AD1H2+2 ; 8D lo hi

;Load pointer to table of lo-bytes of (argB * lo-nib Y).
LDA LXL RPT,Y ; 89 HH HH
;Write pointer into load instruction for 2nib1 of argA,
;lo-byte argB, byte1 result.
STA AD2L1+2 ; 8D lo hi
STA AD2H2+2 ; 8D lo hi
ADC #$10 ;Point at hi-byte table. 69 10
STA AD2L2+2 ; 8D lo hi
STA AD2H3+2 ; 8D lo hi

;Load pointer to table of lo-bytes of (argB * hi-nib Y).
LDA HXL RPT,Y ; 89 HH HH
STA AD3L1+2 ; 8D lo hi
STA AD3H2+2 ; 8D lo hi
ADC #$10 ;Point at hi-byte table. 69 10
STA AD3L2+2 ; 8D lo hi
;Write pointer into add instruction for 3nib1 of argA,
;hi-byte argB, byte3 result.
STA AD3H3+2 ; 8D lo hi

LDX ARGBLO ;X <-- lo-byte of argB. A6 M0
LDY ARGBHI ;Y <-- hi-byte of argB. A4 M1
    
```

```

;Pointers are written. Following code must reside in alterable
;memory. Absolute addresses $FF00 changed to $xx00.
;Perform multiplication by addition of indexed part products.
;(Carryflag clear for first addition)
    
```

```

;Product byte 0 <-- lo-byte (lo-byte argB * 0nib1 argA)
;+ lo-byte (lo-byte argB * 1nib1 argA)
LD0L0 LDA $FF00,X ; BD 00 FF
AD1L0 ADC $FF00,X ;(possible carry to byte 1) 7D 00 FF
STA PRODO ; 85 M2

;Get product byte 1 similarly, taking care of any carries out of
;the several additions.
LD0L1 LDA $FF00,X ; BD 00 FF
AD1L1 ADC $FF00,X ; 7D 00 FF
AD2L1 ADC $FF00,X ; 7D 00 FF
BCC AD0H1 ;Skip if no carry to byte 2. 90 03

INC CARRY2 ;Accumulate carry from byte 1. E6 M4
CLC ;Clear carryflag for next add. 18

AD0H1 ADC $FF00,Y ; 79 00 FF
BCC AD1H1 ;Skip if no carry to byte 2. 90 03

INC CARRY2 ;Accumulate carry from byte 1. E6 M4
CLC ;Clear carryflag for next add. 18

AD1H1 ADC $FF00,Y ; 79 00 FF
BCC AD3L1 ;Skip if no carry to byte 2. 90 03

INC CARRY2 ;Accumulate carry from byte 1. E6 M4
CLC ;Clear carryflag for next add. 18

AD3L1 ADC $FF00,X ;(Another cy to byte 2 ?) 7D 00 FF
STA PROD1 ; 85 M3

;Get product byte 2 similarly, including any carries from byte 1
;and taking care of any carries out to byte 3.
LDA CARRY2 ; A5 M4
ADDH2 ADC $FF00,Y ; 79 00 FF
AD2L2 ADC $FF00,X ; 7D 00 FF
AD2H2 ADC $FF00,Y ; 79 00 FF
BCC AD1H2 ;Skip if no carry to byte 3. 90 03

INC CARRY3 ;Accumulate carry from byte 2. E6 M5
CLC ;Clear carryflag for next add. 18

AD1H2 ADC $FF00,Y ; 79 00 FF
BCC AD3L2 ;Skip if no carry to byte 3. 90 03

INC CARRY3 ;Accumulate carry from byte 2. E6 M5
CLC ;Clear carryflag for next add. 18

AD3L2 ADC $FF00,X ; 7D 00 FF
BCC AD3H2 ;Skip if no carry to byte 3. 90 03

INC CARRY3 ;Accumulate carry from byte 2. E6 M5
CLC ;Clear carryflag for next add. 18

AD3H2 ADC $FF00,Y ;(Another cy to byte 3 ?) 79 00 FF
TAX ;(Could be STA PROD3!) AA

;Get product byte 3 similarly, including carries from byte 2.
LDA CARRY3 ; A5 M5
AD2H3 ADC $FF00,Y ; 79 00 FF
AD3H3 ADC $FF00,Y ;Carryflag now clear. 79 00 FF
RTS ;Exit prod in A,X,PROD1,PROD0. 60
=====
    
```

## Sexy mover

Dr Hugh O'Neal of Lewes was the first of many readers to point out that Tony Cheal's 68000 character-rotating routine (CHROT1, January) contains a bug.

Because speed was the most important consideration in writing CHROT1, Tony tried hard to minimise the routine's execution time. One of the 'speed-up tricks' he used was to replace the usual two MOVEM.W instructions for saving and restoring complete 32-bit register contents by the far quicker MOVEM.W which saves only the low-order 16-bit words of the eight data registers. This use of MOVEM.W in CHROT1 saves 64 cycles on the 68000 or 128 cycles on the 68008 (but none on the 68020). It also lessens stack use by 16 bytes.

Unfortunately, 'MOVEM.W (SP)+,DO-D7' (restore) is not the exact inverse of

'MOVEM.W DO-D7, - (SP)' (save). Each word of data pulled from stack is sign-extended to 32-bit data before being restored to the appropriate register. After CHROT1, bits 16-31 are copies of bit 15 in each data register.

More unfortunately, CHROT1 was tested in a word-length data environment where the sign-extension feature of the routine went totally unnoticed. In fact, the routine produces no errors when called from any program section that uses only the low-order words of the data registers and has previously secured the high-order words.

So, to remove the bug, you can either change the register-saving instructions to the slower MOVEM.L, or insert the appropriate information about changed registers in the routine's documentation and use CHROT1 with care. After all, bugs are only inadvertently undocumented features.

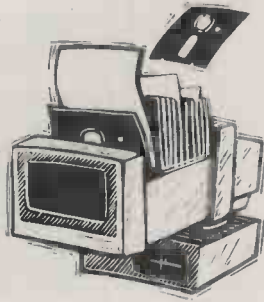

# Organised chaos

**Andy Redfern emerges from a mountain of readers' cassettes and disks to introduce image processing and his pick of your programs.**

Readers of *Byte* will be familiar with Chaos Manor. At *PCW* we have a scaled-down version called Chaos Corner, and that's where I now work. The chaos is no longer terminal but it has meant delays in certain areas of Program File. The disk library is now completely up to date, with even the files in the updated listing opposite ready for copying. I realise that some people have been waiting a long time for disks and I apologise for this delay. Now that the initial set-up problems are over, the disks should start to flow.

Some people have complained that they are unable to obtain the relevant back issues of *PCW* which accompany the disks. The *PCW* Disk Library is intended to supplement the magazine rather than be an outlet for cheap software. We do not provide documentation, as all the information you will need is in the magazine and back issues for most months are available. However, we do realise that it can be very frustrating if the issue you want is out of print. If this is the case and you *don't* have a copy of the documentation, say so when you apply for your disk; we will then forward you a copy of the original listing and documentation. *I must stress that this only applies to documentation from issues of PCW that are out of print.*

## Making changes

Things are changing in Program File. The number of listings will reduce and the number of programs available will increase. The new format will have many advantages, but the major one is that I can now include programs that were previously too long or contained too much machine code. Program File will only contain the clever routines and ideas, while

the Disk Library will contain a full listing and an executable version of the program. So, if you have a large or complex program that previously wasn't suitable, send it in and I'll see what I can do.

## Algorithms: image processing

Last month in the algorithms section I looked at data compression; this month it is the related issue of image processing. In the November 1987 issue of *PCW*, we published an article all about image processing techniques and a small section on how to implement them. We thought that a few programs might arrive on the Program File desk, but they didn't.

So, this month I'm going to look a little more at the ever-expanding field of image processing.

Data compression of images is the most common application for compression techniques, especially in the field of communications where the volume of data is critical. Unfortunately, during the capturing, sending and storing of images, substantial amounts of noise can be added to the original. In fact, some of the advanced data compression techniques are 'lossy': that is, they degrade the image in the transform to achieve greater compression. To remove this noise, the image has to be enhanced through a series of transformations.

As more digitisers become avail-

## Guidelines for program listings

*PCW* is interested in publishing quality programs written in any of the major programming languages for all popular home and business micros. When submitting your programs, include a disk or cassette version of your program, comprehensive documentation and a clear, dark listing on white paper.

The listing should be no more than 80 characters wide and, if possible, sample output from that program should be included. Ensure that you have marked the software, listing and documentation with your name and address, program title, machine (along with any minimum requirements) and a daytime telephone number.

We will be including some of the programs published in Program File in the *PCW* Disk Library. If you have any objections to your program being included, please indicate them, otherwise it will be assumed that the program can be included in the Disk Library. A total royalty of 50p is paid per disk sold. The sum is shared among the authors of the programs on the disk.

Here are some guidelines for submitting programs. Check through previous Program Files to see the sort of programs we prefer. Original ideas are always welcome, as are good implementations of utilities and applications. Obviously the programs should be well-written, easy to understand and preferably not too long. All programs should be fully debugged and must be your own, original, unpublished work.

We will try to return submissions if they are accompanied by an appropriate stamped, addressed envelope, but please keep a copy of everything. Programs are paid for at the rate of £50 per page of published listing, plus a £50 bonus for Program of the Month.

Send your contributions to Andy Redfern, Program File, *PCW*, VNU House, 32-34 Broadwick Street, London W1A 2HG.



able for more machines, having a frame-grabbed image on the screen of your Amiga, PC or Atari ST is becoming a reality. With DigiView for the Amiga, SAM for the ST (see page 116, this issue), a Solid-Disk system for your BBC or Archimedes, and numerous packages for the PC, even the average home user can afford to indulge. But, the one thing that is apparent in all the budget systems is the lack of quality. A cheap frame-grabber may add a considerable amount of distortion to the image; this is characterised by a single pixel or groups of pixels of the wrong value being present. To remove this noise, algorithms have been developed over the last 20 years.

The most obvious technique, if the image is stationary, is to grab the image many times and then average over all the collected values. This can remove most of the typical Gaussian noise added by the majority of cheap digitisers, but it takes time and requires the image to be fixed.

## Filtering

The next stage of enhancement is a simple filter, and the type of filter used depends very much on the type of image present. High-pass filtering cuts out the low-frequency elements of a picture. (The low-frequency elements of an image are the slowly-changing parts like a shadow on a wall, while high-frequency elements are the fast-changing aspects of the image that occur in detailed areas.) This will enhance the edges and will appear to bring into focus an out-of-focus image, often useful with a bad camera. But, as well as enhancing the edges, it will also enhance the noise present.

The opposite form of filtering to this one is low-pass filtering, which tends to blur or smooth the image. This will remove large amounts of noise but will also reduce the edge detail.

To improve the edges and to reduce the noise, a technique called median filtering is employed. This will enhance the edges but leave the smoother areas of the image smooth. This is perhaps the easiest method to implement as it only requires the list of values in a neighbourhood to be sorted and the middle value placed in the centre replacing the previous value.

All these filters work in a similar way. Firstly, they select a neighbourhood of the image to work on. Then a mask is applied to the neighbourhood and, finally, the answer is entered as the middle value of the neighbourhood. The bigger the neighbourhood the better, but also the slower. Most applications use a 3x3 matrix, or a 5x5.

For example, a low-pass filter would be performed as follows. Load the first three rows of input file. Save the first row into the output file as it has insufficient neighbours for filtering, then select the first 3x3 block of data. For this exercise our data is:

3	4	5
2	12	4
1	2	3

and it appears that the centre pixel is

suffering from additive noise. Multiply the 3x3 data matrix by the low-pass filter matrix which could be:

1	2	1
2	4	2
1	2	1

giving a result of

$$= (3*1) + (4*2) + (5*1) + (1*2) + (2*4) + (4*2) + (1*1) + (2*2) + (3*1) = 77.$$

## PCW Disk Library details

- The disks cost £5 each, including VAT, postage and packing. Of this money, 50p goes to the author, being split evenly between them if there is more than one.
- The disks are *not* public domain and may *not* be copied at will. If you have one and friends want a copy, they must order their own.
- Programs are not immediately available in the Disk Library after being published in *PCW* — there will be some delay in sorting programs out. Programs intended for the Disk Library will carry the Disk Library symbol on the listing. As soon as a program is available, it will appear in the catalogue.
- No documentation is provided with the disks except that which is embedded in the programs themselves. Only order disks which you have copies of *PCW* for, unless a lack of documentation is not a problem. Back issues of *PCW* can be ordered from the Back Issues Department at VNU House, 32-34 Broadwick Street, London W1A 2HG, or by telephoning (01) 439 4242 and asking for the Back Issues Department.
- The catalogue list is organised by machine and disk size. The first number is the disk's catalogue number which should be quoted when ordering. The date is the issue of *PCW* in which the program appeared, and the rest is a brief description of the disk's content.
- **IMPORTANT** Disks can *only* be ordered from S&S Enterprises, PCW Disk Library, 31 Holloway Lane, Amersham, Bucks HP6 6DJ. Payment can be made by credit card, cheque, banker's draft, postal order or cash. Telephone orders can be made by credit card on (0494) 724201 or (0494) 728095. **Please do not contact PCW about orders — we cannot help.**

## PCW Disk Library catalogue

Here is the list of programs currently available: the disk number is given first

IBM PC 5.25 inch 360K

- |                 |              |   |
|-----------------|--------------|---|
| IBM5-OCT87-0001 | Oct 87       | MBasic Molecular Models                                 |
|                 |              | Create and display correct 3D molecular models          |
|                 | Sept 87      | MBasic MSDOS File Manager                               |
|                 |              | Access files via a menu system with password protection |
| IBM5-APR87-0002 | Apr 87       | Turbo Pascal Circuit Validation                         |
|                 |              | Create and analyse logic circuits on screen in graphics |
|                 | Apr 87       | PC/AT CMOS RAM Editor                                   |
|                 |              | Examine and modify the AT's CMOS RAM                    |
| IBM5-SEP86-0003 | Sept 86      | Turbo Pascal Logiprolog                                 |
|                 |              | Interpreter for simple version of Prolog                |
|                 | Aug 86       | Turbo Pascal Sideways Printer                           |
|                 |              | Print things out sideways on the printer                |
| IBM5-JUL86-0004 | Jul 86       | Turbo Pascal 6502 Emulator                              |
|                 |              | Run 6502 code on your PC. Can run the BBC Micro OS!     |
|                 | Feb 86       | MBasic Expert System                                    |
|                 |              | Powerful expert system shell                            |
| IBM5-NOV87-0005 | Nov 87       | Turbo Pascal Menus                                      |
|                 |              | Front end menus for programs and DOS in Turbo           |
|                 | Sep 87       | Graphics Algorithms                                     |
|                 |              | Very fast graphics routines in assembler and Turbo      |
| IBM5-FEB87-0012 | Feb87-Apr 87 | Teach Yourself Prolog                                   |
|                 |              | Programs from the teach yourself Prolog series          |
| IBM5-NOV87-0015 | Nov 87       | MBasic Number Pursuit                                   |
|                 |              | Educational arithmetic game based on Trivial Pursuit    |

# PROGRAM FILE

Dec 87 Turbo Pascal Circuit2  
Design and layout circuit boards (with disk 2 above)

IBM5--DEC87-0017 Dec 87 C Screen Writer  
Fully featured scrolling sign display on screen

Jan 88 C Pop-Down Menus  
A set of routines for pop-down menus written in Turbo C

Feb 88 C Fdump command  
A simple memory dump program in hex, octal or decimal

IBM5--JAN88-0018 Jan 88 Turbo Pascal Organ  
Used to play chords by switching the tones very fast

Jan 88 Turbo Pascal Christmas Tree  
Shows how to use 16 colours on an Amstrad PC-1512-CM

Jan 88 MT+ Textchecker  
Style checking program to accompany feature in PCW

IBM5--FEB88-0019 Feb 88 Turbo Pascal Movie Maker  
Lets you create animation sequences on a CGA screen

Apr 88 Turbo Prolog Universal Parser  
A parser useful as a front end to other systems

BBC Micro (single sided/single density 100K disks)

-----

BBC1--JUL87-0006 Jul 87 Artwork  
Fully featured painting program, icon based

Mar 87 1d Cellular Automata  
Investigate a fascinating mathematical world

BBC1--NOV87-0013 Nov 87 \*USE  
Text file display and search utility for help files

Nov87 Empty Drive  
Checks if a drive is empty, works with most DFS's

Apple Macintosh single sided disks

-----

MAC--JUL87-0007 Jul 87 Worm Plotter  
Unusual mathematics based patterns

Jun 87 Excel Macros  
Derive rules from tables of data using Excel

MAC--DEC86-0008 Dec 86 Mac Mandelbrot  
Mandelbrot program with a new, fast plotting algorithm

Mar 86 Mac Fractal  
Create realistic 3D landscapes using pseudo fractals

Atari ST single sided disks

-----

ST---JAN87-0009 Jan 87 Darwin's Lens  
Investigate natural selection (black and white)

Sept 86 Super Breakout  
The old favourite in black and white

Amstrad PCW single sided disks

-----

PCW--JUN87-0010 Jun 87 Mailout  
Mailmerge program for LocoScript

Jun 86 Touch Typing Tutor  
How to untangle your fingers...

PCW--NOV87-0014 Nov 87 Kong  
Donkey Kong game written in Basic - design screens!

Dec 87 File recovery  
Menu driven undelete program - good and classy

PCW--MAR88-0016 Mar 88 Nimble Fingers  
Useful typing game for brushing up your technique.

Apr 88 Communications program  
Excellent comms package with Prestel capabilities.

Amstrad CPC single sided disks

-----

CPC--AUG87-0011 Aug 87 Adventure Creator  
Superb text adventure creation system

Nov 85 Amsquill  
Powerful and fully featured word-processor

Commodore Amiga

-----

AMGA--DEC88-0020 Dec 87 Amiga 3-D image maker  
Using the Amiga's blitter for 3D moving graphics

Feb 88 Amiga Label Printing Utility  
An address label printer to accompany PCW feature

We then multiply this by one sixteenth, which gives a final result of 4.8125. This value is substituted in the file instead of the centre value of 12, and is in the region of what the original result should have been. We could have weighted the final multiplication even higher, but this leads to distortion within the image and smooths out actual data.

To achieve a high-pass filter, we perform exactly the same operation with a different matrix. This matrix weights the areas of the picture differently and enhances edges (and noise) to make the picture sharper. A typical high-pass matrix could be:

$$\begin{matrix} -1 & -2 & -1 \\ -2 & 19 & -2 \\ -1 & -2 & -1 \end{matrix}$$

finally multiplied by one seventh.

## Edge detection

Another area of neighbourhood image manipulation is edge detection, which is extremely useful as the first stage in a computer vision system. To find the edge of an image, we apply a matrix to a local neighbourhood and look for the presence of a slope — for example, a row of high values (white pixels) followed by a row of low values (black pixels). The mathematical way of looking for a slope is to look for the second differential. This sounds complicated but the matrix is quite simple.

A typical matrix would be:

$$\begin{matrix} -1 & 0 & 1 \\ -1 & 0 & 1 \\ -1 & 0 & 1 \end{matrix}$$

To use it, multiply the neighbourhood data matrix by the above matrix and sum all the components. Then select a threshold point. If the answer is above the threshold, replace it with the highest pixel value (white); and if it is equal or below, replace it with the lowest pixel value (black). This will leave the edges of the image and nothing else. It will only work on vertical edges, and we have to turn the matrix through 90 degrees and perform the whole operation again to find the horizontal edges.

I'm interested in fast ways of implementing these routines and the effect the order of operation has on the finished result. Also, I'd like to see what effect the threshold value has on edge detection, or whether filtering should occur before or after edge detection.

## Experimentation

Experiment all you like, and remember that in image processing the maths is sometimes important but, if you achieve a good-looking result, people will use it irrespective of whether it's provable from first principles or not. So, send in techniques



# MICROMART

# MICROMART

# MICROMART

## DATA COLOUR FLOPPY DISKS



### COLOUR YOUR DATA

DATA COLOUR FLOPPY DISKS provide an exciting concept in storing and retrieving the data used on your Personal Computers.

DATA COLOUR FLOPPY DISKS are available in four different colour pack configurations — **PAINTBOX, PASTEL, NEAPOLITAN** and **CARTE BLANCHE** for use on 5.25" SS/40, DS/40, DS/80, DS/1.6MG AT and compatible PC's and also for 3.50" SS and DS PC's.

COLOUR YOUR DATA... and develop your own colour coding system permitting data category identification and security of data files.

For further information including your "FREE" unique DATA COLOUR FLOPPY-DISK PVC guide... CALL US NOW ON 0252 616378.

Diskette Marketing Services Maris House,  
Albert Street Fleet, Hampshire GU13 9RL  
Telex No: 859699 Acorn-G Fax No: 0252 625099

## WANTED DEAD OR ALIVE!!!

### CASH! CASH! CASH!

An Arabian exporting company will pay top cash for **COMPUTERS -**

(IBM) OLIVETTI, APRICOT, APPLE (etc, etc).

PRINTERS, Telephone Systems on behalf of their Middle Eastern eager buyer. Unlimited cash available for immediate decision.

Please telephone 01-368 0909

(NO HOME COMPUTERS, PLEASE!)

The Best Public Domain Software & Shareware for the IBM PC, Amstrad PCs & all compatibles  
£4 per disk, fully inclusive. Available on 3.5" or 5.25" disk.  
FREE disk when you order ten (10)

From 1000+ of Programs we have selected the best and most useful. Below are listed a few items from our Select Catalogue, numbers in brackets refer to the number of disks in a set.

#### SPECIAL OFFER

We have put together a COMPLETE SOFTWARE package from our Shareware catalogue. This complete package has been carefully selected and consists of all the software you may ever need! It includes a compatible word processor, database and spreadsheets, a desk top organiser, a file management program, A menu drive DOS shell, A complete PC Tutorial, the Games Chess, Bridge and Backgammon. This is not merely a complete software package, but also a superb introduction to Shareware and Public Domain Software. There are ten (10) disks in all and they come in a useful plastic case. The price is just £35.

#### HOW TO ORDER

Please write your order clearly. You need only mention the software number (eg. WF1) or you may mark the disks you want on this advertisement and cut it out. Send your order (no stamp required) with your name and address to DIRECT SOFTWARE at the address below. Allow £4 for each 5.25" disk (7 disk sets £13, 3 disk sets £12) and £5.50 for each 3.5" disk (2 disk sets £11, 3 disk sets £16.50). Please make cheques payable to DIRECT SOFTWARE. Note - we only use good quality disks. All disks come with hub rings, sleeves and labels.

#### DELIVERY

We aim to give a fast, reliable service. We send all orders out by FIRST CLASS post and we normally dispatch them either on the SAME day as they are received or NEXT day.

#### SELECT CATALOGUE

We will send you our full catalogue on request or if you place an order. Our aim is to save you time and trouble by including in it only the best available PD software and Shareware.

#### WORD PROCESSORS

WF1: COMPASS  
WF2: PC-WRITE 2.7 (2)  
WF3: GALAXY  
WF4: CH-WRITER  
WF5: PC-TYPE PLUS (2)  
WF6: NEW YORK WORD 2.2 (3)  
WF7: EDIT  
WF9: PC-OUTLINE 3.24  
WF10: MIND READER

#### FILE MANAGERS

U4: FILE COMMANDO  
U7: FILE MANAGER  
U9: ULTRA UTILITIES  
U12: UNPROTECT!  
U14: NEW KEY keyboard macros  
U16: SIDEWAYS PRINT  
U20: DOS UTILITIES 1  
U22: PRINTER UTILITIES  
U24: HARD DISK UTILITIES

#### DESK TOP ORGANISER

DT01: DESKTEAM  
DT02: HOMEBASE (2)

#### ACCOUNTS PROGRAMS

AC1: FREEWAY (3)  
AC3: PC ACCOUNTING I & II (2)  
AC5: QUICKSTEP  
AC6: PC-TILL  
AC7: MR BILL (2)  
AC8: STOCK INVOICE CONTROL SYSTEM  
AC9: TIME & MONEY

#### BUSINESS MANAGEMENT

LP1: PRADO BASIC GW Basic clone  
LP6: VISIBLE PASCAL COMPILER  
LP7: PASCAL TUTOR (2)  
LP10: C TUTOR (2)  
LP16: ASSEMBLER  
LP17: CHASM  
LP18: DISASSEMBLER

#### RELIGIOUS

REL1: THE OLD TESTAMENT (6)  
REL2: THE NEW TESTAMENT (2)  
REL3: BIBLICAL QUIZ

#### EDUCATIONAL

ED1: PC-DOS HELP  
ED2: PC TUTORIAL  
ED3: PC PROMPT  
ED4: ON-LINE DOS HELP & PC-HELP  
ED5: GAMES FOR KIDS  
ED14: EDUCATIONAL ADVENTURES

#### STATISTICS

ST1: SUPERSTAT (2)  
ST3: UNIX-STAT (2)  
ST4: SPC PROFESSIONAL

#### MISCELLANEOUS SOFTWARE

MIS2: EZ-FORMS  
MIS3: FAMILY HISTORY

#### WP ACCESSORIES

WPA2: EX-SPELLING CHECKER  
WPA3: CITY DESK  
WPA4: LO PRINTER  
WPA5: FANTASTIC FONT DESIGNER  
WPA7: TYPING TUTOR  
WPA8: 4 PRINTER ENHANCEMENTS

#### DATABASES

DB1: FILE EXPRESS ver 4.02 (2)  
DB2: FREEFILE  
DB3: PC-FILE PLUS (2)  
DB4: WAMPJIM ver 3.1b (2)  
DB5: 3 by 5 CARD INDEX  
DB7: DATABOSS (2)

#### SPREADSHEETS

SS1: PC-CALC  
SS2: FREECALC  
SS3: AS-EASY-AS ver 3  
SS4: Turbo-CALC  
SS5: EXPRESS-CALC ver 3.12  
SS6: CUBE-CALC

#### GRAPHICS & ART

GA1: HI-RES  
GA2: PC-KEY DRAW  
GA3: IMAGE 3D - CGA Version  
GA4: IMAGE 3D - EGA Version  
GA5: FINGER PAINT  
GA6: DANCAD - 3D  
GA7: DROEGE (2)  
GA8: PC-PRESENT  
GA9: THE DRAFTSMAN  
GA10: EXPRESS GRAPH  
GA11: HANDLEBOT GRAPHICS (EGA & EGA)

#### UTILITIES

UZ: PC BOSS DOS SHELL  
UZ3: MAGIC MENUS

## DIRECT SOFTWARE

FREEPOST, DUKINFIELD CHESHIRE SK16 4YD. TEL: 061 330 5412

## COMPUCOVER

### 'THE PROFESSIONALS'

On site maintenance (all levels)

Ad-Hoc (fast turnaround)

Repairs Upgrades & Network Cabling

**REPAIRS & MAINTENANCE CARRIED OUT ON THE FOLLOWING:**

IBM, COMPAQ, VICTOR, SIRIUS, APRICOT, TANDON, OLIVETTI, TOSHIBA

Most makes of printers & much more

For details please call us and find out how we tailor a contract for your needs.

### 'THE PROFESSIONALS'

## COMPUCOVER

Unit 3, Graham Park Way,  
(NEXT TO THE RAF MUSEUM,) HENDON  
London NW9 5QY.  
01-200 8787 (5 lines)

## mousemats



## makemicro micemove

HARD WEARING REVERSIBLE BLACK LAMINATED POLYESTER QUIK FIX PAD  
SIZE 30 x 21 cms

### SHORE BREAK DESIGNS LTD.

High Street, Staithes, Saltburn, Cleveland TS13 5BQ

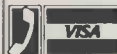

0947 840711

£4.50

incl., VAT & Carriage



## smart computers

NOW AVAILABLE!!  
PC1640 + PPC RANGE



REGISTERED DEALER

AMSTRAD 1640 ECD 30Mb £989  
AMSTRAD 1512 COL 30Mb £829

OPUS PCII Turbo 30Mb £1199  
OPUS PC5 AT EGA 30Mb £1499

SAMSUNG XT Dual Drive £633  
SAMSUNG AT EGA 30Mb £1878

STOP PRESS Apricot and Acorn range now available at unbelievable prices.

Get SMART and buy at unbeatable prices

Prices exclude VAT and Delivery

Phone Sheffield (0742) 474324

## MACDUNC'S DISKS

Britain's Only Truly International Apple Mac Public Domain Software Club

We specialize in only the best in proven, current and continuously updated Public Domain Software! Let us scour the networks and bulletin boards of 2 countries for you. Our international library contains over 1750 files with NO duplications. Monthly disks contain current releases before being categorized into our Main Library.

### £15.00 Membership Fee Includes:

- Disk FULL of fonts
- Disk FULL of desk accessories
- Disk with our complete catalogue listing
- One year of monthly newsletters
- £2.00 discount against first purchase

Or send £5.00 for our catalogue and a sample newsletter. With 3 years of experience and offices in the UK and the USA, we think it is worth a £5.00 experiment on your part to find out why we say that we are the best club of this kind - anywhere!



TRANSLATUM INTERNATIONAL (UK) LTD  
GLOUCESTER HOUSE - 10 GLOUCESTER STREET  
MALMESBURY, WILTSHIRE SN16 0AA  
TEL: (0666) 822499



OCL's new range of CAD/GUARD anti-glare, image enhancement filters for large CAD monitors offers a unique standard of protection from eyestrain, headaches, fatigue suffered by CAD system operators.

Eliminating 99% of reflections and mirror images, and with a built-in anti-static system to guard against shocks, dust and data loss, the new CAD/GUARDS are the most technically advanced filters available today.

OCLI Optical Coatings Ltd  
Tel: (0383) 823631

# MICROMART

## SOFTWARE BONANZA FOR PC1512/1640 IBM & COMPATIBLES

We now have over 600 disks of Public Domain/Shareware Supported software with new additions every month! If you can see a programme elsewhere in this magazine but not in our ad, you may be sure we can supply it — probably at a fraction of the cost!

Single Disks £4 each, 3 for £10, 10 or more £3 each

WRITE OR TELEPHONE (041) 954 6853 FOR FREE CATALOGUE

<b>Wordprocessing</b> Sh Writer Multi Font Wp Galaxy - Fast Wordstar Clone Childrens Wordprocessor Mindreader (Intelligent WPI) New York Word (2) PC Outline - Thought Organizer PC Style - Writing Analyser PC Type + (3) PC Write ver 2.6 Spell Check (ASCII) Files Touch Type (Typing Tutor)	<b>Games/Trips</b> ASCII Trivia Poker Arcade Games (3) Bushido - Martial Arts Dungeons & Dragons E13 Embargo B74 Jet, Tron Golden Wombat Mahjong - Oriental Cards Monopoly/Tune Trivia PC Chess Sleuth (Detective Game) The Amulet of Yendor Triva (3 disks)	<b>Languages/Programming</b> L1 Editor Fig/Hayden/MVP Forths flow-chart GWBasic Comp Intepret Lisp/Temp (2) Pascal Compiler Prolog
<b>Libraries/Measurement</b> Lord Index System Dbase III clone (2 disks) Instant Recall - Memory Reg PC File + 2 disks, latest ver	<b>Education</b> Epistat Statistics Maths/Statistics Pop-UP DDS Help PC Tutorial The IBM PC	<b>Business</b> Budget Tracking (2) Forms Creation Job costing estimating (5) Job Quotation Make My Day (2) Portfolio Management Project Mngmt (1000 tasks) Stock Market Analyzer Stock Portfolio Management Surveyors Tools
<b>Spreadsheets</b> Lotus 123 clone (As easy As) 123 Tools/Sheets/Units (10) PC Calc SideWriter - Sideways Print Turbo Calc V8.31	<b>Utilities</b> Deskteam - Sidekick Bashor Masterkey - Disk Utils System/Disk Utils like Norton	<b>Special Interests</b> Biblical quotations (2) DartCAD/diamond (4) Droge CAD PCB Design (2) Express graph Printain Grfx Expert System 2 (Impshell) Genealogy (Family Ties) Image 3D Design Package PC Key Draw CAD/Library (2) PC Musician - Compose/Cor

Overseas Please add £2 to all Orders 24 Hour Ordering

(041) 954 6853/(01) 266 3218

Same Day Despatch - First Class Post

### COMPUTER SERVICES (SCOTLAND)

Royal Terrace Glasgow G3 7NT.  
Enquiries: Please tel: (041) 954 6853  
Fax 265871 MONREF G  
Quote Ref: 72 MAG70290

11 Unbridge Street  
Kensington London W8 7TQ

## SIGNWRITER

instant display lettering from most printers **£92** (PC version)

- \* Characters any size - big & sharp!
- \* Prints banners too
- \* Powerful formatting capabilities
- \* Sign revision (most versions)
- \* On-screen design of logos etc
- \* 24 extra fonts (£5.75 each)

DECO   

Versions also for BBCs, Amstrads, Apricots, Archimedes

ALSO: LABELWRITER for product labels  
PAPERBASE DE LUXE for bibliographies  
POSTGRAPH for plotting graphs  
OXSTAT for statistics

See us about: VINYL-CUTTING  
POINT-OF-SALE DISPLAY

WIGHT SCIENTIFIC (01) 858 2699  
44 Roan Street London SE10 9JT

This advertisement was printed A4-size with SIGNWRITER

## SCANNING SERVICE

DTP facilities without DTP equipment!

We can scan (digitize) your company logo, illustrations, photographs, diagrams, mpas, letter-heads etc.

We also scan, edit and typeset text.

Nation-wide postal service. Complete page-make up service available for leaflets, news-letters etc. Off-set printing available! We sell disks!

Write or phone for full details of services.

COAST & COUNTRY PUBLISHERS  
3 Mayfield Avenue Scarborough YO12 6DF



## PROGRAM FILE

for image manipulation. The usual rule applies: if you use routines or ideas from someone else's work, make sure you give them the credit.

To make the programs useful, try to make them read different types of data files or, if that isn't possible, one of the standard data formats such as run-length coding, IFF format or a standard flat-file serial image. Remember that people don't want to spend two days waiting for the result to be completed, so look for ways of reducing the inherent redundancy in some of the techniques.

## Computer Answers

PCW's 'problem page', Computer Answers, will no longer appear in the magazine as a section by itself. Instead, readers' problems and solutions will be incorporated in Program File. This will allow the overlap between hardware and software queries to be less apparent, and will allow the inclusion of longer listings where applicable.

If, in the course of your programming, you come across a problem which you think will interest other readers, send it in and I'll try to answer it. Also, if you've solved what previously seemed an unsolvable problem, send in the details and your solution. If they are published you'll be paid the usual Program File rates.

This month's problems are all IBM PC or compatible-based. This is not intended to set a precedent, but obviously, I can only answer and discuss the ideas that I receive. So, all you Amiga, ST, Archimedes and BBC users, stop whingeing about Program File being PC biased and send in your submissions!

### Mouse removal

I have received a few complaints about incompatibilities in the Amstrad mouse driver, and people are apparently having trouble with the disk-copying program, COPYIIPC. It seems the problems are related.

COPYIIPC grabs a large number of interrupt vectors which, unfortunately, clash with the mouse driver. Consequently, COPYIIPC doesn't copy. The only solution I can find is to remove the mouse driver from memory before using COPYIIPC.

The only other program that won't work with the Amstrad mouse driver is Microsoft Word. Fortunately, since the launch of version 3, Microsoft has shipped an Amstrad-compatible version of the driver so that Word and the mouse can communicate. Copy the new version into the root directory of your boot-up disk, rename it MOUSE.SYS and add the following line to your CONFIG.SYS file:

DEVICE=mouse.sys

The mouse will function as before but will work with Microsoft Word.

### Hard times

With the price of hardcards falling all the time and the increasing volume of files accompanying applications, installing two in one machine can be a necessity rather than a luxury. It is simple to install two cards in the same machine, provided there is enough space. Some of the cheaper hardcards are quite bulky — the Miniscribe and the Tandon cards require two free slots. If you need two hardcards in a machine with a limited number of slots, you will have to buy a narrow card like the Hardcard Plus or the Mountain hardcard.

To include two hardcards in a single machine, you will have to change the DIP switches to indicate which drive is to be C: and which D:. The Reference Manual which accompanies each of the cards mentioned here indicates how the switches must be set. **Warning:** DOS will only support drives up to 32Mbytes in size. If you use a 40Mbyte card, you will need to partition the drive into two separate drives, C: and D:. If you then add a second card, these should be lettered E: and F:. This will only work if you add the following line to your CONFIG.SYS file:

LASTDRIVE=F:

The drive letter can be anything up to and including drive Z:. Generally, you can make your hardcard any letter you want, provided that the DIP switches can select that port address.

### WordStar substitute

Many programs are notoriously bad at finding the overlay files which accompany them. The files have to be in the default directory or the programs can't find them when they need them. So, unless you really do want to store all your files in the same directory, you have a problem.

The little-used SUBST command can help. It allows you to substitute a drive name for a directory, which is handy for programs like the original WordStar which do not understand path names.

The following is a sample batch file which shows how to use the SUBST command with WordStar:

```
ECHO OFF
ECHO Entering WordStar — Drive
d: is set to directory %I
SUBST D: C:\%I
C:
CD WS
WS
SUBST D: /D
C:
CD \
```



## PROGRAM FILE

To use this batch file, type the text into a file and call it WS.BAT. To run it type 'WS directory', where the directory is the location of your data files. The first SUBST command sets up drive D: to be the data directory, and the second SUBST command disables the substitution.

### Oops!

In Program File, PCW March, part of the Commodore 64 Toolkit listing was omitted. Due to the very small number of enquiries I've had so far (two) I'm not going to publish the missing portion of code. If you want a copy, send an *sae* to Andy Redfern, Program File, Personal Computer World, VNU House, 32-34 Broadwick Street, London W1A 2HG.

### This month's programs

The Program of the Month is by Alan Gorton Jnr and is for the Amstrad CPC range of machines. It is a well-written text outliner which allows you to add, change and restructure your ideas onscreen. It is quite easy to include extra features or delete rarely-used ones. For the program to be fast enough, machine code routines have been included. This will make it difficult to transfer directly to other machines, but many of the techniques which have been

used can be directly transferred.

Alan is a student and reckons it took him around three months hard work to complete the system. He uses it for planning presentations and reports, and for recording information about back issues of PCW. He also uses it in programming, a technique I also use and recommend you try. Using an outliner as a program editor encourages a 'top-down' technique rather than the more usual 'bottom-up'. The top-down method creates a modular program rather than a sprawling one, so making the program easier to understand and the transfer of routines between programs far simpler.

When we published a letter in the January issue that wasn't too complimentary about the Z88, we received a large volume of replies in favour of the machine. PCW editorial staff regularly use the Z88 and have found little to complain about. However, we receive very few Z88 programs, and the offering published here is strictly functional and could be enhanced. Do send in your Z88 programs, whether they are in machine code, BBC Basic or Z88 CLI.

Also included in this month's selection are an Atari ST synthesiser interface and an Amstrad PCW Basic file manager.

## Program of the Month Amstrad CPC Brainchild — an Outline Processor

by Alan Gorton Jnr



This is a fully-functioning outline processor for the CPC range. Although it was written for a CPC464, I tested it on a 6128 and it ran OK. Therefore, I assume that it will run on the whole range of machines. The program is menu-driven and provides some very advanced features.

#### Command summary

Editing a line of text is done in a similar manner to editing in the CPC Basic editor, although some extra functions are involved.

- CTRL + TAB** Toggle between insert/overtyping (flashing cursor indicates insert mode).
- CTRL + D** Delete contents of

**TAB**  
**ENTER**

**CTRL + N**

**CTRL + B**

**CTRL + W**

current line.

Move to next tab stop.  
Insert a line at the current level.

Insert the next line one level lower.

Insert the next line one level higher.

Toggle word-wrap On/Off.

The word-wrap feature is useful and advanced. At the end of a line, BrainChild will automatically start a new line. If a line doesn't exist or the next line is on a lower level, it will automatically insert one. It also supports 'wrap-back', which occurs when a word is deleted and the next line contains text. If the wrap-back

## MICROMART

### READ & PRINT BAR-CODES USING ANY COMPUTER

Complete identification system including microprocessor controlled scanner hardware plus software to print barcodes on Epson (or similar) dot matrix printer. Most industrial & commercial codes can be read. Packages available for virtually any computer. Our systems are in regular use by many private & public sector organisations worldwide. Prices start from £250. More information on request.

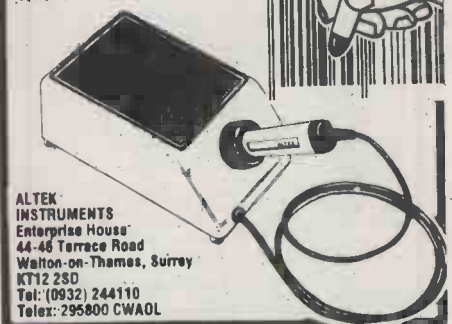

**ALTEK INSTRUMENTS**  
Enterprise House  
44-46 Tarreco Road  
Walton-on-Thames, Surrey  
KT12 2SD  
Tel: (0932) 244110  
Telex: 295800 CWAOL

## EALING COMPUTER CENTRE

All models on Display. Retail & mail order

**NEW OPUS PC**  
PCIII SF £499, PCIII TF £629  
PCIII HD 30Mb £995  
NEW PCIV/T 30Mb £1295  
EGA UPGRADE £300  
NEW OPUS PCIV XT  
EGA 20Mb CALL  
**ATARI ST**  
520 STFM £249 1040 STF £348  
**STAR PRINTERS**  
LC10 (IBM Centri) 4 fonts £177  
LC10 colour £200 NX15 (132col)  
£300, NB24/IG 24pin £584  
LAZAR PRINTER 8 £1649.  
(limited stock)



19 Queens Parade, Ealing,  
London W5  
Tel: 01-991 0928

All prices excl VAT

We welcome education & government discount enquiries

Authorised dealer

**ATARI** **Opus** **THE stair**  
Power Without the Price™ PC COMPUTERS PRINTERS FOR BUSINESS

### THE NEW OLIVETTI PC RANGE

Available now! The Olivetti M15 portable, M240 (8086) M280 (80286) and M380 (80386) personal computers. We also offer a wide range of printers and other add-on devices and most software packages.

Call us for prices and literature.

Authorised Olivetti Personal Computer Dealer

**Columbus Computing Ltd**

5 Mere Green Road  
Sutton Coldfield  
West Midlands B75 5BL

**021 308 8309**



## PUBLIC DOMAIN

SOFTWARE LIBRARY

The UK Source for Shareware & PD Software for IBM PC & CP/M, 200+ disks stocked.

A SELECTION OF OUR POPULAR DISKS FOR IBM PC & CLONES, AVAILABLE ON 5.25 or 3.5

501 BROWN BAG collection consisting of:-  
 \*\*\* MINDREADER PC-OUTLINE HOME/BE/SE/POWERMENU  
 \*\*\* RAMTEST & GOALSEEKER (all on 3 disks)

- TS540 FASTYPE nice touch typing tutor
- 129 XLISP artificial intelligence language
- 146 The original COLLOSAL cave adventure
- 181 SMALL C language compiler
- 201 PC-WRITE super WP package v 2.6
- 208 CP/M emulator run com prog; guide DOS
- 217 EZ-FORMS generate customised forms
- 221 PC-ARGL Accounts receivable/general ledger
- 233a/b FAMILY history genealogy (2 disks)
- 242 PC/M Critical path project management
- 245/7 FREEWAY Full UK accounts/payroll(3 disks)
- 268 EPISTAT Statistical package
- 273 PROCOMM super communications package
- 421/2 FASCAL very fast Pascal tutorial(2 disks)
- 306 Nine PINBALL games on one disk
- 309/10 WAMPUM Dbase 3 based Database package
- 325/6 WORDWORKER King James new Testament
- 328 P-BASIC a GW basic look-alike with tutor.
- 330/1 HACK Vast D&D adventure game(2 disks)
- 352 QUBECALC 3d spreadsheet
- 361 STOCK TRADER Stockmarket trading package
- 370 EXPRESS GRAFIC printed circuit CAD system
- 380/81 DROEGE printed circuit CAD design(2 disks)
- 385 PC-STYLE Writers analysis tool
- 388 PC-FILE Plus version 2,super database package  
 \*\*\* now with documentation disk (3 disks)
- 442/3 FILE EXPRESS database system(2 disks)
- 485 NEW FIG FORTH language
- 528/9/30 PC-TYPE+ full feature WP package(3 disks)
- 534 ABS Best 8086/8088 menu refresh
- 548 EZ SPELL spelling checker program
- 550 GREYCOM Prestel comms package
- 600/1 TENANT & PROPERTY Management system(2 disks)
- 602/3 HAM RADIO fil,Shirato,TNCL,Log,bearings\*(2 disks)
- 608 PFSA ALGEBRAIC calculator package
- 611/16 THE KING JAMES OLD TESTAMENT (6 disks)
- 617 FAR Fixed Asset Depreciation package Tax accounting
- 618 QUICKSTEP financial modelling planning & analysis
- 619 ASEASYAS Lotus 123 lookalike spread sheet v3.0
- 620 WORLD MAP with zoom & PKARC v3.5 archive utils
- 622 BAKERS DOZEN Unerase,Calc,Calendar,Sort & others
- 623 COMPOSER Create/play/save view music
- 624 BRIDGE learn & play the card game for CGA & EGA
- 630 LABELMASTER v3.0 A versatile mailing list system
- 631 IMAGE 3D Create/View/Edit etc 3d drawings(EGA)
- 631a IMAGE 3D as above but CGA version
- 633 COMPASS combined WP/Spreadsheet/Database package
- 636 IMP Expert system development & use package
- 643/5 DBASE 3(3 disks)Utils & Routines for DBASE  
 \*\*\* programmers & developers
- 647 PURCHASE ORDER generator & tracking system
- 651 SIDEFILE Resident Data management system
- 654/7 CROSS ASSEMBLERS 6800,685,690,1802/4/15/6  
 \*\*\* 280,8085,8748,8751 (4 disks)
- 670/6 CLIPPER/DB3 enhancements (6 disks).  
 \*\*\* Windows,menus,Help routines,function & source  
 \*\*\* Libraries,Calculator,MSC add-ons etc.
- 684 PACKDISK 1.2,Typing tests,DOS menu Refresh etc.
- 686/90 MICRO EMACS(4 disks)A very full implementation  
 \*\*\* of the well know Unix Editor compiled and source.
- 691 Sideways Print,Fast copy,Work log/charging system
- 692 Fast BACKLOG commands used find updated files etc
- 696/7 C SOURCE-Free Generate,Editor,Windows etc(2 disks)
- 698/701 PACKET Radio Net software from KA9Q(4 disks)
- 702/4 QMODEM Version 3.0 nice comms package(3 disks)
- 706 STILL RIVER Dos shell v1.82,THE DRAAG color editor.
- 708 COGO Coordinate Geometry Engineering s/w(2 disks)
- 711 ICHING predictions & BETTERWAY calc spread sheet
- 712 Nice MONOPOLY game,Venture,Stock-market trader
- 713 GENERALOGY on Display v5.0(needs Gwbasic see vol328)
- 717 KERMIT version 2.29b update
- 719 MSPATOC table/index generator,TIME share,Text tools
- 720 RIGHTHAND MAN desktop organiser,CALCplus,POPedit
- 724/5 MR BILL Time and activity logging & billing(2 disks)
- 730 HERCULES prog,emulate CGA,43 col,graphic drivers
- 731 FASTBUCKS accounting and budgeting package.
- 732 CHEWVIEW & MOLLY molecular animation & weights.
- 734 TECHNOJOCKS TURBO pascal programmers toolkit
- 735 COOK-PUTING Recipe fil/retreive with exotic meals
- 736 ASTROMOMY planets etc(EGA),Weather record system
- 738/9 MODULA2 Compiler with MakeLink etc(2 disks)
- 740 RACE Manager track contestants/results for contests
- 741 GARDENERS Assistant- plan your garden and crops etc
- 742/3 MAGIC MENUS Applications menus & more(2 disks)
- 746 FARMING and agricultural programs.
- 751/2 CATALIST Complete mailing system (2 disks)
- 754/5 SUPERSTAT Statistical analysis package(2 disks)
- 758 PCKEY/DRAW super graphics/drawing package(update)
- 763 TURBO pascal window/menu screen generator/tools
- 766 LASER Printer util;setup/load fonts,fonts,symbols etc
- 767 MORIA huge D&D mainframe adventure similar to Hack.
- 772 GALAXY Wordstar like WP package ver 2.3
- 773 SE excellent programmers screen editor
- 774 NUMBER cruncher financial modelling package.
- 777 BOYAN a nice Procomm style comms package.
- 778/9 Assemble & run 370 code on PC(2 disks)
- 780/1/2 PC-CALC PLUS super SPREADSHEET(3 disks)
- 783 DOS HELP system, memory resident pop up help
- 784 EASY DRAW, CAD and drawing package
- 785/6 MODULAR 2 language tutorial(2 disks)
- 787 HARD DISK util;-format,test or erase etc
- 790 EASY PROJECT management 1000 tasks/100 sub tasks
- 791 XXXPERT expert system with english like syntax
- 792 PDS\*QUOTE costing /quotation system (update)
- 793/94 PDS\*BASE Relations database (2 disks, update)
- 795 TURBO C & Datalight C Source libraries.
- 796 68000 cross assembler
- 797 PC BILL MASTER simplified business/home accounting.
- 798 SCREEN ENGINE Turbo Pas graphics screen generator
- 799 EGA screen FONT editor
- 800 BEYOND the TITANIC nice text adventure game.
- 803 REFERENCE articles catalogue/data base system
- 804 SURVEYSOFT land/site surveyors software(update)
- 805 LASER printer fonts for HP/compatibles
- 806 FILE BACK UP from HD automated !
- 808 HAM radio-IF/VHFprop,Cheby,Ohms,Zmatch
- 809 ENGINEERING heating/cooling/pipedata
- 811 XWORD crossword puzzles generator.
- 813 GAMES ASTROTTI(adults only)3DIT,April,Rolex
- 815 FONTASTIC Multi font printing/definition
- 816 PC DRAFT nice drawing/drafting/graphics prog(CGA)
- 820 Directory Master(Xtree clone)Anadisk.Diskut
- 821/2 TURBO C programming language tutorial(2 disks)
- 823 NETHACK enlarged Hack d&d advent(needs Hard disk)

PRICES SHOW BELOW ARE FOR 5.25 PC FORMAT DISKS, FOR 3.5" IBM FORMAT ADD 85p PER DISK, FOR OTHER MACHINES & CP/M CALL OR WRITE.

PRICES: 1-4 disks £4.50 each, any 5 £20.00, any 10 £33.00, any 20 £60.00 (fully inclusive). Send orders to:- 'PDSL', Winscombe House, Beacon Rd, Crowborough, Sussex TN6 1UL. Or telephone Orders using ACCESS/VISA to 0892 663298.  
 NOTE:- All disks listed above are for IBM PC/clones and many are 'shareware' items. Send 2x18p stamps for full list covering CP/M and other PC disks. This software is free, charges are to cover copying, media and distribution only.

causes the line below to contain no text at all, it deletes that line.

### Menu summary

At the top of the screen, the menu bar contains the titles of the menus that can be selected. To pull down a menu, press the COPY key; this will highlight the menu bar. Use the cursor keys to select the menu item required and press COPY again to view it. Use the cursor keys once more to select the item, and COPY to execute it. Pushing ENTER will abort the selection and return you to the edit window.

Fig 1 contains all the commands available in the menus. It also lists the keystrokes used to access the

functions without having to go through the menu structure.

### Templates

The following are commonly-used template outlines which, when selected, will insert the desired text at the cursor: Report, Months of the Year, Weeks Of The Month, Days of the Week and Nine 'til Five. They are very useful and make the creation of a diary, for example, very simple. They are available from the disk library or can be made yourself.

To use the program type in the two modules, saving the loader in a file called BC.BAS and the main program in a file called BCHILD.BAS. To run, type 'RUN "BC'.

FILES		
Menu Entry	Keystroke	Description
Model to Disk	CTRL + S	Save model in .OUT format
Save as ASCII	—	Save model in .ASC format
Merge to Cursor	—	Insert a .OUT file at cursor
Kill Worksheet	—	Restart BrainChild, the current model is lost
CURSOR		
Menu Entry	Keystroke	Description
End of model	CTRL + down	Move cursor to end of model
Start of model	CTRL + up	Move cursor to start of model
Next header	SHIFT + down	Move cursor to next header
Last header	SHIFT + up	Move cursor to last header
Fall 10 lines	CTRL + F	Move cursor down 10 lines
Up 10 lines	CTRL + U	Move cursor up 10 lines
Hunt a string	CTRL + H	Search for input string and move cursor to it
GOODIES		
Menu Entry	Keystroke	Description
Promote line	CTRL + Z	Promote line and subordinates by one level
Demote line	CTRL + X	Demote line and subordinates by one level
Overlay grid	CTRL + L	Overlay grid showing levels; press any key to continue
Cut text	CTRL + C	Cut line and subordinates
Paste text	CTRL + G	Paste cut lines and subordinates
Delete line	CTRL + Q	Delete line and descendants
PRINT		
Menu Entry	Keystroke	Description
Entire model	—	Dump entire model to printer
Headers only	—	Print level one headers only
Cursor to end	—	Print from cursor to end of model
Top to cursor	—	Print from top of model to cursor
Cut text	—	Print the current text

Fig 1

10	Brainchild - Outline Processor
20	(c) Alan Gorton jnr 1987
30	
40	
50	MODE 2
60	INK 0,2: INK 1,1: BORDER 2:PAPER 0:PEN 1
70	SYMBOL AFTER 200
80	SYMBOL 212,255,255,192,192,192,192,192,192
90	SYMBOL 213,255,255,3,3,3,3,3,3
100	SYMBOL 214,3,3,3,3,3,3,255,255
110	SYMBOL 215,192,192,192,192,192,192,255,255
120	SYMBOL 226,255,255,231,231,255,255
130	SYMBOL 227,255,255,231,231,255,255,0
140	SYMBOL 228,255,255,128,159,128,159,128,159
150	SYMBOL 229,0,252,12,207,15,207,15,207
160	SYMBOL 230,128,159,128,159,128,255,63



```

170 SYMBOL 231,15,207,15,207,15,255,255
180 SYMBOL 232,106,106,106,122,207,192,193,195
190 SYMBOL 234,184,184,176,176,224,192,128,0
200 SYMBOL 235,198,204,248,224,255,0,0,0
210 MEMORY &93FF
220 GOSUB 250
230 RUN"BCCHILD"
240
250 'RSX data
260
270 FOR t=&A0B0 TO &A0B0+&F9
280 READ t$
290 b=b+VAL("&" + t$)
300 POKE t,VAL("&" + t$)
310 NEXT t
320 IF b<>&6CDA THEN PRINT"Error":STOP
330 CALL &A0B0
340 RETURN
350 DATA 01,66,a1,21,7b,a1,cd,d1,bc,c9
360 DATA 2e,01,26,00,22,7e,a0,c3,9a,a0
370 DATA 21,00,00,22,7e,a0,dd,6e,00,dd
380 DATA 66,01,22,78,a0,dd,7e,02,dd,46
390 DATA 04,90,3c,6f,26,00,22,7c,a0,dd
400 DATA 66,08,25,dd,6e,04,2d,cd,1a,bc
410 DATA 22,76,a0,e5,dd,66,06,25,dd,6e
420 DATA 04,2d,cd,1a,bc,50,c1,7d,91,82
430 DATA 6f,26,00,22,7a,a0,2a,7e,a0,7d
440 DATA b7,ca,24,a1,0e,08,2a,7a,a0,45
450 DATA 2a,76,a0,ed,5b,78,a0,7e,12,23
460 DATA 13,10,fa,0d,79,b7,28,13,2a,76
470 DATA a0,cd,26,bc,22,76,a0,2a,7a,a0
480 DATA 45,2a,76,a0,c3,eb,a0,2a,7c,a0
490 DATA 7d,3d,6f,22,7c,a0,b7,c8,2a,76
500 DATA a0,cd,26,bc,22,76,a0,ed,53,78
510 DATA a0,c3,de,a0,0e,08,2a,7a,a0,45
520 DATA 2a,76,a0,ed,5b,78,a0,1a,77,23
530 DATA 13,10,fa,0d,79,b7,28,10,2a,7a
540 DATA a0,45,2a,76,a0,cd,26,bc,22,76
550 DATA a0,c3,31,a1,2a,7c,a0,2b,7d,b7
560 DATA c8,22,7c,a0,ed,53,78,a0,2a,76
570 DATA a0,cd,26,bc,22,76,a0,c3,24,a1
580 DATA 6e,a1,c3,8a,a0,c3,94,a0,45,58
590 DATA 50,4f,52,d4,49,4d,50,4f,52,d4
    
```

## BrainChild Variables

### Functions

FNson	Extracts next line pointer from h\$.
FNdad	As above but for last line.
FNwot	Find level pointer to next line.
FNat	Gives x-coordinate, given current level.

### Arrays

#### String

h\$	Contains all information about current line, including forward and backward pointers in hex, actual text and pointer to level of next line.
m\$	Pull down menu option data.

### Strings

#### Constant

l\$	Contains all possible level pointers.
c\$	Contains control key characters.
e\$	Holds control keys which add or insert a new line into the model.

## ACE FOR TRAINING ALSO RE-TRAINING

WANG, MULTIMATE,  
DISPLAYWRITE 4  
WORD PERFECT,  
WORDSTAR 2000

★ INTRODUCTORY OFFER ★

£99 per 2 day course

£120 per 3 evenings

Ring now on 01-735 8171 ext 30  
or 582 8629

## Public Domain Software

# £1.75

Per Disk

Inclusive of VAT and P&P

Too many to list, so here is a selection of our most popular titles:

PC - File + (2 disks)	MindReader
Image - 3D (state EGA or CGA)	PC - Write
Small C compiler	PC - Calc+ (2 disks)
PC - Type +/PC - Label (3 disks)	ProComm (2 disks)
PC - Outline	CGA Games (some of the best!)

Prices:  
£1.75 per disk (up to 4 disks)  
£7.50 for 5 disks (includes free library case)  
£14.00 for 10 disks (2 free library cases)

Send SAE (8.5"x4.25") for complete lists.

Cambridge PD Software  
12 Beaulands Close  
Cambridge CB4 1JA

Bureau Service  
Xpress - RSG  
Pagemaker  
Ventura

Linotronic 300  
Film or  
Bromide

Imagesetting  
from a Quality  
Typesetter

# W

---

ple

## Wordwork

PLAISTON PLACE  
LONDON SE11 5NS  
TEL: 01-403 7040  
FAX: 01-403 0402

## £3 SOFTWARE

All disks are for the IBM-PC, and compatibles, and are priced at only £3 per disk.

WORD-PROCESSORS		
PC-Write	Excellent and extensively documented	1 disk
Chwriter	Multi-font word processor	1 disk
NY-Word	Has macros, mailmerge, windows etc	2 disks
Mindread	Superb artificial intelligence WP	1 disk
Spell	Fast spell-checker for most WP's	1 disk
LQ-Print	Letter quality from a normal dot matrix	1 disk
LANGUAGES		
Forth	F83, with built-in editor and compiler	1 disk
Lisp	XLisp, artificial intelligence language	1 disk
Prolog	The best of the Art. Intell. languages	1 disk
C Library	Routines, aids & utilities for 'C'	6 disk
C Interp	'C' language interpreter	1 disk
C Comp	'C' language compiler	1 disk
Assembler	Fast, powerful macro-assembler	1 disk
DATABASE MANAGEMENT		
PC-BM	Enormous R-Base clone (req. hard disc)	3 disks
FreeFile	User friendly, powerful 2,000,000 records	1 disk
Wampum	Fully Dbase III compatible system	2 disks
Qubecalc	Very powerful, 3D spreadsheet	1 disk
GAMES		
Arcade 2	Collection of 8 fine arcade games	1 disk
Chess	More great arcade games	1 disk
Chess	The very best chess system	1 disk
Monopoly	The great classic. Bankrupt your micro	1 disk
Pinball	3 superb pinball tables here	1 disk
Willy Worm	High quality. Make your own screens	1 disk
Name Tune	Introducing. In the Trivia tradition	1 disk

Cheques/Postal order to:  
**SOFTSELL CONSULTANTS**  
 33 GLADMUIR ROAD,  
 HILLINGTON,  
 GLASGOW G52 1HX  
 Tel: 08 9865 4123 — 24 hours  
 For full catalogue on a disk, send £1, or free with first order  
 Prices are fully incl.

### PC PUBLIC DOMAIN

For a limited period only we have reduced the price of disks in our PC public domain library from £3 to just £2. This is a special offer to PCW readers so please mention this ad when replying. PC software is supplied on 5.25" disk. Just part of our library can be listed here.

CHASM	PC-Chess
A86 Assembler	Adventure Game Compiler
D86 Debugger	Backgammon/Mah Jong
XLISP	Chinese Checkers
Laxen & Perry Forth — 2 disks	Salling Simulator/Sam Spade
Ladybug Logo	Hangman
Small C Compiler	Softpom Adventure
C Interpreter	Origami — excellent graphics
C Language Tutor	Cavequest
Pascal Compilers	Amulet of Yendor
Turbo Pascal Tutorial	Space Invaders
PC-Write	Trivia Quiz — 2 disks
PC-Spell — spelling checker	Casino
New York Word — 2 disks	DANCAD — 3D CAD
Chi Writer — scientific wp	Draughtsman — graphics system
PC-Outline — document planner	Kermit — full source — 2 disks
NLQ — dot matrix letter quality	PC-General Ledger/Accounts
PC-Font — font creator	EZ Forms
PC-Typet — 3 disks	Stock Trader
As Easy As — 123 clone	Simplified Book Keeping
PC-Calc	PC-Money — money manager
Qubecalc	CP/M Emulators
PC-File+ — 2 disks	ESIE — expert system
Freefile	Q&A Expert System
Pinball — 9 games	Map Maker
Flight Simulator	PC-Desk — desk management

### AMSTRAD CP/M PUBLIC DOMAIN

We have a good selection of software on 3" disk for Amstrad CPC 6128 and PCW machines at £4 each. For example:

Expert 86 — is an expert system builder which may be used to create powerful expert systems of your own. Written by ourselves, it is not third party public domain software, nor is it merely user supported. We provide full documentation. The disk is supplied with over 88K of help information and a separate 73-page printed manual is available. The price of the manual has recently been reduced from £19.95 to just £10.

There are many other programs in our CP/M library. Send for a full catalogue. In addition to the disk-based documentation (which is often extensive) we produce our own 'Getting Started' guides to make sure that you can get the software up and running quickly.

POSTAGE — please add 50p for the first disk and 10p per disk thereafter.

CATALOGUES — send an 18p stamp or an international reply coupon — please state which machine you have.

DESPATCH — all orders are now normally despatched by return of post.

VAT — all prices include VAT at 15%.

### BLANK DISKS

Maxell 3" CF2 blank disks — £2.19 each including postage and packing. Top quality 5.25" DS/DD disks — £2.50 for 5, inclusive.

PROSPEC Computer Systems, PO Box 28, Beeston, Nottingham NG9 1PH. (0602) 701080

Authors and distributors of quality public domain software.

# PROGRAM FILE

## Variable

r\$	Holds string currently being edited before it is stored in h\$.
k\$	Holds key just been pressed.
w\$	Used to hold word(s) to be wrapped.
t\$	General use temporary string.

## General

### Constant

lmax	Maximum number of lines allowed in a model.
------	---

### Variable

P	Position of cursor in current string being edited.
h	Current position in array h\$.
hp	Where to add the next line.
l	Current level.
x	x-coordinate on screen for input line.
y	As above, but for y-coordinate.
i	x-coordinate on screen for pull down menu.
j	As above, but for y-coordinate.
k	Holds ASCII value of k\$, key just pressed.
wl	Length of word(s) to be wrapped.
ml	Gives maximum length of current line or menu option.
f	General purpose variable.
t	As above.
n	As above.

## Booleans

### Flags

fw	Shows if forward wordwrap has been invoked or not.
bw	As above except for backward wordwrap.

### Toggles

ww	WordWrap on or off.
io	Holds state of insert or overtype mode.

## Loop controllers

done	Simple boolean used in WHILE .. WEND loops.
over	As above.

## Files Cursor Goodies Print Templates

Model to	End of no	Pyrombe li	Entire n	Essay outline
Save as	Start of	Denote li	Headers	Months of year
Merge to	Next head	Open lau	Cursor h	Weeks of month
Kill wor	Last head	Cut text	Top to g	Days of week
	Fall 18 l	Paste text	Cut text	Nine 'Bill five
	Up 18 l m	Delete lin		
	Hunt a st			



```

Files  Cursor  Goodies  Print  Templates
-----
End of model
Working Start of model
Headings Next header
Text Last header
Info Fall 10 lines
Diary Hunt & string
Text
Brainchild v1.0 - Writeup Outline
Introduction
Ideas/outline processing
Commercial programs
Think tank, MORE, Brainstorm - my inspiration!
What do they do?
Outline manipulation
Promotion/demotion of entries and descendants
Cutting & pasting between lines
Simple report generation

Body
Level 1 # Used 13 %

Files  Cursor  Goodies  Print  Templates
-----
Entire model
Simple
Body
Brainchild itself
User interface
Full down
Single key
List them...
Line editing
As Windows editor but...
CTRL+D, TAB, COPY &c.

Conclusion
What do I use it for?
Essay outlines
Formalising ideas
Personal organisation
Diary
Films
Timetabling
Anything!

Info
Level 2 # Used  %
    
```

```

10
20
30
40      BrainChild - Outline Processor
50      (c) Alan Barton Jnr 1988
60
70 MODE 2
80 GOSUB 250
90 GOSUB 470
100
110 'Main program loop
120
130 WHILE NOT armageddon
140   LOCATE#2,6,25:PRINT#2,1
150   #=MID$(#$(#),8):#1=#0
160   LOCATE #FNat(4),#
170   GOSUB 3820
180   #$(#)=LEFT$(#$(#),7)+#
190   IF #w THEN GOSUB 2890
200   IF #b THEN GOSUB 3230
210   IF INSTR(#$,#*)<>0 THEN GOSUB 650
220   IF INSTR(#$,#*)<>0 THEN GOSUB 730
230 WEND
240
250 'Setup display
260
270 LOCATE 1,1:RESTORE 290
280 GOSUB 4460
290 DATA 5,Files,Cursor,Goodies,Print,Templates
300 FOR #=1 TO 80 STEP 10
310   LOCATE #,3:PRINT STRING$(9,CHR$(226))+CHR$(227)
320 NEXT
330 LOCATE 1,3:PRINT CHR$(227):LOCATE #,23:PRINT STRING$(80,CHR$(226))
340 WINDOW#0,1,80,4,23
350 WINDOW#1,1,80,24,25
360 WINDOW#2,1,80,1,25
370 PRINT CHR$(23)+CHR$(1)
380
390 'Status line
400
410 LOCATE#2,1,25:PRINT#2,"Level 1"
420 LOCATE#2,15,25:PRINT#2,"Used 0%"
430 LOCATE#2,30,25:PRINT#2,"Wordwrap on"
440 LOCATE#2,60,25:PRINT#2,CHR$(177)"BrainChild "CHR$(144)" ABJ 1988";
450 RETURN
460
470 'Default variables
480
490 OPENOUT"DUMMY"
500 MEMORY HIMEM-1
510 CLOSEOUT
520 CLS
530 #1=#1:#hp=1:#l=1:#lo=0:#ww=-1:#y=1:#max=300
540 DIM #$(#max)
550 #$(1)="00000000"
560 #=$CHR$(241)+CHR$(240)+CHR$(249)+CHR$(248)+CHR$(6)+CHR$(21)+CHR$(245)+CHR$(2
44)+CHR$(8)+CHR$(12)+CHR$(26)+CHR$(24)+CHR$(17)+CHR$(3)+CHR$(7)+CHR$(19)+CHR$(22
4)
570 #=$CHR$(14)+CHR$(13)+CHR$(2)
580 #=$"+0123456"
590 DEF FNwot(h)=INSTR(1,$,MID$(#$(h),1,1))
600 DEF FNson(h)=VAL("%"+MID$(#$(h),2,3))
610 DEF FNdad(h)=VAL("%"+MID$(#$(h),5,3))
620 DEF FNat(i)=MAX(1,((i-1)*5))
630 RETURN
640 GOSUB 390
650
660 'Control codes
670
    
```

# COMPUTER TRAINING

PRICES STARTING AT

# £65.00

Full day courses including course notes and tutorial disk.

Please ring  
**KENT COMPUTER SYSTEMS**  
**(0732) 823845**

## CLARE HUCKLE

training for computer users

Proper training is one of the most valuable investments you can make.

We can provide professional training at your premises in the following:

- DisplayWrite 4
- WordStar
- WordStar Professional
- MultiMate Advantage
- Lotus 1-2-3
- Lotus Symphony
- dBase III Plus
- Cardbox Plus

Why not telephone

Brighton (0273) 205750  
for further details, or  
write to

Clare Huckle  
17 Vernon Terrace,  
Brighton,  
East Sussex BN1 3JG

Can your staff do EVERYTHING that your Word Processing package can do?

## TRAINING MAKES SENSE

First class training by qualified teachers on top Word Processing packages

**WORDPERFECT/WORDSTAR  
MULTIMATE**

**For more information  
contact**

**NS**  
ENTERPRISES  
Practical Computing

4 Robin Hill, Ashlyn's Estate  
Berkhamsted, Herts HP4 2HX  
Tel: 04427 71630



## MAIN BOARDS

PCB-999 AT COMPATIBLE MAIN BOARD .....	£195.00
BAY-999 BABY AT COMPATIBLE .....	£222.00
BABY AT MAIN BOARD + BIOS + 640K .....	£343.00
TUB-550 TURBO XT COMPATIBLE .....	£64.60
TURBO XT MAIN BOARD + BIOS + 640K .....	£177.00

## PARALLEL SERIAL, GAME CARDS

PSJ-320 PARALLEL/SERIAL/GAME CARD FOR XT/AT .....	£35.20
PSC-320 PARALLEL/SERIAL/CARD FOR XT/AT .....	£28.60
PTC-880 PARALLEL PRINTER CARD FOR XT/AT .....	£9.75
JSC-880 JOYSTICK CARD FOR XT/AT .....	£9.75
M10-880 MULTI I/O CARD FOR XT/AT .....	£33.00
STC-880 SERIAL/CLOCK CARD FOR XT .....	£22.00
RSC-880 SERIAL CARD FOR XT .....	£15.75
RSC-880B 2ND PORT SERIAL KIT .....	£7.00

## DISK CONTROL CARDS

HFC-310 HARD/FLOPPY DISK CONTROL CARD FOR AT .....	£125.00
FDC-310 FLOPPY DISK CONTROLLER CARD FOR XT/AT .....	£72.55
FDC-660 FLOPPY DISK CONTROL CARD FOR XT .....	£16.50
HOC-770 HARD DISK CONTROL CARD FOR XT .....	£62.70
DIO-880 DISK-I/O SHORT CARD FOR XT .....	£46.20

## COLOUR AND MONO CARDS

EGA-330 ENHANCED COLOUR GRAPHIC/MONochrome/GRAPHIC PRINTER SHORT CARD FOR XT/AT .....	£128.50
EGA-340 ENHANCED COLOUR GRAPHIC/MONochrome GRAPHIC HALF CARD FOR XT/AT .....	£130.00
MGP-990 MONochrome GRAPHIC/PRINTER SHORT CARD FOR XT/AT .....	£36.20
CGP-990 COLOUR GRAPHIC/PRINTER SHORT CARD FOR XT/AT .....	£36.00

## INPUT DEVICES

KBD-320 KEY KEYBOARD FOR XT/AT .....	£33.00
KBD-330 102 KEY KEYBOARD FOR XT/AT .....	£41.80
MUS-880 MICROSOFT COMPATIBLE MOUSE .....	£42.00
JOS-880 JOYSTICK .....	£9.75

## COMPUTER CASES

CAS-320 AT CASE .....	£48.00
CAS-330 BABY AT CASE .....	£43.00
CAS-883 XT CASE .....	£29.00
CAS-993 TOWER CASE .....	£180.00

## POWER SUPPLIES

PSY-880 150W POWER SUPPLY FOR XT/AT .....	£38.00
PSY-320 200W POWER SUPPLY FOR AT BABY AT .....	£58.00

## HARD DISKS

HDD-882 20MB HARD DISK DRIVE .....	£202.00
+ CONTROLLER 20MB HARD DISK DRIVE .....	£160.00
HDD-884 40MB HARD DISK DRIVE 28ms FULL HEIGHT .....	£415.00
40MB HARD DISK DRIVE HALF HEIGHT .....	£267.00

## FLOPPY DISKS

360K FLOPPY DISK DRIVE .....	£67.00
1.2MB FLOPPY DISK DRIVE .....	£92.00
3.5" FLOPPY DISK DRIVE .....	£82.00

## MONITORS

12" GREEN MONochrome MONITOR .....	£69.00
14" B&W MONochrome MONITOR .....	£89.95
14" EGA MONITOR .....	£295.00
14" RGB MONITOR .....	£209.00

## CONVERSION CARDS

SPC-880 80286 SPEED AND CONVERT CARD FOR XT .....	£210.00
---	---------

## BIOS

B10-880 PHOENIX BIOS FOR XT .....	£12.00
B10-999 PHOENIX BIOS FOR AT .....	£25.00

## MANUALS & SOFTWARE

USM-550 XT MANUAL & BINDER .....	£10.00
USM-999 AT MANUAL & BINDER .....	£20.00
MS-DDS 3.2 & MANUAL, GW BASIC & MANUAL .....	£50.00

## MEMORY CARDS

2.5MB MEMORY CARD UNPOPULATED .....	£120.00
3.0MB MEMORY CARD UNPOPULATED .....	£120.00

## MEMORY CHIPS

256/12-15 .....	£3.28
4164/12/15 .....	£2.38

Excl. VAT & Delivery

MANY MORE PRODUCTS AVAILABLE,  
PLEASE RING OUR TRADE COUNTER  
FOR FULL PRICE LIST & CATALOGUE



MILLMEAD BUSINESS CENTRE  
MILLMEAD RD, LONDON N17 9QU 01 801 1838

```

680 f=INSTR(c$,k$)
690 ON f GOSUB 940,1010,1050,1140,1190,1260,1330,1390,1580,1740,1880,2020,2300,2
470,2520,3670,4580
700 k$="nul1"
710 RETURN
720
730 'Add a line
740
750 f=INSTR(e$,k$):p=1
760 IF 1+2-f<1 OR 1+2-f>7 THEN RETURN
770 'Entry point for merging and pasting routines
780 IF hp=1max THEN RETURN
790 l=1+2-f:hp=hp+1:y=y+1:h$ (hp)="000000":t$=MID$(1$,f,1)
800 LOCATE#2,20,25:PRINT#2,STR$(INT((hp/1max)*100))%"
810 IF y>20 THEN LOCATE 1,20:PRINT CHR$(10):y=20:oy=oy+xx
820 MID$(h$ (hp),5,3)=HEX$(h,3)
830 MID$(h$ (hp),2,3)=HEX$(FNson(h),3)
840 MID$(h$ (h),2,3)=HEX$(hp,3)
850 n=FNson (hp)
860 IF n=0 THEN MID$(h$ (h),1,1)=t$:h=hp:RETURN
870 MID$(h$ (n),5,3)=HEX$(hp,3)
880 WINDOW#3,1,80,MIN(23,y+3),23
890 PRINT#3,CHR$(11)
900 MID$(h$ (hp),1,1)=MID$(1$,FNwat (h)+2-f,1)
910 MID$(h$ (h),1,1)=MID$(1$,f,1)
920 h=hp
930 RETURN
940
950 'Cursor movement
960
970 'Down
980 GOSUB 1450
990 IF y>20 THEN LOCATE FNat (1),20:PRINT CHR$(10)+MID$(h$ (h),8):y=20:oy=oy+xx
1000 RETURN
1010 'Up
1020 GOSUB 1520
1030 IF y<1 THEN LOCATE FNat (1),1:PRINT CHR$(11)+MID$(h$ (h),8):y=1
1040 RETURN
1050 'End of model
1060 WHILE FNson (h)<>0
1070 GOSUB 1450
1080 WEND
1090 IF y<21 THEN RETURN
1100 CLS
1110 LOCATE FNat (1),1:PRINT MID$(h$ (h),8)
1120 y=1
1130 RETURN
1140 'Start of model
1150 h=1:l=1:y=20
1160 CLS
1170 LOCATE FNat (1),y:PRINT MID$(h$ (h),8)
1180 RETURN
1190 'Fall 10 lines
1200 n=1
1210 WHILE n<10 AND FNson (h)<>0
1220 GOSUB 940
1230 n=n+1
1240 WEND
1250 RETURN
1260 'Up 10 lines
1270 n=1
1280 WHILE n<10 AND Fndad (h)<>0
1290 GOSUB 1010
1300 n=n+1
1310 WEND
1320 RETURN
1330 'Next header
1340 GOSUB 940
1350 WHILE FNson (h)<>0 AND 1<>1
1360 GOSUB 940
1370 WEND
1380 RETURN
1390 'Last header
1400 GOSUB 1010
1410 WHILE Fndad (h)<>0 AND 1<>1
1420 GOSUB 1010
1430 WEND
1440 RETURN
1450 'Next line
1460 IF FNson (h)=0 THEN RETURN
1470 t=FNwat (h)
1480 IF t<>2 THEN p=1
1490 IF t=1 THEN l=l+1 ELSE l=1-t+2
1500 h=FNson (h):y=y+1
1510 RETURN
1520 'Last line
1530 IF Fndad (h)=0 THEN RETURN
1540 h=Fndad (h):y=y-1:t=FNwat (h)
1550 IF t<>2 THEN p=1
1560 IF t=1 THEN l=l-1 ELSE l=1+t-2
1570 RETURN
1580 'Hunt a string (forward search only)
1590 IF FNson (h)=0 THEN RETURN
1600 WINDOW SWAP 0,2
1610 m1=50:oy=y
1620 t$="Hunted string"
1630 GOSUB 2670
1640 WINDOW SWAP 0,2
1650 IF r$="" THEN y=oy:RETURN
1660 GOSUB 1450
1670 WHILE FNson (h)<>0 AND LOWER$(MID$(h$ (h),8))<>LOWER$(r$)
1680 GOSUB 1450
1690 WEND
1700 y=1
1710 GOSUB 2170
1720 RETURN
1730
1740 'Level pointer
1750
1760 done=1
1770 WHILE NOT done
1780 done=done-1
1790 FOR t=1 TO 7
1800 PLOT MAX(0,((t-1)*40)-8),357
1810 DRAW MAX(0,((t-1)*40)-8),33
1820 NEXT
1830 WHILE INKEY$="" AND NOT done
1840 WEND
1850 WEND
1860 RETURN
1870
1880 'Promote line and descendants
1890
1900 IF l=1 THEN RETURN
1910 done=0:f=Fndad (h):l=1-n:1
1920 GOSUB 3730
    
```



# PROGRAM FILE

```

1930 WHILE NOT done
1940 IF y<21 THEN LOCATE FNat(1),y:PRINT MID$(h$(h),8)+CHR$(18)
1950 IF FNson(h)=0 THEN done=-1 ELSE GOSUB 1450:IF 1<n THEN GOSUB 1520:done=-1
1960 WEND
1970 IF FNson(h)<>0 THEN MID$(h$(h),1,1)=MID$(1$,FNwot(h)-1,1)
1980 MID$(h$(f),1,1)=MID$(1$,FNwot(f)+1,1)
1990 GOSUB 3780
2000 RETURN
2010
2020 'Demote line and descendants
2030
2040 done=0:f=FNdad(h)
2050 IF 1=7 OR FNwot(f)=1 OR FNdad(h)=0 THEN RETURN
2060 1=1+1:n=1
2070 GOSUB 3730
2080 WHILE NOT done
2090 IF y<21 THEN LOCATE FNat(1),y:PRINT CHR$(17)+MID$(h$(h),8)
2100 IF FNson(h)=0 THEN done=-1 ELSE GOSUB 1450:IF 1<n OR 1=8 THEN GOSUB 1520:
done=-1
2110 WEND
2120 IF FNson(h)<>0 THEN MID$(h$(h),1,1)=MID$(1$,FNwot(h)+1,1)
2130 MID$(h$(f),1,1)=MID$(1$,FNwot(f)-1,1)
2140 GOSUB 3780
2150 RETURN
2160
2170 'Display to end of page
2180
2190 done=0
2200 GOSUB 3730
2210 WHILE y<21 AND NOT done
2220 IF FNson(h)=0 THEN done=-1
2230 LOCATE FNat(1),y:PRINT CHR$(17)+MID$(h$(h),8)+CHR$(18)
2240 GOSUB 1450
2250 WEND
2260 IF y<20 THEN LOCATE 1,y+1:PRINT CHR$(20)
2270 GOSUB 3780
2280 RETURN
2290
2300 'Delete line and descendants
2310
2320 IF FNdad(h)=0 THEN RETURN
2330 done=0:n=1:f=y
2340 GOSUB 1520
2350 GOSUB 3730
2360 GOSUB 1450
2370 WHILE NOT done
2380 IF FNson(h)=0 THEN h=0:done=-1 ELSE GOSUB 1450:IF 1<n THEN done=-1
2390 WEND
2400 MID$(h$(ch),2,3)=HEX$(h,3)
2410 MID$(h$(ch),1,1)=MID$(1$,MAX(1,2+(a1-1)),1)
2420 IF h<>0 THEN MID$(h$(h),5,3)=HEX$(ch,3)
2430 GOSUB 3780
2440 GOSUB 2170
2450 RETURN
2460
2470 'Cut line and descendants
2480
2490 ch=h
2500 RETURN
2510
2520 'Paste line and descendants
2530
2540 IF ch=0 THEN RETURN
2550 done=0:a1=1:oh=ch
2560 WHILE NOT done
2570 n=1
2580 h$(h)=LEFT$(h$(h),7)+MID$(h$(ch),8)
2590 LOCATE FNat(1),y:PRINT CHR$(17)+MID$(h$(ch),8)+CHR$(18)
2600 f=FNwot(ch):ch=FNson(ch)
2610 IF f=1 THEN n=n+1 ELSE n=n+2-f
2620 IF n<a1 OR n=8 OR ch=0 THEN done=-1 ELSE GOSUB 770
2630 WEND
2640 ch=oh
2650 RETURN
2660
2670 'Enter a simple line
2680
2690 op=psp=1:r$="" :y=25
2700 IEXPORT,1,80,y,y,&9400
2710 LOCATE 1,y:PRINT t$:" ";
2720 x=POB(#0)-1
2730 LOCATE x+p,y:PRINT CHR$(140)+CHR$(18)
2740 WHILE k<>CHR$(13)
2750 k=0
2760 WHILE k<>13 AND k<>127 AND (k<32 OR k>122)
2770 k$=""
2780 WHILE k$=""
2790 k$=INKEY$
2800 WEND
2810 k=ASC(k$)
2820 WEND
2830 IF y<31 AND k<123 AND p<m1+1 THEN r$=r$+k$:LOCATE x+p,y:PRINT k$+CHR$(140)
:p=p+1
2840 IF k=127 AND p>1 THEN r$=LEFT$(r$,p-2):p=p-1:LOCATE x+p,y:PRINT+CHR$(140)+
""
2850 WEND
2860 IIMPORT,1,80,y,y,&9400
2870 p=op
2880 RETURN
2890
2900 'Wordwrapping (forward)
2910
2920 GOSUB 3730
2930 done=0
2940 WHILE NOT done
2950 GOSUB 3070
2960 IF y<21 THEN LOCATE FNat(1),y:PRINT MID$(h$(h),8)+CHR$(18)
2970 GOSUB 3160
2980 IF FNdad(h)=oh AND p>m1-w1 THEN p=p-m1+w1:GOSUB 3730
2990 IF 1=0 AND w$<>" " THEN h$(h)=LEFT$(h$(h),7)+w$+" "+MID$(h$(h),8)
3000 IF NOT 1=0 AND w$<>" " THEN h$(h)=LEFT$(h$(h),7)+s+MID$(h$(h),8)+w1)
3010 IF y<21 THEN LOCATE FNat(1),y:PRINT MID$(h$(h),8,m1)
3020 IF LEN(h$(h))<m1+7 THEN done=-1
3030 WEND
3040 GOSUB 3780
3050 fw=0
3060 RETURN
3070 'Find word(s) to wrap (forward)
3080 FOR t=m1+7 TO 8 STEP -1
3090 IF MID$(h$(h),t,1)=" " OR MID$(h$(h),t,1)=" " THEN f=t:t=0
3100 NEXT
3110 IF NOT t THEN w$="" :w1=0:RETURN
3120 w$=MID$(h$(h),f+1)
3130 w1=LEN(w$)
3140 h$(h)=LEFT$(h$(h),f-1)
3150 RETURN

```

# MICROMART

## MS-DOS FLEX UNIFLEX OS-9 OS-9/68K CROSS ASSEMBLERS

A suite of cross assemblers supporting the following devices:

1802 1805 6303 6502 6503 6800 6801  
6802 6803 6804 6805 68HC05 146805  
6808 6809 68HC11 8020 8021 8022 8031  
8035 80C35 8039 80C39 8040 8048  
80C48 8049 80C49 8050 8051 8080 8085  
8748 8749 8751 Z8 Z80 68000

Extensive directives support modular, conditional and structured programming. Supplied with conversion utilities and powerful macro preprocessor.

COMPLETE SUITE £295 + VAT  
INCLUDING FULL 'C' SOURCE (not 68000)  
INDIVIDUAL ASSEMBLERS £40 each

Micro Concepts Tel: 0242 510525  
2 St Stephens Rd, Cheltenham, Glos

## DISCOUNT MAIL ORDER

FUTUREPLACE LIMITED, 105 ARICA ROAD,  
LONDON SE4 2PS.

Telephone Enquiries 01-639 5479  
All prices include VAT/CWO. P&P

### ACORN

ARCHIMEDES (A)  
A305 BASE ..... £750.00  
A305 MONO ..... £800.00  
A305 COLOUR ..... £950.00  
A310 BASE ..... £830.00  
A310 MONO ..... £880.00  
A310 COLOUR ..... £1035.00  
★ Add £66.00 to A310 for A310M MS-DOS ★

### AMSTRAD

PC1512 SDMM ..... £439.99  
PC1512 SDCM ..... £579.00  
PC1512 DDM ..... £529.99  
PC1512 DDCM ..... £689.99

### CAMBRIDGE

Z88 ..... £270.00

### PSION

ORGANISER II CM ..... £89.99  
ORGANISER II XP ..... £129.99



47 NORTHCOTE RD, LONDON SW11  
Tel: 585 0891

(All 1512 come with 4 US Games +  
Might ability) RPM Phone 01-585 0891  
Opening hours Mon-Fri 9am-6pm Sat-Sun 10am-5pm

## 80 COLUMN DOT MATRIX PRINTER AMAZING OFFER

MP 135 DOT MATRIX PRINTER 135 CPS 2 YEAR GUARANTEE  
£112.00

★ MP40 DAISYWHEEL PRINTER £265 ★

AMIGA A500 ..... £369.00  
AMIGA A500 + HI-RES MON. .... £607.00  
ATARI 520 ..... £328.00  
ATARI + HI-RES MONITOR ..... £566.00  
CANON 1080A printer 80cps/190cps ..... £210.00  
AMSTRAD Portable PPC 640 dual D/D + Modem ..... £355.00  
PCW 9512 ..... £430.00  
PC Analogue Joystick + Controller Card ..... £25.00

AMSTRAD PC WITH SINGLE DRIVE + (RPM) 20M HARD DISC  
1512 PC Mono Computer ..... £585 inc VAT  
1512 PC Colour Computer ..... £845 inc VAT  
1640 PC Mono Computer ..... £795 inc VAT  
1640 PC CGA Colour Monitor ..... £295 inc VAT  
1640 PC EGA Colour Monitor High Res ..... £195 inc VAT  
★ RPM Phone 01-585 0891 — 20M hard discs for Amstrad compatibles —  
From £250 inc VAT ★

AMSTRAD PC SINGLE DISC DRIVE  
1512 PC Mono Computer ..... £437 inc VAT  
1512 PC Colour Computer ..... £598 inc VAT  
1640 PC Mono Computer ..... £546 inc VAT  
1640 PC CGA Colour Monitor ..... £295 inc VAT  
1640 PC EGA Colour Monitor High Res ..... £246 inc VAT  
Amiga/Atari/Amstrad software also available. Please ring for prices.  
Prices correct at publication

Amstrad PC 1512 Mono SD and hard discs in stock. Prices + VAT & P&P  
FOR GREAT DEALS ON AMIGA AND ATARI SOFTWARE

PHONE 01-585 0891

**NSG**

**NORTHERN PC SOFTWARE GROUP**

**Collieston, Aberdeen, AB4 9RT**

Telephone and Help Line:- 035887 - 336  
Telex: 265871 MONREF G. Quote 72: MAG35916

NSG offer to ALL members a unique, new concept in Computer Services. The following are available to Registered Members.

**PUBLIC DOMAIN:** The finest programmes compiled by leading PD Authors, containing IBM Compatible material on 5.25 Floppy Disks, are offered on Public Domain. Including WPs, Spreadsheets, Databases Games, Utilities, Graphic programmes, and many more. All are available to NSG Members, at the best available discount.

**24 HOUR HELPLINE:** Our 24 Hour Help-Line Service can be of instant assistance to any Member. Especially valuable to newcomers to these excellent PD programmes.

**DISK EXCHANGE:** Disk Exchange Service offered (See Catalogue for Details)

**PUBLISHING:** Design and Publishing facilities are available for Software Programmes. We do not accept PIRATED MATERIAL.

**NEW HARD AND SOFTWARE:** New Hard Ware and Soft Ware by the Leading Manufacturers available at excellent Discounts, when purchased through NSG. (All Trade Marks Recognised)

**SPECIAL INTERESTS:** Special Interest Groups encouraged. Share your particular expertise with other enthusiasts, through our News Letter.

SEND FOR YOUR FREE CATALOGUE - NOW AND TAKE ADVANTAGE OF OUR LIMITED OFFER OF FREE MEMBERSHIP. THIS OFFER CLOSES APRIL 1988.

**THE BEST IN THE WEST - PLUS !!!**

YOU ONLY NEED TO ADD V.A.T. AT 15%  
OUR PRICES INCLUDE CARRIAGE!

<b>AMSTRAD</b>	
<b>PC1512</b>	
Single Drive Mono Monitor	£380.00
Single Drive Colour Monitor	£519.00
Double Drive Mono Monitor	£474.00
Double Drive Colour Monitor	£614.00
*All 1512's C.W. MIGENTABILITY plus FOUR U.S. GOLD games!	
<b>PC1640</b>	
Single Drive Mono Monitor	£474.00
Double Drive Mono Monitor	£559.00
Single Drive Colour Monitor	£579.00
Double Drive Colour Monitor	£659.00
HDD/M20 MB (With Hard Disk)	£835.00
HDD/M20 MB (With Hard Disk)	£963.00
<b>PC1640 - ENHANCED COLOUR DISPLAY</b>	
SDE C.D.	£745.00
DDE C.D.	£829.00
HDD 20 MB E.C.D. (With Hard Disk)	£1099.00
<b>PCW SERIES</b>	
PCW 8256 + Locoscript/Basic/DR Logo/CP/M	£298.00
PCW 8512 + Locoscript/Basic/DR Logo/CP/M	£379.00
PCW 9512 + Locoscript/Basic/DR Logo/CP/M	£469.00
All our PCW's also come with FREE Disk Storage box AND a 3" disk containing a FREE W.B.B.S. DATABASE + other programs	
<b>SANYO</b>	
PC/MBC-16 PLUS 1 Single Drive Mono Monitor	£575.00
PC/MBC-16 PLUS 1 + MEMORY UPGRADE + 20 MB HARD DISK	£811.25
AT MBC-17 PLUS 1 1.2MB Floppy/20MB HARD DISK HI-RES MONITOR	£1,562.50
These prices include ON-SITE MAINTENANCE on the Sanyo machine	
<b>DAISYWHEEL PRINTERS FROM AN ASTONISHING £190.00 !!!</b>	
<b>SOFTWARE - JUST A TINY TINY SELECTION OF WHAT IS AVAILABLE</b>	
MAP INTEGRATED ACCOUNTS	£110.00 (dBASE II/PC or PCW)
CANSOFT PROFITMAKER	£199.00 (dBASE III + TAS)
VOLKSWRITER DELUX	£390.00 (DEVELOPER (database))
VOLKSWRITER III	£155.00 (Single user)
GEMWRITE	£64.00 (Multiple user)
DAC WORD II	£30.00 (TurboCAD (full version))
IF YOU SEE ANYTHING WE SELL BEING SOLD CHEAPER ELSEWHERE PHONE US BEFORE YOU BUY - OUR AIM IS TO MAKE OUR CUSTOMERS HAPPY !!!	
PRICES INCLUDE POSTAGE JUST ADD V.A.T. - SUBJECT TO AVAILABILITY	
TELEPHONE FOR DETAILS 9am-9pm 7 DAYS A WEEK	
WEST OF BRITAIN BUSINESS SERVICES (DEPT 74)	
CAPEL TOBI, FAIRFACH, LLANDEILO, DYFED, SA19 6PR.	
CHEQUES/P.O.'S PAYABLE TO: "W.B.B.S." - TEL (0558) 823782	

## SMART USERS!

Using the SMART integrated system?

We specialise in SMART applications development and support, and can provide analysis and programming services to SMART users.

### SMART systems developers!

Pull-down menus & pop-up help

- ★ Only £49 plus VAT, including source code
- ★ Text-file driven
- ★ Reduces program development time
- ★ Provides a standard, easy to use menu system
- ★ Written in SPL for simple integration with your programs

**XYSTUS SYSTEMS LIMITED**  
**Guildford (0483) 898498**

## PROGRAM FILE

```

3160 'Move to next line
3170 f=FNwot(h):n=FNson(h)
3180 IF f=2 AND MID$(h$(n),8)<>" " AND n<>0 THEN GOSUB 970:RETURN
3190 f=2
3200 GOSUB 770
3210 RETURN
3220
3230 'wordwrapping (backward)
3240
3250 GOSUB 3730
3260 done=0
3270 WHILE NOT done
3280 GOSUB 3340
3290 IF NOT done THEN GOSUB 3400
3300 WEND
3310 bw=0
3320 GOSUB 3780
3330 RETURN
3340 'Move to next line and check it
3350 IF FNson(h)=0 OR FNwot(h)<>2 THEN done=-1:RETURN
3360 n=
3370 GOSUB 1450
3380 IF MID$(h$(h),8)=" " OR MID$(h$(h),8,1)=" " THEN done=-1
3390 RETURN
3400 'Find word(s) to wrap (backward)
3410 w1=m1+B-LEN(h$(n))
3420 IF LEN(MID$(h$(h),8))<w1 THEN w=MID$(h$(h),8):GOSUB 3560:RETURN
3430 f=0:over=0
3440 WHILE NOT over
3450 t=INSTR(MID$(h$(h),f+7)," ")
3460 IF f+t<w1 THEN f=f+t ELSE over=-1
3470 IF t=0 THEN over=-1
3480 WEND
3490 IF f>2 THEN w=MID$(h$(h),8,f-2) ELSE done=-1:RETURN
3500 'Update lines
3510 h$(n)=h$(n)+" "+w$
3520 h$(h)=LEFT$(h$(h),7)+MID$(h$(h),f+7)
3530 IF y<22 THEN LOCATE FNat(1),y-1:PRINT MID$(h$(n),8)
3540 IF y<21 THEN LOCATE FNat(1),y:PRINT MID$(h$(h),8)+CHR$(18)
3550 RETURN
3560
3570 'Delete line
3580
3590 h$(n)=h$(n)+" "+w$
3600 MID$(h$(n),2,3)=MID$(h$(h),2,3)
3610 MID$(h$(n),1,1)=MID$(h$(h),1,1)
3620 GOSUB 1450
3630 MID$(h$(h),5,3)=HEX$(n,3)
3640 IF y<21 THEN GOSUB 3780:GOSUB 2170
3650 RETURN
3660
3670 'Save model
3680
3690 m=1
3700 GOSUB 5340
3710 RETURN
3720
3730 'Stack current position
3740
3750 oh:h:ol:oy=y
3760 RETURN
3770
3780 'Pop stack
3790
3800 h=h:ol=MAX(ol,1):y=MAX(oy,1)
3810 RETURN
3820
3830 'Edit line or paragraph
3840
3850 done=0:r=r$+SPACE$(m1+1-LEN(r$))
3860 x=POS(#0)-1:y=VPOS(#0)
3870 k$=""
3880 WHILE k<>CHR$(13) AND NOT done
3890 k$=""
3900 LOCATE x+p,y:PRINT CHR$(24)+MID$(r$,p,1)
3910 WHILE k$=""
3920 LOCATE x+p,y:PRINT MID$(r$,p,1);
3930 IF io THEN z=z+1:IF z=15 THEN PRINT CHR$(24);:z=0
3940 k$=INKEY$
3950 WEND
3960 PAPER 0:PEN 1:LOCATE x+p,y:PRINT MID$(r$,p,1);:z=14
3970 k=ASC(k$)
3980 IF io AND k>31 AND k<127 THEN GOSUB 4210
3990 IF NOT io AND k>31 AND k<127 THEN GOSUB 4290
4000 IF k=9 THEN IF p=50 THEN p=1 ELSE p=MIN((x+p+10)\10)*10,x+50)-x
4010 IF k=242 OR k=243 OR k=250 OR k=251 THEN GOSUB 4140
4020 IF k=225 THEN io=NOT io
4030 IF k=4 THEN r$=SPACE$(m1+1):p=1:LOCATE x+p,y:PRINT CHR$(18)
4040 IF k=23 THEN ww=NOT ww:LOCATE 2,40,25:IF ww THEN PRINT 2,"n " ELSE PRINT 2,"ff"
4050 IF k=127 OR k=16 THEN GOSUB 4360
4060 IF INSTR(e$+c$,k$)<>0 THEN done=-1
4070 WEND
4080 t=INSTR(r$,SPACE$(3))
4090 IF t>0 THEN IF MID$(r$,t)=SPACE$(m1-t+2) THEN r$=LEFT$(r$,t-1):RETURN
4100 FOR t=m1 TO 1 STEP -1
4110 IF MID$(r$,t,1)<>" " THEN r$=LEFT$(r$,t):t=0
4120 NEXT
4130 RETURN
4140 'Cursor
4150 IF k=250 THEN p=1:RETURN
4160 IF k=251 THEN p=m1:RETURN
4170 p=p+(k=242)-(k=243)
4180 IF p<1 THEN p=m1:k$=CHR$(240)
4190 IF p>m1 THEN p=1:k$=CHR$(241)
4200 RETURN
4210 'Insert
4220 IF MID$(r$,m1,1)<>" " AND NOT ww THEN RETURN
4230 r$=LEFT$(r$,p-1)+k$+MID$(r$,p,m1-p-ww)
4240 p=MIN(p+1,m1-ww)
4250 LOCATE x+p-1,y:PRINT MID$(r$,p-1);
4260 IF NOT ww THEN RETURN
4270 IF MID$(r$,m1,1)<>" " OR p>m1 THEN fw=-1:done=-1 ELSE r$=LEFT$(r$,m1)
4280 RETURN
4290 'Overtyp
4300 LOCATE x+p,y:PRINT k$
4310 MID$(r$,p,1)=k$
4320 p=MIN(p+1,m1-ww)
4330 IF NOT ww THEN RETURN
4340 IF p>m1 THEN fw=-1:done=-1
4350 RETURN
4360 'Delete
4370 p=p-(k=16)
4380 IF p=1 THEN RETURN
4390 r$=LEFT$(r$,p-2)+MID$(r$,p,m1-p+3)+" "
4400 p=p-1

```



# PROGRAM FILE

```

4410 LOCATE x+p,y:PRINT MID$(r$,p);
4420 IF NOT ww THEN RETURN
4430 IF FNson(h)=0 OR FNwt(h)<2 THEN RETURN
4440 bw=-1:done=-1
4450 RETURN
4460
4470 'Setup menubar
4480
4490 READ mb
4500 FOR t=1 TO mb
4510 READ ms
4520 PRINT " "+ms+" "
4530 ms=ms+CHR$(48+t)+ms+" "
4540 NEXT
4550 LOCATE#2,78,1:PRINT#2,CHR$(232)+CHR$(234)
4560 LOCATE#2,78,2:PRINT#2,CHR$(235)
4570 RETURN
4580
4590 'Menubar driver
4600
4610 LOCATE#2,78,1:PRINT#2,CHR$(228)+CHR$(229)
4620 LOCATE#2,78,2:PRINT#2,CHR$(230)+CHR$(231)
4630 MOVE 0,400-((y+3)*16)
4640 DRAW# 639,0
4650 j=1:t=1:done=0
4660 WHILE NOT done
4670 i=INSTR(ms,CHR$(48+t))
4680 LOCATE#2,i,j:PRINT#2,CHR$(24)+" "+MID$(ms,i+1,INSTR(MID$(ms,i+1)," "))+CHR$(24)
4690 k$=""
4700 WHILE k$=""
4710 k$=INKEY$
4720 WEND
4730 k=ASC(k$)
4740 LOCATE#2,i,j:PRINT#2," "+MID$(ms,i+1,INSTR(MID$(ms,i+1)," ")))
4750 IF k=242 THEN t=t-1:IF t=0 THEN t=mb
4760 IF k=243 THEN t=t+1:IF t>mb THEN t=1
4770 IF k=13 OR k=224 THEN done=-1
4780 WEND
4790 MOVE 0,400-((y+3)*16)
4800 DRAW# 639,0
4810 IF k=13 THEN t=0
4820 IF t THEN GOSUB 5210
4830 LOCATE#2,78,1:PRINT#2,CHR$(232)+CHR$(234)
4840 LOCATE#2,78,2:PRINT#2,CHR$(235)+" "
4850 RETURN
4860
4870 'Pull down menu driver
4880
4890 MOVE 0,400-((y+3)*16)
4900 DRAW# 639,0
4910 m1=15
4920 READ ts
4930 READ m
4940 :EXPORT,i,i+m1+2,j,j+m+3,&9400
4950 LOCATE#2,i,j:PRINT#2,CHR$(24)+" "+ts+" "+CHR$(24)
4960 LOCATE#2,i,j+1:PRINT#2,CHR$(212)+STRING$(m1,CHR$(208))+CHR$(213)
4970 FOR t=1 TO m
4980 READ ms(t):ms(t)=ms(t)+SPACE$(m1-LEN(ms(t)))
4990 LOCATE#2,i,t+j+1:PRINT#2,CHR$(211)+ms(t)+CHR$(209)+CHR$(207)
5000 NEXT
5010 LOCATE#2,i,t+j+1:PRINT#2,CHR$(215)+STRING$(m1,CHR$(210))+CHR$(214)+CHR$(207)
5020 LOCATE#2,i+1,t+j+2:PRINT#2,STRING$(m1+2,CHR$(207))
5030 j=j+1:t=1:done=0
5040 WHILE NOT done
5050 LOCATE#2,i,j+t:PRINT#2,CHR$(24)+" "+ms(t)+" "+CHR$(24)
5060 k$=""
5070 WHILE k$=""
5080 k$=INKEY$
5090 WEND
5100 k=ASC(k$)
5110 LOCATE#2,i,j+t:PRINT#2,CHR$(211)+ms(t)+CHR$(209)
5120 IF k=242 THEN t=t-1:IF t<1 THEN t=m
5130 IF k=243 THEN t=t+1:IF t>m THEN t=1
5140 IF k=13 OR k=224 THEN done=-1
5150 WEND
5160 :IMPORT,i,i+m1+2,j-1,j+m+2,&9400
5170 MOVE 0,400-((y+3)*16)
5180 DRAW# 639,0
5190 IF k=13 THEN t=0
5200 RETURN
5210
5220 'Pull down menus
5230
5240 LOCATE 1,j
5250 ON t GOSUB 5280,5960,6050,6130,6810
5260 RETURN
5270
5280 'Files
5290
5300 DATA Files,4,Model to disc,Save as ASCII,Merge to cursor,Kill worksheet
5310 RESTORE 5300
5320 GOSUB 4860
5330 IF t=0 THEN RETURN ELSE IF t=4 THEN RUN ELSE m=t
5340 CLS
5350 ts="*.OUT"
5360 :DIR,ts
5370 GOSUB 3730
5380 ON m GOSUB 5470,5470,5630
5390 GOSUB 3780
5400 PRINT", hit a key to continue: "+CHR$(143)
5410 WHILE INKEY$=""
5420 WEND
5430 CLS
5440 y=1
5450 GOSUB 2170
5460 RETURN
5470 'Model to disc
5480 GOSUB 5830
5490 IF r$="" THEN PRINT"Bad filename":RETURN
5500 IF m=1 THEN r$=r$+".OUT" ELSE r$=r$+".ABC"
5510 GOSUB 1140
5520 OPENOUT r$
5530 done=0
5540 WHILE NOT done
5550 IF m=1 THEN PRINT#9,MID$(hs(h),1,1)+MID$(hs(h),8)
5560 IF m=2 THEN PRINT#9,SPACE$(FNat(1)-1)+MID$(hs(h),8)
5570 IF FNson(h)=0 THEN done=-1 ELSE GOSUB 1450
5580 WEND
5590 CLOSEOUT
5600 GOSUB 3780
5610 PRINT"File successfully exported";
5620 RETURN
5630 'Model to memory
5640 GOSUB 5830
5650 IF r$="" THEN PRINT"Bad filename":RETURN

```

# MICROMART

## AEON COMPUTER HOUSE COMPUTER CONSULTANTS COMPUTER SYSTEMS

### UPPLIES & TRAINING BUSINESS MICRO SPECIALISTS

Try our professional and friendly service for all your computing requirements!

(Sample prices:)

Micros:	
PCW8256	285.00
PCW8512	379.00
PCW8512 cw "Locoscript II+" high quality, wide carriage	474.00
PC1640 HD/20 Mono	754.00
PC1512 SD/MD.cw "Migent Ability" 4 Agents	375.00
Printers: (Dot-Matrix)	
MP165(180cps) 3yr warranty	170.00
Epson LX800	195.00
Star NL10	189.00
(Daisy-wheel)	
Juki 6100 20cps	254.00
Software:	
Sagenet	289.00
Sage Accountant Plus	155.00
Top Copy Plus	80.00

★ Full range of software and peripherals for single and multiuser systems. ★ Networked Systems  
★ Installation service. ★ Repair service. ★ Maintenance contracts. ★ Training courses. ★ Supplies

All prices exclude VAT & delivery. Prices also subject to availability and subject to change without notice. Export educational & official purchase orders welcome. Open Monday-Saturday 9am-6pm.

Telephone Orders Welcome

46 Christchurch Rd, Oxtou, Wirral L43 5SF  
Tel: 051 652 9196/7 Telex: 265871 MONREF G  
(Quote Ref: 72 MAG50053)

## SCIENTIFIC SOFTWARE

**STATIS 2** — Scientific Statistics Package.

Parametric and nonparametric methods - ANOVA including repeated measures - Simple & Multiple linear regression - Nonlinear regression to user defined function (1)

Power analysis - Graphical output pie & bar charts, line plots & scatter diagrams (2)

and much more £250

**REF** — Reference database application

Allows references to be stored and retrieved according to AUTHOR, JOURNAL, KEYWORDS etc., ready for publication £50

**INTEG** — Hard disk utility

Define your own menu  
run your applications by a single keystroke. Similar menu for MSDOS commands £50

All applications run on IBM or compatible eg. AMSTRAD XEN under MSDOS.

Please send cheque or write for details to:

### ClydeSoft

78 Meadows Avenue, Larkhall,  
Lanarkshire ML9 2JG. Tel: 0698 885266  
(1) MSBASIC Compiler-Microsoft (2) GSX Graphics-Digital Research



French, First Aid, Football, Spelling, Science, Spanish, Sport, Scotland, England, English Words, German, General Knowledge, Geography, Italian, Arithmetic, and Natural History.

### Let your computer help you learn

Write or phone for a FREE 20 page illustrated catalogue of our Leisure and Educational Software.  
Available for IBM PC Compatibles and most home computers

## KOSMOS SOFTWARE LIMITED

FREEPOST (no stamp needed)

DUNSTABLE, Beds LU5 6BR

Tel: 05255 3942 or 5406

## BUSINESS COMPUTERS AND W/P?

We have the answers!  
All our key staff are university graduates.

**APPLICATIONS:** Accounts, W/P, Cad, DTP, Bespoke Systems

**HARDWARE:** Amstrad, AST, Compaq, Epson, Opus, Tandem, Toshiba, Zenith, 386 and Multiuser Systems.

**SOFTWARE:** Amstrad, Pegasus, dBase3, Sycero, Autocad, Ventura, Pagemaker.

Competitive pricing, Free delivery anywhere in UK, Rent or Buy, Maintenance and Training.

BUSINESS SYSTEMS CENTRE LTD  
(We are opposite R.C. Cathedral)  
10 Unthank Road  
NORWICH NR2 2RA.



TEL. (0603) 662176

Corona IBM - Compatible PC Twin drive 256Kb Ram, Hi-Res Graphics, 4 Full length expansion slots,

LOOK! No U.L.A.s,

and Maintenance Manual Available

Now at £399 including VAT

10Mb & 1 Floppy ..... add £125.00  
512Kb Ram ..... add £60.00  
Okimate 20. 4 colour printer parallel ..... £220.00  
Line Printer OKI star ..... £100.00  
Hard Disk (IBM 10 Mb) ..... £77.00  
10 MB Hard Drive (6 head) ..... £75.00  
Ram expansion card ..... £75.00  
Tape Streamer: Nestar ..... £55.00

## WYLAM LOGIC LTD

71 Ash Road, Tewkesbury,  
Glos. GL20 8QA.

0684 293097

## ★ PELLER DATABASES ★

The CHEAPEST for AMSTRAD products.

PPC512S	£369.00
PPC512D	£469.00
PPC640S	£469.00
PPC640D	£555.00

	PC1640		
	MD	CD	ECD
SD	£455	£579	£ 705
DD	£535	£659	£ 785
HD20	£795	£920	£1050

All prices exclude VAT. We stock a wide range of other business computers & peripherals. Why not give us a call for fast friendly advice and low prices.

To order please send cheque/POs made payable to Peller Databases, 20 Yew Lane, Sheffield, S5 9AN. Telephone (0742) 460141.

Allow 7 days for delivery.  
Postage & Carriage not inc.

```

5660 rs=f$+".OUT"
5670 CLS
5680 IDIR,gr$
5690 IF VPOS(#0)=7 THEN PRINT"File does not exist";:RETURN
5700 OPENIN r$
5710 done=0
5720 WHILE NOT done
5730 LINE INPUT#9,t$
5740 n=1;sy=1
5750 h$(h)=LEFT$(h$(h),7)+MID$(t$,2)
5760 f=INSTR(1$,MID$(t$,1,1))
5770 IF f=1 THEN n=n+1 ELSE n=n+2-f
5780 IF n=8 OR EOF THEN done=-1 ELSE GOSUB 770
5790 WEND
5800 CLOSEIN
5810 PRINT"File successfully imported";
5820 RETURN
5830 'Filename input
5840 WINDOW SWAP 0,2
5850 t$="Filename"
5860 m1=8
5870 GOSUB 2670
5880 WINDOW SWAP 0,2
5890 r$=UPPER$(r$)
5900 FOR t=1 TO LEN(r$)
5910 f=ASC(MID$(r$,t,1))
5920 IF f<48 OR f>90 OR INSTR(";<>?","CHR$(f)")<>0 THEN r$=""t=999
5930 NEXT
5940 RETURN
5950
5960 'Cursor
5970
5980 DATA Cursor,7,End of model,Start of model,Next header,Last header,Fail 10 1
ines,Up 10 lines,Hunt a string
5990 RESTORE 5980
6000 GOSUB 4860
6010 IF t=0 THEN RETURN
6020 ON t GOSUB 1050,1140,1330,1390,1190,1260,1580
6030 RETURN
6040
6050 'Goodies
6060
6070 DATA Goodies,6,Promote line,Demote line,Overlay grid,Cut text,Paste text,De
lete line
6080 RESTORE 6070
6090 GOSUB 4860
6100 ON t GOSUB 1880,2020,1740,2470,2520,2300
6110 RETURN
6120
6130 'Print
6140
6150 DATA Print,5,Entire model,Headers only,Cursor to end,Top to cursor,Cut text
6160 RESTORE 6150
6170 GOSUB 4860
6180 IF t=0 THEN RETURN
6190 GOSUB 3730
6200 IEXPORT,1,80,25,25,89400
6210 LOCATE#2,1,25:PRINT#2,"Insert paper and ready printer, hit any key to print
ENTER to abort: "+CHR$(143)+CHR$(20)+CHR$(8);
6220 k$=""
6230 WHILE k$=""
6240 k$=INKEY$
6250 WEND
6260 IF k$=CHR$(13) THEN t=0 ELSE PRINT#2,"Ok...":GOSUB 6760
6270 ON t GOSUB 6340,6420,6500,6570,6650
6280 LOCATE#2,1,25:PRINT#2,"Print run successfully completed, hit a key to conti
nu: "+CHR$(143)+CHR$(20)
6290 WHILE INKEY$=""
6300 WEND
6310 IIMPORT,1,80,25,25,89400
6320 GOSUB 3780
6330 RETURN
6340 'Entire model
6350 done=0:h=1:l=1
6360 WHILE NOT done
6370 IF FNson(h)=0 THEN done=-1
6380 GOSUB 6730
6390 GOSUB 1450
6400 WEND
6410 RETURN
6420 'Headers only
6430 done=0:h=1:l=1
6440 WHILE NOT done
6450 IF l=1 THEN GOSUB 6730
6460 IF FNson(h)=0 THEN done=-1
6470 GOSUB 1450
6480 WEND
6490 RETURN
6500 'Cursor to end
6510 done=0
6520 WHILE NOT done
6530 GOSUB 6730
6540 IF FNson(h)=0 THEN done=-1 ELSE GOSUB 1450
6550 WEND
6560 RETURN
6570 'Top to cursor
6580 done=0:h=1:l=1
6590 WHILE NOT done
6600 IF h=ch THEN done=-1
6610 GOSUB 6730
6620 GOSUB 1450
6630 WEND
6640 RETURN
6650 'Cut text
6660 IF ch=0 THEN RETURN
6670 done=0:h=ch:l=1
6680 WHILE NOT done
6690 GOSUB 6730
6700 IF FNson(h)=0 THEN done=-1 ELSE GOSUB 1450:IF l<=1 THEN done=-1
6710 WEND
6720 RETURN
6730 'Output a line to printer and screen, next line
6740 PRINT#8,SPACE$(FNat(1)-1)+MID$(h$(h),8)
6750 RETURN
6760 'Setup printer - see user handbook to adjust style
6770 'Double Strike - ESC G
6780 PRINT#8,CHR$(27)+"@"+CHR$(27)+"G"
6790 RETURN
6800
6810 'Templates
6820
6830 DATA Templates,5,Essay outline,Months of year,Weeks of month,Days of week,N
ine 'till five
6840 RESTORE 6830
6850 GOSUB 4860
6860 IF t=0 THEN RETURN

```



```

6870 ON t GOSUB 6970,7010,7050,7090,7130
6880 k$=CHR$(13)
6890 READ m
6900 FOR t=1 TO m
6910 READ t$
6920 h$(h)=LEFT$(h$(h),7)+t$
6930 LOCATE FNat(1),y1PRINT CHR$(17)+t$+CHR$(18)
6940 IF t<m THEN GOSUB 7030
6950 NEXT
6960 RETURN
6970 'Report outline
6980 DATA 7,Title -,Author -,Date -,Introduction,Main body,Conclusion,Notes
6990 RESTORE 6980
7000 RETURN
7010 'Months of year
7020 DATA 12,January,February,March,April,May,June,July,August,September,October
,November,December
7030 RESTORE 7020
7040 RETURN
7050 'Weeks of month
7060 DATA 4,Week 1,Week 2,Week 3,Week 4
7070 RESTORE 7060
7080 RETURN
7090 'Days of week
7100 DATA 7,Monday,Tuesday,Wednesday,Thursday,Friday,Saturday,Sunday
7110 RESTORE 7100
7120 RETURN
7130 'Nine 'till five
7140 DATA 9,09.00,10.00,11.00,12.00,13.00,14.00,15.00,16.00,17.00
7150 RESTORE 7140
7160 RETURN
    
```

## Amstrad CPC Sound & Light by CP Vickerstaff

This simple little program is probably better described as a diversion, and would be very useful for livening up one of those dull little parties. It will run on any of the CPC machines but does require a tape recorder to be attached to the tape port.

Type in the program, insert your

favourite tape and watch the effects. The screen effects can be modified to your own taste, so parties for special occasions can be celebrated in a slightly unusual manner. (For further ideas on how to liven up your party, see the Sainsbury's *Childrens' Party Guide*.)

```

100 REM SOUND TO LIGHT DEMO
110 REM BY PAUL VICKERSTAFF
120 REM
130 REM POKE MACHINE CODE
140 REM must be present for
150 REM any screen display
160 REM
170 addr=&9000:start=addr:ln=290
180 MEMORY addr-1
190 FOR i=0 TO 5
200 sum=0:READ a$,check
210 FOR j=1 TO LEN(a$) STEP 2
220 byte=VAL("&"+MID$(a$,j,2))
230 POKE addr,byte:sum=sum+byte
240 addr=addr+1
250 NEXT
260 IF sum<>check THEN PRINT"Error in line":ln
270 ln=ln+10
280 NEXT
290 DATA CD6EBC3E42CD1EBB20463EF5DB00CB7F,%7DB
300 DATA 2B1CCB472B0C3A56B0EE193256B00602,%4B1
310 DATA 18263A5780EE143257B00603181ACB47,%4A7
320 DATA 280C3A58B0EE0F3258B00604180A3A59,%40C
330 DATA B0EE0A3259B006054F7841CD32BC18B3,%61C
340 DATA CD71BCC302BC00000000,%37B
350 REM
360 REM SET UP INK VALUES
370 REM
380 a=12:INK 2,a:POKE start+&1A,a
390 a=18:INK 3,a:POKE start+&26,a
400 a=15:INK 4,a:POKE start+&36,a
410 a=10:INK 5,a:POKE start+&42,a
420 REM
430 REM DEMO SCREEN DISPLAY
440 REM you may write your
450 REM own display here
460 REM
470 DEG:DEFINT a-r,t-z:REM do not define s as used by start
480 MODE 0:ORIGIN 320,200
490 INK 0,0:BORDER 0
500 a=90:b=180
510 z=1:c=0:d=7
520 FOR i=360 TO 15 STEP -15
530 c=c+1:IF c=d THEN c=0:z=z+1:d=d-1
540 k=a:a=b:b=k
550 IF a>b THEN k=-z ELSE k=z
560 FOR j=a TO b STEP k
570 x=COS(j)*i:y=SIN(j)*i
580 MOVE x,y:DRAW -x,-y,i MOD 4+2
590 MOVE -x,y:DRAW x,-y
600 NEXT
610 NEXT
620 CALL start
    
```

### MAIL ORDER Price List Mar 88

Disk box for 10 3.5" Disks 1.50 inc VAT & Postage					
" " " 90 "	" " " 14.00 "	" " " "	" " " "	" " " "	(Lockable)
" " " 40 "	" " " 11.00 "	" " " "	" " " "	" " " "	(Lockable)
" " " 10 5.25" "	" " " 1.50 "	" " " "	" " " "	" " " "	
" " " 50 "	" " " 11.50 "	" " " "	" " " "	" " " "	(Lockable)
" " " 100 "	" " " 14.50 "	" " " "	" " " "	" " " "	(Lockable)

Express Same Day Despatch £1/10 Disks (by first class post)  
Next Day Delivery £10 (up to 25kg) 3 Day £7.50 (up to 25kg)  
Remember Prices include VAT & Postage

### 3.5" Disks

Quantity	Unbranded (Memorex/Wabast/Verbatim/Other)		Branded Wabash Datatech		Delivery 2nd Class Parcel
	DS/DD	SS/DD	DS/DD	SS/DD	
10	11.50	10.95	15.00	14.00	
25	26.60	26.10	34.00	32.50	
50	52.90	49.90	64.00	61.00	
100	100.05	94.30	119.00	114.00	
150	146.63	138.00	Call	Call	
200	189.18	177.68	Call	Call	
300	267.38	250.13	Call	Call	
400+			Please Call for Best Price		

**NEW LINE Branded SONY 3.5" MFD-2DD Pack of 10 only £19.95 inc. NEW LINE**

The Original and the best, SONY, when your data really matters.

—Now in Stock 3.5" HD—

Branded 3.5" MFD-2HD (2mb Unformatted) Box of 10 £39.95 inc

### 5.25" Disks

Unbranded Quantity	DS/DD48		HD AT	Branded HD AT	
	tpi	tpi		1.6Mb	1.6Mb
10	5.70	6.50	16.00	19.00	
25	11.50	13.50	35.00	38.50	
50	22.00	26.00	68.00	71.00	
100	40.00	46.50	125.00	135.00	
200	77.00	85.00	248.00	270.00	
300	Please Call				

Examples 10 Branded 3M 5.25" DS/DD/RH 48tpi only £11.00 inc  
10 Branded Athana 5.25" DS/DD 96tpi only £11.00 inc

BRANDED 5.25" (3M, DYSAN) please Call...  
Credit Cards Welcome  
All Disks supplied with labels  
All Disks are supplied with a lifetime guarantee plus a 14 day money back guarantee

Please Call us Last, we will try and better any current disk price  
IBM PC Database Application Design, low rates or fixed fee.

Intuitive Solution Dealer  
VAT Reg No: 459 6976 71 DP Reg No: B1015 08 1

### Athene Consultants

33 Holly Grove, Fareham, Hants  
PO16 7UP England  
Tel 0329 282083  
Int. Tel 44 329 282083  
TELEX: 934999 TXLINK G MBX 329282083



# MICROMART

## AMSTAT & STATMODE MODULAR STATISTICS AND MATHEMATICS PACKAGES

MARKETED BY

### S. C. COLEMAN LIMITED

AMSTAT for PCW & CPC STATMODE for PC Compatibles

AMSTAT (STATMODE 1) - means, st. dev., variance, skew, kurtosis, 1-sample, 2-sample and paired t-tests, 1-way ANOVA with error and multi-com. contrasts, 2-way ANOVA, correlation, regression, histograms, scattergrams, transformations, the chi and square, output to HP file, manual. Flexible variables and observations to a total of 500 (4 data points 10000 STATMODE).

AMSTAT (STATMODE 2) - 22 nonparametric tests providing a complete Sign, Binomial, Chebyshev, Kolmogorov-Smirnov, Rank-Sum, Sign, Median, Mann-Whitney, Rank-Sum, Friedman, Fisher, Median, Median-Sign, Kendall, Kendall partial Correlation.

AMSTAT (STATMODE 3) - FORECASTING: An array of business oriented mathematical and statistical software. Linear and Polynomial regression, Trend and Seasonal Variation, Multiple Regression Analysis, Transformations, Exponential Smoothing, Adaptive Filtering, Graphic display, full printed manual, series to simulate use and for teaching (4-coloured screen for PC).

AMSTAT (STATMODE 4) - RESOURCE MANAGEMENT - LINEAR PROGRAMMING MODULE: General Purpose Linear programming. Specialized Transportation and assignment variants. Capable of analyzing and solving problems of sequencing, scheduling, blending and allocation of scarce resources. 40 Page manual, 18 worked examples.

AMSTAT (STATMODE 5) - ANOVA: Up to 8-way analysis of variance for usual cell sizes. Unequal cell sizes up to 1000. ANOVA. Maximum of 2000 data points. 200 on one standard PC/M 2.2, 4000 on PC/L Inval from ASCII Files. Output to screen or file. Use full ASCII data - mean and interaction means and Newman-Kuls on main effects. Manual (100 only).

AMSTAT (STATMODE 7) - RESOURCE MANAGEMENT II - STOCK AND PRODUCTION ANALYSIS: Calculation of economic order quantities for both single and multiple items. Dynamic programming to calculate optimum production schedules for single items and consideration of inter-relationships into a multiple schedule. Also Pareto and Lorenz analyses. Manual (100 only) on printer, includes operational manual with work on examples.

The program have applications in research of all kinds, education, sales, production planning work and method study, financial planning, personnel, social work etc.

"I will certainly be using them myself in the future and no reviewer can offer a warmer recommendation than that." Dr. Peter Morris, *Amstrad Professional Computing*, May 1987.

Program	PCW	PC	STATMODE 1	STATMODE 2
AMSTAT 1	£75.95	£72.95	£79.95	£79.95
AMSTAT 2	£79.95	£79.95	£79.95	£79.95
AMSTAT 3	£79.95	£79.95	£79.95	£79.95
AMSTAT 4	£79.95	£79.95	£79.95	£79.95
AMSTAT 5	£79.95	£79.95	£79.95	£79.95
AMSTAT 7	£79.95	£79.95	£79.95	£79.95

ANY 2 - 15% DISCOUNT ANY 4 - 20% DISCOUNT

Please enquire for educational quantity discounts

ALL PRICES INCLUDE POST AND PACKAGING IN THE U.K. BUT EXCLUDE VAT.

24 Hour Answerphone. Technical enquiries after 6.00pm.

CHEQUES AND P.O. TO  
**S. C. COLEMAN LTD.**

33 CECILIA ROAD, SEELY DE LA BEOUCH  
LEICESTERSHIRE LE16 5DA

TELE 0530 415678

# PROGRAM FILE

## Amstrad PCW Basic File Manager

by MJ Field



When the Amstrad PCW was launched, it was aimed solely at the word-processing end of the market as a typewriter replacement. It was the user interface of the word processor that was designed for ease of use, and many people were put off using the machine's other facilities because of its unfriendliness.

This is a simple Basic file manager that seeks to make using the Basic interpreter easier. It allows the files to be listed, renamed, run or erased. To run the program, simply type 'BASIC FILEMAN' at the 'A>' prompt after you've entered and saved the

program in a file called FILEMAN.BAS. This process can be automated by creating a file called PROFILE.SUB on the CP/M boot-up disk. At the end of this file include the lines:

```
COPY A:*.BAS M:
BASIC FILEMAN
```

This will automatically load the file manager and transfer all the Basic files to drive M: for faster operation. If you do use this method, don't forget to transfer the files from M: before the machine is switched off, or you will lose them.

## CALLING ALL GARDENERS!

Plan your garden more effectively by selecting the right plants for every location and purpose.

Only **£29.95** (+ £1.60 P&P)

- ★ Select the type of plant you want and the conditions where it is to grow from over 40 different categories including foliage colour, height, flower arranging, cottage garden, easy to grow and scented.
- ★ Suitable plants are automatically selected from an extensive database of 2,000 named plants including many choice and unusual specimens.
- ★ Plant descriptions, including growing requirements, can be displayed for the list of selected plants or for named plants on demand.
- ★ PLANT SELECTOR is informative, useful and fun to use.
- ★ If you have a garden, PLANT SELECTOR is a *must*.

Please make cheques payable to

### ALDEX SOFTWARE

Portland House, 6 High Street, Sutton,  
Ely, Cambs CB6 2RB Tel: 0353 778012

Runs on all IBM compatible MSDOS computers (inc Amstrad) with 512k RAM.

# WRENCOM

01-698 3576/5975  
BY MAIL ORDER

AMSTRAD HARDWARE	SOFTWARE
PCW 8256 ..... £327.75	Payroll 2 (PC) ..... £149.00
PCW 8512 ..... PLEASE	Accountant (PC) ... £129.00
PHONE	Pop payroll (PC) ... £82.95
PCW 9512 ..... PLEASE	Retrieve (PC) ..... £63.50
PHONE	Pop Accounts (PCW) £75.95
PC 1512 from .... £431.25	Pop payroll (PCW) .. £53.95
PC 1640 from .... £539.35	
PPC 512 from .... £431.25	<b>HIGH QUALITY COVERS</b>
PPC 640 from .... £539.35	PC 1512/1640 ..... £9.95
DMP 3160 ..... £217.35	PRINTERS from ..... £5.50
DMP 4000 ..... £327.75	PCW 8256/8512 ..... £8.95
LQ 3500 ..... £327.75	PCW 9512 ..... £19.50
LQ 5000 DI ..... T.B.A.	
	<b>ACOUSTIC COVER (9512)</b>
DMP 3160 ribbon 2's ..... £11.50	..... £34.45
PCW 9512 ribbon 2's ..... £7.70	<b>MANY OTHER PRODUCTS</b>
Address labels (1000) ..... £9.50	<b>AVAILABLE</b>
Listing paper ..... £23.00	<b>ALL PRICES INCLUDE VAT</b>
	<b>AND DELIVERY</b>

356 VERDANT LANE, CATFORD, LONDON SE6 1TP

```

10 CLEAR: OPTION FILES "A"
20 DIM ds(132): DIM stack(12,2): in$=CHR$(255)
30 DEF FNat0(x,y,a0)=e0**Y+CHR$(31+y)+CHR$(31+x)+a0
40 DEF FNcs0(w,x,y,z)=e0**X+CHR$(32+w)+CHR$(32+x)+CHR$(32+y-1)+CHR$(32+z-1)
50 e0=CHR$(27): on$ = e0**0 : off$ = e0**1 : PRINT e0**0
60 bell$ = CHR$(7): cls$ = e0**E+e0**M: vers$ = e0**D: rev$ = e0**Q
70 PRINT cls$, " Please wait while reading directory "
80 GOSUB 790: z=0: GOSUB 130
90 ll=66: OPTION FILES "M"
100 GOSUB 790 : ll=ll-66: z=66: GOSUB 130: GOTO 330
110 REM ** sort data **
120 :
130 s=1: stack(1,1)=1 : stack(1,2)= ll-1
140 l=stack(s,1) : r=stack(s,2) : s=s-1
150 i=1 : j=r: x0=d0(INT((l+r)/2)+z)
160 IF d0(i+z)<x0 THEN i=i+1 : GOTO 160
170 IF d0(i+z)>x0 THEN j=j-1 : GOTO 170
180 IF i>j THEN GOTO 230
190 w=d0(i+z) : d0(i+z)=d0(j+z) : d0(j+z)=w
200 i=i+1 : j=j-1
210 IF i>j THEN GOTO 230
220 GOTO 160
230 IF j-l<r-i AND i<r THEN s=s+1 : stack(s,1)=i : stack(s,2)=r
240 IF j-l>r-i AND l<j THEN s=s+1 : stack(s,1)=l : stack(s,2)=j
250 IF j-l<r-i THEN r=j ELSE l=i
260 IF l>r THEN GOTO 280
270 GOTO 150
280 IF s=0 THEN GOTO 300
290 GOTO 140
300 RETURN
310 :
320 REM *** Draw Menu ***
330 PRINT FNat0(1,1, " BASIC FILE MANAGER use arrow keys to move about the screen (c) Michael J. Field 1987 ")
340 PRINT FNat0(1,2, rev$+STRING$(90, CHR$(32))+vers$)
350 GOSUB 1310
360 PRINT FNat0(1,4, vers$+STRING$(90, CHR$(32))+rev$)
370 PRINT FNat0(1,5, STRING$(14, CHR$(32))+vers$+( " DRIVE IS 'A'" )+rev$+STRING$(14, CHR$(32))+CHR$(133)+STRING$(14, CHR$(32))+vers$+( " DRIVE IS 'M'" )+rev$+STRING$(15, CHR$(32)))
380 ln=14: op = 22: xl = 2 : yl = 5: sl=6
390 FOR w = 1 TO sl
400 PRINT FNat0(xl-1,yl+1, rev$+STRING$(ln, CHR$(138))+CHR$(142))
410 FOR y=yl+2 TO yl+op+1
420 PRINT FNat0(xl-1,y, rev$+STRING$(ln, CHR$(32))+CHR$(133)+vers$)
430 NEXT y
440 xl=xl+15: NEXT w
450 PRINT FNat0(45,6, rev$+CHR$(143)+vers$)
460 PRINT off$: xl=1: FOR w = 1 TO sl
470 v=1: FOR n=op+2w-(op-1) TO w*op : v=v+1: PRINT FNat0(xl,yl+v, rev$+ds(n)+vers$): NEXT n
480 xl = xl+15: NEXT w
490 :
500 REM *** move to get file ***
510 PRINT off$
520 ch=1: dr=1: gk=1
530 IF d0(ch)= " " THEN d0(ch)= "A"
540 IF ch > op*3 THEN OPTION FILES "M" ELSE OPTION FILES "A"
550 PRINT FNat0(gk,yl+1+dr, d0(ch))
560 in$ = INKEY$: IF in$="" THEN GOTO 560
570 ON ERROR GOTO 1340
580 IF in$=CHR$(17) THEN GOTO 1420
590 IF in$=CHR$(13) THEN GOTO 750
600 IF in$=CHR$(26) THEN GOTO 1560
610 IF in$=CHR$(21) THEN GOTO 870
620 IF in$=CHR$(16) THEN GOTO 940
630 IF in$=CHR$(27) THEN GOTO 1400
640 IF ASC(in$)<31 AND ASC(in$)>30 AND ASC(in$)<>30 AND ASC(in$)<>1 THEN GOTO 560
650 IF ASC(in$)=6 AND ch < op*5+1 THEN GOSUB 720 : gk=gk+15: ch=ch+op: GOTO 530
660 IF ASC(in$)=1 AND ch > op+1 THEN GOSUB 720 : gk=gk-15: ch=ch-op: GOTO 530
670 IF ASC(in$)=31 AND dr=1 THEN GOSUB 720: dr=dr-1: ch=ch-1: GOTO 530
680 IF ASC(in$)=30 AND dr < op THEN GOSUB 720: dr=dr+1: ch=ch+1: GOTO 530
690 IF ASC(in$)=30 AND dr = op AND ch < op*5+1 THEN GOSUB 720 : gk=gk+15: ch=ch+1: dr=1: GOTO 530
700 IF ASC(in$)=31 AND dr = 1 AND ch > op+1 THEN GOSUB 720 : gk=gk-15: ch=ch-1: dr=op: GOTO 530
    
```



```

710 GOTO 560
720 IF d$(ch)= "" THEN d$(ch)="
730 IF ch >= 3 THEN OPTION FILES "M" ELSE OPTION FILES "A"
740 PRINT FNats(1,3,revs+d$(ch)+vers);RETURN
750 IF RIGHT$(d$(ch),4)= "BAS " THEN 760 ELSE 1390
760 PRINT revs+ons+es+1";RUN d$(ch)
770 END
780 ' ** input files **
790 FOR c = 1 TO 64
800 fs = FIND$( "x,x",c) : IF fs <= "" THEN c = 65 ELSE 810
810 ds = "
820 rs = "
830 RSET ds = fs : LSET rs = ds : ll = ll + 1 : d$(ll) = rs
840 NEXT
850 RETURN
860 ' * erase file *
870 PRINT FNats(1,3,vers+ " File to erase is "+revs+d$(ch)+vers+" Type (Y) to continue (CANCEL)
will abandon "+STRING$(6,CHR$(32))+revs)
880 GOSUB 1030
890 IF os = "y" THEN KILL d$(ch)
900 IF ch>66 THEN mn = 130 ELSE mn = 65
910 FOR n = ch TO mn : ds(n)=d$(n+1) : NEXT
920 GOSUB 1310 : GOTO 460
930 '
940 ' * rename file *
950 PRINT FNats(1,3,vers+ " File to rename is "+revs+d$(ch)+vers+" Type (Y) to continue (CANCEL)
will abandon "+STRING$(6,CHR$(32))+revs)
960 GOSUB 1030
970 PRINT FNats(1,3,vers+ " Type name of file "+revs)
980 fs=d$(ch);x=1;GOSUB 1100
990 NAME fs AS d$(ch)
1000 GOSUB 1310 : GOTO 460
1010 '
1020 ' * subroutines *
1030 os = INKEY$ : IF os = "" THEN GOTO 1030
1040 IF os = CHR$(8) THEN GOTO 1050 ELSE RETURN
1050 GOSUB 1310 : GOTO 560
1060 os = INKEY$ : IF os = "" THEN GOTO 1060
1070 IF os = CHR$(8) THEN RESUME 1050 ELSE RETURN
1080 '
1090 ' * INPUT from keyboard *
1100 ins=INKEY$
1110 WHILE ins=""
1120 ins=INKEY$
1130 WEND
1140 xs=CHR$(7)+CHR$(127)+CHR$(13)+CHR$(1)+CHR$(6)+ins
1150 key=INSTR(xs,ins)
1160 ON key GOTO 1170,1180,1190,1200,1210,1220
1170 ins=" " : x=x+1 : GOTO 1230
1180 ins=" " : GOSUB 1270 : GOSUB 1240 : x=x-1 : GOTO 1250
1190 PRINT on$ : RETURN
1200 x=x-1 : GOSUB 1270 : PRINT vers+CHR$(8)+revs : GOTO 1250
1210 x=x+1 : GOSUB 1270 : PRINT vers+CHR$(8)+revs : GOTO 1250
1220 x=x+1
1230 GOSUB 1270 : GOSUB 1240 : GOTO 1250
1240 MID$(d$(ch),1,14)=MID$(d$(ch),1,x-1)+UPPER$(ins)+MID$(d$(ch),x+1,14):RETURN
1250 ks = MID$(d$(ch),x+1,1)
1260 PRINT FNats(21,3,d$(ch)+vers+FNats(21+x,3,ks)+revs) : GOTO 1100
1270 IF x >= 14 THEN x=13 : PRINT bell$
1280 IF x <= 1 THEN x=1 : PRINT bell$
1290 IF x = 10 THEN ins=""
1300 RETURN
1310 PRINT FNats(1,3,vers+ " f1 change disc f3 display file (CVT) erase f7 rename (EXIT) system
(RETURN) to run "+revs) : RETURN
1320 '
1330 ' * ERROR trapping *
1340 IF ERR = 58 THEN PRINT off$ FNats(1,3,revs+ " ERROR FILE ALREADY EXISTS CANCEL
OPERATION "+STRING$(35,CHR$(32))+vers);GOSUB 1060 :1400
1350 IF ERR = 53 THEN PRINT off$ FNats(1,3,revs+ " ERROR FILE NOT FOUND CANCEL
OPERATION "+STRING$(35,CHR$(32))+vers);GOSUB 1060 :GOTO 1350
1360 IF ERR = 61 THEN PRINT off$ FNats(1,3,revs+ " ERROR DISC FULL CANCEL
OPERATION "+STRING$(35,CHR$(32))+vers);GOSUB 1060 :GOTO 1360
1370 IF ERR = 64 THEN PRINT off$ FNats(1,3,revs+ " ERROR FILE NAME INVALID CANCEL
OPERATION "+STRING$(35,CHR$(32))+vers);GOSUB 1060 :GOTO 1370
1380 IF ERR = 70 THEN PRINT off$ FNats(1,3,revs+ " ERROR READ ONLY DISC CANCEL
OPERATION "+STRING$(35,CHR$(32))+vers);GOSUB 1060 :GOTO 1380
1390 PRINT off$ FNats(1,3,revs+ " ERROR NOT A BASIC FILE CANCEL OPERATION "+
STRING$(35,CHR$(32))+ vers);GOSUB 1030 :GOTO 1390
1400 PRINT cls+revs+ons : SYSTEM
1410 '
1420 ' ** display file **
1430 IF d$(ch)= "" THEN RUN d$(ch)
1440 PRINT FNats(6,0,25,91)+revs+es+1"+off$
1450 PRINT " Press "+revs+15"+revs+ " or "+revs+[ALT]+S"+revs+ " to suspend output a second
time to continue output "
1460 PRINT:PRINT " PRESS SPACE BAR TO CONTINUE "
1470 ins=INKEY$:IF ins="" THEN 1470
1480 PRINT cls$
1490 DISPLAY d$(ch)
1500 PRINT:PRINT " PRESS SPACE BAR TO CONTINUE "
1510 ins=INKEY$:IF ins="" THEN 1510
1520 PRINT cls$
1530 PRINT FNats(10,0,33,91)
1540 GOTO 380
1550 '
1560 ' *** change disc ***
1570 GOSUB 740:OPTION FILES "A"
1580 In=14: op = 22: xl = 2 : xl = 5 : st=3
1590 FOR n = 1 TO 64 : ds(n)="" : NEXT n
1600 ll=0 : GOSUB 790 : z=0 : GOSUB 130 : GOTO 390

```

Variations on an

## OPUS

The Incomparable Compatible

£ 599	Opus PCIII Turbo 10MHz 512k Twin Floppy
£ 599	512k 1.2Mb Floppy
£ 725	512k 10Mb Hard Disk
£ 820	640k 20Mb Hard Disk
£ 880	640k 30Mb Hard Disk
£ 940	640k 40Mb Hard Disk

Add for colour upgrades

£ 199	CGA Card and Med. Res. VDU
£ 365	EGA Card and EGA VDU
£ 560	VGA Card and NEC Multisync All Standards VDU

### THE OPUS PC5

80286 CPU, 640k RAM, 1.2Mb FDD, Parallel/Serial Ports, Keyboard and hi-res monitor	
30Mb hard disk	£1275
40Mb hard disk	£1395
2Mb Ram Card fully populated	£315

### 80286 Based Network

3 User £2950

4 User £3499

Inclusive of 12 months on site maintenance  
 XT Upgrading to AT. Call for quote.  
 Maintenance Contracts on all systems.

## THE PACIFIC TRIO

PACIFIC 88 with INTEL 8088-2 CPU, 640k RAM, 360k or 720k FDD, Parallel/Serial/Games Ports, Battery backed Clock/Calendar, 84 key AT Style keyboard, Hi-res mono monitor  
 £449..... with IFDD  
 £525..... with twin FDD  
 £735..... 20Mb hard disk version  
 £880..... with 40Mb 33 m/s hard disk

PACIFIC 286 with INTEL 80286 CPU, 640k RAM, 1.2Mb FDD, Parallel/Serial Ports, Battery backed Clock/Calendar, 101 key AT Style keyboard, Hi-res mono monitor  
 £849..... with no hard disk  
 £1095..... with 20Mb HD  
 £1295..... with 40Mb 33 m/s HD  
 £1395..... with 40Mb 28 m/s HD  
 £1895..... with 71Mb 28 ms HD

PACIFIC 386 with INTEL 80386 CPU, 1024K RAM, 1.2Mb FDD, Parallel/Serial Ports, Battery backed Clock/Calendar, 101 key AT Style keyboard, Hi-res mono monitor  
 £1987..... with 40Mb 33 m/s HD  
 £2695..... with 71Mb 28 m/s HD

### PACIFIC COMPUTERS (UK) LTD

565-569 Chiswick High Road,  
 London W4 3AY  
 Call 01-994 1054  
 Telex: 291432 Bellil G  
 Fax: 01-994 5578

## SUPER USER BUREAU PROFESSIONAL USER CLUB

DO YOU USE AN  
**OPD, TONTO, or QL**

DO YOU NEED ADVICE AND SUPPORT?  
DO YOU NEED INFORMATION ON SOFTWARE?  
DO YOU NEED INFORMATION ON HARDWARE?  
WOULD YOU LIKE CONTACT WITH OTHER USERS?

If the answer to any of the above is YES, then contact us for details of our NEW support service!

We offer the following services —  
Friendly informed telephone support  
Discounts on hardware and software  
Club Magazine, and much more . . .

We are now affiliated to the British Association of  
Computer Clubs.

Phone Richard or Julie on 0388-773 737  
Fax 0325-467164. Prestel MBX 21999 8590  
Telex 934999 TX LINK G. Ref 21999 8590  
PO Box 3, Shildon DL4 2LW

# WATTS COMPUTING LIMITED

Thinking of buying or  
selling a computer?

WE ARE A USED  
COMPUTER AGENCY

We specialise in  
Microcomputers,  
Minicomputers and all  
peripherals

RING NOW  
FOR DETAILS

(0270)  
764315

OPEN 7 DAYS A WEEK

```

BASIC FILE MANAGER use arrow keys to move about the screen (c) Michael J. Field 1987
-----
DRIVE IS 'A'
DRIVE IS 'M'
BASIC.COM
COMPILER.BAS
FILEMAN.BAS
HOLDALL.BAS
J14CPM3.BAS
KING.BAS
NSHEEP.COM
PHONE.DTA
PIP.COM
PROFILE.SUB
STD.DAT
STD.DEX
SUBMIT.COM
SYSIN59.###
TELECOM.BAS
WORK.BAS
COMPILER.BAS
FILEMAN.BAS
HOLDALL.BAS
KING.BAS
TELECOM.BAS
WORK.BAS
    
```

```

BASIC FILE MANAGER use arrow keys to move about the screen (c) Michael J. Field 1987
-----
RUN NOT A BASIC FILE CANCEL OPERATION
-----
DRIVE IS 'A'
DRIVE IS 'M'
BASIC.COM
COMPILER.BAS
FILEMAN.BAS
HOLDALL.BAS
J14CPM3.BAS
KING.BAS
NSHEEP.COM
PHONE.DTA
PIP.COM
PROFILE.SUB
STD.DAT
STD.DEX
SUBMIT.COM
SYSIN59.###
TELECOM.BAS
WORK.BAS
COMPILER.BAS
FILEMAN.BAS
HOLDALL.BAS
KING.BAS
TELECOM.BAS
WORK.BAS
    
```

```

BASIC FILE MANAGER use arrow keys to move about the screen (c) Michael J. Field 1987
-----
File to rename is 'WORK' .BAS Type (Y) to continue (CANCEL) with abandon run
-----
DRIVE IS 'A'
DRIVE IS 'M'
BASIC.COM
COMPILER.BAS
FILEMAN.BAS
HOLDALL.BAS
J14CPM3.BAS
KING.BAS
NSHEEP.COM
PHONE.DTA
PIP.COM
PROFILE.SUB
STD.DAT
STD.DEX
SUBMIT.COM
SYSIN59.###
TELECOM.BAS
WORK.BAS
COMPILER.BAS
FILEMAN.BAS
HOLDALL.BAS
KING.BAS
TELECOM.BAS
WORK.BAS
    
```

## Atari ST/Yamaha TX81Z Editor by Robin Kanagasabay



This program allows Atari ST users to edit voices on the Yamaha TX81Z and, with a few modifications, FB-01 synthesisers. It displays all the voice parameters onscreen and speeds up the creation of new voices, especially when compared with the synthesiser's own buttons and two-line display.

The program requires that the TX is set to MIDI channel 1 and PLAY SINGLE mode. MIDI OUT should be connected to MIDI IN of the ST, and vice versa. When the program begins it will alert you if the TX is not connected; but if it is connected, the program will load the currently-selected voice in the TX and display as shown in the sample screendump.

To alter any of the voice parameters, point the mouse at the number you wish to edit and press the

LEFT button to decrement and the RIGHT button to increment. The speed of increment or decrement can be modified by holding down the LEFT SHIFT key or the CONTROL key respectively. When the voice is displayed onscreen, you can connect a MIDI keyboard to the ST's MIDI IN port and play the sounds you are editing.

The three buttons on the right of the screen are All Notes Off, Quit and New Voice. A parameter change and a key release can occur at the same time. This results in a droning, continuous note which can be switched off with the All Notes Off button. Quit is self-explanatory, but make sure the voice is stored in the TX before you do. New Voice allows you to select a new voice to edit, and after selecting it you must reconnect



the TX's MIDI OUT to the ST if it was previously disconnected. If you don't want to lose the current TX voice, you must store it using the TX buttons. Having done all this, select the New Voice button.

It is important not to move the mouse while the TX is transmitting, as this will interfere with the program timing and will cause some of the MIDI voice data to be lost.

The frequency display is somewhat different from that of the TX, as displaying the actual frequency would have taken up a considerable amount of room. This program uses boxes that display the relative ranges, with coarse and fine controls to represent the TX's actual frequency. If you want to see this frequency, click on the relevant frequency box and the

TX will display the frequency on its LCD screen.

The program has been written for use with Fast Basic, but should work with other ST Basics. Users of Fast Basic will be able to incorporate the program as a pull-down desk accessory to allow the editor to be co-resident within other programs. Whether it will work, however, does depend on the programs you run from within it, as some programs may interfere with the timing or the MIDI interface.

Although the program is for a TX81Z, I have it on good authority that it is easily adaptable for the FB-01 synthesiser. Check the MIDI manuals provided with the FB-01 to highlight the differences between the two machines.

## Desk File View Options

TX Editor (c) 1987 Robin Kanagasabay

op status	on	on	on	on	bend range	2	poly mode	Poly
ratio/fixed	rat	rat	rat	fix	porta time	0	name	RubberBass
range				3	porta mode	0	middle C	12
coarse	4	0	0	0	FC vol	99	reverb	off
fine	0	0	0	0	FC pitch	0		
waveform	0	0	5	0	FC amp	0	algorithm	
detune	+3	+0	-3	+3	HW pitch	50	[3]	3-->2-->1-->
output level	99	80	96	99	HW amp	0		
rate scaling	1	1	2	3	amod sens	3		
level scale	0	35	28	35	pmod sens	5		
A1R	23	31	31	31	LFO wave	2		
D1R	15	15	19	18	LFO speed	31		
D2R	12	5	6	15	LFO delay	0		
RR	8	5	8	15	Pmod depth	0		
D1L	15	14	11	4	Amod depth	0		
EG shift (dB)		24	off	off	sync	off		
feedback	7				BC pitch	50		
amod enable	off	on	off	off	BC amp	0		
EG bias sens	7	1	7	7	BC Pbias	+0		
key velocity	4	7	3	7	BC Egbias	0		

New Voice  
Quit  
All notes off

A sample screen showing the position of the variables and the necessary control buttons

```

TAMMM TABL EDITOR BY ROBIN KANAGASABAY
1987

IF OUTHANDLE<-1 THEN
  ULOSEWIND OUTHANDLE      :\Close Fast Basic window if already open
  DELEWIND OUTHANDLE
ENDIF
TXHANDLE=CREATEWIND(+1,0,19,640,381) :\Prepare a window to output into
RESENE mytitle%,80
(mytitle%)%=" TX Editor (c) 1987 Robin Kanagasabay "
SEIWINDITILE TXHANDLE,mytitle% :\Set the title that will be displayed
OPENWIND TXHANDLE,0,19,640,361 :\at the top and then open the window
MKUC_setup :sets up lookup tables to enable the program to
PROC_alg_setup :\decode the information sent by the TX81Z
MKUC_fullout :\make the window fill the screen
CLS 0 :\and then clear it
PROC_announcements :\display some messages in alert boxes
REPEAT :\This part is the main loop within the program
  PROC_fullout :\and calls all the other procedures
  PROC_drawlabels :\draw the basic output screen
  FILLSTYLE 2,7
  restart=FALSE
  PROC_clear_buffer :\clear the ST's MIDI buffer of any residual data
  PROC_read_a_voice :\read the current TX voice over MIDI
  PROC_print_a_voice :\and print it on the screen
  quit=FALSE
  FILLSTYLE 1,1
  FILLCOL 0
  REPEAT
    mid)=0
    MUUSE X%,Y%,K%,K% :\read the mouse
    TIME=0
    timestep=6
    IF K% AND %0010 THEN timestep=12 :\set the repeat speed according
    IF K% AND %0100 THEN timestep=1 :\to what keys are being pressed
  REPEAT
  UNTIL INPSTAT(3) OR TIME>=timestep :\wait to see if there is MIDI
  IF INPSTAT(3) THEN

```

## PC PEANUTS

£ 2.99/Disc (5.25") !!! £ 3.99/Disc (3.5") !!!

No Minimum !! Free Membership !!

More than 7500 Programs on 1250 discs  
for I.B.M. or Compatibles

Mark your choice with X

- A001 File Express (Super Data Base) (2 disks)
- A002 Deskmate-bloc note (Calculator, Typewriter, Notepad, Telephone, etc)
- A003 FANSI Console : The world beater (2 disks)
- A004 HOME Base : A bit more than S\*dek\*ck (2 disks)
- P001 PC Write (The Word Processor !)
- P002 PC File (Database)
- P003 PC File (Toolbox) (3 disks)
- P004 PC Calc (Spreadsheet)
- P005 PC Talk 2.0 : Communications (2 disks)
- P006 PC Draw (P. DRAW)
- P007 PC Musician
- P008 PC Input : (Basic Screen Generator)
- P009 PC Key Draw : Graphics (2 disks)
- P010 PC Pad (Spreadsheet)
- P011 PC Talk 3.0 : Communications (4 disks)
- P012 PC Professor (Basic Tutorial)
- P013 PC Dbms (spreadsheet)
- P014 PC Graph
- P015 PC Print
- P016 PC Picture
- P017 PC Zap : Utility
- P018 PC DOS (\*TM) Dos Help Aides
- L001 Chasm (assembler, disassembler and tutorial) (3 disks)
- L002 Turbo Pascal : Utilities 1 (6 disks)
- L003 Pascal : Compiler
- L004 Pascal : Utilities 1 (6 disks)
- L005 Forth (3 disks)
- L006 Forth (Laxen and Perry) (3 disks)
- L007 Forth : Utilities
- L008 Basic Routines 1 (2 disks)
- L009 Basic Routines 2 : Aides + Tutorial (4 disks)
- L010 Basic Routines 3 : language + tools (6 disks)
- L011 Basic Routines 4 (6 disks)
- L012 Basic Cross Reference (3 disks)
- L013 Prolog
- L014 Lisp (2 disks)
- L015 C Routines 1/0
- T001 Printer Utilities (3 disks)
- T002 Recover Lost Files (2 disks)
- T003 Unprotect (3 disks)
- T004 Kermit (2 disks)
- T005 Menu System : File Transfer Utility
- T006 E-Z Menu
- T007 Sysmenu : Creation
- T008 Menus - Creation
- T009 Maths Functions (4 disks)
- T010 Maths Routines (3 disks)
- T011 Best Tools
- T012 Disk Tools
- G001 Games - Chess, etc (2 disks)
- G002 Games - Space war/startrek, etc (2 disks)
- G003 Games - Flight/Football (U.S.)etc
- G004 Games - Top Games
- G005 Games - Pascal Games

Write Now !!

Name \_\_\_\_\_  
 Address \_\_\_\_\_  
 City \_\_\_\_\_  
 Post code \_\_\_\_\_ Telephone \_\_\_\_\_  
 Company \_\_\_\_\_  
 Membership n° \_\_\_\_\_  
 Total no discs \_\_\_\_\_  
 Format 5.25" Total cost \_\_\_\_\_  
 Price £ 2.99  
 Format 3.5" Shipping - handling \_\_\_\_\_ 2.20  
 Price £ 3.99  
 Total enclosed £ \_\_\_\_\_  
 Visa - Access - Diners Club - American Express Welcome  
 Réf. \_\_\_\_\_ Exp. Date \_\_\_\_\_  
 Signature \_\_\_\_\_

Catalogue on Disk - Free with first order !

Send your order to : PCUG PO Box N° 258,  
Kingston upon Thames, Surrey KT1 3EF

# MICROMART

## IBM-PC DIGITAL I/O CARD WITH BBC PORT SIMULATION

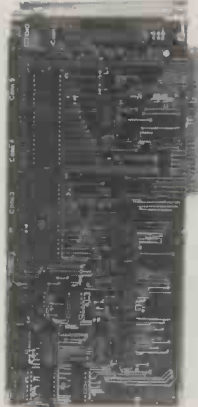

Provides 32 I/O lines for the IBM-PC and compatibles connected via four 20W connectors to emulate BBC user ports together with a buffered bus port on a 34W connector. Utilises familiar 6522 VIA's and is supplied with software and manual.

**£95.00**  
Plus £2 delivery plus VAT.

**BBC BASIC 86**  
For the IBM-PC/AT

**£95.00**  
Plus £2 delivery plus VAT.

## GRAFITEK ELECTRONICS LTD

REED HOUSE, 45 ST. LUKES ROAD,  
BRISTOL BS3 4RX, ENGLAND. TEL: 0272  
719173 TELEX: 8951580

## GOLDFINCH COMPUTERS

PO Box 397, London SE15 1DW

Suppliers & Consultants

Telephone: 639 3775 (24 hours)

Opus PC IV Turbo, XT, 768kb ram, 1 X360kb floppy 20Mb hard disk, 4.77/10MHz, clock speeds, mouse port, 14" High Res EGA cikay monitor. £895.00

**PRINTERS Dot Matrix**  
Brother M1209 140cps draft/35 cps NLQ £209.00  
SF20 Cut Sheet Feeder for M1209 £110.00

### SAGE ACCOUNTING SOFTWARE

Payroll £149.00 Accountant £129.00  
Accountant Plus £179.00 Financial Controller £255.00  
Stage Training Disks £26.00 1 Day Training Course £149.00  
(please ask for details)

### WORK PROCESSORS

Wordstar 2000 + rel 3 £365.00  
Wordstar Prof. Pagset £410.00  
Ed £350.00  
Word 4 £350.00  
Wordstar Prof. rel 4 £299.00

### DATABASE MANAGEMENT

Paradox 2 £475  
dBase III + (UK vers) £480.00  
PFS Professional Filer £229.00

### PROFESSIONAL DISKETTES

	1+	2+	5+	10+
5 1/4" D2D 48 tpi	£12.95	£11.95	£10.95	£9.95
5 1/4" D2Q 96 tpi	£13.95	£12.95	£11.95	£10.95
5 1/4" D2HD 1.6Mb	£25.00	£24.00	£23.00	£21.00
3 1/2" D2HD 720Mb	£24.95	£22.95	£20.95	£19.95

We are Opus and Brother dealers. All models supplied please enquire.

Please add 15% VAT  
Delivery: Hardware £10, Software £3  
FREE INSTALLATION WITHIN HOME COUNTIES



**FAIRLINE**  
DISTRIBUTION LTD.

## CO-PROCESSORS

8087 8MHz .....£130    8087 10MHz ....£150  
80287 6MHz .....£125    80287 8MHz ....£175  
80287 10MHz    £210

## AUTOSWITCHES

MP401 4 into 1 Printer Parallel .....£89  
MS401 4 into 1 Printer Serial .....£99  
MP801 8 into 1 Printer Parallel .....£132  
MS801 8 into 1 Printer Serial .....£149

All cables and accessories stocked.  
NEW range of Buffers and Switches  
coming soon! Phone for details

## Acorn Business Centre

Invicta Works, Milton Street  
Maidstone, Kent ME16 8LL  
Tel: (0622) 26633

# PROGRAM FILE

```

\coming through, and if there is then echo it
mid% = INF(3)
REPEAT
  UNTIL OUTSTAT(3)
  OUT 3, mid%
ENDIF
UNTIL (B%>0)
IF K% AND Z1000 THEN PROC_singleclick : \this prevents auto repeat from
row% = 0
col% = 0
row% = ((Y% - B) / 16) + 1
IF X% > 490 AND X% < 600 THEN col% = 6 : \work out which parameter is being
IF X% > 570 AND X% < 400 THEN col% = 5 : \selected in terms of the row and
IF X% > 219 AND X% < 254 THEN col% = 4 : \column on the screen
IF X% > 186 AND X% < 219 THEN col% = 3
IF X% > 154 AND X% < 186 THEN col% = 2
IF X% > 122 AND X% < 154 THEN col% = 1
IF (row% > 0 AND row% < 21 AND col% < 0) THEN PROC_select(col%, row%)
  UNTIL restart : \update the parameter selected
FILLCOL 1
FILLSTYLE 2,7
UNTIL FALSE
END
-----
DEF PROC_annoncements : \displays the message below in an alert box
BEEP
dummy = ALERT(["[O] [ TX Edit version 1.8; (c) 1987 Robin Kanagasabay; FAST BASI
C by Computer Concepts: (ser:0001)][OK]", 0])
ENDPROC
-----
DEF PROC_clear_buffer : \clears the ST's MIDI buffer of any residual data
\clear up to 128 bytes from the input MIDI buffer
FOR count% = 1 TO 256
  TIME#0
  REPEAT
    UNTIL INPSTAT(3) OR TIME#2
    IF INPSTAT(3) THEN dummy = INF(3)
  NEXT
ENDPROC
-----
DEF PROC_setup : \sets up lookup tables (see below for details)

LOCAL count%, count2%, value%
XTSIZE 13
FILLCOL 1
colmax = 6
rowmax = 20
DIM polymono$(3)
DIM parmnum%(colmax, rowmax) : \Relates TX parameter number to the field pos
DIM minval%(122), maxval%(122) : \min and max values for the TX parms
DIM xpos%(colmax) : \tell where to print values for each column
DIM parmvalue%(123), special%(122) : \value holds the actual values
\ (index is 100 greater for ACED parms)
\special indexes special print routines
DIM midibuffer%(200) : \buffer to read MIDI data into
DIM mask1%(4), mask2%(4)
DIM ratfix%*(1), onoff%(1)
polymono$(0) = "Poly"
polymono$(1) = "Mono"
coldata: DATA 16, 20, 24, 28, 47, 62
: \relates columns to actual screen tabs
RESTORE coldata
FOR count% = 1 TO 6
  READ xpos%(count%)
NEXT
ratfix$(0) = "rat"
ratfix$(1) = "fix"
onoff$(0) = "off"
onoff$(1) = "on"
maskdata: DATA 4, 4, 2, 2, 3, 3, 1, 1
parmdata: DATA 93, 100, 101, 11, 102, 103, 12, 10, 6, 5, 0, 1, 2, 3, 4, 104, 53, 8, 7, 9
RESTORE maskdata : \gives the order in which the parameters are printed
FOR count% = 1 TO 4
  READ mask1%(count%), mask2%(count%)
NEXT count%
RESTORE parmdata
FOR count% = 1 TO 20
  READ value%
  FOR count2% = 1 TO 4
    IF value% < 100 THEN
      parmnum%(count2%, count%) = value% + (13 * (mask1%(count2%) - 1))
    ELSE parmnum%(count2%, count%) = value% + (5 * (mask2%(count2%) - 1))
  ENDIF
  IF value% = 93 THEN parmnum%(count2%, count%) = 93
  IF value% = 53 THEN parmnum%(count2%, count%) = 53
NEXT count2%
NEXT count%
parm2data: DATA 64, 66, 65, 67, 121, 122, 71, 72, 61, 60, 59, 54, 55, 56, 57, 58, 73, 74, 75, 76
RESTORE parm2data
FOR count% = 1 TO 20
  READ value%
  parmnum%(5, count%) = value%
NEXT count%
parmnum%(6, 1) = 63
parmnum%(6, 2) = 77
parmnum%(6, 3) = 62
parmnum%(6, 4) = 120
parmnum%(6, 5) = 52
FOR count% = 0 TO 3
  minval%(3 + (count% * 13)) = 1
NEXT count%
maxdata: DATA 31, 31, 31, 15, 15, 99, 3, 7, 1, 7, 99, 63, 6
\this gives the maximum
RESTORE maxdata : \allowable values for the various parameters
FOR count% = 0 TO 12
  READ value%
  FOR count2% = 0 TO 3
    maxval%(count% + (count2% * 13)) = value%
  NEXT count2%
NEXT count%
max2data: DATA 7, 7, 99, 99, 99, 99, 1, 3, 7, 3, 48, 1, 12, 1, 99, 99, 1, 1, 1, 99, 99, 99, 99, 99, 99
RESTORE max2data
FOR count% = 52 TO 76
  READ value%
  maxval%(count%) = value%
NEXT count%
max3data: DATA 1, 7, 7, 7, 3, 1, 7, 7, 7, 3, 1, 7, 7, 7, 3, 1, 7, 7, 7, 3, 7, 99, 99
RESTORE max3data
FOR count% = 100 TO 122
  READ value%
  makval%(count%) = value%
NEXT count%
ENDPROC
-----

```



```

DEF PROC_fullout : \makes the output window fill the screen

LOCAL x,y,w,h
IF TXHANDLE<>-1 THEN
  GETWINDFULL TXHANDLE,x,y,w,h
  SETWINDCOORDS TXHANDLE,x,y,w,h
  GETWINDWORK TXHANDLE,x,y,w,h
  TXTRECT x,y,w,h
  GRAFRECT x,y,w,h
ENDIF
ENDPROC
\-----
DEF PROC_drawlabels
\Draws the labels for the voice editor
\Uses only local variables

LOCAL columnloop%,rowcount%,texts%,y%,x%
labels:DATA "op status","ratio/fixd","range","coarse","fine"
DATA "waveform","detune","output level","rate scaling"
DATA "level scale","AIR","DIR","D2R","RR","DIL","EG shift (dB)"
DATA "feedback","amod enable","EG bias sens","key velocity"
DATA "bend range","porta time","porta mode","FC vol"
DATA "FC pitch","FC amp","MW pitch","MW amp","amod sens","pmod sens"
DATA "LFO wave","LFO speed","LFO delay","Pmod depth","Amod depth","sync","BC pit
ch"
DATA "BC amp","BC Pbias","BC Egbias","poly mode","name","middle C","reverb"
FILLSTYLE 2,7
CLG 1
FILLSTYLE 0,0
RECT 8,TXTYBASE-30,255,331
RECT 270,TXTYBASE-30,400,331
RECT 410,TXTYBASE-30,600,119
RECT 490,136,578,192
RECT 490,168,538,184
RECT 490,200,599,216
\Print labels first
RESTORE labels
TXTRECT 0,30,SCREENWIDTH,SCREENHEIGHT
FOR columnloop%=0 TO 1
  FOR rowcount%=1 TO 20
    READ texts%
    PRINT TAB(2+(33#columnloop%),rowcount%) texts%
  NEXT
NEXT

\Last column labels
FOR rowcount%=1 TO 4
  READ texts%
  PRINT TAB(52,rowcount%) texts%
NEXT
PRINT TAB(52,6)"algorithm"
PRINT TAB(62,9)"New Voice"
PRINT TAB(62,11)"Quit"
PRINT TAB(62,13)"All notes off"
\Draw boxes and lines
LINEWIDTH 1
FOR y%= TXTYBASE-6 TO 312 STEP 16
  LINE 8,y% TO 255,y%
  LINE 270,y% TO 400,y%
  IF y%<86 THEN LINE 410,y% TO 600,y%
NEXT
FOR x%=14#8+11 TO 14#8+108 STEP 32
  LINE x%,TXTYBASE-24 TO x%,331
NEXT
LINE 370,TXTYBASE-24 TO 370,331
LINE 490,TXTYBASE-24 TO 490,119
FILLSTYLE 2,7
\FILL 1,1,1
FILLSTYLE 2,7
FILL 156,272,1
FILL 188,272,1
FILL 221,272,1
ENDPROC
\-----
DEF PROC_read_a_voice : \reads the current TX voice over MIDI

\First request a voice dump from the TXB12
LOCAL count%.value%.offset%.mess%
requestdata:DATA 240,67,32,126,"LM 897bAE"
\code to request a voice
restart:RESTORE requestdata

FOR count%=1 TO 4
  READ value%
  TIME=0
  REPEAT
    UNTIL OUTSTAT(3) OR TIME>10
    IF OUTSTAT(3) THEN OUT 3,value%
  NEXT count%
  READ mess%
  FOR count%=1 TO LEN(mess%)
    TIME=0
    REPEAT
      UNTIL OUTSTAT(3) OR TIME>10
      IF OUTSTAT(3) THEN OUT 3,ASC(MID$(mess%,count%,1))
    NEXT count%
    TIME=0
    REPEAT
      UNTIL OUTSTAT(3) OR TIME>10
      IF OUTSTAT(3) THEN OUT 3,247
    NEXT count%
    TIME=0
    REPEAT
      UNTIL INPSTAT(3) OR TIME>TX+20
      IF INPSTAT(3) THEN midbuffer%(0)=INP(3)-65280
      UNTIL midbuffer%(0)=240 OR TIME>200
      IF midbuffer%(0)<>240 THEN PROC_noTX : \can't read the voice so assume the
      IF midbuffer%(0)<>240 THEN GOTO restart : \TX isn't connected correctly!
    FOR count%=0 TO 140
      TIME=0
      REPEAT
        UNTIL INPSTAT(3) OR TIME>1
        IF INPSTAT(3) THEN midbuffer%(count%)=INP(3)-65280
        IF OUTSTAT(3) THEN OUT 3,254
      NEXT count%
      \SUCCESS!!
      \Now assign the contents of the buffer to the appropriate variables
      FOR count%=0 TO 23
        parmvalue%(count%+100)=midbuffer%(count%+15)
      NEXT count%
      offset%=3
      REPEAT
        offset%=offset%+1
        UNTIL midbuffer%(offset%)=240
      FOR count%= 0 TO 93

```

## ★★ NETCODE LTD★★

HOTLINE TELEPHONE 01-577 2720  
DUE TO DEMAND ALSO AVAILABLE  
IN MARCH

FREE PRINTER WITH  
20MB AMSTRAD SYSTEM

[Seagate 20mb h/disk PLUS  
Panasonic 1081 Or Citizen 120D.]

PC1640 20MB MONO.....£849.00  
PC1640 20MB COL .....£999.00  
PC1640 20MB/ECD.....£1099.00

3½" Conversion kit for IBM PCXT/AT 1Mb (720k).  
Into 5¼" slot and takes 5¼" Data Cable and power  
supply ..... Only £99 + VAT  
2Mb (reads and writes to 720k) ... Only £139 + VAT

### AMSTRAD

Call for full Amstrad range

### CITIZEN PRINTERS

MSP 15E .....£269.00  
MSP 10E .....£310.00  
MSC45 .....£399.00  
MSP 50 .....£399.00  
MSP 55 .....£499.00  
45 HOP .....£570.00  
110 LASER .....£1330.00  
MX15 .....£329.00  
ND10 .....£279.00  
MB24/10 .....£499.00  
MB24/15 .....£599.00

### ZENITH

(For full range please call)

### EPSON

Call for Epson Printers full range and best prices

### NEC

Pin Writer 2200 .....£299.00

### APRICOT

Call for full range.

### IBM

Call for full range.

### STAR

LC 10 Parallel I/F .....£179.00

### BROTHER

For full range call.

### PANASONIC

1082 .....£199.00  
1083 .....£299.00  
1592 .....£349.00  
1540 .....£499.00  
1595 .....£499.00  
3131 .....£249.99  
3151 .....£419.00

### KITS

20 MB SEAGATE HARD DISK KIT .....£195.00  
40MB (28ms) SEAGATE H/D KIT .....£499.00  
30MB WESTERN DIGITAL HARD .....£259.00  
30MB WESTERN DIG H/D KIT .....249.00  
WANGTEC TAPE STREAMER KIT ..... CALL  
5¼" to 3½" conversion kit .....£99.00

(FOR ANYTHING NOT LISTED PLEASE CALL  
WE HAVE LOTS MORE HARDWARE &  
SOFTWARE AVAILABLE IN STOCK)  
WE ARE SPECIALIST IN ACCOUNTING  
SOFTWARE SERVICE CONTRACTS  
AVAILABLE ON PRINTERS, DISK DRIVES  
AND IBM COMPATIBLE COMPUTERS.

DEALER OVERSEAS AND  
EDUCATION ENQUIRIES WELCOME

ALL prices exclusive of VAT, postage & packing.

SAME DAY DESPATCH,  
GUARANTEED NEXT DAY DELIVERY

TO ORDER PHONE 01-577 2720.  
or send cheque to:-

367 CIPENHAM LANE,  
SLOUGH BERKS SL1 2YE

BANKLABS HOUSE, 2nd FLOOR  
CROSSLANDS ROAD, HOUNSLOW MIDDXX.

## ARC Scientific Limited

Over 30 years scientific computing experience, from PC to Cray.

Consulting on all aspects of scientific computing.

Mathematical modelling for engineering and science.

Software development in Fortran, C or Basic. Advice on choice of numerical software.

Agents for two superb UKAEA programs (ask for leaflet):

**FACSIMILE/CHEKMAT** — for numerical modelling of a wide range of continuous systems, especially in reaction kinetics with or without diffusion, and much more including parameter fitting.

**FACSIMILE/HOWGOOD** — for estimating uncertainty in results from any modelling program, arising from uncertainty in data.

Do you use an Amstrad CPC or PCW and a PC or compatible?

We offer low-cost file copying between CP/M (Amstrad 3") disks and 5.25" MS-DOS disks (3.5" soon). £6 for one Amstrad side, £10 for two, plus media and VAT.

Phone us or write about your scientific computing problems.

ARC Scientific Limited, Dept PCW, 257 Woodstock Road, Oxford OX2 7AE. Phone: 0865 310167.

## PC CASINGS

OEMs/TRADE WELCOME

SOFTMACHINE DISTRIBUTION LTD

UNIT F-25,  
HARBET RD,  
LEA VALLEY,  
EDMONTON,  
LONDON N18 3LR.

ENGLAND.

TEL: 01-807 76441

TLX: 9312100158

TDG

FAX: 01-807 2748

Office Hours:

10am-6pm

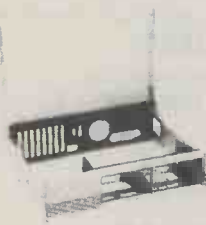

**SOFTMACHINE**  
DISTRIBUTION LTD

Tel: 01-807 7644 FAX: 01-807 2748

## DISKS • DISKS • DISKS

### Floppy Disks

5.25" Universals (96 tpi) unbranded

10 disks in 'Vision-10' library case £6.15(a)

100 disks (unboxed).....£44.95(b)

3.5" Disks (135 tpi) unbranded.

10 SS/DD disks in plastic library case

£12.95(a)

10 DS/DD disks in plastic library case

£13.95(a)

### Continuous Stationery

1500 sheets 90gsm A4 microperf £18.35(d)

2000 sheets 60gsm 11" X 9.5" microperf

£12.65(c)

Prices include VAT.

Please add postage at the appropriate rate:

(a) £1.00 (b) £2.65 (c) £3.60 (d) £4.75

## TALBOT COMPUTER SUPPLIES

Kensway House, 388 High Road, Ilford,  
Essex, IG1 1TL. Tel: 01-478 2781

# PROGRAM FILE

```

parmvalue%(count%)=midibuffer%(count%+offset%+6)
NEXT count%
parmvalue%(93)=15 :\\the TX doesn't seem able to transmit this!!
OUT 3,240 :\\(so you have to set it from the ST
OUT 3,67
OUT 3,16
OUT 3,16
OUT 3,93
OUT 3,15 :\\turn all operators on!
OUT 3,247
ENDPROC
\\-----
DEF PROC_print_a_voice :\\print the values that have been read
: \\to the screen
TXMODE 2
FOR rowcount%=1 TO 20
FOR colcount%=1 TO 6
temp%=xpos%(colcount%)
temp2=parmvalue%(parnum%(colcount%,rowcount%))
IF rowcount%=17 AND colcount%<5 AND colcount%>1 THEN GOTO skip
IF rowcount%=3 AND colcount%<5 AND parmvalue%(parnum%(colcount%,2))=0 THEN GOTO skip
XX%=IR$(temp2)
IF rowcount%=1 AND colcount%=6 THEN XX%=polynom$(temp2)
IF rowcount%=16 AND colcount%<5 THEN
XX%=STR$(2^(3-temp2))+12)
IF XX%="96" THEN XX%="off"
ENDIF
IF rowcount%=4 AND colcount%=6 AND XX%="0" THEN XX%="off"
IF (rowcount%=16 AND colcount%=3) THEN XX%=onoff$(VAL(XX*))
IF (rowcount%=7 AND colcount%<5) THEN XX%=FN_detune(XX*)
IF rowcount%=19 AND colcount%=5 THEN XX%=FN_BC_pbias(XX*)
IF colcount%=6 AND rowcount%>4 THEN GOTO skip
IF rowcount%=2 AND colcount%=6 THEN
FOR count%=0 TO 9
temp%=xpos%(colcount%)+count%
PRINT TAB(temp%,2) CHR$(parmvalue%(77+count%));
NEXT count%
ELSE IF rowcount%=2 AND colcount%<5 THEN
PRINT TAB(temp%,rowcount%) ratf%$(parmvalue%(parnum%(colcount%,rowcount%)));
IF parmvalue%(parnum%(colcount%,rowcount%))=0 THEN PROC_norange(colcount%,rowcount%));
ELSE IF rowcount%=18 AND colcount%<5 THEN
PRINT TAB(temp%,rowcount%) onoff$(parmvalue%(parnum%(colcount%,rowcount%)));
ELSE IF rowcount%=1 AND colcount%<5 THEN
temp2=parmvalue%(93)
temp2=(temp2 AND (2^(colcount%-1)))
temp2=(temp2>0)+1
PRINT TAB(temp%,rowcount%) onoff$(temp2)
ELSE PRINT TAB(temp%,rowcount%) XX%:
ENDIF
ENDIF
ENDIF
NEXT colcount%
NEXT rowcount%
FILLSTYLE 2,7
FILLCOL 1
RECT 123,244,154,263
PROC_draw_alg(parmvalue%(52)) :\\draw the algorithm graphically
TXMODE 2
ENDPROC
\\-----
DEF PROC_alg_setup :\\lookup tables for the algorithm display
LOCAL count%,count2%
DIM algbits*(7,3)
algdata:DATA " 4->3->2->1 "
DATA " " " "
DATA " 3 "
DATA " 1 "
DATA " 4->2->1-> "
DATA " 4 "
DATA " 3->2->1-> "
DATA " 4->3-> "
DATA " 1 "
DATA " 2->1-> "
DATA " 4->3-> "
DATA " 2->1-> "
DATA " " " "
DATA " 1 2 3 "
DATA " " " "
DATA " 4 "
DATA " 1 "
DATA " 1 2 3 "
DATA " " " "
DATA " 1 2 3 4 "
DATA " 1 1 1 1 "
RESTORE algdata
FOR count%=0 TO 7
FOR count2%=1 TO 3
READ algbits*(count%,count2%)
NEXT count2%
NEXT count%
ENDPROC
\\-----
DEFPROC_draw_alg(n)
LOCAL count%
FILLCOL 0
FILLSTYLE 1,1
RECT 491,73,598,119
FOR count%= 1 TO 3
PRINT TAB(62,4*count%) algbits*(n,count%);
NEXT count%
TXMODE 1
PRINT TAB(52,7) "[;:n+1;]"
TXMODE 2
ENDPROC
\\-----
DEF PROC_norange(n)

```



```

\To blank out the range fields when in ratio mode
FILL (32*n)+92,41,1
ENDPROC
-----
DEF PROC_blank(coino%,FLAG)
\clears a range box when in ratio mode
FILLSTYLE 0,0
SWITCH coino%
CASE 1
RECT 123,41,134,55
LINE 123,40 TO 123,56
CASE 2
RECT 155,41,186,55
LINE 155,40 TO 155,56
CASE 3
RECT 187,41,218,55
LINE 187,40 TO 187,56
CASE 4
RECT 240,41,255,55
LINE 219,40 TO 219,56
ENDSWITCH
IF FLAG=0 THEN
FILLSTYLE 2,7
FILLCOL 1
FILL (32*coino%)+93,42,1
FILLSTYLE 0,0
ELSE
temp=xpos%(coino%)-8
PRINT TAB(temp,3) parmvalue%(parmnum%(coino%,3));
ENDIF
ENDPROC
-----
DEF PROC_opswitch(columnOP%,FLAGOP) :\turns the operators on/off
FLAGOP=-1 for off, 1 for on
columnOP%=5-columnOP%
tempOP=2*(columnOP%-1)
IF FLAGOP=1 THEN
IF (tempOP AND parmvalue%(93))=0 THEN parmvalue%(93)=parmvalue%(93)+tempOP
XX*="on"
ENDIF
IF FLAGOP=-1 THEN
IF (tempOP AND parmvalue%(93))>0 THEN parmvalue%(93)=parmvalue%(93)-tempOP
XX*="off"
ENDIF
work=parmvalue%(93)
ENDPROC
-----
DEF PROC_range(screencol%,direction)
\To simulate the range parameter as the TX doesn't seem to
\receive this properly
OUT 3,240
OUT 3,27
OUT 3,16
OUT 3,18
SWITCH screencol%
CASE 4
OUT 3,11
OUT 3,parmvalue%(11)
CASE 3
OUT 3,37
OUT 3,parmvalue%(37)
CASE 2
OUT 3,24
OUT 3,parmvalue%(24)
CASE 1
OUT 3,50
OUT 3,parmvalue%(50)
ENDSWITCH
OUT 3,247 : \GOTO CRB PARAMETER

OUT 3,240
OUT 3,67
OUT 3,16
OUT 3,19
OUT 3,65
OUT 3,127

OUT 3,247 : \ And then on one parameter

OUT 3,240
OUT 3,67
OUT 3,16
OUT 3,19
IF direction=1 THEN
OUT 3,72
ELSE
OUT 3,71
ENDIF
ENDIF
OUT 3,127
OUT 3,247 : \ And then the data +1 button
ENDPROC
-----
DEF PROC_select(scol%,srow%) : \decide what to do
LOCAL work,group%,actnum%,tempnum%
noaction=FALSE
IF scol%=6 AND srow%=9 THEN
PROC_new_voice
noaction=TRUE
ENDIF
IF scol%=6 AND srow%=11 THEN
PROC_quit_prog
noaction=TRUE
ENDIF
IF scol%=6 AND srow%=13 THEN
PROC_allnotesoff
noaction=TRUE
ENDIF
IF noaction THEN GOTO skipaction
noaction=FNcheck(noaction)
IF scol%=6 AND srow%=2 THEN PROC_nameupdate
IF noaction THEN GOTO skipaction
IF scol%=6 AND srow%>4 THEN srow%=5
tempnum%=parmnum%(scol%,srow%)
inc=((24B%)-3)
IF scol%<5 AND srow%=1 THEN
PROC_opswitch(scol%,inc)
ELSE
work=parmvalue%(tempnum%)+inc
IF work<0 THEN
work=0
noaction=TRUE
ENDIF
IF work<minval%(tempnum%) THEN

```

## ESTATE AGENTS

Do you want to know exactly how many sales you have on hand? How many applicants are active?

Are your applicants getting the property details they said they wanted?

Have you 'lost' applicants or properties or viewings? Do want a reminder of tasks you need to do?

If you answered any of these questions with a 'Yes', you should be talking to us.

We have the right package at the right price, you can contact us at the address or phone below, for further details.

Your clients are waiting.

**Gaia Systems, Suite 9A, Cardigan House,  
Waterloo Road, Bournemouth, DORSET  
BH9 1AU**

**(0202) 521072**

**Ask for Kieran Davie**

## I/O CARD

For IBM PC XT/AT or Compatibles

Features include:

- ★ 24 or 48 I/O lines, also OV and +5V, -5V
- ★ Terminal Board supplied as standard with fuses and power indicators
- ★ 24 I/O lines option easily upgraded to 48 I/O lines
- ★ TTL compatible

## FREE

- ★ Fully documented Programs and Utilities supplied on 5.25 disk
- ★ Application Notes

All Software is written in Basic and Turbo Pascal

24 Line I/O card **£99**  
48 Line I/O card **£145**  
Send or phone for literature. Please add VAT to all prices



**W. M. AUTOMATION**

Unit 18, Kilroot Park, Larne Road  
Carrickfergus, N Ireland  
Tel: 09603 50955

## KARIR INTERNATIONAL LTD

Authorised Dealers: **ACORN/AMSTRAD**  
36 Eastcastle Street, W1N 7PE  
Telex: 8951182 Fax: 01 441 6813

Amstrad PC 1512 SD Mono	£375.00
Amstrad PC 1640 DD Mono	£540.00
Archimedes A 310 Mono	£825.00
Archimedes A 440 Colour	£2324.00
BBC Master 12B	£359.00
Z80 Second Processor	£328.00
Software & Manuals/Guides	Call
Plotters/Plotmate Upgrades	Call
Printers:	
Epson LX800	£189.00
Juki 6100	£259.00
Panasonic	£139.00
Taxan KP815	£297.00
Brother 1409	£335.00
Brother HR20 tractor	£112.00
Data Switch 2port/4port from	£36.95
I.B.M. Printer Cable	£9.95
Centronic	£12.95
Nimbus/Amstrad & others	Call
Nashua Branded & approved Mag Media	
3.5 DS/DD per box of 10	£11.50
5.25 DS/DD per box of 10	£8.75
Meg Tape 2400	£9.86
Meg Tape 3600	£13.99
HELP LINES: 01 440 0803 or 01 636 6614	
(callers by arrangement only)	
Trade & Export inquiries welcomed	

## WANTED

Home & Business Computers, especially Amstrad 1640, 1512, 8256, 512, BBC 'B' and Master. Commodore C64, Amiga, Atari ST. IBM PC etc. Also Printers & Disk Drives.

## THIS MONTH'S OFFERS

Amstrad 1512 D.D Col.Mon.	£430
Atari ST-FM	£215
Amstrad CPC 464 with choice of Mod-G/Mon - C/Mon from	£95
Commodore 1541 Disc Drives (new)	£110
Spectrum Plus 2 from	£75
Commodore C64 from	£75
Plus other bits & pieces	

We have equipment coming in and going out all the time. Please phone for availability and latest stock list.

All prices + carriage + VAT.

**DMR Electronics**  
(0274 817889)

Unit 7, Drum Hill Works, Clayton Lane, Bradford, West Yorkshire BD14 6RF

## UNBEATABLE

# 5 1/4

## DISC PRICES

Life-time guaranteed, double sided, double density 48 TPI bulk wrapped discs

Quantity	Price	LOCKABLE DISK STORAGE BOXES
10	£3.50	50 Capacity £8.49
20	£6.50	100 £7.49
25	£9.99	120 £10.49
50	£15.50	
105	£31.00	

30% OFF RRP for all Amstrad Software Ring for Hardware and Peripheral Prices

Prices include VAT and label sets  
All Post and Packing FREE  
Access & Visa orders accepted by telephone or mail order  
Send cheque or POs to:

## CESTRIAN SOFTWARE

2 Waterloo Road, Off Liverpool Road  
Chester CH2 2AL  
Phone 24hr 0244 371952

## T.COMPUTERS

TC offers discs at the right price!  
So phone today.

AMSTRAD PC1640 50 MONO	520.00
AMSTRAD PC1640 50 COLOUR	689.00
AMSTRAD PC1640 50 ECD	630.00
AMSTRAD PC1640 50 20MEG HD MONO	950.00
AMSTRAD PC1640 50 20MEG HD ECD	1250.00
AMSTRAD PC1512 50 MONO	437.00
AMSTRAD PC1512 50 COLOUR	580.00
AMSTRAD PCW 8256	335.00
AMSTRAD PCW 8512	499.00
AMSTRAD PPC512 50 PORTABLE	449.00
AMSTRAD PPC540 50 PORTABLE INC MODEM	545.00



AMIGA A500	425.00
AMIGA A500 1MEG RAM	549.99
AMIGA A500 + COLOUR MONITOR	699.99
AMIGA 500 system	799.00
ATARI 520STFM	279.99
ATARI 520STFM + COLOUR MONITOR	549.99
MEGA ST 2MEG + MONO	889.99
MEGA ST 4MEG + MONO	1199.99

CITIZEN LSP-100	219.00
CITIZEN MPS 106	249.00
CITIZEN HOP 40 (24 PIN)	554.00
LO 3500 24 PIN PRINTER	343.00
NEC P220 24 PIN	399.00
NEC P5 XL WIDE BED COLOUR PRINTER	1066.00
CITIZEN OVERLURE 110 LASER PRINTER	1750.00
10 PAGES PER MINUTE	



\*SPECIAL OFFER PRICES  
ALL PRICES INCLUDE VAT AND ARE SUBJECT TO AVAILABILITY  
SEND S.A.E. FOR INFORMATION ON OFFER AND PRICE LIST (stating computer)

## T.COMPUTERS

19 HAVENVALE, WANTAGE,  
OXON OX12 7AJ. Tel: 02357 60177

```

work=minval%(tempnum%)
noaction=TRUE
ENDIF
IF work>maxval%(tempnum%) THEN
work=maxval%(tempnum%)
noaction=TRUE
ENDIF
IF noaction THEN GOTO skipaction
group%=18
actnum%=parmnum%(scol%,srow%):IF actnum%>99 THEN
actnum%=actnum%-100
group%=19
ENDIF
parmvalue%(tempnum%)=work
IF scol%<5 AND srow%=3 THEN
PROC_range(scol%,inc)
ELSE
OUT 3,240 :\\this part actually transmits the new voice data
OUT 3,67 :\\to the TX
OUT 3,16
OUT 3,group%
OUT 3,actnum%
OUT 3,parmvalue%(tempnum%)
OUT 3,247
ENDIF
\\Now update the screen
XLEFT%=(xpos%(scol%)-16)*8+124
YTOP%=(srow%-1)*16+9

IF scol%=6 THEN
RECT 491,YTOP%,599,YTOP%+14
IF srow%>4 THEN RECT 491,73,599,119
ELSE RECT XLEFT%,YTOP%,XLEFT%+27,YTOP%+14
ENDIF
IF tempnum%<>93 THEN XX%=STR$(parmvalue%(tempnum%))
IF scol%=6 AND srow%=1 THEN
XX%=polymono$(work)
ELSE
IF scol%=5 AND srow%=19 THEN XX%=FN_BC_bias(XX%)
IF (srow%=16 AND scol%=3) THEN XX%=onoffs(VAL(XX%))
IF srow%=4 AND scol%=6 AND XX%="0" THEN XX%="off"
SWITCH srow%
CASE 7
IF scol%<5 THEN XX%=FN_detune(XX%)
CASE 16
IF scol%<5 THEN
XX%=STR$(2^(3-work))*12)
IF XX%="96" THEN XX%="off"
ENDIF
CASE 18
IF scol%<5 THEN XX%=onoffs(work)
CASE 2
IF scol%<5 THEN
XX%=ratfix$(work)
IF XX%="rat" THEN PROC_blank(scol%,0)
IF XX%="fix" THEN PROC_blank(scol%,1)
ENDIF
ENDSWITCH
ENDIF
ENDIF

IF scol%=6 AND srow%=5 THEN
PROC_draw_aig(parmvalue%(52))
ELSE
PRINT TAB(xpos%(scol%),srow%) XX%
ENDIF
skipaction:ENDPROC
\\-----
DEF PROC_noTX :\\when the program can't establish contact
GROWBOX 0,0,0,0, 150,150,300,100
BEEP
dummy=ALERT("[3][There does not seem to be a TXBIZ connected. It must be set to
MIDI channel 1.][Retry/Quit]",1)
SHRINKBOX 150,150,300,100, 0,0,0,0
IF dummy=2 THEN
CLOSEWIND TXHANDLE
DELEWIND TXHANDLE
END
ENDIF
ENDPROC
\\-----
DEF PROC_de_full :\\set window back to original size
LOCAL x,y,w,h
IF TXHANDLE<>-1 THEN
GETWINDPREV TXHANDLE,x,y,w,h
SETWINDCOORDS TXHANDLE,x,y,w,h
TXTRECT x,y,w,h
GRAFRECT x,y,w,h
ENDIF
ENDPROC
\\-----
DEF PROC_new_voice :\\select new voice to edit
GROWBOX 490,136+38,88,16,150,150,300,100
dummy=ALERT("[1][Select the new voice on the TX;and click OK.;Be sure to store t
he voice you;were working on first!][Cancel;OK]",1)
SHRINKBOX 150,150,300,100,490,136+38,88,16
FOR LOOP=1 TO 2
OUT 3,240
OUT 3,67
OUT 3,16
OUT 3,19
OUT 3,70+LOOP
OUT+ 3,127
OUT 3,247
NEXT LOOP
IF dummy=2 THEN restart=TRUE
ENDPROC
\\-----
DEF PROC_quit_prog
GROWBOX 490,168+40,48,16,150,150,300,100
dummy=ALERT("[3][Quit program?][No;Yes]",1)
SHRINKBOX 150,150,300,100,490,168+40,48,16
IF dummy=2 THEN
CLOSEWIND TXHANDLE
DELEWIND TXHANDLE
END

```



```

ENDIF
ENDPROC
\
DEF FN_BC_pbias(xtemp$)
temp$=STR$(VAL(xtemp$)-50)
IF LEFT$(temp$,1)<>"-" THEN temp$="+"temp$
=temp$
\
DEF FN_detune(xtemp$)
temp$=STR$(VAL(xtemp$)-3)
IF LEFT$(temp$,1)<>"-" THEN temp$="+"temp$
=temp$
\
DEF FNcheck(dummy)
temp=dummy
temp=FALSE
IF srow%=16 AND scol%=1 THEN temp=TRUE
IF (srow%=17 AND scol%>1 AND scol%<5) THEN temp=TRUE
IF (srow%=3 AND scol%=1 AND parmvalue%(parmnum%(1,2))=0) THEN temp=1KUE
IF (srow%=3 AND scol%=2 AND parmvalue%(parmnum%(2,2))=0) THEN temp=1KUE
IF (srow%=3 AND scol%=3 AND parmvalue%(parmnum%(3,2))=0) THEN temp=1KUE
IF (srow%=3 AND scol%=4 AND parmvalue%(parmnum%(4,2))=0) THEN temp=1KUE
=temp
\
DEF PROC_nameupdate :\to change voice name
HIDEHOUSE
FILLCOL 1
RECT 591,25,600,39
FILLCOL 0
REPEAT
    MOUSE AZ%,BZ%,CZ%,DZ%
UNTIL CZ%<>B%
RECT 491,25,590,39
TXMODE 1
TXMODE 2
PRINT TAB(xpos%(6),2) " ";
OLDNAME$=""
FOR I=77 TO 86
    OLDNAME$=OLDNAME$+CHR$(parmvalue%(I))
NEXT
INPUT NAME$
IF NAME$="" THEN NAME$=OLDNAME$
NAME$=NAME$+" "
RECT 491,25,600,39
FOR I=0 TO 9
    temp=ASC(MID$(NAME$,I+1,1))
    OUT 3,240
    OUT 3,67
    OUT 3,16
    OUT 3,18
    OUT 3,I+77
    OUT 3,temp
    OUT 3,247
    parmvalue%(77+I)=temp
NEXT
PRINT TAB(xpos%(6),2) LEFT$(NAME$,10);
LINE 490,168 TO 600,168
noaction=TRUE
SHOWHOUSE
ENDPROC
\
DEF PROC_allnotesoff :\turns off all TX voices
GROWBOX 0,0,0,0, 150,150,300,100
SHRINKBOX 150,150,300,100, 0,0,0,0
ENDPROC
\
DEF PROC_singleclick
REPEAT
    MOUSE AZ%,BZ%,CZ%,DZ%
UNTIL CZ%<>B%
ENDPROC
\
\END OF PROGRAM
    
```

## Psion Organiser Enhanced FIND Command by Bas Beima

This program is an improved version of the built-in Psion Organiser FIND command. One advantage is that you don't have to know where the data is located in the machine, as the program will search through all the data-packs that are present.

Another advantage is that you can step back through the items which match the search criteria. Simply press SPACE and the program will go back to the previous match. The 'Z' key is used to restart the search with the previously-used parameters.

To use the program, type it into the Organiser and save as ZK, or whatever you want to call it (you will find that the Organiser runs more effectively if all the items on the main menu have different first letters). The program should then be translated, and ZK can be included in the main menu by pressing the MODE key. This will allow you to insert the item into the menu list, and the program can be executed by typing the first letter, or by selecting it and pressing the EXE key.

```

CLOSE
B%=B%+1
IF B%=4
IF N%=0
ZK:
REM V3.7
REM COPYRIGHT 1987
REM BAS BEIMA
GLOBAL A$(10),B$(3,1),B%,C%,D%,P%,P1%,N%
    
```

**BBD**  
DUST  
COVERS

**GET SMART!**

**BBD**  
DUST  
COVERS

### Protect Your Computing Equipment With BBD PROFESSIONAL DUST COVERS

In today's economic climate where equipment failure costs time and money protecting your hardware from wear and tear is the smart thing to do and the smart way to do it is with dust covers from the BBD Professional Range.

Manufactured from top quality ivory coloured washable nylon and attractively finished with brown piping BBD covers are simply the smartest protective covers available.

BBD covers can be washed and ironed without fear of fading or shrinking and will never crack or lose their shape.

With all these superlative features you might expect BBD covers to be a little expensive. Nothing could be further from the truth, e.g.

Covers for Amstrad PC1512/1640	£9.00
Covers for Archimedes	£9.00
Covers for IBM PC/XT	£9.00

Please indicate whether colour or monochrome monitor.

BBD also offer a wide range of matching covers for printers from only £5.00.

These include Amstrad DMP 2000, 3000 and 3160, Amstrad DMP 4000 and LQ3500, and a selection from Brother, Canon, Citizen, Epson, Star etc. etc. Generally covers for 80 column printers are £5.00 and for 132 column £6.00.

GET SMART! GET BBD!



**BBD Computer Dust Covers**

The Standish Centre

Cross Street, Standish, Wigan WN6 0HQ

Tel. 0257 422968 Ext 45. Fax. 0257 423909

DEALER ENQUIRIES WELCOME



## ON-SITE MAINTENANCE CONTRACTS

COVER FOR ALL  
COMPUTER EQUIPMENT IS  
AVAILABLE INCLUDING  
AMSTRADS. FAST  
EFFICIENT SERVICE WITH  
PRICES FROM  
£29.99 PER ANNUM

**RING NOW FOR QUOTE  
TEL - 0279 726406**

HIGH QUALITY, LOW PRICED COMPUTER  
STATIONERY AVAILABLE

HardSoft • international

1a The Square, Sawbridgeworth, Herts. CM21 9AE

Telephone (0279) 726406 & 726488

## IS YOUR COMPANY GROWING EVERY YEAR?



We're getting  
smaller  
More compact  
More efficient  
More cost  
effective

For Expert Advice  
on Stand Alone or Network Systems  
and all Computer Processing Supplies  
at Competitive Prices

**Call 01-737 1264 today**

**SYNTAX Computer Systems Sales Limited**  
5 Arlington Parade, Brixton Hill, London SW2 1RH

Service + training also available

**MERIDIAN TECHNOLOGY**  
7 BRO SILYN, TALYSARN  
CAERNARVON, GWYNEDD LL54 6AU  
TEL: 0286 880818

## 'MINIDISC' A NEW 'GEM' BASED DISC EDITOR

For the Atari ST (Med/High res.) . . . . £9.99  
ST Public Domain software (per disc). £2.00  
10 D/S 3-5" branded discs in box . . . £11.99  
10 D/S 5-25" branded discs in box . . . £6.99  
500 3-5" disc labels . . . . . £10.00  
Lockable disc box holds 80 3-5" discs £9.99  
Quickshot II plus joystick. . . . . £9.99  
Computer data recorders . . . . . £22.95

A4 S.A.E. for list stating computer owned.  
Prices include VAT. Please add 10%  
postage and packing.

## Personalised Software Written for the ATARI ST Computers



## PAY LESS WITH SMS

- |                        |                        |
|------------------------|------------------------|
| PC-WRITE 2.7 (2)       | PC-DIAL (1)            |
| PC-TYPE - (3)          | Q-MODEM (2)            |
| MIND READER (1)        | CITY DESK (1)          |
| PC-FILE - (2)          | FORMS GENERATOR (1)    |
| WAMPUN (2)             | CASH-TRACK (2)         |
| FILE EXPRESS (2)       | PC-ACCOUNTING (1)      |
| ASEASY AS (1)          | INVENTORY CONTROL (1)  |
| GOAL SEEKER (1)        | LABEL MAKER (1)        |
| HOME BASE 2.5 (3)      | NEW KEY (1)            |
| PC-OUTLINE (1)         | BASIC INTERPRETER (1)  |
| POWER MENU (1)         | PC GRAPH (1)           |
| AUTO MENU (1)          | FINGER PAINT (1)       |
| RAM TEST (1)           | 3D CHESS (1)           |
| DESK TEAM (1)          | DETECTIVE (1)          |
| PC-DOS HELP (1)        | CARD GAMES (1)         |
| 5 1/4" £3 (Members £2) | 3 1/2" £4 (Members £3) |
|                        | Membership £10         |

Send £2/disk to cover media p-n  
Make cheques PAYABLE to:

**SUPER MONEY SAVERS**  
19 Carshalton Road, Camberley  
Surrey GU15 4AQ  
SMS (PCW OFFER)

Tel: 0276 681864

```

PRINT "NOT FOUND "
PRINT A$
PAUSE 10
GOTO IN::
ELSE
B%=1
ENDIF
ENDIF
ENDWH
FT::
IF ERR<206
B%=B%+1
IF B%=4
B%=1
ENDIF
GOTO LP::
ELSE
RETURN
ENDIF

ONERR FT::
B$(1)="A" :B$(2)="B" :B$(3)="C"
IN::
PRINT "LOOK FOR",
TRAP INPUT A$
B%=1
LP::
N%=0
WHILE A$<"XXX"
TRAP OPEN B$(B%)+".MAIN",A,V$
FIRST
TRAP USE A
P1%=0
WHILE FIND(A$)
P%=POS
N%=1
D%=DISP(-1,A$)
IF D%=1
RETURN
ELSEIF D%=32
IF A$<" "
FIRST
C%=0
DO
P%=POS
NEXT
C%=C%+1
UNTIL FIND(A$)=P1%
IF C%>1
P1%=P%
ELSE FIRST
ENDIF
ELSEIF D%=%Z OR D%=%Z
ZK:
ELSE
NEXT
P1%=P%
ENDIF
ENDWH
    
```

## Z88 Utilities by Matthew West

PCW  
DISK  
LIBRARY

These utilities have been written in Z88 CLI. The programs are not brilliant and have a few rough edges, but I've published them to encourage other Z88 owners to send in ideas.

The programs are rather restricted in nature, and are useful rather than elegant. They show how to go about writing CLI programs: for example,

BOOT.CLI will automatically boot-up the system after a hard rest. When this happens, the user-defined options will be lost. To retrieve them, initialise the system again — this file allows you to automate that process. Enter the functions you want to run at boot-up time and save the file on EPROM.

### BOOT.CLI

This command file is an example of a command file that will be executed on reboot if it is found on the EPROM. The command file changes the repeat rate to 8, the default device to :RAM.1, and calls the Time PopUp so the date and time can be reset if a hard reset was invoked.

### BOOT.CLI

```

#S8-D-D-D|-R-X1-E ;Get Settings sheet, set
;autorepeat to 8 and set device to
:RAM.1.
#F ;Get Filer.
|SV|-R-X1-E ;Set device to :RAM.1
#T-R-E ;Get Time.
    
```

### TODIARY.CLI Listing

```

-I ;COMMENT COLUMN, DO NOT ENTER.
This routine takes you to the ;Go to Index page.
DIARY option on the index page.
|CARD| ;Go to CARD display and escape.
    
```



# PROGRAM FILE

-D-D-D-D-D-D-D-D-D-D-D-D-D

```
|CARD| |
-U-D
|CARD| |
```

## ECAT.CLI

This file catalogues the EPROM  
#F  
.:>:RAM.-/EPROM.CAT  
|CE  
.:>:SCR.0

This returns you to the current top entry on the functions menu on the Index page.  
;Because of the way the cursor works on the options, by moving the cursor and repeating the process of going to the CARD display and returning you can guarantee to end up on the Diary option.

```
;COMMENT COLUMN, DO NOT ENTER.
;Enter file.
;Set output to EPROM.CAT.
;Catalogue EPROM.
;Return output to screen.
```

## RAMCAT.CLI Listing

This routine catalogues the current directory of the RAM Disk.  
.:>:ram.l/ram.cat  
|CF\*.\*-E  
.:>:SCR.0

```
;COMMENT COLUMN, DO NOT ENTER
;Set output to file.
;Catalogue directory.
;Return output to screen.
```

## MSAVEE.CLI

This command file creates a second command file, SAVEE.CLI, which when executed will save all the files in the main directory of device RAM.1 to the EPROM in slot 3. This utility is particularly useful after an EPROM has been filled and has to be erased to create fresh storage space.

This program only works where all files are held in the main directory of device :RAM.1. However, it is possible to edit the command files provided to perform the same functions for other devices.

The command file starts by calling two other command files. The first, RAMCAT.CLI, creates a file RAM.CAT with a catalogue listing of the device and directory defined in the command file. The second command file, TODIARY.CLI, takes the CLI to the Diary option on the index page as a way of initialising the program. The main command file then edits this file using PIPEADREAM to create another command file, SAVEE.CLI, to save the files to EPROM. This file can then be further edited manually or executed.

To create a command file, enter the commands as text (do not include comments), and when saving the file, set the SAVE AS PLAIN TEXT option to "Yes".

```
To execute a command file:
Enter "Square" F
Enter "Diamond" EX
At the prompt
Enter :Device\Directory\..\Filename
```

NB. This command file is written using Version 2.2 of the operating system. This may not be compatible with either earlier or later versions of the operating system.

## MSAVEE.CLI Listing

```
This command file produces a
command file to save all the
files in the current directory
to the EPROM.
*:RAM.1/RAMCAT.CLI
*:RAM.1/todiary.cLI
-D-E
|FL:ram.l/ram.cat-D-D-D-Dy-E
|Y
|BRP|D^B^S-D||ES-D-D-Dn-E
|BRP|D^S ^## ^##:###:### ^## ^##:### ^## ^##-D|D--E-D-D-Dn-E
-E|Z|-D
|Z|BD
|BRP|~R-X-X-X^S-D-D-D-Dn-E
-U
|FS|T:ram.l/savee.cli-D-D-D-Dy-E
```

```
;COMMENT COLUMN, DO NOT ENTER
;Execute RAMCAT.CLI
;Execute TODIARY.CLI
;Start PIPEADREAM
;Load catalogue file
;Edit file
```

END

# MICROMART

## NEW AND USED EQUIPMENT BARGAINS (Used unless stated otherwise)

Dec Vax, Unibus and Qus — Systems and Options	Call
Dec Printers and Terminals — VT100, LA120 etc.	Call
Dec Rainbow's, Pro's, Decmate's	Call
Data Dynamics Sig/Net 3 System 3FND	300.00
Superbrain SD, JD, JR — 1 & II, also Compustar	Call
Apple IIe with Symbiotic 20Mb Winchester	Call
Televideo TS806/02 Multi-user CPM System	500.00
Diablo Tractor (for 630, 1640, 1650, 1345 etc.)	75.00
Diablo 630, 1345A, 1641, 1650 Printers	Call
Facit C7500 Serial and Parallel Printer	800.00
Datasouth DS180 Printer	500.00
Intel SBC 304 128k Memory expansion	NEW 150.00
MICROBAR DBC88K Multibus 68000 Single Card	250.00
Archive 90201 Cartridge Tape Drive	NEW 350.00
Matrox RGB 1000, VGM1000 Multibus RGB Colour	300.00
3COM Multibus Ethernet Controller	NEW 350.00
Claude Lyons LVE800 Line Voltage Conditioner	300.00
FARNELL 05-40A Power Supply (5V — 40A)	NEW 100.00
LAMBDA L052-5 OR L0DX-152 Power Supply	NEW 60.00
Mitsubishi D3919 19" Colour Monitor	250.00
Summagraphics Bit Pad One — IEEE Int.	NEW 300.00
Summagraphics 20 x 20 SGPOP Controller	200.00
INTECOLOUR 8001G Colour VDU	350.00
Dataproducs 2230 300LPM Drum Printer	300.00
Facit 4513, serial & par, IBM & Epson, LOP & Graf.	250.00
Cal Comp 1039, 36" drum plotter, serial	1250.00
Citoh C1101 VDU	150.00
WICAT WS150 system, 20Mb, 512kb	750.00
OKI 2410 Printer	500.00
PC DOS (IBM) 3.2/3.3 GTO etc.	NEW Call
Vis-on Optical Mouse (Mouse Systems) — IBM	NEW 100.00
PC Paint (IBM) + Mouse	NEW 65.00
TAXAN 770 +, 760 Colour Monitors	NEW Call

## BOUGHT AND SOLD AT ASHLING UK

Call Tom Tobin on 0788 70618

## SOFTWARE THAT SPEAKS YOUR LANGUAGE

Multi-Lingual Scholar™, word processing and font editing software for the IBM PC or compatible. All characters display on screen with accents, vowel points, diacritics and print (highest quality!) on most dot matrix and laser printers with no hardware changes to computer or printer. Arabic and Hebrew type from right to left, and Arabic characters change shape automatically as you type.

Basic package: US\$350 + 20 airmail shipping, prints on dot matrix printers. Add US\$150 for laser printer support. (Demo US\$22 includes airmail.) Includes: Arabic, Bulgarian, European (also Eastern Europe), Greek, Hebrew, Latin, Persian, Russian, Scandinavian, Serbian, Turkish, Ukrainian, Urdu, Yiddish. Plus one free optional language: Bengali, Gurmukhi, Hindi, IPA, Khmer, Sanskrit, Tamil, Thai, Vietnamese. Additional languages: Amharic, Aramaic, Armenian, Assyrian, Coptic, Phoenician, Syriac, Ugaritic — please inquire. Requires IBM PC/XT/AT or PS/2 or compatible graphics (monochrome or color), 640k, 1 parallel port.

Payment by VISA/MC/AMEX or draft in US dollars payable on an American bank.

### Gamma Productions, Inc.

710 Wiltshire Blvd, Suite 609, Sana Monica, California 90401 USA.

Tel: 213-394 8622 Tlx 510 600 8273 Fax 213-393 7608

Dealer/Distributor inquiries welcome.

## THE MEMORY STORE 136 INGRAM STREET GLASGOW G1 TEL: 041-552 4222

Free virus antidote for Amiga owners with every purchase!

UNBRANDED DISKS				
DS/DD	25	50	100	500
3.5" BULK	£22	£43	£83	£385
5.25" BULK	£10	£19	£35	£140

### ALL DISKS COME WITH LABELS

Lockable Disk Box  
Holds 80 3.5" Disks £7.50

## ALL DISKS GUARANTEED

# MICROMART

## COMPUTER REPAIRS

SPECTRUM 16/48 .....	£19.95
SPECTRUM + .....	£19.95
QL .....	£27.95
COMMODORE 64 .....	£35.00
AMSTRAD 464/664 .....	£24.95
AMSTRAD 6128 .....	£27.95
AMSTRAD PCW 8256/512 .....	P.O.A.
AMSTRAD PC 1512 .....	P.O.A.
PLEASE PHONE FOR DETAILS	

THE PRICES SHOWN ARE FULLY INCLUSIVE OF PARTS, LABOUR, POSTAGE, INSURANCE, VAT AND 3 MONTH GUARANTEE. SEND ITEM WITH CHEQUE AND DESCRIPTION OF FAULT TO:



**BUREDATA**  
COMPUTER REPAIR AND MAINTENANCE

DEPT PCW, UNIT 6,  
STANLEY HOUSE, STANLEY AVENUE,  
WEMBLEY, MIDDX HA0 4JB.  
Telephone: 01-902 5218

# MICROMART

## LASERSETTING SERVICE

Printing • Layout • Production

### Lasersetting

Cheaper than typesetting, faster than any standard computer printer. 300 dots per inch. Wide range of typefaces.

### Full production service

Colour / black & white printing, finishing, binding.

### Design service

Layouts, original artwork, paste-ups, camera-ready copy.

### Copy writing

Experienced technical and marketing writers on hand.

### Disk and Tape conversions

We can accept text on over 1,000 disk and tape formats, as well as offering a keying-in service. We also run a comprehensive disk conversion bureau, starting at £10 per disk + VAT.

### Scanning

Service for photos and artwork. Typereading also available.

### Fast printouts

Straight dumps from disk to paper. Up to 450 pages / hour. From 25p / A4 page.

### See for yourself

This advert was laser-set in-house. Call us now for a quotation.

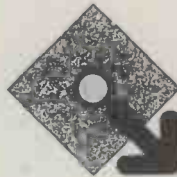

25p/page lasersetting.  
£25/hour layout.  
£15/hour word processing.

### A.L. DOWNLOADING SERVICES

VOYSEY HOUSE  
BARLEY MOW PASSAGE  
LONDON W4 4PT  
Fax: 01-994 4959  
Tel: 01-994 5471

# MICROMART

## Mr Retailer Retailers Point of Sale System

### Now

All the benefits of Point of Sale enjoyed by the Multi Nationals without the prohibitive cost.

Replace your till with a modern computer, as the BIG MONEY EARNERS DO.

all Bookkeeping instantly updated. Immediate access to completely updated Stock records. VAT returns at the press of a key. Even a complete Double entry Balance Sheet available instantly.

All this up to date at the moment you press the key to put your money in your up-to-date till.

The Retailers Dream is Now a reality! Mr Retailer is the complete solution to your headaches and at a FRACTION of the cost. The same type of programme is costing the big boys vast sums of money.

### Mr Retailer Software System

ONLY £495. Dealers required

Complete Mr Retailer system with High quality Tandon 20 Meg Hard disk computer, printer etc £1700. Electronic cash draw available  
All prices plus VAT

## Access Computers

Cranbrook Road, Hawkhurst, Kent TN18 4AT

Phone: 05805 3774 or 0622 58356

## SALT DISK COMPANY 4 CAROLINE ST., WIGAN LANCASHIRE WN3 4EL Telephone: 0942 825550

### GOLD STAR DISKS

#### Main Distributor

All disks bulk or boxed, lifetime guarantee

Individually certified 100% error free at all levels

Equal to above ANSI, DIN, ECMA, ISO and JIS standards

Engineered to the highest possible quality for the maximum in long archival life, accuracy, data integrity and reliability

Average clipping factor of over 80%

Dealers wanted, Phone for quote:

Telephone: 0942 825550

## OPUS STOCKIST

Opus PCIII SF or TF (10MHz PC compatible)  
Hercules from £499 EGA from £799

Opus PCIII HD (10MHz XT compatible)  
Hercules from £995 EGA from £1295

New Opus PCIV (10MHz XT) EGA  
approx £995

Opus PCV (10MHz AT compatible)  
Hercules from £1295 EGA from £1595

Opus Systems-Solver  
(computer desk/workstation)  
£149.95 including chair

Free price list available.  
Computers, peripherals, software and consumables etc.

### R.H.C.C.

Abbey House, 28/29 Railway Approach  
Worthing, Sussex BN11 1UR  
Tel: (0903) 211455 or 213551

## J.C.S

Atari 2 MEG – phone

Atari 4 MEG – phone

Atari A520 STFM – £229

Including starter pack

Amiga A500 – A500 – £449

Including starter pack

Sega Master Systems – £94.95

Atari PC Now in Stock

ALL HARDWARE AND SOFTWARE  
AVAILABLE NOW!!

MAIL ORDER OFFER

4 Graham Street, Airdrie,  
Scotland ML6 6BU  
Telephone: (0236) 69874

# Nashua

## DISKETTES

3 1/2"	100+	500+	1000+
SSDD	1.00	0.96	0.91
DSDD	1.14	1.09	1.04
DSHD 1.4Mb	3.55	3.35	3.15
5 1/4"			
SSDD 48TPI	0.43	0.41	0.39
DSDD 48TPI	0.54	0.51	0.49
SSD 96TPI	0.67	0.64	0.61
DSD 96TPI	0.72	0.68	0.65
DSHD 1.6Mb	1.14	1.09	1.04

Please add VAT at 15%. Carriage free

## CAROUSEL TAPES

Unit D, Inchbrook Trading Estate,  
Nailworth, Glos GL5 5EY  
Tel: 045383 5500

Mini Office Professional £29.99 inc VAT and postage.  
Plus, for this month only, Two Blank top quality CF2's Free with every order.

We also hold stocks of ribbons, paper, disks, labels and accessories, including Banana 5.25" reversibles £9.95 per box.

Diversions at Exmouth Micros.

Large selection of computer games, probably the cheapest in Devon.

For example:

Atari ST. Guild of Thieves RRP £24.95, our price £18.95.

Backlash RRP £19.95, our price £14.95

Rampage RRP £14.95, our price £10.95

Turbo ST RRP £9.95, our price £7.45

All 16 bit games are reduced equally to above

Wargamers and painters of miniatures. We have a fantastic section of all makes and supply tools, rules, paints, RPG'S, figures.

All prices include VAT and delivery.  
Visa facilities or chequest, PO's to:

### EXMOUTH MICROS

South Street, Exmouth, Devon EX8 2SX  
Telephone: (0395) 267734

# Budget TYPESETTING

The pioneers in high quality, budget-priced typesetting of magazines, books leaflets etc. from your disk [IBM, Amstrad, BBC, Apricot etc.] or by modem via our own Typenet system or Telecom Gold.

Send now for your free information pack, to:

BUDGET TYPESETTING

53 Rowan Walk

Bromley, Kent BR2 8QW

Telephone 0689 53546

Typenet 0689 50866

Telecom Gold 83: BTL001



## Your chance to buy, sell or swap equipment.

### Acorn

- **Archimedes 305 Colour System.** Boxed, as new with software and programmers books. £930 ono. Tel: Cardiff (02221) 531018 weekends or after 5pm weekdays. Ask for Bruce.
- **BBC B Colour monitor,** modem, mouse, W wise+, Interword Intersheet, Pagemaker, SuperArt, 3D Icon, Viglen module, Cumana 100k disk drive, Disk Doctor, all manuals. £700. Tel: Day (01) 670 7865.
- **BBC B Dual Teac DSSD drives,** Solidisk DFS, ZIF, ROMS, Cables, Books, Grapad 2, software etc. £350. Tel: Reigate (07372) 43066.
- **BBC B 1770 DFS+ AD FS.** 40/80 DSSD drive. Wordwise and Exmon ROMS. Joystick, valuable software, magazines and manuals. Boxed, as new. £350. Tel: (0623) 641664.

### Amstrad

- **Amstrad CPC6128.** Mono monitor, Hisoft C and Mini Office II. Excellent condition. All manuals. £150 ono. Tel: (0372) 50486 evenings only. (Leatherhead).
- **Amstrad 6128 Colour Computer.** Very good clean condition in original box. Original manuals in good condition. Best offer taken. That is £1 to £1,000,000. Tel: (0706) 58391 anytime.

### Apple

- **Apple Macintosh Plus.** With software. £1350. 400k external disk drive, £100. Tel: (0679) 66688.
- **Apple Macintosh. 512/800k** with 800k external drive and software, £1150. Will split, offers considered. Tel: (01) 882 5769 evenings.
- **Megascreen II, 19" display**

monitor and interface card for Macintosh. Brand new, still in sealed package. Offers accepted. Tel: Max Toti (0703) 771143.

● **Apple II Europlus.** Disk drive, monitor, paddles, colour, Z80 CP/M, Pascal language boards. Videx enhancer, Epson printer, Microbuffer II card. All leads, disks, manuals, software, games, books. Must collect. £400 ovno. Tel: (0703) 865525.

● **Apple IIe Computer** Monitor, keyboard, 2 disk drives, 80 column card, parallel int card, Epson EX80 printer, manuals, Applesoft Prog Kit, £600. Contact Dr K Siva, 18 Eton Avenue, New Malden, Surrey KT3 5AZ. Tel: (01) 949 0220.

● **Apple II Europlus.** With monitor, keyboard enhancer, slots: 0/128k RAM, 1/Grappler+, 2/Serial, 3/Videx, 80col, 4/Z80, 5/Snapshot, 6/Two drives, 7/Colour. All system books/software. Bit stick, Appleworks, Prodos, games, £495. Telephone Watson on (01) 903 4363.

● **Macintosh SE.** 20Mb internal drive, hypercard etc, £2100. Tel: Cook, daytime (0628) 22339 or evening (0491) 571580.

● **Macintosh 512k.** Internal 20Mb hard disk, external drive, Imagerwriter 10" numeric keyboard, LVS2000 modem, carrying case. Software inc, Jazz, Omnis III, MacWrite, Macpaint. All manuals, £950. Tel: (0908) 690690 (J Little)

● **Macintosh 512E.** 800k, Imagerwriter, HD20 serial hard disk, lots of software including Turbo Pascal, ZBasic, Works, Word 3.0, £1500. Tel: Howson (0632) 895342 daytime (0274) 671523 evenings and weekends.

● **Apple IIe.** 80 col card, disk drive and monitor. 16k PAR printer card (Cirtec), colour TV modulator, Apple disks and manuals, PFS File, Print Shop, spreadsheet, Wizardry and frogger with manuals, £475. 8am-8pm Stockton (0642) 553423.

### Apricot

● **Apricot PC.** 256k, twin 360k disk drives, 9" green monitor, Superwriter, Supercalc 3, dBase II, Superplanner, Manager software, £500 ono. Tel: Gerrards Cross (0753) 882461.

● **Apricot portable,** 256k, 720k disk, MS-DOS, Superwriter, Superplanner, Supercalc, with carrying case and all manuals, £200. Tel: (0639) 830561 evenings and weekends.

● **Apricot XI.** 10Mb HD, 512k RAM. Supercalc 3, Delta 4 Prof, Toolkit, Superwriter plus investment programmes. Lots of disks. All manuals and other software. Epson MX80 printer. All in superb condition, £995. Tel: (061) 872 0951.

● **Apricot F2 512k.** Twin 720k drives, 12" monitor, mouse, GEM software, £400. Tel: (03553) 3527.

### Atari

● **Atari Triange Pro-Draw Tablet.** Accurate drafting. As new, £220. Also Robtek Mac Emulator cartridge with ROMs and software, boxed, £75. Tel: Peter Douglas on (0272) 262429.

● **1040ST.** Upgraded to 4Mb, SCI224 colour monitor, 2nd 1Mb drive, Fast Basic cartridge, joystick, KRam, KSpread 2, Starglider, 1st Word and manuals, £850 ono. Tel: (061) 431 6659 after 6.30.

### Commodore

● **Commodore business System.** 8096 computer, 96k memory, double disk drives, 80 column printer. Software manuals, all in good condition. Sell £225 ono. Tel: (01) 886 0181 days, Mr Clement. Can deliver UK.

● **C128.** £160, 1571 d/drive, £160, 1901 monitor, £225. Green 40/80 monitor, £50. SG10C printer, £80. CBM modem, £15. Datasette £10. All vgc, will accept £650 the lot. Tel: Rayner (0509) 245400.

● **Commodore 64.** Disk drive, cassette unit, printer recently serviced. Over £500 top software and manuals, plus 50 disks. Only £500. Will not split. Tel: Macki (01) 685 1186 evenings and weekends.

● **Amiga A500.** Philips colour monitor, external disk drive, Star NL10 printer, Word Perfect plus £300 worth of software. Only 5 months old, £800 ono. Tel: Paul (01) 514 3725.

● **Amiga A500.** Brand new, TV modulator, two years extended warranty, software, blank disks, disk holder, joystick, audio leads, drive cleaning kit, keyboard cover, worth over £620, £550. Tel: (0233) 23670.

● **C128.** 1571 disk drive, mono monitor, MPS 803 printer, Wordwriter 128, database, CP/M assembler, Hisoft C Compiler and manuals. Worth £900+. Only £500 ono. Tel: (0252) 20547.

### CP/M

● **ICL PC2.** 512k RAM, 20Mb hard disk, 780k floppy, mono VDU, CCP/M-86, Personal Basic, all manuals, OKI 83A printer, £750 ono. Tel: (01) 570 2538.

● **Epson QX10.** 256k, CP/M

2.2, 2x360k DD, Hi-res monitor, Multifonts Basic, Peachtree software, spreadsheet, word proc, spell/MM, dataplot, Pearl Database, Nom/Ledgers, manuals. Original packings, as new, £415. L. Morris, 7 Fitzroy Park, London N6. Tel: (01) 348 3167.

● **Gemini Galaxy 2.** Twin 400k 5 1/4" disk drives, 64k RAM, IVC, keyboard, two green screen monitors, CP/M 2.2, Comal-80, lots of manuals, £250 ono. Tel: (0707) 46654 after 7pm.

● **ICL PCXM.** 800k floppy, 10Mb HD, CP/M 86, C Dos 80286, Co Bol, Green screen, Networkable multiuser. Offers above £400, or will swap for IBM compatible or other MS-DOS portable, must have 2 floppies. Tel: (0480) 75036. (Huntingdon).

● **Sirius I.** 760k, twin drives, excellent condition, MS-Dos 2.11, SC3+GSXE, Delta 4, Select word processor, Graphics toolkit, Magic Memory Manager and manuals. Plus Kode 43 printer, £550. Tel: Ross-on-Wye 62013.

### IBM & Compats

● **Amstrad PC1512.** Dual drive, mono monitor, mouse, MS-DOS plus, Locomotive Basic 2, Turbo Pascal V3.0. Perfect condition, original packaging, £475. Tel: Bristol (0272) 392615 evenings and weekends.

● **Olivetti M24 Computer.** 640k RAM, 10Mb hard disk, monochrome monitor, MS-DOS 2.11, IBM compatible, runs at 8MHz. Complete with manuals, £700 ono. Tel: (054) 04 255.

● **Opus PCII.** 30Mb hard disk, 360k floppy, 1Mb RAM. Hi-res amber monitor, MS-Dos 3.2, GW Basic, private

E  
N  
D  
Z  
O  
N  
E

## TRANSACTION FILE ADVERTISEMENT FORM

All Transaction File ads must be submitted by readers on this form or a photocopy of this form. Maximum 30 words. Print one word per box, very clearly. Name, full address and/or telephone number must be included in the 30 words. All ads must be accompanied by a flat fee of £5. Make cheques or POs payable to *Personal Computer World*. Ads accepted from private readers only. Ads cannot be repeated (unless sent in on another form) and we cannot guarantee to print an ad in any specific issue. Please help our typesetter to help you by writing your ad very clearly. Send your completed form to: Chris Cain, Transaction File, PCW, 32-34 Broadwick Street, London W1A 2HG.

Please find enclosed my cheque/PO for £5, together with details of my name, address and telephone number.

Please tick the appropriate category for your ad from those listed below:

Acorn  Amstrad  Apple  Apricot  Atari  Commodore  CP/M  IBM & Compatibles  Miscellaneous  Monitors  Peripherals  Portables   
Printers & Plotters  Sinclair  Software  Sharp  Tandy  Wanted

use only, £850. Tel: Woking (04862) 23697 evenings.  
 ● **Toshiba T3100/10.** 10Mb hard disk AT compatible portable computer. Only £1900, as new. Also Epson FX80 printer, £200. Microsoft mouse and software, £100. All boxed. Excellent Condition. Tel (0442) 59964.  
 ● **DELL 286.** 2Mb hard disk, Hercules card. Recently bought and still under guarantee. Plus business software, £850. Also Amstrad DMP 4000 printer. Excellent condition, £200. Tel: (01) 892 8129.

### Miscellaneous

● **LOTUS METRO.** Pop-up desktop utility unopened. £35. AST 101-key keyboard (ATE) brand new. £65. AST 3G+ display board (EGA, CGA, MDA, Hercules compatible) 6 months old. £80. (01)-444 8344.  
 ● **Da Comm PC123bis Modem.** As new, with manuals. Internal card for IBM and compatibles, £400 ono. Please Tel: Peter Clark on (01) 328 0047 for more details.  
 ● **Victor Sirius.** Plus Juki with sheet feeder, Vuwriter, Mirabilis, 2 drives. RML 3802, monitor, twin drives plus assembler, Fortran, Wordstar, CP/M etc. Serial Juki 6100 daisywheel printer unused. Tel: (days) (01) 589 4224. Any offers.  
 ● **CGA Card for PC.** New, £80. Hard disk controller, £45. 500k floppy drive, £30. Tel: (01) 794 6247 evenings. Offers considered.

● **Kontron Programmer MPP-80S.** Built in UV-Eraser, Z80 Micro-Processor and 128k Data-memory. Carry case, Modules, MDM II, MDM19 socket adaptor. MPP80 etc. Current price £3000+. Sensible offers. Tel: (037) 387 459. Details available.

### Monitors

● **Taxan Supervision 620II High Resolution 12" colour monitor.** IBM, BBC and Apple compatible. Text mode colours variable. Boxed, leads and instructions, £190. Tel: (01) 341 2187.

### Portables

● **Z88 + 128 RAM.** With 128 EPROM + 3x32 EPROM. EPROM eraser, printer cable, mains adaptor. Excellent machine, £450 for the complete system. Tel: Norman (041) 641 4331, 9-4, (041) 632 3314 after 5pm.  
 ● **Psion Organiser XP.** With 16k RAM plus 32k RAM pack (£190 when new), manual plus book; Using and Programming the Psion Organiser II, £65. Tel: (01) 444 8344.  
 ● **Toshiba T1100.** 512k, serial/parallel ports. New, £600. DisplayWriter 3, new, £180. VP Info £25. Tel: (0922) 30827.  
 ● **Epson PX8 System.** Inc P80 printer, CX-21 Modem, tapes, ribbons, cables and manuals. All in fitted case. Software includes portable Wordstar, £200 the lot. Tel: Andy Skilling (0695) 623377. Lancs.

● **Psion Organiser Model CM.** Includes 64k and 32k Data packs. All boxed with manuals, £100. Tel: (01) 778 1254 evenings or weekends. Anil Bagga, 21 Piquet Road, London SE20 7XY.

### Printers & Plotters

● **Brother HR20 Daisywheel Printer.** Also Auto sheet feeder, £320. Includes two daisywheels. Excellent condition. Tel: (01) 940 3680 anytime.  
 ● **Diablo 635 Daisywheel Printer.** Parallel I/F as new complete with spare print wheels, ribbons, manual, £250 ono. Epson FX100 with tractor feeder, buffered serial I/F, spare ribbons, manual, £100 ono. Tel: (0734) 340736  
 ● **Epson LQ1500.** Full width high duty, 200cps, 24pin printer. Complete with tractor feed option, parallel and serial interfaces and manual, £575. Douglas, (Brentford). (01) 847 5011.  
 ● **Epson FX80 Printer.** With centronics interface, NLQ card fitted, £120. Tel: (0572) 812 447 (Mike).

### Sinclair

● **Sinclair QL.** JS-ROM. 512k ExpanderAM, CST disk interface, twin 3.5" disk drives, mono monitor, printer, Super Toolkit II ROM, BCPL, Utilities, Professional Astrologer, games, books etc, £400. Tel: Cliff on (01) 577 0323 evenings.

### Software

● **Guaranteed untouched MacUser Prizes.** One Laserbase database package. One parcel of goodies (Mat, book, T-shirt etc). Swap for Digitiser tablet or offers. Tel: Lutterworth (045-55) 4494.  
 ● **Condor I for Amstrad 8256/8512.** With manual, £25. Tel: Guildford 892531.  
 ● **Pageability DTP.** Seal unbroken, £85. Pageability, seal broken, £60. Lotus Metro X2, unopened, £25 each. Paradox 1.1 relational database, £50. PC Four, integrated, £20. Sage Financial Controller, Accounts, £90. Tel: (01) 444 8344.  
 ● **IBM Software.** Sidekick, Ability, Turbo Prolog, Deja, Q&A, Budget Delta, Turbo Lightning, £25 each. Apricot 256k RAM card, £50. Tel: (0732) 843384 evenings.  
 ● **Software.** MS Basic. WriteNow, Pascal, Lode Runner, Sargon III, MacAttack, Enchanted Scepters, Dark Castles, Eilevision, Mind, Prober, Transylvania, MacSpell Right, First Book of Macintosh Pascal. The lot for £250. Ansaphone (0303) 57492.  
 ● **DBase III Plus.** Latest version, never used. Cost £455, accept best offer over £250. Lattice C for Atari ST, unused, accept £35. Tel: Chris (0425) 474674.  
 ● **MICRO SOFT PASCAL V.3.3.** With all original documentations. Good reason for sale, £50. Tel: (01) 794 2373 after 6pm.

### Sharp

● **Sharp MZ-80A.** Twin disk drives, P3 printer, software + books, vgc., £475 ono. MZ-80k printer + FD cards. I/O Box software + manuals, £75 ono. Tel: (0934) 742738.

### Tandy

● **TRS80 Model 3.** 48k hard disk, two expansion drives. Manuals and games, needs servicing. Also Newbury high performance ribbon printer, £250 for both: Tel: (0689) 24374 evenings and weekends.  
 ● **1000EX IBM Compatible Computer.** With PFS File, PFS Write, Deskmate, Joystick, colour monitor, 2 games, Epson LX80 printer, £400. J Price, 18 Garret Close, Charterfields Estate, Kingswinford, West Mid., DY6 7RF. Tel: (0384) 279687.

### Wanted

● **Software for IBM-AT.** Professional word processor, database, DTP, painting and graphics to run under Windows or GEM. Also Flight Simulator, PC Tools, Norton Utilities, Sidekick, Desq View and games. Tel: Huntingdon (0480) 57936.  
 ● **REWARD FOR MANUAL OF THE EXIDY SORCERER WORD PROCESSOR PAC.** Could arrange to copy if necessary. Tel: (01) 445 3310 leaving your number or write 31 Temple Avenue, London N20 9EH.

## DIARY DATA

**A look ahead at computer shows to June. Readers are advised to check details before setting out on their journey.**

<b>COMPUTERS IN TRANSPORT AND DISTRIBUTION</b> Wembley Conference Centre, London — Computers in Transport and Distribution (0303) 45979	19-21 April 1988
<b>ATARI COMPUTER SHOW</b> Alexandra Palace, London — Database Exhibitions (061) 456 8383	22-24 April 1988
<b>COMFEST '88</b> Telford Exhibition Centre, Telford — (0952) 505522	12-14 May 1988
<b>COMMODORE COMPUTER SHOW</b> Champagne Suite, Novotel — no further details available at press time	3-5 June 1988

## LEISURE LINES

**Brainteasers courtesy of JJ Clessa.**

### Quickie

How much earth is there in a hole measuring 2 feet by 2 feet by 2 feet? The answer is *not* eight cubic feet.

### Prize puzzle

A short and not too difficult problem in logic this month.

On the island of Asselc, there are only two tribes of inhabitants:

- The Luddites — who always tell lies.
- The Verities — who always

tell the truth.

A visitor to the island sees four natives of Asselc walking down the street, and he asks if they are Luddites or Verities.

The first native says, 'We're all Luddites.'

The second says, 'Only one of us is a Luddite.'

The third says, 'Two of us are Luddites.'

The fourth says, 'I'm a Verity.'

To what tribe did the fourth native belong?

Answers on postcards only,

please, to arrive not later than 31 May 1988.

Send your entry to: Leisure Lines Prize Puzzle — May, *Personal Computer World*, VNU House, 32-34 Broadwick Street, London W1A 2HG.

### February prize puzzle

Alas, the February puzzle contained a typographical error. The word 'total' should have read 'product' — as many of you realised.

Whether it was for this or another reason, only 26 entries were received — and seven of these were incorrect. Perhaps it was more difficult than usual.

Anyway, the cost of the statue was £7 and the winning card, drawn at random from the 19 correct entries, came from Mr DG Sheffield of Haverford West, Dyfed.

Congratulations, Mr Sheffield — your prize is on its way.



## Mike Mudge explains the concept of difference tables.

Many readers will already be familiar with the concept of difference tables. These tables arise in any introduction to numerical methods or, more simply, in the process of interpolation — central to the use of tabulated function values (now, alas, frequently replaced, with a consequent lack of understanding, by the use of the pocket calculator!).

Suppose that  $y = f(x)$  is tabulated at equal increments,  $h$ , in the independent variable  $x$ ; these  $x$ -values being denoted by  $x_0, x_1 = x_0 + h, \dots, x_n = x_{n-1} + h = x_0 + nh$  and the corresponding  $y$ -values by  $y_n = f(x_n)$ .

The first forward differences,  $dy$ , of  $y$  are defined by  $dy_n = y_{n+1} - y_n$ .

The second forward differences,  $d^2y$ , of  $y$  are similarly defined by  $d^2y_n = d(dy_n)$ .

This apparently elaborate algebraic notation is readily clarified by the following example. Suppose  $y = x^3 + 1$  with  $x_0 = 2$  and  $h = 3$ : the difference table begins as shown in Fig 1.

Clearly, the second differ-

ences of  $n^2$  are constant and equal to 2.

**Question** Do there exist non-consecutive integers  $x_0, x_1, x_2, \dots$  such that the second differences of their squares are constant? Specifically, can that constant be equal to 2?

**Answer** Yes! For example (6, 23, 32, 39) see Fig 3.

Duncan A Buell, of the Supercomputing Research Center, 4380 Forbes Boulevard, Lanham, Maryland 20706, USA, has recently (1987) completely characterised such sequences of length 4 but states that the existence of such sequences of length 5 (and above) is still an open question.

He poses an intermediate step, which he calls problem B<sup>7</sup> seeking a sequence of five integers  $n_0^2, n_1^2, n_2^2, n_3^2, n_4^2$  where  $n_0, n_1, n_2$  are not consecutive such that their second differences are constant, say,  $c$ , and specifically with  $c = 2$ .

### Problems

(i) Construct a computer program to input function values

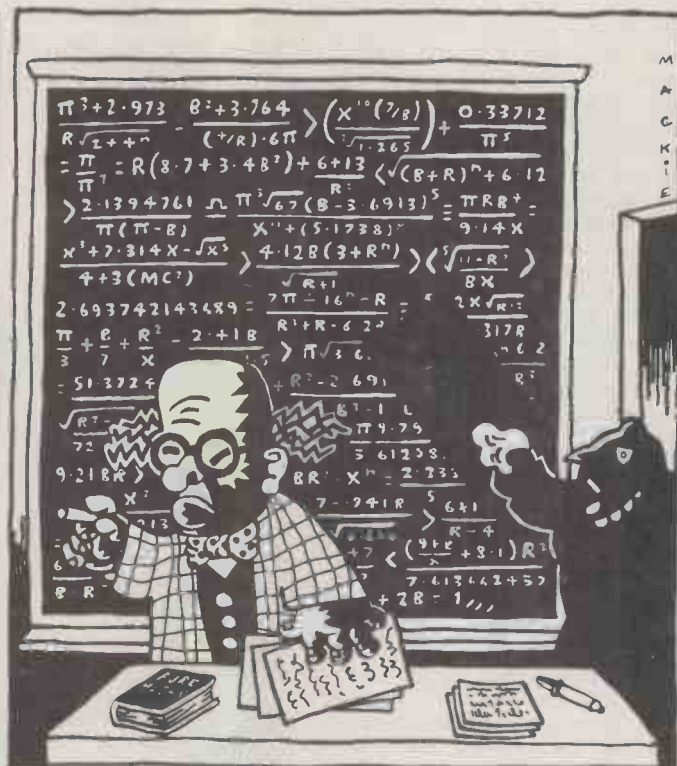

and print out, correctly formatted, the associated difference table up to the  $n^{\text{th}}$  differences.

(ii) Search for sequences of four squares such as (6,23,32,39) and (39,70,91,108) whose squares have second constant differences.

(iii) Extend (ii) to sequences of five integers in the pattern of Buell above.

(iv) Attempt to resolve Buell's open question regarding sequences of five squares.

(v) Given that the  $n^{\text{th}}$  difference of a table of  $n^{\text{th}}$  powers is constant (see  $d^3y$  for  $y = x^3 + 1$  above) investigate sequences of non-consecutive integers whose cubes have constant third differences, and so on, through fourth and fifth powers.

Readers are invited to send their attempts at some, or all, of the above problems to Mike Mudge, 'Square Acre', Stourbridge Road, Penn, South Staffordshire WV4 5NF, tel (0902) 892141, to arrive by 1 August 1988. It would be appreciated if such submissions contained a brief description of the program and a summary of the results obtained in a form suitable for publication in PCW.

These submissions will be judged using subjective criteria, and a prize will be awarded by PCW to the 'best' contribution received by the closing date.

Please note that submissions can only be returned if a suitable stamped, addressed envelope is provided.

### Review, November

This problem produced a variety of responses, the largest powerful number seen being 467 9307774, degree 10, base 10. The geometrical interpretation hinted at in the article may well be a figment of the author's imagination — no-one made significant progress along these lines!

The very worthy prizewinner is Brian Stuart of Düsseldorfstr 11, 8000 Munchen 40, West Germany. Brian searches for powerful numbers for all number bases from 3 to 99 to all possible degrees, with a restartable algorithm. By 24 January 1988 he had reached  $3 \times 10^6$  for all bases and  $10^8$  for some; with a target of  $2^{31}$  'at some 11 million per hour'.

Among the many interesting results were: (a) 19 5 16 base 24 (=11080 decimal) is powerful of degree 3 and the only powerful number base 24 less than  $119 \times 10^6$ ; and (b) no powerful numbers found to base 90.

Mike Mudge welcomes correspondence on any subject within the areas of number theory and other computational mathematics. Particularly welcome are suggestions, either general or specific, for future Numbers Count articles; all letters will be answered in due course.

Isolated readers can be put in contact with others sharing the same interests. However, greater efficiency regarding published problems should result from contacting the prizewinner.

$x$	$y = x^3 + 1$	$dy$	$d^2y$	$d^3y$
2	9			
		126 - 9 = 117		162
5	126		270	
		513 - 126 = 387	432	162
8	513			
		1332 - 513 = 819	594	162
11	1332			
		2745 - 1332 = 1413	756	162
14	2745			
		4914 - 2745 = 2169		
17	4914			

Fig 1

$n$	$y = n^2$	$dy$	$d^2y$
1	1		
		3	2
2	4		
		5	2
3	9		
		7	2
4	16		
		9	2
5	25		
		11	
6	36		

Fig 2 The difference table for  $n^2$

$1$	$n_i$	$y = n_i^2$	$dy$	$d^2y$
0	6	36		
			493	
1	23	529		2
			495	
2	32	1024		2
			497	
3	39	1521		

Fig 3

## Rupert Steele presents his regular round-up of UK user groups.

As regular readers will know, the computer club and user group movement is divided into national user groups, listed in the directory opposite, which typically publish newsletters, and the local computer clubs, where computer people can meet each other.

Spanning both groups, but with a particular responsibility towards the local clubs, is the British Association of Computer Clubs (BACC) — a body which we all used to know and love as the 'Association of Computer Clubs'. The BACC took on its new name just before Christmas, and along with it a new secretary in the shape of Vernon Quaintance who, as many Prestel enthusiasts will know, is system manager for the ClubSpot 810 area.

It continues to operate its referral service, putting people in touch with a local computer club for the price of an *sae* sent to John Dale, the database manager (see the directory for his address). There is an important new benefit for members of clubs that are affiliated to BACC — namely reduced price access to Rod Smith's Public Domain software library of over 2000 disks.

Clubs affiliated to the Association also get free public liability insurance cover to £500,000 (although it is planned to upgrade this to £1m) and can also purchase *unspecified items* all risk cover on equipment brought to their meetings. This is remarkably good value and the price has actually fallen since last year. For example, cover to the tune of £4000 now costs £14.50 a year. Certainly, in the days when I ran the Kensington & Chelsea Computer Club we regarded this as essential when inviting speakers to bring their expensive equipment to us.

### Spin speed

While on the subject of local clubs, I have been sent a newsletter by the Bournemouth & Poole Atari User Group. This newsletter, called *8:16*, caters for the range of Atari machines, including the ST. It was actually produced on an Apple Mac Plus with a laserprinter and Pagemaker, although the group hopes to move to running on an ST with Timeworks or Fleet Street Publisher.

The design is very good and the content interesting, including articles on a CD-ROM/CD audio player for £399, a program to check the physical speed of rotation of your ST

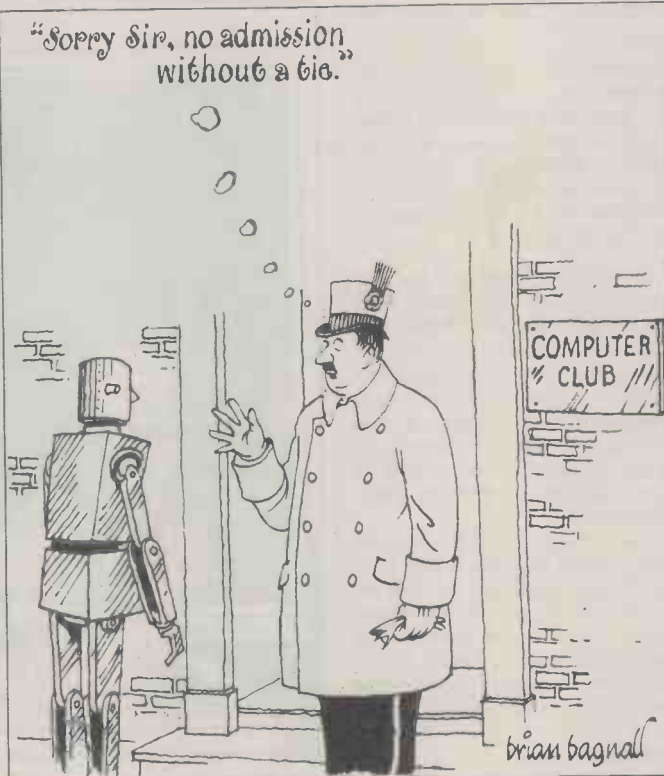

disk drive, and information on how to drive the icon handler on an ST. In short, *8:16* is one of the best local computer club newsletters I have seen.

The group meets on the first Friday of every month at the Kinson Community Centre, Pelhams, Millhams Lane, Kinson. Details from Colin Hunt, 248 Wimborne Road, Oakdale, Poole, Dorset; or call him on (0202) 677895. The group is a member of the Association of Atari User Groups and will no doubt be visiting the Atari User Show at Alexandra Palace from 22-24 April.

### Arcade action

Moving east, we come to the Reading Computer User Group (RUG). This meets on the first and third Thursday of each month in the senior common room of Reading University at 7.30pm.

Each meeting has a theme, and subjects cover the range from database to arcade games. The group produces a very neat A4 newsletter called *RUG NEWS*. The use of an Apple Mac with a laserprinter helps to keep things tidy. In the issue just sent to me, there was the first part of a simple introduction to C, a crossword style puzzle, details of various online services and lots of programs for the Beeb. Contact Richard Rowlands, 28 Anstey Road, Reading RG1 7JR or call him on (0734) 596825.

Onwards toward London, and I received a note from the West London Personal Computer Club, one of the few still active in the capital. The group is celebrating its 10th Birthday, having been founded in 1978. It is a long-standing member of the BACC. It meets on the first and third Tuesday of each month from 7.30 to 11pm at the *George and Dragon*, Acton High Street, Acton. The first meeting of the month is usually a formal talk, while the second generally consists of informal demonstrations of whatever equipment members have to hand.

There are a number of informal sub-groups in the West London club. The major ones are for the BBC machines, comms and MS-DOS. However, it is rumoured that the most powerful sub-section is the Pizza Subgroup that operates across the road on club night meetings. The details are available from the chairman, nicknamed 'Blue', and you can contact him on (01) 579 5415.

### Spotlight on Sharkey

Continuing east, the spotlight rests on Alan Sharkey of the Anglia PC User Group. The group has been running for almost two years, covering the IBM PC and its various clones. There are about 60 members who come together for 'extremely irregular meetings',

but the main purpose of the club is as a source of public domain software and cheap floppy disks, as Alan has a library of around 400 PD disks and access to cheap floppies in bulk. The group does not make any profit and Alan runs it in his spare time as he has a 'real' job with DEC.

He charges £20 to join the group and then makes available PD software disks at £5, while selling the floppies at 50p each. For details, contact Alan at Warren Cottage, Warren Lane, Elmswell, Suffolk IP30 9DT or call him on (0359) 41601.

Finally, returning to national matters, I have received the second newsletter from TUG — the Transputer Users Group. Howard Oakley writes to say that the club now has over 110 members in seven different countries. Most of the interest remains in add-in cards for PCs and other systems like the Atari Mega ST. Nobody seems to be making full-blown transputer systems at a reasonable price.

My old friend Leon Heller (who many of you may know as a leading light of NATGUG and Quanta — the QL group), now with Concurrent Techniques, is also reported to be beavering away at budget transputer systems, including a 7.5 MIP card for around £475 — although you'll have to find another £150 to plug it into a PC. Leon is also a keen member of TUG.

Perhaps the best feature of TUG's newsletter is a four-page Product News section where the transputer developments from no less than 18 companies are reported. This is backed up with a further page of unattributable product gossip.

It is certainly very refreshing to read a journal from a user group which is so clearly involved with the breaking of new ground in technology — a far cry from those groups supporting more conservative products like the various 8086-based offerings from Amstrad. For full details, contact Howard Oakley, TUG, Brooklands Lodge, Park View Close, Wroxall, Ventnor, Isle of Wight PO38 3EQ.

If you would like your user group or club to have a mention in this column, or you wish to be considered for the Directory of User Groups, please write to Rupert Steele, 12 Philbeach Gardens, London SW5 9DY or tel: (01) 370 0601.



## Machines H-Z

**HEWLETT-PACKARD HANDHELD**  
HPCC Membership Secretary,  
Geggs Lodge, Hempton Road,  
Deddington, Oxford, OX5 4QG.

**HITACHI MBE 16002 PC**  
Bruce Ainge, HICUPS, 16 Nine  
Acres Road, Cuxton, Kent,  
ME2 1EL. (0634) 715759

**IBM PC**  
IBM PC User Group, PO Box  
830, London, SE1 0DB.  
01-620 2244. £25 personal;  
£95 corporate. Professional.

**JUPITER ACE**  
Mr J R Charter. Jupiter ACE  
Users Group, 8 Abney Close,  
Cheadle Ave, Chesterfield,  
S40 4PF. (0246) 37555. SAE.

**MEMOTECH**  
Phil Eyres. Memotech Owners  
Club, 23 Denmead Road,  
Harefield, Southampton,  
SO2 5GS. SAE.

**MOTOROLA 68xxx MICROS**  
Rick Applegate,  
68 Microgroup, 8 Great Cob,  
Springfield, Chelmsford,  
Essex. BBS 01-316 7402.

**MSX SYSTEMS**  
Keith Neal, MSX Link.  
Austerby House, 80 Austerby,  
Bourne, Lincs. PE10 9JL. (or)  
Craig Bell, North Lodge,  
Calrnhill Road, Airdrie, Lan-  
arkshire, Scotland, ML6 9RJ.

**MSX SYSTEMS**  
Lee Simpson. MSX User  
Group, 3 Mayfair Pl, Tuxford,  
Newark, Notts. NG22 0UD.

**MSX SYSTEMS**  
Memory Alpha, 16 Mayfield,  
North End, Portsmouth,  
Hants. SAE.

**NASCOM/80-BUS/CPM**  
Scorpio Systems, PO Box 286,  
Aylesbury, Bucks, HP22 6PU.  
(0296) 624868.

**NEWBRAIN**  
Gerald McMullon, NBUG,  
36 Armitage Way, Cambridge,  
CB4 2UE. SAE.

**NEWBRAIN**  
Ron Bury. OPEN#STREAM,  
70 Cranberry Lane, Darwen,  
Lancs, BB3 2HL.  
(0254) 771891.

**ORIC**  
Gary Ramsey, IOUG,  
1 Kingsway Crescent,  
Burnage, Manchester,  
M19 1GA. Newsletter.

**OSBORNE/CPM/MSDOS**  
Jeremy Browne, BOOG Ltd.,  
102A Aldershot Road, Hants,  
GU13 9NY. (0252) 621745.  
BBS on (0252) 626233.

**PSION ORGANISER**  
Mike O'Regan, Independent  
Psion Organiser User Group,  
130 Stapleford Lane, Beeston,  
Nottingham, NG9 6GB. Monthly  
newsletter. SAE.

**RESEARCH MACHINES (RML)**  
RML National User Group,  
Steve Burrows, Wirral CAE  
Services Ltd, Gorse Lane,  
Wallasey, Wirral, L44 4HE.  
051-639 8237. All RML micros.

**SAMURAI S16**  
Andrew Lee, Samurai S16  
Self-Help User Group,  
57 Darnley Rd, Gravesend,  
Kent, DA11 0SF. SAE. S16 is  
discontinued MSDOS non-PC.

**SANYO MBC-550**  
Mr M H Syed, Wistaria, 53  
Acacia Grove, New Malden,

Surrey, KT3 3BP.  
01-942 9009. Informal group.

**SHARP**  
Andrew Fergusson, Sharp  
User Group, 11 Harcourt Clo,  
Henley on Thames, Oxon, RG9  
1UZ. (0491) 574850. £6.  
60pp Newsletter. Software.

**SINCLAIR QL + COMPATIBLES**  
Brian Pain, Quanta, 24 Oxford  
Street, Stony Stratford,  
Milton Keynes, MK11 1JU.

**SINCLAIR QL + COMPATIBLES**  
Richard Turner, QL Super  
User Bureau, PO Box 3,  
Shildon, Durham, DL4 2LW.  
£15 (£30 business). 50p for  
sample of monthly newsletter.

**SORD M-23**  
Mr B Nicholson, c/o Aberdeen  
Reservoir Interpretation  
Centre, Woodlands Drv, Kirk-  
hill Industrial Estate, Dyce,  
Aberdeen. (0224) 771117.  
Informal group.

**TANDY/GENIE/AMSTRAD/MSDOS**  
Roger Storrs, NATGUG,  
Oakfield Lodge, Ram Hill,  
Coalpit Heath, Bristol,  
BS17 2TY. (0454) 772920.  
Newsletter. PD software.

**TEXAS TI99/4a**  
Peter Walker, TI99/4a User  
Group (UK), 24 Bacons Drive,  
Cuffley, Potters Bar, Herts,  
EN6 4DU. (0707) 873778. £10.  
Newsletter. Software library.

**TEXAS TI99/4a**  
Gordon Pitt/Peter Brooks,  
International TI User Group,  
259 Sneyd Lane, Bloxwich,  
Walsall, WS3 2LS. £12.50.  
Bloxwich 476373. Newsletter.

**TRANSPUTER**  
Dr Howard Oakley,  
Transputer Users Group,  
Brooklands Lodge, Park View  
Close, Wroxall, Ventnor, Isle  
of Wight, PO38 3EQ. £5.

## Local clubs

**DETAILS OF YOUR LOCAL CLUB**  
SAE please to John Dale,  
British Association of Com-  
puter Clubs, Banc-y-rhosyn,  
14 Bron Y Glyn, Bronwydd  
Arms, Carmarthen, SA33 6JB.

## Amstrad

**AMSTRAD (SERVICES USERS)**  
LtCol Charles Joint, Services'  
Amstrad Society, Leros TA  
Centre, Sturry Rd, Canter-  
bury, CT1 1HS. (0227) 61397.  
£5. Newsletter.

**AMSTRAD 1512/1640**  
1512 Independent User  
Group, PO Box 55, Sevenoaks,  
Kent, TN13 1AQ. (0732) 63157.  
£22 pers; £25 business.

**AMSTRAD ALL MACHINES**  
National Independent Amstrad  
User Club, 1 The Middle Way,  
Wealdstone, Harrow, HA3 7EG.  
£9 (specify machine). A5  
SAE. Discounts. Newsletter.

**AMSTRAD ALL MACHINES**  
Jeffrey M Green, Advantage,  
West One House, St Georges  
Road, Cheltenham, GL50 3DT.  
(0242) 222307. Newsletter;  
software lib; SAE.

**AMSTRAD BUSINESS USERS**  
Amstrad Professional User  
Club, Enterprise Hse, PO Box  
10, Roper St, Pallion Indus-  
trial Estate, Sunderland, SR4  
6SN. 091-510 8787. £39.95.

**AMSTRAD CPC HOME USERS**  
Jeff walker, WACCI, 75 Great-

fields Drive, Hillingdon,  
Uxbridge, UB8 3QN. (0895)  
52430. £12. Newsletter.  
Special offers. Good fun.

**AMSTRAD LOCAL GROUPS**  
Amstrad Groups Federation,  
4 Sutton Road, Gorton,  
Manchester, M18 7PN.

**AMSTRAD PCW**  
Robert Moberley, PCW Users  
Group, 37 Clifford Bridge  
Road, Binley, Coventry,  
CV3 2DW. (0203) 441417.  
Monthly newsletter. SAE.

**AMSTRAD PCW**  
Ron Morland, The PCW  
Computer Club, 12 Deneve  
Avenue, Poole, Dorset,  
BH17 7LR. SAE.

**AMSTRAD PCW**  
Chris Bryant, PCW File,  
11 Havenview Road, Seaton,  
Devon, EX12 2PF. £7 with  
free PD software. Large SAE  
for sample newsletter.

**AMSTRAD PD SOFTWARE**  
Peter Vass, Computer  
Services (Scotland), PO Box  
244, Glasgow.

**AMSTRAD SOFTWARE**  
Amstrad User Software  
Database, PO Box 11,  
Gosforth, Newcastle-upon-  
Tyne, NE3 1RP. 091-285  
6017. Fido bulletin board.

## Software & networks

**ASHTON TATE SOFTWARE**  
Clare Winter, Servicellne,  
Ashton Tate UK Ltd, 1 Bath  
Road, Maldenhead, Berks.  
(0626) 33123. Online support  
via Telecom Gold.

**C LANGUAGE**  
Martin Houston, CUG, 36  
Whetstone Close, Farquhar  
Road, Edgbaston, Birmingham,  
B15 2QN. £10.

**CPM MACHINES**  
PIP, 28 Gordon Mansions,  
Torrington Place, London,  
WC1E 7HF. Supports Amstrad,  
Einstein, Osborne etc; BBS.

**CPM USERS**  
Diana Fordred, CPM Users Gp  
(UK), 72 Mill Road, Dartford,  
DA2 7RZ. (0322) 22669. PD  
Software. Also covers MSDOS.

**ECONET**  
Michael Ryan, Econet User  
Group, Balkeerie Cottage,  
Eassie by Forfar, Angus,  
DD8 1SR. £8.60. Newsletter.

**ENET (Ilike Econet)**  
Mr T K Boyd, Enet (Amcom)  
User Group, Seaford Cottage,  
Petworth, West Sussex, GU28  
0NB. Frequent info sheet in  
return for SAEs to despatch.

**LOTUS PRODUCTS**  
Lotus User Group, 79-80  
Peascod St, Windsor, Berks,  
SL4 1DH. (0753) 841686. £95.  
Magazine, helpline etc.

**LOTUS PRODUCTS**  
World of Lotus, Telecom Gold  
Ltd, 60-68 St Thomas Street,  
London, SE1 3QU. Online  
(Gold) support £9.60/hour.  
Free macros, drivers etc.

**PC SOFTWARE**  
PC-SIG, ISD Ltd, PO Box 872,  
Sutton Coldfield, W Midlands,  
B75 6UP. £6/disk + donation  
to author. 700+ disks.

**PC/APRICOT/CPM SOFTWARE**  
PD-SIG Ltd, 90 Braybourne  
Close, Uxbridge, UB8 1UJ.

(0895) 51978 or 01-864 2611.  
BBS on 01-864 2633. PD  
software & disk conversions.

**SINCLAIR SPECTRUM SOFTWARE**  
Neil Smith, The One & Only,  
42 Hayes Road, Bromley, BR2  
9AA. Software exchange. SAE.

**SOFTWARE VIA BBS**  
Frank Thornley, Compulink,  
67 Woodbridge Rd, Guildford,  
GU1 4RD. BBS (0483) 573337  
V21/23. Voice (0483) 65895.

## Special interest

**AMATEUR RADIO**  
Trevor Tugwell (G6TJT),  
AMRAC, 6 Kestrel Drive,  
Mudford, Christchurch,  
Dorset, BH23 4DE. Tel Phil  
Bridges G6DLJ (0703) 847754.  
BBS V21 (0736) 518818.

**CHRISTIAN USERS**  
Phillip Clark, Christian Micro  
Users Association, 136 Bram-  
well Gdns, Sheffield, S3 7PW.

**CHURCH ADMINISTRATION**  
Rev Stoker Wilson, Church  
Computer Users Group, St  
John's Vicarage, Greenside,  
Ryton, Tyne & Wear,  
NE40 4AA. 091-413 8281.

**COMMUNICATIONS**  
Comms File, TP Group,  
FREEPOST, London, N1 1BR.  
01-833 3501. £75. Newsletter.

**COMMUNITY COMPUTING**  
Pete Rowan, Community Com-  
puting Network, 5 Windmill  
St, Frindsbury, Rochester,  
ME2 3XQ. £5 (£1 unwaged).  
Good contacts; left wing  
opinlons.

**DISABLED**  
Jeff Hughes, Special Needs  
User Group, 39 Eccleston  
Gardens, St Helens,  
WA10 3BJ. (0744) 24608.

**EDUCATION - VARIOUS MICROS**  
TECUG, 27 Ingoldsby Road,  
Gravesend, Kent, DA12 2LF.  
Schools/colleges support grp.  
£50. Sample pack £3.65.

**GENEALOGISTS**  
Computer Group, Society of  
Genealogists, 14 Charterhouse  
Buildings, London, EC1M 7BA.  
01-251 8799. Meets monthly  
re micros to trace ancestors.

**GENERAL HARDWARE**  
Andy Leeder, Amateur  
Computer Club, Church Farm,  
Stratton St Michael, Norwich,  
NR15 2QB. Large SAE.

**LOCAL AUTHORITIES**  
Local Authority Microcom-  
puter User Group, c/o John  
New, Borough Engineer's  
Dept, Municipal Offices, North  
Quay, Weymouth, Dorset,  
DT4 8TA. (0305) 785101 x 272.

**MAGAZINE INDEX**  
Find-it, Orkney Computing,  
60 Albert Street, Kirkwall,  
Orkney, KW15 1HQ. (085 686)  
268. Index to PCW & 5 other  
business micro mags. Sent  
out on disk - requires PC.

**PRESTEL**  
Andy Leeder, ClubSpot 810,  
Church Farm, Stratton St  
Michael, Norwich, NR15 2QB.  
Hobby database on Prestel  
(key \*810#). Clubs may be  
able to edit own free pages.

**SEAFARERS**  
Mr C E Watson, 29 Doods  
Place, Doods Road, Reigate,  
Surrey. RH2 0NS.

END

# A small price to pay for a complete accounting package.

£7

**Here are a few of the many excellent general features offered in this fully integrated accounting package:-**

Nominal Ledger                      Billing  
Accounts Receivable              Purchase Order  
Accounts Payable                  Forecasting  
Inventory Control

**And some specifics:-**

- Hundred's of different reports
- Password Protected
- Extensive manual with accounting primer
- List of accounts
- Cash flow analysis
- Physical inventory routine with count sheets
- Full back order control
- Hundreds of different reports
- Financial statements
- Unlimited accounts
- Open invoice or balance forward
- Flexible ageing
- Mailing labels
- 99 items per purchase order
- Full purchase journals
- Unique forecasting module

**Awards**

- 1st - 1986 - PC World Magazine "World Class Award" - 300,000 Readers voted for DAC Easy Accounting with a margin of 5:1 over any other accounting package.
- 1st - 1985 - PC World Magazine "World Class Award"
- 1st - 1985 - Infoworld "Product of the Year" and "Best Software Value".
- 1st - PC Magazine "Editor's Choice".

**Press**

- "Dac-Easy is a genuinely amazing deal" - PC Magazine
- "Remarkable, amazing, revolutionary, and sensational" - Computer Buyers Guide
- "Dac-Easy is an incredible value" - PC Week
- "I enthusiastically award four stars and recommend the purchase" - Business Software
- "Dac Software has taken the industry by storm" - Dun & Bradstreet Reports
- "Dac-Easy is a program we highly recommend" - InfoWorld

To receive your copy of the world's favourite accounting package simply fill in the coupon or call (0753) 47021

## Dac-Easy for only £7

I enclose a cheque for £9.55 (£7 for Dac Easy, plus 15% VAT and £1.50 postage), for each copy I require.

Name \_\_\_\_\_ Company \_\_\_\_\_

Address \_\_\_\_\_

Tel no: \_\_\_\_\_

Cheques should be made payable to ACM and sent to 31 High Street, Datchet, Berkshire.  
Offer ends June 30th 1988. Please allow 14 days for delivery.

**ACM**

ADVANCED  
COMPUTING MANAGEMENT

31 High Street, Datchet



# Apricot — THING OF THE PAST?

Not for us...

We are still operating a full service for users of "generic" Apricots. We produce new software, and continue to support the old. 100,000 Apricot customers can't be wrong! If you are one of them, make the most of your **PC, Xi, Xen, F2, F10 or Portable**. Ask for our information sheet and discover why we have never been busier.

Here are a few clues:

- ACOLYTE** A suite of memory resident utilities, key configuration, printer problem-solver, etc.
- LOG** Appointments database.
- ASD** Ansible SuperWriter Disk: the complete Apricot accessory disk.
- WORDPERFECT** We supply the latest Apricot version, discounted, supported
- PARAGON** Our own WordPerfect utilities... exclusive!

**PUBLIC DOMAIN** We offer a full library of software — games, rare utilities, arcane documents files — and charge only for copying.

And if you're yielding to the inevitable and have recently bought an IBM clone... our latest package is **APE**, the Ansible Apricot Emulator! This runs most Apricot software: the 'Super' pack, Turbo Pascal, dBase II, Wordstar, etc.

We publish a regular information news-sheet for Apricot users, plus much more! Full details in our brochure and price list.

**ANSIBLE INFORMATION LTD**



94 London Road, Reading  
Berkshire RG1 5AU

Tel: 0672 62576

# LOWEST PRICES IN UK?

<b>MICROS</b>		<b>PSION</b>		Letter organiser	£30
Amstrad PCW8256	£299	Psion II CM	£86	Harvester S Chip	£86
Amstrad PCW8512	£399	Psion II XP	£121	Finance Pack	£26
Amstrad PCW9512	£449	8K Datapak	£11	Maths Pack	£26
Amstrad PC1512SD/MM	£399	16K Datapak	£17	Developer	£43
Amstrad PC1512DD/MM	£549	32K Datapak	£30	Pocket Spd Shrt	£34
Amstrad PC1512DD/CM	£499	32K Rampack	£47	Comms Link	£52
Amstrad PC1512dd/CM	£649	64K Datapak	£52	Adaptor	£11
Amstrad PC1640SD/MD	£499	128K Datapak	£86	Formulator	£26
Amstrad PC1640SD/CD	£649	Formatter	£39	<b>Data Bank</b>	
Amstrad PC1640DD/MD	£799	<b>CASIO</b>		SF3000	£56
Amstrad PC1640DD/CD	£749	Scientific		SF4000	£65
Amstrad PC1640DD/ECD	£899	FX451	£17	IF8000	£86
Amstrad PC1640HD/MD	£899	FX570	£14	PF3200	£35
Amstrad PC1640HD/CD	£1049	FX580	£22	<b>ACCESSORIES</b>	
Amstrad PC1640HD/ECD	£1199	FX3800P	£17	RP8	£14
Amstrad PPC512S	£399	FX5000F	£30	RP16	£29
Amstrad PPC512D	£499	FX7000G	£43	RC2	£17
Amstrad PPC640S	£499	FX8000G	£78	OR4	£24
Amstrad PPC640D	£599	FX7500G	£61	OR8	£60
Commodore 64C pack	£130	<b>Packet Computers</b>		FA3	£20
Commodore Amiga 500/Monitor	£587	PB1000	£120	FA7	£60
<b>PRINTERS</b>		FX850P	£78	FP12S	£44
Amstrad DMP3160	£169	FX790P	£52	FP40	£85
Amstrad DMP2160	£135	FX730P	£43	RP32	£35
Amstrad DMP4000	£275	PB700	£103	RP33	£35
Amstrad LQ3500	£275	PB410	£43	HP11C	£39
Epson LX 800	£189	PB110	£35	HP18C	£122
Citizen 120D	£135	<b>TYPEWRITERS &amp; CASIO</b>		<b>CALCULATORS</b>	
Citizen 120D (Serial)	£150	Canon		Casio	
Citizen 120D (Commodore)	£150	Typestar 90	£165	HR100	£175
Panasonic 1081	£140	Typestar 80	£148	CW25	£130
Star LC10	£169	Typestar 7	£165	DR11DS	£59
Star NL10 (Commodore)	£175	Typestar 6 II	£148	DR120S	£79
Juki 6100 (Daisywheel)	£265	Typestar 5 II	£129	HR100	£30
<b>SOFTWARE</b>		Ribbons 1 bx	POA	HR16	£29
<b>PHOTOCOPIERS &amp; FAX MACHINES</b>		Ram 4k, 8k, 16k	POA	TV 200	£43
Canon FC3	£450	Silver Rd EP10	£108	TV 400	£86
Canon FC5	£550	Olympia Travler	£50	TV 1500	£130
Canon Fax 110	£1325				
PC Cartridge	£62				
FC Cartridge 3K	£72				

Complete range of Casio, Commodore & Amstrad add ons at discount prices. Prices/Goods subject to availability and change without notice. ALL PRICES EXCLUDE VAT. P&P £5 (within UK). Export Enquiries welcome. TELEX: 8951182 GCOMS G.

# K.K. STATIONERS

187 Edgware Road  
Marble Arch  
London W2 1ET  
Tel: 01-723 1436

Open Mon-Sat  
9.30am-6.30pm

126 Edgware Road  
Marble Arch  
London W2 2DZ  
Tel: 01-402 4592

# DISKETTES

## UNBEATABLE PRICES FROM DENMARK

- 5 1/4" -DSDD 19p
- 5 1/4" -HD 49p
- 3 1/2" -1Mb 59p
- 3 1/2" -2Mb Ring Now! It's worth it!

## WE ARE ATHANA DISTRIBUTORS

Please contact us regarding branded disks  
Above prices are for reasonable quantity.  
Volume orders welcome.

# HEXASOFT APS

18 Hovedgaden DK 4440 Mørkøv  
Fax: 010 (45) 347 4122  
Telephone: 010 (45) 3 474122/4277/4417

BONDWELL MASTER DEALER  
OFFICIAL DEALERS ★ AMIGA ★ AMSTRAD ★ ATARI

<b>COMPUTERS</b>		Star LC10 Colour	190.43
AMIGA BUSINESS SYSTEM: A500 + 1084 + MPS1200 + The Works! + Transformer		NEC P2200 NEW 24 pin 168/56cps	303.48
PC Emulator	699.00	<b>MONITORS</b>	
AMIGA 2000 1Mb RAM & Colour Mon	1173.00	Atari High Res Mono Monitor	119.00
AMIGA 2088 PC/AT Bridgeboard + 5.25" Drive	419.00	Philips 8833 14" Col RGB/Comp Med Res	216.52
AMIGA 2086 PC/AT Bridgeboard + 3.5" Drive	599.00	Philips BM7502 Green 12" Comp Video + Sound	73.91
AMIGA 500 + dPaint	364.35	Philips BM7522 Amber 12" Comp Video + Sound	81.74
AMIGA 500 + Philips 8833 or Commodore 1084	564.35	<b>DISKS DRIVES</b>	
Amstrad PC Range	from 399.00	A2010 Internal 3.5" Disk Drive	129.00
Amstrad PCW9512 with Daisywheel Printer	499.00	A2092 20Mb PC Hard Disk Drive	£399.00
Atari 1040STF	468.70	A2094 Amiga 20Mb Hard Disk Drive	519.00
Atari 1040STF Mono System	581.74	Supra 20Mb Hard Disk for Atari ST	468.70
Atari 520STFM + Demo Disks	312.17	Cumana CSA354 1Mb Disk Drive for Atari ST	123.00
Atari 520STFM Mono System + Demo Disks	425.22	Cumana CAX354 Disk Drive for Amiga	117.39
Bondwell 8s Laptop 512K RAM 720K Drive		Scribecard 32Mb Hard Disk Card	269.00
Supertwist LCD	699.00	<b>ACCESSORIES</b>	
SBC FD Twin Drive 640K 8MHz HDA/CGA		Amiga A2052 2Mb RAM Expansion Card	319.00
Clock/Calendar	579.00	Amiga A2058 8Mb RAM Expansion Card	1849.00
SBC FD Single Drive + 32Mb Hard Card	759.00	Amiga 500 512k RAM & Battery Backed Clock	9.91
SBC 286AT 20Mb Drive 1Mb RAM 8/10MHz	1259.00	Surge Protector 13A plug	1.26
Psion Organiser CM 8k RAM	79.00	Surge Protector 3-way Adapter	1.80
Psion Organiser XP expandable to 128 Kb		Tilt/Swivel Stand + Clock for 1081/84/8833	15.95
RAM	109.00	Uninterruptable PSU (Typical 5mins backup)	199.00
Psion Hardware/Software Add-ons	PHONE	<b>SOFTWARE (Examples)</b>	
<b>PRINTERS</b>		Reflex Database for Amstrad PC1512	49.90
Citizen 120D Dot Matrix 120/25cps (parallel or Commodore)	143.48	Sage PC Planner (123 Clone)	9.90
Okimate 20 colour printer for PC/ST	155.65	Tas Plus Relational Database	92.90
Okimate 20 Full Graphics Colour Printer for Amiga	155.65		
Star LC10 with 8 Fonts (parallel or Comm)	173.04		

Please add 15% VAT to above prices  
CARRIAGE £8, EXPRESS DELIVERY £12, Software & Small items FREE

*Delta Pi Software Ltd*

8 Ruswarp Lane, WHITBY, N. Yorks, YO2 1ND.  
Tel: 0947 600065 (9am-7pm)



**ALL OUR PRICES INCLUDE CARRIAGE & VAT**  
**HSV COMPUTER SERVICES LIMITED (PCW)**  
 23, Hampstead House, Town Centre, Basingstoke, RG21 1LG

Diskette Storage Boxes	Price Each
10x5 1/4" Library Case	1.25
50x5 1/4" Hinged Lid	6.50
50x5 1/4" Hinged Lid Lockable	7.50
100x5 1/4" Hinged Lid Lockable	10.50
120x5 1/4" Hinged Lid Lockable	12.50
10x3 1/2" Library Case	1.25
40x3 1/2" Hinged Lid Lockable	7.95
80x3 1/2" Hinged Lid Lockable	10.95
10x3" Hinged Lid(Ams)	5.95
20x3" Hinged Lid Lockable(Ams)	12.95

Continuous Stationery	Quantity	Price
Micro Perf All Edges	250	5.00
9.5" x 11" 60 GSM	500	4.95
True A4 90 GSM	1,000	8.95
True A4 100 GSM	2,000	14.95
White, Cream, Blue or Grey Bond		8.75
Labels 3.5" x 1.5" (1 across)	8.50	15.95
Labels 4.0" x 1.5" (1 across)		29.95
Labels 4.0" x 1.5" (2 across)		2.95
Labels 4.0" x 1.5" (2 across)		4.95
Labels 4.0" x 1.5" (2 across)		3.25
Labels 4.0" x 1.5" (2 across)		5.50
Labels 4.0" x 1.5" (2 across)		6.50
Labels 4.0" x 1.5" (2 across)		11.95
Labels 2.75" x 1.5" (3 across)		2.75
Labels 2.75" x 1.5" (3 across)		4.50

	Quantity	10	20	30	40	50	100
3 1/2" SS/DD	135 TP1	9.95	18.95	27.95	36.95	45.95	89.95
DS/DD	135 TP1	10.95	20.95	30.95	40.95	50.95	99.95
5 1/4" SS/DD	48 TP1	5.95	8.95	12.75	16.00	18.75	36.95
DS/DD	48 TP1	6.95	9.95	13.95	16.95	19.95	37.95
DS/QD	96 TP1	7.95	10.95	14.95	17.95	21.95	39.95
DS/HD	1.6 MB	15.95	29.95	44.95	58.95	71.95	139.95
AMSTRAD							
Amssoft/Maxell 3" CF2		1-£2.50	5-£11.95	10-£22.95			

Dust Covers	Price
Grey Anti-Static	8.95
Nylon with Blue Piping	8.95
Amstrad PC 1512	8.95
Amstrad PCW 8256/8512 3Pce	4.50
Amstrad DMP 2000/3000/3160	4.50
Amstrad DMP 4000	4.50



Credit Card Hotline (0256) 463507 Faxline (0256) 841018



## NEW PRESENTATION FROM FULLINK:

Introducing three innovative new products to make your computer more functional as well as more streamlined. Our products give you new options in computing, opening up limitless possibilities.

### I. 3 IN 1 MAIN BOARD MAIN BOARD + MULTI I/O + DISPLAY

- CPU and memory control system
  - a. 8088-1 CPU
  - b. M1101 gate array
  - c. 4.77/10 MHz speed (switchable)
  - d. RAM: expandable to 640K Byte
  - e. ROM: 8KB for BIOS, 32KB for user
  - f. 8087 coprocessor option
  - g. Key lock

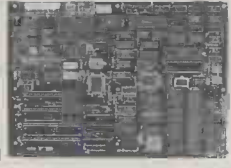

FK-1001

- Hercules/MGA or color display port.
- Tow RS232 serial port. (COM2 option)
- One printer port. Game port.
- Light pen port. Real time clock.
- Floppy driver adaptor on board.

### II. VOICE MODEM CARD

- Hayes SmartModem command compatible
- Voice Port. Compatible with CCITT V.21/V.22 and bell 103/212A
- Full or half duplex 300/1200 bps  
 (One smart telephone answer machine program will be given for free)



VM-102

And by using simple basic program on our card, you can also develop other powerful & marvelous functions, such as:

- Telephone reservation
- Telephone operator
- Vocal security guard system
- Remote control system

### III. LOGITERMINAL

- 12 programmable function keys
- Emulation ADM3A, TVI 925, VT100 ANSI selected by DIP switch
- PC/AT Terminal compatible

We bring new dimensions to the conventional terminal: with your PC keyboard and PC monochrome monitor, our products work wonders.



LOGITERMINAL KT-111

PC/AT, VT100, TVI925 ADM3A SMARTMODEM ARE MANUFACTURING REGISTERED TRADE MARK

## Distributor & Agent Wanted

MANUFACTURED BY:  
**FULLINK COMPUTER CO., LTD.**  
 5TH-FL., NO. 145  
 CHUNG SHAN N. RD., SEC 1  
 TAIPEI, TAIWAN, R.O.C.  
 TEL: (02)5631686 5313252  
 TLX: 24702 BEST YUAN  
 FAX: 886-2-5611603



£280 ≠ £168 =

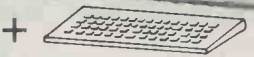



# SIERRA Computer Consultants Ltd.

## FERRANTI

"Buy British"

XT 20mb  
AT 20mb  
AT 40mb  
AT 76mb

## OLIVETTI

"New Ranges"

M240 20mb  
M280 20mb  
M280 40mb  
M380 40mb

## TANDON

"Unbeatable Prices"

PCX 20mb  
PCA 20mb  
PCA 40mb  
PCA 70mb  
TARGET 20mb  
PAC 286 30mb

**CALL FOR SPECIAL PRICES ON ALL RANGES**

### SOFTWARE

DBASE 111 PLUS	£415
FRAMEWORK	£340
LOTUS 123	£259
MULTIMATE	£225
SAGE ACCOUNTANT PLUS	£185
SAGE PAYROLL	£95
SYMPHONY	£377
SMART	£395
WORDPERFECT	£295

### PRINTERS

EPSON FX800	£376
EPSON FX1000	£459
EPSON LQ1000	£731
JUKI 6100	£348
JUKI 6200	£542
JUKI 6300	£839
CITIZEN MSP 25	£357
BROTHER 1509	£464
HP LASERJET SER.11	£2050

### BARGAIN BASEMENT

Tandon half height floppy drives	£45
QUME QVT119 + TERMINAL	£350
VENTURA D.T.P.	£450
JUKI 6200 DAISYWHEEL Printer	£350
EPSON LX86 PRINTER	£150
64K D-RAM CHIPS	£1

**THE ABOVE ARE JUST SAMPLES OF THE WIDE RANGE OF PRODUCTS WE OFFER — PLEASE CALL**

SIERRA COMPUTER CONSULTANTS LTD., Third Floor, Carrick House, Stakes Hill Road, Waterlooville, Hants PO7 7JB  
Tel: 0705 256123

**LT3200**  
**LI3200**  
**LI3200**  
**LI3200**  
**P & C**



IBM-AT Compatible

**high  
speed  
high  
performance  
Laptop**

80286, 6/12 MHZ clock  
1.44 MB 3-1/2" Floppy  
Drive  
20/30/40 MB Hard disk  
640x400 high resolution  
Plasma Display



HANNOVER MESSE  
**CeBIT '88**  
HALL 007 STAND E59

**P & C SHITEN**  
**ENTERPRISE CO., LTD.**  
12F-10, NO. 109,  
ROOSEVELT RD., SEC. 3, TAIPEI,  
TAIWAN, R.O.C.  
P.O. BOX: 30-291, TAIPEI,  
TAIWAN, R.O.C.  
CABLE: PCSHITEN  
TEL: (02)395-1400  
TLX: 19206 PCSHITEN  
FAX: 886-2-3512073

IBM PC/AT® are registered trademarks of IBM

# "The Micro Midget" PC



*Illustration: Dual Drive System with 640k RAM and 12" Monochrome Monitor*

**Probably the smallest intelligent workstation on the market today!**

**At just 10" square this PC can easily be used anywhere in either the home or office.**

**Weighing just 4 Kgs (9 lbs) it is also easily transported.**

The Micro Midget has many features built in which are not always included with larger PC's such as:-

- Real time clock
- Floppy disk controller
- 2 Serial and parallel ports
- Intel 8088-1 (10 M/Hz) processor
- Optional 8087 Maths Co-processor
- Mono, Hercules, RGB and LCD video output

**Plus many more!!**

Realistically priced "The Micro Midget" PC is a good investment for both business and home users alike.

**From only £395 for a 256k RAM,  
Single Drive Unit! AND MSDOS 3.21**

**Call us now!!**

0227-712882

**A.C.P.M**

**Associated Computer Product Marketing  
Office Units 6 & 8, Wealden Forest Park,  
Herne Common, Herne Bay, Kent, CT6 7LG**



# PC TO PS/2 COMPATIBILITY

(IN 360Kb and 1.2Mb FORMATS)

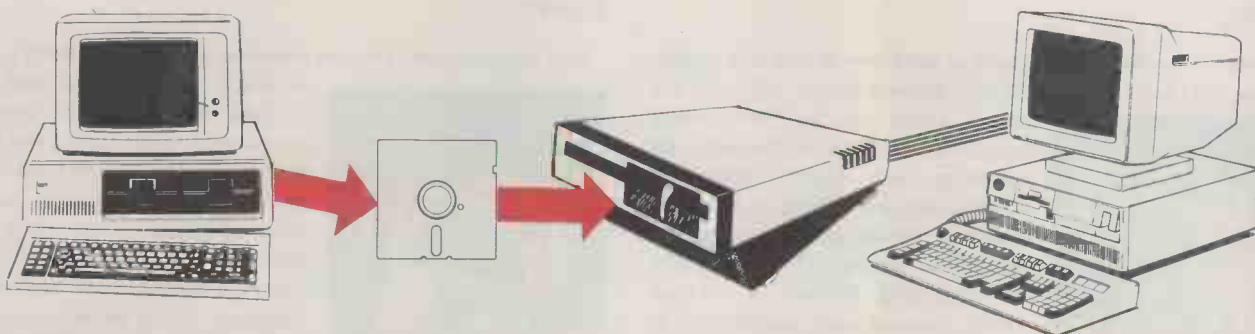

If you are looking for a fast and convenient way to transfer those valuable files from your IBM PC/XT/AT or compatible to the new IBM PERSONAL SYSTEM/2 then the PLUS-FD 500 Series is the answer.

FD-500 is an external 5¼" floppy disc drive for the IBM PS/2, available as either a dedicated 360Kb unit or software detected 360Kb / 1.2Mb unit.

FD-500 is supplied in an attractive compact case and is easy to install via a single flat ribbon cable connected to the PS/2.

## PRICES

Model	Host	Capacity	R.R.P.
FD530	PS/2.30	360Kb	£300
FD550	PS/2.50	360Kb	£300
	Upwards		
FD55H	PS/2.50	Dual Format	
	Upwards	1.2Mb/360Kb	£350

## PLUS-FD 'OPTIONS'

The PLUS-FD range offers many options for floppy disc transfer between micro's of different formats and/or drive sizes including:

- FD3I 3½" internal / external floppy drive (720K) for IBM PC/XT/AT or compatible to read, write and format a variety of 3½" formats, including IBM PS/2, APRICOT AND TOSHIBA.
- FD5A 5¼" external floppy drive (360K) for APRICOT PC/Xi to read, write and format IBM 180K and 360K formats.
- For the SIRIUS/VICTOR 9000 we offer both 5¼" IBM format floppy drives and 3½" IBM/Apricot format drives. A dual 5¼" plus 3½" unit is also available.

**PLUS 5 ENGINEERING LIMITED**

Crowborough Hill, Crowborough, Sussex TN6 2EG  
Tel: (08926) 63211. Fax: (08926) 65389. Telex: 95538 PLUS G.



Mail and Telephone Orders welcome.



# SUCCESS! POWER! MONEY! INFLUENCE!

## NEW BUSINESS SIMULATION SOFTWARE GIVES YOU ALL FOUR.

### Success.

To succeed in any business you have to know how to deal with people. What they don't teach you at Harvard Business School" will teach you how. Based on the best selling publication by Mark McCormack this fascinating and highly entertaining program takes you through the steps of developing a multi-million dollar sports management company. This competitive and challenging software is a most valuable business asset enabling you to improve your own management skills and business techniques in order to achieve success. By creating various business scenarios it enables you to learn the art of negotiation, how to delegate responsibilities, how to allocate your time and resources and the concepts of business opportunities. Stay ahead of your rivals and discover how Mark McCormack became a multi-millionaire by putting proven concepts into practice.

### Money.

The Business Simulator sets five companies against each other in marketing new products. You are put in charge of one of the companies and given the task of running the company over a 25 year period from start-up to maturity. The concept is to create a successful organisation by making the right decisions that will ensure the companies profitability and growth. Setup a marketing strategy, define production levels, plan factory capacities, finance R & D and explore future expansion options. The Business Simulator is a highly entertaining introduction to the world of big finance and an interactive learning tool that can improve your decision making skills.

### Power.

Step into the shoes of today's executives with Business weeks - Business Advantage. This unique and realistic business simulation model puts you in the 'hot seat' of managing a real company by forcing you to face the tough decisions that can result in runaway success or devastating failure. Sharpen your business skills through interactive case studies based on articles from Business Week Magazine. Using the various sources of information which are available you can analyse the competition, the economy, the market trends and the products. Explore all options, develop a strategic plan and put it into action. Immediately process your decisions and view the effect of your strategy on resources, investment and profits. Find out what is really like to run: Compaq, Chrysler, Microsoft, Motorola,

### Influence.

A sophisticated executive training tool which enables customised environments to be created. The package allows various scenarios to be setup in which a business is to compete. You can change the industrial and commercial climates and see how it effects the business market. What if the interest rate fell to 6% ? What if inflation increased to 25% ? What if oil prices increased by 50% ? How would your company react and what decisions would you have to make to influence its future development and growth.

The Business Strategist incorporates complex simulation models in which you can manipulate the criteria and analyse situations using "What If" tests in order to devise and implement appropriate plans of action.

**InfoSoft  
Systems**  
Tel: 0905 795588.

YES I want to know how to achieve:

SUCCESS	POWER	MONEY	INFLUENCE	METHOD OF PAYMENT.
<input type="checkbox"/>	<input type="checkbox"/>	<input type="checkbox"/>	<input type="checkbox"/>	What they don't teach you at Harvard Business School. 65.00
<input type="checkbox"/>	<input type="checkbox"/>	<input type="checkbox"/>	<input type="checkbox"/>	Business Weeks - Business advantage. 95.00
<input type="checkbox"/>	<input type="checkbox"/>	<input type="checkbox"/>	<input type="checkbox"/>	The Business Simulator. 95.00
<input type="checkbox"/>	<input type="checkbox"/>	<input type="checkbox"/>	<input type="checkbox"/>	The Business Strategist. 349.95

Name: \_\_\_\_\_ Company: \_\_\_\_\_

Address: \_\_\_\_\_

Post Code: \_\_\_\_\_

Signature: \_\_\_\_\_

Please add 2.00 for Carriage and VAT.

Return to: InfoSoft Systems Limited,  
FREE POST, Droitwich, WR9 8BR.



# DESIRE Computer Operators

## DON'T JUST KEY IN... JOIN IN!



Desire is an on-line service that allows you to communicate directly with other users. Working through your PC via your modem, it features information, games and of course, whatever you want to say. Just phone in — and join in.

- Available 24 hours a day
- Menu gives you a choice of 5 services from just one call...

### CHATTER BOX

The interactive message board. Say what you want to say — stir up a hornets' nest, start up a friendship! See the immediate response!

### MAILBOX

A handy way to leave messages with friends.

### DESIRE CLASSIFIED

The perfect place to sell your old computer, or even find a top computer job!

### GRAFFITI CORNER

Whatever you want to say, here's where to say it!

### DEBBIE DESIRE'S PROBLEM PAGE

Personal, emotional or sexual problems answered.

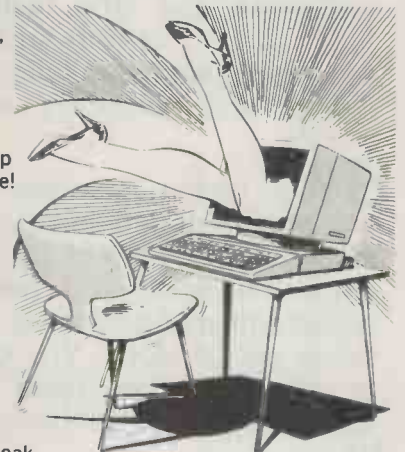

Charge rate: 38p inc. VAT peak and 25p inc. VAT per min. off peak.

DESIRE  
LONDON E14 9TW

PHONE NOW **0898 555 555**



## LEXCOVE COMPUTER SYSTEMS

### LASER PRINTERS

Epson GQ3500	£1295.00
Brother HL8	£1595.00
Canon LPB8 Series II	£1595.00
Hewlett Packard Laserjet II	£1725.00
Kyocera F1000	£1950.00
Kyocera F1200	£2850.00
Kyocera F2200	£3895.00
Kyocera F3000	£5295.00

### SYSTEM UNITS

Kaypro PC-XL 20Mb Mono	£795.00
Kaypro PC-XL 20Mb Colour	£875.00
Kaypro PC-XL 20Mb EGA	£1195.00
Kaypro K286i 20Mb Mono	£1350.00
Kaypro K286i 20Mb Colour	£1550.00
Kaypro K286i 20Mb EGA	£1695.00
Wyse 2108/20 20Mb Mono 286	£1595.00
Wyse 2108/20 20Mb Colour 286	£1775.00
Wyse 2108/20 20Mb EGA 286	£1950.00
Toshiba T1200	£2050.00
Toshiba T3100/20	£2350.00
Toshiba T3200	£3095.00
Toshiba T5100	£3595.00

### TERMINALS

Wyse 30 Terminal	£280.00
Wyse 50 Terminal	£350.00
Wyse 60 Terminal	£415.00
Wyse 85 Terminal	£380.00

Please call for details on our wide product range  
**LEXCOVE LIMITED**  
 19 Montpelier Avenue, Bexley, Kent  
 DA5 3AP. Tel: 01-301 5481  
 Fax 01-301 5481

We accept  
Access & Visa



### MULTIPORT BUFFERED SMART DATA SWITCHES

The Multiport Buffered Smart Automatic Switch can actually multiply the utility of PCs and laser printers by allowing several users to share printers automatically. The internal buffering system allows simultaneous access to users thus freeing the computers for other tasks. The printer can be selected either manually or by software control.

• BOTH PRINTERS PRINTING DIFFERENT DOCUMENTS SIMULTANEOUSLY •

CENTRONICS				SERIAL					
Model	Memory	Inputs	Outputs	Price	Model	Memory	Inputs	Outputs	Price
PB12	64K(E)	1	2	£269(d)	SB42	256K	4	2	£495(d)
PB42	256K	4	2	£415(d)	SB71	256K(E)	7	1	£655(e)
(36 PIN)					SB71	1MB	7	1	£835(e)
PB42	256K	4	2	£365(d)	SB82	256K	9/8	1/2	P.O.A.(e)
(25 PIN)					SB82	768 K	9/8	1/2	P.O.A.(e)
PB22	256K(E)	2	2	£295(d)	SB22	256K	2	2	£375(d)
PB71	256K(E)	7	1	£545(e)					
PB82	256(KE)	9/8	1/2	P.O.A.(e)					
PB82	768 K	9/8	1/2	P.O.A.(e)					

### SMART AUTOMATIC SWITCHES

IPS4A	PARALLEL	4	1	£150(d)	V244A	SERIAL	4	1	£180(d)
IPS8A	PARALLEL	8	1	£200(e)	V248A	SERIAL	8	1	£230(e)

### INTELLIGENT PRINTER BUFFERS

• SELF-TEST FUNCTION • BUFFER/PRINTER READY INDICATOR • BUFFER RAM STATUS INDICATOR • RESET AND MULTIPLE COPY FUNCTION • BUFFER BYPASS SWITCH •

PB64	64K	1	1	£150(d)	PB512	512K	1	1	£325(d)
PB64P	64K	POCKET BUFFER		£100(d)	SB64	64k	1	1	£170(d)
PB642	64K	1/2	2/1	£195(d)	SB256	256k	1	1	£285(d)
PB256	256K	1	1	£215(d)	SB512	512K	1	1	£375(d)
PB2562	256K	1/2	2/1	£260(d)	SB1M	1M	1	1	£540(d)

### UNIVERSAL BUFFER

• SERIAL & PARALLEL INPUT AND OUTPUT • X ON AND X OFF SOFT AND DTR HARD HANDSHAKE • CENTRONICS • 2 FRONT PANEL T SWITCH INPUT AND OUTPUT • COPY • RESET • EXPANDABLE TO 256K •

UB (64K) £190(d)

UB (256K) £275(d)

### ACCESSORIES

KSM101	RS232 SERIAL TO PARALLEL CONVERTER WITH PSU ABOVE WITH 64K BUFFER	£65(a)	KSM109	SERIAL LINE DRIVER (3 MILES)	£80(b)
KSM101-B	PARALLEL TO SERIAL CONVERTER WITH PSU ABOVE WITH 64K BUFFER	£160(c)	KSM110	MULTILINK SWITCH SELECTABLE SERIAL CABLE RS23 (25D-M/F)	£24
KSM104	PARALLEL TO SERIAL CONVERTER WITH PSU ABOVE WITH 64K BUFFER	£70(a)	KSM112	SERIAL-PARALLEL-SERIAL BIOIRECTIONAL CONVERTER ABOVE WITH 64K BUFFER	£110(b)
KSM104B	PARALLEL TO SERIAL CONVERTER WITH PSU ABOVE WITH 64K BUFFER	£170(c)	KSM112-B	BIOIRECTIONAL CONVERTER ABOVE WITH 64K BUFFER	£190(d)
KSM108	CENTRONICS DATA BOOSTER (50N)	£40(a)			

CUSTOM CABLE-MAKING SERVICE AVAILABLE



Add postage: (a) £2.00 (b) £3.00 (c) £4.50 (d) £5.50 (e) £7.50 + Cables £0.75 each + 15% VAT.

**KEYZONE COMPUTER PRODUCTS LTD**

U14, Acton Business Centre,  
School Road, London NW10 6TD  
Telephone: 01-965 1684/1804 Telex: 8813271 GECOMS G



# Seven sure ways to increase your profits

**1** Your profits increase by 3% when you make your customers pay 20% faster. You can do this with smart, accurate Statements, and by prompt and efficient Credit Control.

**2** Your profits increase by 5% when you decrease your stocks by 22%, and by an extra 3% when you never disappoint your customers by being out of stock. You can do this when you have an efficient stock control system.

**3** Your profits increase by 1% when you can persuade your Bank Manager to give you a lower interest rate. You can do this when you have comprehensive figures to support your business plans.

**4** Your profits increase by 2% when you can pay your suppliers 20% slower (but without having your supplies stopped!) You can do this when you have full Purchase Ledger information.

**5** Your after-tax profits increase by a massive 21% when you halve your tax bill. You can only attempt this when you start financial planning early, with full information available in an easily understood form.

**6** Your profits increase by 2% when you more than halve your accountant's fees. This is easy when your accounts are already complete and accurate.

**7** Your profits increase by 10% when your time is spent on real work, rather than paperwork.

■ These are ALL actual estimates from customers.

■ Works on all IBM-PC and AMSTRAD-PC compatibles.

■ Prove to yourself that our software is the easiest, most complete, and most reliable on the market. For only £19.95 you get, not a demo, not a cut-down version, but the complete system to try for 3 months. And even if you do not then stay with us, you will have learned all you ever need to know about keeping your accounts on computer.

Only **£19.95** 3-month trial

## SimpAcct

**COMPLETE.** All you will ever need for your Accounts, Stock Control, Invoicing, and Sales Statements. For all IBM-PC and AMSTRAD-PC compatibles.

**EASY TO USE.** Fully Menu-driven, with Help Screens for each program. Friendly illustrated manual. Hot-line telephone support offered.

**CHEAP.** 3-month trial £19.95 (+p&p+VAT = £26). Complete system £99.95 (+p&p+VAT = £118). Single Ledgers and various options also available.

**RECOMMENDED.** By PC User, What Micro, and Amstrad Professional Computing magazines. Also in the journal of the NFSE&SB. Our 979 UK

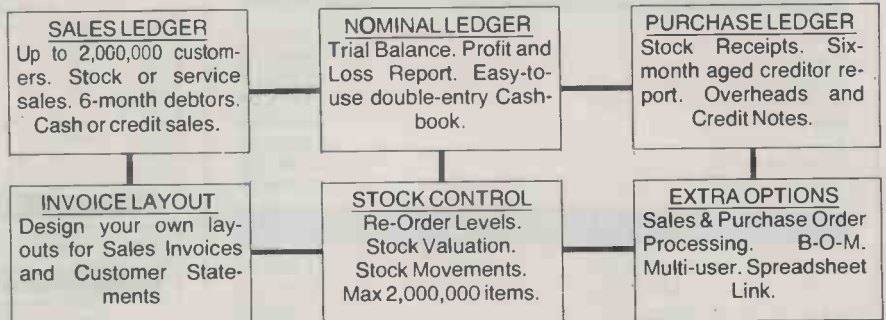

*"Accounts an accountant approves"*

users, since 1980, include British Telecom, Shell, and Warner Lambert. Customer accounts have been audited and approved by Deloitte's, Peat Marwick & Touche Ross.

**RELIABLE & FLEXIBLE.** Pure super-efficient 'C' programs. Guaranteed to be reliable.

■ Please telephone your VISA or ACCESS order, or send cheque, to:

Candy Moyce,  
**FORESHORE SOFTWARE LTD**  
Stone Pier Yard, Shore Road  
Warsash,  
Southampton SO3 6FR

**(04895) 4992/82419**  
**DEALERS WELCOME**



# LOCLAND 286

- 80826 – 12.5 MHZ CPU. Zero Wait State. Landmark speed test 16.8 MHZ
- Up to 4 MB on board Lotus/Intel EMS v.4 or extended memory
- EMS driver software included
- New highly integrated BI-CMOS design.

Each system is assembled, configured to your requirements and delivered direct from our Scottish plant.

## WE'VE CUT OUT THE MIDDLE MAN

30 day money back warranty. 12 months parts and labour limited warranty and technical hotline support. On-site maintenance is also available.

With 20 MB, 65 MS Hard Drive **£1,295**

With 40 MB, 40 MS Hard Drive **£1,450**

With 40 MB, 28 MS Hard Drive **£1,595**

VAT and carriage not included. Call for other options and special configurations.

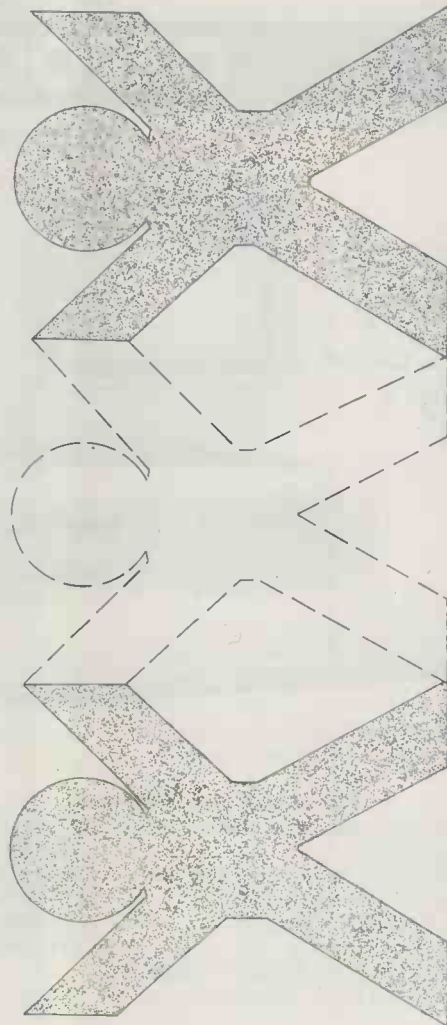

### SPECIFICATION

Small footprint case only  
41 x 43cm

80286 – 12.5 running at  
6 or 12.5 MHZ

One megabyte of fast  
RAM installed

1.2 megabyte, 5.25"  
floppy disk drive

Eight expansion slots,  
five available

System Clock/  
Configuration data in  
CMOS RAM

80287 maths co-  
processor socket

Hercules compatible  
monochrome graphics  
card

2 Serial 2 Parallel Ports

Enhanced 102 key  
keyboard configured for  
the UK

High resolution 14" FLAT  
SCREEN monitor

MS DOS 3.3

Prices and specifications are subject to change without notice.

All orders are subject to Locland's extended terms and conditions of sale, which are available upon request.

**LOCLAND**  
COMPUTER  
LIMITED

47 Carron Place, Kelvin,  
East Kilbride, Glasgow G75 0YL  
Telephone: (03552) 28508  
Telex: 940 15809 LAND G

INTEL, Microsoft, MS DOS, Lotus 1-2-3, Landmark, are registered trade marks of their respective operating companies.

ATARI PC2 SAME PRICES AS AMSTRAD

AMSTRAD BEST PRICES IN THE LAND

# OXFORD HARD DISCS

SAME DAY DELIVERY LONDON AREA

ATARI PC2  
30MB Fuji  
EGA Colour  
£1,025 +

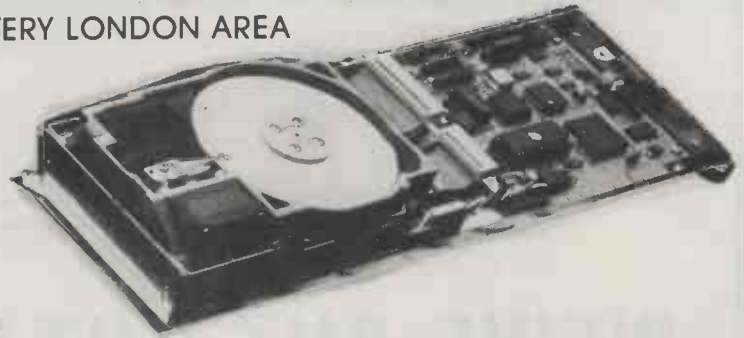

20Mb Tandon Hard Card

Amstrad Floppy Disc Drive 360K  
£85+ Cage

Convert S/D To D/D (PC1512 or 1640)

Internal 40Mb 3 inch Tape Streamer PC or AT ..... £375.00+  
PC1640/1512 50Mb External Tape Streamer ..... £450.00

### PC1512/1640 Hard Disc Prices

PC1512 Mono 20Mb Tandon Seagate ..... £688+£103.2=£791.20  
PC1512 Mono 30Mb Fuji ..... £736+£110.4=£846.50  
PC1512 Colour 20Mb Tandon Seagate ..... £798+£119.7=£917.70  
PC1512 Colour 20Mb Fuji ..... £830+£124.5=£954.50  
PC1640 Ega Mono 20Mb Seagate ..... £739.5+£110.90=£850.42  
PC1640 Ega Mono 30Mb Fuji ..... £781.75+£118.00=£899.00  
PC1640 Ega Colour 20Mb Tandon Seagate  
PC1640 Ega Colour 40Mb Miniscribe .....

Hard Disk Upgrade Installation takes 30 minutes.  
All kits supplied with PC1512/1640 mounting brackets.  
All disks supplied formatted and configured.  
Carriage extra.

3½" 720K Floppy kit internal ..... £125 +  
3½" 720K Floppy kit external ..... £235 +

Part Exchange your PC1512 for a 1640

PC1640 ECD Colour 20MB Seagate

£1,005 +

PC1640 ECD Colour 30MB Fuji

£1,025 +

PC1640 ECD Colour 40MB Miniscribe

£1,081 +

### PPC Portable from £399

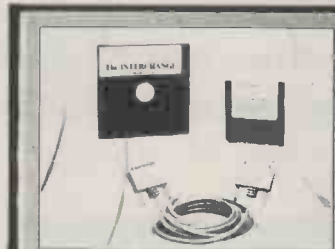

### COPYKIT

£30

How do you get files from your 1512 to your PPC? With the Amstrad PPC now on the market, it's fallen to OHD produce a 5.25 to 3.5 inch disk drive exchange kit which allows you to shunt data from one such machine to the other with the minimum.

TRADE ENQ.  
WELCOME  
DISTRIBUTORS  
WANTED.

### PC1512/1640 Hard Disc Upgrades

#### Hard Cards

20Mb Tandon Hard Card ..... £245+£36.75=£281.75  
20Mb Lapine 65Ms 9W ..... £245+£36.75=£281.75  
20Mb W.D. File Card with Xtree ..... £255+£38.25=£293.25  
30Mb Starcard 65Ms Miniscribe ..... £285+£42.75=£327.75  
30Mb Starcard 40Ms Seagate ..... £295+£44.25=£339.25  
30Mb WD File Card Fuji with Xtree ..... £285+£42.75=£327.75

#### Fixed Discs

20Mb Seagate + WD Controller ..... £220+£33=£253.00  
30Mb Fuji WD Controller ..... £255+£38.25=£293.25  
40Mb Miniscribe + WD Controller 65Ms ..... £285+£42.75=£327.75  
40Mb Seagate + WD 40Ms ..... £335+£50.25=£385.25  
40Mb Seagate + WD 27Ms ..... £420+£63=£483.00

ATARI PC2 SAME PRICES AS AMSTRAD

## SALES: 0836-282225

OXFORD HARD DISCS

Kings Copse Park, Garsington, Oxford OX9 9BU

Tel: (0865) 66471. Fax: (0685) 726753. Sales: (0836) 282225

National Panasonic P1081 80 Col 120 CPS NLQ 28 CPS Printer £155

South Coast enquiries Lymington (0590) 77469.



ATARI PC2 EGA Colour 30MB Fuji £1,025 +



# WE WON'T SELL YOU ANYTHING!

(just the best)

<<<< SPECIAL OFFER >>>>

Buy any Hard Disk MISSION 386.2 and get a FREE Panasonic 24 pin printer or FREE MS DOS Smart Integrated system.

Phone for details

## 386 systems

MISSION 386-40 (16Mhz) 40 Mbyte Hard Drive, Mono Hercules including Keyboard & DOS £2672.20

VICTOR V386A (16 Mhz) 30 Mbyte Hard Drive + 30 Mbyte Addpack (portable Hard Disk), Mono Hercules including Keyboard & DOS £2999.25

UNISYS 800/16 (16 Mhz) 40 Mbyte Hard Drive, Mono Hercules including Keyboard & DOS £3479.20

## 286 systems

MISSION 286-30 (10 Mhz) 30 Mbyte Hard Drive, Mono Hercules including Keyboard & DOS £1455.00

VICTOR 286A (10 Mhz) 30 Mbyte Hard Drive + 30 Mbyte Addpack (portable Hard Disk), Mono Hercules including Keyboard & DOS £1874.25

UNISYS PW500/12 (12 Mhz) 20 Mbyte Hard Drive, Mono Hercules including Keyboard & DOS £2240.00

PC XT systems available from £399.00. Phone for availability

Swan Microsystems Ltd also supply emulation packages to directly connect PC's to the following Mainframes: IBM, DEC, UNISYS, PRIME, Honeywell Bull  
Our expertise spans DOS & XENIX systems, LANs (including TORUS & NOVELL), & CAD

Suppliers of: MISSION, UNISYS, VICTOR, PANASONIC, HP, and other leading makes

SWAN MICROSYSTEMS LTD, 4 PARK ROAD,

SWANLEY, KENT BR8 8AH (0322) 67384

# Clearance.



## Compaq Portable

A virtually bulletproof portable PC. 100% IBM compatible. Fitted with twin 360K 5¼" shock mounted disk drives. 256K RAM. dual-mode text and graphic display plus parallel printer and RGB colour ports. Brand new with manuals. full guarantee. Original RRP £2195.

Now **£595**

<b>COMPAQ</b>	
Compaq Portable 286. 640K RAM. 10Mb and 1.2Mb disks (£4795)	<b>1295.00</b>
<b>IBM</b>	
IBM UK Convertible. 512K RAM 2 X 720K disks (£1948)	<b>895.00</b>
<b>PRINTERS</b>	
IBM Proprinter. 220 cps (£395)	<b>250.00</b>
IBM Proprinter II. NLQ (£416)	<b>270.00</b>
IBM Proprinter X24. 24 wire. NLQ. 360 cps (£600)	<b>425.00</b>
IBM Quietwriter II. 60 cps letter quality (£1172)	<b>695.00</b>
IBM Convertible Printer (£221)	<b>145.00</b>
Dataproducts DP-20 d/wheel (£495)	<b>190.00</b>

## ACCESSORIES

Cipher 5210 25Mb tape streamer and adaptor (£819)	<b>490.00</b>
IBM EGA card (£234)	<b>140.00</b>
Compaq Portable carry case (£60)	<b>30.00</b>
Compaq tilt/swivel stand (£35)	<b>12.00</b>
IBM Convertible carry case (£40)	<b>30.00</b>
Dataproducts sheet feeder (£150)	<b>100.00</b>
HP Laserjet B font (£217)	<b>150.00</b>
IBM Quietwriter II fonts	<b>Call</b>
Toshiba Floppy Link (£139)	<b>99.00</b>

## SOFTWARE

Framework II v1.1 (£550)	<b>325.00</b>
Smartcom II (£99)	<b>69.00</b>
Mace Utilities (£95)	<b>65.00</b>

Prices in brackets are original RRP. E & O.E. All prices subject to 15% VAT

# MORSE

Morse Computers, 78 High Holborn, London WC1.  
Telephone 01-831 0644. Telex 262546. Fax 01-831 1310.

## TAXcalc. from Which?

Try this new program and you could end up saving tax!

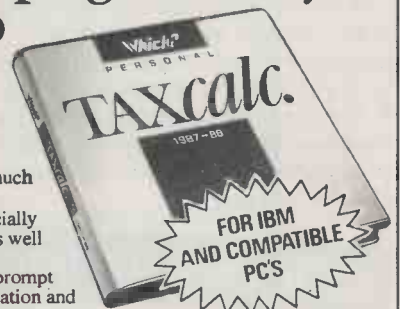

Taxcalc is an easy-to-use computer program that makes it simple to work out exactly how much income tax you should be paying.

The program has been specially designed for use by the layman as well as more experienced PC users.

Step-by-step, Taxcalc will prompt you to enter the necessary information and figures. It will work out your allowances, guide you to the most favourable options and prepare a printed statement that is acceptable to the Inland Revenue in support of your tax return.

You can run Taxcalc again and again because it allows you to edit the details as your circumstances change. You can even change tax rates and bands within the program in order to estimate future tax liabilities.

Which? Taxcalc 1987-88 will help you work out your tax for the period 6th April 1987 to 5th April 1988.

Full instructions are contained within the program which comes on a single 5¼" disc. It costs just £19.95 post free.

**FREE LINKLINE** TPC3A  
0800 252100 (24 hrs)  
Credit card holders can save time by ringing their order through FREE. Just quote your credit card number, and reference.

Which?, Castlemead, Gascoyne Way, Hertford SG14 1YB.

To: Which? FREEPOST, Hertford SG14 1YB.

Yes, Please send me \_\_\_\_\_ copy(ies) of

Mr/Mrs/Miss \_\_\_\_\_

Which? Personal Taxcalc 1987/88 (IBM)

Address \_\_\_\_\_

at £19.95 each.

I enclose a cheque for \_\_\_\_\_

payable to Consumers' Association

or please charge my Access/Visa \_\_\_\_\_

Account No \_\_\_\_\_

Postcode \_\_\_\_\_

Signature \_\_\_\_\_

Please allow up to 28 days for delivery.

Consumers' Association Ltd, Reg. in England. Reg. No. 677665.

Reg. Office 2 Marylebone Road, London NW1 4DX. Reg. under the Data Protection Act. TPC3

# How to develop your own applications

**TAS**  
PLUS RELATIONAL  
DATABASE

ONLY

£99

**STOP PRESS**

TAS Plus Wins  
Software Top 10 Award  
What Micro Magazine  
Feb 88

"TAS Plus really does manage to combine most of the elusive virtues of a good database system, namely power, simplicity, speed and modest cost." (Runners up included Infomaster, PC File+ and Borland Reflex)

With TAS Plus it is now easier and faster to build your own database applications. TAS Plus is for anyone that wants to enter, store, display, report and manipulate information quickly and easily. TAS Plus can work with 16 related datafiles and each file can have up to 16 keys and a maximum of 65,000 records. And we quote What Micro Magazine "It provides the power and flexibility normally expected of programs four or five times the price".

## It's Easy to Use

There is a full menu system which enables the inexperienced user to get to grips with the program straight away. Using windows and pull-down menus you set up new databases, examine existing databases and print reports in minutes. An excellent tutorial and reference manual explain in an easy-to-follow way the steps involved in creating your own applications

## Time Saving Tools

With the Screen Painter you design your own data entry screens by positioning fields and prompts and draw boxes in a variety of colours and styles. A Program Generator, Report Generator, Database Browser and other utilities are all included and help you develop your applications fast.

## For All Applications

TAS includes an integrated editor with which you can modify and expand the automatically generated programs. Even here it is possible to make use of TAS's menu system. Easy to use commands are listed in menus and added to your application by selecting them one at a time. And when finished TAS Plus compiles it to create a superfast executable program.

## Now Fool the Experts

There's no chance of running out of steam. Expand your applications by including extensive calculations, and access multiple related files. Add your own pull-down menus, windows and up to 128 colour combinations. Give your applications that "professional" look like it would have cost thousands to develop. We're the only database that can do this.

## Multi-User Productivity

Thousands of users in Britain alone are using TAS for both simple and very complex applications. There is a large dealer network that use TAS to produce custom applications. Usually in one-tenth of the time it would have taken with the traditional programming methods. Our in-house integrated accounting system (yes it's for sale) was developed using TAS. Running on a multi-user network with full file and record locking, any one of us can instantly answer questions like who owes us what, when and what it was for?

## Money Back Guarantee

Our philosophy is simple. Try it for 30 days. If you like it you keep it. If not you just send it back and we'll give you your money back. No questions asked.

## STOP EVALUATING

dBase III	£595
Dataflex	£575
Dataease	£545
Delta 4	£545
Paradox 2	£595
RBase V	£545
<b>TAS Plus</b>	<b>£ 99</b>

## System Requirements

TAS Plus runs on any IBM PC, XT, AT or PS/2 compatible computer system including the AMSTRAD 1512 and 1640. TAS needs 512KB RAM and at least two floppy disk drives but we recommend a hard disk for development. Run-time applications need little space and will run excellent on single floppy systems. The multi-user version of TAS costs \$349, supports file & record locking and runs on all DOS 3.X Netbios compatible networks incl. Token Ring, PC-Net, Novell, DNA, Northstar, 3-Com etc.

**ACT  
NOW!**

Order your copy today or send for more information. All goods are despatched using 1st Class Recorded Delivery usually on the same day we receive your order.

TO: MEGATECH, 111-113 Wandsworth High Street, London SW18 4HY

Please supply \_\_\_\_\_ copies Card Name \_\_\_\_\_

TAS Plus @ £99 per copy: £ \_\_\_\_\_ Card Address \_\_\_\_\_

Handling & shipping: £6.00 \_\_\_\_\_

Add 15% VAT: £ \_\_\_\_\_

I enclose a total of: £ \_\_\_\_\_

Please send more information: \_\_\_\_\_ Postcode \_\_\_\_\_

Payment: \_\_\_\_\_ Daytime Tel No: \_\_\_\_\_

Cheque  Access  Visa  Signature \_\_\_\_\_

Card No: \_\_\_\_\_

\_\_\_\_\_

Card Expiry Date \_\_\_\_\_

**MEGATECH** 111-113 Wandsworth High Street  
Wandsworth, London SW18 4HY  
Tel: 01-874 6511. Telex: 21768

PCW/POS

TAS Plus is available from many dealers. You can also phone GEM Distribution (0279-44242) or NEWSTAR Software (0217-220573) for a local TAS Plus dealer.



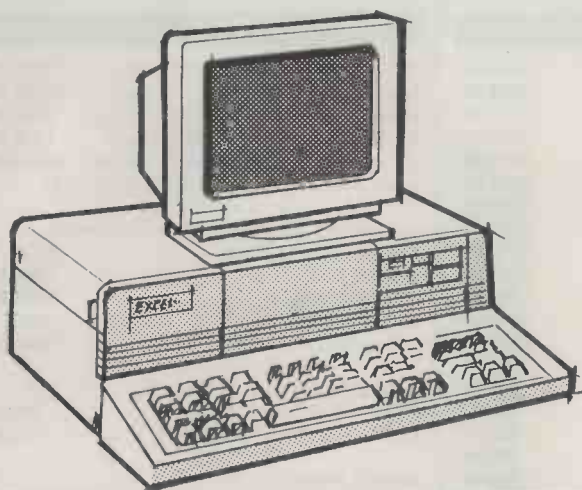

# 386

## EXZEL 386 TURBO

- ★ LIGHTNING FAST 80386 ZERO WAIT STATE
  - ★ 30Mb FIXED DISK, 1.2Mb FLOPPY, 1Mb FAST RAM
  - ★ HI-RES HERCULES COMPATIBLE MONITOR & ADAPTOR
  - ★ PARALLEL, SERIAL, KEYBOARD, 200 WATT PSU
  - ★ FREE ON-SITE MAINTENANCE
  - ★ TELEPHONE HOTLINE
  - ★ 25,000 SYSTEMS SOLD
  - ★ 14 DAY MONEY BACK GUARANTEE
- DEALER ENQUIRIES WELCOME

**£1496.00**

**At last!** colour toner

100% GUARANTEED

- ★ RED, BLUE, GREEN, BROWN, & YELLOW
- ★ RECHARGE YOUR LASER CARTRIDGES AND CUT YOUR COSTS IN HALF

## AMSTRAD portables

PPC 512 SINGLE DRIVE	£378
PPC 512 DUAL DRIVE	£461
PPC 640 SINGLE + MODEM	£465
PPC 640 DUAL + MODEM	£535

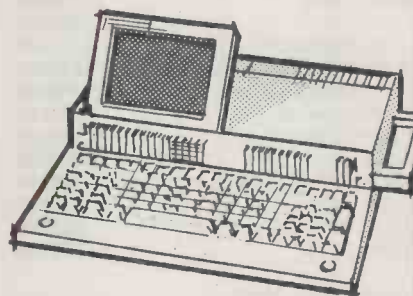

### SOFTWARE

LOTUS 123	£217	WORDPERFECT	£235
DATAEASE	£415	SUPERCALC 4	£215
DBASE III +	£325	DISPLAYWRITE 4	£348
EXCEL	£265	FREELANCE +	£264
PAGEMAKER	£414	SMART	£357

### SPECIAL OFFERS

EPSON LQ 1000 WITH TRACTOR MONITOR & DISPLAY ADAPTOR	£450
for VGA/EGA/MDA & HERC	£499

### BID DESK SUPPLIERS

APPLE	OLIVETTI
AMSTRAD	OKI
APRICOT	STAR
AST	QUME
BROTHER	PANASONIC
COMPACT	TAXAN
CITIZEN	MICROVITEC
CANON	TANDON
DATA PRODUCTS	IBM
EPSON	GENICOM
HP	QUME
KYOCERA	SHARP
NEC	AND MANY MORE
NOVELLE	



## TOSHIBA portables

T1000	£745	T3100/FF	£1495
T1100+	£970	T3100/20	£2245
T1200	£1945	T3200	£2995
T5100	£3400	MODEM	£295



Use the U.K's first 'Bid Desk' for all your computer needs

- from **AMSTRAD** to **ZENITH**



COMMERCIAL  
&  
GENERAL SYSTEMS

☎ 0582 696911

37 EVELYN ROAD, DUNSTABLE, BEDS., LU5 4NG

# PART EXCHANGE YOUR BBC FOR ANYTHING WE CARRY IN STOCK

Allowances from £75 (non-working) to £200 (late model - DFS Machine).

## PRINTERS

Epson LX800	£189.00
SS Feeder	£75.00
FX800	£299.00
SS Feeder	£139.00
FX1000	£439.00
SS Feeder	£139.00
EX800	£399.00
SS Feeder	£148.00
EX1000	£545.00
SS Feeder	£198.00
Colour Ribbon.	£18.00
Colour Option	£55.00
LQ500	£299.00
SS Feeder	£75.00
LQ850	£499.00
SS Feeder	£155.00
LQ1050	£699.00
SS Feeder	£179.00
LQ2500	£789.00
SS Feeder	£198.00
SQ2500	£999.00
GQ3500 Laser	£1495.00
Data Products LZR 1230	£2490.00
Canon PW 1080A	£249.00
A55 132 col	£449.00
Serial Interface	£79.00
PJ 1080 Colour	£399.00
LPB-8 Series 2 Laser	£1649.00
Juki 6100 Daisywheel	£279.00
Serial Interface	£59.00
SS Feeder	£199.00
Tractor Unit	£159.00
6200	£449.00
6300	£699.00
6500	£799.00
National Panasonic Matrix	
KXP 1081	£149.00
KXP 3131	£245.00

## SPECIAL OFFER

Epson LX800 still only £189.00. But only while stocks last.

Acorn/Philips Medium Resolution Colour Monitor. Suitable for BBC B, BBC Master, Acorn Archimedes, Atari and many other micros.

TTL RGB Input, Analogue RGB Input, Audion Input, Button to select green text, 12 months warranty.

Limited Number Only — £199.00

Ideal for 80 column word processing, and for colour graphics.

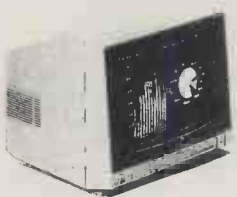

## MONITORS

Microvitec 1431MS Std Res	£168.00
1431DS Std Res	£168.00
1431MS/AP	£219.00
1431DS/AP	£219.00
1451MS Med Res	£219.00
1451DS Med Res	£219.00
1451MS/AP	£249.00
1451DS/AP	£249.00
1441 High Res	£359.00
2030CS Std Res	£380.00
2040CS High Res	£685.00
1456/F12 CGA	£349.00
1322/S12 EGA	£449.00
Touchtech 501	£249.00
Tilt & Swivel	£19.00
Philips 7502 12" green	£69.00
7522 12" amber	£85.00
7542 12" white	£85.00
7513 12" green IBM	£99.00
7713 14" green IBM	£113.00
7723 14" amber IBM	£118.00
8833 14" colour	£249.00
8852 14" colour	£279.00
8873 14" EGA	£499.00
Taxan KX17	£75.00
KX12	£99.00
Acorn ADF32 Med Res colour	£199.00

## PLOTTERS

Linear Graphics Plotmate	
A4 Parallel	£369.00
A4M Multi-interface	£429.00
A3 Parallel	£399.00
A3M Multi-interface	£549.00
Houston Instruments	
EDMP 52 A2/A1 1 pen	£2978.00
High Speed Intelligent Drum	
EDMP 52MP A2/A1 14 pen	£3726.00
High Speed Intelligent Drum	

## MODEMS

Miracle WS 2000 V21/23	£92.00
WS 2000 Auto Dial Card	£27.00
WS 2000 Auto Answer Card	£27.00
WS 2000 Ski Kit	£5.00
WS 2000 User Port Lead	£5.00
WS 4000 V21/23	£135.00
WS 3000 V21/23	£244.00
WS 3000 V22	£409.00
WS 300 V22 BIS	£537.00
(Comes complete with BBC Coms package and Data Lead).	
Pace/Nightingale Modem	£115.00
BBC/Commstar Software	£29.00

## PCB DESIGN

- Professional PCB Layout using Racal RedCAD — no job too small
- EPLD Chips designed. (Erasable Programmable Logic Devices)
- 24 Hours turn round — contact: Russell Clarke 0276-684715

## SATELLITE RECEIVING SYSTEMS

- Complete Systems from £499
- Satellite Decoder Boxes for Filmmet + Sky + BBC from £299

## EURO MICRO

386/16 1Mb Ram, Single 1.2Mb floppy	£1995.00
286/10 1Mb Ram, Single 1.2 Mb floppy	£1295.00
Baby AT 1Mb Ram, Single 1.2 Mb floppy	£995.00
XT-Turbo 640k Ram, Single 360k floppy	£695.00
All complete with Monochrome Monitor, Keyboard Serial and parallel ports, and MS DOS V3.21	
Add-on Hard Disks (including controller where necessary for XT-Turbo, 20Mb	£295.00
for Baby AT, 20Mb	£350.00
for 286/10 20Mb	£200.00
for 386/16 20Mb	£350.00
for 386/16 20Mb + cache	£495.00
Add-on floppy	
for XT-Turbo 360k	£65.00
for Baby AT, 286 and 386 1.2Mb	£95.00
Add-on Memory	
for 286/10 1Mb	£130.00
for 386/16 1Mb	£295.00
EGA Colour monitor	£395.00
EGA Card	£195.00
Euromicro PC reviews have said:	
Which Computer — Startling Good Value	of 386
Which Computer — Best Buy	of 286
PCUser — Excellent	of 386

## SOFTWARE

Delta Professional	£399.00
Delta 4 Budget	£85.00
dBase III Plus	£399.00
PFS: Professional Filer	£199.00
Cardbox	£52.00
Cardbox Plus	£249.00
Wordperfect V4.2	£299.00
Junior Wordperfect	£86.00
Wordstar V3.4	£199.00
Wordstar Professional V4	£249.00
Wordstar 2000 re13	£299.00
Lotus 123 re 2	£349.00
Lotus Symphony	£325.00
Psion Exchange	£325.00
Ability	£99.00
Logistix	£99.00
Sage Bookkeeper	£95.00
Sage Accountant	£135.00
Sage Accountant Plus	£165.00

## ABOUT COMPSHOP

Compshop was established in 1978, and in the nine years of trading numbers among its customers BBC, BOCC, BP, British Aerospace, British Home Stores, British Leyland, BT, CBS, DEC, Ferodo, GEC, Hirst, IIT, ITN, Kodak, Logica, Marconi, Metal Box, MK Electric, Pilkington Glass, Radio Rentals, Rolls Royce, Saatchi and Saatchi, STC, STL, Texal Instruments, Thorn EMI, UDT and Zales.

PRICES EX-VAT AND SUBJECT TO CHANGE WITHOUT NOTICE. PLEASE RING FOR STOCK SITUATION BEFORE MAKING LONG JOURNEYS.

# COMP SHOP LTD

• ESTABLISHED EDUCATION SUPPLIERS •  
WITH APPROVED ACORN • AMSTRAD • CUMANA  
MICROVITEC • EPSON • SERVICE CENTRES

## RETAIL SHOPS

COMPSHOP LTD

14 STATION ROAD,  
NEW BARNET,  
HERTS EN5 1QW  
(NEAR BRITISH RAIL STATION)

SALES: 01-441-2922  
TECHNICAL: 01-449 6596  
TELEX: 298755 TELECOM G

OPEN  
10-7 • Mon-Fri  
10-4 • Sat

INNOVATION HOUSE  
ALBANY PARK  
CAMBERLEY,  
SURREY GU15 2PL  
(BEHIND "PAYLESS")

SALES: 0276-29219  
TECHNICAL: 0276-684715



# COMP SHOP LTD

## NEVER SLEEPS

**24 HOURS A DAY  
7 DAYS A WEEK**

**TELEPHONE: 0276-22677  
01-441 2922 (Office Hours)**

**FAX:  
0276-684716  
01-440-7033**

**Educational enquiries are most welcome**

**PHONE YOUR ORDER NOW WITH CONFIDENCE  
WE GUARANTEE TO MATCH PRICES OFFERED  
THROUGH ANY OTHER SUPPLIER**

**ALL MAJOR  
CREDIT CARDS ACCEPTED**



**CARRIAGE ON  
ANY ITEM  
POST £3.00  
COURIER £10.00**

### BBC MASTER SERIES

Master 128	£369.00
Master Turbo Upgrade	£99.00
Master 512 upgrade	£199.00
Eprom Cartridge	£11.00
Reference Manual Part 1	£14.95
Reference Manual Part 2	£14.95
Advanced Reference Manual	£19.95
View Manual	£10.00
ViewSheet Manual	£10.00
Disk Filing System User Guide	£5.00
Plynth for Master	£12.00
Joystick (switched)	£15.00

### ACORNSOFT

View ROM	£37.00
ViewSheet ROM	£37.00
ViewStore ROM	£37.00
ViewSpell ROM	£29.00
GXR Graphics ROM	£26.00
ISO Pascal ROM	£60.00
Basic 2 ROM	£15.00
OS 1.2 ROM	£10.00
ViewIndex	£12.00
ViewPlot	£22.00
Hiview	£36.00
Printer Driver Generator	£10.00
Speech Upgrade	£39.00
ADFS Rom	£25.00

### COMPUTER CONCEPTS

Wordwise +	£40.00
Intersheet	£37.00
Interword	£39.00
Interchart	£26.00
Interbase	£55.00
Disc Doctor	£28.00
PrintMaster	£24.00
Communicator	£49.00
Termi II	£25.00
Accelerator	£48.00
SpellMaster	£47.00
Edword 2 ROM	£46.00
ATPL Sidewise Board	£39.00
AMX Mouse	£59.00
AMX Pagemaker	£37.00
1770 DFS Upgrade	£49.00

### ECONET EQUIPMENT

Upgrade for		
BBC B	£60.00	10 Station Lead Set £25.00
Module for		100m Cable £86.00
Master/Archie	£43.00	Installation (per day) £150.00
Clock + Term.Set	£86.00	Filestore E01 (server) £828.00
Outlet Socket Kit	£26.00	Filestore E20 (20Mbyte) £721.00
Level 1 Software	£80.00	
Level 2 Software	£216.00	
Printer Server	£42.00	

### DISK SYSTEMS

<b>Acorn Winchester</b>			
30 Mbyte with L3 S/W			£1549.00
<b>Cumana Disk Systems for BBC</b>			
Single without PSU			
CSX100	40T/SS	100K	£89.00
CSX400	80T/DS	400K	£119.00
Single with PSU			
CS100	40T/SS	100K	£109.00
CS400	80T/DS	400K	£139.00
CS354	3.5"	400K	£119.00
Dual with PSU			
CD200	40T/SS	200K	£199.00
CD800S	80T/DS	800K	£239.00
CD358	3.5"	800K	£199.00
CAR20 20Mb HD £599.00			
<b>Cumana disk systems for Atari</b>			
CSA 354 3.5" single 1Mb			£125.00
CDA 358 3.5" dual 2Mb			£225.00
CSA 1005 5.25" single 1Mb			£145.00

### ACORN ARCHIMEDES

A305 Base	£649.00
A305 Mono	£699.00
A305 Colour	£849.00
A310 Base	£725.00
A310 Mono	£775.00
A310 Colour	£925.00
A310M Base PC Emulator	£799.00
A310M Mono PC Emulator	£845.00
A310M Colour PC Emulator	£999.00
A410 Base	£1299.00
A410 Mono	£1349.00
A410 Colour	£1499.00
A440 Base	£2199.00
A440 Mono	£2249.00
A440 Colour	£2399.00
0.5mMbyte Ram	£89.00
Floppy Disk	£125.00
20Mbyte + Controller	£499.00
Podule Backplane	£35.00
I/O Podule	£79.00
PC Emulator Software	£79.00
Archie Reference Guide	£29.95



### AMSTRAD COMPUTERS

PC1640SD mono	£449.00
PC1640DD mono	£549.00
PC1640HD mono	£799.00
PC1640HD20 colour	£599.00
PC1640DD colour	£699.00
PC1640HD20 colour	£949.00
PC1640SD Enhanced colour	£749.00
PC1640DD Enhanced colour	£799.00
PC1640HD20 Enhanced colour	£1099.00
1640 Technical ref manual	£19.95
LQ3500	£349.00
DMP3160 Printer	£199.00
DMP4000	£349.00
Modem Card	£149.00
HD20 Add-on	£449.00
Wordstar 1512 £49.00	
Wordstar Express £69.95	
Supercalc 3.1 £49.00	
Supercalc 3.2 £69.00	
Reflex £69.95	
Sidekick £29.00	
Infomaster £69.00	
Accounts Master £149.00	
Paymaster £49.00	
PCW 8256 £299.00	
PCW 8512 £399.00	
PCW 9512 £499.00	

### BARGAIN BASEMENT

Acorn Z80 Second Processor	£200.00
Acorn Teletext Receiver	£75.00
Anadex 8500 (Non-runner)	£100.00
Acorn 30Mb Winchester with L3 Software	£1200.00
Apple Macintosh Add-on Drive	£200.00

### BBC 'B' (2nd User) PRICES FROM £175 3 Months Warranty

**PLEASE CALL FOR AVAILABILITY**

Apple disk with Controller	£149.00
Apple Additional Disk Drive	£99.00
Duodisk with Controller	£349.00
Apple Monitor	£79.00
Super Serial Card	£69.00
Cirtech 80 Column Text card	£49.00
Cirtech Printer Card	£49.00
Sound + Vision Modulator	£19.00
RGB colour card	£49.00
Appleworks	£99.00
Workbench	£99.00
Juki 6100 printer	£200.00
TECF 10-40	£699.00

### MISCELLANEOUS

5.25" Datatech Diskettes per 10 80T Double Sided	£15.00
3.5" Datatech Diskettes per 10 80T Double Sided	£20.00
3" Diskettes per 10 Single Sided	£30.00
Double Sided	£50.00
5.25" Storage Box 10	£2.50
30	£12.00
80	£18.00
3.5" Storage Box 10	£3.50
30	£9.00
60	£15.00
C12 Cassettes 12 min x 10	£2.00
<b>Ribbons</b>	
Epson MX/FX/RX80/LX800	£4.00
MX/FX/RX100	£8.00
LX/80	£4.00
JX80 (Colour)	£10.00
LQ800	£6.00
LQ1000	£8.00
Canon/Taxan	£6.00
Colour Cartridge	£10.00
Juki MS	£3.00
Juki SS	£2.00
Hermes (Remstar)	£3.00
Imagewriter/Apple DMP	£6.00
Microline	£2.50
Anadex 9500/1	£12.50
TEC/Citoh/Diablo	£5.00
Brother HR15/DX100	£4.00
Amstrad PCW 8256/512	£6.00
PCW 9512	CALL
Amstrad DMP3000	£4.00
<b>Printer lead for</b>	
BBC 1m	£6.00
BBC 2m	£8.00
BBC 3m	£10.00
RS423	£8.00
Compact	£15.00
Apricot, Sanyo	£12.00
IBM/Amstrad PC/Archie	£12.00
IBM RS232	£15.00
Custom made leads	£25.00
<b>Printer Data Switch</b>	
2-way	£69.00
3-way	£89.00
4-way	£99.00
2-Way Crossover	£99.00
<b>Selmour Desks</b>	
4X2 (with shelf)	£119.00
3X2 (with shelf)	£99.00
Shinecrest Desk (3x2)	£69.00
<b>Monitor/Disk/Printer Stand</b>	
Cassette Lead	£4.00
C12 Cassettes (per 10)	£4.00
4-way mains adapter	£8.69



ORDER TODAY  
AND SAVE £5.00

# PC YEAR BOOK 1988

# Paper Back Up!

## Demand the best backup for your PC. Demand the PC Yearbook 1988

Following hot on the heels of the successful PC Yearbook for 1987, here's the completely updated 1988 edition, the brand-new guide for all IBM and compatible PC users. With over 500 pages crammed with essential information, the PC Yearbook 1988 is just what you need to get the best from your PC.

### It's all inside

This resource-full book contains all you need to know about PC hardware, software, services, supplies.

Discover the secrets of networking, the best maintenance deals, the most suitable printers, the new IBM PS/2, and much more. Be briefed on the implications of Desk Top Publishing, and on business graphics, and on micro/mainframe links.



## Turn to the PC Yearbook

Inside you'll find listings — all carefully cross-referenced — of IBM dealers, of training organisations, of peripherals suppliers, of consultants. There are full details on over 3,500 software packages available for your PC, as well as invaluable reviews and articles on the concerns of all PC users.

The PC Yearbook costs just £40 — around 10p a day for a comprehensive reference book that's always to hand, and always useful. Order now using the form below, and claim a special £5 discount for prepayment.

**The PC Yearbook 1988.**  
The essential backup for you and your PC.

### PC YEARBOOK DISCOUNT ORDER FORM

Please send me \_\_\_\_\_ copy/ies of The PC Yearbook 1988.

- I enclose cheque for £35 plus £2.50 UK p&p, SAVING £5 on the published price.

- Please invoice me/my company for £40 plus £2.50 UK p&p.

Signed \_\_\_\_\_

Name \_\_\_\_\_

Company \_\_\_\_\_

Address \_\_\_\_\_

Send to VNU Business Publications, Directories Booksales Dept.,  
FREEPOST 25, London W1E 6EZ. Telephone: 01-439 4242.

**Out Now!**

VNU Business Publications  
32-34 Broadwick St  
London W1A 2HG  
Telephone: 01-439 4242



# BROOKWOOD computers

Brookwood House  
8 Banbury Road  
Kidlington  
Oxford  
OX5 2BT

## Amazing **AMSTRAD** Bargains

Amstrad PC1512 Mono 20Mb .....	£675.00	Amstrad PC1640 Mono 20Mb .....	£735.00
Amstrad PC1512 Mono 30Mb .....	£725.00	Amstrad PC1640 Mono 30Mb .....	£775.00
Amstrad PC1512 Mono 40Mb .....	£850.00	Amstrad PC1640 Mono 40Mb .....	£945.00
Amstrad PC1512 Mono 60Mb .....	£899.00	Amstrad PC1640 Mono 60Mb .....	£999.00

Amstrad PC1512 Colour 20Mb.....	£775.00	Amstrad PC1640 Colour 20Mb.....	£925.00
Amstrad PC1512 Colour 30Mb.....	£825.00	Amstrad PC1640 Colour 30Mb.....	£945.00
Amstrad PC1512 Colour 40Mb.....	£950.00	Amstrad PC1640 Colour 40Mb.....	£1045.00
Amstrad PC1512 Colour 60Mb.....	£1020.00	Amstrad PC1640 Colour 60Mb.....	£1125.00

**Sales Hotlines**  
**(08675) 79950**  
**(08675) 79020**  
**(08675) 5468**

Amstrad PC1640 EGA 20Mb .....	£1050.00
Amstrad PC1640 EGA 30Mb .....	£1099.00
Amstrad PC1640 EGA 40Mb .....	£1250.00
Amstrad PC1640 EGA 60Mb .....	£1275.00



### BROOKWOOD & WESTRA OFFER YOU

A UNIQUE, COMPACT AND  
STYLISH UNIT FOR THE PERSONAL  
COMPUTER USER



**CHEAP!** If you order your microstation from Brookwood Computers now, you get 20% off the retail price.

**PACKAGE!** Space available for your P.C. System with full cable management facilities.

**TRIP!** Make your P.C. mobile for use in any office with this fantastic unit.

**ORDER NOW** and take advantage of this unbeatable offer.

**PHONETODAY!**  
(08675) 79020  
(08675) 79950  
(08675) 5468

Brookwood Computers,  
Brookwood House,  
8 Banbury Road,  
Kidlington,  
Oxford OX5 2BT.

# When we introduced Foxbase, our competitors were speechless...

## ...but journalists couldn't stop talking...

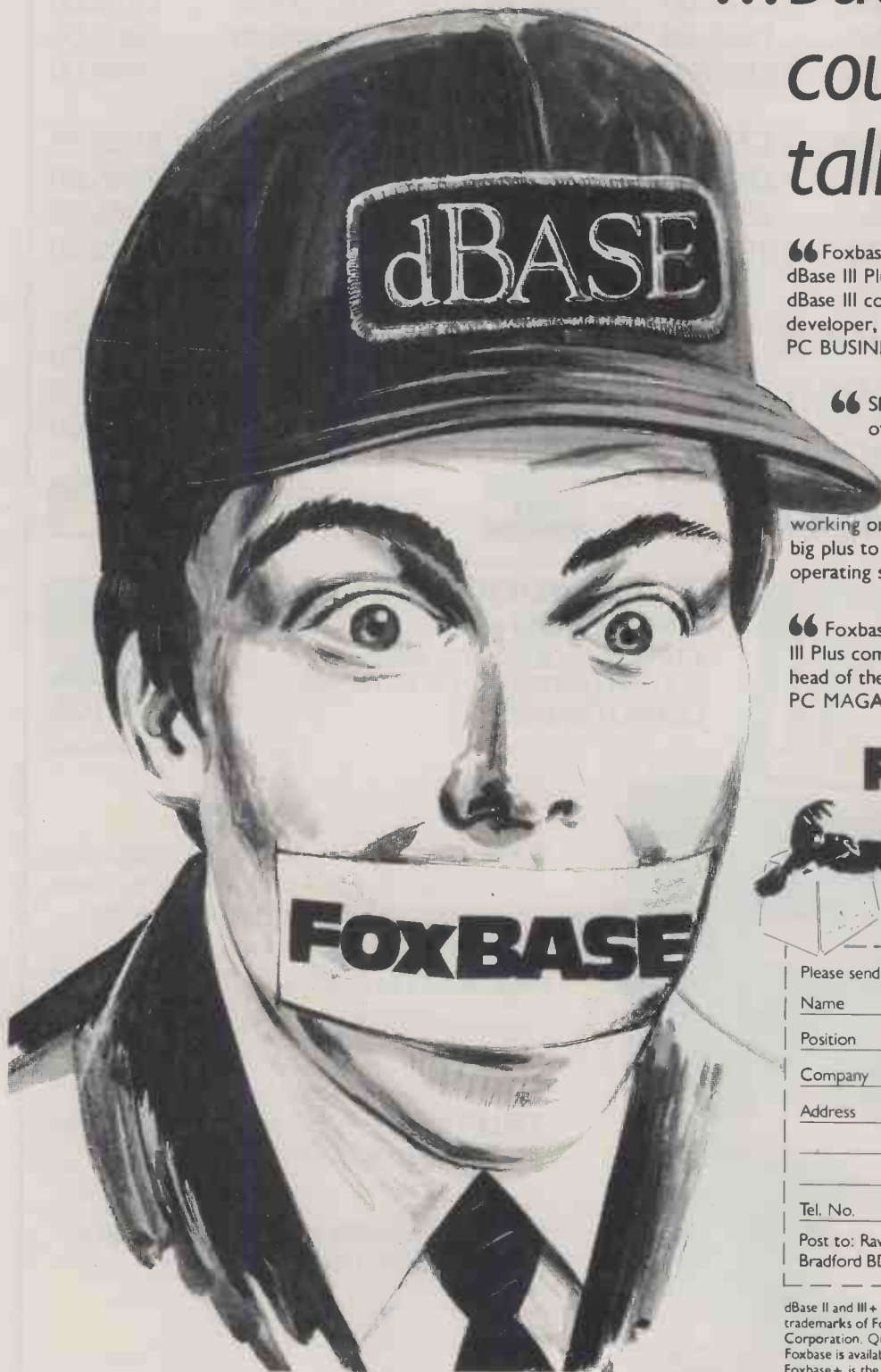

“Foxbase Plus is a speed demon. It easily surpassed dBase III Plus in every category... easily the fastest dBase III compatible program... If you are a dBase developer, Foxbase is a must-have product”  
PC BUSINESS WORLD

“Should you go for Clipper or FoxBase instead of dBase? Our recommendation is yes — FoxBase in particular gives you nearly all the interactive qualities of dBase, like dBase can be converted for multi-user working on a network, is considerably faster, and — a big plus to our way of thinking — is available on other operating systems including Xenix”

“Foxbase Plus maintains stunning speed, adds dBase III Plus compatibility... Foxbase Plus zooms to the head of the dBase compatible class.”  
PC MAGAZINE

**FOXBASE** 

FROM

 **Raven  
Computers**

Please send me further details on Foxbase/Foxbase+

Name

Position

Company

Address

Tel. No.

Post to: Raven Computers, 28/32 Cheapside,  
Bradford BD1 4JA. Or telephone now on 0274 309386

dBase II and III+ are trademarks of Ashton Tate. Foxbase and Foxbase+ are trademarks of Fox Software Inc. Clipper is a trademark of the Nantucket Corporation. Quicksilver is a trademark of Wordtech Systems. Foxbase is available for dBase II applications in single and Multiuser environments. Foxbase+ is the logical replacement for dBase III+.



# PC/AT COMPATIBLES

**BREAKING THE PRICE BARRIER!!!**  
MANUFACTURED IN THE UNITED  
KINGDOM USING HIGHEST  
QUALITY JAPANESE PRODUCTS

**15MHZ AT SYSTEMS AVAILABLE NOW**  
20MB/AT with  
transputer board **£2250**  
**NEW LOW PRICES**

# 386

INTEL 80386 16 MHz. 512KB RAM. 1.2MB FD SERIAL & PARALLEL  
PORTS, HERCULES CARD, EXTENDED KEYBOARD, 8 EXPANSION  
SLOTS, S1-163 **1350.00**

CAS 80386 16 MHz, 1MB RAM +64K CACHE, 1.2MB FD, 20 MB  
HARD DISK, SERIAL & PARALLEL PORTS, HERCULES CARD,  
EXTENDED KEYBOARD, 8 EXPANSION SLOTS, S1-20 **£1650.00**

CAS 386-20 MHz, 1MB RAM +64K CACHE 20MB HD. 1.2MB FD  
SERIAL and PARALLEL PORTS, HERCULES CARD, EXTENDED  
KEYBOARD, 8 EXPANSION SLOTS SI-25, Landmark = 30 **£1980.00**

ALL SYSTEMS ARE EXPANDABLE 4MB ON motherboard &  
INCLUDE MONOCHROME MONITOR & MONOGRAPHICS CARD  
ADD £325 FOR EGA UPGRADE 4MB RAM OPTION  
Memory upgrades, tape streamers are available.  
Price on request.

**PC/XT £280**  
**PC/XT. 20MB.**  
**MONITOR TTL £580**

- ★ 8088/V20 ★ 640k
- ★ "NEC" FLOPPY DRIVE ★ "SERIAL/PARALLEL" PRINTER PORT
- ★ HERCULES GRAPHICS DISPLAY ADAPTOR ★ KEYBOARD NUMS +  
CAPS LOCK ★ 8 SLOTS ★ FLAT SCREEN MONITOR

**AT/TURBO £590**  
**WITH 20MB**  
**MONITOR £880**

- ★ DYNAMIC SPEED CONTROL ★
- ★ 80286 6/8/12 MHZ ★ 1MB RAM
- ★ LEGAL BIOS ★ FLOPPY DRIVE 1.2M ★
- ★ PRINTER PORT ★ GRAPHICS DISPLAY ADAPTOR ★
- ★ AT STYLE KEYBOARD WITH SEPARATE CURSOR PAD ★

286 Plasma EGA Laptop £1950  
EPSON LX800 £160, LCD 20MB AT £1080, LCD 20MB XT £880.

ALL SYSTEMS ARE TOTALLY COMPATIBLE  
HI REST TTL MONITOR £699 20 MB HARD DISK £299  
BILINGUAL SYSTEMS EXPORT ORDERS WELCOME  
12 MONTHS WARRANTY AND SUPPORT INCLUDED PRICES EXCLUDING V.A.T.

**All items are in stock and available now.**

The above prices are subject to a possible surcharge on RAM  
FOR ORDERS AND ENQUIRIES PLEASE CONTACT

**C.A.S. COMPUTER POINT LTD**  
51a DARTMOUTH ROAD, LONDON SE23  
TEL: 01-291 5777. FAX NO: 01-291 4837  
TLX 8952387 ANSWER G

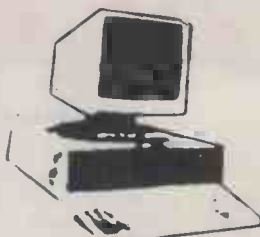

# Computers by Post

**LOWEST U.K. PRICES GUARANTEED**

## DOT MATRIX PRINTERS

THIS MONTH'S SPECIAL OFFERS  
 Amstrad LQ3500 inc. Wordstar 1512 £260  
 Amstrad DMP4000 inc. Supercalc 3 £260  
 Epson LX800 £175

## DAISY WHEEL PRINTERS

<b>BROTHER</b>	HR20	£319
	HR40 inc SSF	£709
<b>CITIZEN</b>	PREMIER 35	£419
<b>JUKI</b>	6100	£253
	6200	£354
	6300	£589
	6500	£737
<b>MICRO-P</b>	MP40	£263
<b>PANASONIC</b>	KXP3131	£227
	KXP3151	£369

## PRINTER CABLES

<b>AMSTRAD CPC</b>	PARALLEL	£8.90
<b>BBC</b>	PARALLEL	£6.50
<b>IBM/AMSTRAD PC/ATARIST</b>	2 METRE PARALLEL	£8.90
	3 METRE PARALLEL	£14.90

<b>AMSTRAD</b>	LQ3500	£260	<b>EPSON</b>	LX800	£175	<b>NEC</b>	P2200	£279
	DMP4000	£260		FX800	£278		P6	£354
	LQ5000DI	£364		EX800	£399		P7	£404
<b>BROTHER</b>	1109	£169		LQ500	£264		P5XL	£689
	1509	£358		LQ850	£413		P9	£899
	1709	£429		FX1000	£372	<b>OKI</b>	ML182	£183
	1724	£499		EX1000	£529		ML192	£278
	2024	£574		LQ1050	£564		ML193	£356
	4018	£1099		LQ2500+	£687		ML292	£445
<b>CITIZEN</b>	120D	£130		SQ2500	£939		ML293	£594
	LSP100	£194	<b>FUJITSU</b>	DX2200	£408		OKIMATE 20	£158
	MSP-10	£198		DX2400	£548	<b>PANASONIC</b>	KXP1081	£137
	MSP-15	£229		DL2400	£719		KXP1082	£173
	MSP-50	£386	<b>MICRO-P</b>	MP135+	£125		KXP1083	£274
	MSP-55	£489		MP165	£154		KXP1592	£329
	HQP-45	£445		MP480	£295		KXP1595	£425
				MP700	£439		KXP1540	£468
						<b>STAR</b>	LC10	£157
							LC10 COLOUR	£195
							ND10	£239
							NR10	£309
							NB24-10	£383
							NX15	£264
							ND15	£329
							NR15	£379
							NB24-15	£489
							NB15	£579

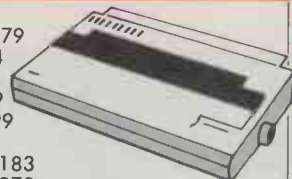

## LASER PRINTERS

THIS MONTH'S SPECIAL OFFERS  
 Epson GQ 3500 £1159.00  
 HP Laser Jet II £1569.00



AST TURBO EL	8PPM	£1499
AST TURBO	8PPM	£2189
AST TURBO (POSTSCRIPT)	8PPM	£2489
BROTHER HL-8	8PPM	£1589
CANON LBP8-II	8PPM	£1469
CANON LBP8-III	8PPM	£1899
CANON LBP8-III	8PPM	£2185
CITIZEN OVERTURE 110	10PPM	£1229
EPSON GQ-3500	6PPM	£1159

<b>HEWLETT PACKARD LASERJET II</b>	8PPM	£1569
KYOCERA F-1000	10PPM	£1749
KYOCERA F-1200	10PPM	£2599
KYOCERA F-2200	10PPM	£3529
KYOCERA F-3000	18PPM	£4899
OKI LASERLINE 6	6PPM	£1299
QMS PS810+ (POSTSCRIPT)	8PPM	£3276
QUME SCRIPT TEN (POSTSCRIPT)	10PPM	£3499
RICOH P6000	6PPM	£1419
RICOH LP4081	8PPM	£2489
SBC SPEED LASER	6PPM	£1299
STAR LP8	8PPM	£1509

ALL LASERS MARKED WITH AN \* INCLUDES ON-SITE SERVICE CONTRACTS

## PLOTTERS AND SCANNERS MONITORS MODEMS

<b>CAMERON</b>	HANDY SCANNER	£264
<b>CANON</b>	SCANNER AND I/F	£889
	SCANNER AND I/F + OCR SOFTWARE	£1259
<b>CHERRY</b>	GRAPHICS TABLET III	£447
<b>HEWLETT</b>	7440A	£746
<b>PACKARD</b>	7475A	£1269
	7550A	£2858
<b>ROLAND</b>	SCANJET AND I/F	£1479
	DX990A	£949
	DX2200	£2539
	DX3300	£3589
	DX980A	£818
	<b>SUMMASKETCH</b>	£369

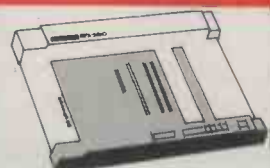

<b>FUJITSU ME503 M/SYNC</b>	£379
<b>GENIUS A4</b>	£1199
<b>MICROVITEC</b>	
M/SYNC 20"	£1269
<b>mitsubishi II M/SYNC</b>	£499
NEC M/SYNC II	£449
NEC M/SYNC+	£674
NEC M/SYNC 20"	£1449
PHILIPS 8852XL	£229
PHILIPS M/SYNC	£479
SONY M/SYNC	£569
TAXAN 770 + M/SYNC	£459

<b>AMSTRAD/PACE</b>	INTERNAL V21/V23 + SOFT	£99
<b>AMSTRAD</b>	MC2400	
INTERNAL V21/V22/V22BIS/V23 + SOFT		£184
<b>DATAFILE DESIGN</b>	STRADCOM INTERNAL V21/V22 + SOFT	£144
<b>STEEBEK/DOWTY</b>	DOWTY QUATTRO V22BIS	£619
<b>MIRACLE TECHNOLOGY</b>	WS4000	from £135
	WS3000	from £239
<b>PACE</b>	LINET V21/V23 AA/AD/HAYES	£114
SERIES 4		from £215

## COMPUTERS

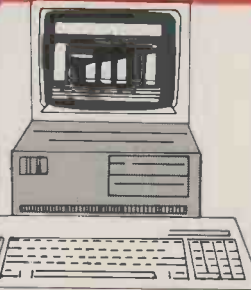

<b>AMSTRAD</b>	PC1640 SDMD	£449	<b>PCW8512</b>	£375	286 AT 40MB	£1189	<b>EPSON</b>		£1079
	PC1640 DDMD	£529	<b>PCW9512</b>	£418	386 AT 20MB	£2970		PC PORT 20MB	£1789
	PC1640 SDMD + 21MB	£659	<b>AST</b>		386 AT 40MB	£3145	<b>SHARP</b>		
	PC1640 SDMD + 32MB	£698	PREMIUM 120	£1574	<b>TANDON</b>		4501A		£659
	PC1640 20MBMD	£798	PREMIUM 140	£1849	PC A20	£1144	4502		£858
	PC1640 SDMD	£578	PREMIUM 170	£2149	PC A40	£1564	4521		£1599
	PC1640 DDCD	£658	<b>EPSON</b>		PC A70	£1808	7000A		£1169
	PC1640 SDMD + 21MB	£794	PCE 20Mb Mono	£895	TARGET 20	£1289	7100		£1395
	PC1640 SDMD + 32MB	£837	PC AX2 20Mb	£1179	<b>HARD DISK UPGRADE</b>		7221		£1999
	PC1640 20MBMD	£924	PC AX40 40Mb	£1489	21 MB HARDCARD	£225	<b>TOSHIBA</b>		
	PC1640 SDECD	£694	PC AX80 80Mb	£1679	32MB HARDCARD	£238	T1000		£799
	PC1640 DDECD	£788	<b>OLIVETTI</b>		<b>PORTABLE COMPUTERS</b>		T1100+		£1085
	PC1640 SDECD + 21MB	£919	M240 + 20MB	£1489	<b>AMSTRAD</b>		T1200		£1919
	PC1640 SDECD + 32MB	£949	M380 + 40MB	£3195	PPC5125	£378	T3100/20		£2349
	PC1640 20MBECD	£1019	<b>OPUS</b>		PPC512D	£469	T3200		£2839
	PCW8256	£279	PC III DD	£649	PPC6405	£469	T5100		£3339
			PC III 30Mb	£899	PPC640D	£569	<b>ZENITH</b>		
			PC V AT 30Mb	£1194	<b>CAMBRIDGE</b>		Z181 PORT		£1195
			EXTRA FOR EGA	£299	Z88	£239	Z183 PORT 20MB		£1495
			FD	£579					
			<b>SBC HD 30MB</b>	£899					

## PERIPHERALS

<b>DISPLAY ADAPTORS</b>		
AST 3-G EGA CARD 256K, MDA,		
HERC, CGA, EGA COMPAT	£217	
CGA CARD	£78	
EGA CARD	£149	
VEGA DELUXE	£179	
EVEREX THE EDGE	£318	
EVEREX GRAPHIC EDGE	£338	
EVA 480	£228	
VEGA VGA	£219	
ORCHID EGA	£220	
SERIAL/PARALLEL CARD AT	£68	
SERIAL/PARALLEL CARD XT	£68	

<b>PROCESSORS</b>		
8087 5MHZ	£88	
8087 8MHZ	£124	
8087 10MHZ	£199	
80287 6MHZ	£139	
80287 8MHZ	£179	
80287 10MHZ	£259	
80387 16MHZ	£369	
<b>RAM EXPANSION</b>		
AST 6 PACK + 64KB 1C, 1S, 1P		
UPGRADE TO 384K	£199	
AST 6 PACK PREMIUM 512K, C,		
1S, 1P (EMS)	£324	
AST ADVANTAGE OK, 1S, 1P		
(AT ONLY)	£345	

AST ADVANTAGE PAK, OK,		
PC/XT		£118
AST RAMPAGE (256K)		
POP UP TO 2MB XT		£199
AST RAMPAGE 286 (512K)		
POP UP TO 2MB AT		£345
INTEL ABOVE		
BOARD XT		£220
<b>EVEREX</b>		
MAGIC CARD AT 1P, 1S, WS		
(OK) POP UP TO 2MB		£254
MINI MAGIC 60K		
POP UP TO 576K		£84
RAM 3000 AT (OK POP)		
UP TO 3MB		£218

## FAX

<b>CANONFAX</b>	N20M	£2399	
FAX110	£1239	N25	£3299
FAX230	£1275	<b>PANAFAX</b>	
FAX410	£1579	UF150	£1179
FAX730	£2359	UF250	£1499
<b>NEFAX</b>		UF600B	£1159
N10 + HANDSET	£1199	UF600SF	£1789
N14 GREY SCALE	£1499	<b>SHARP</b>	
N18	£1699	FO-80	£979
		FO-150	£1149



**MAIL ORDER LEADERS  
SINCE 1982**

**For orders over £300  
claim your FREE Centronics  
Printer Cable or Cleaning Kit.**

**SOFTWARE**

**PRICES FOR 5 1/4" VERSIONS  
PLEASE PHONE FOR FOR 3 1/2" VERSIONS**

**INTEGRATED PACKAGES**

ABILITY + OPEN ACCESS II	£349
FRAMEWORK II	£294
PFS FIRST CHOICE	£107
SMART INC SPELLCHECKER	£399
SMART	£349
SMART SPELL CHECKER	£86
SUPER PROJECT + SYMPHONY	£124
SYMPHONY V1.2	£329
SYMPHONY V2.0	£349
<b>SPREADSHEETS</b>	
EXCEL	£229

LOTUS 123	£221
MULTIPLAN	£106
QUATTRO	£89
SAGE PC PLANNER	£68
SUPERCALC IV	£199
<b>WORD PROCESSORS</b>	
LOTUS HAL	£80
LOTUS MANUSCRIPT	£230
MULTIMATE ADVANTAGE II	£248
MS WORD IV	£234
SAGE PC WRITE	£68
WORDPERFECT 4.2	£183
WORDSTAR 2000 + RELEASE 3	£218
WORDSTAR PROFESSIONAL V4	£188

<b>ACCOUNTS</b>	
ACCOUNT ABILITY	£68
PEGASUS MODULES	£169
SAGE ACCOUNTANT	£104
SAGE ACCOUNTANT +	£134
SAGE BOOKKEEPER	£68
SAGE FINANCIAL CONTROLLER	£202
SAGE PAYROLL	£66
<b>DATABASES</b>	
DBASE III+	£319
DELTA PROFESSIONAL	£318
FOXBASE +	£259
PARADOX II	£275
R-BASE SYS 51.1	£349

SAGE RETRIEVE	£68
<b>DTP/GRAPHICS/CAD</b>	
AUTOSKETCH	£69
FONTASY	£49
FREELANCE +	£264
HARVARD GRAPHICS	£214
PAGEMAKER	£464
PUBLISHERS PAINTBRUSH	£161
VENTURA	£424
<b>MICE</b>	
M/SOFT BUS MOUSE	£119
M/SOFT SERIAL MOUSE	£119
MOUSE SYSTEMS PC MOUSE	£127
<b>NETWORKING SAGE NET</b>	£259

**PRINTER RIBBONS**

<b>AMSTRAD</b>	DMP1	£3.70	£3.10	£2.90
	DMP2000/3000/3160	£4.20	£3.90	£3.80
	PCW8256/8512	£4.10	£3.80	£3.60
	PCW8256/8512 red or blue	£5.10	£4.80	£4.60
<b>BROTHER</b>	PCW9512	£3.30	£3.00	£2.60
	HR5	£3.00	£2.80	£2.60
	HR15 Corr	£2.70	£2.30	£2.10
	HR15 FAB	£3.10	£2.70	£2.40
	HR15 MS	£3.00	£2.60	£2.30
	EP44	£2.90	£2.50	£2.30
<b>CANON</b>	M1009	£3.20	£2.70	£2.50
	PW1080A Black	£2.90	£2.40	£2.20
	PW1080A Red or Blue	£4.30	£3.90	£3.60
	PJ1080 Ink Jet Colour. One Off		£10.70	
	PJ1080 Ink Jet Black. One Off		£8.70	
<b>CBM</b>	MPS801	£3.40	£2.80	£2.60
	802/1526	£3.50	£2.70	£2.50
	803	£3.20	£2.70	£2.50
	MPS1000	£2.50	£2.10	£1.90
	MCS801 Colour. One Off		£18.50	
	DPS1101 SS	£2.20	£1.70	£1.55
	DPS1101 MS	£2.70	£2.30	£2.10
	DPS1101 Corr	£1.60	£1.30	£1.20
<b>CENTRONICS</b>	GLP 1/2	£3.20	£2.70	£2.50
<b>CITIZEN</b>	LSP10/100	£2.50	£2.10	£1.90
	MSP10/20	£2.50	£2.10	£1.90
	As above red or blue	£3.70	£3.00	£2.80
	120D	£4.80	£4.40	£4.10
	MSP15/25	£3.50	£3.10	£2.80
	Premier 35 MS	£2.90	£2.60	£2.10
	Premier 35 FAB	£3.90	£3.60	£3.10
<b>DAISYSTEP</b>	2000 MS	£2.90	£2.40	£2.20
	2000 FAB	£4.70	£4.00	£3.80
<b>EPSON</b>	LX800	£2.50	£2.10	£1.90
	MX/FX/RX80 Black	£2.50	£2.10	£1.90
	MX/FX/RX80 Red or Blue	£3.70	£3.00	£2.80
	MX/FX/RX100	£3.50	£3.10	£2.80
	LX80/LX86	£2.50	£2.10	£1.90
	JX80 Colour. One Off		£18.30	
	LQ800/850	£3.50	£3.10	£2.90
	LQ1000/1050	£4.30	£3.70	£3.40
<b>JUKI</b>	6000/2200 Corr	£2.90	£2.50	£2.30
	6100 MS	£2.70	£2.30	£2.10
	6100 SS	£2.20	£1.70	£1.55
	6100 Corr	£1.60	£1.30	£1.20
<b>KAGA</b>	KPB10 Black	£2.90	£2.40	£2.20
	KPB10 Red or Blue	£4.30	£3.90	£3.60
<b>M/TALLY</b>	MT80 MS	£3.50	£2.70	£2.50
	MT/80 FAB	£4.70	£4.40	£4.10
<b>NEC</b>	P2200	£6.50	£6.20	£5.80
	P2/P6	£3.90	£3.60	£3.20
	P5	£4.70	£4.40	£4.10
	P3/P7	£5.60	£5.30	£5.00

<b>OKI</b>	80/82	£1.20	£0.90	£0.80
	84	£3.70	£3.20	£3.00
	Mate 20 Colour	£7.00	£6.50	£6.20
	Mate 20 Black	£6.60	£6.20	£6.00
<b>PANASONIC</b>	Dot Matrix	£4.80	£4.40	£4.10
<b>QUENDATA</b>	DWP1120 MS	£2.90	£2.40	£2.20
	DWP1120 FAB	£4.70	£4.00	£3.80
<b>QUME</b>	Sprint 7/9 MS	£2.60	£2.10	£1.90
	Sprint 7/9 FAB	£3.80	£3.50	£3.20
<b>SEIKOSHA</b>	GP50	£5.80	£5.30	£5.00
	GP80	£2.50	£2.00	£1.80
	GP100/250	£2.40	£2.00	£1.80
	GP500/550	£3.70	£3.10	£2.90
	GP700 Colour. One Off		£18.50	
	SP1000	£5.80	£5.30	£5.00
<b>SHINWA</b>	CP80 MS	£3.50	£2.70	£2.50
	CP/80 FAB	£4.70	£4.40	£4.10
<b>SMITH</b>	Fastext 80 (Twinpack)	£11.70	£11.20	£10.90
<b>CORONA</b>	TPI M/S	£12.50	£10.70	£9.95
	TPI Fabric	£5.70	£5.25	£4.95
	TPI Corr	£5.00	£4.70	£4.50
	D100/200	£4.60	£4.20	£3.70
	D300	£5.80	£5.30	£5.10
<b>STAR</b>	DP/GEMINI/SG	£1.20	£0.90	£0.80
	SR15	£4.70	£4.30	£4.10
	NL10	£5.00	£4.40	£3.70
	NX/NB/NR 15	£8.00	£7.60	£7.20
	NB24-10	£6.50	£6.20	£6.00
	NB24-15/NB15	£8.00	£7.60	£7.20

**DISK STORAGE**

<b>LOCKABLE DISK BOXES</b>				
<b>MODEL</b>	<b>SIZE</b>	<b>CAPACITY</b>	<b>PRICE</b>	
DD40L	3 1/2" 3.5"	40	£8.50	
DD80	3.5"	80	£13.90	
DD50	5 1/4"	50	£8.90	
DD70	5 1/4"	70	£10.20	
DD100	5 1/4"	100	£11.70	

**COMPUTER STATIONERY**

<b>PLAIN WHITE WITH MICRO-PERF EDGES</b>				
<b>SIZE</b>	<b>GSM</b>	<b>QUANTITY</b>	<b>1 BOX</b>	<b>2 BOXES</b>
11 x 9 1/2	60	2000	£13.50	£13.00
11 x 9 1/2	70	2000	£16.50	£15.50
EXACT A4	70	2000	£21.90	£19.75
EXACT A4	90	1000	£14.20	£12.25
11 x 14 1/2	60	2000	£19.00	£17.00
11 x 14 1/2	70	2000	£21.00	£19.00

**LASER PRINTER CONSUMABLES**

<b>TONER CARTRIDGES</b>				
Epson GQ3500	£16.50	Canon A1/A2	£68.95	
Ok! Loserline 6	£16.50	Canon A8 Mk II	£68.95	
HP Laserjets	£68.95	QMS KB	£68.95	
HP Laserjet MkII	£68.95	Citizen Overture	£22.50	
QUME 2 pack	£89.00	KYOCERA 2 pack	£69.00	

**FLOPPY DISKS**

<b>5.25" BOXES OF 10 DISKS</b>				
<b>JVC inc Plastic Case</b>		<b>1-2</b>	<b>3-9</b>	<b>10+</b>
MD-2D	D/side D/dens 40TR	£11.99	£11.50	£11.25
MD-2DD	D/side Q/dens 80TR	£15.99	£15.50	£15.25
MD-2HD	D/side H/dens 1.6MB	£26.99	£25.99	£25.49
<b>DYSAN</b>				
MD-2D	D/side D/dens 40TR	£11.99	£11.50	£11.25
MD-2DD	D/side Q/dens 80TR	£13.50	£13.00	£12.75
MD-2HD	D/side H/dens 1.6MB	£19.50	£19.00	£17.95
<b>IBM</b>				
MD-2D	D/side D/dens 40TR	£17.95	£16.95	£15.95
<b>VERBATIM - DATALIFE</b>				
MD550	D/side D/dens 40TR	£11.50	£11.00	£10.50
MD557	D/side Q/dens 80TR	£14.50	£13.70	£13.00
M2HD	D/side H/dens 1.6MB	£20.00	£19.50	£19.00
<b>3M</b>				
MD2D	D/side D/dens 40TR	£12.99	£12.50	£12.25
MD2DD	D/side Q/dens 80TR	£16.50	£16.00	£15.50
MD2HD	D/side H/dens 1.6MB	£22.00	£21.50	£19.50
<b>3.5" BOXES OF 10 DISKS</b>				
<b>SONY</b>	S/side D/dens	£16.49	£15.50	£14.50
<b>SONY/VERBATIM/DYSAN</b>	D/side D/dens	£16.79	£16.00	£15.00
<b>SONY HIGH DENSITY</b>	1.44MB	£42.90	£38.90	£35.00
<b>3" DISKS</b>				
CF2 5 Disks		£2.59 each	£12.95 pack	
BULK 10 Disks		£2.29 each	£22.90 pack	

**BULK DISKS**

<b>PRICE PER 10 DISKS</b>	<b>10</b>	<b>20</b>	<b>50</b>	<b>100</b>
5 1/4"SS/DD 40TR	£5.40	£4.90	£3.80	£3.60
5 1/4"DS/DD 40TR	£6.40	£5.90	£4.80	£3.90
5 1/4"DS/DD 80TR	£7.40	£6.90	£5.80	£4.50
Life time guarantee. Disks include envelopes, labels, hub-rings and write protect.				
3 1/2"DS/DD	£12.00	£10.00	£8.00	
Life time guarantee.				

**3M DATA CARTRIDGES**

	<b>2+</b>	<b>5+</b>	<b>10+</b>
DC100A	£12.50	£11.50	£11.00
DC1000	£12.50	£11.50	£11.00
DC2000	£22.50	£21.50	£20.00
DC300XLP	£21.90	£20.50	£19.50
DC600A	£22.90	£21.90	£20.90
DC600XTD	£27.80	£26.80	£25.80

**Export Enquiries Welcome**

E & OE. All prices subject to change without notice. Please call before ordering.

Official orders welcomed from PLC's, government and education establishments. Minimum order value £30.00.

**COMPUTERS BY POST GUARANTEE** If after buying any of the hardware or software in this advertisement, you find the same item offered at a lower price locally within one week, we will refund the difference.

**DELIVERY**

Consumables Free delivery on orders over £10. Orders under £10 please add £1.00 p+p. Hardware and Software Immediate despatch on receipt of cleared payment normally five working days for cheque clearance. Secunor F Service, 4 working days £5 per parcel. Secunor B Service, next working day £10 per parcel. Lasers and Fax Datapost next day including Saturdays £15 per parcel. Please ring to check availability and delivery charges.

All prices exclude VAT  
**CREDIT CARD HOT-LINE**



**01-760 0014**

Computers by Post (PCW), 14 Emmabrook Court, Sea Road, Rustington, West Sussex BN16 2NG.

To: **Computers by Post, 14 Emmabrook Court, Sea Road, Rustington, West Sussex BN16 2NG.**

I wish to order \_\_\_\_\_

My computer is \_\_\_\_\_ inc VAT

I enclose cheque/PO for £ \_\_\_\_\_ or charge my Access/Visa No: \_\_\_\_\_ Exp. date \_\_\_\_\_

Name \_\_\_\_\_

Signature \_\_\_\_\_

Address \_\_\_\_\_

Postcode \_\_\_\_\_ Tel No: \_\_\_\_\_

In 21 years **Dateline** introductions have been the start of many, many thousands of Love Stories...

If you would like a 'love story' of your own, a compatible partner to love and care for, and you are starting to wonder where you can find that special person, come to Dateline.

Many tens of thousands of people of all ages and occupations, from all over the country, join Dateline every year looking for someone to love. They want to meet someone with the same hopes, ambitions and interests as themselves, and are simply not meeting them socially or at work. Dateline, the largest, longest established, and most successful computer dating agency in the world, opens up a whole new circle of compatible people; people who could be living very close to you, but who, without Dateline, you might never meet.



*'Independence didn't seem to matter any more.'*

Janet, long divorced, and bringing up a son on her own, joined Dateline to meet people, though 'maybe marriage was in the back of my mind' she says. David, 39, a computer network manager, thought Dateline would be an ideal way to improve his social life, but almost got cold feet, and only Janet's confidence and persistence got a first meeting arranged. After that they were together at every available opportunity — 'the way we felt together was so natural'. They are married now and Janet says, 'Dateline changed my life for the better without a doubt. I still do all the normal things, but it's changed because I've got somebody to share my life with, and that just makes the world of difference, doesn't it?'

# You can find love



Pat felt ready to share her life again, and Peter felt Dateline might give his life something more than work and sleep. Initially the speed of their attachment frightened Pat, but they knew marriage was what they both most wanted.

- Dateline is **INEXPENSIVE**.
- **LOCAL INTRODUCTIONS** — Dateline is the only national computer dating company which lets you choose where your dates live.
- Dateline **GUARANTEES** its service. We have the confidence of 21 years of caring experience.
- **COME AND SEE US** if you can or phone anytime. We take a personal interest in your success, and have no need to hide behind an anonymous box number address.
- Over the last 21 years many people have tried to copy the Dateline system hoping to emulate the success and service for which Dateline is famous, and have not succeeded. If you are interested in joining a computer dating agency, there is only one choice.

## IF YOU ARE LOOKING FOR LOVE AND MARRIAGE, OR SIMPLY FRIENDS

Dateline has the widest selection of compatible people for you to meet, living as locally to you as you wish. Our reputation for a genuine, caring, and personal service is second to none, and Dateline's success speaks for itself in the many thousands of people who have found love and happiness through our service. Some of these true stories of people who were looking for someone special to share their lives, and were happily, amusingly, surprisingly matched by Dateline, are told in 'All you need is love' (a Sphere paperback £2.50).

If you would like to find out how Dateline's experience and care can work for you, simply complete the coupon below, and we will send you, totally free and without obligation, and of course in confidence, a full colour, comprehensive guide to exactly how Dateline works and also a FREE copy of 'All you need is love'. Send today to: Dateline, 23 Abingdon Rd., London W8 6AH. Tel: 01 938 1011.



### FREE

START HERE ▼ 1  
I am over 17

Single Widowed Divorced  
Your Sex put M or F  
Your Height ft ins.  
Your age yrs  
Age you would like to meet min max

First Name \_\_\_\_\_  
Surname \_\_\_\_\_  
Address \_\_\_\_\_  
\_\_\_\_\_  
\_\_\_\_\_  
\_\_\_\_\_

Occupation \_\_\_\_\_  
Religion \_\_\_\_\_

- 'All you need is love' (a Sphere paperback) — stories of real people matching and meeting through Dateline.
- A full colour guide to how Dateline can work for you.
- Details of just one of the many Dateline members who could be your 'Perfect Partner'.

I enclose 3 first class stamps.

2 Tick ✓ which characteristics best describe you.

3 Tick ✓ those activities you enjoy, put a X against those you dislike, and leave blank those where you have no preference.

#### ARE YOU:

Warmhearted   
Serious   
Considerate   
Shy   
Romantic   
Fashion conscious   
Practical   
Conventional   
Reliable   
Adventurous

#### DO YOU ENJOY:

Wine bars/Eating out  Jazz/Folk music   
Pubs  Classical music   
Sports/Keep Fit  Theatre/Arts   
Politics/History  Watching TV   
Reading  Smoking   
Travelling  Drinking   
Science/Technology  Being with children   
Cinema  Homemaking   
Pets/Animals  Gardening   
Pop/Rock music  Countryside

# Dateline

**Dateline** Dept( PCU ) 23 Abingdon Rd.  
London W8 6AH. Tel: 01 938 1011.

THE WORLD'S LARGEST AND MOST SUCCESSFUL AGENCY



## Matmos Ltd

1 Church Street, Cuckfield, West Sussex RH17 5JZ  
Tel: (0444) 414484/454377

## Computer Appreciation

30/31 Northgate, Canterbury, Kent CT1 1BL  
Tel: (0227) 470512

**TA/ROYAL OFFICE MASTER 2000 DAISY WHEEL PRINTERS.** Our purchase of nearly 2000 of these printers direct from West Germany enables us to offer them at enormous savings!

Features include:

- \* 20 cps operation
- \* Full **DIABLO 630** and **IBM** compatibility
- \* **CENTRONICS** compatible parallel interface
- \* **132** column with variable pitch capability including micro proportional spacing
- \* Subscripts, superscripts, bold type, underline etc.
- \* Manufactured to highest standards (rigid steel chassis etc) in West Germany by Europe's largest typewriter manufacturer
- \* 6 month full guarantee
- \* Ribbon & typewheel included

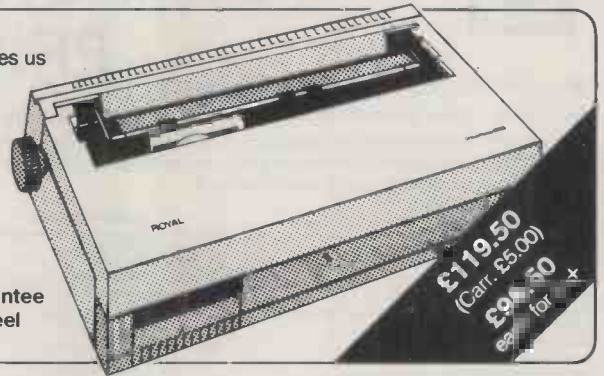

**PANASONIC Model JU-363 3 1/2" Disc Drives.** Shugart interface, 1/2 height, 1 megabyte double sided double-density 80 track, low component. Will interface to just about anything. (A quantity discount of at least 20% is available for 10 + off).

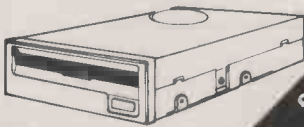

£59.50  
(Carrr. £3.00)

**ITT SCRIBE III WORD PROCESSING SYSTEM.** Professional system originally selling at around £6000 without printer. Now offered with software included & a variety of different options available. This system is available from us **ALL BRAND NEW** at the cost of current budget systems, but with office-quality performance & features. Colour leaflet available.

**SOFTWARE INCLUDES** — DATABASE \* AUTOMATIC LETTER WRITING \* HELP FILES \* BASIC \* PROGRAMMABLE COMMANDS \* MATHS/ACCOUNTS FUNCTIONS \* FULL EDITING  
**HARDWARE INCLUDES** — 128k SCREEN/WORKSTATION \* DUAL DSDD SHUGART 5 1/4" DISC DRIVES



£200.00

**DUPLEX Model M100 Monochrome Monitors.** With 12" high resolution green screen & composite video input. Equivalent to other models such as ZENITH & PHILIPS.

£39.50  
(Carrr. £5.00)

### Please note:

We have only a few 3" HITACHI SSDD drives left at **£24.95**. Cases now available for 3" drives at **£4.99** (single) and **£7.99** (dual). VAT and carriage must be added to all items. New acoustic couplers available at **£14.95**.

**PLESSEY Model T24 V22/V22 bis 1200/2400 Baud MODEM.** Compact automatic modem featuring the latest technology & the highest data rate over the ordinary phone system. Features:

- \* Software available for **IBM PC** & compatibles & **MATMOS PC**
- \* High speed **PRESTEL** compatibility
- \* Auto call & auto answer
- \* New low price

Now £169.00  
(Carrr. £5.00)

## CASHFLOW PLANNING?

### FINANCIAL BUDGETING FOR GROWTH

Then you need **CASHFLOW FORECASTER!** for **APRICOT COMPUTERS, AMSTRAD PC, IBM PC** or compatible,

**CASHFLOW FORECASTER** specifications:

- ★ A cashflow forecast based on bank's format plus Profit & Loss and Balance Sheet essential for loan applications.
- ★ An efficient credit forecast to improve your cashflow.
- ★ A detailed analysis of your trading expenditures.
- ★ A comprehensive list of financial ratios giving you a wealth of information on the health of your firm.
- ★ A fully formulated spreadsheet design so your only task is to enter data to well laid out calculation sheets.
- ★ A handy tool to Monitor your cashflow position throughout the year.
- ★ An easy to use turnkey system so you can get CASHFLOW FORECASTER working in no time at all.
- ★ A high performance software package written in the C language for single or double disk drive systems.

The **MANUAL** specifications:

- ★ Business finance simply explained.
- ★ Strategies for credit forecasts and bank overdraft.
- ★ Multi-period financial forecasting.
- ★ How to determine forecast accuracy.
- ★ In addition to all these, a step by step manual enables you to start cashflow forecasting without previous experience.

IMPROVE YOUR BUSINESS FINANCE WITH **CASHFLOW FORECASTER FOR ONLY £59.95**

Order with cheque for £59.95 + VAT + p&p £1. (£69.94) direct from MayGee Systems or send SAE for details. Please specify computer type. Allow 10 days for delivery.

## MAYGEE SYSTEMS

9 Kelvin View, Torrance, Glasgow G64 4HQ  
Tel: (0360) 22247

## UNIQUE INTRODUCTORY OFFER!

Preregister for the most modern international network now going public. **On-line this June.** In direct competition with existing networks that cost 4X as much and offer half the facilities.

### \* \* \* PERSONAL NETWORK \* \* \*

Your own mailbox - unlimited number.

Create your own open/closed bill boards (clubs, shops, etc)

Free world-wide public domain software

Join multi-user games, chat lines, swap shops.

.....AND MUCH MORE.

### COMPANY NETWORK

Bureau - for downloading and accessing data. 24 hours.

PC conferencing - ideal for sales teams "on the road"

Specialist information databases

Access Fax and Telex facilities world-wide

Stock controls - ordering and monitoring

Language interpretation.

only £15 registration



**MENSA SYSTEMS LTD**

5 London St. Chertsey, Surrey.

8am till 8pm and wk.ends

Tel: (0932) 562310



# UNBEATABLE DEALS

## SMB COMPUTER ELECTRONICS (UK)

### PRICE LIST

**We GUARANTEE Our PRICES are UNBEATABLE!!**

All Computers listed below are inclusive of VAT, but carriage is £10 inc. via Securicor in UK on each item.

Items are only available via Mail Order and are covered by our unique 1 year full guarantee at no extra cost. You can, however, obtain our extended guarantee, underwritten by an enormous insurance group, on our behalf, at a nominal 1 payment fee for a maximum of 5 years guarantee. Please phone or write to us for further details, conditions, and an application form.

#### BBC COMPUTERS

BBC Master 128k	£379.00
BBC with Turbo Board	£486.00
512k Processor Board	£217.35
Universal 2nd Processor	£86.25

#### BBC MASTER COMPACT RANGE

We have a large selection for you to choose from, as follows

#### ENTRY SYSTEM

BBC 128k, 640k Disc Drive, and Software	£360.00
---	---------

#### TV SYSTEM

BBC 128k, 640k Disc Drive, UHF Modulator, and Software	£375.00
--	---------

#### MONO SYSTEM

BBC 128k, 640k Drive, Software, 12" High Res Monitor	£410.00
--	---------

#### COLOUR SYSTEM

BBC 128k, 640k Drive, Software, 14" Med Res Colour Monitor	£565.00
2nd Drive Kit	£113.00

#### COMPACT ACCESSORIES

2nd 3.5" Drive	£103.00
Compact RS232 Interface	£29.00
PAL TV adaptor	£29.00
Compact 5.25" Disc Lead	£12.00
Compact Printer Lead	£10.00

#### ARCHIMEDES AT SPECIAL PRICES

300 Series	
305	
Basic	£790.00
Mono (green)	£850.00
Colour	£1010.00
310	
Basic	£865.00
Mono (green)	£925.00
Colour	£1100.00

#### NEW 310M Series

Basic	£935.00
Mono (green)	£1005.00
Colour	£1175.00

#### 400 Series

410	
Basic	£1595.00
Mono (green)	£1650.00
Colour	£1823.00

#### 440

Basic	£2615.00
Mono (green)	£2680.00
Colour	£2850.00

Archimedes Information and Booklets available on request.

Archie Games are available NOW for ALL machines.

Please ask for List.

#### PRINTERS (EX VAT)

AMSTRAD	
2000	£P.O.A.
3000	£145.00
3160	£165.00
4000	£289.00
NEW LQ3500	£299.00

#### EPSON (EX VAT)

EX800	£369.00
EX1000	£535.00
FX80	£285.00
FX1000	£400.00
LQ800	£345.00
LQ1000	£519.00
LQ2500	£690.00
LX800	£879.00
SQ2500	£179.00
Epson Paper Roll Holder	£17.00
EX800/1000 Colour Option	£55.00
EX800/1000 Colour Ribbon	£18.00

#### DANONIC (EX VAT)

Dot Matrix IBM/Epson Compatible	
KX-P 1081	Special price £140.00
KX-P 1082	£170.00
Daisywheel	
KX-P 3131	Special price £240.00

#### ALSO AVAILABLE

Single Sheet Feeder	£190.00
Tractor Feed	£85.00
Share Ribbons	£3.00

#### TRACTOR FEED UNITS

LQ800	£41.00
LX800 out Sheet Feeder	£70.00
LQ1000 Tractor Feed Unit	£48.00

#### Brother Daisywheels

SPECIAL PRICES	
HR15 RS232 Daisywheel	£229.00
HR20 Daisywheel	£379.00

#### Juki Daisywheels

Juki 6100 Daisywheel	£250.00
Juki 6200 Daisywheel	£390.00
Juki 6300 Daisywheel	£630.00
Juki 6400 Daisywheel	£890.00

#### PRINTER LEADS

For BBC	£8 ex VAT
Master Compact	£11.00
Master	£8.00

#### Plotters

HITACHI	
Hitachi 672 Colour Plotter	£465.00

#### RIBBONS (ALL EX VAT)

Amstrad 8512/8256	£3.71
Amstrad Coloured	£4.82
Amstrad Longlife	£4.76
Amstrad Coloured	£6.27
Brother M1009/GLP	£3.10
Brother Coloured	£3.95
Brother HR15/25/35	£3.00
Brother Coloured	£3.80

Canon PW1 158/1080	£2.85
Epson FX/MX/FT/RX/80/85	£2.70
Epson Coloured	£3.75
Epson LX80	£2.50
Epson Coloured	£3.50
Epson MX/FX/RX/1000/105	£3.10
Epson Coloured	£4.20
Epson LQ/LP 1500	£2.90
Epson LQ2500	£4.80
Epson Coloured	£3.80
Shinwa CP80	£3.70
Shinwa Coloured	£4.90
Star Gemini 10/15	£1.20
Star Coloured	£1.75
Star NL 10	£4.55
Star Coloured	£5.70
Star Radix 15	£2.50
Star Coloured	£4.25

Other Ribbons available. Details on request.

#### PLAIN LISTING PAPER (perforated) (EX. VAT.)

1000 9 1/2" x 11 1/2" fanfold	£6.00
1000 9 1/2" x 36mm (single row)	£11.00
1000 15" x 11" fanfold	£3.00
1000 Sheets full A4 fanfold	£13.00
2000 Sheets full A4 fanfold	£19.00
Tekoprinter roll (econo paper)	£4.00

(No carriage on less than 5 rolls).  
All fanfold has mikro perforated feed strips and leaves a smooth clean edge when detached from Printer.  
Carriage on 1000 sheets £1.50, 2000 sheets £2.50.

#### Printer Labels

(mounted on a continuous fanfold sheets)	
1000 80 x 36mm (single row)	£4.50
1000 80 x 36mm (twin row)	£4.70
1000 90 x 49mm (twin row)	£11.00
1000 102 x 36mm (twin row)	£6.00
Carriage on 1000 sheets £1.00	

#### II LOWEST PRICES EVER !!

Disks 5 1/4" and 3 1/2"			
(supplied in plastic boxes of 10)			
All our Disks are top quality II			
Fully 100% error-free guaranteed			
48tpi	96tpi	SS/DD	DS/DD
5 1/4"	5 1/4"	3 1/2"	3 1/2"
10.....£0.00	£0.00	£8.50	£10.45
20.....£8.50	£15.00	£18.00	£19.75
30.....£12.75	£24.00	£26.50	£24.00
40.....£15.80	£33.00	£31.00	£40.60
50.....£18.50	£47.00	£47.50	£47.50
100.....£35.00	£50.00	£87.00	£93.00
200.....£70.00	£95.00	£175.00	£175.00
500+.....£170.00	£210.00	£280.00	£427.50

All Disk prices inc VAT

Disk Boxes available on request, and are in Stock!	
100 Disk Box	£10.00
50 Disk Box	£5.00
Plastic Boxes for 10 Disks	£1.05 only

#### Monitors—MONO

PHILLIPS	
Philips BM7502 12" Hi-Res. CVBS Input, Audio Input, 20MHz band width, 2000 CHRS display, adjustable viewing angle. Green display	£79.00
Philips BM7522 Amber screen	£95.00
Philips BM7542 dedicated WD Phosphor screen monitor	£95.00
Philips BM7513 12" IBM compatible	£120.00

#### COLOUR MONITORS

TAXAN	
New Taxan KX117 12" screen P31	£89.00
Taxan KX118 12" screen P39	£99.00
Taxan KX119 12" Pul amber screen	£99.00

#### MICROVITEC

Microvitec 1431 Std Res	£201.25
Microvitec 1437 Med Res	£255.00
Microvitec 1441 High-Res	£391.00
Microvitec 2030 CS20 Std Res	£425.00
Microvitec 1431 AP	£224.25
Microvitec 1451 AP Med Res	£293.25

#### Philips

NEW Philips CM8653 14" CVBS and RGB Med Res Colour Monitor, IBM PC Compatible, Fast Blankup to enable Superimposing, Stereo Audio Sound Earphone socket 600 x 285 lines vertical	£259.00
(£10 off usual price)	
Philips CM8852 14" RGB Professional Med Res Colour, 700 dots x 285 lines	£279.00
(£10 off usual price)	
Philips CM8873 14" RGB High Res Colour Monitor, Res 850 x 480	£540.00
(£10.00 of usual price)	

Taxan Super Vision 620  
High Res Monitor with several unique features, at a price you can afford.

#### SUPERVISION 620

12" RGB High Res monitor, IBM, BBC, APPLE and most PC's 835 x 312 lines. Positive or negative sync input. Text colour switchable to green, amber, white or blue or inverse white. Super high contrast tube. Optional swivel base with clock-calendar available	
SPECIAL INTRODUCTORY OFFER	£289.00
(£10.00 off)	

#### NEW SUPERVISION 625

12" High resolution colour monitor 681 dots x 312 lines	£359.00
(£10.00 off usual price)	

#### MONITOR TO TV CONVERTER

Well built AV 7300 colour tuner module. Push button control, 12 present channels. Built in aerial. Compact design. Composite Video only	£65.00
(£4.00 off usual price)	

All prices inc. of VAT. Carriage on Monitors £10 inv. via Securicor—

All Drives are covered by our special 2 year guarantee.

All 40/80 Drives have switch all the front of drives.

#### DISC DRIVES—Viglen & Pace available

5.25" & 3.5" Drives	
40 track single psu	£P.O.A.
40 track single	£P.O.A.
80 track single psu	£115.00
80 track single	£113.00
40/80 track dual vertical psu	£219.00
40/80 track dual vertical	£235.00
40/80 track dual pinth	£265.00
3.5" single drive	£85.00
3.5" single drive psu	£149.00
3.5" single drive psu	£135.00
3.5" dual drive psu	£179.00
5.25" & 3.5" COMBO	
40/80 track 3.5" psu	£189.00

Winchester Drives

Large range of Winchester drives available. Please enquire for details.

#### Accessories

Twin Eprom cartridges	£10.00
Teletext/Prestel Receivers	
Morley Teletext Adaptor	£95.00
Acorn Teletext Adaptor	£P.O.A.
Acorn Prestel Adaptor	£P.O.A.

#### EPROM PROGRAMMERS

Eprom Programmer with Software	£30.00
ROMS/EPROMS	
2764	£2.10
27128	£3.00
27256	£4.80
6264 (8k)	£2.80

#### COMPUTER CONCEPTS

Inter-Word	£41.50
Inter-Sheet	£37.00
Inter-Base	£55.00
Inter-Chart	£26.00
Spell Master	£49.50
Graphics ROM	£23.00
Wordwise Plus	£40.00
Wordwise	£24.00
Disc Doctor	£28.00
Caretaker	£25.00
Termi	£25.00
Speech ROM	£24.00
Printmaster	£24.00
Accelerator	£48.00
MEGA 3	£95.00

#### ACORN

View 2.1	£35.00
View 3.0	£48.00
View Professional	£85.00
Hi-View	£36.00
View P. D. Generator	£9.00
Viewsheet	£37.00
Viewstore	£38.50
View Spell & 80 track	£29.00
View Plot	£24.00
(Master Compact/Speech)	
View Index	£12.00
Over View	£75.00
(Packs 1 & 2 Master)	

#### ADVANCED COMPUTER PRODUCTS

Adv. Disc Toolkit	£29.00
Adv. 1700 for M/C	£29.00
Adv. 1700 for BBC/B+	£29.00
Adv. Disc Invest	£24.00
Adv. Control Panel	£29.00
Adv. Rom Manager	£13.00

We also have other ACP Products available.

Please Ask !!

#### MODEMS—All 'Special Prices' subject to availability

Commstar II, Special Price	£29.00
Bundled Package—Nightingale Modem	
Commstar II and RS232/432 Cable	£96.00
Bundled Package—Linnet Modern & Commstar II Software	£140.00
Bundled Package Series Four 1200S & Commstar II Viewdata/Terminal Software	
Special Xmas price offer	£425.00
Bundled Package—Series Four 2400S & Commstar II Viewdata/Terminal Software special Xmas price offer	£550.00

Acorn Electron Special Xmas Offer Box  
RS423 interface including Commstar Viewdata/Terminal Software

Bundled Package—Nightingale Modem, Serial Interface and Commstar

£140.00

All Modems complete with 'FREE' memberships to Micronet.

#### Send orders to:

Purchasing Department (Mail Order)  
SMB Computer Electronics (UK)  
Dept (MM)  
16 Pangbourne,  
Stanmore, Middlesex HA7 4QT  
Tel: 01-958 4476  
(24 hour answering service)  
Co. Reg. No.  
VAT Reg. No.  
New Showroom and Office, opening soon at:  
7 Sedley Place, Bond St.,  
London W1



ALL VISA CARDS WELCOME

All prices inclusive of VAT unless otherwise stated.

We also have a ROM Eprom programming service @ £5.00 inclusive ROM Eprom. Just send Disc/Tape with machine specification BBC Master Electron.



## FROM STAND ALONE TO NETWORKS

I.B.R.S. PROVIDES

FROM STAND ALONE TO NETWORKS

I.B.R.S. PROVIDES

### NETWORKS

SAGENET Starter kit	£275
SAGENET User card	£135
ORCHID PC Net Starter kit	£595
ORCHID Adapter card	£305
M-LINK Starter kit	£650
M-LINK Adapter card	£275
M-LINK Net-BIOS	£42
TRANSNET Starter	£380
TRANSNET Adapter card	£180

### IBRS NETWORK SYSTEM

Consisting of BS103, B101, MS DOS, 3.2GW BASIC, Transnet starter kit	£1450
Additional Station BS101 + Adapter card	£580

### MAINTENANCE

COMPUTERS	
XT-Compatibles from	£85
AT-Compatibles from	£130
Please enquire for details.	

Personal Service by Qualified team providing reliable back-up. Hotline support. Guaranteed 24 hour response.



### COMPUTERS

#### IBRS BUSINESS SYSTEMS

BS101 XT Single Floppy	£425
BS104 XT 30Mb HDD	£690
BS201 AT Single Floppy	£796
BS203 AT 20Mb HDD	£1050
EGA Option for XT	£395
EGA Option for AT	£430

#### PACKARD BELL

VX88 20Mb	£815
VX88 40Mb	£975
PB286 20Mb	£1245
PB286 40Mb	£1615
EGA Option add	£475
Prices include 14" monitor	

TANDON	POA
AMSTRAD	POA

Other HARDWARE and SOFTWARE available  
All prices are excluding VAT

LEASING FACILITY AVAILABLE

### ADDONS & UPGRADES

Hercules EGA	£105
Professional EGA	£120
3.5Mb multifunction for AT+386	£99
Multi I/O card for XT	£59
RAM expansion for XT (OK)	£89
2Mb RAM expansion for AT (OK)	£99
Mouse	£40
Joystick	£19
20Mb Seagate + wd controller	£220
5 1/4" Floppy disk drive (EAC)	£88
1.2Mb 5 1/4" floppy disk drive	£120
720kb 3 1/2" floppy disk drive	£110
5 1/4" floppy disks (10)	£6.50
3 1/2" floppy disks (10)	£15

### SPECIAL OFFERS

MS-DOS 3.2 GW BASIC MS Windows and a Mouse RRP	
£170 (with IBRS system)	£140
Copal dot matrix printer 132col	£210
Daisywheel printer	£175
Canon Series 2 Laser printer	£1725
OKI Laserline 6ppm	£1475
Taxan 770 Multisync mon	£545
Mitsubishi Multisync mon	£450
Pegasus Senior software (per mod)	£295
Cashlink (Comp Accounts)	£700



INTEGRATED BUSINESS RESEARCH SYSTEMS LTD

10 ST. JAMES PARK, WEST CROYDON  
SURREY CR0 2UT. Tel: 01-684 9041  
01-689 1804 Telex No: 94016720 IBRS G

# JetSetter

## Desktop Publishing

for IBM PC/XT/AT and compatibles

Over 500,000 Font Variations

on standard 512k Laser Printer (HP LaserJet+ compatible)

NO Need for Postscript!

NO Need for Font Cartridges!

- Fully WYSIWYG including Full Page View
- Simple to use/easy to learn - Single Menu
- 10 Basic Font Styles + Symbols
- Many Font Enhancements e.g. **Bold Italic Bold/Italic V.Bold Inverse OUTLINE** etc.
- 4pt to 108pt incl. **condensed & extended**
- Input from Word Processors & Keyboard
- Multi Columns - Leading - Auto Kerning etc.
- Graphics/Scanner input via .PCX/.IMG/.PIC files
- Line Drawing & Shading
- Full Formatting/Editing functions
- Hotline Support

Only £295 (+P&P and VAT total £345) Demo Disk £5.75

Send your order stating disk format required and including cheque to:

**GARBO** Systems Ltd, Champion's Yard, Causewayhead,  
PENZANCE, TR18 2SP, ☎ (0736) 67166

DEALER ENQUIRIES WELCOME

# Here Is Today Here Is Tomorrow

NEW ENHANCED AT/80286-12/16MHZ



### Model: NEAT 286

1. 100% IBM PC/AT COMPATIBLE NEW ENHANCED CHIP SET
2. SUPPORTS 12-16 MHZ 80286 OPERATION
3. SEPARATE CPU AND AT BUS CLOCK MANTAIN I/O COMPABILITY
4. MEMORY EXPANSION 1 MB — 2 MB ON BOARD (640K + 384K) INTEGRATED LOUTUS-INTEL-MICROSOFT EXPANDED MEMORY SPECIFICATION MEMORY CONTROLLER (LIM EMS)
5. REAL TIME CLOCK

6. VGA/PEGA/HEGA/MONOCROME GRAPHIC DISPLAY CARD
7. FDD + HDD CONTROLLER CARD
8. 1.44 MB/720 K FLOPPY DISK DRIVE 3.5"
9. 40 MB/20 MB HARD DISK DRIVE 5.25"
10. 102 KEY KEYBOARD
11. 200W SWITCHING POWER SUPPLIES 110V/220V
12. MINI TOWER CASE/DESK

### Model: 80386 AT SYSTEM 16-20 MHZ

1. INTEL 80386-16 CPU, SUPPORTS MULTI CLOCK RATE AT 6-8-16-20 MHZ
2. 8 EXPANSION SLOTS
3. REAL TIME CLOCK IN BATTERY
4. ON BOARD MEMORY EXPANDABLE 1MB/2MB/4MB/8MB
5. 2 SERIAL + 1 PARRALLEL + GAME I/O CARD



### GATE CO., LTD.



No. 21, Lane 67, Sec. 1, Chien-kuo  
N. Rd., Taipei, Taiwan, R.O.C.  
P.O. Box: 7-646 Taipei, Taiwan, R.O.C.  
Tel: (02)5061966~7  
Tlx: 14875 GATE Fax: 886-2-5079681

**NOW AVAILABLE ON 3 1/2" disks (please add 50%)**

**ButtonWare, INC.**  
 10000 Old Highway 111, Suite 100, Dallas, TX 75243

# SHAREWARE

★★★ A MARKETING REVOLUTION ★★★

Quality professional software for the Amstrad PC1512 and true CGA/EGA clones.  
 Price covers medium, VAT & postage. Documentation on disk where appropriate.

☎    
**0732 771344**

"SINGLE DISKS £7.99; ANY 5 for £25; 10 for £39; 20 for £65"

★ PRODUCT OF THE MONTH ★

**MindReader (disk 182) £7.99**

*A revolutionary Word Processor developed*

MindReader is a full-featured word processor that incorporates new, and unique technologies to make the creation and production of correspondence easy and quick. Using Artificial Intelligence (AI) techniques, MindReader "learns" from its user and quickly becomes a highly personalized word processor. It Stores frequently-used words, phrases and paragraphs for instant and sometimes automatic retrieval. Once learned, MindReader can reduce keystrokes typically 500%, and produce error-free correspondence.

MindReader consists of a number of integrated modules which include a "WordStar-like" Word Processor, an on-line Glossary, Name and Address File, Dictionary/Spell Checker, FrequentWord generator, and AI Interface. Together, these modules form the basis of this very powerful product.

As you type, MindReader "anticipates" the word or phrase that you are typing, and presents it in a pop-up window just to the right of the cursor. If MindReader has chosen the correct word or phrase, the user need only hit the semicolon (;) key to insert the remaining text. Through multiple pop-up windows, the user has access to all of the essentials of normal daily correspondence at his fingertips:

- NAME AND ADDRESS. The complete name and address of those whom you correspond regularly. Three keystrokes retrieves and name and address block and places it at the head of the correspondence.
- GLOSSARY.260 "canned" phrases, sentences, paragraphs or pages of every-day text. Three keystrokes retrieves and text and inserts it into the document.
- FREQUENTWORD. Even when you are typing, MindReader is trying to reduce keystrokes. With the depression of your first stroke, MindReader pops-up a small window containing 5 possible words, the most likely word being accessed by depressing the semicolon (;) key.
- WORDCOMPLETE. If FrequentWord did not have the correct word or phrase, on your third or fourth keystroke, the WordComplete feature pops-up a "more educated" list of possible words, the most likely being accessed the ; key.
- SIGNATURE BLOCK. Just as every letter begins with name and address information, they end with one or more closings. The Glossary entry "SI" is reserved for this purpose. Three keystrokes moves the desired closing into the document.

With features like Macros, Split Screens, Mail Merge, Line Drawings, Calendars, Diary, Calculator, Encryption, and more, MindReader can produce everything from a simple letter or memo, to a full blown Direct Mail effort. Everything that the travelling executive needs is at his fingertips all the time. MindReader requires an IBM-compatible computer, two 360K drives (or one 3.5" drive), 256K of available memory, and DOS 2.0 or higher.

**ACCOUNTS**

- 94 Home Budget Management. 7.99 Useful nominal ledger.
- 21 Time & Money 7.99 OK for small business. Does more than just accounts.
- 106 Mr. BILL 11.50 Billing system for professionals. (ie. Accountants, solicitors etc.) Counts as 2.

**DATABASES**

- 703 PC-File Plus 11.50 Paint screens,71 relational files,screen tutorial, inbed & nest calculations, sophisticated report writer, Works with PC-Type Plus. Easy. Supported by us. Counts as 2
- 700 U-Mind 7.99 Generates (GWBASIC) programs. A bit like The Last One.
- 70 Biblical Quotations 11.50 Huge database of Biblical quotes. Min. 2 drives. Can be memory resident. Counts as 2.
- 101 Family Tree 7.99 Genealogy program.
- 113 Newsbase 7.99 Helps publishers keep track of the contents of each issue. Useful for both advertising & editorial.
- 701 Wampum/ Wampum docs. 11.50 Menu driven dBase III clone. Best on hard disk. Counts as 2.

**GAMES (Please note that you need a CGA card. All 1512's ok)**

- 55 Games V 7.99 Monopoly, Kong, Golf, Striker.
- 800 PC-Chess 7.99 2 games. Graphical simulation.
- 100 Computer pranks 7.99 Lots of high jinks to play on your friend's computer!! Safe.
- 93 Sam Spade 7.99 Text adventure on the sleamier side of town.
- 92 Bermuda Triangle 7.99 A sort of yacht simulator with a quest! EGA only.
- 802 PINBALL 7.99 9 Pinball machines emulated. Fast!
- 90 ZAXXON 7.99 The famous game from SEGA. CGA/EGA but DOS 2.1 or 3.1 ONLY!!!
- 807 Games III 7.99 Backgammon/Strategic US War Game (Maps etc.)/Big Rig
- 81 Card Games I 7.99 Bridge, Canasta, etc.
- 801 Games I 7.99 Frogger, Digger, Paratroo, Willy, Rogue, Sopwith.
- 804 Games II 7.99 Golf, American Football, Blackjack, Archery & much more.
- 53 Adult Trivia/Poker 7.99
- 47 Sleuth 7.99 Great detective adventure with graphics.
- 64 Cavequest 7.99 Graphical adventure. Reminds me of Elite with castles!
- 52 Games IV 7.99 Mahjong, Backgammon, Spacewar, Nightmare, Dragons.
- 60 Pianoman 7.99 Play music on keyboard, "record" it on disk, play it back!

**GRAPHICS**

- 903 PC-Key-Draw 7.99 CAD/Animation/Graphics/Scale/Rotate/Slides/Text. More facilities than ProDesign & PC-Paint. Represented by us in UK.
- 72 Express Graph 7.99 Very easy to use colour business graphics. Pie, Exploded Pie, Segmented Lines, 3D bars etc. from typed data or Imported.
- 108 DROEGE V1.85 11.50 CAD for printed circuit design. Now supports dot-matrix but ideal for HP plotters. Counts as 2.
- 99 HI-RES 7.99 Super painting program. Works with mouse. Lots of facilities but no text on Shareware version. Ok single drives so could replace GEM paint. CGA in colour/ EGA in mono.
- 121 PCPG 7.99 PC Picture Graphics. Create libraries. Enlarge, Reduce, Flip. Plotter support.

**LANGUAGES**

- 25 Macro Assembler (A86) 7.99 Probably the best 8086 assembler in the world. With debugger. We are the UK agents for this superb product. Version 3.07 (later version available to registered users).
- 408 Fig-Forth 7.99 Very good implementation
- 83 "C" Tutorial 7.99
- 400 Z80/8080 Emulators 7.99 Runs CPM software if on MSDOD format disks.
- 409 Small "C" 7.99 With primer and compiler.
- 502 P-Basic / PC-Prof 7.99 GWBasic clone with hands-on Basic tutorial.
- 155 Z80 Cross-Assembler 7.99 Pseudo-Sam 80Z
- 406 CHASM 7.99 CHeap A86Mbler. Compiled version of old standby. Retained mainly for the tutorial - otherwise use disk 25. (Now compiled)
- 63 Lisp/Xlisp 7.99
- 122 Assembler routines 11.50 Misc. utilities & routines. Counts as 2.
- 178 Turbo Pascal utls. 15.00 Various programming tools & routines. Counts as 3.
- 7 PD-Prolog V1.95c 7.99 Latest version with expert systems demo.
- 59 Expert System 7.99 This one works well and is straightforward to set up. See also PD-Prolog.

**WORDPROCESSING**

- 36 PC-Type Plus / PC-Label 15.00 Includes 100,000 word on-line "Fault Finder". Work 10 files simultaneously. Easy to learn (interactive tutorial) Mailmerge/Direct access to PC-File Plus databases. Direct access to PC-Style & DOS.Multi-columns. Maths. Graphics. Support by us.Counts as 3.(ok single drives), ted by us.
- 6 PC-Outline V3.30 7.99 Famous Outline processor.Now supported in UK.
- 3 PC-Write V2.6 7.99 Famous wordprocessor.
- 102 Screen Write 7.99 Special word-processor for script-writers. Unique formatting features.
- 8 Galaxy V1.2 7.99 Perhaps the fastest WP in the world. Wordstar keys.
- 31 Query Wordprocessor 7.99 Probably the best one for novices. Includes comprehensive hands-on training course.
- 111 H-KEY 7.99 Super letter writer for handicapped. Type using space bar.
- 17 EZ-Spell 7.99 Spell-checker. Works with PC-Write.

**NEW PRODUCTS (Please note these include updates).**

- 9 Deskteam 1.04 7.99
- 125 SimCGA 7.99
- 126 Snobol4
- 58 The Shareware Book 7.99
- MOD Modern Bundle 16.95
- 127 Quickstep 7.99
- 128 SOAR 7.99
- 130 Manage 11.50
- 132 Old Testament 30.00
- 138 Composer 7.99
- 139 Image-3D (EGA) 7.99
- 140 Image-3D (CGA) 7.99
- 141 Minigen 7.99
- 142 Expert System 2 7.99
- 143 Compass 7.99
- 144 IN-CONTROL-2 30.00
- 150 Finger Paint 7.99
- 151 Writer's Heaven 7.99
- 152 SideFiler 7.99
- 143 Image-3D (CGA) 7.99
- 154 PseudoSam 18 7.99
- 155 PseudoSam 80Z 7.99
- 156 PseudoSam 85 7.99
- 157 PseudoSam 51 7.99
- 158 PseudoSam 48 7.99
- 159 French verbs 7.99
- 160 Spanish verbs 7.99
- 161 Purchase Order Processing 7.99
- 84 TASM 7.99
- 162 Present 7.99
- 163 Fixed Assets Register 7.99
- 164 Ramtest 7.99
- 165 CashTrac V6 11.50
- 166 PC-Shell 11.50
- 168 FREEWAY UK Sales/ Purchases/Payroll 15.00
- Homebase v.2.0 Counts as 3
- 171 15.00
- 174 Genealogy I 11.50
- 181 Micro-Cook-Puting 7.99
- 182 Mindreader 7.99

Please note that we are authorised representatives for various authors so we get the latest versions first!

**EDUCATIONAL**

- 68 MS-DOS Tutor 7.99
- 39 Foreign Languages I 7.99
- 1025 Educate I 7.99
- 119 Amy's First Primer 7.99
- 85 Fasttype 7.99
- 51 Educate II 7.99
- 54 Learn Japanese 7.99
- 7.99 Tutorial for learning about MS-DOS!
- 7.99 French, German, Spanish, Italian, Needs Basic.
- 7.99 High quality programs incl. Maths. Analogies etc. Needs Basic.
- 7.99 Ages 3 to 8. Needs Basic.
- 7.99 At last a decent touch typing course from beginner to advanced under ShareWare. (not perfect). Won't work on 1640 mono.
- 7.99 Quality young children's games

**COMMUNICATIONS**

- 86 Greycom 7.99
- 10. Procomm V2.42 7.99
- 74 PC-Board 11.50
- 7.99 Prestel comms. program from Paul Fletcher. All speeds to 9600 baud. CGA/EGA cards required. Most modems. Save frames
- 7.99 Caroussel. Download telesoftware. Easy to use.
- 11.50 Famous COMMS program.
- 11.50 Useful bulletin board system. Counts as 2.

(For brief reviews and full list send 75p stamps)

Please send cheque/postal order or Access/Visa to:-

Educational & Government orders welcome

**Shareware Marketing, Dept. P, 87 High Street, Tonbridge, Kent 0732 771344**



# A PERFECT GRAPHIC SOLUTION - SIMPLE AND EFFECTIVE

We know how sceptical people are when you launch low cost products and claim they produce results that are better than products costing up to 5 times as much.

## So here's the *PROOF*.

This page was designed on an Amstrad PC using The Electric Studio Video Digitiser with a black and white, high resolution video camera. The Video Digitiser together with a camera and all leads, costs the remarkably low price of

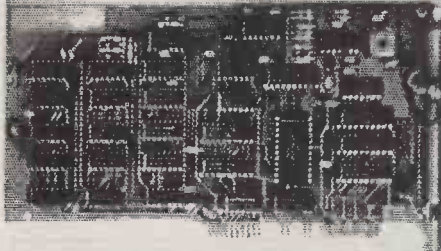

**Only £299.95 + VAT**

and really does produce results as good as scanners which can cost well over a thousand pounds.

We have included pictures of the digitiser card and the camera which show a further advantage this system has over a scanner. These are physical objects and no scanner will enable you to include pictures of objects such as these, with the four other example pictures shown below which were captured from coloured photographs and slides.

Many desk top publishing programs cannot correctly handle multi-shaded digitised images. so we used **UNIPRINT**, our specially developed software program, which correctly prepares images for printing. You can see the quality of the final results on this example page, where all the pictures have been printed using **digitised images and UNIPRINT** which costs only **£24.95 (inc. VAT)**.



# NewsFlash

## Introducing *SNIP ART* for *EVERYONE*

Whichever DTP program you use, whether it be Ventura, PageMaker, Gem, Page-Ability, Fleet Street Editor, Fontasy, Newsdesk International, or many others, the whole range of **Snip Art** images can now be used with our unique file format transfer program. Load the **Snip Art** disc into your computer and you will be able to save the images to disc as .IMG .PCX .TIF .PIC .EPS .ART or .MAT for use with your own programs.

This means YOU



SNIP ART comprises:  
 Disc 1 - General Images.  
 Disc 2 - Nature & Travel.  
 Disc 3 - Sports & Leisure.



If you require a full Arts and Graphics program you can order a copy of **Screen Master** for full colour images or use **Newsdesk International** as a DTP program or use it in conjunction with **Snip Art** to produce black and white original drawings for inclusion in all the programs mentioned above. **Screen Master with Light Pen** costs only **£39.95 inc. VAT** **Newsdesk International** is only **£49.95 inc. VAT**.



# the electric studio



Order direct from our Telephone Hot Line:  
**0462 420222**

Please rush me the items indicated in the boxes below:

Digitiser and Camera with Screen Master software.	£344.95.....
Digitiser with Screen Master software.	£149.95.....
Camera and leads (I already own a Digitiser)	£212.75.....
UNIPRINT software .	£24.95.....
Snip Art Multi-Format Discs	£14.95 each
Newsdesk International software.	£ 49.95.....
Screen Master software with Light Pen controller.	£ 39.95.....
I enclose a cheque/P.O. to cover the cost of the goods ordered or debit ACCESS/VISA/AMEX card .....	
Name & Address :	

1	2	3
---	---	---

The Electric Studio Products Limited.  
 Unit 8, The Cam Centre, Wilbury Way,  
 Hitchin, Herts. SG4 0TW.



**d-Smallest!** With Clipper the smallest program you can create is 120k. And it goes up from there! dBFast creates programs as small as 1k with typical program sizes from 5 to 10k. Now it's possible to run your programs off only one floppy disk.

**d-Fastest!** dBFast compiles and links in blistering seconds. Clipper slugs along taking minutes, dBFast compiled programs also run faster. Programs that took 2 or 3 minutes in dBase, took 50+ seconds in Clipper and less than 20 seconds with dBFast!

**d-Cheapest!** See for yourself why dBFast is d-Biggest bang for d-Buck! Nowhere can you get all these features for such a low price.

- dBase III Plus Compatible
- LAN Compatible  
(DOS 3.1 File & Record locking)
- Unlimited Runtime
- Protected Source Code
- Speed, Efficiency, Price!

**dBFAST VS CLIPPER**  
SMALLER EXE'S ■ FASTER COMPILATION ■ FASTER EXECUTION ■ LOWER PRICE

**PRICE REDUCED**

**LIMITED TIME OFFER**  
 EXPIRES 1ST MAY 1988

**£69**

OPERATION	dBFast	Clipper	dBase III Plus
Prog 1, Append From	18 sec	53 sec	3 min 5 sec
Prog 2, Sum/Average	19 sec	51 sec	1 min 41 sec
Prog 2, Compile/Link	3 sec	2 min 16 sec	N/A
Prog 2, .Exe Size	1.2 kB	126 kB	N/A
Price	<del>£149</del> £69	<del>£59</del>	£595

**HURRY**  
 POST COUPON TODAY

DISTRIBUTED BY  
**MEGATECH**

111-113 Wandsworth High Street  
 Wandsworth, London SW18 4HY  
 Tel: 01-874 6511. Telex: 21768



**COMPILER**

TO: MEGATECH, 111-113 Wandsworth High Street, London SW18 4HY

Please supply \_\_\_\_\_ copies

dBFast @ £69 per copy      £ \_\_\_\_\_

Postage and handling @ £6.00 £ \_\_\_\_\_

Add 15% VAT £ \_\_\_\_\_

I enclose a total of £ \_\_\_\_\_

Payment: Cheque  Access  Visa

Card No: \_\_\_\_\_

Card Expiry Date: \_\_\_\_\_

Card Name: \_\_\_\_\_

Card Address: \_\_\_\_\_

Postcode \_\_\_\_\_

Daytime Tel No: \_\_\_\_\_

Signature \_\_\_\_\_

A VAT invoice will be included in the Parcel. Enclose a company letterhead if invoice name and address needs to be different from card name and address.





Computer  
Manuals Limited

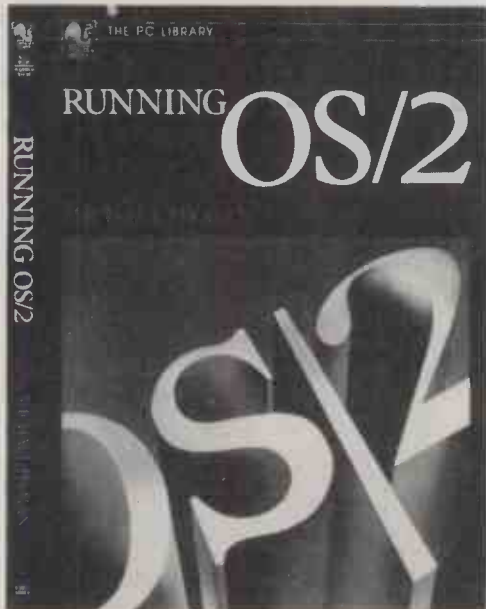

'Running OS/2' is THE book for every present and prospective OS/2 user, acting as both tutorial and reference guide. Make the transition from DOS to OS/2 quickly and easily. Included are basic and advanced OS/2 commands and functions as well as instructions for DOS compatibility, installing programs, Program development with OS/2, Multi-tasking capabilities and trouble-shooting.

To order simply telephone 021 706 6000  
or write to **COMPUTER MANUALS LTD**  
30 Lincoln Road, Olton, Birmingham B27 6PA  
**WE CARRY OVER 1000 TITLES**

**PROMPT COMPUTING**  
SPECIALISES IN  
**COMPUTER AIDED DESIGN**  
& Desk Top Publishing

authorised dealer for  
**ROLAND PLOTTERS**

WIDE RANGE OF CAD SOFTWARE

High Definition Monitors

80386 or mini based Work Stations with

**FREE ONSITE MAINTENANCE**

or

PHONE US TO DISCUSS THE BEGINNERS PLAN  
ie 80286 machine that may be up-graded stage by  
stage as you require more speed and facilities

**LATE NIGHT & WEEKEND SUPPORT**

9 Holmbrook Way, Frinton, ESSEX CO13 9LN

**0255 672573**

**FAX NUMBER 0255 220672**

**35MM SLIDES**

*create your graphics on*

**LOTUS FREELANCE**

**HARVARD**

**DAVRELLE**

and many other packages.

Send the data to us for conversion

to high resolution (4000 line)

colour slides and OHPs, overnight

**£5.00**

each + VAT

Phone Tony Lester on (01) 749 9091

**eido  
graphics**

26 Agnes Road, London W3 7RE

**LOWEST PRICE  
IN THE UK**  
(monitor and disc  
drives not included)



ACCESS/VISA  
Trade and Government  
orders welcome.

**1MB RAM-AT+super EGA**  
**£599.95 + VAT**

**This superb 80286 AT compatible system includes:**

- 12MHz 80286 CPU (switchable from 12MHz to 10, 8 and 6MHz).
- 1 Megabyte of RAM (640k+384k split).
- Genoa Super EGA card (resolution up to 640 x 480).
- Real Time Clock, RS232, parallel and printer port.
- High quality 102-key UK keyboard (ATE layout).
- Legal PHOENIX BIOS.
- Microsoft DOS 3.2.
- One Year Guarantee.

To order or for more information, write to:  
**SOLIDISK AT, 17 Swayne Avenue,**  
Southend-on-Sea, Essex, SS2 6JQ.  
Telephone: Southend (0702) 354674.  
FAX: (0702) 512426

# MULTICOM NET

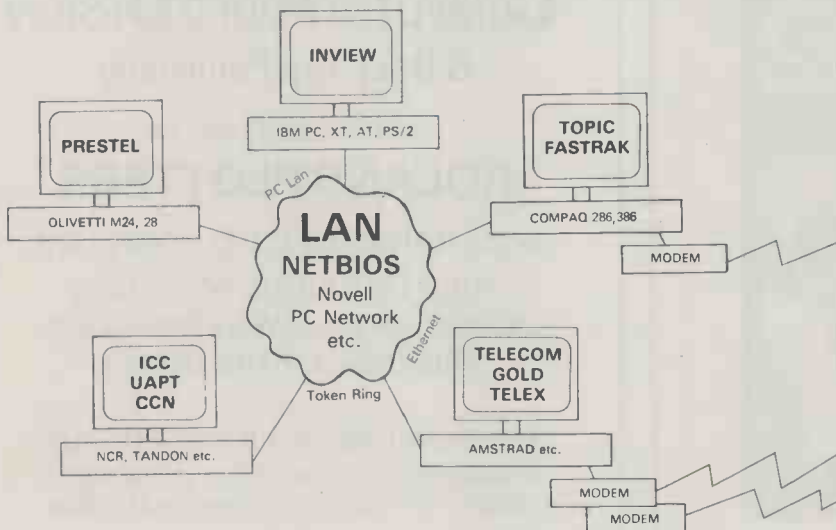

- Communications access from any PC
- Any network hardware with NETBIOS
- Modems attached to any PC
- Versions for 1, 2, 4 or 8 modems
- Full MULTICOM PLUS functions
- Upgrade option from MULTICOM PLUS

## MULTICOM

The Professionals Choice

*The Professionals Choice*  
MULTICOM NET from Richard Cumming & Associates brings all the benefits of MULTICOM PLUS, their leading videotex and general communications software, to the LAN user.

Available in 1, 2, 4 or 8 port versions MULTICOM NET offers a cost effective method of gaining access to videotex services from PCs linked to LANs. Savings are made in both hardware and software by eliminating the need for each PC to have its own modem or its own emulation software.

MULTICOM NET retains all the features of MULTICOM PLUS including CEPT and STREAMA secure printing. Menus can be customised and routines automated by the end user using MULTICOM's powerful command language. Data for transmission can be prepared offline saving telephone and connection charges while information from videotex services can be stored as videotex screens or ASCII standard data format for links to spreadsheet and database packages.

For further details of MULTICOM NET

Contact Andrew Collins  
Richard Cumming & Associates  
3 Matts Hill Road  
Hartlip, SITTINGBOURNE  
Kent ME9 7XA  
Tel: Medway (0634) 363541

## M-TEC

At last BBCBASIC to run on YOUR IBM or IBM Compatible running under MSDOS

# BBCBASIC(86)

All the features of BBC BASIC including:

- > Multi-lined named procedures
- > In-line assembler using standard mnemonics
- > Serial random and indexed disk files plus the ability to access any byte in the file
- > BBCBASIC VDU commands; graphics; sound
- > Full screen editing
- > Plus all the standard commands
- > 500 page user manual
- > Program examples on disk
- > Price £95.00 + £3.00 P&P + VAT

*You need never say GOTO again but we won't stop you!*

Also available comms program including serial lead to download from Acorn to IBM requires BBC Basic (86). Please state 40 or 80 track Acorn Format.

Price £16.00 plus £1.00 carriage plus VAT

## M-TEC COMPUTER SERVICES (UK)

4 Church Hill Reepham Norfolk NR10 4JL  
Tel: (0603) 870620 Fax: (0603) 870436

## DATA COM PERIPHERALS/ACCESSORIES

### "GOOD WAY"

NOT ONLY PROVIDES QUALITY PRODUCTS, BUT ALSO PROVIDES RIGHT SOLUTION IN YOUR DATA COM'S PROBLEMS



- INTERFACE CABLE
- DATA SWITCH BOX (WIRING & PCB CONSTRUCTION)
- DATA CONVERTER, S/P, P/S, RS-232/422, RS-422/232 IEEE-488/RS232 OR CENTRONICS
- DATA BOOSTER
- MODULAR ADAPTOR.
- GENDER CHANGER
- PHONET (FOR APPLE COMPUTER)
- S.C.S.I. TERMINATOR.

## GOOD WAY INDUSTRIAL CO., LTD.

OFFICE: P.O. BOX 91-202 TAIPEI TEL: (02) 5017197-8, 5055285  
TELEX: 12445 SUWORS FAX: 886-2-5056377  
FACTORY: NO. 14-1 DAH HER LANE 2 SHI TWEN DISTRICT  
TAICHUNG, TAIWAN TEL: (04) 2551192-3 • 2551220





# MGC Ltd



DIRECT NO FRILLS SERVICE FOR THE  
BEST POSSIBLE PRICES  
FREE DELIVERY ANYWHERE IN ENGLAND

### COMPUTERS

Bondwell BV8 Laptop	£699
Opus PCIII TF Mono	£589
Opus PCIII TF EGA	£879
Opus PCIII HD Mono	£859
Opus PCIII HD EGA	£1139
Opus PC V Mono	£1139
Opus PC VEGA	£1419
Tandon PCA 20 Mono 8MHz	£1139
Tandon PCA 40 Mono 8MHz	£1529
Tandon PCA 70 Mono 8MHz	£1809
Tandon EGA instead of Mono add	£250
Tandon 10MHz 'Plus' Systems add	£200
Please note long-lead times on Tandon	
Zenith Z-181 TF	£999
Zenith Z-183 HD 20Mb	£1859

Hercules Plus card	£139
NEC Multisync II	£429
Vega deluxe EGA	£169
Vega VGA, EGA, CGA, Herc	£199

### Printers

Brother 1509	£352
Brother 1709	£418
Brother 1724	£529
Brother 2024	£559
Brother 2518	£795
Brother 4018	£1069
Brother HR20	£326
Brother HR40	£719
Citizen I20D	£129
Citizen LSP100	£165
Citizen MSP10E	£198
Citizen MSP15E	£229
Citizen MSP40	£278
Citizen MSP45	£349
Citizen MSP50	£359
Citizen MSP55	£479
Citizen HQP40 24 pin	£339
Citizen HQP45 24 pin	£399
Citizen Premier 35 Daisy	£379
Citizen Overture 110 Laser	£1199
Epson LX800	£178
Epson FX800	£286
Epson FX1000	£369
Epson EX800	£369
Epson EX1000	£489
Epson LQ850	£418
Epson LQ1050	£559
Epson LQ2500	£688
LQ500	£279
SQ2500	£969
NEC P2200	£279
Panasonic KX-P1081	£139
Panasonic KX-P1592	£307
Panasonic KX-P3131	£227
Panasonic KX-P3151	£349

### SOFTWARE

Borland Quattro	£89
Borland Sidekick	£35
DS Backup Plus (Fast b/up)	£69
DBase III +	£299
Lotus 123 2.01	£218
Lotus Symphony 1.2	£317
Microsoft Excel	£239
Microsoft Windows	£55
Microsoft Word 4.0	£248
Migent Ability	£39
Multimate Advantage II	£269
Nantucket C.Lipper	£299
Paradox 2.0	£279
Pasafirst Choice	£99
Sage Accountant +	£133
Sage Financial Controller	£204
Smart System	£359
Supercalc 4.1	£195
Wordperfect 4.2	£218
Wordstar 2000 + Rel 3	£226
Add-ons	
Microsoft Bus or Ser Mouse	£119
Logitech Ser C7 Mouse	£69
Logitech Bus Mouse	£89
Miniscribe 32Mb Hard Card 40ms	£259
Miniscribe 40Mb hard disk kit	£289
Amstrad Int. Modem card + S/W	£119
DACOM Unity Gold + S/W	£289
Cypher 1520 20Mb streamer	£349
Cypher 1525 (Amstrad)	£299
Orchid Tiny Turbo 286	£229

Maths Co-Processors	
Intel 8087	£89
Intel 8087-1	£169
Intel 8087-2	£129
Intel 80287-6	£119
Intel 80287-8	£179
Intel 80287-10	£239
Intel 80387-16	£369
Intel 80387-20	£559

Cheques should be made payable to MGC Ltd. Send to: MGC Ltd, PO Box 743, High St., Slough SL1 1AU. Telephone orders on Slough (0753) 694253. Please add 4% for telephone orders, 3% for deliveries to Scotland and Wales and 15% VAT to all prices. Prices subject to change without notice.

# SL DATA

## 4 INTO 1 AUTOMATIC PRINTER SHARER

NOW  
£90



NOW  
£90

MP/MS401 Autoswitch £90 MP/MS801 Autoswitch £130

### MANUAL DATA SWITCHES

DS25/DP36 2 way	£24	DS25/DP36 3 way	£35
DS25/DP36 4 way	£41	DS25/DP36 x/over	£44

### PRINTER BUFFER 64K



PB64	£95	PB256	£155
PB64-2	£125	PB256-2	£180

Computer cables (2 metre) - others available  
36m-25m £10.50 25m-25m £10.50 36m-36m £12.50

Add £3.50 p+p + 15% VAT to UK orders

Trade and Educational enquiries welcome  
Ex-stock supplies

## SL DATA Ltd

Miswell Suite  
Tring House  
77/81 High Street  
Tring, Herts HP23 4AB

TEL: 0442 890205  
0442 890302  
TX: 826715 AERO G  
FAX: (044282) 7272

NEW!

# AUTOROUTE

Your mile-saving,  
time-shrinking, petrol-hoarding,  
cost-cutting

# FAST COMPUTERISED UK ROUTE PLANNING

AUTOROUTE automatically routes you through any UK journey and gives you the quickest, shortest, cheapest or most pleasurable drive you could ever plan!

AUTOROUTE brings you 67,000 miles of Ordnance Survey mapped motorways, A, B, and minor roads... over 6,000 place names covering the whole of Great Britain... plus the easiest-ever user-friendly routing program.

Pick your own starting and finishing points. Choose places you wish to visit en route. Note all sections the news has told you to avoid. Choose to save time or petrol, drive fast or slowly, use motorways or minor roads...

...And AUTOROUTE plans, displays, times and calculates your entire route - and shows alternatives, too. Pick the route you prefer and print off detailed driving instructions (eg. "In 2 miles, turn left, on to A661 towards Harrogate").

See the total route on the screen with all road numbers and place names. For closer checking, zoom right in for a 2" to the mile close-up of any section. All in full colour or black and white.

AUTOROUTE is fast (plans routes at up to 900 miles per minute!)... easy to use... has annually updated Ordnance Survey maps... can be used in-car on portables... saves motoring time and money. Extensive business and personal use.



Full colour, high resolution  
Ordnance Survey based map  
displays



Comprehensive  
instruction manual

● Plan ANY journey in Great Britain ●  
● Extremely easy to use ● View maps on screen  
● AB journey times calculated and reduced to a  
minimum ● Full map and directions print out ●  
For all IBM PC-compatibles (min. 512K) ● Can  
save up to 20% of driving time and costs  
(Department of Transport Survey)

PHONE 0372-49011 TO ORDER DIRECT OR RETURN THIS COUPON TO  
NextBase Limited, March House, Churt Road, Hindhead, Surrey GU26 6PR.

Please send my AUTOROUTE Pack. I have an IBM PC-compatible with at least  
512K memory and (tick one box):

- |  |  |
|--|--|
| <input type="checkbox"/> Two 5 1/4" floppy drives                | <input type="checkbox"/> One 5 1/4" floppy drive and a hard disc |
| <input type="checkbox"/> One 3 1/2" floppy drive and a hard disc | <input type="checkbox"/> One or two 3 1/2" floppy drives         |

Please tick one of the following:

- I enclose a cheque for £149.50 (including VAT) payable to NextBase Ltd.  
Please debit my Access/Visa acc. Expiry date \_\_\_\_\_  
 no.  
by £149.50 in payment for AUTOROUTE  
 Please send me a FREE brochure

Name \_\_\_\_\_

Address \_\_\_\_\_

Tel \_\_\_\_\_

AUTOROUTE is also available through most good software dealers

Special Launch Price of Just £130 (+VAT)

RETURN COUPON NOW  
TO RECEIVE AUTOROUTE WITHIN 28 DAYS

# A NEW BREED OF PC from Viglen



## Vig I HD30M

■ Fully IBM XT Compatible ■ Superfast NEC V20 Processor with 8087 socket ■ 4.77/8 MHz switchable ■ 640K Ram Expandable to 1Mb ■ 30MB Fast Winchester Hard Disc ■ 360K Floppy Drive or 720K 3.5" (option for both available) ■ Mono graphics Hercules compatible card ■ 14" High Resolution Amber Monitor ■ Enhanced 102 Keyboard ■ Real Time Clock ■ 1 Parallel and 1 Serial Port (option for 2nd port) ■ 8 expansion slots (4 free) ■ 180 watt power supply ■ New compact case ■ MS-DOS 3.21 with GW Basic ■ Norton SI (V4.0) test: 3.2 ■ Games Port

**£795 + VAT**

Vig I HD30E: EGA Colour System £1095.00 + VAT

Vig I HD30V: VGA Colour System £1295.00 + VAT

Vig I SD: Single Floppy Drive Monochrome System £549.00 + VAT

Vig I DD: Double Floppy Monochrome System £599.00 + VAT



## Vig II HD40M

■ Fully IBM AT Compatible ■ Intel 80286 Processor with 80287 co-processor socket ■ 8/12MHz switchable ■ 1024K Ram. 640K Main Memory + 384K Ram Disc ■ 40MB fast Winchester Hard Disc ■ 1.2MB 5.25" Floppy Drive as standard or 1.44MB 3.5" (option for both) ■ Mono graphics Hercules compatible card ■ 14" High Resolution Amber Monitor ■ Enhanced 102 Keyboard ■ Real Time Clock with battery backup ■ Latest BIOS capable of handling OS2 Compatible Drives and with SETUP in BIOS ■ 2 Parallel, 2 Serial and 1 Games Port ■ 8 expansion slots (5 free) ■ 180 watt power supply ■ New compact case ■ Mouse and Microsoft Windows ■ Latest MS-DOS 3.30 with GWBASIC ■ Norton SI (V4.0) test: 11.70

**£1295 + VAT**

Vig II HD40EM: EGA Colour System £1695.00 + VAT

Vig II HD40VM: VGA Colour System £1895.00 + VAT

Vig II Plus: 16MHz 0 Wait State available soon at an extra £299.00 + VAT

### How to Order

Simply write to us with your requirements and enclose a cheque/postal order or credit card No. for the total amount plus £10.00 for Courier Delivery plus 15% VAT. Credit card holders may order by telephone on our sales hotline 01 843 9903 (8 lines). Allow 7-10 days for delivery. Personal callers welcome to our showroom.

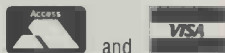

Showroom open Mondays to Fridays 9.30 till 5.30



## Vig III HD40M

■ 32bit Intel 80386 cpu with 80287 & 80387 socket ■ 8/16/20MHz 0 wait state switchable ■ 2MB Ram (640K + 384K Shadow + 1MB extended) expandable to 8MB on board (16MB with add on card) ■ 40MB fast Winchester Hard Disc ■ 1.2MB 5.25" Floppy Drive as standard or 1.44MB 3.5" (option for both available) ■ Mono graphics Hercules compatible card ■ 14" High Resolution Amber Monitor ■ Enhanced 102 Keyboard ■ Real Time Clock with battery backup ■ Latest BIOS capable of handling OS2 Compatible Drives and with SETUP in BIOS ■ 2 Parallel, 2 Serial and 1 Games Port ■ 8 expansion slots (5 free) ■ 180 watt power supply ■ Mouse and Microsoft Windows ■ New Compact case ■ Latest MS-DOS 3.30 with GWBASIC ■ Norton SI (V4.0) test: 22, Landmark test 25.9MHz

**£2495 + VAT**

Vig III HD40EM: EGA Colour System £2895.00 + VAT

Vig III HD40VM: VGA Colour System £3095.00 + VAT

All the above Viglen PCs are ready for use and have specifications of the highest standard which include the following:

■ New compact FCC (essential US requirement) approved case (smaller than standard footprint size only 1.6 sq ft in area) capable of accepting 4 drives (1 internally 3.5") ■ Japanese Drives (Not Taiwanese) ■ All keyboards are high quality FCC approved with superior click type keys. 102 key keyboard is standard though 84 key keyboard can be supplied as an alternative. ■ Very high quality certified 180 watt power supply designed to meet full UL/CSA safety standards ■ 12 months warranty with option for on-site maintenance ■ Full manuals ■ Technical Support second to none ■ The Viglen PCs are guaranteed to run all software that runs on the equivalent IBM PC/XT/AT such as DOS, Lotus, DBase, Wordstar, Autocad, Novell, Xenix, Sams, Sims, Corinth and all others. Specific requirements of disc drive and Winchester combinations can be supplied.

Viglen also supply a full range of peripherals such as Monitors, Floppy Drives, Winchester, Tape Streamers, Add on cards, Network Cards, Co-processors, Mouse and many others at incredible prices. Please call. Official orders from Education Establishments, Government departments and Plc Companies accepted. All Trademarks Acknowledged

**SPECIAL OFFER  
WHILST STOCKS LAST**  
All EGA Systems include  
a Fujitsu 14" colour  
multiscan monitor.

# Viglen

Viglen Ltd., Unit 7 Trumplers Way  
Hanwell, London W7 2QA Telephone: 01-843 9903  
Telex: 919 304 VIGLEN G Fax: 01-574 5126

Prices correct at time of going to press and subject to availability.



# JILUTECH SYSTEMS

Jilutech Systems Specialises in Computer Hardware Products, we supply to many Government bodies, corporates and small/medium sized businesses. Another side to our business is distributing to trade.

## HARD DISKS

	OUR PRICE
Miniscribe 20Mb 3425 Package	£195
Miniscribe 40Mb 3650 Package	£290
Seagate 20Mb ST225 Package	£185
Seagate 30Mb ST238 Package	£227
Seagate 40Mb ST251 Package	£325
Seagate 80Mb ST4096	£650
Miniscribe 20Mb Hard Card	£250
Miniscribe 30Mb Hard Card	£280

**Package – Drive/WX1 Controller/Cables/Fixing Kit/Instructions/Portioning Software**  
Other drives available from stock

## TAPE STREAMERS

	OUR PRICE	RRP
Everex 40Mb Internal Package	£499	£895
Everex 40Mb External Package	£549	£995
Everex 60Mb External Package	£599	£1395

**Package – Drive/Controller/Cables/Manuals Everex Software/Data Cartridge**

**PS2 compatible tape streamers available.**  
**External Everex Tape Streamers can be stored between PCs, XT's, AT's and PS2's using additional controller cards.**  
Data Cassettes and Cartridges available

## MEMORY BOARDS

CAN BE SUPPLIED POPULATED AT NO EXTRA COST		
	OUR PRICE	RRP
Everex Mini Magic Card (XT/AT use)		
Fills Out Base Memory to 640kb	£80	£95
Everex Maxi Magic EMS (XT/AT use)		
Up to 2Mb of EMS Memory (LIM)	£145	£190
Everex RAM 2000 (AT use)		
2Mb Expanded/Extended memory LIM)	£130	£152
Everex RAM 3000 Deluxe (AT use)		
3Mb Expanded/Extended Memory (LIM)	£175	£260

**PS2 COMPATIBLE MEMORY BOARDS AVAILABLE**

## COMPUTERS & GRAPHICS

AMERICAN MANUFACTURED – MEAN MACHINE		OUR PRICE
Lightning Fast 286-12 Processor ★ 0 Wait 1Mb System		
Memory Expandable to 16Mb ★ 80ns Dram ★ MS DOS		
3.3 and GW Basic 3.3 ★ 360k/1.2Mb Floppy Disk ★		
2 Parallel/2 Serial ★ Small Footprint		
★ 12 Months Full Warranty		
AT286 20Mb Mono System		£1650
JT-AT286-40Mb Mono System		£1750
JT-AT286-20Mb EGA System		£1850
JT-AT286-40Mb EGA System		£1950
JT-AT286-20Mb VGA System		£2050
JT-AT286-40Mb VGA System		£2150

## RAM CHIPS + COPROCESSOR

Dram 64kb (150ns)	£ Please call
Dram 256kb (150ns)	£ Please call
Dram 256kb (120ns)	£ Please call
GENUINE INTEL COPROCESSORS	
Maths Coprocessor 8087-4.77MHz	£120
Maths Coprocessor 80287-6MHz	£170
Maths Coprocessor 80287-8MHz	£240
Maths Coprocessor 80287-10MHz	£270
Maths Coprocessor 80387-20MHz	£650

## TURBO CARD

Replaces PC/XT 8088 with the 80286 Microprocessor and Fills out Base memory to 640kb		
	OUR PRICE	RRP
Everex Excellerator		
Replaces 8088 with 80286 Chip	£359	£499

**INFO & ORDER HOTLINE: (01) 991 5044**  
QUANTITY DISCOUNTS AVAILABLE

All our products are covered by a one year warranty

Jilutech Systems  
Research House, Fraser Road  
Greenford, Middx UB6 7AQ  
Fax: (01) 991 2653

VAT + Delivery charges are not included

# DIGITASK

## AXIOM PERSONAL COMPUTERS

Digitask have been producing PC compatibles and supplying computer hardware for over four years, to end users, corporates and dealers. Our customers include some of the biggest names in the business and almost every university and technical college in the land.

These customers demand the most exacting specification for their computer systems and this is achieved by evaluating hundreds of possible component products. Most don't pass the test. We even turn away products that our competitors choose. Built and tested in the UK and containing only "industry standard" components from specialist suppliers, each a market leader in their own field, we provide some of the most reliable PC compatible systems currently available. Why save a few pounds on an inferior computer? If you want reliability then choose Digitask.

We are a wholly owned British company totally committed to the PC market, with an exceptional reputation for service and support over the past four years. How many of our competitors can say the same?

Maybe that is why over 12000 computer users have chosen Digitask.

**Desktop**



**Portable**



**Mini Portable**

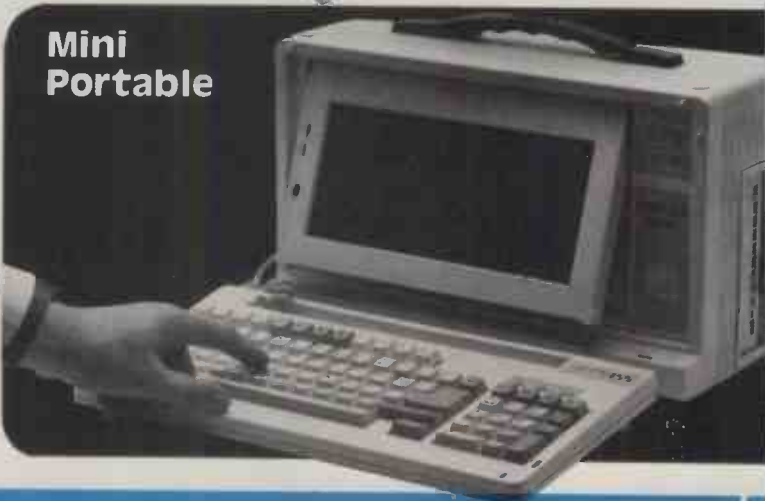

**PHONE 0293 776688**

or Contact Digitask  
Unit 2, Gatwick Metro Centre  
Balcombe Road, Horley  
Surrey RH6 9GA  
Fax 0293 786902 Telex 878761 DIGIT G



EXPORT ENQUIRIES WELCOME



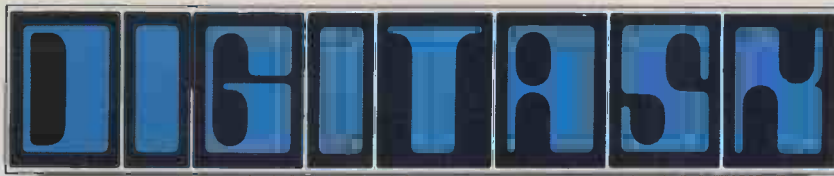

## AXIOM XT range

### STANDARD FEATURES

- Intel 8088 processor running at 4.77 MHz or 10 MHz
- Software or hardware switchable
- Award BIOS
- Provision for 8087 co-processor
- Full 640 KB memory
- Choice of either TTL hi-res mono monitor and mono card or composite mono monitor and CGA card
- Single floppy disk drive 360k (Toshiba)
- 7 IBM compatible expansion slots on desktops
- 1 x Parallel port, 1 x Serial port (2nd Serial Opt.)
- Clock, games port and light pen interface

#### INCLUDES:

Free Application/Utilities software

## AXIOM AT range

### STANDARD FEATURES

- Intel 80286 processor running at 6 MHz or 12 MHz
- Software or hardware switchable
- Provision for 80287 co-processor
- Award BIOS
- Full 1 MB of memory
- Choice of either TTL hi-res mono monitor and mono card or composite mono monitor and CGA card
- Single floppy disk drive 1.2 MB (Toshiba)
- 6-16 bit IBM compatible expansion slots on desktops
- 2-8 bit expansion slots
- 2 x Parallel port, 1 x Serial port (2nd Serial Opt.)
- Clock, and light pen interface

INCLUDES: Hard disk/Floppy disk controller, Free Application/Utilities software

Whether you choose the Digitask Axiom XT (8088) or the Axiom AT (80286) range of computers, you will have the choice of three very attractive, but different styles of cases.

#### Desktop:

The popular desktop system incorporates a small footprint case with an easy access flip-top lid, and comes complete with monitor and 101 key expanded keyboard.

#### Portable:

The portable range offer compactness with the inbuilt 9" amber monitor and keyboard. Room for three half-height disk/tape devices and seven IBM compatible expansion slots. Facility to connect external monitors.

#### Mini Portable:

The new range of mini portable systems provide a backlit LCD display, which can be selected as normal or inverse video. This superb machine can accommodate two half-height disk/devices and five IBM compatible expansion slots. Facility to connect external monitor.

All of the Digitask range of computers come complete with free Application/Utilities Software and a full one year parts and labour warranty. National on site maintenance is available.

<b>AXIOM XT DESKTOP</b>	<b>£499</b>
<b>AXIOM XT PORTABLE</b>	<b>£699</b>
<b>AXIOM XT MINI PORTABLE</b>	<b>£1099</b>

<b>AXIOM AT DESKTOP</b>	<b>£1099</b>
<b>AXIOM AT PORTABLE</b>	<b>£1155</b>
<b>AXIOM AT MINI PORTABLE</b>	<b>£1499</b>

### AXIOM UPGRADES

	XT	AT
Second 360k floppy drive	£75	£75
Second 1.2MB floppy drive	£125	£99
Seagate 20MB hard disk (65ms)	£275	£195
Seagate 30MB hard disk	£295	£295
Hitachi 40MB hard disk (22ms voice coil)	£499	£450
Seagate 60MB hard disk	£539	£599
Quantum 80MB hard disk (12ms)	£1099	£1099
Seagate 80MB hard disk (17ms)	£799	£849

	XT	AT
8087 Maths Co-processor 5MHz	£95	—
8087 Maths Co-processor 8MHz	£134	—
80287 Maths Co-processor 5MHz	—	£149
80287 Maths Co-processor 8MHz	—	£220
80287 Maths Co-processor 10MHz	—	£289
CGA monitor (Taxan)	—	£245
EGA monitor (Tatung) with EGA card	—	£450
For VGA/Multisync Adaptors & Monitors	PLEASE CALL	
Internal Tape streamer 44MB	—	£450
Microsoft MS DOS	—	£50

Many more options available. Please call for details

\* PRICES SUBJECT TO CHANGE/SURCHARGE DUE TO CURRENT VOLATILITY OF MEMORY MARKET.

Prices Do Not Include VAT or Carriage

# DIGITASK

## DOT MATRIX PRINTERS

	RRP	Our Price
AMSTRAD DMP 3160 80col 160cps 25NLQ F/T P	169	155
AMSTRAD DMP 4000 136col 200cps 50NLQ F/T P	349	260
BROTHER		CALL
M1409 110col 180cps 45 NLQ F/T P&S	425	300
M1509 136col 180cps 45 NLQ F/T P&S	495	353
CITIZEN		CALL
120D 80col 120cps 25 NLQ F/T P	245	149
MSP 55 132col 300cps 60 NLQ T	695	512
EPSON		CALL
LX-800 80col 160cps 25 NLQ F/T P	275	185
FX-800 80col 200cps 40 NLQ F/T P	430	292
EX-800 80col 300cps 50 NLQ T P	555	369
FX-1000 136col 200cps 40 NLQ F/T P	550	380
EX-1000 136col 180cps 60 NLQ F P	745	509
FUJITSU DX2100 80col 220cps 44 NLQ F/T P (S OPT)	475	345
MICRO-P MP Series		CALL
OKI ML 182 80col 120cps NLQ F P	269	183
OKI ML 293 132col 200cps P or S or I	799	599
STAR LC10 80col 120cps 30 NLQ F/T P	278	187
PANASONIC		
KXP1081 80col 120cps 28 NLQ	245	159
KXP1592 132col 180cps 38 NLQ	495	328
KXP1595 132col 240cps 51 NLQ	695	445

## 24 PIN PRINTERS

BROTHER M1724 132col 240/72cps P&S	695	597
EPSON LQ500 80col 150/50cps, P	385	295
EPSON LQ-850 80col 180cps 60 NLQ F P	625	425
EPSON LQ-1050 136col 180cps 60 NLQ F P	835	585
EPSON LQ2500- 136col 270cps 90 NLQ T P	1045	695
FUJITSU DL2600 132col 240/80cps P&S	1350	1074
NEC P2200 80col, 140/56cps P	395	287
STAR NB 24-25 136col 216cps 72 NLQ F/T P 360 dpi	759	515
STAR NB 24-10 80col 216cps 72 NLQ F/T P 360 dpi	599	407

## DAISY WHEEL PRINTERS

BROTHER		CALL
BROTHER HR20 117col 22cps F P & S	445	327
JUKI		CALL
JUKI 6100 132col 20cps F P	399	255
JUKI 6200 132col 30cps F P	579	394
JUKI 6200 132col 30cps F P	579	394
FUJITSU		CALL
QUME		CALL
RICOH		CALL

## LASER PRINTERS

AST TURBOLASER POSTSCRIPT	3695	2966
BROTHER HL8 8ppm HP+/Diablo/FX/IBM	2195	1925
CANON 8 SERIES II 8ppm	2095	1805
CENTRONICS PP8 8ppm LJ+	1995	1675
CITIZEN OVERTURE 110 10ppm FX/Diablo	1995	1480
EPSON GQ3500 6ppm LJ+/D	1795	1295
HP LASERJET Series II 8ppm	2248	1960
KYOCERA F1000 10ppm LJ+/FX/Diablo/Qume/IBM/NEC 36 Fonts	2320	1889
OKI LASERLINE 6 6ppm LJ/FX/DI/QM/NEC	1899	1370
QUME LASER 10- 10ppm LJ+ FX/QM/IBM	2683	2216
STAR LASER 8 8ppm HP/IBM/Diablo	2195	1745
WENGER 12/1 12ppm	3095	2580

## PLOTTERS & SCANNERS

AST TURBOSCAN	1495	1195
CANON IX-12 Scanner + Interface + OCR S/W	1500	1260
FACIT 4550 A4 6 pen	495	399
HP 7440A A4 8 pen	995	820
HP 7475A A3/4 6 pen	1796	1480
ROLAND 885 A3 8 pen NEW	895	735
ROLAND 990 A3 8 pen NEW	1275	1050
TAXAN KPL710 A3 6 pen	895	755
TAXAN TX300 Scanner + IF	1298	1012

## MICE & DIGITISING TABLETS

CHERRY A3 GRAPHICS TABLET		455
GENIUS MOUSE	90	55
GENIUS GM6+ inc DR. HALO III	114	75
LOGIMOUSE & SOFTWARE (SERIAL)	104	75
LOGIMOUSE & SOFTWARE (BUS)	125	83
SUMMASKETCH 12 x 12 & GEM DRAW+	659	499
SUMMASKETCH 9 x 6 & GEM DRAW+	599	479
SUMMASKETCH BIT PAD +	399	265

## MODEMS

EXTERNAL		
DACOM DSL2123AD V21, V23	259	209
DACOM DSL123 V21, V22, V23	399	319
DOWTY TRIO V21, V22, V23	595	489
DOWTY QUATTRO V21, V22, V23 V22bis.	795	639
MIRACLE		
WS2000 V21, V23	109	89
WS4000 V21, V23	170	133
WS3000 2123 V21, V23	295	205
WS3000 22 V21, V22, V23	495	385
WS3000 22bis. V21, V22, V22bis. V23	650	499
RACAL MILGO MPS24 V26bis.	530	496
INTERNAL		
AMSTRAD		
NEW M/C - 2400 MODEM V21, V22, V23, V22bis.	199	189
DOWTY TRIO CARD V21, V22, V23	595	495
DOWTY QUATTRO CARD V21, V22, V22bis, V23	795	639
LION SYSTEMS ORATOR V21, V22, V23, V22bis.	795	630
MIRACLE KEYCARD 2123 V21, V23	275	225
MIRACLE KEYCARD 1200 V21, V22, V23	425	345
MIRACLE KEYCARD 2400 V21, V22, V22bis, V23	545	440

## MONITORS

GENIUS A4 (736 x 1008)	1649	1475
HITACHI MULTISCAN 14" NEW	625	529
MICROVITEC 20H727 ES' (1365 x 866)	1600	1450
NEC MULTISYNC II 14" NEW	649	469
PACKARD BELL 12" AMBER TTL MONO	125	95
PACKARD BELL EGA 14"	599	349
SONY MULTISYNC CPD140ZE 14"	795	579
TAXAN SUPERVISION 620 12" RGB HI RES COLOUR.	389	265
TAXAN SUPERVISION 760 14" EGA	579	399
TAXAN SUPERVISION 770+ MULTISCAN	699	545
THOMPSON MULTISCAN 14"	669	559
THOMPSON 960W 20" (1024 x 768) without adaptor	799	695
VIKING I 19" (1280 x 960) + Driver S/W	2299	1956
WYSE 700 (1280 x 800) DTP MONITOR	895	779

## EGA ADAPTORS

EVA 480 H/M/C/E/RA+ Pan and Zoom	315	229
VEGA Deluxe H/M/C/EGA	249	195
VEGA VGA H/M/C/E/VEGA 800x600/256col PS/2 comp.	299	237
AUTOMODE 480 (Paradise) H/M/C/E/VGA + 132 + Autoswitch	249	159
EG 2000 (genoa) H/M/C/E/VGA + 132 + 43		139
600 EGA (genoa) M/C/E/VGA + 800 x 600 NEW		CALL

## SOFTWARE

### TOP FIFTY SELLING PROGRAMS

DATABASE		
CLIPPER COMPILER	595	325
CORNERSTONE	100	61
DABSE III+	595	340
PARADOX II	595	349
RAPIDFILE	275	189
REFLEX	100	57
WORD PROCESSORS		
WORD IV	425	238
WORD PERFECT	425	238
WORDPERFECT LIBRARY	149	120
WORDSTAR	295	144
WORDSTAR 2000 REL2	465	228
WORDSTAR PROFESSIONAL REF 4	399	193
DTP/GRAPHICS/CAO		
ALDUS PAGEMAKER	795	469
AUTOSKETCH	79	49
FONTASY	80	68
FREELANCE +	320	265
HARVARD GRAPHICS	395	285
VENTURA DESKTOP PUBLISHING (XEROX)	795	569
SPREADSHEETS		
LOTUS 123	395	235
LOTUS HAL	120	81
SUPERCALC IV	396	189
PERSONAL PRODUCTIVITY		
ABILITY+	159	115
FRAMEWORK II	550	347
LOTUS SYMPHONY	550	317
SMART	695	445
SMART SPELLCHECKER	95	87
SUPERPROJECT +	495	290
ACCOUNTS		
ACCOUNTABILITY	99	68
SAGE ACCOUNTANT	140	105
SAGE ACCOUNTANT +	199	138
SAGE BOOK-KEEPER	99	71
SAGE FINANCIAL CONTROLLER	299	211
PROGRAM DEVELOPMENT & LANGUAGES		
MICROSOFT C	345	245
TURBO BASIC	70	47
TURBO C	70	53
TURBO GAMEWORKS	50	29
TURBO PASCAL V4	70	45
TURBO TUTOR	30	23
COMMUNICATIONS		
CROSSTALK MARK 4	150	107
DATATALK	129	103
SAGE CHIT-CHAT (S/WARE)	99	68
SMARTERM 240	229	178

### TOP TEN RISING STARS

ADVANCED NORTON UTILITIES	99	85
BORLAND QUATTRO	130	89
EXCEL (MICROSOFT)	395	269
FLIGHT SIMULATOR II M/S	45	34
FOXBASE +	395	325
GEM DESKTOP PUBLISHER	295	188
JAVELIN PLUS	190	149
PROTEXT	60	42
TURBO PASCAL V4	70	45
TRANS-SEND (ULTIMATE COMMS PROG)	50	45

PHONE 0293 776688 NOW

or Contact Digitask, Unit 2, Gatwick Metro Centre, Balcombe Road, Horley, Surrey RH6 9GA. Telex 878761 DIGIT G Fax 0293 786902



# DIGITASH

## HARD DISK DRIVES

SEAGATE 20MB H.HT ST225 (65ms)	189
SEAGATE 30MB H.HT ST238R (65ms) RLL	225
SEAGATE 40MB H.HT ST251 (40ms)	395
SEAGATE 40MB H.HT ST251-1 (28ms)	425
SEAGATE 65MB H.HT ST277R (40ms) RLL	599
SEAGATE 20MB H.HT ST125 (40ms)	
3.5" 5.25 chassis	225
SEAGATE 20MB H.HT ST125-1 (28ms)	
3.5" 5.25 chassis	279
HITACHI 40MB H.HT DK521 (22ms)	449
HITACHI 87MB H.HT DK522C (22ms) SCSI	925
SEAGATE 30MB F.HT ST4038 (40ms)	399
SEAGATE 40MB F.HT ST4053 (28ms)	469
SEAGATE 80MB F.HT ST4096 (28ms)	779
SEAGATE 122MB F.HT ST4144R (28ms)	1099
FUJII 21MB H.HT FK309 (60ms) 3.5" 5.25 chassis	175
FUJII 32MB H.HT FK309R (60ms) RLL 3.5" 5.25 chassis	196
<b>HARD DISK CONTROLLERS</b>	
WESTERN DIGITAL XT (2HD) contr.	75
WESTERN DIGITAL XT (2HD) contr. RLL	109
WESTERN DIGITAL AT (2HD) contr.	128
WESTERN DIGITAL AT (2HD 2FD) contr.	149
WESTERN DIGITAL AT (2HD 2FD) contr. RLL	175
SEAGATE SCSI host adaptor XT or AT	84
<b>HARD CARDS</b>	
DIGITASK (FUJII + WD) 21MB (60ms)	239
DIGITASK (FUJII + WD) 32MB (60ms)	259
XT/AT CABLE SETS	14.95
WORM DRIVES	CALL

**NEW!**  
WINCHESTER UPGRADE KITS FOR IBM  
PS/2 MODELS 30 & 50 - 45MB (28ms)  
£795

## TAPE STREAMERS

GOLDSTORE 40MB internal strmr XT & AT	460
DIGITASK 40MB PS/2 Tape back-up	525
WANGTEK 5099 EK 60MB int.	630

## FLOPPY DRIVES AND CONTROLLERS

TOSHIBA 360KB Half Height	79
TOSHIBA 1.2MB Half Height	125
BROTHER 720KB 3 1/2" (in 5 1/4" chassis)	95
MITSUBISHI 720KB 3 1/2" (in 5 1/4" chassis)	99
TOSHIBA 1.44MB 3 1/2" drive	159
COMMUNICATOR controller 360/720/1.2MB/1.44MB	99
COMMUNICATOR controller 360/720/1.2MB	79
DUAL FLOPPY adaptor	44
QUAD FLOPPY adaptor	54
GREAT COMMUNICATOR 1.2MB FLOPPY Drive, and contr. cables ROM S/W XT	179

## COMPUTER SYSTEMS

DIGITASK PC's see other advertisement

★ AMSTRAD ★ AST ★ COMPAQ ★ ★  
★ EPSON ★ OLIVETTI ★ SHARP ★  
★ TANDON ★ TOSHIBA ★

## BRANDED PERIPHERALS

★ 3COM ★ AST ★ CHASE ★ ★ EVEREX ★  
★ FASTOATA ★ HERCULES ★ INTEL ★  
★ INTERQUADRAM ★ MOUNTAIN ★ ORCHID ★  
★ PARADISE ★ PERSYST ★

## NEW! RAM 3000 Deluxe (EV-159)

16 bit expansion/extension RAM card for PC/AT and compatibles. Populate up to 3MB each, up to 16MB with multiple boards. Backfills to 640KB. With LIM spec - 4 drivers.  
**£169.00**

## DIGITASK PERIPHERALS

<b>MAINBOARDS</b>	
12MHz BABY AT Mainboard	395
4.77/10MHz XT Mainboard	169
INTEL 16MHz 80386 Mainboard	CALL
<b>RAM EXPANSION/MULTIFUNCTION CARDS</b>	
SUPER RAM 286/386 2MB (OK) Ext. up to 16 MHz	119
EMSPAGE 2MB XT or AT (OK)	95
MEMO 2000A 2MB AT EXP/EXTEND EMS OK	179
576K RAM CARD (OK) XT	45
128K BRIDGING CARD (OK) AT	64
640K MULTIFUNCTION ADAPTOR IP IS IG IC or XT/AT	97
DIQ-200 XT MULTIFUNCTION IP IS IG IC	69
DIQ-500 AT MULTIFUNCTION IP IS IG	78
MULTI 8255 I/O ADAPTOR	119
MULTI I/O CARD (SHORT)	89
<b>GRAPHICS CARDS</b>	
EGA	see separate section
MONO GRAPHICS ADAPTOR (HERC/COMPAT)	79
COLOUR GRAPHICS ADAPTOR	79
COLOUR GRAPHICS/PARALLEL ADAPTOR	94
MG 132,132 COL-MON GRAPHICS ADAPTOR	119
PAL CTV GRAPHIC ADAPTOR	129
<b>SERIAL/PARALLEL UPGRADES</b>	
ASYNC ADAPTOR XT 1 PORT	27
ASYNC ADAPTOR XT 2 PORT	39
MS 400X ASYNC ADAPTOR XT 4 PORT	109
MS 422X RS232/422 ADAPTOR XT	97
ASYNC CHIP UPGRADE SET XT	12
SERIAL/PARALLEL CARD AT	69
MS 400A ASYNCDAPTOR AT 4 PORT (DOS)	169
MS 422A RS232/422 AT 2 PORT	109
ASYNC CHIP UPGRADE SET AT	23
PARALLEL PRINTER ADAPTOR XT/AT	22
GAMES ADAPTOR XT/AT	24
CLOCK CARD + SW XT	39
<b>EPROM PROGRAMMERS</b>	
6000A SINGLE-GANG (max 512k)	129
6000F 4-GANG (max 512k)	179
6000S 6-GANG (max 512k)	199
6000E 8-GANG (max 512k)	229
6000X 10-GANG (max 512k)	259
6000T 12-GANG (max 512k)	299
3000 PAL/EPROM (max 512k)	369
<b>OTHER</b>	
TRANS NET TR001 Networking Board	255
TRANS NET Utility Software	99
VOICE RECORD/PLAY CARD + Mic + Loudspeaker	69
VIDEO SENDER UT66	29
2450 LOGIC ANALYSER 50 MHz	599
2400 LOGIC ANALYSER 100 MHz	999

**SPECIAL**  
LCS-6620 Floppy/Hard AT Adaptor £79

## HARDWARE

150 Watt power supply for XT	89
180 Watt power supply for Baby AT	99
200 Watt power supply for AT	124
Mini AT case 32-580	74
XT Flip-top case	55
Tower case 32-386	329
FK-555 101-key keyboard UK	95
FK-727 84-key keyboard UK	79
CS-600 Joystick	19
BAG-02 (bag for mini portable)	35
EPROM Eraser	89
YU-D100L Lockable disk bank—100 x 5.25" disks	17
YU-D010 Disk holder—10 disks—5.25"	2
YU-DD080L Lockable disk bank—80 x 5.25" disks	14

PS-100 Parallel/Serial Converter  
SP-100 Serial/Parallel Converter  
£45

## CABLES/CONNECTORS ETC.

XT FDD 2nd Port Drive Cable (37-way D to dual)	15
C-008 RS232 Interface Cable	15
C-010 RS232 Modem Cable	15
C-011 9-Pin Extension Cable for IBM B/W Monitor	9
C-015 RGB Monitor Cable	9
C3011 RGB Monitor Cable	9
GA 1001-AMT (3036-N) Printer Cable	14
GA 3004 Keyboard Extension Cable	5
GA 3016 FF RS232 Jumper Box	7
GA 3016 MF RS232 Jumper Box	8
GA 3016 MM RS232 Jumper Box	7
GA 3018-15 FF 15-Pin Gender Changer	7
GA 3018-15 MM 15-Pin Gender Changer	7
GA 3018-25 FF RS232 Gender Changer	7
GA 3018-25 MM 25-Pin RS232 Gender Changer	7
GA 3018-9 FF 9-Pin Gender Changer	7
GA 3018-9 MM 9-Pin Gender Changer	7
GA 3019 MF Null Modem	7
GA 3019 MM RS232 Null Modem	7
GA 3020 RS232 Surge Protector	12
GA 3027 FF Centronic Gender Changer	14
GA 3027 MM Centronic Gender Changer	14
RS232 Loopback Tester	9
RS232 Mini Tester	9
RS232 Reverser (Test adaptor)	7

SERIAL DATA T-SWITCH **£39**  
PARALLEL DATA T-SWITCH **£37**

**NEW! SPRINT 2000 - 2MB Non-Volatile**  
RAM for AT and 386 machines. Battery backed—retains data for up to 5 Days. Copying data periodically eliminates need for UPS! 2MB Daughter board available. Install up to 4 boards for 16MB.  
**£749.00**

## BOOKS

We now distribute an incredible list of titles by reputable authors on PC Hardware and Software  
Ask for our Book List

ALSO AVAILABLE—ALL RELATED ACCESSORIES INCLUDING PRINTER STANDS, COPYHOLDERS, ACOUSTIC HOODS, CABLES, RIBBONS, SHEETFEEDER AND COMPUTER FURNITURE, ETC.

**OUR PRODUCT RANGE IS TOO EXTENSIVE TO ADVERTISE IN ITS ENTIRETY,  
SO IF YOU DON'T SEE WHAT YOU WANT—CALL FOR MORE DETAILS.**

PRICES MAY CHANGE. ALL THE ABOVE PRICES DO NOT INCLUDE VAT AND CARRIAGE. MINIMUM ORDER VALUE OF GOODS EXCLUDING CARRIAGE AND VAT IS £15.00

Prices-Do Not Include VAT or Carriage



## ABT NOW STOCKS

**THE GENIUS MOUSE GM-6 PLUS**  
 MICROSOFT AND PC MOUSE  
 COMPATIBLE  
 DR HALO III GRAPHICS PACKAGE  
 MENU MAKER SOFTWARE  
 MOUSE PAD  
 CUTTING PAD  
 MOUSE POCKET



ALL THIS FOR ONLY £69.95 TO YOUR DOOR

We will match any genuine lower price for the GM-6 Plus advertised in this issue of PCW.

Also:

Joystick and Card £45.99 to your door.  
 Extra RS-232 Card £35.99 to your door.

### And this month's special offer:

**MP 135 Dot Matrix Printer** 80col, 135cps, Tractor  
 and Friction Feed, NLQ mode, Graphics mode,  
**Amazing value — £149**

(Watch out for next month's special offer)

Dealer and Educational orders welcome

**Free Games disk with every order**

Seven day money back guarantee with every order.  
 All prices include VAT and delivery, no hidden extras.

To place your order Tel: 0203 410464 between 8am-10pm.,  
 or Fax: 0203 414077. Access card holders welcome.

## ABT COMPUTERS

25 Warwick Ave, Earlsdon  
 Coventry CV5 6DJ

We reserve the right to change prices.  
 We acknowledge all Trademarks.

## Olivetti Desktop Publishing Centre

**olivetti**  
 CHOICE OF FREEDOM

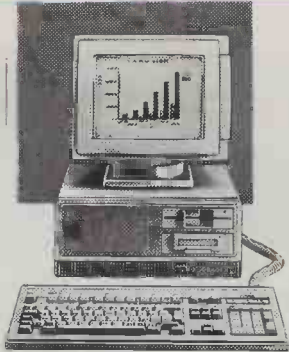

The Olivetti range starts with the M240. At 10MHz it is now the fastest PC compatible in its class. Only Olivetti could improve on the world's most successful PC compatible.

Olivetti's flagship is the M380, so powerful it can do the work of eight standard PC's. As with the complete Olivetti range the M380 has the flexibility to be tailored to your needs. Right from the choice of display to choice of system. Expanding perfectly to your individual requirements and future industry standards.

**Authorised Olivetti Dealer**

**We also supply a wide range of single and multi-user business systems**



Telephone  
 01-453 0123

HK Systems Limited 6 Sunbeam Road  
 London NW10 6JL  
 Telex 9401 2228 LAMB G

Approved  
 Signa  
 Dealer

## SIMTECH

118 Doggett Road, London SE6 4QB. (01) 690 3569

Electric  
 Distribution  
 Dealer

### Atari

520STM	313.49
520STFM	379.99
1040STF	569.99
1040 STF + Monitor	664.59
Mega ST2 + Monitor	997.49
Mega ST4 + Monitor	1282.49
Mega ST2 + Monitor + Laser Printer + S/W	2231.40
Mega St4 + Monitor + Laser Printer + S/W + 20 Mb Hard Disc	2996.16
PC Compatible with Amber Monitor (EGA Compatible) with 1 x 5.25" Disc	569.99
with 2 x 5.25" Discs	710.12

### Amiga

A500	474.99
+ Colour Monitor	664.99
Mono Business Pack	1029.95
Colour Business Pack	1279.95
A2000	
+ Colour Monitor	1637.19

### HAWK Scanner

The Scanner that  
 knows its a Photocopier  
 and a printer but also  
 thinks its a Fax \*  
**£1250.00 inc VAT**

\*requires correct modem

### Peripherals

HAWK Scanner	1250.00
CRP A4 Tablet	414.00
CRP A3 Tablet	828.00
NEC P2200 + Signum 2	529.00
SAM Digitizer	249.95

NEC & Star Printers  
 Cumana, Triangle & Power  
 Discs

Phillips & NEC Monitors  
 Software for Atari ST and  
 Commodore Amiga.

Business and Educational enquiries welcome.

**All prices include VAT.**  
**Hardware includes  
 Courier Delivery.**  
**Software includes**



# Genius Mouse



## GM-6 PLUS MOUSE

**MENU MAKER SOFTWARE  
DR. HALO III SOFTWARE  
MOUSE PAD, CUTTING PAD  
MOUSE POCKET**



**MORE PRACTICAL  
MORE CONVENIENT  
LESS EXPENSIVE**

The Genius Mouse GM-6 Plus is the most versatile and convenient Mouse there is. It comes in its own handy casing, ready to use any time you need it. No matter what your set-up is nor what program you use, the Genius Mouse GM-6 Plus will run its mazes.

Product Function	Genius Mouse GM6	Logimouse C7 Logi Mouse
	Microsoft PC Mouse	
Interface	Serial	Serial
Power Supply	Internal	Internal
Resolution (dot/inch)	22-200 dpi	200 dpi
Button clicks	programmable 1 million	0.3 million
Menu maker	YES	NO
Driver	YES	YES
Paint software	DR. HALO III	NO
Slide show	DR. HALO III	NO
Pad	Mouse/cutting pad	NO
pocket	YES	NO

Click a button, flip a switch and your Genius Mouse GM-6 Plus is compatible with PC Mouse and Microsoft Mouse. It compares favorably with other in its category, even with Logitech Mouse.

A house for your mouse, makes it more practical, more convenient to use. When the surface is not smooth, it has its own running pad. Flip the pad, and you have a very convenient cutting board.



Genius Mouse Pocket and Pad

### GENIUS MENU MAKER

With most other software is too hard to create a pop-up menu. Even with built-in software, you cannot create your own. Using the Genius Menu Maker, you may create a special pop-up menu for any applications. For example, DBASE II, DBASE III, WORDSTAR, SYMPHONY, MS WORD, GBASIC, FRAME WORK, PERSONAL EDIT, VISICALC, SUPERCALC & SMART WORK... etc.



Creat a Pop-up Menu and Run in Your Applications

### PROFESSIONAL PAINT & SLIDE SHOW - DR. HALO III

The Professional Graphics Software:

- \* Includes 256 color types
- \* Create and store symbols
- \* Lasso — move or cut-and-paste an irregular shape, nondestructively across the screen
- \* On-screen help function

- \* Can work on CGA, EGA, Hercules, PGA and VGA displays
- \* Make more than 200 slide show presentation of all pictures stored in memory, one by one, automatically and timed.



Paint & Slide Show

**KYE**

**Kun Ying Enterprise Co., Ltd.**  
Chung-Hsiao W. Road, Sec. 1,  
No. 41, Suite 1311  
Taipei, Taiwan, ROC  
Telex: 11388 Kunying  
Fax: 2-361-5300  
Tel: 02-3813682 • 3118545

Lotus 123, Wordstar, Logitech, Microsoft, PC Mouse, Hercules, DR. Halo III are registered trade markers.

~~FOX~~BASE+ or

**FOXBASE MAC**  
and

**FOXTOOLBOX**

**PROGRAMMING WITH THE POWER OF TWO**

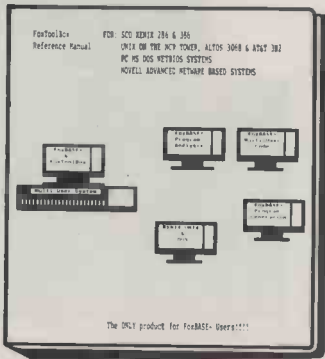
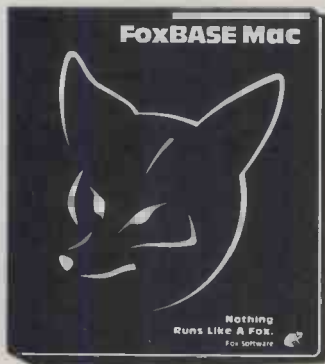

FoxBase+ and FoxBase Mac (for the Apple Macintosh), the world beating total replacement for dBase III+ (TM), is now joined by FoxToolBox, the most powerful suite of software development tools available.

FoxToolBox provides:-

- menu generation and screen painting allowing the developer to assign variables either from new or existing dataBases;
- the most advanced program analysis and documentation utilities available;
- automatic key-word index creation;
- automatic conversion of single user FoxBase applications to multi-user;
- a host of utilities and batch command features including a comprehensive printer configuration suite.

FoxBase+, as every developer knows, provides total user satisfaction.

Available **exclusively** from Management Innovation Software, FoxBase+ and FoxToolBox operate under PC DOS, MS DOS, Xenix and Unix.

Please call: 0634 827755; 814931  
Facsimile : 0634 830358

Lyons House, 9 New Road, Rochester, Kent ME1 1BG

**MANAGEMENT INNOVATION SOFTWARE**



When is a plain paper printer so quiet, so small, and so fast you could mistake it for a Diconix 150? When it's the new 300 Desktop printer or the 300w Wide-Carriage printer from Diconix. So before you select a PC printer, reflect on these.



**Distributors:**

Norbain Micro  
tel. (0734) 752201 fax. (0734) 867298

Softsel  
tel. (01) 568 8866 fax. (01) 840 7559

Systems Connections  
tel. (0628) 70912 fax. (0628) 784008

**DICONIX**  
A Kodak Company

Dayton, Ohio  
U.S.A.

- Semi-automatic paper handling
- 308 characters per second
- IBM & Epson emulation

# TAS-SPELL PC

## THE SPELLING CHECKER

Tasman Software Ltd and Longman Group UK Ltd

# TAS-SIGN PC

## THE SIGN MAKER

# TASWORD PC

## THE WORD PROCESSOR

# TASPRINT PC

## THE STYLE WRITER

# TASCOPY PC

## THE GRAPHICS PROCESSOR

Five powerful programs for the IBM PC and compatibles. Use the coupon below and send today for our free comprehensive brochure. Quality, performance and great value for money.

### TAS-SPELL PC

THE SPELLING CHECKER

Spelling mistakes and typing errors spoil any document. TAS-SPELL PC can check the spelling of TASWORD PC text at over 4000 words per minute.

TAS-SPELL PC includes a comprehensive dictionary of over 70,000 words provided under license from the Longman Group UK Ltd. You can add your own specialised words to the dictionary. The dictionary contents can even be displayed giving on-screen reference at the touch of a key!

£39.95

### TAS-SIGN PC

THE SIGN MAKER

Produce and print your own signs, posters, banners and large notices to get your message across with maximum impact.

Print across the paper in the usual direction OR along the length of the paper to produce large eye-catching banners and notices. Four distinctive lettering styles, in addition to italics, underlining, constant or proportional letter spacing. Characters can be printed at any height from less than one inch to the full width of the paper.

£39.95

### TASWORD PC

THE WORD PROCESSOR

Power and versatility combined with a remarkable ease of use. Whatever your needs, from a simple letter to a best selling novel, TASWORD PC can meet your requirements. Simply and efficiently.

Tasword PC combines a remarkable ease of use with a host of useful features: detailed on-screen help at the touch of a key, comprehensive print options, on-screen formatting, an indispensable range of text editing commands and even a built-in mail merge. Power, flexibility and ease of use combined into one program.

£29.95

### TASPRINT PC

THE STYLE WRITER

Give your dot matrix printer a new dimension of exciting capabilities. Print output from TASWORD or almost any other program in one of the distinctive TASPRINT typestyles. Ideal for notices, headings within documents, and for that special letter that must command attention.

TASPRINT PC drives all dot matrix printers with full bit image graphics capabilities to form, with a double pass of the print head, output in any of 25 distinctive fonts. The program also includes a font editor which you can use to create your own lettering styles.

£29.95

A complete graphics package for dot matrix printer owners. Edit and enhance screen copies and create your own diagrams and pictures. Capture copies of the screen while running almost any other program. Print diagrams and pictures from within Tasword and most other programs. Create your own lettering styles, formulae, symbols and logos to annotate your TASCOPY diagrams. The applications of this suite of programs are enormous — letter headings, logos, formulae, chemical structures, bar charts and graphs.

£39.95

Available from good stockists and direct from:  
DEPT. PCW, TASMAN SOFTWARE LTD., SPRINGFIELD HOUSE, HYDE TERRACE, LEEDS LS2 9LN. TEL: (0532) 438301.  
If you do not want to cut this magazine simply write out your order or brochure request and post to the above address.

All prices include VAT and post and packing.

Please send me your comprehensive brochures on your PC products.

I enclose a cheque/PO. made payable to TASMAN SOFTWARE LTD or charge my ACCESS/VISA number.....  
for the items marked below (tick box):

Expires: \_\_\_\_\_

TAS-SPELL PC £39.95

TAS-SIGN PC £39.95

TASWORD PC £29.95

TASPRINT PC £29.95

TASCOPY PC £39.95



Telephone ACCESS/VISA orders:  
LEEDS (0532) 438301.



Name: \_\_\_\_\_  
Address: \_\_\_\_\_

PCW/02/88

Overseas: The following distributors of Tasman products may be contacted for the address of local suppliers. Many products are supplied in translated form. FRANCE & SWITZERLAND: Semaphore Logiciel La Plaine CH 1283 Geneva. NORWAY: Kelydata Postboks 152, 1371 Asker. PORTUGAL: Informova Campo Grande 28 4 A 1700 Lisbon. NEW ZEALAND: Software Supplies, PO. Box 865 Christchurch. GERMANY: Profisoft Suhlhauser Str. 50/52 D 4500 Osnabruck. RSA: Spectra Rentals PO. Box 2733 Johannesburg. BENELUX: Filisoft PO. Box 1353 9701 B Groningen. DENMARK: Quicksoft Bakkegaard's Alle 9-11 DK-1804 Fredensberg C Copenhagen. AUSTRALIA: Dolphin Computers Unit 2, 7 Walham Street Artarmon NSW 2064.



# A NICE TOUCH



**Memory-Pro**  
 12 function keys  
 13 programmable soft keys  
 Diagonal cursor movement  
 Click On/Off key  
 Double zero key

## IBM PC/XT\* and AT\* plug compatible keyboards by **EECO**<sup>®</sup>

- Switch select between PC/XT and AT modes
- Conductive elastomer technology giving superior tactile response.
- Designed for volume data entry and increased typing speeds.
- Oversize 'reverse L' enter key that touch typists prefer.
- Four basic models: 84 key, 101 key, 102 key, and Memory-Pro. All available from stock in UK English, plus other European languages on request.
- Assembled in the USA and in the UK with a 12 months warranty (3 years on 101/102 key!).

\* Trade marks of the International Business Machines Corporation

**COMPETITIVE PRICING – PHONE 0767 292414**

**JMA (Sales), 18 Market Square, Sandy, Beds, SG19 1LA. Tlx 825266 Fax 0767 292470**

# Real Speech for your PC.

## The New **AUDIOCARD 300E**

*Record – Store  
 Play and Edit.*

Audiocard, a unique high quality speech recording and playback facility for PCs; 80 minutes of audio recording directly into a 10M byte memory with total user/program control. Graphics and/or text can be reinforced by interactive, synchronised audio.

Audiocard can also be operated as a background function of the application software, providing information independent of graphics and text.

Provide a cost-effective audio utility for your PC, which is not synthesised, but true voice reproduction.

### Features

- IBM PC & Compatibles' Interface
- High Quality Speech and Sounds
- Synchronisation with Graphics, Text
- Easy to use Recording Facility
- Background Operation
- Direct Memory Access (DMA)
- Software, Microphone and Loud-speaker included
- Supports Basic, Turbo Pascal, Assembler and 'C'

### Applications

- Interactive Training Program
- Schools and Universities
- Language Tuition
- Telephone Information
- Voice Therapy
- Security Systems
- Public Address/Information
- Office Dictation/Mailing
- OEM Products



**£299 + VAT**

For further details contact:

**AUDIOCARD SALES**

**STC MERCATOR, South Denes,  
 Gt. Yarmouth, Norfolk NR30 3PX.**

Telephone: 0493 844911

**AUDIOCARD 300E**

# DR SOLOMON'S £10 SOFTWARE

## DR SOLOMON'S DATA RECOVERY SERVICE

We can tackle anything!



FLOPPY  
HARD DISK  
CARTRIDGE  
TAPE

Phone us if you've lost data, and never assume we can't help you. We can do things you thought were impossible.

We can rescue data from hard disks, floppy disks, tapes and cartridges; whether they are formatted, corrupted have bad directories or even claim not to be there. Deleted files and directories are just routine. Parked head disks can be fixed.

Its not cheap, - but no fix no fee.

Phone for a quote. (0494) 728095

## DR SOLOMON'S ADVANCED PROGRAMMING SERVICES

Need a device driver?  
A printer emulator?  
A peripheral interface?  
Copy protection?  
Memory resident software?  
Bioses?

Anything that can be done, we can do, and a lot more besides.

Ring (0494) 724201 for a quote

- DOSMENU** A menu-driven front end for DOS, lets you choose any application (e.g. 123 or Word Star) or DOS command with a single key stroke command from a menu.
- UNDELETE** Lets you recover files that you have accidentally deleted from floppy or hard disk; also works in subdirectories. Works on all versions of DOS. £15
- PC-PRESTALK\*** A comms package; all speeds including 1200/75, and does Prestel graphic. £20
- REDIRECT\*** Lets you redirect printer output to a file.
- SIDELINE** Prints your wide spreadsheet printouts sideways. Needs IBM graphics printer or EPSON or compatible.
- BURN\*** Blanks the screen after a given time to prevent burn-in.
- QPRINT\*** Lets your printer run while you use your PC for other jobs.
- FASTHELP\*** You can design your own help screens, which are just a keystroke away, even when running a program. Also has cut-and-paste from one program to another.
- SNAPSHOT\*** Dumps the contents of a screen to a file.
- GRAFSHOT\*** Dumps the contents of a graphic screen to a file.
- IANKEY 1** Crash course in typing for beginners. £26
- IANKEY 2** Two fingers to touch typing conversion course. £26
- INDEX** Gives you a master list of all the files on all subdirectories, sorted alphabetically.
- QDEL** Quick deletion of files on a disk; you can use wild cards, and it will show you each file and ask for confirmation that you want it deleted
- ANTIVIRUS** Write Protects your hard disk. Makes it safe against computer virus. £10

- BUFF 128\*** Increases the type-ahead buffer from 15 to 128
  - FASTKEYS\*** Makes your keyboard repeat keys much faster. Speeds up moving around in spread sheets, word processors etc.
  - TYPEWRITER** Turns your computer into a typewriter. Works with all printers.
  - ENCRYPT** Encodes and decodes files with any length password up to 1024 characters, so they are useless without it. incorrect passwords are detected. Works on individual or multiple files.
  - LABELWRITER** Prints identical labels, using all Epson styles. Labels are any size, several across the page. Prints logos.
  - SEE\*** Displays a file on the screen, and lets you page up, down, right, left. Faster than TYPE
  - SUBSTLPT\*** Lets your parallel printer substitute up to 7 desired symbols for 7 unwanted ones. eg a \$ for a }
  - DEFTFILER** A Full-screen display of files and directories; tidy up your hard disk deftly instead of using complex commands
  - SOLID123** Consolidates many LOTUS 123 or SYMPHONY spreadsheets into a total. £15
  - ANOTHERDOS** Lets you run another copy of DOS whilst inside a program
  - C-COURSE** Teach yourself C with 'Carol Weaver's C course £15
- Special offer - C course plus C compiler - £39

189 PROGRAMS  
NOW AVAILABLE  
PLEASE PHONE FOR FREE  
CATALOGUE

**CHOOSE ANY FIVE  
FOR £40!** + VAT

£10 & £15 Programs only

**3 1/2 INCH DISK DRIVE?**  
All Programs  
are available on 3 1/2 inch  
disks -  
at no extra cost

**HOLDFAST**  
Backs up your data fast,  
at low cost and great  
convenience, using the  
diskette drive you  
already have. A daily  
back up takes about a  
minute and can be run  
with a one word  
command. £20.00



\* IBM's AND COMPATIBLES ONLY  
These programs cost £10.00 (except where stated) + VAT  
You can buy a package of any nine programs for £65.00 or any five for £40.00 This offer includes only our £10.00 and £15.00 programs.  
PLEASE ADD VAT TO ALL ORDERS

Send your orders to:  
S&S Enterprises, PC Division  
31 Holloway Lane, Amersham  
Bucks HP6 6DJ



**S&S ENTERPRISES (AMERSHAM) LTD. (0494) 724201 & 728095**



# Dan Technology Ltd

## I/O ADAPTERS

IO-1 4 Serial Ports Adapter (3 Optional, W/C).....	£34.00
IO-2 3 Serial Port Kit for IO-1.....	£26.50
IO-3 2 Serial Ports Adapter (1 Optional).....	£14.00
IO-4 2nd Serial Port Kit for IO-3.....	£7.00
IO-5 2 Serial Ports/1 Parallel (1 Port Optional, W/C).....	£27.00
IO-6 2nd Serial Port Kit for IO-5.....	£9.00
IO-7 Printer Adapter.....	£9.00
IO-8 Game Adapter.....	£11.00
IO-9 Multi Function I/O Adapter (W/C).....	£41.00
IO-10 Clock/RS232C Adapter.....	£24.00

## VIDEO ADAPTERS

Vid-1 Colour Graphics Printer Card.....	£30.00
Vid-2 Monochrome Graphics Printer Card.....	£33.00
Vid-3 Hega-II Card (Paradise Chip Set Autoswitch).....	£90.00
Vid-4 Hega-III Card (Autoswitch, 640x480, 132 col).....	£101.00
Vid-5 Paradise Ega Card Autoswitch.....	£102.00

## HARD DISKS

Hard-1 20MB + Controller Segate/Miniscribe.....	£198.00
Hard-2 20MB Segate/Miniscribe.....	£160.00
Hard-3 20MB Hardcard (Miniscribe).....	£248.00
Hard-4 30MB Hardcard (Miniscribe).....	£264.50
Hard-5 40MB + Controller (Miniscribe).....	£268.00
Hard-6 40MB (Miniscribe).....	£234.00

## DISK CONTROL CARDS

Dis-1 Hard/Floppy Disk Control Card for AT.....	£99.00
Dis-2 1.2MB/360KB Floppy Disk Controller for XT/AT.....	£31.00
Dis-3 360K Floppy Disk Control Card for XT.....	£13.00
Dis-4 Hard Disk Control Card for XT.....	£46.00

Tel: 01-961 6959. Fax: 01-907 1175  
Dealer Enquiries Welcome

# THE NEWEST FROM PROTECH

**THE NEWEST XT WITH "SI" 7.7**  
FASTER SPEED THAN AT AT ALMOST  
THE SAME PRICE AS XT

### PROTECH-286 XT

- 80286 HIGH SPEED OF SI 7.7,
- LANDMARK 8.8 MHz
- 80287 COPROCESSOR
- UP TO 1MB RAM ON BOARD
- 1.2 MI/360K FLOPPY DISK DRIVER
- USES XT ADD ON CARD
- 8 XT EXPANSION SLOTS
- LEGAL BIOS
- PARTITION 640K + 384K MEMORY
- ZERO WAIT STATE



### THE NEWEST 386 SYSTEM

- PROTECH-386 AT
- 16 MHz 80386 ZERO WAIT STATE 80287 OPTIONAL
  - CS8230 CHIPSET
  - P82C206 INTEGRATED PERIPHERALS CONTROLLER
  - 64KB EPROM
  - 2MB DRAM ON BOARD
  - 8 SLOTS (5 FOR AT, 3 FOR XT)
  - 12 IN x 13.75 IN (MINI TYPE)
  - POWER SUPPLY, KEYBOARD, BATTERY, SPEAKER, LED.
  - RUNS AT/XT SOFTWARE
  - PHOENIX BIOS



Specialize in Manufacturing

- 6/8/10 TURBO XT SYSTEM
- XT/AT ADD ON CARD
- 150W/200W POWER SUPPLY
- 6/10 6/12 TURBO AT SYSTEM ZERO WAIT STATE
- 1M OR 4M RAM ON BOARD EMS SET UP
- XT/AT MAIN BOARD
- 84/101 KEY BOARD

## PROTECH SYSTEMS CO., LTD.

559 YUNG CHI ROAD, TAIPEI, TAIWAN, R.O.C.

TELX: 14266 PROTEK FAX: 886-2-7560254 TEL: 886-2-7683173

# MICRO ECONOMICS

## LIMITED AVAILABILITY AT THESE PRICES

Epson PC AX40 640K RAM.....	£159	Stradcom V22 & Software.....	£150
Zenith Z181 Portable 2x720.....	£799	Pace Series 4 V21/V23.....	£185
Amstrad 1512 20Mb Colour.....	£699	Pace Series 4 V22.....	£275
Kaypro 386 40Mb HD 2.5 Ram, 16MHz, EGA and Monitor.....	£2995	Pace Series 4 V22bis.....	£350
Televideo 20Mb HD Mono, 256.....	£500	Racal 2123 Internal & Soft.....	£125
<b>OLIVETTI</b>		Unity Gold V21/23/22 + Datatalk.....	£295
M240 64Mb HD, Colour, Keyboard.....	£1590	Miracles WS4000 V21/23 ext.....	£125
M24 20Mb, Colour, Keyboard.....	£1395	Micom X25 pad.....	£350
Victor 286 70Mb, EGA, 40Mb tape EGA Monitor.....	£3195		
Acorn Electron Starter Pack.....	£95		
Ring for Compaq/Tandon/Toshiba/AST/NEC/Zenith/Apricot Models.....			
Multi-User Micros and Networking Please call for your requirements.....			
Xenix, PC/MOS 386/Quattro/Northstar.....			

<b>MONITORS</b>	
Genius A4 (736 x 1080).....	£995
Mitsubishi EGA.....	£395
<b>NEC Multisync</b> .....	£399
Princeton HX12E EGA.....	£300
Princeton HX12 RGB Hi-Res.....	£250
Princeton SR-12P.....	£395
Philips Multisync 14".....	£495
Philips CGA colour.....	£185
Taxan 620 12" RGB Hi-Res.....	£195
Thomson 4375M Ultrascan.....	£425
Viking 1 (1280 x 960).....	£1790
<b>Wyse 700 (1280 x 960)</b> .....	£625
Wyse 30 terminal.....	£199
Tandon EGA Colour.....	£325

<b>SOFTWARE</b>	
Chartmaster.....	£125
Signmaster.....	£110
Mapmaster.....	£195
Diagramaster.....	£135
Ability/plus.....	£50/£135
Amstrad Supercalc 3.1.....	£50
Amstrad Wordstar.....	£50
Account Ability.....	£65
Software Carousel.....	£25
Business Publisher.....	£150
<b>BOOKWORKER</b> .....	£90
Crostalk XVI.....	£95
Copy II PC.....	£30
Reflex.....	£60
Chitchat.....	£70
Datatalk.....	£85
Carbon Copy Plus.....	£95
Cardbox Plus.....	£195
Delta Professional.....	£300
Doodle Lazer.....	£350
Domino Professional.....	£650
<b>DBase III Plus</b> .....	£395
Davrelle.....	£295
Flight Simulator II.....	£35
EasyCAD.....	£90
Framework II.....	£295
Gem Collection.....	£70
Gem Draw +.....	£100
Generic CADD.....	£79
Javelin plus.....	£150
Lightning.....	£75
Lotus Manuscript.....	£199
<b>Lotus 123 V2.01</b> .....	£195
Lotus Freelance +.....	£230
Lotus Graphwriter.....	£200
Living C.....	£50
Dbase Programmers Util.....	£45
MS C Compiler.....	£200
Metro.....	£50
MS Windows + Paint + Write.....	£50
<b>MS Word v3.1</b> .....	£235
Norton Utilities/Advance.....	£50/£95
Page Maker.....	£395
Page Ability.....	£175
Portex (WP + Labelling).....	£75
Pegasus/Multi user.....	£160/£290
Paradox.....	£325
PC Paintbrush.....	£65
Publisher's Paintbrush.....	£165
Quicksilver-dBase Compiler.....	£200
Ready Set Go (Mac).....	£175
Sage Accountant.....	£120
Sage Payroll.....	£75
Samma Word IV.....	£300
Samma Plus IV.....	£350
Superkey.....	£40
Sidekick (unprotected) v1.5.....	£25
<b>Smart System V3.1</b> .....	£325
Supercalc 4.....	£185
Superproject +.....	£250
Statgraphics 2.1.....	£295
<b>Sage Financial Controller</b> .....	£195
Financial Controller (Ex-demo).....	£75
Sage Planner/Macro set.....	£90/£50
Sage Payroll.....	£65
Timeline Statistics.....	£45
<b>VCN Concorde</b> .....	£300
VP Planner.....	£55
Ventura.....	£425
Wordperfect Library.....	£75
<b>Wordcraft 3</b> .....	£275
Wordstar Prof (Apricot).....	£180
Wordstar 2000.....	£200
Wordperfect Mathplan.....	£75
Wordperfect v4.2.....	£235
Wordfinder (Spelling).....	£75
Xtree.....	£50
Zorland C.....	£30
Zorland C.....	£20
Ring for games and other software.....	

<b>PRINTERS</b>	
Apple Imagewriter.....	£200
Brother Twinwriter.....	£750
Epson LQ1000.....	£550
Epson EX1000.....	£495
Epson EX800 80 col, 300cps.....	£395
Epson LQ800 80 col, 180cps, 24pin.....	£450
Epson SQ2500 450cps.....	£900
Epson LQ2500 270cps 24pin.....	£700
Fujitsu DL2400 136, 220cps.....	£695
Infoscipe 1100 heavy Duty.....	£895
<b>Mannesman Tally MT85</b> .....	£275
Mannesman Tally 330 24pin.....	£995
Olivetti DM296/2.....	£350
Olivetti DM286.....	£285
<b>Olivetti DM800</b> .....	£795
Olivetti DM580.....	£495
Star NB24-10 80 col, 216cps.....	£399
Star NB24-15 136 col, 300cps.....	£499

<b>LASER PRINTERS</b>	
Canon LBP-8 A2.....	£2450
Centronics PP8.....	£1495
Epson GQ3500.....	£1375
ILaser plus 2Mb.....	£699
<b>QMS PS800 Postscript</b> .....	£2995
Ricoh Postscript 6.....	£2999
<b>SCANNER</b>	
Microtek MS300A + Interface.....	£1295

<b>PLOTTERS</b>	
HP 7475 A3, 6 pen.....	£1295
Hitachi 672 HP Comp, 6 pen.....	£399
Houston DMP42 A0.....	£4500
Roland DXY880 A3, 8 pen.....	£600
<b>Roland DXY885 A3, 8 pen</b> .....	£650
Roland DXY990 300mm/sec.....	£850
Roland DXY980 A3, 8 pen.....	£895
Roland DPX2200 A2 8 pen.....	£2395
Roland DPX3300 A1, 8 pen.....	£3295

<b>DIGITISERS &amp; MOUSE</b>	
Cherry A3 cursor, pen.....	£450
Calcomp 2200.....	£495
Kraft Joystick.....	£20
Logimouse.....	£75
MS Mouse Bus.....	£90
<b>Mamanger Mouse Serial</b> .....	£65
Summasketch 12 x 12.....	£350

<b>CARDS/ADDONS</b>	
1Mb hard disks from.....	£150
2Mb Memory card for PC/XT Dk.....	£125
2Mb Memory card for PC/AT Dk.....	£135
20Mb internal hard disk kit.....	£225
360k Floppy drives.....	£65
40Mb Internal tape streamer.....	£495
40Mb Internal hard disk kit.....	£395
64Mb HD Upgrade for Olivetti.....	£395
640k Memory Upgrade Card Dk.....	£50
64k/256k Ram Chips (each).....	£3/£8
<b>8087-5/8087-8</b> .....	£95/£125
Everex stream 20Mb external.....	£450
Everex stream 60Mb external.....	£695
Genoa Super EGA/PGA.....	£225
Hercules Graphics Card.....	£165
<b>Mountain 20Mb hard card</b> .....	£495
Orchid EGA card.....	£150
Plus hard card 20MB.....	£450
Quad EGA Prosync.....	£195
Seagate 40Mb upgrade kit.....	£399
Seagate 40Mb upgrade kit.....	£399
Talgrass internal 40Mb tape.....	£550
Video 7 Vega Deluxe.....	£195
Helit Disk box.....	£30
Maxell DC600 Data tape.....	£35
Nashau 3 1/2" DSDD.....	£20
Nashau 5 1/4" DSDD.....	£15
Nashau 5 1/4" DSDD.....	£25
Power & Keyboard lock.....	£15

<b>MODEMS</b>	
Dowty Quattro V21/22/22BIS.....	£550
Chitchat with V21/23 Modem.....	£250

<b>MODEMS</b>	
Dowty Quattro V21/22/22BIS.....	£550
Chitchat with V21/23 Modem.....	£250

IF YOU CANNOT FIND WHAT YOU ARE LOOKING FOR IN OUR LIST GIVE US A RING FOR THE MOST COMPETITIVE PRICES.

Terms: Cheque with order. Mail order only. All goods carry manufacturers warranty. All prices exclusive of VAT. Delivery (£10 per item). Government, Local Authorities, Universities, PLC and EXPORT orders are welcome. Limited availability at these prices. All software has UK licence.

SUITE 78, KENT HOUSE, 87 REGENT STREET, LONDON W1R 7HF  
01-391 4142

*What's the best buy in  
Personal computers  
for business?*

*What's the ideal  
software package?*

*Is it IBM  
compatible?*

*How much  
will it cost?*

*What  
about  
net-  
working?*

*Help!!*

*What about  
Desk-Top  
publishing?*

If you're in the dark about any area of business computing, you need Personal Computer World's 1988 Business Computing Survival Guide.

It takes an illuminating — and entertaining — look at the world of business computing, with in-depth reviews, comments and comparisons.

It's written by a hand-picked team of experts. And it'll set you back a mere £2.95.

So send off for your copy today. And see business computing in a new light.

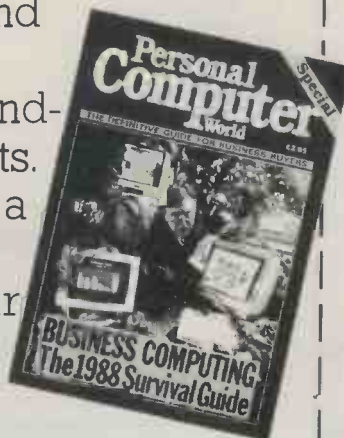

#### **PRIORITY ORDER FORM**

Please send me a copy of Business Computing — The 1988 Survival Guide costing £2.95. Simply complete this order form and return with your remittance to the address stated. No postage is required.

Please Tick

I enclose a cheque made payable to Personal Computer World for £2.95.

Please charge  Visa  Access  American Express

CARD NO:

EXPIRY DATE:

SIGNED

NAME

JOB TITLE

COMPANY

ADDRESS

Please send this order with your remittance to Personal Computer World, Subscription Dept, FREEPOST 25, 32-34 Broadwick Street, London W1E 6EZ.



# DO YOU HAVE A COLLEAGUE?

needing to use your PC at the same time as you

\*\*\*\*\*

By installing a PC SHARE Kit you can both run the same or different programs simultaneously. You can even share the data on your hard disk!

## £675

including Display and Keyboard will enable you to run Lotus 123, Pegasus, Wordstar plus many more programs on an AMSTRAD PC1512 or any IBM PC Compatible

## SAVTEC

Farnham (0252) 725507

Lotus 123, Pegasus, Wordstar, AMSTRAD and IBM are registered trademarks

dBASE III  
UTILITY

# ExpressBASE III

Only  
£60  
plus VAT

The dBASE Utility which cuts programming time and costs in half.

ExpressBASE III is the best dBASE utility available.

### Selected ExpressBASE III Features

- Batch process up to 250 programs
- Indents & debugs programs
- Program listings with line numbering
- Cross reference listings
- Multi-program string searching
- Multi-program string substitutions with conditions & audit trail
- Write dBASE programs 3 times faster
- Paint screens & reports

### Selected ExpressBASE Credits

<b>PRACTICAL COMPUTING</b>	"can do wonders for a dBASE programmer's productivity"
<b>PC USER</b>	"ease of use ..... good amount of function ..... excellent value for money ..... excellent"
<b>ASHTON-TATE QUARTERLY</b>	"this excellent program is worth the added effort of ordering from the publisher"
<b>SOFTWARE MAGAZINE</b>	"an excellent A5 manual makes getting to know the package an easy task"

Upward/downward compatible with all versions of dBASE III, dBASE III Plus, Clipper, FoxBASE +, and dBASE. Not copy protected. Site Licence

30 day money-back guarantee  
Free technical support service

For further information phone:

## 01-741 8632

dBASE Consultancy - £120 per day



Send your order to:  
Salamanca Software Limited, 64 More Close, St. Paul's Court,  
West Kensington, London W14 9BN

NEW  
LOW PRICES

# MicroCache

## ELECTRIFYING PERFORMANCE!

BOOST FLOPPY & HARD DISK SPEEDS UP TO 20 TIMES

The speed and performance of your computer system can now be dramatically and inexpensively increased by the amazing MicroCache software package. It's a 3-in-1 system which will accelerate not only the accesses to and from your disks, but also your printer and screen display. MicroCache is compatible with all leading software.

**DISK CACHE.** The world's fastest disk cache accelerator. Uses spare RAM (70K to 4Mb) to automatically hold frequently-used disk records ready for INSTANT access. SpeedWrite: Improves performance still further by writing to disk in the background while you continue with other tasks.

**SPEEDPRINT BUFFER.** Print-out and compute at the same time! Up to a breathtaking 2000 characters per second. Much faster than costly hard-

ware print buffers. Perfect for plotters, matrix, daisy wheel and laser printers

**SCREEN ACCELERATOR.** Many sluggish screen displays are transformed by this superb feature.

**RAVE REVIEWS**  
Practical Computing tested MicroCache and rated it "EXCELLENT"

**PRICES**

SpeedWrite Upgrade (for existing users)	£39 · VAT
Disk Cache	£69 · VAT
SpeedPrint Buffer	£69 · VAT
Cache + SpeedWrite	£99 · VAT
Cache + SpeedWrite + SpeedPrint	£149 · VAT

Use your ACCESS Card and order your MicroCache by phone NOW!

**FREE DEMO DISK!**  
IBM 5 1/4"  
Try MicroCache with YOUR system.

FREE Demo Disk by coupon only.

NAME COMPANY ADDRESS

TEL

Microcosm Limited Setting the pace.

26 Danbury Street, London N1 8JU, Tel: 01-226 9092 Telex: 94011285 COSM G.

# Semaphore cards

## For high quality and reliability.

### 2Mb EMS MEMORY CARD

Memory board for the PC AT offering upto 2Mb of Extended Memory and full compatibility with the Lotus/Intel Expanded Memory Specification

- ◆ 12MHz running speed
  - ◆ Extended or EMS memory selectable
  - ◆ Configurable start address at 512K, 1Mb, ... 16Mb
  - ◆ Software Zero K installed
- Add £90 for each 512K memory (120ns)

£149

2Mb Memory Card for the PC, XT available at £129

### 3Mb MULTIFUNCTION CARD

Multifunction card for the PC AT offering standard I/O functions and up to 3Mb of Extended Memory

- ◆ Fully socketed memory
  - ◆ Configurable start address at 256K, 512K, 1Mb, ... 16Mb
  - ◆ 1 serial port, 2nd optional
  - ◆ 1 parallel printer port
  - ◆ Game port
- Zero K installed
- Add £90 for each 512K memory (120ns)
- Add £15 for 2nd serial port

£175

### 4Mb MEMORY CARD

A short size card providing fully configurable standard I/O functions

- ◆ Short card 4 x 5"
  - ◆ Parallel printer port
  - ◆ One serial port, 2nd optional
  - ◆ Clock-calender with battery backup
  - ◆ Game port
- Add £15 for 2nd serial port

£69

### 1200/1200 MODEM SHORT CARD

Remarkable high performance half-size modem card

- ◆ CCITT V22/V21 Full Duplex and Bell 212A/103 compatible
- ◆ Software compatible with Hayes Smartcom II and AT command set
- ◆ Auto dial & Auto answer
- ◆ Selective COM1-COM4 port
- ◆ Built-in speaker
- ◆ Fail-safe line protection circuit

£99

Non Telecom approved.



### EGA MULTIMODE CARD

Powerful Multimode Graphics Short Card to satisfy all your display requirements

- ◆ Supports IBM EGA, CGA, MDA & Hercules displays
- ◆ Supports 640 x 400 CGA
- ◆ Supports 640 x 480 graphics on a Multisync monitor
- ◆ 132-column & PGA drivers
- ◆ 256K video memory
- ◆ Flicker free display

£129

### MULTI I/O CARD

Extended Memory card for the PC AT offering up to 2Mb on main board with a further 2Mb on piggyback board

- ◆ Configurable start address at 256K, 512K, 1Mb, ... 16Mb
  - ◆ Fully socketed memory
- Zero K installed
- Add £90 for each 512K memory

£175

### ETHERNET CARD

Intelligent High speed 10Mbits/sec Network Card with on-board 80186 processor

- ◆ Network technique: IEEE 802.3 CSMA/CD
  - ◆ Topology: distributed bus, baseband
  - ◆ 82586 LAN co-processor
  - ◆ Protocol is in the firmware
  - ◆ Power on diagnostic
  - ◆ NETBIOS level compatible
  - ◆ Network programs supported
- NetWare, PC-NET and MS-NET

£345

### MONO GRAPHICS SHORT CARD

High resolution graphics for your monochrome display monitor

- ◆ Short card 4x6"
- ◆ Text mode: 80x25
- ◆ Graphics mode: 720x348
- ◆ One parallel printer port
- ◆ Full compatibility with Hercules monochrome graphics card

£69

### COLOUR GRAPHICS SHORT CARD

Colour/Graphic Adaptor, fully compatible to IBM's

- ◆ Text mode: 40x25 80x25
  - ◆ Graphics mode: 320x200 2 colours
  - ◆ 640x200 4 colours
  - ◆ Composite video ports
- Add £10 for printer port

£59

### 384K MEMORY CARD

The cost effective solution for filling out the base memory on your PC, XT

- ◆ Short card 4x5"
  - ◆ Uses 64K and 256K chips
  - ◆ Configurable start address
  - ◆ High reliability
- 384K installed

£115

Other Cards in range

384K Memory Card + Multi I/O (XT) @ £175

Floppy Controller + Multi I/O (XT) @ £89

Hard Disk Controller (XT) @ £79

Hard/Floppy Controller (AT) @ £125

Multi Serial Card 4 port @ £119

Dual Serial Card RS422/232 @ £89

EGA Multimode Card 800x600 @ £165

We offer a full 12 months warranty and if you have any problems or questions you can call us for Technical Support.

Access & Visa accepted.

Please add VAT to all prices.

Carriage is free within mainland UK.

Call us for a catalogue of complete product range and further information.



## SEMAPHORE SYSTEMS LIMITED

7 Moreland Ct, Finchley Rd, London NW2 2PJ  
Tel: 01-435 6315/01-433 1255





# WEST ONE BUSINESS SYSTEMS

## NEW IBM Personal System 2 Available now Telephone for Demonstration

Model 30-021 with 20Mb Hard Disk, one 720k Floppy drive serial and parallel port, 640k memory, and enhanced keyboard.....	£1395
Model 50 10MHz 80286 Desk Top system with 20Mb Hard Disk, one 1.2Mb Floppy drive, serial and parallel port, 1Mb memory and enhanced keyboard.....	£2395
Model 60 10MHz 80286 free standing system with 44Mb Hard disk, one 1.2Mb Floppy drive, serial and parallel port, 1Mb memory and enhanced keyboard.....	£2295
For Model 80 prices please call 01-636 7142.	
IBM Mono Monitor 8503.....	£156
IBM Colour Monitor 8513.....	£460
IBM Colour Monitor 8512.....	£410
IBM DOS 3-3.....	£59

## LIMITED OFFER!

IBM ATX 80286 processor with 30Mb Hard disk, one 1.2Mb Floppy, serial and parallel port, 512k RAM,.....**£1995**

IBM XT286 80286 processor, with 20Mb Hard disk, one 1.2Mb Floppy drive, serial and parallel port, 640k RAM.....**£1545**

Up to 35% Discount on IBM ATX and 286 Systems!

Clearance prices on Olivetti, Apricot, Sperry and Sanyo Systems.

Telephone for details

**Authorised IBM DEALER**

## TRAINING AND INSTALLATION

Full onsite training and installation is available on all products. Ask us for a quotation! We also supply and install a range of Multi user and Network products including Xenix and Novell. Telephone for further details on 01-636 7142 or 01 323 2840.

### The Akhter P.C. IBM Compatible System

P.C. 1000 Single 360k floppy drive, 256k RAM.....	£495
P.C. 1500 Dual 360k floppy, 256k RAM.....	£595
P.C. 2000 Single 360k, 20Mb hard disk, 512k RAM.....	£795
P.C. 2500 Dual 360k, 20Mb hard disk 512k RAM.....	£849
P.C. 3000 Dual 720k-3.5" disk drives 512k RAM.....	£645
P.C. 3500 Single 720k-3.5" disk, 20Mb hard disk 512k.....	£829

Features 80286 Processor, 6/8/10 MHz speed. Switchable EGA, Colour, Mono or Hercules adapter card. Serial parallel, clock-calendar and light pen interface, 20Mb or 40Mb hard disk, 1Mb memory, 102 key enhanced keyboard. MS DOS, GW Basic. Complete with Monochrome monitor.

Prices from

**£1295**

### MONITORS

Philips 7513 IBM compatible Monochrome Monitor.....	£69
Philips 8833 IBM compatible Colour Monitor (Resolution 600x200).....	£225
Enhanced colour monitors.....	£329
New 14" flat screen amber.....	£109

### DISK DRIVES

20Mb hard disk and controller.....	£295
40Mb hard disk and controller.....	£420
360k 5.25" floppy disk drive.....	£82
1.2Mb 5.25" floppy disk drive.....	£109
720k 3.5" floppy disk drive.....	£112
Monochrome adapter Card.....	£72
Colour adapter Card.....	£72
640k Multi Function Card.....	£79
EGA Card.....	£195
3Mb AT Multi Function Card.....	£195

Call 01-636 7142 for more information on products

### PRINTERS

Superb range of High Quality Star and IBM Printers

Star NL10	
- 9pin, 120cps draft - 30cps NLQ 80 col.....	£199
Star LC10-120cps 80col, 8 res fonts.....	£159
Star ND 15	
- 180cps, 136 col, NLQ 45cps.....	£399
Star NX 15	
- 9in, as above but 132 col.....	£295
Star NR 15	
- 9pin, 240cps draft - 60cps NLQ 132 col.....	£495
Star NB 24/10	
24pin, 216cps draft - 72cps LQ 80 col.....	£475
Star NB 24/15	
24pin, as above but 132 col.....	£575
IBM Quietwriter	
Model III.....	£794
Cannon LBP8	
Laser Printer.....	£1695
Epson FX 1000	
200cps draft/40cps NLQ.....	£399
Hewlett Packard	
Laserjet II.....	£2095
Full range of Epson printer available - Telephone for details	

## NETWORKING NOW!

The new Akhter NET — featuring MS NET from Microsoft, Arcnet Interface cards. The Akhter AT File Server, complete with 5 terminals, Networking Software and full documentation.

**£5995 + VAT**

For free Site Survey and alternative configuration

Tel: 01-636 7142

## Desktop Publishing

A complete system including

- ★ 20Mb AT compatible system ★
- ★ Enhanced Graphics Monitor ★
- ★ New Cannon LBP Laser printer ★
- ★ A choice of Aldus Pagemaker or Ventura ★

Unbeatable price ★

**only £3995**

All prices exclude VAT. Visa and Access accepted. Prices exclusive of postage and packing. Price subject to change without notice. All goods subject to availability.

37 STORE ST. OFF TOTTENHAM COURT RD, LONDON WC1  
01-636 7142 or 01-323 2840 (4 lines)

Sanyo Special Offer

# Heart to heart

System to system compatibility with our AF Disc Drives

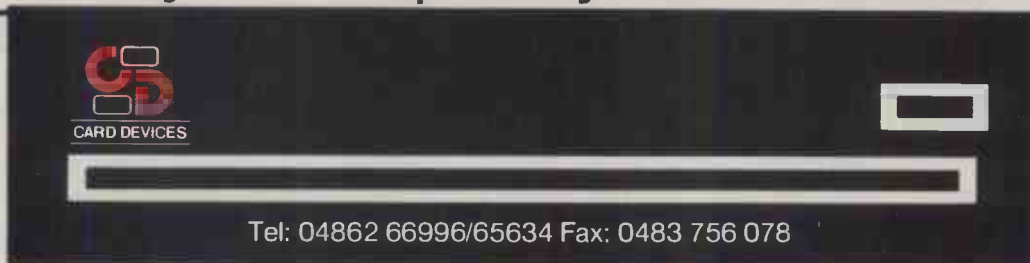

The increasing number of systems on the market has naturally increased the problems of data transfer between one system and another. Now you can solve those problems easily and simply with one of the Card Devices AF Disc Drive systems and achieve full compatibility between systems.

## IBM PC/AT (and clones) to PS/2-Amstrad Portable

**£295** AF300 PC 3.5" add-on disc drive for IBM PC giving data file compatibility with Apricot computers (720K).

**£295** AF300 AT 3.5" add-on disc drive for IBM giving data file compatibility with Apricot range of computers (720K).

**£250** AF300 PC/2 3.5" disc drive for IBM PC/AT for compatibility with IBM PS/2.

## 8" DRIVE SOLUTION

**P.O.A.** An add-on 8" drive connected to any IBM or IBM clone computer to read 8" disc formats including IBM 34, 36, 38, 8100, JACQUARD, DISPLAYWRITER, EBCDIC-ASCII, DEC PDP11, RX01 and many more.

Prices quoted do not include VAT and delivery.



## AMSTRAD 1512/1640 to PS/2-Apricot-Amstrad portable compatibility.

**£295** AF300 AMSTRAD 3.5" add-on disc drive for the Amstrad for reading and writing Apricot data files on Amstrad.

**£250** AF300 AMSTRAD PS/2 3.5" add-on disc drive for Amstrad to read and write IBM PS/2 - Amstrad Portable discs on Amstrad.

## APRICOT/SIRIUS to IBM PC/AT

**£295** AF500A 5.25" add-on disc drive for Apricot range allowing reading and writing of IBM PC/AT discs on Apricot PC/Xi/F Series.

**£295** AF500S 5.25" add-on disc drive for Sirius/Victor 9000 to read and write IBM PC/AT discs on SIRIUS/VICTOR 9000.

## IBM PS/2 to IBM PC/XT/AT

**£350** AF300 PS2 5.25" add-on disc drive unit for IBM PS2/30 to read and write IBM PC/AT discs on IBM PS/2.

**£450** AF300 PS2 + 5.25" add-on disc drive for IBM PS2/50/60/80 disks on IBM PS/2.

**XENOCOPY** A program to format, duplicate, read and write more than 300 formats including HP, DEC, SAGE, APRICOT, AMSTRAD, TOSHIBA and many more. Program operates on different disc drive sizes including 3", 3.5", 5.25" and 8".

**£350** AF300X 3.5" add-on disc drive for IBM PC/AT, Amstrad and IBM clones with Xenocopy enabling reading and writing of many 3.5" formats.

**£350** AF500X 5.25" add-on disc drive with Xenocopy for systems as above using 5.25 80 formats.

**£90** XENOCOPY software only on 5.25" disc to format, duplicate, read and write more than 300 different formats.

## PLUS! SUPER VALUE UPGRADES FOR APRICOT

£120 XM512K RAM card memory upgrade for PC Xi/F Series £150 XEN 512K RAM card memory upgrade for XEN and XENi  
20 MB WINCHESTER UPGRADE FOR APRICOT PC F SERIES £395 internal £495 external

## PLUS CARD DEVICES EXTRA SERVICES

### DISC DRIVE REPAIR FACILITY

For most manufacturers disc drives we offer a comprehensive repair service. 8" Drives - standard charge £40 + parts 5.25" Drives - standard charge £30 + parts. FULL RANGE OF SHUGART SPARES AVAILABLE.

### DISC COPY SERVICE

Disc copying service to required format. £10 per disk.

Card Devices Ltd,  
Unit 9, Padmores Yard, St. Johns,  
Woking, Surrey GU21 1SE.



CARD DEVICES



Tel: 04862 66996/65634 Fax: 0483 756 078



# NEW LOW PRICE ST!

## ST PRICE INCREASE

Due to a worldwide shortage of memory chips, prices of many computers have gone up. From April 1988, the Atari ST range is also likely to be affected. For details of any price increase, please return the coupon below for our latest literature.



## ONLY FROM SILICA

Finally, there's a personal computer that not only solves problems like other computers, but also solves the one problem that other computers have created. Affordability. Silica Shop are pleased to present the ST range of personal/business computers from Atari. The ST was designed utilizing the most recent breakthroughs in semiconductor technology, producing a personal computer that performs tasks with fewer parts. Which means it costs less to make. And less to buy. The latest ST computers now include built-in power supplies and built-in disk drives. The TOS operating system and GEM window environment are now on ROM chips which are already installed in the ST keyboard. This enables automatic instant booting when you switch on. Silica Shop are pleased to offer the complete Atari ST range. Our mail order department is situated in Sidcup and we have 3 retail outlets at Sidcup, Lion House (Tottenham Court Rd) and Selfridges (Oxford Street). We have eight years experience of Atari products, longer than any other UK company, and are well established as the UK's No.1 Atari specialist. With a group turnover of over £9 million and in excess of 80 staff, we offer you unbeatable service and support. We provide several facilities which you will find invaluable during your Atari computing life and most of these facilities are available ONLY FROM SILICA. We suggest that you read through what we have to offer, before you decide where to purchase your Atari ST.

### FREE STARTER KIT - Only From Silica

When you purchase any Atari ST keyboard, you will not only receive the best value for money computer on the market, but you will also receive the following from Atari Corporation as part of the package:  
 \* BASIC Language Disk \* BASIC Manual \* ST Owners Manual \* TOS/GEM on ROM  
 \* MEGACHROM Sampler - colour graphics program \* 1st Word - Word Processor  
 In addition, we at Silica would like to see you get off to a flying start with your new computer, so we have put together a special ST STARTER KIT worth over £100, which we are giving away FREE OF CHARGE with every ST computer purchased at our normal retail prices. This kit is available ONLY FROM SILICA and is aimed at providing users with a valuable introduction to the world of computing. We are continually upgrading the ST Starter Kit, which contains public domain and other licensed software, as well as books, magazines and accessories all relevant to ST computing. Return the coupon below for full details.

### DEDICATED SERVICING - Only From Silica

At Silica Shop, we have a dedicated service department of seven full time Atari-trained technical staff. This team is totally dedicated to servicing Atari computer products. Their accumulated knowledge, skill and experience makes them second to none in their field. You can be sure that any work carried out by them is of the highest standard. A standard of servicing which we believe you will find ONLY FROM SILICA. In addition to providing full servicing facilities for Atari ST computers (both in and out of warranty), our team is also able to offer memory and modulator upgrades to ST computers.  
**1Mb RAM UPGRADE:** Our upgrade on the standard Atari 520ST-M or 520ST-FM keyboard will increase the memory from 512K to a massive 1024K. It has a full 1 year warranty and is available from Silica at an additional retail price of only £86.96 (VAT = £100).  
**TV MODULATOR UPGRADE:** Silica can upgrade the 1040ST-F to include a TV modulator so that you can then use it with your TV set. This is an internal upgrade and does not involve any untidy external boxes. A cable to connect your ST to any domestic TV is included in the price of the upgrade which is only £49 (inc VAT). The upgrade is also available for early 520ST computers at the same price.

### THE FULL STOCK RANGE - Only From Silica

We aim to keep stocks of all Atari related products and our warehouse carries a stock of over £1/2 million. We import many software titles direct from the USA and you will find that we have new releases in advance of many of our competitors. Unlike dealers who may only stock selected titles, we have the full range. In addition, we carry a complete line of all books which have been written about the Atari ST. A range as wide as ours is something you will find available ONLY FROM SILICA.

### AFTER SALES SUPPORT - Only From Silica

Rest assured that when you buy your ST from Silica Shop, you will be fully supported. Our free mailings give news of releases and developments. This will help to keep you up to date with new software releases as well as what's happening in the Atari market. And in addition, our sales staff are at the end of a telephone line to service all of your Atari requirements. If you purchase an ST from Silica and would like any technical advice, we have a full time technical support team to help you get the best from your computer. Because we have both the staff and the systems specifically dedicated to providing after sales service on Atari ST computers, we are confident that our users enjoy an exceptionally high level of support. This can be received ONLY FROM SILICA.

### FREE CATALOGUES - Only From Silica

At Silica Shop, we recognise that serious users require an in-depth information service, which is why we mail free newsletters and price lists to our ST owners. These are up to 48 pages long and are crammed with technical details as well as special offers and product descriptions. If you have already purchased an ST, we would like to have your name added to our mailing list, please complete the coupon & return it to us. This information service is available ONLY FROM SILICA.

### FREE OVERNIGHT DELIVERY - From Silica

Most orders are processed through our computer within 24 hours of receiving them. Most hardware orders are sent by the overnight GROUP 4 courier service FREE OF CHARGE to customers within the UK. This method helps to ensure minimum delay and maximum protection.

### PRICE MATCH - Only From Silica

We hope that the combination of our low prices, FREE UK delivery service, FREE Starter Kit and FREE after sales support, will be enough to make you buy your Atari equipment from Silica Shop. If however, there is something you wish to purchase, and you find one of our competitors offering it at a lower price, then please contact our sales department, providing us with our competitor's name, address and telephone number. If our competitor has the goods in stock, we will normally match the offer (on a 'same product - same price' basis) and still provide you with our normal free delivery. We realise that we are not the only company who will match a competitor's price. However, if you come to us for a price match, you will also be entitled to our after sales service, including free newsletters and technical support. This makes our price match promise rather special, something you will receive ONLY FROM SILICA. We don't want you to go anywhere else for your Atari products. So shop at Silica, the UK's No.1 Atari Specialist.

# £260

+VAT=£299

## SO MUCH FOR SO LITTLE!

There is nothing that can compare with the incredible value for money offered by Atari's 520ST-FM. For only £260 (+VAT=£299), you can purchase a powerful 512K RAM computer, with a 95 key keyboard (including numeric keypad), MIDI interface, GEM, a palette of 512 colours, mouse controller, and a 512K built-in disk drive. The 520ST-FM has a TV modulator built-in, and comes with a lead to allow you to plug it straight into any domestic colour television set. The mains transformer is also built-in to the keyboard, so there are no messy external boxes. You couldn't wish for a more compact, powerful and stylish unit. Atari ST computers are now firmly established in the UK, there are nearly 500 software titles already available for a wide variety of applications and the list is growing all the time. And that's not all. When you buy your new 520ST-FM (or any Atari ST computer) from Silica Shop, you will get a lot more, including a FREE Silica ST Starter Kit worth over £100. Read the ONLY FROM SILICA section on the left, to see why you should buy your new high power, low price 520ST-FM from Silica Shop, the UK's No.1 Atari Specialists. For further details of the range of Atari ST computers and the FREE Silica ST Starter Kit, complete and return the reply coupon below.

**ATARI 520ST-FM NOW ONLY £260 (+VAT=£299)**  
 520ST-FM with 512K RAM & mono monitor £399 (inc VAT) Upgrade from 512K RAM to 1024K RAM £100 (inc VAT)

### ATARI 1040ST-F - NEW PRICE

We are pleased to announce a new reduced price point on the 1040ST-F which is now available for only £499 (inc VAT). The 1040 is a powerful computer with 1Mb of RAM and also includes a built-in 1Mb double sided 3 1/2" disk drive. The 1040 has been designed for use on business and professional applications most of which require a high resolution monochrome or colour monitor. It does not therefore have an RF modulator for use with a domestic TV set. Modulators can be fitted for £49 (inc VAT).  
 1040ST-F Keyboard - Without Monitor ..... £499 (inc VAT)  
 1040ST-F Keyboard + High Res SM125 Mono Monitor ..... £599 (inc VAT)  
 If you would like further details of the 1040ST-F, return the coupon below.

### MEGA ST's NOW IN STOCK

For the user who requires even more RAM than the 520 or 1040 ST's offer, the new MEGA ST computers are now available. There are two MEGA ST's, one with 2Mb of RAM and the other with a massive 4Mb. Both new computers are fully compatible with existing ST's and run currently available ST software. The MEGA ST's are styled as an expandable Central Processing Unit with open architecture and a detachable keyboard. They are supplied with GEM, a free mouse controller and all extras as with the 520 or 1040. Prices are as follows:  
 MEGA ST 2Mb Keyboard + CPU ..... £899 (inc VAT)  
 MEGA ST 2Mb Keyboard + CPU + SM125 Mono Monitor ..... £999 (inc VAT)  
 MEGA ST 4Mb Keyboard + CPU ..... £1199 (inc VAT)  
 MEGA ST 4Mb Keyboard + CPU + SM125 Mono Monitor ..... £1299 (inc VAT)  
 If you would like further details of the MEGA ST's, return the coupon below.



**SIDCUP (& Mail Order)** 01-309 1111  
 1-4 The Mews, Hatherley Road, Sidcup, Kent, DA14 4DX

**LONDON** 01-580 4839  
 Lion House (1st floor), 227 Tottenham Court Rd, London, W1P 0HX

**LONDON** 01-629 1234 ext 3914  
 Selfridges (1st floor), Oxford Street, London, W1A 1AB

To: Silica Shop Ltd, Dept PCW588, 1-4 The Mews, Hatherley Road, Sidcup, Kent, DA14 4DX

## PLEASE SEND ME FREE LITERATURE ON THE ATARI ST

Mr/Mrs/Ms: ..... Initials: ..... Surname: .....

Address: .....

Postcode: .....

Do you already own a computer  
 If so, which one do you own?



# PRINTOUT

ISSUE 2

FEBRUARY 1988



## NEXT ISSUE MAY 1988 APPLY NOW FOR YOUR COMPLIMENTARY COPY

1. Name \_\_\_\_\_

Job Title \_\_\_\_\_

Company Name \_\_\_\_\_

Company Address \_\_\_\_\_

\_\_\_\_\_

Postcode \_\_\_\_\_

Signed \_\_\_\_\_

2. Approximately how much does your company intend to spend on printers in the next 12 months?

Under £500    £500-£2,000    £2,000-£5,000

£5,000-£10,000    Over £10,000 please tick

3. I am involved in purchasing printers for my company. Please send me a complimentary issue of PRINTOUT May 1988

Date \_\_\_\_\_

Send to: PRINTOUT. VNU BUSINESS PUBLICATIONS FREEPOST 25, LONDON W1E 6EL.



# PREMIUM SERVICE

AT

# LOWEST PRICES



**HEWLETT PACKARD**  
Laser Jet/Series 2  
Laser Printer  
Our Price £1688.00

**KYOCERA F-2200**  
Laser Printer  
Our Price £3427.00



**MANNESMANN TALLY 910**  
Laser Printer  
Our Price £2175.00



**OLIVETTI PG208M2**  
Laser Printer  
Our Price £1570.00



### LASER PRINTERS

Brother Laser	£1765.00
H.P. Laser Jet 500 +	£2650.00
CANON LPB-8/Ser. 2	£1500.00
KYOCERA F1010	£2096.00
KYOCERA F2010	£3446.00
Toner Cartridge/A1	£66.50

CITIZEN & HERMES also available from stock

ALL PRICES EXCLUDE VAT & DELIVERY CHARGES. PRICES ARE CORRECT AT TIME OF GOING TO PRESS

### COMMUNICATION BOARDS

IRMA Board	£785.00
------------	---------

Other Comm. Boards also in stock.

### HARDCARDS & DISKS

PLUSCARD 20	£595.00
PLUSCARD 40	£821.00
MiniScribe 20	£245.00
MiniScribe 30	£285.00
Seagate 20MB Kit	£235.00
Seagate 40MB Kit	£345.00



NEC 20MB Kit	£245.00
NEC 40MB HardDisk	£365.00
I.O. Mega 10 + 10 Box	£1200.00
I.O. Mega 10MB Cartridge	£52.00
I.O. Mega 20MB Cartridge	£58.00

### GRAPHIC CARDS

Hercules Mono Plus	£155.00
Hercules Colour Plus	£285.00
Hercules Compatible Mono	£89.00
Paradise AutoSwitch EGA	£225.00
Sigma EGA Card	£135.00
Genoa Spectrum 4 Cards in 1	£185.00
Genoa Super EGA L3	£130.00
Genoa Super Hi-Res L5	£245.00

### ADD-ON BOARDS

MultiFuction 384K	£165.00
256K Ram Card	£85.00
384K Ram Card	£119.00
Maths Co-Pro.8087-5Mhz	£125.00
Maths Co-Pro.802878Mhz	£225.00
AST. Orchid Tech. Intel Etc.	

### PRINTERS

Citizen 120D	£165.00
Citizen MSP25	£405.00
Citizen Premier 35	£485.00
Epson LX800	£195.00
Epson FX1000	£410.00
Epson EX1000	£475.00
Epson LQ800	£456.00
Epson LQ2500	£750.00
Star NL-10 Parallel	£185.00
Star NX-15 Parallel	£325.00
Star NR-15	£485.00
Panasonic P1080	£180.00
Panasonic P1092	£284.00
Panasonic P1592	£365.00
Panasonic P1595	£477.50

### KEYBOARDS

Keytronics 5150 (83 Keys)	£130.00
Keytronics 5151 (99 Keys)	£195.00
EECO 8600 for AT/PC/XT (94 Keys)	£99.00

M240 2x360	£777.75
M240 360K - 20MB	£1129.50
M240 720K - 20MB	£1129.50
2" Hi-Res Mono Monitor	£180.00
102 Keys Keyboard	£120.00



**Olivetti M240**  
20MB, MSDOS, OGC/Mono  
and keyboard .....£1126

NEW M380C NOW IN STOCK!

Free software with M15 Olivetti Portable  
£625.00 Bookkeeper, Desk Set (Sage-  
soft), Able One (Concept Data), Portex  
(Showerings).

**COMPAQ PC Price Reduction**  
Please Call

### IBM PC

PC/XT 286-20MB	£1750.00
PC/ATX/30MB	£2250.00
PC Enhanced keyboard	£150.00
ProPrinter XL	£425.00
EGA Hi-Res Moitor	£485.00
PS/2 30-021	£1252.80
PS/2 50	£2136.00
PS/2 60-41	£3123.60

### MULTISYNC SPECIAL

NEC Monitor	£465.00
TAXAN 770 +	£550.00
SONY MULTISYNC	£635.00
EIZO 8086 FlexiScan	£495.00
IDEK Multiflat	£485.00
Cable for PS2 System	£15 extra

### AMSTRAD COMPUTERS

PC1512SD	PLEASE CALL FOR SPECIAL PRICE
PC1512DD	
PC1512HD 10Mb	
PC1512HD 20Mb	

Colour Monitor £175.00 extra

New PC1640 in stock.

All softwares available including SAGE  
Soft and others.

Please ring for quote.

### SOFTWARES

LOTUS, MICROSOFT, SAGE, MICRO-  
PRO, BORLAND, ASHTON-TATE  
DIGITAL RESEARCH ETC.

### MODEM CARD

Special Modem for Amstrad PC1512	£129.00
Dowty Quatro Card V22 bis	£635.00
PC Com Quatro Card	£635.00
Miracle Tech WS4000	£150.00
Thorn EMI VX524	£380.00

### TAPE BACK-UP

Maynard 20Mb Portable	£450.00
Maynard 60Mb Portable	£750.00
Maynard 20MN Internal	£420.00
Maynard 60Mb Internal	£720.00

Also stock MOUNTAIN, EVEREX,  
IRWIN.

## KIRIN COMPUTING SYSTEMS LTD,

Unit 69, Abbey Business Centre, Queenstown Road, London SW8 3NS.

Tel: 01-720 7722 Fax: 01-627 4667

# KIRIN



HEWLETT  
PACKARD



CITIZEN

Canon

AMSTRAD



**olivetti**  
PERSONAL  
COMPUTER





# Shoot for Quality Aim for Ling Yih



Golden Wing assists you in the PC world, with quality, delivery, service and price, contact us today for more information.

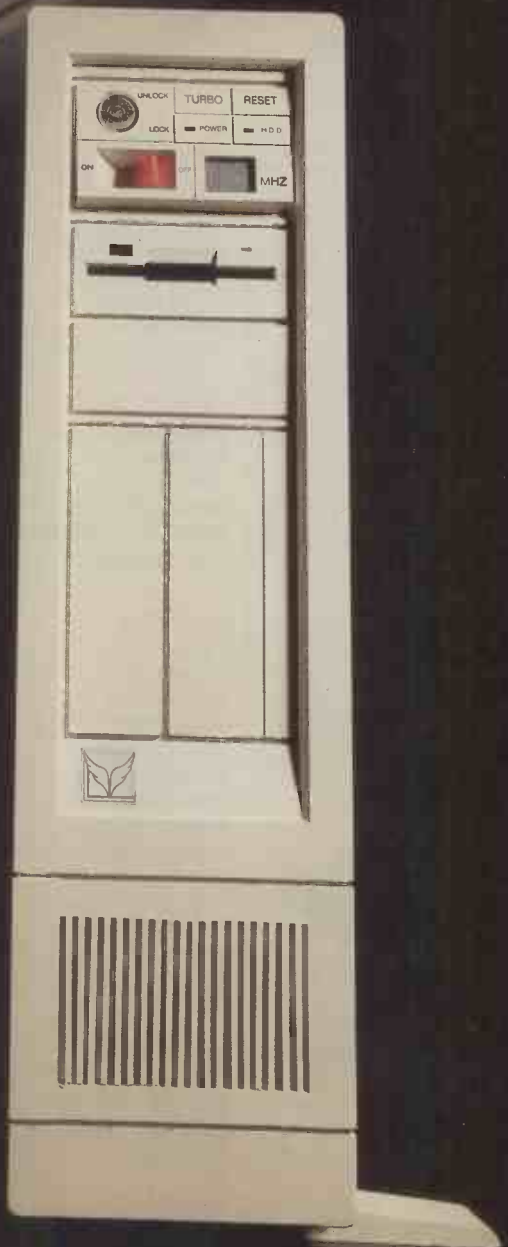

LING YIH

**LING YIH CO., LTD.**

9F-3 #57 Fu-Hsing N. Rd., Taipei, Taiwan, R.O.C.

TEL: (02) 771-7166 TLX: 20232 LINGYIH FAX: (02) 711-3506

• IBM is the registered trademark of International Business Machine Corp.



## THE INSTITUTION OF ANALYSTS & PROGRAMMERS



An association which is widely recognised and respected, endorses the status of its members, protects and promotes their interests, assists their careers and encourages their ethical standards is the foundation of every profession.

With members in over sixty independent countries and states the Institution of Analysts & Programmers is the leading association for English-speaking programmers and systems analysts in the Free World. It is also the most highly regarded supplementary association for practising accountants, actuaries, bankers, doctors, designers, engineers, lawyers, lecturers, managers, mathematicians and scientists who use, develop and organise systems analysis and computer programming as a significant part of their professional undertakings.

\* \* \* \*

A guide to the requirements and gradings of membership is available, free of charge, upon request to the Applications Officer either by letter or telephone.

01-898 2385

The Institution of Analysts & Programmers  
GIBSON HOUSE, FOURTH CROSS ROAD, TWICKENHAM  
MIDDLESEX, TW2 5EL, ENGLAND

## If you need any of these:

- Real-time Multitasking
- Interactive Debugging
- Modular Programming Support
- Language Extensibility
- 8087 Floating Point Support
- Windows and Graphics
- Asynchronous Communications
- On-line Documentation Aids
- Additional Cross Compilers for:  
68000, 8086, 8080, Z80, 64180,  
8031, 6809, 6303, 1802, NC4016  
6502, H400

Then you need:

## MODULAR FORTH

Call MPE now:

(0703) 631441



Microprocessor Engineering Limited  
133 Hill Lane  
Southampton  
SO1 5AF

## IBM COMPATIBLE GRAPHICS PRINTER

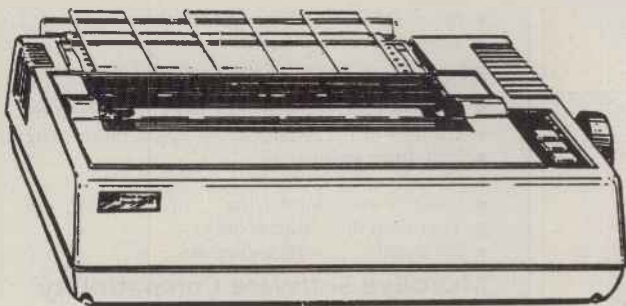

Amazing value Tecnova 777 dot matrix printer, indistinguishable from the IBM Graphics printer. 80 cps print speed with full graphics capability and IBM character set. Supplied with tractor feed, paper separator, mains lead and manual. Parallel interface. Brand new, boxed and guaranteed. **£99.99**  
Mail order available.

### Morgan Computer Co.

64-72 NEW OXFORD STREET WC1. 01-255 2115  
179 TOTTENHAM COURT ROAD W1. 01-636 1138

Phone with Access or Visa number for immediate dispatch. VAT extra

# SURIPACE

*Typesetting  
Design & Artwork  
Data Capture*

## MILTON KEYNES' FIRST DESKTOP PUBLISHING BUREAU

Full Desk Top Publishing output to Linotronic 300  
Image Setter from Apple Macintosh and  
IBM compatibles of all software generating Postscript  
Fast turnround · Full Adobe Font Library  
Modem Services · Electronic Mailbox

Contact Iain Harper at

**SURIPACE LIMITED**  
27 DARIN COURT, CROWN HILL  
MILTON KEYNES MK8 0AD  
TELEPHONE: (0908) 565007  
FAX: (0908) 568512  
ELECTRONIC MAIL: 81:TWHI 70

# MICROEYE

## FULL COLOUR VIDEO CAPTURE CARD

The MicroEye Video Capture Card is a low cost capture device for use with IBM PC, XT, AT or compatible microcomputers. The card captures full colour graphics which can be displayed on an EGA or a MCGA graphics screen.

The MicroEye card is supplied with software utilities which enable images to be formatted, accessed by software running under PC DOS and merged with text.

The MicroEye Colour card opens up your personal computer to a wealth of applications such as picture databases for estate agents, product design, point of sale display, personnel recording, image transmission or simply for capturing images from a video stream. The output from the MicroEye software can be configured for use with PCPaint, GEM, or for the Concorde presentation package.

The ability to capture a 24 bit deep colour image also makes the MicroEye card ideal for image analysis applications.



Camera Format Save Files Load Files Digithurst Ltd.

.PCX  
.IMG  
Byte Map  
Screen Dump  
Text  
Composite

Camera Format Save Files Load Files Digithurst Ltd.

.PCX  
.IMG  
Byte Map  
Screen Dump  
Text  
Composite

Camera Format Save Files Load Files Digithurst Ltd.

Make Text Window  
Make Image Window  
Show Image  
Show Text



### MicroEye Card

- A multiplexed 8 bit flash A to D convertor
- DMA transfer
- 3xone and a half second capture time in RGB mode
- Standard PAL video input
- Single PC, AT slot card

### MicroEye Software

- Libraries accessible from C language routines
- Utility routine callable from applications programs
- Pull down menus
- Camera setting utilities
- Image formatting facility
- Text field definition facility
- Relocatable graphics window

### MicroEye Software Compatibility

Images can be output to a variety of PC based packages in the following formats:-

- PCX Format
- GEM Format
- VCN Concorde Format
- Byte Mapped Image
- EGA Screen Dump

Prices from £495 + VAT

\* IBM is a trademark of International Business Machines

\* Concorde is a trademark of VCN

\* Gem is a trademark of Digital Research

# DIGITHURST

DIGITHURST LTD,  
7 Church Lane,  
Royston, Herts SG8 9LG

Tel: 0763 42955

Telex: 818451 DHURST G



# Astonishing storage from Fujitsu



Trust Fujitsu!

For astonishing high performance combined with miraculous capacity, take a look at Fujitsu's range of storage products – you won't believe your eyes.

Fujitsu offers a complete range of state-of-the-art Winchester disk drives from the 3½ inch 51 megabyte through to the compact 8-inch 1 gigabyte. Fujitsu's technological wizardry combines compactness and economy with much higher capacity and performance.

Just about the only feature that shouldn't surprise you is their reliability (MTBF in excess of 30,000 hours, with

no preventive maintenance, and a MTTR of under 30 minutes). Fujitsu customers expect absolutely no hocus-pocus from the most respected computer maker in Japan.

For further details of what Fujitsu could conjure up to make your business run more smoothly, fill in the coupon below or call sales on 01-573 4444.

**FUJITSU** Japan's No. 1 computer maker  
 Fujitsu Europe Ltd., 2 Longwalk Road, Stockley Park, Uxbridge, Middlesex UB11 1AB. (01) 573 4444



Please send me further information on the following (TICK APPROPRIATE BOXES)

WINCHESTER DRIVES

FLOPPY DRIVES

TAPE DRIVES

OPTICAL DRIVES

Send to: Fujitsu Europe Ltd., 2 Longwalk Road, Stockley Park, Uxbridge, Middlesex UB11 1AB.

Name \_\_\_\_\_

Title \_\_\_\_\_

Company \_\_\_\_\_

Address \_\_\_\_\_

City \_\_\_\_\_

TEL: \_\_\_\_\_ FAX \_\_\_\_\_

# ADVANCE TECHNOLOGY FOR TODAY AND TOMORROW

## 32 bit Computer



## ASI 386A SUPER FAST

80386 CPU 20/16MHz  
 1Mb on Ram Card (exp to 10Mb) 80NS  
 8 expns, Parallel Serial Ports  
 Ext keyboard, 14" Mono Monitor  
 1 x 1.2Mb FDD  
 1 x 40Mb (28M/S) HDD  
 1 x 44Mb (25M/S) HDD  
 1 x 70Mb (28M/S) HDD

**£2340**  
**£2415**  
**£2585**



## ASI XT Workstation (4kgs)

8088-1 CPU 10MHz  
 640k Ram 1 expansion, Parallel  
 Serial Port, 84 key keyboard,  
 Monochrome Monitor  
 1 x 720k FDD  
 2 x 720 FDD

**£395**  
**£450**

## ASI 386x'

80386 CPU 16MHz  
 1Mb Ram, 120NS  
 8 expansions, Parallel Serial Ports  
 Ext Keyboard, 14" Mono Monitor  
 1 x 1.2Mb FDD. 1 x 720k FDD  
 1 x 40Mb HDD (28M/S)  
 1 x 44Mb HDD (25M/S)

**£1875**  
**£1945**

## ASI XT

8088-1 CPU 10MHz  
 640k Ram 8 expansion, Parallel  
 Serial Games Port, extended keyboard,  
 12" flat screen mono monitor,  
 1 x 360k FDD  
 1 x 30Mb HDD (67M/S)

**£425**  
**£650**

## ASI AT

80286 CPU 12MHz  
 640k Ram, 8 expansion Parallel  
 Serial Port, extended keyboard,  
 12" flat screen mono monitor  
 1 x 1.2Mb FDD  
 1 x 720k FDD 3.5"  
 1 x 20Mb HDD (67M/S)  
 1 x 40Mb HDD (60M/S)  
 1 x 40Mb HDD (28M/S)

**£995**  
**£1075**  
**£1195**

## ASI XT286

As ASI XT but with additional 80286 CPU  
 1 x 30Mb HDD (67M/S)

**£795**

## SYSTEM UPGRADES

CGA System  
 EGA System  
 Multi-Sync  
 2Mb Exp Board for XT with OK Ram  
 2Mb Exp Board for AT with OK Ram  
 2Mb Exp Board for 386 with OK Ram

**£150**  
**£275**  
**£395**  
**£80**  
**£85**  
**£105**

### ★ ★ NETWORKING ★ ★

Starter kit for 2PCs **£425**  
 Additional Stations **£185**



**UNBEATABLE PRICES  
 FOR ADDON AND  
 ACCESSORIES**

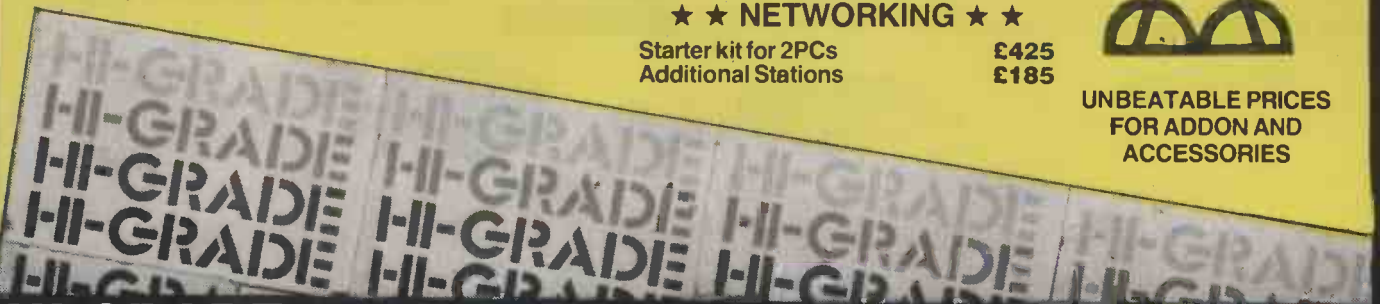

## HI-GRADE

COMPUTERS LTD  
 13 KENTISH TOWN ROAD  
 LONDON NW1 8NH

Tlx 262563 XENON

Tel: 01-482 4024  
 01-267 6138

PRICES EXCLUSIVE OF VAT



# Sanyo MBC 775

## Portable PC Compatible £495

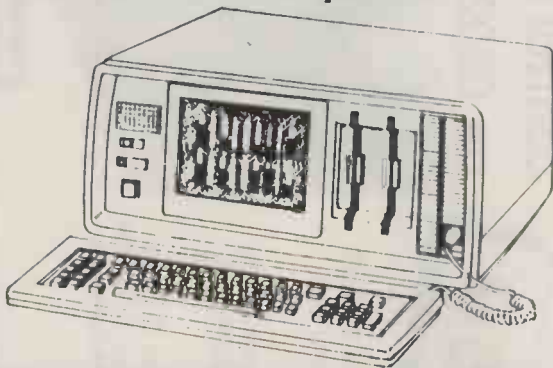

### Including "famous name" bundled software suite

Feature packed portable IBM compatible computer, switchable 8" colour display, two 360k floppy disk drives, 256k RAM, 8088 processor with 8MHz clock speed, twin full size expansion slots. Runs Lotus 1-2-3 and Microsoft's Flight Simulation. With MS-DOS, full bundled "household name" wordprocessor, spreadsheet, database, GW-BASIC and extensive documentation. Brand new, limited supply.

## Morgan Computer Co.

64-72 NEW OXFORD STREET, WC1. 01-255 2115  
179 TOTTENHAM COURT ROAD, W1. 01-636 1138

## N. A. SOFTWARE LIMITED

Advanced Tools for Scientists and Engineers.  
We specialise in scientific PC software.  
What we sell, we use ourselves.  
What we use, we can really support.

ADVANTAGE 2.0 A validated Ada compiler from Meridian Software, 640K ram and hard disk required (plus maths processor for numerical work). Including DOS environment and utility package. **£800**

ADASTARTER compiler, as above, but with limitations on the number of library units and statements in a compilation unit. **£150**

ARTEK/ADA Ada on a micro in 512K ram and two 360K floppies. No hard disc required. **£350**  
(Demo system) **£ 20**

ADA SCIENTIFIC LIBRARY Covers the main areas of scientific and numerical computing. Basic functions, complex numbers, random numbers, linear equations, sorting, etc. **£120**

CATALYST Memory resident Ada encyclopaedia and reference manual. **£640**

ALGOL 68 From *Algol Applications*, a powerful and elegant language. As easy to use as Basic, otherwise infinitely superior. (Interactive version) **£175**  
(Interactive + Batch) **£350**

ALGOL 68 MINI LIBRARY Twenty routines in *Algol Applications* Algol 68. Integration, linear algebra, random numbers, linear programming and sorting. **£ 50**

FS-FORTRAN77 An excellent version of this most popular scientific language, with graphics routines (CGA/EGA) included. **£ 35**

CHIWRITER A full mathematical word processor. What you see on your screen is what you get on your printer. EGA/CGA, most 9 pin printers. (24 pin and Laser printer support available.) **£ 69**

Prices are for single machine usage. Other prices on request. Educational Discount on most items. Please add 15% VAT and £3 p+p (£5 for multiple items and outside U.K.)

Call or write for further information.

**N. A. Software Limited**  
(Numerical and Computational Consultants)  
Merseyside Innovation Centre, 131 Mount Pleasant,  
Liverpool L3 5TF Tel: 051 708 0123

DEALER ENQUIRIES WELCOME

Ada is a registered trade mark of the U.S. Government AJPO.

## WHOLESALE DISK PRICES



- ◊ 3.5" D/S D/D 135 tpi
- ◊ Add 1p per disk for labels
- ◊ Fully Guaranteed.
- ◊ Minimum order is ten
- ◊ 82p (200-500)
- ◊ 80p (over 500)
- ◊ Top Quality unbranded.

### U.K.'s LOWEST PRICES



- ★ 5.25" D/S D/D 48 tpi
- ★ Fully Guaranteed
- ★ Incl. Sleeve/Label/Tab !
- ★ Top Quality unbranded
- ★ Minimum order is 25
- ★ 28p (300-600)
- ★ 25p (over 600)

ALL PRICES INCLUDE VAT AND DELIVERY !

No Quibble refund or exchange if you are not 100% satisfied  
Don't let the price put you off - top quality. Why pay more?  
Become another of our regular customers now...

**CHEVRON ELECTRONICS LTD**  
PO BOX 24, HORNCURCH, ESSEX, RM12 6LY  
Telephone (04024) 55453

Callers are welcome by appointment. Trade and Educational Establishments supplied.  
Cheques and Postal Orders payable to 'Chevron Electronics Ltd.' please.  
Post & Package free only to UK and BFPO.  
Prestel Mailbox :219997149 Telex 265871 MONREF G (Ref: 72:MAG40440) Fax 04024 59835

## We've got you covered with Seal 'n' Type



- \* Protective keyboard cover through which you can type freely & easily.
- \* 24-hour dust/spill cover.
- \* Removable, washable, re-usable.

**£10.55**

Patent & registered design pending

### Screen 'n' View £14.50

- Superior anti-glare VDU filter.
- Ultra-fine framed mesh. Velcro fittings.
- Available for mono or chromo.

### Plonker Box £4.99

- Working disc holder.
- Plonk your discs out of harm's way.
- Holds all standard sizes of discs.

### Data Switch Box £26.95

- \* Provides easy switching of data from PC to 2 outlets: printers/micros/modems.
- \* No more constant plugging and unplugging. Cables £5.75 each.

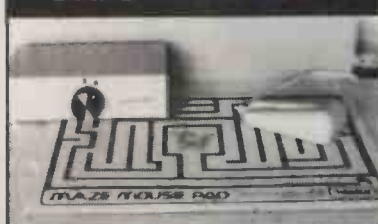

### Kador Mouse Pad £5.95

- Prolongs life of your mouse & protects work surface.
- Generous size (34x29cm).
- Anti-friction, anti-static.

SEND FOR OUR CHRISTMAS CATALOGUE

Cheques/P.O. payable to KADOR, UNIT 18 ABERMAN

Prices are fully inclusive INDUSTRIAL ESTATE ABERDARE MID GLAM

**kador**

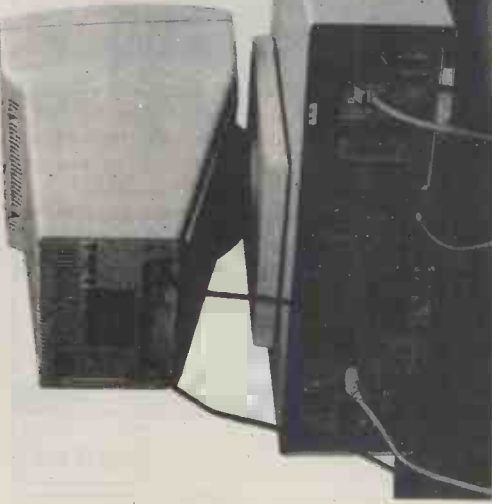

# X-BUFFER FROM MICRO CONTROL SYSTEMS FOR ALL THOSE WHO'VE GOT BETTER THINGS TO DO WITH THEIR PC THAN WAIT FOR THEIR PRINTER

Imagine you've got a 30 page report on your PC. The average printer will take about 17 minutes to print out, during which time your PC is either completely incapacitated or operating far slower than usual.

So, what can you do?

With the MCS X-Buffer, lots.

**WHY THE PROBLEM?**

A printer operates at a slower rate than a computer, forcing the PC to wait whilst the printing job is completed. And with a plotter producing a complex CAD schematic, that could be several *hours*, not minutes. Fine if you've got time to waste — but most of us haven't.

**WHAT IS THE X-BUFFER?**

X-Buffer is an intermediate storage device that acts as an extension to the computer's own memory. It allows text or data to be downloaded in seconds and 'held' in the buffer ready to be fed to the printer at the correct rate.

So there's no waiting for printing to finish, the PC is free to be used for other tasks.

In the case of your 30 page report, downloading to the X-Buffer would take around 28 seconds, leaving you 16½

minutes to get on with something far more constructive.

**VERSATILITY**

Until recently printer buffers had to be specified according to the type of PC and the printer used and the interfaces each had. The X-Buffer is designed for maximum flexibility and incorporates four interfaces: RS232 Serial i/o and Centronics parallel i/o.

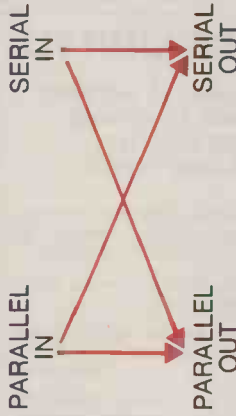

The interfaces can be used simultaneously so the buffer can be used in a variety of ways. Two computers sharing one output device (printer, plotter, modem). One computer driving two devices. Two computers using two devices.

**EXPANDABILITY**

The X-Buffer is also easily expandable by the user, plug-in memory modules offering from 64K to 4 Mbytes of buffer memory.

That's not only good news for users but great news for dealers too — instead of holding large stocks of varying fixed capacity buffer units, the X-Buffer modules allow custom configuration depending on the users' needs.

**EXTRAORDINARY VALUE**

And the price of the X-Buffer is probably the best feature.

**X**buffer  
FROM  
**£159**

The 64K basic unit costs a mere £159 RRP including a standard two year parts and labour warranty.

X-Buffer from Micro Control Systems. Don't let your printer (or plotter or modem) keep you waiting.

The X-Buffer is just one of a range of buffer products manufactured and supported in the U.K., available from Micro Control Systems.

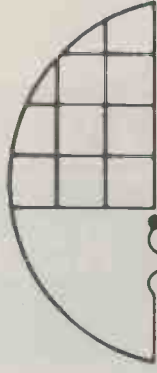

**micro**  
control systems

on 0602 391 204

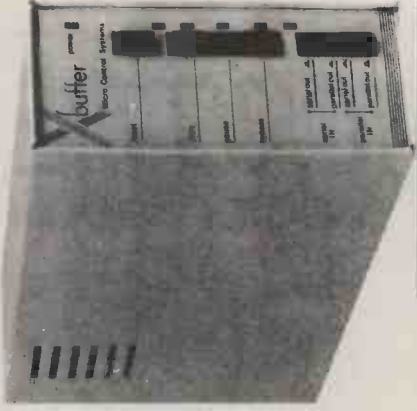

**Micro**  
Peripherals Ltd

**Northamber**

**Westwood**  
Distribution



## PRICES & DELIVERY

Prices do not include VAT or other local taxes but do include delivery in UK and Europe. Please check prices at time of order, ads are prepared some weeks before publication.

This page lists some of our products. Call us for a complete price list.

Order by phone with your credit card.

## LINKERS

Latest version Link and Locate supports Microsoft C v5.

Plink-86 Plus v2.24	MS-DOS	£285
Link & Locate v3.2d	MS-DOS	£265
Plink-II	CP/M-80	£315
SLRINK (Z80)	CP/M-80	£ 45
SLRINK-PLUS (Z80)	CP/M-80	£150

## PROGRAM EDITORS

Kedit and Norton are new to us. So many good editors, spoilt for choice.

BRIEF v2	PC-DOS	£140
EC Editor v2.1	PC-DOS	£ 40
Epillon v3.2	PC-DOS	£105
Lattice CVUE	PC-DOS	£ 95
FirstTime for Pascal	PC-DOS	£180
FirstTime for Turbo-P	PC-DOS	£ 55
Kedit v3.53	PC-DOS	£ 75
Norton Editor V1.3	PC-DOS	£ 80
PC VI	PC-DOS	£105
Pmate PC v4	PC-DOS	£105
RED v6.6 (with C source)	PC-DOS	£ 65
XTC (with Pascal source)	PC-DOS	£ 69
Vedit-Plus v2.03	PC-DOS	£105
CSE (with C source)	MS-DOS	£ 75
MIX Editor	MS-DOS	£ 20
Pmate 86 v4.00	MS-DOS	£105
Vedit-Plus	MS-DOS	£105
Vedit-Plus	CP/M-86	£120
CSE (with C source)	CP/M-80	£ 75
MIX Editor	Z80 + CP/M-80	£ 25
Red v6.6 (with C source)	CP/M-80	£ 65
Vedit-Plus v2.33	CP/M-80	£110

## PASCAL LIBRARIES

Most Turbo Pascal libraries have not yet been updated to work with the new v4. Please call us for advice.

### TURBO PASCAL LIBRARIES

Blaise Power Tools Plus	PC-DOS	£ 65
Blaise Turbo Asyn.Plus	PC-DOS	£ 80
Mathpak 87 (TP3)	MS-DOS	£ 60
Paragon Supertools	PC-DOS	£ 65
RM Graph Nimbus +	MS-DOS	£ 49
Science & Eng.Tools	MS-DOS	£ 50
Report Builder	MS-DOS	£ 70
System Builder	MS-DOS	£ 90
Turbo Halo Univ.Graph.	PC-DOS	£105
T-Debug Plus v2	PC-DOS	£ 35
Turbo Database	CP/M & MS-DOS	£ 45
Turbo Editor Toolbox	PC-DOS	£ 45
Turbo Extender	PC-DOS	£ 55
Turbo Gameworks	PC-DOS	£ 35
Turbo Graphix Toolbox	PC-DOS	£ 49
Turbo Advantage (Lader)	MS-DOS	£ 60
Turbolink Plus v3.15A	PC-DOS	£ 60
Turbopower Utilities	PC-DOS	£ 60
Turbo Optimiser	PC-DOS	£ 45
Turbo Professional	PC-DOS	£ 45
Turbo Screen	CP/M, MS, PC-DOS	£ 60
Turbo Tutor	CP/M & MS-DOS	£ 29
TurboWINDOWS/Pasc. (TP)	PC-DOS	£ 55

## ASSEMBLERS

The new OS/2 version of Macro-86 should now be in stock.

2500AD 8086 Asm.	MS-DOS	£ 75
Dig.Res. RASM-86	MS-DOS	£180
MS Macro-86 v5.0	MS-DOS	£ 90
Phoenix PASM-86	MS-DOS	£115
Phar Lap 386	MS-DOS	£415
2500AD 8086 Asm.	CP/M-86	£ 75
Dig.Res. RASM-86	CP/M-86	£180
2500AD Z80 ASM	CP/M-80	£ 80
Dig.Res. RMAC	CP/M-80	£180
Microsoft Macro-80	CP/M-80	£ 60
SLR Z80ASM	CP/M-80	£ 45
SLR Z80ASM-PLUS	CP/M-80	£175
SLR MAC	CP/M-80	£ 45
SLR MAC-PLUS	CP/M-80	£175
SLR 180 (Hitachi)	CP/M-80	£ 45
SLR 180-PLUS (Hitachi)	CP/M-80	£175

## ADA COMPILERS

AdaVantage v2 now validated by American Department of Defence.

AdaVantage v2	PC-DOS	£ 700
Artek Ada v1.25	MS-DOS	£ 350
JANUS/Ada C-Pack	MS-DOS	£ 65
JANUS/Ada ED-Pack	MS-DOS	£ 285
JANUS/Ada D-Pack	MS-DOS	£ 825
JANUS/Ada S-Pack	MS-DOS	£2890
Augusta (with source)	CP/M-80	£ 75
JANUS/Ada C-Pack	CP/M-80	£ 80
JANUS/Ada D-Pack	CP/M-80	£ 260
Supersoft Ada	CP/M-80	£ 250

## DISK COPYING SERVICE

We can copy files to and from 400 disk formats including CP/M, CP/M-86, MS-DOS, PC-DOS, ISIS APPLE, SIRIUS, BBC, TORCH, APRICOT, HP15 TRSDOS, DEC RT-11, IBM BEF, ATARI520, AMSTRAD.

Our charge is £10.00 + disk + VAT with discounts on small quantities and disks are normally despatched within 24hrs of receipt.

For more information call us.

### GENERAL PASCAL LIBRARIES

Blaise Tools (s'ce) (MS)	PC-DOS	£ 85
Blaise Tools 2 (s'ce)	PC-DOS	£ 80
Blaise Asynch (s'ce) (MS)	PC-DOS	£120
Btrieve	(MS) PC-DOS	£160
MetaWINDOWS	(MS) PC-DOS	£110
Halo	(MS) PC-DOS	£175
Blaise View Mngr.	(MS) PC-DOS	£205
Shark database (Propas)	MS-DOS	£250
Prospect v2	(Pro) MS-DOS	£ 80
Panel (Screen)	(MS) MS-DOS	£205
Shark database (Propas)	CP/M-86	£250
Prospect Graphics (Pro)	CP/M-86	£ 80
Shark database (Propas)	CP/M-80	£150

## PROLOG LANGUAGE

Arity Standard	PC-DOS	£ 7
Arity Prolog v4.0	PC-DOS	£285
Arity Interpreter+Compil.	PC-DOS	£630
LPA PROLOG Prof. Int. v1.5	MS-DOS	£265
LPA Micro-PROLOG v3.1	MS-DOS	£ 75
Prolog-86 v2.01	MS-DOS	£115
Prolog-2 Personal	PC-DOS	£145
Prolog-2 Programmer	PC-DOS	£495
Prolog-2 Professional	PC-DOS	£995
Turbo-Prolog v1.1	PC-DOS	£ 60
ADA Educ.Prolog	MS-DOS	£ 45
ADA FS Prolog	MS-DOS	£ 55
ADA VMI Prolog	MS-DOS	£ 85
ADA VML Prolog	MS-DOS	£165
Prolog-1 v2.2	CP/M-86	£299
LPA Micro-Prolog v3.1	CP/M-86	£ 75
LPA Micro-prolog v3.1	CP/M-80	£ 60
Prolog-1 v2.2	CP/M-80	£225

## BASIC LANGUAGE

The OS/2 version of Quickbasic should be in stock by now.

### BASIC INTERPRETERS

BBC Basic (86)	PC-DOS	£ 95
Professional BASIC	PC-DOS	£ 70
TrueBasic v2.0	PC-DOS	£ 70
Microsoft MS-BASIC	MS-DOS	£210
MEGABASIC v5.2	MS-DOS	£235
Dig.Res. CBASIC	CP/M-86	£290
MEGABASIC	CP/M-86	£235
MEGABASIC	MP/M-86	£365
BBC BASIC	Z80+CP/M-80	£ 95
Dig.Res. CBASIC	CP/M-80	£130
Microsoft MBASIC	CP/M-80	£ 75
MEGABASIC	CP/M-80	£195

## PROGRAMMING TOOLS

Ada Compilers	Algol Compilers
Assemblers	Assembler Libs.
Basic Compilers	Basic Interpreters
Basic Utilities	Basic Libraries
BCPL Compilers	C Compilers
C Interpreters	C Libraries
C Utilities	Cobol Compilers
Comms Libraries	Cross Assemblers
Database Libs.	Debuggers
Dis-assemblers	Editors
Engineers Libs.	Expert Systems
Forth	Fortran Compilers
Fortran Libraries	Graphics Libraries
Icon	Linkers
Lisp	Modula-2
Nial Interpreters	OPS 5
Pascal Compilers	Pascal Libraries
Prolog	Rexx
Screen Libraries	Smalltalk
Snobol	

We stock many items for which there is no space in these advertisements.

## MODULA-2 COMPILERS

New Farware compiler. FTL is an excellent value learning tool.

Pecan P-Sys. w.Mod-2	PC-DOS	£ 80
Farware Modula-2	MS-DOS	£ 70
FTL Modula-2 (sml.mem)	MS-DOS	£ 45
FTL Modula-2 (lge.mem)	MS-DOS	£ 55
Interface M2-SDS	PC-DOS	£ 75
Interface M2-SDS-XP	PC-DOS	£185
Mod-2/86 Compiler pack	PC-DOS	£ 58
Mod-2/86 Dev.system	PC-DOS	£145
Modula Corp.PC Mod.2	PC-DOS	£150
FTL Modula-2	Z80/CP/M-80	£ 45
Hochstrasser Mod.2	Z80/CP/M-80	£100
Turbo Modula-2	Z80/CP/M-80	£ 50
Modula-2 (Mod S/W)	ATARI 520ST	£ 75
MacModula-2 v4.1	MACINTOSH	£100

Library source is available with some compilers. Please enquire about other utilities available.

### BASIC COMPILERS

Microsoft QuickBASIC v4	PC-DOS	£ 60
Softaid MTBASIC	PC-DOS	£ 60
Turbo Basic	PC-DOS	£ 60
ZBASIC v4	PC-DOS	£ 69
Microsoft MS-BASIC	MS-DOS	£235
Dig.Res. CBASIC	MS-DOS	£390
Dig.Res. CBASIC	CP/M-86	£390
Dig.Res. CBASIC	CP/M-80	£395
ZBASIC	Z80+CP/M-80	£ 75
Softaid MTBASIC	Z80+CP/M-80	£ 60

### LIBRARIES & UTILITIES

#### Database

CADSAM (source code)	MS-DOS	£ 75
Btrieve	MS-BASIC + MS-DOS	£160
Btrieve/N	MS-BASIC + MS-DOS	£380
Multikey	MS-BASIC + MS-DOS	£145
T.Basic database libx.	PC-DOS	£ 65
CADSAM (source code)	CP/M-80	£ 75

#### Graphics

Enhanced Graph.Tlkt QB +	MS-DOS	£145
Halo	MS-BASIC + MS-DOS	£175
GSS Graph.Dev.Tkt	PC-DOS	£305

#### Sundries

Finally Quickbasic +	PC-DOS	£ 70
PANEL Screen Manager	MS-DOS	£ 80
Wiley Scientific Lib.	PC-DOS	£ 90
Screen Sculptor QB +	MS-DOS	£ 90

#### Tuning & Debugging

Betatools Dev.System	PC-DOS	£100
Vicar	MS-DOS	£ 45

# GREY MATTER

4 Prigg Meadow, Ashburton, Devon TQ13 7DF.  
TEL. (0364) 53499

4 Prigg Meadow, Ashburton, Devon TQ13 7DF.  
TEL. (0364) 53499

4 Prigg Meadow, Ashburton, Devon TQ13 7DF.  
TEL. (0364) 53499





## PROGRAMMING TOOLS

Ada Compilers	Algol Compilers
Assemblers	Assembler Libs.
Basic Compilers	Basic Interpreters
Basic Utilities	Basic Libraries
BCPL Compilers	C Compilers
C Interpreters	CLibraries
CUilities	Cobol Compilers
Comms Libraries	Cross Assemblers
Database Libs.	Debuggers
Dis-assemblers	Editors
Engineers Libs.	Expert Systems
Forth	Fortran Compilers
Fortran Libraries	Graphics Libraries
Icon	Linkers
Lisp	Modula-2
Nial Interpreters	OPS 5
Pascal Compilers	Pascal Libraries
Prolog	Rexx
Screen Libraries	Smalltalk
Snobol	

We stock many items for which there is no space in these advertisements.

## DISK COPYING SERVICE

We can copy files to and from 400 disk formats including CP/M, CP/M-86, MS-DOS, PC-DOS, ISIS, APPLE, SIRIUS, BBC, TORCH, APRICOT, HP15 TRSDOS, DEC RT-11, IBM BEF, ATARI520, AMSTRAD.

Our charge is £10.00 + disk + VAT with discounts on small quantities and disks are normally despatched within 24hrs of receipt.

For more information call us.

## THE C LANGUAGE

Microsoft C OS/2 version should be in stock and also OS/2 tools for High C.

### C COMPILERS

Aztec C Personal 1.06D	CP/M-80	£120
Aztec Commercial 1.06D	CP/M-80	£200
BDS C 1.60	Z80 + CP/M-80	£ 65
Eco-C v3.48	Z80 + CP/M-80	£ 50
Hi-Tech C	Z80 + CP/M-80	£ 99
Mix C	Z80 + CP/M-80	£ 35
Toolworks C/80 v3.2	CP/M-80	£ 45
Advantage C++	MS-DOS	£440
Aztec C86 Professional	MS-DOS	£120
Aztec C86 Developer	MS-DOS	£185
Aztec C86 Commercial	MS-DOS	£285
CI C86 Plus	MS-DOS	£290
CI Optimizing C86	MS-DOS	£230
De Smet C Starter	MS-DOS	£ 85
De Smet C Programmer	MS-DOS	£125
De Smet C Enhanced	MS-DOS	£165
De Smet C Professional	MS-DOS	£200
ECO-C88 V3.22	MS-DOS	£ 50
HIGH C (Metaware) v1.4	MS-DOS	£415
HIGH C 386 v1.3	MS-DOS	£575
Hi-Tech C	MS-DOS	£115
Lattice C v3.21	MS-DOS	£215
Mark Williams LETS C v4	MS-DOS	£ 60
Microsoft C v5.1	MS-DOS	£260
Microsoft Quick C v1.0	PC-DOS	£ 60
MIX C	MS-DOS	£ 29
Turbo C v1.5	PC-DOS	£ 65
Toolworks C v3.2	MS-DOS	£ 45
Zortech C v2	PC-DOS	£ 29
Zortech C Power Pack v2	PC-DOS	£ 59
Zortech C Optim. (for v2)	PC-DOS	£ 29

Aztec C86 Developer	CP/M-86	£250
Aztec C86 Personal	CP/M-86	£150
CI Optimizing C86	CP/M-86	£270
De Smet C Starter	CP/M-86	£ 85
De Smet C Programmer	CP/M-86	£125
De Smet C Enhanced	CP/M-86	£165
Hi-Tech C	CP/M-86	£115
Lattice C v1.04	CP/M-86	£260
HIGH C (Metaware)	Flex OS 286	£415
Aztec C65 V1.05	Apple DOS	£195
Aztec C65 V3.20	Apple PRO-DOS	£250
Aztec C68 Commercial	MACINTOSH	£28
Aztec C68 Developer	MACINTOSH	£185

### DATABASE

Btrieve v4.10	MS-DOS	£160
Btrieve/Multi user	MS-DOS	£380
Btrieve/Network	MS-DOS	£380
XQL	PC-DOS	£380
CBTREE (source any C)	£ 80	
C-Index/Plus (source any C)	£175	
C-ISAM (L,MS)	MS-DOS	£210
C-to-dBase (source CI)	MS-DOS	£120
C-tree (source any C)	£230	
R-tree	MS-DOS	£175
db-VISTA v2.x (most C's)	MS-DOS	£135
db-VISTA v2.x (with sce)	MS-DOS	£340
db-VISTA v2.x multi-us.	MS-DOS	£340
db-QUERY v1.x single-us.	MS-DOS	£135
db-QUERY v1.x sngl. (sce)	MS-DOS	£340
Lattice dBCII (L)	MS-DOS	£160
Lattice dBCIII (L,MS)	MS-DOS	£160
SftFcus Btree&Isam (sce any C)	£ 80	
Virtual Memory File Man.	PC-DOS	£150

### GRAPHICS

Enhanced Graphics Tlkt	PC-DOS	£145
Essential Graphics	PC-DOS	£145
GFX Graphics	PC-DOS	£ 50
GraphiC v4.0 (CI,L,DS,MS)	PC-DOS	£255
GSS Kernel	PC-DOS	£305
GSS Lattice Binding	PC-DOS	£110
GSS Graph.Tlkt (L,MS,+)	PC-DOS	£305
GEM Prog.Toolkit (L)	PC-DOS	£405
GSX Prog.Toolkit (DR)	PC-DOS	£270
HALO (AZ,CI,L,MS,T)	PC-DOS	£175
MetaWINDOWS (CI,L,MS,T)	PC-DOS	£110
MetaWINDOWS Plus	PC-DOS	£155
Turbo WINDOWS/C (Turbo)	PC-DOS	£ 55

### C CROSS COMPILERS

We supply Aztec, Lattice, IAR and Hi-Tech Cross Compilers hosted on MS-DOS and targeted on Z80, 8085, 6502, 6801, 68HC11, 6301, 8051 and 68000. Please call for information or advice.

### C INTERPRETERS

Latest v3.00 of C-terp has improved debugging facilities.

C-terp V3	PC-DOS	£180
Interactive C	PC-DOS	£195
Introducing C	PC-DOS	£ 85
Living C-personal	PC-DOS	£ 60
Living C Plus	PC-DOS	£135
Instant-C v2.2	MS-DOS	£380
RUN/C	MS-DOS	£ 60
RUN/C Professional	MS-DOS	£110

## PASCAL LANGUAGE

We should now have the new Microsoft Pascal v4 with OS/2 support.

ALICE Pascal Intrprtr.	PC-DOS	£ 80
Dr Pascal Interpreter	MS-DOS	£ 39
Marshall Pascal v2.01	MS-DOS	£150
Metaware Prof.Pascal	MS-DOS	£415
Metaware Prof.Pas/386	MS-DOS	£575
Microsoft Pascal v3.32	MS-DOS	£180
Mystic Pascal v1.6E	PC-DOS	£ 29
Oregon Pascal-2	MS-DOS	£280
Prospero Pascal v3.12	MS-DOS	£240
Prospero Pascal for GEM	MS-DOS	£ 75
Turbo-Pascal v3	MS-DOS	£ 60
Turbo-Pascal v4	MS-DOS	£ 69
Pecan P-Sys w.UCSD Pas.	IBM-PC	£ 80
Pecan P-Sys Pascal Prof.	IBM-PC	£155

### SCREEN & WINDOWS

Blaise View Mngr. (s'ce)	PC-DOS	£245
Curses Screen Mngr. (L)	PC-DOS	£120
Entelekon Windows (s'ce)	PC-DOS	£ 99
Multi-windows (MS,L)	PC-DOS	£220
Panel Plus (source)	PC-DOS	£270
Vitamin C (source)	PC-DOS	£130
Windows for Data (most)	PC-DOS	£200
Windows for C (most C)	PC-DOS	£135
Greenleaf DataWindows	MS-DOS	£ 90

### GENERAL FUNCTIONS

C-Worthy Int.Lib (L,MS)	MS-DOS	£180
Greenleaf (source)	PC-DOS	£ 85
G'leaf C Sampler (TC,QC)	PC-DOS	£ 65
Smorgasbord (source)	PC-DOS	£130
Blaise Tools Plus (sce)	PC-DOS	£ 80
Blaise Tools Plus/5.0	PC-DOS	£ 80
Blaise Turbo C Tools	PC-DOS	£ 80
Blaise Light Tools (ZOR)	PC-DOS	£ 65
ESI Utility Lib (source)	PC-DOS	£105
Entelekon Funct (source)	PC-DOS	£ 95
Phoenix Pforce (source)	PC-DOS	£205
Phoenix Pforce C++ (sce)	PC-DOS	£220
Pro-C (most C)	PC-DOS	£720
Security Library object	MS-DOS	£ 95

### COMMS LIBRARIES

Blaise Asynch (source)	PC-DOS	£115
Essential Comms (L,MS,T)	PC-DOS	£110
Greenleaf Comms (source)	PC-DOS	£ 85
Multi Comms (L,MS)	PC-DOS	£120

### SCIENTIFIC LIBRARIES

Wiley Scientif.Lib.v2	ANY C	£145
Mathpak 87 (L,MS)	MS-DOS	£ 80

### PROGRAMMERS UTILITIES

PC-Lint v2.13	MS-DOS	£ 80
Pre-C (Phoenix Lint)	MS-DOS	£175
C-Documentor	PC-DOS	£355
C-Scan	PC-DOS	£355
C Toolset	MS-DOS	£ 90
Lattice Cross Ref.	MS-DOS	£ 40
Lattice Text Utilities	MS-DOS	£ 85

### REAL TIME & MULTI-TASKING TOOLS

Csharp (CI,L,MS) s'ce	MS-DOS	£445
Concurrent C (PC/MPX) sce	MS-DOS	£ 60
Multi C (L,MS,CI)	PC-DOS	£110
Multiforms (L,MS)	PC-DOS	£125
Op.Sys.T'box (MS) s'ce	PC-DOS	£ 69
Timeslicer v3.01 (L)	PC-DOS	£155
Timeslicer v4.01M (MS)	PC-DOS	£165

## PRICES & DELIVERY

Prices do not include VAT or other local taxes but do include delivery in UK and Europe. Please check prices at time of order, ads are prepared some weeks before publication.

This page lists some of our products. Call us for a complete pricelist.

Order by phone with your credit card.

# GREY MATTER GREY MATTER GREY MATTER

4 Prigg Meadow, Ashburton, Devon TQ13 7DF.  
TEL. (0364) 53499

4 Prigg Meadow, Ashburton, Devon TQ13 7DF.  
TEL. (0364) 53499

4 Prigg Meadow, Ashburton, Devon TQ13 7DF.  
TEL. (0364) 53499

There's a story going round about IBM's negotiations with the Taiwanese over the licensing of its Micro Channel Architecture technology. The story is that IBM is asking the Taiwanese for a royalty of one per cent on all machines sold *back-dated to cover all the XT's and AT's the Taiwanese have ever made.* We know this can't be true. As far as we know, IBM doesn't have such a developed sense of humour...

IBM isn't the only company protecting its company reputation. Adobe, which is known for developing the page description language, PostScript, and the typeface processing that goes behind it, might well be expected to be particularly fussy about its own corporate image. But this time its gone over the top. We've received a 12-page booklet which goes into amazing detail. 'PostScript will give you greater printing versatility' is wrong, whereas 'A PostScript interpreter will give you greater printing versatility'. Never use PostScript — sorry, Post-SCRIPT® — as an adjective, possessively or without invoking the name of the great god Adobe — sorry, **ADOBÉ**.

Amstrad got hot under the collar with a dealer advertising low-cost second drives for Amstrad PCW machines. Amstrad claimed that the dealer could not be selling genuine FD4 drives as they were being priced too cheaply. Amstrad didn't realise that the dealer's source of cheap drives had dried up and it was selling genuine Amstrad drives instead...

Some computers' real-time clocks haven't reacted too well

to the leap year. One we came across didn't recognise 29 February as a valid date and skipped straight to 1 March from the 28th...

Prestel had better stick to electronic communication. The February issue of its magazine which arrived early in March contained a letter from Customer Relations chap, Dave King. 'I hope this edition arrives on your doormat or desk in time for Valentine's Day,' it said. Well, at least he's early for next year...

The latest Micronet ad shows an Amstrad PC user accessing the system which is represented by an assortment of colourful youths spilling out of the screen onto the desk. Not that it's an Amstrad colour screen, but a Taiwanese ADC monitor. Wonder where they put the power supply...

If you're going to use flattery to gain editorial space, it must at least contain a glimmer of truth. No chance, then, for Manor Micro Systems Centre which sent us details of its training schemes. Apart from questioning the usefulness of a training company that hasn't yet worked out how to get its laser printer to produce a '£' sign, we were a little unconvinced by the statement that 'your training diary is being used and appreciated by your readers.' PCW doesn't carry a training diary...

You probably remember the *Monty Python* sketch about Eric the half-bee. Fleet Street Publisher has come up with a parallel. At one point in the manual you are instructed to give the mouse a 'half-click'. We'll leave you to work out what it means...

Appropriate misprints

bedevilled Migent's launch of its Emerald Bay database. The best of them concerned 'divers applications'. A new trend in underwater software?...

I suppose we're spoiled in the computer world. After all, when you've finished with a floppy disk you can erase the files and use it again. And, if it's been on the shelf for a while and has been corrupted, you can always reformat it. Clearly, those operating in the less electronic world of office stationery have been jealously eyeing up this recyclability of computer media. So enter Emerson, a company offering to 'reformat' your envelopes. Actually, what they will do is revive the gum or self-seal adhesive on envelope stocks that have gone stale on the shelf. Now, if only they'd come up with a means of refixing sprocket edges that have come adrift from listing paper...

For under £20, Eclipse Software in Pelsall will sell you a disk containing 100 form letters. You know the sort of thing: 'Dear Blah, We are pleased to inform you that you



are one of 10,000 people in your Blah Street specially chosen to be eligible to win prizes worth Blah million pounds. The order form for our thermal underwear is enclosed... My favourite is a set titled respectively: *Overdue payment complaint, gentle; Overdue payment complaint, 2nd reminder; and Overdue payment, more forceful reminder.* I couldn't find the last one: *Overdue payment complaint, we're sending the boys round...*

## This Month



With 386 machines flooding in, it's been a difficult task deciding which ones to review in PCW. The Mission (review, page 96) is clearly the fastest one we've seen yet and we expect that more manufacturers will start easing the bottlenecks which make many 80386-based machines behave like Ferraris stuck in an M25 traffic jam. It is a sobering thought, though, that 386 machines are still far more expensive in the UK than they need be. The Zenith Z386-40, also reviewed in this issue, costs nearly £5000. Ads in US magazines show it available for *half* the price. £2500 buys a lot of air travel...

The Hewlett-Packard DeskJet printer reviewed on page 108 is one of the most exciting products I've seen for quite some time and brings laser quality within many more users' reach.

This month sees some personnel changes. Stephen Applebaum has relinquished his 'Screenplay' slot to devote more time to his college work. His place is being taken by PCW's editorial assistant, Chris Cain, who will continue Steve's tradition of reviewing the most innovative games being launched each month. Technical editor Owen Linderholm has now left both PCW and the UK for the hub of the computer world — California. Owen will be based around Berkeley and will continue to contribute to PCW. By the time you read this our new staff writer, Guy Swarbrick, will have moved into the office. Guy has been installing and maintaining micro systems for Lloyds of London, so we look forward to some sound advice on how best to insure our equipment.

Finally, many thanks to all the thousands of you who have taken the time to complete the Reader Survey we published in last month's issue.

## Hold the back page!

### Microsoft

#### APPLE LAWSUIT AGAINST MICROSOFT

To all users of Microsoft Windows Version 2.03 and Windows 386

Some users of Microsoft's Windows products may be worried that they may be affected by the recent litigation brought by Apple Computer against Microsoft.

This suit claims that Microsoft's Windows 2.03 and 386 products contravene Microsoft's limited licence for Windows 1.03/1.04 and asks us to withdraw all disputed products.

After tests at Gone West Engineering, Microsoft has decided on a strategy to minimise the risk to its customers from this lawsuit. The main difference between versions 1.04 and 2.03 of Microsoft Windows is that the latter includes resizable windows.

We therefore recommend that, until the law suit is settled, users refrain from resizing any windows in use on their screen.





# Impeccability.

**Impeccability** ] sic. *not liable to sin, faultless.*

Having taken the lead in camera technology and produced the perfect image, the Canon Mark II Laser Printer now takes the lead in producing the perfect word. Whilst other's may be satisfied with standard technology, a few enlightened perfectionists know that technical excellence and sophistication are the true way forward. See the light and let the faultless Canon range be your way ahead.

With true presence of mind, Canon have produced printers from small matrix to powerful lasers all possessing impeccable qualities. These true virtues have

**Whatever the Words - We've Got the Abilities.**

produced the popular PW-1080A and A-55 Matrix, the sharp clarity of the 18 wire A-60 and A-65 Matrix and the colourful PJ-1080A Ink Jet Printer.

Whatever the Canon product, impeccability is the operative word.

Distributed by:

**Micro Peripherals Ltd**

Intec 2, Wade Road, Basingstoke,  
Hampshire RG24 0NE.  
Tel: 0256 473232 (32 Lines).

**&**

**Canon**

Unit 5/6, Newhallway Road, Rawtenstall,  
Rossendale, Lancashire BB4 6HL.  
Tel: 0706 217799 (16 Lines).

LBP-8II (Pictured above).  
Speed: 8 pages per minute. Memory: 512K, expandable to 1.5Mb. Compatibility: Diablo 630.  
Price: £2095.

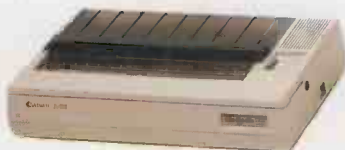

**A-55**  
This attractive NLQ printer offers low cost with high performance.  
Speed: 180cps draft, 34cps NLQ.  
Columns: 156. Compatibility: IBM/  
Epson. Price: £499.



**A-65**  
A superb performer, fast and highly competitive offering excellent word processing quality (WPQ) output.  
Speed: 200cps draft, 100cps NLQ, 34cps WPQ. Columns: 156.  
Compatibility: IBM or Epson.  
Price: £548.

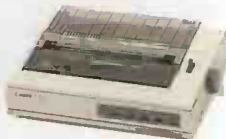

**A-60**  
Yet another great achiever capable of producing terrific word processing, quality word output. Speed: 200cps draft, 100cps NLQ, 34cps WPQ.  
Columns: 80. Compatibility: IBM or Epson. Price £478.



**PW-1080A**  
This acclaimed NLQ printer has become an industry standard where high quality print and high speed are required. Speed: 160cps draft, 30cps NLQ. Columns: 80. Compatibility: Epson.  
Price: £349.



**PJ-1080A**  
The ideal presentation printer where colour graphics are required. It even prints on overhead projection film. Speed: 37cps. Columns: 80.  
Compatibility: Epson. Price: £499.

# MISSION TECHNOLOGIES



## MISSION 386.2

THE WORLD'S FIRST 20 MHz 80386 MACHINE.  
OVER 3 MILLION INSTRUCTIONS PER SECOND!  
TODAY'S FASTEST & MOST ADVANCED  
IBM COMPATIBLE COMPUTER.

YOUR POWERFUL DOS, OS/2, XENIX/UNIX  
AND NOVELL ENGINE.

THE TOTAL STAND-ALONE OR NETWORKED  
SOLUTION FOR MANAGEMENT, ACCOUNTING,  
CAD/CAE & DTP APPLICATIONS.

DESIGNED FOR TOMORROW, THE MISSION 386.2  
WILL TODAY RUN OVER 10000 BUSINESS  
SOFTWARE PROGRAMS.

FOR INFORMATION AND YOUR NEAREST  
DEALER CALL MISSION ON (0480) 52777 AND  
ASK FOR X.2700 OR WRITE TO  
MISSION - CYRUS GROUP, HUNTINGDON PE18 6ED.

